

The
Authoritative
Magazine
About
High Fidelity

Audio

AUGUST 1982 • \$1.50 • F06030

**SPECIAL ISSUE
ON LOUDSPEAKERS**

**SUB-BASS
ON A BUDGET**

**SIMPLE CROSSOVERS
FOR BIAMPING**

REVIEWS

Black Night Speaker

**Fostex 250
Recorder/Mixer**

**Magnum
Antenna Amp**

**AKG P25MD
Cartridge**



460350 MXW 67126099 A4 6 JUL82
MR FRED B MAXWELL
16712 GOLDSBOROUGH
MD 20707
LAUREL
08 3DG

TURISMO 2.2

0 to 50 in 6.4 seconds*

41 **26** mpg**

EST HWY

EST

\$7,345***



IT LEAVES MORE EXPENSIVE SPORTS CARS IN ITS DUST.



Who says you can't have it all? Plymouth's new Turismo 2.2 gives you outstanding performance and outstanding fuel economy, 0-50 in 6.4 seconds.* 26 EPA estimated MPG, 41 estimated highway.**

That kind of performance costs up to \$7,000 more in a 280 ZX, \$6,000 more in a Toyota Supra, and over \$9,000 more in a Porsche 924.*** And you still wouldn't have Turismo 2.2's mileage.

Turismo 2.2 is built with a new kind of engineering excellence in one of the world's most technologically advanced automobile plants. And Turismo 2.2 is powered by the best quality engine ever produced by Chrysler. A 2.2 liter OHC Trans-4 that stomps out 111 foot pounds of torque at 2400 RPM.

Aerodynamically superb with front wheel drive, steel belted radials, rack and pinion steering and front disc brakes, Turismo 2.2 hugs the road the way a driving glove hugs your hand. USAC was impressed. They officially certified Turismo 2.2 as

a sports car.

Other standard equipment includes an S14 Sports Suspension System. A Performance Exhaust System. A 3.13:1 overall top gear ratio. Reclin-

own a Turismo 2.2 for \$7,345.***

Now Plymouth gives you your moneysworth with a 5 year, 50,000 mile protection plan.†

Now Plymouth backs its quality and your investment with a 5 year/50,000 mile protection plan. Protection for your engine and powertrain. Protection from outer body rust-through. And free scheduled maintenance. All for 5 years/50,000 miles. Now that's your moneysworth! See your dealer for details.

Buy or lease one at your Chrysler-Plymouth dealer and buckle up for safety.



ing bucket seats with lateral support. Rallye instrument cluster with tachometer and quartz clock. And dual racing mirrors. For more demanding enthusiasts there are Direct Connection performance parts available for off-road use. And a host of options to choose from.

Now for the best part. You can

The American way to get your moneysworth



THE NEW CHRYSLER CORPORATION
Quality engineered to be the best.

†5 years or 50,000 miles, whichever comes first. Limited warranties. Deductible may be required. Excludes Trucks and imports. *When equipped with optional Goodyear Eagle GT tires. **Use EPA estimated MPG for comparison. Your mileage may vary depending on speed, trip length and weather. Actual highway mileage lower. Calif. est. HWY 36. EPA est. MPG 26. ***Base sticker prices excluding taxes, title and destination charges. Standard equipment levels vary. Raised-white-letter tires \$84 extra on Turismo 2.2.

Audio

AUGUST 1982

VOL. 66, NO. 8

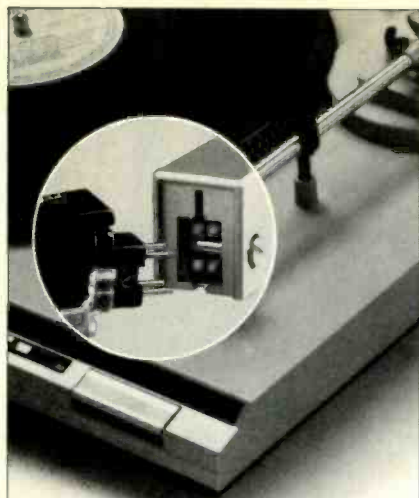

**PLUG IN
THE #1
CARTRIDGE!**



**SHURE
P-MOUNT
PHONO
CARTRIDGES.**

A Shure P-Mount phono cartridge is the proven, easy way to upgrade the performance of any linear tracking or conventional turntable with a direct plug-in connection system.

A full line of Shure P-Mount models is available now to meet your performance needs. Simply plug the cartridge in, tighten one screw, and you've got Shure quality, trackability, and unsurpassed performance—with no wires to connect or tracking force or alignment adjustments necessary.

For great sound, get the Shure P-Mount phono cartridge that maximizes your turntable's capabilities. Send for brochure AL699.

SHURE

Shure Brothers Inc., 222 Hartrey Avenue, Evanston, IL 60204



FEATURE ARTICLES

| | | |
|--------------------------|--------------------|----|
| CROSSOVERS FOR SUBWOOFER | | |
| BIAMPING | Richard J. Kaufman | 28 |
| SUB-BASS ON A BUDGET | A.L. Newcomb | 36 |
| ONE-BRAND SYSTEM REVIEW: | | |
| YAMAHA CONCERT SYSTEM 70 | Leonard Feldman | 40 |

EQUIPMENT PROFILES

| | | |
|---------------------------------|--------------------|----|
| FOSTEX MODEL 250 RECORDER/MIXER | Howard A. Roberson | 48 |
| BLACK NIGHT LOUDSPEAKER | Richard C. Heyser | 52 |
| PIONEER PL-7 TURNTABLE | George W. Tillett | 58 |
| MAGNUM 95FM SLEUTH | | |
| FM ANTENNA AMPLIFIER | Leonard Feldman | 60 |
| AUDIO-TECHNICA SAFETY RAISER | B.V. Pisha | 61 |
| NAKAMICHI NR-100 DOLBY C | | |
| NOISE-REDUCTION PROCESSOR | Howard A. Roberson | 62 |
| AKG P25MD/24 CARTRIDGE | B.V. Pisha | 66 |

RECORD REVIEWS

| | | |
|-------------------|---|----|
| AUDIOPHILE DISCS | | 14 |
| CLASSICAL REVIEWS | Edward Tatnall Canby | 16 |
| THE COLUMN | Michel Tearson, Jon & Sally Tiven | 20 |
| JAZZ & BLUES | John Diliberto, John Lissner, Francis Davis | 83 |

AUDIO IN GENERAL

| | | |
|------------------------|----------------------|----|
| BEHIND THE SCENES | Bert Whyte | 6 |
| AUDIO CLINIC | Joseph Giovannelli | 11 |
| WHAT'S NEW | | 12 |
| TAPE GUIDE | Herman Burstein | 24 |
| THE BOOKSHELF | | 46 |
| CLASSIFIED ADVERTISING | | 69 |
| ADVERTISING INDEX | | 80 |
| AUDIO ETC | Edward Tatnall Canby | 81 |
| VIDEO SCENES | Bert Whyte | 86 |

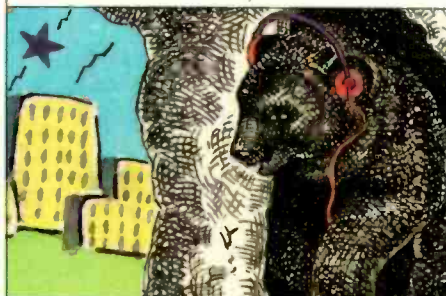

The Cover Photographer: Robert Lewis
The Cover Equipment: Black Acoustics
Night Loudspeakers

Audio Publishing, Editorial and
Advertising Production Offices,
1515 Broadway, New York, N.Y. 10036

Subscription Inquiries, (800) 525-9511; in
Colorado (303) 447-9330

Five of the music world's finest instruments are made by TDK.



Like any fine musical instrument, TDK Professional Reference audio cassettes and open reel tapes are products of genius. In TDK's case, it's the genius of constantly-advancing audio technology. And now, TDK technology has advanced again in the reformulation of our MA-R metal, SA-X high bias, and AD-X normal bias cassettes.

MA-R, SA-X and AD-X are formulated to an incredibly strict, new set of audio tape standards based on measurements and values no audio cassette manufacturer has ever attempted to meet. TDK cassettes deliver clarity, fidelity and quality unmatched by any other cassettes on the market today. MA-R, with its unique unibody metal

alloy frame and Reference Standard Mechanism is the first metal reference tape in the industry. SA-X pushes high bias to its limits. AD-X normal bias is extraordinary in its wider dynamic range and its freedom from saturation at high frequency. SA-X and AD-X both feature TDK's specially engineered Laboratory Standard Mechanism. Each cassette comes with a Lifetime Warranty.

TDK's superior technology is just as evident in our SA/EE (Extra Efficiency) and GX open reel tapes. TDK SA/EE is the first open reel tape to use TDK's famous Super Avilyn particle. This gives SA/EE almost double the coercivity and high frequency MOL of conventional open reel tapes. GX

mastering tape offers a wide dynamic range, high MOL and low noise. Both SA/EE and GX feature low distortion and extended frequency response.

MA-R, SA-X, AD-X, SA/EE and GX—they're five of the music world's finest instruments for all of the music and instruments you record. One final note. TDK's new Professional Reference Series of audio cassettes now comes in bold, new packaging. So they stand out in sight just as they stand out in sound.

TDK
THE MACHINE FOR YOUR MACHINE[®]

Paradox.

Quad products incorporate the same traditional values of engineering and craftsmanship which have made early Quad products collectors items.

Quad products incorporate innovative ideas which put them ahead of their time and set standards for the industry.

Paradoxical? Not if you think about it. Quad is designed and

manufactured by a company which for 45 years has been unremittingly devoted to the cause of excellence in music reproduction, a company in which respect for tradition and a quest for improvement go hand in hand to produce products which represent an investment in musical enjoyment.

Quad ESL 63 Electrostatic Loudspeaker – successor to the legendary Quad Electrostatic, uses concentric annular electrodes fed via a sequential delay line to produce a sound pressure pattern which approximates to that of an ideal point source.

Quad 405 Power Amplifier – with current dumping, an ingenious circuit developed by Quad using feed-forward techniques, the merit of which is now widely recognized



Quad FM4 Tuner – superb ergonomics and a level of performance limited only by the quality of the incoming signal.



Quad 44 Preamplifier – uses a system of modular inputs to permit the owner to tailor the system to his own needs and tone controls which enable more enjoyment to be obtained from more records.

Music systems for thinking people

For further information on Quad products and a list of authorized dealers please write to:

QUAD
425 Sherman Avenue
Palo Alto, California 94306

In Canada:
May Audio Marketing Ltée, Ltd.
Longueuil, Quebec J4G 1P8

QUAD

for the closest approach to the original sound

© 1982 QUAD

Audio

Editor
Eugene Pitts III

Technical Editor
Ivan Berger

Executive Editor
Gerald Astor

Assistant Editor
Kay Blumenthal

Editorial Assistant
Andrea Lynne Hecker

Art Director
Cathy Cacchione

Production Manager
Elaine S. Geiger

Associate Editors:
Edward Tatnall Canby, Bert Whyte

Senior Editors:
Richard C. Heyser, B. V. Pisha
Howard A. Roberson

Contributing Editors/Artist:
Tom Bingham, Herman Burstein,
Ted Costa, John Diliberto,
Leonard Feldman, Joseph Giovanelli,
Edward M. Long, C. G. McProud,
Jon Sank, Walter I. Seigal, Donald Spoto,
Michael Tearson, George W. Tilleit,
Jon & Sally Tiven

Vice President/Executive Publisher
Charles Stentiford

Publisher
Jay L. Butler
Associate Publisher
Marlene Jensen

AUDIO (ISSN0004-752X) is published monthly by CBS Publications, The Consumer Publishing Division of CBS Inc. 1515 Broadway, New York, N.Y. 10036.
Robert J. Krefling, President
George H. Allen, Senior Vice President/Magazines
Michael Brennan, Vice President and Gen. Manager
Leon Rosenfield, Circulation Marketing Director
John J. Miller, Group Business Manager
James Slockbower, Associate Business Manager
Karen L. Rosen, Production Director

ADVERTISING SALES
Audio, 1515 Broadway, New York, N.Y. 10036
Jay L. Butler, Publisher
Telephone (212) 719-6330
Stephen W. Wiltholt, Eastern Adv. Mgr
Telephone (212) 719-6337

West Coast Sales Office:
Audio, 3807 Wilshire Blvd., Suite 1201
Los Angeles, Calif. 90010
Jay Martin, Western Adv. Mgr.
Telephone (213) 487-5880

Classified Advertising:
Audio, 1515 Broadway, New York, N.Y. 10036
Laura J. LoVecchio, Classified Adv. Mgr.
Telephone (212) 719-6338

England: The Paul Singer-Lawrence Media Group,
54 Burton Court, London SW 3 5Y4, England
Telephone, 01-730-3952

AUDIO is a registered trademark of CBS Inc. © 1982. CBS Publications, The Consumer Publishing Division of CBS Inc. All rights reserved.

Dewey Decimal Number 621.381 or 778.5

Editorial Contributions are welcomed but should be accompanied by return postage. Submissions will be handled with reasonable care, but the publisher assumes no responsibility for safety or return of manuscripts, photographs, or artwork. The Publisher, in his sole discretion, reserves the right to reject any ad copy he deems inappropriate.

Printed in U.S.A. at Columbus, Ohio. Second Class postage paid at New York, N.Y. 10001 and additional mailing offices.

U.S. Subscription Rates: 1 year \$13.94, 2 years \$22.94, 3 years \$29.94

Other Countries: Add \$6.00 per year.

Back Issues, when available, \$5.00 postpaid.

Audio Publishing, Editorial and Advertising Production offices, 1515 Broadway, New York, N.Y. 10036.

Audio Subscription Offices, P.O. Box 5318, 1255 Portland Place, Boulder, Colo. 80322

Postmaster: Send change of address to P.O. Box 5318, 1255 Portland Place, Boulder, Colo. 80322.

The top half of the advertisement features a dark background with a grid of small, glowing white dots. On the left, a tall, dark speaker cabinet is shown in profile, containing four distinct speaker drivers: a small tweeter at the top, a midrange driver, a large woofer, and a bass reflex port at the bottom. To the right, a smaller speaker cabinet is visible. A large, semi-circular pattern of white dots radiates from the center, creating a sense of depth and sound field. In the bottom right corner, a white silhouette of a human head is shown in profile, facing left, with the ear clearly defined.

Space-contoured Sound.

Introducing the finest listening instruments Acoustic Research has ever built. The AR9LS and 98LS. Two speakers that reach such shimmering highs and thundering lows they evoke a new experience in high fidelity. An intensified sonic experience in which listener, living space and speakers form an integrated relationship. Where optimum sound is achieved within the natural acoustics of the living space—not just in a scientific test chamber. This experience we call Space-contoured Sound.

To contour sound to human living spaces, both the 9LS and 98LS feature a revolutionary Lambda driver. A Dual Dome™ mid-highrange configuration that eliminates crossover interference and achieves totally coherent dispersion. In the 9LS, we've introduced a down-firing woofer coupled with a Bass Contour Chamber. When you hear it, you'll know why Acoustic Research is more than our name. *For details and local dealer names call 1-800-824-7888* toll-free. Ask for Operator 14.*

AR Hear what you've been missing.

TELEDYNE ACOUSTIC RESEARCH 10 American Drive, Norwood, MA 02062, USA. Dunstable, England.
*In California call 1-800-852-7777. In Alaska and Hawaii call 1-800-824-7919.

BERT WHYTE

PORTABLE DIGITAL

I have recently been making digital tape recordings for which all of the digital equipment, plus microphones, were contained in three medium-sized tote bags, which my wife Ruth and I carried to the recording location. This "have digital, will travel" equipment consists of the new Sony PCM-F1 digital processor and SL-2000 Betapak portable VCR and associated power supplies, described in my April 1982 column in *Audio* and Len Feldman's review in the March 1982 issue.

I am not, however, implying that this lightweight Sony digital equipment, despite its truly excellent performance, can fully supplant professional digital recording equipment. Editing problems alone would preclude the F1 from professional use; more on this point a bit later. But for sheer high quality sound, the Sony F1 is remarkably close to the performance of professional digital recording equipment.

Recording with the F1 is a fairly simple affair. For one thing, the F1 is completely compatible with either the Beta or VHS VCR formats. The companion Beta SL-2000 portable VCR unit works quite well, with the advantage of touch-type motion controls and a digital display tape timer. Its ability to operate on a built-in rechargeable nickel-cadmium battery means that with the F1, which can be similarly battery-powered, you can make digital recordings outdoors.

Any of the larger Beta format recorders can be used with the F1, with the proviso that no videotape thinner than L-500 be used. An L-500 videocassette will afford two hours of continuous recording in the Beta Two mode. The thinner L-750, while perfectly suitable for normal video recording, is too prone to dropouts in digital recording, though BASF has just introduced a pure chromium dioxide L-750 videotape which may cope with the problem. BASF claims an extremely low noise level as well as smoother surfaces for better head drum contact.

Speaking of dropouts, in many hours of recording with the F1, I encountered just *one* of these pesky digital glitches. That is quite remarkable, although I will admit that I used the high-grade versions of Sony, Maxell, BASF and Fuji videocassettes, which helps to reduce the dropouts. I used



both the JVC 6700 and the new JVC 7650 VHS video recorders with the F1 with complete success. In this case, since T-120 VHS cassettes have the same thickness of tape as the shorter T-90, T-60, etc., the caution here is that standard play, *not* extended play, must be used to record. With T-120 cassettes, this also affords two hours of continuous recording. Of course, if money is no object, the F1 can be used with U-Matic video recorders using 3/4-inch tape, but this limits you to one hour of continuous recording.

The record metering system on the F1 is quite helpful, having a peak-hold mode so that maximum levels can easily be determined. A further aid in maintaining correct levels is a rectangular, frosted or opaque area on the meter face. If maximum peaks are kept within that area, low distortion recordings are virtually assured. One absolute dictum in recording with the F1: You must not exceed 0 dB or the result is horrific clipping. Unlike analog recording practice, where levels of +3 and more are commonly reached (mostly in an effort to improve signal-to-noise ratios), even a slight excursion into +1 dB drastically increases distortion. If you should reach +3 dB, third-harmonic distortion of 10% is the unhappy result! In my recording with

the F1, if I kept my maximum recording peaks at -5 dB all was well, with dramatically low, totally inaudible levels of distortion. As you may know, digital recording has the peculiarity that distortion decreases as levels approach 0 dB, but conversely, increases at very low levels. Some people criticize digital recording for this, claiming that at -50 and -60 dB, they can hear this distortion. Since most digital recorders have third-harmonic distortion figures of about 0.2 to 0.3% at 1 kHz at -50 dB, I and other recording engineers who have made digital recordings tend to be skeptical about these assertions. If you go way down to -70 dB, third-harmonic distortion at 1 kHz may reach 2.5 to 3.0%. This seems alarming until you realize that 3% harmonic distortion is considered the tolerable upper limit in analog recording.

The F1 has low-impedance, unbalanced phone plug mike inputs. This can be a problem in running long mike lines; such a setup is susceptible to r.f. pickup. The headphone amplifier has a maximum output of 775 mV which, with medium efficiency headphones, is usually sufficient. However, when monitoring with headphones during a concert, and circumstances dictate that you must be in the hall (rather than an anteroom), the level of the live music

Once again, JVC harnesses higher tech in the pursuit of higher fidelity.

The power of higher tech, harnessed by superior engineering. Once again, it's the mark of JVC's leadership. Even in the realm of moderately priced components like these.

The intricacy of JVC turntable design.

You see it, and hear it, in attention to subtle, yet significant details. Like a straight, low-mass tonearm with *tracing hold* to stabilize tracking. And quartz control to insure virtually perfect platter rotation.

Powerful, yet musically pure receivers.

A JVC innovation called *Super-A* removes subtle forms of distortion. So

musical overtones and transients are amplified intact for a pure, musically natural sound. Add graphic equalization and quartz tuning, and you have receivers unsurpassed for performance and versatility.

The innovators in metal cassette decks.

It was JVC who first put together the technology needed to record metal tapes. Now we've added Dolby® C for ultra-quiet recordings. Plus features like Music Scan to find selections automatically. Spectro-Peak metering. Logic controls, digital indication, memory and more.

Speakers more precise than the ear itself.

Our Dyna-Flat ribbon tweeter extends to 100 kHz, higher than the ear can hear. By doing so, it helps provide correct amplitude and phase characteristics in the audible range. So music takes on the focus, detail and spatial image of live sound.

Your JVC dealer is waiting to demonstrate the full new line of higher tech components. Computerized tuners. "Thinking" tonearms. Self-optimizing cassette decks. Higher tech engineering all focused on one goal — achieving the highest fidelity possible.



JVC

US JVC CORP.

41 Slater Drive, Elmwood Park, N.J. 07407
JVC CANADA INC., Scarborough, ONT.

*Dolby is a registered trademark of Dolby Laboratories

CAMEL

Where a man belongs.



LIGHTS: 8 mg. "tar", 0.7 mg. nicotine av. per cigarette, FTC Report DEC. '81.
FILTERS: 15 mg. "tar", 1.1 mg. nicotine av. per cigarette by FTC method.

Warning: The Surgeon General Has Determined
That Cigarette Smoking Is Dangerous to Your Health.

Experience the
Camel taste in Lights and Filters.

For sheer high quality sound, the Sony PCM-F1 is remarkably close to professional digital recording equipment.

masks the sound from the headphones. Incidentally, only the input can be monitored, there being no playback head available for off-tape monitoring. Of course, playback of the recorded tape through the headphones is possible. Thus, more headphone output on the F1 would be desirable, as would balanced mike inputs with XLR connectors. As it stands, an input console or mixer with balanced XLR inputs can be used, and its output connected to the line input jacks on the rear panel of the F1. This permits long mike lines and clears up r.f.i., but at the possible expense of signal-to-noise ratio and general sonic purity.

The F1 has a resolution switch on the rear panel, with one position being the EIAJ Consumer Digital Standard of 14-bit quantization with 44.056-kHz sampling rate. Uniquely, in the consumer digital processors thus far on the market, the other switch position is for 16-bit recording at the same sampling rate. These switches operate only in the recording mode. On playback, the F1 automatically switches to 14 or 16 bits, depending on how the tape was encoded. I used both the 14- and 16-bit modes in my recordings, and they both sounded equally impressive. I used 16 bit more often, probably because Sony claims the 16-bit mode is "compatible with their professional 16-bit recorders."

With the kind cooperation of Seymour Solomon, President of Vanguard Records in NYC, I was invited to bring the F1 to their big Masonic Temple studio to record a special program by the talented New York Quintet. Jeff Zaraya, the helpful Chief Engineer of Vanguard, made a standard analog recording of the group while I recorded them digitally on the F1. The first recording was a rather tongue-in-cheek version of the Bach Sixth Brandenburg Concerto, which included double bass and marimba! Then came a *piece de occasion*, specially composed by one of the Quintet musicians to explore the dynamic range capabilities of the F1. This was written in a sort of "quasi-Japanese" style wherein, from a dead silent background, you begin to notice the breathy sound of a flute becoming apparent at the very threshold of hearing. At a slightly higher level, the double bass, played arco,

is heard from the right. Suddenly, perhaps 70 to 80 dB up the dynamic scale, comes a tremendous crash of a tam-tam, followed by bass drum, tympani, and cymbals. Silence again, more low and medium level sounds from flute, clarinet, double-bass, marimba, and outbursts from the huge

percussion battery.

With the F1 and the SL-2000 Beta-pak, I recorded with Vanguard's mike setup, and then used a coincident pair of Beyer M130N figure-of-eight dynamic ribbon microphones in the classic Blumlein configuration. The Beyer ribbons have a particularly smooth top

The ALLSOP 3 cassette deck cleaner recommended by YAMAHA

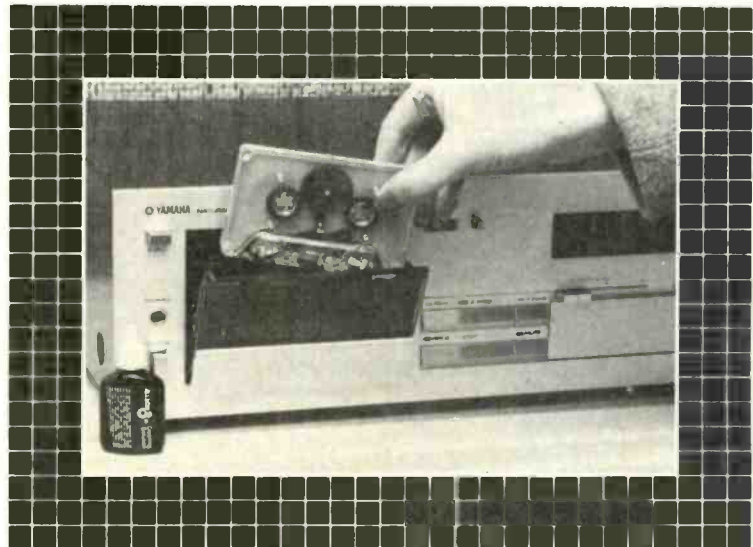

The makers of high quality Yamaha audio products, like the K-960 cassette deck, know that abrasive dry cleaning methods can damage their precision tape heads. That's why they recommend ALLSOP 3. Yamaha knows the patented, center wiper maintains a constant and complete swabbing action across the entire tape head. Moistened with a specially formulated solution, the virgin wool pads that distort sound quality. Plus, the two outer cartridges clean outer cartridges clean ruin valuable cassettes by tape. ■ ALLSOP 3 and in audio quality, two great around.



World Leaders In Fidelity Cleaning.

ALLSOP, INC.

P.O. Box 23, Bellingham, WA 98227 U.S.A. (206) 734-9090 Telex 15-2101/Allsop BLH

ALLSOP 3

Playback through the F1 revealed utterly clean sound with razor-sharp attacks and an awesome lack of noise.

end and ultra-fast transient response. In the Blumlein pattern they afforded precise instrumental imaging and localization along with a splendid presentation of depth. The playback through the F1 revealed a sound that was utterly clean, with razor-sharp attacks, great dynamic range, and an

awesomely total lack of noise. The musicians of the Quintet were enthralled with the sound quality, commenting particularly favorably on the preservation of harmonic detail and the fabulous signal-to-noise ratio.

Next recording with the F1 was of the Washington Bach Orchestra at the

Kennedy Center in Washington, D.C. This time Schoeps figure-of-eight mikes were used, also in Blumlein fashion. Results were again outstanding with particularly lovely string sounds and nary a trace of stridency in the Haydn Seventh Symphony. An aria, from Handel's rarely performed opera "Agrippina," featured much florid vocal ornamentation, which was totally articulate and tonally superb in the F1 digital recording.

The prestigious Berklee School in Boston, which enjoys the support and encouragement of the likes of Woody Herman and other jazz greats, holds an annual contest to select the "best high school big band on the Eastern seaboard." They recently held a big band bash with five bands, including the exciting Potsdam College Jazz Ensemble, and I was invited to record the event with the Sony F1. I once again opted for the Beyer ribbon mikes in the Blumlein pattern. This might seem an odd choice for a big band, but as they were arrayed in concert fashion on the stage, it worked very well, with good localization along with plenty of punch and sharp attacks—a very exciting group captured very accurately.

I hope I have whetted your appetite for digital recording with the versatile Sony PCM-F1. I hear voices protesting, "Hey Bert, the idea of digital sound is great, but I can't make my own live recordings, so what about software?" The answer comes from that ever-pioneering company Mobile Fidelity. Gary Giorgi, the Chief Engineer, is very high on the F1 and has decided to issue prerecorded digital cassettes of a number of his productions—in both Beta and VHS formats. He has sent me preproduction samples, including "Dark Side of the Moon" and Solti conducting the London Philharmonic in Holst's "The Planets." While it is quite true that these were analog masters, a one-to-one digital copy of the original master is quite a sonic thrill. Both productions were reproduced with awesome sonority and clarity, with the quiet sections of "The Planets" singularly free of noise. This idea holds great promise.

As you can see, I'm most impressed with the Sony PCM-F1 and for what it offers, \$1,900 seems a reasonable price. 

FOR THE SHEER LOVE OF MUSIC

The Linn Basik LV-X

The second best tonearm in the world. Surpassed in performance only by the renowned Linn Ittok LV-II, and incorporating several design features of the Ittok, it provides an exacting link between turntable and cartridge. Both the sound, and the price, will astound you.

Linn Basik. It must be heard.



For further information contact:
AUDIOPHILE SYSTEMS LTD., 6842 HAWTHORN PARK DRIVE,
INDIANAPOLIS, INDIANA, USA 46220
ALDBURN ELECTRONICS LTD., 50 ROLARK DRIVE,
SCARBOROUGH, ONTARIO, CANADA M1R 4G2

Noisy Pink Noise

Q. I play records fairly loudly. With most conventionally made recordings, this represents a volume control setting of -26 to -24 dB. At this level the background noise from the amplifier is acceptably low.

With direct-to-disc and half-speed-mastered recordings, however, I generally need to increase the volume control setting to its -18 or -16 dB positions to get equivalent sound levels. At these settings, noise is clearly audible across the room.

I wonder if a substantially higher powered amplifier would alleviate the problem.—Name withheld

A. Is the noise you speak of really produced by the sound equipment or is it present on the discs themselves?

To determine which of these conditions exists, set your controls as you would when playing, say, a half-speed mastered disc with the volume control at its -16 dB setting. Do not put the arm on the disc. If noise is present to the degree you have described, it would appear that the phono section of your equipment does not have a good enough signal-to-noise ratio for your needs. If, on the other hand, no noise is present, or very little, you will know that this noise is generated from the discs themselves.

Assuming that your noise problem is in the phono stages, a more powerful amplifier will not help matters. You need a phono section having a better signal-to-noise ratio than your present one has. Alternatively, you need a cartridge capable of supplying more signal to your phono stage.

Dear Mr. Giovanelli:

Thank you for your response to my letter. You may be interested to know that, upon receipt of your answer, though I had previously determined the noise to be from my equipment as opposed to being produced from the discs, I decided to recheck. It occurred to me to switch my equalizer/analyzer out of the system. The noise was dramatically reduced.

After much switching, I isolated the problem to be from the pink-noise connections which feed into the AUX inputs of my amplifier. As soon as these connections were unplugged from the equalizer/analyzer, the sound with the

equalizer switched in was as quiet as that produced by the amplifier alone.

I did not think that my equalizer/analyzer produced pink noise in its play mode, but apparently it does.

All Ohms Not Equal

Q. I plan to install a biamp system in my car. I have 8-ohm woofers in the rear deck and 4-ohm tweeters in the dash, but I have been told that all speakers should be of the same impedance. Will this impedance difference be detrimental to the operation and performance of my system?—R. E. Fortwon, Panama City Beach, Fla.

A. In the case of a conventional passive crossover network, it is true that it is best for the speakers to be of the same impedance. In the case of a system driven by a separate amplifier for each speaker, crossover will not be affected by the impedance of the individual speakers. Therefore, since the amplifier can handle the 4-ohm load, there is no problem with your plans to biampify your auto system.

The Sounds of Silence

Q. What is meant by muting?—Daniel Walter, Brooklyn, N.Y.

A. Muting refers to a silencing. Most notably, a muting circuit results in silence when tuning from one FM station to the next one. Without such circuits, there is a large amount of noise between stations. Because some people find this noise to be annoying, manufacturers provide a means of suppressing sound produced by the tuner or tuner section of a receiver in the absence of a desired station.

Muting can also refer to the absence of sound during the change cycle of a record player. The signal from the cartridge is shorted out so that the raising and lowering of the tonearm produces sound as would normally be produced when the stylus leaves or touches the disc. Transients of this sort can be a danger to speakers and some amplifiers, so muting in this instance also serves the practical purpose of protecting components.

Muting is also used in tape machines so that no sound is produced except when the tape is actually playing. The high-speed "chatter" of the tape passing by the heads during fast winding is eliminated.

Unmasking Ambience

Q. It is well known that connecting a third speaker to the "hot" terminals of the R and L amplifier and the ground of neither creates a differential which uncovers previously masked ambience. This signal, however, is 6 dB too loud, and placing a 10 to 20 watt variable resistor in series with the speaker will allow this speaker to be so balanced that L and R difference information will not be obtrusive. True ambience then can be produced by this third, or rear, speaker.

After experimentation, I find that this same signal can be produced in four-channel headphones by removing the common ground from one pair.

If I remove the ground lead from the phones as I described and then use a Y-connector to feed the phones from a stereo receiver, what value of resistor will I need in order to drop the "rear" channel 6 dB? Would a variable resistor be better in order to allow for a fine balance adjustment? If so, what value? Is any possible damage likely to occur to the amplifier as a result of this arrangement?—Jon A. Hand, Pulaski, Tenn.

A. You will need a variable resistor of at least 25 ohms to drop the signal 6 dB and allow for some fine balancing. I suspect that it may be necessary to drop the signal by more than 6 dB because of the dramatic spatial dimension always present with headphones. You may, therefore, wish to use a 50-ohm resistor. The wattage of this resistor can be low, no more than 10 watts.

Another reason for using a variable resistor is that the amount of recoverable ambience will vary from one program to another. You well might wish to have some means of adjusting for such differences.

I see no possible damage to your equipment through this arrangement. In the case of a power amplifier, the headphones are usually fed by way of a rather large series resistor. Hence, no overload or overall impedance reduction is possible. 

If you have a problem or question about audio, write to Mr. Joseph Giovanelli at AUDIO Magazine, 1515 Broadway, New York, N.Y. 10036. All letters are answered. Please enclose a stamped, self-addressed envelope.



Acoustic Image Loudspeaker

The Model V, from Acoustical Physics Laboratories, is a multi-driver system that uses two rubber-suspended, long-excursion 10-inch woofer drivers in a push-pull configuration; a rubber-suspended, 5-inch midrange driver; a 1½-inch

upper midrange soft-dome driver, and a 1-inch soft-dome tweeter. All are time-domain corrected and mounted in separate, staggered enclosures. Frequency response is from 21 Hz to 22 kHz, ±3 dB. Price: \$2,400.00 per pair (including electronic crossover).

Enter No. 100 on Reader Service Card

Polk Audio Loudspeaker

The Polk RTA 11 is a less expensive and less complex version of the Hi Fi Grand Prix Award-winning RTA 12B. A full floor-standing system, the new speaker incorporates the trilaminate polymer drivers, 12-inch planar subwoofer and 1-inch moving-coil high-frequency radiator found in the RTA 12B. The RTA 11 is rated for use with clean 10 to 500 watts/channel amplifiers. Price: \$399.95 each.

Enter No. 102 on Reader Service Card



Shure Phono Cartridge

The V15 Type V's increased high-frequency trackability results from new technology in fabricating ultra-light beryllium for the

stylus shank. A Dynamic Stabilizer helps eliminate warp-related problems by acting as a miniature shock absorber, and a Side Guard system protects the hyperelliptical stylus from accidental damage (the stylus will withdraw into the cartridge housing before damage can be done). The design of this cartridge is intended to provide superior performance at a tracking force of one gram. Price: \$250.00.

Enter No. 103 on Reader Service Card

Bush Industries TV Game Cart

The G 900 stores video games, paddles, and cartridges, and game wires can be neatly wrapped on rear-mounted hooks so that they will not be seen. The hickory-vinyl finished cart, which moves on casters, measures 21 in. high x 21½ in. wide x 12¾ in. deep. Price: \$59.95.

Enter No. 101 on Reader Service Card



Revox Open-Reel Recorder

The B77 MKII, an updated version of the B77, has a variable speed control to allow pitch-matching with off-speed tapes. When activated, this feature will adjust tape speed by as much as two musical half-tones above or below the fixed speed. Easier editing can be accomplished because the front record-head shield remains in the down (open) position, regardless of the transport operating mode, when the edit switch is on. Price: \$1,799.00.

Enter No. 104 on Reader Service Card

Kenwood Amplifier and Preamp

The Basic-M1 amp and Basic-C1 preamp were designed together to provide high technology and top performance at a low total price. The M1, using the company's patented Dynamic Linear Drive and Sigma Drive circuitry, has connections for two separate speaker pairs or two pairs combined. Key specifications include: 105 watts/channel into 8 ohms, from 20 Hz to 20 kHz, with no more than 0.005% THD; S/N is 120 dB (IHF-A curve). Price: \$330.00. The C1 features an FET input differential amp EQ, connections for two tape decks, two phono inputs (MM and MC) plus inputs for tuner and AUX. Key specs include: S/N of 70 dB (0.25 mV) for MC and 87 dB (2.5 mV) for MM. Price: \$225.00.

Enter No. 105 on Reader Service Card

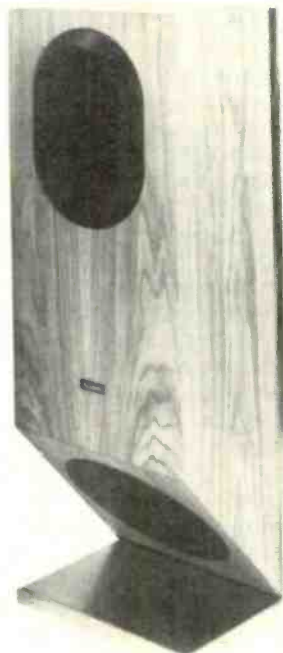

Allison Acoustics Loudspeaker

The Model Nine is a three-way system employing the Allison Convex-Diaphragm midrange and tweeter units and a 10-inch, long-excursion woofer driven through an integral crossover network. Two sets of linked input terminals offer the option of biamp or conventional single amp operation. The oak cabinet is mounted on a nickel-plated, brushed steel base with overall dimensions of 12½ in. W x 10¾ in. D x 37¼ in. H. Price: \$495.00 each.

Enter No. 106 on Reader Service Card

Acoustat ES Loudspeaker

The Professional Series Model Eight uses the same full-range elements as the firm's Slimline series but the new design offers improved vertical dispersion, increased sound pressure level and dynamic range, and extended low bass. The system can be bi-amped and has a nominal impedance of 6 ohms. Frequency response is specified as 24 Hz to 20 kHz ± 2 dB for this electrostatic-type speaker, which stands 7 ft., 10 in. tall with a depth of 4 in. and a width of 3 ft. Price: \$4,750.00 per pair.

Enter No. 107 on Reader Service Card

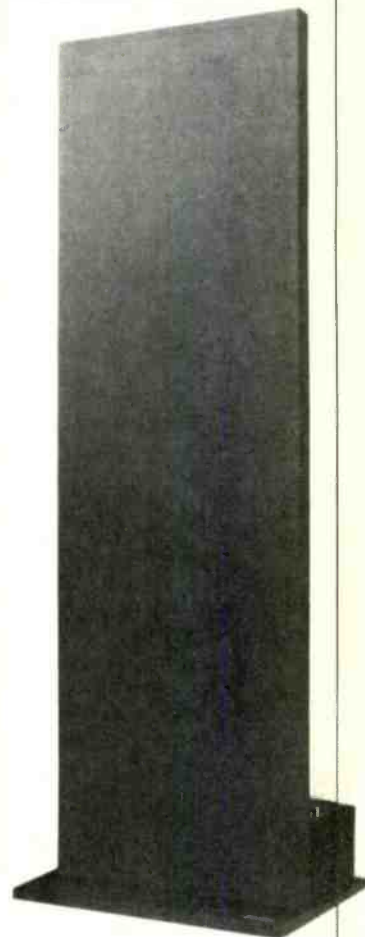

STRIKE UP THE BAND



Music from Big Pink: The Band
Mobile Fidelity MFS11-039, stereo,
 \$15.98.

Sound: B Performance: A

Nobody really knew what to make of this album when it was originally released nearly 15 years ago. I mean, it was a little overbearing to call yourself "The Band," and the cover painting was a bit primitive, plus nowhere on the album was there information as to who played what. Unless you were a stone Bob Dylan maniac this was completely foreign stuff. Of course, the critical acclaim hipped the public to who The Band was, and several albums later they were more than an institution.

Today, the album is looked upon as a classic, and for good reason. The mystique of The Band is almost as strong as that of their mentor, Bob Dylan—Robbie Robertson is retired from music but occasionally makes movies, Levon Helm keeps a high profile as an actor but musically has laid rather low, Rick Danko makes albums irregularly but nobody hears them, Garth Hudson plays with some West Coast group called The Call, and the whereabouts of the brilliant but underrated Richard Manuel is anybody's guess. With their current activities decidedly of small impact, their past becomes rock leg-

end, and listening to their first album in this newly revamped version adds kindling to the fire. The sparse textures, innovative keyboards, cutting guitar, and quirky vocal approach laid the foundation for the sound that later would be beefed up, better recorded, sweetened with horns, and generally processed so that it more keenly resembled mainstream rock. But the meat of *Music from Big Pink* is the songs, and of the 11 at least half are now considered standards. Several were cowritten with Bob Dylan, since The Band was his backing band before this album (and became his band once again for a reunion tour years later), and the elusive Bob also provided the cover illustration.

As far as being a sonic masterpiece, the record isn't exactly what you'd put on to impress friends as to how super your stereo is. It's an honest recording, a bit crude in places, but Mobile Fidelity does its usual high-quality job of making it resemble a piece of art rather than a piece of product fit for three-inch speakers. It overwhelms in a way that only understatement can, and the basic difference between this and the original is that this time around The Band is playing in your living room rather than your garage or bathroom. As it should be.

Jon & Sally Tiven

Brahms: Piano Trio #2 in C, Op. 87.
 Marilyn Thompson, piano; James Carter, violin; David Karadanck, cello.
Sound Storage SSR 2010, stereo,
 \$13.98. (Distributed by AudioSource,
 1185 Chess Dr., Foster City, Cal.
 94404.)

Recording: A+ Performance: C
 Surfaces: A+

The chamber music of Johannes Brahms is considered among the peak achievements in small ensemble compositions of the classical period, and it's no easy feat to interpret and play. Here is a less-than-lyrical performance enhanced by what is probably the finest recording of a chamber group I have had the pleasure to hear. The dynamics in this recording are near live and the instrumental balances absolutely beautiful and correct. In fact, the balance is so real that the cello is almost completely drowned out when the piano plays fortissimo — just exactly as occurs in a live performance. Hopefully, you'll have all the amplifier power to do justice to these dynamics without clipping or compression.

This is one of those rare recordings which literally brings the performers into the listening room. Although recordings claim to do it, this is one of the few instances where it actually seems to happen. And the balances and position of the instruments do not appear to vary with changes in level and dynamics — the instrumental image is consistently rock (mirror) solid.

It's unfortunate that such a magnificent recording is not complemented by a similarly magnificent performance — because, simply, a Golden Gate Bridge it ain't. But perhaps I'm spoiled by the innumerable fine performances I've heard of this composition through the years at the Marlboro Music Festival in Vermont.

The processing of this recording sets an example for others to follow. It leaves the products of the major domestic record companies so far behind that anyone responsible for the quality of these companies' recordings should be shamed into resigning to become an apple vendor. The microphones and recording techniques are identical to those in Sound Storage's Debussy/Bondon record, and none of the material used in the record was

edited. The recording locale for this excellent performance was the Convent of the Sacred Heart in San Francisco. *C. Victor Campos*

Bondon: Le Soleil Multicolore (side 1); **Debussy: Sonata #2 (1916) for Flute, Viola and Harp** (side 2). Anne Adams, harp; Rebecca Friedman, flute; James Carter, viola.

Sound Storage SSR 2020, \$13.98. (Available through AudioSource, 1185 Chess Dr., Foster City, Cal. 94404.)

Performance: A Surfaces: A+
Recording: A-

"Sonata #2" is a superb performance of a gorgeous composition by one of the great musical colorists and sensuous composers of our century, played with great sensitivity and understanding. Considering the musical performance, combined with the superior recording and outstanding record processing and pressing, I would not hesitate to declare it the preferred version above all those listed in Schwann. The only reservation I have is that the microphone pickup appears just too close—particularly with the harp and flute. It's as if you're sitting in with the group rather than seeing them perform in front of you—even close up. As a result, the harp periodically takes on a wooden sound in the middle registers that tends to be distracting.

"Le Soleil Multicolore" is Jacques Bondon's initial entry into the Schwann catalog. There appears to be no other composition by this contemporary composer available in the U.S. as a recording. My initial impression on listening to this piece was that it sounded much like "A Frenchman in San Francisco." It was only upon reading the album annotations that I found it would be "informing musically that it was composed to commemorate mankind's first walk on the moon in 1969." But, no matter, it is an interesting, lilt-ing piece, fun to listen to but without great musical depth. It is aided substantially by the superior recording and processing.

The recording itself was made with an XY mike technique (two figure-eight microphones in a coincident arrangement with the axes of the diaphragm at a 90° angle) and recorded on an ana-

log tape recorder running at 30 ips. The use of transformers and any form of limiting or compression was completely avoided. No editing of any kind was employed, thus maintaining the integrity and spontaneity of the musical performance (which speaks highly of the musicians' technique itself—

without aid of the editing process for a "no clinkers" performance). These recordings were made at the Convent of the Sacred Heart.

A beautiful record overall with superb surfaces, processing second to none, super quiet sound, and a magnificent performance. *C. Victor Campos*

An irresistible combination!

MICHAEL MURRAY
ENCORES à la française
THE ORGAN AT
SYMPHONY HALL, BOSTON

TELARC
DIGITAL

DG 10069
Encore!

Telarc captures it all. The full scope of the remarkable Aeolian-Skinner organ, the renowned ambience of Symphony Hall, Boston, the prodigious talent of Michael Murray...and, above all, the music. Couperin: *Chacone in G minor*.

Dupré: *Carillon, Op. 27, No. 4*. Gigout: *Scherzo*. Frank: *Pièce Héroïque*. Widor: *Toccata, Symphony V*. Bach: *Sinfonia, Cantata 29 (transcr. Dupré)*. Vieme: *Final, Symphony I*. Dupré: *Musette, Op. 51*. Lemmens: *Fanfare*.

Other Telarc Digital and Direct-to-Disc recordings by Michael Murray

The Great Organ at Methuen
—Bach: *Passacaglia and Fugue in C Minor, Fantasia and Fugue in G Minor "The great," Toccata in F, two chorale-pretudes* Digital DG-10049

"...a real treat for lovers of Bach organ music — and if you don't like organ music, this may just change your mind." —*Popular Electronics*

The Great Organ at Methuen, Vol. 1 — Works by Widor, Vierne, Dupré, Karg-Elert, and Marcello recorded at the Methuen Memorial Music Hall, Methuen, Mass. Direct-to-Disc TEL-5036

"A 'must' for organ lovers and a stringent test for your audio system." —*HiFi Buyer's Review*

Saint-Saëns: Symphony No. 3 ("Organ") with Eugene Ormandy and the Philadelphia Orchestra Digital DG-10051

"...It was a sort of sonic time bomb waiting for my ears. Wow! This is the demo disc of all time!" —*Audio*

Give the gift of music.



audio-technica

AUDIO-TECHNICA U.S., INC., 1221 Commerce Drive, Stow, OH 44224

EDWARD TATNALL CANBY

PLAY A WEILL



Teresa Stratas—The Unknown Kurt Weill. Richard Woitach, piano. **Nonesuch D-79019**, digital, stereo, \$11.98.

Sound: A Recording: B – Surfaces: A –

A single voice plus piano—yet this is a sensational and memorable record for all who at one time or another have fallen for the magic of Kurt Weill, and particularly, Kurt Weill as interpreted over so many years by his wife Lotte Lenya. All of this is new Kurt Weill—that is, songs which few of us have ever heard before, spanning his career from the Threepenny Opera days all the way to his last songs composed in America to English words. It is a fabulous find worth a prominent place on your Kurt Weill shelf.

New songs, but the best of it all is Teresa Stratas. So few singers have ever managed to hit that special in-between mood of passionate communication, not classical, not pop either, which belongs to Weill and was so poignant in Lotte Lenya's singing! No—Stratas isn't imitating. She is quite different. Perhaps not as subtle, more of an actress, bigger in the voice. But somehow she hits the exact mood of these wry, often bitterly humorous works as no one else has to my knowledge since Lenya. A German Piaf! That French singer will often come to mind. Weill wrote some songs in French and here Stratas turns purely Gallic as Piaf leaps out at you in Weill's music.

Stratas is a fabulous musical actress, a woman who passionately projects herself into a *style*, a manner, with the deepest understanding. (Not surprisingly, she also does grand opera at the Met.) But even better, she is also a superb musician, impeccable in her pitch, phrasing, diction in spite of all the slidings, the emotional tremors, those frightening baritone outbursts and the pitiful child-soprano tearfulness, even the muttered spoken words. It is a masterpiece of singing.

A fascinating bound-in profusion of detailed notes and photos, with original texts and translations, adds much to the impact. You can spend weeks on this album.

Only one thing leaves me curious. Why does the pianist, Richard Woitach, go entirely unmentioned on the album? He is excellent, if a bit in the background in the recording. Fortunately, his name appears in the traditional small print on the disc itself.

Stravinsky: Apollo (Apollon Musagète) 1928; Orpheus 1947. Orchestra of St. John's Smith Square, Lubbock. **Nonesuch H-71401**, stereo, \$5.98.

Sound: A – Surfaces: B +
Recording: A

We are moving forward in time. Soon, many listeners will be discovering this middle "neo-classic" Stravinsky, from the '20s into the late '40s,

following after the big early pieces, "Petrouchka," "Le Sacre" and even "Firebird," which have been the popular items by the composer. I discovered "Apollo" (under its mellifluous French name) back in my college years and have always loved the sound. All strings, a wonderfully gentle and elegant work, full of shiny melody and sensuous dissonance; it is part of Stravinsky's Greek phase, devoted often to ballet. I was actually at the premiere of "Orpheus" in 1947, so this record has wonderful connotations for my musical ear. It could well please yours too.

A curious set of performances. Not for dancing—that is what struck me quickly. I know the ballet tempi, though no dancer myself, and this conductor is not conversant with that scene, it seems. He directs the music simply as music, slower or faster than the dancers might desire. OK! It is a different approach but a good one. These are gentle, almost loving performances, neatly played, with feeling, very accurate, and we can ask for no more.

The British recording is ideally set up for the music, somewhat "chamber" in style yet with a good resonance and presence, the occasional solo strings well balanced against the whole. This is not "symphony music" but a species of theater music, remember. It is best heard somewhat close and intimately. They do it right here.





Pinnock: photo, Julian Hann

D. Scarlatti: Harpsichord Sonatas.
Trevor Pinnock.
Vanguard VSD 71250, stereo, \$7.98.

Sound: A - Recording: B Surfaces: A -

There are so many of these brilliant little one-movement Scarlatti sonatas, each a few minutes long, that almost any enterprising harpsichordist can come up with novelties. Thus, though I've been listening with pleasure to these works for decades, this record brings me a whole batch I've never heard before.

Trevor Pinnock, current British sensation on the instrument (he also conducts older music), is a lively player, perhaps not up to that large man, Igor Kipnis, who coaxes such fey and bewitching sounds out of his instrument, but certainly far ahead of many a dogmatic and doctrinaire player on records. Pinnock is highly aware of all the pleasing finger stunts and harmonic oddities in this music and delights in showing them off to you—also, he gets the frequent allusions to Spanish popular rhythms, guitar style, and plays them with great naturalness. In other words, this isn't one of those musicological recordings. It's music to enjoy. As it always was.

Is it the instrument that is a bit metal-

lic and edgy? Or the recording? Not really possible to tell. Pinnock's harpsichord registration, the choice of the various "colors" available for contrast, is not very varied compared to some, but perhaps just as well. Old Wanda Landowska, the grandma and originator of all this harpsichord revival, did

absolutely magical things in the way of harpsichord color for her own Scarlatti. But this was perhaps freakish and a bit beyond anything the composer had in mind. Who cares! I thrilled to Landowska (and still have some of the 78 rpm records), but I thoroughly enjoy Pinnock too.



Introducing . . .

MAGNUM 'Power Sleuth'

Tunable FM Antenna Amplifier For all FM Antenna Systems

With fully controllable gain, the MAGNUM 95FM 'Sleuth' provides up to 30db of clean, crisp gain (boost) to your antenna's FM signal. Also, it will attenuate to -10db to relieve that annoying front end overload from strong, local stations. Continuously variable tuning provides a tight 600khz bandwidth, adding significantly to your tuner's selectivity and sensitivity. The Sleuth installs in minutes at the tuner end of your antenna lead-in.

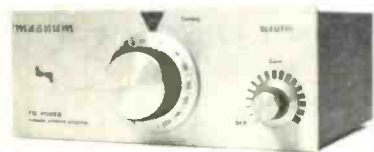

Technical: 3 rf stages, varactor tuned using noise-free, Gold CERMET control; Gain, variable +30 to -10db; Noise figure 4db; Tuning range 88 - 108mhz; Input/output 300 ohms; 110vac op'n @ 10 watts.

TWO GREAT NEW FM ANTENNAS from GAM Electronics

The Stereo One is a revolutionary new vertical FM antenna that is fully omnidirectional and provides up to double (3db) gain over your present dipole ('T' or turnstile) antenna. Its unique vertical design is less susceptible to annoying multipath and it may be mast or window sill mounted and even used indoors.

Technical: Gain 3db (approx.) @ 98mhz/300 ohms; Range 88 - 108mhz; Construction 2-section (S.S. whip & PVC transformer housing); Height 76"; Weight 12 oz.; Output 300 ohms; Mounting brkt. for mast or window sill.

Introducing the GAM Stereo Two. Designed specifically for cramped mounting situations, such as balconies, windows, etc., the Stereo Two has already proven itself a high-gain alternative to 'rabbits ears' and wire dipoles. It has substantially* the same great characteristics as its big brother, the Stereo One, yet it mounts neatly and unobtrusively on balcony rail or by a window. Its slender whip 'blends' nicely with hardly a hint that it's even there.

Technical: Gain 3db (approx.) @ 100mhz/75 ohms; Range 88 - 108mhz; Construction stainless steel whip with shielded base loading coil; Height 54"; Weight 12 oz.; Output 75 ohms; S.S. 'L' mtg. brkt. & 25 ft. cable ass'y. included.

*Gain taken with lead-in cable 25 ft. maximum.

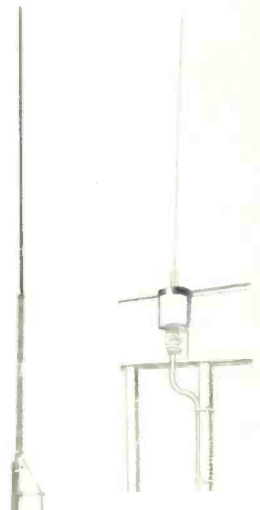

NOTE: MAGNUM and GAM products also available in automotive versions.

Introductory Offer (limited offer) Send check or money order to

MAGNUM 95FM Amplifier . . . (reg. \$159.95) **\$139.95**
 GAM Stereo One or Two . . . (reg. \$ 69.95) **\$ 59.95**
 MAGNUM Amp
 GAM Antenna (reg. \$229.90) **\$189.95**
 (N.Y. residents add 7% State Tax)
 Please add \$3.50 shipping for one—\$2. ea. add'l. item.

Castle Marketing

Holland Street
 P.O. Box 219
 Alexandria Bay, N.Y.
 13607

VISA & MASTER CARD buyers are welcome to call for FAST service (315) 482-2589.

Enter No. 7 on Reader Service Card



Chopin: Polonaise-Fantaisie, 3 Waltzes/3 Nocturnes, Impromptu in G Flat. Peter Serkin.
RCA ATC1-4035, digital, stereo, \$15.98.

Sound: A Recording: A Surfaces: A-

RCA (ex-RCA Victor) always purveyed excellent piano recording, right back through the fabulous Rachmaninoff days, and still does a splendid piano job. Something tells my ear that digital—Dr. Diamond or no—is very good for piano. Probably no more than a wider tolerance for all sorts of sonic strains and percussions in the sound.

This, too, is a superb example of one major style of piano recording, that in which the instrument seems to provide its own liveness and one is really not aware of any "hall" even though it may be there. (The opposite technique, equally legitimate, puts the piano at some distance and clearly "on stage.")

Added to the above technicalia we have Frederic Chopin and Peter Serkin, at this point an equally felicitous and happy combination. Serkin, son of the earlier and still-operating Rudolf Serkin, is a "neo-Romanticist"—my own invention—unafraid of passionate, mannered playing where an earlier younger generation was bound up by the restrictions of neo-classicism, all hard and "modern." Chopin had, literally, a very hard time from the '30s onward, as I well remember. Bang-bang was the approach! Sometimes musical, sometimes just awful. But now, this younger Serkin plays Chopin as it must be, super-salon music, big but always personal and intimate, never wrought-up and bangy in the fin-

gers. I found it wholly natural, easy, relaxed, and I am sure it is ideal for home listening, so much closer to Chopin's own environment than our modern big halls and vast audiences. Best Chopin I've listened to for many years.

Satie/Entremont. Philippe Entremont, piano.

CBS 37247, digital, stereo.

Sound: A- Recording: B Surfaces: A-

Here, recorded in France, is CBS' long-time French piano stalwart, an excellent man to have around. And here is that cryptic old goat, Satie, a man whose music stirs up controversy every time it gets heard, and has since around 1890. He really endures. And he is the dullest composer who ever lived, at least most of the time on first hearing. Even Entremont, French to the core, doesn't change that.

The reasoning behind it all is that Satie was an iconoclast—an image-smasher. He was a gentle John Cage in his day, doing outrageous things in a sharply humorous way, designed to shock people. But not the noisy kind of shock! The opposite. When Mahler and Bruckner and Sibelius were launching vast symphonies, when Tchaikovsky was pounding away with the "Pathétique" and Dvorak with "The New World," this Satie was launching nasty little pieces of nothing at all, lasting a minute or two, with names like "Piece in the Shape of a Pear," and assorted ribald comments written in here and there. It was deliberately underplayed mayhem and a lot of perceptive musicians got the point—Debussy, for instance. You think you hear Debussy in some of these little pieces; actually it's the other way around.

Satie, really, was no composer. Just clever with what he had. His later music, borrowing back from the bigger of his disciples, has more sparkle and style to it in musical terms but I wish somebody would bury those three deadly "Gymnopédies," always played together, like three very wet blankets. And several others too. Too much! Anyhow, Entremont being French, does these things up faithfully and well.

It may be digital but the recording of the piano is rather small sounding and confined, not very impressive. Suits Satie, I guess, but does it suit our digital aspirations? It's OK—just uninter-



That cryptic old goat Satie endures as an iconoclast and stirs controversy whenever his music is heard.

esting as piano sound. Well, I said Satie was controversial! Everything he touches seems to be the same, even the recording.

Brideshead Revisited—Original Music from the TV Series. Composed and conducted by Geoffrey Burgon. **Chrysalis CHR 1367**, stereo, \$8.98.

Sound: B+ Recording: B Surfaces: B+

I played this before I had seen any of the TV segments. But eventually I got to look at the final number in the series. So at least I experienced the music on its own and in its function as part of the show.

The sound without a doubt is what most people call "classical," all gentle strings, horns, oboe solo, vaguely in a



pseudo early 19th-century style (the story, of course, is in the 20th century!), let's say the music aims conservatively for 1820. So this is a classical review, necessarily.

As a part of the TV show this music does do discreet and unobtrusive justice to the much more important things going on via the tube. No more need be said—it is one way in which music can be used as sonic wallpaper behind more vigorous visible actions.

As sheer music, on its own? Don't bother. It's totally insipid. The stuff is very elegant but it is nevertheless the sheerest nothing-music. It just dribbles along, sounding terribly gracious. Indeed it is the *sound* of music, without the music. Give me a solidly vulgar Hollywood score any day!

PROTECT YOUR VALUABLE RECORD COLLECTION

REPLACE YOUR STYLUS -NOT YOUR RECORDS

Even a precision-crafted diamond stylus (needle) will eventually become worn, and a worn stylus will degrade your hi-fi system's sound quality . . . it may actually ruin precious records in just a single play! Have your stylus checked at least once a year and replaced if necessary. Insist on the name "Shure" on your replacement stylus and be assured of getting the full listening enjoyment your Shure phono cartridge was designed to produce.

SHURE

Shure Brothers Inc., 222 Hartrey Ave., Evanston, IL 60204

Enter No. 15 on Reader Service Card

Revox B795. Short arm, no waiting.

At 1½ inches, the B795's tonearm is the world's shortest. In fact, it's hardly a tonearm at all.

The secret of our shortness is Linatrack,® a revolutionary linear tracking system. Guided by an ultra-sensitive servo mechanism, the Linatrack® "tonearm" glides smoothly straight across the disk. The result? Ideal resonance characteristics. No tracking error. And no waiting for a conventional linear tonearm to

crawl back before changing records. Because, with a flick of your fingers, the entire Linatrack® module pivots aside.

The B795 also offers a quartz-regulated, Hall-effect direct drive motor; precise cueing; and solid German craftsmanship.

When it comes to tonearms, short is beautiful. Hear the Linatrack® difference today, at your Revox dealer.

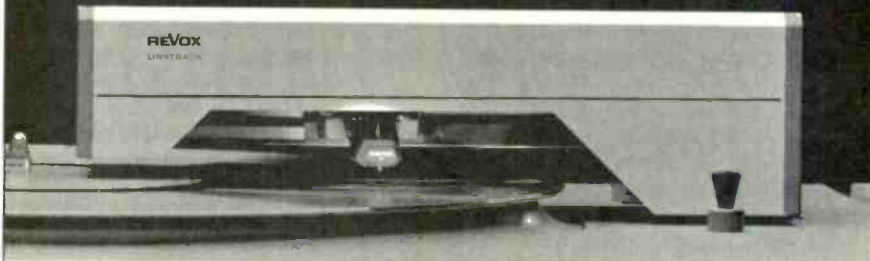

STUDER REVOX
Europe's premier audio components.

Studer Revox America, Inc. • 1425 Elm Hill Pike • Nashville, TN 37210 • (615) 254-5651

Enter No. 11 on Reader Service Card

THE COLUMN

MICHAEL TEARSON
JON & SALLY TIVEN

TWO VIEWS OF VAN HALEN

Diver Down: Van Halen
Warner Bros. BSK 3677, stereo,
\$8.98.

Sound: A- Performance: A-

Too late to make the first generation of heavy metal and a little early to get in on headbanger revivalism, Van Halen continually mystifies critics and industry moguls—why are these guys so successful? As difficult as it may be to swallow, Van Halen's path to glory is paved with artistic triumph—a finer bunch of players of this genre is difficult to find. They may not be able to write songs, and this album consists of 50% cover tunes, but who cares if you can play your guitar into the ground? With a tip of the hat to the likes of Ritchie Blackmore and Rick Derringer, Edward Van Halen exhausts his guitar stock-riff catalogue in a manner that's distinctive and entertaining. David Lee Roth is not one of the great singers of this or any other decade, but he screams a lot and makes up for whatever he lacks in pipes with a *bad* attitude. It beats using live animals in your act, or regurgitating old Guess Who songs. You could say that Eddie Van Halen is the whole act, but Roth manages to be no more distracting from the master's music than, say, Daltrey was from Townshend's or Plant from Page's.

Aside from a handful of heavy-metal send-ups (which nobody performs or records better than this crew and their ace producer Ted Templeman), *Diver Down* embraces a variety of song genres and succeeds in bringing them across about half of the time. "Secrets," a relatively mellow tune for these boys, is distinguished by pretty guitar picking parts, lead riffs that make up for a lack of substance, and recessed rhythm tracks that afford the song the delicacy shared by the guitar parts. The solid blues base of this group is spotlighted well in the slow section of "The Full Bug," but the outstanding track on the LP is undoubtedly the single "(Oh) Pretty Woman," on which the guitar world's current fave device, the chorus pedal, is displayed with consummate effect. There are a few examples of filler on this record—the Dixieland jazz number "Big Bad Bill (Is Sweet William Now)" and "Happy Trails" should be funny but they aren't



quite—but the instrumentals thrown in as transitional pieces are worthy of expansion into full-fledged songs.

As trashy as these boys would have us believe they are, their artistry shines through. Van Halen makes its contribution—albeit unwillingly—to 1980s state-of-the-art rock.

Jon & Sally Tiven

Diver Down: Van Halen
Warner Bros. BSK 3677, stereo,
\$8.98.

Sound: A- Performance: B+

I start to worry about my mental health, not to mention the very state of music, when the new Van Halen album sounds really good compared to nearly anything else surrounding it. I mean this is the most unrelentingly stupid successful American band going. And they are coming off an album that even their fans hate.

Still, there was stuff on the first two albums (before they got clever enough to name albums) that wears the mantle of time better and better. Especially their covers. And if you think about it, you gotta be real canny to perpetually maintain that dumbness so central to VH's music.

Diver Down is canny. Their covers dominate the album. The Kinks' "Where Have All the Good Times Gone?" is terrific, Van Halen's first

world-weary song. Their update of Roy Orbison's signature "Oh Pretty Woman" is brilliant, and "Dancing in the Streets" again threatens to become a summer anthem of a whole new generation. And for something completely different, that chestnut from New Orleans, a dapper "Big Bad Bill (Is Sweet William Now)."

The album's pacing is key to its success, and the instrumental bridges, a diverse lot, make it happen.

As for originals, past Van Halen albums are all varying degrees of songs and postures for when they don't have songs. *Diver Down's* song/posture ratio is uncommonly high. "The Full Bug" is a bit of a satire of the ZZ Top sound. That, "Hang 'em High" and "Little Guitars" are additional threats: They will become AOR staples for the future.

Never thought I'd ever write about Van Halen, let alone give them a good review. One more hole in the old "Ignore 'em, they'll go away" theory.

Michael Tearson

Sweets from a Stranger: Squeeze
A&M SP-4899, stereo, \$8.98.

Sound: B Performance: B+

Nobody is more of a hard luck band than Squeeze. With nothing but the critics and sheer excellence on their side they put out five U.S. albums before a bona fide hit popped from out of

left field on their fifth, and then that song's singer left the band.

They have regrouped with Don Snow as the new keyboard player and rebounded with a generous new album (12 songs, 45 minutes). Squeeze always seems to give you your money's worth. And as usual they have diversified an already diverse musical attack. Some of the fun is in playing musical Sherlock Holmes and seeing what riff from what song Glenn Tilbrook and Chris Difford have refurbished into what newie. Like "Black Coffee in Bed" based on "Tracks of My Tears." Or "I've Returned" built over the glockenspiel riff from "Thunder Road." Or "Tongue Like a Knife" which is an inverted form of, of all things, "My Favorite Things," but this one they make easy as the coda quotes directly from the source melody.

There's much more to the Tilbrook/Difford songwriting than smart riff mongering. They pack in plots and twists in their lyrics that very few are capable of doing. "His House, Her Home" is sung from the point of view of a divorcee's new lover who is all too conscious of both the ex and the son. "Black Coffee in Bed" takes off from a coffee stain in

a notebook to ramble on eloquently about a finished affair. "I Can't Hold On" is a smart vignette of dance-club love. "When the Hangover Strikes" could have been written for Sinatra, for as a boozy quarter-past-closing song it is dandy.

Each new album Squeeze puts out is a disappointment on first listen, but each time through, the merits glow brighter and the subtleties come into focus a bit more. *Sweets from a Stranger* is no exception. In addition it has a classy recorded sound replacing the purposely trashy sound last year's *East Side Story* got from Elvis Costello's production.

Squeeze got it *all* right this time on *Sweets*. If there is justice this time, the world around them will finally catch on.

Michael Tearson

Shoot Out the Lights: Richard & Linda Thompson

Hannibal HNBL 1303, stereo, \$8.98.

Sound: B+

Performance: A

Class from end to end, *Shoot Out the Lights* is as good as any album Richard Thompson has ever appeared



Richard & Linda Thompson

on, either as a founding member of Fairport Convention or in collaboration with his wife Linda Thompson. Although the echoes of English and Scots traditional folk music resound in the Thompsons' music, this time around they have attempted a distinctive half-step toward rock and roll acceptance and achieved it gracefully without watering down their identity a bit. The sheer quality of Richard's songwriting is never in doubt either up tempo on the title song and "Don't Reneg on Our Love" or on his uncommonly sensitive ballads like "Walking on a Wire" and the detective thriller "Did She Jump or Was She Pushed?" Despite the doomy lyrics that so abound in Thompson's writing, the music never lapses into morbidity.

Some old friends assist. Former Fairporters Simon Nicol, Dave Pegg and David Mattacks, England's crispest drummer, are all here as is bassist Pete Zorn. They make a unit totally comfortable with Richard's stark, often startling, always inventive and dynamic guitar leads.

Excellent songs superbly and caringly played with empathetic production make *Shoot Out the Lights* more than just another solid album. It is a triumph for Richard and Linda Thompson.

Michael Tearson

DE⁷: Dave Edmunds

Columbia FC 37930, stereo.

Sound: A

Performance: A

Dave Edmunds' current LP, *DE⁷*, proves that obsession with a particular genre need not be boring for one's

Squeeze



Edmunds' greatness lies in performing and recording simple songs that transcend the idiom.

*Powerful
musical
accuracy*



M-1.5

At last, all the power you need for the accurate reproduction of music.

From CARVER, of course.

Pound-for-pound the most powerful high fidelity amplifier ever built.

Truly musical. Absolutely accurate.

When you hear how the M-1.5's vast power reserves eliminate clipping distortion and thus free the music for full dynamic range you'll understand CARVER's quest for Enough Power.

Stripping away the arcwelder bulk and searing heat of conventional amplifier technology, the M-1.5 is light, compact, cool, and affordable with impeccable sound quality.

350 watts RMS/chan. into 8 ohms, 20-20kHz with less than 0.1% THD. And most importantly, the rating that is musically significant: 600 watts/chan. Long-Time-Period Reserve Power with 750 watt/chan. Dynamic Headroom.

Weight: 16 lbs.

Carver Corporation
P.O. Box 664
14304 N.E. 193rd Place
Woodinville, WA 98072

In Canada distributed by
Evolution Audio.

CARVER

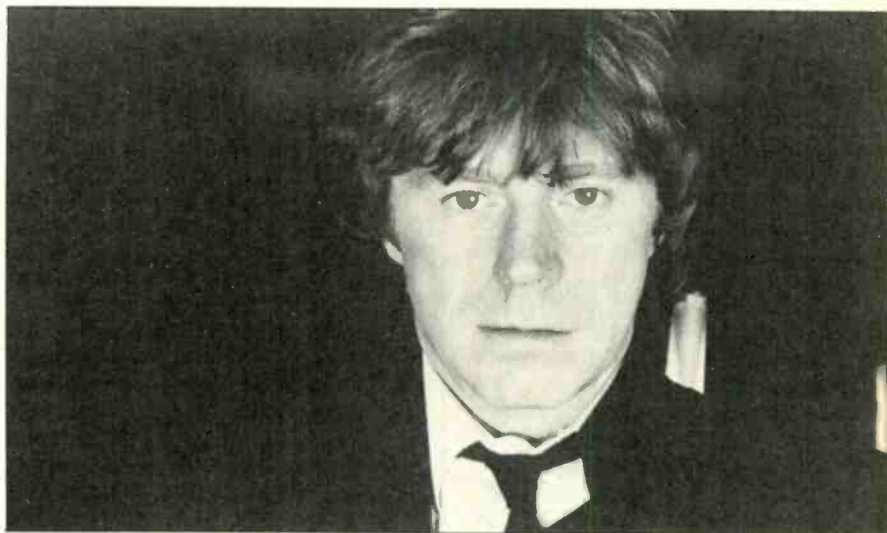

Dave Edmunds

audience. His musical sights may have lodged permanently on the Carl Perkins school of rockabilly sound, but Edmunds' mastery of the form makes what could have been "same old same old" rehashes sound fresh and in many cases exciting.

What separates Edmunds from other '50s rock revivalists—compare the limp attempts of Robert Gordon, The Blasters, and Levi & The Rip-chords to parlay pompadours and stand-up basses into a sad facsimile of Gene Vincent—is the excellence of playing on his records and the good taste displayed in his choice of cover material. Last time out, Edmunds breathed new life into old chestnuts like "Almost Saturday Night" and "Three Time Loser," and here he makes magic with as apparently dead an issue as "The Wanderer" (it's a live version and it cooks) and Chuck Berry's "Dear Dad" (last notably covered with a slightly more manic feel by Roger C. Reale on his debut LP). Like his rock idols from the '50s, Edmunds' greatness lies in performing and recording simple songs with such drive and expression that the idiom is transcended.

The album opens with a Bruce Springsteen song that's typical only in its narrative—a romanticized tale of blue-collar Americana called "From Small Things Big Things Come." In addition to an outstanding vocal, this track boasts a honky-tonk piano that adds much to the blues chording

we've come to (rightly) expect from Edmunds. Another kettle of fish entirely is "Me and The Boys," in which he goes for an unusual production sound and pulls it off, thereby making a slight composition more interesting than the sum of its parts. With a mountain of delay on the vocals and drums, he manipulates the arrangement and dynamics of the tune into a creation that proves him one of the few artists who can produce himself well, and with imagination. Other highlights include the Cajun-flavored "Bail You Out" and bump and grinder "Generation Rumble," but the four songs on the live EP included in this package are uniformly outstanding.

As the members of Rockpile pursue their disparate musical paths, it becomes easier to decipher who was responsible for the wheat and who the chaff; Dave Edmunds fans no longer need suffer through cloying cleverness or a distillation of the man's talent. *DE*⁷ breathes new life into a guitar master previously suffocating in saccharine.

Jon & Sally Tiven

The Slide Area: Ry Cooder
Warner Bros. BSK 3657, stereo, \$8.98.

Sound: C+ Performance: C

Ry Cooder rocks out harder than ever this time around, aggressively courting the elusive big one. Afraid this



Ry Cooder

isn't it. The playing is gritty and determined, occasionally special, but only occasionally.

Both albums Cooder has made on his own since the marvelous *Bop Till You Drop*, *Borderline* and this latest one, have tried to expand on the sly, funky road that *Bop* first paved for Ry. Neither has succeeded, mostly due to poor song selection and sound that is clearly less than Cooder's amazing achievement on *Bop*, the first rock digital album.

The Slide Area is no disaster, but it isn't very distinctive. *Michael Tearson*

Dry Dreams: The Jim Carroll Band
Atco SD 38-145, stereo, \$8.98.

Sound: B Performance: C +

The first album by The Jim Carroll Band got lots of press and attention mostly due to the throat-grabbing intensity of "People Who Died." That album's pure drive is matched on *Dry Dreams*, although Carroll's songs are not as strong as the previous crop with the obvious exception of "Jealous Twin," the clear stand-out.

The band has the snap and crackle Carroll's songs need, but however sturdy a group they are, when the lead voice is as limited as Jim Carroll's, the poetry had better be brilliant. This time around, except for the occasional flash and the aforementioned "Jealous Twin," nothing is that remarkable. A notable addition to the band, especially for *Audio* readers, is my colleague Jon Tiven's presence on guitar and organ. *Michael Tearson*

Nine independent reviews you should read before you buy a stereo cartridge.

The XSV/4000 emerges a clear winner*
—AUDIO/GENE



This 16-page book of reviews from High Fidelity, Stereo Review and Stereo is available at your local audio dealer... or write to: Pickering & Co., 101 Sunnyside Blvd., Plainview, NY 11803

THE SOURCE OF PERFECTION



PICKERING

"for those who can hear the difference"

Enter No. 17 on Reader Service Card

FREE

McIntosh

STEREO CATALOG and FM DIRECTORY



Get all the newest and latest information on the new McIntosh stereo equipment in the McIntosh catalog. In addition you will receive an FM station directory that covers all of North America.

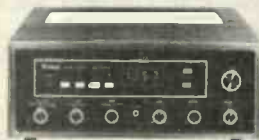

SEND TODAY!

McIntosh Laboratory, Inc. A
East Side Station P.O. Box 96
Binghamton, N.Y. 13904-0096

NAME _____

ADDRESS _____

CITY _____ STATE _____ ZIP _____

If you are in a hurry for your catalog please send the coupon to McIntosh. For non rush service send the Reader Service Card to the magazine.

Enter No. 9 on Reader Service Card

TAPE GUIDE

HERMAN BURSTEIN

Normal Care Needed

Q. After reading a favorable test report in Audio on a cassette deck, I purchased that unit. Later, a salesman in another audio store said, to my dismay, that the heads on my deck are going to wear out very quickly. He recommended constant care of the heads, and indicated that I should have bought another make of deck from him. What do you think?—Robert Tombo, Youngstown, Ohio

A. I would be inclined to take the salesman's comments with several large grains of salt. Because of the slow speed at which cassette decks operate, and due to substantial advances in heads, one seldom has to worry about head wear in the case of decks of reputable make. Salesmen often push particular products, not because the products are better or offer more for the money, but because they are under pressure to sell merchandise which hasn't been moving particularly well. They often receive extra commissions from their employer or from equipment manufacturers when they sell particular brands and models of merchandise.

On the other hand, one can't fault the salesman in question for recommending constant care of the heads; this is true for any tape deck. Heads should be regularly cleaned, say after about every eight hours of use.

Transfer Tapes

Q. How do I transfer a Dolby-encoded cassette to another cassette so that the copy will be Dolbyized? Do I set the Dolby switch to off for the playback deck, and to on for the recording deck? Does the original have to be played back on the same deck which recorded the cassette in order to get proper Dolbyizing in the transfer?—Robert Durham, Tarzana, Cal.

A. Play the Dolby-encoded cassette with the Dolby switch on. Record (dub) this onto the second cassette with the Dolby switch on. The dubbing will be Dolbyized.

If both decks are correctly adjusted with respect to Dolby level (some decks have user-accessible adjustments), there should be no problem in interchanging decks. But the correct Dolby adjustment varies with brand and type of tape. If one deck is set for

a particular tape type, while the other deck is adjusted for a different type, there may be significant problems. The chief difficulty that tends to arise as the result of incorrect adjustment is either loss or exaggeration of treble response; treble loss seems to be the more frequent case.

The Leading Edge

Q. In open-reel, is the track nearest the edge of the tape the left or right track according to standard use?—Joe Gorin, Loveland, Colo.

A. It is standard that the track nearest the edge of the tape, in either direction of travel of open-reel tape, is the left track.

Upgrading Recording

Q. I have recorded a lot of material with an inexpensive two-head cassette deck, but I intend to replace it with a superior three-head cassette deck. Must I re-record all my material to get a substantial improvement from my new deck, or will there be an improvement if I merely play the old cassettes on my new deck?—Paul Goldwhite, South Pasadena, Cal.

A. You may get some improvement by merely playing your old cassettes with your new deck. Owing to a better playback head (finer gap) and better playback electronics, you may get somewhat better treble response and lower noise. But to get the full improvement, you should re-record. By "re-record" I assume you mean making tapes of a collection of phono discs.

Test Tape Sources

Q. Would you have any idea where I could obtain an NAB playback equalization tape for a quarter-track 7½ ips tape recorder?—Richard Freid, Hyde Park, Mass.

A. Possible sources for such test tapes are, the following: Ampex Corp., 2201 Lunt Ave., Elk Grove Village, Ill. 60007; Taber Manufacturing and Engineering, 2081 Edison Ave., San Leandro, Cal. 94577; Magnetic Reference Laboratory, 999 Commercial St., Palo Alto, Cal. 94303; Audiotex, 400 South Wyman St., Rockford, Ill. 61101; Nortronic, 8101 West 10th Ave., North Minneapolis, Minn. 55427, and LC Engineering, 9451 N. Kostner Ave., Skokie, Ill. 60076.

Open-Reel Lengths

Q. I recently bought 10½-inch reels containing 3,600 feet of tape and obtained very good recordings, in addition to which I get over 12 hours from one reel when it is recorded in both directions at 3¾ ips. I would like to know why there aren't any 7,200-foot reels on the market.—G. Tsimis, Downsview, Ont., Canada

A. As a tape is made thinner in order to permit more footage on a reel, its quality tends to deteriorate in terms of distortion and signal-to-noise ratio. Also, the tape is more subject to print-through, and there are increased physical problems in transporting it at high speed; hence the absence of 7,200-foot tapes. According to the NAB, tapes thinner than those permitting 3,600 feet on a 10½-inch reel are "not recommended" for open-reel decks.

Which Tape for Which Deck?

Q. I have open-reel, cassette and cartridge tape decks. Their manufacturers do not give enough information about recommended tapes or bias and equalization settings for the various tapes on the market. The tape manufacturers want consumers to select tapes by a trial and error system. If coupled with the right tape, my decks would give their best performance.—Henry Stafford, Jr., Cincinnati, Ohio

A. The reason some manufacturers of tape decks tend to hedge about equalization and bias settings and about which tapes are best for their decks is because there are so many uncertainties in a rapidly changing field. A deck manufacturer is often hesitant to recommend specific types and brands of tape because new types are constantly appearing. Old tapes change characteristics from time to time, and a given tape may even change characteristics from one lot to another because of normal variation in oxide formulation. There is also a range of variation from one deck to another of the same brand and model. Hence, the advice to experiment is good counsel. Furthermore, if a given tape doesn't give you quite the flat or extended frequency response you desire, there are bass and treble controls in your audio system to make adjustments.

Set Positions

Q. I have a cassette deck with facilities for normal and chromium dioxide tapes. Recently a friend purchased two BASF ferric super LH cassettes for me. I would like to know whether these will cause any damage to my deck if used on the chromium dioxide setting, and, if not, what the sound quality would be like.—Michael Pollard, Kingston, Jamaica

A. Use of these BASF cassettes cannot possibly harm your deck. If they are used with the chromium dioxide setting, they will probably tend to sound a bit dull in playback, that is, treble reproduction may be somewhat attenuated. You might try recording these tapes with the deck set for chromium dioxide but playing them back with the "Normal" setting. If response is still too dull, then record and play in the "Normal" position.

NAB Playback Equalization

Q. What is NAB playback equalization?—Tom Kappel, Lockport, Ill.

A. To achieve flat response, a tape requires treble boost in recording and bass boost in playback. NAB (National Association of Broadcasters) standards provide for specific bass boost curves, varying with tape speed and sometimes with tape type, in playback. (These bass boost curves are modified somewhat to compensate for deviations of the specific playback head from performance of an "ideal" head which exhibits no bass or treble aberrations.) The required treble boost in recording is such that, when the tape is played with standard playback equalization, flat response is achieved.

At 15 and 7½ ips, bass boost commences (3 dB up) at 3,183 Hz and levels off (3dB below maximum) at 50 Hz, for a total of 36 dB bass boost.

At 3¾ ips, bass boost begins at 1,768 Hz and levels off at 50 Hz. At 1½ ips, bass boost begins at 1,326 Hz for ferric tapes and at 2,274 Hz for metal, chromium dioxide, ferrichrome, and cobalt-modified tapes. At 1¼ ips, the bass boost levels off at 100 Hz instead of 50 Hz. A

If you have a problem or question on tape recording, write to Mr. Herman Burstein at AUDIO, 1515 Broadway, New York, N.Y. 10036. All letters are answered. Please enclose a stamped, self-addressed envelope.

Get more out
of your system
by investing
less in it.

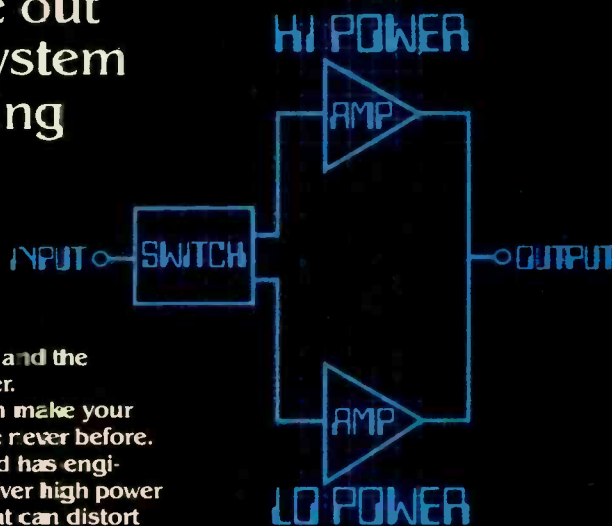

Introducing
the Kenwood Basic
M1 Power Amplifier and the
C1 Control Amplifier.

Together they can make your
system perform like never before.

Because Kenwood has engi-
neered a way to deliver high power
without the heat that can distort
sound quality.

It's called Dynamic Linear Drive.

And it's a Kenwood exclusive designed to analyze
the size of the input signal and then switch on
the appropriate amp, high or low, with no signal
dropout. Since the high power amp is only on when
needed, much less heat is generated.

At 105 watts per channel,* we think the Basic
M1 and C1 is one of the most sophisticated
dual amplifier systems available today.

But, best of all, by investing less in our
Basic M1 and C1 amp, you'll have more
to spend on the rest of your system.

KENWOOD Audio Purist™

For the Kenwood Audio Purist Dealer nearest you write:
Kenwood Audio Purist P.O. Box 6213, Carson, CA 90749
*minimum RMS, both channels driven at 8 ohms from 20 Hz to 20 KHz
with no more than 0.005% total harmonic distortion.



Few men dominate a sport the way Richard Petty rules the world of stock car racing. 517 top-five finishes. 195 career victories — seven at Daytona alone. Riding on Goodyear for close to two decades, he's made the NASCAR record book look like the Petty family album.

But those big NASCAR slicks aren't the only Goodyear Eagles in King Richard's domain.

When Richard rides home to Randleman, N.C., he rides on Goodyear street Eagles, the performance tires with real racing credentials.

**EAGLE GT, NCT AND ST —
TAMED FOR THE STREET
BUT FAR FROM TAME.**

Few companies dominate a sport the way Goodyear dominates motor racing. So race breeding just came naturally to our line of per-

formance Eagles for the street.

All three have an aggressive low-profile stance and a tread pattern derived straight from the track. On our NCT and GT, the tread pattern was inspired by our Formula One racing rain tire. Eagle ST's tread is a direct descendant of our two-time IMSA RS Champion tire.

All three Eagles are designed to deliver precise handling, cat-quick steering

GOODYEAR
Quality and Innovation

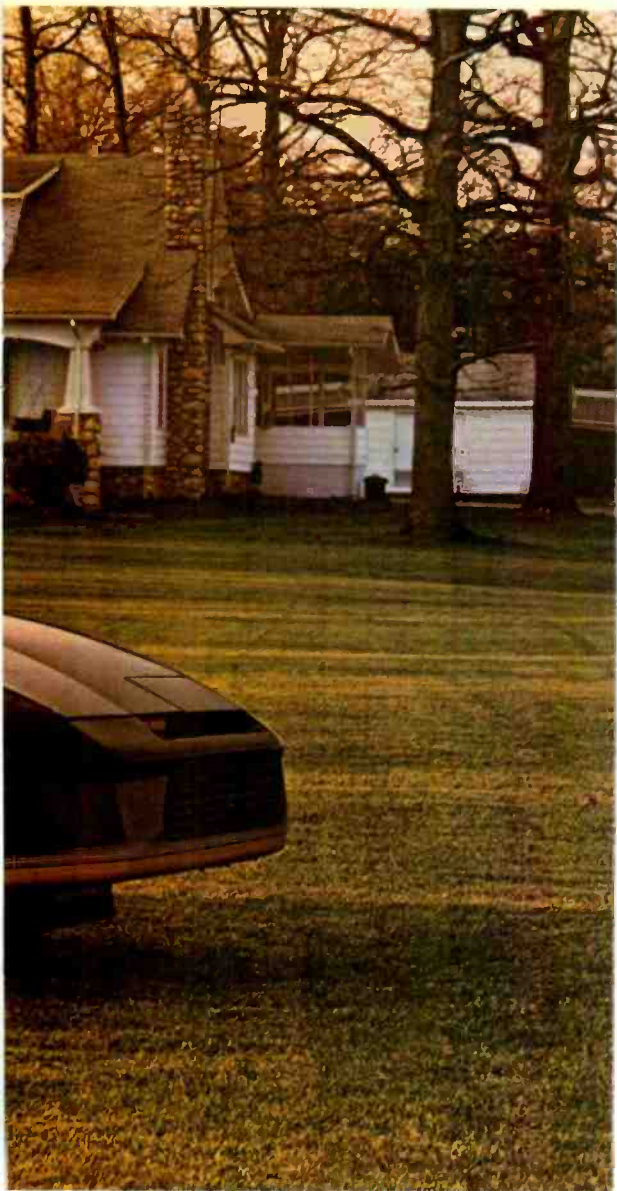

King Richard's at home on Eagle GTs.

response and tenacious
traction in both wet and dry.

Performance fit for a king.
And to fit your car, too. See
the Eagles in the Eagles' Nest
at your Goodyear Dealer or
Store.

And join us in saluting
King Richard as he goes for
career victory
number 200
on Goodyear
all the way.

COME UP TO GOODYEAR

GOODYEAR

QUALITY & INNOVATION







RICHARD J. KAUFMAN

CROSSOVERS FOR SUBWOOFER BIAMPLING

Audio electronics are nearer to perfection than the
mechanical parts, so it's logical to attempt enhancement
of overall system performance by electronic means.
One such method is biampification.

Photograph: Robert Lewis

Biamplication is surprisingly ancient by the standards of audio history, perhaps used first by Hollywood in the '30s.

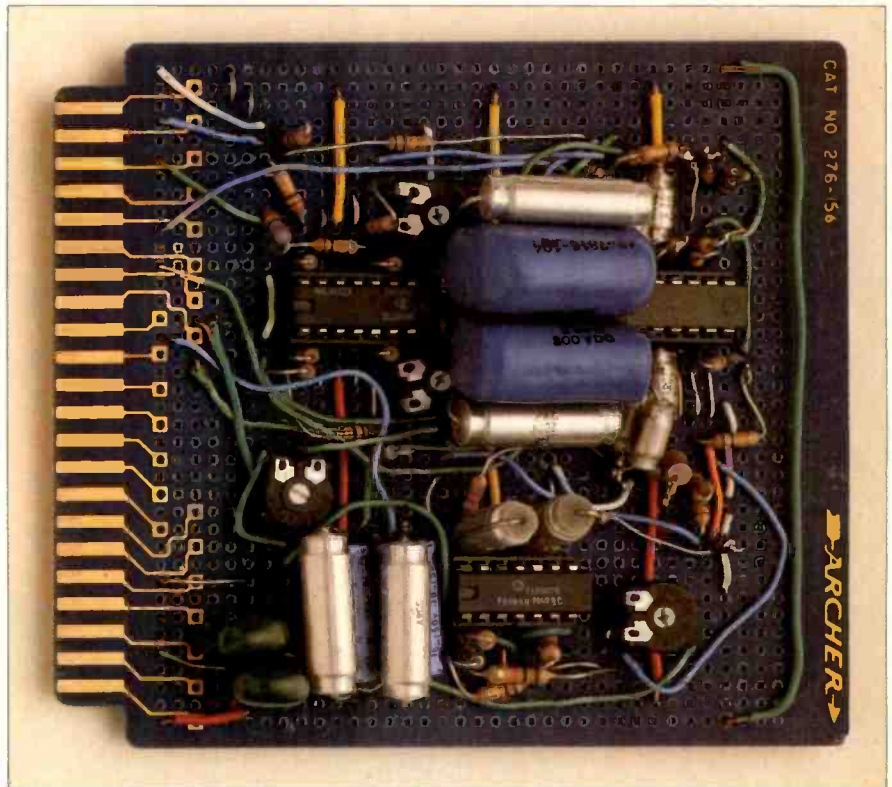

Printed circuit card, used in the author's crossover, has components mounted on a pre-etched breadboard.

Biamplication is an electronic technique that significantly improves the quality of sound from a system by the use of one or more extra amplifiers. In a conventional system, a single amplifier delivers power for a speaker system, as in Fig. 1A. The signal is then split by a passive crossover network of capacitors and inductors to feed separate drivers that are specialized to handle different portions of the audio spectrum. Biamplication splits the signal with an active crossover before power amplification, and separate amps are used for the different drivers in the speaker, as in Fig. 1B.

Like the stereophonic recording and the linear tracking tonearm, biamplication is surprisingly ancient by the standard of audio history. It may have been used first by Hollywood soundmen in the '30s. In the '50s, biamplication was the vogue in high-end audio, but the arrival of stereo made more dramatic use of a second amplifier, and biamplication disappeared

from the consumer marketplace. Now it is being revived, mainly for subwoofer applications.

Biamping offers a number of very real advantages that have contributed to its commercial rebirth. Among these are a greater effective power handling capability, and hence a wider dynamic range, which is significant for reproducing digital recordings. To give an oversimplified example, a woofer capable of handling 100 watts and a tweeter capable of handling 25 watts, when combined in a conventional system, can safely handle 100 watts at most. When biampified, the system can sound as loud as if it were handling 125 watts. A speaker system that can handle 75 watts, combined with a subwoofer capable of 150 watts, can sound like 225 watts.

Passive crossovers have problems that don't exist with active crossovers. A speaker's impedance is not constant with frequency. The impedances of capacitors and inductors also vary with frequency, and with temperature,

voltage, age, humidity and from one production run to another. These problems are nonexistent or much less severe in the values needed for active circuits. The proper design of a passive crossover is difficult at best.

Subjectively, the listener's approval of biamping goes beyond what one might expect from specifications alone. Distortion is measurably lowered, but there seems to be a qualitative improvement as well. The amps have to deliver less power for a given loudness, and distortion tends to be lower at lower power levels—for amps and speakers alike. Clipping is masked in the bass, where it's most likely to occur, since the woofer won't reproduce clipping transients and the tweeter continues putting out undistorted sound. Isolating the tweeter from clipping transients in the bass channel protects it from burnout.

Using biamplication to feed a subwoofer at frequencies below 100 to 200 Hz offers some special advantages. Doppler distortion (sometimes

called frequency modulation distortion) has been shown by P. A. Fryer to be inaudible when cone excursion is less than 4 mm. Such extreme excursions only occur at the lowest frequencies, and therefore isolating these frequencies eliminates Doppler distortion and reduces other forms of intermodulation distortion.

Below 300 Hz, many authorities feel that pure tones are not perceived as

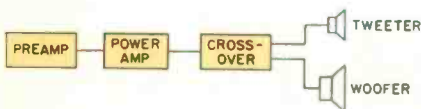

Fig. 1A—Conventional audio system.

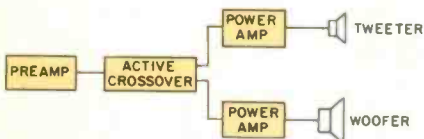

Fig. 1B—Biamplified audio system.

directional. Using a crossover frequency much lower than this will filter out all traces of tones that are directional from the bass channel. This makes it possible to combine channels and use only one driver for the bass, saving space and the expense of extra equipment. Some people prefer two subwoofers, which allows 3 dB more loudness. While this approach simplifies speaker placement for phasing and stereo imaging, finding two locations that don't set off undesirable room resonances may be difficult. Both methods can give good results, both can have problems. In my opinion, there is no innate superiority to either approach.

The subwoofer format allows one to use bookshelf or mini-speakers as satellites. The smaller size and lesser number of drivers in such systems, as well as the simpler crossover networks, allow better dispersion and a more linear phase response in the midrange and high frequencies. This means better imaging and transient re-

Crossovers— An Active Approach

Filters

Any crossover network consists of filters. For loudspeakers, two basic types are used: High pass and low pass. As the names imply, a high-pass filter passes high frequencies and blocks low frequencies, and vice versa. A filter's cutoff frequency is the point where response is down by 3 dB and is sometimes called the half power point. A typical speaker system will have a low-pass filter for the woofer and a high-pass filter for the tweeter. In a three-way system the midrange driver will have a low-pass and a high-pass filter, resulting in a broad bandpass response.

This is simple enough, but there are different *orders* of filters. The term "order" refers to the order of the equation that describes the filter's response as a function of frequency, i.e., the largest exponent in the equation. The higher the order, the greater the filter's ultimate rate of attenuation and the greater the phase shift at the filter's cutoff point. The simplest filters are first order, consisting of either a single capacitor or inductor (coil). The ultimate rate of attenuation is 6 dB per octave. Second-order filters (a capacitor and an inductor) roll off at 12 dB per octave, third (three elements) at 18, fourth at 24, etc.

Fig. 2—Filter-response curves. First-, second-, and third-order high-pass Butterworth responses (A) and second-order high-pass responses with different damping factors (B).

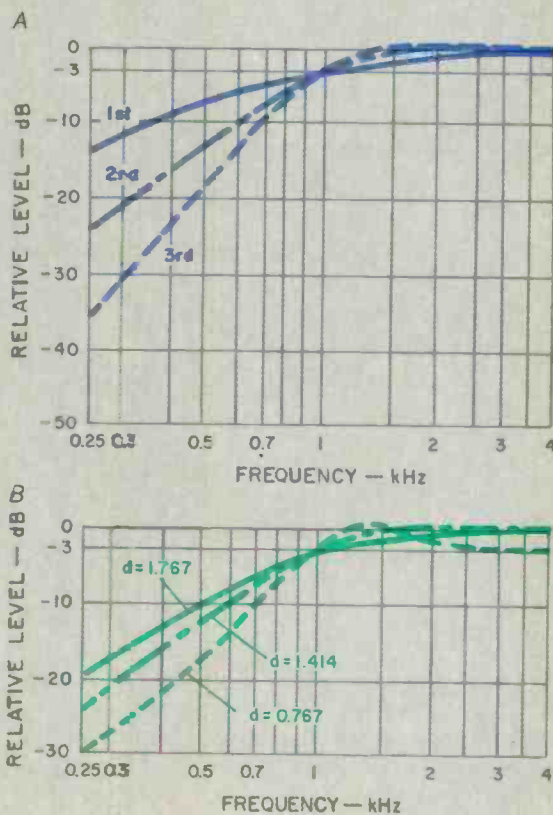

An active crossover allows the speaker components to work in their proper range to produce the best sound.

sponse. On the negative side, the large size of a typical subwoofer can be awkward, and so can finding an optimum place to put it. As a compensation, the satellite speakers can be smaller, and only one subwoofer may be used, so it is possible to use less total floor space. Some subwoofers are surprisingly compact, but the laws of physics dictate that any efficient subwoofer must be large, and thus also judged as a piece of furniture.

There are obstacles to bi-amplification. One must have a separate preamp, or preamp outputs on an integrated amp or receiver. An extra amp is needed, and so is an active crossover. These latter devices are still considered somewhat exotic; the sidebar describes their inner workings sufficiently so that the more technically minded can design their own, and it also details a specific design that can be built by a skilled amateur.

Choosing a Crossover Frequency

There are two major factors to consider in choosing a crossover frequency: Subwoofer placement and the resonance frequency of the satellite speakers. If the crossover frequency is too high, one will hear the subwoofer as a separate sound source, since attenuation of the directional, higher frequencies will not be great enough to completely eliminate them from the subwoofer. (If one is using two sub-

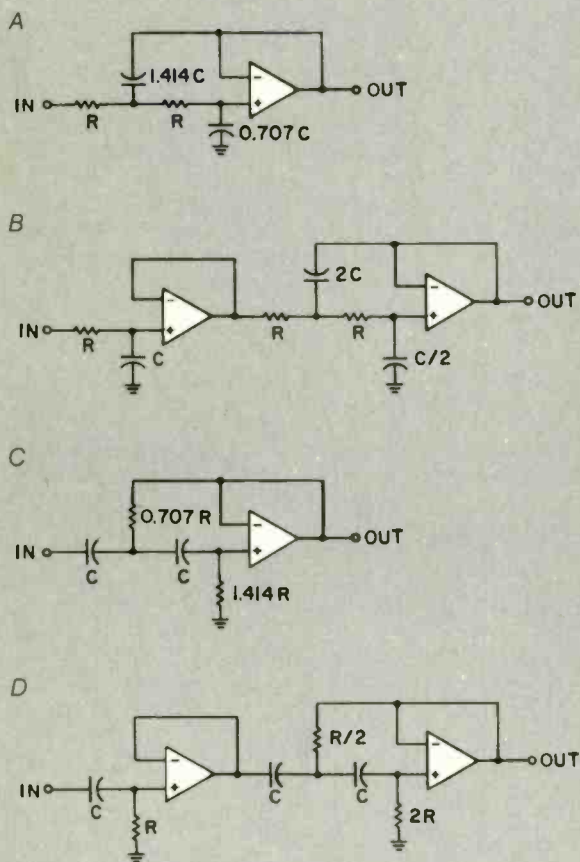

Fig. 3—Unity-gain Sallen & Key filters, where cutoff frequency

$$F = \frac{1}{2\pi RC}$$

R is in ohms, and C is in Farads (1 μ F = 0.000001 F).

Filters illustrated are second-order low pass (A), third-order low pass (B), second-order high pass (C), and third-order high pass (D).

First- and second-order networks are the most common in speakers, though occasionally third and fourth order are used. Figure 2 shows several filter responses.

Another factor that affects filter response for orders greater than one is Q, the ratio of reactance to resistance in the filter network. The Q factor determines the rate of attenuation near the cutoff frequency, the smoothness of response in the pass band, and the linearity of phase shift. (Q is specified here by its inverse, damping or d.) Butterworth filters (d = 1.414 for the second order) have the best all-round combination of characteristics for most network applications.

Active Filter Circuits

Passive filters are made from capacitors and inductors. Active filters generally eliminate the inductors, using a device with gain, such as an FET or an op-amp, to supply the energy that would be stored in an inductor. One of the more popular circuits, due to its simplicity, is the unity-gain Sallen and Key filter. Design parameters for second- and third-order Butterworth responses are summarized in Fig. 3. Separate high- and low-pass filters of this type may be combined to make an active crossover network, but the responses are unlikely to be exact mirror images, due to component variation, and the required values, especially for capacitors, may be hard to locate. Note that for second-order networks, the high-pass and low-pass outputs are 180° out of phase, leading to signal cancellation. This is usually corrected by inverting the high-pass signal, though overall phase relationships

woofers, they should be placed with the main speakers.) For a second-order, 12-dB-per-octave roll-off, 80 Hz is the highest frequency that will give totally nondirectional bass. With a third-order, 18-dB-per-octave response, any frequency below 120 Hz should be satisfactory. If the subwoofer is placed between the satellites and at about the same distance from the favored listening area, higher crossover frequencies may be used. I prefer

such placement, for it gives better phase and frequency response characteristics. Some commercial designs use a second-order crossover as high as 180 Hz, though here I would recommend an 18-dB-per-octave slope for a single subwoofer, unless a slight loss of stereo separation is tolerable.

The satellite speakers produce a significant amount of sound below the crossover frequency. It is especially important for their resonant frequency

to be low enough to ensure that phase shift and response peaks that occur near this frequency do not impact the overall system response. As a rule of thumb, an acoustic suspension speaker's -3 dB response point should be at least an octave below the filter crossover frequency. Bass reflex speakers require a slightly greater margin, as much as 1½ octaves, to avoid phase shift. A satellite that can be crossed in at 80 Hz must already

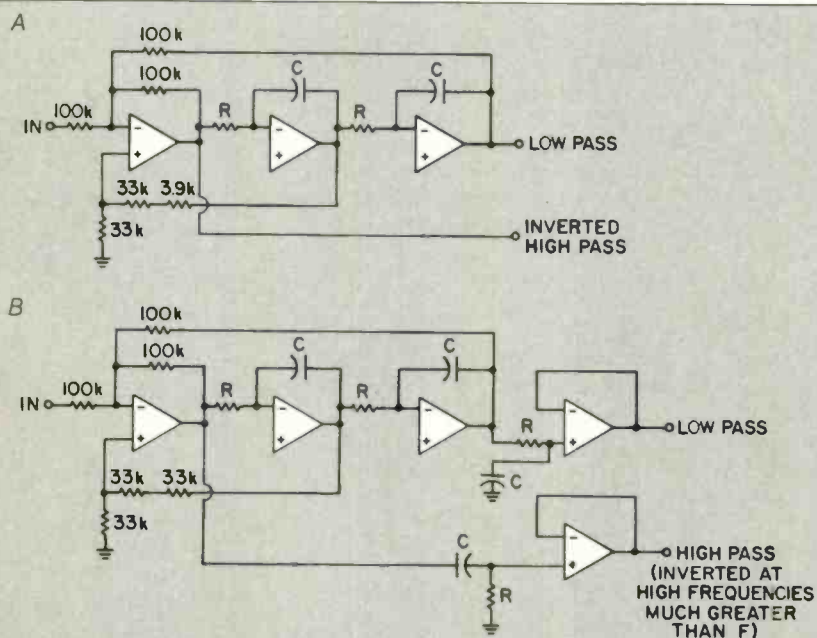

Fig. 4—State-variable filters, where

$$F = \frac{1}{2\pi RC}$$

as in Fig. 3; circuits shown are second-order (A) and third-order (B).

become problematic.

A circuit that avoids some of these problems is the state-variable filter, illustrated in Fig. 4. It is actually an analog computer that "calculates" the desired response and provides simultaneous high- and low-pass outputs. The ratios of component values are easier to obtain, and it is less sensitive to component variation than a Sallen and Key filter. A disadvantage is that the circuit takes time to stabilize when power is applied or disconnected, sometimes resulting in

transient "thumps" which must be circumvented.

Still another type of crossover, only recently available, uses a differential filter consisting of a single low-pass (or high-pass) filter. The complementary response is generated by subtracting the filter's output from the original signal. If a system's drivers are properly aligned, the theoretical result is an all-pass response with no phase shift and hence no degradation of transient response. One claim made for active differential cross-

overs is that they give a more uniform pressure response in a reflective listening environment, such as a home, than do conventional circuits. My own informal listening panel tests show differential crossovers to be preferred at 110 Hz. I have had no chance to test at higher frequencies, but judging from product reviews, a differential crossover will perform very well at higher crossover points.

The Circuit

Figure 5 is a schematic of the active crossover I am currently using. Circuit IC1A inverts the input signal, and R1 provides bias return for IC1B, which forms a second-order low-pass filter. The values shown for R4, R5 and C1A, C1B and C2 give a 112-Hz cutoff frequency. It can be lowered to 75 Hz by replacing R4 and R5 with 150-kilohm resistors. A third-order filter can be made by replacing IC1B and its associated components with the circuit in Fig. 6, which also gives component values for 160- and 106-Hz crossovers.

Circuit IC2A is an inverting summing amplifier, and its output is the high-frequency differential response. Capacitor C5 blocks any d.c. offset from the output, and P1 allows output level adjustment. The second channel is similar. (To biamp a tweeter, it is better to use a high-pass filter for the primary response, since the sharper cutoff improves the tweeter's effective power handling ability.)

It is possible to stop here and take low-pass signals from the outputs of IC1B and IC1D, but if there is only one subwoofer it's necessary to combine the bass signals; IC2C averages them. Even with two subwoofers there are advantages to

sitioned at a standing wave maximum. Whenever a piano recording contained a loud, low B, the howl of feedback was horrendous. The use of good damping feet, and moving the subwoofer out from the wall, cured the problem. In general, keep subwoofers out of corners and perhaps a foot or two away from any walls to avoid setting off room resonances of this sort. Experiments will determine what suits a particular listening environment.

Even if you are not manually inclined, the information presented here should enable you to make an intelligent choice among the active crossovers on the market. **A**

Suggested Reading

Colioma, Martin, *High Performance Loudspeakers*, Pentech Press Estover Road, Plymouth, Devon PL6 7PZ, England (1978).

Includes an extensive survey, with

examples, of active and passive crossover techniques, plus all other known aspects of speaker design.

Jung, Walter G., *IC Op-Amp Cookbook*, Howard Sams, Indianapolis, Ind. 46268 (1974).

If it can be done with op-amps, this book tells how.

Lancaster, Don, *Active Filter Cookbook*, Howard Sams (1975).

The best guide to active filter design for the amateur.

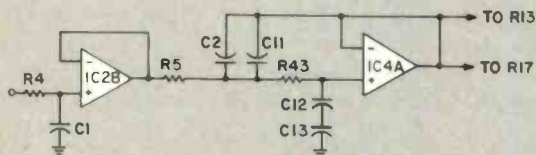

Fig. 6A—Circuit schematic for third-order filter.

| Component | Frequency | |
|-------------------|--------------|--------------|
| | 106 Hz | 160 Hz |
| R4, 5, 43 | 150 kilohms | 100 kilohms |
| C1, 2, 11, 12, 13 | 0.01 μ F | 0.01 μ F |

Fig. 6B—Table of component values for third-order filter.

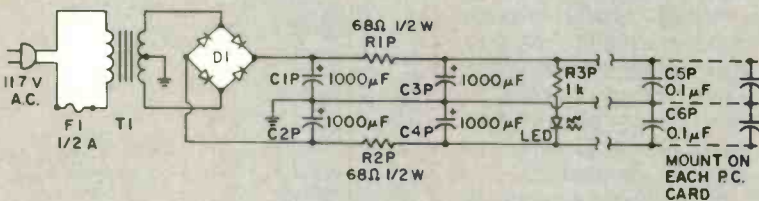

Fig. 7—Schematic of power supply where T1 is 12 V, at least 250 mA, center tapped; D1 is bridge rectifier, 50 V, 1 A; C1P, C2P, C3P, and C4P are 1000 μ F, 35 V electrolytic; C5P,

C6P are 0.1 μ F, 20% ceramic or plastic film (mount a pair of these power supply decoupling capacitors on every board); R1P, R2P are 68 ohms, 1/2 watt; R3P is 1 kilohm, 1/2 watt.

essary cone excursion, and this function is performed by ICs 2D, 3A, 3B and 3C. They are an elliptical filter. The high-pass output of a state-variable filter is summed with part of the low-pass output by IC3C. This results in a response null at a specific frequency, due to phase differences, and the null can be tuned by adjusting P3. At maximum resistance, the null frequency is 2.6 Hz; with P3 at minimum, the null is at 12.8 Hz. Above the null, attenuation is greater

than for a second-order filter and is greater than a third-order filter at most settings. Below the null the response rises again, but, for a 10-Hz setting, is always down by more than 10 dB, which is the attenuation at d.c. With the 2.6-Hz setting, response at d.c. is down 20 dB; phase and transient response are about the same as for a simple second-order filter. I suggest setting P3 to maximum resistance and increasing the null frequency only if subsonics turn

out to be a problem. (If P3 and R30 are omitted, the result is a plain second-order high-pass filter.)

The subsonic filter's cutoff frequency is set to 19 Hz by R24 and R25. Though 82 kilohms is a standard value, it is not widely stocked. Substituting two 39-kilohm resistors in series will raise the cutoff to 20 Hz; 100 kilohms will lower it to 16 Hz.

The output of IC3C is inverted, and IC3D flips it right side up again. Two outputs can be taken from the wiper of P4. Capacitor C9 is a 10- μ F non-polarized electrolytic. Some audiophiles claim that bypassing such a coupling capacitor with a polypropylene or silver mica capacitor will improve the sound, even for low-frequency applications. Capacitor C10 and P5 provide an inverted output if one is desired.

A pre-etched printed circuit breadboard (Radio Shack #276-153 or similar) was used to mount the components. Standard layout techniques are adequate for low-noise operation. Because of the large number of possible options, I have not supplied a parts list. Except for C9 and C10, which are nonpolarized electrolytic, all capacitors are plastic-film types. Polystyrene is superior but may not be readily available. Mylar is adequate and available from most electronics suppliers. The power supply is shown in Fig. 7. Capacitors C5P and C6P are the power supply decoupling capacitors, and a pair should be mounted on every printed circuit card used.

It is possible to assemble an active crossover entirely from parts bought at Radio Shack. Even including a fancy case, the project cost should be less than \$40. **A**

SUB-BASS ON A BUDGET

A. L. NEWCOMB

You own a perfectly good pair of wide range speakers having all the necessary capabilities, but still they seem to lack something at the low end—that extra punch heard in a friend's system or down at the stereo showroom. If you don't wish to make major system changes, you might consider the alternatives offered here, described in order of diminishing expense and complexity.

One possibility is to buy a subwoofer/amplifier. This is perhaps the most expensive choice, requiring space for another piece of furniture. Cost: \$300 and up. A second alternative is to purchase an equalizer, either graphic or one specially designed to enhance the weak frequency range. Depending upon its capabilities, however, this could push the amplifier into voltage clipping. Cost: \$150 and up. A third option is to build the simple circuit described here, borrow or buy a single-channel power amplifier, or another stereo amplifier. If the results sound good, a permanent arrangement then can be made. Cost: Less than \$20 plus amplifier.

Bridging or Differential Amplifiers

Bridging circuits have been around for a long time and are used extensively in automotive and RV sound systems where output power is limited by the 12-volt supply. Clipping must occur at about 5 or 6 volts peak.

Figure 1A shows a load, (RL), connected differentially across the outputs of amplifiers PA1 and PA2. With outputs of equal amplitude and phase, RL sees no voltage difference between the amplifiers and no power is transferred.

Figure 1B shows how PA2 can provide a differential voltage across RL by becoming a "virtual" ground (return) for PA1. In order to do this, PA2 provides an equal current, thereby maintaining its output voltage at zero (or ground potential). This is done handily by modern feedback amplifiers with their very low output impedances.

Figure 1C demonstrates how by inverting the input to PA2, voltage across RL can be differentially doubled. Since the voltage across RL is doubled, the current has doubled, thereby quadrupling output power.

The scheme described here combines, in effect, the operation of Fig. 1B and 1C by adding a low-pass inverting filter in front of PA2 as shown in Fig. 2. Inputs from both channels from the speaker output terminals are mixed, as is done with subwoofer systems. This succeeds because output from the two channels is increasingly in phase and of equal magnitude at lower frequencies; also our stereo perception diminishes below about 100 to 300 Hz. At frequencies above the filter break-point, the amplifier becomes a virtual ground as in Fig. 1B; below that frequency the amplifier functions as in

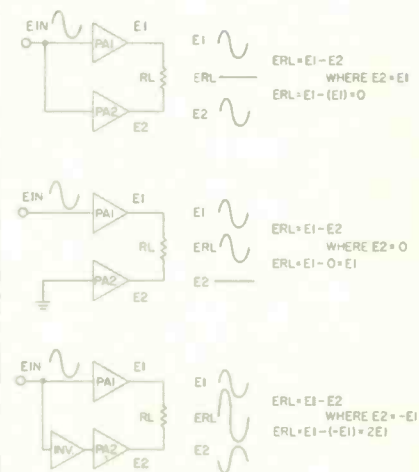
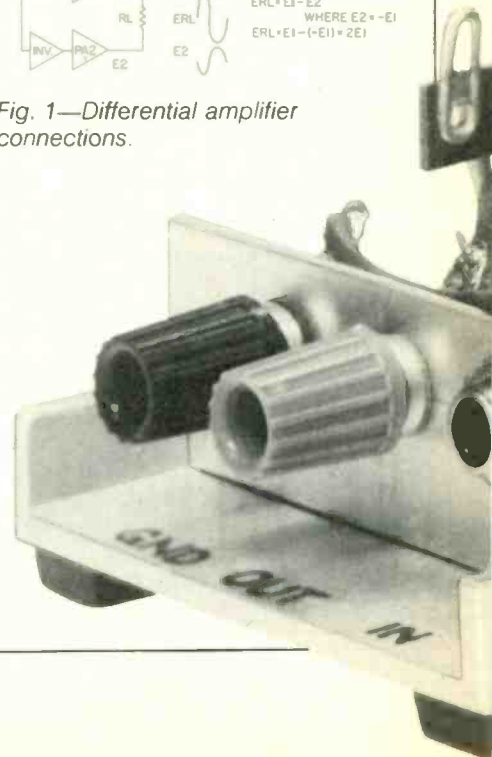
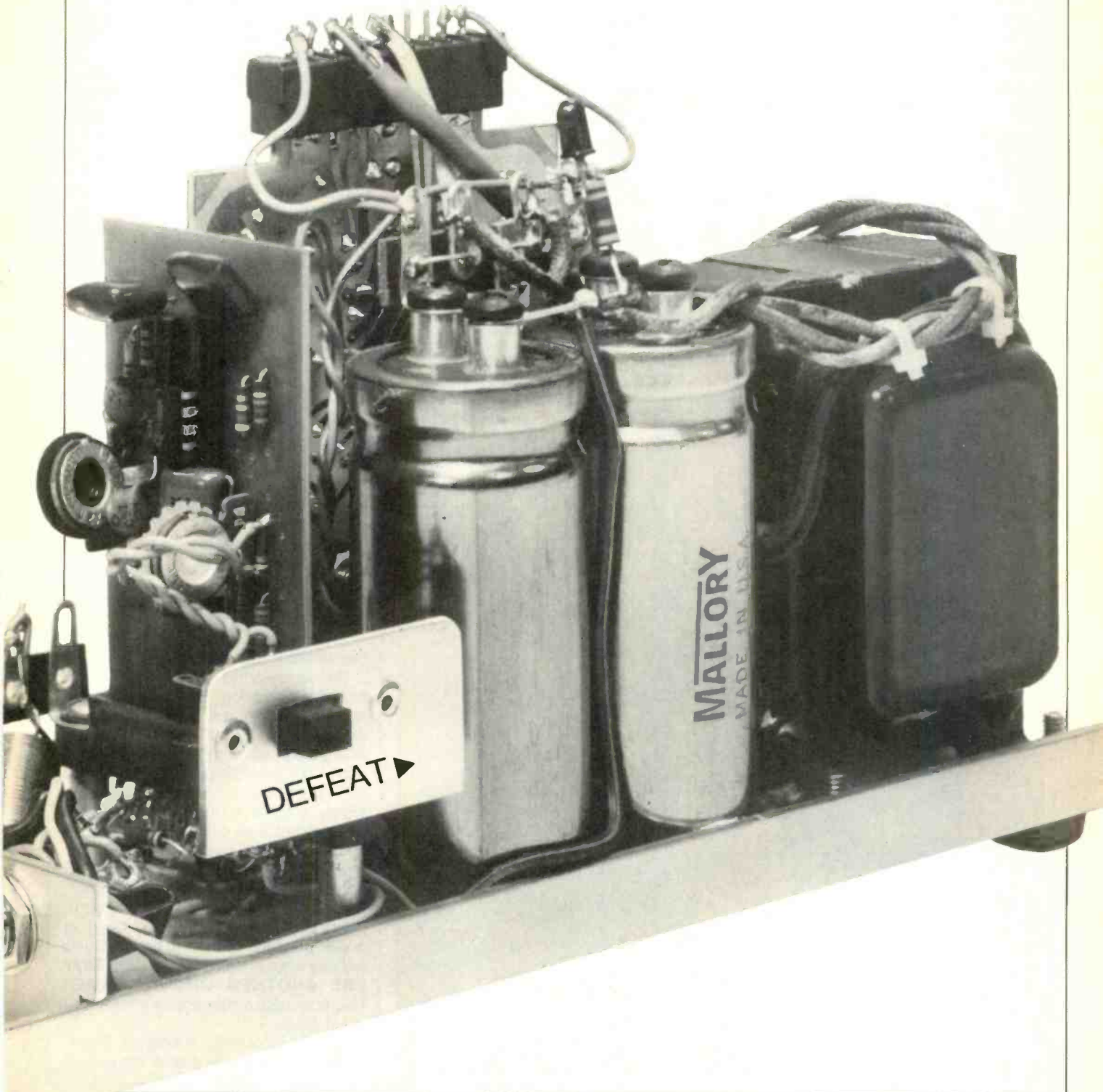

Fig. 1—Differential amplifier connections.



The power output of the third amp adds to the system without pushing the prime stereo amp toward clipping.



For as little as \$20 and an extra amp, speakers can be enhanced with the added punch of a subwoofer.

Fig. 1C by differentially boosting the output. One of the prime advantages of this approach to bass reinforcement is that the power output of the third amplifier is selectively added to the system without pushing the prime stereo amplifier toward clipping as an equalizer does.

The Low-Pass Filter/Inverter

The schematic shown in Fig. 3 consists of a simple summing network (R1, R2, and R3) inputting a one-sided, boost only, Baxandall-type 6-dB-per-octave low-frequency amplifier. Note that the network also applies the signal to the positive input through C1 to can-

cel all frequencies above the boost frequency. Capacitor C4 provides additional roll-off of high frequencies beginning at about 700 Hz. The defeat switch across R3 is recommended for adjustment and demonstration purposes, and R3 permits level adjustment if necessary.

Figure 4 illustrates the total circuit response (at the speaker) when connected as shown. Experiments were made with a number of filters using steeper slopes of 12 and 18 dB per octave, but phase shift caused objectionable response ripples, only slightly evident in Fig. 4, in the "near bass" midrange above the boost frequency. The Baxandall circuit is well-suited to this application because a near constant slope boost begins at the low-frequency end (where it is usually needed) and increases as the control is advanced.

Power for the filter may be supplied by the circuit of Fig. 5A. The circuit of Fig. 5B may be used if the new amplifier uses balanced plus and minus polarity supplies. The simple zener circuit uses a series resistance which will allow about 10 mA to flow. The value for Rx will therefore be:

$$R_x = \frac{V_s - 12}{0.01} \Omega$$

where V_s = measured voltage of the plus or minus supply.

Connection and Operation

Recommended connections are also shown in Fig. 3. The two return leads from the speakers are simply disconnected from the stereo amplifier and connected together with the output of the new amplifier. The R1 and R2 inputs are connected from each stereo amplifier output and need not be shielded. Use only *one* ground connection from the output terminal of the new amplifier to the ground at the output of the stereo amplifier as shown. This will allow for lead reversal (if needed in the case of an inverting power amplifier or if done by accident) without equipment damage. **DO NOT USE ANOTHER GROUND LEAD!** This may cause damage or blown amplifier fuses.

Ideally, frequency response measurements should be made for control

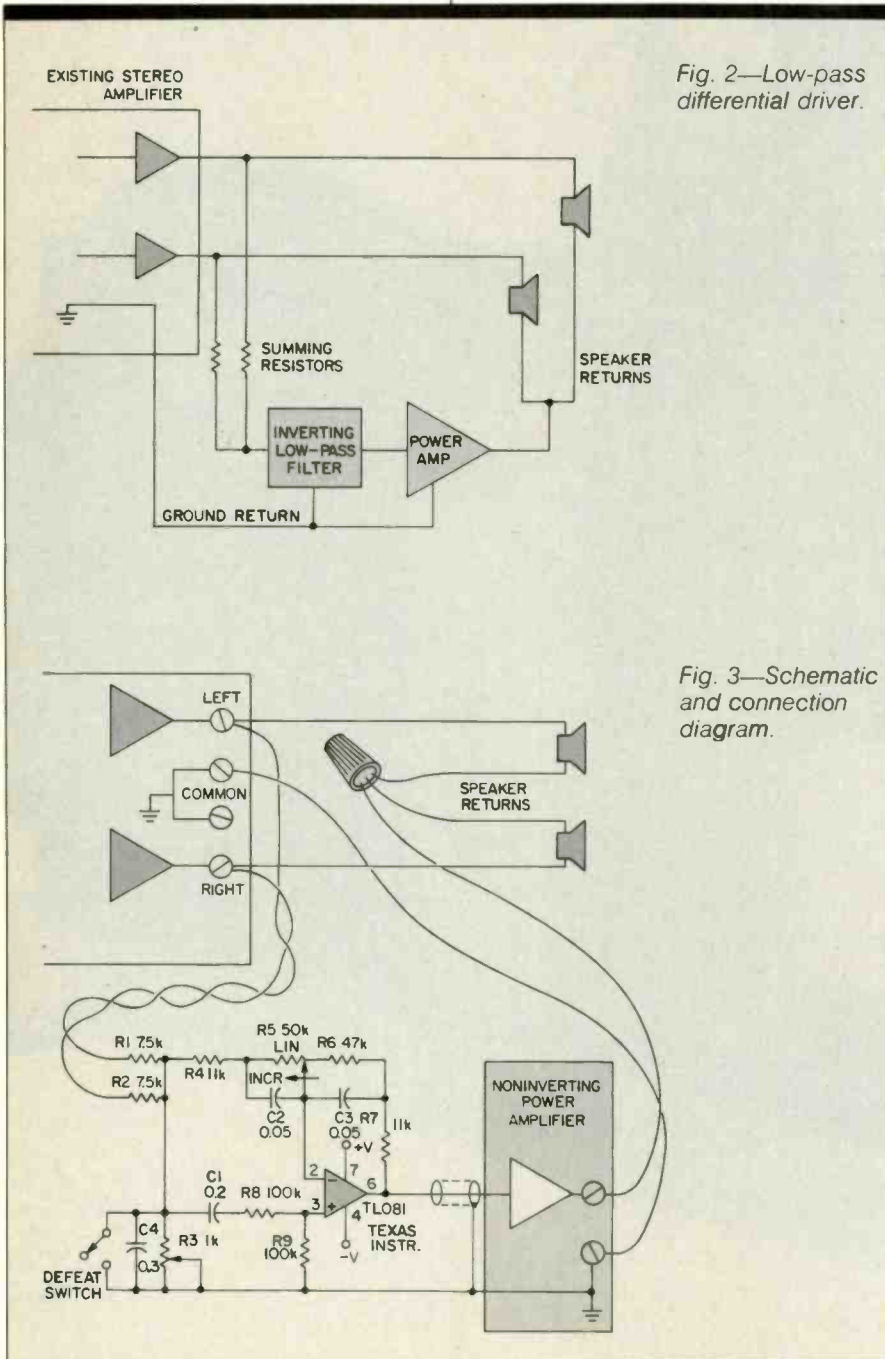

Fig. 2—Low-pass differential driver.

Fig. 3—Schematic and connection diagram.

The extra power amp must be full range and close in quality to the existing stereo amp.

adjustment. A test record with warble tones in the 30 to 150 Hz range would be helpful. Simple listening tests will prove satisfactory, however, using the defeat switch.

Requirements and Possible Problems

As noted earlier, the stereo amplifier should have the capability of driving speakers which have half the impedance of those in use (i.e., with 8-ohm minimum speakers, an amplifier should be capable of driving 4 ohms). If this is not the case, internal protection circuits or devices (fuses) may operate (blow).

The added power amplifier must be full range and at least of similar quality to the existing stereo amplifier. *This is essential.* Although the unit is only active at frequencies below 150 Hz, it must have a good damping factor in order to provide a "virtual" ground over the entire range of the system.

The extra amplifier must also be capable of driving speakers having one-fourth the impedance of the speakers in use. It must drive two speakers in parallel and in bridge configuration. Used with 8-ohm speakers, it must drive, therefore, an equivalent 2 ohms at low frequencies. Finding an amplifier to do this will probably be difficult, but for experimental purposes it can be accomplished at low volume or by means of another stereo amplifier with both channels connected to the output of the filter circuit and individually connected to the speaker returns. An amplifier which will deliver 50 watts into 4 ohms will probably drive 25 watts into 2 ohms without current limiting. If current limiting does occur, a virtual ground will no longer exist and output at all frequencies will be distorted.

The speakers obviously must be able to handle the additional power. If the added amplifier inverts the output, simply reverse the output and ground leads. An inverting power amplifier will cause the circuit to subtract low bass components. Also, the existing stereo amplifier must have a common ground for both speakers. Some amplifiers may incorporate protection circuits which cause the individual returns to be other than grounded. In this case, the experiment should not be tried.

Resistor value variations will manifest themselves as an appropriate, but minor, increase or decrease in system gain. For instance, an overall mismatch of 12% between the plus and minus filter inputs will amount to a barely perceptible 1 dB change in gain at all frequencies. For a nearly

perfect gain match, match R6 to R5 (pot measured leg to leg); use 1% resistors at R4, R7, R8 and R9, and use 10% (or less) capacitors at C2 and C3.

Finally, if the experiment produces pleasing results you can now make a more lasting amplifier selection. If not, you have invested less than \$20. **A**

Fig. 4—Frequency response vs. potentiometer rotation.

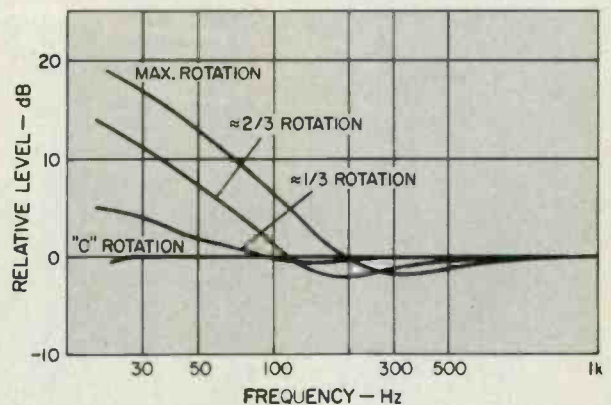
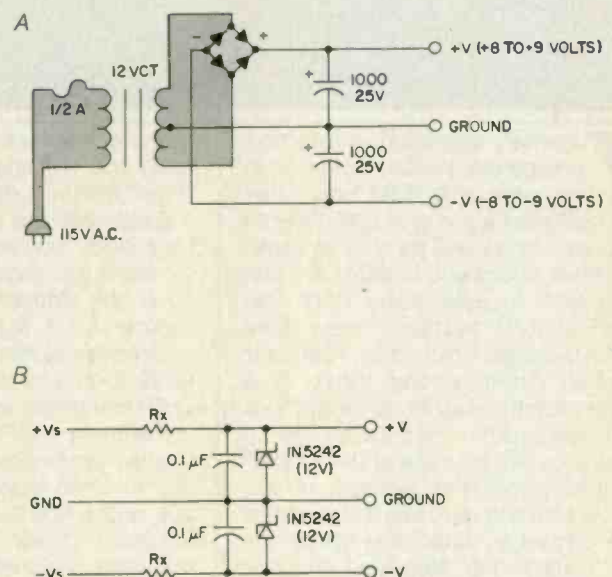

Fig. 5—Power-supply circuits.



YAMAHA CONCERT SYSTEM 70



Yamaha's approach to matched component system design is, in my view, a brilliant one. They have designed a group of components which could very well be sold as separates (their specs and features are that good) and, in assembling them into attractive total systems, they have added features which offer *real* user features. Chief among these is a unique control-signal arrangement which obviates the need for the user to select program sources at the amplifier's front panel. For example, if you insert a cassette tape into the supplied K-20 cassette deck and press its "Play" button, the integrated amplifier will automatically switch over to the tape mode. The same thing happens with the tuner (when you turn on its

power or depress one of its preset buttons) and with the turntable (when its "Play" button is depressed).

Essentially the same electronic and tape deck components are supplied for either the Yamaha Concert System 70 or the Concert System 60. These include a full featured, powerful (65 watts/channel rated, at 8 ohms, 20 Hz to 20 kHz, with no more than 0.02% THD) integrated amplifier, Model A-20, a matching AM/FM stereo digital frequency-synthesized tuner (Model T-20), a stereo cassette deck (Model K-20), and a fully automatic, direct-drive turntable (Model P-20) with a pre-mounted magnetic cartridge. Both systems also include a pair of three-way loudspeakers (with 12-inch woofers, 4-inch midrange drivers, and 1-

inch dome tweeters) housed in oiled-walnut veneer cabinetry. A cassette storage drawer component is supplied in the Concert System 70 but is an option with the Concert System 60. Optionally available equipment for both systems include Model DT-2 digital timer and Model GE-5 graphic equalizer. The chief difference between the two systems is in cabinetry configuration. The Concert System 70 is supplied with a horizontally oriented "low-boy" cabinet in the same finish as the loudspeakers, while the Concert System 60 features a vertical cabinet with glass doors. Suggested retail prices are \$1,999.00 for the System 70 and \$1,899.00 for the System 60.

The A-20 integrated amplifier has prominent output level displays which

read power directly in watts referred to 8 ohms. This amplifier serves as the central component of the entire system, and in order for its automatic function selection to operate, special control signal plugs from the cassette deck, tuner and turntable must be plugged into appropriately marked receptacles on its rear panel. An important feature for which Yamaha separate components are admired is incorporated into this amplifier: The totally

independent loudness control which enables you to reduce listening levels without altering the main volume control while achieving proper bass and treble compensation for low-level listening levels. A unique fade-out/fade-in control need only be touched once to provide a gradual 20 dB of muting for answering phone calls or doorbells, and touched again to smoothly fade up to previously desired volume levels. Since the system includes a tape

deck, which needs to be connected via one tape loop, a second signal-out/signal-in loop is provided (and selectable at the front panel) for connection of other add-ons such as the optional graphic equalizer. Bass and treble tone controls are conventional, with center points mechanically detented for easy flat-response setting.

As the overall rating chart indicates, the amplifier exceeded both its rated power output and its distortion claims by a comfortable margin. Phono frequency response was excellent, and the measured signal-to-noise ratio of 77 dB does not suggest a failure to meet specs (Yamaha claimed 85 dB). Rather, it is because Yamaha still measures phono hum-and-noise by a now-obsolete test method, whereas I use the new EIA Amplifier Measurement Standard; the reading of 77 dB is quite good.

The T-20 AM/FM tuner features manual or automatic scan tuning as well as the ability to store six AM and six FM stations for instant recall at the touch of a button. Tuning is precise, thanks to the frequency-synthesized quartz phase-lock-loop tuning system. There is, therefore, no need for a center-tune indicator, though the T-20 does have a "station lock" light which comes on when the tuner zeroes in on a station. Signal strength is shown with a five-LED display. Small batteries installed at the rear serve as a backup for station memory storage in case of a power failure or if the a.c. outlet is accidentally unplugged. While I regarded the basic performance of the FM section of this tuner as adequate, my chief criticism was the inordinately high levels of subcarrier (19 and 38 kHz) products which were present in its output. Used with a cassette deck that is not equipped with proper filtering, this could lead to poor recording quality, especially when Dolby noise reduction is used. Fortunately, since Yamaha had total control of the entire system here (an advantage of the one-brand approach), they chose to incorporate such filtering into the K-20 cassette deck instead of designing appropriate filters for the tuner so that it would have no problems with any deck.

As for the cassette deck, it has a most unusual single transport control "pad" which handles all tape motion

ONE-BRAND SYSTEM RATINGS

Manufacturer: Yamaha
Dimensions: Not available.
Price: \$1,999.00.

Model: Concert System 70

| Component & Specification | Claimed | Measured | Rating |
|---|----------------|----------------|--------|
| <i>Power Amp Section (A-20)</i> | | | |
| Power/Channel, watts | 65 | 73.2 | ♪♪♪ |
| Rated THD, % | 0.02 | 0.015 | ♪♪♪ |
| <i>Preamp/Control Section (A-20)</i> | | | |
| Freq. Response, Phono | RIAA ±0.5 dB | RIAA ±0.3 dB | ♪♪♪ |
| Phono S/N, dB | 85† | 77 | ♪♪♪ |
| <i>FM Tuner Section (T-20)</i> | | | |
| 50-dB Quieting, Stereo, dBf | 37.5 (41.2 μV) | 38.0 (43.7 μV) | ♪ |
| S/N, Stereo, dB | 76 | 63† | ♪ |
| THD, Stereo, 1 kHz, % | 0.2 | 0.14 | ♪♪ |
| Separation, 1 kHz, dB | 45 | 46.5 | ♪♪ |
| Alt. Chan. Selectivity, dB | 85 | 85 | ♪♪♪ |
| <i>Turntable/Cartridge Section (P-20)</i> | | | |
| Freq. Response, Hz-kHz, ±dB | N/A | 20-20, ±1.5 | ♪ |
| Separation, 1 kHz, dB | N/A | 22.5 | ♪ |
| Rumble, DIN B, dB | 77 | 75 | ♪♪ |
| Wow & Flutter, % wtd. rms | 0.015 | 0.013 | ♪♪♪ |
| <i>Cassette Recorder Section (K-20)</i> | | | |
| Freq. Resp., Hz-kHz, ±3 dB | | | |
| Normal Tape | 40-16 | 20-18 | ♪♪♪ |
| Chrome Tape | 40-18 | 20-20 | ♪♪♪ |
| Metal Tape | 40-20 | 20-20 | ♪♪♪ |
| S/N, Best Tape, with NR, dB | 60 (No NR) | 58 | ♪♪ |
| Wow & Flutter, % wtd. rms | 0.04 | 0.026 | ♪♪ |

† See Text.

Rating System

♪ = Poor; ♪♪ = Good; ♪♪♪ = Very Good; ♪♪♪♪ = Excellent; ♪♪♪♪♪ = Superb.

General Comments

Power Amplifier: Sound quality excellent, reliable operation with no tendency to overheat. **Preamp:** Superb loudness control arrangement; system takes advantage of component interrelationships (see text). **Turntable & Cartridge:** Smooth, silent and automatic; cartridge chosen could have had better specs and lower tracking. **Tuner:** Weakest link of the system, but received acceptable FM and stereo FM; perfect tuning and favorite station presets a definite plus here. **Cassette Deck:** Superb panel layout, easy to use, and performs extremely well with all premium types of tape, from normal to metal. Great human engineering here—this is the star component of the system.

Overall Comment: I admired the automated control feature (see text).

Overall Rating: ♪♪♪

The System 70 is by far the closest to a high-grade component system that I have seen.



The Concert System 60 features a vertical cabinet, glass doors.

(fast forward, rewind, play and stop) depending upon which section of the pad is depressed—sort of a flat joystick arrangement that's easy to use.

Tape selection is *completely* automatic, with the deck able to accommodate normal, high-bias (chrome or equivalent), and metal tapes properly. Dolby B noise reduction is incorporated, as is a momentary record-mute button. Both in terms of frequency response and its other electrical specifications and in terms of its ease of use and features, I regarded this little deck as the outstanding component in the group, without in any way demeaning the others. In my tests, I used TDK-AD as the normal tape sample, TDK-SA for the high-bias tape, and TDK-MA as the sample of metal tape.

While I found an excellent 75 dB DIN B rumble figure for the P-20 turntable system, I was even more impressed by the 60 dB unweighted rumble figure scored by this fully automatic player. Wow and flutter was also outstandingly low. Response of the supplied cartridge extended well out to beyond 20 kHz but exhibited a slight peak at around 16 kHz or so. I feel the turntable

is capable of handling a cartridge that requires somewhat less than the 2.0 grams of tracking force demanded by the unidentified pickup supplied by Yamaha. The P-20 owner's manual says very little about the cartridge other than its weight and required tracking force. I would urge users who are not totally satisfied with this choice of cartridge to upgrade to a better one. Yamaha, incidentally, has been nice enough to throw in an extra tonearm headshell for just such a contingency!

My overall impression is that this system is by far the closest to a high-grade separate component system that I have seen. The fact that Yamaha has included fine cabinetry and matching speakers and has taken advantage of features that could only be incorporated when all elements of the system are under a single manufacturer's control makes the Concert System 70 that much more desirable.

Leonard Feldman

Enter No. 98 on Reader Service Card

1. Tapered *laser-hollowed* Ruby cantilever
2. Laser-drilled rectangular stylus mounting hole
3. Nude rectangular-shank Straight Line Contact stylus
4. Toroidal coils hand wound of pure Silver wire
5. One-piece "Omega shaped" coil core/pole pieces
6. Three year warranty

And if that doesn't convince you...listen!

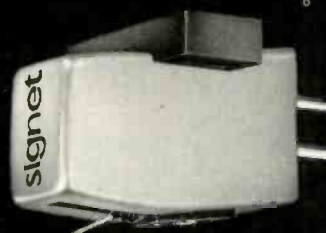

signet © 4701 HUDSON DRIVE, STOW, OH 44224

NEW TK100LC

Enter No. 20 on Reader Service Card

The Kyocera Series D-801 Cassette Deck with 3 motors and a direct driven dual capstan...

With only 0.02% WRMS wow and flutter.

If you think 3 motors impress you, think of what they can do for tape performance. One drives our dual capstans to insure constant and highly accurate speed with remarkable low wow & flutter of 0.02%. A second motor drives both the take-up and feed reels while the third motor gently positions the record/playback head against the tape surface. An innovative approach resulting in accurate head-to-tape positioning and optimal head azimuth alignment. But motors alone do not insure top

performance. That's where both Dolby* B and C noise reduction circuits come in, along with a Sendust alloy tape head; electromagnetic braking on both take-up and feed reels; selectable bias and equalization for all types of tapes; 30-20,000 Hz response range; full LED function indication; feather-touch controls; APMR for automatic program search; auto stop; auto repeat, memory and a full bank of operational controls concealed behind a flip-down access panel; plus the convenience of a

4-digit LED electronic timer/counter for precise elapsed time, remaining time, stopwatch and memory stop and registering time and/or counter reference of recorded programs... and more.

But our most impressive feature awaits at your local audio retailer... a demonstration of the D-801...it's just one of a very impressive list of distinguished audio components and systems from Cybernet...where the future is now!



Cybernet.
A Division of Kyocera

Seven Powder Horn Drive, Warren, N.J. 07060 U.S.A. Telephone: (201) 560-0060 Telex: 642529 CYBERNET WARE.

Enter No. 6 on Reader Service Card

*Dolby is a reg. t.m. of Dolby Laboratories, Inc.

©1982 CYBERNET

*The Franklin Mint Record Society,
in collaboration with Count Basie, Les Brown, Lionel Hampton, Woody Herman,
Harry James, Sammy Kaye and a panel of distinguished music authorities,
is proud to present . . .*

THE GREATEST RECORDINGS OF THE BIG BAND ERA

ARCHIVE COLLECTION

*The most comprehensive collection of
original big band recordings ever assembled.
And the first ever issued on superior proof-quality records.*

© 1982 FMRS



"We wanted this collection to have it all! The great bands, the soloists and the singers. It's good to know this music is all here . . . all together . . . for now and the future."

—Count Basie

The greatest authorities on the music of America's big band era—musicians and music critics alike—have joined together, for the first time, to assemble the definitive collection of big band recordings.

This is a collection unlike any issued before. For the bandleaders, writers and critics who comprise this panel are the very same ones who shaped the big band era.

These experts enlisted the cooperation of the record companies which now hold the original master recordings of the big name bands. Thus, the panel was able to make its selections from virtually every big band performance ever recorded—making this the first such collection ever assembled from all the big band record labels.

As a result, this will be the most complete, comprehensive and authoritative collection ever devoted to big band music. And it will be the first ever available on proof-quality records of exceptional fidelity.

All the great bands, singers and soloists in their greatest recorded performances

The Archive Collection of *The Greatest Recordings of the Big Band Era* will be all-encompassing. A collection which reflects the musical diversity of the era. The crisp swing of Benny Goodman and Artie Shaw, the relaxed rhythm of Count Basie and Jimmie Lunceford, the bright dixieland of Bob Crosby, the sophisticated stylings of Duke Ellington, the dreamy delicate sounds of Ray Noble, the soft, sweet music of Guy Lombardo and Sammy Kaye. It will also include:

The musical forerunners of the era—Paul Whiteman, with Bing Crosby and Bix Beiderbecke; Fletcher Henderson, who influenced Benny Goodman and many others; the early sounds of Glen Gray and Fred Waring.

The nostalgic themes of the big bands—Glenn Miller's "Moonlight Serenade" . . . Tommy Dorsey's "I'm Getting Sentimental Over You" . . . Louis Armstrong's "When It's Sleepy Time Down South" . . . Vaughn Monroe's "Racing with the Moon."

The greatest hits of an entire generation—Charlie Barnet's "Cherokee," Duke Ellington's "Take the 'A' Train," Artie Shaw's "Frenesi," Frankie Carle's "Sunrise Serenade," Tommy Dorsey's "Opus One," Eddy Duchin's "Stormy Weather," and Benny Goodman's "Sing, Sing, Sing," with Gene Krupa.

The big band vocalists that audiences loved . . . and still remember. Frank Sinatra with Tommy Dorsey, Peggy Lee with Benny Goodman, Doris Day with Les Brown, Anita O'Day with Gene Krupa, Bob Eberly and Helen O'Connell with Jimmy Dorsey. And many more, including Perry Como, Lena Horne and Ella Fitzgerald.

The ultimate collection of original big band recordings

This is a collection that would be difficult—or impossible—for any individual to assemble. For these selections have been drawn from the archives of all the major record companies . . . and such vintage labels as Brunswick, OKeh, Vocalion, Bluebird and Perfect.

Many of these recordings—like Wayne King's "Melody of Love"—have been unavailable for years. Others are hard to find recordings of early radio broadcasts . . . such as Frank Sinatra's emotional farewell to the Tommy Dorsey Orchestra, doing his spectacular rendition of "The Song Is You." Still others were only released on 78s—and never re-issued: Bob Crosby's "Black Zephyr" and Gus Arnheim's "A Peach of a Pair" with Russ Columbo.

In many cases, the panel considered several different versions of the same song, before selecting a particular recording for the collection. Thus, every selection will be a classic performance. An original recording of the era . . . recaptured on records of superior listening quality.

Superb quality for today's audio systems

These records will be produced to the highest standards possible by The Franklin Mint Record Society—judged by audio experts to produce some of the finest records available today.

Each recording will first undergo a painstaking restoration process—electronically "cleaned" groove-by-groove to eliminate extraneous surface noise and preserve the original brilliance of the music.

The records will be pressed in a dust-free "clean room" using a special vinyl that contains its own anti-static element. This meticulous pressing technique, together with the special record vinyl, results in a more rigid, durable and dust-resistant record. A proof quality record that actually sounds better than the original—and may be played through any audio system.

Hardbound albums and big band histories provided

In keeping with the importance of this collection, special hardbound albums have been designed to house and protect all one hundred proof-quality records.

Each album holds four long-playing records, with an expertly written commentary—prepared by members of the advisory panel, and illustrated with photographs of the bands. A complete reference index to bandleaders, songs and solo artists will also be provided.

Available by subscription only

If you remember the big bands . . . if you've ever



Strict record pressing standards, and audio and visual inspection, assure high quality. Ordinary records (left) have static charges that attract dust, causing surface noise. But the special anti-static vinyl used in Franklin Mint records (right) assures clearer sound. Electrostatic meter tests show that the Franklin Mint record has only one-fifth the static charge of ordinary records.

wished to relive the music of that period . . . or if you've only just discovered this unique sound in American popular music . . . this is your opportunity. An opportunity to share and enjoy—with all the members of your family—the unforgettable sound of the big bands.

The collection may be acquired only by direct subscription. It will not be sold in record stores. To subscribe now, mail the attached application to The Franklin Mint Record Society, Franklin Center, Pennsylvania 19091. Please do so by August 31, 1982.

The Advisory Panel

COUNT BASIE for more than 40 years, leader of one of the most consistently swinging bands in history.

LES BROWN outstanding writer, arranger and leader of one of the era's most popular dance bands.

DAVE DEXTER, JR. a record producer for 31 years, former *Down Beat* editor and author of *The Jazz Story* and *Playback*.

LIONEL HAMPTON a leader whose exuberance has inspired musicians and audiences alike for more than five decades.

WOODY HERMAN who continues to be one of the most popular and successful of all leaders—discoverer of many talented musicians.

HARRY JAMES a brilliant trumpeter of both beautiful ballads and rip-roaring swing.

SAMMY KAYE "Mister Swing and Sway," master of the sweet sound—always popular, always danceable.

NEIL McCAFFREY music critic and editor of *American Dance Band Discography* and *The Complete Encyclopedia of Popular Music and Jazz*.

GEORGE T. SIMON music critic, record producer, author of the definitive work on dance bands—*The Big Bands*—and *The Best of the Music Makers*.

RICHARD SUDHALTER jazz critic of *The New York Post*, author of *Bix: Man and Legend*, and a widely respected jazz cornetist.

JOHN S. WILSON jazz and popular music critic of *The New York Times*, author of *Jazz: The Transition Years*, *The Collector's Jazz: Traditional and Swing*, *The Collector's Jazz: Modern*.



TOTAL ROCK RECALL

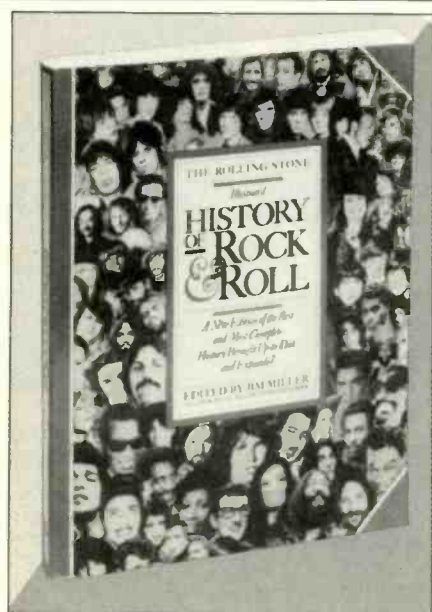

The Rolling Stone Illustrated History of Rock & Roll edited by Jim Miller. Random House/Rolling Stone, paperback, \$10.95.

In attempting any kind of rock history, one's perspective is probably the most important factor in determining exactly how authoritative such a compendium can be. Not only does the critical slant affect the actual portrayal of history, but the choices of whom to include, the placement of each, and how much space is devoted to individual performers can give either a fair or colored picture of what actually went on. *The Rolling Stone Illustrated History of Rock & Roll* is an intelligent, careful and probing look at the rock years, but due to its highly personalized perspective (which isn't entirely consistent throughout the book) it is almost entirely worthless, at least as any kind of *History* (which it claims to be).

Granted, one must have some criteria when writing about music, for there are far too many garbage piles masquerading as artistic projects to include everything. However, many of the writers utilized in this project are what we would call Johnny-come-late-lies to the rock 'n' roll idiom, people whose own sense of rock has less to do with history than histrionics. It would have been in *Rolling Stone's* best interest to use experts in the field

rather than those outspoken critics who are more interested in the "put-down" than anything resembling serious reportage.

Of course, there are exceptions: Paul Nelson on Folk Rock, Bud Scoppa on The Byrds, and Robert Palmer's R&B pieces are truly the works of well-researched fans. But unfortunately most of the book reflects the same self-serving attitudes that the magazine itself has been grandstanding over the past few years. If exclusions of Queen, The Pretenders, and the solo work of ex-Beatles (except for cursory mentions) tip you off that the music they've covered here isn't exactly what you've been listening to, then you might think twice about picking up *The Illustrated History*. However, if the magazine seems to reflect your point of view, go ahead and grab a copy of this — but keep in mind that what you're reading is only someone else's version of what happened.

Jon & Sally Tiven

Rock Record by Terry Hounsome and Tim Chambre, Facts on File, 1981, 526 pp., paperback, \$9.95.

You can imagine the late drunken night that spawned this new reference book. Terry and Tim are sitting up terribly late and Terry says to Tim (or Tim says to Terry, it really doesn't matter), "Say, why doesn't someone put out a book listing every album ever made with everyone that played on it, listed with dates and labels and cross-indexes and everything?"

Now it's been published.

Rock Record is a potentially invaluable source despite, as the authors graciously note in their forward, omissions and inevitable errors. The reader is invited to note these and forward them to the authors for the second edition of the book.

Once you get the hang of the book's modified computer layout and methodology, *Rock Record* is fun thumbing. The index in which all of a musician's listed appearances are gathered is most useful. Some obvious problems become very apparent. Anthologies are totally omitted, even those of otherwise unavailable live performances by many artists on one album, rarities like the *Woodstock* and *No Nukes* albums.

Then there is the surprisingly complete inclusion of blues, even country blues artists, but spotty at best coverage of R & B or C & W or folk artists. Inconsistent thinking here.

However, never have the names of so many, remembered by so few, been gathered in one place. Yes, it was a dirty job, but it had to be done. The second edition ought to be *absolutely* definitive.

Michael Tearson

Radio Enters the Home. The Vestal Press, 128 pp., \$12.50. (Add \$.75 for shipping directly from Vestal Press, 320 North Jensen Rd., P.O. Box 97, Vestal, N.Y. 13850.)

Radio Enters the Home is a reprint of a 1922 radio equipment catalog originally put out by the young Radio Corporation of America. Its 128 pages consist of descriptions of the latest RCA had to offer, plus explanations of the use of many of the items listed.

The catalog starts out with a brief introduction to what radio broadcasting was all about and of the various forms of entertainment then being offered. Up until that time, entertainment had not been considered a legitimate function of radio. In 1922, radio was just entering the home, and RCA issued this catalog to help sell the medium, as well as its own products.

What I, as a vintage radio collector, found to be most useful was the book's detailed product explanations. Circuits for various receivers are given, tube characteristics listed, and most important, set operation explained. A beginning radio collector will find these set operations most useful. I can attest to the bewilderment experienced when confronted by an array of completely unfamiliar controls. *Radio Enters the Home* can actually serve as a short operator's manual for many "antique" sets.

I showed a copy of this book to a good friend of mine, a printer, and he confirmed my opinion that the reproduction quality of this Vestal Press book is as good as one can get. Considering that an original copy would almost be guaranteed to be in extremely fragile condition, this is an excellent addition to any radio collector's library.

Michael N. Stosich

HEAVY VELVET.

Massively built. Delicately precise. Elegantly styled. That's Yamaha's PX-2 tangential tracking quartz-locked turntable.

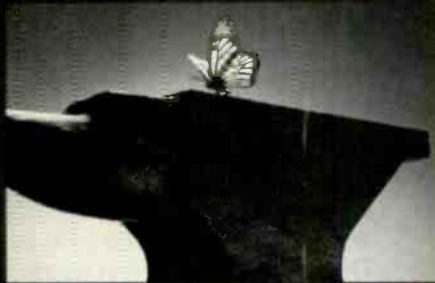

The one that knows its way around records because it plays them the same way they were cut — straight. Yet, the PX-2 is not the first turntable to do this.

It's just the first to do it with the precise performance and rugged construction the others lack.

Precise performance that results not only in negligible tracking error and harmonic distortion, but also in dramatically reduced intermodulation distortion, minimum crosstalk, precise left/right balance,

exceptional stereo imaging, and an unbeatable 30dB signal-to-noise ratio.

Rugged construction such as 5mm-thick diecast aluminum base, solid aluminum headshell, even a 5mm-thick acrylic

dustcover. All contributing to resonance-free performance.

And if you're big on performance but smaller in budget, the PX-3 offers an unbeatable cost/performance ratio.

Yamaha's PX-2 and PX-3. Built like anvils. Yet perform as delicately as a butterfly. All to bring out the music in you.

Get a load of one at your Yamaha Audio Specialty Dealer. Or write Yamaha Electronics Corporation, USA, P.O. Box 3660, Buena Park, CA 90622 for more information.

For the music in you.

YAMAHA

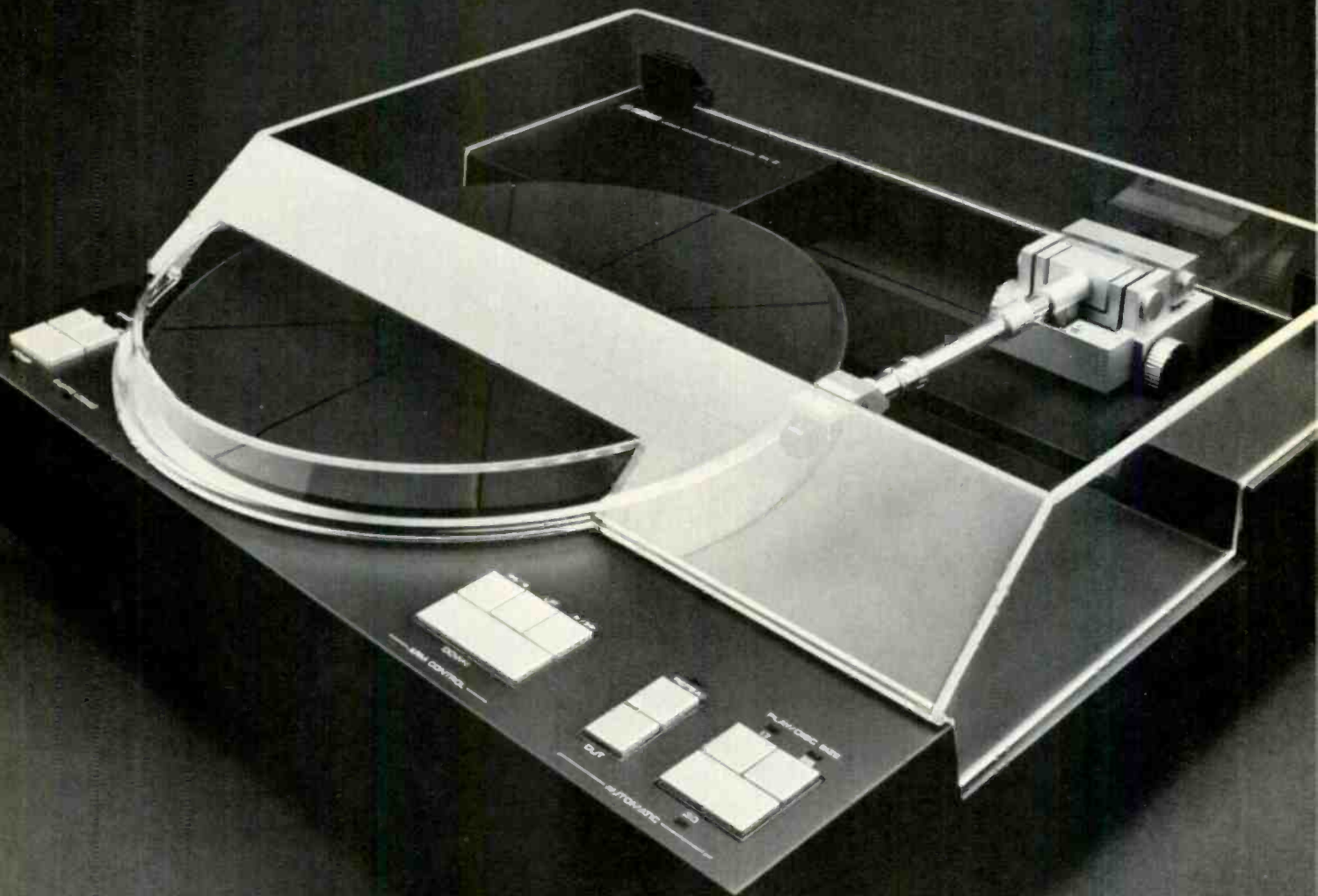

1

FOSTEX 250 MIXER/ RECORDER

Manufacturer's Specifications

Mixer Section

Frequency Response: 20 Hz to 20 kHz.

Distortion: 0.05%.

S/N Ratio: 65 dBA with one mike in, 75 dBA with one line in.

Crosstalk: -65 dB.

Input Impedance: Mike/line, 50 kilohms; rec in, 20 kilohms; AUX in, 20 kilohms.

Input Level: Mike/line, 1 mV/0.3 V; rec, 0.3 V; AUX in, 0.3 V.

Output Levels: 0.3 V nominal, 5.6 V maximum.

Equalizer: ±12 dB at 4 kHz, peaking, and 300 Hz, shelving.

Recorder Section

Format: Special 4-track cassette.

Speed: 3¼ ips.

Frequency Response: 20 Hz to 18 kHz.

Distortion: 1.5%.

S/N Ratio: 75 dBA with Dolby C NR.

Crosstalk: -50 dB.

Erase: 70 dB.

Pitch Control: ±10%.

Wind Time: 80 seconds for C-60.

Tape Type: Type II (high bias and 70-µS EQ).

General Specifications

Dimensions: 17 in. (430 mm) W x 3¼ in. (80 mm) H x 14 in. (355 mm) D.

Weight: 19 lbs. (8.5 kg).

Price: \$1,300.00.



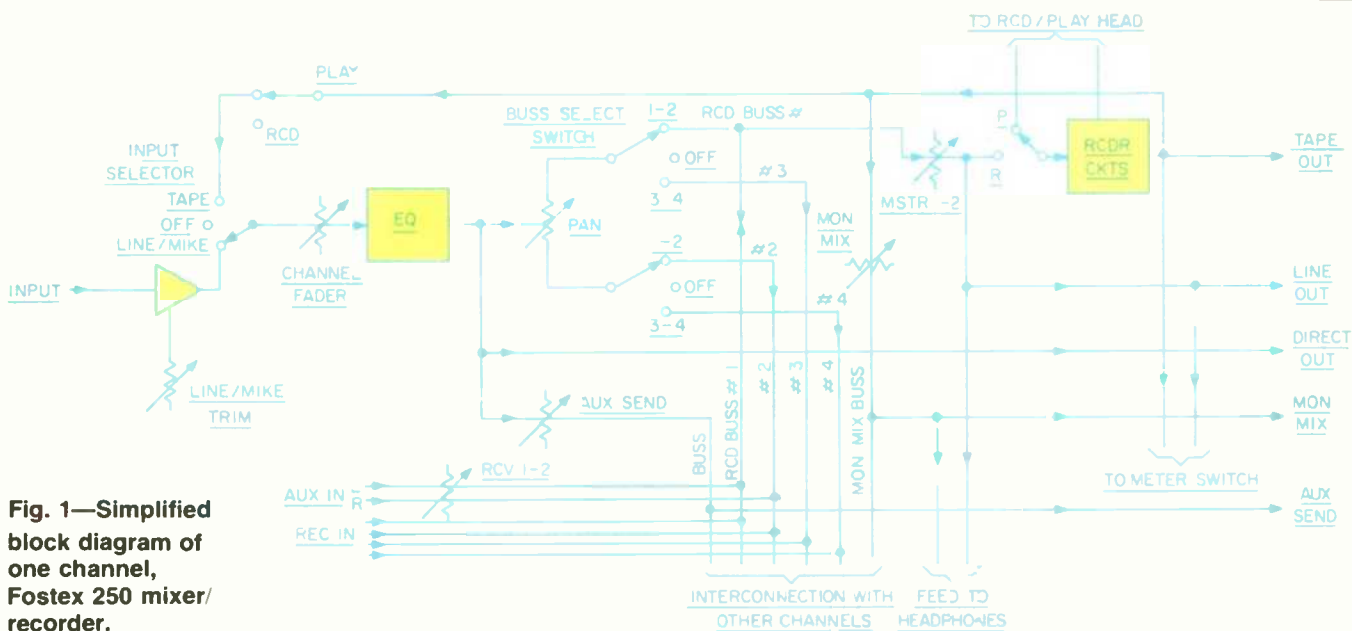

Fig. 1—Simplified block diagram of one channel, Fostex 250 mixer/recorder.

The Fostex Model 250 recorder/mixer is one of a new breed of units which combines a four-channel mixer and a four-track cassette recorder. Because it operates at 3¾ ips in one direction only, the recorder is definitely nonstandard, but it can do many things that a regular cassette deck cannot. This is especially so when the recorder is used in conjunction with the mixer which has considerable facility for routing and combining signals. A look at the top panel of the Model 250 immediately conveys some of the complexity involved and indicates the possibilities for musicians, band soundmen and others. Basically, there are four sets of knobs, controls, switches and jacks—each set associated with one channel. Further description of the panel features will be most easily understood with reference to Fig. 1.

The input phone jacks are on the front apron, as are two parallel headphone jacks. The signal initially feeds an amplifier with a "Line/Mic" trimming pot (CCW for line level, more CW for lower levels) and then through the input selector switch to the slide-type channel fader. The fader is closest to the front edge, with the trimmer just behind it, the best location. The lever-type input switch has positions for "Tape" (for mixdown and track bouncing), "Off" and "Line/Mic." The next set of controls for the signal are two equalizer controls with a range of ±12 dB. The 300-Hz filter is a shelving type which is good for controlling a range of bass frequencies. The 4-kHz filter is a peaking type of moderate Q and is easily used for controlling the general brightness or presence of an input.

After the EQ section, the signal splits three ways: The pan pot, "Direct Out," and "Aux Send." There are two outputs from the pan pot. When it is at the center of its rotator the signal is fed equally to two record busses. When it is all the way CCW, the signal is fed only to the lower numbered buss (1 or 3), and when completely CW, the signal feeds only to the higher numbered buss (2 or 4). The buss select

switch immediately behind the pan pot offers the choice of feeding busses 1 and 2, or 3 and 4, or none. Note in Fig. 1 that although the switch position designation is "1-2," the upper arm feeds only record buss 1, the lower arm only record buss 2. All of the record busses are tied to all channel inputs in the same manner. Record buss 1 also connects to the slide-type "Master 1-2" fader. From that point, the signal goes to the line output and the recorder circuits if the system is in record mode. In similar fashion, the other three record busses connect to the remaining recorder tracks. There is no master fader for channels 3 and 4, however, as there is relatively little need for it. There are no line-output jacks for these channels, only direct-out jacks.

Also at the output from the EQ section is a connection to the "Direct Out" jack for feeding to another recorder, insertion of external processing, etc. Behind the buss selector lever-type switch are the "Aux Send" and "Mon Mix" rotary pots. The "Aux Send" buss combines the inputs from the four channels, and it is available at the "Aux Send" jack for external processing, such as adding reverberation. The "Mon Mix" pot and buss perform a similar function with the signal from the recorder—playback when in play mode, and the signal being recorded when in record mode.

"Aux In" jacks feed in a line-level signal into record busses 1 and 2, with the level controlled through the "RCV 1-2" pot. "Rec In" jacks provide entry into the record busses without passing through any on-board circuitry. Each channel's record buss (line out) and each tape output have connections to the meter switch which selects "Recorder" or "Mixer" levels for indication. Additionally, there are "Mon Mix" and line feeds to the headphone volume control: CW for stereo four-channel (1+3 and 2+4), CCW for the monaural mix, and in the center detent for off. All of the rotary-control knobs have colored caps, which look nice and also help minimize operating errors. The designations are white

This recorder/mixer promises great acoustic boons if used with imagination and inventiveness.

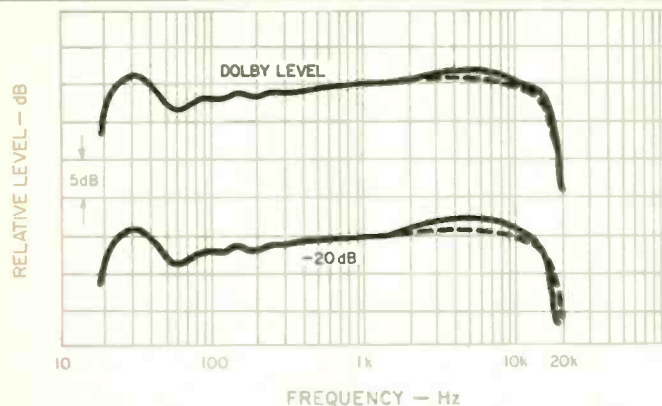

Fig. 2—Frequency responses with TDK SA-X tape with and without (---) Dolby C NR, before EQ adjustment.

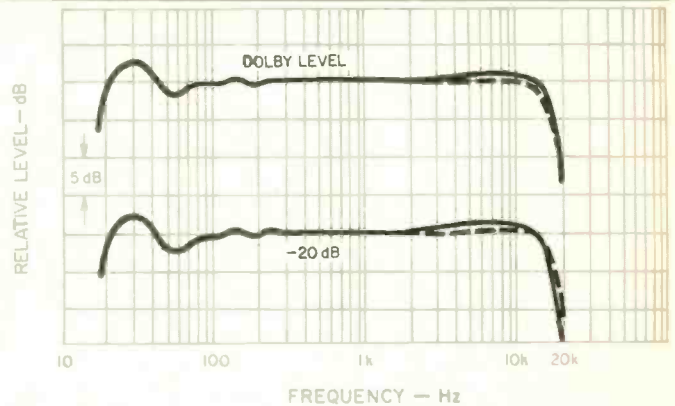

Fig. 3—Frequency responses with TDK SA-X tape with and without (---) Dolby C NR, after EQ adjustment.

on a medium-tone background, legible in fairly dim light.

The four meters at the back of the panel have good illumination, and the good-size scales are very clearly printed. They are VU-type with an overload LED next to the "5" on each meter. The cassette well's lift-up cover keeps dust out of the horizontal transport, and a cassette inserts easily. A strip over the head assembly snaps out, giving excellent access for maintenance.

The tape counter has four LED digits of good brightness, counting below "9999" after rewind past zero. A pitch control offers a range of $\pm 10\%$, and it is effective in either record or play mode. Varying speed for a certain effect in recording can be useful, but I would have preferred some status indicator to warn of possible inadvertent off-speed recording. There are record-preset buttons for each track, and a red indicator flashes for any one that is readied for recording. When "Record" is pushed, its indicator flashes as well. When "Play" is also pushed, recording starts and all indicators are steady. Flying-start recording can be initiated from any mode, as long as "Record" and "Play" are both held. The Fostex 250 has the normal wind buttons but also has one labelled "Zero Rtn," which automatically stops rewind at "0000."

On the back skirt of the recorder/mixer is a collection of phono jacks: Four sets of "Rec In," "Direct Out" and "Tape Out"; the two "Aux In" jacks; the two "Line Out" jacks, and the "Mon Mix" and "Aux Send" jacks. The designations are molded plastic which are hard to read. There is also a phone jack for punch-in/punch-out recording for external control of recording by contact closure, such as with a foot switch. The power on/off switch is also on the back, but it is easily felt without looking. There is more of a question on the location of the Dolby C NR switch; it is on the bottom of the unit, near the left edge at the back. With practice most users will remember which direction of slide obtains NR, but a topside indicator might prevent some errors.

Taking off the bottom cover of the mixer/recorder was done cautiously to make certain *only* the correct screws were loosened. The soldering on the several p.c. boards was quite good, with a little flux residue in evidence. Part numbers on both sides of the cards were visible and inter-

connections were made with multi-pin cabling. There was a rigid metal frame for the drive assembly with a good-sized flywheel. The power transformer was shielded, and there were three fuses in clips.

Measurements

The first tests run on the Fostex 250 were restricted to the mixer section. The input impedances at 1 kHz and lower were 68 kilohms for the mike/line inputs, 22 kilohms for "Rec In" and 20 kilohms for "Aux In." There were lower figures with increasing frequency, but all results were satisfactorily high even at 20 kHz. With the same signal (1 kHz) fed to all channels, all meters were within a dB with all slide faders at the nominal 7.5 setting. The sensitivities for this condition were 1.0 mV for mike and 0.3 V for line. The minimum input level for zero indication was 0.48 mV, and the input overload point was 4.0 V.

With the same signal to all "Rec In" jacks, meter indications matched within 0.4 dB, with zero obtained at 0.3 V. The maximum input level was 1.45 V in record mode. This was less than the specified 2.5 V, but the level was equivalent to +15 dB on the meters. There was also a close match between channels with "Aux In," with zero indications at 0.28 V input. The maximum input level was 5.5 V with the "RCV" pot at maximum, but greater than 20 V with the pot turned down. The line, "Aux Send," "Mon Mix," and direct outputs all had maximum output levels of 5.0 to 6.0 V, with clipping at a level equivalent to +25 on the meters. The maximum level at "Tape Out" was about 1.3 V, equivalent to +13.5 dB on the meter. All output impedances were satisfactorily low for all purposes: 482 ohms for line and "Mon Mix" outputs, and 94 ohms for direct and tape outputs, with "Aux Send" even lower than that. The headphone output was 300 mW (1.7 V) with an 8-ohm load, which could be set for any level.

The peak of the 4-kHz filter was at 4.2 kHz, plenty close enough to the nominal specification. The maximum boosts were consistent from channel to channel with an average of +13.5 dB. There was a little more variation from channel to channel and less control in cut with an average of -10.9 dB, still sufficient for normal purposes. The 300-Hz shelving

Sending the 250 back to Fostex will be tough; too many hands to pry loose before I can pack it up.

filter was checked for effect at 200 Hz. At that frequency, the average boost was +10.7 dB and the average cut was -9.2 dB. The effect of EQ adjustments was apparent with relatively small rotations of the knobs, so precise zero setting was required for frequency response tests. The response from line in to line out was within 1 dB from 19 Hz to 42.5 kHz, with the -3 dB points at 5.6 Hz and 74.9 kHz. The meter responses were 3 dB down at 25 Hz and 84.9 kHz, actually higher than need be.

The harmonic distortion at nominal level was 0.023% or less from 100 Hz to over 20 kHz, rising to about 0.08% at 20 Hz. There was no increase in distortion with increasing level until the approach of clipping. The signal-to-noise ratios were 66 dBA with one mike in and 84 dBA with one line in. The crosstalk from one channel to any other channel was -73 dB at 1 kHz, quite good and really necessary for best use of the unit. The meters showed a slightly faster response than standard VU meters, reaching zero with a 220-mS burst, overshooting about a dB with the 300-mS burst. The CW threshold of the peak indicators was +6.5 dB re meter zero on the average. They required a burst of 55 mS for a slight flicker, 75 mS for a bright turn-on. The meter scale calibrations were very close, particularly from -10 to zero.

Next, I focused on the recorder section. Meter indications with playback of a Dolby-level tape were about +2 dB, but there were no marks on the meters to show Dolby reference level. Play speed was about 1.5% fast, on the high side. Checks of record/playback responses with a pink-noise source and an RTA display showed that a number of premium Type II tapes gave basically good results.

TDK SA-X was selected for the detailed tests to follow. The EQ pots were set for zero indication, and swept-frequency responses were made at Dolby level and 20 dB below that, both with and without Dolby C NR. Figure 2 shows the somewhat disappointing results with a droop around 100 Hz and an undesirable boost around 5 kHz. A careful check of the responses of all channels showed that the area of discrepancies corresponded to the frequency ranges of the EQ filters. Slight mechanical offsets secured much flatter responses as shown in Fig. 3. The -3 dB points were at 18 Hz on the low end and very close to 16 kHz at the high end, in all cases. The responses were very flat between 80 Hz and 13 kHz, with the exception of a slight boost with Dolby NR; the head bumps are rather obvious, with the dip around 60 Hz and the boost at 30 Hz.

The phase jitter in the playback of a 10-kHz tone was only 10°, a very good figure. Separation between tracks with a 1-kHz test tone was at least 65 dB in all cases, a good figure and an important characteristic for this equipment. Erasure of a 1-kHz signal was greater than 80 dB, excellent performance. The third-harmonic distortion was measured over a range of levels with a 315-Hz signal and using Dolby C NR. At Dolby level (+2.5 VU), the distortion was just 0.4%. The 3% distortion limit was reached 6.8 dB above that (+9.3 VU), and HDL₃ was down to 0.04% at -8 dB (-5.5 VU). At this same signal level, HDL₃ was 0.1% at 100 Hz and less than 0.03% at 4 kHz—excellent performance. With reference to the 3% limit, the signal-to-noise ratio was 74.8 dBA with Dolby C, 60.8 dBA without NR.

The pitch control had a range of -13.8% to +12.8%, over a full tone. Flutter was very low: ±0.045% wtd. peak and 0.038% wtd. rms. The average wind time for a C-60 was 68 seconds. Changing of modes, such as reversing wind direction, usually took less than a second. Punch-in/punch-out recording was checked using a simple contact closure, and recording always started on any tracks that had the necessary record presets.

Use and Listening Tests

The 30-page owner's manual has very good text and illustrations covering setup and operation for several different configurations. Although the unit is quite complex, its use is explained clearly in most instances. A section on interface details is generally helpful, but there is some fuzzy writing. A good block diagram is helpful to users who want to know how internal connections are made.

In general, all of the controls and switches were reliable throughout the testing. There were two exceptions: The channel 2 slide fader was sometimes noisy at the start but quieted with use, and the channel 4 "Mon Mix" pot required a push toward 7 o'clock to ensure its working.

All of the other pots worked very well, and the colored caps speeded familiarization. The range of adjustments matched very well with all of the sources tried. Most of the time it was possible to keep the sliders near their indicated nominal positions by means of the trimmers. The spring-loaded lever switches had good snap action, and the tape transport switches gave a similar sense of contact. The track record presets and their flashing indicators were continually helpful, as was the zero return function. The meters with the peak indicators provided good guidance in setting record levels. Dolby C NR was used for all in-use tests, so it wasn't inconvenient to have the on/off switch on the bottom.

Using the log sheet form in the manual, I planned an in-house recording session. The first step was to lay down a piano track (4) of several favorite hymns. With the piano playback on her headphones, my wife sang the soprano parts. Then, with a set of headphones for each of us, we listened to the piano/soprano playback and put the alto and tenor parts on track 2. Finally, I put the bass on track 1 to finish the master tape. For the mixdown, I panned the bass (1) to the left, the soprano (3) to the right and centered the alto/tenor (2) and the piano (4). There was some trial and error, of course, but we had a lot of fun and have tapes that astound our friends.

The Fostex recorder-mixer can do the above and much more for the musician or band soundman and will reward imagination and inventiveness. The 3¾ ips speed is non-standard, and cassettes last only half as long, but these are not serious limitations, and the high-frequency headroom is very good. A few weeks after this writing, I'll be working on sound for a production of "Hair." The sound reinforcement will be mono, but I'm thinking about how to feed the 250. Bruce Clapper, the soundman who will do the mix, has stated that it "looks great" for use with his regular band, Shenandoah, which normally plays with Arlo Guthrie. Sending the 250 back will be difficult as there will be a number of hands to pry loose.

Howard A. Roberson

Enter No. 90 on Reader Service Card

2

BLACK ACOUSTICS NIGHT SPEAKER

Manufacturer's Specifications

Impedance: 6 ohms nominal, 4.5 ohms minimum.

Drivers: Two 6½-in. (165-mm) mid/bass and 1-in. (25-mm) soft dome tweeter.

Frequency Response: 41 Hz to 19.5 kHz, ±3 dB.

Crossover: 25 kHz, variable slope.

Sensitivity: 87 dB at 1 watt/1 meter.

Dimensions: 40 in. (101.2 cm) H × 10 in. (25.3 cm) W × 8 in. (20.2 cm) D.

Weight: 35 lbs. (15.9 kg).

Finish: Optional; six tops and 15 colors of grille cloth.

Price: \$750.00 per pair; optional stands, \$60.00 per pair.



The Night is a floor-standing loudspeaker system manufactured by Black Acoustics in Costa Mesa, Cal. Standing slightly over a meter in height, this attractive tower contains two 6½-inch (165-mm) mid/bass drivers and a one-inch (25-mm) soft dome tweeter.

The low-frequency enclosure is described by Black Acoustics as a "quasi-transmission ducted vent" consisting of dual ducts for both upper and lower bass chambers. And although identical 165-mm drivers are used, they are treated with different thermoplastics which serve to dampen the mid frequencies on the lower driver while the top driver has extended highs. Both mid/bass drivers are treated with magnetic damping fluid to increase power handling capability.

An unusual aspect of the enclosure design is the use of a tight fitting, doubleknit polyester grille which covers all four sides and is called, what else, Blacksox. The Blacksox can be removed and washed if necessary, and 15 different color fabrics are available should a change be desired. The speakers, as originally delivered, did not include the stabilizing platforms, though I did subsequently receive them, and they are now listed as an optional item. These platforms are important because the unassisted Night column speaker is definitely unstable and, if placed on a thickly carpeted floor, can easily be tipped over.

The physical aspects of the enclosure are simplicity itself. A recessed rear panel houses a protective fuse and banana plug terminals for electrical connections. Double banana plugs are provided, and an excellently detailed owner's manual explains not only the proper manner of electrical connection but virtually all aspects of proper care and use of the loudspeaker system. I only wish that most loudspeaker manufacturers would supply an owner's manual that is as complete and helpful as this one. Warranty is seven years in length and is the limited type.

Measurements

The terminal impedance for the Night loudspeaker is plotted in Fig. 1; its complex impedance is plotted in Fig. 2. On average, the impedance of the Night is moderately low, dropping below 5 ohms at 20 Hz, 200 Hz and 8 kHz. The substantial excursion in upper register impedance, from 17 ohms at 2.2 kHz to 4.6 ohms at 8 kHz, dictates the use of low-impedance hookup wire in order to minimize changes in frequency response due to line loss. A worst-case amplifier load occurs at 5 kHz with a 38° capacitive reactance angle and impedance of 6 ohms. High-quality power amplifiers should be used with this speaker.

The one-meter axial anechoic frequency response is plotted in Figs. 3 and 4. Response extends uniformly from a low bass cutoff of 60 Hz to a midband driver transition at around 1 kHz. Variations in axial response above 1 kHz are due to small arrival time differences between midrange and tweeter drivers. Relative sonic efficiency is quite high, and a drive level of 8 volts peak-to-peak, which would produce 1 average watt into 8 ohms, results in an average sound pressure level near 90 dB.

The phase response, Fig. 4, is corrected for an air-path time delay of 3.2480 mS. This shows that midrange sound arrives slightly before the sound from the tweeter, and

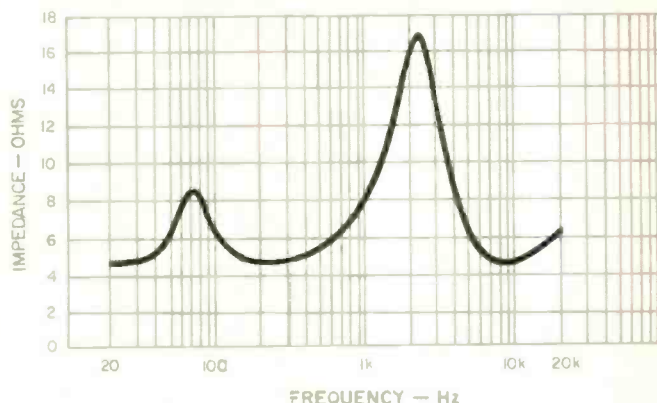

Fig. 1—Magnitude of terminal impedance.

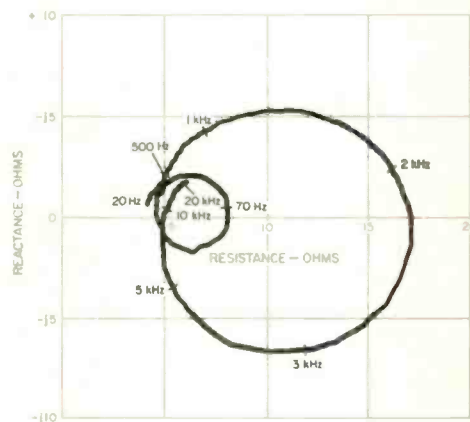

Fig. 2—Complex impedance plot.

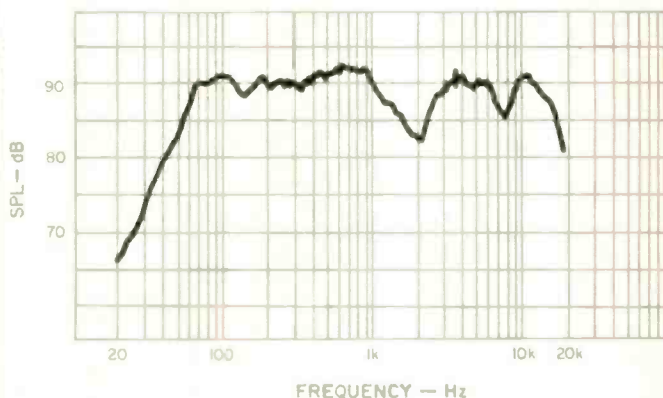

Fig. 3—One-meter anechoic axial sound pressure amplitude response with constant

voltage drive corresponding to 1 average watt into 8 ohms.

Black Acoustics Night produces a good stereo illusion, with no instrumental wandering.

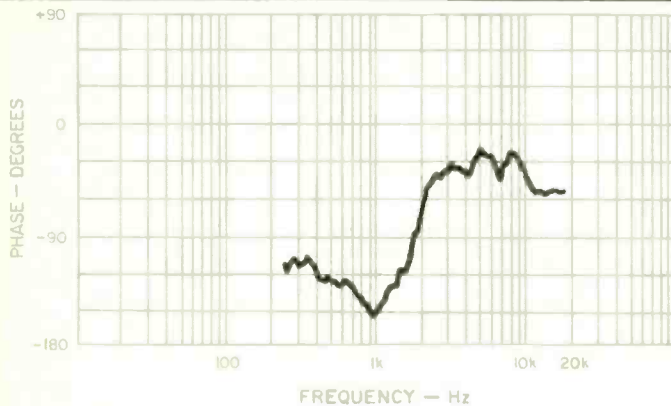

Fig. 4—One-meter anechoic phase response corrected for air-path delay of 3.2480 mS.

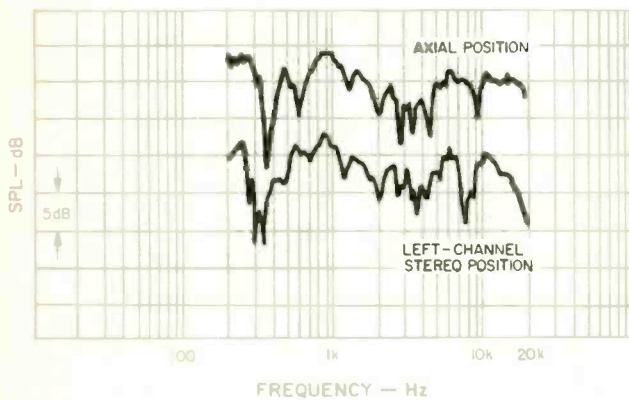

Fig. 5—Three-meter room response.

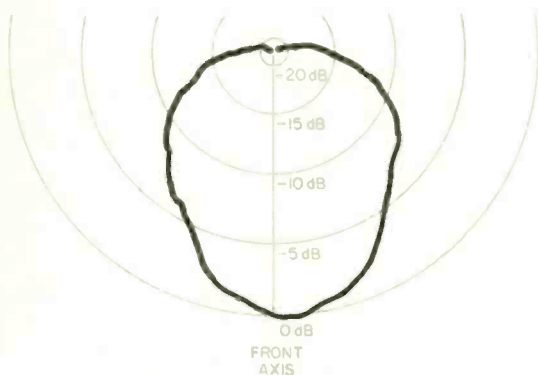

Fig. 6—Horizontal polar energy response.

accounts for the phase shift pattern from 1 to 3 kHz. Polarity convention for this measurement caused the speaker's white terminal to be considered positive.

The three-meter room response is more indicative of perceived timbral balance in a typical listening environment. The three-meter response, Fig. 5, is shown for two cases, one in which the listener is seated directly in front of the speaker, and the other in which the speaker occupies a conventional left-channel-stereo location relative to the listener. The Night speaker was positioned 50 centimeters in front of a wall for this measurement and the response includes only the first 11 mS of direct and early reflected sound. This measurement indicates that room response is slightly colored by early reflections from the floor and ceiling. While overall spectral balance is maintained, this measured data implies a timbre change with movement from one listening position to another.

Horizontal polar energy response is shown in Fig. 6, while the vertical response is plotted in Fig. 7. There is some overall horizontal confinement of sound, and best balance should be obtained when listening within 15° of the frontal axis position. I recommend rotating the Night loudspeaker toward the listening position for best balance of sound. The vertical dispersion is sufficiently large to indicate that the Night should be positioned away from projecting shelves and similar objects which could reflect early sound back toward the listening area. On average, the polar response shows that this speaker can maintain a respectable balanced stereo illusion with good lateralization.

Harmonic distortion for tones of E_1 , A_2 , and A_4 is shown in Fig. 8. The midbass and upper registers are respectably clean up to drive powers of 100 average watts. During this test I also searched for the upper register harshness which was noticed in the earlier listening tests. Examination by means of a Fast Fourier Transform (FFT) analyzer on tones up to 10 kHz failed to disclose any apparent acoustic problem or to account for the harshness which I had heard. The bass response, however, shows distress at drive levels above 10 average watts, and the Night should not be driven to such robust levels on low bass (41 Hz) material.

IM distortion on 440 Hz (A_4) due to 41 Hz (E_1), when both are mixed in equal portion, is plotted in Fig. 9. Even though the acoustic harmonic distortion is high for a pure tone at 41 Hz, the intermodulation is moderately low due to this same tone. At 10 average watts the IM is only 2.02% and is composed of 6° peak-to-peak phase modulation and 3% peak-to-peak amplitude modulation. At 40 average watts the 440-Hz tone is still modulated only 6° peak-to-peak, while the amplitude modulation component has risen to approximately 10% peak-to-peak. This indicates that while deep bass may become overloaded if driven at high level with single tones, the upper register will remain relatively free of crossmodulation mud.

Acoustic transfer linearity was measured at frequencies corresponding to the musical tones E_1 , A_2 and A_4 . In this test, a change is made in voltage drive level and the corresponding change in acoustic output is observed. Each decibel increase in voltage should produce a corresponding decibel increase in sound pressure level. If it does not, then a distortion has occurred. At 440 Hz (A_4), the Night

Impulse response for the Night indicates a respectable response for sharp transients.

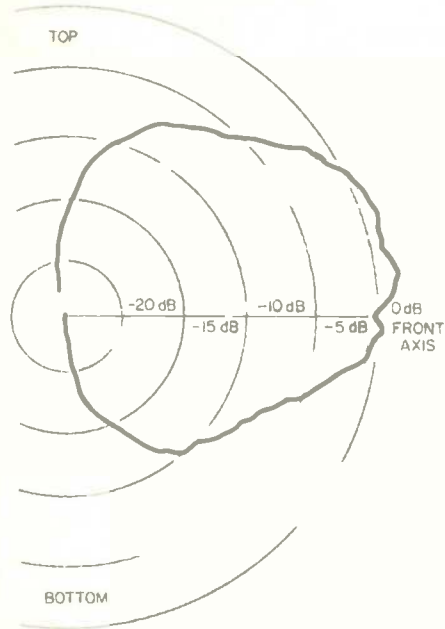
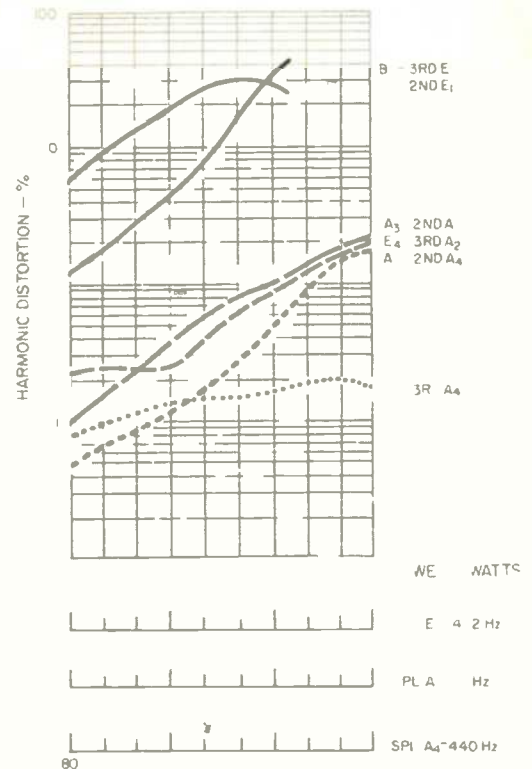

Fig. 7—Vertical polar energy response.

Fig. 8—Harmonic distortion for the tones E_1 (41.2 Hz), A_2 (110 Hz) and A_4 (440 Hz).



sound pressure level follows within 0.1 dB of perfection up to 10 average watts, then drops slightly to produce a sound, at 100 average watts, which is only 0.5 dB below its proper level. At 110 Hz (A_2), each decibel increase in drive voltage produces a 0.99 dB increase in sound pressure above 0.5 average watt. At 41.2 Hz (E_1), each dB added in drive level produces a 1.05 dB increase in sound pressure above 0.1 average watt; this trend continues to 8 watts, then the gain rapidly drops above this power level. As a result, a musical chord composed of these tones and which is perceived with a particular timbre at 0.1 average watt will change timbre as the sound intensity increases. For example, at a sound level which should be 20 dB higher, the tone of A_4 will be at the correct level, the tone of A_2 will be down 0.5 dB, and the tone of E_1 will be up almost a full dB.

The crescendo test measures the amount by which a weaker inner musical voice is modified by the presence of much stronger, but unrelated, musical signals. Tones of A_4 and Middle C were checked with and without wideband noise which was added at average levels 20 dB above those of the pure tones. The Night fares reasonably well in the crescendo test; Middle C is uniformly reduced by 0.2 dB up to peak levels of 300 watts combined tone plus noise, while A_4 is reduced less than 0.1 dB.

These two measurements, the acoustic transfer linearity and crescendo tests, infer that wideband orchestral music will undergo noticeable timbre drifts with changes in drive intensity, but little or no stereo image wander should exist

within the orchestra illusion for corresponding dynamic changes.

The energy-time curve for the Night is plotted in Fig. 10. The first sound from the midrange arrives at 3.10 ms, while the first sound from the tweeter arrives at 3.2 ms for a one-meter axial listening location. Subsidiary peaks at 3.33 ms and 3.45 ms are due to internal tweeter reflections. The energy cluster from 3.6 to 4.2 ms is due to later midrange and woofer arrivals. On average, the Night's impulse response is well confined and indicates a respectable response for sharp transients.

Use and Listening Tests

For auditioning, the Night loudspeakers were positioned as suggested in the owner's manual. A space of 50 centimeters was allowed between the rear of the enclosures and a back wall, and the speakers were rotated inward to align the frontal axis with the listening position.

The general impression is that the midbass response is slightly dominant, although the extreme low bass is a bit weak. There is a mild spectral dominance around Middle C with a gradual roll-off of the extreme top end above about 15 kHz. To my ears I found that the best spectral balance was obtained with a mild drop in bass equalization, amounting to about 2 dB at 50 Hz, with a gradual increase in high-frequency response by an amount corresponding to 3 dB at 10 kHz. This equalization improved the accuracy of both vocal and instrumental material. On average, the ability of

The Night speakers can be recommended for higher quality sound reproduction at a reasonable price.

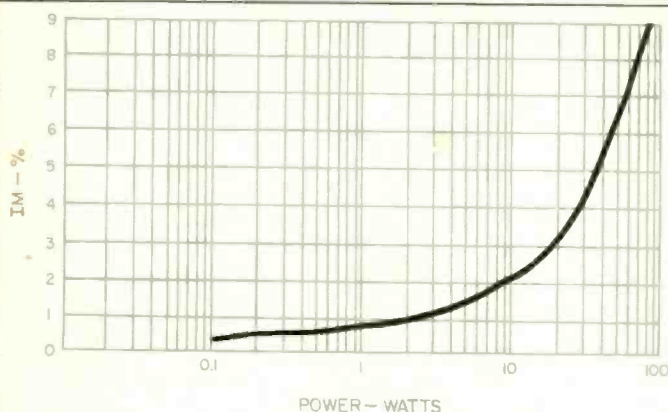

Fig. 9—Intermodulation distortion of A₄ (440 Hz) by E₁ (41.2 Hz) mixed one to one.

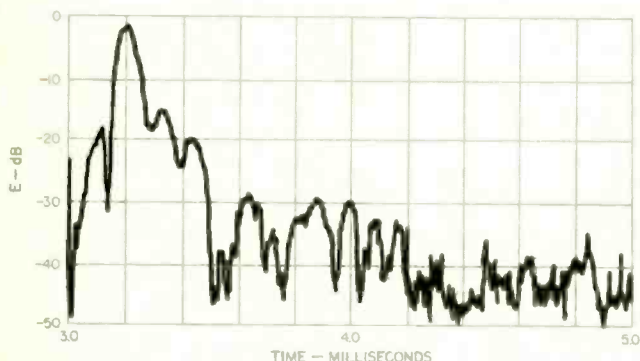

Fig. 10—Energy-time response.

the Night to go down to the lowest frequencies is outstripped by its capacity to go up to the highest frequencies in contemporary program material. In my opinion, the addition of a good quality subwoofer would improve sonic balance if accuracy of low bass fundamentals is desired.

This system can produce robust sound levels without audible breakup. On program peaks, I did sense a "blasty" or bright harshness in the upper midrange from 1 to 5 kHz when the system is driven hard, and there is a somewhat unclear definition of the inner musical voices in the mid-range from 500 Hz to 1 kHz when reproducing at high sound levels.

Piano and female vocal are two of the most difficult types of program material to reproduce with acceptable accuracy. The Nights produced a piano sound that was well balanced, and female vocals were handled with a punchy quality often associated with some of the more popular recording studio monitor speakers. There is a decidedly vertical concentration of high-frequency sound so that the overall timbre of percussive program material was modified when a listener stood rather than sat.

Stereo lateralization is good and there is no instrumental wandering in the stereo illusion. Stereo depth is a somewhat more elusive quality than lateralization, and I was not so well satisfied with the Night's illusion of depth.

The Black Acoustics Night speakers are not physically obtrusive and can fit in well with almost any room decor, especially so if the different colored Blacksox are considered. They can be recommended for higher quality of sound reproduction in a moderately large listening space at a reasonable price.

Richard C. Heyser

Enter No. 91 on Reader Service Card



The Night stands tall with the often difficult to reproduce piano sounds.

...and then came the SE-9.

35 years ago, to satisfy listening preferences, serious music lovers had to redesign their listening rooms. Remove the drapes. Add a rug here. Rearrange the upholstered sofa there. Get rid of that crystal chandelier!

Bass and treble tone controls came later, and they helped—but only a little. When you needed a boost in that lowest bass region, you had to accept boosted upper bass and mid-range tones as well—whether you needed them or not.

By 1958, the first equalizers appeared. They allowed you to alter specific bands of tones to suit the needs of the listening room—and the music program. With special mics, a pink noise generator, and a real-time

analyzer, you could electronically adjust your system to your listening preference. If—that is—you didn't mind spending several thousand dollars and a half hour adjusting and readjusting controls to enjoy a half hour of listening.

Then came Sansui's remarkable SE-9 Compu-Equalizer. It takes the guesswork and the frustration out of equalization. At the touch of a button, the SE-9's built-in pink noise generator feeds its signals first to one speaker, then the other. Sounds picked up by the SE-9's calibrated microphone are then analyzed by its microprocessor. Sit back and watch in amazement, as the SE-9's motorized system moves each of its

16 fader controls (8 per channel) to create the curve that yields precisely flat response at your preferred listening location.

Touch another button, and the curve is memorized for future, instant recall. Move to another location—even another room—and the SE-9 can create and store a new curve—up to four of them.

At last, after 35 years, a perfect equalization system without errors or frustration. And, at a price that makes perfect equalization affordable for all serious music lovers.

See the SE-9 and Sansui's truly complete line of high quality components and systems at your Sansui dealer today. Or write to us for details.



SANSUI ELECTRONICS CORPORATION
Lyndhurst, New Jersey 07071, Gardena, CA 90248
Sansui Electric Co., Ltd., Tokyo, Japan

Sansui

Enter No. 12 on Reader Service Card

3

**PIONEER
PL-7
TURNTABLE**

Manufacturer's Specifications

Speeds: 33 $\frac{1}{3}$ and 45 rpm.

Motor: Direct-drive, Hall type, PLL quartz controlled.

Platter: Aluminum alloy, diecast.

Wow & Flutter: Less than 0.035% (DIN), 0.025% wtd. rms.

Rumble: Better than 78 dB (DIN B).

Tonearm: Static-balance type, 8.7 in. (221 mm) long.

Overhang: 0.61 in. (15.5 mm).

Facilities: Repeat, record-size selection.

Dimensions: 16 $\frac{1}{2}$ in. (41.65 cm) W x 14 $\frac{1}{2}$ in. (36.69 cm) D x 4 $\frac{1}{4}$ in. (10.75 cm) H.

Price: \$200.00.



Although we live in an age of inflation with the prices of homes, cars, medical services, food and clothing on a seemingly endless, upward spiral, the costs of many electronic products actually have decreased. The first transistors cost several dollars apiece and I well remember paying \$20 for small, ordinary devices. But now, microcircuits containing the equivalent of several thousand transistors can be bought for only a few cents! Indeed, radio and television sets are less expensive than they were 10 years ago.

Another example bucking the tidal price wave is the modern turntable with its precision, quartz-controlled drive system. Pioneer's new PL-7 sells for about \$200 and yet it works better than many models costing twice as much only five years ago.

The PL-7 is fully automatic with a better-than-average tonearm, considering the price, made from polymer graphite. This sturdy tonearm is of a straight, tubular design, measuring 8.35 inches from pivot to stylus and is finished entirely in black. Etched into the rather elaborate base for the tonearm are the words, "Low-mass, high-tracking-ability tonearm." The anti-skating dial, calibrated from 1 to 3 grams, is to the right of the pivot. Located immediately in front of the clearly legible dials is a cue lever. Installed behind the tonearm rest is a small, red indicator light which is activated when the motor starts.

With the exception of the aforementioned cue lever, the remainder of the controls are all at the front of the base where they are easily accessible even with the dust cover closed. At the extreme left lies the two-position speed switch for 33 $\frac{1}{3}$ or 45 rpm discs. Roughly in the middle of the controls is a quartz-lock indicator light. To the right of the light is a record-size switch for 7- or 12-inch discs. The next control is for repeat, and at the extreme right is the start and stop switch. These controls are all in the form of polished metal bars, clearly labeled, and the entire panel is slightly angled for convenience.

The diecast platter is neatly recessed into the base. Only 2 $\frac{1}{2}$ inches high, the molded base is handsomely finished in champagne gold. The styling of the black tonearm and its base, along with the sleek lines of the rest of the unit, creates an attractive, low profile.

A Hall-effect drive motor is used in a conventional PLL quartz-controlled circuit. Both motor and arm are isolated from the top panel by springs. The four flexible mounting feet also help to inhibit acoustic feedback.

Measurements

For test purposes, an ADC Astrion phono cartridge was mounted on the low-mass shell. A considerable plus was that it locked tightly to the arm by means of a screw. Tracking force and anti-skating bias were both set to 1.6 grams, a combination which seemed optimum for this particular cartridge. The tracking force calibration accuracy was within 5% down to 1.5 grams, while the anti-skating dial provided good matching. Using a Cart-A-Lign protractor, the tracking error was reduced to +1.5°, -2.0°. Both vertical and lateral arm bearing friction were insignificant, and there was no noticeable looseness or "play."

Arm resonance occurred at 8.5 Hz with a rise of 4.0 dB. Wow and flutter measured 0.03% (DIN 45-507), while rum-

ble was 62 dB, using the ARRL standard. These last results are both excellent.

I had just received the Thorens rumble test unit, which rejoices in the name "Rumpelmesskopler." This ingenious device clamps on the turntable spindle and is more accurate because the record itself is eliminated. Testing the PL-7 with it, I was not surprised to measure a figure of 68 dB, or 6 dB better than the figure obtained using the test record.

The automatic arm return appeared to be faster than usual, requiring less than four seconds from the run-off groove to the rest position. As the arm moves from its rest, the indicator at the base lights up and the motor starts. The quartz control LED on the front panel lights up after the platter has turned half a revolution.

Use and Listening Tests

The unit struck me as less prone than most to problems of acoustic feedback, and its general performance makes this Pioneer turntable an excellent value for the money. The only fault I find is the position of the cue lever; it is not accessible with the dust cover closed. However, it must be said that the only way to avoid this problem would be a complicated linkage system or separate control motor, necessitating a price increase of \$50 or more.

George W. Tillett

Enter No. 92 on Reader Service Card



the perfect combination...

The musical accuracy of Bryston components is a revelation. Every note emerges with perfect clarity from a background of silence, then vanishes. The progression of musical events seems real, tangible, almost visual in its presentation...

Bryston believes there is a need for reference standards of musical accuracy. That is why we designed our Models 2B, 3B and 4B power amplifiers, and our Model 1B preamplifier. Their only reason for existing is to provide the most faithful electronic rendition of a musical signal possible within the bounds of available technology. Write to us and we'll tell you how we do it, and where you can listen to our perfect combination.

IN THE UNITED STATES:

BRYSTON VERMONT
RFD#4, Berlin, Montpelier, Vermont 05602
(802) 223-6159

IN CANADA:

BRYSTON MARKETING LTD
57 Westmore Dr., Rexdale Ont., Canada M9V 3Y6
(416) 746-0300

Enter No. 3 on Reader Service Card

4

MAGNUM 95FM SLEUTH FM ANTENNA AMPLIFIER

Manufacturer's Specifications

Number of Tuned Circuits: Three (LC).

Tuning Range: 87.5 to 108.5 MHz.

R.f. Gain: 30 dB.

Noise Figure: 4.0 dB maximum.

Bandwidth: 600 kHz.

Variable Gain Control Range: -10 to +30 dB.

Input/Output Impedance: 300 ohms.

Power Requirements: 120 V, 50/60 Hz, 10 watts max.

Dimensions: 8¼ in. (20.96 cm) W × 3¼ in. (9.53 cm) H × 7½ in. (19.05 cm) D.

Weight: 4 lbs. (1.8 kg).

Price: \$159.95.

Magnum Electronics, Inc. is a company located in Toronto, Ontario, which has been specializing in the manufacture of r.f. amplifiers such as the 95FM Sleuth since 1976. This amplifier or "booster" is distributed by the same firms who handle the GAM Stereo One FM antenna. The 95FM Sleuth can be used with any FM antenna, however, with the choice of antenna type and gain dependent upon location, terrain and the other factors which normally determine the type of antenna to be used with FM sets.

The circuitry of the 95FM amplifier is contained in a steel chassis and housing. The front is augmented with a sol-



id aluminum panel having only two controls. A tuning control at the center of the panel is calibrated in approximate 1-MHz steps, from 88 to 108 MHz. A smaller rotary knob, at the right lower corner of the instrument, serves the dual purpose of turning the amplifier on and off and of varying its r.f. gain. The rear panel of the 95FM is equipped with 300-ohm input and output terminal pairs. The terminals used are of the "push to insert wire ends" type, which I found to be a bit inappropriate, since many supplied dipole antennas come equipped with spade-lug terminals that are meant to fit under the heads of screw terminals. A lug can be fitted into the terminal or, better, the leads stripped by hand in order to connect them properly to the type of terminal incorporated in the 95FM. There is no provision for direct connection of 75-ohm coaxial cable, so that if this type of transmission line is used it is necessary to employ a matching transformer of the type commonly used in hooking up antenna cables to video recorders, etc.

The manufacturer of this r.f. amplifier has sealed its electronics inside its en-

closure with a Robertson screw which defied my best intentions (and tools) to loosen. Therefore, all I can tell you about the circuitry is what the manufacturer tells in the owner's manual, namely that there are three stages of tuned circuitry (LC types) and that the transistors used in the amplification stage are low-noise MOS Field Effect types. Beyond that, I had to rely on my lab test results for any indication as to the effectiveness of the circuitry.

Measurements

I decided to use a standard half-wave dipole as a reference antenna for testing the Magnum 95FM Sleuth. A field strength meter was tuned to incoming signals at the low, middle and high ends of the FM dial, using identifiable station signals. Field strengths for these signals, obtained using only the dipole antenna, were recorded. Then, the Magnum 95FM amplifier was interposed between the antenna and the field-strength meter. The short length of 300-ohm twin-lead supplied with the unit was used to connect from the amplifier output terminals to the field strength input (via a 300/75-ohm trans-

Table I—Signal strength readings with and without the Magnum 95FM antenna amplifier.

| Frequency, MHz | Dipole, μV | Dipole plus 95FM, μV | |
|----------------|-----------------------|---------------------------------|--------------|
| | | Maximum Gain | Minimum Gain |
| 89.3 | 230 | 3500 | 30 |
| 97.1 | 380 | 9000 | 95 |
| 104.3 | 180 | 4000 | 55 |

5

former needed to match the input impedance of the field-strength meter). Signal strength readings were then observed for the same three incoming signals at maximum and minimum gain settings of the 95FM amplifier's gain control. Results are tabulated in Table I.

Note that the range of gain is very nearly 40 dB, exactly as claimed by the manufacturer. Of significance, too, is the fact that with the gain control set at minimum, it is possible to *attenuate* incoming signals by approximately 10 dB. This feature may prove to be just as useful as the positive gain aspects of the device, since in many situations, overload of a front-end (in close-in areas) can be just as annoying a problem as inadequate signal strength.

In FM reception, signal strength alone does not determine ultimate audio quality. Most "boosters" I have tested in the past, while amplifying the incoming signal strength (in absolute microvolts or dBf), tend to amplify noise levels as well. That was not the case with this amplifier, which boasts a very low internal noise figure of its own. My listening tests, which followed the measurements described above, indicated that much of the available gain of this device was translated usefully into a quieter, better-sounding audio program signal for my reference tuner in the lab as well as for two other tuners which were on hand when these tests were conducted.

The extra tuned circuits contained in this amplifier serve to improve the effective adjacent and alternate channel selectivity of any tuner or receiver with which it is used. While it would be difficult to determine the exact increase in alternate channel selectivity afforded by the device (among the variables here are the tuner with which the 95FM might be used), I would estimate the improvement in alternate channel selectivity as being between 10 and 15 dB—not an insignificant amount for this important specification.

If you are having problems with weak signal FM reception (and are already using a decent outdoor FM antenna) or with alternate channel interference, the Magnum 95FM amplifier might well be worth a try.

Leonard Feldman

Enter No. 93 on Reader Service Card

AUDIO-TECHNICA AT 6006a SAFETY RAISER

Price: \$19.95.

Audio-Technica offers an excellent device for lifting the tonearm from the record when the stylus reaches the lead-out groove, thus eliminating the annoying sounds of the stylus tracking the end of the disc as well as reducing unnecessary record and stylus wear. The Safety Raiser is compatible with almost all manual turntables.

The device is activated by pushing down on the lift arm, which is attached to a piston-like rod that fits into a vertical cylinder mounted on the turntable. Placing the yellow trip lever at its inside position holds the lift arm down and ready for use. When the tonearm reaches the lead-out groove on the record and touches the yellow trip lever, the lift arm is released, raising the stylus about a quarter of an inch above the record. A red dot seen on the center column indicates that the tonearm is in the raised position. To defeat the lifting action, the red lever is placed to its inside position. To avoid interference with the tonearm, the lift must be in the "down" position at all times.

The Safety Raiser must be positioned on the turntable by experimentation because of the variation in turntable and tonearm dimensions as well as the variations in lead-out groove di-

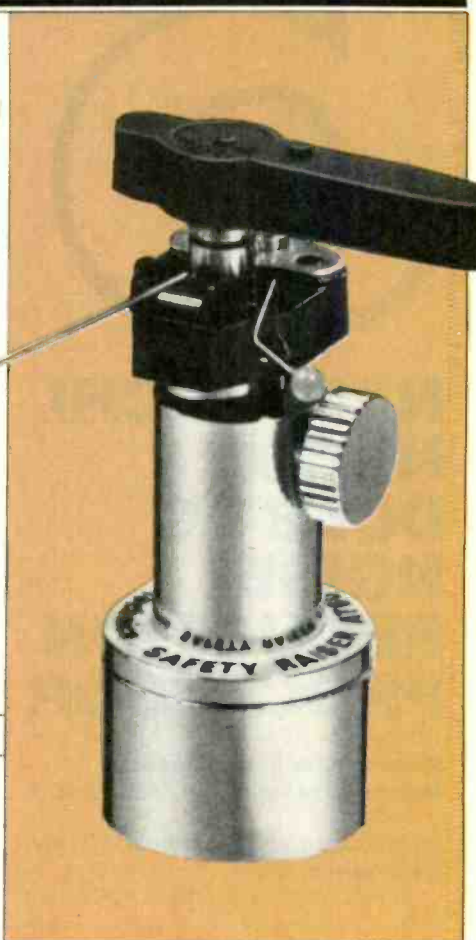

ameters on different records. Once the proper location is found, double-sided adhesive discs are used to hold the Safety Raiser firmly in place. A 7/16-inch high spacer is provided for use on those turntables whose platter height is above average. For proper operation, the device should be mounted close to the tonearm pivot for maximum lift and have its yellow and red operating levers facing forward. The overall height of the unit should be adjusted so that the lift arm is below the tonearm when it is in the "down" position and moves the stylus about a quarter inch above the record in the "up" position. The final height adjustment and minor rotational position changes can be made and secured with the thumbscrew located on the cylinder base.

Having used the Safety Raiser for some time, I find it to be most effective for its stated purpose.

B. V. Pisha

Enter No. 94 on Reader Service Card

6

NAKAMICHI NR-100 DOLBY C NOISE- REDUCTION PROCESSOR

Manufacturer's Specifications

Noise Reduction: Up to 20 dB above
1 kHz.

Input/Output Voltage Levels: 100 mV.

Dimensions: 4¾ in. (120 mm) W x 1⅝
in. (41 mm) H x 9-7/16 in. (240 mm)
D.

Weight: 1.9 lb. (0.9 kg).

Price: \$230.00.

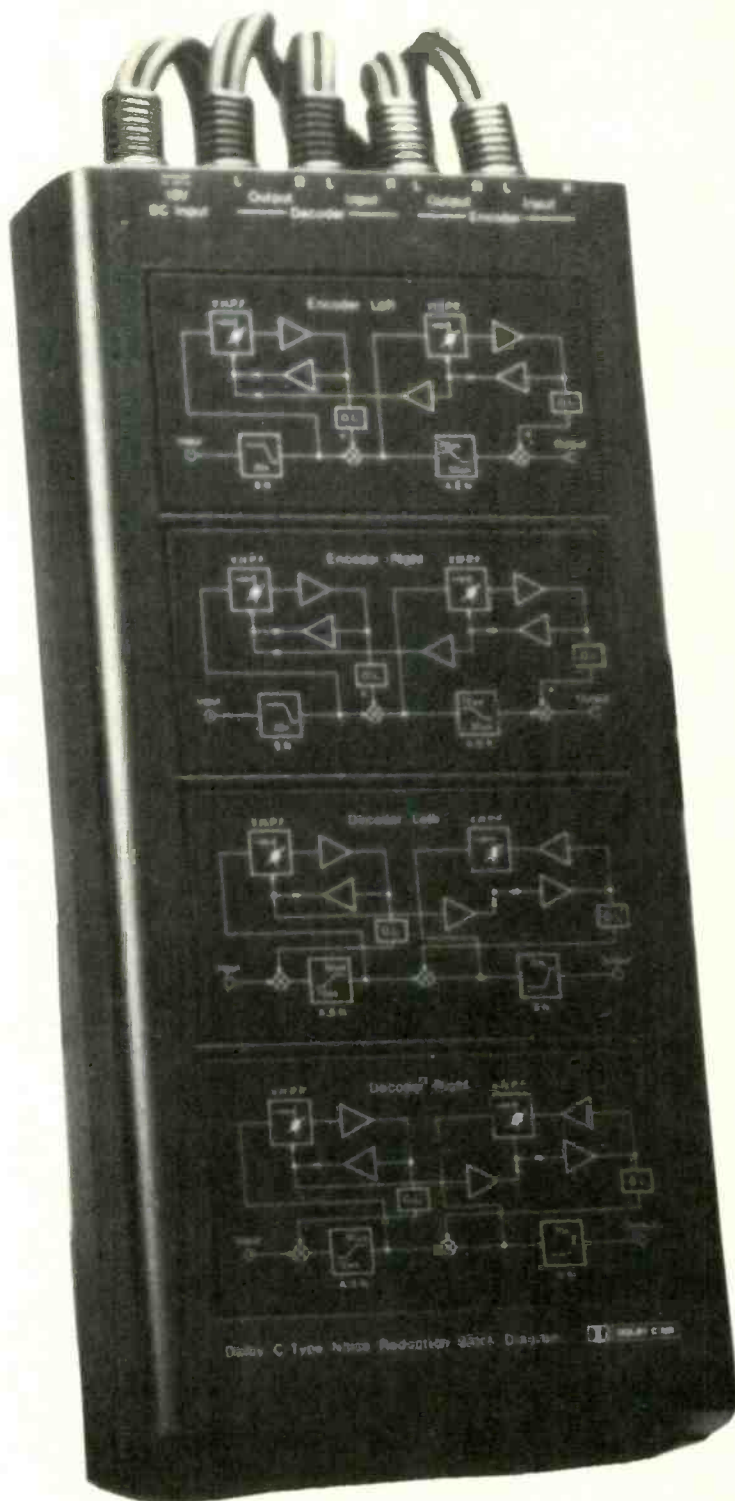

The Nakamichi NR-100 Dolby C add-on unit is intended for specific use with the Nakamichi 700ZXL or 1000ZXL decks. Both of those units have the eight input/output jacks required for connection, and front panel selection of "Ext NR" will switch the Dolby C encoder into the record path and the decoder into the playback. All tests were run with the 700ZXL deck.

The processor is a simple black box with eight high-quality signal cables, complete with excellent strain reliefs and gold-plated connectors for minimum contact noise. The power supply cable plugs into the remote-control socket on the back of the 700ZXL (or 1000ZXL), and that cable has a cable socket that can be used with the remote control. The unit has a small red "On" indicator, and there is a set of block diagrams on the top, showing some details of the circuit. With the top removed, it was immediately evident that the construction was high quality: Excellent soldering, complete parts labelling, the eight Dolby 16-pin DIPs in sockets and the inside set of strain reliefs, anchored in a metal bracket. The instructions provided include a very brief discussion of Dolby C and an interconnection diagram, actually sufficient for this unit which has no adjustments of any kind. There will be some details in this report

Table I—Record/playback responses (–3 dB limits).

| Tape Type | With Dolby C NR | | | | Without Dolby NR | | | |
|-----------------|-----------------|------|--------|------|------------------|------|--------|------|
| | Dolby Lvl | | –20 dB | | Dolby Lvl | | –20 dB | |
| | Hz | kHz | Hz | kHz | Hz | kHz | Hz | kHz |
| Nakamichi EX II | 12 | 21.2 | 12 | 25.6 | 12 | 12.4 | 12 | 25.7 |
| Nakamichi SX | 12 | 20.6 | 12 | 24.9 | 12 | 11.9 | 12 | 25.2 |
| Nakamichi ZX | 12 | 23.5 | 12 | 25.7 | 12 | 15.4 | 12 | 25.7 |

concerning Dolby C, but the reader who would like to dig further is referred to Joseph Hull's article which appeared in the May 1981 issue of *Audio*.

Measurements

A basic requirement of any encoding and decoding system is that it be linear for the final output compared to the input. The output of the encoder was connected to the input of the decoder, and a series of swept-frequency responses were made (Fig. 1). The reference voltage level was the 100 mV used for each of the processors, and it is shown as Dolby level on the figure as that is the corresponding record/playback level. The input was varied in 10 dB steps from +20 dB (1.0 V) down to –50 dB (0.32 mV). The tracking was certainly very good with less than 1.5 dB deviation, except for the frequency extremes at –50 dB. Figure 2 is a plotting of the same swept inputs, but with the output just after the encoder. The important characteristics to note are: The gentle downward slope starting just below 2 kHz at –20 dB and above for preventing tape saturation; the sharper roll-off above 10 kHz, referred to as spectral skewing, to prevent expander errors from poor cassette response above 10 kHz; the 19 dB compression re: –50 dB from 1 to 10 kHz, with any effects which extend a bit below the 100-Hz mark.

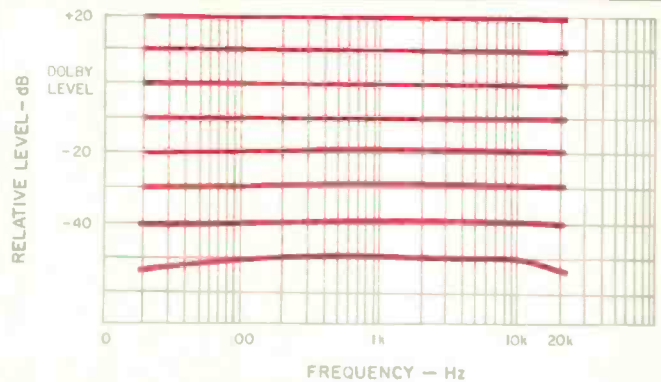

Fig. 1—Encode/decode responses over 70 dB range of input levels.

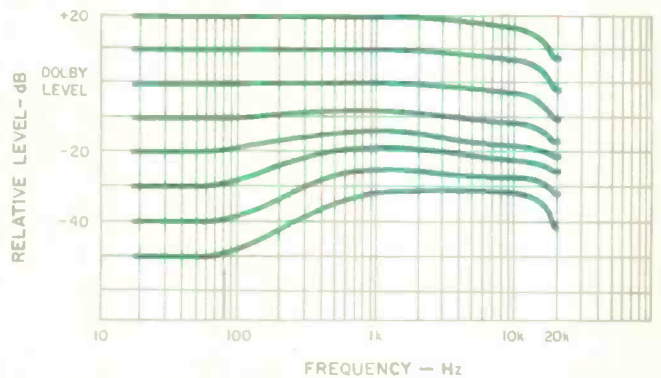

Fig. 2—Encode responses over 70 dB range of input levels.

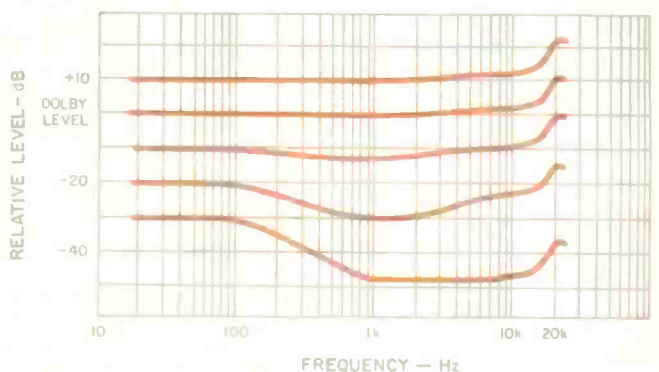

Fig. 3—Decode responses over 40 dB range of input levels.



NOW YOU CAN HAVE DIGITAL RECORDING WHERE YOU WANT IT MOST: AT HOME.

There are moments when a musician is so inspired he stops making music and starts making magic. And, as most artists agree, these peak periods of supreme inspiration don't always occur in the clinical conditions of the recording studio.

Which explains why Sony, the inventor of digital audio processing, has just created the world's smallest, lightest and most compact digital audio processor — the PCM-F1.

Already touted by every major audio magazine, the PCM-F1 leaves one awestruck by its vital statistics.* Its level of performance surpasses that of even the most sophisticated analog recording studio. Its unique 3-way power supply allows you to use it anytime, anywhere.

And because Sony consciously designed it without a built-in VCR, it can be used with any VCR — 1/2 or 3/4 inch.

But perhaps its greatest feature is its price.

Obviously, we can go on and on about the brilliance of this new machine, but by now we figure you've heard enough about it and you're ready to go to your Sony dealer and hear it for yourself.



SONY® The one and only.

*Features and Specifications: Wow and flutter — unmeasurable; dynamic range — greater than 90dB; distortion — less than 0.005%; frequency response — 10-20,000 Hz, ± 0.5 dB. Weight — 9 lbs.; height — 3 1/4"; depth — 12"; width — 8 1/2". 14- and 16-bit quantization. © 1982 Sony Corp. of America. Sony is a registered trademark of the Sony Corp.

Enter No. 16 on Reader Service Card

The responses are all excellent, particularly the increase in high-frequency headroom at Dolby level and +10 dB.

Table II—Signal/noise ratios with IEC A and CCIR/ARM weightings.

| Tape Type | IEC A Wtd. (dBA) | | | | CCIR ARM (dB) | | | |
|-----------------|------------------|-------|------------|-------|---------------|-------|------------|-------|
| | W/Dolby NR | | Without NR | | W/Dolby NR | | Without NR | |
| | @ DL | HD=3% | @ DL | HD=3% | @ DL | HD=3% | @ DL | HD=3% |
| Nakamichi EX II | 64.4 | 69.5 | 49.5 | 53.8 | 65.2 | 70.3 | 46.4 | 50.7 |
| Nakamichi SX | 67.0 | 72.6 | 52.3 | 57.5 | 67.9 | 73.5 | 50.0 | 55.2 |
| Nakamichi ZX | 66.3 | 75.5 | 52.2 | 60.9 | 67.4 | 76.6 | 49.3 | 58.0 |

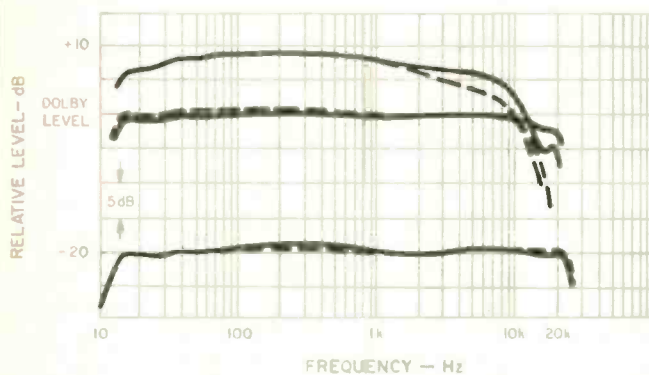

Fig. 4—Record/playback responses with and without (---) Dolby C NR using Nakamichi SX tape on Nakamichi 700ZXL cassette deck.

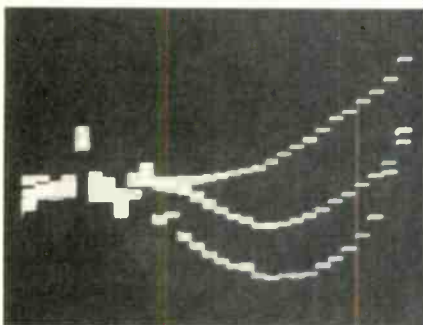

Fig. 5—Output noise spectra with Nakamichi SX tape on Nakamichi 700ZXL deck with no noise reduction (top), Dolby B NR (middle), and Dolby C NR (bottom). Vertical scale: 10 dB/div.

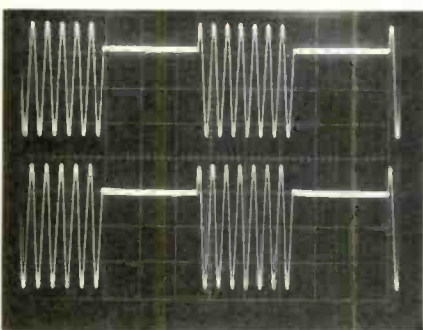

Fig. 6—Five-kHz tone burst from generator (top) and after passing through both encoder and decoder (bottom). Sweep: 0.5 mS/div.

Swept responses were then taken of the decoder with input levels from +10 to -30 dB re: Dolby level (100 mV). Because of the expansion process in the decoding, it was not possible to cover the same range of input levels. The output levels as shown range from close to -50 dB from 1 to 10 kHz to over +20 dB at 21 kHz. These curves show how the roll-off effects from anti-saturation and spectral skewing are removed in the playback decoding, and how the high noise reduction is accomplished over a good part of the range. A number of record/playback responses were run with the NR-100 and the 700ZXL deck. The results with Nakamichi SX tape are shown in Fig. 4 both with and without Dolby C at Dolby level and at -20 and at +10 dB. The responses are all excellent. Notice particularly the increase in high-frequency headroom both at Dolby level and at +10 dB. This extension is very obvious in Table I, with the -3 dB point shifted from 11.9 kHz to 20.6 kHz by using Dolby C. There were similar benefits obtained with the other tape types.

Figure 5 is a set of three 1/3-octave noise spectra from the 700ZXL deck without any noise reduction (top), with Dolby B NR (middle), and with Dolby C NR. There is no doubt about the great reduction of noise with Dolby B. Also very apparent is the additional reduction that Dolby C secures, below the other curves from about 150 Hz. (Some 60- and 180-Hz from the test interconnections caused the apparent discontinuities.) At the 16- and 20-kHz bands, the Dolby C noise levels are slightly higher than those for Dolby B, an expected effect from the spectral skewing in Dolby C.

A check of the signal-to-noise ratios with the 700ZXL and the NR-100 was made with the three Nakamichi tapes. Table II shows that with IEC A weighting, Dolby C gained over 15 dB at the 3% points for the three tapes. With CCIR/ARM weighting, the gain was at least 18 to almost 20 dB with the use of Dolby C NR. These are superlative figures for a cassette deck, and it should be kept in mind that these very low noise results go with a combination (Nakamichi 700ZXL and NR-100) that has outstanding high-frequency headroom.

To check the dynamic response of the encoder/decoder combination, the units were connected directly together as in earlier tests, and a 5-kHz tone burst was fed to the encoder input. The start phase of the burst was purposely offset, but as Fig. 6 shows the final waveform had substantially no distortion.

Use and Listening Tests

Listening tests were run using a number of dbx-encoded discs. It was interesting to find out that Dolby C matched some of these very low noise discs (when decoded). With others, however, the noise with Dolby C was higher than on the original discs. The test did require, however, that the preamp volume be set extra high and that all fluorescent lights in the lab be turned off to eliminate all ballast hum. It would appear that in most listening environments the noise from the tested combination would not be detectable. The NR-100 at \$230.00 is a Dolby C unit of excellent performance and a very worthwhile addition to the Nakamichi 700ZXL and 1000ZXL decks.

Howard A. Roberson

Enter No. 95 on Reader Service Card

7

AKG P25MD/24 CARTRIDGE

Manufacturer's Specifications

Frequency Response: 10 to 28,000 Hz.

Sensitivity: 0.75 mV at 1 cm/S.

Channel Separation at 1 kHz: 30 dB.

Channel Separation at 10 kHz: 25 dB.

Channel Balance: 1 dB.

Frequency IM Distortion at -6 dB: 0.3%.

Impedance: 900 ohms.

Inductance: 170 mH.

Recommended Load: 47 kilohms and 470 pF.

Tracking Force Range: 1.0 to 1.5 grams.

Optimum Tracking Force: 1.25 grams.

Compliance (Static): 24 mm/N.

Tracking Ability: 300 Hz, 80 μ m; 10.8 kHz, 0.6% distortion at 30 cm/S.

Effective Mass: <0.4 mg.

Diamond Mass: 0.015 mg.

Tip Radii: 5 \times 18 μ m, "Analog 6."

Weight: 3.5 grams.

Price: \$250.00.

AKG, located in Vienna, Austria, is a world-renowned manufacturer of high-class professional microphones. A few years ago, AKG entered the phono cartridge market with the introduction of a line of stereo phono cartridges using their patented transversal suspension (TS) for the stylus cantilever. The current AKG stereo phono cartridge

series includes the P25MD/24, the top-of-the-line cartridge, using an "improved" induced-magnet design and their previously used TS for the stylus cantilever. The cantilever is a rigid thin-wall tube made from an aluminum-magnesium-silicon alloy that has both low mass and low resonance. To reduce the effective tip mass, AKG uses a micro-diamond

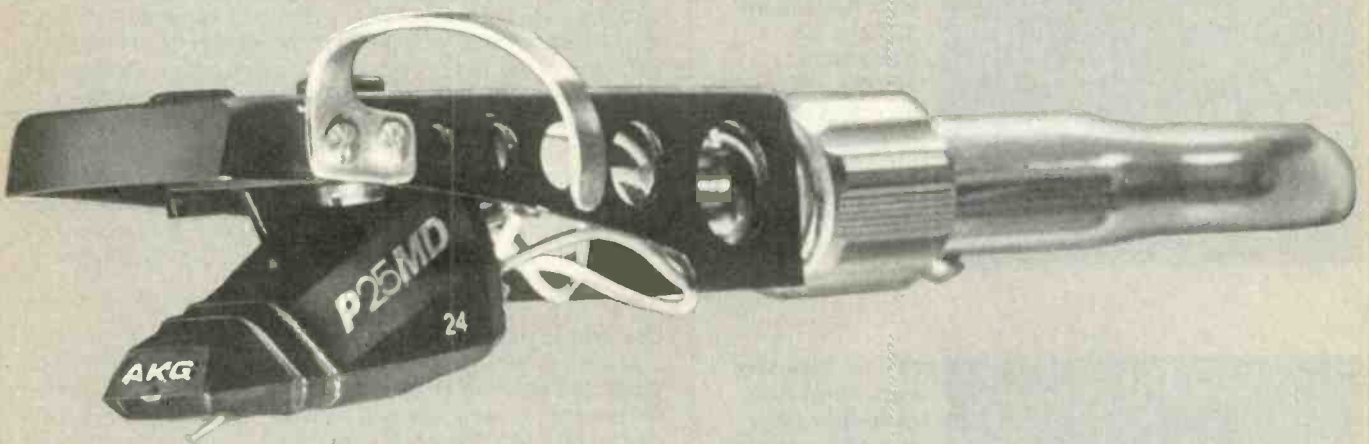

(MD) stylus with a very short shank that is nude-mounted on the cantilever. The shape of the diamond stylus, called "Analog-6," appears to be another version of the well-known extended-line-contact type. The newly developed transducer system consists of a cylindrical samarium-cobalt magnet that encloses the four nickel-iron alloy pole pieces upon which the coils are mounted, thus increasing the basic sensitivity and permitting a reduction in coil inductance. The lightweight plastic housing is claimed to be free from resonances which would impair the sound. The housing is made from electrically conductive plastic material so as to provide a path to ground, thus preventing an electrostatic charge build-up on the cartridge body. The front of the molded plastic housing has a gold-colored arrowhead-type point to indicate the stylus location for ease in cueing a record.

The AKG P25MD/24 stereo phono cartridge comes packed in handsome black vinyl case that also contains a stylus-cleaning brush, a screwdriver, the necessary mounting hardware, a wedge-shaped weight to be used with tonearms that will not balance a lightweight cartridge or as a wedge to raise the back of the cartridge (should it be too close to the record surface so as to scrape it), a flexible plastic damping compound to be inserted between the headshell and the cartridge, and a unique installation and alignment gauge. This useful gauge may be used to adjust the overhang, vertical alignment of stylus axis, azimuth, and vertical tracking angle; to secure the cartridge for both mounting in the headshell and attaching the headshell wires to the cartridge pins; to clean the stylus; to inspect the stylus for dirt with the supplied magnifying glass and, finally, as a balance to measure the stylus tracking force (1.0 to 1.5 grams). Each cartridge comes with a copy of its own frequency response and crosstalk curve. The installation manual as well as the operating instructions for the gauge are well written. I noted that some of the manufacturer's specifications in the instruction manual did not agree with those in the advertising brochure. The maker tells us that this has to do with the U.S. version, the "/24," being slightly different from the European model, the "/34," which has its specs given in the installation manual.

Measurements

The AKG P25MD/24 stereo phono cartridge was mounted in a Technics headshell, and used with the Technics EPA-100 tonearm mounted on a Technics SP-10 Mk II turntable. The cartridge was oriented in the headshell and tonearm with the Dennesen Geometric Soundtracktor. When the flat bottom at the stylus end of the cartridge touched the record surface, warped records produced a serious problem.

Laboratory tests were conducted at a temperature of 68° F, $\pm 1^\circ$ (20° C) and a relative humidity of $\pm 3\%$. The tracking force for all reports

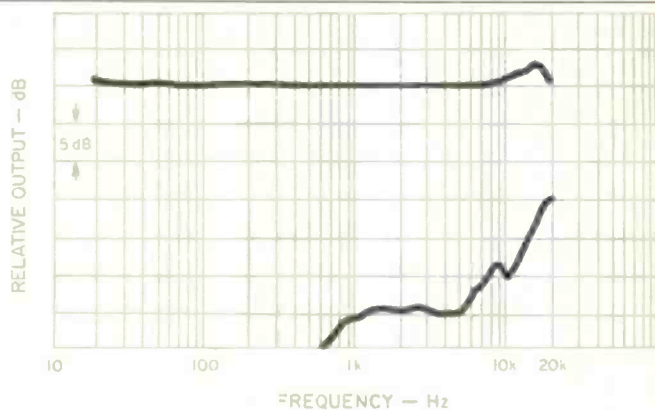

Fig. 1—Frequency response and separation, AKG P25MD/24.

ohms, and the load capacitance was 489 pF.

The following test records were used in making the reported measurements: Columbia STR-170, STR-100, STR-112; Shure TTR-103, TTR-109, TTR-110, TTR-115; Deutsches HiFi No. 2; JVC TRS-1007; Nippon Columbia XL-7004; B & K CR-2010, and the Ortofon Pickup Test Records 0001 and 0002.

I have been measuring phono cartridge frequency response and separation (crosstalk) for many years. It has never been a very satisfactory measurement since it is wholly dependent on the combination of the cartridge and the sweep-frequency record used for measuring these parameters. My usual practice is to use the Columbia STR-170 test record for this job. However, for certain cartridges the separation is worse when measured with the STR-170 than if some other test record were used, e.g., the JVC TRS-1007. Since neither the cutting lathe, cutting stylus, phono cartridge, nor the test record is perfect, many factors come into play when a test record is used to measure the frequency response and separation of a given phono cartridge. Whether the separation of the two stereo channels is 15 or 20 dB is not that important insofar as maintaining good stereo imagery is concerned. Of course, separation greater than 15 dB, e.g., 30 dB, will undoubtedly improve the stereo imagery, producing an audible difference that most people will hear. In my opinion, any audible crosstalk has an adverse effect upon the recorded sound we listen to. Accordingly, it appears to be most important that the cartridge manufacturers strive to improve separation of their product to an even

response of the AKG P25MD/24, using the test record, is -0 dB, +1 dB from 20 Hz to 100 Hz, +2.5 dB at 15 kHz, +2.9 dB at 20 kHz. Separation is 20.5 dB at 1

FOR SALE

AT LAST—IN THE ROCKFORD/MADISON AREA, David Berning amplifiers, Dayton Wright ESL's, Dennesen electronics. Used McIntosh, JBL, others. Write: Hanson Audio, 1420 Latham Place, Rockford, Illinois 61103 (815) 964-9634).

AT VIBE ACOUSTICS, WE'VE GOT A SUBWOOFER SO GREAT YOU'LL NOT ONLY LISTEN TO ITS BOTTOM END, YOU'LL KISS IT! ONLY \$450 DIRECT (NO DEALER MARKUP!). FOR INFORMATION OR APPOINTMENT, WRITE VIBE ACOUSTICS, 107 MANCHESTER DRIVE, STATEN ISLAND, NY 10312.

ALL QUAD ELS OWNERS obtain improved accuracy, definition & extended bass with proven update. \$140/pr. No risk, 30 day trial. For information send **SASE** to John Koval, Llinear Acoustics Labs, 11521 Cielo Pl., Santa Ana, CA 92705. (714) 838-6555.

Affordable "State of the Art" audio is now available for your audition in the relaxed, comfortable atmosphere of our listening room. We feature:

| | | |
|-------------------|--------|---------|
| Dynavector | Thiel | Sony |
| PS Audio | Grace | SME |
| Fidelity Research | Denon | AKG |
| Audio Linear | Onkyo | DCM |
| Audible Illusions | Grado | Epicure |
| Pyramid | Amber | Genesis |
| Rogers | Marcof | Thorens |
| Micro Acoustics | Supex | Haffler |
| Satterburg | Shure | Mayware |

free shipping anywhere in U.S.

ONE MORE STEREO STORE—408 946-0500
1231 E. Calaveras Blvd, Milpitas, CA 95035

ALL MAJOR BRAND AUDIO @ WHOLESALE. A&T AUDIO, SPRINGFIELD, MA 413-737-6227.

AMBER products are in stock at **HCM AUDIO**. (916) 343-0558. **FREE SHIPPING.**

A&S SPEAKERS has raw drivers, kits and high-end auto speaker systems. Specializing in plastic cone drivers, our brands include Audax, Dalesford, Jordan, Dynaudio, SEAS, JVC, Philips, Becker, Falcon-Acoustics, Strathearn, and Peerless. Featuring the "Bill Reed" Signature Kit and Jordan Module. Free price list. **A&S SPEAKERS**, Box 7462A, Denver, CO 80207. (303) 399-8609.

DISTRIBUTOR PRICING! Audio Research, Robert Grodinsky Research, Haffler, Electrovoice, B and W, Meridian, Vandersteen, Onkyo, Technics, Snell, 3D Acoustics, and more... For information: P. K. Audio, 4773 Convention Street, Baton Rouge, LA 70806 or (504) 924-1001.

ATTENTION NY—NJ!!

| | | |
|----------------------|-----------------------|------------------|
| •ACOUSTAT | •DCM | •MUSIC REFERENCE |
| •ACOUSTICELECTRONICS | •DENON | •NAD |
| •AUDIO RESEARCH | •FUTTERMAN | •ORACLE |
| •B&O | •HAFLER | •PETERSON |
| •BOSTONACOUSTICS | •WINMC-10 | •RGR |
| •B&W | •KENWOOD AUDIO PURIST | •SNELL |
| •CARVER | •LINN PRODUCTS | •SUMO |
| •C.J. WALKER | •MONSTER | |

•DAHLQUIST and more only at



The Audio Professionals since 1972. Only knowledge and experience equal superior sound and service. Discover high performance stereo with complete customer satisfaction. For orders and information (serious inquiries by phone only)

201-744-0600

VISA, Master Charge Accepted

CSA AUDIO

193 Bellevue Avenue

Upper Montclair, NJ 07043

Sound system consultations to home music lovers, professional theatrical arts and the audio industry

FOR SALE

ATTENTION OWNERS OF RACK MOUNT EQUIPMENT
Beautiful walnut oak cabinets designed to fit all 19" EIA rack mount components. Send for free details. Wood Tailoring Box 11314, Portland, Oregon 97211.

ATTENTION ALL DYNACO AND DYNA KIT OWNERS:

Frank Van Alstine can rebuild and/or repair your Dyna amplifiers, preamplifiers, and tuners. We have all new PC cards and all new highest quality internal circuits for most Dyna units. New **POWER MOS-FET** circuits for Dyna St-150, ST-300, and T-120 amplifiers. New **J-FET** circuits for Dyna PAT 5 and Bi-Fet preamplifiers. All new circuits for FM-5 tuners with phase-locked loop Mplx, new 8 stage differential IF, new buffed outputs, no drift, super musical, super sensitive. We rebuild all ST-400, 410, 416 amplifiers and can repair any, no matter how badly blown. External 100,000 mid power supplies for ST-400 and 415. All new internal circuits for Dyna PAS tube preamps. New Noble precision stepped controls for all Dyna preamps. New Mos-Fet circuits for Dyna PAT-4 preamps. Improved audio circuits for T-70 tube amps. Rebuilt Nagatron, Sonus, and Grado phono cartridges. Read **AUDIOGRAM, MR. AUDIO'S BI-MONTHLY, AND SENSIBLE SOUND** for reviews on our equipment. No charge for repair labor when we rebuild your Dyna unit. We ship worldwide and have brand new 120 volt and 240 volt modified Dyna units available. For details and our recommendations on how to make a hi fi system sound like music, write or call:

JENSENS STEREO SHOP
2202 RIVER HILLS DRIVE
BURNSVILLE, MINNESOTA 55337 (612) 890-3517

ATTENTION DEALERS: DECCA IS ALIVE AND WELL and making immediate shipments of the best-selling Decca "Zerohm" Records Brushes. Contact Andy at Audio Access, P.O. Box 385, Whitestone, N.Y. 11357. 212-767-4958

AUDIO RESEARCH D120 REVISED. Mint. Dealer warranty. \$1600. 615-483-6293.

— GOODWIN'S GROWS —

Goodwins Music Systems proudly announces a new expanded location. Goodwin's now features larger listening rooms, additional staff, and more of the very finest audio components. Goodwins Music Systems offers sales and service for Mark Levinson, Quad, HQD, Linn, Goldmund, Bryston, NAD, MIT, Tandberg, Symdex, Pyramid, Futterman, Magnepan, Stax, Celestion SL-6, Rega, Koetsu, Oracle, B&W, Soundlab, Astatic, Cotter, Janis, FR, Dynavector, Grace, Spectral, VPI, Dan Queen, Keith Monks, Monster, D&K, Esotech, Vandersteen, Mirage, Live Wire, Haffler, and more. Goodwin's dedication to the purity and integrity of music reproduction is widely acknowledged. Goodwin's is unique in New England, representing products of classic quality, value and performance. If you would like to avoid the planned obsolescence of most stereo components and are interested in the finest music reproduction, please call or come visit.

16 ELIOT ST.
HARVARD SQUARE
CAMBRIDGE
MASSACHUSETTS
02138
492-1140

EXPORT SPECIALISTS

MAIL AND PHONE
ORDERS WELCOME
CABLES MADE
TO ORDER

GOODWIN'S

G MUSIC SYSTEMS

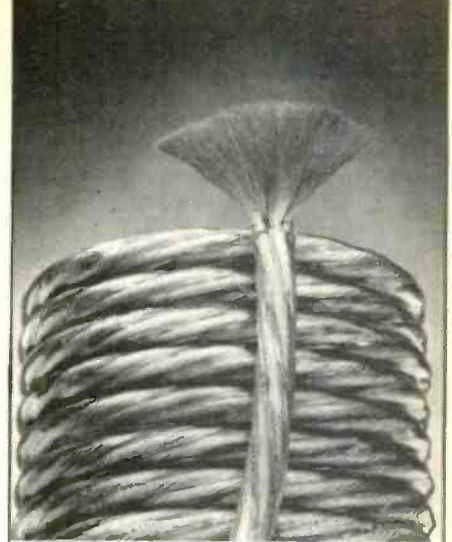

Powerful Performer

POWERLINE by MONSTER CABLE allows your sound system to recreate your favorite performance with an accuracy not possible with ordinary speaker wire.

Powerline's unique four conductor configuration allows the magnetic fields traveling in opposite directions to cancel themselves, dramatically reducing dynamic distortion.

The result?

Smooth, easy to listen to highs, tight, well articulated bass, precise imaging, with all the dynamic impact of the original musical event. Revitalize your system simply by changing from your current speaker wire to Powerline. The price of admission? Much less than you would pay for similar improvements in a pre amp, better speakers, or even a better cartridge. And it's easy to install!

Your Monster Cable dealer is prepared to custom cut your Powerline to your exact requirements and terminate the ends with any of Monster Cable's famous gold connectors.

Rated no. 1 by critics and professionals, Powerline establishes a new standard of performance and value in state of the art speaker cables. All at a price you can afford.

The next powerful performance begins at your place, with Powerline. Won't you join us?

POWERLINE™
by **MONSTER CABLE Co.**

Monster Cable Co. 101 Townsend St.
San Francisco, CA 94107 (415) 777-1355

LEGENDS AS USUAL.

These highly respected names can be found at Chestnut Hill Audio: Acoustat, Adcom, Amber, Apature, Apres, Audio Pro, B&W, Berning, Cabasse, Cotter, Dahlquist, Dayton Wright, Dennesen, Denon, Discwasher, Dynavector, Fidelity Research, Fourier, Gilmore, Grace, Grado, Haffler, Impulse, Janis, Kenwood Punst, Leach, Marcof, Mariah, Monster Cable, Mordaunt-Short, NAD, Oracle, PS, Audio, Quad, R.G.R., Rogers, Signet, Sendor, Stax, Symmetry, Tandberg, Theta, 3D Acoustics, Thorens, Threshold, VPI, Vandersteen, 311 Cherry Street, Philadelphia, Pa 19106 (215) 923-3035

CHESTNUT HILL AUDIO LTD.

FOR SALE

ATTENTION LONG ISLAND and METRO NEW YORK AUDIOPHILES: Audition Frank Van Alstine modified Dynaco equipment in a home environment. Find out why audio reviews have been astounded by his latest modifications. Auditions by appointment only. Nassau (516) 541-0312. Suffolk (516) 277-5336.

ATTENTION: AUDIOPHILES IN SOUTH TEXAS, MEXICO Concert Sound specializes in quality hi-fi gear previously unavailable in this area: Acoustal, Amber, Berning, Citation, Goldring, Harman/Kardon, Mission Electronics, Ohm Walsh 2, PS Audio, Polk Audio, Rega, SOTA, Thorens, Vandersteen—plus variety of specialty cables, accessories, etc. Pro service on all lines we carry. Concert Sound 6104 Broadway/San Antonio, Tx. 78209 (512) 822-1224.

ATTENTION SOUTHERN AUDIOPHILES: Nakamichi, Bang & Olufsen, Polk Audio, Dahlquist, Carver, V.P.I., Ortofon, Jensen, Fultron, Visonik, Kloss, Sanyo. Mail orders welcome. Free shipping. Sound Advice, Village Plaza, Ruston, LA 71270. 318-255-8000.

ATTN: WANTED, MCINTOSH, MARANTZ, ARC, TUBE, JBL HARTSFIELD & ELECTROVOICE PATRICIAN SPKRS. 713-728-4343, M. CORB, 11122 ATWELL, HOUSTON, TX 77096.

ATTRACTIVE PRICES: LINN ITTOCK, ASAK, DYNVECTOR DENON, GRACE, FULTON, KOETSU, LUSTRE, BRB SYSTEMS, QUAD 63. ALSO SOTA SAPPHIRE & TUBE CLASSICS. C.O.D. SHIPPING, S.A.S.E. QUOTES. 713 728-4343 MAURY CORB 11122 ATWELL HOUSTON, TX. 77096

*****AUDIO EMPORIUM, MILWAUKEE**—a progressive alternative. Free catalog. 6914 W. Brown Deer Rd., Milwaukee, WI. 53223, 414-354-5082.

AUDIONICS PZIIIPRO AMPLIFIER, Space & Image Composer, CC-2 Amplifier MINT—Call Shane 402-483-4511

Le Cube.

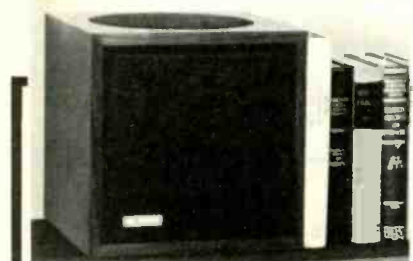

Full-range performance is possible from loudspeakers that can be used as bookends on an open shelf.

Revue du Son, in a feature review, *said "La 'petite' Allison: Six est une grande enceinte [loudspeaker]." *No. 32 (Nov. 1979).

For literature and information call (800) 225-4791 [in MA (617) 237-2670] or send coupon

The Allison: Six costs \$160 in walnut vinyl, \$172 in black or white lacquer.

ALLISON ACOUSTICS

Seven Tech Circle/Natick, MA 01760, U.S.A.

Name _____

Address _____

City _____ State _____ Zip _____

FOR SALE

AUDIO CONNECTION IN NORTHERN NEW JERSEY

| | | |
|-----------------|------------------|-------------|
| ADS | Electrocompaniet | PS Audio |
| Audio Pro | Fuselier | Proton |
| Belles Research | Grace-Grado | Rogers |
| Benchmark | Leach LSR&D | Spica |
| Clarke Systems | Logic | Thiel |
| Delphi | Lurne | Vandersteen |
| Denon | Magnum 95 FM | VPI |
| Dynavector | Michell | Win MC-10 |

615 Bloomfield Ave., Verona NJ 07044
(201) 239-1799

AUDIO HOUSE—FLINT MICHIGAN

| | | |
|-----------|-------------|----------------|
| ACCOUSTAT | LEACH LSR&D | MORDAUNT-SHORT |
| ROGERS | SYMMETRY | ARISTON |
| AUDIO PRO | | REVOX |

Big #12 gauge Gonza speaker wire 100 ft. \$45. Sample \$1.00. 4304 Brayon, Swartz Creek, Mich 48473, 313-655-8639 by appointment.

AUDIO MAGAZINE—1974 thru 1980, best offer. H-M Engineering, 149 Norfolk, Clarendon Hills, IL 60514 (312) 323-0297

AUDIOPHILE CASSETTE INSERT CARDS

Improved design of ones provided by tape manufacturers. Don't reuse those old cards, replace them! 1 pack of 10 cards \$1.50 plus 50¢ postage & handling. Or send a SASE for a free sample to: RECORDING INDEX SYSTEMS, BOX 1624, LAFAYETTE, CA. 94549

AUDIO PRO B2-50 SUBWOOFER, HARDLY USED. COST \$995 TAKE \$600 OR OFFER. (413) - 253-5415 EVES. KEEP TRYING.

audio renaissance, inc.

audio research ☆ music reference ☆ linn products ☆
audible illusion ☆ theta ☆ precision fidelity ☆ kef ☆
mordaunt-short ☆ dynavector ☆ revox ☆ grace ☆
meridian ☆ stax ☆ chartwell ☆ ps audio ☆ rega ☆
and more
we stock one of the largest
collections of audiophile albums in mid-america
try our modifications for improved high end
bryston mod-amplifiers ☆ ☆ dahquist dq10 mod
4122 broadway, kansas city, mo 64111
(816) 531-3261

FOR SALE

AUDIO RESEARCH 6B. Six months old. Mint. \$995. Phone 517-792-7492.

AUDIO RESEARCH SP6C-1 PREAMP, HARDLY USED. \$1,700 OR OFFER (413) - 253-5415 EVES. KEEP TRYING.

AUDIO RESEARCH SP6, D100A, D350, SP4A. Call Shane for best price 402-483-4511

AUDIO SHOP—A SPECIALTY STORE WITH a few select lines for your musical pleasure: GRACE, FR, C.J. WALKER, SOTA, Michell, Coloney, Rega, Audre, PSE, Conrad-Johnson: Vandersteen, Sound Labs, Daybreak. Inquires Welcomed. The Audio Shop, 1124 East Elizabeth Street, Fort Collins, CO 80524. (303) 221-1496.

BARGAIN HUNTERS BEWARE. Anyone trying to represent a Grace F-10L as being identical to an F-11L is either misinformed or lying. It took us two years of R & D to develop the F-11L from the old F-10L. Get the whole story before investing your bucks. Joe Abrams, Sumiko Inc. 415-843-4500.

BASS REPRODUCTION AT ITS BEST. The newly developed Q/LC Bass Module is incredibly accurate, cosmetically beautiful and reasonably priced. Call or write for more information on this outstanding product. Q/LC Audio, 1006 Berkshire Road, Dayton, Ohio 45419 or (513) 293-7287. Dealer Inquiries welcome.

BEFORE YOU BUY-CHECK OUR PRICES. Send for free catalog featuring audio and video equipment and accessories at discount prices. Discount World P.O. Box 191 Minneola N.Y. 11501

BENCHMARK—if you are into "time delay", this one is! It Set up & stocked at Audio Connection (201) 239-1799

BEST TRADES OFFERED. We carry ACCOUSTAT, BERNING, COUNTERPOINT, FUTTERMAN, P.S., THIEL, REGA, SOTA, VPI, AMBER, DYNVECTOR, etc. Audio Doctor, 5731 North Pine St., Davenport, Iowa 52806. 319-386-8794.

BEVERIDGE Preamp, Ramm updated, B&O M100 Speakers, M100-II Speakers, BG4004, BG4002, BM8000, SC80, BRAUN PS600 Turntable, TG1000-Open Reel, RGPRO16 Dynamic Range Expander, SYMMETRY ACS-1 Electronic Crossover—Call Shane for best price 402-483-4511

NY METRO AREA

ADS, AGI, APT, Astatic, Audio Control, Audionics, Audio Pro, Audio Research, Audio Technology, Beyer, Blaupunkt, B&O, Burwen, B&W, Carver, CAT, Coiter, CWD, Dahlquist, DCM, Denon, Dynavector, Ev, Fidelity Research, Grace, Grado, Hafler, Janis, KEF, Koetsu, Linn, Sondek, Live Wire, Lustr, Nakamichi, Pyramid, Quad, Queen Labs, Revox, RG Dynamics, RGR, RH Labs, Rogers, Snell, Stax, Symmetry, Tandberg, 3D Acoustics, VPI, Yamaha

Audiocom

high technology audio

SERVICE ON PREMISES • CUSTOM INSTALLATIONS
THREE LISTENING ROOMS ON TWO LEVELS
LARGE INVENTORY • PROMPT DELIVERY
INFORMATION LINE 203-637-3821
TOLL FREE ORDER LINE 800-243-7516

177 Sound Beach Avenue, Old Greenwich, CT 06830
Major credit cards honored. Open 10 AM-6 PM Mon-Sat.

Houston and the Gulf Coast

Mark Levinson/Linn/Apt-Holman/Hafler/Nakamichi/Magneplanar/Boston/Dahlquist Adcom/NAD/Meridian/NAIM Audio/Rega/Amber/Dennesen/Gold Line/Grace Klipsch/Fidelity Research/DCM Time Window/Cizek/Signet/Cotter/Ivlie Analyzers

AudioConcepts

2200 SW Freeway at Greenbriar Houston, Texas 77098 713/527-0774
Credit Cards Accepted Freight Prepaid in Continental USA

FOR SALE

BEVERIDGE SYSTEM III, Magnepan MG IIA's, Levinson ML-3 amp, Audio Research D-90A, Rega Planar Three, Magnepan Tonearm, Adcom and Linn Asak cartridges (713) 663-6045 after 6 P.M.

BRAIDED CABLE—THE AMAZING INTERCONNECT. These beat the best. Pure music at dealer cost. \$16.50/set. 1626 N. Wilcox Ave., L.A., CA 90028. 213-467-5689.

BRB SYSTEMS

Model 1B Moving Coil Amplifier—Finally, a truly state-of-the-art moving coil amplifier at a reasonable price. Class A design, Class A sound. Ultra quiet. Battery life of 2500 hours. 200kHz bandwidth. Adjustable gain and load impedance. Steel enclosure for magnetic as well as electrostatic shielding. Auto-biasing; no trim pots to adjust. Retail price \$139.95.

Model 10 Preamplifier—A full function preamplifier based on the use of custom linear modules for the amplification of moving coil, moving magnet, and high level signals. All Class A circuitry using dual differential stages for maximum power supply rejection. Fully regulated power supply. Semitoroidal transformer. Quasi-complementary outputs for exceptional current drive capability under the most demanding conditions of load and drive. Ultra high speed, low noise circuitry. \$529.95.

Model 120 and Model 200 Reference Amplifiers—Finally, Class A performance has been achieved without compromising efficiency, reliability, and high power output. The BRB Reference Amplifiers operate Class A up to rated output and have low TIM, low static distortion, high slew rate, and are unconditionally stable when driving the most difficult speaker loads. They run cool to the touch. These are the only amplifiers that eliminate Transient Thermal Distortion (TTDD), a major cause of transient crossover distortion in ANY design that is not PURE Class A. \$599.95 and \$899.95.

To find out more about the full line of products from BRB Systems, send for full product information and the name of the dealer nearest you. Dealer inquiries welcome. BRB Systems, P.O. Box 2235, Sunnyvale, California 94087. (408-730-1363).

CABLE TV DESCRAMBLERS AND CONVERTERS. Plans and parts. Build or buy. For information send \$2.00. C&D Electronics, Inc., P.O. Box 21, Jenison, MI 49428.

CALL TOLL FREE 1-800-826-0520 FOR ACOUSTAT, CARVER, NAD, POLK, 3D, ONKYO, AUDIOCONTROL, B&W, AMBER, BEDINI, MICRO-SEIKI, DAHLQUIST, DENON, HAFNER, dbx, TANDBERG, VANDERSTEEN, DCM, GRACE, DYNAVECTOR, AND MORE! THE SOUND SELLER, 1706 MAIN St., MARINETTE, WI 54143. (715) 735-9002.

CAPACITORS-CABLES-CONNECTORS

Custom designed 200 volt Polypropylene capacitors with solid copper leads-Teflon dielectric interconnect cables-Gold plated solid brass connectors. Send \$2.00 for our catalog and price list.

RANDALL RESEARCH (714) 760-1539
719 Fernleaf, Corona Del Mar, Ca. 92625

CARTRIDGES 40% to 50% off retail: Grace F9E's, Accuphase AC-2, etc. No price list. Audioworkshop, 3303 East Denny Way, Seattle, WA 98122, 206-323-4987 after 5 pm.

ELECTROCOMPANET—Audio Connection, (201) 239-1799

I Believe In Used Equipment

and I put my money where my mouth is. I offer you a money back guarantee.

Thousands of high end & tube products in stock and on display, from basic to esoteric. All at great prices!

BUY SELL TRADE BROKER CONSIGN

MASTERCARD & VISA WELCOME
95 Vassar St. Cambridge, MA 02139
617-547-2727

Smarten up, America. Recycle with
BOB HEENAN.

FOR SALE

A BUY OF THE DECADE EXPERIENCE THE NEW 3D ACOUSTICS "DECADE"

From 3D Acoustics, the company that brought you the famous 3D Satellite System that was awarded widespread critical acclaim, comes the buy of the decade.

Appropriately named the "DECADE," this new floor-standing loudspeaker at first excites you with its striking appearance. But after just one listening, the "DECADE" quickly reveals a sonic transparency, and detailed realistic image that seems impossible at the price of \$395.00 for the pair!

Comprising a 3/4 inch polycarbonate dome tweeter, a 6 inch midrange driver, and a 10 inch resistively loaded passive radiator, the "DECADE" results in a frequency response of ± 2 db, 40-20 kHz, and at 65° off axis, the "DECADE" is down only 1 db at 10 kHz.

Drop in now to audition this particular loudspeaker. Mention this ad and receive a free pair of custom stands with your purchase of the "DECADE." THIS OFFER ENDS AUGUST 31, 1982.

IN NEW YORK, AUDITION THEM AT SOUND STAGE AUDIO

184-10 HORACE HARDING EXPRESSWAY
FRESH MEADOWS, NY 11365
(212) 762-3220 Exit 25, LIE SERVICEROAD

IN TEXAS, AUDITION THEM AT THE AUDIOFILE

1202 SOUTH CONGRESS AVENUE
AUSTIN, TEXAS 78704
(515) 433-9295 1 BLK S. OF RIVERSIDE

CARTRIDGES ANYONE??? We have the most incredible display of demo cartridges you've ever seen!! Mounted, aligned and ready to compare are over 40 top notch cartridges from: DYNAVECTOR * GRACE * FIDELITY RESEARCH * DENON * SUPEX * GRADO SIGNATURE * PREMIER. If you can't come by, give us a call. We'll be happy to spend time with you over the phone discussing the various models that will best suit your needs. Our service is fast and our prices are very competitive. HCM AUDIO, 1363 Longfellow, Chico, CA 95926 (916) 343-0558. We take cartridges seriously!

ULTIMATE SUBWOOFER!! ACOUSTIC ELECTRONICS AT CSA AUDIO!

FOR SALE

CIRCUIT BOARDS, ELECTRONIC PARTS, and CONSTRUCTION PLANS for power amps, preamps, prepreamps, and loudspeakers. Send SASE to Custom Components, Box 33193, Decatur, GA 30033 for price list and newsletter.

CLOSEOUT BARGAINS! (list prices bracketed): [MARANTZ] (\$600.00) 2130 Oscilloscope Tuner, \$349; (\$450.00) SD4000 3-Head/2-Speed Deck, \$239; (\$830.00) SD9000 3-Head Computer Deck, \$477; (\$700.00) SD8000 2-Head Computer Deck, \$358; [EUMIG] (\$1985.00) "Senes 1000" Amp, Preamp, Tuner, \$895; [KLH] (\$1200.00) Model One Computer Loudspeakers [pair] \$695. VISA/MC/COD. Shipping extra. SCC, Box 551, Dublin, OH 43017; (614) 889-2117.

COMPRESSORS—UTILIZING SSM2020 V.C.A.S

Fully assembled P.C.B.s. Features: 20-20,000 \pm 0.5db. 0.5% THD. -90db noise. Adjustable threshold, attack, release. Jumper selects 2:1 or 20:1 ratio, both soft knee. Balanced or unbalanced input. Overload indicator. Model CX-5 is a strapped stereo version. Model CX-7 is a single channel version with "output" and "gain reduction" meter outputs. (V.U. meter not included). Either unit \$79.95 plus \$3.00 shipping. 90 day warranty. Requires \pm 12 to 15v. STELLATRON, 4942 Whitsett-205, N. Hollywood, CA 91607 (213) 506-0415

COTTER MK-2, UNUSED. 802-295-7629.

CROWN PL-1, SL-1, DL-2, 5RV, D150A Call Shane. 402-483-4511

CUSTOM POLYACETIC FOAM RUBBER SPEAKER GRILLS MADE TO YOUR SPECIFICATIONS. Any size, color, pattern or quantity. Audiophile, speaker builder or manufacturer inquiries invited. Send SASE for information to Custom Sound, Algonac, MI 48001.

DAYTON WRIGHT SPA PREAMP—includes headamp. Mint. New \$1200. Asking \$575. Make offer. Call (802) 763-8039 evenings.

db AUDIO'S modest opinion on **THE ARM:** using all the latest geometric tools, test equipment, and the finest ears, we can find no fault with **THE ARM.** Come listen to David W. Fletcher's **THE ARM** at db AUDIO, 2578 Shattuck Ave., Berkeley, CA 94704.

DENON DP1200, DL103D, DP6000, DA307, DP750. Call Shane 402-483-4511

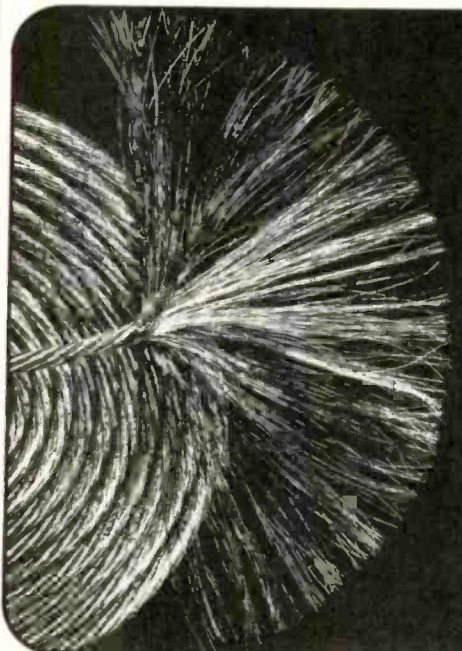

Vampire Wire™

Speaker cable is no longer the weak link in your audio system.

VAMPIRE WIRE™ is a ten-gauge, 826 strand, oxygen-free, 99.9% pure copper speaker wire which can help to improve the sound of any audio system.

VAMPIRE WIRE™ is also an affordable speaker cable.

For more information on VAMPIRE WIRE™ and the name of your local VAMPIRE WIRE™ dealer contact:

Sound Connections Intl.
P. O. Box 16543
Tampa, FL 33687
(813) 985-7033

FOR SALE

DB SYSTEMS OFFERS IMPROVED SIGNAL FLOW FROM YOUR CARTRIDGE through every metal-to-metal contact in your audio system. Connectors develop an oxide film which causes noise and distortion. Repeated twisting (wiping) helps to break some of the non-conducting film. CRAMOLIN dissolves oxides entirely and protects connections up to 2 years. DBP-CK CRAMOLIN AUDIO KIT is probably a lifetime supply. Available for \$12.95 at stereo shops or directly (add \$2.50 handling) from DB SYSTEMS, Main St., Rindge Ctr. NH 03461.

DB SYSTEMS OFFERS IMPROVED FREQUENCY RESPONSE FOR YOUR MOVING MAGNET CARTRIDGE. Flattest response is possible only when proper capacitance matching is achieved. Improper loading causes easily audible coloration due to frequency errors up to 3 dB. Our DBP-6 Phono Equalization Kit allows you to achieve proper loading by plugging in various capacitor plugs. There is no need to solder anything or go inside your unit. Send for our free literature and table of loading requirements for many cartridges. The DBP-6 is available for \$32.95 at knowledgeable audio stores or direct from DB SYSTEMS, Main St., Rindge Center, NH 03461. Include \$2.50 handling for orders under \$45.

DENON DR-330 3 HEAD CASSETTE DECK, very low hours, mint, \$350. Music Reference RM-4A pre-preamp, mint, \$375. Magnepan Mg-IIIB, as new w/X-01 passive crossover for biamp, \$825. Threshold SL-10 preamp, mint, \$600. Magnepan MG-I Improved, as new, \$525. Magnepan SMG, as new, \$335. Theta 1-B preamp, mint, \$600. Win SDC-10 turntable, SDA-10 tone arm, SDT-10 cartridge, SPG-10 control center, all 4 pieces \$2000. Grafyx SP-10 2 way box speaker, mint pair, \$225. Nelson Pass source module for use w/Win or Panasonic cartridge, mint, \$195. Call (912)746-1539. If my machine answers leave message & I will return call.

DYNACO OWNERS: 60,000 LBS PARTS/FINISHED GOODS! Complete inventory list: \$1.00. Amplifier, tuner, preamp, equalizer "Parts Packs" ... PLUS rackmounts, meters, fans, cabinets, speaker drivers, manuals, etc. NEW: (tube) power/output transformers, filter caps. SCC. Box 551, Dublin, Ohio 43017; (614) 889-2117, Noon-6.

ACTIVE ELECTRONIC CROSSOVERS

Plug-in Butterworth (maximally flat) filters in 6 db., 12 db., or 18 db., per octave attenuation, any frequency specified. Filters flat beyond 100 KHz.

Complete crossover in attractive metal cabinet with all terminations and regulated power supply.

STEREO BI-AMP \$139

Tri-amp, quad-amp, and monaural types available at comparable prices. Other available features: Summer for "single woofer" systems, Subsonic noise elimination filters supplied with or without bass boost, level controls.

FOR OEM'S AND HOME ASSEMBLERS

500 Series dual filters and/or plug-in filters, regulated power supplies.

FREE CATALOG & PRICE SHEET

Write to:

DeCoursey ENGINEERING LABORATORY

11828 Jefferson Bl. • Culver City, CA 90230
Phone (213) 397-9668

FOR SALE

DIAMOND NEEDLES and STEREO CARTRIDGES at DISCOUNT PRICES for SHURE, PICKERING, STANTON, EMPIRE, GRADO, AUDIO TECHNICA, ORTOFON, ACUTEX and ADC. SASE free catalog. LYLE CARTRIDGES, Dept. S., Box 69, Brooklyn, NY 11218. For fast COD service Toll Free 800-221-0906. N.Y. State (212) 871-3303. 9AM - 8PM except Sunday.

DYNAVECTOR RUBY, NEVER USED, \$130. Fontek A4 headphones & C4 coupler, \$90. Mark Zenon, 2301 S. Jefferson Davis Hwy., Apt. 1231, Arlington, VA 22202. (703) 521-0836 evenings.

EARS NOVA. VITA BREVIS. So don't wait another minute! EARS NOVA wants you to audition the **PREMIER LMX** moving coil cartridge before it's too late. Can you imagine another moving coil cartridge sounding this good for only \$200? Not likely. Call (or write) **EARS NOVA, 749 Middle Neck Road, Great Neck, NY 11024, 516-466-5674.**

ELECTRONIC X-OVERS: 6, 12, or 18dB/octave. Kits from \$97.00. Also transient-perfect crossover model 6000-6, \$175.00. Free folder with reviews. ACE AUDIO CO. 532-5th Street, E. Northport NY 11731-2399. (516) 757-8990.

FIDELITY-RESEARCH FR-64 without base \$275 no import duty. airmail \$10. R.H. Box 61561-Den Haag-Holland

FIELD EQUIPMENT: UHER and Sony Portable Recorders. Sony and AKG Professional Line Microphones. Sennheiser Full Line Microphones (In Quantity). Audio-Technica Microphones. Send SSAE (Specify models and quantity). J.A. Carpenter (sound), P.O. Box 1321, Meadville, Pa. 16335-0821.

FINEST AUDIO COMPONENTS, PHONE OR MAIL ORDER, LOW, LOW PRICES, FULL DEALER AND FACTORY WARRANTY & SERVICE, PREPAID SHIPPING, PHONE CHARGES REFUNDED WITH PURCHASE, EXAMPLES: KEF R101 \$495., R103.2 \$749., R105.2 \$2295., R105.4 \$1895., QUAD ESL 63 \$2695., 33&303 \$700., 44&405 \$1095., LINN LP12 \$860., ISOBARAK WN. DMS \$3095., KANN \$495., ITTOK \$495., ASSAK \$299., AND MUCH MORE! ALL STOCK ABSOLUTELY FRESH! RAPID SERVICE AND DELIVERY. MONEY ORDER, PERS. CHECK, C.O.D., VISA, MC. SATISFACTION GUARANTEED!! B&K IMPORTS, 24160 TWIN VALLEY CT., FARMINGTON, MICH. 48024, 313-471-3076, 5:00 to 10:00 PM EST.

IF YOU CARE ENOUGH TO HEAR THE VERY BEST—



MODEL BPA-100B

LISTEN TO THE **SPECTRASCAN BPA-100B (BASIC) AND BPA-100M (METERED) HIGH TECHNOLOGY, HIGH DEFINITION AMPLIFIERS • MEETS ALL DESIGN CRITERIA OF OTALA AND CHERRY • NESTED MULTIPLE FEEDBACK LOOPS. WIDE BANDWIDTH, HIGH SLEW RATE • 15KHZ DOMINANT POLE. CONSTANT FEEDBACK, ZERO PHASE-SHIFT AND HIGH DAMPING FACTOR FROM DC TO 20KHZ • REGULATED POWER SUPPLY FOR TRUE DC COUPLING AND INCREDIBLY SOLID BASS • FULL PROTECTION CIRCUITRY. ACTS ON POWER SUPPLY, NOT AMPLIFIERS • 100 W/CH, 8 OHMS • 175 W/CH, 4 OHMS • 350 W, 8 OHMS, BRIDGE/MONO**

SPECTRASCAN INC

5923 N. NEVADA AVE.
COLORADO SPRINGS COLO. 80907

WRITE FOR DETAILS DEALER INQUIRIES INVITED

FOR SALE

F. M. STEREO MULTIPLEX TRANSMITTER P.C.B. KIT, range up to 1/2 mile. Frequency response 20-15,000 hz ± 1 db. THD 0.5%. Crystal controlled 19 & 38 khz subcarriers. 16-turn trimpot finely tunes ultra stable oscillator anywhere within 88-108 mhz. Accepts any line level audio source. Operates from ± 12 V. Kit includes all parts and 18-page assembly and technical manual. Model FX-2, \$89.95 + 3.00 shipping. Model FX-2A, 95% assembled-tested version (requires only r.f. osc assembly), \$109.95 + 3.00. STELLATRON, 4942 Whitsett-205, N. Hollywood, CA 91607

FREE SPEAKER CATALOG!

Woofers, mids, tweeters, hardware, crossovers, grille cloth, plans, kits, information, much more. Discount Prices! UNIVERSAL SOUND, Dept. AC, 2253 Ringling Blvd., Sarasota, Fla. 33577 (813) 953-5363.

FRIED SPEAKERS & KITS

State-of-the-art sound. Try our prices! Fast, free shipping. **READ BROS. STEREO, 593 King St., Charleston, S.C. 29403, (803) 723-7276.** Also Halfer, PS Audio, NAD, Carver, more.

FUSELIER, ELECTROCOMPANET, DAVID BERNING, SOTA SAPPHERE, PS AUDIO, BELLES, PYRAMID, AUDIOMATIC, NITTY GRITTY, VPI, SPICA, CJ WALKER. The Mountain Ear, Box 774, Aspen, CO 81612. (303) 963-3269.

FUSELIER MODEL 3 LOUDSPEAKER & BELLES A-MODS: a great team! Audio Connection, 201-239-1799.

FUTTERMAN OTL AMPLIFIERS CALLING TEXANS CALIFORNIANS ARIZONIANS NEW MEXICANS COLORADANS and all

when visiting **SANTA FE** to audition Julius' living legends in real life habitat. For appointment call (505) 988-2571

GENE RUBIN AUDIO—LOS ANGELES

| | | |
|----------|-------------|-----------|
| PS AUDIO | LINN SONDEK | ACOUSTAT |
| NAD | REGA PLANAR | THIEL |
| HAFLER | PYRAMID | LS3/5A |
| PREMIER | GRACE | SPENDOR |
| QED | DYNAVECTOR | CHARTWELL |

Pre-paid shipping (213) 571-1299 (Pacific time)

GRACE AND SUPEX

We offer the Grace 747, 707MK2 (Linn Mods for each), 704, F-9E & Supex cartridges. By appt. Free shipping in U.S. & P.R. Visa & M.C. OXFORD AUDIO CONSLTS. INC., Box 145, Oxford, OH 45056, 513-523-3333, TLX 427791.

GRACE CARTRIDGES & TONEARMS are always in stock at HCM AUDIO. (916) 343-0558. FREE SHIPPING.

HAFLER IN THE SOUTH!

In stock, the superb Halfer DH-101 preamp and DH200 amp, kits & factory assembled. Also new models. Immediate free shipping. Also Fried (Speakers, Kits), Carver, Vandersteen, NAD, Mirage, Audire, PS, Klipsch, more. **READ BROS STEREO, 593 King Street, Charleston, S.C. 29403 (803) 723-7276.**

HAFLER-NEW PRODUCTS

We are stocking the following: DH101K, \$199.95; DH101A \$299.95; DH101AP \$399.95; DH102 \$55.00; DH103 \$19.95; DH104 \$24.95; DH105 \$24.95; DH106 \$19.95; DH110K \$299.95; DH110A \$399.95; DH110AP \$499.95; DH112 \$74.95; DH200K \$329.95; DH200KE \$339.95; DH200A \$429.95; DH200AE \$439.95; DH201 \$24.95; DH202 \$24.95; DH203 (200 Mod Kit) \$11.95 for one kit, \$9.95 each for two or more; DH500K \$599.95; DH500KE \$619.95; DH500A \$749.95; DH500AE \$769.95. By appt. Free shipping in U.S. & P.R. We ship WORLDWIDE. Visa & M.C. OXFORD AUDIO CONSLTS., INC., Box 145, Oxford, OH 45056, 513-523-3333, telex: 427791, cable: OX-AUDCON.

HAFLER PRODUCTS are always in stock at HCM AUDIO. (916) 343-0558. FREE SHIPPING.

I'm very picky about my phono cartridges, and so are my customers! That's why the **PREMIER LMX** was such a pleasant surprise. Imagine a moderately priced MC many people prefer to the Dynavector Ruby. You may prefer it, too. Come listen. **THE STEREO SHOP, 3907 Washington Rd., Martinez, GA 30907.**

innovative audio

Music for your home. We make it simple.

We are experts dedicated to musical excellence. Our demonstrations of audio and video components offer personal attention and unlimited time for evaluation. Our extensive library of quality recordings will help you decide which components are a perfect match to your home environment. Our service policies provide continued satisfaction. Trade-Ins accepted.

APT-HOLMAN, AUDIO RESEARCH, BANG & OLUFSEN, BEDINI, BOSTON ACOUSTICS, B & W, BRYSTON, COITER, DAHLQUIST, DENON, DYNAVECTOR, FIDELITY RESEARCH, GRADO, INNOTECH, KLIPSCH, KLOSS NOVABEAM, KOETSU, LS3/5A, LINN SONDEK, MISSION, NAD, NAKAMICHI, OBELISK, OHM, PYRAMID, QUAD, REVOX, SIGNET, SUPEX, ETC.

182 HENRY STREET • BROOKLYN HEIGHTS, NY 11201 • (212) 596-0888

FOR SALE

GNP LOUDSPEAKERS

Over the years we have developed a certain respect for the intended purposes of many of the "underground" audiophile magazines. Although we do not always agree with their reasoning or conclusions, the issues they address are often stimulating and provocative. The disagreements we have, and the dialogue that sometimes follows from these differences of opinion, often result in constructive and progressive changes in everyone's thinking about equipment design. And we have noticed that many of these publications sometimes find it necessary to reshape their own thinking about the review process. And, as it should be, all of these advances ultimately benefit you, the consumer.

To the best of our knowledge, no audio component is perfect, though we at GNP will strive to attain this goal. In an imperfect world, the design of any product involves the intelligent balancing of a number of critical factors. A sensitive and educated designer attempts to achieve this balance without compromising the musical values of his product. As long as both designers and responsible members of the audiophile review community keep this in mind, we shall all come closer to attaining that most elusive of all goals: sonic perfection in the reproduction of music in the home.

With this in mind, we would like to make note of the **INTERNATIONAL AUDIO REVIEW**. In a comparatively short period of time, IAR has established itself as one of the most respected and prestigious audiophile journals. At the recent Winter CES in Las Vegas we had the opportunity to meet the editor of IAR, Mr. J. Peter Moncrieff. We found Mr. Moncrieff to be as fascinating and provocative as his writings would suggest. He is conversant with the technical aspects of product design and, more importantly, he understands the nuances associated with the sound of live acoustic music.

We would therefore like to call your attention to a recent issue **HOTLINE #18 of the INTERNATIONAL AUDIO REVIEW** in which Mr. Moncrieff offers an especially lucid and comprehensive description of the underlying philosophy and unique design properties of our **GNP LEAD CYLINDER** (Pat. Pend.) loudspeaker system. We believe you will find it informative and interesting, particularly since Mr. Moncrieff appears to have described our loudspeaker system better, and more clearly, than we sometimes do ourselves in our own writings. (Reprints will be available from GNP upon request.)

We encourage you to listen to our loudspeakers at your own specialty audio dealer. We trust that when you have the opportunity to audition the **LEAD CYLINDER** system for yourself, you will be able to better appreciate how these technical principles have been translated into superior music reproduction.

There is little doubt that GNP now takes its place in that select group of companies in the forefront of the search for the ultimate in music reproduction.

For further information, see your local dealer or write:

GNP LOUDSPEAKERS, INC.
1244 E. COLORADO BLVD.
PASADENA, CA 91106
(213) 577-7767

INFINITY QUANTUM 2 SPEAKER SYSTEM, still in boxes \$895. (313) 588-4457.

HAFLER SUPERMOD PREAMP BY MUSICAL CONCEPTS

Audiogram says "The sound of the Super Mod transcends its origin, its parts, and its piddling cost, fulfilling our musical expectations . . . for the here and now, this is the one."

The Super Mod is available as a kit for \$200, or installed for \$250. Also available are an am mod kit for the DH 200, and a more modest preamp mod kit for \$100.

Musical Concepts
1060 Fifth Plaza
Florissant, MO 63031
(314)831-1822 Dealer Inquiries welcome.

JANIS WOOFERS

are the best universal subwoofers available. Hear them together with the Interphase crossover amp at **OXFORD AUDIO CONSLTS., INC.**, Box 145, Oxford, OH 45056, 513-523-3333, telex: 427791, cable: OXAUDCON. Free shipping in U.S. We ship WORLDWIDE.

JANZEN 412HP electrostatic speakers \$300.00 (312) 771-4660 9am/6pm CST

FOR SALE

HIGHEST QUALITY USED COMPONENTS; Marantz 7C, \$295; McIntosh MR 75, \$800; IMF Monitor mk IV, \$2000/pr; Dahlquist DQ 10, \$595/pr; Magnepan MG2a \$595/pr; McIntosh C 32, \$1100; McIntosh 2205, \$1100; McIntosh MC2200, \$900; Tandberg 2075 rcvr, \$550. Nakamichi 730 rcvr, \$700; Nakamichi 700II deck, \$650; B&W 801 rosewood, \$3000/pr. Marantz 10B, \$600; Threshold Stasis 3 amp, \$1400; Threshold SL10 preamp, \$900; Paragon preamp, \$250; McIntosh C27 preamp, \$500; AudioPulse II, \$295; B&O 4002 itable, \$600; Luxman C1000 preamp, \$500; B&O 2400 rcvr, \$400; B&O 4400 rcvr, \$550; Tandberg TD20A deck, \$1050; B&O 8000 deck, \$795. All used equipment guaranteed 90 days parts and labor. Audio Consultants, Inc, 1014 Davis Street, Evanston, Illinois 60201 (312) 864-9565.

IT'S A CRIME to sell a cartridge this good for only 200 bucks! That's how we feel about the new **PREMIER LMX**. It's smooth and neutral, yet detailed and dynamic. In a word, unquirky. We'd love to let you hear it on our GEM turntable. Now in progress at **AUDIOVISIONS**, 1067 Montauk Hwy., West Babylon, NY 11704.

JBL: HARTSFIELD + WHARFEDALE "WARWICKS"
408-379-7965, Box 1211, Campbell CA 95009

JBL RARE C-50 OLYMPUS W/S8R \$1,400.00, LE15-A \$275.00/Pr., 375 \$600.00/Pr., 075 \$150.00/Pr., LX 5 \$100.00/Pr., N-1200, N-2400, N-7000 \$80.00/Pr., match set 150-4 32 ohm 2 pair \$600.00. 313-229-5191 E. S. T. Eves. & Wknds.

Luxman
ADS
M & K
Heller
Tandberg
Wharfedale
Thorens
3-D Acoustics
Audio Control
NAD
Ortofon
AIWA
Revox
Kenwood
Mitsubishi

Grace
Denon
Hiltech
Onkyo
SME
MXR
Sherwood
& Many More!

Get it Free!

We Deliver FREE
Anywhere in the
Continental USA

the SOUND Approach
6067 Jericho Tpke., Commack, N.Y.
Charge It...Call 516-499-7680 Ext-82

FOR SALE

J.B.L. SPEAKER SYSTEMS AND COMPONENTS bought, sold and traded. 1-313-229-5191 or 5115 Red Fox, Brighton, MI 48116.

JIM FOSGATE PRESENTS THE ULTIMATE BLACK BOX! A TRUE SECOND GENERATION **TATE SYSTEM** AT AN AFFORDABLE PRICE. THROW AWAY YOUR TIME DELAYS, AMBIENCE RECOVERY AND IMAGING DEVICES. WE SOUND BETTER ON YOUR STEREO RECORDS, VIDEO LASER DISCS OR SO MATERIAL. IN FACT YOU WILL HAVE TO HEAR IT TO BELIEVE IT. QUAD MAGAZINE SAID "ITS PERFORMANCE IS CHARACTERIZED BY SMOOTHNESS OF OPERATION. INCREDIBLE DEPTH AND DIMENSION, AND STARTLING SEPARATION". EVOLUTION MAGAZINE SAID: "IF I WAS BLINDFOLDED, I WOULD NOT BELIEVE THAT I WAS ACTUALLY HEARING AN ENCODED RECORD. IT SOUNDED MORE LIKE A DISCRETE 4-CHANNEL TAPE". WRITE OR CALL FOR PRICES AND INFORMATION: **TETRASOUND, INC.**, 714 CLUBHOUSE DRIVE, PRESCOTT, ARIZONA 86301

KEF 105.2 MINT, below dealer cost. Call Shane 402-483-4511

KLYNE SK-1 HEAD AMP, MINT COND., \$450. Stax Sigma Headphones \$350. (212) 874-5756.

LEACH LSR&D at Audio Connection, 201-239-1799.

WE WILL NOT BE BEAT!
SUPER SELECTION • FULL WARRANTY • FAST DELIVERY
• HI-FI, HIGH END & VIDEO •



VISA **CALL (203) 934-5291 NOW!** MAC

AUDIO PEOPLE

1000 Orange Ave., West Haven, CT 06516

GALA SOUND



A NEW STANDARD OF EXCELLENCE

Pianist James Gala has established an extraordinary audio salon in Rochester, New York.

Representing only the finest product lines, GALA SOUND sets a new standard in customer service, staff professionalism, and engineering expertise.

Audiophiles from throughout the United States are now relying on GALA SOUND for the finest selection and service of audio components.

Select your home audio system from what is fast becoming a national institution . . . GALA SOUND.

ORACLE • THRESHOLD • QUAD • KEF • B&W • FIDELITY RESEARCH • MAGNEPAN
GRACE • BELLES • MISSION • LUX • NAD • B&O • POLK • AMBER • MCINTOSH
AUDIO PRO • THORENS • CARVER • NAKAMICHI • DYNAVECTOR

650 MONROE AVE. ROCHESTER, N.Y. 14607 (716) 461-3000

GALA SOUND

FOR SALE

KEF, POLYDAX, DALESFORD—\$46.80/PAIR for U.S. manufactured equivalent 8 inch (1 1/2 VC-20 oz.) with SOTA copolymer cone a rubber surround. Immediate delivery. Distributors/OEM's pricing available, inquiries invited. SEYMOUR SOUND SYSTEMS, 705 N. Bowser, Suite 103 Richardson, Texas 75081 (214) 644-7206

LINN DISC SYSTEM ALWAYS IN STOCK! GENE RUBIN AUDIO (213) 571-1299 (PAC).

KOSS ELECTROSTAT SALE

Koss 1 originally \$3650, now \$2500 pr., Koss 2 originally \$1750, now \$1300 pr., all mint condition with full factory warranty. Neal's Speakers & Stereo, (916) 486-9372, 1728 Fulton Ave., Sacramento, Calif.

LINN PRODUCTS, MODIFICATIONS & NAIM

We are pleased to offer the complete line of Linn products: LP12, Asak, Ittok, Basic, PMS, DMS, SARA, KAN & Nirvana mod for LP12; and, Naim electronics: head amp, preamps, & amps. By appt. Free shipping in U.S. & P.R. Visa & M.C. OXFORD AUDIO CONSULTS., INC., Box 145, Oxford, OH 45056, 513-523-3333, TLX 2427791.

LINN-SONDEK LP-12 W/GRACE 707 MKII ARM, mint, \$695. (714)595-7839

★ LOGIC DM 101 AND WALKER CJ 55 ★

TWO SUPERB BRITISH TABLES WITH THIS DIFFERENCE—AN AFFORDABLE PRICE! You can hear these wonders in Pittsburgh only at **BETTER SOUND CONCEPTS**, 3281 West Liberty Ave., Pgh., PA 15216, (412) 561-3312.

MARANTZ 2500 receiver mint condition \$600.00 (312) 771-4660 9am/6pm CST

Mark Pinkerton has strong views on the **GRACE F-11L** moving coil cartridge: more natural than Koetsu, but spectacular at the same time. The **GRACE F-11L** takes time to set up properly, but when you do, it's magical. Hear it on demo with our GEM turntable. **PINKERTON'S AUDIO**, 4132 Manzanita Ave., Carmichael, CA 95608.

FOR SALE

MARK LEVINSON ML-1 #3158 with A-3, A-4e and D-6 phono boards. Will accept virtually any output cartridge. Plus complete set of silver coated LEMO to RCA cables. Both an enjoyment and an investment. \$1600. **YAMAHA B-6** pyramid amp, \$700. **B&W DM-7** speakers, teak, \$680/pr. (605) 335-1859.

MCINTOSH BOUGHT, SOLD AND TRADED. 1-313-229-5191 or 5115 Red Fox, Brighton, MI 48116.

MCINTOSH C27, MC2200, MX112, MX117, MA6200. Call Shane 402-483-4511

MARANTZ 2's \$800: Sony TAN8550 V-fet \$440; JBL SE460 \$175; Dynas: Stereo 70 \$100; 35 \$40; II \$50; IV \$65; Preamps: etc. Marantz #6 stereo adapter \$200; GAS Thoebe \$340; Dyna PAS3X \$65; Crown VFX-2 \$160; Audio Pulse #1 \$300; Denon PCC1000 crosstalk eliminator factory sealed \$180; Blonder-Tongue Audio Baton mint \$150; Recorders: Sony EL-7 Elcaset factory sealed \$299; EL-4 factory sealed \$139; Ampex 300 1/2 track stereo low speed rebuilt \$650; DBX 128 \$275; Advent 100 \$120; Speakers KLH 9's rebuilt w/original carton perfect \$1100; Ohm F's w/new never used drivers, grilles \$1000; Celestion 66's \$500; Hartley H300's demos \$350; H100's \$125; Tannoy Royale 85's \$650; Turntables: AR \$70; Thorens TD125MK2 arm never mounted \$225; Thorens TD124MK2 w/large base, SME 3012 just rebuilt by Ortofon \$375; Marantz SLT12U \$175; Tuners: Lux 5T50 \$600; Marantz 23 \$100; Dyna FM3 \$50; Integrated amps: Lux 5L15 factory sealed \$500; Dyna SCA35 \$65; Video: Sony 1800 U-Matic \$650; Magnavox Laser Video Disc \$375; Citation cabinet never used \$25; McIntosh cabinet never used \$30; 260 pre-recorded reel to reel tapes. I'm moving next January must sell everything. Martin Gasman, 779 Worcester Street, Wellesley, MA 02181, phone 617-CEL-TICS evenings.

MCINTOSH MC-2300 \$1,300.00 MC 2205 \$1,200.00, MC 2105 \$550.00, MC 2505 \$425.00, MC 502 \$600.00, C-32 \$1,300.00, C-28 \$425.00, C-26 \$250.00, C-24 \$175.00, MR-80 \$1,600.00, MR-78 \$850.00, MX 113 \$575.00, MPI-4 \$1,250.00, MI-3 \$300.00, 313-229-5191 E. S. T. Eves. & Wknds.

FOR SALE

MCINTOSH MC60, C-4, Rel Precedent Tuner, Janzen Electrostatic, (212) 535-5738.

MCINTOSH TUBE EQUIPMENT—MINT

MC60's, C22, MR71, MR67, MC40, MC30, MR55, C8, Heath tuner AJ-15. Muirhead 1/3 octave audio wave analyzer. Thorens TD-124 never used. RCA MI9354 Class A tube amps. Best offers. SP3-A absolutely mint \$550. 609-767-9093, Joe.

MILWAUKEE'S MAIL ORDER SPECIALIST, PIONEER, MARANTZ, KENWOOD, TECHNICS, ADC, ORTOFON, DAHLQUIST, DUAL, JVC, SAE, DBX, TEAC, AND OTHERS. MAXELL, SONY AND TDK TAPES. SEND FOR PRICE LIST OR CALL FOR QUOTES. WACK'S. 5722 W. NORTH AVE. MILW. WI. 53208 (414) 442-3441

MODIFIED PANASONIC LEAF TWEETERS.

The best super tweeter under \$500, and sells for \$120, per pair. Crossovers available. **NEW YORK ACOUSTICS**, 578 Nepperhan Ave., Yonkers, NY 10701, 914-476-4900.

NAD PRODUCTS AT

GENE RUBIN AUDIO (213) 571-1299 (PAC)

NAIM AUDIO AVAILABLE AT GENE RUBIN AUDIO (213) 571-1299.

NAKAMICHI 250 DECK, \$175; Blaupunkt Frankfurt Tuner, \$100; Fosgate-Rockford PR2100 amp, \$300; JBL LE8T B' woofers, \$100 pair; JBL A20 2" tweeters, \$75 pair; call (505) 662-9111.

N.C.A.S.

The Northern California Audio Society is the country's fastest growing, most active organization for audio professionals and hobbyists. Hear what the leading experts have to say, learn about the latest equipment and kits, read about the results of our listening panels and much more. Members receive our information packed monthly newsletter and our quarterly journal with in-depth articles. For free information, write to N.C.A.S., P. O. Box 14156, San Francisco, CA 94114.

NEW! ACOUSTIC ELECTRONICS AMP NOW AT CSA AUDIO!

NEW REFERENCE STANDARD AT AFFORDABLE PRICE! C.J. WALKER/LINN LV-X ARM/GRACE F-9 RUBY AT CSA AUDIO!

NETTY GRITTY AT

GENE RUBIN AUDIO (213) 571-1299 (PAC)

"NOW APPEARING LIVE" AT AUDIO-AUDIO

| | |
|-----------------------|-----------------------------|
| AUDIO CONTROL | ELECTRO VOICE |
| BLAUPUNKT | CELESTION |
| ORTOFON | PREMIER |
| THORENS | LUXMAN |
| LUSTRE | ALPINE |
| GRACE | BEYER |
| AIWA | LAST |
| DNR | QED |
| DUAL | SONY |
| KOSS | TEAC |
| AMBER | SUPEX |
| NAIAD | NIKKO |
| AUDIO-PRO | OPTONICA |
| DYNAVECTOR | 3D ACOUSTICS |
| VAMPIRE WIRE & OTHERS | MONSTER CABLE 110-220 VOLTS |

REALISTIC SOUND REPRODUCTION WITH AFFORDABLE ESOTERICA.
Open 7 Days, 11am-6:30pm EST.
42 Canal St., New York, NY 10002
(212) 925-5868, Mastercard & Visa

ONKYO, JBL, SONY CAR STEREO, PIONEER, TECHNICS—The Stereo Factory, Box 1326, Huntington, W. Virginia 25714. Phone, 304-522-8031. MC & VISA OK.

OUTPUT TRANSFORMERLESS TUBE AMP

For a series of technical papers and reviews on the world's only tube amplifier that uses no output transformer, send \$1 to:

JULIUS FUTTERMAN ELECTRONICS, INC.
33 No. Riverside Ave.
Croton-On-Hudson, NY 10520
(914) 271-5147

Accuphase

Accuphase is a group of Audio Specialists dedicated to the highest standard of quality. Its products are produced in a limited quantity to be sold through a limited number of audio specialist stores. Every single piece of equipment we develop is engineered for long life and long term user satisfaction.

C-240

Precision Stereo Control Center

In this top quality amplifier, each amplification stage consists of a Class A push-pull DC amplifier circuit. Except for volume control and balance adjustment, all the functions in the front panel layout are operated by a unique array of Push Switch Buttons.

The C-240 was honored with the highest awards—the State of the Art Prize and the Grand Prix—by the most authoritative Japanese Audio Magazine. This component proudly represents the finest in Japan's advanced technology.



P-400

MOS FET Stereo Power Amplifier

The P-400 is a DC servo controlled power amplifier using a MOS FET output stage, a high speed switching device. This design employs two monophonic amplifiers which feature completely separate independent power supplies for the left and right channels. Switching to "pure" Class A mode is done electronically.

The P-400 delivers high power with high sound quality 200 W channel at normal operation and 50 W channel during Class A mode (20 Hz—20 kHz into 8 ohms, not exceeding 0.01% THD). This amplifier was also awarded a Grand Prix.

For more information and dealers near you, contact

D & K IMPORTS

146E. Post Rd. White Plains, NY 10601-914-946-3031 Dealer inquiries invited

FOR SALE

ONKYO, SHERWOOD ON SALE! IN STOCK immediate shipping, guaranteed perfect! More available, HI-FI Distributors, 176 Harvest Hill, Kensington CT 06037. Call (203) 828-9906, 5:30-10:00 P.M.

ORACLE MAGNEGAN/RUBY. Call Shane, 402-483-4511

ORACLE STRAIGHT-LINE ARM TURNTABLE sporting two 1/2-inch black plexiglas plates, 4 towers. Oracle approved. Upgrade existing table or purchase new. Photos/details. AUDIOETC, 613 So. 8th, La Crosse, WI 54601 (608) 782-5845

PARAGON OF SOUND presents a combination that surpasses anything we've ever heard—the new F-11L MC from GRACE matched to Dave Fletcher's THE ARM. If the rest of your system has the resolving capacity, you deserve to hear the pick-up system that removes the last veil. Audition them at PARAGON OF SOUND, 7021 Buxton Terrace, Bethesda, MD 20817.

PORTABLE TAPE RECORDERS: Sony TC-5550-2 (same as TC-510-2) half-track stereo open reel, takes 5 inch reels, 15 lbs., uses 8 D cells or AC. Current model, not sold in U.S.; with carrying case, service manual. Mint, \$460. Nakamichi 550 cassette, with hard case. Very clean, \$390. (617) 926-0319 eves.

POWER TO THE PEOPLE. 55 PAGES, 15,000 + words on laboratory quality power supply voltage regulators for tubed equipment. Includes schematics, PCB layouts, wiring diagrams, extensive parts availability listings and all necessary information for constructive B+, B-, filament and cascaded sub regulators. Eliminate NFB in preamps. Build a power amp regulator (less than .03% fluctuation at clipping) for \$20.1 PTPP \$15. **MEGACABLE** 300MHz precision video cable for Audio Interconnects. Ultra low loss, capacitance; 99.6% shielding. Finest small transmission line produced. Affordable prices! Send SASE for regulator/cable information, prices. MIDWEST AUDIOPHILE SUPPLY, BOX #3, EMERSON, NE 68733, (402) 695-2509.

QUAD ESL-63 \$2800/pr. Janis W1 with Interphase 1A \$2000/pr. Mark Levinson ML-3 H564 \$3500, ML-7 (L3A) \$3000. Goldmund Studio-T3 \$3600. Koetsu Black (new in box) \$450. Keith Monks record cleaning machine \$1650. (405) 341-7980.



Accurate Audio
7 LOCATIONS IN SOUTHERN CALIFORNIA

WE TAKE YOU TO THE CONCERT, NOT TO THE CLEANERS. Although there are some audio products at very exorbitant prices, there are also some great audio products at very low prices, and that's what we're all about—finding those low priced products and telling you about them. We realize how important music can be to people's lives, as it is to ours, and we enjoy giving you what we feel is the very best sound possible for your money.

DCM, NAD, DENON, PSE, SUMO, HAFNER, PYRAMID, ROGERS, DYNAVECTOR, PETERSON, LIVEWIRE, GRACE, ANDANTE, KINDEL, STAX, PROTON, MARCOF, MUSICAL FIDELITY, VPI

| | |
|--------------|----------------|
| SANTA MONICA | (213) 399-HIFI |
| STUDIO CITY | (213) 766-7478 |
| PASADENA | (213) 792-4444 |
| VALENCIA | (805) 255-2487 |
| LAGUNA BEACH | (714) 494-2030 |

1027 N. Coast Hwy., Laguna Beach, CA 92651
By appointment 7 days a week

FOR SALE

PREMIER LMX at HI FI HAVEN. Audition the new moving coil cartridge that breaks all the barriers for tracking, focus, definition in a reasonably priced moving coil. The PREMIER LMX with "cutter analogue" stylus. At HI FI HAVEN, 28 Easton Ave., New Brunswick, NJ 08901.

PS AUDIO at Audio Connection, Verona, NJ... a rare example of superb sound combined with great price.
201-239-1799

PS AUDIO—FANTASTIC!

In stock! Fast, free shipping. READ BROS. STEREO, 593 King St., Charleston, S.C. 29403, (803) 723-7276. Also FRIED KITS.

PS AUDIO IN THE PACIFIC

The complete line of PS Audio electronics is available at Hawaii's finest audio store.

AUDIO REFERENCE SYSTEMS
MANOA MARKETPLACE
HONOLULU, HAWAII 96822
(808) 988-3305

PS AUDIO PS IV PREAMP WITH BUILT IN HEAD AMP. Sounds more musical than transistors ought to. Available at Threshold Audio 409 S. 22nd Street, Heath, Ohio 43055, 614-522-3762.

PS AUDIO = SUPERB VALUE

GENE RUBIN AUDIO (213) 571-1299.

QUAD ESL-63 STANDS

Beautifully made of solid teak or zebrawood and shaped to cradle the contoured bottom base of the Quads. The stands securely elevate the speakers by about 12" above the floor with overall audible benefits: tighter bass extension, cleaner midrange and whole openness of the treble end.

EKO P.O. Box 656 Hampton, VA 23669

QUALITY ELECTRONIC KITS, including FM/SCA adapter. \$10. Free catalog. FM Atlas, Adolph MN 55701.

RAW DRIVERS, ACCESSORIES, and lotsa help! Catalog 25c. Meniscus Systems, 3275 Gladola, Wyo. MI 49509.

ESOTERIC



Fine audio products at affordable prices. Informed audio advice on the world's largest selection of esoteric components and accessories.

Send \$1.00 for our latest catalogue.

VISA M/C Am Exp

The Audio Advisor, Inc.
Box 6202, Grand Rapids, MI 49506
616-451-3868

FOR SALE

Raise your standards. **SOUND BY SINGER** presents the phenomenal new **GRACE F-11L** moving coil. When your reference is live music, when your commitment is to excellence, you set your standards high. Raise your standards. Listen to the **GRACE F-11L** at **SOUND BY SINGER**, 227 Lexington Ave., New York, NY 10016.

REGAL REGA RESEARCH

We are pleased to offer the complete line of Rega tables: Planar 2 & Planar 3, armed or armless. By appt. Free shipping. Visa & M.C. OXFORD AUDIO CONSULTS., INC., Box 145, Oxford, OH 45056, 513-523-3333, TLX 427791.

REGA PLANAR TURNTABLES IN STOCK!

GENE RUBIN AUDIO (213) 571-1299 Pac.

REVOX B790 turntable, new with warranty card \$600.00 (312) 771-4660 9am/6pm CST

ROGERS-NEW SPEAKER & CHARTWELL

The Rogers Studio 1 is a significant addition to the line of superb Rogers products. All of the Rogers speakers, electronics & Chartwell speakers are available at OXFORD AUDIO CONSULTS., INC., Box 145, Oxford, OH 45056, 513-523-3333. Visa & M.C. Free shipping in U.S. & P.R.

ROGERS, REGA, AUDIRE, ARCAM, CLARKE SYSTEMS, SATTERBERG, SHERWOOD, KENWOOD PURIST, DELPHI, ADCOM, HAFNER, HARMON KARDON, GRACE, GRADO, LIVEWIRE, MICROSEIKI, PSE, THORNS... E.A.R.S. (213) 961-6158 evenings, weekends PST. **FREE SHIPPING!!** P.O. Box 658-U, West Covina, CA 91790. M.C. VISA. MONTHLY SPECIALS. DEMO CLOSEOUTS.

ROGERS SPEAKERS AND ELECTRONICS AVAILABLE in Houston. Call Alexis Torres, (713) 937-8810.

In New England...



No hyperbole — just the kind of knowledge, creativity and dependability you expect from a dealer who represents these manufacturers.

| | |
|-------------------|---------------|
| Acoustat | KLH |
| ADS | LAST |
| ADS Pro | Magnepan |
| Apt-Holman | Marcof |
| Audel | M & K |
| Audio Pro | Monster Cable |
| Bryston | NAD |
| Carver | Nakamichi |
| Cotter | Nitty Gritty |
| Dahlquist | Oracle |
| Denon | Pyramid |
| DCM | Signet |
| Dynavector | Supex |
| Fidelity Research | Threshold |
| Gem | Vandersteen |
| Grace | VPI |
| Hafner | Win Labs |
| Keith Monks | Yamaha |
| KEF | & more... |

Listening rooms... New England's largest Audiophile record dealer... Keith Monks record cleaning... In-store service... All shipments pre-paid and insured in the continental U.S.

5 TAKE AUDIO

105 Whitney Ave., New Haven, CT
(203) 777-1750
Mon., Tue., Wed., Fri. 10-6, Thurs. 10-8, Sat. 10-5

AudioVisions

a new store with a fresh view... on the audio and video horizon

At AudioVisions you will find the very latest in technology, combined with truly old-fashioned hospitality

Within your budget, which speaker will sound the best in YOUR listening room? Which cartridge will work best in your turntable? AudioVisions specializes in balanced System Packages, offered in "SOUND SENSE" price ranges. Have you heard about our seminars with noted musicians and engineers? Ask for our free newsletter.

THREE LARGE AUDIO ROOMS

electronics
ADCOM • BRYSTON • DENON
HAFNER • MITSUBISHI
PLEXUS • TOSHIBA

WE LOVE MUSIC. DO YOU?

loudspeakers
ALLISON • DAHLQUIST
DESIGN ACOUSTICS
INFINITY • M&K
TAMANTON • THIEL

IN-HOME SPEAKER TRIALS AVAILABLE

tables & cartridges, tape decks
ADC • ASTATIC • DENON
GRACE • GRADO • NAKAMICHI
PREMIER • SUMIKO • WALKER

real wood select AUDIO CABINETS • large selection of AUDIOPHILE RECORDS
phono needles • headphones • microphones by AKG • Discwasher • Monster cable

Charge Cards • convenient to the Southern State Pkwy. and to the L.I.R.R. • FinanceAmerica

1067 MONTAUK HIGHWAY • WEST BABYLON • NEW YORK 11704 • (516) 661-3355

FOR SALE

A BETTER DEAL for your McIntosh, Marantz tube components. 713-772-4653 or 713-726-9070.

BRAUN TG-1000 tape recorder wanted. Also other Braun recorders, turntables, tuners, receivers, amplifiers, radios, televisions. Give description, condition and price. Carleton Sarver, 256 West 88th Street, New York, NY 10024. 212-874-3529.

SAVE 60% TO 75%. BUILD YOUR OWN SPEAKER SYSTEMS. P/C CROSSOVERS, WOOFERS, MIDS, TWEETERS, INSTRUCTIONS. COMPLETE SELECTION, HI-FI, M.I., PRO, DISCO AND AUTO SYSTEMS. SEND \$2.00 FOR CATALOG REFUNDABLE WITH PURCHASE. DKI AUDIO, BOX 284, DAVIS, IL. 61019

SHEFFIELD MISSING LINC. 1 sealed \$1000., 1 played twice \$500. P. Pflieger 518-459-1396 eves.

SHURE 565D unisphere-I microphone \$65.00 (312) 771-4660 9am/6pm CST

SONY TC55 dictation cassette recorder & accessories \$90.00 (312) 771-4660 9am/6pm CST

SONY XL55 moving coil cartridge (new) mounts in any tonearm \$150.00 (312) 771-4660 9am/6pm CST

SOUND CONCEPTS IR2100 IMAGER, Mint, Original carton, \$135 P. Pflieger 518-459-1396 Eves.

ORPHEUS S505 Mini Monitor

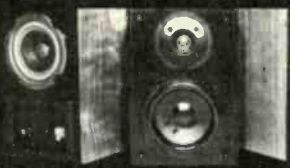

Accurate, Smooth and Musical SPECIFICATIONS

FREQUENCY RESPONSE: 60Hz - 20KHz ± 3dB
POWER: Min. 15 watts, Max. 200 watts contin.
SIZE: 10" x 6 1/4" x 6 1/2"
PRICE: \$250.00/pair

FOR LITERATURE, REVIEWS AND DEALER INFORMATION, PLEASE CONTACT:

ORPHEUS
 87 South Sixth Street
 Locust Valley, N.Y. 11560

Two-channel sub-woofer, 12dB/octave 100Hz passive filter, bi-amp connections, mode switch disables passive network, bass driver level controls to vary sensitivity, polypropylene drivers, non-directional bass response.

Slimline satellites, 18dB/octave filter, polypropylene mid-range, soft dome tweeter with control, Mylar capacitors. Exceptional dynamic range. Flawless imaging. Natural walnut veneers, full dealer serviceability, limited 5 year warranty. Tremendous value. Incredible sound.

DESIGN INNOVATION

DYNAMIC Acoustics
 P.O. Box 646
 San Ramon, CA 94583
 (415) 820-5765

Adjustable stands optional

FOR SALE

SILVER + TEFLON + GOLD = SWL'S QUICKSILVER INTERCONNECT CABLE. Fine strand silver coated copper cable with teflon dielectric and outer jacket. Low capacitance, hi cond. & propagation vel. Highest quality commercial duty heavy gold plate RCA plugs machined to exact tolerances. Available in 1/2, 1, & 2 meter stereo sets (\$25, \$30, \$45 respectively. Add \$2 S&H. TX res. add 5% sales tax). Custom lengths & connectors, VISA & MC also. Send SASE for complete product listing. STEPHEN WORSHAM LABS 3720 Maplewood Dr., Dallas, TX 75205, Ph. 713-763-6061.

SPENDOR SPEAKERS AT
 GENE RUBIN AUDIO (213) 571-1299 (PAC)

The Sound ...
 Open, natural, musical, detailed ...
 The Look ...
 Genuine Oak or Walnut, rugged construction ...
 The Price ...
 Much lower than you thought possible ...
 A Dream?
 No, it's a Phantasy!

PHANTASY SPEAKERS, by Kindel Audio
 Builders of the Phantom
 1710 Newport Circle
 Santa Ana, CA, 92705

SPEAKER BIBLE. Over 20 pages of vital information for the speaker builder. Send \$2. to NEW YORK ACOUSTICS, 578 Nepperhan Ave., Yonkers, NY 10701, 914-476-4900.

SPEAKER BLOWN? Ripped? Save yourself \$\$\$ by re-coning it! All work guaranteed. For information send S.A.S.E.—A&TRC, 527 Charles Ave., Solvay, NY 13209. (315) 468-4031.

SPENDOR-NEW SPEAKERS & LOWER PRICES
 In addition to the renowned SA1 & BC1, we offer TWO NEW Spendor speakers, the SA2 & SA3. Lowered prices on all speakers. By appl. Free shipping in U.S. & P.R. Visa & M.C. OXFORD AUDIO CONSULTS., INC., Box 145, Oxford, OH 45056, 513-523-3333

SPICA AUDIO CONNECTION
 If a small speaker is your cup of tea, Spica's SC-50i is the answer: musical, open, non-fatiguing. Hear it at Audio Connection in Verona, NJ, 201-239-1799.

STAX equipment new with warranty cards, SIGMA & SRX-III headphones \$260.00 & \$150.00, SRM-1 amplifier \$235.00, UA7GF tonearm \$220.00, CPY cartridge system \$310.00 (312) 771-4660 9am/6pm CST

STEREO REPRESENTATIVES NEEDED!!! LOWEST POSSIBLE PRICES!!! OVER 100 BRANDS!! KRASCO Rep-AO, 998 Orange Ave., West Haven, CT 06516

FOR SALE

SYMDEX LOUDSPEAKERS

We are pleased to introduce the further improved Symdex Sigma and the new companion subwoofer, a three-way system of unparalleled accuracy and low coloration. This reference system, which sets new standards for definition and transparency, is a result of thorough optimization of all design factors plus construction and components of a quality never before used in loudspeakers. The sonic results of this effort have been described by listeners as a redefinition of the state of the art of dynamic loudspeakers.

For further information, contact: Symdex Audio Systems, Inc., P.O. Box 8037, Boston, MA 02114, 617-938-8180.

Current Symdex owners note that factory updates are available.

TANDBERG NEW TD20A (high speed), 9000X open reel. Call Shane 402-483-4511

TEAC A-103, needs new RP head, \$50 (404) 633-3822 evenings.

TEAC V-40, \$125. (404) 633-3822 evenings.

TELEFUNKEN, APMPEREX, GENALEX and other top quality audio tubes available. Contact S.J. Wallace, 1203 Success St., Pittsburgh, PA 15212.

THE FINEST IN TUBE ELECTRONICS. ROGER MODJESKI'S superb MUSIC REFERENCE RM-5 preamp and RM-4A headamp are in stock at HCM AUDIO. (916) 343-0558. FREE SHIPPING.

- **THE MERRILL AR TURNTABLE MOD KIT,** complete with new suspension chassis and bearing, makes your old AR "state of the art" and allows new tone arm accommodation—\$54.00. Additional AR innovations—Solid oak AR base—\$125.00. AR record weight—\$7.00.
- **UNDERGROUND SOUND** performance mod kit for the Halfer DH-200—\$27.00.

UNDERGROUND SOUND
 2125 Central Ave., Memphis, TN, 38104
 (901) 272-1275

"THE TEMPEST"

RR-10 is finally available! Professor Johnson's first orchestral recording, highlights from Paul Chihara's tuneful ballet, is well worth the wait. This half-speed mastered JVC pressing contains more than 53 minutes of orchestral music—at 45 rpm! Thrill to the natural string tone, three-dimensional sound stage and complete dynamic range of Keith Johnson's newest and best analog recording. Order from Reference Recordings, Box 77225X, San Francisco, CA 94107. 408-289-1462. Only \$15.00 Postpaid. Visa/MC welcome. Dealer inquiries invited.

THIEL LOUDSPEAKERS AT
 GENE RUBIN AUDIO (213) 571-1299 (PAC)

THORENS 125-II turntable, SME3009-III tonearm, DECCA gold cartridge all mint condition \$515.00 (312) 771-4660 9am/6pm CST

THORENS NEW TD160IIB, TD160IIIB Super, plus tonearm deals. Call Shane 402-483-4511

THRESHOLD AUDIO is offering Dynavector, Pyramid, PS Audio, Grado, Sony, Marantz, Infinity, Stax, VPI, YSL, and more. Prepaid shipping. Trade-ins welcome! 409 S. 22nd Street, Newark, Ohio 43055, (614) 522-3762.

THRESHOLD (4000, SL10), Watson 10, Lynn-Sondek. 201-991-6311 (5PM-9PM)

THRESHOLD S-1000 MONO AMPS. Cotter CM-2 pre-amp system, Sota table. Call 518-438-0180.

THRESHOLD'S HOMETOWN DEALER, KEITH YATES AUDIO, can have your new-generation Stasis amp or FET Stasis preamp shipped **DIRECTLY FROM THE FACTORY TO YOUR DOOR.** Also: Bryston, Linn, Michell Gyrodec, KEF, Acoustat, Pyramid, NAD, Denon, VPI, Koetsu, Dynavector, Technics Pro. more. 2209 Ninth Avenue. Sacramento 95818. (916) 441-0443.

VANDERSTEEN IN THE SOUTH!

In stock, the superb new Mod. 2C. Fast, free shipping.
READ BROS. STEREO
 593 King St., Charleston, SC 29403 (803) 723-7276
 & M/C OK. Carver, Halfer, PS, Mrage

FOR SALE

Tom Houghton on David Fletcher's **THE ARM**: Impressive. I've never before seen this level of integrity in construction. Matches perfectly to a broad range of today's best cartridges. **THE ARM** is the best pivoted tone arm available today. On demonstration at **AUDIO THRESHOLD**, 36633 Gratiot St., Mt. Clemens, MI 48043.

WHOLESALE PRICES: Pioneer, Concord, Sanyo, Technics, JBL, Bose, Savard, Rich Acoustic. Call 205-792-0706 for quote or write Savard Sound, Mail Order Dept 260, 2413 Ross Clark Circle, Dothan, ALA. 36301—Visa-MC-COD.

Want to hear what's really on your records? The **F-111** moving coil from **GRACE** is the most revealing phono cartridge. If you settle for the other \$600 cartridges you'll be settling for less. Audition the **GRACE F-111** at the **AUDIO CONNECTION**, 615 Bloomfield Ave., Verona, NJ 07044.

WE TAKE CARTRIDGES SERIOUSLY at **HCM AUDIO**. We spend a lot of time auditioning and comparing. That's why we're so impressed with **PREMIER'S** new **LMX** moving coil with the Van den Hul II stylus. Amazing resolution in a moderately priced cartridge. **HCM AUDIO**, 1363 Longfellow Ave., Chico, CA. 95926.

WIN LABS MC-10 CARTRIDGE AT CSA AUDIO!

RECORDS

AUDIOPHILE RECORD GALLERY discounts ultra sound direct disc, digital, half mastered, Japanese Imports, more! Free Catalog, P.O. Box 2668, La Mesa, CA 92041 or P.O. Box 1073, Vienna, VA 22180.

"FRESH AIRE" limited offer \$13.95 each. All four volumes available. (add \$2/album to Canada) Visa, M/C, AmX, C.O.D., check. Free update on new audiophile recordings. Complete descriptive catalog with over 500 titles: \$2.00. Supersound Record Service, Box 82-A, Forest Park, IL 60130. (312) 366-1300.

GET THE BEST SOUND YOUR DISCS CAN OFFER Write today for samples of a unique Antistatic Record Care System. Copack, Box 443B, Fairport, NY 14450.

IMPORTED & DOMESTIC CLASSICAL RECORDINGS. Also Jazz/Gifts Books. Full 64 page catalog. \$1.00 (refundable). **MUSICAL CONCEPTS**, Box 53AA (7,8,9), Cedarhurst, N.Y. 11516.

JAPANESE IMPORTED RECORDS EXCLUSIVELY. 10,000+ **TITLE MAILORDER CATALOG** \$3.00 **POST-PAID**. **YSL RECORDS**, BOX 8330-A, Van Nuys, CA 91409.

MERIDIAN RECORDS. Critically acclaimed natural recording, superbly pressed, a must for serious listeners. (714) 438-1282.

RECORDS

PERSONAL AUDIOPHILE ALBUM COLLECTION; Direct-Disc, collectables, limited quantities. Jim 415-861-1093

PROTECT YOUR LPs. POLY SLEEVES FOR JACKET 12c. SQUARE BOTTOM INNER SLEEVES 7c. POLY LINED PAPER 15c. WHITE JACKETS 35c. POSTAGE \$2.00. HOUSE OF RECORDS, HILLBURN, NEW YORK 10931.

WANTED TO BUY OR TRADE

AR LST SPEAKERS. Johnny Fong, 130 Fallen Leaf Drive, Hillsborough, CA 94010.

ASIA AUDIO ASSOCIATION WANTED: WESTERN ELECTRIC tubes (used ok), amps, tweeters, drivers, speakers, horns, networks, mixers, microphones. **WESTREX** amps. **MCINTOSH** or **MARANTZ TUBE TYPE** amps. **THORENS TD-124. GARRARD 301, 401. QUAD 2, 22. ARC D-75, D-76A.** Tel: 213/576-2642. David Yo, PO Box 832, Monterey Park, CA 91754

SHEFFIELD DIRECT-DISC S-10 FACTORY SEALED \$400, LAB-1 PLAYED ONCE \$300, LAB-2, \$100 POST-PAID. J. ADAMS, BOX 712, PROVIDENCE, RI 02901. 401-421-7430.

THOUSANDS OF LIKE NEW LP's and prerecorded tapes. Catalogue—\$2.50. House of Records, Hillburn, New York 10931.

ULTRA FIDELITY LP's, Cassettes. Excellent prices! Catalogues—\$1.00. Aesthetic Audio, Box 478-A, Carlin, Nevada 89822.

AAA-TOP PRICES PAID: McIntOSH and MARK LEVINSON all models. **McINTOSH, MARANTZ, and AUDIO RESEARCH** tube equipment. **WESTERN ELECTRIC** and **ERPI** speakers, drivers, horns, etc. (206) 323-4987

CALL ME FIRST ABOUT SELLING YOUR HIGH END ESOTERIC TUBE EQUIPMENT, KLIPSCH HORNS, E. V. PATRICIANS, HARTSFIELD, AND WESTERN ELECTRIC. CONTACT KURLUFF ENT., 4331 MAXSON RD. EL MONTE, CA. 91732 (213) 444-7079.

KENWOOD KA7002, KC6060, KF8011, KM8002, KA6000. (201) 671-8699.

MARANTZ MODELS 2, 3, 6, 7, 8, 9 & 10B; MCINTOSH C-22, MC240, MC275 & MC3500. Sam Abersl, P.O. Box 5455, Beverly Hills, CA 90210 (415) 889-7729.

SPECTRO-ACOUSTICS 217 or 217R PREAMP. Nell Shattles, 2243 Emerald Castle Dr., Decatur, GA 30035, 404-289-5374.

WANTED: PAIR OF ACROSOUND TO-330 output transformers new or good used. Al Manieri, 384 Bates, Phillipsburg, NJ 08865, (201) 454-3699.

"...the excitement of a live performance." —Hifi Buyer's Review
 "...low distortion, tremendous dynamic range, thunderously clean bass... the sound certainly set me back on my heels!"

—J. Atkinson, Hifi News & Record Review
 "The sound emanating from this system is breathtaking in its opulence. Bass is super with no doubling."

—B. V. Pisha, Stereo & Hifi Times

"I was literally flabbergasted! Very smooth and clean, highly detailed, with tight, rock solid bass fundamentals, minimal coloration, and no sense of disparate sound sources."

—Bert Whyte, Audio

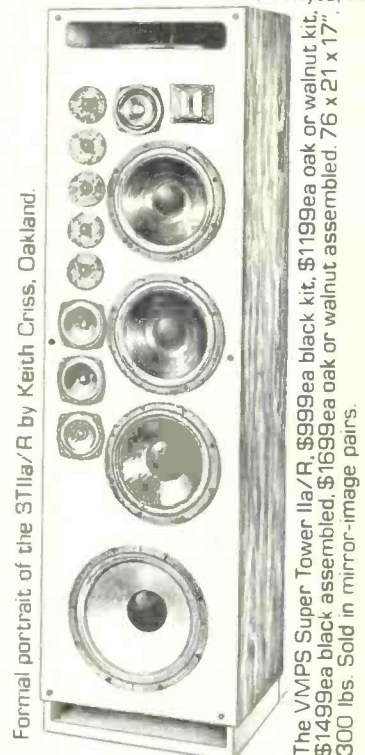

Formal portrait of the STIIa/R by Keith Criss, Oakland.

The VMPS Super Tower IIa/R, \$999ea black kit, \$1199ea oak or walnut kit, \$1499ea black assembled, \$1699ea oak or walnut assembled. 76 x 21 x 17", 300 lbs. Sold in mirror-image pairs.

The VMPS floor-standing loudspeakers offer greater dynamic range, wider bandwidth, and lower total harmonic distortion than any other production system regardless of price. Exclusive features such as minimum phase response, completely nonresonant enclosure/driver design, polypropylene/mylar crossover networks, internal wiring with Monster Cable, and now **polypropylene cone** 12" lowbass and midbass drivers are included in all the larger VMPS systems, such as the **MiniTower II** (\$309ea kit, \$439ea assembled), **Tower II** (\$419ea kit, \$599ea assembled), and **Super Tower/R** (\$649ea kit, \$969ea assembled). All prices include **free shipping** in USA, and kits are supplied with fully assembled cabinets. Write for literature and full test reports.

VMPS AUDIO PRODUCTS

a division of Itone Audio
 1016 Contra Costa Drive
 El Cerrito, CA 94530
 (415) 526-7084

Hear VMPS at The Listening Studio, Boston; Mike Hilliard Audio, Shreveport, LA; Star Audio, Oklahoma City; Sound Alternative, Ft. Myers, FL; Odin Sound, Longmont, CO; Bedini Electronics, Sylmar, CA; Itone Audio, El Cerrito, CA; The Long Ear, Big Bear Lake, CA; Avid Electronics, Long Beach, CA.

Here are
54+
 reasons for
 visiting
**Sound Components
 by Peter McGrath.**

Plus a record room featuring a large collection of imported pressings and specialty records.
 Plus complete international export facilities. Spanish spoken
 Plus American Express, Diners Club, Master Card and Visa accepted

**Sound
 Components, Inc.**

| | | | |
|----------------|------------------|------------------|-------------------|
| Adcom | Dynavector | John Marovskis | Nitty Gritty |
| Ampex | Esotech | Audio | Oracle |
| Apt Holman | Electrocompaniet | KEF | Proton |
| Bang & Olufsen | Fidelity | Klyne | Pyramid |
| Braun | Research | KMAL | Quad Electro- |
| Bryston | Fourier | Koetsu | acoustics |
| Celestion | Goldmund | Last | Ram Labs |
| Daybreak | Grado | Linn Products | Rega Research |
| DCM | Hafner | Magnepan | Rogers |
| Dennessen | Hartley | Mark Levinson | Sequera |
| Denon | H.Q.D. Reference | Milab | Snell Acoustics |
| D & K Imports | System | Monster Cable | Sound Connections |
| Discwasher | Insync | Musical Fidelity | Spectral Audio |
| | | NAD | Stax |
| | | Naim Audio | Symmetry |
| | | Nakamichi | Tandberg |

2710 Ponce de Leon Blvd., Coral Gables,
 Florida 33134 Open Tuesday-Friday
 11AM-8PM Saturday 11AM-5PM. Closed
 Sunday and Monday
 Sales: (305) 446-1659
 Service: (305) 448-6553

WANTED TO BUY OR TRADE

WANTED 3M 1/4" PROFESSIONAL TAPE TRANSPORT. J.P. Sammul, P.O. Box 214615, Sacramento, CA 95821, 916-726-2263.

PLANS & KITS

KTS AUDIO—world's finest highend speaker kits include EVERYTHING you need. Custom crossovers too! Send \$1.00 to: KTS-Dept 7A 4840 N. Leavitt, Chicago, IL 60625. (312) 769-3629

TAPE RECORDINGS

AMPEX & COLUMBIA prerecorded open reel tapes (90) all mint condition \$450.00 lot (312) 771-4660 9am-6pm CST

TAPE AND TAPE RECORDERS

A TRUCKLOAD AMPEX AUDIO TAPE SALE

High quality reel to reel 1800' or 2400' on 7" reels, used once. \$45.00 case of 40. C. Thlers, Box 6, Richboro, Pa. 18954.

CROWN RECORDERS. We upgrade SX-824 with installation of DBX-150. Gives lower distortion and 90dB SN. Permits use of Crown mixer. Full tape monitor. Crown service our speciality. Ideal Acoustics, 110 Willow Road, Starkville, MS 39759. 601-324-1020 anytime.

OPEN REEL TAPES from studio masters. Philips, Argo, Telefunken, Vanguard, Unicorn, MHS. Catalogue \$1.00. Barclay-Crocker, Room 1470-A, 11 Broadway, NYC 10004.

A SINGER'S DREAM!

REMOVES VOCAL FROM MOST STEREO DISCS
The Thompson Vocal Eliminator can actually remove most or virtually all of a solo vocalist from a standard stereo record and yet leave most of the background music untouched! Not an equalizer! We can prove it works over the phone. Write or call for a brochure and demo record below. COST: \$349.00

YOU SHOULD SEE US

For:

- Time Delay/Ambience
- Studio Echo/Reverb
- Tape Noise Reduction
- Parametric Equalization
- Electronic Crossovers
- Compressor/Expanders
- Mic Preamp/Mixers

We manufacture a full line of high quality audio and recording equipment. You will probably have to pay twice as much elsewhere to obtain comparable quality. Only Direct Sales make our prices and quality possible. Write or call for a 24 page brochure and demo record.

Write to: **LT Sound**, Dept. AU, P.O. Box 338, Stone Mountain, GA 30086, Phone (404) 493-1258

TAPE AND TAPE RECORDERS

C-10 CASSETTES FOR HIT SINGLE RECORDING! Manufacturer Prices! Fully Guaranteed. Superior Quality. 24-Pak with Custom Cases, 89¢ each. \$3.00 UPS. TOLL-FREE 1-800-426-4747 Ext-480. MICRO-80 INC. Busby Road, Oak Harbor, WA 98277.

SERVICES

AUDIO PULSE REPAIR SPECIALISTS. Modification Kits available for Model One's. WALT'S AUDIO SERVICE. 398 Granada Street, Rialto, CA 92376, (714)-875-0776.

AUDIO PULSE SERVICE. Factory trained technicians. For reservations/information, write to White Labs, 10528 Lower Azusa Rd., Suite 192A, El Monte, CA 91731.

CUSTOM RECORDING SERVICE. Tapes, discs, and cassettes. Stereo and mono. Live and copies. Editing. Masters and pressings. High quality at reasonable rates. Joseph Giovannelli, Audio-Tech Laboratories, 1158 Stewart Avenue, Bethpage, NY 11714, (516) 433-0171

GAS REPAIR SERVICE, factory trained techs. Call or write for price info. S&M Electronics 17200 Parthenia St. Northridge, Calif. 91325. 213-701-7897.

NASHVILLE RECORD PRODUCTIONS WILL PRESS HIGH QUALITY PURE VINYL RECORDS FROM YOUR TAPES. SEND FOR SAMPLE RECORD AND PRICE LIST. ALSO FINEST DISC MASTERING. 469 CHESTNUT ST., NASHVILLE TENNESSEE 37203

STYLUS RETIPPING—DIAFIX 99. Maple Stream Rd. Hightstown, N.J. 08520. 609-443-5765.

I.Q.

Are you smart enough to

WIN A

DYNAVECTOR RUBY DV23R CARTRIDGE a \$310 Value

answer the following Questions correctly.*

1. WHO designed the PYRAMID MET 7 loudspeaker?
2. WHAT is a GRADO GTE-1?
3. WHERE are HAFLER amplifiers made?
4. WHEN is a PS Model 2 amp 160 watts?
5. HOW did the KRELL brand name originate?

*In the event of several correct entries, a winner will be selected by a random drawing.

Deadline August 31, 1982

Q Audio

Unique in all the world.

95 Vassar St. Cambridge, MA 02139
Monday-Saturday 10-8 617-547-2727

Send \$2 for our NEW, expanded catalog.
MASTERCARD & VISA WELCOME

AD INDEX

| Firm (Reader Service No.) | Page |
|---------------------------|--------------|
| Acoustic Research | 5 |
| Allsop (1) | 9 |
| Audiophile Systems (2) | 10 |
| Bryston Manufacturing (3) | 59 |
| Carver Corp. (4) | 22 |
| Castle Marketing (7) | 17 |
| Chrysler Plymouth | Cover II & I |
| Cybernet (6) | 43 |
| Franklin Mint | 44 & 45 |
| Goodyear | 26 & 27 |
| J & R Music World | 88 |
| JBL (8) | Cover IV |
| JVC | 7 |
| Kenwood | 25 |
| Kool | 84 & 85 |
| McIntosh (9) | 23 |
| Mission (14) | Cover III |
| Pickering (17) | 23 |
| Quad (10) | 4 |
| R.J. Reynolds | 8 |
| Revox (11) | 19 |
| Sansui (12) | 57 |
| Shure Bros. (13, 15) | 2, 19 |
| Signet (20) | 42 |
| Sony (16) | 64 |
| Soundcraftsmen (22) | 87 |
| Studer-Revox (11) | 19 |
| TDK (18) | 3 |
| Telarc (21) | 15 |
| Yamaha | 47 |

- ACOUSTIC ELECT.
- APRES AUDIO
- AUDIO PULSE
- AUDIO STATIC ESL
- B&W
- THE DAVID BERNING CO.
- CRAMOLIN
- DAHLQUIST
- DENON
- DYNAVECTOR
- ELECTRO RESEARCH
- FULTON
- GOLDMUND
- GRACE
- GRADO
- HAFLER

- HILL PLASMATRONICS
- JANIS
- KEITH MONKS
- KOETSU
- LAST
- LINN SONDEK,
- LIVE WIRE
- LUSTRE
- MARCOF
- MONSTER CABLE
- MUSIC REFERENCE
- NAD
- NAKAMICHI
- NITTY GRITTY
- PLATTER MATTER

- PSE
- POLK AUDIO
- PRECISION FIDELITY,
- PROMETHEAN
- PYRAMID
- SNELL ACOUSTICS
- SPATIAL
- SPICA
- STAX
- SUMO ELECTRIC
- SUPEX
- TANDBERG
- THETA ELECTRONICS
- VPI
- YAMAHA

the listening room

590 Central Park Avenue, Scarsdale, N.Y. 10583

Mon., Thurs., 10-9 P.M. Tues., Wed., Fri., 10-7 P.M. / Sat., 10-6 P.M.

Ample Free Parking • Credit Cards Accepted

We Ship FREE Anywhere in the Continental U.S.A.

914-472-4558

MINI NOISE REDUCTION

Behold—right in the middle of our purest audio (i.e., where video is most unlikely), the two kings of NR (noise reduction) are neck and neck into this year's hottest technological innovation, the ultra-low-voltage, mass-produced, inexpensive, tiny NR chip. Both Dolby and dbx now have them and manufacturers should soon be working with them.

Both units operate at as low as 1.8 volts and a negligible current. Out of AA batteries, for instance, and yet, both are uncompromised electronically, identical with their larger, earlier counterparts. As chips they will be used in all sorts of new ways but let's not beat around the mini-bush: The intention is strictly Walkman, to revert to Sony's durable trade name. You get the idea? This is the beginning of Walkman Revolution No. 2.

It's also a sort of Cassette Revolution No. 2, since the audio cassette recorder is very much involved in the new mini-equipment. We've watched the cassette grow over the years, improbably, into the prime mover for those relatively behemoth tape machines that now dominate hi-fi's high end. But with inexpensive and uncompromised noise control now available for the tiny portable systems, the cassette may have found its ultimate destiny, not far from its origins. In mini-form it has no competition at all, from tape or disc (unless, of course, the mini-cassette!), and it fits uniquely into the whole Walkman concept, as it was designed—an automated miniature tape transport intended for portability and small spaces.

The big gap, until now, has been the lack of *standard* NR for the new equipment. Too bulky, demanding too high a voltage and too much current, costing too much. It could be done but only via expensive batteries and/or unwieldy converters. That isn't the Walkman way at all. The low-voltage chip was the obvious answer, and you may be sure that research in that direction has been absolutely frantic ever since Sony put the Walkman on the road. Now, finally, the chips are ready! And the audio cassette, of course, is their first target.

The Dolby B units should be available for R & D just about now, as per a Dolby announcement some months



back. (Can Dolby C be far behind?) Dbx had its actual NRX chips in hand and in operation back in mid-April, inside little plastic bubbles attached to the backs of a batch of Panasonic mini-players. That was a temporary adaptation; regular factory installation will take less room and go further in performance. But I must admit that I was bowled by over that little jury-rigged Panasonic, held casually in my hand as I walked around the room with Sony phones on my head, listening to a full-fledged hi-fi classical recording. Dbx out of cassettes, through phones! It's a whole new phone game.

Dbx and Dolby have chosen their voltages cleverly. Most mini-equipment works out of AA batteries, small single-unit cells that are inexpensive and available everywhere. Two of them give a nominal 3 volts; four together provide six—when new. But a by-the-book minimum of 3 volts for the NR chips would be a disaster since most batteries in actual use are already on the way down to the inevitable zero. Operable at 1.8 volts, these new units will work even with batteries that are already half dead. Other elements in the system will conk out long before the NR. And if by chance some particular unit uses four cells for 6 volts (new), they can take it, too.

I don't see any reason why every

portable player (and maybe FM radio) can't include one of these chips built in. Maybe even both of them, for a choice. The NR software will be available. There are quantities of Dolby B cassettes already around, plus millions made on home Dolby equipment. As for dbx, it has simultaneously launched a new line of dbx II cassettes to go with its chip, with some 50 items in the first catalogue, both classical and pop. In addition, I should think we might expect a new range of mini-portable recording equipment, in the higher end, for complete record/play, compatible with all larger home-based equipment.

We may have a larger, long-range change going on here, almost a social revolution of sorts. The biggest difference between loudspeaker and headphone listening is a social one. Loudspeakers are basically social sound producers; the thrust of their sonics, out in the open, is always towards the group, small or large, even though, like dinner, you can enjoy a one-person experience. Remember, it was the loudspeaker that gave radio its first big success.

On the other hand, phones are the opposite. It's easy enough to accommodate more than one listener if you add more phones to the circuit (dbx had maybe 75 sets going at their April

With noise control now available for tiny portable systems, the cassette may have found its destiny.

demo) but the special thrust of phone listening is inevitably towards the single listener in his own private world. That's how radio began, before there were loudspeakers.

These differences are inherent in the very nature of the two types of listening and thus in the social styles that go with them. The Walkman revolution of these last several years was a technical breakthrough, of course, including the use of the mini-phones that draw microscopic power and yet make big sound at the ears—comfortably. But the technical feat wasn't what sold. It was the subjective effect, the whole special new sound of liberated phone listening, on the hoof, the old private world rediscovered in a new setting, far, far from the living room!

Relatively few of us were familiar with phone listening before the Walkman brought it to the multitudes. We had it in the older "in-house" format and it was not good. The stereo phone makers did nobly, the sound steadily improved, the phones got lighter (though not light enough), but the listening situation was always poor. Those implacable cords, tying us to our immovable hi-fi, snagging the furniture, tangling arms and legs, toppling lamps, the unpleasant and often painful pressure on the ears, but most of all the sheer incongruity of it—in the middle of a sociable living room, one person out of it all, off in another world, sitting there brazenly! Or even worse, two, cords entangled, speech impossible, communicating by hand signals in the middle of a home. Crazy. Unnatural, very antisocial.

How very much more free, in that situation, is loudspeaker listening. How suitable, how acceptable! You socialize even when the music is loud. You are THERE, sharing the sound. Not off in some vacuum inside phones. You just can't insert phones into home hi-fi unless you are really dedicated. And the biggest bore around, as well.

But once the uncomfortable phones give way to the featherweights that sit on the ears like a part of your costume, once the wires go no more than a few inches to the nearest shirt pocket, once the entire hi-fi system can be carried lightly in the hand or anywhere else on the person—you are free. Un-

encumbered and movable. So you move! Out and away and to heck with the living room. This new freedom initially was adopted by the young. But the boon spread to their seniors; men in three-piece suits, career women in the corporate world toted their sound through the streets. Here is a whole new way to listen, fundamentally unlike the old but existing beside it and along with it, for we remain social animals and we aren't moving out of our homes yet. Or our cars.

And the best of it is that these new mini-items may be tiny but they are not the squalling monstrosities that came with the first wave of transistor freedom, back years ago. Those were status symbols; so are these. But this time the sound is good. Astonishingly good. There is, this time, a very large overlap in quality as there was between the old fixed and larger hi-fi for loudspeakers (in cars as well as living rooms) and the then newly movable sort with phones. Different but comparable. I'd put the average Walkman-type sound, for instance, well ahead of its older "hi-fi" competition that still floods department stores and mail order catalogues at similar prices.

There is also the nature of the sonic experience. We'll be hearing a lot about "phone stereo" in the coming times. The proper term is still "binaural." What counts is a profound difference, between our highly successful stereo illusions through loudspeakers, out in the open before us, and the curious effect of two entirely separated channels of different sound, one exclusively for each ear, propagated only inches from the ear canal. There is a vast amount to be said and written on this, my favorite subject, but let's keep to the point: Noise.

The joker in the entire Walkman-style movement has been the lack of noise control in the playback through phones—and this is made far more serious by "phone stereo," the *binaural* effect of noise. It is a lot more unpleasant than the noise through speakers. Just as binaural listening has a peculiarly visceral impact, close to the ears, so noise is more telling, even distressing. It almost hurts.

Those who work habitually with tape via two-channel phones know what I mean. The noise not only seems loud-

er (though it isn't); it is more obtrusive, distracting, bothersome. Vaguely frightening, as if the ear were somehow endangered, even at moderate levels. The phones are so close to the ear mechanism, the sound so enveloping! Not at all like loudspeaker noise. You get the same touch of gut fear when a probing pencil gets too close to your ear canal, or a knife or scissors approaches the eyeball.

So you can understand the special importance of the new noise-control chips for headphone listening. Filling the gap, making the mini-equipment compatible with our other fi, is good. But only half the story.

Anyhow, now you can record Dolby B at home and play it Dolby B anywhere you like—in your car (another use for an NR chip), through the mini-phones. You can jog to Dolby, bicycle, play tennis. Also to dbx. The competition between these worthy opponents is the next item on the bill, and each has a lot of value, knowhow and persuasive power. By all means, let's have both!

In this one special area, the Walkman-type mini-portable cassette player with phones, I think myself that dbx has the winner. It's a matter of relative values. If noise is so much more of a subjective problem in phone listening, then the elimination of that noise becomes a greater priority. Dolby reduces noise but it is still there, faintly, along with a totally clean signal as always. Dbx removes ALL audible noise from cassette sound. Is there a concomitant risk of some distortion, pumping and so on, in the musical playback? If so, I haven't heard it, though others say they can't stand it. But the absence of noise is something hard to believe.

At the dbx demo I thought my phones were disconnected (all that mess of wiring under chairs and tables). They were dead. Then suddenly—WHAM! I jumped a good six inches the first time that happened. Out of a cassette! And there is also that incredibly widened dynamic range, up to 80 dB out of the same cassettes. These things, mind you, put the mini-systems far ahead of a lot of big home hi-fi, at least in these aspects. Something to think about. **A**

JOHN DILIBERTO, JOHN LISSNER
FRANCIS DAVIS

ELECTRIC JAZZ

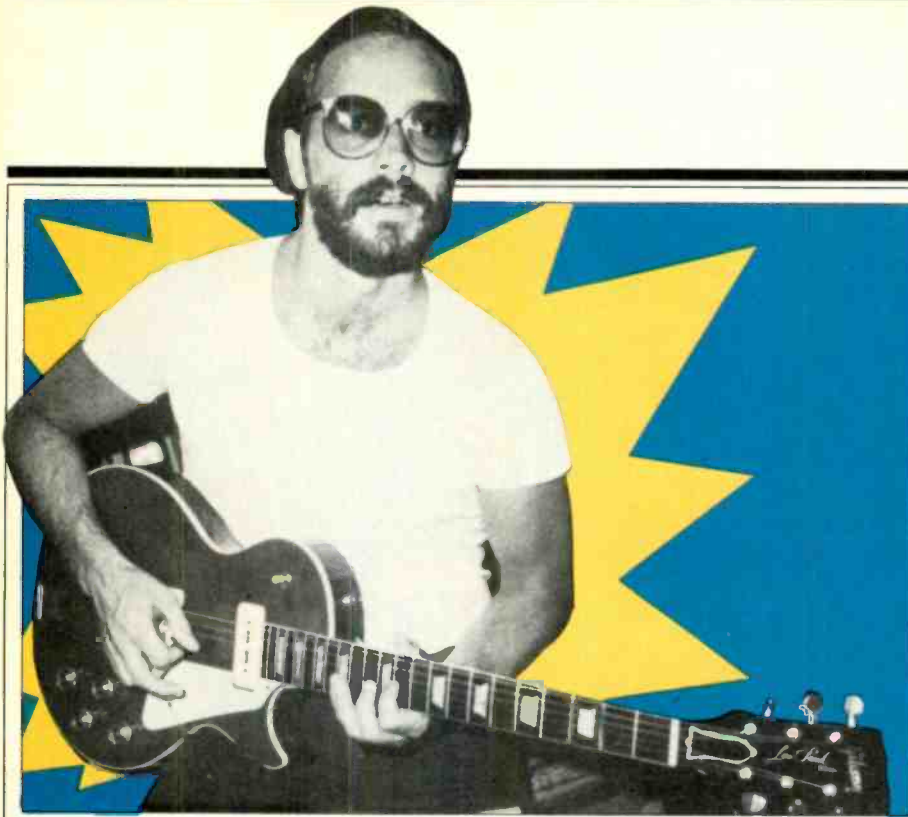

Electric Rendezvous: Al DiMeola
Columbia FC37654, stereo.

Sound: B Performance: C+

To Be Continued: Terje Rypdal, Miroslav Vitous, Jack DeJohnette
ECM Records ECM-1-1192, stereo,
\$9.98.

Sound: B+ Performance: B

The electric guitar was the instrument of the gods for fusion music artists during the early '70s. Able to merge rock electricity and textures with the free moving rhythms and improvisation of jazz, the electric guitar was the skyscraping steel girder that held it all together. Al DiMeola was one of the second-generation fusionists who took the explorations of John McLaughlin and Larry Coryell to their highest commercial potential. McLaughlin and Coryell, however, have abandoned the plugged-in sounds for acoustic guitars or simplified amplification. With improvisatory brilliance absent from the field, fusion artists formalized their sound into set pieces. Groups such as The Dregs, Jeff Lorber's Fusion, and even Weather Report are dazzling with their impeccable arrangements, but no longer exhilarating.

Al DiMeola's *Electric Rendezvous* is a less expansive and more direct outing than his previous solo disc, *Splen-*

dido Hotel. On *Rendezvous* he puts the heavy-metal edge back into the music, while sacrificing improvisational latitude. He continues to merge Spanish rhythms and melodies into his music in a less self-conscious way than his former employer, Chick Corea.

The strongest cuts are grouped on the first side. "God Bird Change" is a fiery exposition with DiMeola's guitar melodies ricocheting off the interplay of percussionist Mingo Lewis and drummer Steve Gadd. Jan Hammer turns in his best playing in years on *Rendezvous*, using his synthesizer's colors and shadings instead of trying to imitate an electric guitar. The title track alternates between the supple rhythms and electroacoustic interplay of the bridges and the hard-rock riffing of the main theme, which is used as a basis for trade-offs between DiMeola and Hammer. These trade-offs were a signature of the original Mahavishnu Orchestra, and their use here points up the lack of spontaneity that some true improvisation might have given this music.

It is just that sort of improvisation that makes the Rypdal/Vitous/DeJohnette LP a more enveloping listening experience. Rypdal is a Norwegian guitarist whose lack of commercial acceptance is directly proportional to his lack of formularization; compositions are not rigid edicts to be adhered to,

but guidelines for common explorations. "Maya" is a long tone poem with Rypdal playing violin-like tones which seem to traverse a landscape accompanied by Miroslav Vitous' warm bass tones and DeJohnette's ebb-and-flow drumming. The title piece contrasts with an all-out foray that highlights Rypdal's expert use of signal processors. While DiMeola's guitar lines seem carved out of rock, Rypdal is sculpting air. The album occasionally lapses into the "notes-in-space" syndrome as on Vitous' "Morning Lake" and the collaborative "This Morning" with Rypdal playing flute. But like all Rypdal albums, it seduces you with its quiet introspection, then sends you reeling through his inner world.

Given the choice between successful compositional playing and successful improvisation, Rypdal's latter technique offers more rewards, at least in these offerings. Yet DiMeola is still playing electric guitar like he means it.
John Diliberto

Swingin' for Hamp: Ellis Larkins & Tony Middleton

Concord Records CJ134, stereo,
\$7.98.

Sound: A Performance: A

Ever since his superb work accompanying Ella Fitzgerald on her memorable Decca album, *Ella Sings Gershwin*, I have been charmed with pianist Ellis Larkins' gently persuasive touch. On this thoroughly engaging Concord recording, he teams with singer Tony Middleton to offer us an album of compositions played and featured over the years by Lionel Hampton. All of the numbers credited to Hamp or his collaborator, composer/lyricist Ruby Fisher, are obscure, but they lend themselves to Larkins' mellow, easygoing style.

Middleton, a new name in jazz circles, has been doing Broadway shows for some years and has also been a fixture on the jazz cabaret circuit in Europe and the States. On numbers like "Jazzland," "Thai Silk," "Riverboat," "Twilight in the City" and "The Ingenue," Middleton displays a warm, compelling voice that combines elements of Joe Williams and Al Hibbler in a smoothly textured approach. The Ellis Larkins Trio, with Jack McAllister on

KOOL JAZZ FESTIVAL

Come and listen to the most famous names in jazz. Some time this year, somewhere near you, they'll be playing and singing their unforgettable sounds. Don't miss them.



Warning: The Surgeon General Has Determined That Cigarette Smoking Is Dangerous to Your Health.

© 1987 B&W T Co.

Kings, 16 mg. "tar", 1.1 mg. nicotine; Longs, 14 mg. "tar", 1.0 mg. nicotine av. per cigarette. FTC Report Dec. '81.

KOOL JAZZ FESTIVALS, 1982

| | |
|--------------------------|-----------------|
| Washington, D.C. | May 29-30 |
| San Diego | May 30-June 5 |
| Orlando | June 4-13 |
| Philadelphia | June 6-13 |
| Pittsburgh | June 13-20 |
| Atlanta | June 21-27 |
| Hampton, Va. | June 24-27 |
| New York | June 25-July 4 |
| Minneapolis/ St. Paul | July 12-18 |
| Cincinnati | July 12-17 |
| Seattle | July 30-Aug. 6 |
| Milwaukee | Aug. 11-15 |
| Newport, R.I. | Aug. 21-22 |
| Chicago | Aug. 30-Sept. 5 |
| Detroit | Sept. 1-6 |
| New Orleans | Sept. 15-19 |
| Houston | Sept. 16-19 |
| Dallas/ Ft. Worth | Sept. 23-26 |
| San Francisco | Nov. 6-12 |
| Los Angeles | Nov. 6-10 |

Famous soloists to big bands... come hear them all!

| | |
|-----------------|-------------------|
| Count Basie | Carmen McRae |
| George Benson | Gerry Mulligan |
| Dave Brubeck | Oscar Peterson |
| Ornette Coleman | Preservation Hall |
| Ella Fitzgerald | Jazz Band |
| Stan Getz | George Shearing |
| Dizzy Gillespie | Mel Tormé |
| Benny Goodman | McCoy Tyner |
| Spyro Gyra | Sarah Vaughan |
| Herbie Hancock | Weather Report |
| Al Jarreau | Joe Williams |

And many, many more.

(Not all artists appear at every festival.)

Weather Report

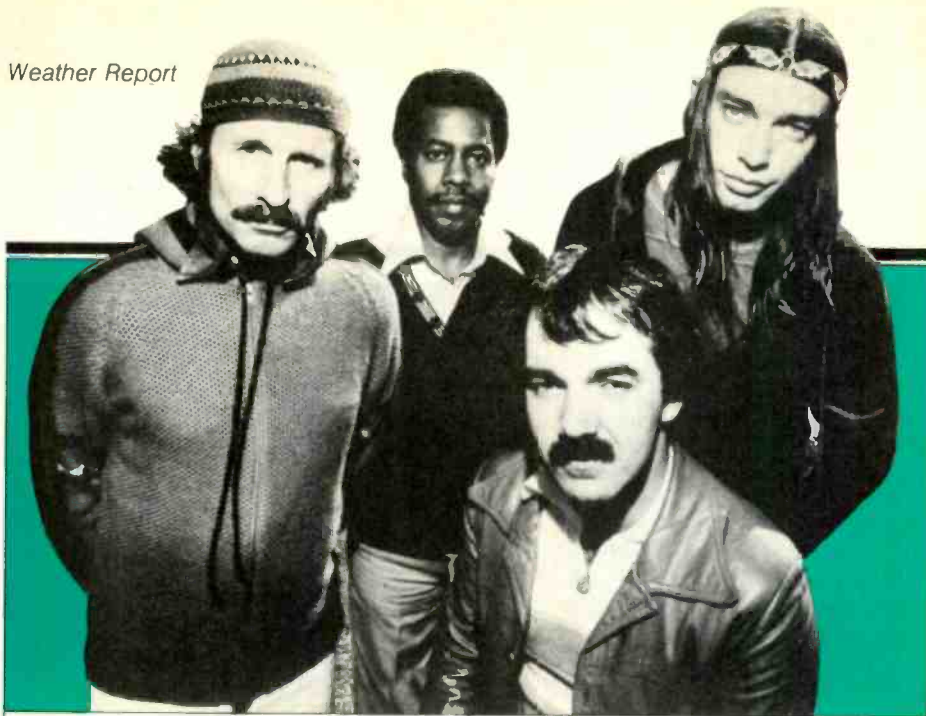

drums and Billy Popp on bass, provides a splendid synthesis of talent with the Middleton vocals, and McAllister's masterful brush work on three instrumentals is a special delight.

Swingin' for Hamp is top-drawer, easy listening, well-recorded jazz and enthusiastically recommended.

John Lissner

Night Passage: Weather Report
ARC/Columbia JC36793, stereo,
\$7.98.

Sound: A — Performance: D

Weather Report voyages into its second decade as a working band with keyboardist Joe Zawinul and saxophonist Wayne Shorter the only charter members still on board. The newer recruits — Jaco Pastorius on bass guitar, Robert Thomas Jr. on hand drums, and Peter Erskine on traps — have all been handpicked by Shorter and Zawinul after many seasons of trial and error with other bassists and percussionists. While this is the most unified, most cohesive Weather Report to date, this new record, the band's tenth, sounds as tentative and as contrived as the first did 10 years ago.

The question of whether or not a fusion of jazz and rock is feasible is no longer pertinent. Like it or not, fusion is fact, and some younger musicians, like Pastorius, have come of age never having played any other kind of jazz. The question relevant now is whether fusion's leading soloists will ever be able to make meaningful improvisational use of the genre's limited possibilities.

Several of the livelier, more intricate compositions here — "Fast City" and the title track, both by Zawinul, and Shorter's "Point of Entry" — might actually have been good vehicles for improvisation had either man been inclined to venture beyond multi-voiced synthesizer scribbles or fugitive saxophone honks and bleeps. Shorter, whose potential seemed unlimited when he was with Miles Davis and Art Blakey, begins each of his solos promisingly but soon vanishes into the sonic vapor surrounding him on all sides. He needs a higher harmonic lift than this instrumentation can give him. Pastorius' bass lines move fast and furiously, but for the little support they lend a soloist, he might as well be strumming an imaginary bass guitar, like a dancer on "Soul Train."

Zawinul's "Dream Clock" and "Forn" and Pastorius' "Three Views of a Secret" are watery mood pieces that never congeal, and "Madagascar," recorded live, proves that the group can transport its studio wizardry and emotional reserve to the concert stage — a dubious accomplishment for an improvising ensemble. But the real nadir is reached on the track that sounds the most like a bid for another crossover hit on the order of "Birdland": A prissy, mechanized desecration of the lusty Ellington classic "Rockin' in Rhythm."

This record, produced by Zawinul with assistance from Pastorius, is, like all previous Weather Reports, sumptuously recorded, and it will no doubt be greeted with ecstasy by the group's legions of admirers. The rest of us will continue to wonder what all the commotion is about.

Francis Davis

There's only
one way to
play it.



Free Festival brochure
Write to P.O. Box 2526
Highland Park, IL 60035
or call 513-321-5557
Specify city or cities.

BERT WHYTE

VIVID VIDEO

In the June 1982 issue of *Audio*, I reported on the Guard Stabilizer/RF Converter and Proc Amp video accessories made by Vidicraft of Portland, Ore. This company also makes a video image-enhancement device, the Detailer Two. To make this unit more versatile, it incorporates a video and audio switcher and a video distribution amplifier. The Detailer Two is designed to work with Beta, VHS and $\frac{3}{4}$ -inch (U-Matic) video recorders as well as vidiodiscs, video cameras, and direct off-the-air television viewing.

The Detailer Two is housed in a black aluminum enclosure, with the same attractive blue front panel as the other Vidicraft units. The front panel "Mode" switch turns the unit on and off and is used to select "Bypass," which eliminates enhancement but preserves the distribution amplifier function; "Color," which is the normal control for enrichment of color video, or "Mono," which is for improvement of black and white video. By switching between "Bypass" and "Color" you have an A-B comparison between original and enhanced images. Three LEDs to the left of the "Mode" switch indicate mode selection. Next is the "Detail" control, used to compensate for loss in that respect. The "Sharpness" control increases image acuity from VCR, vidiodisc, video cameras and off-the-air viewing. A control labeled "VNX" is Vidicraft's proprietary system for noise reduction, which in video terms means reduction of "snow" in a TV picture. The last control is a three-position input selector which switches between three RCA jacks on the rear panel. These three audio and video sources could be all VCR, for example, or could include vidiodiscs or video cameras. In addition to the inputs, the rear panel has four RCA type audio and video outputs. The Detailer Two is powered from 115 V a.c. Also, there is an input jack suitable for 12 V battery operation.

The Detailer Two can be thought of as a sort of video equalizer which boosts high-frequency picture information. This enables the device to increase detail and sharpness which represent high-frequency video at different amplitudes. Unfortunately, video noise (snow) operates in the same high-frequency region as detail. When



detail is enhanced, so is snow. Thus, trade-offs must be made in the operation of the Detailer Two by judicious use of controls to balance image improvement on one hand versus degradation on the other.

The VNX control on the Detailer Two minimizes snow by suppressing certain low-amplitude high frequencies. By using different amplitude thresholds, a portion of the snow can be removed, but here again we are dealing with trade-offs. By its nature, the VNX is the opposite of the "Detail" control. In a video image, detail should be regarded in a textural sense—the detail in people's hair and face, clothing, brick, wood, grass, etc. In short, detail is *within* or *on* an object, as contrasted to sharpness which is the *outline* and *contour* of objects.

The many ways of hooking up the Detailer Two to associated video equipment are outlined in the excellent instruction manual. Basically, the Detailer Two is interposed between a video source (tape, etc.) and the TV set via an r.f. modulator. With *one* VCR you can enhance tape playback and off-the-air viewing, but you cannot enrich recordings. With *two* VCRs, video recordings can be enhanced as well.

The Detailer Two makes the most dramatic improvements with good quality video program sources relatively free of snow. With a third-generation video dub of an old movie (a "basket case" as Vidicraft so aptly describes it), don't expect miracles. Most

off-the-air video is of good quality and if you are viewing the program on a high quality monitor like the Sony Profeel, a little touch of the "Sharpness" control may offer some improvement.

The Detailer Two really proves its worth in two areas. Most prerecorded videocassettes of movies are of fairly good quality, but inevitably the duplicating process entails loss of detail and sharpness. Using the "Sharpness" and "Detail" controls plus the "VNX" noise-reduction control on an interactive basis can wonderfully enhance overall picture quality. Hair is no longer an amorphous color, but possesses texture and sheen. Grass is not merely a green area, but reveals its grain, and even shows individual blades. Object outlines no longer appear soft but are more sharply defined, as if focus had been improved.

The other major benefit of this Detailer Two is in off-the-air recording or in dubbing videocassettes. Although most VCRs do a pretty good job of recording, the process involves some losses in image quality. Using the "Sharpness" and "Detail" controls on the Detailer Two to grossly exaggerate line contours and textural details *before* recording precompensates for the VCR recording losses. The result is a video recording with quality close to that of the original off-the-air image.

Getting the maximum benefit from the Detailer Two requires development of skills in the interplay between the "Sharpness," "Detail" and "VNX" con-



Soundcraftsmen

FOR THE EIGHTIES...

Music reproduction that is faithful to the original has become increasingly demanding of high fidelity equipment. Modern recording techniques which permit the recording of extremely wide dynamic range for the first time have made it theoretically possible to virtually re-create the live performance—If every link in the music system chain can handle the increased dynamics without distortion. This capability is known as "headroom."

Every component in Soundcraftsmen's new product line, from our graphic equalizers to our power amplifiers, was designed specifically for the flawless reproduction of the high-dynamic-range audiophile recordings available now and in the future.

CX-decoding circuitry is integral to each of our Preamplifiers and Preamp-Equalizers, making it as simple as pushing a button to enjoy the latest in high-dynamics records. Soundcraftsmen Equalizers and Scan-Alyzers, fundamental to the ultimate performance of any stereo system, now feature our

exclusive **Differential/Comparator**[®] circuitry which eliminates the possibility of "clipping" the music signals as they pass through this crucial link in the component chain. The **Differential/Comparator**[®] is also utilized in our Scan-Alyzers to guarantee absolute accuracy in the room analysis process. Adequate headroom is thus assured. The Soundcraftsmen **Class H** "signal-tracking" and **POWER MOS-FET** amplifier designs provide substantial dynamic headroom while producing up to 250 watts* of continuous power, with vanishingly low noise and distortion.

After you've seen and heard Soundcraftsmen for the Eighties we think you'll agree that no other company offers as beautiful and as complete a line of American-made stereo components for the demanding audiophile, at remarkably modest prices. Write for complete details, and for your **FREE** copy of "The Whys And Hows Of Equalization!"

Soundcraftsmen—ready now for the audio demands of the future!

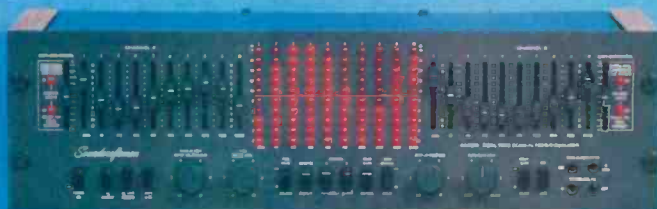

World's Most Accurate **Differential/Comparator**[®] Auto-Scan-Alyzer...\$699



Full Dynamic Range **Differential/Comparator**[®] Graphic Equalizer...\$299



Digital Quartz **AM-FM Stereo Tuner** w/14 Memories...\$469

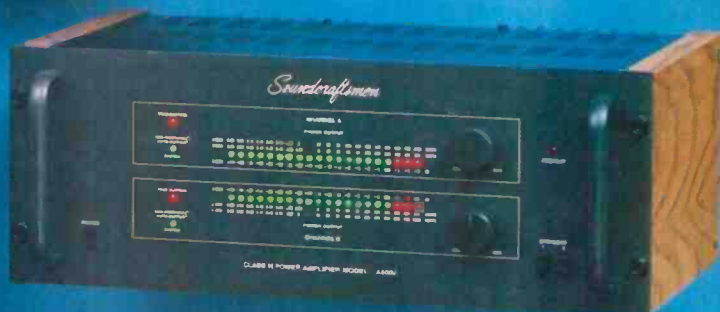

Class H Signal-Tracking 250-Watt^{*} Stereo Amplifier...\$899



CX4200: World's Most Versatile Component. Superb Phono Preamp w/CX, Adjustable Capacitance, Moving-Coil Inputs; Full-Coil Equalizer w/Differential/Comparator, Signal Processor Loop, Headphone Amplifier..... \$699

SPECIAL \$10.00 OFFER: Regular \$19.95 EQ Evaluation Kit includes 12" LP Frequency Spectrum Analysis Test Record, 2-Sets Computone Charts, Connector Cable, Instruction Folder. Mail \$10.00 check or money order to:

SOUNDCRAFTSMEN INC., 2200 SO. RITCHEY, SANTA ANA, CA 92705

Enter No. 22 on Reader Service Card

*250 watts per channel @ 8 Ohms, 20Hz to 20KHz with no more than .09% THD. Hardwood end panels shown available at slight extra cost.

ORDER TOLL FREE: (800) 221-8180 IN NEW YORK: (212) 732-8600

J&R MUSIC WORLD

RATED NO. 1 FOR SERVICE & RELIABILITY

THIS MONTH'S SUPER SPECIALS

| AUDIO TAPES | | REEL-TO-REEL | |
|-------------------------------|--------|------------------------------|--------|
| MINIMUM ORDER 12 TAPES | | | |
| MAXELL UDXL I OF UDXL II C-60 | 12.49 | TEAC X1000 R (10") | 1895 |
| MAXELL UDXL I OF UDXL II C-90 | 12.95 | TEAC X7-B (7") | 1485 |
| MAXELL XLII OF XLII C-60 | 15.17 | TEAC X7 (7") | 1495 |
| MAXELL XLII OF XLII C-90 | 15.99 | PIONEER BT-909 (10") | 1495 |
| MAXELL MX-90 (MAX II) | 16.99 | | |
| MAXELL XU 35-60B | 119.99 | | |
| MAXELL XU 35-180B | 119.99 | SHURE V15 Type V | 1129 |
| MAXELL XU 35-180 | 119.99 | SHURE V15 Type IV | 1079 |
| TDK SA C-60 | 12.37 | SHURE V15L7 (Linear Track) | 154.95 |
| TDK SA C-90 | 12.79 | SHURE M57M | 159.95 |
| TDK SAK C-60 | 13.99 | SHURE SC398D (Studio Series) | 143.95 |
| TDK ADX C-60 | 13.59 | SHURE SC398L (Studio Series) | 143.95 |
| TDK ADX C-90 | 17.89 | STANTON 8815 | 177.95 |
| TDK CR 35-60B | 18.59 | STANTON 8815E | 152.95 |
| TDK SA 35-90 | 10.59 | PICKERING KSV-3000 | 154.95 |
| SONY UCX15 C-60 | 13.29 | PICKERING KSV-3000 | 154.95 |
| SONY FCX7 C-60 | 12.99 | MICRO ACOUSTICS 3002 | 184.95 |
| | | MICRO ACOUSTICS 3002 | 192.95 |
| | | EMPIRE EDR 9 | 197.95 |
| | | EMPIRE 6004AC | 102.95 |
| | | AUDIO TECHNICA AT1554C | 167.95 |
| | | AUDIO TECHNICA AT1404C | |

ADDITIONAL 3% DISCOUNT ON 100 OR MORE ASSORTED TAPES

| EQUALIZERS / MIXERS | | MICROPHONES | |
|----------------------------------|------|-------------------------------|--------|
| ADC SOUND SHAPER 3-4C (12 Bands) | 1279 | SHURE 5M58 (unidirectional) | 124.95 |
| MIXER 12B (12 BANDS) | 1249 | SHURE 5M77 (unidirectional) | 124.95 |
| MIXER 13 (15 BANDS) | 1259 | SHURE 5M78 (unidirectional) | 124.95 |
| PIONEER SC-9 (12 BANDS) | 1124 | SHURE 5155AC (high impedance) | 154.95 |
| MURARK 60-2400 (10 BANDS) | 1279 | SHURE 5155B (low impedance) | 154.95 |
| MURARK DM-1800 (mixer) | 1189 | SHURE 5855D (ON/OFF SWITCH) | 184.95 |
| MURARK DM-1500 (mixer) | 1189 | SHURE 5855AC (high impedance) | 184.95 |
| GLI PMX-9000 (EQ Mixer) | 1318 | SHURE 5855B (low impedance) | 184.95 |
| | | SHURE 5166D (Equalizer Mic) | 179.95 |
| | | TEAC ME-120 (electret Mic) | 179.95 |

| ACCESSORIES | | CASIO KEYBOARDS | |
|-------------------------|--------|-----------------|-----|
| DISCWASHER DIRECT | 133.99 | CASIO MT-31 | 199 |
| DISCWASHER D-4 System | 18.99 | CASIO MT-40 | 159 |
| DISCWASHER DISCFOOT | 14.95 | CASIO CT-101 | 209 |
| | | CASIO CT-403 | 189 |
| | | CASIO CT-701 | 169 |
| DISCWASHER SMOG LIFTERS | | | |
| 10 meter (individual) | 19.95 | | |
| 5 meter (pair) | 29.95 | | |
| 3 meter (pair) | 19.95 | | |
| DISCWASHER GOLDENS | | | |
| 1/2 meter | 16.95 | | |
| 1 meter | 17.95 | | |
| 2 meter | 18.95 | | |

| HEADPHONES | |
|----------------------|--------|
| SONY MDRB1 (Micro) | 158.95 |
| SONY MDRB2 (Micro) | 172.95 |
| SONY MDRB3 (Micro) | 147.95 |
| SONY MDRB4 (Micro) | 174.95 |
| SONY MDRB5 (Micro) | 172.95 |
| SONY MDRB6 (Micro) | 172.95 |
| SONY MDRB7 (Micro) | 172.95 |
| SONY MDRB8 (Micro) | 172.95 |
| SONY MDRB9 (Micro) | 172.95 |
| SONY MDRB10 (Micro) | 172.95 |
| SONY MDRB11 (Micro) | 172.95 |
| SONY MDRB12 (Micro) | 172.95 |
| SONY MDRB13 (Micro) | 172.95 |
| SONY MDRB14 (Micro) | 172.95 |
| SONY MDRB15 (Micro) | 172.95 |
| SONY MDRB16 (Micro) | 172.95 |
| SONY MDRB17 (Micro) | 172.95 |
| SONY MDRB18 (Micro) | 172.95 |
| SONY MDRB19 (Micro) | 172.95 |
| SONY MDRB20 (Micro) | 172.95 |
| SONY MDRB21 (Micro) | 172.95 |
| SONY MDRB22 (Micro) | 172.95 |
| SONY MDRB23 (Micro) | 172.95 |
| SONY MDRB24 (Micro) | 172.95 |
| SONY MDRB25 (Micro) | 172.95 |
| SONY MDRB26 (Micro) | 172.95 |
| SONY MDRB27 (Micro) | 172.95 |
| SONY MDRB28 (Micro) | 172.95 |
| SONY MDRB29 (Micro) | 172.95 |
| SONY MDRB30 (Micro) | 172.95 |
| SONY MDRB31 (Micro) | 172.95 |
| SONY MDRB32 (Micro) | 172.95 |
| SONY MDRB33 (Micro) | 172.95 |
| SONY MDRB34 (Micro) | 172.95 |
| SONY MDRB35 (Micro) | 172.95 |
| SONY MDRB36 (Micro) | 172.95 |
| SONY MDRB37 (Micro) | 172.95 |
| SONY MDRB38 (Micro) | 172.95 |
| SONY MDRB39 (Micro) | 172.95 |
| SONY MDRB40 (Micro) | 172.95 |
| SONY MDRB41 (Micro) | 172.95 |
| SONY MDRB42 (Micro) | 172.95 |
| SONY MDRB43 (Micro) | 172.95 |
| SONY MDRB44 (Micro) | 172.95 |
| SONY MDRB45 (Micro) | 172.95 |
| SONY MDRB46 (Micro) | 172.95 |
| SONY MDRB47 (Micro) | 172.95 |
| SONY MDRB48 (Micro) | 172.95 |
| SONY MDRB49 (Micro) | 172.95 |
| SONY MDRB50 (Micro) | 172.95 |
| SONY MDRB51 (Micro) | 172.95 |
| SONY MDRB52 (Micro) | 172.95 |
| SONY MDRB53 (Micro) | 172.95 |
| SONY MDRB54 (Micro) | 172.95 |
| SONY MDRB55 (Micro) | 172.95 |
| SONY MDRB56 (Micro) | 172.95 |
| SONY MDRB57 (Micro) | 172.95 |
| SONY MDRB58 (Micro) | 172.95 |
| SONY MDRB59 (Micro) | 172.95 |
| SONY MDRB60 (Micro) | 172.95 |
| SONY MDRB61 (Micro) | 172.95 |
| SONY MDRB62 (Micro) | 172.95 |
| SONY MDRB63 (Micro) | 172.95 |
| SONY MDRB64 (Micro) | 172.95 |
| SONY MDRB65 (Micro) | 172.95 |
| SONY MDRB66 (Micro) | 172.95 |
| SONY MDRB67 (Micro) | 172.95 |
| SONY MDRB68 (Micro) | 172.95 |
| SONY MDRB69 (Micro) | 172.95 |
| SONY MDRB70 (Micro) | 172.95 |
| SONY MDRB71 (Micro) | 172.95 |
| SONY MDRB72 (Micro) | 172.95 |
| SONY MDRB73 (Micro) | 172.95 |
| SONY MDRB74 (Micro) | 172.95 |
| SONY MDRB75 (Micro) | 172.95 |
| SONY MDRB76 (Micro) | 172.95 |
| SONY MDRB77 (Micro) | 172.95 |
| SONY MDRB78 (Micro) | 172.95 |
| SONY MDRB79 (Micro) | 172.95 |
| SONY MDRB80 (Micro) | 172.95 |
| SONY MDRB81 (Micro) | 172.95 |
| SONY MDRB82 (Micro) | 172.95 |
| SONY MDRB83 (Micro) | 172.95 |
| SONY MDRB84 (Micro) | 172.95 |
| SONY MDRB85 (Micro) | 172.95 |
| SONY MDRB86 (Micro) | 172.95 |
| SONY MDRB87 (Micro) | 172.95 |
| SONY MDRB88 (Micro) | 172.95 |
| SONY MDRB89 (Micro) | 172.95 |
| SONY MDRB90 (Micro) | 172.95 |
| SONY MDRB91 (Micro) | 172.95 |
| SONY MDRB92 (Micro) | 172.95 |
| SONY MDRB93 (Micro) | 172.95 |
| SONY MDRB94 (Micro) | 172.95 |
| SONY MDRB95 (Micro) | 172.95 |
| SONY MDRB96 (Micro) | 172.95 |
| SONY MDRB97 (Micro) | 172.95 |
| SONY MDRB98 (Micro) | 172.95 |
| SONY MDRB99 (Micro) | 172.95 |
| SONY MDRB100 (Micro) | 172.95 |

FOR PROMPT AND COURTEOUS SERVICE, SEND MONEY ORDER, CERTIFIED CHECK, CASHIER'S CHECK, MASTERCARD, VISA, DISCOVER CARD NUMBER, INTERBANK NO. CASHIER'S CHECK, MASTERCARD, VISA, DISCOVER CARD NUMBER, INTERBANK NO. CHECKS MUST CLEAR OUR BANK BEFORE PROCESSING. SHIPPING, HANDLING & INSURANCE CHARGE A 3% OF TOTAL ORDER WITH A \$3.95 MINIMUM. WE SHIP TO: CONTINENTAL U.S., ALASKA, HAWAII, PUERTO RICO, AND CANADA ONLY. Canadian Orders Add 10% Shipping, with a 10% handling charge. For shipments by air, please double the shipping charges. NEW YORK STATE RESIDENTS PLEASE ADD SALES TAX. ALL MERCHANDISE SHIPPED BRAND NEW, FACTORY FRESH AND 100% GUARANTEED.

23 PARK ROW, DEPT. AB, NYC NY 10038
SEND FOR FREE 240 PAGE AUDIO/VIDEO CATALOG

The Detailer Two wonderfully enhances both texture and sharpness in video images.

trols. For example, you may do a nice job of enhancing detail on a prerecorded movie, only to find that video noise has increased. If you use the "VNX" control to reduce the snow, the detail begins to attenuate. It is a juggling act and takes time to learn and control the various parameters.

The Detailer Two can have cumulative benefits as well. Use it to record off the air, use it again when playing

back the recording. Use it when making a duplicate tape, and use it in playing back the duplicated tape! The switcher and distribution amplifier are nice bonuses for the videophile with multiple video program sources. Not cheap at \$349.00, and demanding the development of skill to use it, the Detailer Two works as advertised and is a valuable tool for the dedicated videophile.

FLASH: MINI VIDEO RECORDER

Showing a new type of videocassette the size of a deck of playing cards and a highly miniaturized recorder weighing only 4½ lbs., JVC introduced the VHSC compact videocassette to the U.S. press corps only a week before the June Consumer Electronics Show. Both Fuji and TDK had shown tape samples just days earlier and less than a month after a group of a dozen Japanese makers had announced their support for the new system in Tokyo.

JVC's HR-C3U system can draw power from a car battery, household

current, or its own nickel-cadmium rechargeables in a snap-on pack. The TC-20 compact videocassette uses ½-inch Super HG tape with a better S/N and durability than current tape.

The unit provides a maximum of 20 minutes of continuous recording, not enough for taping TV shows but plenty for the memorabilia of parties, family outings, kids' sports. Compatible with all VHS recorders through a cassette adaptor, the unit also features an automatic start control system, full remote-control capability, and an easily visible indicator for checks on tape recording time available. Price was not announced.

1. Compact VCR.
2. Remote control.
3. Videocassette.
4. Regular battery pack.
5. High-capacity battery pack.
6. Battery charger.
7. A.C. power pack.

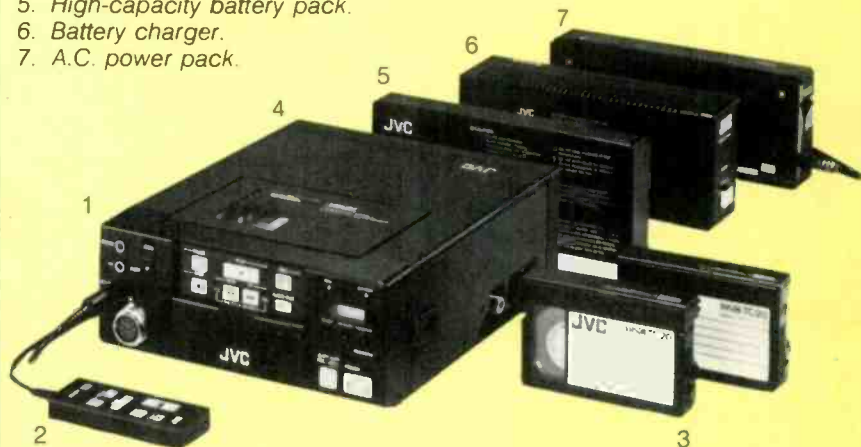

AUDIO, CBS Publications, 1515 Broadway, New York, N.Y. 10036

- 1981 1979 1977
 1980 1978 1975

Name _____

Address _____

City _____ State _____ Zip _____

and when you switch over to the 770's
you will smile and say...it's magic
because there is nothing like it
under the sun!

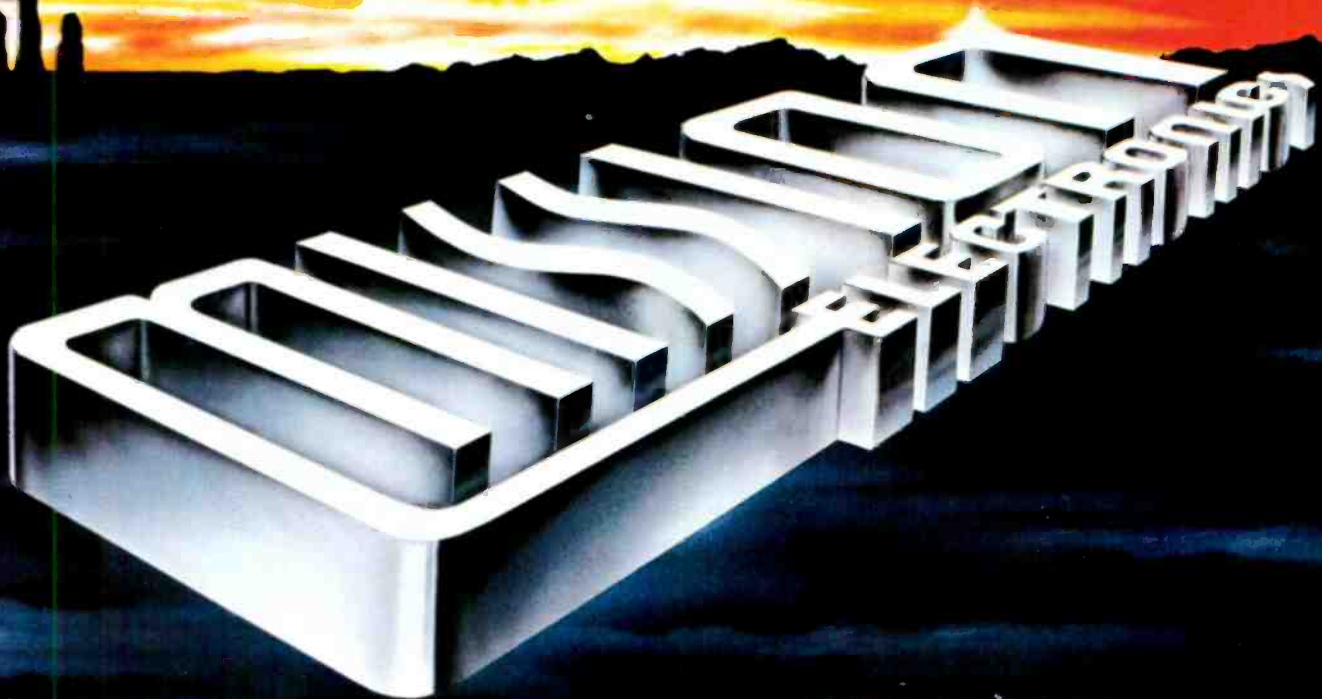

Enter No. 14 on Reader Service Card

Mission North America, 89 Galaxy Boulevard, Rexdale, Ontario, M9W 6A4 Canada
Mission Electronics, George Street, Huntingdon, Cambridgeshire, PE 18 6BD England

The number one selling audiophile loudspeaker in Japan isn't Japanese.

Over the years, Japan has introduced some of the most innovative audio products in the world. So it's not surprising that the Japanese are highly critical when it comes to selecting components for their own homes. What might surprise you, however, is that the number one selling audiophile loudspeaker in Japan isn't Japanese. It's made in the U.S.A. by JBL.

In fact, in a recent survey conducted by one of that country's most highly regarded audio magazines,* JBL was voted the most desired loudspeaker by an amazing 44% of those surveyed. The closest competitor received only 11.9%. Even more importantly, over 25% indicated that they already owned JBL speakers.

To find out a few more surprising facts about JBL, visit the audio specialists at your local JBL dealer.

**Stereo Sound*, Summer 1981 Speaker Systems Market Research



First with the pros.

JBL / harman international



Enter No. 8 on Reader Service Card