

The  
Authoritative  
Magazine  
About  
High Fidelity

# Audio

**SCENES**  
At Summer CES

SEPTEMBER 1980 • \$1.50 • © 06030

**37**

**CASSETTE  
TAPES  
TESTED**

**IN THE  
GROOVE**

**CLOSE-UP  
VIEW OF  
RECORD  
WEAR**



0

27100 06030

# atching Receivers with g drastically reduce ou higher fidelity.

drift free. Once it electronically locks onto a broadcast signal, it holds it. So that anything that would normally interfere with the quality of your signal on conventional receivers is automatically eliminated by the SX-3900 and SX-3800.

You can be sure you'll get to appreciate our tuning section's specs, too.

Our digital quartz tuning systems give five digit readouts that exactly correspond to actual tuned frequencies. Our Fluroscan metering systems will let you see you're getting the most out of your speakers, as well.

Because the meter's usable range is over 50dB from .001 to 120 watts of power.

If you're beginning to think these receivers are like none you've ever seen or heard, you're right. That's why we suggest you get down to your nearest Pioneer dealer to see and hear the SX-3900 and SX-3800 receivers with Non-Switching Amplification.

You'll not only be impressed with what you hear, you'll be impressed with what you don't.

NON SWITCHING

**PIONEER**<sup>®</sup>  
We bring it back alive.

## Non-Switching Receivers.



SX-3900

# Our new Non-Switching Quartz Lock Tuning eliminates switching distortion and gives you

It seems like a simple enough premise.  
And it is.

Eliminate distortion and you clear the path for cleaner, crisper sound.

Unfortunately, many receiver companies have been more concerned about offering you a low price tag than they have been with offering you high fidelity.

But at Pioneer, we believe you shouldn't have to deal in high finance to get true high fidelity. And our new SX-3900 and SX-3800 receivers are proof of it.

**The SX-3900 and SX-3800 eliminate the most significant form of audible distortion. Switching distortion.**

And although you may not have heard of it before, you probably have heard it on your hi-fi system. It's distortion caused by output transistors as they click on and off in response to music signals.

But we at Pioneer prefer to reproduce sound, rather than create it. That's why we've designed our new SX-3900 and SX-3800 receivers to completely eliminate switching distortion.

The Non-Switching SX-3900 and SX-3800 have revolutionary new amplifier circuitry that keeps output transistors from ever completely switching off. So they never have to click back on.

These transistors are exclusively ours. And you'll find they do as good a job of eliminating audible distortion at high frequencies as they do at greatly increasing frequency response.

The end result is that the SX-3900 and SX-3800 have Non-Switching Amplifier sections that deliver uncanny distortion levels of 0.005% THD at 20-20,000 hertz at 120 (and 60) watts per channel, both channels driven into 8 ohms.

**Our specs bring in compliments, but our receivers are best at bringing in something else. Radio stations.**

The Pioneer SX-3900 and SX-3800 receivers also have our exclusive Quartz-Servo Lock Tuning System that's virtually

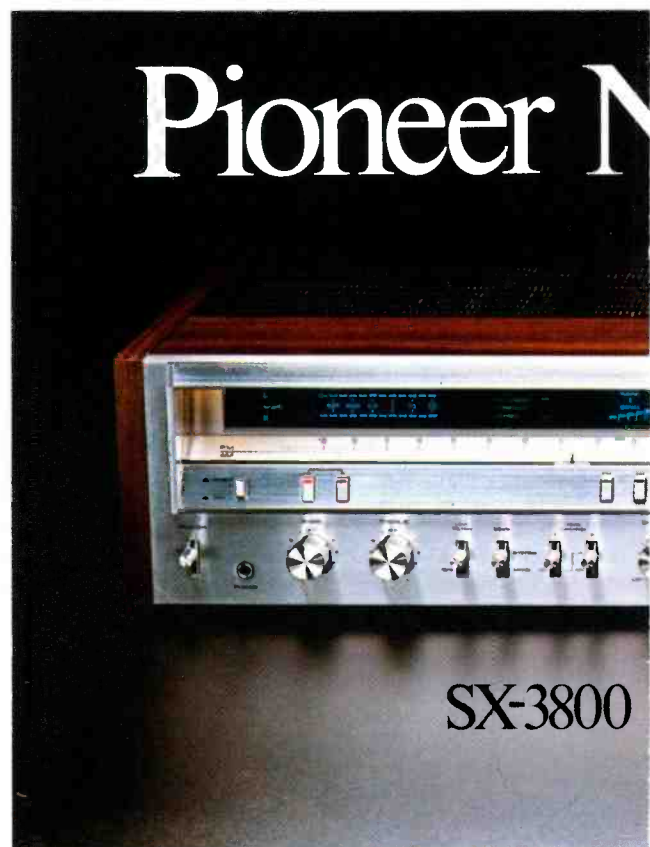

**LOWER  
DISTORTION  
MEANS  
HIGHER  
FIDELITY.**

0 Frequency in kHz 100 200

Distortion in dB -100

-120

-140

-160

Conventional Receivers.

Pioneer Non-Switching Receivers.

300

400

500

Enter No. 22 on Reader Service Card

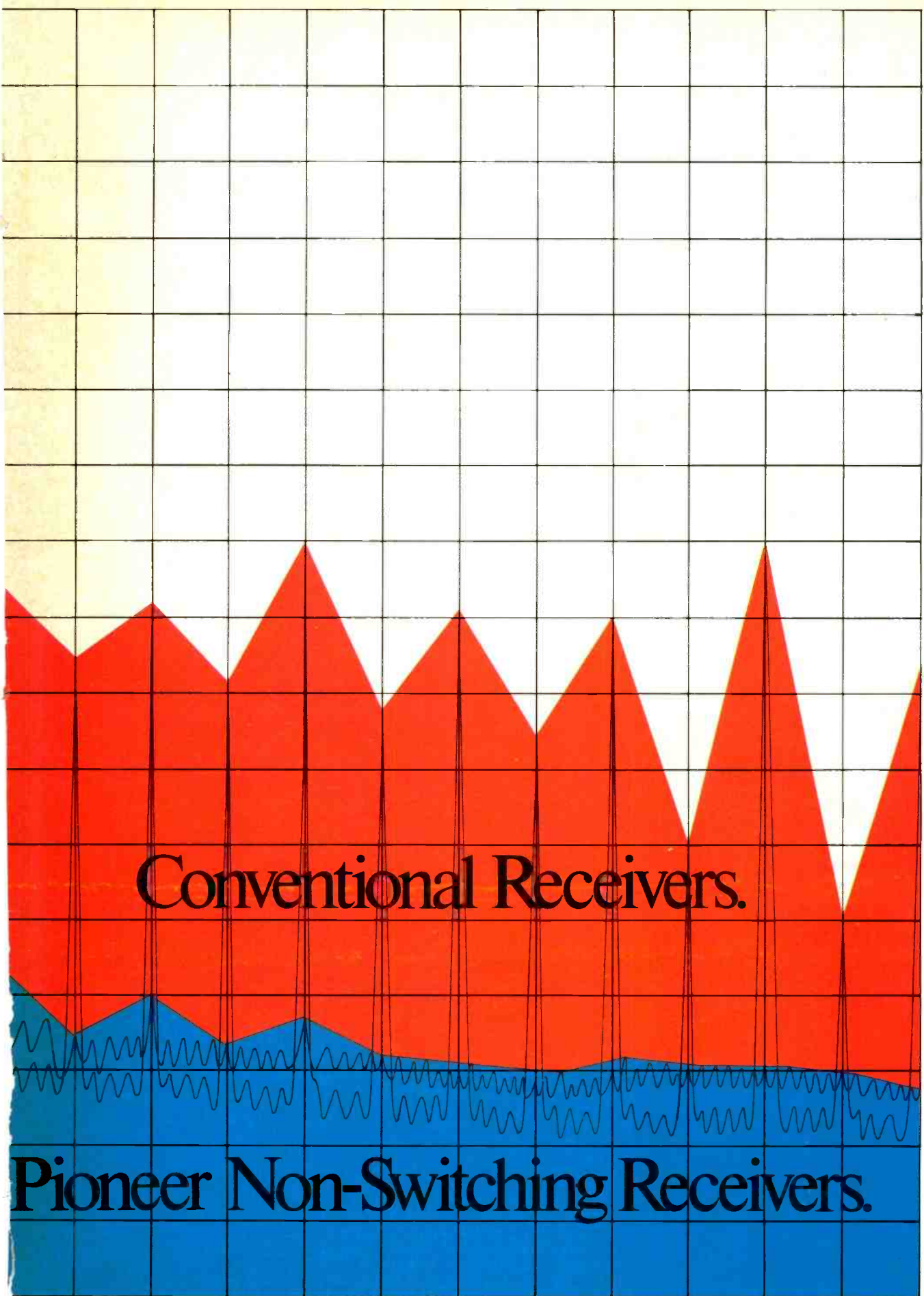

# Audio

"Successor to **RADIO**, Est. 1917"

## Feature Articles

- |  |    |                    |
|--|----|--------------------|
| In The Groove:<br>Close-Up Record Wear | 38 | Walter Davies      |
| 37 Cassette Tapes Tested               | 44 | Howard A. Roberson |

## Equipment Profiles

- |   |    |                   |
|---|----|-------------------|
| Nakamichi 680ZX Cassette Deck   | 56 | Howard Roberson   |
| Nakamichi High-Com II<br>Noise-Reduction System                             | 62 | Howard Roberson   |
| Dual C-820 Cassette Deck  | 67 | George W. Tillett |
| Denon DL-103D Phono Cartridge,<br>DA-307 Tonearm,<br>and AU-320 Transformer | 70 | Edward M. Long    |

## Record Review

- |            |    |                 |
|------------|----|-----------------|
| The Column | 75 | Michael Tearson |
|------------|----|-----------------|

## Audio in General

- |                        |    |                      |
|------------------------|----|----------------------|
| Audio ETC              | 8  | Edward Tatnall Canby |
| Tape Guide             | 18 | Herman Burstein      |
| Behind The Scenes      | 22 | Bert Whyte           |
| Audioclinic            | 30 | Joseph Giovanelli    |
| VideoScenes            | 32 | Bert Whyte           |
| Classified Advertising | 75 |                      |
| Advertising Index      | 85 |                      |

**About the Cover:** Who's the new leader in the cassette performance race? Read Howard Roberson report on 37 cassette formulations, starting on page 44. Photo by Susanne Buckler.



Audio Publishing, Editorial and Advertising Production Offices,  
1515 Broadway, New York, N.Y. 10036.

Subscription Offices, P.O. Box 8167, 1 Fawcett Place, Greenwich, Conn. 06830.

Subscription Inquiries, (800) 243-8002; in Connecticut, (800) 852-8593.

Postmaster: Send Form 3579 to above address.

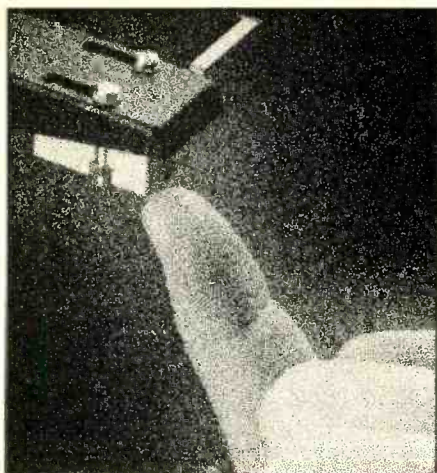

## SC-2 gives your cartridge more than The Finger!

The famous SC-1 stylus brush (standard of the record and hifi industries) now has a synergistic fluid called SC-2.

SC-2 Fluid enhances and speeds cleaning and yet protects diamond adhesives, cartridge mounting polymers and fine-metal cantilevers against the corrosive effects of many other "cleaners."

The Discwasher SC-2 System. Stylus care you can finger as clearly superior.



**discwasher**<sup>®</sup>  
PRODUCTS TO CARE FOR YOUR MUSIC

1407 N. Providence Rd.  
Columbia, Missouri 65201

# The balance between bias and EQ is too delicate to be handled by switches. We use a computer.

For every tape on the market, there's an ideal balance of bias and equalization which yields flattest response combined with least distortion.

Unfortunately, even among presumably standardized formulations, this optimum balance varies widely from brand to brand.

So deck designers shoot for approximate values, which you select with a switch, hoping the deck's pre-set values match your tape.

But with the B.E.S.T.\* computer system included in our new KD-A66 deck, bias, EQ and even noise-reduction levels are all determined from tests the computer actually performs *on your tape*. The result isn't a designer's best guess. It's precise. So you'll hear accurate recordings with virtually any tape. Because the B.E.S.T. system creates conditions that let every tape perform to its optimum.

For dynamic range (another key ingredient in recording accuracy), the KD-A66 has Super ANRS.<sup>™</sup> Besides virtually eliminating tape hiss

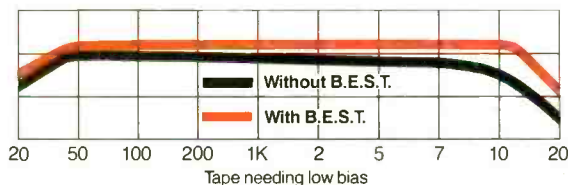
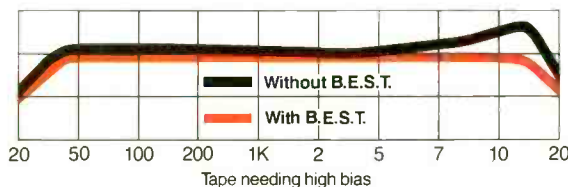

(-70 dB S/N ratio), it also extends high-frequency headroom. So trumpet blasts, cymbals crashes and other "hot" sounds come out clear and lifelike instead of dull and distorted.

For transport accuracy, there's our 2-motor, independent-drive system. It keeps wow and flutter down to 0.04% WRMS, which is

lower than you'll ever hear. While our Sen-Alloy heads<sup>®</sup> make the most of Sendust's low distortion and superb durability. They'll give you clean recordings through years of use.

And for all this, you don't have to sacrifice convenience and operating ease. The KD-A66 gives you logic-governed, solenoid controls. Auto-rewind and play. LED peak-level indicators. And optional remote control.

Just dial 800-221-7502 for the location of your nearest JVC dealer (in N.Y. State 212-476-8300). And go hear what happens when a computer makes tapes sound their B.E.S.T.

\*Bias/Equalization/Sensitivity (of) Tape

Enter No. 11 on Reader Service Card



58-75 Queens Midtown Expressway, Maspeth, NY 11378

**JVC**  
US JVC CORP.

There's only one  
audible difference  
between our  
professional turntable  
and Technics SP-15  
... "\$600.05\* please"



Let's face it. Inaudible specifications are exactly what they say they are... inaudible! Compare our ADC 3001 direct drive professional turntable to Technics SP-15 and you won't hear any difference. Both wow and flutter and rumble are inaudible. So why does their SP-15 cost \$850 when our ADC 3001 costs only \$249.95? Don't ask us. Ask Technics. Our ADC 3001 direct drive turntable comes precision mounted in a high-density Synergite® base. Includes an isolation suspension system that virtually eliminates acoustic feedback. Electronic speed controls. And variable pitch adjustment of  $\pm 5\%$ . There is one thing our turntable doesn't come with... the dust cover. It's optional. But then, so is Technics'. If you'd prefer to hear more about our turntable than pay more for theirs, call us toll-free (800) 243-9544 for your nearest ADC 3001 professional turntable dealer.



\*Based on May 1980 suggested retail prices for both turntables with base.

Enter No. 1 on Reader Service Card

# Audio

**Editor**  
Eugene Pitts III

**Assistant Editor**  
Kay Blumenthal

**Editorial Assistant**  
Deirdre Frank

**Art Director**  
Cathy Cacchione

**Production Manager**  
Carol Schlossman

**Advertising Coordinator**  
Carolynn Sumner

**Associate Editors:**  
Edward Tatnall Canby, Bert Whyte

**Senior Editors:**  
Richard C. Heyser, B. V. Pisha  
Howard A. Roberson

**Contributing Editors/Artists:**  
Tom Bingham, Herman Burstein,  
Ted Costa, John Diliberto,  
Leonard Feldman, Joseph Giovanelli,  
Edward M. Long, C. G. McProud,  
Gary Roseman, Jon Sank,  
Donald Spoto, Gary Stock,  
Michael Tearson, George W. Tillett,  
Jon Tiven

**Publisher**  
Jay L. Butler

AUDIO (155N0004-752X) is published monthly by CBS Publications, The Consumer Publishing Division of CBS Inc., 1515 Broadway, New York, N.Y. 10036. Robert J. Kretling, President  
George H. Allen, Senior Vice President/Magazines  
Francis P. Pandolfi, Vice President and Group Publisher  
Michael Brennan, Vice President and Gen. Manager  
Leon Rosenfield, Circulation Marketing Director  
William Ganz, Advertising Marketing Director  
John J. Miller, Business Manager  
Marlene Jensen, Group Business Manager  
Karen L. Rosen, Production Director

**ADVERTISING SALES**  
Audio, 1515 Broadway, New York, N.Y. 10036  
Jay L. Butler, Publisher  
Telephone (212) 975-7247  
Stephen W. Witthoft, Eastern Adv. Mgr.  
Telephone (212) 975-7654

**West Coast Sales Office:**  
Audio, 3807 Wilshire Blvd., Suite 1201  
Los Angeles, Calif. 90010.  
Jay Martin, Western Adv. Mgr.  
Telephone (213) 487-5880.

**Classified Advertising:**  
Audio, 1515 Broadway, New York, N.Y. 10036  
Carolynn Sumner, Classified Adv. Mgr.  
Telephone (212) 975-7530

**Continental European Representative:** V. B. Sanders, International Publishers Advertising Service, Raadhuisstraat 24, P.O. Box 25, Graft-De Ryp, Holland. Telephone, 02997-1303

**England:** The Paul Singer-Lawrence Media Group, 54 Burton Court, London SW 3 5Y4, England. Telephone, 01-730-3592

©1980, CBS Publications, The Consumer Publishing Division of CBS Inc. All rights reserved.

Dewey Decimal Number 621.381 or 778.5

**Editorial Contributions** are welcomed but should be accompanied by return postage. Submissions will be handled with reasonable care, but the publisher assumes no responsibility for safety or return of manuscripts, photographs, or artwork.

Printed in U.S.A. at Columbus, Ohio. Controlled circulation postage paid at Columbus, Ohio and New York, N. Y.

**U.S. Subscription Rates:** 1 year \$11.94, 2 years \$19.94, 3 years \$25.94.

**Other Countries:** Add \$6.00 per year. Back issues, when available, \$5.00 postpaid.

Audio Publishing, Editorial and Advertising Production offices, 1515 Broadway, New York, N.Y. 10036. Audio Subscription Offices, P.O. Box 8167, 1 Fawcett Place, Greenwich, Conn. 06830

Postmaster: Send Form 3579 to above address.



# Beauty...Without the Beast

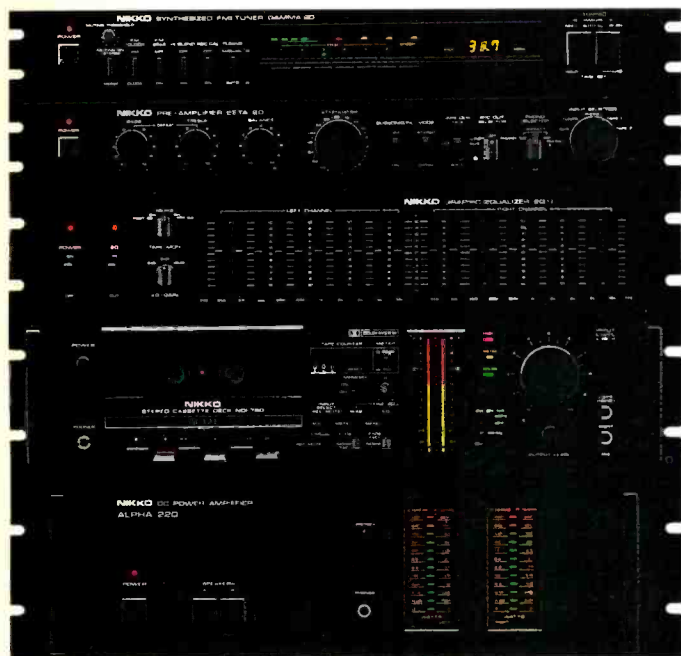

The finest reproduction of sound... matched with the advanced technical design, reliability and aesthetics that make NIKKO AUDIO the stereo components you cannot afford to overlook.

Even more so when you consider their extraordinary value for your money.

Shown here: The Gamma 20 frequency-synthesized digital tuner with 6-station programmable memory, Beta 20 preamplifier with performance, construction and many features of far more costly units, EQ-1 graphic equalizer, ND-790 **NIKKO AUDIO** metal cassette deck

(with optional rack-mounts), Alpha 200 DC servo nonswitching power amplifier.

Experience these and other quality NIKKO AUDIO components at your authorized dealer—all except cassette decks backed by a transferable 3-year parts & labor limited warranty.

© 1980 Nikko Electric Corp. of America, 320 Oser Ave., Hauppauge, N.Y. 11787

# DON'T LET YOUR EGO STAND BETWEEN YOU AND BETTER SOUND.

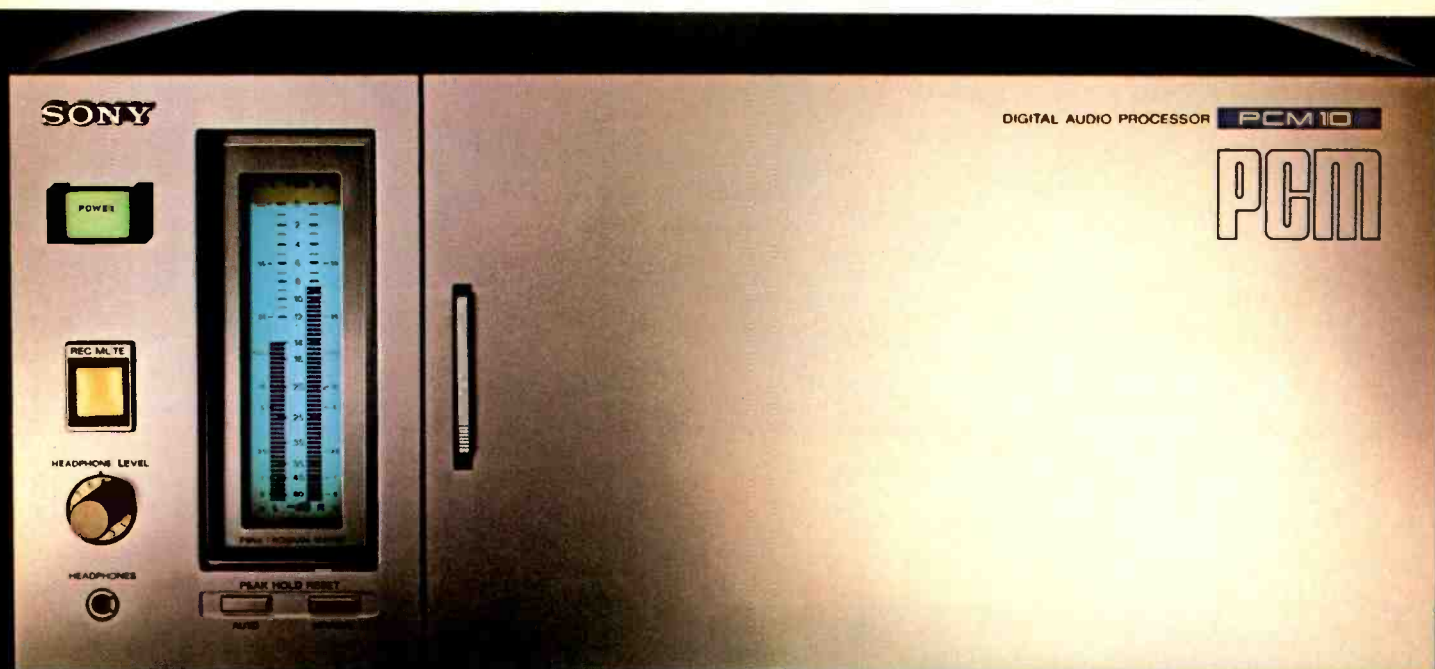

PCM 10 TWO-CHANNEL DIGITAL AUDIO PROCESSOR: Advanced sampling and quantization of musical signals / Specially designed to be used with home-use video tape recorders such as Sony Betamax™ / 14-bit quantization (12-bit, 3 polygonal linear) provides better than 85 dB dynamic range / Frequency response DC-20 kHz  $\pm$  1 dB / Features include liquid crystal (LCD) Peak Program Meters and Record Mute control / Conforms to EIAJ standard format.



PS-380 TURNTABLE: Velocity Feedback (VFB) electronically controlled tone arm system allows automatic tracking, antiskating, and tone arm damping operation / Microprocessor-programmable functions and replay flexibility / Quartz X-tal locked, fully automatic DD turntable, with high-torque BSL motor and Magnedisc servo control / SBMC chassis material, with height-adjustable viscous feet.

XL-55 PRO CARTRIDGE: Sony developed figure 8 moving-coil voltage generating system / 'Air core' armature design, with multiple cantilever construction / Integrated magnesium die-cast low-resonance head shell.

There are those who insist that the most sophisticated audio equipment can only be produced by relatively unknown companies.

At Sony, we take exception to this unwarranted position.

First, because there's probably no audio company in the world that can match the technological resources and research facilities of Sony.

Second, because it is our contention that the Sony Audio Lab components pictured here represent the absolute state of the audio art.

And finally, because no other audio company can match Sony's record for innovation and quality.

So the point of all this is simple.

If you're looking for the ultimate in audio equipment and you find yourself unduly prejudiced at the sight of our name, do us both a big favor.

Close your eyes. And just listen.

**SONY**  
High Fidelity

© 1980 Sony Industries, a division of Sony Corp. of America, 9 West 57th Street, New York, N.Y. 10019. Sony is a registered trademark of the Sony Corporation.

Enter No. 26 on Reader Service Card



TC-K88B CASSETTE DECK: Sendust & Ferrite record / playback head / Metal tape capability / 3 BSL motors, quartz lock direct drive / Micro-processor-IC solenoid logic controls, with Automatic Music Sensor / Power Loading Cassette Module / 33-element LCD Peak Program Meters.



ST-J88B TUNER: Quartz lock frequency synthesis tuner / Varactor diode-MOS FET front end, with Uni-Phase IF filters / Auto and manual 'step' tuning or full 8-station memory with nonvolatile Sony MNOS memory IC / 2 discrete IF circuits for narrow and normal modes.



TA-E88B PREAMPLIFIER: All-stage DC configuration / 'Dual mono' straight-path-signal design / Subchassis isolated dual power supplies / Built-in self-powered head amplifier using Sony LEC low-noise transistors / Selectable-phono impedance and capacitance.



TA-N88B AMPLIFIER: Pulse Width Modulation (Class D) amplifier design / Vertical FET (V-FET) power output transistors / High regulation Pulse Locked Power Supply (PLPS) / 'Dual mono' amplifier configuration / 3-stage protection circuitry.



TA-D88B ELECTRONIC CROSSOVER NETWORK: Plug-in filter modules offer choice of 12 crossover points / Bessel-function filters provide up to 24 dB per octave slopes / Up to -30 dB attenuation range / 'Dual mono' configuration, with subchassis isolated power supply.

# Audio etc.

Edward Tatnall Canby

If you remember the **Collegium Whom** from last month (a 21st century classical resurrection of the well-known WHO, courtesy of Canby), you will know where I am going next. Straight into the immediate hypothetical future — the hypofuture — of the classical disc. This month's hype has to do with the last days of the LP during the Great Interim, now beginning, thanks to that phenomenon of our time, the audiophile disc. It is one of two brave ways we are facing up to the awesome potential of the still absent digital superdisc. We may have a long wait for that. So the audiophile disc could have a long future. But as I see it, it won't, and for quite other reasons. Too many technological leaks.

The Great Interim is that period during which the shadow of digital disc technology, with all its incredible powers, hovers over us but does not descend. The LP is put in the shade, the densest, blackest shade you can imagine. The LP system is obviously very much out of date. Yet it is still our present operating standard and a splendidly useful one after so many years of refinement — and it remains our biggest base for continued hi-fi viability during the Great Interim. *How long?* Who can say? It's going to be a difficult period but the LP is still available and we can use it.

After all, the record and hi-fi business can't just stop and wait. Nor will audiophiles, music lovers, or hi-fi consumers stop and wait either, until they can toss out all their LP-related and/or analog-powered equipment in favor of digital-for-everything. Life goes on. So — the Great Interim begins but has no visible end.

Already there are ominous signs of fights to the digital death among the

big world conglomerates who propose an all-digital audio disc, with their obdurately incompatible systems. There are further dangers in the omnivorous power of TV utilizing the same digital techniques. Maybe the Great Interim will extend forever? Could be! Even though in theory the digital disc seems, at last, to be the ideal way to exploit the already huge and formidable advantages of the disc as an infor-

these high-priced LP goodies are making a lot of noise in the market place, you are right. They are all we've got.

Do not worry — the LP still has potential. Improvements are honest and will continue to be real, not hoked up. If digital had never been imagined, we still could go onwards with LP for a good time. And so we will. We are not yet "dumping" obsolete material on a gullible public! Remember Walter P.

Chrysler? Around 1923 or so he bought out the old Maxwell auto company and by some sort of drastic internal bracing managed to fix up and sell off a whole fleet of orphaned and very shaky Maxwells before launching his own fabulous new 1924 Chrysler. No, the audiophile disc is not an LP Maxwell.

Now I hate to say so, but I think the audiophile concept, even so, is ephemeral. As I say, it is leaky. By which I mean, its very substance will leak away to ever larger and larger record areas — thanks to its success, until it is in effect just our current "regular" or first-line disc. Technology

does update. The benefits spread upwards. The audiophile LP can keep plugging along two steps ahead, of course — if it can swing it. But there isn't that much headroom left and it isn't going to be easy.

Oh, so you think I'm barking up the wrong tree and it is *tape* in the form of the ever-improving cassette that will sustain our hi-fi software during the Great Interim? Including even a possible digital metal cassette? Well, maybe so, but I'm talking about disc. To put it differently, I must remind you that tape and disc have been successfully competing now for almost 30 years with immense benefits to *both* media, and neither one nor the other is about to win. That might be a disas-



mation carrier, that is size and accessibility.

Who knows? By the time you read this, there just might be a sudden surprise disc right there in your local record emporium, some tiny digital thing with hours of playing time on each side, enormous dynamic range, incredible fidelity, no noise at all (well, hardly any), no wear, a shoebox player, and the whole costing pennies. What — the Great Interim over before it's begun? The new age upon us? I have my doubts. Especially about those pennies.

Let us face it, then. We are now into audiophile discs via the old but excellent LP system; we are now into coded discs via the same, and if you think all

Illustration: Leo Pando

**SAVE 50% ON**

**Audio**

**YES, send me a one-year subscription for \$5.97—  
Half the regular rate and  
over \$12.00 off the news-stand cost.**

Payment Enclosed       Bill Me

Name \_\_\_\_\_

Address \_\_\_\_\_

City \_\_\_\_\_

State \_\_\_\_\_ Zip \_\_\_\_\_

Outside the U.S. add \$6.00 per year for additional postage. Payment must accompany order. Your first copy will be in the mail within 6 weeks.

**New subscribers only, please.**

(AU)BOIN28

**SAVE 50% ON**

**Audio**

**YES, send me a one-year subscription for \$5.97—  
Half the regular rate and  
over \$12.00 off the news-stand cost.**

Payment Enclosed       Bill Me

Name \_\_\_\_\_

Address \_\_\_\_\_

City \_\_\_\_\_

State \_\_\_\_\_ Zip \_\_\_\_\_

Outside the U.S. add \$6.00 per year for additional postage. Payment must accompany order. Your first copy will be in the mail within 6 weeks.

**New subscribers only, please.**

(AU)BOIN10



**BUSINESS REPLY CARD**

FIRST CLASS PERMIT NO. 1064 GREENWICH, CT

POSTAGE WILL BE PAID BY ADDRESSEE

**Audio**

P.O. Box 8168  
One Fawcett Place  
Greenwich, Ct. 06835



**BUSINESS REPLY CARD**

FIRST CLASS PERMIT NO. 1064 GREENWICH, CT

POSTAGE WILL BE PAID BY ADDRESSEE

**Audio**

P.O. Box 8168  
One Fawcett Place  
Greenwich, Ct. 06835

NO POSTAGE  
NECESSARY  
IF MAILED  
IN THE  
UNITED STATES

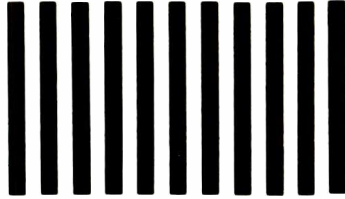

NO POSTAGE  
NECESSARY  
IF MAILED  
IN THE  
UNITED STATES

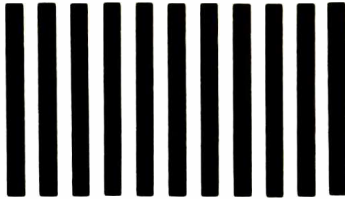

FROM PICKERING

# *The New Shape of Sound*

## THE STEREOHEDRON<sup>®</sup> SERIES

From one of the oldest names in sound development comes the latest sound innovation... the Stereohedron Stylus tip... with expanded contact area for truest fidelity. And now it's available from Pickering in three great cartridges. The critically acclaimed XSV/3000, the new XSV/4000 with expanded frequency response range, and the ultimate in lightweight compliance, the Pickering XSV/5000 which captures all the high frequency information contained in today's finest recordings... creating a whole new experience in recorded sound.



**XSV/3000**



**XSV/4000**



**XSV/5000**

© 1979 PICKERING & CO. INC.



**PICKERING** "for those who can hear the difference"

101 Sunnyside Blvd., Plainview, N.Y. 11803

Enter No. 28 on Reader Service Card

ter! The competition has driven the technicians on both sides to veritable *tours de force* of engineering in the effort to overcome the inherent weaknesses of both media. It's a happy marriage of foes, I say.

The LP came along in 1948 (with 16-inch discs, pre-tape, for its masters) and "pre-recorded" tape began to edge in a few years later — the great hope for progressive recording, destined to supercede the ancient disc medium (so they said). The *coup de grace* should have been that blockbuster from the tape people, stereo sound, the first time commercially, via

two separate and discrete tracks on a single tape. Sensation! Expensive, to be sure (about the same per shot as our present audiophile discs) but inimitable. The obsolete disc, with a single groove, was stuck with mono sound.

But around 1957 the disc people for once agreed on something in a hurry. With a huff and a puff, the entire industry shifted overnight, almost, to the ingenious 45/45 stereo disc, with scarcely a peep from any rival arrangement. Amazing. So the LP was born again. And then tape appeared to be doomed — its stereo was too costly and too clumsy.

Ah yes. Nothing daunted, remember: Tape grabbed hold of an RCA idea, not two, but an incredible *four* tracks on a single tape, two each way in stereo — a neat adaptation of the half-track system earlier introduced (mono) by Ampex. (The four tracks came out of an early RCA stereo cassette, much like ours but vastly bigger — it flopped). Lo, we had four-track reel-to-reel stereo at enormous savings and tape, once again, survived. Then there was high (ever-higher) speed duplication, not good for fi but an answer to a major tape weakness, inadaptability to mass production. And there was Dolby, to meet another problem, noise.

When a little widget called a cassette, with preposterously tiny tapes inside that crawled like a worm — tape worm, began to sprout hi-fi wings (to everyone's astonishment), the LP disc was again on the skids. Now, we said and still are saying, tape was on the winning stretch and gaining fast.

Well, the cassette, indeed, is still gaining in the same old race but the disc is running fast, and out ahead, though no two-year old. As the cassette shows more and more of its true mettle (urgh!), RCA's big eight-legged monster (well, I couldn't say *eight-track*, could I?) still pounds along on all eight, er, limbs (I'll drop this metaphor mix before I crash) but first note those little horseys, and a few big ones off there on the sidelines, grooming up for a future race. Those horseys are all-digital horseys and, if I spy rightly, every one of them flies the disc colors. So, back to disc.

The audiophile disc is the nominal successor to the old and durable "demo" disc but it has already gone far beyond that category. A complex of numerous recent improvements in LP technology, this is a catch-all for elements, formerly separate but happily brought together under one heading for greater impact: Direct-to-disc, digital/analog, high tech (i.e. state-of-the-art plus extra care) along with many specialized details, like half-speed cutting and transformerless electronics, super vinyl, and again, much TLC, tender loving care. All that, plus the new engineering aesthetics of simplicity — fewer mikes, fewer everything (see last month's discussion of pop recording) for ever-greater sonic purity. All of these elements and more go variously into present audiophile discs, which sell at premium prices because they are indeed well ahead of most (but not all) "regular" LP offerings, particularly those that are mass produced by the big outfits.

More and better — a big order! But if the audiophile disc can *keep ahead*

## There's a new sound out of Cambridge ... and it's good enough for digital

The Cambridge 310 tweeter's moving mass of only 1/4 gram gives it flat response to a frequency well beyond human hearing, a sure guarantee that it will reproduce all the harmonics and overtones on your newest digital and direct-to-disc records.

And the 310 midrange with liquid cooling plays louder than you can tolerate, without a trace of audible distortion, as proven in tests by a well-known independent acoustical laboratory.

And if you like bottom end, the Cambridge 310 woofer's low frequency response extends a half-octave lower than competitive speakers to reproduce all the bass that's on the new audiophile discs.

To hear the Cambridge sound that's good enough for digital, take your favorite high technology demo disk to your Cambridge dealer and ask him to A-B the Cambridge 310 against any other speaker he has in the house regardless of price. For the name of your nearest demonstrating Cambridge dealer, circle reader service number or write to us.



# Cambridge

Cambridge Physics, 26 Fox Road  
Waltham, Mass. 02154/(617) 890-1560

Enter No. 6 on Reader Service Card





# Empire's EDR.9

## The Phono Cartridge Designed for Today's Audiophile Recordings



Direct-to-Disc and digital recording have added a fantastic new dimension to the listening experience. Greater dynamic range, detail, stereo imaging, lower distortion and increased signal-to-noise ratio are just a few of the phrases used to describe the advantages of these new technologies.

In order to capture all the benefits of these recordings, you should have a phono cartridge specifically designed to reproduce every bit of information with utmost precision and clarity and the least amount of record wear.

The Empire EDR.9 is that cartridge. Although just recently introduced, it is already being hailed as a breakthrough by audiophiles, not only in the U.S., but in such foreign markets as Japan, Germany, England, France, Switzerland and Sweden.

What makes the EDR.9 different?

1. \_\_\_\_\_

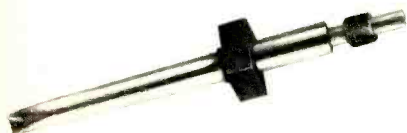

Within the cantilever tube, we added a mechanical equalizer. It serves two purposes: (1) to cancel the natural resonance of the cantilever tube, and (2) to

improve the overall transient response of the cartridge. The end result is a stylus assembly that has a mechanically flat frequency response. The frequency response extends from the 20Hz to 35Hz with a deviation of no more than  $\pm 1.75$  dB. No other magnetic cartridge has that kind of performance. We call this stylus assembly an "Inertially Damped Tuned Stylus," the refinement of which took over 6 years.

2. \_\_\_\_\_

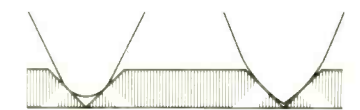

Contact area of ordinary Elliptical Diamond.

Large contact area of LAC Diamond.

In order to reproduce a groove containing extreme high frequency musical overtones, the stylus tip must have small enough dimensions to fit within the high frequency portion of the groove. Yet, the smaller the stylus tip, the greater the pressure applied to the record surface and the more severe the record wear. In the EDR.9, we have responded to these conflicting requirements by developing a stylus that has the proper dimensions from side-to-side, a much

smaller dimension from front-to-back, and a very large, low pressure degree of contact between stylus and groove top-to-bottom. The net result of this large contact area, which engineers call a "footprint," is that the stylus of the EDR.9 can track musical signals to the limits of audibility and beyond, yet has the lowest record wear of any cartridge presently available. The stylus shape of the EDR.9 is called L.A.C. for "Large Area of Contact."

3. \_\_\_\_\_

Conventional cartridges exhibit radical changes in their frequency response when connected to different preamplifiers. This is because the load conditions—the amounts of capacitance and resistance provided by the preamp—vary tremendously from one preamp to another, and from turntable to turntable. Consequently, most phono cartridges, even expensive ones, have their frequency response determined essentially by chance, depending on the system they are connected to.

But the electrical elements of the EDR.9 have been designed to remain unaffected by any normal variations in load capacitance or resistance. Thus, the EDR.9 maintains its smooth frequency response and accurate transient-reproduction ability in any music system, irrespective of loading conditions.

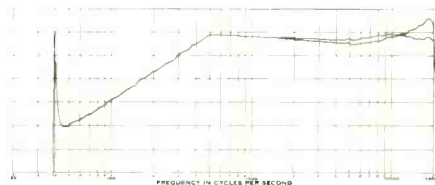

A conventional cartridge's frequency response changes when connected to different preamps.

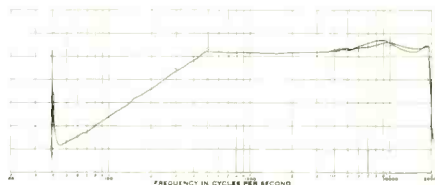

EDR.9 is not affected by changes in loading conditions.

4. \_\_\_\_\_

Then, as a final test of performance, we listen to every EDR.9 to make certain it sounds as good as it tests. At \$200, the EDR.9 is expensive, but then again, so are your records.

For more detailed information and test reports, write to:

Empire Scientific Corp.  
Garden City, NY 11530

**EMPIRE**

EMPIRE EMPIRE EMPIRE EMPIRE EMPIRE EMPIRE EMPIRE EMPIRE EMPIRE EMPIRE EMPIRE EMPIRE EMPIRE EMPIRE EMPIRE EMPIRE EMPIRE



Enter No. 9 on Reader Service Card

# fact: the ultimate ...made more affordable



® **SHURE** ®

**SME**

## Series IIS tone arm

The designers of the award-winning Series III tone arm took on the challenge of developing a tone arm with essentially *the same* outstanding performance characteristics as the Series III, but at a significant reduction in price.

The Series IIS tone arm is an instrument that is still definitely in the connoisseur class employing state-of-the-art materials and technology for unsurpassed strength-to-weight ratios in critical areas. Perfectionists will achieve the same flawless performance they have come to expect only in the SME Series III.

The tone arm and shell are combined into a one-piece "cartridge carrier," which is removable and interchangeable. Coupling is close to the fulcrum so the carrying arm makes a minimum contribution to the Series IIS total effective mass.

Tracking force and bias adjustments are controlled by a sliding weight adjustment. A fluid damping system is available separately.

® **SHURE** ®

Shure Brothers Inc., 222 Hartrey Ave., Evanston, IL 60204  
Manufacturers of high fidelity components, microphones,  
sound systems and related circuitry.

in a convincing way, it will continue to be favored by buyers with extra cash for guaranteed supersound. But can it keep ahead?

That, as Shakespeare observed, is the rub. Never discount progress, it's a multi-edged sword. Ahead of what? OK, right now it is as above — but will the rest of the LP pack continue to oblige by remaining inferior? Not if it can be helped. Especially if the audiophiles sell in ever larger quantities — which means, alas, ever less and less TLC. Contradictions galore.

### High-Tech Cylinders?

Those leaks. There is not much that is literally exclusive in audiophile technology — not even TLC, which can be summoned up by anybody, given enough reason. Anybody can try this audiophile game; anybody can attempt to match audiophile quality at "regular" prices. Or even at high prices but minus the deluxe business. And most noticeably of all, the BIG companies can jump into it whenever they are so moved. Impossible? Never underestimate the big company when it is up against a wall! (Most are, right this minute).

The idea of an extra-tech disc, sold at a premium price, is hardly new, though this is the first element in the audiophile's appeal to us. I can think of dozens of examples in past times, back into 78 days and much further — Thomas A. Edison tried it with his oversized cylinders. There was Emory Cook, beginning on 78s, and X, and Y and Z — the ones I am forgetting to mention. There was the Westminster Lab Series (especially processed from original masters) and Concert Hall Society's bright red 78 vinyl records in fancy red albums, then later, red LPs. (That company reversed engines and shifted to extra-low-priced LPs, with huge success, take that as a caveat). All of these and more played upon the theme of extra quality and limited, careful, methodical production. That is supposed to be the way our premium audiophile discs are made.

But is the concept getting out of bounds? They're selling too many. How can you produce "custom" records on a mass basis? Anyhow, how can a *small company* do it? Success is breeding contradiction.

It remains true that a small company can more easily produce quality products than a big outfit, where quality must filter down through a long chain of command and, too often, simply disappears. But what happens when success among the small companies elicits envy, or "notice" from the big? Suddenly the big people see the light and start ponderously to move in with

all their superior heft. We are at that point right now. Columbia, for instance, announced itself as being squarely in the audiophile disc business last June. I have not heard the Columbia records but my fingers are favorably crossed — big companies can indeed perform miracles when they absolutely *have to*.

What if the relatively mass-produced biggie Audiophiles turn out to be just as good as the careful, slow, TLC-type custom disc we already know? Definitely likely. With enormous resources, a big company can find undreamed-of ways to improve its technology, ways that are impractical for any small outfit. So here is a disastrous "leak" that could bleed the present audiophile disc firms to death.

There is still one more element in the audiophile disc that leads to paradox. These discs are offered, as the name implies, primarily to the audiophile — the listener who wants first of all the very best fi. Music is assumed to be a vehicle, here, for the advantageous exposition of sonic virtues. It's the "demo" disc again. Accordingly, we already have on audiophile records most of the old familiar demo items including the inevitable cannons of 1812. But demo repertoire has in the past been decidedly limited and the art of music has been pretty badly served for the most part. I groan when another demo turns up — if the music is good, it's a miracle.

But look, Ma, what's happening, no hands. Things have changed and the reason is simple. How many 1812 Overtures can you have in an expanding audiophile market? The old demo repertory has run short, and has had to expand. Miracle! Suddenly, all sorts of interesting music (from the musical viewpoint) is appearing on audiophile disc! A necessity, unless you want a couple of hundred 1812s on as many labels. So, willy-nilly, for very practical reasons, the audiophile disc is becoming a musical disc as well, in ever-widening variety. Another contradiction! The Schwann Record & Tape Guide has already integrated its audiophiles into the regular listings. A hint of the future? I would say so.

As you see, the audiophile concept, successful as it is, and *because* it is successful, is already leaking its very guts out all over the place. It will have to fight violently to keep ahead, as standard technology moves forward; it will lose heavily as "regular" lines of records get the idea and find ways to do the same things at maybe a bit less cost. The whole thing is like water in a sieve. How can it be otherwise? Even without the massive intervention of the big companies.

# YOU DON'T OFFER A BETTER WARRANTY WITHOUT A CASSETTE TO MATCH.

**INTRODUCING NEW, IMPROVED SOUND  
FROM NEW, IMPROVED SCOTCH® MASTER™ CASSETTES.**

Redesigned cassette shells have new snubber posts and better tape guides. Result: flutter problems are virtually eliminated.

Master II has a different, better oxide formulation. Sounds great!

Greatly improved manufacturing process gives Master III higher and brighter highs than ever before.

Better lubricant and binder insure Master III against squeal and head clogging.



Pressure pads that hold tape against heads have short, tight fibers to help prevent possibility of dropouts.

Inside our cassettes is a new kind of shim that improves tape feed—winds better.

Redesigned album boxes are stronger, protect better.

All of these improvements are part of our continuing effort to make Scotch Master Cassettes sound better than ever. Try it and save with the coupon below.

## INTRODUCING THE NEW SCOTCH® LIFETIME SATISFACTION WARRANTY

With our new and improved cassettes you'll probably never have to use our new warranty. But it's good to know that if the unexpected *ever* happens, here's what we'll do: If, *for any reason*, you're not satisfied with a Scotch® Master™ Cassette, send it back to 3M and we'll replace it free.

**\$1**

**\$100 OFF**  
TO TRY ANY  
**SCOTCH® MASTER™ CASSETTE**

**\$1**

To consumer: Your dealer will redeem this coupon only with the purchase of a Scotch Master Cassette. Any other use constitutes fraud. To dealer: 3M will redeem this coupon for \$1.00 plus 5¢ handling, in the form of a credit memo on any purchase of Scotch Magnetic/AV retail product, provided you and your customer have complied with the terms of this offer. Any other application constitutes fraud. Invoices showing purchase of sufficient stock to cover coupons redeemed must be shown on request. No reproduced copies of this coupon accepted. Not good on special dealer or consumer promotional packs. Coupon void where prohibited, taxed or restricted. Customer must pay any sales tax. Offer good only in U.S.A. To redeem coupon, mail to 3M Co., 3M Center, 223-5N, Scotch Master Coupon, St. Paul, MN 55144. Cash value: 1/20¢. LIMIT ONE COUPON PER PURCHASE. OFFER EXPIRES JUNE 30, 1981.

**SCOTCH® MASTER™ CASSETTES. THE TRUTH COMES OUT.**

# 3M

Enter No. 14 on Reader Service Card

## The pre-eminent pick-up arm

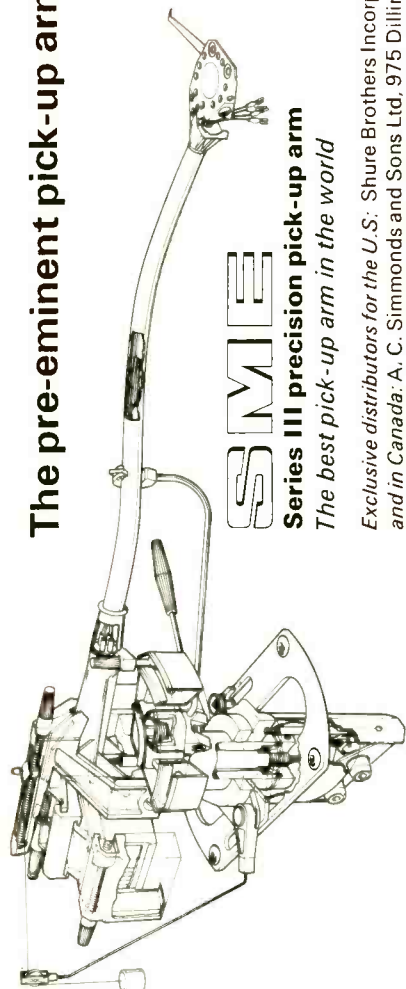

**SME**

**Series III precision pick-up arm**  
*The best pick-up arm in the world*

*Exclusive distributors for the U.S.: Shure Brothers Incorporated, 222 Hartrey Avenue, Evanston, Illinois 60204  
 and in Canada: A. C. Simmonds and Sons Ltd, 975 Dillingham Road, Pickering, Ontario, L1W 3B2*

Whilst able to explore the best of the present, the Series III precision pick-up arm anticipates the greater engineering elegance of impending miniature cartridges which may weigh as little as one and a half grammes.

Its unique patented balance system minimises mass and inertia, presenting optimum conditions for even the most delicate transducer.

No other pick-up arm is as versatile, a reason why the Series

Write to Dept 1457, SME Limited, Steyning, Sussex, BN4 3GY, England

III is already playing its part in the development of tomorrow's cartridges.

Choose it for your listening pleasure today with confidence in the future.

*\*Another accolade for SME: the Series III precision pick-up arm was one of the Design and Engineering Awards at the 1979 U.S. Summer Consumer Electronics Show, the only pick-up arm to be acknowledged in this way.*

## Too Much TLC

When the big companies move in, you small guys will just have to get out of the way, as always. And maybe wait awhile, until they (also as usual) begin once more to bog down in their own chains of command — then back you come! But by that time maybe the Great Interim will be over.

Oddly, though, I feel that perhaps the biggest threat to the whole audiophile disc concept comes inconspicuously from the very same type of small company that originated it. Don't think that abundant TLC, loving, careful, expensive production, goes only into high-priced specials! Human beings are fallible, engineers included. They often can't resist doing their utmost for perfection even when it doesn't pay. One of the heartening developments of the past decade or so has been the remarkable quality of sound that has come out of dozens of small record companies, even microscopic (one-disc) companies — thanks precisely to this very human aspiration plus, of course, the availability of superb professional audio equipment and processing. A few of the little labels are already into the audiophile category, to bring in a prestige dollar or two, but most, I expect, will just keep right on making excellent "standard" records at the regular price, whatever that may be, even if they lose their shirts. Human nature. A lot of these discs, I must say, are now and will be more often, indistinguishable from audiophile, further blurring the whole audiophile concept of something extra-special.

It's all extremely positive, in every aspect, and it could not happen without success. We can be glad that the ancient LP is still so versatile after 32 years, under pressure of present circumstances — the approach of digital disc techniques. But if you ask me, one of these days the audiophile LP is just going to have to freeze its prices where they are and declare itself THE LP. A sort of *coup d'etat*. It will simply merge with the regular lines and then everybody can charge those higher prices. How lovely.

Until, that fatal day when the Great Interim suddenly is over and we have a new all-digital record system. I suppose that it is bound to happen some day, because digital techniques are here. When digital arrives and a new disc system with it, the whole LP shebang will vanish into thin air, and not with a bang but a whimper, as T.S. Eliot once said.

It will be my whimper. I love the LP and have lived most of my audio life with it. I will hate to see it go. 

# IT'S JUST LIKE BEING THERE



**AKG  
K-340**

**ELECTROSTAT  
DYNAMIC  
HEADPHONES**



**AKG ACOUSTICS, INC.**  
 77 SELLECK STREET  
 STAMFORD, CT 06902

# Reel Versatility At a Cassette Deck Price. The New Realistic® Upgrader.

Upgrading is for music lovers who can hear the difference. For them, Radio Shack has made "the difference" affordable . . . for example 30-28,000 Hz ( $\pm 3$  dB) frequency response, extended dynamic range, low distortion, low noise — you get it all in the easy-to-be-creative open reel format. Tape handling is no problem because the TR-3000 is totally logic controlled. A pushbutton-activated solenoid system controls all tape movement — you can switch functions instantly, without tape spills or snarls. Pause and mute controls even let you edit, electronically, as you record.

The TR-3000 has three motors. A precision servo-controlled capstan motor reduces wow and flutter to less than 0.06% WRMS. And two high-torque reel motors maintain constant tape tension for smooth, fast winding. Separate play, record and erase heads give you "off-the-tape" monitoring. Individual mike and line input controls work like a built-in mixer. High/low bias and EQ switches for an optimum match with any tape.  $7\frac{1}{2}$  and  $3\frac{3}{4}$  ips speeds. And lots more. Realistically priced at only \$499.95.\* Check its superb sound and specs at one of our 7000 locations today!



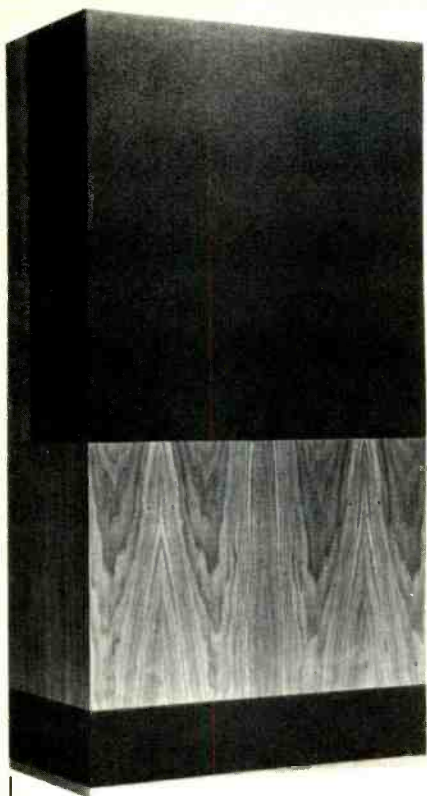

## The Snell Type A

- Flat power response and flat early arrival response
- Freedom from room boundary interference effects
- Near total elimination of diffraction delayed signals
- Correct reconstruction of spatial information through frequency-constant ratio of early arrival and reverberant sounds
- Optional bi-amplification with Snell Acoustics Electronic Crossover
- Extremely wide dynamic range

The Snell Acoustics Type A Loudspeaker is designed for convenient placement near a rear or side wall so as to control room boundary reflections and augment bass performance. Individual tuning of crossovers to drivers in each speaker, together with exhaustive testing including listening comparisons with our reference Type A result in closer quality/performance tolerances than are obtainable through large scale assembly line production.

The theoretical benefits of the 5 year development of the Type A can be examined in more detail by requesting our brochure, or experienced directly by an audition at one of our dealers.

**Snell Acoustics**  
10 Prince Place, Newburyport, MA  
01950 617-462-3194

Distributed in Canada by Esoteric Audio Systems, Milliken, Ontario

Enter No. 25 on Reader Service Card

# SNELL ACOUSTICS

Herman Burstein

# Tape guide

## Solving Dropout Problems

**Q.** I have a cassette deck that I use to make recordings for playback on an automobile player. After 40 to 50 playings, some spots of the tapes I use begin to suffer high-frequency dropouts. This is very annoying. I clean the heads on both machines and demagnetize them after every six to eight hours of operation. Is it possible that the cassette tape has worn out? — Richard Bailey, Lynchburg, Va.

**A.** The following are factors which might account for your dropout problem: (1) The oxide coating on cassette tape is quite thin compared with open-reel tape; the longer the playing time of the tape, the necessarily thinner is the coating, and the more subject it is to wear. (2) You may have obtained an inferior batch of tape. (3) The tape guide finger may be causing wear. (4) One tape manufacturer may be doing a better job than another in providing an oxide coating that is uniform and resistant to wear, and in providing properly lubricated tape. (5) After cleaning the heads, you may not have allowed sufficient drying time; the head cleaner (if a liquid) can dissolve the coating.

## Proximity of Speaker Magnets

**Q.** Because of space limitations I would like to put my cassette deck on top of one of my speakers. Will this cause problems due to the closeness to the speaker magnets?—Dan Puzbanz, Shawano, Wisc.

**A.** It is extremely unlikely that placing your cassette deck atop your speaker cabinet will cause any problems or harm. A distance of about two or three inches between the speaker magnet and other components is sufficient safeguard. I suggest that you read my article, "Magnetic Shielding," in the April, 1979 issue of *Audio*, which indicates how little danger is ordinarily presented by speaker magnets, audio power transformers, etc.

## Disengagement of Transport

**Q.** I recently bought a radio and cassette player for my car. This player can be switched off by the ignition. I have read that switching the power off with the cassette player in operating posi-

tion can cause a flat spot on the pinch roller. I try to remember to shut off the player before turning off the ignition, but this is an irritation. Is this really necessary? — David Benker, Victoria, Texas.

**A.** Yes, it is important to disengage the capstan and pinch roller from the tape when the transport is not in motion, otherwise the roller tends to go out of round. However, the roller tends to remember its original shape and to return to it when disengaged or in motion. If you leave the capstan and pinch roller engaged only for a short period when the transport is stopped, probably no permanent harm will be done. However, a permanent flat spot might occur if they are engaged for a long time but not in motion.

## Metal Tape and Non-Metal Decks

**Q.** If a metal tape has been recorded on a metal tape deck, can it be played on a standard deck? Do the electronics of the playback amps have sufficient headroom for the higher level obtained from a metal tape? Can the playback head of a standard deck take the wear and level of metal tape? Can I convert a standard deck to record metal tape? — Charles Wilson, Wheaton, Ill.

**A.** For playback, recorded metal tapes are generally compatible with non-metal decks. The playback amps in such decks usually have no problem in accepting the higher level of metal tapes, nor do the playback heads. I have heard nothing authoritative about metal tape being more abrasive than other tapes, but I doubt there is any problem.

It would be only with great difficulty that you could convert your deck so that you can record metal tape. Many changes would be needed, including new record and erase heads, greater output from the bias-erase oscillator, more audio drive current, etc.

If you have a problem or question on tape recording, write to Mr. Herman Burstein at AUDIO, 1515 Broadway, New York, N.Y. 10036. All letters are answered. Please enclose a stamped, self-addressed envelope.

# AFTER 500 PLAYS OUR HIGH FIDELITY TAPE STILL DELIVERS HIGH FIDELITY.



If your old favorites don't sound as good as they used to, the problem could be your recording tape.

Some tapes show their age more than others. And when a tape ages prematurely, the music on it does too.

What can happen is, the oxide particles that are bound onto tape loosen and fall off, taking some of your music with them.

At Maxell, we've developed a binding process that helps to prevent this. When oxide particles are bound onto our tape, they stay put. And so does your music.

So even after a Maxell recording is 500 plays old, you'll swear it's not a play over five.



**IT'S WORTH IT.**

# Recording engineers rely on Crown amps to make better music.



THE BARN Recording Studio, Alexandria, Indiana.



# So can you.

## CROWN IN THE STUDIO

The recording engineer, who employs both art and science to create the final tape, does not listen to the music "live" while he is recording.

He wants to hear the music in the same way *you* will hear it. So while he's creating the final recording, he listens to the output of his mixer board through a carefully selected speaker/amplifier system in the control room. The system is identical to those available to you at quality audio dealers.

BILLBOARD Magazine, each year, surveys U.S. recording studios to determine brands of equipment used. Year after year, the #1 power amplifier has been Crown, selected by more recording studios to drive monitor speakers than the next three brands combined.

MIX Magazine publishes equipment lists for U.S. recording studios. Again, the favorite brand of power amplifiers is Crown. Most interesting is the fact that as you consider studios with

more sophisticated capabilities (16 or 24 track and up), the proportion of studios selecting Crown as their *only* monitor amplifier increases. The more experienced the professional, the greater is his reliance on Crown.

The music which is so important a part of your life was probably first heard by a recording engineer through a system powered by Crown amps. We think it makes good sense to use that same Crown quality when you're listening to that music at home.

## CROWN AT HOME

The Crown Information Package tells all about Crown and its products, and is possibly the finest collection of audio information easily available to you from a manufacturer. In over 50 pages, we have included Crown technical papers on audio concepts, discussions of product design and operation, product reviews from publications, specifications, prices, dealer locations – and much more. Many illustrations are in full color.

To order the package, send three dollars with the coupon. If it's not worth it, send it right back. We'll refund your money.

Or you can, if you wish, simply check our number on the reader service card in this magazine, and we will send you – free – a listing of nearby Crown dealers. They have much of this same information for free. They are also very knowledgeable about Crown amps, and would be pleased to spend some time discussing your needs for a better system, and demonstrating our products. It's worth your time to visit them, just to keep up with what's new from Crown.

## CROWN AND GOOD SOUND

Whatever your taste in music – symphonic, acid rock, chamber music, pop, baroque, disco, opera or c & w – it will sound more like it should with Crown amps in your system. Since the good sound of your kind of music is important to your lifestyle, you owe it to yourself to check out the equipment that makes it sound good in the first place – Crown.



Enter No. 7 on Reader Service Card

Product shown with options



1718 W. Mishawaka Road, Elkhart, Indiana 46514

*Innovation. High technology. American. That's Crown.*

TO: Crown International

1718 W. Mishawaka Rd., Elkhart, IN 46514

Here's my three dollars. Please rush my Crown amp information package.

Name \_\_\_\_\_

Address \_\_\_\_\_

P.O. Box No. \_\_\_\_\_ Apt. No. \_\_\_\_\_

City \_\_\_\_\_ State \_\_\_\_\_ Zip \_\_\_\_\_

# Behind the scenes

Bert Whyte

The Summer Consumer Electronics Show made its annual stand in Chicago June 15 to 18, and the reception afforded it by the attendees was about the same as the weather in Chicago... cool. Long considered the premier showcase of the industry and a bellwether of its economic health, the mood at the SCES was somber and subdued, a reflection of the recession which afflicts our country.

Oh, there were some brave noises from the hierarchy of the CES about "record registration," but advance registrations by mail do not necessarily mean warm bodies at the Show. There was no question whatever that traffic was light, and some industry wags said you could throw a bowling ball down the aisles at McCormick Place without hitting anyone. An exaggeration, of course, but dealer attendance was down and there were fewer representatives from the larger retail organizations. Most were playing things close to the vest and being very selective and restrictive in their buying. Ironically, in the midst of all this depressing scene, some manufacturers with interesting new products to show, exulted that this was their "best Show ever." (Editor's Note: While I do agree with friend Bert about attendance, the large majority of the makers and distributors with whom I spoke indicated that they wrote good business at the show. My feeling is the attendance level was indicative of some further belt-tightening over the previous six months to a year — that instead of six fellows from a store coming to the CES, just the chief buyer showed up. — E.P.)

In an industry that has never known a deep recession until now, some organizations are obviously coping bet-

ter than others with the realities of the present situation. The sad thing about this low-key SCES is that in spite of some great expenditures of energy and money, the results were generally disappointing. Believe me, the exhibits were as glittering and glamorous and as well executed as ever. To say there was a plethora of products is a gross understatement. There were unending vistas of them and, as usual, far more

which has a design feature I have for years been hoping would be incorporated into a consumer turntable. As I am sure you are aware, when a lacquer is cut on a recording lathe, it is held tightly in place on the lathe platter by means of a vacuum "chuck." The lathe platter has a series of concentric channels machined into its surface, with tiny holes in the channels directly connected to a vacuum pump. When the

pump evacuates air from the channels, a vacuum is created and the lacquer is "sucked" tightly onto the platter. The Lux PD-555 operates on the same principle. The platter is an 18-pound aluminum die casting, with a sort of bell chamber on the underside of the platter. On the top perimeter and the "label" areas of the platter are two seal rings, with two air holes connected to the bell chamber and thence to a vacuum pump. With our present low-weight, thin-profile phonograph records, those infuriating dish and pinch warps are the rule rather than the exception. When these pesky discs are



than even the most dedicated reporter could possibly cover. There were many comments that this SCES was heavily video oriented (see my "VideoScenes" report), but there was also a staggering array of audio equipment. As usual, the more exotic audio equipment was to be found in the Pick-Congress, McCormick Inn, and a few other hotels. As has been my practice for the past several years, I will not attempt a "shotgun" coverage, but rather a selective report on those audio products which I feel are interesting and can make a contribution towards the realistic reproduction of music.

As far as I am concerned, one of the most exciting new products at the Show was the Lux PD-555 turntable,

placed on the platter of this Lux turntable and the vacuum switched on, the air is evacuated between the seal rings and the warps are eliminated as the disc is sucked tightly to the platter. I tried to remove the disc from the turntable with the vacuum on, and even using considerable force, it is almost impossible to do so. Playback of flat discs removes a number of distortions, not the least of which is warpage induced low frequency overload. A considerable bonus is the virtually complete damping of vinyl resonances. Under vacuum, when the disc was sharply struck, there was a most satisfying non-resonant "thunk." The Lux PD-555 is a belt-driven unit using a brushless, slotless d.c. servo motor.

# Music sculptor.



Meet the music sculptor. The new EQ400 car stereo graphic equalizer. Sensitive. Perceptive. And remarkably precise. Simply connect it between your stereo source and power amplifier.

Then reshape the response of your music to your own taste. Enhanced mid-bass... a little more sheen to the strings... a bit more bite on the brass. Contour, mold, enhance the music until it's just right for your ears.

## 15 bands: total control.

That's right. A full *fifteen* bands are at your command with this graphic equalizer. To shape your music like no other car equalizer can.

Looking at the EQ400 you'll see five sliding controls with a  $\pm 12$  dB range. Look closer, and for each control lever there's a selector for three different bands. Fifteen in all.

Center frequencies controlled are:

60 Hz	80 Hz	125 Hz
160 Hz	250 Hz	400 Hz
630 Hz	1000 Hz	1600 Hz
2400 Hz	3500 Hz	5000 Hz
7000 Hz	10,000 Hz	14,000 Hz

## Even more precision.

Our desire for precision doesn't stop with the fifteen bands.

The EQ400 offers you more precise tuning *within* each band as well.

The top-mounted sliding scales on the EQ400 are physically almost twice as long as the short, front-mounted controls on most other equalizers. Which means far better resolution. For much more precise adjustments... and much more precise sound.

You can instantly compare any boost or attenuation you

the dash equalizer.

The EQ400 rests unassumingly under the dashboard. That is, until you're ready to use it.

Then... a slight pull slides it out to reveal a full, top-mounted illuminated control panel.

The top-mounted controls are easier to see, easier to reach and easier to use.

When you're finished adjusting, just slide the unit back under the dash. That way the controls aren't exposed where they can be accidentally bumped out of position. And meanwhile, an LED on the front glows to indicate the unit is on.

The same bracket can also be used to mount the equalizer right at your fingertips, between the bucket seats of smaller cars and vans.

## Your own kind of sound.

No longer do you have to settle for someone else's interpretation of your music.

Because now you can shape it and enhance it with music sculptor. The Jensen EQ400 graphic equalizer. Or the EQA3000 5-Band Graphic Equalizer with built-in dual 12-watt power amplifiers. Hear what they can do... soon.

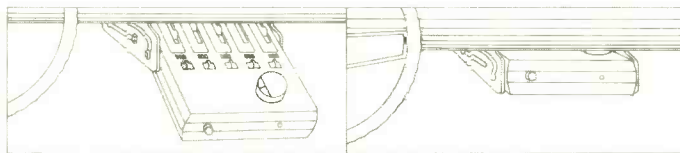

The EQ400 has a special under dash mounting. This enables you to slide it out for easy adjustment. When you're finished, slide it back. The controls then can't be accidentally knocked out of adjustment.

make with the equalization defeat switch. A front-to-rear fader control offers additional flexibility. And with its switchable 10/47 ohm input impedance, the EQ400 can be connected to any low impedance stereo source.

## Slide out, tune in.

This is no ordinary under

**JENSEN**  
SOUND LABORATORIES  
AN ESMARK COMPANY

All the operating components are in a heavy, diecast aluminum frame, heavily insulated to prevent acoustic feedback. This unit is a three-speed turntable and has provisions for mounting two tonearms. The vacuum pump supplied can provide up to 20 cm Hg pressure, twice what is needed for operation of the vacuum chuck. A vacuum pressure meter is mounted on the turntable base, and I found the operating pump virtually inaudible. A major development, this Lux PD-555 turntable, with the only rub being the \$2800.00 price, but I would speculate that this technology will ultimately be found on lower priced units. In the meanwhile, I can hardly wait for a hands-on experience with this fascinating new turntable.

Staying with the utilization of air,

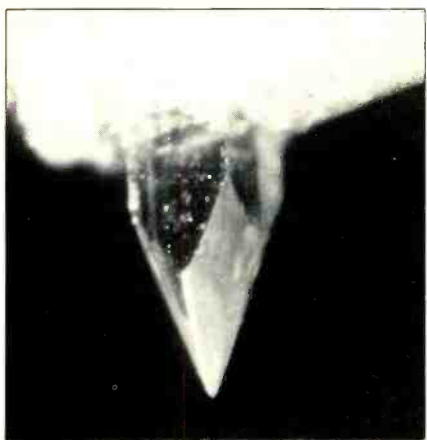

**Stylus Tip, Marovskis MIT-1**

the Dennesen ABLT-1 air-bearing, linear-tracking tonearm might just well be the ideal arm for the Lux PD-555 turntable. Dennesen was showing the first production models of this arm, and a beautiful sight they were, plated with 24-karat gold. As I have described previously, an air pump supplies a stream of air which impinges on an "air foil" connected to a skeletal arm structure, causing the arm to "hover" on a frictionless air bearing above the air-bearing assembly tube. The air bearing allows frictionless lateral transit of the arm across the record and eliminates some audible resonances. A built-in micrometer permits dynamic adjustment of the vertical tracking angle, and a damped cueing system raises and lowers the arm. With the elimination of significant resonances and having zero tracking error, one can hear the result of changes in VTA much more easily than with conventional arms. A clever idea, well executed, and I hope to mate one of these arms with the Lux PD-555 in the not too distant future.

Many people keep talking about

how true digital disc recordings will finally make the venerable phonograph record obsolete. Quite possibly true, but that day is far distant in the future, and for a threatened technology, there is a great deal of activity in the field. Witness the two reports above, and there are quite a few other new developments. For example, John Marovskis (of Janis sub-woofer fame) has introduced a new moving-coil cartridge with a radical new playback stylus configuration. This stylus is the patented invention of A. J. van den Hull of Holland, and with its constant contact radius looks frighteningly like a typical cutting stylus! Rest assured it doesn't cut your precious recordings, but with the same critical dimensions and profile of a cutting stylus, it compensates for errors in the geometry of the cut-

require pre-preamps or transformers to step up voltage as with moving-coil designs. Both cartridges have samarium-cobalt magnets, an effective tip mass of only 0.2 mg, very low 1-mH inductance. The rise time quoted is a very fast 10 microseconds, and they are said to track velocities as high as 100 microns.

Sony has taken the plunge into moving-coil cartridges, with their top-of-the-line model featuring a diamond cantilever a la Dynavector. Bob Fulton has a new high-precision arm with special bearings, and it uses Fulton headshell wire throughout the length of the arm. No interchangeable headshells on this arm. Dave Fletcher of Sumiko, importer of Supex and Koetsu cartridges, has now put The Arm into production and is said to have bear-

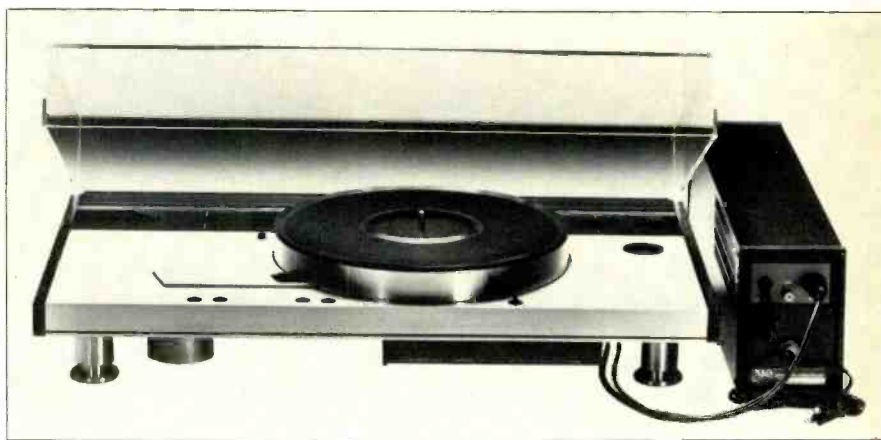

**Luxman PD-555**

ing system and the resilience of the recording and playback media. Because of this, John has named his cartridge the Mirror Image Transducer MIT-1. The cartridge itself was especially designed to complement the advantages of the new stylus profile. Very flat 20 Hz to 20 kHz response is claimed as is an altogether remarkable channel separation of 40 dB at 1 kHz. The mirror image nature of the stylus profile is said to give dramatically improved dynamic phase characteristics, with subsequent focus and stereo image stability, and superior tracing of high-frequency transients. Inner groove distortions are said to be non-existent in playback with this new stylus. Price of the MIT-1 is \$550.00.

Micro-Acoustics has a new group of Series Two cartridges which they claim are the "fastest" in the industry, utilizing hair-thin beryllium cantilevers and styli with very low tip mass. Stanton has introduced their 980 LZS and Pickering their XLZ-750. Both cartridges are quite a departure for these firms, being moving magnet cartridges, but with an extremely low 0.2 mV output, which

ings even more precise than the vaunted Breuer from Switzerland. Price has been finalized at a somewhat breathtaking \$1250.00.

Besides the radical Lux PD-555, there were other interesting new turntables at the SCES. Lateral tracking turntables are "in" now, with models from Yamaha and Aiwa (I've not seen these), the diminutive Technics discussed some months ago, the new Mitsubishi LT-30, and the up-dated Phase Linear 8000 Series Two. The Phase Linear unit's big feature is the direct-induction linear motor for the arm assembly. Essentially the arm base has a permanently magnetized armature driven by an electro-magnetic coil. Thus there are no mechanical linkages, gears, belts, etc. between arm and linear-drive motor. When a current is applied to the coil, the tonearm assembly glides along guide rails underneath. An opto-electronic sensor detects any tracking errors (as little as 0.2 degrees is claimed) and sends corrective signals to the differential amplifier that powers the drive coils. Phase Linear states that this type of



An acknowledged world leader in loudspeaker design and engineering, KEF has developed a monitor-standard speaker system that is both small — only ¼-cubic foot in size—and truly “high” fidelity. While these objectives are not new, the Reference Series Model 101 speaker system represents the first time that both are available in one product.

The Model 101 is, therefore, ideal for use in locations where an accurate small speaker is required in keeping with the rest of a high quality audio system.

### System Design

Despite all the ingenious ideas that have been proposed by various speaker manufacturers over the years, the three basic parameters of Enclosure Volume, Bass Response and Efficiency are still related by unchanged physical laws. What is different is the thorough manner in which KEF engineers have, with the use of advanced technology, optimized the relationships between these parameters.

Starting with the premise that prospective Model 101 users will have substantial amplification available, KEF engineers achieved a response from this small enclosure of 90Hz–30kHz  $\pm$ 2dB (–10dB at 47Hz).

KEF's leadership in computer-aided digital analysis techniques enabled them to optimize the design of the drivers, crossover network and enclosure to achieve a Target Acoustic Response without repetitious trial and error experimentation. Much of this technology, which did not previously exist, has been applied to the design and production of a small high fidelity speaker system for the first time in the Model 101.

Once the desired prototype was completed, KEF applied the same unique computer-aided techniques developed for the production of the critically acclaimed Model 105, so that the sound quality originally achieved in the laboratory prototype will be available to every user.

In addition, the high standards of the computer-aided production and assembly procedures enable precision-matched pairs of stereo loudspeakers to now be offered. For example: every Model 101 driver is tested and matched to tolerances of better than 0.5dB, and crossover networks to tolerances of 0.1dB; each pair of drive units is matched not only to each other, but to the other components in the system as well.

### Loudspeaker Protection

The major problem with small, relatively less efficient loudspeakers is thermal overloading of the voice coils. KEF engineers have developed a unique self-powered electronic overload protection circuit, S-STOP (Steady State and Transient Overload Protector).

Musical peaks are generally of short duration, so tweeters can handle far in excess of their normal program rating. A similar situation exists with low frequencies and their effect on the bass unit. Consequently any form of fuse protection can reasonably limit the instantaneous peak handling ability of the system, yet fail to protect the system against a very high average power level. KEF's solution is to incorporate a protection circuit which takes into account the instantaneous power applied to each drive unit and also computes the length of time the signal is applied. The law under which it operates resembles very closely the temperature rise within the voice coil. A potentially damaging signal is immediately attenuated by about 30dB, and the full signal is automatically reconnected when it is safe to do so.

As a result, the Model 101, although only ¼-cubic foot in size, is fully protected against fault conditions when used with amplifiers of up to 100 watts per channel.

The Model 101 is obviously not your average “miniature” speaker system where the quality of sound or power handling capacity is compromised by the small size of the enclosure. Nor is it inexpensive. If you require a speaker system that

is both small and truly high fidelity, visit your authorized KEF dealer for a thorough demonstration. For his name, write: KEF Electronics, Ltd., c/o Intratec, P.O. Box 17414, Dulles International Airport, Washington, DC 20041.

# KEF Reference Series Model 101:

## Accurate, Small, Protected.



Enter No. 13 on Reader Service Card

linear-tracking arm permits badly warped and off-center records to be tracked. The turntable employs a stable hanging-rotor d.c. motor in which the motorshaft does not rotate. Unlike most turntables, the main bearing is above a fixed motorshaft at the center of gravity of the rotating assembly. Phase Linear maintains that this system enables a wow and flutter figure of 0.013 percent W rms, lowest in the industry. The rumble spec is quoted at -78 dB (DIN B). The Mitsubishi LT-30 is another linear-tracking turntable. Their philosophy differs from Phase Linear in that they have a fairly massive arm assembly (almost three pounds) driven by a servo-motor with optical sensors, coupled with a worm reduction gear and a nylon-covered stainless wire to activate the arm assembly which rides on stainless steel rods and sintered metal bearings. They claim this is a better system than free arm assemblies which can have "objectionable slippage." Mitsubishi incorporates their own LSI microprocessor chip which permits automatic control of record size, lead-in, auto cue and lift, auto repeat, and other functions including stylus protection in the form of an arm "lock" which prevents the arm from descending if no record is on the turntable platter.

Linn Sondek now offers their own

complete disc playback system consisting of the LP12 turntable, the new Linn Ittok-LV-11 pickup arm, Linn Asak moving-coil cartridge, and Linn moving-coil pre-preamplifier. Linn's philosophy can be summed up easily: Spurious resonances are the "arch-enemy" of high-quality record reproduction. Their goal is to eliminate or damp resonances wherever they occur in the record playback system. This design aspect of their LP12 turntable is quite well known. The new Ittok arm carries on in a similar vein, with thin-walled but large-diameter magnesium arm tube and magnesium non-interchangeable headshell. The bearings, bearing housings, arm pillar and all related parts are made of stainless steel, thus all have the same coefficient of expansion, so that temperature changes in a room will affect all these parts equally. The steel shaft of the arm has a special locking mechanism which couples it rigidly with the turntable base. Similarly, the Asak cartridge has an unusually wide body of especially high strength and recessed cartridge mounting holes, so that no screw slippage can occur. Here again, the idea is to rigidly couple the cartridge to the headshell. The importance of ultra-tight coupling of arm and cartridges for the damping of resonances has been documented in

studies by Poul Laadegaard of Bruel and Kjaer in Denmark. There apparently is much merit in this idea, and the new Linn system appears to be a well-executed reflection of this design philosophy.

Apparently Audionics of Oregon is also in the anti-resonance camp of turntable design. Heretofore known for their pre-amps, amplifiers, and such exotica as their Space and Image Composer with Tate SQ decoder, they have introduced their first turntable, the LK-1. For innovative use of new materials in turntable design, this Audionics unit is a premier example. The turntable platter is made of a special high-density urethane, which is acoustically inert with no ringing modes, and an anti-static agent has been incorporated in the urethane compound. The turntable base and dust cover are made of a dense silica/epoxy compound, also containing the anti-static agent. Audionics states that with the dust cover in place, the density of the cover, base and platter and their inert nature creates a "damped acoustical chamber" for the phonograph record. The platter shaft is ground and honed surgical steel. The platter is belt-driven from a Pabst, outer-rotor, Hall-effect motor with d.c. servo-control and PLL. The motor is independently suspended, and the turntable

## THE PHASE LINEAR 8000 IS AS CLOSE TO PERFECT AS YOU CAN GET.



Phase Linear Corporation, 20121 48th Ave. W., Lynnwood, WA 98036

*Phase Linear*

**SIGNAL/NOISE: -78dB.**  
**WOW & FLUTTER: 0.013%.**  
**TRACKING ERROR: 0.**  
**SKATING FORCE: 0.**

No other turntable can match the Phase Linear 8000, because no other turntable has such advanced motors. You can't buy a quieter turntable. Or one with as low wow & flutter. Or one that tracks better.

The Phase Linear 8000's tangential tracking tone arm keeps the stylus in perfect 90° tangent with the grooves. It's the same way the master disc was cut, so the motion of your stylus is identical to the cutterhead stylus. There's absolutely no tracking distortion. No crosstalk. No skating force that can actually re-cut your grooves.

### NEW LINEAR MOTOR ELIMINATES MECHANICAL LINKAGE

Other manufacturers have tried to move tangential tone arms with worm gears. Belts. Rollers. All with the same sad result. Mechanical connections pass on the noise and vibration of the motor.

The Phase Linear 8000 solves this problem with an ingenious Linear Motor. The tone arm base is a permanently magnetized armature that glides along guide bars above electro-magnetic coils. The arm moves by direct induction—not mechanical connection. So there's virtually no noise. Inside the tone arm, an opto-electronic detector cell senses the slightest tracking error, and instantly sends correcting signals to keep the arm on track.

### NEW QUARTZ-PLL DIRECT DRIVE

Our new slotless, coreless Stable Hanging Rotor DC motor virtually eliminates "platter wobble." Quick start/stop. Speed deviation is lower than 0.002%. If you want to hear all these technical advantages translated into musical improvements, contact your Phase Linear audio dealer.

T E A C

# TEAC TODAY: THE ALL-TIME LOW IN TAPE NOISE.

On paper, the specifications\* look unbelievable:

80dB signal-to-noise ratio, 95dB dynamic range and 15dB more headroom than you've ever had. The sound is so noise-free, it's scary. And once you listen to the audio performance of the A-550RX, you'll know that cassette recording will never be the same.

You'll hear signal without noise or hiss. Louder louds and softer softs. And you'll never have to be bothered by tape saturation again. All this because the A-550RX is the only mid-priced cassette deck ever to include integral dbx\*\* noise elimination plus complete metal tape capabilities.

A few years ago, the dbx system helped us revolutionize professional recording. Now the same technology is helping us move cassette performance into a new era. On the A-550RX, dbx II gives you broadband noise elimination and dramatically improved dynamic range. Signal articulation that's better defined than anything you've ever heard from a cassette tape. And the A-550RX doesn't stop there.

And the A-550RX doesn't stop there.

On the A-550RX, dbx II gives you broadband noise elimination and dramatically improved dynamic range. Signal articulation that's better defined than anything you've ever heard from a cassette tape.

And the A-550RX doesn't stop there.

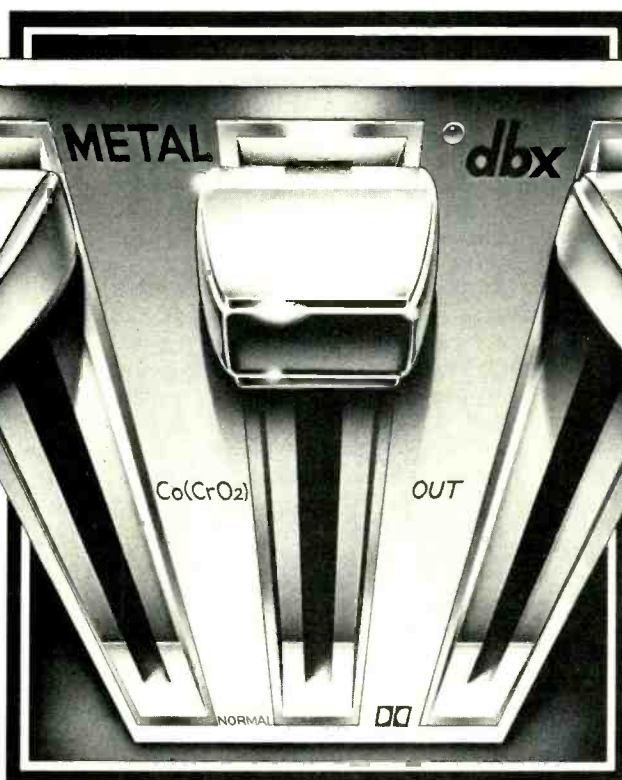

Its designed to handle all the new metal tape

formulations. Which means you get the unprecedented performance of dbx II with the additional improvements provided by metal tape.

You'll hear the all-time low in tape noise. The all-time high in dynamic range.

Peak reading dB level meters help you get as much signal on tape as possible without distortion. And clutched record level controls make adjustments faster and easier.

To make sure you have complete compatibility with your current tape library, the A-550RX has Dolby NR† as well.

Full logic micro-switches control the high-stability transport. The A-550RX accepts our RC-90 remote control unit. And rack mounting hardware is available optionally. So listen to something you've never heard before.

The amazing A-550RX. You'll hear completely noise-free cassette recordings with the broadest dynamic range available.

## TEAC®



\*Measurements made with metal particle tape  
\*\* dbx is a trademark of dbx, Inc.  
†Dolby is a trademark of Dolby Laboratories

# Interface: C

## Series II It sounds like music.

Interface: C Series II is the fulfillment of our six-year association with optimally vented speakers based on the theories of A.N. Thiele – speaker designs first introduced by Electro-Voice in 1973: The Interface: C offers you a unique combination of high efficiency and high power capacity – the only way to accurately reproduce the 120+ dB peak sound pressure levels found in some types of live music.

The SuperDome™ tweeter, an E-V exclusive, and the VMR™ vented midrange driver, the first to apply optimally vented design to mid frequencies, ensure your music is reproduced without the coloration normally found in other high-efficiency drivers. An honest 30 Hz low end totally eliminates the need for expensive subwoofer assemblies.

When you spend \$1,000 for a speaker system, get your money's worth. Audition the Interface: C Series II at your nearest Interface dealer. If you want a speaker that sounds like music, the Interface: C Series II is the one you'll buy.



**Electro-Voice**

a gulton company

600 Cecil Street, Buchanan, Michigan 49107

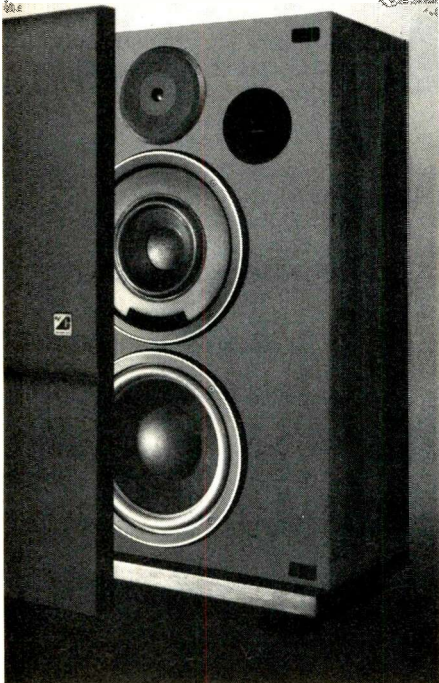

Thorens Reference turntable

base is on a unique three-point suspension system with a 3-Hz spring rate. The turntable base, dust cover, and platter are dimensionally stable over a wide range of temperatures. The whole thrust of this LK-1 turntable is to create a stable platform for the phono cartridge, free from the resonances usually generated by most conventional turntables. The price of the unit is \$697.00.

At the opposite poles of turntable design from the Linn and Audionics units are the Sony PS-X75 and the JVC QL-Y5F. The Sony unit has all the usual features now associated with high-quality Japanese turntables... direct-drive motor with their Magnedisc servo speed control and automatic control function, but in addition features their micro-processor-controlled Biotracer arm. The arm employs a sensor system with correcting servo motors that "monitors" the conditions of playback, including such things as off-center records and various warps. Tracking force and anti-skate are under dynamic control, and the system is claimed to attenuate spurious arm/cartridge resonances. The JVC turntable has their Electro-Dynamic Servo tonearm. Two coreless linear motors are used in the ED Servo arm. Each motor has a velocity detection coil and a drive coil. One servo controls the arm's vertical position, the other motor controls the horizontal position. Here too there is positive tracking of off-center and warped records, while tracking and anti-skating forces are dynamically controlled by continuously variable mechanisms. Low-frequency resonances are damped through the servo-monitoring system, and both airborne and floor-borne vibration and feedback are also damped. As you might expect, this is a direct-drive turntable with what JVC calls their Double Servo quartz control system and coreless d.c. servo motor. Thus the Sony and JVC turntables wage their

anti-resonance battles through the agency of their very sophisticated servo arm systems, while the Linn and Audionics turntables use more basic methods. If all these turntables manage to control the very real problem of spurious resonances during record playback, how this is accomplished is purely academic.

One other highly interesting unit was shown a couple of weeks earlier by Thorens, which is now being distributed in the United States by the Epicure organization. This was the Reference turntable, on which engineers were said to have been given carte blanche to "design the finest turntable modern technology would permit without concern for cost." Well now, what does such a turntable have to set it apart, other than its cost which, by the way, friends, is \$15,000.00? For one thing, rather extraordinary performance is claimed for the unit, including wow and flutter of less than 0.02 percent DIN and rumble of less than -84 DIN B (which, incidentally, was measured via the Thorens rumble measuring device). A specially damped, 14½-pound platter is driven by an electronically controlled synchronous motor. To help conquer various types of feedback, each corner of the turntable has a gold-plated suspension housing which is adjustable to set the resonance of the iron-filled, cast-aluminum chassis anywhere from 1 to 5 Hz. The Thorens Reference turntable is available only on special order and there is a 3 to 6 month delivery schedule.

Obviously, I've managed to fill a column with new developments in the technology of phonograph record playback. The analog phonograph record may be feeling the first faint tendrils of senility, but it's not ready for the digital gravediggers yet! Next month, I'll cover interesting developments in amplifiers, speakers, and tape decks at the SCES.



# Now you can hear how good a Revox system really is.

Studer Revox is known for recorders. The best in the business. But since even the finest recorder is limited by what it is connected to, we recently developed a line of tuners, turntables and amplifiers to optimize the signals going to and coming from our tape machines.

Now the system is complete. We have a new speaker factory. We make our own drivers. And we're introducing three innovative, high performance speaker systems so you can finally have a system that is *all* Revox. With unmatched sonic quality and a special pride of ownership.

The **Revox Triton** has the uncommon ability to reproduce undistorted bass frequencies as low as 30 Hz, yet it fits almost unnoticed in rooms of any size or decor.

Triton is a three-piece system. Frequencies from 200 to 25,000 Hz are reproduced by two 3-way compact bookshelf speakers that can be easily placed for maximum stereo effect. And the lowest frequencies, which are essentially non-directional, are reproduced by a pair of subwoofers mounted in a single cabinet that may be placed anywhere in the room. The subwoofers are spring-mounted within the cabinet and their resonance is so low that no vibration is transferred to the cabinet. It can be used as a shelf for other components, even a sensitive turntable.

We are also proud of the new **Revox BR530** speaker system. It's a 3-way bass reflex system with the accuracy and musicality customarily expected from much less efficient units. The mid- and high frequency drivers are placed to eliminate interference beats, and ringing is eliminated by a specially damped phase modulator tube. The cabinet on this and all Revox speakers is as beautiful as the sound, with magnificent hand rubbed and oiled walnut veneers.

Our new **Revox BX350** makes use of the latest research in phase-coherent wave propagation. The cabinet is precisely stepped, to ensure that all frequencies reach the listener at the same time—even if they are coming from drivers with different depths. The five drivers are specially made with cast aluminum chassis and a new kind of cone treatment, and are arrayed for optimum dispersion and overall transparent sound.

Three superb, but different, new speakers. Hear how good they are at your Revox dealer.

## STUDER REVOX

Studer Revox America, Inc.

1425 Elm Hill Pike,

Nashville, TN 37210, (615) 254-5651

Offices: LA (213) 780-4234; NY (212) 255-4462



# Realism.

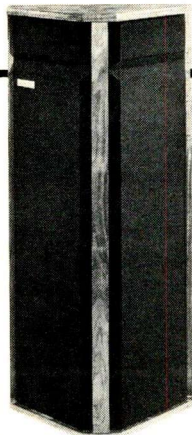

**ALLISON: ONE®** loudspeakers were used by Diversified Science Labs in reviewing nine "audiophile discs." The reviews were published in a special section of the Winter, 1980 issue of *Stereo* magazine. Here are some excerpts:

"Stereo imaging has excellent width and depth and is rock stable."

"What we heard was as *real* a piano as we have ever heard on a recording."

"... percussion is crisp and clean and even the triangle stands out clearly in the presence of the full orchestra. Brass is excellent in all registers; cellos and basses are clearly defined..."

"Undoubtedly, this is one of the most sonically thrilling recordings we've ever heard..."

"... super-solid kick drum, magnificent transients, scintillating cymbals..."

"... contains a truly perfect transcription of the sound of a bass drum."

"The imaging, dynamics, and accuracy are so perfect that the three musicians seem to be performing in your living room."

These words are from record reviews. But the sounds described were not created by the records alone; they had to be reproduced by loudspeakers before the reviewers could hear them and judge their realism.

The loudspeakers were Allison One systems, with the Electronic Subwoofer™ to extend response flat to 20 Hz.

One reason why Allison® systems reproduce original sounds so accurately is that they have flat bass power response in real rooms. The chart below shows how conventional loudspeaker systems are affected by reflections from room surfaces.

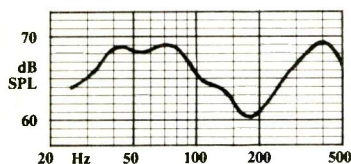

Allison Room-Matched® design avoids these effects. A series of technical papers on the room-boundary problem and its solution is available, along with our catalog and other literature, free on request.

**ALLISON: ONE** \$460/\$483 (each)  
(Price varies with shipping distance)

**THE ELECTRONIC SUBWOOFER:** \$290.

# ALLISON ACOUSTICS

Seven Tech Circle/Natick, MA 01760, U.S.A.

For literature and information call (800) 225-4791  
In MA (617) 237-2670

Enter No. 3 on Reader Service Card

# Audioclinic

Joseph Giovanelli

## Tweeter Phasing

**Q.** *In wiring together three tweeters of different makes, how can I positively ascertain the correct phasing since it is not possible to see the cones move when I pass a current through the voice-coils?* — A. J. Rizzo, West Palm Beach, Fla.

**A.** Using tweeters of different makes can be troublesome, not because of phasing considerations but because of differences in efficiency. If one tweeter happens to be far more or far less efficient than the rest, the system is usually operating with the most efficient tweeter(s).

As for determination of phase, connect one tweeter. Feed a test tone into the amplifier at a frequency which is covered by that tweeter, somewhere just above the crossover frequency, and then connect one of the remaining tweeters. If the volume increases, the wiring of the second tweeter is correct as to phase. (It just could happen that the volume increased because the second tweeter is much more efficient than the first one. To check, reverse the connections to the second tweeter and note if the volume decreases. If the efficiency of the second tweeter is far greater than that of the first tweeter, reversing the connections won't make an audible volume difference. What you must do is to pad down the most efficient tweeters to match the efficiency of the least efficient unit. Then the reversal of connections will have meaning.)

Next, disconnect the second tweeter and wire in the third one. If the sound produced by the combination of tweeters one and two is louder, this third tweeter is wired correctly also. If it isn't, reverse the connections so that it does become louder.

Once all three tweeters are phased with respect to one another, the entire tweeter array must be phased with the woofer or midrange. As for how this is to be accomplished, well, this depends on the crossover networks used and their phase shifts. It may be necessary to put the tweeters out of phase with respect to the midrange at the crossover frequency. You might have to listen to program sources and check the phase this way. Another method is to take the completed speaker system out of doors and set up phasing with a sound level meter. The outdoor approach is useful because it tends to re-

duce reflected sound; the ear or the sound level meter has a much better chance of telling you the truth.

## Noise From a Timer

**Q.** *Having separate components connected to a preamplifier which is, in turn, connected to a programmable timer, I experience a "pop" emanating from the speakers whenever the timer turns the equipment on or off. This sound is noticeably loud; I fear it may eventually damage the speakers.*

**Q.** *Would it help to connect the power amplifier directly into the a.c. line, bypassing the timer? I am not sure if the power amplifier should be left on continuously, as would be the case under these conditions. Is it harmful to do so?* — Edward J. DeLauter, APO N.Y.

**A.** Chances are that leaving your power amplifier running all the time would not solve the "pop" problem. The transients involved with turning on and off the timer would be fed from the output of the preamplifier into the input of the power amplifier, and still result in the "pops" you now hear. The sound might even be louder than it presently is.

If your timer has mechanical contacts (and I presume it does), locate them and shunt them with a series network consisting of a 200-ohm half-watt resistor and a 0.02 pF capacitor at 600 V d.c.

## Minispeaker Cone Excursions

**Q.** *My minispeakers display a large amount of passive radiator cone movement (approx. one-half inch) during deep bass passages at normal listening levels. Is this amount of excursion normal?* —SFC Gary M. Jartman, APO N.Y.

**A.** Minispeakers have relatively small cones. If these small cones are to be successful in producing bass, they must make up by motion what they cannot do by size, in terms of the amount of air they move. It is therefore to be expected that your cones will exhibit a large amount of motion when reproducing bass. A

If you have a problem or question about audio, write to Mr. Joseph Giovanelli at **AUDIO Magazine**, 1515 Broadway, New York, N.Y. 10036. All letters are answered. Please enclose a stamped, self-addressed envelope.

# More recorders ask for Fuji by name than any other brand.

Recorders are very outspoken  
in their preference of tapes.

Take video recorders.

They insist on Fuji VHS and  
Beta videocassettes. Put in anything  
less and they may give you snow.  
Washed-out or shifted colors. Or all  
kinds of distortion.

Unhappy audio recorders with-  
out Fuji audiocassettes stubbornly  
give you less music in return. Plus  
distortion on loud music. Noise dur-  
ing soft passages. And limited  
frequency response. Problems our  
premium FX-I, FX-II and our low-  
noise FL help you overcome.

Then comes new Fuji Metal  
Tape. Cassette recorders equipped for  
metal are all in love with it. Not just  
because it won't clog heads or jam.  
But because of its inaudible noise.  
Greatly expanded dynamic-range.  
And smooth, ultra-wide response.

So watch and listen.

If you see or hear your recorder  
talk, you'll know what it's asking for.  
Fuji. The tape that makes it look and  
sound its best.

## FUJI TAPE

One brand fits all. Better.

Magnetic Tape Division, Fuji Photo Film U.S.A., Inc.  
350 Fifth Avenue, New York, New York 10001 (212) 736-3335



# Video scenes

Bert Whyte

At the Summer Consumer Electronic Show in Chicago, as soon as the dealers started the tramp the endless aisles of McCormick Place, there was a chorus of grumbling that there was "too much emphasis on video." There certainly was no question that video was indeed heavily displayed and promoted. You name it: TV sets, Beta and VHS video cassette recorders in myriads of models, four different flavors of videodisc, new ideas in projection TV, portable VCRs, video color cameras... all were there in profusion.

Why the grumbling, however, aren't the dealers interested in the glamorous new video technology? Unfortunately, the answer is that even at this early stage in the video revolution, the opportunity to make a decent profit on video equipment has been severely eroded. Rampant discounting of video cassette recorders, whether it be in appliance stores, department stores or specialty shops, is of epidemic proportions. Many audio dealers, who were genuinely trying to effect a marriage of audio and video technology have given up trying to compete with the discount operators. Many audio dealers say they are apprehensive about discounting of the forthcoming videodiscs. Most feel that the stereo sound capabilities of three of the videodisc systems offer the best opportunity to tie-in an audio system with a video purchase. But if they can't make a buck, why bother? In spite of all this, and even with the recession blues, new video equipment continues to proliferate and the video market continues to grow. To put it bluntly, many dealers will have to learn the "video way of life," and develop a whole new marketing philosophy if they are to reap the profits that un-

questionably are possible in this burgeoning new video technology.

As you might expect, the stars of the Show were the videodisc systems. Magnavox was showing its production model optical videodisc player, and had opened up more markets in addition to the initial four cities. However, there still appears to be a holdup in the availability of software for this system, since few new titles were in evi-

problems in producing these discs in sufficient quantities.

An important announcement was made by JVC just prior to the CES. They detailed that a consortium of JVC, Matsushita, Thorn/EMI, and General Electric had been formed for the joint production and marketing of players and videodiscs using the JVC VHD (Very High Density) grooveless, capacitance videodisc system. The en-

try of giant General Electric into the videodisc sweepstakes caused quite a stir at the Show, and the consensus was that now the JVC VHD system must be considered as a most serious contender in the battle for videodisc supremacy. As I have said before, with RCA SelectaVision, the Philips optical videodisc, and the JVC grooveless, capacitance videodisc all committed to the marketplace, the chances for the establishment of an industry standard videodisc are still remote.

At the CES, both JVC and Matsushita were giving demonstrations of their VHD systems, and the workings of this

videodisc system have been detailed in these pages before. Suffice to say, the picture quality was superb, the special effects of slow motion, freeze frame, etc. worked to perfection, and we were given a tantalizing few minutes of listening to a genuine digital disc recording of some pop material. This was via the add-on PCM playback adaptor which both JVC and Matsushita are pushing hard as a big advantage of their system in terms of easy adaptability and the ability of PCM playback on the same unit for the videodisc. The big plus for the VHD system, in the opinion of some people I talked to, was the advantage of being able to replicate the videodiscs from PVC using regular record-pressing facilities.

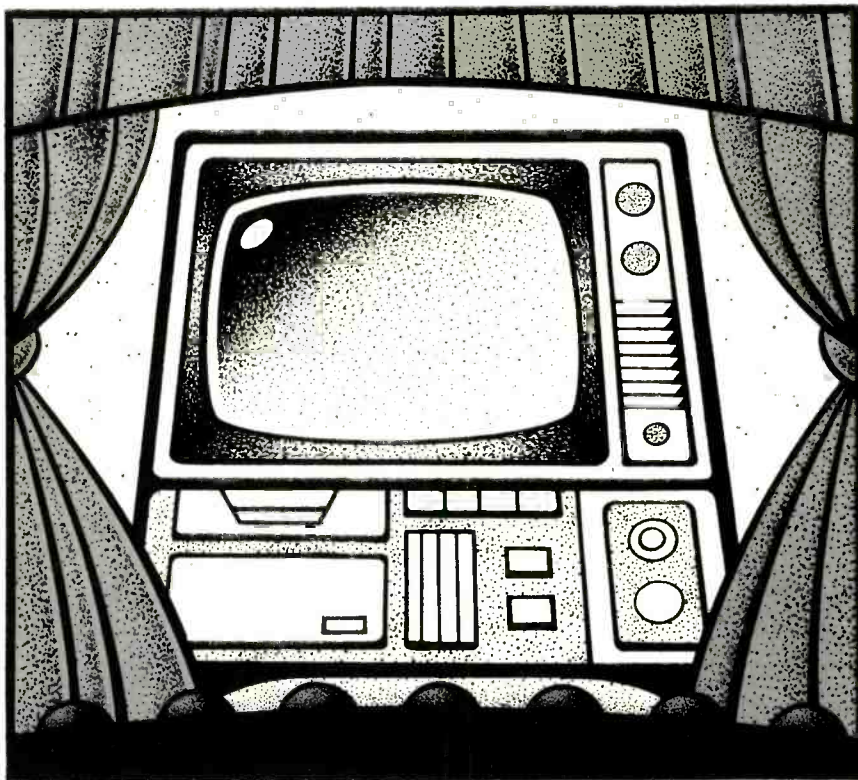

dence. Pioneer, another licensee for the Philips optical videodisc system, used the occasion of the Show to officially launch the marketing of its video-disc player, a joint product with DiscoVision Associates, which is named LaserDisc. Details of the Pioneer video disc were given in my June Video Scenes column. As in the demonstrations at the Waldorf, picture quality shown at the SCES was superb with vibrant rich colors, clean whites, and excellent resolution. I expect to have a Pioneer LaserDisc player shortly, and I am looking forward to testing it. The only rub is that for the present the LaserDisc player will be using the same software as the Magnavox unit, and apparently there are still some

Illustration: Leo Pando

# “Listening tests confirmed what the excellent measurements implied: the Eumig FL-1000 is a superb performer.”

JULIAN HIRSCH—STEREO REVIEW, APRIL 1980

What you are about to read is Julian Hirsch's unedited conclusion in his review of the Eumig FL-1000.

“Listening tests confirmed what the excellent measurements implied: the Eumig FL-1000 is a superb performer. Dubbing from FM or phono discs revealed no audible differences between the original and the copy, and even FM interstation noise—our most severe test—could be recorded and played flawlessly up to levels of approximately -5 dB. The Computest adjustment for different brands of tape was not only accurate but contains a built-in rewind mechanism that returns the tape to the precise point where you began your adjustment. The counter was the most accurate we have ever used. And for people who are “into” computers, the one-of-a-kind (so far) Eumig FL-1000 cassette deck opens up endless possibilities.”

We couldn't have said it better. We wouldn't even try. For the complete text of the review, write to us. Or, better yet, visit your nearest Eumig dealer and find out for yourself what it takes to make a reviewer rave.

**eumig**<sup>®</sup>

Eumig (USA) Inc., Lake Success Business Park,  
225 Community Drive, Great Neck,  
New York 11020, (516) 466-6533



Enter No. 10 on Reader Service Card

# McIntosh

## "A Technological Masterpiece..."



McIntosh C 32

### "More Than a Preamplifier"

McIntosh has received peerless acclaim from prominent product testing laboratories and outstanding international recognition! You can learn why the "more than a preamplifier" C 32 has been selected for these unique honors.

Send us your name and address and we'll send you the complete product reviews and data on all McIntosh products, copies of the international awards, and a North American FM directory. You will understand why McIntosh product research and development always has the appearance and technological look to the future.

Keep up to date.  
Send now - - -

McIntosh Laboratory Inc.  
Box 96 East Side Station  
Binghamton, NY 13904

Name \_\_\_\_\_

Address \_\_\_\_\_

City \_\_\_\_\_ State \_\_\_\_\_ Zip \_\_\_\_\_

If you are in a hurry for your catalog please send the coupon to McIntosh. For non-rush service send the Reader Service Card to the magazine.

The RCA SelectaVision system also has this software advantage. RCA was giving private demonstrations of their SelectaVision discs at a nearby hotel, thus disappointing many who thought they were going to be able to see it on the Show floor. RCA gained a great deal when licensee CBS, through their CBS Video Enterprises Division, made a deal with MGM for the joint marketing of all MGM films. It will be handled under MGM/CBS Home Video. Having thousands of films with legendary stars in the MGM library quite obviously puts RCA into a most enviable software position.

In other videodisc news, to everyone's surprise, Sanyo has decided to market the Philips-type optical videodisc principally in the European countries, as well as making OEM SelecaVision players for the RCA capacitance system in the U.S.

There were many new models of VHS video cassette recorders from a broad spectrum of Japanese companies. Fortunately, from the marketing standpoint, most of the units have standardized on the six-hour record and playback capability. New portable VCRs from Panasonic, JVC, and Akai also feature six-hour record/play. Sony, keeping their Beta format busy, announced the Model SL-5800, their most advanced Betamax to date. The unit is equipped with a double-azimuth video head, which permits freeze frame and frame-by-frame viewing with no distortion of the picture and without annoying noise bars. New variable Betascan allows backward or forward search at from five to 20 times normal speed. As with the earlier SL5600, this unit also has 14-day programmable tuner. For those who want really extended recording — say over a holiday period — the new AG-300 BetaStack programmable autochanger provides up to 20 hours of record/play by actually changing videocassettes. No price on this unit yet.

LVR (longitudinal video recorder) seems to have run into trouble. Jack Dreyer, VP of BASF in Massachusetts, says their entire LVR program is to be scrapped, including the already constructed factory in California that was to manufacture the recorders. He cited economic and "other factors" for the decision. Toshiba actually introduced three new LVR units . . . one with two video channels to record separate programs, another with one video track and stereo, and the other a straightforward normal unit. Neither delivery schedules nor price were given, so it would seem this is the last hurrah for this format. They can give various reasons for this — my own opinion is that

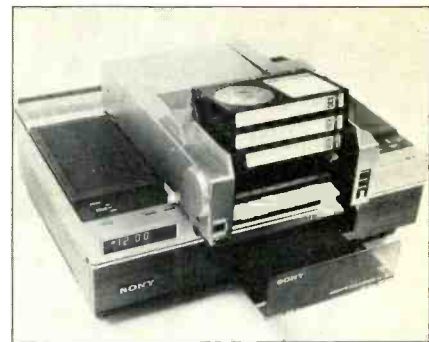

Sony's BetaStack AG-300 programmable autochanger can record up to 20 hours using 4 cassettes.

the six-hour record/play of the standard VCRs killed it. The record time most likely could be accomplished in an LVR, but not at competitive prices.

Projection TV is bound to become a more marketable item with a number of new one-piece systems ready for consumers. Back projection also seems to be a trend. GE, who pioneered this concept, has a new model of their Widescreen 1000, with one-third greater brightness and less light fall-off at increased viewing angles. Quasar has a new back-projection system, with the same 45-inch picture size as the GE unit. It offers direct video input for VCR, videodisc and camera, 105-channel tuner and 16-function remote control. Cost is \$3800.00. Panasonic has a similar back-projection system, the Model CT-4500. Screen size is also 45-inches, a three-lens video tube is used, and the system has provisions for stereophonic sound. Toshiba has a one-piece front-projection system on the market in Japan but not yet in this country. Henry Kloss's Novabeam two-piece projection unit continues to sell well at \$2495.00, and Advent, who pioneered projection TV with its two-piece system, now has a one-piece system, the Model 125, with a five-foot screen.

### Sony combo

There were scads of other video equipment, including some smaller color cameras, but I still insist that until a color video camera gets down to the size and simplicity of the old Brownie Cine Kodak which really opened up the 8-mm movie business, it won't be a big factor. Well, this is in fact very nearly what Sony has done in developing a combination video cassette recorder and camera, the Video Mate, which weighs a mere 4.4 pounds. The prototype unit was shown in New York a couple of weeks after CES, will probably sell for less than \$1,000.00 when it finally gets to

# Morning Concert



You've driven to the end of the world. Alone.  
The engine is still warm.

Amid the roar of the waves and the cries of the gulls, you fire up your mobile high-fidelity system for a morning concert.

What will it be? Bach? Mozart? Perhaps some Keith Jarrett.

Whatever you choose, your system is equal to the task because you've chosen ADS.

The ADS Power Plate 100 Automotive Amplifier and the ADS 300i Automotive Loudspeaker System deliver the kind of power it takes to be heard above road noise, engine noise, and ocean waves. And it's not just brute power, but power with performance, subtlety and nuance — qualities collectively known as musical accuracy.

Easily the most sophisticated automotive audio components available today, the Power Plate 100 amplifier and 300i speakers are exactly what you'd expect from ADS, the company that literally invented mobile high-fidelity.

To find out more about putting an ADS system in your automobile, write ADS, Department AU18, or call 1-800-824-7888 (California 1-800-852-7777) toll free and ask for Operator 483.

The more time you spend with your automobile, the more you owe it to yourself to listen to ADS.

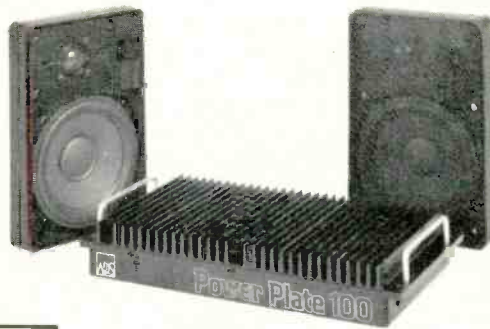

**ADS** Audio for the critically demanding

Analog & Digital Systems, Inc., One Progress Way, Wilmington, MA 01887 (617) 658-5100

# IF YOU THINK YOUR STEREO DELIVERS GREAT BASS, ALLOW US TO LOWER YOUR STANDARDS.

Right now, your stereo system doesn't deliver bass frequencies much below 50Hz. Simply because that's the limit of most records, tapes and FM signals.

But now there's a way to hear the kind of bass so deep, you actually feel it. With the dbx Model 110 Subharmonic Synthesizer.

Technically, what the 110 does is simple. It samples the low frequency signal of your music, reproduces it a full octave lower, and then mixes it back in.

Musically, what the 110 does is extraordinary. It re-creates the natural subharmonics of the original sound so your room vibrates with a depth of bass you've never heard before. Or felt.

Except in a live performance.

Visit your authorized dbx retailer for a demonstration.

Because just one listen to the dbx Model 110, and your standards will be lowered forever.

dbx, Incorporated, 71 Chapel Street, Newton, MA 02195. 617/964-3210



Enter No. 8 on Reader Service Card

**dbx**  
MAKING GOOD SOUND BETTER

## The Audio Critic reports a major speaker development.

In its forthcoming ninth issue (Vol. 2, No. 3). The Audio Critic acquaints you with a new speaker system that just might shake up the whole speaker world.

Although of conventional woofer/midrange/tweeter configuration and no costlier than dozens of other medium-sized floor-standing dynamic speakers currently sold to audiophiles, the new system is distinguished by its avoidance of the typical design errors, large and small, that The Audio Critic's comprehensive laboratory tests and listening evaluations have uncovered in all such speakers reviewed until now, even in the recommended models. The resulting sound quality is equaled or exceeded only by the most expensive full-range electrostatics—and not all of them.

The Audio Critic prints absolutely no commercial advertising and is the only "underground" review for which the top technologists and academicians of the audio world have the slightest respect. We recommend that you start your subscription retroactively with the sixth issue, which is a cumulative reference work with over 150 equipment reviews.

Send \$30 for 6 consecutive issues by first-class mail (no Canadian dollars, \$6 extra for overseas airmail) to The Audio Critic, Box 392, Bronxville, NY 10708.



## Collector's Magazine Case

These "Modern See-Through" cases measure 11½" high x 8¼" deep x 4" wide and hold a complete year's supply. Constructed of clear, sturdy ½" acrylic, they are a great way to keep your back issues intact for easy reference. Order more than one—and save money.

1 case	60292	\$ 8.95
2 cases	60291	\$16.95
3 cases	60290	\$24.95

TO ORDER: Print the words COLLECTOR'S MAGAZINE CASE, the quantity, number and price on a piece of paper along with your name and address. Enclose check or money order for the cost, plus S/H: \$1.50 for orders to \$10; \$2 for orders \$10.01-20; \$2.50 for orders \$20.01-\$50. Add local sales tax.\* Mail to:

HAMILTON HOUSE, (a CBS Company)  
32275 Mally Rd., P.O. Box SG, Dept. 9000  
Madison Heights, MI 48071

U.S. and Canadian residents only; offer expires Sept. 30, 1981

\*The government requires us to collect sales tax in all states except AK, DE, MT, NH, and OR.

the market in 1985, and uses a new, very small cassette format which can be edited on a "home editor" in combination with a standard recorder. Sony's Chairman, Akio Morita, says that the new format is to be a supplement to the present recorders, which are of course much heavier and larger.

Last, but not least, there were a number of companies selling satellite-antenna, earth-station equipment. One in particular sounds too good to be true, and I sure would like to test it to see if it's for real. What else am I going to say when American Value of Rolling Meadows, Ohio offers a 10½-foot disc, plus low-noise amplifier, tuner, and r.f. adaptor for \$4995.00 installed! This is by far the least expensive unit yet offered, and if it really performs well, could be a breakthrough in this area. By contrast there was the system from Third Wave Communications of Ann Arbor, Michigan. They had an actual 12-foot dish installed outside McCormick Place and with the system operating, the picture quality and clarity were stunning. Their earth station with 12-foot dish, low noise amplifier, tuner, and r.f. interface sells for \$12,000.00 plus installation. Even *this* price is considerably less than similar units offered just six months ago. Admittedly, there is a great disparity in the systems described above, but you must admit the "cheapie" sounds intriguing. ...

## FLASH — FLASH — FLASH

Philips and Sony have jointly developed a compact digital audio player, using 4.72 inch or 12 cm discs. This has been improved in the area of modulation and error correction over the PCM unit Philips announced in March, 1979. Polygram and CBS have committed to supplying software for the Philips-Sony system.

The 16-bit digital player will be small enough to fit into the dashboard of a car and suitable for operation in a moving vehicle because of the non-contact feature of the optical pickup. Each disc will offer 60 minutes per side.

A top-end player should retail at about \$450.00. No price has been suggested for the discs which could be cheaper than conventional LPs because they will use less material and an ordinary paper jacket. The non-contact laser pickup should give the discs and player longer life. Expect to see the Philips-Sony unit in the marketplace during the latter part of 1982.

— Deirdre Frank



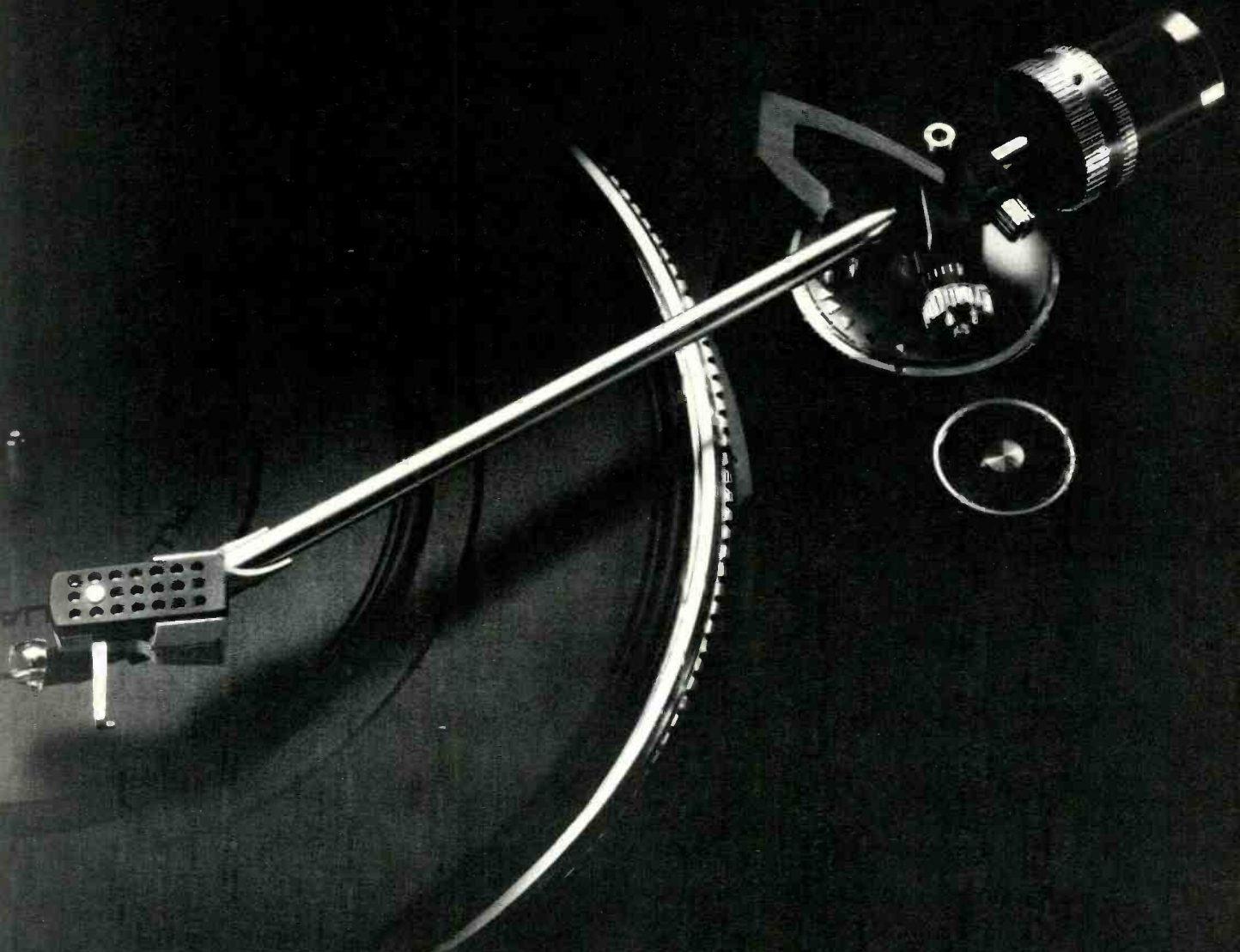

### **The 731Q is the finest turntable Dual has ever made.**

There is always a special attitude at Dual about the turntable that is to represent the most advanced thinking and accomplishments of Dual's designers and engineers.

The materials, the care in manufacturing, assembly and quality control must exemplify all that has made Dual precision and reliability so highly regarded throughout the world.

And in every measure of performance, this model must set the standard by which other fine turntables are judged. Even more, it must make a significant contribution to the art of record playback.

This year, the quartz PLL direct drive 731Q, with its ultra-low-mass (ULM) tonearm and cartridge system, expresses our attitude perfectly.

If your other components and your record collection warrant consideration of such a turntable, we invite you to visit your franchised Dual dealer. And if you have a record that is warped to marginal playability, but too valuable to discard bring it with you.

That's all you will need to share our attitude and sense of pride about the Dual 731Q.

For the complete ULM story, please write directly to United Audio, 120 So. Columbus Ave., Dept. Q, Mt. Vernon, New York 10553.

**Dual**

## IN THE GROOVE

# CLOSE-UP VIEW OF RECORD WEAR

Walter E. Davies  
The Last Factory, Livermore, Calif.

*This scanning electron microscope study shows the quality of vinyl used to press discs plays a large part in record wear. One primary type of defect is fracturing of the disc surface, which even occurs during the pressing cycle.*

The LP record, which made its debut about 30 years ago, brought about a dramatic improvement in sound quality over the shellac-based 78s in addition to providing much more playing time per disc. Following this, the rapid change from sapphire to diamond styli brought the twin benefits of lower record wear and very much longer stylus life. Record wear shows up as a loss in audible sound quality, and the audio industry responded to the problem by choosing quality vinyl mixes for the LP record base and by continually improving tonearms, pickups, stylus designs, and stylus loading characteristics. Today the public has available relatively inexpensive but nonetheless high-quality transducer systems. With this excellent equipment widely available, our ears tell us just how marvelous a record can be when it is played for the first time. Then, depending on the qualities of the record base material, the quality of pickup, and pickup loadings, critical ears can hear loss of sound quality after as few as two to 10 plays. Interested in how records wear and with the ultimate

Fig. 1—Three stylus types. This illustration shows the relationship of the moving stylus to the groove walls. The ideal contact areas are shown.

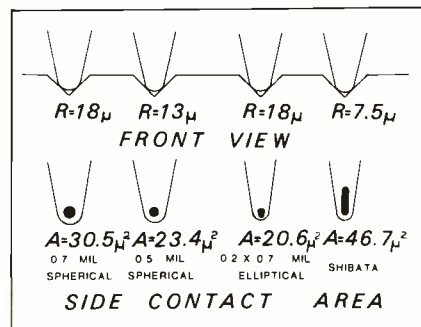

goal of reducing record wear, we have used the scanning electron microscope (SEM) to help us to see how wear occurs.

Currently, there are three general stylus designs; these are the spherical, elliptical, and Shibata types (Fig. 1). Note that the elliptical and Shibata de-



signs were developed to solve particular problems brought about by LP discs and quadraphonic reproduction. With all three of these designs, the pressure on the vinyl remains very high, ranging from 30,000 to 69,000 pounds per square inch with a stylus tracking force of 1 gram. These high pressures have

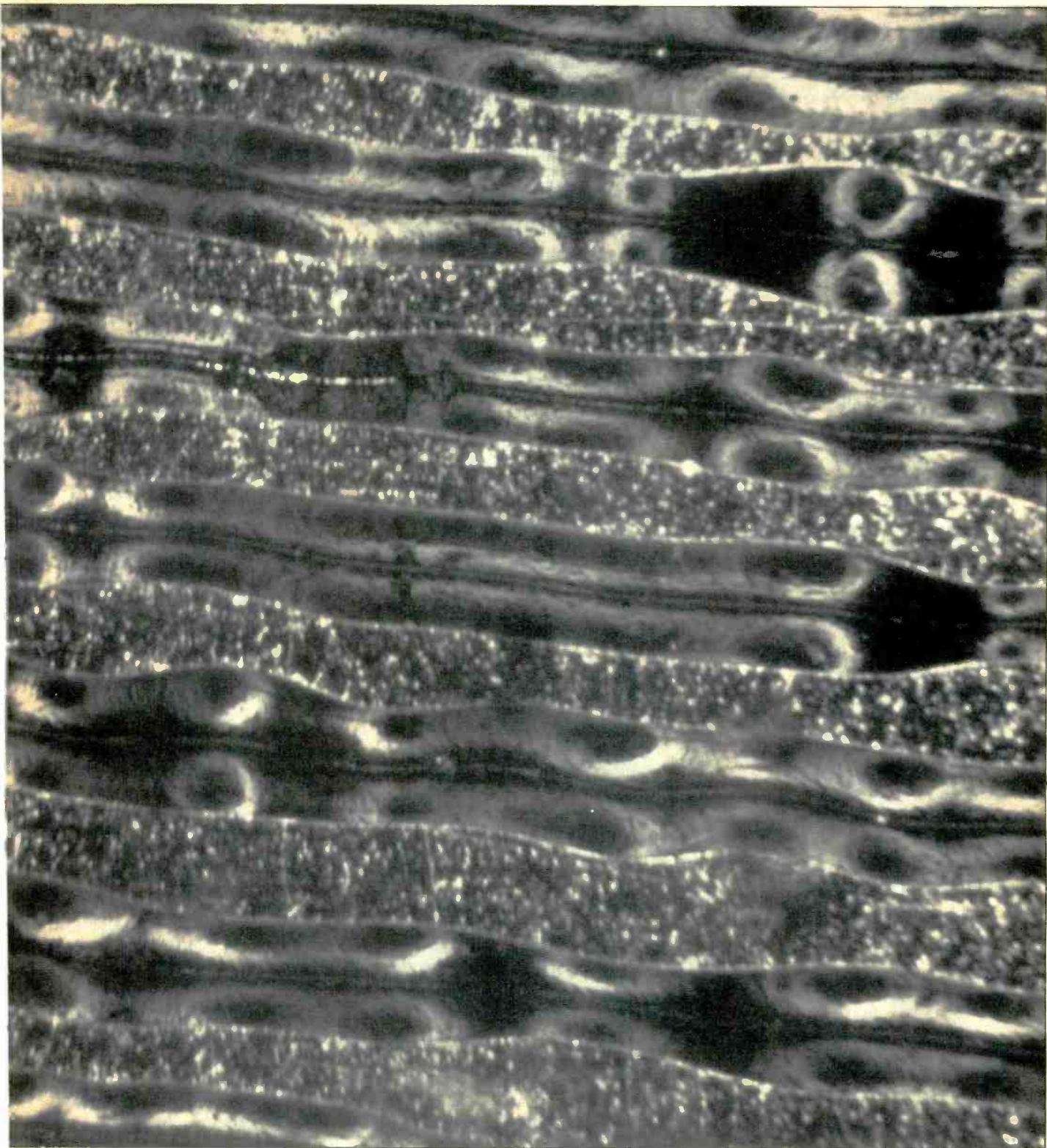

led people to assume that inelastic, permanent or plastic deformation occurred, especially after repeated plays, and also that local melting occurred. The plastic deformation was presumed to be a major factor in loss of sound quality.

Our SEM study shows that deforma-

tion is not a terribly important factor in loss of sound quality, but does indicate some other factors that are important. Optical microscopy could not be used for these studies because the optical microscope does not have the depth of field necessary to be able to see other than very small areas of the

**Fig. 2—An optical microphotograph of an unplayed Kotekan record. The information in the groove walls is very difficult to read using this technique, which uses reflected light via conoscopic illumination.**

**Fig. 3—Scanning electron microscope (SEM) microphotographs of an unplayed Kotekan record.**

record surface. As an example, the photo shown in Fig. 2 was taken by reflected, conoscopic illumination — effectively a ring light around the objective lens of the optical microscope. The view is perpendicular to the record. The hills and valleys on each side of the groove are manifested by changes in reflection. The information on the record groove is not easily read because of the viewing angle (90 degrees). If the viewing angle is changed, the depth of field severely limits the surface area that can be viewed. The depth of field difficulty disappears with the SEM. The SEM photos for this article were taken with an angle of 60 degrees between the viewing electron beam and the record surface. The enormous depth of field allows us to see all of the audio information and, in addition, all of the surface imperfections.

#### Reading SCM Photos

However, viewing SEM photographs can be frustrating, as they do show a large amount of detail, some of which is important and some of which is not. Thus, interpretation of the photos can be difficult. At times a depression may appear to be a particle lying on the surface, and at times a hill on the surface may appear to be a depression. Turn the magazine upside down and view the low magnification photos. What were grooves now appear to be mountain ridges; concave features appear convex. "Up" and "down" appearances are, to a large extent, psychological phenomena. We learn to identify "up" and "down" by relationships between objects and the light shining on them. The sun is always up! Only by carefully studying a sequence of SEM photos in light of the background knowledge of the spatial relationship between the surface and the electron beam, can one be certain whether one is observing a hill or a valley.

Figures 3 through 5 are three sequences of six photos each, taken of a small area on an individual record with varying magnification. Figure 3 is of a very high-quality, unplayed, audiophile record (Kotekan, which was kindly provided by Reference Recordings, 400 Pennsylvania St., San Francisco, Calif. 94101). In the low-magnification pictures, one can see the wealth of audio information; the percussive notes with harmonics are superim-

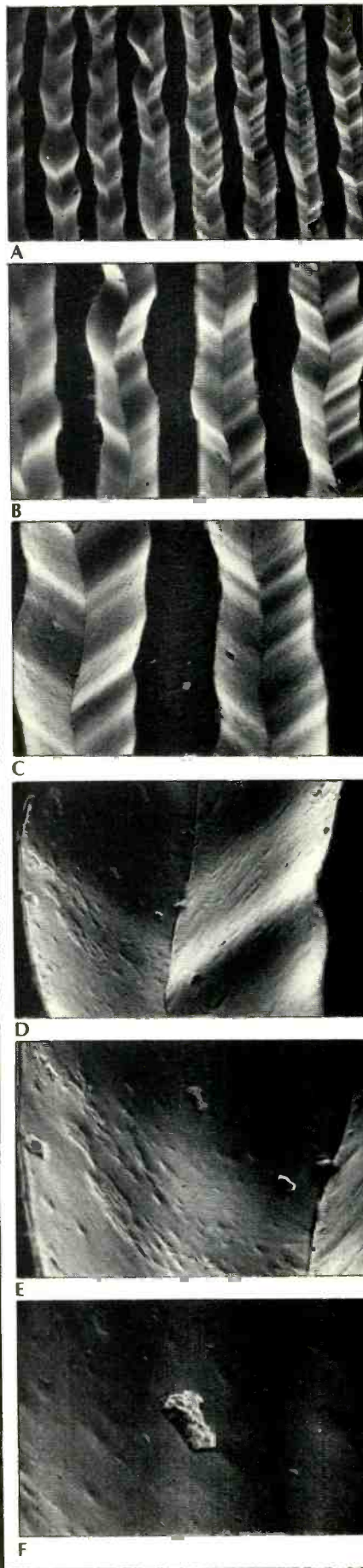

**Fig. 4—SEM microphotographs of a Kotekan record played 50 times.**

posed upon the basic frequency. The width and depth of the groove give amplitude information (loudness). As the magnification is increased, we begin to see imperfections in the surface of the vinyl. Notice the small perturbances of the surface. It is not smooth. In Fig. 3D and 3E we can also discern several small holes in the groove surface. These are imperfections arising from the pressing operation. There are also holes in the bottom of the groove. These imperfections probably came from the process of releasing the record from the press mold. Since the stylus rides on the sides of the groove, imperfections in the very bottom of the groove do not lead to deterioration of the audio quality.

The Kotekan is a record of superb audio quality. The imperfections seen at high magnification are both of low number density (number per unit area of the groove) and of small size. In these studies of record wear, the number density of imperfections, their sizes, and their types are the important data.

For these tests, all of the records were played with a new Shure M91ED cartridge (elliptical) loaded at 1 gram with proper anti-skate adjustment. The records were cleaned with 50 percent isopropyl alcohol. (Dirt could have caused erroneous interpretation by gouging out the groove surface.) Records had adjacent serial numbers so that they came from the same master and presumably pressed within minutes of one another.

Figure 4 is the sequence of SEM photos of a Kotekan record played 50 times. The loss of audio quality is easily heard. The SEM photos show that there are now many small pieces of vinyl that have come off of the surface. These little depressions are very reminiscent of glass surfaces that have been chipped by fine sand, that is, these imperfections appear to be due to surface conchoidal fractures. Examples of conchoidal fractures are broken or shattered glass. Note that by comparison with Fig. 3, there are many more imperfections of this kind and that their individual sizes are larger than those of Fig. 3. Notice too the distinct wear lines that are parallel to the record groove.

Figure 5 is a sequence of SEM photos taken of a record of Holst's *The Planets*. This record was also played 50 times. After 50 plays, it is almost unlis-

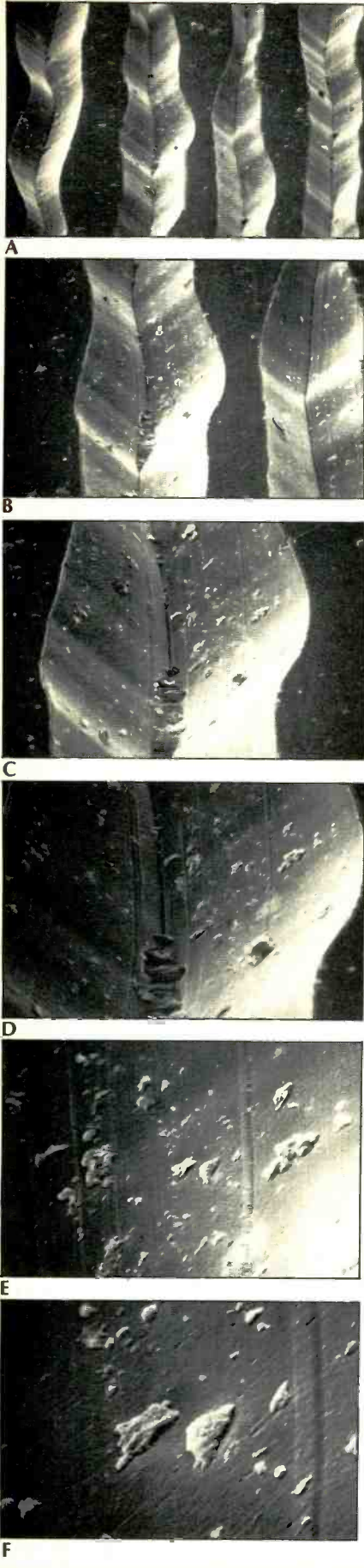

Fig. 5—SEM microphotographs of a record of Holst's *The Planets*.

tenable. The groove walls clearly show enormous damage. Notice that the damage is mainly of the conchoidal fracture type and that there are many longitudinal wear lines. In Figure 5F, we can clearly see why high frequencies become distorted by the wear process. The wall modulations in the right channel are very badly damaged by the conchoidal fracturing that has occurred. In this photo, the dimensions of the fractures are a sizable fraction of the width of the wall modulations.

The wear damage shown in Figs. 4 and 5 is predominantly of the conchoidal fracture type. But this is not the only kind of wear damage that can occur. Figures 6A, B, and C show examples of another kind of wear process, tearing and gouging in addition to the conchoidal fracture, which may be associated with a "stick-slip" frictional phenomenon. These photos were taken from a recording of Rachmaninoff's *Symphony No. 1*, used as demonstration record in an audiophile specialty house. The pickup was a moving-coil type loaded at 2.5 grams, and the record was thoroughly cleaned prior to each playing.

Several points should be noted from these SEM pictures. First, there is a large difference in wear, depending upon the quality of the vinyl used in the record pressing. The Kotekan is not only a superb recording, but the discs are also made of high-quality vinyl. Second, the unplayed records have many defects visible under high magnification. It is the number density (number per unit area of the groove) and the sizes of the defects that account for the deterioration of audio quality. Third, the smooth lines worn into the side walls produced by the wearing operation probably do not do as much sonic harm as the conchoidal fractures or the tearing and gouging wear.

The SEM data indicate that, despite the very large unit area loading at the record groove walls, repeated plays do not, in themselves, lead to large permanent deformations of the groove as has been widely presumed. A very strong implication from this data is that, to a large extent, the crackling and popping sounds presumed to be caused by static electricity are caused by the conchoidal fracturing, the tearing, and the gouging wear. There is no question, however, that static electricity is built up in the course of playing a

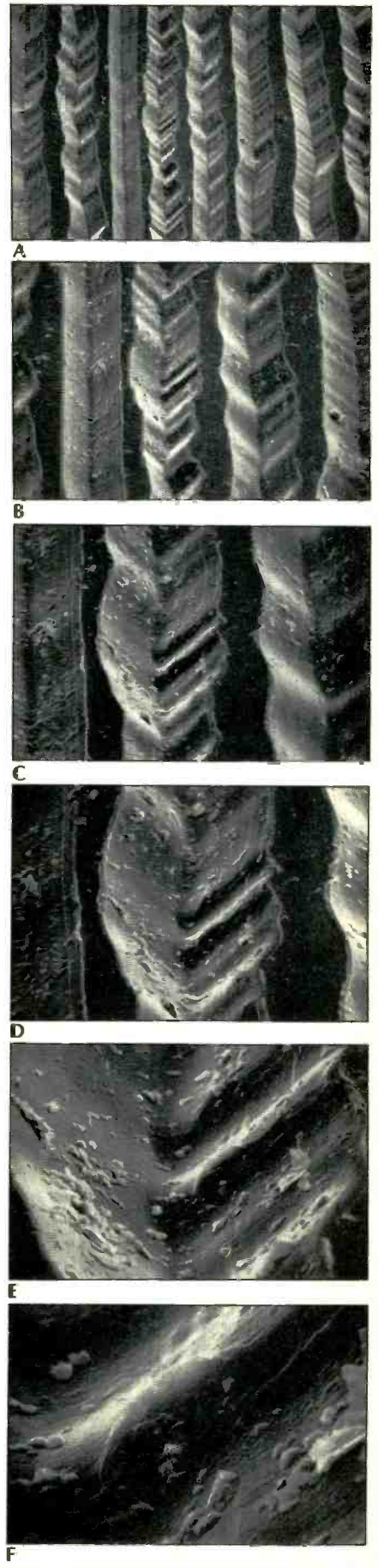





Fig. 6—SEM microphotographs of a recording of Rachmaninoff's *Symphony No. 1*.

record, but the purely static charge effect appears minor compared to deterioration of audio quality due to the generation of wear defects. Static probably causes more harm by attracting dirt to the playing surface where it subsequently is pushed and pounded into the groove wall or forced along in front of a stylus, scouring and gouging the groove wall.

Pure vinyl is not used in pressing records, rather vinyl with various fillers is used, and variations in the ratio of vinyl to fillers and the dispersion of fillers are common. The conchoidal fracturing wear is indicative of too large a concentration of filler; the tearing and gouging wear is indicative of a poor choice of the type of filler material. SEM data could help the manufacturers develop and provide the consumer with a better product. Although human ears may be able to discern the audio deterioration, they cannot point to the cause.

The SEM is a powerful tool for the detailed study of surfaces. This study

points to several mechanisms for wear in phonograph records. It also points to contributing factors that affect the wear processes which are introduced in the manufacturing processes. Microscopic fracturing, gouging, and tearing along with the detrimental effects of surface contamination are mechanical factors contributing to the wear processes. This study also clearly indicates that the quality of the vinyl record base material has an enormous effect on the type of wear and the total quantity of wear.

Much can be and has been done to slow the wearing process. Audio equipment technology has made large strides towards this goal, and the audiophile has become more aware of the importance of cleaning and proper record storage. Some record preservatives are presently being marketed and new ones are about to be introduced to the public, and with the escalating cost of records, these new materials and processes can help keep good music affordable to the consumer. 

## Now get moving coil perfection for the price of a common cartridge.

Most music lovers dream of owning a fine moving coil cartridge. But it's been an impossible dream for many because of the high cost. Until now.

Satin, world leader in moving coil technology, has brought the suggested retail price of a high-quality moving coil cartridge **below \$100**, well within the budget of most buyers.

Our new Satin 117Z has the extended frequency range, superb stereo imaging, gloriously open, spacious and—above all—realistic sound quality that Satin MC's are famous for.

### User-replaceable stylus.

And like all the Satin cartridges, it features a unique user-replaceable stylus that you can change in seconds, like a common cartridge. The stylus is a perfectly formed diamond, with Satin's

exclusive single-point pivot and special magnet/lubricant damping system for high compliance and separation.

### No transformer or pre-preamp.

And, of course, the high-output 117Z uses Satin's ultra-thin 10-micron aluminum ribbon coil and high energy magnet so you don't need an expensive noise-prone pre-amplifier or transformer like most other moving coil cartridges. The 117Z connects directly to any quality amp, preamp or receiver.

Visit your authorized Satin dealer as soon as possible. For under \$100, why postpone perfection?

Osawa & Co. (USA) Inc.  
521 Fifth Avenue  
New York, New York 10017

Distributed in Canada by Intersound Electronics,  
Montreal, Quebec



**SATIN**<sup>®</sup>  
by  **OSAWA**  
The Measure of Quality

Enter No. 19 on Reader Service Card

# THE REALIZATION OF GREAT EXPECTATIONS.

## THE SANSUI "Z" SERIES.

Music lovers expect uncommon products from Sansui. And Sansui delivers. The new Sansui "Z" Series of synthesized digital receivers are designed and built with a loving logic that can be seen, touched and heard. Take the Sansui 5900Z, a reasonably priced receiver with every important feature you could possibly want for the heart of your high fidelity system.

### SYNTHESIZED DIGITAL TUNING

You can't mistune a Sansui synthesized digital receiver. Not even a little. Press the up/down tuning buttons. The digital circuitry ensures that every station received is automatically locked in for lowest possible distortion, with its frequency indicated both on a digital readout and by an LED indicator along an analog type dial.

### TOUCH VOLUME CONTROL & LED PEAK POWER LEVEL INDICATOR

The Sansui 5900Z uses a pair of touch-buttons to adjust the listening level. Relative volume control setting is indicated on a fluorescent display. Actual peak power amplifier output is shown by 14-segment LED indicators.

### 12 PRESET STATIONS

To make FM and AM tuning still easier, up

to 12 user-selected stations may be "stored" in the 5900Z's memory circuits for instant recall. The last station received will be remembered when the tuner is turned on again; and memories are kept "live" even during a power outage.

### DC-SERVO AMP FOR DEPENDABLE POWER

The leader in DC technology, Sansui uses a servo-controlled amplifier circuit in all "Z" receivers to eliminate unwanted ultra-low frequencies — like record warps — while maintaining the advantages of direct-coupled circuitry in their amplifier sections. The 5900Z delivers 75 watts/channel, min. RMS, both channels into 8 ohms, from 20-20,000Hz, with no more than 0.03% THD.

And there's more. Like LED's for every important function. Two Muting Modes. AM stereo capability. And much more.

Visit your Sansui dealer and make sure you

see all the wonderful stereo receivers in the Sansui "Z" Series. And expect great things. You won't be disappointed.

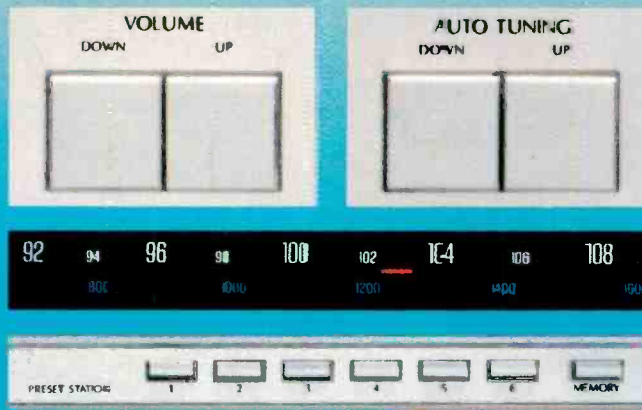

*Sansui*

### SANSUI ELECTRONICS CORP.

Lyndhurst, New Jersey 07031  
 Gardena, Ca. 90247  
 SANSUI ELECTRIC CO., LTD., Tokyo, Japan  
 SANSUI AUDIO EUROPE S.A., Antwerp, Belgium  
 In Canada: Electronic Distributors



Enter No. 24 on Reader Service Card

# 37 CASSETTE TAPES TESTED



## Howard A. Roberson

New tape formulations continue to appear with some regularity, and the manufacturers are also refining many of the present products. This article will cover changes since our September, 1978 mass test and discuss the significance of the test results. A total of 37 tapes are evaluated here in a num-

ber of important performance areas. There are 17 Type I (normal bias/ $120\mu\text{S}$ ), 12 Type II (chrome bias/ $70\mu\text{S}$ ), one Type III (FeCr), and seven Type IV (metal particle). Note that Type II includes all  $\text{CrO}_2$ , FeCo and other formulations that use high bias and  $70\mu\text{S}$  EQ. Frequency responses were checked at Dolby level (200 nWb/m at 400 Hz) and 20 dB below

that. The  $\text{HDL}_3 = 3$  percent points were determined at 100, 400, 1000 and 2000 Hz, with the 400-Hz level the reference for the signal-to-noise ratio in dBA. The twin-tone IM distortion 3 percent distortion-limit points were measured with 5 and 6 kHz, and 10 and 11 kHz tone combinations. Playback of a 3-kHz tone was analyzed for flutter and output-level stability, in-





0.00% switching distortion. 0.00% FM drift.  
 Two reasons Technics has a lot to say about nothing.

Technics SU-V8 amplifier with New Class A circuitry eliminates switching distortion. The ST-S7 quartz synthesizer tuner eliminates FM drift. And as you'll discover, the more we eliminate, the more we add.

Take the SU-V8. You won't hear any switching distortion because, unlike most of today's amplifiers, its output transistors don't switch on and off as the input waveform goes from positive to negative. The reason: Technics synchro-bias circuitry. What it does is employ high-speed diodes that constantly send minute amounts of current to the transistor not in use. And since the transistors are always on, switching distortion is eliminated.

And there's nothing minute about the SU-V8's power

output: 110 watts per channel from 20 Hz to 20 kHz into 8 ohms with no more than 0.005% THD. The results: Music that's rich, crisp and bursting with dynamic range.

In concert with the SU-V8 is the ST-S7. With its quartz-crystal oscillator, only the broadcast frequencies you select can be received. And since both frequencies are quartz-synthesized, the tuner can't drift. That means any station you tune is perfectly in tune.

And the ST-S7's microprocessor allows you to preset eight AM and eight FM stations and even turn the power on and tune three stations all by itself.

Discover Technics new amps and tuners. When it comes to New Class A and quartz, Technics gets an A plus.

**Technics**  
 The science of sound

Enter No. 31 on Reader Service Card

cluding dropouts. The modulation noise tests utilized a 1-kHz test tone, notched out in playback with band limiting at 500 and 1500 Hz. Consistency of tape skew and bias requirements were checked with pink noise and a 1/3-octave RTA.

The new formulations reported on here include three tapes from EMI (distributed in this country by Empire), three tapes each from Ampex and RKO, TDK's OD and SA-X, one from Tape 5, Denon's DX7 and DXM, TSI from Tape Specialty, Lux XM-II and XM-IV, Maxell MX metal tape,

Memorex High Bias, and entries from Sony, including a metal-particle formulation. Improved versions were received from BASF, Maxell, Sony, TDK, Realistic (Radio Shack) and Scotch, and they were subjected to the same testing procedure. The TSI cassettes from Tape Specialty received immediate interest and some skepticism because of the low price. Little labels indicated that some had tape material from Agfa and some had material from BASF. The claims by Tape 5 to be superior to some major brands generated a similar reaction.

## Test Results

The results from most of the tests are listed in Table 1. Note that the tapes are grouped under the type numbers mentioned earlier. The bias and sensitivity figures shown for the two metal tapes are referenced to Nakamichi ZX tape on a Nakamichi 582 deck. The "bias" figure shown is actually the change in the tape's response at 15 kHz when the bias was shifted to that for ZX tape. There are frequency response plots for each of the tapes, as well as comments on these and other results, tape by tape.

# TABLE I-TEST RESULTS

BRAND	DESIGNATION	TYPE	RESPONSE AT -3 dB (kHz)		MAXIMUM RECORD LEVEL dB re Dolby Level						S/N RATIO dBA	MOD NOISE -dB	400 HZ	
			0 dB Level	-20 dB Level	100	400	HDL <sub>3</sub> = 3%		TT IM=3%				SENS dB	BIAS dB
							1k	2k	5k	10k				
Ampex	Grand Master I	I	10.5	23.5	+6.0	+6.9	+7.0	+5.7	-0.2	-7.0	56.5	50.0	+0.7	-0.8
BASF	Studio I	I	8.4	22.2	+4.0	+4.6	+5.5	+4.2	-1.6	-9.8	56.8	46.5	0.0	+0.3
EMI	Standard	I	8.4	22.2	+2.8	+2.9	+3.2	+2.8	-3.7	-11.3	53.4	40.5	0.0	-1.3
EMI	Super	I	8.6	20.8	+4.9	+4.8	+4.7	+4.0	-3.0	-10.2	54.9	43.1	+0.6	-1.0
EMI	High Fidelity	I	9.8	23.2	+5.1	+5.8	+6.0	+5.1	-3.6	-9.8	55.3	44.0	+0.7	-0.4
Maxell	UDXLI	I	10.4	24.2	+7.5	+7.3	+7.6	+5.4	-0.2	-6.8	57.0	49.5	+1.7	+0.4
RKO	XD	I	8.6	21.4	+4.1	+4.7	+4.6	+2.6	-3.2	-9.3	54.7	46.5	+1.6	-0.8
RKO	Broadcast I	I	9.1	23.4	+6.0	+6.8	+6.2	+5.6	-0.4	-10.3	54.4	48.1	+1.0	+1.0
Sony	LNK	I	9.2	22.6	+1.5	+1.8	+1.9	+2.0	-3.6	-11.3	53.2	47.4	-0.2	-1.2
Sony	HFX	I	9.5	23.1	+2.3	+3.4	+5.0	+3.5	-2.9	-10.0	53.0	47.0	+0.3	-0.3
Sony	SHF	I	11.0	24.2	+6.1	+7.0	+7.8	+5.7	-0.1	-8.2	55.2	49.2	+1.4	0.0
Tape 5	Wide Latitude	I	10.0	20.7	+2.3	+3.0	+5.0	+4.2	-2.0	-9.1	50.9	49.0	+0.2	-0.7
TDK	D	I	9.6	22.8	+3.6	+4.1	+5.2	+3.4	-1.8	-10.4	54.8	49.5	-0.4	-0.5
TDK	AD	I	10.2	22.9	+6.6	+6.8	+7.7	+5.1	-1.4	-10.1	55.4	49.0	-0.4	-0.1
TDK	OD	I	10.5	25.1	+6.6	+7.1	+7.7	+5.0	-0.2	-9.1	55.7	49.7	+0.8	-0.3
TSI	(Agfa)	I	9.2	24.2	+3.6	+5.0	+7.0	+7.2	+0.2	-10.0	53.0	45.9	+1.3	-0.2
TSI	(BASF)	I	9.4	22.6	+6.1	+6.0	+6.0	+2.9	-0.8	-11.0	54.8	46.0	+1.3	0.0
Ampex	Grand Master II	I	9.3	22.7	+1.2	+2.2	+2.6	+1.3	-6.3	-12.0	55.5	52.8	+0.8	-0.9
BASF	Studio II	II	8.3	21.0	+3.9	+5.0	+4.9	+1.5	-3.6	-11.4	57.0	48.5	+1.0	-0.7
Denon	DX7	II	8.4	22.8	+2.3	+2.8	+2.4	+0.6	-6.0	-11.0	56.2	50.8	+1.0	-0.5
Lux	XM-II	II	9.5	21.7	+5.7	+6.6	+7.0	+3.2	-4.0	-13.2	56.8	49.5	+1.2	-0.7
Maxell	UDXLII	II	9.5	21.1	+5.8	+6.7	+6.7	+3.1	-3.8	-11.4	57.8	51.3	+2.0	-0.6
Memorex	High Bias	II	9.8	21.8	+6.7	+7.3	+6.8	+2.9	-3.8	-11.2	58.8	51.4	0.0	+1.0
Realistic	Supertape CrO <sub>2</sub>	II	8.0	20.9	+5.1	+5.7	+4.3	+1.6	-6.0	-13.8	57.0	53.5	+0.5	-0.5
RKO	Ultrachrome	II	9.6	22.3	+5.7	+7.0	+5.6	+2.3	-4.5	-9.5	60.0	46.2	+1.3	-0.2
Scotch	Master II	II	9.5	22.7	+6.1	+7.8	+6.4	+2.6	-4.6	-11.3	58.8	45.6	+2.2	-1.7
Sony	EHF	II	9.2	21.5	+3.7	+4.6	+5.8	+1.9	-4.8	-11.9	56.3	49.0	+1.0	-1.0
TDK	SA	II	9.1	21.5	+5.2	+5.9	+6.1	+2.6	-4.8	-12.9	57.5	51.0	+1.4	-0.7
TDK	SA-X	II	12.0	24.1	+6.2	+7.1	+7.7	+4.3	-2.5	-7.8	60.3	51.1	+2.0	+1.2
Sony	FeCr	III	5.4	23.0	+5.8	+6.1	+3.4	-1.8	-11.2	-15.7	59.7	45.7	+0.3	-0.8
Ampex	MPT	IV	11.4	23.4	+7.0	+8.3	+7.5	+4.1	-2.5	-8.7	61.4	49.8	+0.5*	0.0*
Denon	DXM	IV	11.5	22.7	+8.5	+9.4	+9.4	+5.3	-1.1	-9.3	60.7	51.1	+0.3*	+0.2*
Fuji	Metal	IV	11.7	22.2	+6.0	+7.9	+7.6	+4.6	-1.5	-7.3	60.0	49.7	-0.2*	+1.0*
Lux	XM-IV	IV	11.8	24.4	+4.6	+6.0	+6.3	+3.8	-3.0	-6.8	59.7	51.8	-0.3*	0.0*
Maxell	MX	IV	12.0	24.7	+8.0	+9.2	+9.3	+5.5	-1.5	-7.5	60.1	50.0	+0.6*	+0.3*
Sony	Metallic	IV	12.2	23.4	+7.7	+8.9	+9.0	+5.4	-1.2	-7.5	60.8	52.4	0.0*	-1.0*
TDK	MA-R	IV	12.0	23.8	+8.0	+9.5	+9.3	+5.0	-1.5	-7.6	60.3	53.3	+0.5*	+0.6*

\*See text.

# TDK Metal. Now you can have ninety minutes in either case.



TDK sets the metal standard for most metal deck manufacturers. With good reasons. Superior high frequency MOL for extended response. Up to 8 dB greater MOL at high frequencies than any high bias tape. High coercivity and remanence for superior sensitivity and additional recording headroom.

This unsurpassed sound comes housed in two different cases. In the case of the MA-R, there is a unique TDK die-cast metal frame. Its unibody construction creates perfect integrity between sides A and B. This insures against signal overlap, channel or sensitivity loss from one side to the other. The Reference Standard Mechanism assures a lifetime\* of superior performance. TDK MA has a computer-molded cassette shell. Like MA-R, it's specially designed for the best interfacing with the 3-head metal deck.

its Laboratory Standard Mechanism assures years of pure metal sound.

Now in both cases, TDK gives you a choice of 60- or 90-minute lengths. Whichever you choose, you'll hear how TDK makes a perfect case for metal.



\*In the unlikely event that any TDK cassette ever fails to perform due to a defect in materials or workmanship, simply return it to your local dealer or to TDK for a free replacement.

©1980 TDK Electronics Corp., Garden City, New York 11530

**TDK**  
The machine for your machine

Enter No. 30 on Reader Service Card

## Type I

**Ampex Grand Master I:** This new formulation from Ampex takes its place as one of the best of the Type I tapes, with extended frequency responses, high MRLs and S/N ratio, and the lowest modulation noise measured for a ferric. Sensitivity consistent among all C-90 and C-60 samples. Bias quite consistent, although C-60s required slightly less. Relatively little skew shown when flipping the cassette. Output level variations were about 0.3 dB, occasionally a little higher. Drop-outs never approached the audibility threshold.

**BASF Studio I:** This tape is an improved version of BASF Studio, and the performance has been definitely bettered in substantially all respects. Particularly noteworthy are the high MRLs and the excellent S/N ratio. Skew among samples was fairly close, and bias needs and sensitivity were consistent. There were some output-level variations of 0.5 dB with a three-second period, and there were occa-

sional dropouts that were close to being just audible (CBS criteria).

**EMI Standard:** This is billed as EMI's lowest performance cassette. Skew and bias were consistent among the samples, but there were sensitivity differences with a 2-dB spread. Level variations within a sample were usually less than 0.2 dB, quite smooth. Some infrequent dropouts were detected only with concentrated listening.

**EMI Super:** This formulation is definitely better than the Standard, for the Super delivers wider responses, higher MRLs and S/N ratio, and lower modulation noise. Overall, this is an above-average ferric. There were some sensitivity variations from cassette to cassette with a spread of 1.4 dB, but shorter term variations were 0.3 dB or less. Rare dropouts were just detectable. Flutter was lower than with most cassettes.

**EMI High Fidelity:** This cassette gets a higher overall ranking than EMI Super, and it is a very good Type I tape. It had higher MRLs across the band, and a

very good S/N ratio. The sensitivity was more consistent, but still had a dB spread. There were a few dropouts which caused infrequent and minor perturbations in the music playback. Flutter was consistently low, better than the great majority of cassettes.

**Maxell UDXLI:** As the data in Table I shows, this is an outstanding tape of its type. There were some improvements over the results of two years ago. Most notable in the current tests were a higher signal/noise ratio and lower modulation noise. All samples received were very consistent in sensitivity, skew, and bias requirements. Long-term amplitude variations were very small, and there were no dropouts.

**RKO XD:** This recent addition to the RKO line has good performance overall, as shown in the results table. Bias and sensitivity were consistent among the C-90 samples received. There was some tape skew, evidenced when the cassette was flipped. The output level varied regularly, but the total spread

# TYPE I

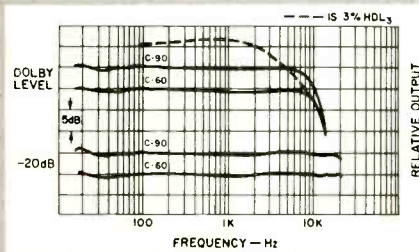

Ampex Grand Master I, C-90 HDL<sub>3</sub>.

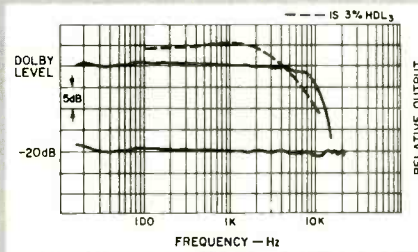

BASF Studio I

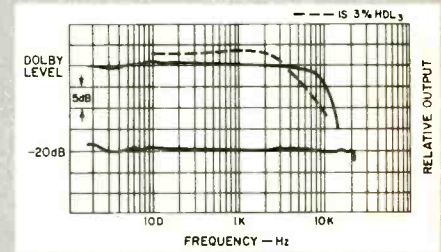

EMI Standard

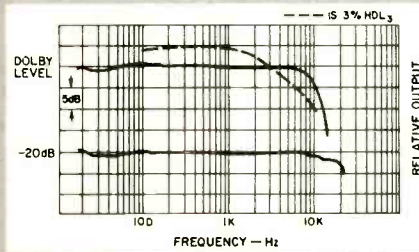

RKO XD

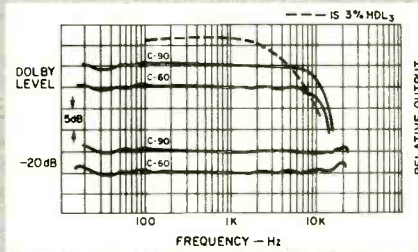

RKO Broadcast I

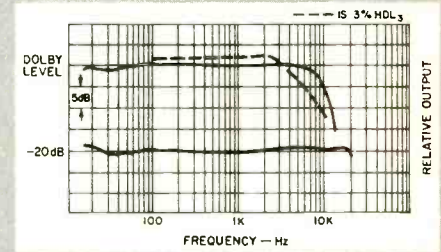

Sony LNX

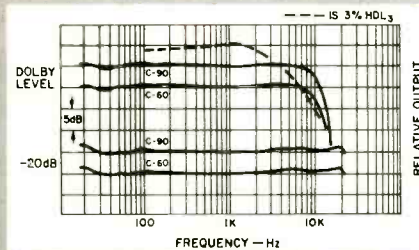

TDK D

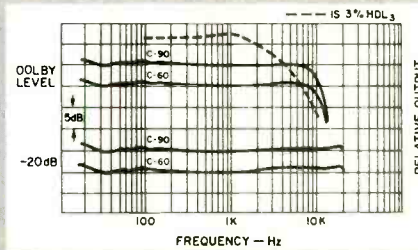

TDK AD, C-90 HDL<sub>3</sub>

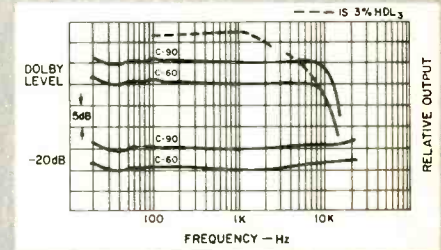

TDK OD, C-90 HDL<sub>3</sub>

was limited to 0.3 dB. There were no drop-outs observed.

**RKO Broadcast I:** In general, this is a very good addition to the Type I (normal bias) tapes available, providing above-average headroom and fine frequency responses. The signal/noise ratio is typical for the category; modulation noise is lower than average. There was exact consistency in sensitivity, skew, and bias needs, with the exception of a skew shift on the second side. There were random output variations up to about 0.3 dB, not considered significant. Dropouts were below the point of detectability.

**Sony LNX:** This appeared to be an updating of Sony LN, and there were some slight improvements in MRLs and frequency responses. Dropouts, however, were more evident in the analyzer display, and there were slight, occasional effects in the playback sound. The output level was very steady on a long-term basis, however, and skew and bias were consistent.

**Sony HFx:** This formulation is more of

a premium ferric oxide than LNX, according to Sony, and the MRLs were higher across the band. The HFx samples were also free of any audible dropouts. Tape skew, record sensitivity, and bias requirements were consistent among all of the samples.

**Sony SHF:** This is Sony's premium Type I formulation, and it is one of the best of all tapes in this category. The responses are extended, the MRLs and the signal/noise ratio are high, and the modulation noise is low. The amplitude stability was very good, in general, with an occasional cyclic variation limited to 0.3 dB. There were quite a few small dropouts, but they never approached the threshold of audibility. Two of the the samples were completely consistent in sensitivity, skew and bias, but the third had higher sensitivity, which itself was varying.

**Tape 5 Wide Latitude:** As mentioned earlier, this tape was of more than casual interest because of the claims for performance superior to more expensive and better known tapes. Immedi-

ately, we can say that the measured responses are more than respectable, and that the MRLs are fairly good. Examination of the response figure, however, shows that there was a drop in the response of the C-60 at 0 dB, and that the two -20 dB responses do not match well. The deviations from the expected responses appeared to have had one fundamental cause — tape skew kept changing with time and with any shift in tape motion. For example, rewinding the tape to play back the swept test tone, changed the response every time it was done. The results shown are the best achieved. Because of the constantly changing skew, it was very difficult to align the record head and set the bias precisely. Based upon the samples received, a conclusion: This tape should not be used with three-head decks. The S/N ratio was 50.9 dBA, 6.6 dBA poorer than TDK SA — in contrast to the claim of 10-dB superiority.

**TDK D:** TDK has improved the D formulation since the last testing, and

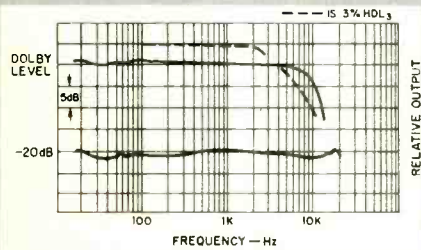

**EMI Super**

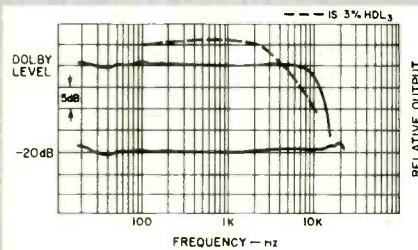

**EMI High Fidelity**

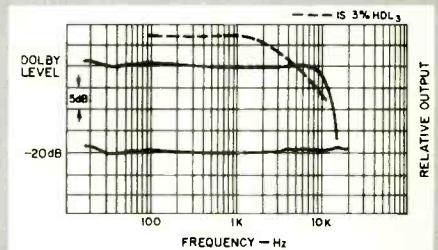

**Maxell UDXL I**

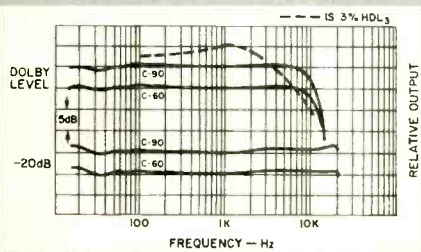

**Sony HFx**

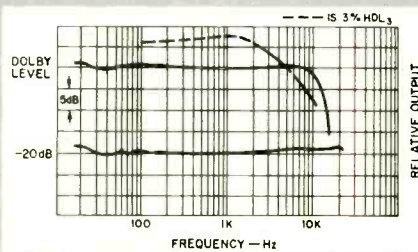

**Sony SHF**

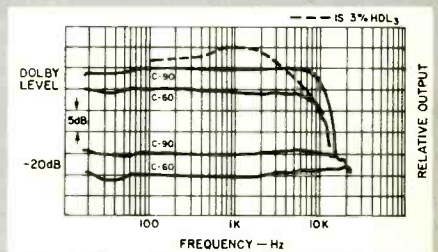

**Tape 5**

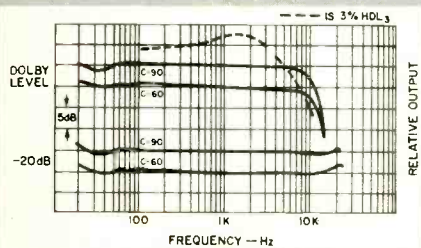

**TSI (Agfa), C-90 HDL3**

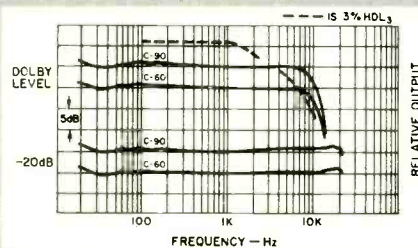

**TSI (BASF), C-90 HDL3**

# YOU CAN PAY A LOT FOR GOOD SPEAKER DESIGN,



**\$1275.<sup>00</sup>**

each

### SPECS

Horn loaded, folded-horn woofer design  
Frequency response: 35-17,000 Hz + 5 dB  
Height: 52"  
Width: 31 1/4"  
Depth: 28 1/2"  
Maximum power input: 105 watts RMS/channel

# BUT YOU DON'T HAVE TO!



**\$690.<sup>00</sup>**

each

### SPECS

Horn loaded, folded-horn woofer design  
Frequency response: 35-18,000 Hz + 5 dB  
Height: 51 7/8"  
Width: 31 1/2"  
Depth: 28"  
Maximum power input: 250 watts RMS/channel

If they both have the same design, how come you pay so much less for ours? Because they come direct from the Factory—no retail mark-up. You also get our unconditional Guarantee of Satisfaction.

Our new color catalog tells you all about Speaker Factory's 10 money-saving speakers—plus a lot more.

Send for your copy today by mailing in the coupon. Do it now!

## FREE CATALOG

YES! I WANT TO SAVE MONEY ON SPEAKERS.

- I can hardly wait! I'm enclosing 50¢ for 1st class postage and special handling.  
 I'm anxious to find out more, but regular mail is O.K.

Name \_\_\_\_\_

Address \_\_\_\_\_

City/State/Zip \_\_\_\_\_

Mail to: **SPEAKER FACTORY, Dept. HF 9**  
1101 N. Northlake Way, Seattle, WA 98103

there were measurable changes in MRLs, signal/noise ratio and modulation noise — all to the better. There was some spread in sensitivity among the samples, a little on the high side for the C-60s. Skew and bias needs, on the other hand, were completely consistent including flipping the cassettes. There was also improvement in level stability, which was very smooth, and in dropouts which were relatively few and well below audibility.

**TDK AD:** The changes made in this tape have garnered higher MRLs, lower modulation noise and slightly widened responses, making it one of the best Type I tapes. There was fairly good consistency among all C-90 and C-60 samples in sensitivity and bias needs. Skew was consistent among the C-90s and among the C-60s, but there was a small discrepancy between the lengths. At some points, there was a cyclic variation in amplitude of 0.7 dB. Dropouts were infrequent, but there were rare ones greater than the audibility criterion, although none were detected in listening.

**TDK OD:** According to the manufacturer, this formulation uses "ultra-refined particles made from gamma-hematite." The responses were extended, the MRLs and the S/N were high, and the modulation noise was low. Sensitivity, skew, and bias were consistent among all samples, including the flip side. Dropouts were all well below the threshold of audibility. Overall, OD is a superior Type I formulation.

**TSI (Agfa):** Examination of the results in Table I will show that this tape is one of the better performers in the Type I (normal bias) category. There was a spread of about a dB in sensitivity for both C-90s and C-60s, with the C-60s about 0.6 dB more sensitive on the average. Bias was consistent for all samples, as was skew with the exception that the other side of each of the C-90s was slightly different. Dropouts were well below audibility, but there were some amplitude variations of about a dB with a 2-second period. In toto, this tape provides good performance per dollar.

**TSI (BASF):** Overall this tape is quite comparable to the TSI (Agfa). On the plus side are higher MRLs at the lower frequencies and a bit better S/N ratio. On the other hand, high-frequency MRLs are not quite as good. Consistent bias and skew among C-90s and C-60s are a plus for this cassette. The spread in sensitivity was less than a dB, quite acceptable. All dropouts were below the audibility threshold, and long-term amplitude variations were

less than 0.3 dB. Good quality at a low price.

## Type II

**Ampex Grand Master II:** This Type II formulation has good responses, but the MRLs are rather low over the entire band. The S/N ratio, as expected from the low MRLs, is not impressive, but the modulation noise was among the lowest for all tapes of all types. Sensitivity was consistent among all samples. Bias for C-60s was very slightly lower, compared to that for C-90s. There was substantially no skew among all of the samples. The output level was very steady, usually within 0.2 dB. With the fast analyzer scan looking for drop-outs, the display was very smooth: Occasional perturbations were less than a dB.

## TYPE II

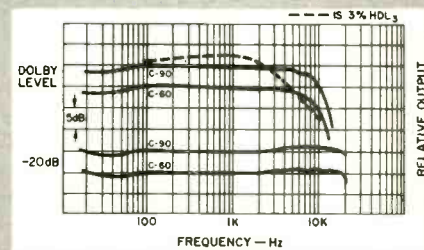

Ampex Grand Master II, C-90 HDL<sub>3</sub>

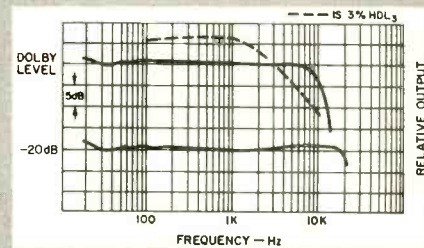

Maxell UDXL II

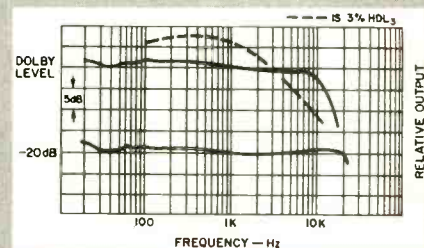

Scotch Master II

**BASF Studio II:** This tape is an improved version of the BASF CrO<sub>2</sub> reported on over a year ago. The change is substantial, and Studio II takes its place as a well-performing tape. Responses are wide and smooth, and the MRLs are good. Consistent sensitivity, skew and bias. There were some cyclic 0.5-dB amplitude variations occasionally, and most dropouts were well below audibility.

**Denon DX7:** This tape had performance generally comparable to the Ampex tape. Bias and sensitivity were consistent, and there was no skew observed in the two C-60s tested. There were occasional output level variations up to 0.8 dB, which appeared in the plot swept at -20 dB. At other times, the level was very steady, and there were no drop-outs.

**Luxman XM-II:** Most results were fair-

ly typical for Type II tapes, but the MRLs were above average, a great improvement over earlier samples. Sensitivity, skew, and bias were consistent among the samples. Level stability was very good, with variations limited to 0.2 dB. Dropouts were infrequent and just reached the audibility threshold on rare occasions. The cassettes included a scheme for adjusting skew, which is discussed later.

**Maxell UDXL II:** In general, the results in testing the latest samples of this excellent tape are very close to those reported a year ago, but there is evidence in Table I of the benefits of using the Nakamichi 582 this time. Sensitivity, skew, and bias needs shifted very little among all the C-90s; there were no C-60s to check against. The amplitude variations were generally less than 0.1 dB, and the average level

was very steady. The maximum fast deviation (dropout?) was just 0.3 dB, superb output-level smoothness.

**Memorex High Bias:** This addition to the company's product line is the first in this category, and an excellent performer it is. The formulation delivers wide responses, superior headroom, and an excellent S/N ratio. There were some variations in sensitivity and skew among the samples, but the total spread was quite acceptable. Bias requirements were constant. With time, there were amplitude variations up to about 0.5 dB, a little on the high side. There were fairly regular dropouts, but rarely did one reach the audibility threshold. None were detected in a listening test.

**Realistic Supertape Chrome:** This formulation is a good chrome tape, and it is better than its predecessor. This was

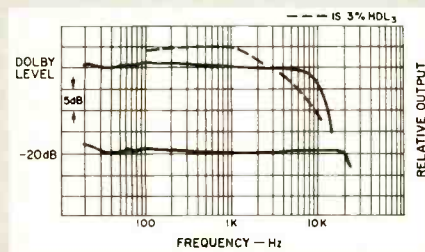

**BASF Studio II**

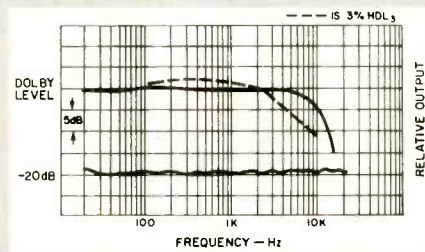

**Denon DX7**

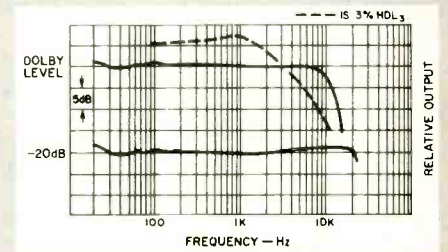

**Luxman XMII**

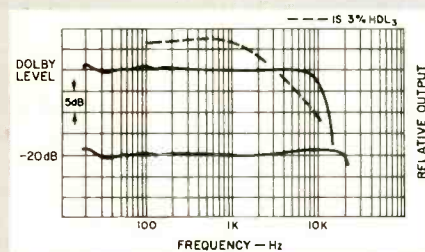

**Memorex High Bias**

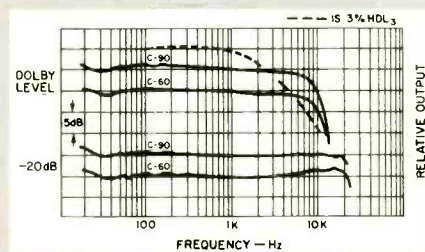

**Realistic Supertape CrO<sub>2</sub>**

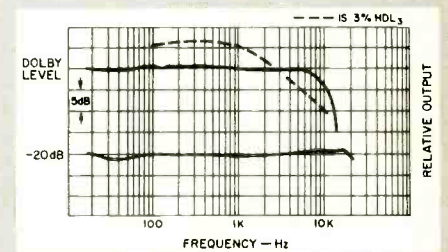

**RKO Ultrachrome**

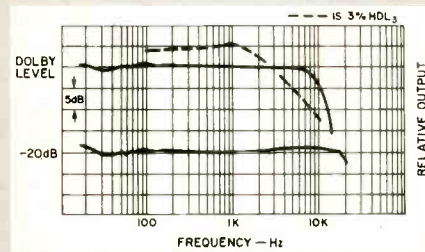

**Sony EHF**

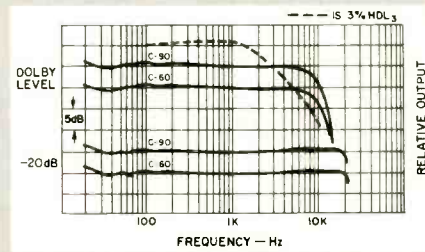

**TDK SA, C-90 HDL<sub>3</sub>**

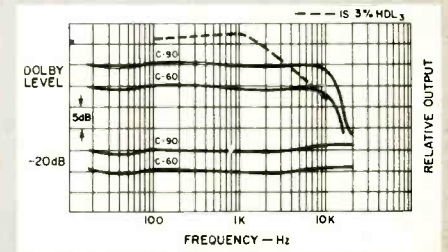

**TDK SA-X, C-90 HDL<sub>3</sub>**

most apparent in the area of improved headroom and lower modulation noise. There was a spread of a dB in the sensitivity of the C-90s, but the C-60s consistently matched the average of the C-90s. Skew and bias requirements were consistent for all of the samples. At some spots on a minority of samples, there were amplitude variations over a dB every three seconds. There were bursts of dropouts at times, but there was very little aural evidence of a problem. There was more edge curl than on most cassette tapes, and that was considered a possible source of the dropouts observed at times. One C-90 jammed during the testing.

**RKO Ultrachrome:** There are those who think that CrO<sub>2</sub> tape is dead, or ought to be, but Du Pont and RKO feel that Crolyn II (Du Pont's material) has lots of life left. The test results say that this is a very good performer, whatever is inside the box. The signal-to-noise ratio is excellent, through the modulation noise figure is on the high side. The average sensitivity was consistent among all samples, but there were variations with time. No dropouts even approached the audibility threshold. Flutter was higher than for most cassettes, and there was a slight, scraping-like sound in fast wind.

**Scotch Master II:** The results listed in Table I for this tape are quite close overall to the reporting a year ago. Perhaps there has been little or no change in the magnetic properties of the material, but there has been a definite improvement in the product. Amplitude variations are now restricted to within 0.2 dB, dropouts have been reduced, and there were no discernible effects from either on the music playback. This is an excellent tape which would be better yet with some reduction in the modulation noise.

**Sony EHF:** This is a cobalt-absorbed ferric oxide which replaces the long-time Sony CrO<sub>2</sub>. In general, it can be said that the change appears to have been worthwhile, but there was some evidence of possible manufacturing start-up problems. The C-90 sample had excellent responses and had very smooth amplitude characteristics, with very little that could even be called a dropout. On the other hand, the C-60 varied in sensitivity, with a great deal of high-frequency level "breathing."

**TDK SA:** The upgrading of this widely used tape brought along improved performance in all areas—wider response, greater headroom, higher signal/noise ratio, and lower modulation noise. All C-90 and C-60 samples were very consistent in sensitivity, skew, and bias requirements. Sensitivity

shifts with time were minor with a random, occasional shift of 0.3 dB maximum. Dropouts were infrequent and never approached the audibility threshold.

**TDK SA-X:** This formulation utilizes what TDK calls Avilyn particles in a two-coating layer with two, different coercivities. One gets cautious when the expression "dual layer" is used, but TDK claims that because both layers are Avilyn particles, there is no problem in compatibility and stability.

### Type III

**Sony FeCr:** Sony continues as one of the relatively few manufacturers of this type of tape, and the results call for about the same rating overall. Some figures were not quite up to previous results; the 0-dB response wasn't as wide, and high-frequency MRLs were low. There was an improvement in bias and skew consistency, with a dB spread in sensitivity. There were periods of 1-dB amplitude variations, but a smooth and steady level was more typical. Many dropouts gave a rough appearance to the analyzer dis-

The results of the testing demonstrate that they must have done a number of things right since this tape has the widest responses, the highest MRLs, the highest S/N ratio of all the Type II tapes tested to date. Sensitivity and bias were very consistent among all samples, both C-90s and C-60s. There was no skewing among any of the samples, including the second side of each cassette. Output level variations had a total spread of 0.3 dB, and there were no drop-outs.

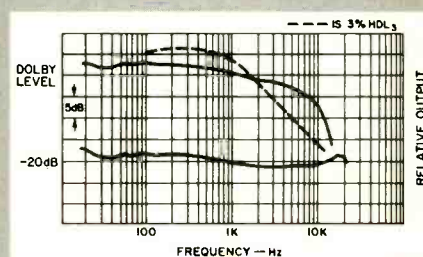

Sony FeCr

play, but detectable effects were infrequent at most.

### Type IV

Everyone agrees that metal-particle tapes are expensive, but it is not easy to state simple guidelines that will ensure that you will spend no more than you have to for the performance you want and/or need. With the current state of the art in tape and machine, metal tapes can provide improvements, but not necessarily as much as some claim or hope. Take note of the fact, for example, that with the exception of MRLs, TDK SA-X is in many ways equivalent to TDK MA-R in performance, per Table I. One thing to keep in mind: The S/N ratio is referred to the 400-Hz MRL, and higher MRLs help most when tape noise is also reduced. Metal tapes from Ampex, Denon, Maxell and Sony were new to the testing process. Reports are also given on the C-90s by Fuji and TDK.

**Ampex MPT:** The C-60 samples provided gave excellent performance, as is to be expected from a metal-particle tape. Of particular note is the 61.4 dBA S/N ratio, next to the highest ever measured. Bias and sensitivity were very consistent, and there was no skew in any of the samples, either side. Output level variations were usually less than 0.3 dB, and there were no dropouts.

**Denon DXM:** This tape generated very smooth responses, and it had very high MRLs, overall one of the best. Other characteristics were also excellent, including the consistency of the two C-60s received. There were level variations of about 0.3 dB. In the dropout check, there were occasional drops of a dB of very short duration, above the -3 dB audibility threshold.

**Fuji Metal:** This is primarily a reporting of the results of testing a C-90 sample; shorter lengths had been tested a year ago. The measured MRLs are less than those obtained with the C-60s, but a change in the testing method accounts in part for any discrepancy that might be noticed. The results are still excellent, and output-level variations were very low, with no drop-outs.

**Luxman XM-IV:** The results are excellent, again expected with a metal tape. Though the MRLs are lower than the other tapes of this type, skew, sensitivity and bias needs were very consistent for all samples, including the flip side. The amplitude stability was very good with most variations less than 0.2 dB, better than many metal tapes. There were a fair number of dropouts, but only rarely did any reach the audibility threshold, and none were detected in



# TEST TAPES:

## What They Are and What They Mean

Because tape formulations are not all the same, and because the differences can result in significant changes in performance, it is important to evaluate the tape products available to the consumer. As many of the important characteristics of the formulations do not lend themselves to assessment by the end user, *Audio* utilizes a battery of tests to cover important areas of performance. Because the evaluation must be done on a recorder, the characteristics of the deck itself becomes significant. It is our position that the deck used should be at the current state of the art, which is essential if the full potential of the tape is to be reported. In the current series of tape tests a Nakamichi 582 has been used because of its superior utilization of the capabilities of all current tape types, including metal particle. It is true that your own deck might not do as well as reported with a particular tape, but, on the other hand, someone might get better results with a deck of later design than the 582.

One advantage of the Nakamichi deck for testing is that it has built-in provisions for calibrating sensitivity and bias and aligning the record head. The first step with each formulation is making the adjustment to calibrate the reference flux level on the tape: 200 nWb/m at 400 Hz or Dolby level. Then, the record head gap is made to match that of the play head magnetically, even if there is some effect from tape skew, or curving. Setting the bias for the flattest response at this point ensures that each tape's frequency response will be shown at its best. Information on the bias and sensitivity values relative to DIN standards is helpful in that the data indicate how the tape might perform in a deck adjusted for the standard. Examples: A relatively high bias tape would sound extra bright on a recorder with standard bias, and a sensitivity rating not matching the recorder could cause some Dolby NR mistracking, if it is not adjusted for.

After the first test sample has been matched as exactly as possible, pink noise is recorded at -20 dB, and the playback is displayed on a Tektronix 5111 oscilloscope which is fed by an

Ivie IE-30A 1/3-octave RTA. All of the samples supplied are checked in similar fashion to see if there is an exact match in sensitivity, bias, and skew. Any changes in sensitivity shows up at all frequencies. Drooping of the high-frequency response could be from a change in tape skew or a need for less bias. A touch of record-head aligning pinpoints the cause. An increase in the level of the higher frequencies would indicate the need for more bias for best response. In this manner, the typical but also reliable-for-test cassette is chosen. Notes are made on all of the deviations among samples including any effect from turning the cassette over.

Most of the cassettes appearing on the market are fairly consistent, and they should be for a number of reasons. First of all, the user should be able to use any one of however many cassettes he may have of a particular formulation, and he should be able to rely on the deck-to-tape matching for bias and sensitivity to remain the same. Shifts of over a dB will not only be confusing, but will have some effect on Dolby tracking. It is best that a cassette have no skew, and there are some that substantially meet this ideal. At the very least, particularly if a three-head machine is being used, the skew should be constant from cassette to cassette to minimize the need for record-head alignment.

One measure of headroom is the taking of frequency response data at a fairly high level. To this end, swept-frequency response plots are made at the Dolby reference level. The sweep covers from 20 Hz to 20 kHz. The swept tone is used because it shows each and every point in the response. The plots are made from a playback of the tape, even with a three-head deck being used, to eliminate errors from any sort of leakage. The response plots are repeated 20 dB lower, and at both levels for a second tape length, if needed. The sweeping source is an Exact 128 function generator, the playback is fed to a UREI 200 system which feeds an MFE 715 X-Y recorder. More accurate data on the -3 dB points is gained with a Fluke 8050A DMM in dB mode. As the data in the tape survey

shows, it is quite possible to have 20 Hz to 20 kHz response with a cassette recorder now. For many, a response restricted to perhaps 30 Hz to 18 kHz would be satisfactory, but it should be flat, including when in Dolby mode.

By common practice, the MRL (Maximum Recording Level) has come to mean that level at which the third-harmonic distortion reaches three percent. The problem with harmonic distortion tests in the high-frequency region is that the third harmonic may be above the limits of response. The MRL test combination now used is for HDL<sub>3</sub> tests at 100, 400, 1k and 2k Hz and twin-tone IM distortion checks with combinations of 5 & 6, 7 & 8, and 10 & 11 kHz. The Sound Technology 1701A is used for the HDL<sub>3</sub> tests, and a Hewlett-Packard 3580A spectrum analyzer measures the TTIM.

The signal-to-noise ratio is measured with IEC "A" weighting (without Dolby NR), and the reference level is that which causes three percent HDL<sub>3</sub> at 400 Hz. This is a fundamental indicator of the dynamic range limits with a particular tape. For really good results, this no-Dolby figure should be 55 to 60 dBA, or even more. The dBA measurement is made with the Nakamichi T-100 audio analyzer.

Modulation noise is a measure of noise sidebands that are generated by strong, discrete tones. Modulation noise might be masked by other music sounds, but lower modulation noise can mean a cleaner sounding tape. It is measured by recording a 1-kHz tone at 0 dB, notching out the tone in playback, restricting the bandwidth to 500 Hz to 1500 Hz and measuring this noise level relative to the level of the tone before notching. Test instrumentation includes a UREI 560 used for notching, a Gen Rad 1952 filter set and the Fluke 8050A DMM.

A steady 3000-Hz tone is recorded for checking flutter, output-level variations, and drop-outs. Tests of flutter in the past have shown that the deck and the cassette both affect the reading. For really good results the combination used should have 0.10 percent weighted-peak flutter at the most. Output level variations should be less than a dB at all times, 0.5 dB is much better and 0.3 dB is desirable and quite possible these days. Drop-outs are defined as not audible if, by measurement, they are not more than 3 dB down for more than 25 mS. That pretty well covers the tests, although we might try something special, such as looking at bias noise with an RTA but this isn't reported here. 

## Cartridge Impedance Interaction

*In this series we shall discuss the various aspects of preamplifier performance which vitally affect the overall sound of your high-fidelity music system.*

The first factor is cartridge impedance interaction. The designer of your moving-magnet-type phono cartridge intended that it be terminated in a specific resistance and capacitance: only this way will it deliver the full frequency response performance of which it is capable.

But many preamplifiers *interact*, that is, they do not provide a strictly fixed input resistance and capacitance. Interaction occurs because the cartridge sees not only the fixed input resistors and capacitors, but also the phono preamp input as well. The input impedance of the phono preamp can *add or subtract* input resistance and capacitance to the fixed values.

The subjective effect of this interaction varies. In one common situation, the 8 kHz region is up about 1 dB, and the 20 kHz region is down by about 5 dB. This causes the upper partials of voice frequencies to be exaggerated thus making voices overly "present," while the "airiness" due to the top octave is lacking.

Many otherwise-good units leave off adjustable input resistance and capacitance, thus enormously limiting the range of cartridges with which the unit will work without modification.

The Apt/Holman Preamplifier is the only unit, to the best of our knowledge, to offer both adjustable input resistance and capacitance *and* the important specification that it does not interact with the cartridge impedance.

For more information, write:  
**Apt Corporation**  
 Box 512  
 Cambridge, Massachusetts 02139

- For a technical brochure.
- For a set of reviews.
- For an Owner's Manual, please send \$4 (\$5 foreign).
- For a set of six preamp papers, please send \$2 (\$3 foreign).

Name \_\_\_\_\_

Address \_\_\_\_\_

a listening test. The tape skew adjust scheme incorporated into the cassette is discussed below.

**Maxell MX:** Maxell was not one of the earliest manufacturers of metal-particle tape, but now they have jumped in, complete with lengths of C-90. The results in Table I speak for themselves: One of the best, with nothing to fault! All samples in all lengths, including C-46s, were consistent in sensitivity, bias, and lack of skewing. Output-level steadiness was excellent, less than 0.3 dB total spread. There were no dropouts.

**Sony Metallic:** This new entry into the metal tape area made a very favorable impression, evidenced to a considerable extent by the results in Table I. Of particular note were the very high MRLs across the band. Sensitivity, skew, and bias were consistent among all samples, including the flip side. The output-level stability was excellent, with most variations within  $\pm 0.1$  dB. Dropouts infrequently approached the

audibility threshold: There was a rare one or two just over, but no audible effects were detected in listening.

**TDK MA and MA-R:** Both of these designations are for TDK's metal tape, but the MA tape has what TDK calls the Laboratory Standard Mechanism and the MA-R has what is called the Reference Standard Mechanism. The MA-R version immediately stands out from all others because of its clear covers and die-cast metal frame. The formulation is the same for both versions, and there was consistency among all samples in all performance parameters and in skew, sensitivity, and bias needs, including the flip sides. There was generally close agreement with the results reported a year ago, but there were improvements, and this is one of the best Type IVs. A series of tests of flutter and tape speed showed that the MA-R had steadier tape motion than the MA cassette, and was also superior in this regard to any of the other brand cassettes that were tried.

# TYPE IV

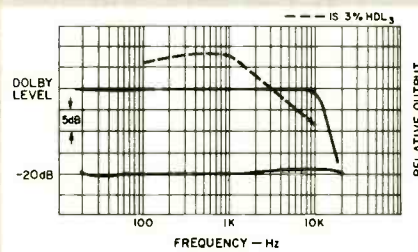

**Ampex MPT**

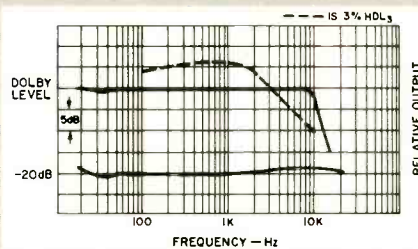

**Luxman XM IV**

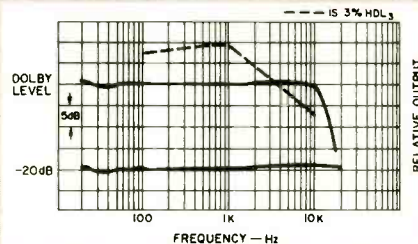

**Sony Metallic**

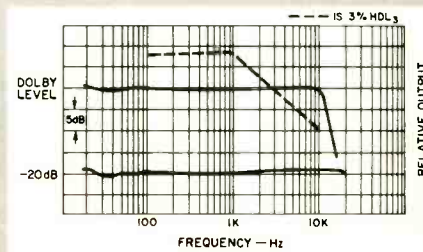

**Denon DXM**

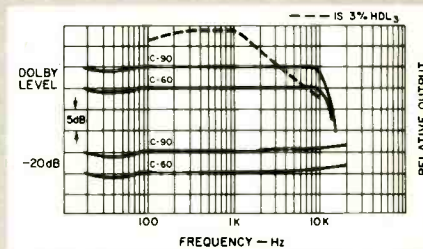

**Maxell MX, C-90 HDL3**

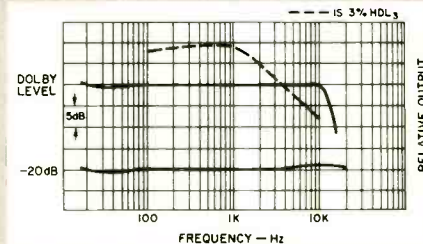

**TDK MA-R**

## Summary

As this latest update/survey shows, improvements on existing formulations and the introduction of new tapes and recorders all continue the process of expanding the capability of the cassette format. Note that some of the ferrics (Type I) are delivering excellent performance in most respects, with the better tapes having high MRLs and S/N ratios — giving the other types a good battle, especially for the money. In fact, some Type Is have higher MRLs across the entire band compared to Type II tapes. The 70- $\mu$ S EQ benefits are indicated with the higher S/N ratios for tapes other than Type I. As Table I shows, the metal-particle tapes do, in fact, out-perform all other types.

Unfortunately, there is another side to this report: There are decks available which have sufficient bias and erase capability to utilize metal tape, but the magnetic design is limited, with the result that the distortion with

metal tape is quite high and the response limited. The conclusion appears inevitable: Be very cautious about just any deck which offers a "metal-tape capability." Another conclusion, somewhat tentative, is that a deck which gives you excellent performance with metal tape will also give you great results with other tape types.

A number of manufacturers are improving boxes, labels, and packaging, as well as the cassette shell and guts. The Lux cassettes incorporate screws for use in both play and record for matching tape skew, for both directions of travel. The play skew could be adjusted about  $\pm 270$  degrees, and record skew could be varied about  $\pm 100$  degrees, both based on the phase shift between tracks with a 10-kHz tone. The actual adjustment had to be kept small, for there was interaction from one side to the other. My own judgment is that the scheme works all right, but that it could be a possible source of unwanted skewing. Further, cassettes from a few of the better makers have consistently shown substantially no skew from cassette to cassette and from side to side. That's the result of good design and mechanical manufacture of the entire cassette assembly and its tape.

Boxes should be easy to open and close, but dust tight, and the package should be sealed in plastic at the time of purchase. The new Memorex box appeared to be much more dust resistant than many of the standard-design boxes. TDK, for one, had improved versions with the higher priced cassettes. On the other hand, some boxes from TSI, Realistic, and others seemed cheaply made by comparison. The great majority of cassettes are now screw assembled, but the Memorex samples were not. At this time, the TDK MA-R Reference Standard Mechanism is what can be used to rate the others. It requires stick-on labels, however, as do many present-day cassettes. There are, unfortunately, some manufacturers who use label material which is almost impossible to write on. Include these considerations when you decide what to buy.

From bargain-basement tape to TDK MA-R cassettes, we find a range of one to 10 in cost. Is it worth it? Isn't there a best buy? There are probably several good choices you could make; local availability, label design, etc., could be the deciding factor. If you need reliability — a life free from jamming and stretched tape — be most careful of low-cost cassettes of poor construction. In any event, never forget: The record/playback performance is determined by the tape and the deck.  $\Delta$

# 1

Series 2, Number 1

## Dynamic Headroom

In this series we shall discuss the various aspects of power amplifier performance which vitally affect the overall sound of your high-fidelity music system.

The first of these is that music does not consist of pure sine tones alone; rather, it is a mixture of many tones sounding simultaneously. This causes it to have a higher peak-to-average ratio than a pure sine wave. Therefore, an optimum solution for reproducing music requires the power amplifier to have *Dynamic Headroom*, that is, the ability to reproduce peaks beyond the rated power.

The subjective effect of having a good deal of Dynamic Headroom relates more to how cleanly and effortlessly the amplifier will play, than to how loud it will play. In fact, a more distorted amplifier will often sound "louder" at the expense of accurately reproducing the program material. In amplifiers designed for music reproduction rather than music creation then, cleanliness is of first importance, and Dynamic Headroom adds undistorted power output capability to extend the dynamic range of the system.

The Apt 1 Amplifier offers the unusually large IHF Dynamic Headroom of +3 dB beyond its 100 watt/ch (20–20k Hz, 0.03% THD) rating. This means that for 20 mS each  $\frac{1}{2}$  sec the amplifier will produce 200 watts per channel. In addition, for the most difficult situations, the amplifier may be switched to a mono "bridging" mode to make a 200 watt mono amplifier with unprecedented headroom. How headroom is retained without the usual sacrifice of difficult load driving capability is the subject for next time.

For more information, write:

**Apt Corporation**  
Box 512  
Cambridge, Massachusetts 02139

- For a technical brochure.
- For a set of reviews.
- For an Owner's Manual, please send \$4 (\$5 foreign).
- For a set of power amp papers, please send \$2 (\$3 foreign).

Name \_\_\_\_\_

Address \_\_\_\_\_

\_\_\_\_\_

apt 1-1

Audio 9/80

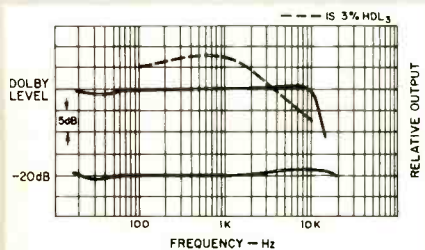

Fuji Metal

# Equipment profiles

## Nakamichi 680ZX Stereo Cassette Deck



The Nakamichi 680ZX cassette deck is the premier unit in the new ZX series and features Auto Azimuth Alignment, a scheme that automatically aligns the record head with the play head. These decks also offer a second recording speed of 15/16 ips with response to 15 kHz claimed and met. The front panel is black, and the labels and designations are white, easily seen with medium level illumination. At the right side is a vertical row of lever switches, spring-loaded for good snap action from position to position. There's selection of EX (ferric), SX (chrome-type) and ZX (metal) bias; 120 or 70  $\mu$ S EQ; NR with and without multiplex filter and *Out* for Dolby NR; *Rec*, *Off* or *Play* for the timer control; tape or source monitor, power off or on, and three display functions.

The fluorescent bar display can be placed in *VU*, *Peak Hold*, or *Cal* mode. In *VU*, the attack and decay of level indications match that meter type. In addition, however, a brightened bar segment (cursor) moves in accordance to the peak levels — providing two types of information at the same time, a great idea. In *Peak Hold*, the display has a very fast attack and a slow decay, and the cursor decays at about one-tenth that speed to provide a helpful, longer look at the highest levels. There are a total of 48 segments for each channel, covering from -40 to +10 dB. As each segment has a separate threshold, the resolution is excellent. In *Cal*, which is used for AAA (Auto Azimuth Alignment) and record sensitivity adjustment, the display scaling is switched to -5 to +3 with 32 of the segments. This is an excellent utilization of bar-graph capabilities, enabling accurate and speedy calibration (discussed later).

Tape motion is logic controlled with six light-touch rocker switches with good-sized rectangular push bars. Each function has a status light just above: Red for record, green for the

others. There is no flying-start recording, but a number of other things can be accomplished with the buttons and the associated logic system. For example, pushing down *Rec* during recording mutes the signal being recorded, which will continue to show on the display with monitor on *Source*. If you want a cue signal during a fast wind, pushing the pause button will shift the play head closer to the tape with Nakamichi's exclusive cam drive and will reduce wind speed to a third. Holding down the appropriate wind button at that point will reduce the wind speed to about one-fifth of normal for more exact cueing. From the first cue mode, it is possible to go into a program location scheme called RAMM, Random Access Music Memory. Pushing *Pause* a second time causes "RAMM" and "1" to appear at the left of the display. An increase in the count is obtained by successive pushes of *Pause*. If a decrease in count is needed, *Rec* is pushed. The deck will wind, counting the spaces between selections, and stop and go into play when RAMM has counted down to zero.

The 680ZX includes a potentially useful pitch control with a range of  $\pm 6$  percent in tape play speed, up or down a musical semitone. There is a tape counter with reset and simple memory—rewind to stop at "999." Access to the three heads and dual-capstan drive for maintenance was very good, particularly with the clear door window removed. There was also ready access to head and guide adjustments with removal of a plate below the door. These are not to be diddled with by the curious, but my own view is that this approach is a good one as there are all too many decks that are not easily adjusted when service is needed. Tape speed is easily switched between 1 $\frac{1}{8}$  and 15/16 ips, with separate green indicators to call attention to the setting—although

**Manufacturer's Specifications**

**Frequency Response:** 10 Hz to 22 kHz;  
10 Hz to 15 kHz at 15/16 ips.

**Harmonic Distortion:** 0.8 percent for  
400 Hz at 0 dB; 1.5 percent at 15/16  
ips.

**S/N:** 66 dBA with Dolby NR; 60 dBA at  
15/16 ips.

**Separation:** 37 dB.

**Crosstalk:** 60 dB.

**Erasure:** 60 dB.

**Input Sensitivity:** Line, 50 mV.

**Output Level:** Line, 1000 mV; head-  
phone, 45 mW at 8 ohms.

**Flutter:** 0.04 percent W rms, 0.08 per-  
cent wtd. peak; 0.08 percent W rms,  
0.14 percent wtd. peak at 15/16 ips.

**Dimensions:** 19 in. (482 mm) W x 5 1/2  
in. (143 mm) H x 13 3/8 in. (340 mm) D.

**Weight:** 19.8 lbs. (9 kg).

**Price:** \$1,550.00.

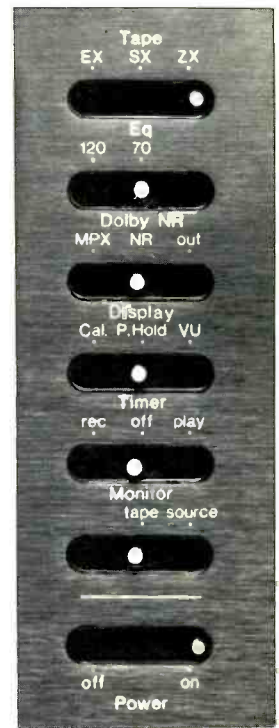
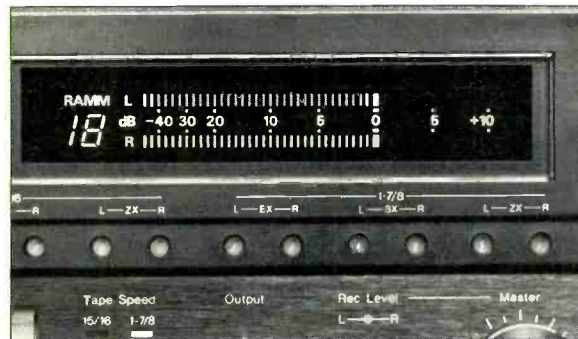
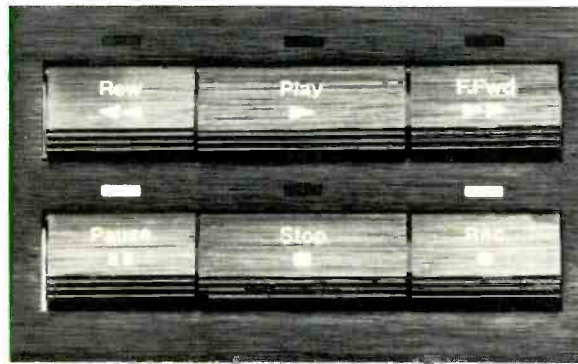

orange might have been better to emphasize the 15/16 ips setting.

Record levels are controlled with dual-concentric non-friction-coupled channel pots plus a useful master control. The channel pot knobs are the same diameter, and they can be grasped at the same time. Turning would be easier, however, with rougher knob surfaces. There is an output level control (jack at the left), but it does not affect the display. Above the knobs and tape-motion switches and below the level display are six sets of record sensitivity adjustments. There are left- and right-channel set pots for EX, SX and ZX tapes both for 15/16 and 1 7/8 ips. Now let's take a look at the calibration scheme used in this deck.

Calibration of the Nakamichi 680ZX involves two distinct tasks: Auto Azimuth Alignment (AAA) and setting record sensitivity for optimum Dolby tracking. AAA is a closed-loop scheme with two major elements: (1) The control mechanism, which is illustrated in Fig. 1, and (2) a 400-Hz source and phase comparator with drive to the mechanism motor. It works this way: (1) The 400-Hz source is fed to the record head, (2) the output of the recorded signal from the play head is fed to the phase comparator, (3) any discrepancy in alignment results in an error-correction drive signal from the comparator to the mechanism drive motor, and (4) the record head is tilted in the direction and in the amount necessary to eliminate the error/phase discrepancy. The procedure for the user is very simple — just put the deck in record, and switch to *Cal*. The *Play* indicator flashes while the head is being adjusted, and cursors move up in each level display, indicating the results of the adjustment. When the flashing stops, the record sensitivity pots are used to set the display

indication to exactly zero, most easy with the 0.25-dB resolution provided with the *Cal* scaling. (See the performance section of this review for the results of the tests on this innovative feature.)

On the back panel are the line in/line out phono jacks and sockets for the optional remote control and for feeding d.c. power to the optional Nakamichi black boxes: Mike preamp, line amp, etc. Removal of the steel top and side cover revealed rugged chassis construction, actually needed for rack

**Fig. 1—Auto Azimuth Alignment control mechanism, Nakamichi 680ZX cassette deck.**

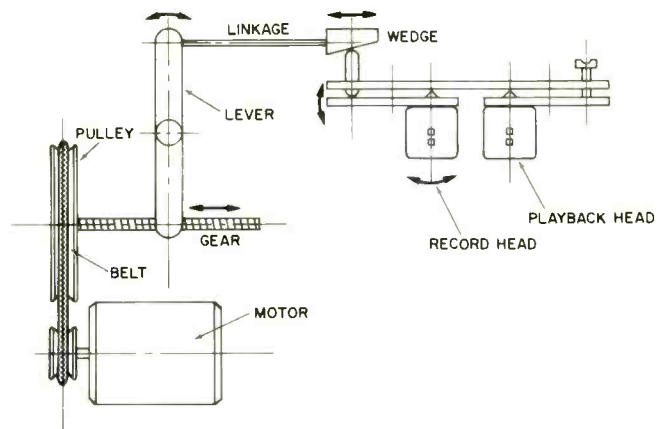

mounting which is possible with the 680ZX in a 5¼-inch space with the feet removed. All of the p.c.b.s had excellent soldering with no flux residue. Interconnections were made with wire wrap and multi-pin plugs. Adjustments were labeled, and parts were identified on both sides of the cards. There was much of quality in evidence, including the dual-capstan tape drive and the head-assembly cam-drive mechanism. One attention-catching feature was the metal drive band from the motor assembly to the record-head assembly. Examination and observation of an adjustment cycle proved that it was really quite rigid, which is necessary for consistent and accurate alignment.

### Measurements

The playback responses with standard alignment tapes were within 2 dB at all frequencies for both equalizations.

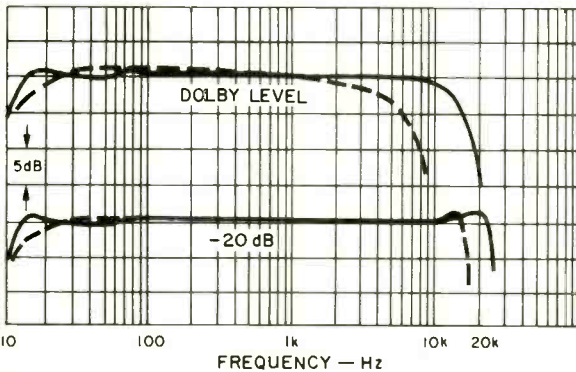

Fig. 2—Frequency responses at 1% and 15/16 (---) ips with Nakamichi EXII tape.

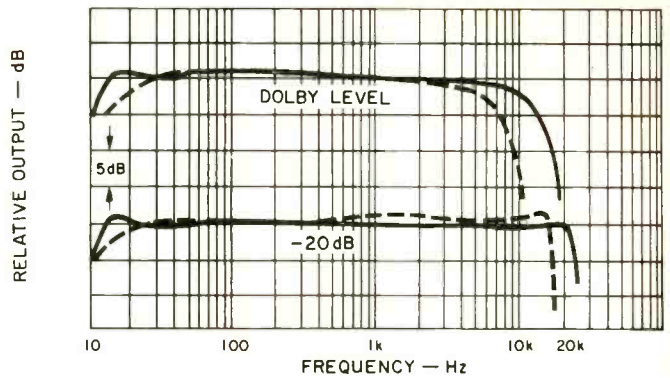

Fig. 3—Frequency responses at 1% and 15/16 (---) ips with Nakamichi SX tape.

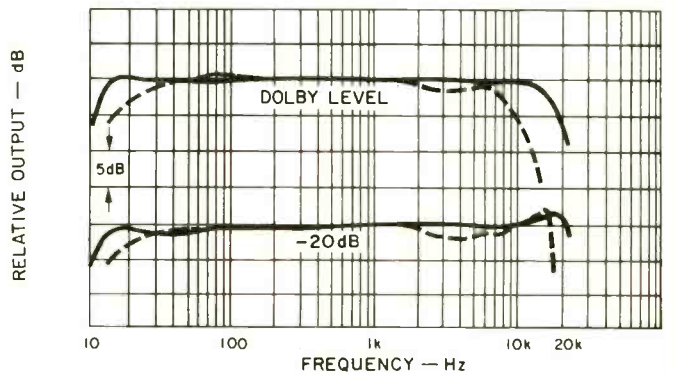

Fig. 4—Frequency responses in Dolby mode at 1% and 15/16 (---) ips with Nakamichi ZX tape.

# Basic control, honest reproduction.

For the audio purist who demands elegant design, faithful sound reproduction, and essential control, MXR has developed the Linear Preamp.

The MXR Linear Preamp serves as the central control unit in any high-quality stereo system, passing audio signal without adding any perceptible distortion or coloration of its own. A unique Gain switch offers 20 dB of additional gain only when needed, for optimum signal-to-noise ratio. Innovative circuit design and superior components provide sonic integrity and accurate stereo imaging, at all levels.

The Linear Preamp is housed in a tasteful, black anodized enclosure with solid walnut end pieces. Compact 1¾"(h)x19"(l)x6"(d) dimensions and

optional rack ears allow for convenient placement in any stereo system.

Like all MXR products, the Linear Preamp reflects the latest advances in American audio technology. The MXR Linear Preamp has been designed with thought and care, to provide quality sound for the discriminating listener.

**MXR Innovations, Inc.**, 740 Driving Park Ave., Rochester, New York 14613, (716) 254-2910

**MXR** Consumer Products Group

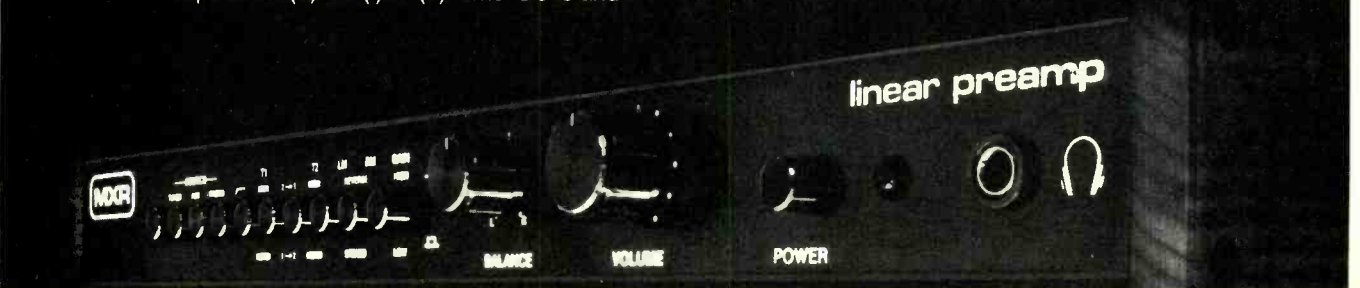

Enter No. 15 on Reader Service Card

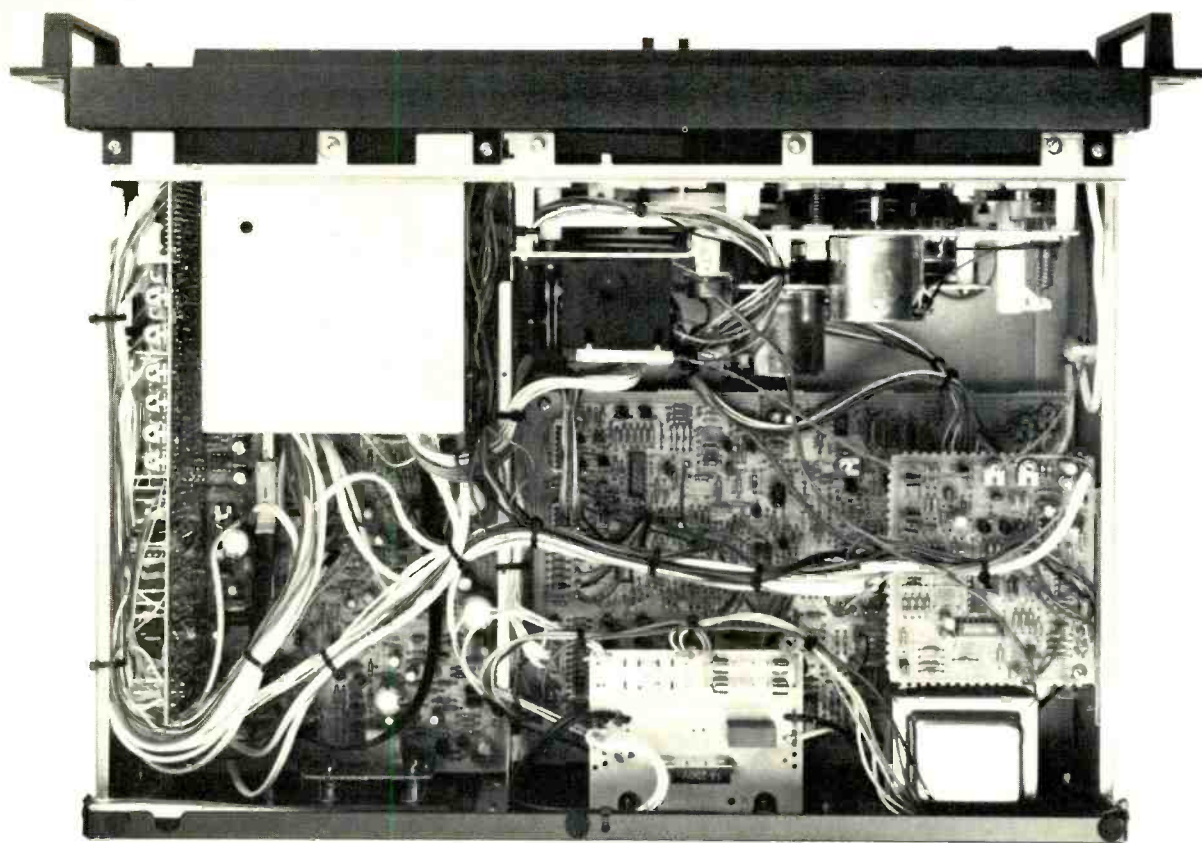

# The Tuneable Tonearm.<sup>TM</sup> Ultracraft.

It always happens. You put together your dream tonearm/cartridge combination. And along comes a new "super" cartridge with parameters that just won't work with your arm. Unless you own a tuneable Ultracraft—so adjustable you get the utmost performance from any cartridge.

The Ultracraft AC-30, AC-300 MK-II and AC-3000 MC all use our unique ADJUSTABLE DAMPING SYSTEM, with a control that lets you regulate clearance between the damping bowl and oil cup for perfect tracking and customized frequency response.

Our famed jewel-bearing UNIPIVOT DESIGN assures stylus freedom so you hear every nuance of every recording. AC-3000 MC and AC-300 MK-II accept interchangeable PLUG-IN ARM STEMS in straight and S-shapes, of different diameters and materials, with integral or separate headshells.

Ultracraft's uniquely precise lateral balancing device, and anti-skating system (never before used on a single-point suspension arm), plus features like a 650 gram stabilizer, special litz wires and a 3-step counterbalance, clearly make Ultracraft the ultimate tonearm. Let your Osawa dealer tune one up for you.

OSAWA & CO. (USA) Inc., 521 Fifth Avenue, New York, New York 10017  
Distributed in Canada by Intersound Electronics, Montreal, Quebec

Exclusive tuning control



**OSAWA**  
The Measure of Quality

Enter No. 20 on Reader Service Card

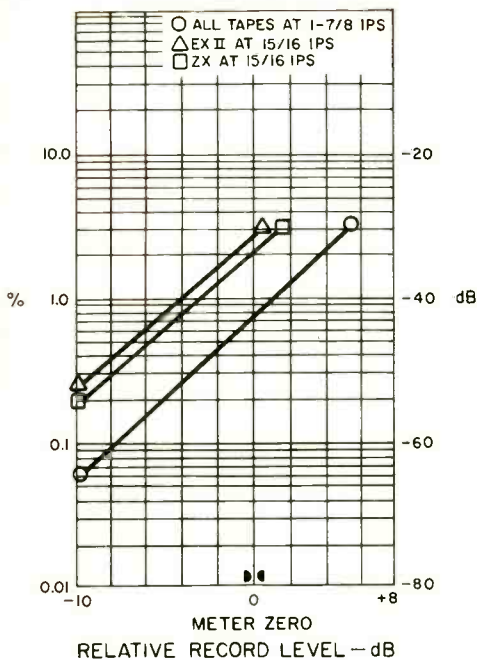

**Fig. 5—Third harmonic distortion vs. level in Dolby mode at 1 kHz with Nakamichi EXII, SX, and ZX tapes.**

Playback of standard level was about a dB high, and tape play speed was 0.35 percent high. The deck was supplied with samples of Nakamichi EXII, SX and ZX (metal) tapes, and the great majority of tests were conducted with them. Some limited testing showed that TDK AD and SA, Maxell UDXL-II, and Fuji and Sony metal tapes gave the same performance, in general. The record sensitivity pots had a range of -5 to +3 dB re meter zero for all of the Nakamichi tapes. Quite a bit of time was spent evaluating the alignment scheme — to see how well it did and what its limits might be.

**Table 1—Record/playback responses (-3 dB limits).**

Tape Type	Tape Speed Ips	With Dolby NR				Without Dolby NR			
		Dolby Lvl		-20 dB		Dolby Lvl		-20 dB	
		Hz	kHz	Hz	kHz	Hz	kHz	Hz	kHz
Nakamichi EX II	1 7/8	10.5	12.6	11	24.1	10.5	12.7	10.1	25.3
	15/16	12	5.3	11	15.4	12	5.4	11	16.6
Nakamichi SX	1 7/8	11	12.0	11	24.3	11	12.1	10.4	25.4
	15/16	14	5.9	15	15.7	14	6.0	11	16.5
Nakamichi ZX	1 7/8	11	16.4	11	25.3	11	17.0	10.6	26.9
	15/16	14	8.0	15	16.6	15	8.2	11	16.7

**Table II—Signal/noise ratios with IEC "A" and CCIR/ARM weightings.**

Tape Type	Tape Speed Ips	IEC "A" Wtd. (dBA)				CCIR/ARM (dB)			
		W/Dolby NR		Without NR		W/Dolby NR		Without NR	
		@ DL	HD=3%	@ DL	HD=3%	@ DL	HD=3%	@ DL	HD=3%
Nakamichi EX II	1 7/8	58.2	63.5	49.1	54.3	57.2	62.5	47.2	52.5
	15/16	60.4	60.9	51.4	51.9	58.5	59.0	48.5	49.0
Nakamichi SX	1 7/8	61.0	66.0	52.3	57.3	60.2	65.2	50.0	55.0
	15/16	59.8	60.3	51.1	51.6	58.9	59.4	48.8	49.3
Nakamichi ZX	1 7/8	61.6	67.1	52.9	58.4	60.8	66.3	50.4	55.9
	15/16	59.5	61.0	50.3	51.8	58.5	60.0	48.5	50.0

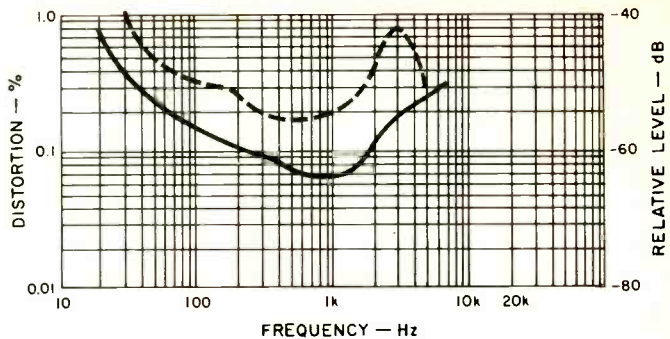

**Fig. 6—Third harmonic distortion vs. frequency in Dolby mode at 10 dB below Dolby level at 1 7/8 and 15/16 (---) ips with Nakamichi ZX tape.**

The test cassettes were inserted one way, and then the other, with a calibration cycle after each insertion. To pinpoint the accuracy of the AAA scheme, a 10-kHz tone was recorded on both channels after calibration, and the phase difference checked at this much higher frequency. The corrections made were very consistent, with B usually lagging A by 30 degrees. This error would be equivalent to only about a degree at 400 Hz, and some of the phase difference measured at 10 kHz might be from interchannel phase shifts not associated with alignment. In any event, the final results were excellent. The question of range remained, and the front-panel head adjustment was used to set in purposeful misalignment. B was made to shift  $\pm 540$  degrees relative to A, at which points the 10-kHz level in B was down more than 15 dB. The Auto Azimuth Alignment system corrected the large error in both cases within five seconds — a most impressive achievement, a capability to handle any skew ever observed. (Note that the front-panel head adjustment should normally be left alone to ensure that AAA has its full range of correction.) The phase jitter at 10 kHz was just 10 to 15 degrees at most, one of the best figures yet measured.

The record/playback responses were run at Dolby level and at 20 dB below that for both tape speeds with most of them run in Dolby mode. The 3-dB down points were determined for all combinations, however, with the results listed in Table I. There are a number of responses particularly worthy of note: All those at Dolby level at 1 7/8 ips extend to 12 kHz or more, all responses at -20 dB extend to 24 kHz or more, and the low end extends to 10 to 11 Hz. The responses at 15/16 ips go to at least 15.4 kHz at -20 dB in all cases and aren't that bad at 0 dB, especially with metal tape. The plots in Figs. 2 to 4 show the smoothness desired at both speeds. Dolby tracking was generally quite superior: Note the slight lift around 1 kHz for 1 7/8 in Fig. 2 and for 15/16 ips in Fig. 3. More deviation is shown with Dolby NR with metal tape (Fig. 4) at 15/16 ips, but no more than many recorders have at 1 7/8 ips. The MPX filter was 3 dB down at 16.5 kHz and 32.5 dB down at 19 kHz. Bias in the output during recording was very low.

Measurements of HDL<sub>3</sub> were made with record levels from -10 dB (re Dolby level) to the three-percent distortion limit in Dolby mode at both speeds. The results for the three tape types at 1 7/8 ips were so close that just one line is shown in the plot of data in Fig. 5. Data were plotted for EXII and ZX at 15/16 ips; the results for SX tape fell in between. It is apparent that higher distortion is one of the prices paid for using a lower tape speed, but the plots are all perfectly straight lines, linear functions with the scaling used. HDL<sub>2</sub> and HDL<sub>5</sub> were very low in all cases. Data on HDL<sub>3</sub> were taken at -10 dB from



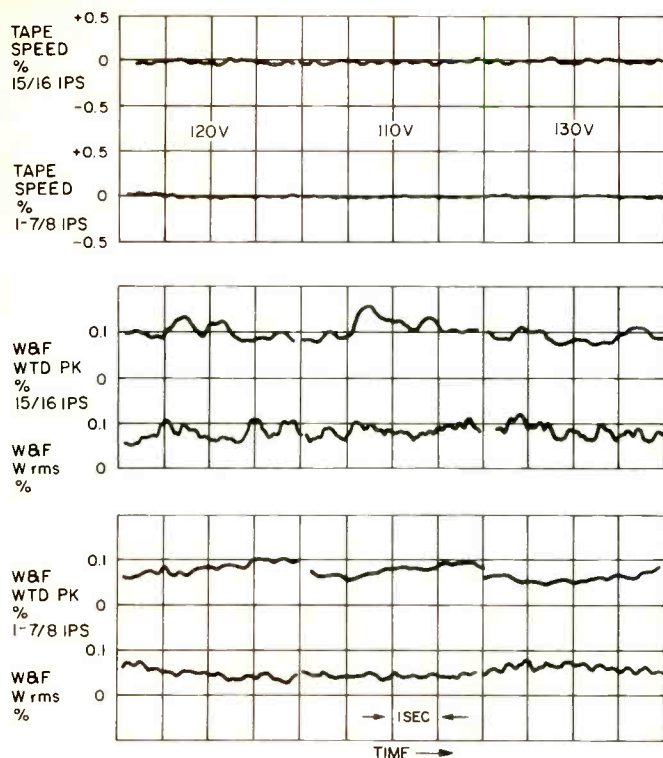

Fig. 7—Wow and flutter (three trials) and tape play speed vs. line voltage, Nakamichi 680ZX cassette deck.

20 Hz to 7 kHz at 1 $\frac{7}{8}$  ips, from 30 Hz to 5 kHz at 15/16. At the higher speed, the distortion stayed lower at the extremes than is the case with most recorders. There's the expected increase in distortion with the lower speed, but the results look quite good, considering the challenges. In general, distortion figures were about 30 percent higher without Dolby NR, with less of a difference at the lowest frequencies.

Table II lists the results of signal-to-noise ratio tests using both IEC "A" and CCIR/ARM weightings. The 67.1-dBA figure with ZX tape is certainly very good, but somehow that 61.0-dBA result at 15/16 ips seems more impressive. It might appear confusing that the data at Dolby level show ratios for EXII at 15/16 ips that are higher than those obtained at the higher speed. Just keep in mind that the *distortion* is considerably higher at the lower speed for the same flux level. The built-in 400-Hz oscillator (413-Hz actual) had about one-percent distortion, mostly third harmonic, adequate for the purpose of alignment and level calibration. Separation between channels was 51 dB, and crosstalk was down greater than 85 dB. Erasure of metal tape was greater than 80 dB at 1 kHz and greater than 70 dB at 100 Hz. All of these results are much better than the specifications.

Line input sensitivity was 49 mV, and the input overload point was at least 29 V. The output clipping appeared at a level equivalent to +16.3 dB meter. Sections of the master level pot tracked within a dB from maximum down more than 60 dB—excellent! The channel pots tracked within a dB for about 40 dB. The line output was 1,000 mV, exactly as specified, but it dropped to 870 mV with the standard IHF load. This is the expected result with the 2.2-kilohm source impedance of the line output. The headphone drive at 0 dB

produced 50 mW into 8 ohms, plenty for all of the phones tried. The output level control tracked within a dB from maximum down for 25 dB, quite acceptable for most purposes.

The level display read somewhat high at "-40" and "-30," but was accurate from "-20" to "+10." The response was 3 dB down from less than 2 Hz to 26.9 kHz. The dynamic response in VU mode was very close to standard with a slight overshoot with the peak-level cursor with the 300-mS burst; the other bars required 350 mS for full response. In peak-response mode, the results were in accordance with IEC Standard 268-10, and the display was just 1 dB down with a 5-kHz, 10-mS burst. Decay time for the bar display was 3 S for 20 dB, and 30 S for the peak-level cursor — all in all, an excellent combination of timings. The use of the display in the calibration process was a distinct pleasure, with appreciation of the excellent level resolution provided by the rescaling in Cal. My only criticism of the peak metering is that tests showed it to be sensitive to the polarity of pulses, with a lower level indicated with positive pulses. For the best indication of peak levels, the metering should not be polarity sensitive.

Flutter figures of 0.05 percent W rms and 0.075 percent wtd. peak were obtained at 1 $\frac{7}{8}$  ips, and 0.085 percent W rms and 0.12 percent wtd. peak at 15/16 ips — overall, basically to specification. There were higher speed variations with time at the lower speed, but they were quite minor, and there was no effect on speed from changing line voltage. Wind times for a C-60 cassette averaged 63 S. The pitch control had a range from -6.5 to +7.7 percent change in play speed, a little over a semitone (5.9 percent). All changes in tape motion were accomplished in one second or less. The deck includes a loose-loop take-up which spins the take-up hub upon insertion, but with minimal tape advance.

### Use and Listening Tests

Every tape loading and unloading and maintenance task was easily handled. All switches, knobs and logic worked smoothly and without any sort of malfunction. Timer control, cueing and RAMM functions worked reliably. The pitch control was used to good advantage when recopying some tapes that were off-speed. Record sensitivity calibration was very straightforward, but Auto Azimuth Alignment was the star of this procedure, aided by the excellent proof-of-alignment display. The owner's manual has 24 pages of very good text, especially on recording levels and calibration, and its illustrations are pertinent and helpful.

I used FM to some extent for record/listening tests, but records more so, including Mike Aldridge's **Blues & Blue Grass**, Rob McConnell's **Big Band Jazz**, and a version of Strauss' **Also Sprach Zarathustra**. It was obvious that the Dolby tracking was really good, for there were no response jumps with switching NR in and out, but the change in noise level was obvious. The metering was excellent for setting high levels without distortion. The extended low-end response of the deck was apparent, and impressive, a number of times. The results at 15/16 ips were not great, but much better than what I thought was possible. The need for Dolby NR was certainly more obvious, and levels in the range of -5 to 0 dB generated some harshness. There were no record or pause sounds detected, and stop clicks were just out of tape noise.

With its \$1550.00 price tag, the Nakamichi 680ZX cannot be purchased by many. It does offer a collection of unusual features, however, with excellent performance as well. It's a nice deck to look at, even if you just want to see what's possible with the present technology.

Howard A. Roberson

Enter No. 90 on Reader Service Card

## Nakamichi High-Com II Noise-Reduction System

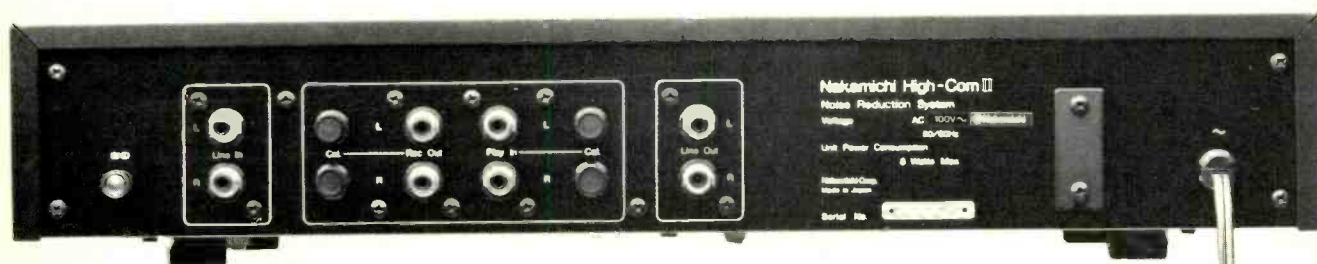

### Manufacturer's Specifications

**Compression Ratio:** Encoding, 2:1; decoding, 1:2.

**Noise Reduction:** 20 to 25 dB.

**Distortion:** 0.1 percent at reference level.

**Frequency Response:** 20 Hz to 20 kHz,  $\pm 1$  dB.

**Input Sensitivity:** Line, 60 mV; tape playback, 200 mV.

**Output Level:** To recorder, 300 mV; line, 600 mV.

**Dimensions:** 19 in. (482 mm) W x 3-7/32 in. (82 mm) H x 10<sup>5</sup>/<sub>16</sub> in. (270 mm) D.

**Weight:** 11 lbs. (5 kg).

**Price:** \$480.00.

The Nakamichi High-Com II noise-reduction system, developed in cooperation with Telefunken, should be of immediate interest to many because of its claims for improved performance over both Dolby and dbx II NR systems. The basis for these claims and the results of the performance and listening tests appear later in this article. First, let's take a look at the front panel of the unit. The channel level meters cover a range from  $-40$  to  $+10$  dB. The white scales are well illuminated against a black background, and are very legible over a wide range of ambient lighting. There is a short red index lined up to meter zero and labeled in red, "20 mM/mm," and

that is hard to read. (Note: 20 mM/mm is 20 milli-Maxwells/mm, the same as the more common form for Dolby flux level: 200 nWb/m, or nano-Webers/m.) Two four-position rotary switches control *Mode* and *Filter* selection: *Cal 400 Hz*, *Rec*, *Pass* and *Play* for modes, and *Subsonic*, *Off*, *MPX* and *MPX/Subsonic* for filter settings. The High-Com II unit reviewed here has one set of stereo processors and must be switched to encode (recording) or to decode (playback). It cannot do both at the same time — a second unit is required if simultaneous record/encode-playback/decode is desired.

In *Cal*, a 400-Hz tone is shown at 0-dB reference level on

both meters and fed to the line inputs of the associated tape recorder. With its level controls at maximum, set pots on the back of High-Com II are used to set indication on the recorder's meters for a recorded level of 200 nWb/m, or Dolby level. The recorder, of course, should not be in Dolby mode. The recorded test tone is played back, and other set pots on the back are used to get the reference-level indications in *Play* mode. Once calibrated, the recorder controls and the set pots are not used. Setting of input levels is done with the High-Com II's separate channel-level controls and the master pot. There is an output pot which controls the level to the outside world — the preamp tape monitor input, for example. The subsonic filter is designed to cut out below-band signals, such as might be generated by record warps. The multiplex filter should be used to remove any 19-kHz pilot tone in the output from an FM tuner or receiver. The filters remain in the *Rec* signal path in *Pass*, so it's possible to use them without the noise reduction — a nice design touch.

The black-anodized front panel with white lettering matches other current Nakamichi products, and all the labels are quite legible even with medium-dim illumination. The top and side cover is steel, adding to the rugged construction which includes accessory rack-mounting brackets. The unit will fit in a 3½-inch high rack space with the feet removed, but the mounting slots will not match some racks unless the chassis is slid up or down from a normal position.

Inside the unit was one large p.c.b. which had excellent soldering with substantially no flux residue. Off-card connections were with wirewrap, in general, with one multi-pin cable used. Parts were identified on both sides of the p.c.b. The Telefunken processor chips were easy to locate: Four

large, 24-pin ICs in sockets, labeled "TFK U401B." There were also many discrete components, as well as a dozen 4558 dual-amp mini-dip ICs. There certainly was a lot more circuitry in evidence than might be expected from comments to the effect that High-Com II utilized a new Telefunken chip based upon their professional noise-reduction system, Telcom C4D.

### Circuit Highlights

One channel of the High-Com II noise-reduction system is shown in simplified block form in Fig. 1. Most readers will probably be able to follow the various signal paths, but a few comments are in order. Note that there is a low-pass filter on the line input at all times; this keeps out above-band garbage that could affect the processing. *SW1* makes the filter selections in the record-signal path, and *SW2* selects the operating mode, including *Cal* and *Pass*. In record, the output of the two-band processor is fed back to be subtracted at the input, which obtains the desired encoding compression. In play, the *PB Amp* feeds the processor, and the expansion of the decoding removes the previous compression.

The processing involved and the rationale for the High-Com II's design can be understood more easily with close examination of Fig. 2. The reference point for the system, and the following discussion, is where the input and output levels are both at 0 dB — which is the calibration reference level discussed previously. Let's take a look at what happens first: Recording with encoding. The incoming signal is compressed 2:1 on a dB basis with the result that a range of signals from +20 to -20 dB at the input are fed to the recorder with a range from +10 to -10 dB. Below an input level of about -23

# For the world's most critical listeners...



XK50

MK111E

**a low-mass, high-tracking moving coil cartridge and a planar-pivot tone arm... from the creative laboratories of Signet.**

The Signet MK111E is a major advance in moving coil cartridge design, with its Dual Moving Micro-Coils™ geometrically located for best separation and lowest distortion, and one of the world's smallest whole-diamond styli (just 0.0035" square).

Hand built in small numbers, it is the perfect complement to the new fluid-damped XK50 Signetrace

tone arm. A radical low-mass concept which places the vertical arm pivot at the record surface plane for unparalleled tracing accuracy.

See and hear these achievements in record playing technology at your exclusive Signet sound consultant. Or write us for product details and dealer list.

SIGNET DIVISION A.T.U.S., Inc., Dept. 90A  
4701 Hudson Drive, Stow, Ohio 44224

  
**signet**™

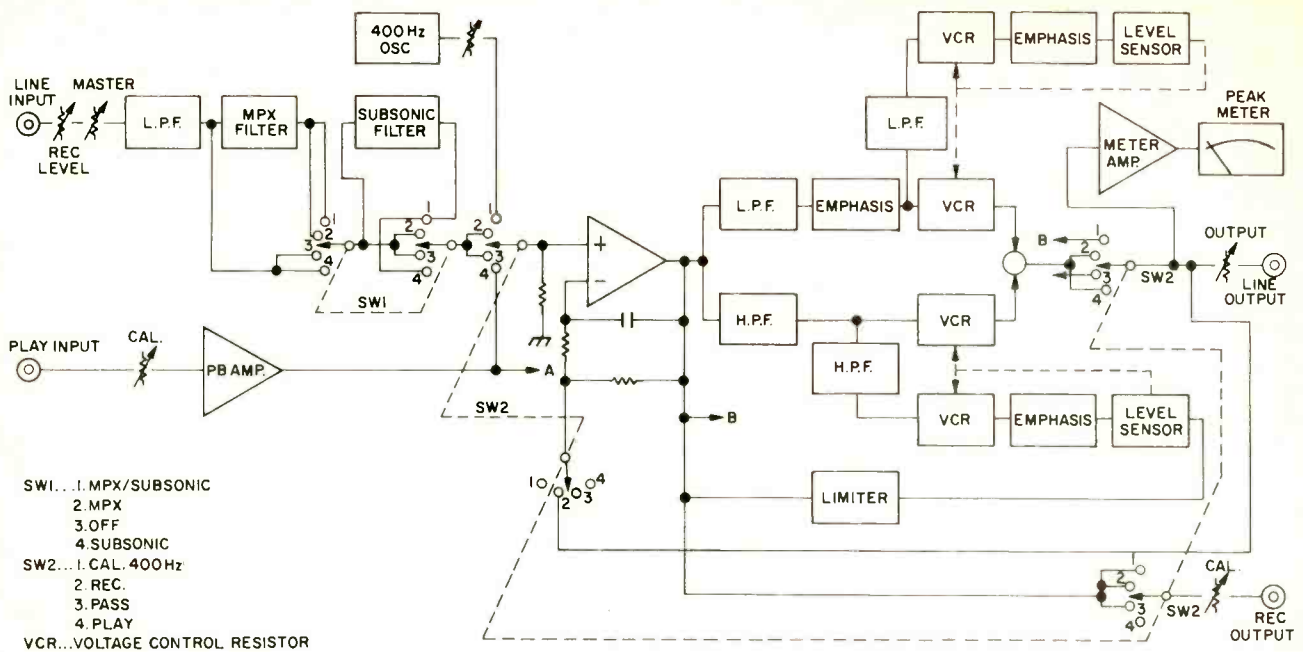
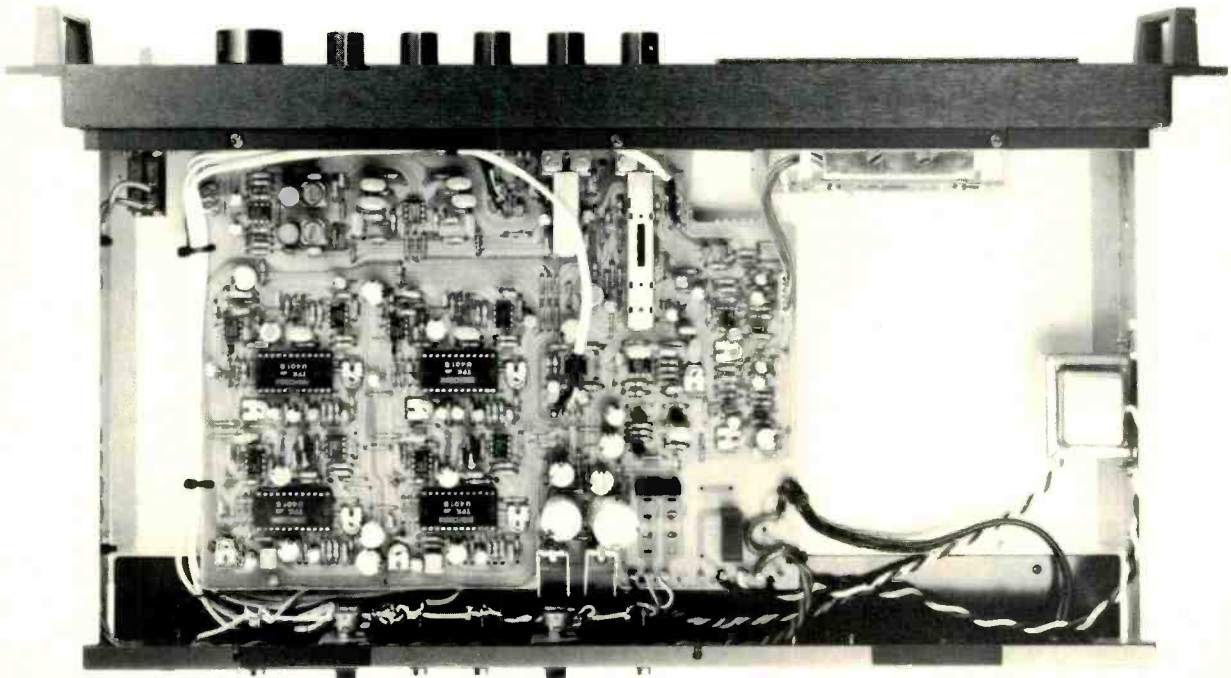

Fig. 1—Circuit diagram of one channel of Nakamichi High-Com II noise-reduction system.

dB, the compression at 50 Hz ceases — evidenced by the change to the 45-degree slope. Because of the earlier compression, however, an input level of -50 dB is fed to the recorder at about -40 dB, or 10 dB higher, relatively. We can see that there are similar break points for 400 Hz at an input level of about -33 dB and for 3 kHz at about -37 dB. A -50 dB input at 400 Hz is fed at -34 dB to the recorder; the same level at 3 kHz is fed at -31 dB. The separate line for 10 kHz shows that there is a roll-off at 10 kHz in addition to the compression; this will be clearer in looking at the later response plots. The

2:1 compression continues at 10 kHz to about -47 dB, where the feed to the recorder is about 25 dB down.

The audio signal, of course, does not consist of just four discrete frequencies, but the curves do show how the processing varies with frequency. We can see that the lowest frequencies have the least compression, and the highest frequencies have the most. Similarly, the decoding applied during playback is the complementary function which expands those levels that have been compressed in accordance with the basic 1:2 relationship, modified by the frequency content.



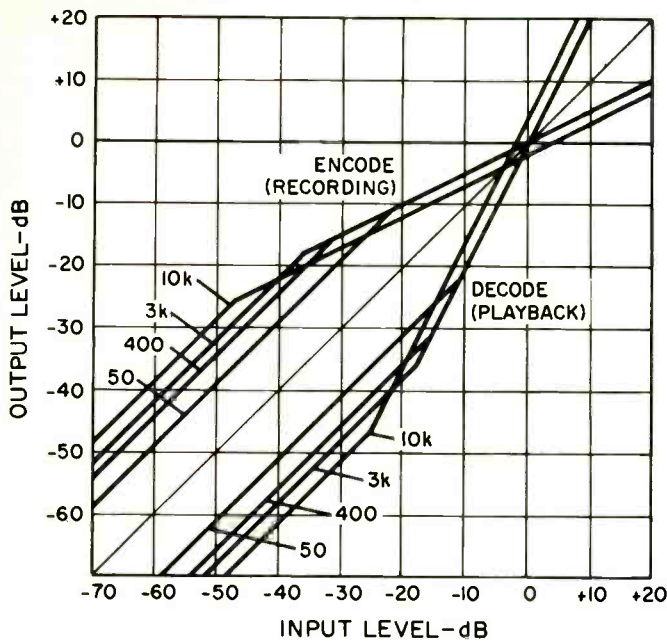

Fig. 2—Encoding and decoding characteristics.

We might note at this point that this High-Com II system has some similarities to both dbx II and Dolby NR systems and, of course, some differences. Right off the bat, there is a 400-Hz reference tone, and the associated flux level is exactly the same as with Dolby Type B (nonprofessional) systems. The 2:1 compression in encoding and the 1:2 expansion in decoding are the same as in dbx II. There are important differences, however, and they are the basis for some of the manufacturer's claims.

First of all, we would note that the compression in encoding stops at a certain point as the level is being reduced, returning to a dB-in/dB-out relationship, while dbx II's slope is constant. Nakamichi claims this reduces negative effects that occur with compression/expansion in the noise-limited region. The Nakamichi High-Com II scheme uses two frequency bands of processing to further reduce noise pumping and other spectrum interactions, while single-band operation is used in Dolby B and dbx II. Because of the greater compression all the way across the band compared to Dolby, High-Com II can offer 10-dB greater noise reduction across the entire audio band. A rough summary of the claimed advantages would be this: High noise reductions as with dbx II without noise pumping, and much higher noise reduction than Dolby all across the band. To gain better judgment on these claims, the test program included comparisons among High-Com II, dbx II and Dolby B.

### Performance

To check the action of the encoder at various levels across the band, swept responses were made with inputs from +10 to -50 dB. As Fig. 3 shows, the first steps were 5-dB ones on the output. Then, with the input at -30 dB, the lowest frequencies are moving out of the compression portion of their curves (Fig. 2). In the next two steps of 10 dB each, most of the audio band moves down into the linear section. Also note that the high end rolls off above 4 kHz, being down about 7 dB at 20 kHz at the output of the processor. This is a desirable characteristic to minimize high-frequency overload in recording, particularly below 0 dB where the compression

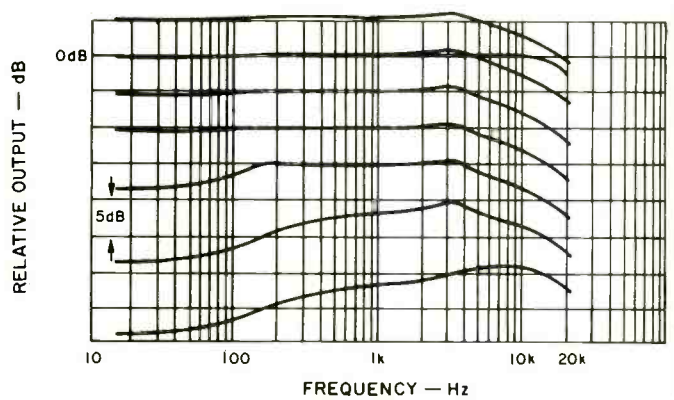

Fig. 3—Frequency response of record processor with 10-dB steps from +10 to -50 dB, re reference level.

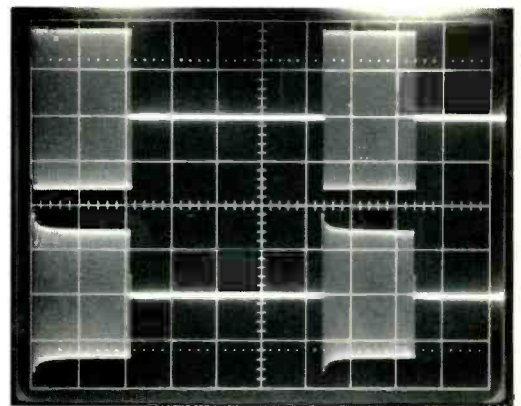

Fig. 4—Record processor response to 10-mS 2-kHz tone burst.

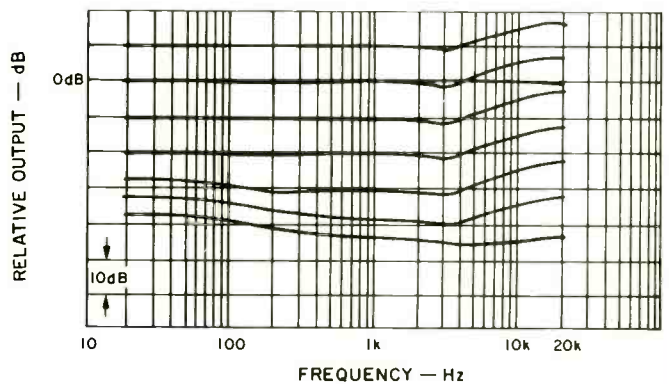

Fig. 5—Frequency response of play processor with 5-dB steps from +5 to -25 dB, re reference level.

raises levels that would normally be lower. The 50-dB spread in input levels from 0 dB down has been reduced to 29 to 38 dB, depending upon frequency. Figure 4 shows the encoder response to a 10-mS 2-kHz tone burst; it will be compared with the decoder response later.

The frequency/level response of the decoder was checked in similar fashion with 5-dB level steps at its input. It is not possible to find matching curves, because a flat output from *Play* would require an input sweep such as shown in the encoder plots. Without two units to do simultaneous encoding/decoding, it was necessary to do a little calculation of specific points, which showed the net response to be quite flat. Figure 6 shows the decoder response to the 10-mS 2-kHz

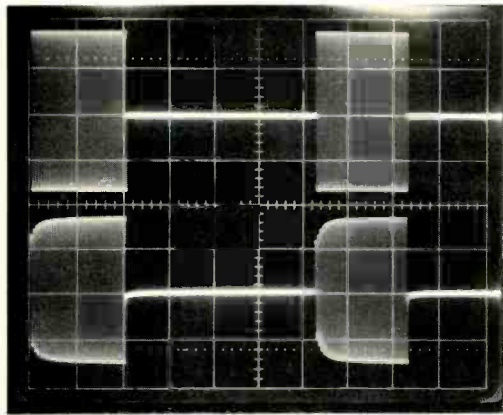

Fig 6—Play processor response to 10-mS 2-kHz tone burst.

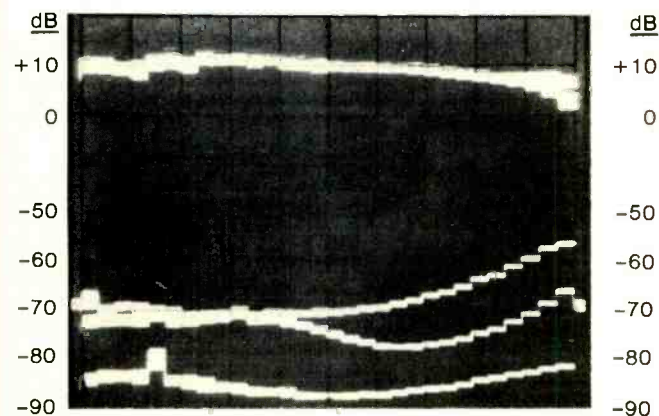

Fig. 7—Responses with High-Com II and Dolby NR; see text.

tone burst, and it appears that the total effect of the two functions should make a very good waveform.

The next step was to measure High-Com II's noise-reduction capability compared to Dolby NR and to no noise reduction. A comparison in responses at +10 dB was also made. A Nakamichi 680ZX cassette deck was used for the tests with its output fed to an Ivie IE-30A spectrum analyzer. The Ivie 1/3-octave spectrum output was stored on a Tektronix 5111 'scope to allow showing all curves at the same time (Fig. 7.). Immediately take note of the fact that the vertical scale is broken between the zero reference and "-50 dB."

With metal tape and the pink-noise source and the extended response of the 680ZX, there wasn't a great deal of roll-off with a +10 dB level on the meters. It is possible to see, however, that there is more roll-off with Dolby NR than with High-Com II. (The new Dolby HX scheme should not show this limitation.) The topmost curve in the lower set of three is the noise output from the recorder with Nakamichi ZX tape without any sort of NR. The middle curve is the noise output with Dolby processing and shows a fairly constant 10-dB improvement above 3 kHz. With High-Com II (bottom spectrum), the reduction is 20 dB or more over a good part of the spectrum, with reductions of 10 dB or more compared to Dolby NR. Especially noteworthy is the sizable reduction at the lower frequencies, where Dolby NR was actually slightly higher in noise than without NR, and at the highest frequencies where the noise with Dolby NR curves up more sharply.

Relative to the reference level, the signal/noise ratios were 61.6 dBA with Dolby NR and 71.5 dBA with High-Com II. Relative to the level for  $HDL_3 = 3\%$ , the ratios were 67.1 dBA with Dolby NR and 82.0 dBA with High-Com II, certainly a most impressive number. Obviously, the compression above zero level effectively shifts the distortion limit to a much higher input level, although it's the same actual level on the tape.

Distortion tests were attempted on the unit, but only general conclusions could be drawn. With a compressor, for example, what's the significance of a harmonic so many dB down? Will it be expanded back down into noise? Two units are really needed to prove that the two functions complement each other for minimum distortion. Most distortion components *appeared* as though they would be at least 57 dB down, or about 0.14 percent — only two-unit tests would tell positively. In record/playback tests,  $HDL_3$  at 1 kHz was higher at some levels with NR than without — always less than 0.2 percent, but there was a shift.

The subsonic filter was 3 dB down at 26 Hz, 13 dB down at 20 Hz, and 38 dB down at 10 Hz. The multiplex filter was -3 dB at 16.8 kHz and 30 dB down at 19 kHz. The input low-pass filter was -3 dB at 25.9 kHz and 10 dB down at 38.7 kHz. The meters were 3 dB down at 10 Hz and 24.4 kHz. The response time was about 140 mS, fairly fast compared to a standard VU meter, but isn't a true peak level type. Line input sensitivity was 52 mV; record out level was 290 mV. Play input sensitivity was 182 mV; line out level was 540 mV. All of these figures are substantially to spec, but the source impedance of record out (5 kilohms) is on the high side for general use, and the IHF load caused the level to drop to about 200 mV.

### Use and Listening Tests

Because Dolby B and dbx II had been used successfully in many cases, I conducted a few tests for direct comparison. Records were used, as it was desirable to be able to switch among the three systems and the original at any point. In general, there was a lot of good reproduction from all of the systems. With **The Great Organ** record with Michael Murray, High-Com II had a slightly better articulation, a cleaner separation between bass and treble than the other two schemes — particularly when there were low pedal notes. In the quiet portions, it was possible to hear the reduction in noise with High-Com II compared to Dolby B. The Fiedler/Boston Pops direct disc of Tchaikovsky's **Capriccio Italien** gave similar evidence, and there were also a few low-level passages where there was some breathing noted with dbx II. Another test used a mike pickup of speech with music playing in the background and a heater blower running off and on. For those who haven't had the experience, this odd combination is not so far from some of the conditions you might find in remote recording. In this case, Dolby B performance appeared to be just as good as High-Com II, and the playback sounded natural. The dbx II system, however, generated a number of odd gain changes from some sort of interaction between the processing, the low-level music, and the whirring of the heater blower.

The actual test time was short, particularly in comparison with the number of hours spent with other NR systems. High-Com II did perform well in the tests, and the listening experience was quite impressive. The noise reduction was definitely greater than with Dolby B, the high-level high-frequency headroom was greater, and the low-level breathing/pumping was less than with dbx II. The dollars for High-Com II are not low, but the performance warrants a good look.

Howard A. Roberson

Enter No. 91 on Reader Service Card

## Dual C 820 Cassette Deck



### Manufacturer's Specifications

**Wow & Flutter:** 0.04 percent W rms.

**Frequency Response:** With metal tape, 20 Hz to 19 kHz; with CrO<sub>2</sub> tape, 20 Hz to 17 kHz.

**S/N:** 64 dB to 67 dB with Dolby NR.

**Separation:** 40 dB at 1 kHz.

**Erase:** 70 dB.

**Dimensions:** 17¼ in. (431.25 mm) W x 14½ in. (362.5 mm) D x 5½ in. (137.5 mm) H.

**Price:** \$419.95.

Like other Dual decks, the C 820 uses an array of LEDs for VU indication which are located on a sub-panel on the right-hand side. The 0-VU position corresponds to 200 nW/m (the Dolby level), and there are 12 LEDs for each channel — five red ones for +1 to +5 and six green ones calibrated down to -20 dB. Also on this charcoal black panel are a switch to disconnect the display, a digital counter, a memory switch, and indicator lights for *Record* and *Dolby NR*. Under the panel is a six-position switch for tape selection (*Fe*, *FeI*, *Cr*, *Cr II*, *FeCr*, and *Met*) plus a group of four lever switches. The first two control the Dolby system with the MPX filter, the third is the limiter switch, and the last controls the input from microphones, line and a DIN socket. Next is a large dual-concentric input control and a pair of standard ¼-inch microphone sockets. The on-off switch and phono socket are way over on the left, next to the cassette compartment. And here is where the 820 differs from most other decks: There is no eject button, as the cassette is placed in position and retrieved manually. No matter what the operating mode — including fast wind — the tape can be removed. In addition, the manufacturer has provided a neat cover to protect the heads from dust: When the power switch is depressed the cover opens automatically. Dual calls this system "DLS," Direct Load and Lock, and I must say it works very nicely. Another innovation is the provision of two separate *Stop* keys, in the form of vertical bars, positioned conveniently on each side of the cassette compartment. The five control keys below the cassette compartment operate a sophisticated logic circuit that allows fast switching from one mode to another. An electronic tape-motion sensor stops the tape transport within 1.5 S if a tape should jam. The d.c. motor is servo-controlled with the correction signals obtained from an integral frequency generator; the actual drive system uses twin belts.

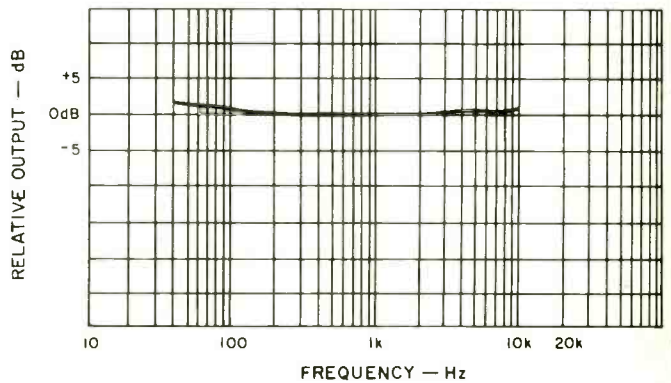

Fig. 1 — Playback response with a standard test tape.

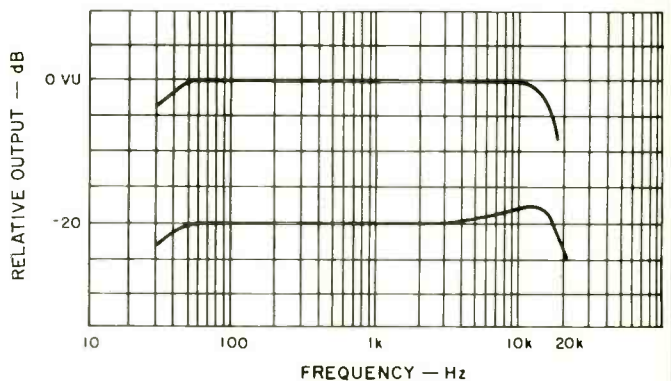
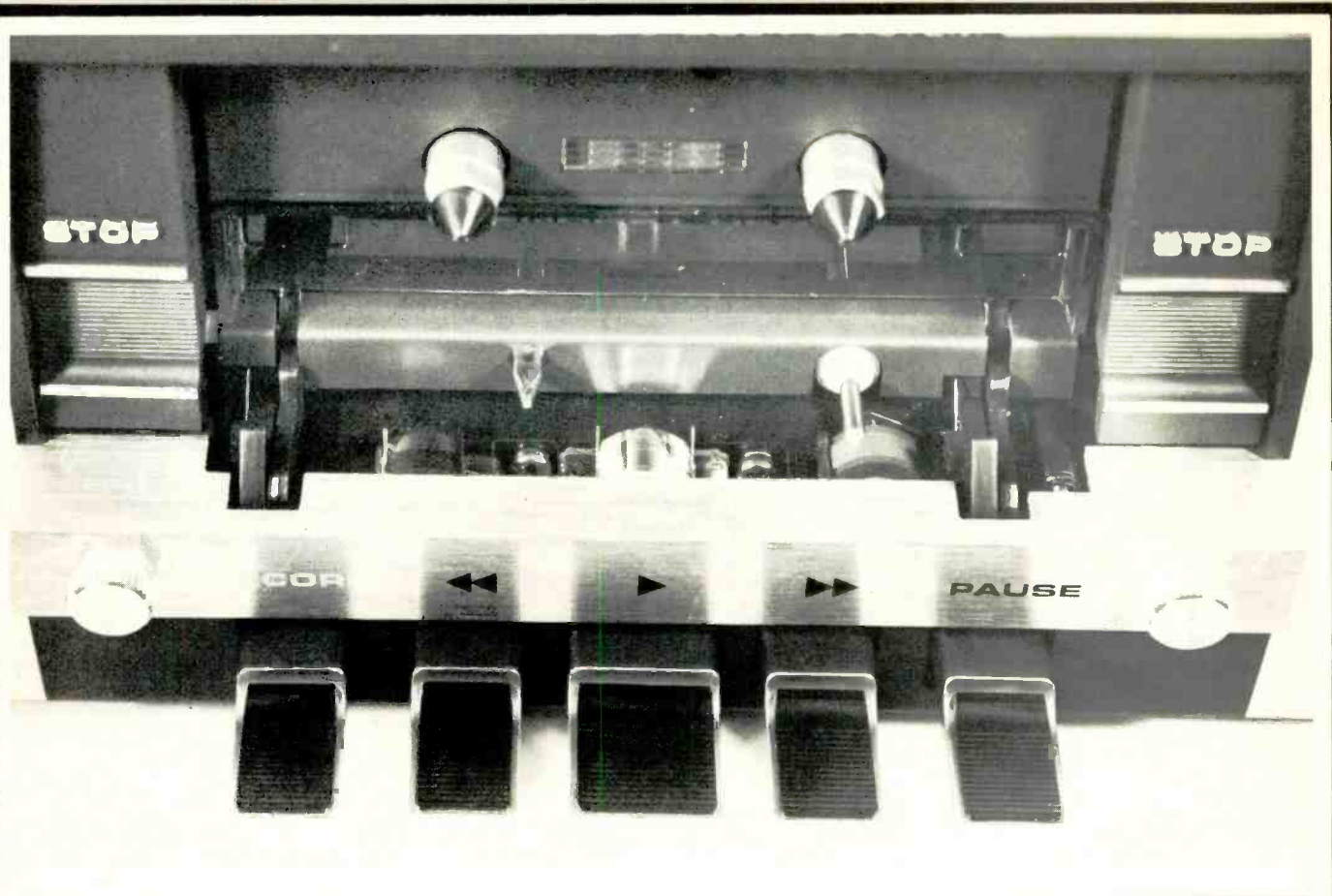

Fig. 2 — Record-replay response with TDK MA-R metal tape.



### Measurements

Figure 1 shows the playback response from a standard test tape, the output being within 2 dB from 40 Hz to 10 kHz. The first record-replay tests were made with a TDK MA-R metal tape, and the results can be seen in Fig. 2. Note that saturation at 0 VU is exceptionally low and that the response at -20 dB shows a slight rise from around 8 kHz with the -3 dB point at 19.3 kHz. As mentioned earlier, the tape selector has six positions, the *Fe* for high-energy types and *FeI* for super high-efficiency kinds. The latter includes Maxell UDXL-I, so this was the one selected for the next test. Figure 3 shows the results: High-frequency saturation at 0 VU (Dolby level) is fairly significant, but the low-level response is quite linear with the -3 dB frequency at 16.5 kHz. Next, a CrO<sub>2</sub> type of tape was checked out, a Fuji FX-II, and here the saturation was rather less, with a slightly falling response to a -3 dB point at 16.6 kHz.

Figure 5 shows the distortion and headroom for all three tapes at 1 kHz, and Fig. 6 shows distortion vs. frequency, measured at a level of -3 dB (ref. 1 kHz). Signal to noise (ref. 3 percent THD) measured 58 dB for the Maxell UDXL-I and 57.5 dB for the FX-II and TDK metal. Switching in the Dolby system increased these results by about 9 dB. Input required for 0 VU was 85 mV line and 0.3 mV for microphones, output then being between 480 and 590 mV. Maximum signal-handling capacity at the microphone inputs was 40 mV. The Dolby system had an error of less than 1.5 dB down to -40 dB, and the MPX filter introduced an attenuation of 30 dB at 19 kHz with a loss of 0.75 dB at 15 kHz and 12 dB at 18 kHz. The limiter had a fast response time, cutting sharply at levels above 0 VU. Erase efficiency was better than 70 dB, as specified. Wow and flutter measured 0.04 percent (DIN 45-507), and speed was exactly 1 7/8 ips. The fast-wind time for a C-90 cassette was 90 seconds.

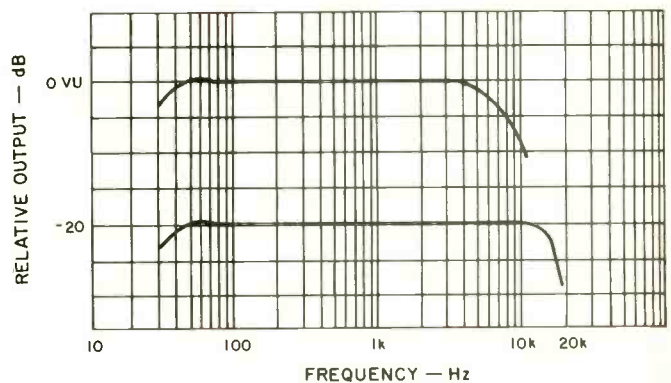

Fig. 3 — Record-replay response with Maxell UDXL-I tape.

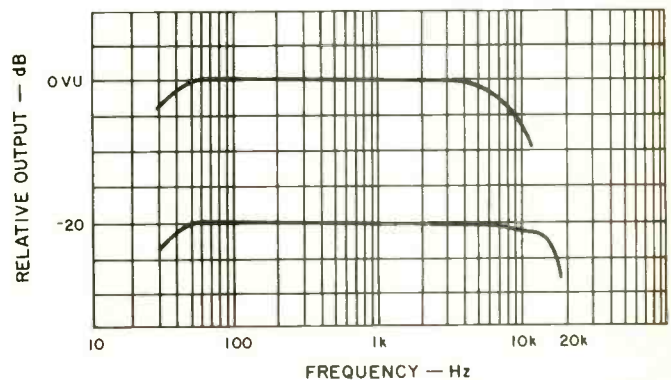

Fig. 4 — Record-replay response with Fuji FX-II (chrome substitute) tape.



## In-Use Tests

As the test results indicate, the 820 has obviously been designed to take full advantage of metal tapes. Not that "ordinary" tapes are far behind, but the increased high-frequency headroom means a greater margin against overload plus better transient definition. The six-position equalizing facility enables optimum results to be obtained with all the present formulations, including super-chrome. The logic controls all worked nice and smoothly, and I found the twin Stop bars very convenient after I got used to the idea. With this tape control system, it is possible to go from fast forward to fast reverse directly — a severe test, but it can be done without breaking the tape. Amazing when you see just how quickly the speed changes!

Opinions differ about LED displays, with some people still preferring the "readability" of VU meters. However, one must admit that the new displays — whether fluorescent or LEDs — are much faster in response and far more accurate in indicating peaks.

Sharp-eyed readers will have noticed that I mentioned a third input from a DIN socket. Sensitivity is quoted at 1 mV, which is much too high for most amplifiers or receivers, but this socket could possibly be used for high-output microphones.

To sum up, the Dual C 820 deck is a well-designed model offering impressive performance and versatile facilities and is unlikely to be outdated for many years.

George W. Tillett

Enter No. 92 on Reader Service Card

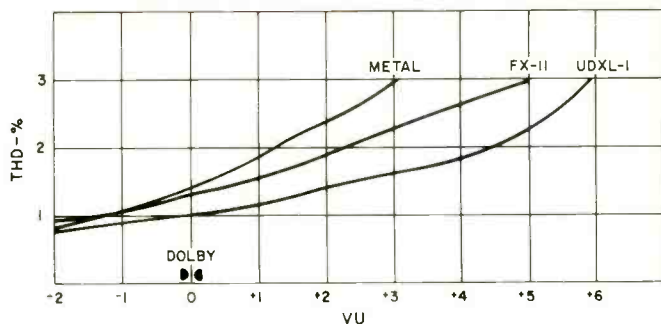

Fig. 5 — Distortion and headroom at 1 kHz.

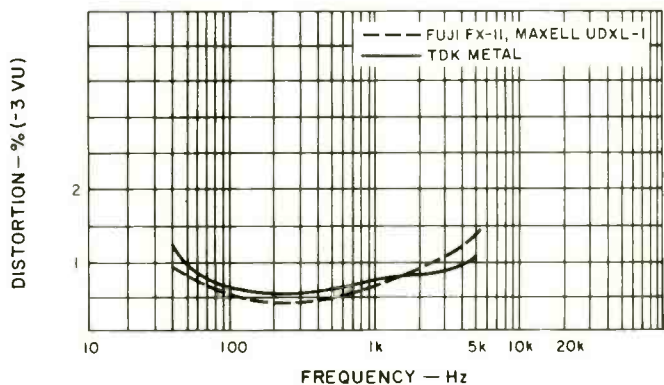
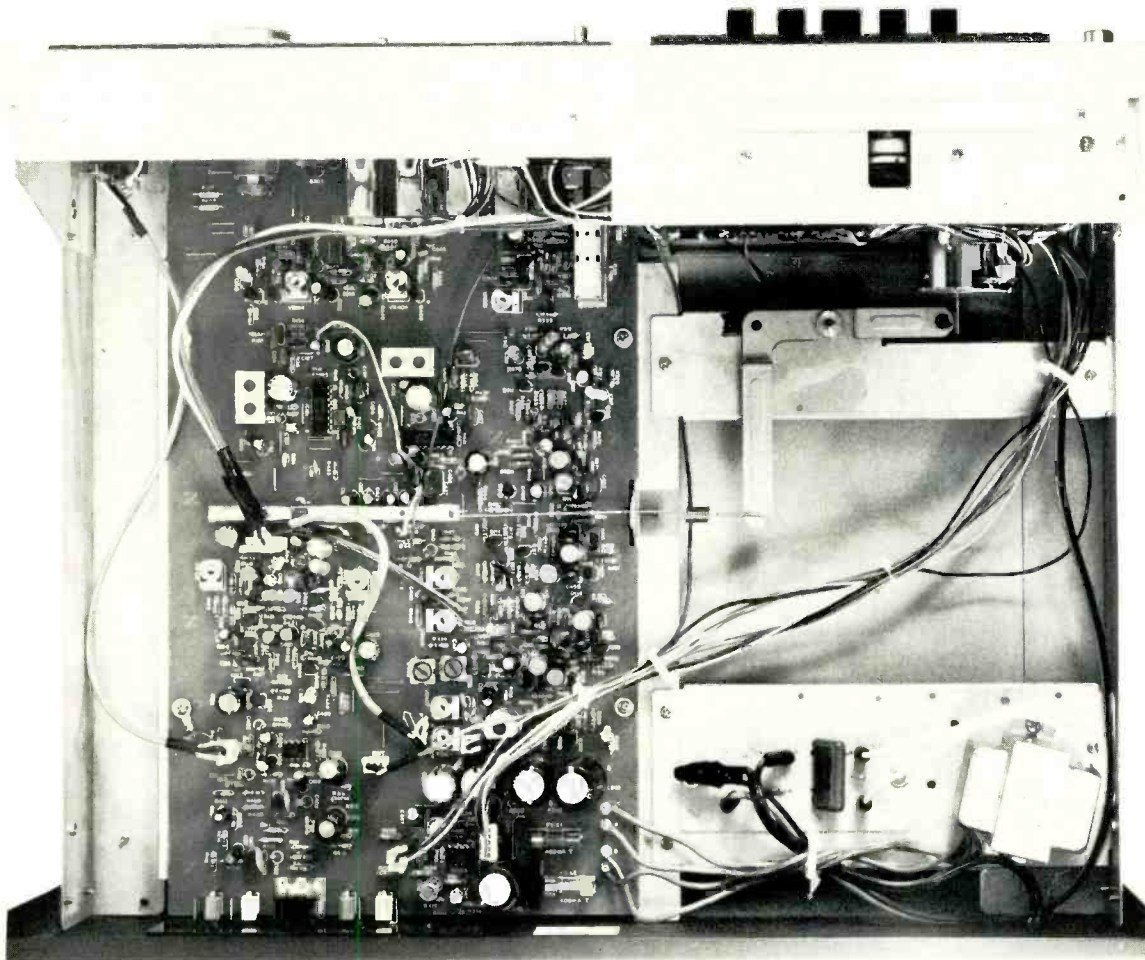

Fig. 6 — Distortion vs. frequency.



## Denon DL-103D Phono Cartridge, DA-307 Tonearm, and AU-320 Transformer



### Manufacturer's Specifications

#### DL-103D Phono Cartridge

**Generating System:** Moving coil.

**Output Voltage:** 0.25 mV (1 kHz, 50 mm/S, horizontal).

**Channel Sensitivity Difference:** 1 dB or less at 1 kHz.

**Channel Separation:** Over 28 dB at 1 kHz.

**Electrical Impedance:** 33 ohms,  $\pm 20$  percent at 1 kHz.

**Compliance:**  $12 \times 10^{-6}$  cm/dyne (on disc).

**Recommended Tracking Force:** 1.5 grams,  $\pm 0.2$  grams.

**Playback Frequency Response:** 20 to 65,000 Hz.

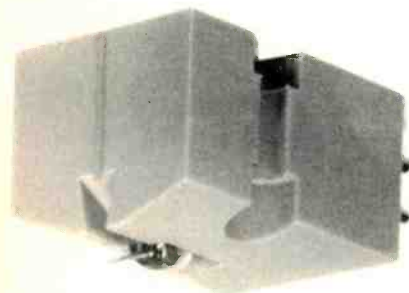

**Weight:** 7.5 grams.

**Recommended Load Resistance:** 100 ohms or more, except when transformer is used.

**Price:** \$267.00.

#### DA-307 Tonearm

**Type:** Static balance, dynamic damping.

**Overall Length:** 332 mm (13.071 in.).

**Effective Length:** 244 mm (9.61 in.).

**Overhang:** 14 mm (0.55 in.).

**Height Adjustment Range:** 42 to 70 mm (1.65 to 2.76 in.).

**Acceptable Weight of Cartridge:** 5 to 10 grams.

**Price:** \$275.00.

#### AU-320 Transformer

**Step-Up Ratio:** 1:10 at 40 ohms: 4 kilohms.

**Primary Impedance:** 3 ohms, 40 ohms.



**Secondary Impedance:** 4 kilohms.

**Frequency Response:** 10 Hz to 100 kHz,  $\pm 1$  dB.

**Crosstalk:** 60 dB or less, 20 Hz to 50 kHz.

**Overall Dimensions:** 97 mm (3.82 in.) W x 65 mm (2.56 in.) H x 160 mm (6.3 in.) D.

**Weight:** Approx. 800 grams (28.57 oz.).

**Price:** \$160.00.



In previous tonearm reports, we have evaluated low-mass types. For this report, we had a chance to check out the Denon DA-307 tonearm which is a medium- to high-mass device. It is designed for use with relatively low-compliance cartridges, such as the Denon moving-coil DL-103D, also reviewed here. Moving-coil cartridges are designed to be extremely lightweight reciprocals of moving-coil disc cutterheads used to make original disc masters. While this reciprocity of design does not guarantee exceptional performance, in the past few years they have gained a reputation for excellence and a large following in the audiophile market. There are always trade-offs, of course, and to use such a cartridge, the audiophile must contend with such things as low output voltage and non-user-replaceable stylus. (There are some moving-coil designs, notably from Audio-Technica, Osawa and Satin, which do have a user-replaceable stylus).

The compliance of the Denon DL-103D cartridge is about  $12 \times 10^{-6}$  cm/dyne, and it matches well the effective mass of the DA-307 tonearm, which is about 20 grams with the DL-103D installed. The inductance of the coils proved too low to measure, and the 32.9-ohm resistance of the coils provides the major part of the internal impedance.

Since the low output voltage of the DL-103D cartridge re-

quires a step-up device, such as a pre-preamplifier or transformer, we used the Denon AU-320 transformer which provides a nominal 40-ohm input. This input is designed to match the nominal 33-ohm internal impedance of the DL-103D. When a pre-preamplifier is used, Denon recommends that its input impedance be greater than 100 ohms. The Denon AU-320 transformer also provides a 3-ohm input which may be switch selected.

The Denon DA-307 tonearm was mounted on a Denon DP-6000 turntable. This combination is also available preassembled, as the Model DP-6700, which was used for this report. This is certainly an impressive combination, and it is easy to see why Denon, known in Japan as Nippon Columbia, has been a major supplier to NHK, the Japanese broadcasting corporation. For the past few years, they were represented in the U.S.A. by American Audioport. Denon has more recently set up a division in New Jersey, and it is headed up by Eric Fossum who was previously in charge of Denon products for American Audioport. Readily available product support, especially for imports, can be a major consideration to prospective purchasers; since the DL-103D must be returned for stylus replacement, it is especially true in this case.

Because previous reports on tonearms have been made us-

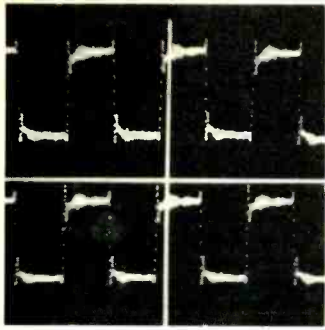

**Fig. 1 — Response of Denon DL-103D cartridge in DA-307 arm to 1-kHz square wave of CBS STR-112 band 1, left channel. Top trace is without AU-320 transformer, bottom is with transformer at 40-ohm setting.**

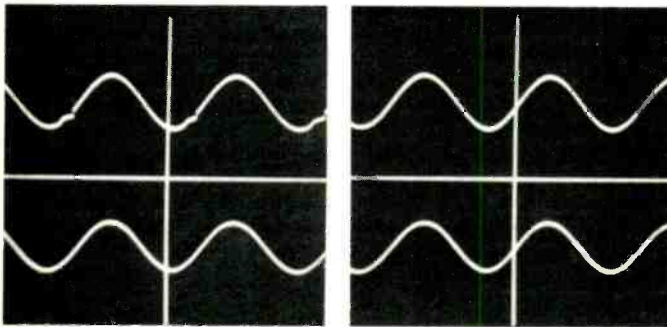

**Fig. 2 — Response of Denon DL-103, DA-307, and AU-320 to 300-Hz signal in band 9 of CBS STR-112, +18 dB re: 11.2  $\mu$ M. Fig. 2A, left, is with 1.7 g tracking force and 2.5 g sidethrust correction. Fig. 2B, right, is with 1.8 g tracking force and 2.8 g sidethrust correction.**

ing the Pioneer PLC-590 turntable, we should make some mention of some of the features of the Denon DP-6000 direct-drive turntable. This turntable was supplied with a heavy wooden base and a clear plastic dust cover. The base included four large mounting feet which are a combination of rubber and conical spring. Each of the feet is adjustable so that the turntable may be leveled. The hinges which hold the dust cover to the base are also adjustable so that the cover may be set to stay open at any given angle. This dust cover is also removable, which is handy in case the whole unit were to be mounted in a drawer or cupboard.

The turntable has speeds of 33 $\frac{1}{3}$  and 45 rpm. The 4-lb. turntable platter is driven from an a.c. servo motor which is phase locked to a crystal oscillator. A 9-in. diameter magnetic track is employed underneath the turntable providing for 1000 pulses per rotation. A magnetic recording head reads these pulses, and suitable circuitry is employed resulting in a pulse-width-modulation signal which is fed through an appropriate amplifier to the a.c. servo motor. The turntable speed can be locked to the crystal control oscillator or adjusted by means of a variable knob to  $\pm 6$  percent of the selected speed. During turn-on or between speed changes, a special speed-up signal or d.c. braking signal is fed to the motor. The d.c. braking signal is also available when the unit is turned off, which helps to slow down the turntable rotation more quickly than otherwise would occur. The turntable is fitted with a 1-lb. rubber mat and also comes with a 145-gram weight which fits over the spindle once the record is put in place. The heavy rubber mat and the weight are intended to reduce record vibrations during playing. It was determined through experimentation that the DP-6000 turntable was relatively impervious to both airborne and structural vibrations

## Measured Data

### Denon DA-307 Tonearm

**Pivot-to-Turntable Center Distance:** 9.06 in. (230 mm).  
**Pivot-to-Stylus Distance:** 9.5 in. (244 mm).  
**Pivot-to-Rear of Arm Distance:** 3.46 in. (88 mm).  
**Arm-Rear Clearance from Turntable Center:** 12.52 in. (318 mm).  
**Overall Height Adjustment:** 1.11 in. (28 mm).  
**Maximum Tracking Force Adjustment:** 10 g  
**Tracking Force Calibration:** 2.5 g per 360 degree revolution of counterweight in 0.1-g steps.  
**Tracking Force Accuracy:** Marked vs. measured, 0.5/0.5; 0.7/0.7; 1.0/0.9; 1.2/1.1; 1.5/1.4; 1.7/1.6; 2.0/1.8, and 2.5/2.3.  
**Cartridge Weight Range:** 5 to 10 g.  
**Counterweight:** Integral.  
**Counterweight Mounting:** Slip fit into arm tube.  
**Sidethrust Correction:** Variable magnetic; uniformity varies with disc radius, see test.  
**Pivot Damping:** None. **Headshell Offset:** 24 degrees.  
**Lifting Device:** Oil-damped lever. **Fingerlift:** Integral with headshell.  
**Headshell Weight:** 6.0 g. **Mounting Screws Weight:** 0.4 g.  
**Overhang Adjustment:** Slots in head shell.  
**Bearing Alignment:** Excellent in both planes.  
**Bear Friction:** Too low to measure.  
**Bearing Types:** Vertical, two needle point; horizontal, ball and race.  
**Lead Torque:** Too low to measure.  
**Dynamic Mass:** See text.  
**Lead Capacity:** Total, 53 pF; arm leads, 6 pF; external leads, 47 pF.  
**Lead Resistance:** Total, 1.05 ohms; arm leads, 0.05 ohms; external leads, 1.0 ohm.  
**Lead Length:** 47 in. (185 mm).  
**Structural Resonance:** Minor resonance at 90 Hz.  
**Base Mounting:** Locknut on 0.75-in. dia. threaded metal tube with 1.875-in. dia. flange.  
**General Comments:** Arm lift and arm height independently adjustable

for different turntable applications. Forward part of arm is isolated from pivots via rubber.

### Denon DL-103D Phono Cartridge

Serial No. 5130	Left	Right
<b>Inductance, mH</b>	See text	
<b>Resistance, ohms</b>	32.9	32.9
<b>Output,</b>	0.27	0.27
mV/cm/S at 45 $^\circ$		
(B&K 2009, band 3)		

#### Dynamic Tracking Force,

grams required to track B&K 2010 (Gms x 980 = dynes)  
 Band 3, 0 dB (= 7.07 cm/S at 45 $^\circ$ )

	0.7	0.7
Band 4, +2 dB	0.8	0.8
Band 5, +4 dB	1.0	1.0
Band 6, +6 dB	1.8	1.8
Band 7, +8 dB	2.0†	2.0†

†Visual distortion on scope trace.

#### Tracking Force vs. Radius, grams

(HFS-75, 300 Hz, +15 dB re 1.12 x 10 $^{-3}$  cm)

Outer grooves, 1.1 grams  
 Middle grooves, 1.1 grams  
 Inner grooves, 1.2 grams

**Cartridge Mass:** 7.9 grams.

**Microphone:** Excellent.

**Hum Rejection:** Good.

**High-Frequency Resonance:** 66.7 kHz.

**Rise Time:** 9.0  $\mu$ S, see text.

**Low-Frequency Resonance:** 8 Hz.

**Low-Frequency Resonance Q:** 6.0

**Recommended Load Resistance:** Above 100 ohms, see text.

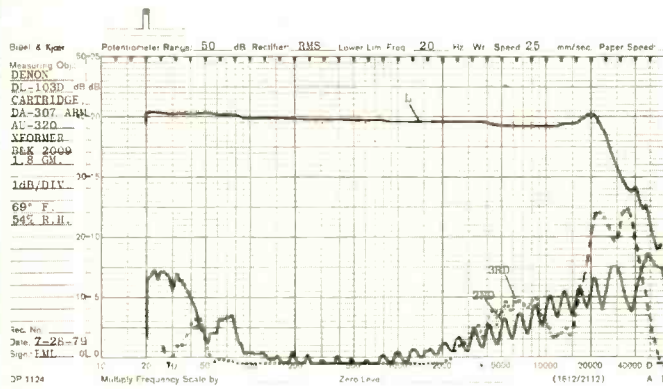

**Fig 3 — Second and third harmonic distortion vs. left-channel output. Distortion is very low from 100 Hz to 1 kHz, and the distortion of the test record is included (Distortion components are measured only to 20 kHz).**

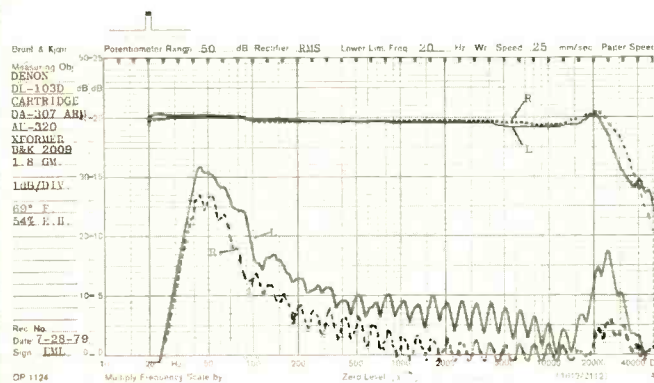

**Fig 4 — Interchannel output vs. frequency. Notches in crosstalk are due to filter switching. Crosstalk from right into left is greater than from left into right. No "fingers" are apparent which indicates that no serious resonances are present to color the reproduction. The effect of the rubber arm decoupler can be seen at 90 Hz.**

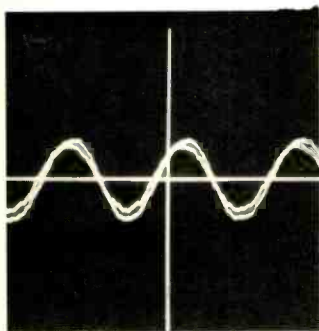

**Fig. 5A — Amplitude vs. time on both channels of the B&K 2009 test record, band 3. Sweep is from 20 Hz to 20 kHz, with stop action at 3 kHz.**

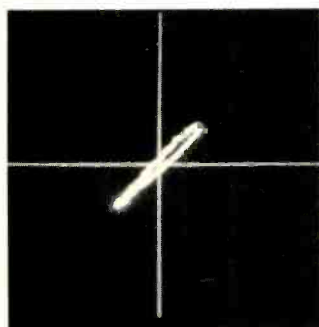

**Fig. 5B — X-Y display of the right vs. left channel for the same signal as Fig. 5A. Identical channel output would make a straight 45-degree line.**

and therefore did not significantly affect the results of either technical measurements or the listening tests.

The Denon DA-307 tonearm employs an interesting form of dynamic damping which we had not seen previously. In other designs the rear of the arm, which includes the counterweight, is usually decoupled by some means. The usual method is to use rubber between the rear of the arm and the counterweight. The DA-307 has a rubber decoupler on the cartridge side of the tonearm, near the pivots, which decouples the arm tube and cartridge from the main pivots. The cartridge balancing and tracking force adjustment weights on the rear of the arm are divided into two sections, each allowing adjustment of the counterweight. A small knurled wheel at the back of the arm is used to set the initial balance of the arm when the cartridge has been installed. The other adjustment, which adjusts the tracking force, is a rotating ring calibrated in 0.1-gram increments. This ring is calibrated for 2.5 grams for each 360-degree rotation. There are four complete turns, and so the total adjustment range is 10 grams. Denon indicates in their literature that cartridges weighing between 5 to 10 grams may be used with the DA-307 tonearm. The detachable magnesium alloy headshell has an integral finger lift; the DA-307 accepts EIA standard headshells so that other brands of headshells may also be used. An adjustable oil-damped cueing lever is integral with the arm. The bearing friction is claimed to be less than 25 milligrams both vertical and lateral, and this seems reasonable although it was too low to measure accurately. Since the arm was supplied already mounted to the turntable, we did not have a template at hand to check the offset angle of the head. This offset angle is not mentioned in any of the Denon literature but we calculated that the optimum offset angle should be 22.5 degrees. As nearly as we could measure, the offset angle appeared to be 20 degrees. The overhang specified by Denon was 14 millimeters but we calculated that the optimum overhang should be 16.9 millimeters. The slots in the Denon headshell allowed us to adjust the overhang and the offset angle to the optimum values for our tests. The effective mass of the tonearm including headshell (6 grams) and the cartridge (7.9 grams) is about 20 grams.

When first setting up a new tonearm and cartridge combination, one of the tests we usually perform first is to play band 1 of CBS Test Record STR 112, which consists of a 1-kHz square wave. This provides a quick means of adjusting the optimum load resistance and capacity. By alternating between this square-wave test and a swept-tone test from one of the B & K records, it is possible to determine these optimum values. Since the Denon DL-103D cartridge is a very low impedance device, the external load capacity has only a slight effect. We did use this test, however, to determine if there were any major differences between operating the cartridge directly or through the Denon AU-320 step-up transformer. Figure 1 indicates there is very little difference with respect to this square-wave test when using the cartridge directly or through the step-up transformer. The ringing shown in the photographs is at a very high frequency. The major overshoot, on the leading edge, occurs at about 25 kHz, and the ringing, which is relatively damped, occurs at 66.7 kHz. Both of these resonances are well outside the audible band of frequencies. The main reason that they are visible at all is because there is no band-limiting mechanism, either in the cartridge itself or in the input of the measuring amplifier, which would roll off the output at these frequencies. The cartridge is free to show the results of trying to negotiate the severe changes in acceleration required when tracing the square wave on the CBS STR 112 Test Record. Therefore, what appears to be, at first glance, a fault can

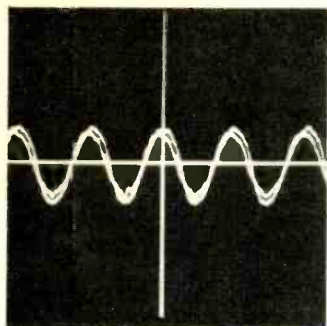

Fig. 6A — Same as Fig. 5A with stop action at 5kHz.

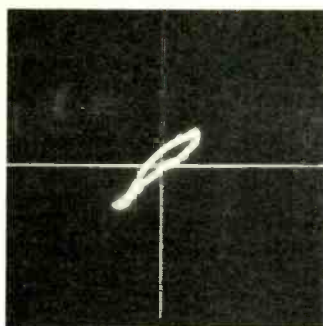

Fig. 6B — Same as Fig. 5B with stop action at 5 kHz.

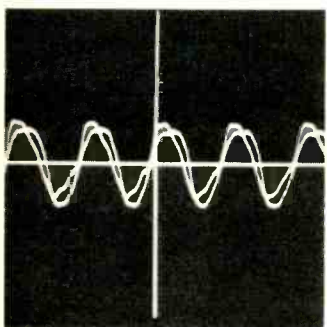

Fig. 7A — Same as Fig. 5A with stop action at 10 kHz.

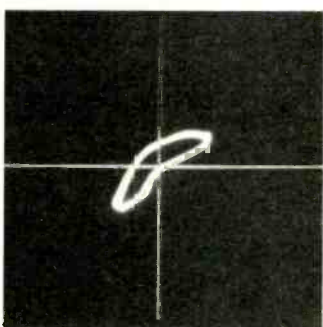

Fig. 7B — Same as Fig. 5B with stop action at 10 kHz.

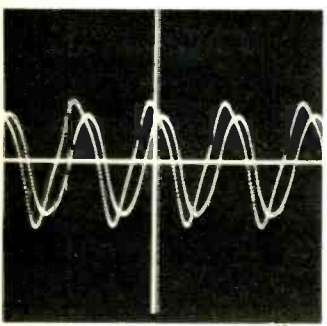

Fig. 8A — Same as Fig. 5A with stop action at 20 kHz.

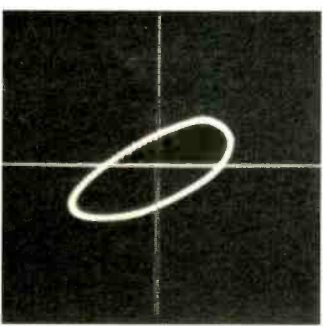

Fig. 8B — Same as Fig. 5B with stop action at 20 kHz.

Fig. 9A — Response to 1-kHz square wave from STR-112, 3.54 cm/S. Top trace is left channel.

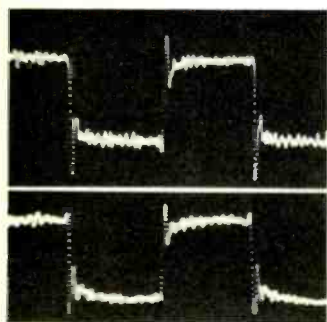

Fig. 9B — Same as Fig. 9A except expanded to show leading edge. Frequency of "ring" at leading edge is 25 kHz; later "ring" is 66.7 kHz.

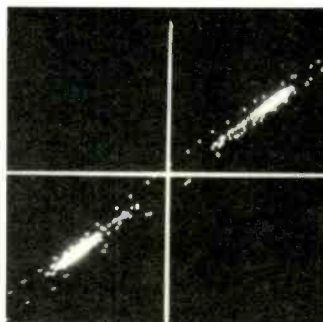
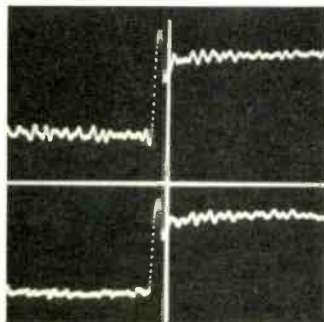
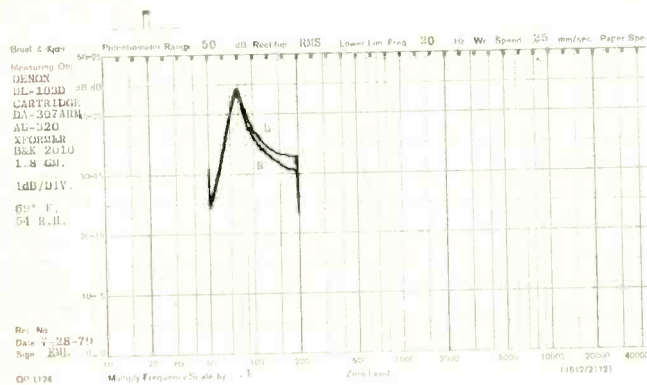

Fig. 9C — Same as Fig. 9A except is a left vs. right presentation. This is an excellent interchannel relationship for a complex signal.

actually be considered a virtue. It is also, as John Curl has previously pointed out in *Audio*, (Aug., 1979), further proof that extremely high frequencies can be seen at the output of moving-coil cartridges when tracing phonograph records. It is also a further indication that preamp design criteria, which provide high-frequency filtering at, say, 40 kHz, are appropriate. If left unfiltered, such signals can cause distortion in wide-band preamplifiers and power amplifiers. During the listening tests, the listening panel was able to determine that there were subtle changes in the quality of the sound reproduction when such a 40-kHz filter was removed from the signal path. The general listening tests were therefore performed with this 40-kHz filter in the signal path to avoid subtle differences which might occur due to possible amplifier limitation.

Figures 2A and 2B indicate the tracking capabilities of the Denon DL-103D cartridge and DA-307 tonearm combination. Figure 2A shows that the left channel is mistracking on the highest level band. Although the side thrust correction on the DA-307 tonearm is easily adjustable while playing the test record, we were unable to exactly balance the tracking of both channels at the point where the first indication occurred. It should also be noted from the figure that a setting of 2.5 on the sidethrust corrector was needed to accommodate the tracking force at 1.7 grams for optimum results. This sidethrust correcting force is also designed so that it increases toward the center of the disc. Figure 2B is also for the highest level band of the test record STR 112. Raising the tracking force to 1.8 grams and the sidethrust correction to 2.8 allows the Denon combination to track this band. This has to be considered most excellent performance in tracking such a high-level test cut. The listening panel evaluations were conducted using this 1.8-gram tracking force setting. During the listening test no one commented about any sound which could be regarded as being caused by mistracking. During our tests with the British test record HFS-75, we determined that the tracking force required on the inner grooves was slightly higher than that required for middle or outer grooves. It is possible that on some modern digitally-based recordings a tracking force of 2.0 grams might be required but it is recommended that for general use a tracking force of about 1.8 grams be set up.

Figure 3 shows the second and third harmonic components for the left-channel output only. The distortion components from about 100 Hz to 2 kHz are about as low as we have so far measured on any cartridge/toner combination. During the listening evaluations, the general consensus was that this combination of cartridge and tonearm provided a very smooth, clean sound, which was neutral almost to the point



**Fig. 10 — Low-frequency resonance due to arm effective mass and cartridge compliance; Q is 6.**

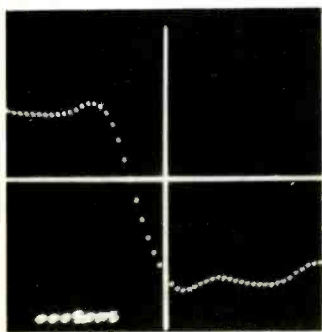

**Fig. 11 — Rise time of Denon DL-103D and AU-320 transformer, 9  $\mu$ S.**

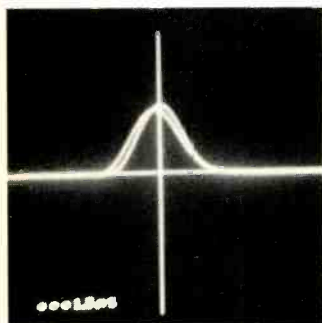

**Fig 12 — Response of the AU-320 transformer to 30-kHz cosine pulse shows 1.5-  $\mu$ S delay through the 40-ohm input.**

of having no character of its own. The lack of distortion, plus the gentle swayback character of the frequency response curve, may account somewhat for a "reticent" character of the overall sound. The sound of brass, for instance, while having the same general timbre as that of the reference system, appeared to be a little less bright.

Figure 4 shows the frequency response and crosstalk characteristics of the left and right channel. There are no prominent "fingers" sticking up in the crosstalk information, which

would indicate resonance problems that could color the sound. While listening to various records which included different instruments and voice, there were no really adverse comments by the listening panel regarding changes in timbre or shifts in spatial positioning for small ensemble or single instruments. Figures 5 through 8 indicate that spatial positioning should be at least reasonable up to 10 kHz. From 10 kHz to 20 kHz there is some shifting in the phase relationship between the two channels. The bending of the ellipse in Fig. 7B also shows, in another form from Fig. 3, the results of nonlinear distortion occurring at 10 kHz. However, none of the listening panel members actually made any comments regarding spatial smearing of instruments such as cymbals which contain energy at these frequencies. It should be pointed out that the multi-microphone recording of drums and cymbals prevalent in modern pop recording could cause some confusion in the sound image.

Figure 9 shows the output for a 1-kHz square-wave signal. Both the left (upper) and right (lower) channels are shown in Fig. 9A; Fig. 9B is an expanded view of Fig. 9A. In Fig. 9B we can see the leading edge overshoot which is caused by some phase shift at 25 kHz. The smaller ripples are at 66.7 kHz and appear to be well damped. Figure 9C shows the relationship between the left and right channels for this 1-kHz square wave, and the pattern in this photo shows that for a complex signal, such as a 1-kHz square wave, the correlation in the time domain is excellent. This indicates that, for complex signals, the spatial perspective and positioning will remain fairly consistent. Comments from the listening panel during the playing of complex music passages by large ensembles indicated that this indeed was true. Figure 10 shows the low-frequency resonance for the combination of the tonearm mass and the cartridge compliance, and this resonance occurs at approximately 8 Hz. The Q of this resonance is 6, quite high by today's standards. This may account for the comments by the listening panel that the lower registers of guitar, piano, and cello seemed to be a little less tight than the reference system. However, extremely low organ pedal and bass drum seemed to be quite good and elicited comments to this effect.

Figure 11 shows that the rise time of the Denon DL-103D cartridge is 9  $\mu$ S, an extremely fast measurement. This test was performed with the Denon AU-320 step-up transformer in the circuit which makes the results even more amazing.

Figure 12 shows the response of the Denon AU-320 transformer by itself to a 30-kHz cosine pulse. There is a 1.5- $\mu$ S delay added to the signal when this transformer is used in the 40-ohm switch position. In the 3-ohm switch position, there is a 2- $\mu$ S delay. The AU-320 comes with gold-plated phono input sockets and a one-meter cord set with gold-plated phono plugs. The hum rejection of this transformer is also excellent.

Besides the usual listening panel evaluation of the Denon arm/cartridge combination, it was also used in a long-term, day-to-day listening evaluation in combination with the DP-6000 turntable. This setup exhibits sturdy, professional qualities which were easily apparent, as was its freedom from long-term listening fatigue effects. While some of the turntable's qualities, such as long-term speed stability of 0.002 percent and absolute speed accuracy regardless of changes in power line frequency, may not be required in a home music system, nevertheless it is an excellent turntable. Overall, the Denon DL-103D moving-coil cartridge, AU-320 transformer, DA-307 tonearm, and DP-6000 turntable is an excellent, albeit expensive combination, and can be highly recommended.

*Edward M. Long*

Enter No. 93 on Reader Service Card

Jon Tiven

Michael Tearson

# The column

**Emotional Rescue:** The Rolling Stones  
Rolling Stones Records COC 16015,  
stereo, \$8.98.

**Emotional Rescue** is, to be trite, an apt successor to **Some Girls** which clearly was a highlight in the Rolling Stones' long and fabled recording career and not only for fully revitalizing the appeal of the group. The new album's sound has been handled by Chris Kimsey who also did **Some Girls**. This time around he has been promoted to associate producer to the ever-present Glimmer Twins of course. The clarity of this new one fully equals that of **Some Girls** despite obviously complicated situations in both cases. Again the mix-down tracks are as fully loaded as multi-tracking will allow without any sense of clutter.

In recent years Rolling Stones songs have been almost bewilderingly diverse, and those of **Emotional Rescue** are no exception. *Dance, Send It to Me* and the title track are dancing numbers. *Summer Romance, Let Me Go* and *She's So Cold* are pure rockers. *Where the Boys Go* unashamedly adopts New Wave energy and lower class London accents like latter day Pistols. *Down in the Hole* is blues. And *Indian Girl* and *All About You* are curve balls. That's a lot of territory.

Most of all I think that **Emotional Rescue** is meant to be a party album. Fun first. Starting with the post-disco *Dance*, with reggae star Max Romeo singing backup, is a sure sign, and *Summer Romance* following it, perhaps the most carefree rocker of the album, is the proof. They fire aces at the start.

Next *Send It to Me* is a dance number, but very much a reggae song, this album's sequel to *Some Girls*, as funny but not nearly as incendiary. *Let Me Go* covers some classic Stones motifs leading to *Indian Girl* which is far more satisfying than *Far Away Eyes*. This last is the album's wildest card, incorporating mariachi horns as well as country music. It also has the album's most probing lyrics.

For reasons already cited *Where the Boys Go* has the purest energy thrust of the album, and the blues piece *Down in the Hole*, featuring Sugar Blue's harmonica, is a fully countering

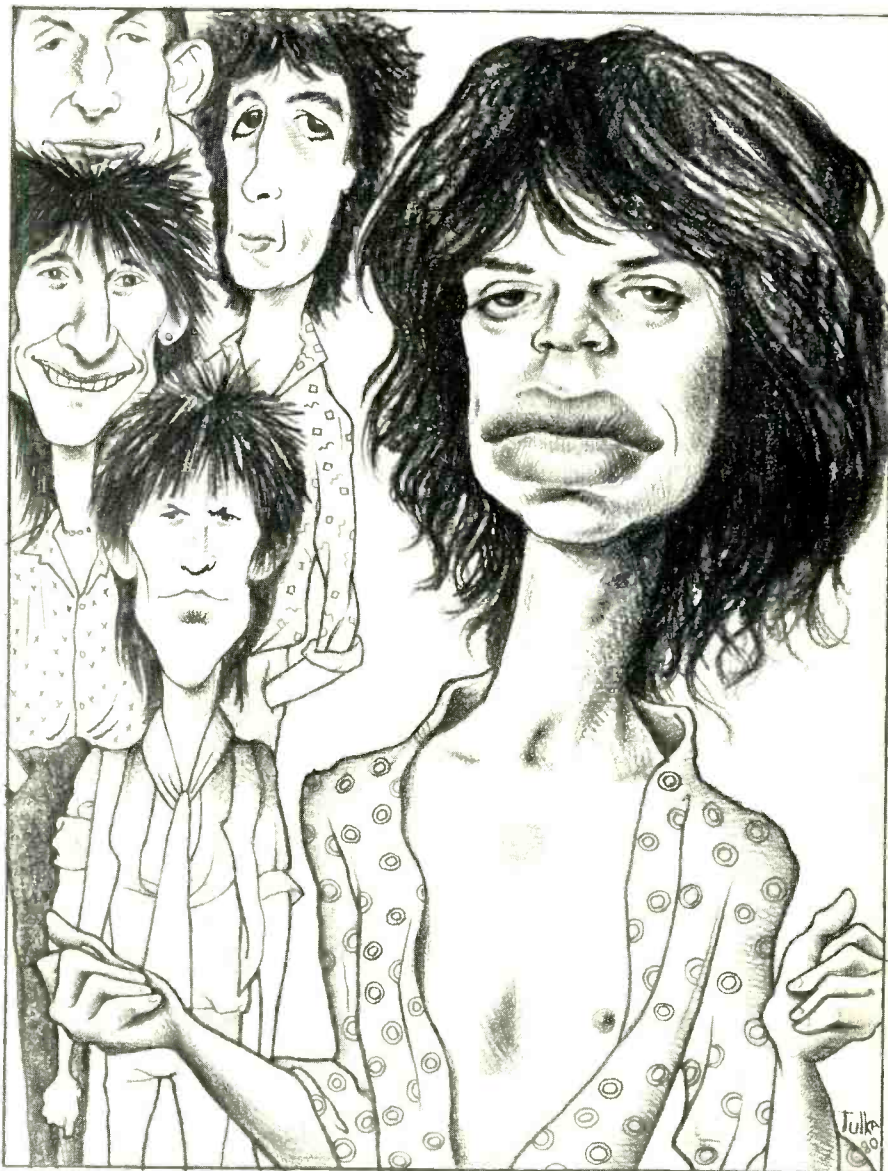

point. *Emotional Rescue* is the album's silliest song, exhuming the chipmunk voices of the Saturday Night Fevered Bee Gees. *She's So Cold* is a churning, nasty rocker (how close to deadline did the lines about the volcano seep in?). The closer *All About You*, a ballad that Keith Richards sings, seems strangely out of place in the scheme of *Emotional Rescue*.

Any answer to the question of how good this album is, has got to include

some judgment of whether this set of tunes will stand up over the long haul.

I think it will wear well — and that some of it will wear well for years. Although it is an apt successor to **Some Girls, Some Girls** it isn't. This is *real* good music, but just not monumental Rolling Stones; still that's saying quite a lot.

M.T.

Sound: A-

Performance: A-

# Classified

## CLASSIFIED ADVERTISING RATES

**BUSINESS ADS-** For Sale. Help Wanted. Services. Business Opportunities. Tape Recordings, etc. etc. \$5.25 per line. First line set in bold face type at no extra charge. Extra lines \$9.60 per line. One point ruled box, extra charge \$8.00. Full payment must accompany order.

**NON BUSINESS ADS-** Situations Wanted, used equipment for sale by private individuals \$3.50 per line. First line set in bold face type at no extra charge. Extra lines set in bold face type \$7.00 per line. Full payment must accompany order.

**FREQUENCY DISCOUNT-** 3 times, less 10%. 6 times, less 15%. 12 times, less 20%. (line copy ads only)

**DEADLINE-** 1st of two preceding months. (Dec. 1 for Feb. issue).

**BLIND ADS-** Box numbers may be used at \$5.00 extra for handling and postage.

**GENERAL INFORMATION** Ad copy must be typewritten or printed legibly and received on or before the 1st of the month, two months preceding the cover date. Display advertisers must make a space reservation on or before the closing date, material (Camera Ready Only) may follow by the 10th. The Publisher, in his sole discretion, reserves the right to reject any ad copy he deems inappropriate. All advertisers must supply: Complete name, Company name, Street address (P.O. Box is insufficient), and telephone number before ads can be published. Classified ads are not acknowledged and do not carry Reader Service Card Numbers. Frequency contracts not fulfilled will be short-rated accordingly. Ads submitted for a 3 time frequency or less are unchangeable. Classified ads are payable in advance (Sorry, we can not accept credit cards.). Additional information available upon request. Contact: Carolyn Sumner, Advertising Coordinator, 1515 Broadway, NYC 10036 . . . Direct Dial (212) 975-7530.

### MAIL ORDER AND DISPLAY CLASSIFIED RATE

1 col x 1"	\$150
1 col x 2"	\$225
1 col x 3"	\$300
2 col x 1"	\$225
2 col x 2"	\$395

Advertiser must supply complete film negative ready for printing for display ads.

AUDIO Magazine  
1515 Broadway  
New York, N.Y. 10036

### HOW TO ANSWER BOX NUMBER ADS

When replying to an Audio Box Number Ad, please use this address Box No. — c/o Audio, 1515 Broadway, New York, N.Y. 10036

## FOR SALE

### CARVER Sonic Hologram PREAMP Now IN STOCK at DESIGNATRON

You've heard about it, you've read about it, NOW YOU CAN OWN IT: The Carver 4000 Preamp with built-in Sonic Hologram, built-in Time Delay and rear amplification, Peak Unlimiter Circuits and the AUTO-CORRELATOR System! All this and full control flexibility in one knock-out preamp! The CARVER 4000 from DESIGNATRON'S STEREO STORE, INC. 260 OLD COUNTRY ROAD HICKSVILLE, NY. 11801 (516) 822-5277. SHIPPED PREPAID & INSURED in Cont. USA. Write for literature and quote.

**CRITICAL RECORD REVIEW** in bimonthly newsletters offers Bill's Corner (controversy, comment), new equipment news, our renown record reviews, and much more. Subscribe now and watch us grow! Only \$6/year; P.O. Box 8766, Jacksonville, FL 32211.

### CROWN DISTINCTION SERIES from DESIGNATRON

The ultimate expression of Crown's Expertise! Super Quality, Super Durable. Computer controlled DL 2 Amplifier; Fun-to-use, magnificent sounding SA-2 Preamplifier; Incomparable EQ-2 Equalizer. All available from DESIGNATRON'S STEREO STORE, INC. 260 OLD COUNTRY RD., HICKSVILLE, N.Y. 11801 (516) 822-5277 Shipped Prepaid & Insured in Cont. USA

### FRIED SPEAKERS & KITS

State-of-the-art sound. Try our prices! Fast free shipping. READ BROS. STEREO, 593 King St., Charleston, S.C. 29403 (803) 723-7276

### A BETTER DEAL!

Retail Pricing Slightly Above Wholesale! Audio/Video Components Ant Tapes. MC/VISA. B & J, Box 248A, Howard Beach, NY 11414. M-F 10-6 PM EST. (212) 845-2861.

### AFFORDABLE ESOTERICA

Central N.Y. State  
Audionics • Apt-Holman • Hafler • Dahlquist  
NAD • Spectro-Acoustics • Mordaunt/Short  
Reference Recordings • Ortofon  
Cizek • Grace • B&O • KEF • Crown  
STELLAR STEREO  
384 Elmira Rd. Ithaca, N.Y. 14850 607-272-2644

## FOR SALE

### A BARGAIN INDEED FROM BALTIMORE!

Apt/Holman Preamp. Sonic Integrity, versatility and outstanding reliability. Only \$493. Apt One Amplifier. More of the same magic! Polk, Marcof, Amber, KEF, Dahlquist, Rogers, Spendor, Grace, G.A.S., Yamaha, H.K., Lux, Philips, Thorens. Various moving coil cartridges. Audio Pulse. Soundcraftsmen. Alpine Car Audio. All shipped freight prepaid in continental U.S. UNSURE OF YOUR CHOICE? Many items available with 30 day full refund (However you assume freight cost both ways. Example: 25lb coast to coast round trip is \$17.90. A Fair Deal!) Fifty years continuously in audio electronics retail. References. SOUNDSCAPE, 406 W. Coldspring Lane, Baltimore, MD 21210 (301) 889-1134 12-8 pm E.S.T. M-Fri.

### ABATE THE HIGH COST OF YOUR NEXT AUDIO PURCHASE!

DIRECT DISCOUNTS LTD. offers many of the finest lines of audio gear from budget equipment to typically non-discounted components and cartridges. But more important is our concerned attitude that your next audio purchase be best suited for your individual needs. Whether you're a novice or seasoned audiophile, we believe that our wide selection, low prices and helpful advice could make us your one-stop audio bargain place. As an added service to our customers we also offer top-notch camera equipment, TV's, video recorders, and many interesting gift items including the new wireless extension telephone from ATE. Just call us at 212-254-3125 for prices and information, or send \$2.00 for our current brochure to Direct Discounts Ltd., P.O. Box 841, Cooper Station, NY 10003. Shop with us by phone with your M/C or VISA. We ship worldwide! Foreign inquiries invited.

### ABSOLUTE BEST PRICES AND FLAT RATE SHIPPING

Onkyo	Advent	JVC	Kenwood	Technics
Sansui	Scott	SAE	Marantz	Pioneer
Sony	Adcom	JBL	Dual	Blaupunkt
Grado	Rotel	BIC	Altec	Sharp
Sonus	Grace	B&O	TEAC	Jensen

Harmon/Kardon, Dynavector Ruby and many others

### AUDIO SYSTEMS II

175 5th Ave., Suite # 917

New York, N.Y. 10010

(212) 477-1891

MONTHLY SPECIAL: TECHNICS SA-505 \$254 plus \$5 shipping

**ABSOLUTELY MINT:** PSE STUDIOS I and II, Denon DP-755, AUDIOCRAFT AC-300 II (NOW CALLED OSAWA ULTRACRAFT AC-300), PAIR OF TANGENT RS2'S. MUST SELL, NEED THE MONEY, BEST OFFER, (805) 682-2754.

## Bob Heenan Sells Great Used Equipment

Sound Advice  
Box 782  
Brookline Village  
MA 02147

AR	Mark Levinson	GAS
dbx	Magneplanar	SME
KLH	QUAD LSI	Denon
Bose	Rappaport	Dynaco
Advent	Bryston	Thorens
McIntosh	LS3/5A	Dahlquist
API/Holman	Hafler	Nakamichi
Bang & Olufsen	IBL	Marantz (tubes)
Audio Research	DB	and much more

Equipment bought, sold  
traded & brokered  
(617) 969-2727

## Just what Miami was listening for.

ACOUSTAT • AGI • AUDIO TECHNOLOGY • AUDIRE • C M LABS (220V also)  
CONNOISSEUR • CONRAD-JOHNSON • DAYTON WRIGHT • DECCA • DENNISEN  
DYNVECTOR • FRIED (Kits also) • GOLDRING • GRACE • KEITH MONKS • KENWOOD PURIST  
J. A. MICHELL • MARCOF • NAD • PETERSON AUDIO • POLK AUDIO • R. H. LABS  
SHAHINIAN • SPICA • STD • SUPEX • THRESHOLD • WIN LABS

**Audio by Caruso**  
13831 S. Dixie Highway (U.S. 1) Miami Fla. 33176 (305) 253-4433



## FOR SALE

**AUDAX AND SEAS DRIVERS FOR THE SPEAKER BUILDER.** SEAS speaker kits and crossover networks. Dynaco replacement woofers and tweeters. We sell both wholesale and retail! For literature and information, send \$1. refundable upon purchase, to: The Speaker Works, P.O. Box 303, Canaan, NH 03741 (603) 523-7389.

### GUSS 3-D SPEAKERS — A SONIC REVELATION

... "totally superior" ... Pablo Elvira, Metropolitan Opera. Spine-tingling realism. Awesome bass impact and 3-D imagery. Custom-built by "One of the most powerful men in sound," (Modern Hi-Fi, 6/75) for connoisseurs disenchanted with all top-rated speakers. Priced from \$3000. Limited edition only 36 systems per year. For demo telephone: (212) 580-7401.

**ABLE TO MAKE YOU FORGET YOUR TURNTABLE:** That's our direct-duped metal cassettes. List \$1, sample newsletter, \$2. Audio Art, Box 25252, Rochester, NY 14625.

**An Audiophiles Dream Has Come to the Metro Area**  
Welcome to Audio Guild, or the house that Thomas built. Thomas Tashjian is an audiophile, and what he built in Englewood, New Jersey, is simply the retail store of his dreams. At Audio Guild there are four listening salons which masquerade as living room settings but which are really four totally isolated listening environments for pure sound reproduction. Each of these salons is dripping with audio equipment carefully arranged into the best possible systems in each price category. Thomas realizes service should go beyond merely selling, and so he built a complete servicing facility. Audio Guild customers can have their warranty work done quickly and efficiently right at Audio Guild. Thomas also demands that every item sold be carefully tested before it is delivered. Thomas sells only those products he believes have merit, such as:

Threshold (including Stasis 1, 2, 3)	Rega
Linn Sondek	Audio Pro
Bang & Olufsen	Pyramid
Shahinian Obelisks	Dayton Wright
B & W	Mordaunt Short
NAD	Boston Acoustics
Thiel	Hatler
Mariah	Plasmatronics
Audionics	Technics R&B
Canton	Oracle
Micro Seiki	and many more

Music systems need records and maintenance items which are also stocked in ample supply from Monster Cable and Audio Technica items to Telarc and Mobile Fidelity records in bulk. In addition, a professional record-cleaning service is provided on the premises.

If you would like to experience this audiophile's dream come true, call us at 201/569-7766 or stop by at 3 Grand Avenue in Englewood, New Jersey or write for a free brochure. We are conveniently located only five minutes from the George Washington Bridge.

Audio Guild, we can fit your needs and your budget.

# POCO

A NEW PRE-PREAMP FOR MOVING COIL CARTRIDGES - \$175

Ultra Clean Sound - -100dB Signal/Noise (Ref. to 50mV out)  
Cartridge Compatibility - Switchable Gain/Impedance  
High Freq. Roll-off Points - Switchable 48kHz/1MHz

Before you make a final decision, take the opportunity to listen to the POCO, you will be amazed how much better your system will reproduce the realism of being there. Available at your nearest AUDIRE dealer.

Get more information by writing to

AUDIRE, INC.  
9578 El Tambor Avenue, Fountain Valley, CA 92708. (714) 988-1238

## FOR SALE

### APT/HOLMAN Power Amp HERE!

Tom Holman's incredible APT ONE Power Amp is waiting for you. The APT ONE eliminates current limiting that can rob you of sound. The APT ONE gives you a full 3 db of headroom to deliver all the dynamics of your music. Rated at a min. of 100 watts RMS/Channel. Write for Details and Lit. APT MODEL ONE AMP only \$641. Shipped prepaid and insured in Cont. USA from Designatron's Stereo Store, Inc. 260 Old Country Road, Hicksville, N.Y. 11801 (516) 822-5277

### APT/HOLMAN Preamp in Stock

Tom Holman rocked the audio industry with this revolutionary preamp. While other manufacturers charge over \$2000.00 for this quality and performance, you can own an APT for under \$500! Incredible Sound PLUS you control capacitance and resistance for your cartridges. Full complement of controls and there's no program leak-thru to tape circuits. The APT Preamp from DESIGNATRON'S STEREO STORE, Inc. 260 Old Country Road, Hicksville, N.Y. 11801 (516) 822-5277. Write for info and a quote. Shipped prepaid and insured in Cont. USA.

## FOR SALE

### CUT HIGH SPEAKER COSTS.



Speaker Factory has ten sound ways to save you money on speakers. Ours sound just as good, but save you up to 50% compared to other brands. Why? Because you get them direct from the Factory! Cut out the coupon and we'll rush you our new color catalog absolutely free!

**Free Catalog**

I can hardly wait! I'm enclosing 50¢ for 1st class postage and special handling.  
 I'm anxious to find out more, but regular mail is O.K.

Name \_\_\_\_\_  
Address \_\_\_\_\_  
City/State/Zip \_\_\_\_\_

Mail to: **SPEAKER FACTORY** Dept. ADC 9  
1101 N. Northlake Way, Seattle, WA 98103

## 914-472-4558

- HILL PLASMATRONICS
- KEF 105 II
- B & W 801
- SNELL ACOUSTICS (IMPROVED)
- QUAD ESL
- PERSPECTIVE SPEAKERS
- THRESHOLD
- BRYSTON
- PRECISION FIDELITY
- BERNING
- SPATIAL
- GOLDMUND RADIAL TONE ARM
- LUSTRE
- KOETSU
- DYNAVECTOR
- JVC MC-1, QL-10
- MARCOF
- MUSICAL FIDELITY
- R. H. LAB
- NAKAMICHI
- YAMAHA
- TANDBERG
- JANIS
- GRADO
- SEQUERRA
- POLK AUDIO
- GRACE
- S.M.E.
- DAHLQUIST
- PYRAMID
- DRACO CPU FM TUNER
- HAFLER
- JR
- LINN SONDEK
- SUPEX
- VPI
- FULTON

# the listening room

590 Central Park Ave., Scarsdale

Mon, Thurs 10 AM-9PM • Tues, Wed, Fri 10 AM-7 PM • Sat 10 AM-6 PM

Ample Free Parking • Credit Cards Accepted

We Ship FREE Anywhere in the Continental U.S.A.

## Our Goal: Recreation of a Musical Event

Mark Levinson/Sales & Service in the West

On Display: Mark Levinson Audio Systems — HQD Reference System, Linn Products, Rega Planar, Oracle, Fidelity Research, Koetsu, Goldmund Tone Arm, Bryston, Pyramid Metronome-3 and T-1, QLN, Rogers LS3/5A

*Fidelis*

2984 Washington Street  
San Francisco, California 94115  
415/346-2991

christopher  
hansen  
ltd.

9014 Burton Way  
Beverly Hills, California 90211  
213/858-8112

Mastercharge, Visa, American Express accepted. We ship prepaid within the U.S.

## FOR SALE

**ABSOLUTELY THE FINEST QUALITY AUDIO COMPONENTS AVAILABLE. UNBEATABLE PRICES, WARRANTIES, AND SERVICE. INCLUDING AR BOSE ESS JBL & PRO AIWA SAE H.K. PHASE-LINEAR HATICHI AND MORE, FOR MID AND HI-END LINES WE DONT ADVERTISE. FOR PRICES CALL 301-593-8244 OR SEND \$2.00 TO: AUDIO DISCOUNTS, 1026 McCENEY AVE., SILVER SPRING, MD 20901 FOR PRODUCT LIST AND SPECIFIC PRICE QUOTES, MON. THRU SAT. 10AM TO 9PM SUN 11AM TO 8PM EST ALL ORDERS FACTORY SEALED SHIPPED WITHIN 48 HRS. C.O.D. FOR YOUR CONVENIENCE.**

**ACCURATE AFFORDABLE AUDIOPHILE EQUIPMENT** at lowest prices available ex. SME 3009III \$196.100+ brands specialists in turntables-arms-cart. Call/write for quotes: HCM Audio, P.O. Box 2029, Chico, CA 95927. (916) 343-0558 7-9 pm.

**ACCURATE, QUALITY AUDIO - REASONABLE PRICES!** Car/Home components. Send stamp, call: Denco Audio, P.O. Box 6104-U, El Monte, CA 91734. (213) 444-9978 evenings, weekends. Monthly specials.

**AGFA—THE BEST OPEN REEL TAPE! CASSETTES:** ASF (C66 & C96) and DIRECT TYPE II (C96) are the best available! Direct-to-Tape Recordings offer the finest sound available only on reels, cassettes & cartridges. Ampex video cassettes also available. WRITE for FREE brochure & current special offers. Direct-to-Tape Recording Co., 14 Station Ave., Haddon Heights, NJ 08035.

**Get with the Audio Pros!**



## AUDIO CONCEPTS

- Franchised Dealer
- Full Warranty Service
- Highest Quality Lines
- Same Day Shipment



1127 W. Huntington, Arcadia, CA 91006  
Tollfree California  
**(800) 423-4170 (213) 445-3663**

Call for best price!

## FOR SALE

**ADIRONDACK AUDIOPHILES** Northern New York State House of Hi-Fi is now open with Hegeman, Conrad Johnson, Fidelity Research, Marcof, Grafyx, Hafler, D.C. Time Windows, Ampzilla (G.A.S.) Polk Audio Monitors, KEF, Harman Kardon ST8, Sleeping Beauty, Audionics, N.A.D., Mayware formula 4 tonearm, Signet moving coils, AKG cartridges, Toshiba, Sony, and Aiwa. For info. call 518-793-6639 Mon. to Fri. 11-9 Sat. 10-6. House of Hi-Fi, 50 Miller Rd. (Rt. 9), Glen Falls, NY 12801.

**AGAIN AVAILABLE - "BASIC DISC MASTERING"** NOW IN ITS THIRD PRINTING. THIS BOOK DEALS WITH DISC RECORDING AND RECORD PRESSING. OVER 70 PICTURES AND ILLUSTRATIONS MAKE IT A MUST FOR THE RECORD CONNOISSEUR. INNER WORKINGS AND PERFORMANCE LIMITATIONS OF THE STEREO GROOVE EXPLAINED. USED BY MAJOR RECORD LABELS, RECORDING STUDIOS, PRESSING PLANTS AND TURNTABLE MANUFACTURERS. \$12.50 POSTPAID. L. BODEN, BOX 3043, GLENDALE, CA 91201.

**ALLEVIATE DIFFRACTION WITH YOUR TWEETER DAMPING RINGS.** 1/4" thick felt with adhesive backing 2" I.D. 4" O.D. for one inch or smaller domes \$4.00/pr. Check or M.O. only. Spectrum Loudspeakers, Caller #2998, Toledo, OH 43606.

**AMBER ELECTRONICS**  
Affordable State of the Art  
audition them in a friendly relaxed atmosphere at  
**SOUND STAGE AUDIO**  
184-10 Horace Harding Expwy  
Fresh Meadows, New York 11365  
(212) 762-3220 EXIT 25 on the L.I.E.

**AMBER SERIES 70 POWER AMP**  
Q/LC Audio, 1006 Berkshire Rd., Dayton, OH 45419 (513) 293-7287, (513) 298-9330 M-F 5-10 SAT 10-6.

**AMBIENCE DECODER FOR REAR CHANNELS, \$149.95.** Literature 50c. Huntington Electronics, Box 2009-A, Huntington, Conn. 06484

**AMPEX 600 1/2 Tr Deck \$250.00, AMPEX 620 Speaker Amp \$75.00, AKAI X-330 10 1/2" Reversing Deck \$375.00, KENWOOD Audio Scope KC-6060A \$150.00, DYNACO Mark III Amps \$250.00 pair, PHASE LINEAR 400 Amp \$325.00, SANSUI QS-1 \$100.00, DUBIE CD-5 unused \$50.00. ALL MINT. Pat Martines, 410 Oakwood Rd., Huntington Station, NY 11746 (516) 423-2777 or (516) 423-3614.**

**AN AUDIOPHILE TURNTABLE FOR \$299? WITH A GRACE tonearm? Impossible you say? Call or write: HCM Audio, P.O. Box 2029, Chico, CA 95927. (916) 343-0558 7-9 pm.**

**ANTI-INFLATIONARY PRICES.** Cut the high cost of speakers - save 30 to 50%. State of the Art Speaker systems featuring high efficiency, low distortion, phase coherency and quality enclosures. Seven models in five finishes. For information write: D.S.R.P., P.O. Box 75, Webster City, IA 50595.

## FOR SALE

**\*ANNOUNCING — PHOENIX AZ AUDIOPHILES\***  
**\*AUDIRE** amps, preamps, headamps (incredible)  
**\*AUDIO-PRO** subwoofers (tight, authoritative bottom)  
**\*DENON** cartridges, turntables, electronics  
**\*HAFLER** amps, preamps (best buy)  
**\*HEGEMAN HAPI II** (reference preamp)  
**\*VANDERSTEEN 2A** (purist's delight)  
**\*LS3/5A** and **JR 149** (reference mini's)  
**\*OBELISK** speakers (big, ambient 3-D sound)  
**\*PHANTOM** speakers (smoother, tight, seductive)  
 \*Supex • Grace • Mirage • Spectra • AGI • Adcom  
 The best values in Audiophile equipment are **HERE!**  
 Shipped U.S.A. **THE LISTENING POST**  
 (602) 967-1250 by appt. **TEMPE, AZ**

**ANOTHER AUDIOPHILE PUBLICATION?**  
**AUDIO UPDATE** is published ON TIME. This bi-monthly includes modifications construction projects, improvement methods, data available nowhere else. It's provocative, informative, and a MUST if you enjoy audio. Annual: \$12.00 USA/Canada, \$14.00 elsewhere. MasterCharge/Visa welcome. **AUDIO DIMENSIONS**, 8888 Clairmont Mesa Blvd., San Diego, CA 92123. (714) 278-3310. TF

**ANTI-SKATING for AR TURNTABLES!!** Proven counterweight design of nickels steel & aluminum construction. Install yourself in minutes. \$7.95 postpaid. (Dealer inquiries invited.) **AUDIO INNOVATIONAL PRODUCTS**, P.O. Box 1607, Portsmouth, N.H. 03801.

A  
**PRACTICAL REFERENCE SYSTEM**  
**FOR THE MUSIC LOVER**

- 1 pr. Beveridge System 3 loudspeakers
- 1 Beveridge RM-1 tube preamplifier
- 1 Levinson ML-3 power amplifier
- 1 FM Acoustics 212 preamplifier
- 1 Linn Sondeck LP-12 turntable & tonearm
- 1 Levinson MLC-1 moving coil cartridge

For further information & literature, please call or write.  
**SOUND COMPONENTS INC.**  
 2710 Ponce de Leon Blvd.  
 Coral Gables, FL 33134  
 (305) 446-1659

**ARC D350 \$1300.00. (305) 485-7918.**

**ARC SP-5, D-52, \$1150; HEATH AA-1640, \$450. ALL MINT. (414) 332-0542.**

**ARC SP6A \$750, D52B \$865, Cotter NFB w/PW2 \$625, MK2L \$575, Koetsu \$650, Audio Stndrds MX10A \$265, Breuer 5A \$1095, Levinson ML-1 sn # 2508 w/A cards, extra lemos \$950, Win Trntrl \$2250, Win arm/cart. \$1150, FR B-60 \$240, Pyramid T-1 tweeters w/Janis active crsvr. 6300Hz \$1175, Audionics CC2 \$350. (315) 437-3357 or 637-8119. EDT.**

**ARIZONA STEREO BUYERS**

AUDIO TECHNICA	CARVER	A.D.C.
DAHLQUIST	REVOX	STAX
NAKAMICHI	CROWN	KLIPPSCH
SENNHEISER	YAMAHA	J.B.L.
STANTON	THORENS	A.D.S.
TOSHIBA	AIWA	LUXMAN
DBX	SIGNET	B & O
MITSUBISHI	SONY	SHURE
BOSE	KENWOOD	MICRON

J.A.E. INC., 332 E. Camelback Rd., Phoenix, Arizona 85012  
 Mail-order hotline Mr. WOZ 602-265-4830.

**Now in Fort Lauderdale...**  
**State of the art components for the audio perfectionist and serious listener.**

Audio Research • Acoustat • Denon • B & W • Armstrong • Chartwell • Lux Tangent • Polk • GAS • Conrad Johnson • Audire • Ariston • Connoisseur ADC • Grace • Supex • Grado • Goldring • DB Systems • Quatre • Stax Theta • Plasmatronics • Transcriptors • Dynavector • Vandersteen  
*Complete selection of direct to disc recordings.*

**AUDIO INSIGHT**

The Promenade at Bay Colony  
 6286 N. Federal Hwy., Ft. Lauderdale, FL 33308 • 305/491-7677



## FOR SALE

**AT LAST! AN UNDERGROUND YOU DON'T HAVE TO WAIT FOR!** Stereophile is now published monthly, with the most up-to-date reports on equipment and events. \$16 from Stereophile, P.O. Box 1948A, Santa Fe, NM 87501, or write for free prospectus.

### ATTENTION DCM TIME WINDOW OWNERS

We now offer a convenient and attractive way to improve the sound of your speakers. The DCM Time Window, when raised 9 inches off the ground, has an airier and tighter sound: the image is raised and standing waves reduced.

THE DCM TIME WINDOW PEDESTALS are made of heavy duty wrought iron and suit the shape and appearance of the Time Window perfectly. They sell for \$65, per pair. If there is no dealer nearby, order postpaid (Master Charge & Visa accepted) from

**R. S. PARK AUDIO ASSOCIATES**  
5 SUNRISE PLAZA, VALLEY STREAM, NY 11581  
**(516) 561-7555**  
DEALER INQUIRIES INVITED

### ATTENTION DYNA ST-120 OWNERS.

Frank Van Alstine announces an incredible POWER MOS FET modification for any Dyna ST-120, working or not. All new complementary power Mos Fet output amplifiers, all new power Mos Fet regulated power supply. Unbreakable, absolutely stable into capacitive loads, no output inductors or R-C network. More musical than any amp you have ever heard at any price. Cost to rebuild any Dyna ST-120, working or not is \$185.00. Unit must have good transformer and be complete. You won't believe it until you hear it.

JENSENS STEREO SHOP 2202 River Hills Dr Burnsville, Minn. 55337 612-890-3517

### ATTENTION: "FOREIGN" AUDIOPHILES AND DEALERS!

Western World Audio Exporters can supply virtually ALL brands of hi-fi components, speakers, cartridges, etc. (incl. esoteric lines) at VERY attractive prices. Quotes, terms and availability furnished on request. Write To: WESTERN WORLD AUDIO EXPORTERS, 373 Fifth Avenue, Suite 1556; New York, NY 10016. TELEX—230176 SAKI UR.

### ATTENTION SOUTHERN AUDIOPHILES

Yamaha	Great American Sound
Dahlgquist	Ortofon
Polk Audio	Denon
Bang & Olufsen	Klipsch
Advent	Technics
M & K	Visonik
Aiwa	Sonus
Philips	Maxell

Available at Sound Advice

Village Plaza Ruston LA. 71270 (318) 255-8000. 9-9

## FOR SALE

### AUDIO DEN AND POLK AUDIO

The Audio Den is proud to have on display and demonstration the amazing Polk Audio Monitor Series. Our customers say "Fantastic! Compares with the finest loudspeakers I have heard. Probably the best value in the history of Audio!!!" Audiogram<sup>®</sup>, from the Audio Advisor said, "We were so impressed that we could not believe the prices. . . Other \$200 speakers simply do not come close to the standards set by the Model 10. . . And at their price, they are simply a steal." Come in for an audition or write us for information on Polk or our other state-of-the-art products. Polk is shipped free in the continental U.S. Audio Den Ltd. 1320-34 Stony Brook Rd., Stony Brook L.I., N.Y. 11790, 516-751-3350. TF

### AUDIO FOUR PAGE REPORT on

### Stan White, Rohrenverstärker

Hi Fi Exklusiv (Germany 5/79) reports on Stan White, Inventor of the GLASSCONETM speaker: "Stanley White der Konstrukteur des vorliegenden Veteranen, zählt neben Paul Klipsch, Saul Marantz und Avery Fisher zu den Wegbereitern der High Fidelity. Er baute neben einer Reihe von Vorund Endverstärkern den erten Motional Feedback Hochtoner und einige zu ihrer Zeit unter Audiophilen hochgeschätzte Lautsprecher wie den Mach I und den 4000 Mark teuren 4-D." Write TACHYON, P.O. Box 204, Bloomington, IL 61018. 10-0

### ACTIVE ELECTRONIC CROSSOVERS

Plug-in Butterworth (maximally flat) filters in 6 db., 12 db., or 18 db., per octave attenuation, any frequency specified. Filters flat beyond 100 KHz.

Complete crossover in attractive metal cabinet with all terminations and regulated power supply.

### STEREO BI-AMP \$139

Tri-amp, quad-amp, and monaural types available at comparable prices. Other available features: Summer for "single woofer" systems, Subsonic noise elimination filters supplied with or without bass boost, level controls.

### FOR OEM'S AND HOME ASSEMBLERS

500 Series dual filters and/or plug-in filters, regulated power supplies.

FREE CATALOG & PRICE SHEET  
Write to:

*DeCoursey* ENGINEERING LABORATORY

11828 Jefferson Bl. • Culver City, CA 90230  
Phone: (213) 397-9668

## FOR SALE

### H & H INTERNATIONAL

*is proud to present its family of new products*

### AUDIO-STATIC LOUDSPEAKERS

This Dutch-made electrostatic loudspeaker was extremely well received at the summer C.E.S. Efficient, hearty, not amplifier-sensitive, with surprising bass performance and dynamic range, this is a most unusual electrostatic. Available in 2 or 4 panel configuration, ivory or black. \$1995 to \$3495.

### DUNLOP SYSTEMDEK TURNTABLES

Top-rated Scottish turntable from noted designer with oil-pumped bearing, unique suspension, and 10½ lb. platter. Sonically (and aesthetically) outstanding. \$795.

### SYRINX TONEARMS

England's top-rated and best sounding tonearm using SME mounting hole. What else is there to say? \$550.

### SKS "INTAGLIO" LOUDSPEAKERS

Selected by Koetsu as their demonstration speaker at Cunard-London '80, this surprising British loudspeaker combines the clean and accurate British sound with heretofore unheard-of dynamic range & 120 db SPL capability! \$995 pr.

### HADCOCK TONEARMS

An updated, well-damped version of a moderately priced British favorite. New features, top-sounding, and compatible with the broadest range of cartridges. \$250.

### AVF STANDS

Probably the handsomest, best constructed and finished speaker stands we've seen. More expensive and worth it. From England. \$75/pr. and up.

### H & H INTERNATIONAL

3047 West Henrietta Road  
Rochester, NY 14623  
(716) 424-4827

## AUDIO HORIZONS

P.O. BOX 10973  
St. Louis, Missouri 63135

Issue #4 is now available. It contains reviews of CRAMOLIN contact cleaner, the DYNAVECTOR DV-100R and DV-100D moving-coil cartridges, the LINN Ittok LVII pickup arm, the MARCOF "Glass Mat" platter plate, the HAFER DH-200, MICHAELSON & AUSTIN TVA-1 SUMO "Power", and SUMO "Gold" power amplifiers, the MICRO SEIKI BL-91 and ORACLE turntables, the MUSICAL FIDELITY bb-1 and POWERLIGHT MC-4 pre-amplifiers, the SACS SS-300 platter plate, and the SPECTRA Disc Cushion. Issue #4 also features a survey of interconnecting cables with reviews of cables from AGI, AUDIO-CRAFT, AUDIONICS, AUDIO NOTE, AUDIO TECHNICA, BELDEN, DISC-WASHER, FULTON, MELCO, MITCH COTTER, NEUMANN, PETERSON, SAEC, SOUND CONNECTIONS, SOLAR TRADING, SUPEX, and ZEPHYR.

Subscription rates to AUDIO HORIZONS™ for four (4) issues are: U.S. - \$16 (\$20 by FIRST CLASS MAIL); Canada and Mexico - \$18 (\$22 by FIRST CLASS MAIL); and outside North America - \$24 (AIR MAIL). PLEASE REMIT IN U.S. FUNDS ONLY. Sample copies of all issues of AUDIO HORIZONS are available for \$5.50 each (U.S., Canada, and Mexico), and \$7.00 each (outside North America).

## FOR SALE

### AUDIO EXCELLENCE IN N.E. PENNA!

Stock: Hafler, Rogers, SME, JR, Sonus, The Dalco/Dynaco A30XL, Technics, NAD, Alpine Car Audio, Gold Line Analyzers and more. JANNEN SYSTEMS, Hazleton, PA. Free shipping. Call (717) 459-5722.

### Audio House — Flint Mich

Mordant Short Conrad-Johnson Linn Sondek  
Rogers LS3/5A Audionics Marcof  
Linn Isobariks Symmetry Bryston  
Theta DB Systems Leach LSR+0  
M & K Volkswuffers Adcom Audio Linear  
TMA Record Cleaning Machine \$695. Record Sleeves 100 for \$25 ppd. 4304 Brayan Drive, Swartz Creek, Mich. 48473 (313) 655-8639 by appointment.

AUDIO RESEARCH D-110 mint \$1700 (603) 224-6721.

FRANKLIN LAKES

## STEREO CENTER

when you care to listen to the very finest ... and appreciate the finer things — the sensible way to enjoy the sound of music is in our most unusual audio salon.

DECCA LONDON

- SOUND CONCEPTS
- GRANT LUMLEY
- TRANSCRIPTORS
- BURHOE ACOUSTICS
- ROGERS/CHARTWELL
- IRVING M. FRIED
- DAVID HAFLER
- D. B. SYSTEMS
- M. A. COTTER
- DUNLAP CLARKE
- CROWN
- MICRO-SEIKI
- SATIN
- BEYER
- GRADO SIGNATURE
- ARISTON
- MERRILL SYSTEMS
- MTI/USH and more!

AURAL

NAD

STAX

AVID

M & K

POLK • KEF

SUPEX • CROWN

DENON • EUMIG • LUX

GRACE • AMA • SATIN

HITACHI • THORENS

MAYWARE FORMULA FOUR

FLS

FRANKLIN LAKES STEREO CENTER

792 FRANKLIN AVENUE, FRANKLIN LAKES, NEW JERSEY (201) 891-4745  
We ship prepaid throughout Cont. U.S.A. Financing Arranged

## FOR SALE

### AUDIO DEN LTD.

Long Island's leading audio store has on demonstration THE STATE OF THE ART AUDIO RESEARCH ELECTRONICS THE NEW SP6 TUBE PREAMP THE NEW D79 TUBE AMPLIFIER THE NEW SCHEIBER 4 CHANNEL DECODER THE NEW ACOUSTAT MONITOR III'S THE NAKAMICHI 680 CONRAD-JOHNSON ELECTRONICS GRADO SIGNATURE CARTRIDGE FULTON CARTRIDGE AND TRANSFORMER LINN-SONDEK

(AUDIO CRAFT) ULTRA CRAFT UNI-PIVOT TONEARM

We also have the following lines, Connoisseur, Denon, Grace, Luxman, Magneplanar, Magnepan, Polk, Quad, Rogers, Sherwood, Sonus, Thorens, Yamaha, the largest selection of Audiophile Recordings or Long Island.

FREE "SET UP" IN NY AREA

UTILIZING IVIE SPECTRUM ANALYZER

COME IN WITH 2 RECORDS AND WE WILL DEMONSTRATE THE WORLDS FINEST RECORD CLEANING MACHINE BY KEITH MONKS.

### AUDIO DEN LTD.

1320-34 Stony Brook Road  
Stony Brook, New York 11790  
516-751-3350

10-0

### Audio Ltd.

in Central Illinois

Audio Research KEF Snell Acoustics  
David Hafler IMF Marcof  
DB Systems STD Carver  
Symmetry SME Grace  
Supex Win Labs Quad  
and more. 115 N. Walnut, Champaign 61820 (217) 359-3774

## AUDIONICS BA-150

This analog-digital hybrid (Class A solid state input tube output) amplifier offers the musical performance of the best tube and solid state designs. The BA-150 represents a new state of the art. It is superb on both dynamic and electrostatic speakers. We offer the BA-150 at \$3250. Free air freight. Worldwide shipping. OXFORD AUDIO CONSULTANTS, Box 145, Oxford OH 45056 (513) 523-333, 523-3895.

## FOR SALE

### AUDIONICS — NEW PRODUCTS & LOWER PRICES

We offer the complete Audionics line: BT2 preamp, RS1 preamp, CC2 amp, Space & Image Composer, BA150 amp, RVP/RVR Replacement Revox A77 Electronics & LKI Turntable. Free shipping in the U.S. We ship worldwide. Visa & M.C. OXFORD AUDIO CONSULTANTS, Box 145, Oxford, OH 45056. (513) 523-3333 & 523-3895.

### AUDIONIC=VALUE

Audionics continues to stand the test of time as a cost effective product. If you are new to high end audio or an old audiophile, consider a product that you will want to keep. Audionics BA-150, CC-2 amps, RS-1 and BT-2 preamps and the composer. FREE shipping and advise from Audio House, 4304 Brayan Drive, Swartz Creek, MI 48473 (313) 655-8639 by appointment.

**Audio Research and Fulton Premiere Loudspeakers in S. Florida.** We offer these other quality products for people interested in music. Kenneth Wagner Audio Systems, 841 S. Dixie Hwy., West Palm Beach, FL 33401 (305) 833-0448. Free shipping in USA - MC/Visa.

### AUDIO RESEARCH DEMONSTRATOR CLEARANCE SALE

D52B (2) ..... \$725.00 ea.  
D100B (2) ..... \$837.00 ea.  
D110B (1) ..... \$1650.00  
D350B (1) ..... \$2100.00  
Prices are firm and sales are final. Purchaser liable for shipping charges.

### SOUND COMPONENTS INC.

2710 Ponce De Leon  
Coral Gables, FL 33134  
(305) 446-1659

AUDIO RESEARCH D-100B, \$1700.00; (216) 524-1185.

AUDIO RESEARCH SP3A-In mint cond. \$500 firm; also EC-2 x-over \$125 Lux T110 tuner \$295 Magneplanar Tympani I-B \$700. (212) 923-7154.

## AUDIO SALON

We care about quality components, accurate music and satisfied clients. We are a very small company and will serve your needs on an individual basis. Call or write for our assistance. See our Ads through the classified section. 608 Pecan Ave., Charlotte, NC 28204 (704) 377-6590. A comfortable showroom is open by appointment.

**AUDIO, VIDEO, ELECTRONIC Products.** BEST Pricing! Prompt Delivery! SONY, DBX, TEAC, TASCAM, ONKYO, SOUND WORKSHOP, MAXELL, MOBILE FIDELITY RECORDS, Others. SOUND IDEAS, Dept. AD, P.O. Box 340 Cary, NC 27511. 1-800-334-2483 (NC 919-467-8462).

**BEDIN-OTA.** Demonstrations by appointment. Baird Audio Systems, Box 80559, Baton Rouge, LA 70898. (504) 769-3204.

### BEGINNER'S DRUM LESSONS\* FOR YOUR CHILD

Parents, how many lessons would your child need to learn the basics of drumming? HOW SOON AFTER THE LESSON WOULD HE FORGET WHAT HE LEARNED? I will instruct your child thru ½ hr. of drum lessons, covering 10 basic rudiments on quality cassette tape. A tape he can play over again, WHENEVER he wants his lessons. Use any inexpensive cassette player. You save \$\$ on expensive lessons, your child has hours of enjoyment, and LEARNS the basics of drumming! Only \$19.95! Send check or M.O. to: Allen-Edwards Enterprises, P.O. Box 656, Dunkirk, NY 14048.

\*Saxophone lessons available.

### BIC, BSR, DUAL, GARRARD: PARTS AVAILABLE

Call or write: Audio Technology, 23800 Hesperian Blvd., Hayward, CA 94541. (415) 782-1303. Between 10 am - 2 pm.

**Big, Safe, Twisted #12 Gauge Gonza Speaker Wire \$40 per 100 ft., Keith Monks Record Sleeves 100 for \$25. FREE shipping, COD O.K. Sample \$1.00. Audio House, 4304 Brayan Drive, Swartz Creek, Mich. 48473 (313) 655-8639.**

## AT SOUND COMPONENTS, INC. WE'VE GOT IT ALL...

ADCOM... APT. CORPORATION... AUDIONICS... AUDIO PRO...  
AURAL ACOUSTICS... BANG & OLUFSEN... BEDINI... BRAUN...  
BRYSTON... DCM... DENON... EMT... FIDELITY RESEARCH... GRACE...  
GRADO SIGNATURE... GOLDMUND... HAFLER... HAROLD  
BEVERIDGE INC... HARTLEY... H. Q. D. REFERENCE SYSTEM...  
JANIS... JVC... KEF... LINN PRODUCTS... MAGNEPAN... MARK  
LEVINSON... MICHAELSON & AUSTIN... PYRAMID METRONOME...  
QUAD OF ENGLAND... REGA RESEARCH... ROGERS... SEQUERRA...  
SCHEIBER... SOUND CONNECTIONS... STAX... SYMMETRY... TANDBERG...  
TRILOGY... YAMAHA... Also a large selection of specialty records.

And the highest quality music recording services available. We ship prepaid in the U.S. Spanish spoken and complete export facilities.

Serving the Audio Community for five years.

# Sound Components, Inc.

2710 PONCE DE LEON BLVD, CORAL GABLES, FL 33134

Visa, Master Charge, American Express & Diner's Club accepted (305) 446-1659.

## FOR SALE

**B & O USES "ANY" CARTRIDGE** with standard mounting centers after our modification kit or at factory. Effective mass 2.5 grams. Adjustable silicone damping. \$199.00 with money back guarantee. JML Company, 39,000 Highway 128, Cloverdale, CA 95425. TF

**B & O 2400, \$200; GAS THALIA, \$225.** (812) 234-7361.

### CAMPUS REPS FOR ESOTERIC EQUIPMENT

We need campus reps immediately to sell esoteric as well as a vast selection of major brands. We have an unusually high selection of high end equipment, excellent prices, and unique advertising program.

AUDIO SYSTEMS II  
200 WEST 57th STREET, Suite 1004  
New York, N.Y. 10019

9-0

**CAR STEREO INTOLERABLE? SOLUTION — USE YOUR HOME GEAR IN CAR.** CALL MARK (312) 798-0743.

## CHARLOTTE, NC

HAFLER PS AUDIO  
FULTON SME  
THORENS (704) 377-6590 SYSTEMDEK  
MORDAUNT-SHORT SUPEX  
DECCA GRACE

FRIED SPEAKER KITS  
AUDIO SALON, 608 PECAN AVE., 28204  
SHIPPED PRE-PAID

**CHARTWELL: SEE ROGERS & CHARTWELL**

### COMMONWEALTH LOUDSPEAKERS

Fine quality loudspeakers also drive units, walnut veneer cabinets, air core inductors, mylar capacitors, crossover networks. Choose from famous manufacturers like: Decca, Coles, Dalesford, Richard Allan, Jordan, Schackman, Radford, and more. Send \$3.00 for design, reprints, plans and catalog (refundable with first purchase.): COMMONWEALTH ELECTRONICS, 300 N. Allen, Pasadena, CA 91106, (213) 793-5184. 11-0

### COMPONENTS FOR THE AUDIOPHILE

Q/LC Audio has Precision Fidelity, Amber, Marcof, Hafler, Vandersteen, DCM, Axiom, Lustre, Thorens, Nakamichi, Audire, Grace, Supex, Bass Mint, Adcom, Hitachi, and more. Write or call: Q/LC Audio, 1006 Berkshire Road, Dayton, OH 45419 (513) 293-7287, (513) 298-9330; M-F 5-10 SAT 10-6. World wide shipping.

**CONNECTICUT:** A.D.S., Advent, A.P.T. Holman Audio Pulse, B&O, B.I.C., Carver, Citation, Dahlquist, D.C.M. Time Windows Polk, Hafler, Harman/Kardon, J.B.L., Mitsubishi, Nakamichi, Ortofon, Phase Linear, Micro-Acoustics, N.A.D., Stax, Tandberg, Yamaha, Cizek, Signet. Will ship prepaid. Sounds Incredible, 39 Federal Road, Brookfield, CT., 06804. (203) 775-1122—phone quotes only. TF

**CONNOISSEUR BD1 TURNTABLE** Belt Drive, 37 logged hours. w/mtg hole for Grace 707. \$75 408-279-1425, 259-9648.

**COTTER MKII "L", LUSTRE GST 801, SUPER SDX 1000** LISTENING ROOM, INC. 2764 Hanover Circle, Birmingham, AL 35205 (205) 939-0702.

**CROWN SX-824 \$1400 MINT** (901) 386-7092.

### CUSTOM WOOD STEREO CABINETS

Beautiful solid wood custom component cabinets. Stock units and designed to specification. SWCC, 608 Pecan Ave., Charlotte, NC 28204 (704) 377-6590 Cabinet work completed by North Carolina Mountain Craftsman.

**Dayton Wright XG-10 Electrostatic Speakers** \$2000; Breuer Dynamic tonearm 5A (short) with both counter weights \$850; Breuer Dynamic tonearm type 6A (long) \$1100; M&K modified Rabco tonearm with all counter weights \$450. (916) 481-0392.

**DAYTON-WRIGHT XG-10 ROSEWOOD WITH 100 HOURS USE**, \$1950 PAIR. DAVE JENSEN, 3875 Claythorne Place, Brunswick, OH 44212, (216) 225-8413.

## FOR SALE

### CSA AUDIO DESIGN

Since 1972 bringing the "Audio Alternative" to the NY-NJ area. Audio enthusiasts everywhere know about our superior service and customer satisfaction. Discover our new expanded UPPER MONTCLAIR headquarters. Specializing in the finest array of stereo names available.

**BEBERIDGE • B & W • BEDINI • AMBER • DCM • HAFLER • HAPI • EUMIG • FIDELITY RESEARCH • GRACE • JR • KEF • LINN SONDEK • LUSTRE • NAD • PRECISION FIDELITY • KENWOOD "AUDIO PURIST" • QMI • REGA • SNELL • PLEXUS**

Plus 50 more great names.

We ship anywhere in the USA freight prepaid. Call us at: (201) 744-0600. Discover courtesy in Audio.

### CSA AUDIO DESIGN

193 BELLEVUE AVENUE  
UPPER MONTCLAIR, NJ 07043

Sound System Design Consultants to HOME MUSIC LOVERS; PROFESSIONAL THEATRICAL ARTS; and the AUDIO INDUSTRY.

Don't miss us at the NY HIGH FIDELITY MUSIC SHOW!

**DBX-3BX \$400, MINT (315) 479-7973.**

**DEMOM DP-1200 DIRECT DRIVE TURNTABLE.** COMPLETE WITH DUSTCOVER AND ARM. FACTORY SEALED, NEVER OPENED. \$249.00 YOU PAY SHIPPING. CALL JEFF (215) 839-0600.

**DIAMOND NEEDLES** and Stereo Cartridges at Discount prices for Shure, Pickering, Stanton, Empire, Grado, Audio Technica and ADC. Send for free catalog. LYLE CARTRIDGES, Dept. A, Box 69, Kensington Station, Brooklyn New York 11218. For fast service call toll free 800-221-0906. TF

## FOR SALE

### DISCO: MOBILE OR FIXED=CASH START

your own disco business. Complete start-up manual explaining sound and lighting systems installation, written by professional disco DJs and designers, \$5. J.C. Enterprises, Dept. A1, P.O. Box 234, Apalachin, NY 13732.

**DYNACO AF-6, FM-5, FM-3, FM-1 FANS:** PLL Stereo demodulator is assembled and tested. Features the KB4437 (T.H.D.: 0.04%, Separation: 45DB) with 19KHz pilot canceller. Free info: VSM Audio, P.O. Box 114, Maspeth, NY 11378.

**DYNA ST-150, with meters, \$250.00.** (212) 454-3205.

**DYNAVECTOR RUBY UNUSED \$185, FR 1, MK 3F New,** \$140. Stephen Sun eves (212) 446-3760.



### HIGH PERFORMANCE SPEAKER CABLE

**\$15.95** buys a pair of 20-foot rolls of 12-gauge, twin-conductor, color-coded speaker cables. You could be losing up to half your system's performance in puny speaker wire! Ultra-low-resistance cable allows maximum damping factor in your system to get the full transient response and dynamic range your speakers are capable of. Supplies limited. Add \$2.50 per set for postage and handling.



Dept. A09, 735 N. Northlake Way  
Seattle, Washington 98103



THE MUCH  
AWAITED

HIGHLY  
TOUTED

WORLD  
CLASS  
TURNTABLE

# AUDIONICS LK-1

IS HERE AT

## AMERICAN AUDIOPHILE

5 Sunrise Plaza  
Valley Stream, N.Y. 11581  
(516) 561-7114

716 Madison Ave.  
New York, N.Y. 10021  
(212) 751-9733



**ALL SHIPMENTS PREPAID AND INSURED  
FREE THROUGHOUT CONTINENTAL U.S.**

MASTER CHARGE & VISA ACCEPTED



## FOR SALE

### LINN DISC SYSTEM, ISOBARIKS & NAIM

We know that some components reproduce sound much more faithfully than others. For those who can hear the difference we offer the Linn Disc System: Linn Sondek LP.12, LV-II arm & Asak Cartridge; the Linn Isobariks: PMS, DMS & S.A.R.A. (uni- or bi-amped); and Naim electronics: head amp, preamps & amps. Free shipping in U.S. OXFORD AUDIO CONSULTANTS, Box 145, Oxford, OH 45056, (513) 523-3333, 523-3895.

### LOW NOISE AUDIO TUBES

TYPE	BRAND	PRICE
KT88	Genelex	\$30.00 Ea.
KT88Mp	Genelex	\$65.00 Pair
12AX7	K Type (Low Noise)	\$ 2.65 Ea.
12AT7	K Type	\$ 3.90 Ea.
12AU7	K Type	\$ 3.90 Ea.
6L6GC	K Type	\$ 3.90 Ea.
6550A	GC	\$ 7.00 Ea.
6550Mp	GC	\$15.50 Pair
7027/12AX7A	GC	\$ 6.75 Ea.
6CA7	Amperex	\$ 4.75 Ea.
6CA7/EL34Mp	Amperex	\$ 9.95 Pair

\*\*PLUS MANY OTHER TYPES AVAILABLE\*\*  
 TEMTRON ELECTRONICS LTD., 15 Main Street,  
 East Rockaway, NY 11518  
 CALL TOLL FREE 800/645-2300  
 IN NEW YORK 516/599-6400  
 \$25.00 Minimum; C.O.D. or NET 30 with references  
 FOR C.O.D. add \$1.50 for shipping and handling

## FOR SALE

### LURNE

Coming from France, designed and improved by Pierre LURNE during 10 years before becoming available, the LURNE tonearm is a unique unipivot design, dynamically optimized, with adjustable inertia, on axis damping and M. Levinson silver wire. Demonstrations made everywhere against all best pivoting tonearms provided superiority in dynamic range, focusing and neutrality. The LURNE tonearm, hand-made by Pierre LURNE himself, is now available in small quantity for \$850. Write to:  
 MBR ELECTRONICS US CORP.  
 One World Trade Center, Suite 1913, NY 10048

### L.A. — SOUTHERN CALIFORNIA

We carry the smallest selection of only the best values and the best equipment. We demonstrate by appointment to insure a meaningful demonstration. Linn Sondek turntable, Linn Asak cartridge, Spatial Coherence TFEF Valve preamp, Rogers BBC LS3/5A speaker, PSE Studio One preamp & Studio Two power amp, Stax headphones, Musical Fidelity preamp, Denon tables, arms, cartridges, Meridian amp, preamp, tuner, Decca Ribbon Tweeters, Koss Electrostatic speakers, Satterberg Subwoofers, SAEC metal record pad & cables, Chartwell polypropylene speakers, LiveWire & Live Wire Litz, Peterson Audio Link cables, Hafler amp & Preamp, Osawa record pad.

### EXECUTIVE AUDIO

BY APPOINTMENT ONLY (213) 395-6400  
 2210 Wilshire Blvd. suite #207 Santa Monica, CA 90403

MAIL ORDER DIRECT FROM AKIHABARA TOKYO: All Japanese brands: Tonearms, Cartridges, Transformers, etc. Latest Quotations sent for free. Please write & ask! Hi-Fi Express, P.O. Box 28 Shitaya, Tokyo, 110-91, Japan.

MCINTOSH EQUIP. BOUGHT-SOLD-TRADED eves. wkends: (607) 865-5387; SDR, Box 387, Walton, NY 13856.

\*\*\*MILWAUKEE! THE AUDIO EMPORIUM: Acoustat, Amber, Audio Perfection Cables, Audio Pulse, Audire, B&O, Beyer, Connoisseur, Conrad-Johnson, Dahlquist, Denon, Dynavector, Genesis, Grace, Grado, Hafler, Linn, Lux, Magnepan, Marcof, Mayware, Musical Fidelity, NAD, Peterson Links, Polk Audio, RH Labs, Revox, Rogers, Snell, Sonus, Stax, Sumo, Technics, Threshold, wide assortment of accessories and direct discs. Open Tues, Wed, Fri, Sat 10-6, Thurs 10-8. Closed Sun & Mon. 6900 W. Brown Deer Rd., 354-5082.

## FOR SALE

### MICHIGAN AUDIOPHILES

Apt Holman	Hafler	Revox
Bryston	Hitachi	Sumo
Cabasse	Linn Sondek	Sherwood
Denon	M & K	Sonus
Dahlquist	NAD	Snell
DB Systems	Nakamichi	Spendor
Grace	Onkyo	Soundcraftsmen
Grado Signature	Polk	Stax
GAS	Pyramid	Threshold
Grafyx	Rega	Visonik

### ABSOLUTE SOUND

"Michigan's High Accuracy Audio Dealer"

Detroit, 12400 Morang Ave. (313) 527-2244  
 Royal Oak, 4354 N. Woodward (313) 549-7550  
 Ann Arbor, 312 S. Stae St. (313) 662-2026  
 Shipping Prepaid

### MONTANA AUDIOPHILES

#### ROCKY MOUNTAIN HI-FI

##### Brings you the Best

NAKAMICHI	HAFLER	MAGNEPAN
DAHLQUIST	ALPINE	HARMON/KARDON
HEGEMAN	G.A.S.	TIME WINDOWS
ACOUSTAT	DENON	MICRO SEIKI
B & W	POLK	AUDIONICS
FULTON	ADCOM	APT HOLMAN

812 Central Ave., Great Falls, MT (406) 761-8683

### NORTHERN CALIFORNIANS

It is our goal to make the joy of music possible for everyone. At any price we offer solid value, superior performance, and traditional service.

We operate on the theory that you as our customer will achieve the greatest long term satisfaction only through a careful analysis of your audio requirements. We strive to offer sober, highly cost effective solutions to meet your specific needs. Please stop in for a refreshing experience with music.

#### OUR SELECTION INCLUDES:

Magnepan	Audiocis	Dahlquist
Tandberg	Threshold	Chartwell
Onkyo	Audire	B&W
JVC	Hafler	Cizek
AKG	P.S.E.	AVID
Denon	Lux	Stanton
Micro	Grado Sig.	AIWA
Connoisseur	Sonus	M&K
Soundcraftsmen	Grace	Rogers

HIGH FIDELITY SHOPPE  
 1511 North Main Street  
 Walnut Creek, Calif. 94596  
 (415) 932-2242

"WE BUILD BETTER SYSTEMS FOR YOU"

# EARS NOVA

With our care and attention,  
 and with components representing  
 the finest available,  
 we at **EARS NOVA** will help  
 satisfy your emotional  
 and intellectual need for music.

Joshua David Cohn ■ Brian Michael Ahearn ■ Alice Berman

# EARS NOVA

749 middle neck road • great neck, ny 11024 • (516)466-5674

Sunday thru Wednesday by appointment  
 Thursday & Friday noon to 8pm ■ Saturday 10am to 5pm

Adcom  
 Allison  
 Audio Pro Sub Woofer  
 Bryston  
 Connoisseur  
 Conrad Johnson  
 Dennesen  
 Grace  
 Hegeman  
 KEF  
 Kenwood Purist  
 Linn Isobarik  
 Linn Disc Playback  
 Marcof  
 Mission  
 Mitchell A. Cotter  
 NAD  
 Naim  
 PSE  
 Pyramid Metronome  
 Rega  
 Rogers  
 Shahinian Obelisk  
 Signet  
 Snell Type A  
 Supex  
 Symdex  
 Thiel  
 3D Acoustics  
 VPI

**LOUD AND CLEAR.**  
 Read all about the K—the amazing speaker that has the power to reproduce even the lowest bass notes—loud and clear. Features the brilliant cornerhorn design with Speakerlab innovations like Magnar™ damped horn drivers. One of the only kits available for this unique loudspeaker. Read about K's and all the other great Speakerlab speakers and parts in our free catalog.

**Speakerlab®**  
 To get yours, write  
 SPEAKERLAB, Dept. A109/2  
 735 N. Northlake Way  
 Seattle, WA 98103

September, 1980 This card expires December 31, 1980

# READER INQUIRY CARD

ENTER NUMBERS IN BOXES BELOW

- A to help me make an immediate decision to purchase.
- B to explore a new method or to keep my files on the subject to date.

Name \_\_\_\_\_

Address \_\_\_\_\_

City \_\_\_\_\_

State \_\_\_\_\_ Zip \_\_\_\_\_

### READER INTEREST INFORMATION

- 1  High Fidelity Enthusiast
- 2  Home Recordist
- 3  Professional Recordist
- 4  Broadcast Engineer/Mgr.
- 5  Audio Service Technician
- 6  Audio Mfg. or Dealer
- 7  Other

Are you a subscriber to AUDIO Magazine?  Yes  No

I have purchased the following equipment after seeing it advertised in AUDIO

I am planning to purchase the following equipment in the next year.

*An Invitation  
from the editors and publisher of*

# Audio

*You are cordially invited to join  
the most knowledgeable high-fidelity  
enthusiasts in the world  
as a subscriber to Audio.*

*As a new subscriber you will  
be entitled to our half price offer of  
12 issues for \$5.97*

Check one:  Payment enclosed  Bill me

Name \_\_\_\_\_

Address \_\_\_\_\_

City \_\_\_\_\_ State \_\_\_\_\_ Zip \_\_\_\_\_

Outside the U.S.: Add \$6.00 per year for additional postage.  
Payment must accompany order. Your first copy will be in the  
mail within 6 weeks.

**NEW SUBSCRIBERS ONLY**

*R. L. V. P.*

(AU)BOIN36

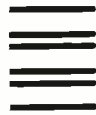

**BUSINESS REPLY CARD**

FIRST CLASS PERMIT NO. 1064 GREENWICH, CT

POSTAGE WILL BE PAID BY ADDRESSEE

**Audio**

P.O. Box 8168  
One Fawcett Place  
Greenwich, Ct. 06835



NO POSTAGE  
NECESSARY  
IF MAILED  
IN THE  
UNITED STATES

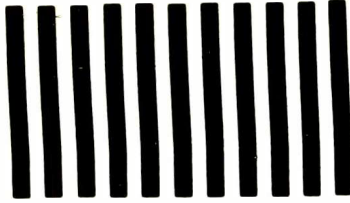

**BUSINESS REPLY CARD**

FIRST CLASS PERMIT NO. 27346 PHILADELPHIA, PA

POSTAGE WILL BE PAID BY ADDRESSEE

**Audio**

P.O. Box 13892  
Philadelphia, PA. 19101

NO POSTAGE  
NECESSARY  
IF MAILED  
IN THE  
UNITED STATES

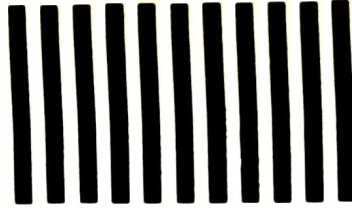



# Advertising Index

<b>Firm (Reader Service No.)</b> .....	<b>Page</b>
ADC (1) .....	4
ADS .....	35
AKG (2) .....	16
Allison Acoustics (3) .....	30
Apt Corporation (4, 5) .....	54, 55
Audio Critic .....	36
Cambridge Physics (6) .....	12
Crown (7) .....	20, 21
dbx (8) .....	36
Discwasher .....	2, Cov. IV
Electro-Voice .....	28
Empire (9) .....	13
Eumig (10) .....	33
Fuji .....	31
JVC (11) .....	3
Jensen (12) .....	23
KEF (13) .....	25
3M (14) .....	15
MXR (15) .....	58
Maxell (16) .....	19
McIntosh (17) .....	34
Nikko (18) .....	5
Osawa (19, 20) .....	42, 59
Phase Linear (21) .....	26
Pioneer (22) .....	Cov. II, 1
Radio Shack .....	45
Revox .....	29
SME (23) .....	16
Sansui (24) .....	43
Shure (29) .....	14
Signet .....	63
Snell (25) .....	18
Sony (26) .....	6, 7
Soundcraftsmen (32) .....	Cov. III
Speaker Factory .....	50
Stanton (28) .....	11
Studer Revox .....	29
TDK (30) .....	47
TEAC .....	27
Technics (31) .....	17
United Audio (Dual) .....	37

## FOR SALE

**NEW AMPEX MASTERING TAPE 406 (7") 2.25, 407 (7") 3.25 New Scotch or Ampex LN-HO 1200x7 1.50, 1800x7 2.25, 4000x10 5.00 min. 20 pp. all boxed. New type 10" metal Reels Boxed \$4 min. 10 pp. other tapes Avail. Large SASE for Details. MJS, 2514 Seaboard Ave., SJ, CA 95131 408-262-8793.**

### NORTHERN N.J.'s BRAND NEW AUDIO SALON The Sounding Board, Inc.

Linn Sondek, Chartwell LS3/5A, B&W, Spondor, Great American Sound, Supex, Stax, Adcom, Ultracraft, Mitsubishi, Decca, Tandberg, D.B. Systems, I.M.F. Electronics, Grado Sig., Obelisk, Monster Cable, Dahlquist, Audio Pro, Grace, Cizek, Avid, Marcof, Micro Acoustics, Dual, Strathclyde (S.T.D.), Audio Source.

We Ship Anywhere in the United States.

**THE SOUNDING BOARD, INC.**

(201) 445-5006

Ridgewood, N.J.

**NORTHWEST! The Tin Ear:** Audio Research, Audionics, B&W, Grado, LUX, Magnepan, Polk Audio, RH Labs, Rogers, Supex, Technics, Yamaha and Audiophile recordings. 704 Symons, Richland, WA 99352, 509-946-4459. 9-0

**OVERSTOCKED, MUST GO** Phase Linear 8000H Turntable \$479, Marantz 3600 Pre-amp \$99, 170D Power Amp \$199, Pioneer Spec 2 Power Amp \$499, MXR 15 Band Equalizer \$199, Technics 8077 Integrated Amp \$169, MUCH, MUCH MORE, WRITE OR CALL: STEREO CLEARANCE HOUSE, 1029 Jacoby St., Johnstown, PA 15902 (814) 536-1611.

**PREMIUM AUDIO GRADE POLYPROPYLENE & POLYSTYRENE CAPS** available now in values from .1  $\mu$  to 5  $\mu$  200v 10%, so you can upgrade your preamp & X'over network (Jung & Marsh, Feb. & Mar.) Build phase coherent, cylindrical wave front line source arrays, w/electrostatic like transient speed that are ready now for PCM, Digital, D to D LP's w/wide range Jordan 50mm Modules. Super subwoofers to match w/dynamic headroom for effortless, articulate deep bass & midbass. Send \$2.00 for 26p Jordan Manual. Polymer EMIT or Ribbon Tweeters for matchless highs, "air", timbre from SOTA records. Catalogue \$1.00. Transcendental Audio, 6796 Arbutus St., Arvada, CO 80004. E. J. Jordan, Decca, Polyad, S.E.N., Unbox Enclosure Systems (303) 420-7356.

**PROPER TONEARM GEOMETRY!** Optimum offset angle, overhang, vertical pivot height and angle. Resonance damping construction. Jewelled pivots. Height adjustable while playing records. Effective mass 2.5 grams. Damped cueing. Anti-skate bias. TA-3A with silicone damping, \$249.00, "Universal" nylon hardware, \$1.00; alignment protractor, \$3.00. Prices include postage and money-back guarantee. JML Company, 39,000 Highway 128, Cloverdale, CA 95425 TF

## FOR SALE

**QUICKEST AIRMAIL DIRECT FROM TOKYO:** All brands of Cartridges & Arms of Japan. Ask for latest Quotations with \$1 for postage. JAPAN AUDIO TRADING CO., LTD., Saikaen Bldg., 4-33-21, Kamimeguro, Meguro-Ku, Tokyo 153 Japan.

### RADIO/TELEVISION BROADCASTING:

Hands-on course at professional studio. Placement/Accredited/Veterans. SCHOOL OF COMMUNICATION ARTS, Division of Communication Arts, Inc., 2526A 27th Ave. South, Minneapolis, MN 55406. Free Catalogue.

**RAW SPEAKERS AND FINISHED SYSTEMS** for Hi-Fi and Sound Reinforcement. Also cabinet plans, hardware, grille cloth, crossovers, microphones, accessories, much more. Information packed catalog, \$1. Universal Discount Sound, Dept. AO, 2243 Ringling Blvd., Sarasota, FL 33577

**REINFORCEMENT, RECORDING DISCO** equipment featuring Electro-Voice, Tapco, Numark, Whirlwind, etc. Competitive prices with fast competent mail order service is our specialty. Write or call SONIX CO., Dept. A, Box 58, Indian Head, MD 20640, (301) 753-6432. 10-0

### ROGERS & CHARTWELL

are both licensed to produce the incredible BBC LS3/5a's. From these common roots, Rogers (using bextrene) and Chartwell (using polypropylene) have developed some of the finest loudspeakers in the world. Rogers: LS3/5a, Compact Monitor, Monitor 2 & Reference Monitor System. Chartwell: LS3/5a, PM110, PM210, PM410 & PM450. See OAC for Rogers electronics too — A75 amp, A100 amp & T75 tuner. Free shipping. Visa & M.C. OXFORD AUDIO CONSULTANTS, Box 145, Oxford, OH 45056, (513) 523-3333 & 523-3895.

**ELIMINATE YOUR "PATCHCORD HEADACHE" with a CPM-31 Universal Component Patching Matrix.**



For more information, write or call: **NILES AUDIO CORPORATION** Dept. A/P.O. Box 160818 Miami, FL 33116/(305) 271-9181

# Audio Excellence

A UNIQUE STEREO SHOWROOM DEDICATED TO THE PERFECTIONIST

Presenting Components from the Prestigious Companies of

<b>THRESHOLD</b>	<b>ROGERS</b>	<b>MAGNEPAN</b>	<b>KOETSU</b>
<b>AUDIONICS</b>	<b>SNELL</b>	<b>PYRAMID</b>	<b>SIGNET</b>
<b>WIN LABS</b>	<b>DENON</b>	<b>OBELISK</b>	<b>HAFLER</b>
<b>BEVERIDGE</b>	<b>AXIOM</b>	<b>SYMDEX</b>	<b>BRYSTON</b>
<b>LINN SONDEK</b>	<b>DCM</b>	<b>MARCOF</b>	<b>SPATIAL</b>
<b>M.A. COTTER</b>	<b>PSE</b>	<b>SUPEX</b>	<b>SYMMETRY</b>
<b>PLASMATRONICS</b>	<b>LUX</b>	<b>TVA</b>	<b>FID. RES.</b>

584 Washington Street, San Francisco 94111 415 433-1335

## FOR SALE

**ELECTRONIC CROSSOVERS — ALL TYPES** Updated definitive booklet describes applications, how to improve speaker systems; \$5.00 postpaid, credited to first purchase. Huntington Electronics, Box 2009-A Huntington, Conn. 06484.

### ELECTROSTATIC PERFECTION

The "RENAISSANCE SERIES" electrostatic panels and subwoofers form Sound Lab, Inc. are the finest speakers available. Immediate delivery.

Precision Fidelity — Fidelity Research — Bedini — Audionics — Harbeth HL Monitors — Symmetry — Ultra-craft — TMA Disc Cleaner — R H Labs — Koetsu.

PACIFIC IMAGE, INC. (415) 488-0293  
P.O. Box 169 By Appointment  
Woodacre, CA 94973 Prepaid Shipping

"FLAT DIAPHRAGM, COHERENT WAVEFORM SPEAKER KITS. 10" WOOFER, 5" MID AND RIBBON TWEETER FULLY WIRED ON BAFFLES. NO CONE DISTORTION OR TIME SMEARING FROM SINGLE PLANE SOURCE. EXCELLENT DEFINITION. FOR MORE INFO SEND \$1 to: STREAM AUDIO, P.O. BOX 370A JAX, ONTARIO, CANADA, L1S 3C5."

### ATTENTION AUDIOPHILES:

#### SPECIAL OFFERING OF VERION PRODUCTS

General Resistance, Inc., the ONLY manufacturer of Verion MK1 Stereo Pickup Transformers, Triaxial Audio Cables, and GS1 Ground Strips has been authorized by Stipulation to sell the remaining inventory of those products:

MK1 Stereo Pickup Transformers (specify pickup impedance): \$350 each.

Triaxial Audio Cable pairs: \$30 per one meter, plus \$5 for each 1/2 meter added to the pair. All Triaxial cables have RCA-type connectors, at one end, and either bare leads, RCA-type connectors, or male or female DIN connectors at the other. Be sure to specify length and choice of connector.

GS1 silver-plated 12" solid copper Ground Strips with hardware and grounding pig-tail: \$20 each.

All above carry 5-year manufacturer's warranty. Quantities are limited since there will be no further production.

Send official bank check or postal money order immediately to avoid disappointment. Orders shipped prepaid UPS in the USA. Others add shipping. No telephone orders accepted.

#### GENERAL RESISTANCE, INC.

130 S. Columbus Ave.  
Mt. Vernon, NY 10553

## FOR SALE

### ELECTROSTATIC CHEESE?

Of course you know Holland produces some fine cheese, but do you also know that the Netherlands are producing one of the finest and most reliable electrostatic speakers, the SO-LOSTATIC? There are two types, a 4-elements and 8-elements hybrid system with a passive or active crossover; each combination proves that affordable state-of-the-art begins here. For export: K. G. TAN Hifi Audio, P.O. Box 5001, 3741 GC Baarn, Holland, Telex 10412 telam nl.

#### Emperic Audio Components in Central New York

Win Laboratories Turntable and Arm

Koetsu MC Cartridge

Mitchell A. Cotter MC Transformer and PSC-2

call for our mailing list: (315) 437-3357 M-F  
REFERENCE AUDIO of Dewitt, division on GM/GP, Ltd.

**FOR BEST PRICE-IMMEDIATE DELIVERY ON** Onkyo, Niko, JBL, Tascam, Celestion, E.V., Technics, Warfedale, Mar-cof, Ariston, Lux, Grace, Eventide, and Sennheiser to name a few — Paul Kadair's, Inc., Baton Rouge, Louisiana, (504) 924-1001.

**FRANK VAN ALSTINE HAS DONE IT AGAIN.** All new ZERO SLEW INDUCED DISTORTION modifications for DYNACO and other equipment. Walt Jung is right of course, but he overlooks a few things we have not, such as the small signal effects of RFI and the low frequency analogy to S. I. D., which relates to the time constant ratio between low frequency cut-off and power supply stiffness after regulation (we can prove that DC coupled inputs guarantee high distortion at low frequencies) Our new mods guarantee zero T. I. M. and until you hear an amp or preamp achieving this, you haven't heard anything yet. For example our all new SUPERPAS mod will outplay any other vacuum tube preamp and its only our fourth best preamp design. Write for our detailed explanation that may shake the world of high end audio.

JENSENS STEREO SHOP 2202 RIVER HILLS DRIVE  
BURNSVILLE, MINN 55337 612-890-3517

### GOLDMUND

after the extraordinary GOLDMUND T3, the \$2400 straight-line tonearm, now considered worldwide as the best tonearm available, GOLDMUND is now presenting the GOLDMUND Studio Turntable, the best sounding to fit the GOLDMUND T3 or the best pivoting tonearms. It costs \$2000. And just out, the GOLDMUND Classique preamp is \$2400. If you find a better preamp, buy it! Only available by selected dealers. Write to:  
MBR ELECTRONICS US CORP  
One World Trade Center, Suite 1913, NY 10048

## FOR SALE

Fulton moving coil cartridge is available at Kenneth Wagner Audio Systems. No other cartridge is as musically correct. Also in stock:

SPEAKERS	ELECTRONICS	TURNTABLES Etc.
Fulton	Audio Research	Systemtek
B&W	Crown	STD
KEF	N.A.D.	Micro Seiki
Dahlquist	Audionics	Supex
J-R	Bravura	Koetsu
Snell		Grace
Spendor		Signet

Visa & M.C. Free Shipping in U.S.  
Kenneth Wagner Audio Systems  
841 S. Dixie Hwy.  
West Palm Bch., FL 33401  
Tel: (305) 833-0448

**GET INTO BROADCASTING!** Learn how to receive free records, tapes, get an FCC broadcast license, start your own station. Free details. "Broadcasting", Box 130-N5, Paradise, CA 95969.

### GET SOUND PRICES ON CAR STEREO-SCANNERS-CB

Call or write Mon - Sat 10-8. (312) 960-1327 Visa MC. R.S. Engineering, 522 Sherman, Downers Grove, IL 60515.

**GOING TO COLLEGE:** Technics SL 1300 MK II — \$350; Pioneer CT-F1000 — \$400; SAE 1800 Parametric Equalizer \$300. (907) 442-3665 after 8:00 pm PST.

### GRACE & SUPEX

We offer the Grace 707MK2, 704, F9-E, F9-L, Linn mods for the 707MK2, Supex SDX-1000, SD-900MK2 & SD-900E+Imp. Free shipping. Visa & M.C. OXFORD AUDIO CONSULTANTS, BOX 145, Oxford, OH 45056 (513) 523-3333, 523-3895.

### GRAPHIC EQUALIZER KIT — ONLY \$100 PPD.

Twelve bands/channel, 100 dB S/N. Free info. or send \$2.50 for instruction manual with Len Feldman's review and copy of May 1978 Radio Electronics cover story. (Refundable with purchase.) Symmetric Sound Systems, Dept. A, 912 Knobcone Place, Loveland, CO 80537.

### Hafler: Amp and Preamp

Audio Ltd., 115 N. Walnut, Champaign, IL 61820 (217) 359-3774.

### HAFLER DH-101 PREAMP

We expect to be in stock on this exciting new preamp by Dec. 12th. Kit price is \$199.95. Custom wired and tested, \$299.95. Immediate prepaid prepaid shipment via UPS. THE AUDIBLE DIFFERENCE, 435 Tasso, Palo Alto, California 94301. (415) 328-1081. TF

Hafler DH101 ultrahigh definition modification - instructions only \$10.00. Modification \$100.00 Amoeba Systems. 1201 Addison Dr., Reynoldsburg, Ohio 43068. (614) 861-8710.

HAFLER DH-200 AMPLIFIER KIT, FACTORY SEALED, NEVER OPENED. \$249.00 YOU PAY SHIPPING. CALL DAN (215) 667-8770.

### HAFLER DH 200

Call or write for quote. Audio Salon, 608 Pecan Ave., Charlotte, NC 28204 (704) 377-6590 Shipped Pre-paid.

HAFLER HEADQUARTERS IN CANTON, OHIO - The Listening Room, 1807 Cleveland Ave. NW. (216) 452-6332. TF

### HAFLER PRODUCTS & MODIFICATIONS

We have in stock the following: DH-101K \$199.95, DH-101A \$299.95, DH-101AP \$399.95, DH-102 \$74.95, DH-103 \$19.95, DH-104 \$24.95, DH-105 \$24.95, DH-106, mod kit for 101's produced before May, 1979, \$19.95, DH-202 bridging kit \$24.95. As for the DH-200's, the supply has been low and the demand high. When this appears we HOPE to have in stock the DH-200K \$329.95, DH-200KE \$339.95, DH-200A \$429.95, DH-200AE \$439.95 & DH-201 rack mount, \$24.95. Free shipping in U.S. We ship Worldwide. Visa & M.C. OXFORD AUDIO CONSULTANTS, Box 145, Oxford, OH 45056. (513) 523-3333, 523-3895.

## SPECTRUM ANALYSIS SYSTEM

The ASA-10 is a true professional quality analyzer that offers:

- A 10-Octave Spectrum Analyzer covering the full audio range
- Built-in flat response microphone
- Adjustable dynamic range display up to 35dB
- Selectable detector response times for either pink noise or signal monitoring
- A Hold Mode for easier analysis

P.O. Box 115 · West Redding, CT 06896

203 · 938 · 2588

**GOLD LINE**



Analyzer ASA-10 ..... \$199.95  
Pink/White Noise Generator ... 49.95  
DEALER INQUIRY INVITED

## FOR SALE

### HAFLER IN THE SOUTH

In stock, the superb Hafler DH-101 preamp. Kit \$199, factory assembled \$299. New: DH-200 amp. Immediate free shipping. Also Fried, Aduionics, Vandersteen, NAD, Advent, Klipsch, more. READ BROS, STEREO, 593 King St., Charleston, S.C. 29403 (803) 723-7276. 7-9

**HEAR DOLBY FM AS IT WAS MEANT TO BE HEARD.** Assembled Decoder for broadcasts or tapes only \$99.50. Also encode/decode KIT for serious recordists. Complete specs and reviews. SA INTEGREX, Box 747, Havertown, PA 19083.

**HEATHKIT TV CABINET, GRA-602-25** for GR-2000 or 2001 TV's. \$150. NO SCRATCHES. 408-279-1425 day. 408-259-9648, eves.

**Hi-Fi Enthusiasts** — Experience what in-house service facilities, quick shipments, low prices and brand selection can mean to you. Team your abilities with the best supplier to make selling discounted hi-fi a pleasure. Write Hi-Fi Warehouse Dept. 20, 1006 Haddonfield Road, Cherry Hill, NJ 08002.

**HIGH END Discounts.** Send SASE and best pricing to: Box 18009, Seattle, WA 98118.

### HIGH END IN THE MIDWEST

Linn Sondek	Rega	Theta
Audible Illusions	Grace	Symmetry
Precision Fidelity	Stax	Acoustat
Mordant-Short	KEF	Meridian
Audionics	Revox	Others
Featuring: Bryston Mod - All Models		

### DAHLQUIST D010MOD FOR IMPROVED HIGH END

Save \$	List	Sale	
Setton	TUS600	\$439.95	\$351.96
	AS1100	379.95	303.96
	AS3300	459.95	367.96
	PS + BS5500	1349.90	944.93
Van Alstine	Model1	600.00	450.00
Harman/Kardon	HK505	399.00	319.20
	HK670	569.00	455.20
KEF-white	104ab	850.00	750.00
used STAX	DA80	1700.00	950.00
JBL	SA660	435.00	295.00

**AUDIO RENAISSANCE** (816) 531-3261

4122 Broadway — Kansas City, MO 64111  
!WHERE THE REFERENCE IS LIVE!

**HIGHEST QUALITY USED EQUIPMENT FOR SALE:** Dynaco PAT 5, \$130; Yamaha C-1 preamp, \$1000; GAS Thalia, \$225; Phase Linear 4000, \$295; H/K Citation 17S, \$250; Marantz 3600, \$260; Yamaha B-1, \$1000; Marantz 24 Tnr/preamp, \$140; Sherwood CPU 100, \$595; Teac 450 deck, \$250; B&O 4002, \$650; Yamaha YP D8 demo, \$295; IMF Supercompact spkrs, \$420 pr.; McIntosh 2105 amp, \$500; McIntosh C28, \$450; Crown IC150, \$175; Crown SX 724 deck, \$600. All used equipment guaranteed 90 days parts and labor. Audio Consultants, 1014 Davis Street, Evanston, IL 60201, (312) 846-9565 and 757 N. Milwaukee Avenue, Libertyville, IL 60046 (312) 362-5594.

### HIGH MAIL ORDER PRICES?

Not at STEREO VILLAGE

ADC, Advent, ALAI, AR, Audiovox, Audio-Technica, Cerwin Vega, Clubman, Craig, dbx, Dual, Empire, EPI, ESS, Fisher, Grado, Inter Ego, Jensen, Jet Sounds, JVC, Kenwood, Koss, Klipsch, Kriket, Linear Power, Magnadyne, Marantz, Maxell, Metro Sound, Micro Acoustics, Mitsubishi, Onkyo, Panasonic, Pickering, Pioneer, Polk Audio, Sansui, Sanyo, Savard, Sony, Sharp, Shure, Sonus, Stanton, TEAC, Technics, TDK, Visonik, Yamaha and more!

### HIGH MAIL ORDER PRICES?

Not at STEREO VILLAGE, 3021 Peachtree Rd. NE, Atlanta, GA 30305, (404) 233-5346.

### HIGH MAIL ORDER PRICES?

Not at STEREO VILLAGE, 1067 Morrow Industrial Blvd., Morrow, GA 30260 (404) 968-0281.

AUDIO • SEPTEMBER 1980

## FOR SALE

### HIGH MAIL ORDER PRICES?

Not at STEREO VILLAGE, 2411 Cobb Pkwy., Smyrna, GA 30080, (404) 953-1030.

### HIGH MAIL ORDER PRICES?

Not at STEREO VILLAGE, 5029 Veterans Memorial Blvd., Metairie, LA 70002, (504) 455-1461.

### HIGH MAIL ORDER PRICES?

Not at STEREO VILLAGE, 516 West Bank Expwy., Gretna, LA 70053, (504) 366-3238.

**HIGH PERFORMANCE LOUDSPEAKERS** factory direct. LS3/5A and other equivalents. European drivers, speaker enclosures, kits, finished systems. Student reps needed. Box 18009 Seattle, Wn. 98118 and Box 12242 Jacksonville, FL 32209.

**H/K CIT 16, \$400; RAPPAPORT PRE-1 \$400.** (302) 368-9854.

**HORNS-WOOFERS-MIDS-TWEETERS** at tremendous OEM savings. A1tec, CTS, Electro-Voice, Pioneer, Panasonic, Peerless, Phillips, Polydax and many others. Dozens of hard to find items. Huge selection of crossover network components, automobile systems, and musical instrument loudspeakers. Send \$2.00 for catalog, refundable with purchase: SRC Audio, Dept. AD, 3238 Towerwood Dr., Dallas, TX 75234.

**INFINITY OLS-1 SPKRS, PERFECT CONDITION. MUST SELL.** \$1450 INCL. SHIPPING. (206) 282-7846.

**IVIE ELECTRONICS REAL TIME ANALYZERS**, etc. Some very slightly used demonstrators at discount. Full factory warranty. Money-back guarantee. JML Company, 39,000 Highway 128, Cloverdale, CA 95425.

**Janis W-1 sub-woofer, Perfect \$450.** (419) 537-8718.

**JBL SA660 amp, LX5, xovers, Hartsfields SME 3009.** Formula 4, MAC SCR-1. 1-313-229-7378.

**John Curt is alive and well and living in Berkeley.** And he has just designed the finest moving coil head amp in the world. It's called the SOTA Head Amp and with it you will for the first time hear what until now has been only the promise of moving coil sound. \$250 postpaid from The Audio Company, Box 13038, Oakland, CA 94661.

**KEF 105 \$1400.** (212) 454-3205.

**Koetsu cart., new, \$550.** (201) 746-2794.

**KOSS MODEL 2 ELS Speakers New w/Warranty \$450 ea.** Will ship C.O.D. (415) 521-7802.

## FOR SALE

**LEVINSON LNC-2 \$900, SME III NEW \$175, Yamaha C2 pre \$350, Mc 225 tubes \$150, Pio TX9100 tuner \$150, Tandberg 10XD \$250, Mc C20 \$200. LISTENING ROOM, INC. (205) 939-0702.**

### LISTENING ROOM INC

590 Central Park Avenue  
Scarsdale, N.Y. 10583  
(914) 472-4558

Cordially invites you to audition our fine line of equipment. THRESHOLD · BRYSTON · SPATIAL · HILL TYPE-1 PLASMA SPEAKER SYSTEM · PYRAMID SPEAKERS · SNELL ACOUSTICS · DAHLQUIST · KEF 105 · B & W 801 · LINN SONDEK · GOLDMUND T-3 TONEARM · QUAD ESL · YAMAHA · TANDBERG · NAKAMICHI · KEITH MONK · PERSPECTIVE SPEAKERS · MARCOF · MUSICAL FIDELITY · ULTRACRAFT · STAX · JANIS · R.H. LAB · GAS · SEQUERRA · POLK AUDIO · DENON · GRACE · GRADO SIGN. III · DYNAVECTOR · KARAT DIAMOND · MICRO-ACOUSTIC · JVC MC-1 MOVING COIL · VISIT OUR PRIVATE STUDIOS.

We ship free anywhere in the Continental U.S. We invite inquiries.

## A SINGER'S DREAM!

**REMOVES VOCAL FROM MOST STEREO DISCS**  
The Thompson Vocal Eliminator can actually remove most or virtually all of a solo vocalist from a standard stereo record and yet leave most of the background music untouched! Not an equalizer! We can prove it works over the phone. Write for a brochure and demo record below. COST: \$249.00

## YOU SHOULD SEE US

- For:
- Delay and Ambience
  - Studio Echo/Reverb
  - Tape Noise Reduction
  - Parametric Equalization
  - Electronic Crossovers
  - Comp/Limiters
  - Mic Preamp/Mixers
  - Patch Bays



We manufacture a full line of high quality audio and recording equipment. You will probably have to pay twice as much elsewhere to obtain comparable quality. Only Direct Sales make our prices and quality possible. Send \$1 for a 20 page brochure and 20 minute demonstration record.

Write to: **LT Sound**, Dept. AU, P.O. Box 729, Decatur, GA 30031. (404) 284-5155

mark  
levinson

AUDIO PRO • BEVERIDGE  
BRYSTON • GRADO  
LYNN SONDEK  
NAKAMICHI  
PYRAMID

LEE KRAMER'S  
High Fidelity \$\$\$

JANIS  
KOETSU  
SEQUERRA  
SNELL  
THORENS  
ETC.

30  
years in Atlanta

404 237 6336  
322 EAST PACES FERRY ROAD ATLANTA GA 30305

## FOR SALE

**Sherwood Receivers;** 20 watt \$154; 30 watt \$171; 40 watt \$202; 65 watt \$235; Complete Audio Catalogue 25¢; Downen Electronics, 206 Main St., Carmi, IL 62821.

**SOUND ADVICE AND POLK AUDIO LOUDSPEAKERS** We have the incredible Polk Audio Monitor Series loudspeakers in stock. The Polk's are definitely the best performance per dollar value ever offered in a truly accurate inexpensive loudspeaker. State of the art sound is now available from less than \$200 per pair. We ship freight prepaid anywhere in the U.S. within 24 hours upon receipt of order. Write or call for information on the Polk Audio Monitor Loudspeakers.

SOUND ADVICE

Village Plaza Ruston, LA 71270  
(318) 255-8000 9-9

### SOUTHERN CALIFORNIA — L.A.

GAS, Cizek, Chartwell LS3/5A, Spondor, Thiel, Connoisseur, Grace, Goldring and more. GENE RUBIN AUDIO (213) 571-1299.

### SPENDORS ARE SPLENDID

We offer the Spondor SA1's, BC1's & BC3's. Free parking. Visa & M.C. By appt. OXFORD AUDIO CONSULTANTS, Box 145, Oxford, OH 45056. (513) 523-3333 & 523-3895.

## the audio advocate

SME	Conrad-Johnson
Polk	Keith Monks
Gale	Nakamichi
Cizek	Acoustat
Supex	LS3/5A
Ariston	Onkyo
Magnepan	Hafner
Apt Holman	Grado
Fulton Cable	Rega
Audio Research	ADC
505 Millburn, Avenue	Millburn, N.J.
(201) 467-8988	

## FOR SALE

### SOUND COMPONENTS INC.

EXCLUSIVE SOUTHEAST  
DEALER FOR THE  
INCOMPARABLE  
MARK LEVINSON H.Q.D.  
REFERENCE SYSTEM

The H.Q.D. reference playback system consists of the following components:

- 2 Hartley 24 in sub-woofers
- 4 Quad ESL loudspeakers
- 2 Decca ribbon tweeters (modified)
- 2 Levinson LNC-2 Crossovers (100 Hz & 7 KHz)
- 1 Levinson ML-1 (LEMO) preamp
- 6 Levinson ML-2 amplifiers
- 1 pr. Hand-crafted oak or ash trestle stands (for Quads & Decca)

THE H.Q.D. SYSTEM WITH GOOD SOURCE MATERIAL, WILL REPRODUCE A MUSICAL EVENT BETTER THAN ANY SYSTEM WE KNOW OF.

For more information, please write or call:

SOUND COMPONENTS  
2710 Ponce de Leon Boulevard  
Coral Gables, Florida, 33134  
305-446-1659

TWX 812-848-7627

tf

**STAX ELECTROSTATIC CARTRIDGE SYSTEM COMPLETE CPX TYPE 2, POD-XE, UA7 TONEARM, \$400. GAS THAEDRA PREAMP, \$400.00 (415) 676-9020.**

### STEREO REPRESENTATIVES NEEDED!!!

Sell 100 brands!! Lowest Possible Prices!! Krasco—REP DEPT. —998 Orange Ave. West Haven, Conn. 06516TFFILE

**TAPE HEAD REFINISHING** - Precision method full frequency response. \$15.00 ea. One day service. E. Maher, 5 Evans Place, Orinda, CA 94563.

**Tape World, Maxell, TDK and others.** SAC:90 \$2.99. Shipping \$3.50 per order. 220 Spring St., Butler, PA 16001. (412) 283-8621. Free Catalog.

**Technics 10" r-r new \$1100.** Revox tt with Grado Sig II \$750, Nakamichi 700 II w/remote \$775, Lux 5T10 tuner \$475, Threshold 400A \$1050, Sony 2251 tt/no arm \$135, Rabco SL8E/xtra shell \$95, Phase Linear 400 with 100k F power supply \$400, electronic x-over for Tympt 1-D, passive hi end, Nelson Pass designed \$250. All excellent with original boxes. Prvt. party. (415) 941-4762, keep trying.

## FOR SALE

**TAPCO and ELECTRO-VOICE,** mixers, equalizers, amps, mics, and raw loudspeakers. Write for low mail order prices, Sonix Co., P.O. Box 58, Indian Head, MD 20640 8-9

**THE AUDIOGRAM,** an independent newsletter with critical integrity and realistic sense of proportion for buyers of the newest and best components. Double issue No. 13 & No. 14 contains:

- Snell Type A Speakers
- Symdex Sigma Speakers
- INTTRA Sound Rack
- Fulton Cables
- TVA-1 Amp
- Theta preamp

A new article by Paul Messenger \$10/4 issues/1 year. AUDIOGRAM, Box 27406, St. Louis, MO 63141.

### "THE 1980 BOB GOODMAN REPORT"

WHICH HIGH END COMPONENTS SOUND BEST? READ THIS ENGINEER'S RECOMMENDATIONS FOR ACHIEVING AS-FOUNDING REALISM. \$10 ppd. ENGINEERING RESEARCH, RT. 1, BOX 640, LIVINGSTON, TX 77351.

### TOP-RATED CARTRIDGES UP TO 70% OFF!!

We feature just about all of the finest phono cartridges on the market at the lowest possible prices. Our selection includes cartridges that are normally sold for the full retail price! Our most popular lines include Acutex, ADC, Crado, Nagatron, Ortofon, Shure, Sonus, Stanton and many others that we can't even mention by name. Just call us at 212-254-3125 for more information or write to Direct Discounts Ltd., P.O. Box 841, Cooper Station, NY 10003. We accept phone orders with your M/C or VISA.

### TRADE UP to the MICRO CPU 100 fm tuner

It may have been out of the question at \$2000, but the new retail is \$995. Subtract even more for your trade-in and this magnificent tuner can be yours at a surprisingly low price. We offer very generous trade-in allowances on your old tuner or other audio equipment. A rare chance to own the best at a reasonable price (see Audio, Nov. '77). Write us for a quote, or better yet, phone after business hours and we can discuss your trade-in: (617) 874-0706, mon.-fri., 6-8 pm. (ask for Dick)  
**AUDIO CALIBRATION,** box 250, Westminster, MASS 01473. TF

### TWO DYNACO MARK VI VACUUM TUBE AMPLIFIER KITS.

FACTORY SEALED, NEVER OPENED.  
\$275.00 EACH. YOU PAY SHIPPING.  
CALL JEFF AT (215) 839-0600.  
11:00 AM - 5:00 PM WEEKDAYS.

**Undergrounds/Audio's outdated (1941) Tonearm Geometry** gives MAXIMUM distortion from the Critical Listening area instead of required MINIMUM. The Alignment Protractor by Percy Wilson M.A. (MK II with Stevenson 1966 Zero error points) \$10 Bill. Mayware, P.O. Box 58, Edgware Middx. England.

**VACUUM TUBES,** tube-peculiar parts. All kits/parts for circuits described in our 230+ page Modification Manual. Write for list to AUDIO DIMENSIONS, 8888 Clairemont Mesa Blvd., San Diego, CA 92123. (714) 278-3310. 9-0

**VAN ALSTINE MODEL ONE PREAMP,** UPDATED, WITH RACK AND 17 INCH FACEPLATES. AS NEW. \$300. (503) 641-5937.

### VANDERSTEEN 2A SPEAKER SYSTEM

Q/LC Audio, 1006 Berkshire Rd., Dayton, OH 45419 (513) 298-9330, (513) 293-7287 M-F 5-10 SAT 10-6.



## Connecticut's Progressive Audio Store

Acoustat/ADS/Apt-Holman/Audionics/Axiom/Bryston/Carver/Connoisseur/Conrad Johnson/M.A. Cotter/Dahlquist/Denon/DCM/Grace/Hafner/JVC Laboratory/KEF/Marcof/Mirage/M & K/NAD/Nakamichi/Pyramid/RH Labs/Signet/Supex/Symdex/Win Labs/Yamaha. 400 titles of direct-digital discs. Audiophile accessories. Keith Monks record cleaning. All shipments prepaid and insured.

# TAKE 5 AUDIO

105 whitney ave., new haven, ct 06511 203-777-1750 m-w 10-6 th&f 10-8 sa 10-5 mc/visa/amex

## innovative audio

DEDICATED TO MUSICAL EXCELLENCE

OUR DEMONSTRATIONS OF AUDIO EQUIPMENT ARE UNIQUE. WE OFFER UNLIMITED TIME TO EVALUATE THE VERY FINE COMPONENTS WE FEATURE. OUR EXTENSIVE LIBRARY OF QUALITY RECORDINGS ENABLES YOU TO DETERMINE WHICH COMPONENTS ARE OPTIMUM. OUR EXPERTISE WILL HELP YOU TO DECIDE WHAT IS BEST AS WELL AS TO ENSURE A PERFECT MATCH TO YOUR LISTENING ENVIRONMENT.

**YAMAHA, NAKAMICHI, BRYSTON, APT-HOLMAN, COTTER, BANG & OLUFSEN, DAHLQUIST, NAD, BOWERS & WILKINS, SHAHINIAN-OBELISK, BOSTON ACOUSTICS, PYRAMID-METRONOME, OHM, KLIPSCH, LUX, INNOTECH, DENON, MARCOF, ADS, LS3/5A, REVOX, DECCA, AKG, FIDELITY RESEARCH, SIGNET AND MANY OTHER FINE COMPONENTS DIGITAL AND DIRECT DISC RECORDINGS.**

TRADE INS...BUY-SELL USED EQUIPMENT...PROFESSIONAL REPAIR SERVICE & HOME INSTALLATION...CREDIT CARDS ACCEPTED. FINANCING AVAILABLE.

182 HENRY STREET • BROOKLYN HEIGHTS, NY 11201 • (212)596-0888

## FOR SALE

**Wisconsin Has;** Audionics, Denon, Luxman, Hafler, Polk, NAD, Aiwa, Connoisseur, Braun, STAX, Nagatronics, Grado, R.G., Grafyx, Soundcable and more. Write or call for prices and literature: Sound Seller, Box 224, Marinette, WI 54143. (715) 735-9002.

**WISCONSIN'S ONLY SENSIBLE AUDIO DEALER.** PRODUCTS FROM: Audionics, AudioPro, Yamaha, Hafler, Connoisseur, Great White Whale, GAS, Ortofon, Technics, DBX, Stax, DCM, Dahlquist, SAE, Audio Pulse, Koss, Draco, MXR, Shure/SME, Soundcraftsman, Grace, Thorens, and much, much more. TAPE RECORDERS FROM: Akai, Sony, JVC, Tandberg, Technics Pro, Revox, Uher and many more. Send SASE for our "blow-out" list. RECORDS FROM: Telarc, Mobile Fidelity, Sheffield, Orion/Nautilus and more. Also, one of the largest dealers for used high-end electronics in the country. WACK ELECTRONICS, INC., 5722 W. NORTH AVE., MILWAUKEE, WI 53208. (414) 442-3441.

**YAMAHA CR2020 Receiver** \$425, exc. cond. D. Altman, 770 Ocean Parkway, Brooklyn, NY (212) 853-1478.

**Yamaha C-2, Absolutely Mint Condition, \$650.00 list; selling for \$325.00** (215) 797-4076 Scott.

**826 STRAND SPEAKER WIRE (10 GA DUPLEX),** any gold connectors, custom lengths, \$1/foot. (608) 782-5845 evenings.

"**LOWEST PRICES: BOSE, SAE, NAKAMICHI, YAMAHA, ADVENT, THORENS AND MORE.** DYNAMIC SOUND, BOX 168, STARKEVILLE, MS 39759. (601) 323-0750. 1pm-9pm."

**PROBLEM: THE HIGH COST OF PREMIUM CASSETTES** "The Audiophile's Choice" has the solution with its guaranteed 20 to 20 cassette. Send \$2.00 for a C-60. Box 888, Kingsport, TN 73660.

**SIEMENS, TELEFUNKEN, GENALEX AND AMPEREX** and other top quality audio tubes available at very competitive prices. Contact Jim Wallace at 1203 Success St., Pittsburg, PA 15212 or (412) 322-4706 TF

**MIXER** made especially for tape duplication. Will produce enhanced high quality second generation tapes. KUHN ELECTRONICS, 1801 Mills Ave., Norwood, OH 45212. TF

**SUPEX SDX 1000 UNUSED, FULL WARRANTY \$260. STEPHEN SUN (212) 446-3760.**

## FOR SALE

**WANTED!**  
Classified Advertisers For Audio

- it works
- it's inexpensive
- it sells

Send your ad today to:  
**Audio Classified**  
1515 Broadway  
New York, N.Y. 10036

## The KA/STAT

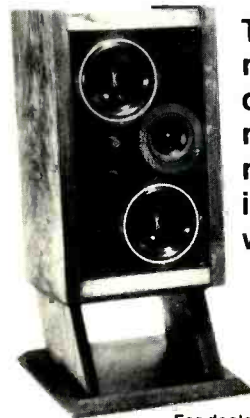

The **NEW** most definitive miniature monitor in the world

For dealer information call:

**KINETIC AUDIO INTL., LTD.**  
6624 W. IRVING PARK RD.  
CHICAGO, ILLINOIS 60634  
312-685-6509

## Central and South Texas

Offering the finest in perfectionist audio—Audition these select products

Conrad-Johnson • Naim Audio • Apt Corp • Sumo • Linn Products • Magneplanar • Acoustat • Dahlquist Spondor • Sound Connections • Supex • Grace • SME • Magnepan Unifrac I • Dennesen • Denon ADS • Boston Acoustics • Bang & Olufsen • Yamaha • Nakamichi • Micro-Acoustics • Advent • Klipsch

**AUDIO CONCEPTS**

2021 Guadalupe • Austin, Texas 78705 • 512/478-7421  
8498 Fredericksburg • San Antonio, Texas 78229 • 512/699-3333  
Master Charge, VISA, and American Express accepted • We ship anywhere

## LEGENDS MOVE AND GROW.

Chestnut Hill Audio has moved and grown. We now represent Audionics, Bowers & Wilkins, Bryston, Cotter, DCM, Denon, Fidelity Research, Grace, Grado, Hafler, Hegeman, Impulse, Janis, JR149, Linn Sondek, Levinson, Marcof, Precedent, Quad, Rappaport, Revox, Rogers, Sequerra, Snell Acoustics, Sony/Pro, Spondor, Symdex, Symmetry, TVA, Tandberg, Tangent, Technics/Pro, Theta, Threshold and Vandersteen. All of these legends at 311 Cherry Street, Philadelphia, Pa. 19106. (215) 923-3035.

**CHESTNUT HILL AUDIO LTD.**

## FOR SALE

### THE THETA PREAMPLIFIER

is a six tube device having a passive RIAA network & using NO feedback! This remarkable component is the most musical preamp that we have ever heard. Hear it at OXFORD AUDIO CONSULTANTS, Box 145, Oxford, OH 45056. Free shipping in U.S. We ship worldwide. (513) 523-3333, 523-3895.

**audio alternatives**  
INC. P.O. BOX 466 MIDLOTHIAN, VIRGINIA 23113

### WHAT? . . . ANOTHER 'HIGH END', AUDIO 'CULTIST' MAGAZINE?

Well . . . Yes . . . and No.

**YES**, we are publishing a new audio periodical, but **NO**, it will not be another cultist-oriented magazine!

The staff of 'AUDIO ALTERNATIVES' will direct its attention and effort toward the great majority of audio and music enthusiasts who have become increasingly disenchanting with the purist approach adopted by other 'quarterly(?)' publications. Although we will test and review all audio components, regardless of price, **WE WILL NOT** attempt to assemble a \$20-30,000 hybrid 'Reference System' by which we will judge the sonic virtues of our tested components. Instead, **WE WILL** evaluate all tested components within several high quality systems representing different price points within the audio market place, focusing on those affordable by only a few. **NOR**, will we be another 'component of the month club,' switching our opinions and recommended components everytime something new and 'hot' comes out. Glorifying a component in one issue and then drastically degrading its stature, or dropping it altogether in subsequent issues seem ludicrous to us. What's good is good! (But if it's bad, we'll tell you!) **WE WILL BE QUARTERLY!** . . . We know you've heard that before (so why should you believe us?). But, we have taken steps to promote (if not guarantee) our promptness. We have made a contractual agreement with our printer to deliver our final manuscripts to him during four predetermined intervals during the year. If we don't, **WE** will have to pay **HIM** a substantial monetary penalty! So, give us a chance to prove ourselves. You won't be disappointed. Subscribe now! \$16.00/yr.

**ISSUE 1: REVIEWS: (& PREVIEWS):** ARC D-79, JANIS bass system, CONRAD-JOHNSON preamp (revised), BELLES class A amp, HAFLEER amp and preamp, CARVER preamp, ADCOM amp, ACOUSTAT (review), BEVERIDGE preamp, MAGNEPAN MG-1's, POLK 7's, DAHLQUIST DQ-10 (retrospective), SUPEX, GRADO & DENON cartridges, and MORE.

**AUDIO ALTERNATIVES,**  
P.O. BOX 466 MIDLOTHIAN, VIRGINIA 23113

ANY QUESTIONS? Call (804) 744-2453 after July 1, 1980.

**FOR SALE**

**TURN YOUR LIVING ROOM INTO YOUR LISTENING ROOM!**

You can spend thousands on the finest audio components, but without the proper "set up" they can still sound merely average. Get the most listening pleasure for your hard earned money! Our plans will make any stereo system sound better no matter what your taste in music. Send \$3.00 plus SASE to: Ideas, Box 680-1, c/o Audio Magazine, 1515 Broadway, NYC 10036.

**FOR SALE**

**Car audio driving you crazy?**

Factory Hook-up doesn't give your car components half a chance at good sound. Let our diagrams show you the correct wiring and speaker positioning for your components. Send \$4.00 plus Self-addressed Stamped envelope to: AutoSound, P.O. Box 1080-1, c/o Audio Magazine, 1515 Broadway, New York, NY 10036.

**RECORDS**

**AUDIOPHILE RECORDS:** Save 20% to 40%. Free catalog. Foreign customers also invited. Super Sound Record Service, P.O. Box 411237, Chicago, IL 60641.

**AUDIOPHILES!** Direct-Disc, Digital, Mobil Fidelity-All labels Low Prices Fast Service. Send 30¢ in stamps for catalog. Direct Disc Discounters, 2245 New Hope Church Rd., Raleigh, NC 27604. 9-9

**DIRECT TO DISC AND DIGITAL RECORDINGS:** All labels at low prices. Telearc, Discwasher, Audio-Technica, Sheffield, Denon PCM, Crystal Clear, Mobile Fidelity Labs. . WE HAVE THEM ALL!! (and more!!) Send for FREE price list and Newsletter or \$2.00 for descriptive catalogue DISConnection, P.O. Box 10705 Tampa FL 33679.

**FREE SOUNDTRACKS & CASTS CATALOG!** Personalities! ST/OC Valuebook: \$4. RTSA 711 W. 17th G-1 Costa Mesa, CA 92627. TF

**Jazz and classical music recordings from Europe and Japan.** Labels include: Proprius, Lyricon and Opus 3, from Sweden, Mark Levinson, Astree, and Sarastro from France, Accent of Belgium, Merlin and Nimbus from England, Phillips RCA, East Wind Three Blind Mice, and Audio Lab from Japan. Analog and direct-to-disc. Pure virgin vinyl pressings, beautifully packaged Send one dollar for catalog, and a one-dollar-off coupon to: AudioSource, 1185 Chess Dr., Foster City, CA 94404.

**PROTECT YOUR LPs.** POLY SLEEVES FOR JACKET 10", ROUND BOTTOM INNER SLEEVES 9", SQUARE BOTTOMS 6", POLY LINED PAPER SLEEVES 15", white jackets 35", POSTAGE \$1.50. HOUSE OF RECORDS, HILLBURN, NEW YORK, 10931. TF

**RECORD HOUND,** Box 88A, Eagleville, PA 19408. Fills want list? Doggone right!!! 33 1/3 specialist. Fast, friendly service. 10-0

**"RECORD JACKETS.** Replace old, torn, LP jackets with clean, glossy, pure white or black jackets. Plastic lined inner sleeves, 78 sleeves, opera boxes. Free catalog. CABCO A6, Box 8212, Columbus, Ohio 43201." TF

**Audiocom** High Technology Audio

ADS, Allison, Apt. Audio Pulse, Audionics, B&W, Bruer, Burwen, Cotter, Dahlquist, DCM, Denon, Draco, EMT, EV, Eumig, FR, GAS, Grace, Grado, Janis, JR, KEF, Mitsubishi, MK, NAD, Nakamichi, Ortofon, RH Labs, Revox, Rogers, Snell, Spectro, Stax, Symmetry, Tandberg, VA Systems

Major credit cards honored. Phone orders shipped promptly.

177 Sound Beach Avenue, Old Greenwich, CT Phone: (203) 637-3621

**CLASS 1 FINALLY NOW AVAILABLE AND IN STOCK \$895.00**

**CANADIAN**

**MASTERCARD AND VISA PHONE ORDERS ACCEPTED.**

**THE SOUND STUDIO INC.,**  
6932 Sherbrooke St. W., Montreal, Quebec H4B 1P9 Canada  
Tel: 1-(514) 487-4270.



**Audio**, the original magazine about high-fidelity, is edited for involved, knowledgeable hi-fi enthusiasts, professional recordists, and commercial sound users—people who appreciate the finer points of audio equipment performance.

We speak their language  
... and for this reason your ad in Audio's Classified section will draw serious inquiries and rapid response.

Fill in coupon, with check or money order attached, and send to:

Audio  
Classified Advertising Department  
1515 Broadway  
New York, N.Y. 10036

For additional information call Carolynn at (212) 975-7530

**COPY:** \_\_\_\_\_  
\_\_\_\_\_  
\_\_\_\_\_  
\_\_\_\_\_

**Name** \_\_\_\_\_

**Company** \_\_\_\_\_

**Address** \_\_\_\_\_

**City/State/Zip** \_\_\_\_\_

**Phone** \_\_\_\_\_

**Signature** \_\_\_\_\_  
*(Order must be signed)*

*Payment must accompany order*

## RECORDS

THOUSANDS OF LIKE NEW LP's and prerecorded tapes. Catalogue—\$2.00. House of Records, Hillburn, New York 10931. TF

**WANTED: FLAMENCO RECORDS, SABICAS JUAN SER-RANO, PACO DIE LUCIA, OTHER ARTISTS. RICH QUILL, 1006 BERKSHIRE RD., DAYTON, OH 45419 (513) 293-7287 after 5 pm.**

## SPEAKERS

**ELECTRO-VOICE INTERFACE and SENTRY SPEAKER SYSTEMS, RAW SPEAKERS, AND PRO-MUSIC PRODUCTS. IMPRESSIVE DISCOUNTS. PROMPT DELIVERY TO ALL U S A AND FOREIGN DESTINATIONS. (305) 462-1976.**

**SPEAKERS, PARTS TO BUILD** superb systems. Send dollar (\$1) for list to: ACL, Box 5246, Willowick, Ohio 44094.

**VENEER SPEAKER CABINETS** Hardwood Walnut Speaker Cabinets with grill. Routed or unrouted, front baffles, or complete **SPEAKER KITS**. Send \$1.00 for complete brochure. **KUSTOMIZED SPEAKER SYSTEMS, 260-A, GLENN CIRCLE, POWELL, TN 37849. (615) 945-3138 after 6:PM.**

**WORLDS GREATEST SPEAKER KITS, KITS, P.O. Box 12242, Jacksonville, FL 32209.**

**SPEAKERS, PARTS TO BUILD** superb systems. Send dollar (\$1) for list to: ACL, Box 5246, Willowick, Ohio 44094.

## WANTED TO BUY OR TRADE

**FOUR CHANNEL PREAMP, PAT MARTINES — (516) 423-2777/(516) 423-3614.**

**Manufacturer Seeking Inventions. Advantek, 1100 17th NW, Washington, DC 20036. 10-0**

## WANTED TO BUY OR TRADE

**MARANTZ MODELS 2, 3, 6, 7, 8, 9 & 10B; MCINTOSH C-22, MC240, MC275 & MC3500. Sam Aberst, P.O. Box 5455, Beverly Hills, CA 90210 (213) 858-8255.**

**Mark Levinson ML-2 amplifiers. Want pair with serial no.'s over 1900. Will partial-trade Win Labs trntbl. (315) 437-3357.**

**WANTED: FISHER MICRORECEIVER 100 table radio. Korvette XAM300 radio. (212) 438-5714.**

**WANTED — JBL HARTSFIELD, MINIGON RAW SPEAKERS + DRIVERS. 1-313-229-7378.**

## PLANS & KITS

**TAPE-SLIDE SYNCHRONIZER, multiprojector lap-dissolve plans, \$5.50. With mixer, compressor, preamp schematics, \$8.50. The Millers, 1896 Maywood, S. Euclid, OH 44121. TF**

## BUSINESS OPPORTUNITIES

**CABLE FM BROADCAST STATION. Unique no investment/experience business makes money! Others work for you! Free Details "CAFME," Box 130-N3, Paradise, CA 95969**

**FIELD REP WANTED FOR SAVARD SPEAKER SYSTEMS. Fast-growing company needs ambitious rep. Dealer inquiries welcome. (504) 383-0474.**

## BUSINESS OPPORTUNITIES

**REPS & COLLEGE DEALERS: Sell exclusive lines of Hi-fi. Request application: A & B Distributors, P.O. Box 2232, Boulder, CO 80306. (303) 443-1386.**

### A UNIQUE AUDIO STORE

Goodwin's is unique among audio dealers, offering a few products which are acknowledged to be the best values or simply the best available. These components are properly set-up and may be auditioned in a comfortable, relaxed living room environment. Our reference is the Mark Levinson HQD system and the ML-5 (Studer A-80) with 30 ips master tapes. We operate by appointment to ensure a meaningful demonstration under nearly ideal conditions.

Goodwin's sales & service for: The reference Mark Levinson ML-1 & ML-6 preamps; ML-2 mono & ML-3 stereo power amps. The best sound/dollar Bryston 2B, 3B & 4B power amps.

The Linn Sondek LP-12 and the best value Rega Planar 3 turntables. The Goldmund straight-line tracking tone arm — our reference.

We also recommend: Symdex, Quad, Scheiber 360° decoder, Win Labs, Linn Ittok arm, Mitchell Cotter, FR, Sequerra, & Vandersteen.

If you would like to avoid the planned obsolescence of most stereo components and are interested in the finest music reproduction, please call Goodwin's for an appointment.

Goodwin's Inc.  
(617) 266-0608

33 Newbury St.  
Boston, MA 02116

Canadian export specialists

**SUPERIOR AUDIO COMPONENTS: Audio Pulse; Audio Research SP-6 tube preamp and D-110 amp; Badap 1; Celestion; Cizek; Crown Distinction Series DL-2, SA-2, and EQ-2; Dayton Wright; dbx; Decca; Denon; Dynavector; EMT; Formula 4; Grace; Hafler kits; KEF; Kenwood Purist; Lux LRS; Magneplanar; Mitsubishi; Mobile Fidelity records; Nakamichi; Plasmatronics; RTR; Verion; Watson speakers.**



**233 East Lancaster Avenue, Wynnewood, Pa. 19096.  
(215) 667-3048 or 649-2965.**

Obelisk



Perhaps the most forgettable loudspeaker ever created.

Once the initial thrill of ownership fades . . . . .

there's nothing left . . . .

. . . . but the music.

Shahinian Acoustics Ltd  
4 Selden Court Selden New York 11784 516 736-0033

## BUSINESS OPPORTUNITIES

**SPEAKER MANUFACTURER SEEKS U.S. AGENTS** to retail small speaker system sonically superior to LS3/5A. Please contact Monitor Accustics Ltd, Box 5746, Auckland, New Zealand for full details and specifications.

**Want money? Hate hard work? Lazy way to big money.** Cleaver plan \$2.00 (Refundable) Noble, Box 10033, Houston, TX. 77206.

## TAPE RECORDINGS

**CHRISTMAS CAROLS CASSETTE** ... 60 minutes ... \$2.95 plus 50c postage ... EKR Classics, GPO Box 1977A0, New York City, 10001. 10-0

**ON OPEN REEL from master tapes.** Argo, Telefunken, Vanguard, Unicorn, MHS. Catalogue \$1.00. Barclay-Crocker, Room 1470-A, 11 Broadway, NYC, 10004. TF

**OPEN REEL TAPES.** 7½ips, Dolbyized releases from RCA, London, DG, Warner and others. Airline tapes, quad. Catalog and updates, \$1. THE REEL SOCIETY, P.O. Box 55099-A, Valencia, CA 91355. 9-9

## FOR SALE

### Western Pennsylvania's Quality Audio Dealer

Threshold	Watson Labs
Bryston	M&K Systems
Apt/Holman	Magneplanar
Nikko	Polk
Sony	DCM Speakers
Hafner	Rogers LS3 5A
Duntech	Infinity
Linn Sondek	Altec Lansing
Grado	Janis
Denon	Thorens
Fidelity Research	ADC
Supex	SAE
Ariston	Visonik
Grace	Blaupunkt
Scheiber Decoder	Grundig
Cotter	AIWA
Marcoff	Sony
Symmetry	Technics Pro

plus much more...

Direct - To Disc Recordings

SHIPPED PREPAID & INSURED

### OVATION AUDIO

6019 Broad St. Mall  
Pittsburgh, Pa. 15206

(412) 441-4550



## RADIO PROGRAMS

**CATALOGS.** Broadcasts, soundtracks. Personalities of Thirties, Forties. Box 225, New York, N.Y. 10028. TF

**RENT RADIO SHOWS:** Make your own copies or just listen. Great way to build your collection reasonably. Catalog \$1 refundable. OTR Rental, Box 1146, Livermore, Ca. 94550 TF

**VINTAGE RADIO and T.V.** -Lowest rates. Post Free, Trading, Video too; Signals, Box 5063 Station E., Edmonton, Alta. Canada T5P 4C1. U.S. Inquiries.

**YESTERDAYS RADIO ON TAPE.** Reels-Cassettes. Quality Sound. Reliable Service. Giant catalog \$1.00 refundable with first order. ADVENTURES, Box 4822-A, Inglewood, California 90302. TF

## TAPE AND TAPE RECORDERS

### The Saxitone Hotline

## 800-424-2490

IT'S HERE! Saxitone, America's #1 merchandiser of recording tape, has just put in new TOLL FREE Phone Order Lines to serve you better. Call now for America's lowest prices on top name recording tape, video tape, recorders, tape decks and recording accessories. Order from a full inventory of TDK, Maxell, BASF, Scotch, Sony, Superscope, B-I-C, Sanyo, EV, Telex & others. Most orders shipped same day! FREE 32-page catalog. Master Charge & Visa honored. Call now and find out why Saxitone is #1.

## SAXITONE TAPE SALES

1776 Columbia Road NW, Washington, DC 20009  
In Washington metropolitan area call 462-0800

## FOR SALE

### AMERICAN AUDIOPHILE

<p>HOME OF</p> <p>ADCOM AUDIONICS AUDIO INNOVATIONS AUDIO STANDARDS AUDIO TECHNOLOGY AUDIRE CIZEK DAYTON WRIGHT DCM DECCA DENON DUNLOP/SYSTEMDEK GOLDLINE GRACE H.A.P.I. IMPULSE IVIE JANIS JMAS KINDEL AUDIO LEACH LUSTRE</p>	<p>MARCOF MARIAH MORDAUNT-SHORT NAD NEXUS P S AUDID PLATTER-MATTER PRECISION FIDELITY PREMIER R G DYNAMICS SHURE SIGNET SME SPECTRD ACOUSTICS SPICA STAX STD SUPEX TANDBERG 3D ACOUSTICS VANDERSTEEN VPI WIN LABORATORIES</p>
--	---

REFERENCE AUDIOPHILE RECORDINGS

### AMERICAN AUDIOPHILE

5 Sunrise Plaza  
Valley Stream, NY 11580  
516/561-7114

716 Madison Ave.  
New York, NY 10021  
212/751-9733

ALL SHIPMENTS PREPAID AND INSURED FREE THROUGHOUT CONTINENTAL U.S.A.

MASTER CHARGE & VISA ACCEPTED

## TAPE AND TAPE RECORDERS

**NAME-BRAND RECORDING TAPE,** custom loaded. Available in cassettes, reels, cartridges. Huge savings from manufacturer. Also low everyday prices on Maxell, TDK, Ampex, Scotch, BASF, etc. New catalogue now available. MJS, 2514 Seaboard Ave., San Jose, CA 95131. (408) 262-8793.

**PROBLEM: THE HIGH COST OF PREMIUM CASSETTES** "The Audiophile's Choice" has the solution with it's guaranteed 20 to 20 cassette. Send \$2.00 for a C-60. Box 888, Kingsport, TN 37660.

**SCOTCH RECORDING TAPE,** lowest prices TAPE CENTER Box 4305B Washington, D.C. 20012. USA, APO, FPO 5-9

### TAPE SALE!

TDK SAC90 \$2.75, SAC60 \$2.10, METAL-CALL, ADC90 \$2.35, DC90 \$1.45, LB800 \$5.10, LB1800 \$6.25. FUJI FX I or II C90 \$2.59. Video prices-call. MC/VISA. \$3 shipping (USA). NY (212) 845-2861.

## PUBLICATIONS

**TERRIFIC SWAP OFFERS NATIONWIDE** Rcvrs., amps, TTs, Audio, Ham Gear, Etc. 5 issues \$2! "Electronic Trader," Box 73-A, Folly Beach, SC 29439. T.F.

## ANNOUNCEMENTS

**Free Promotional Albums,** Concert Tickets, Stereos, Etc. Information: Barry Publications, 477 82nd Street, Brooklyn, NY 11209.

## EMPLOYMENT INFORMATION

**JOURNEYMAN CREDENTIALS GRANTED LEGITIMATE!** Write: National Craftsman Union, 210 Fifth Avenue, Suite 1102, (New York, NY 10010. 10-0

## SERVICES

**CUSTOM RECORDING SERVICE,** Tapes, discs, and cassettes. Stereo and mono. Live and copies. Editing, Masters and pressings. High quality at reasonable rates. Joseph Giovanelli, Audio-Tech Laboratories, 2819 Newkirk Ave., Brooklyn, N.Y. IN9-7134 TF

### Mount your Audio System professionally

Send Name/Type of equipment, plus \$3.50 to: J. Miller, 4336 Vanderbilt Pl., Bham, Ala. 35217.

**NASHVILLE RECORD PRODUCTIONS WILL PRESS HIGH QUALITY PURE VINYL RECORDS FROM YOUR TAPES. SEND FOR SAMPLE RECORD AND PRICE LIST. ALSO FINEST DISC MASTERING.** 469 CHESTNUT ST., NASHVILLE TENNESSEE 37203 TF

**Audio's Classified Ads  
Are Your Best Marketplace  
For Used Equipment!**



# Soundcraftsmen

## THE EQUALIZATION LEADER...

**WHY? Because WE CARE about HOW an equalizer does its job BEST!**  
That's the reason for Our 10-POINT "TOTAL-SYSTEM EQUALIZATION"

**YOU NEED MORE THAN JUST AN EQUALIZER... FOR OPTIMUM EQUALIZATION BENEFITS, HERE ARE THE TEN ESSENTIAL ELEMENTS YOU NEED:**

**1 YOU NEED VISUAL ZERO-GAIN LEVEL INDICATION: SOUNDCRAFTSMEN** combination zero-gain controls with **LIGHT EMITTING DIODE** indicators to show when exact zero-gain is accomplished. Adjusting the zero-gain controls for equal L.E.D. intensity assures you of input vs. output level matching.

**2 YOU NEED FULL-SPECTRUM BOOST OR CUT CONTROLLABILITY: SOUNDCRAFTSMEN'S** "zero-gain" circuit provides an additional 18 dB control-range over the full spectrum 20 to 20,480 Hz on each channel for instantaneous input-output zero-distortion signal matching.

**3 YOU NEED AUTOMATIC/CONTINUOUS OUTPUT-OVERLOAD WARNING SIGNAL: SOUNDCRAFTSMEN'S** 2 top L.E.D.'s glow brightly, (bottom L.E.D.'s off), if output voltage is boosted excessively, thus eliminating the danger of distortion and/or damage to related equipment resulting from the high voltages that can be generated by any fine equalizer.

**4 YOU NEED A POSITIVE METHOD OF READING dB SETTINGS...**

**5 YOU NEED AT LEAST 30 dB TOTAL CONTROL OF EACH OCTAVE...**

**6 YOU NEED A UNIT THAT WILL ADD ZERO NOISE AND DISTORTION: SOUNDCRAFTSMEN'S** signal-to-noise and distortion performance figures are far superior to most high fidelity components. **SOUNDCRAFTSMEN** products are used in professional broadcast and recording systems, assuring you of completely noise-free and distortion-free integration into your system.

**7 YOU NEED TO BE ABLE TO LOOK AT YOUR ACTUAL "EQ" CURVES.**

**8 YOU NEED THE ABILITY TO EQUALIZE TAPE RECORDINGS...**



MADE IN U.S.A.

RP2215-R  
\$370<sup>00</sup>

SUGGESTED LIST PRICE  
INCLUDES WALNUT PANELS, 10-POINT SYSTEM, CHARTS, TEST RECORD

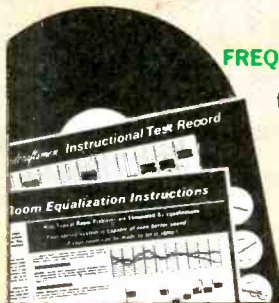

**9 YOU NEED A REAL-TIME FREQUENCY-SPECTRUM ANALYZER TEST RECORD,** using your own ears for read-out. Every Soundcraftsmen equalizer includes a Test Record recorded and designed exclusively for Soundcraftsmen equalizers. Without any expensive test equipment or technical knowledge you can quickly tune the acoustics of your room to  $\pm 2$ dB, just by following the announcer's step-by-step directions



10

**YOU NEED A MEMORY SYSTEM FOR "EQ SET-RESET REFERENCING": SOUNDCRAFTSMEN** provides you with a quantity of "COMPUTONE CHARTS" for recording the exact setting of each octave control for future reference and resetting. Automatic "Instant Memory Programming" is readily available by cutting off the "Computone Chart," holding against front panel, and moving up knobs into position.

### SP4002 Preamp-Equalizer... NEW CLASS "H" 250 w. Amps



- VARIABLE CARTRIDGE LOADING 50 to 800 PF.
- Variable 47k/100 ohm Phono Impedance
- INPUTS for MOST MOVING COIL Cartridges
- Four Mono Phono Preamplifiers
- $\pm 20$  dB phono Level Adjustment
- Two External Processing Loops
- Three-way Tape Dubbing
- Two Amplified Headphone Outputs
- Front Panel Tape Input & Outputs
- PHONO S/N:  $-97$ dB
- THD typ. less than .003, Freq. Resp.  $\pm 1/4$ dB 5 $\tau$ -10K.

The new CLASS "H" ANALOG logic Vari-Portional" circuit with AUTO-CROWBAR protection circuit, input level controls, adjustable range meters, main and remote speaker selection, clipping indicators, VARI-PORTIONAL" indicators and speaker protection. 250 watts RMS minimum p/c 20-20KHz @ 8 ohms, less than 0.1% THD, T.I.M. better than 0.02%. UNLIMITED output assures crisp clean peaks. 3 models. BASIC, METER, AMP-EQUALIZER.

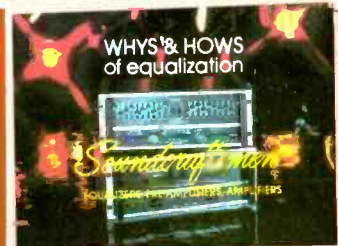

FREE!  
16-page  
Full-Color  
Brochure

Includes TEST REPORTS, complete specifications, Class "H" amplifier ENGINEERING REPORT, EQ COMPARISON CHART, and the "WHY'S & HOW'S" of equalization—an easy-to-understand explanation of the relationship of acoustics to your environment. Also contains many unique IDEAS on "How the Soundcraftsmen Equalizer can measurably enhance your listening pleasures." "How typical room problems can be eliminated by Equalization," and a 10-POINT "DO-IT-YOURSELF" EQ evaluation checklist so you can FIND OUT FOR YOURSELF WHAT EQ CAN DO FOR YOU!

SEND \$6.00 FOR EQUALIZER-EVALUATION KIT: 1-12" LP TEST RECORD, 1 SET OF COMPUTONE CHARTS, 1 COMPARISON CONNECTOR, 1 INSTRUCTION FOLDER

MADE IN U.S.A.

by SOUNDCRAFTSMEN • Santa Ana, CA 92705 • CANADA: E. S. GOULD LTD. Montreal, QUEBEC, H4T 1S9

Enter No. 32 on Reader Service Card

# DISCWASHER D4 SYSTEM



# A NEW STANDARD OF RECORD CARE

## **NEW D4 FLUID**

Inherently more active against record contamination. Inherently safe for record vinyl. Preferentially absorptive formula carries all contamination off the record.

## **NEW D4 FABRIC**

Unique directional fibers preferentially remove fluid and contamination. D4 fabric results in clearly better cleaning, better drying and ultimately residue-free surfaces.

## **UNMATCHED VALUE**

The Discwasher D4 System is enhanced by the durability and aesthetics of the hand-finished walnut handle. Included in the D4 System are the DC-1 Pad Cleaner and new instructions.

**discwasher®**

PRODUCTS TO CARE FOR YOUR MUSIC

Discwasher, Inc., 1407 N. Providence Rd., Columbia, MO 65201