

Audio

Expanded
Tonearm Test

THE AUTHORITATIVE MAGAZINE ABOUT

JANUARY 1979 \$1.25

47425



Heyser –
Rosetta Stone

Antennas – Part V

SCA & Stereo FM
Problems

U0503760 0280 70620015P0101311
DUN L HUNTER
2608 CENTRAL BLVD
EUGENE OR 97403



joined it not only gives the base greater density, the glue between the pieces acts to damp vibration. So when you're listening to a record, you won't hear the turntable.



Common staples can work themselves loose, which is why Pioneer uses aluminum screws to mount the base plate to the base.

THINKING ON OUR FEET.

Instead of skinny screw-on plastic legs, Pioneer uses large shock mounted rubber feet that not only support the weight of the turntable,

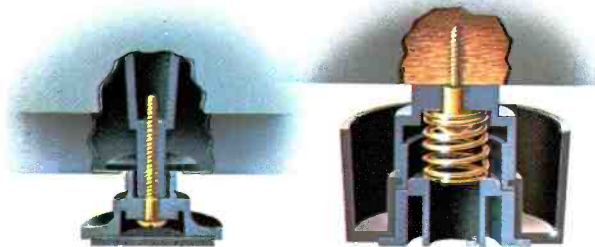

Stiff plastic legs merely support most turntables, but Pioneer's massive spring-mounted rubber feet also reduce feedback.

and absorb vibration and reduce acoustic feedback. So if you like to play your music loud enough to rattle the walls, you won't run the risk of rattling the turntable.

FEATURES YOU MIGHT OTHERWISE OVERLOOK.

Besides the big things, the PL-518 has other less obvious advantages.

Our platter mat, for example, is concave to compensate for warped records.

The platter itself is larger than others in this price range, which means it stays at perfect speed with less strain on the motor.

Even something like our spindle is special. It's .8 microns larger than most, so that the record is always perfectly centered.

Low plastic base, particle board base is susceptible to vibration.

And instead of flimsy staples, we use sturdy aluminum

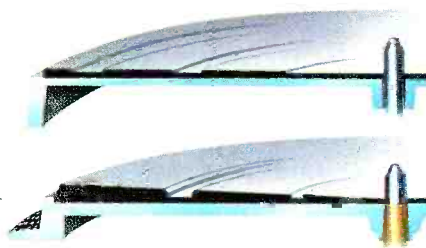

The ordinary platter mat is flat. Ours is concave to compensate for warped records.

Smaller, conventional platters are more subject to speed variations than our massive platter.

screws to seal the base plate to the base.

It's details like these as well as advanced technology that gives the PL-518 an incredibly high signal-to-noise ratio of 73 decibels. And an extremely low wow and flutter measurement of 0.03%. Performance figures you'd be hard pressed to find on any other turntable for this kind of money.

So if you want to get the most out of every piece of music, you should have the turntable that gets the most out of every part that goes into it.



Our spindle is .8 microns larger than others, to keep your records perfectly centered.

PIONEER
We bring it back alive.

BUY A BETTER TURNTABLE FOR UNDER \$175.

Enter No. 55 on Reader Service Card



**TO FULLY APPRECIATE PIONEER'S
NEW DIRECT-DRIVE TURNTABLE,
YOU HAVE TO TAKE APART
THE COMPETITION.**

All turntables are pretty much the same on the outside.

But if you look carefully inside, you'll see the things that separate Pioneer's new PL-518 from others.

Things that add up to a turntable that can reproduce music perfectly, free of audible distortion, acoustic feedback and rumble.

A REMARKABLE DRIVE SYSTEM.

Obviously, all direct-drive turntables have an extremely accurate drive system.

Each offers an immunity to fluctuations in line voltage, pitch control, and a built-in strobe unit to help you regulate the speed of the platter.

But we believe the drive system of the PL-518 is the most accurate found on any turntable selling for under \$175. Because the 16-pole, 24-slot brushless DC Servo motor is much the same as those found in turntables selling for \$250, if not more.

Equally important is the fact that this motor is anchored to a metal bottom plate, instead of suspended from the base, where vibration can affect your music.

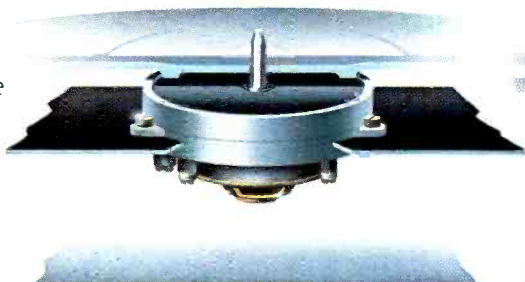

Instead of suspending the motor, Pioneer has anchored it so vibration can't affect the music.

than the auto-return on most turntables.

Then there are two separate ball bearing assemblies used in the tone arm for greater stability as it passes over the record.

A plastic headshell is good enough for most tone arms. It's nowhere near good enough for the PL-518. Tests show plastic tends to

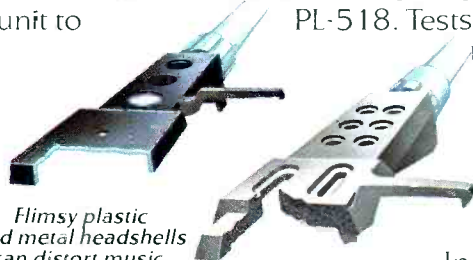

Flimsy plastic and metal headshells can distort music, so Pioneer's is made of glass fiber, which eliminates all resonance above 75 hertz.

resonate at frequencies between 75 and 300 hertz. By using a glass fiber shell, resonance above 75 hertz is all but eliminated.

In fact, nothing vibrates on the tone arm with the exception of the stylus. So nothing comes through the tone arm but music.

SOMETHING YOU RARELY SEE IN A TONE ARM: THINKING.

To give you further insight into the virtues of our PL-518 you only have to look at the way some tone arms are mounted. On piano wire. Or cheap plastic casings.

Instead, ours is gimballed on steel pivot bearings. So it can't vibrate.

A great deal of thought also went into developing an auto-return mechanism with fewer moving parts. It imposes less load on the motor and is more reliable



Many tone arms are mounted on piano wire that vibrates, which is why our tone arm floats on steel pivot bearings.

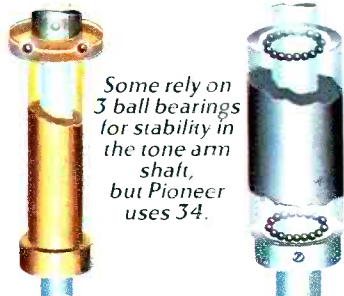

Some rely on 3 ball bearings for stability in the tone arm shaft, but Pioneer uses 34.

A SOLID ARGUMENT FOR THE 2-PLY PARTICLE BOARD BASE.

The base on many turntables is nothing more than a hollow plastic shell. Or worse, sheet metal neatly hidden beneath imitation wood veneer.

Both seem harmless enough, but they tend to vibrate and cause acoustic feedback when the volume is turned up.

The base on the PL-518, however, is made of two solid blocks of compressed wood, each 20 millimeters thick. When the two are



Unlike the hollow plastic shell, our solid 2-ply is far less likely to vibrate.

WHEN YOU PUT IT ALL TOGETHER, YOU CAN'T



PIONEER DIRECT DRIVE
AUTOMATIC RETURN MODEL PL-518

THE PL-518.

DISCWASHER

presents

The Clean Truth About Your Naked Stylus

When your stylus plays over one light fingerprint or one tiny "bead" of vinyl stabilizer, the clean naked diamond becomes a glazed, dust-holding abrasive weapon wearing away at your records and masking their true sound. This unseen build-up may actually hold the tracking tip of the diamond out of the record groove.



Accumulated grit on stylus that looks "clean" to the naked eye.

The SC-1 Stylus Cleaner from Discwasher is designed with a brush that is stiff enough to remove harmful accumulation, but gentle enough to avoid damaging delicate cartridge assemblies. Two drops of Discwasher's D3 Fluid add extra cleaning action to the SC-1 without the side-effects of alcohol, which can harden rubber cantilever mountings.

After cleaning with SC-1 and D3 Fluid by Discwasher.



The retractable, walnut-handled SC-1 includes a magnifying mirror for convenient inspection of stylus/cartridge alignment and wiring.

Get the clean truth from your records; get the SC-1.

SC-1 STYLUS CLEANER



discwasher, inc.
1407 N. Providence Rd.
Columbia, MO 65201

Audio

"Successor to **RADIO** Est. 1917"

Feature Articles

Equipment Directory Addenda II	30	
Rimo FM Tuner Filters	32	Richard Modaferrri
Antennas, Part V,		
Special Antenna Techniques	42	M. J. Salvati
SCA & Stereo FM	50	Stephen R. Waldee
TDS—A Progress Report	58	Don & Carolyn Davis
Acoustic Rosetta Stone	66	Richard C. Heyser

Equipment Profiles

Jensen R-430 AM/FM Car Stereo		
Cassette/Receiver	70	Leonard Feldman
Phase Linear 3000 Series-II Preamplifier	76	Leonard Feldman
Yamaha NS-1000 Loudspeaker System	82	Richard C. Heyser
ADC LMF-2 Tonearm & ZLM-Phono Cartridge	92	Edward M. Long
Sony ECM-56F Electret Condenser Microphone	103	Jon Sank
Burwen TNE7000 Transient Noise Eliminator	105	Leonard Feldman

Record Reviews

Top of the Pile	108	
The Column	110	Michael Tearson & Jon Tiven
Jazz & Blues	116	
Classical	124	Edward Tatnall Canby
Folk Bag	127	Tom Bingham

Audio in General

Audioclinic	6	Joseph Giovanelli
Audio ETC	8	Edward Tatnall Canby
Behind the Scenes	20	Bert Whyte
What's New in Audio	25	
Tape Guide	26	Herman Burstein
Bookshelf	28	
Dear Editor	107	
Classified Advertising	130	
Advertising Index	138	

About The Cover: Buying a good receiver or tuner isn't a backbreaking chore — if you know some of the finer points, as contained in this month's feature articles. Model: Barbara D'Aprile; photo by Photographic Illustrations.



PROFESSIONAL

The New #1 in all Professional Applications....
Stanton's Calibrated 881S Cartridge

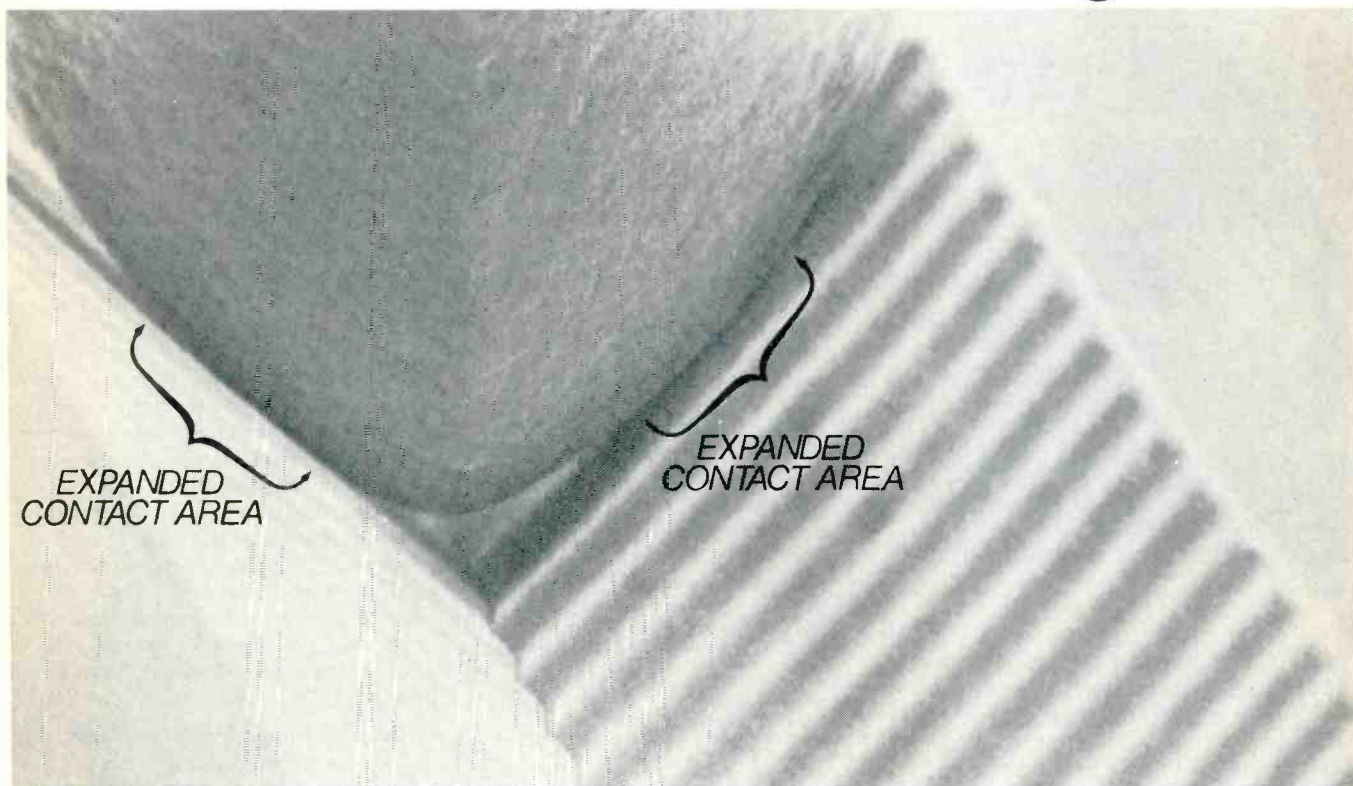

Scanning Electron Beam Microscope photo of Stereohedron stylus; 2000 times magnification. Brackets point out wider contact area.

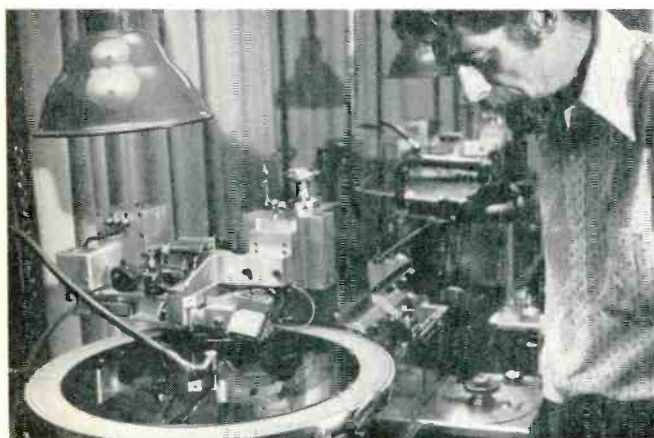

Mike Reese of the famous Mastering Lab in Los Angeles says: "While maintaining the Calibration Standard, the 881S sets new levels for tracking and high frequency response. It's an *audible* improvement. We use the 881S exclusively for calibration and evaluation in our operation"

No wonder this cartridge has achieved such dominance so swiftly. It has design, engineering and quality features that no other cartridge has. Stanton's new Professional Calibration Standard 881S cartridge is designed for maximum record protection. This requires a brand new tip shape, the Stereohedron,TM which was developed for not only better sound characteristics but also the gentlest possible treatment of the record groove. This cartridge also possesses a revolutionary new magnet. It is made of an exotic rare earth compound which, because of its enormous power, is far smaller than ordinary magnets.

Stanton guarantees each 881S to meet its specifications within exacting limits. The most meaningful warranty possible, individual calibration test results come packed with each unit.

Whether your usage involves recording, broadcasting or home entertainment, your choice should be the choice of the professionals...the STANTON 881S.

For further information write to Stanton Magnetics, Terminal Drive, Plainview, New York 11803.

© STANTON 1978



STANTON!

The choice of the professionalsTM

Enter No. 41 on Reader Service Card

Used loudspeakers

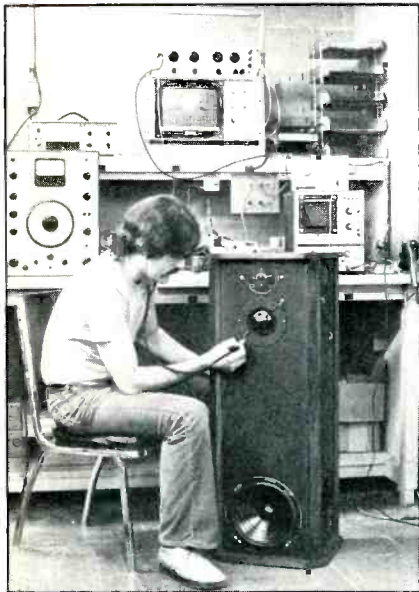

4

Every Allison speaker system you buy as new has actually been "used" for 20 minutes to a half hour. Spending this much time on our test program gives us the confidence to publish a most complete set of specifications for our products, and to provide a full warranty that every one will meet those specifications within ± 2 dB for at least five years.

To that end, we manufacture all our drivers and crossover networks ourselves. (Most of our competitors do not.) We test every driver and every crossover board (not just a random sample) to a set of close-tolerance standards. Only those that meet the standards are installed in cabinets. Then every completed system must pass another long series of performance tests, before the cabinet gets its final coat of oil finish, a careful visual inspection, and is packed for shipment.

We don't have to guess what's inside our shipping cartons. We **know**. If you too would like to know, we'll be glad to send you our free 10-page catalog on request. It includes complete specifications and a statement of Full Warranty for Five Years.

ALLISON ACOUSTICS
7 Tech Circle, Natick, Massachusetts 01760

Enter No. 51 on Reader Service Card

Audio

Editor
Eugene Pitts III

Associate Editors:
Edward Tatnall Canby, Bert Whyte

Assistant Editor
Eugene J. Garvin, Jr.

Design
Frank Moore

Production Manager
Katharine H. Sumner

Assistant Production Manager
Margaret S. Stinely

Senior Editors:
Richard C. Heyser, B. V. Pisha

Contributing Editors:
Tom Bingham, Herman Burstein,
Geoffrey T. Cook, John Diliberto,
Leonard Feldman, Joseph Giovanelli,
C. G. McProud, George Pontis,
Howard A. Roberson, Jon Sank,
Donald M. Spoto, Michael Tearson,
Jon Tiven

Vice President/Publisher
Jay L. Butler



AUDIO is published monthly by
North American Publishing Company
Irvin J. Borowsky, Founder and President

Frank L. Nemeyer, Vice President/General Manager
Harry Feld, Treasurer
Joseph Florentine, Chief Financial Officer
R. Kenneth Baxter, Vice President/Manufacturing
Stan Karol, Production Director
Vic Brody, Promotion Director
Jim Atkins, Subscription Promotion Director
Mary Claffey, Vice President/Circulation
S. O. (Shap) Shapiro, Circulation Consultant
Jean Davis, Subscription Manager

ADVERTISING SALES

Jay Butler, Vice President/Publisher,
545 Madison Ave., New York, NY 10022
Telephone (212) 371-4100.

West Coast Sales Office: Jay Martin, 17000 Ventura Blvd., Encino, CA 91316. Telephone (213) 788-9900.

Continental European Representative: V. B. Sanders, International Publishers Advertising Service, Raadhuisstraat 24, P.O. Box 25, Graft-De Ryp, Holland. Telephone, 02997-1303

England: The Paul Singer-Lawrence Media Group, 54 Burton Court, London SW 3 5Y4, England. Phone, 01-730-3592

Italy: Robert Saidel, Managing Director, Technimedia International, Via G. Fara 30, 20124 Milan, Italy.

Title registered in U.S. Patent Office.

Entire contents copyrighted world wide. No portion may be reproduced in any language without written permission.

World Library Congress Number ISSN0004-752X

Dewey Decimal Number 621.381 or 778.5

Editorial Contributions are welcomed but should be accompanied by return postage. Submissions will be handled with reasonable care, but the publisher assumes no responsibility for return or safety of manuscripts, photographs, or artwork.

Printed in U.S.A. at Columbus, Ohio. Second-class postage paid at Philadelphia, PA and additional mailing offices. **USPS Number 036-960**

U.S. Subscription Rates: 1 year \$12.00, 2 years \$22.00, 3 years \$30.00

Other Countries: 1 year \$18.00, 2 years \$34.00, 3 years \$49.00.

Back issues, when available, \$5.00 postpaid.

Audio Publishing, Editorial, Subscriptions, and Advertising Production offices, North American Building, 401 No. Broad St., Philadelphia, PA 19108.

Telephone: (215) 574-9600.

Postmaster: Send Form 3579 to above address.

Reliably good Sonics



The Apt/Holman Preamplifier was designed to deal most effectively with the wide range of tasks confronted by a preamplifier in a high fidelity music system. As a result, it produces real sonic improvements in virtually every system in which it is installed.

The lack of cartridge impedance interaction, along with flexible cartridge loading, allow optimum performance from moving-magnet cartridges. Internal user-installed cards meet the widely-varying needs of moving-coil cartridges. Sufficient infrasonic filtering eliminates the audible effects of even typically warped records while an anti-TIM filter ameliorates the effects of slew-rate limiting in power amplifiers. Buffered and crosstalk free program and tape switching provide real utility that one must use to appreciate. A unique mode control permits variation in the apparent depth of the stereo image with true stereo recordings. And newly-researched tone control curves provide truly useful loudness compensation and program equalization.

But good sonics are not very useful in an unreliable product. We've all experienced equipment failure and know how frustrating it can be. At Apt we do triply redundant testing on each and every unit, and we *test* many performance qualities that others do not even *specify*. Each unit is delivered with its own test report produced by hand at the final test.

In the unlikely event that you encounter difficulties, we stand behind the unit with a three-year limited parts and labor warranty. If you would like more information about the Apt/Holman Preamplifier, please check the appropriate box(es) below and send to:

Apt Corporation
Box 512
Cambridge, Massachusetts 02139

- For a brochure and the name of your local dealer.
- For reprints of reviews.
- For an Owner's Manual (50 pps.), please send \$4 (Foreign \$5).
- For a set of 5 technical papers by Tom Holman, send \$2 (Foreign \$3).

Name _____
Address _____

Enter No. 53 on Reader Service Card

We didn't have to make a better 2 track than our RS-1500. So we made a 4 track. Introducing the RS-1506.



Ingenuity is truly rare. Repeated ingenuity is true genius. Like the Technics 4-track RS-1506. It offers twice the program time of our 2-track RS-1500.

It also offers the award-winning RS-1500's "Isolated Loop" tape transport with a quartz-locked, phase-controlled, direct-drive capstan.

By isolating the tape from external influences we minimized tape tension to a constant 80 mgs. Providing extremely stable tape transport and low head wear. While reducing modulation noise and wow and flutter to a point where they are barely measurable on conventional laboratory equipment.

Electronically, too, Technics RS-1506 provides the same level of professional control as its predecessor. A separate microphone amplifier. Mixing amplifier. And separate three-position bias/equalization switches. While IC full-logic function permits absolute freedom in switching modes. Also available is an optional full-feature infrared wireless remote control (RF-070). It lets you operate

all transport functions and record from up to 20 feet.

For the same performance as the RS-1506 with the convenience of auto reverse, there's the RS-1700.

Compare specifications. Even with the best 2-track decks. TRACK SYSTEM: 4-track, 2-channel recording, playback and erase. 2-track, 2-channel playback 4-head system. FREQ. RESP.: 30-30,000 Hz, ± 3 dB (-10 dB rec. level) at 15ips. WOW & FLUTTER: 0.018% WRMS at 15ips. S/N RATIO: 57 dB (NAB weighted) at 15ips. SEPARATION: Greater than 50 dB. RISE TIME: 0.7 secs. SPEED DEVIATION: $\pm 0.1\%$ with 1.0 or 1.5 mil tape at 15ips. SPEED FLUCT.: 0.05% with 1.0 or 1.5 mil tape at 15ips. PITCH CONTROL: $\pm 6\%$.

Technics 4-track RS-1506 and auto-reverse RS-1700. A rare combination of audio technology. A new standard of audio excellence.

Technics
Professional Series

Enter No. 44 on Reader Service Card

Audioclinic

Joseph Giovanelli

Electromagnetic Speakers

Q. I recently acquired a very old pair of 12-inch speakers that are well built and in excellent condition. Each speaker has four wires coming from it; two are connected to the voice-coil and two to the magnet. I get some sound by using only the two wires from each voice-coil when my 30-watt amplifier is fully turned up. Is there any way I can use these speakers with my present stereo system? — Rick Nicholson, Lyons, N.Y.

A. Your speakers are of a type not seen these days. The magnet is an electromagnet energized by the two wires that do *not* run to the voice-coil. Such electromagnets were made as either low- or high-resistance types. The low-resistance magnet was designed to be connected in series with the B supply of tube amplifiers. The magnet coil served as a filter choke, as well as serving as the electromagnet for the loudspeaker. If its resistance is from 200 to 400 ohms, you will know that you have one of the series type. The high-resistance magnet was intended to be connected directly across the power supply from plus to minus, and not in series with the load. The resistance of such a magnet could be, perhaps, 10 kilohms.

When these magnets are operating correctly, they should be just luke-warm to the touch. Any really high temperatures, like burning the fingers, means that the voltage supplied must be reduced in order to prevent burning out the coil.

Unless the speakers have a relatively low resonant frequency and really sound good after all the trouble to make them operate properly, the work involved may not be worth the effort. If there is a manufacturer and model number shown on the speakers, this can be checked out. If the firm is still in business, then data related to it can be supplied. If no such information is available, there is likely to be a series of numbers or letters printed somewhere on the speaker frame. Someone involved in reconing loudspeakers will have a code book, enabling him to translate the numbers and letters into the name and maker of the speaker, along with the date of manufacture.

This information should enable you to make the speakers work relatively well.

P.A. Line Voltages

Q. Please explain the details of a 70 volt line in a public address system? — S.A. Elosh Jr., Campbell, O.

A. When an amplifier is operating a certain amount of voltage is produced across its output terminals, which will depend on the voltage of the load and on the output power produced by the amplifier. In the so-called 70 volt system, the amplifier is so set up that when it's run near maximum power, the impedance is such that 70 volts is produced across its output terminals. Often this is accomplished by the use of a transformer. This voltage is used to feed a number of speakers in a paging or public address system. In such systems one does not look to match the impedances between speakers and the amplifier. All that is really required is that there be sufficient power and voltage so that the load, large or small, can draw its required power. Each speaker is not connected directly to the line, but a step-down transformer is connected between the line and the speaker. The impedance of the transformer is much higher than the impedance of the 70 volt line, therefore a number of transformers can be wired across this source.

The transformers also keep the amplifier from overheating and allow for the addition of more speakers later on should this become necessary. Another benefit is the ability to have longer cable runs between the 70 volt source and the transformer as the copper losses in the line will not add up to a significant fraction of the impedance of the transformer. This is probably the major reason why systems of this kind are so popular. For a given cable run, the size of the wire can be much smaller than it would be if the speaker was fed directly by the amplifier.

If you have a problem or question about audio, write to Mr. Joseph Giovanelli at AUDIO Magazine, 401 North Broad Street, Philadelphia, PA 19108. All letters are answered. Please enclose a stamped, self-addressed envelope.

AUDIO • January 1979



6

It sounds like music

An incredibly solid 30 Hz low end gives you bass response not found in any other speaker of this size. This is clean bass. It isn't phony. There is no "hump" around 80 Hz to give the impression of bass when there really isn't any. What's on your source material is what you're going to hear — accurately.

There is no sacrifice at the high end either. Both front and rear-firing tweeters give you the uniform total acoustic power output that takes you into a "live-music" environment.

When you buy your next pair of speakers, do yourself a favor — audition the Interface:B's. If your criteria is musical accuracy, the Interface:B's are what you'll buy.



Electro-Voice®

a gulton company

600 Cecil Street
Buchanan, Michigan 49107

Interface:B™

Enter No. 11 on Reader Service Card



7

Here's another Empire 698 Turntable dashing off the assembly line.

It takes 15½ hours to make an Empire turntable. Each one stands over 80 separate inspections before it reaches the end of the line.

And after the assembly is done, we test it some more. Wow and flutter, rumble, and speed accuracy are electronically confirmed to meet specifications before final approval.

It's not a fast way to finish a turntable, but it's a great way to start one.

EMPIRE

Empire Scientific Corp., Garden City, New York 11530

Enter No. 12 on Reader Service Card

Audio etc.

Edward Tatnall Canby

O, boy, is the disc alive and well! Far from dying as has so often been predicted, it is now likely to become one of the most important of our recording media both as entertainment, on a much wider scale than at present, and strictly business, for information storage. Maybe Edison was right when he launched his phonograph as the stenographer's dream machine.

Of course, I am not talking about the present standard disc, the venerable LP and its junior sibling the little 45, now respectively a bit over 30 and 29 years on the market. What I mean is the next generation of disc — ERA IV a la Shure, counting from the original acoustic shellac — a new superdisc family that will at last close the appalling technological gap that has developed over these years between the LP and current disc capability.

That gap is already greater than the one which was closed in 1948 when LP took over from the 78, then a half-century old, acoustic and electric. When the present enormous gulf is at last closed, as between *standard* and *possible*, we will have a true revolution in hand, in the classical pattern. That is, much more than the mere parameters and system of the present disc will be replaced. The platter, as we know it in the entertainment area, at least, will no longer exist. An immense rearrangement, an upheaval! I wonder which will come first, this or the next California earthquake? The odds are not very different.

Our forces of technology do, in fact, build up very much as do those of the

big quakes, though fortunately they are not let loose as suddenly. New methods, new ideas, new know-how, new processes, new R & D, all these keep right on proliferating, in our field as in others; and yet because there is already an operating *standard*, very little can be directly applied. Everything funnels through the necessary parameters of the standard or is put aside. And the more successful and extensive is that standard operating system, the greater is the vested interest in its *status quo*. Thus the big slowdown — and the larger the gap grows, the greater are the forces required to overcome, to establish the new. Earthquake building.

Nothing wrong! Please don't think that "old" or "established" means something nasty like reactionary! The LP record and system is NOT reactionary — indeed, in its own way, it is the opposite, still active, mature, still moving forward, an enormously successful system, and a useful one. After all, what would we do without standards, long enduring, even beyond their time? Such as, say, railroad track width, the numbers in a round dozen, the ounces in a pound. You can name a hundred that are rightly under challenge though of honorable descent. Go metric! Go binary. Throw out the *d* (British old penny) in favor of the *p* (new penny). How ingenious and wise of the British to toss away their duodecimal-and-worse coinage in favor of

decimals with so very small an upheaval!

What we must always do in these overdue catch-up operations is to minimize the human earthquake that is inevitable, do what we can to make useful links, maximize the benefits and reduce the hurt. In England you can still spend a shilling anywhere in the actual metal, or a florin, or sixpence. They even fit the slot machines. And so right now we are working on a few disc links, ahead of time, to help us over that vast technological gap in disc potential between the present LP/45 and the violently different discs that are inevitably coming, to bring us to up-to-date standards. What'll you bet that the first of these you will see will be, by no coincidence, 12-inch platters, pressed in existing plants out of plastic of a normalish sort, and probably stuck into present paper envelopes and cardboard jackets, shipped in existing cartons and stacked up on regular record shelves? That's the idea. But what a very different record this will be.

Compatible Collusion

So, it is save what you can, cushion the quake, be reasonable, lessen the shock, spread the load, salvage the salvageable. Plenty of salvage, even in such a relatively ancient system as LP and with such an incredible distance to jump. There's a word for this. Compatibility! Its purpose is ever the same, to help in a difficult transition. Sometimes better, sometimes worse, like,

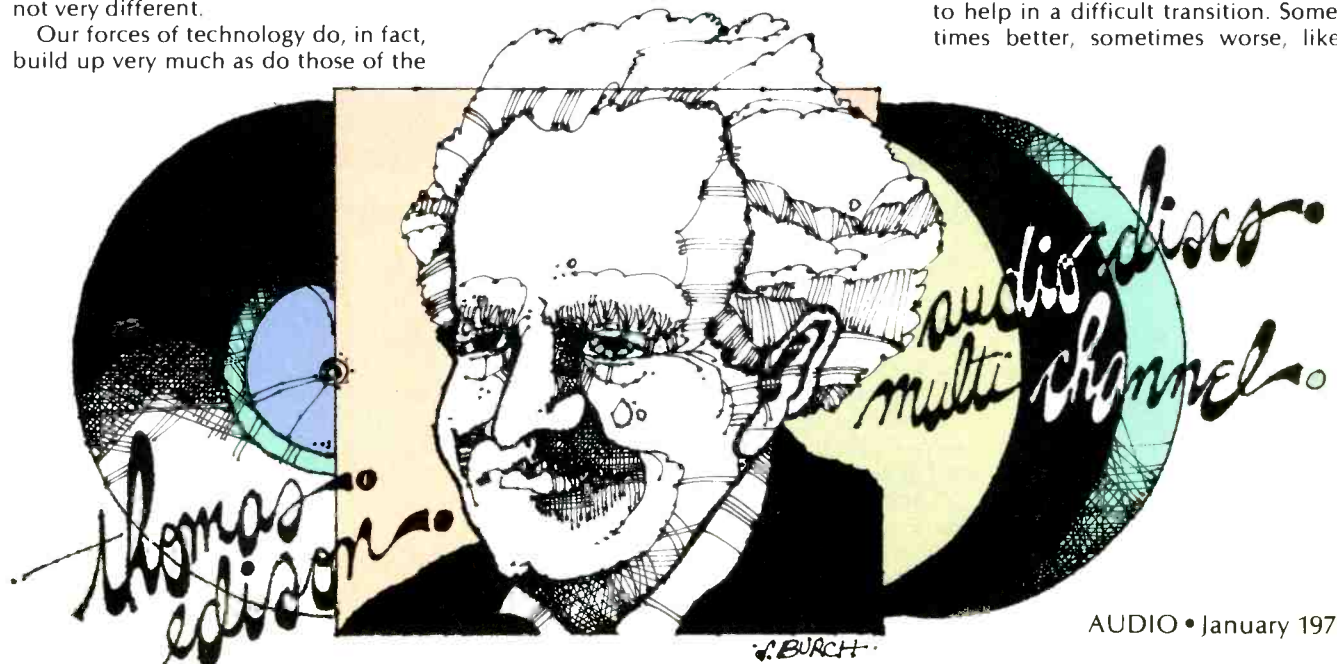

AUDIO • January 1979



While the others were catching up, TDK was moving ahead.

Shortly after it was introduced in 1975, TDK SA, the world's first non-chrome high bias cassette, was accepted by most quality deck manufacturers as their high bias reference standard. This advanced, new cassette enabled their decks to perform to the limit of their capabilities. And because the decks are set in the factory to sound their best with SA, music-loving consumers made SA the number one selling high bias cassette.

The other tape makers set out in pursuit of SA, hoping someday to equal the performance of its Super Avilyn particle formulation and the reliability of its super precision mechanism.

But making the world's most advanced cassette was nothing new for TDK's engineers. They pioneered the high fidelity cassette back in 1968 and for more than a decade they've led the way in cassette tape technology. Over the last three years, they've refined SA and made

it clearly superior to the '75 version.*

That makes the music lovers happy; it means more music with less distortion. It makes the deck makers happy; they've been improving their decks and SA makes them sound better than ever. But for the competition, unappreciably, it means a whole new standard to catch up to.

So if you'd like to raise your own recording standards, step up to TDK SA, the high bias reference tape backed by high fidelity's original full lifetime warranty.**

TDK Electronics
Corporation,
Garden City,
New York 11530

 **TDK**
The machine for your machine.™



*Today's SA has a maximum output level (MOL) more than 3dB better than that of 1975 SA at the critical high frequencies, and improved sensitivity across the entire frequency range. **In the unlikely event that any TDK audio cassette ever fails to perform due to a defect in materials or workmanship, return it to your local dealer or to TDK for a free replacement. ©1978, TDK Electronics Corp.

Enter No. 43 on Reader Service Card

say, the "all-groove" needle, the stylus that would play (more or less) both 78 and LP grooves, or the much less disastrous turnover-style double cartridge. And where do you think our present handy semi-plug in cartridges got their form? Same place — alternative plug-ins for the two grooves. So it's not *saue qui peut*, before this revolution, but save sensibly. And in these last few brief years each new prototype disc of the coming generation has shown more awareness of this critical aspect of change — that, to me, denotes *real* progress.

What we are doing today, and must do for a good while, is to live on two

planes at once. We watch the new discs develop and approach marketability — maybe. And we go right along with the old disc. Curiously, though, this necessary double standard is surprisingly difficult for most of us to understand and evaluate — even for those who are highly knowledgeable in a technical way. Maybe worse for them. It is much more than merely living with the old and the new, perforce. We must give them true *equality*, however different they are.

Now that involves a lot more than you may think. After all, there is that gap, and the comparative performance figures for the old and the new, so in-

credibly different. It's easy to sound off about the new technological marvels and the utter obsolescence of the silly old LP — or, oppositely, mutter away about visionary money-wasting and the importance of the tried and true and a mature, workable, successful existing system. We can't think *either* of these ways. We must think *equality*. Different, but equal — and, moreover, *interdependent*.

So even our thoughts, in the engineering and in the home playing, must exist on two planes, both continuing, both showing advancements of importance. Sort of hard, I admit, but there you are. On one level we have the rarified and money-rash area of R & D where the new miracles go into expensive development — and then, usually, go back to be developed some more or maybe dropped cold. A dangerous game and prone to massive mistakes. Sometimes, oddly, the fault is *not enough* radicality. Or a slant in a wrong direction, out of touch with the future. Who can be sure? Wrong direction can be as fatal as faulty technology. Right direction (as it turns out) — and you're in. Everybody tries to be right. That's R & D and is it nerve-racking, as well as exciting, for all those involved. Nothing too theoretical about our R & D in disc, these days. The gap has long been *bridged* and bridged many times. But the gulf itself isn't yet closed. No new standard — yet.

Evolutionary Improvement

Down on the other level, the other plane, we have the present LP disc and the 45. One of the astonishing things about the LP is that its basic parameters, as set forth by Dr. Goldmark in 1948, have allowed a steady flow of improvements right through these 30 long years, and even for an unforeseen revolution, the introduction of disc stereo. That was a *right* direction, and it was essentially within the LP's capability. Some minor compromises, notably in separation but do we now complain that tape stereo separation is audibly better? LP stereo proved extremely practical, if not ideal in all the specs.

So give the LP its due, for the past and even for the present. And don't forget that it is the underpinning, in the disc area, that makes the upper level of advanced R & D possible and reasonable. Also — keep in mind that LP technology continues to be important in its own right, and it has *not* stopped advancing. The LP is still impressive in plenty of ways and I hope that somebody has remembered to celebrate the anniversary with a long list of its achievements over these years. Not for me to do, but I suggest that, in



ANATOMY OF THE ^{ONLY} 40 OZ. MAGNET, CHROMED CAST BASKET, 1½" VOICE COIL, 120 WATT, 3-WAY CAR SPEAKER...

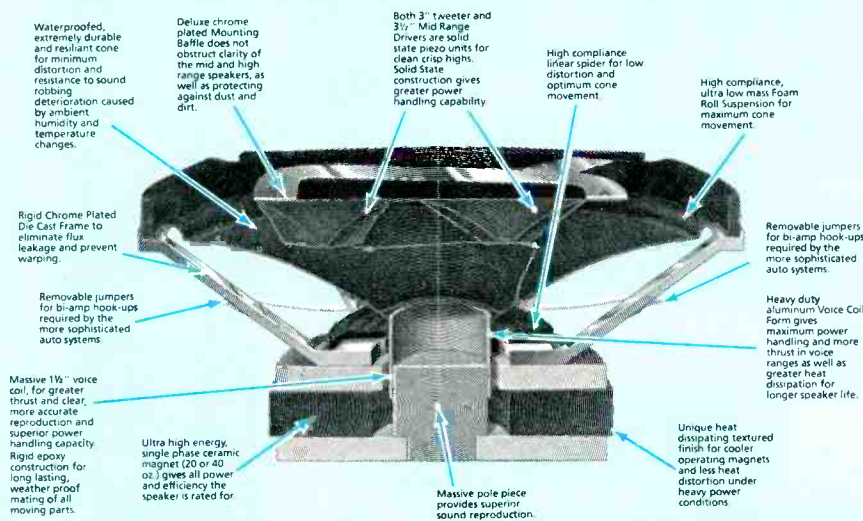

COMPARISON CHART — TRUSONIC VS. COMPETITION

FEATURE	TRUSONIC	WELL KNOWN COMPETITOR	BENEFIT	FEATURE	TRUSONIC	WELL KNOWN COMPETITOR	BENEFIT
Die Cast Frame	Yes	No	Cannot warp or bend due to heat or vibration.	Power *20 oz.	*40 RMS 80 Peak 60 RMS 120 Peak	*30 RMS 60 Peak not made	Heavier magnet structure materials coupled with an over hung voice coil increases linearly at high power levels and enhances the bass frequency reproduction thus minimizing distortion.
Chrome Plate	Yes	No	Chrome plating in conjunction with die cast construction prevents rust.	Response:	20 oz. 5" x 7" coax 40/25,000 Hz 20 oz. 6" x 9" 3-way 30/25,000 Hz 40 oz. 6" x 9" 3-way 25/25,000 Hz	50/15,000 Hz 40/20,000 Hz not made	The selection of totally solid state mid-range and tweeter elements produces superior sound in the 2,000 Hz range and beyond. Superior magnets and 50% larger voice coils provide greater low and performance.
Bi-Amp Capability	Yes	No	Permits hook up to the newer, more powerful dual output automotive systems being introduced.	Warranty	5 Years	1 Year	Superior construction and design insures years of flawless performance without material or sound deterioration.
Waterproof	Yes	No	Completely waterproof design is necessary for marine and outdoor use.	Price*	\$60.00	\$55.95	Great performance at a comparable price.
Voice Coil	1½"	1"	50% larger voice coil handles greater power and reduces distortion.				
Unitized Magnet	Yes	No	Offers 1.6 times more energy than stacked magnets. This permits higher efficiency.				

ALL TRUSONIC CAR STEREO, MUSICAL INSTRUMENT, AND HI-FI SPEAKERS, ARE MANUFACTURED IN U.S.A.

Enter No. 46 on Reader Service Card



0.05%
NAB WRMS

0.05%
NAB WRMS

Neatness counts.

You are looking at graphic measurements of wow and flutter in two different cassette decks. The nice, neat one is ours. The one with the funny spikes is the competition. What is really interesting about this comparison is that the numerical specification for wow and flutter for both machines is identical: 0.05 percent.

How can that be?

The reason is that conventional measurements do not account for some kinds of disturbances caused by momentary tape speed variations. Many manufacturers simply ignore or overlook the spikes. We don't. Because we can hear them. And

if we can hear them, you can hear them. So we build tighter tolerances into our parts—such as our precision-machined reel tables and shafts that prevent cogging of the cassette hubs. The fact is that we use a lot of unconventional methods of getting rid of a lot of conventionally ignored distortions.

We figure our most important test instrument is our ears. You can build good cassette decks in the laboratory. But you build great ones in the listening room. That's why our engineers listen, under dynamic test conditions, to every single electrical and mechanical component of our cassette decks

that can affect the texture of the sound you hear.

You'll find that every one of the new Harman Kardon cassette decks has the features, specifications, the look and the feel you'd expect from equipment made by one of the world's great high fidelity manufacturers.

But you'll find something else too.

The clean, open sound that comes only when a company listens and pays attention to details that others tend to overlook.

That's what makes us so neat.

Come listen soon.



harman/kardon
Hear all the music.

55 Ames Court
Plainview NY 11803

Pictured: The new hk3500 Dolby® cassette deck. Not shown: Model's hk500 and hk2500.

terms of my two coexisting planes, the upper or R & D, and the lower or continuing standard, the LP system has been a model of excellence. It has been good to us. And the LP is still forward looking. Note how recently it has become the vehicle for the most advanced *published* recordings yet, the digital and direct-cut types — yes, you can hear the difference, even via this ancient record!

So the disc situation, the over-all momentary *quo* is clear and sharp and the latest entries on the upper R & D level, the superdiscs, admirably define its shape and nature. We're getting there! After last year's sensational Mit-

subishi/Teac digital disc, laser recorded, laser played (*Audio, Feb., 1978*), we now have a further entry in the pits (pun intended) out of JVC. These two join a number of earlier prototype systems, such as Teldec (two generations if I am right) and others from Europe and — I almost forgot us — such U.S.A. developments as the now rather muted RCA venture, pioneer, though not Pioneer. All of these, it is increasingly clear, have been on similar tracks and offer similarly astonishing new parameters of sheer performance. Big diffs, natch, and corporate war as usual. But it begins to look right now as though there actually *might* be a con-

vergence — what a miracle. Those pits, for instance. They are ever more clearly the digital wave of the disc future. The digital pit replacing the analog groove. Wow — they might even come to an agreement on compatibility of the pits! Would *that* be the earthquake. Let us hope & pray.

Beetlemania

So you begin to get the picture — pun intended. The fundamental revolution is ever closer but the LP marches on and it must and should continue to develop, like the VW Beetle, which did the same right up until this last year, because it, too, was obsolescent but world reliable. (I still drive mine in preference to that thing they now call VW.) Note the careful overlap before the Beetle departed to Brazil. And note the mostly unheralded multiplicity of identical parts, between Beetle and its successors. That's the right game. Save what you can, ease the revolution as it happens.

Now, in all this context, a portentous word or two. Beyond all other reasons, including corporate battles, lack of directionality, technical problems partially solved, too late, too little, the real reason that the quadraphonic disc failed (it has failed, at least here) was simply because, for the first time, the LP was pushed overtly beyond its capacity. You can add all the other arguments you want on top (you will) — this is the basic one. The LP itself couldn't take it. There had to be either an elaborate overstrain or, equally, an elaborate and admirably ingenious compromise — either way, it was too much . . . flogging an elderly race horse, with the young ones almost ready to run.

All you need do is consider what we now have in prospect. Last year's Mitsubishi/Teac disc casually offered, just in case anybody was interested, a potential for 16 discrete audio tracks simultaneously. That would make a nice discrete quadra-quadraphonic, now, wouldn't it? As for JVC, they don't even mention the possibility, but with 14-bit digital PCM they surely could do something of the sort as well. If somebody ordered it.

Well, somebody won't. We need a few more years' worth of long breaths before we tackle all *that* again. But do not think that multi-channel audio space has just faded away, in favor of stereo forever. We learned unexpected new things during all that four-channel flap and many of them are still with us. New cartridge design, new styli, half-speed cutting, and such active offshoots as the home space synthesizer via digital delay. Please note that you do NOT synthesize space in your living room via two channels.

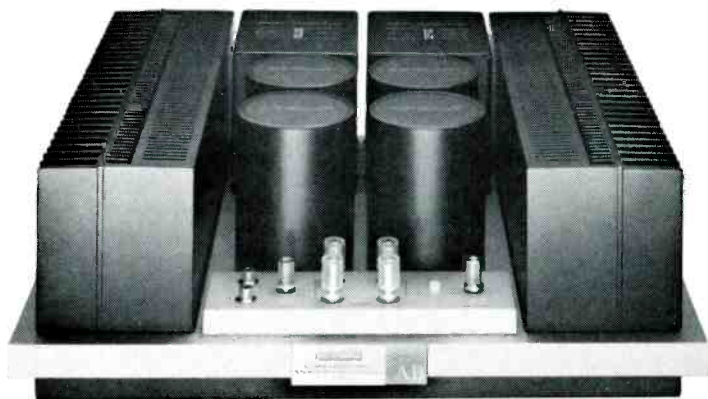

Series 20[®]

IT TAKES GUTS TO BE MORE EXPENSIVE THAN McINTOSH

McIntosh might be considered an expensive extravagance by the average high fidelity consumer. However the true audiophile perceives reliability, proven engineering and classic styling as necessities rather than luxuries.

The true audiophile also appreciates outstanding specs and the state of the art technology that distinguishes Series 20 from the field.

Consider the Ring Emitter Transistor out-put stage in the Series 20 M-25 Class AB Power Amplifier that provides incredible high frequency performance.

Consider the Series 20 F-26 FM Tuner's parallel balanced linear detector that delivers the lowest distortion available.

When you realize how exceptional Series 20 is, you'll marvel at how inexpensive expensive can be.

Series 20[®]

If you would like full information on Series 20, please send us the coupon below.

To: Series 20
Dept AJ
20 Jewell Street
Moonachie, New Jersey 07074

Please send me a complete dealer listing in my area.

Please send me the specs for the following circled Series 20 components.

M-22 Class A-Stereo Power Amplifier	D-23 Multi-AMP Elec. Crossover Netwk.	C-21 Stereo Preamplifier
F-26 Advanced Quartz FM Tuner	A-27 Cass AB Integrated Stereo Amplifier	M-25 Class AB Stereo Power Amplifier
PLC-590 Quartz PLL Servo- Controlled Turntable	PA-1000 Carbon Fiber Tone Arm	F-28 Quartz FM Tuner
		U-24 Program Source Selector

Name _____

Street _____

City _____

State _____ Zip _____



Clean look,  clean sound.

That clean, open look of these new Crown components is intentional. The *Power Line One* amp and the *Straight Line One* pre-amp are designed for people who delight in accurate sound reproduction, whose joy is in listening, and for whom simplicity of operation is important.

They are obviously easy to operate, yet all the basic controls you need for accurate reproduction and monitoring of fine quality sound are there.

But your greatest enjoyment will surely come from the unusual sonic accuracy of these units. They are acoustically as transparent as can be imagined.

Achieving that purity of sound and function wasn't simple. We've had 27 years experience in building state-of-the-art audio components, such as the world-famous DC-300A high-power amp and the newer DL-2 digital logic pre-amplifier. We've learned a great deal about what can and cannot be done with circuit design, with transistors and with IC's.

That experience is reflected in new computer-aided circuit designs. In the *Straight Line One* phono pre-amp section, for instance, internal noise is so low that thermal noise from your cartridge will be the dominant source of noise.

This circuit technology has also made possible other features you're bound to enjoy. The phono pre-amp is a separate module, much like the system developed by Crown in the DL-2. It eliminates troublesome RFI. Note also that Crown put distortion indicators on *both* units. The amplifier has both the unique Crown IOC circuit plus new peak output voltage LED's. Front-panel speaker switching and a new concept in DC speaker protection provide flexibility of layout and security of operation at high levels.

Please don't take our word for all of this. Visit your Crown dealer soon. Listen to the clean, full range sound of the *Straight Line One* and the *Power Line One*. That experience should simplify your buying decision.

15

SPECIFICATIONS

	Frequency Response, 20 Hz-20 KHz	Phase Response 20 Hz-20 KHz	Hum and Noise dB below rated output		IM Distortion at rated output, Max.	Total Harmonic Distortion at rated output 20 Hz-20 KHz, Max.
			unweighted	"A" weighted		
Straight Line One 2-channel pre-amplifier Switching module	±0.1 dB	±10°	97	101	0.00055%	0.0009%
Phono pre-amp (RIAA)	±0.5 dB	±5°	88	94	0.0005%	0.002%
Power-Line One 2-channel amplifier	±0.1 dB	+10° to -15°	110	115	0.00095%	0.05%

Power rating: 50 WATTS/CH. MIN RMS INTO 8 OHMS, 20 Hz-20 KHz, THD 0.05% .
80 WATTS/CH. MIN RMS INTO 4 OHMS, 20 Hz-20 KHz, THD 0.05% .



1718 W. Mishawaka Road, Elkhart, Indiana 46514

American innovation and technology...since 1951.

**When it comes to
speaker design, JVC goes
2969 times further.**



Traditionally, speakers are designed and tested by placing a special microphone in front of the speaker, and examining the sound it picks up on an oscilloscope. The oscilloscope pattern is then drawn or photographed for comparison purposes. And, by a tedious trial-and-error process, speaker design engineers try different speaker, crossover and enclosure combinations to express their sound philosophy.

But JVC has put an end to these archaic and time-consuming procedures.

By using a specially-constructed electro-mechanical transport device that creates a field of 2969 microphone positions; then feeding these sound impulses into a computer, then onto a laboratory video screen and onto motion picture film, JVC engineers can actually see what a speaker will sound like . . . before they get too far down the line in the design process.

This exclusive JVC development is called Phase Moire ("Mor-ay") Propagation Pattern Technology.

How the Phase Moire technology works

The motion picture film produced by the combination of nearly 3000 pickup points, the computer, and high-speed filming of the resulting patterns from the face of the video screen, actually shows how a speaker, crossover network or entire speaker system performs, rather like "sound in action."

It all looks good, but it sounds even better

The SK-1000 is the careful result of Phase Moire Technology and human engineering. Capable of handling up to 170-watt peaks (85 watts RMS), this extraordinary-sounding,

unusually efficient speaker system delivers truly magnificent, rock-solid bass from its 12-inch free-edge woofer and heavy magnet structure. Vocals and midrange are unusually smooth, with a pleasing sense of presence, thanks to our specially-designed 5-inch midrange driver. Clear, crisp brilliant highs are produced with a 1-inch dome tweeter that disperses them evenly within the listening area.

A final note on technology

Once we discovered the technology needed to produce better-performing speaker

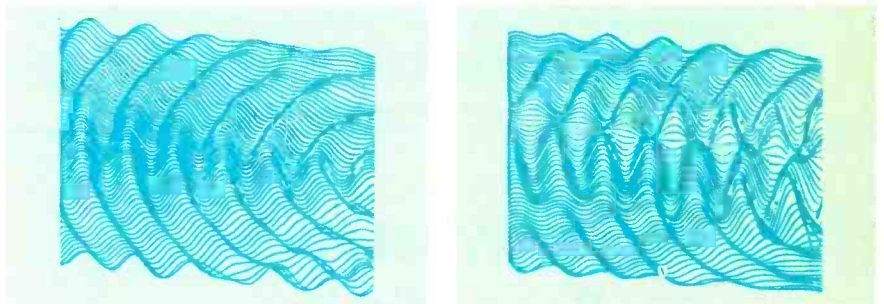

These two Phase Moire patterns represent the crossover frequency response of two similar multi-speaker systems. The left-hand pattern was produced by a JVC SK-1000. Its evenly undulating shapes indicate a smooth transition from one speaker element to another. The turbulent, uneven pattern on the right is typical of a poorly-designed speaker/crossover combination.

components and systems, we put it to work to help us build a modestly-proportioned (and priced) speaker system that would come as close as possible to the highest levels of integrity in musical reproduction. We feel we've succeeded. But all the technology in the world can't fool two of the most sophisticated testing devices known: your ears. And all the words in the world can't really tell you what the SK-1000 really sounds like. So we suggest that you hear what we've been talking about at a JVC dealer.

JVC

We build in what the others leave out.



MID/TREBLE LEVEL CONTROLS
Phase distortion and power loss are kept minimum.

1" DOME TWEETER
Elastic hemispherical diaphragm permits wide-sound dispersion with low distortion.

5" CONE MIDRANGE
Hard surfaced cone and aluminum alloy metal cap for midrange lucidity and tightness.

12" WOOFER
Accepts unusually high power for real-life bass.

Test microphones courtesy of B & K

JVC America Company, Division of US JVC Corp., 58-75 Queens Midtown Expressway, Maspeth, N.Y. 11378 (212) 476-8300
Canada: JVC Electronics of Canada, Ltd., Scarborough, Ont.

Enter No. 17 on Reader Service Card



Rediscover Your Records

We're extremely proud to announce the availability of a complete preamplifier, built around our all new PS III. Our passive RIAA curve along with our completely current sourced class A circuitry and straight wire gain bypass feature, will enable you to really **hear** your records for the first time. Want more? Read issue #4 of the IAR (now available) and write us at PS Audio.

PS PS AUDIO 1529-C Stowell Center, Santa Maria, Ca. 93454

Enter No. 29 on Reader Service Card

See What You've Been Missing... Read Audio's Classified

BUY LIKE THE WHOLESALEERS

 **KENWOOD**

\$188

KR 4070



 **PIONEER**

\$160 HPM 100

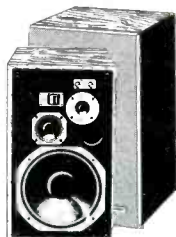

Technics

\$78

SL-210



Over \$4,000,000 in Stock

ALL DISCOUNTED

WDS
WISCONSIN DISCOUNT
STEREO

2517 whalen lane madison, wisconsin 53713

Over 60 Brands like:

Technics	Maxell	Sony	JVC
Pioneer	Empire	Teac	ESS
Marantz	Altec	Akai	JBL
Kenwood	Sharp	Dual	TDK
Sansui	Sanyo	Koss	Audio
Jensen	Shure	DBX	Technica

TOLL FREE
800-356-9514

So we can wait. Via the new systems, when the upper level gets here, multiple-channel sound is going to be easy and very viable, as anybody can see. The whole idea is dormant for the time being, stunned, you might say. But again, we now *have the capability* and, sooner or later, we will use it. But it will never again be via the LP. Meanwhile — many of us still play all our LP recordings "surround" and we will continue as long as we play LPs at all. A great LP advance for those who have the courage to stick with it.

I have deliberately left unmentioned to the last the *real* revolution, obvious to all. *There will never be another purely audio disc system!* The LP is the last of its lineage.

Picture Discs

There will be audio discs, of course. But any future disc system, whatever, will as a matter of course be *picture capable*. We have this technique too and we will use it. The new audio disc will find its place as a modest alternative type, within the ample parameters of the picture-disc system. Inevitable! There can be no argument. And JVC's new disc entry, the unpronounceable "VHD/AHD" system is an interesting illustration. This system is launched two-way. It has a single disc player that accepts alternative discs, either pictures-with-sound (we shouldn't really call it TV) or audio-by-itself, in super digital fi. Take your choice. The system is still technically prototype (whether or not it is for sale), and it looks to be a bit clumsy and maybe expensive — but just wait. And look at the parameters.

A relatively "cheapie" pickup, non-laser (capacitative), that just slides. No grooves, instead, pits, millions of them, in close spirals pressed right into the plastic. An electronic feedback pickup drive for tracking. (Maybe eventually compatible with Mitsubishi?) You guessed it — 12 inches, on only mildly special plastic (conductive), and it can be pressed via existing LP presses. See what I mean.

Performance is par for the course — upper level. Sky high. You get two *hours* of color and stereo sound per disc through your TV set, an hour on each side. That's more than twice the "long play" of the old LP. You can imagine, at 900 rpm, the sort of spiral this means, and the headroom, bandwidth, etc. Gasp, gasp. *That's what we can do now*, friends. As for the audio version of this disc, it probably plays forever. They haven't finished timing it yet.

Oh, so you want *more* details? Sorry, not now. I have to go play an LP. 

AUDIO • January 1979

Enter No. 47 on Reader Service Card

ONE OF THE WORLD'S GREAT POWERS.

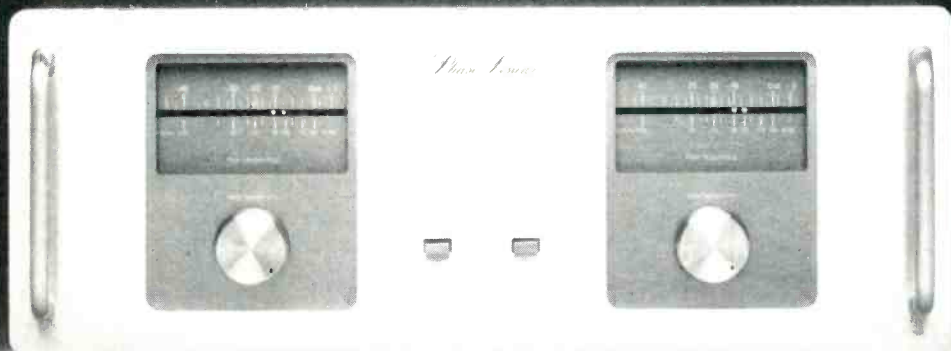

THE PHASE LINEAR 700 SERIES TWO.

Over seven years ago, Phase Linear took the audio world by storm when it introduced the first truly high-power, high-fidelity amplifier: the Phase 700. Everyone was stunned at the incredible 350 watts per channel, with ultra low distortion. (In those days, popular mythology held that amps would never need more than 50 watts to a side. In fact, who had even heard of clipping?)

Naturally, the skeptics scoffed. But audio critics and music-lovers worldwide listened. And for the first time, they heard recorded music reproduced in the home accurately. No muddy rumble at the low end. No harsh, distorted clipping of the highs. The era of great power amps had begun!

Today, it's generally accepted that you need an amplifier with a massive reserve power to drive inefficient high-technology speakers and reproduce all the musical transient peaks without clipping. The amplifier with unquestioned ability to meet this criteria is the Phase Linear 700 Series Two.

GREATER POWER RESERVES MEAN GREATER HEADROOM

The Phase 700 Series Two is rated at 360 watts per channel,

with distortion virtually inaudible at 0.09%. With this tremendous power, the Phase 700 can reproduce musical transients with ease, giving you almost unlimited headroom. As a result, your music sounds lively, with incredible realism. Even the deepest notes are clearly distinguishable.

INCREASED ACCURACY AND PROVEN RELIABILITY

The original Phase 700 was designed for home use, but it rapidly won the approval of the pros. Its proven dependability on the road made the 700 a favorite touring amp for super groups and sound reinforcement companies.

The Phase 700 Series Two retains this legendary reliability, and improves sonic accuracy by utilizing an advanced BI-FET input stage. This integrated circuit keeps the output virtually identical to the input. Beautiful music in, beautiful music out.

The 700's instantaneous LED output meters move at lightning speed, accurately monitoring the output voltage, with calibrations for 8 and 4-ohm applications. If you're listening at quiet levels, you can activate a Meter Range Switch to upscale the meter by 20dB. You have a visual indication of output activity, in addition to the Electronic Energy Limiters that prevent damage from accidental overloads.

If you demand great performance, don't settle for less than a great amplifier.

SPECIFICATIONS:

Output Power: 360 WATTS, MIN. RMS PER CHANNEL 20Hz-20kHz INTO 8 OHMS, WITH NO MORE THAN 0.09% TOTAL HARMONIC DISTORTION.

Continuous Power Per Channel At 1000Hz With No More Than 0.09% Total Harmonic Distortion: 8 OHMS-450 WATTS 4 OHMS-550 WATTS.

Intermodulation Distortion: 0.09% Max (60Hz: 7kHz-4:1).

Damping Factor: 1000:1 Min.

Residual Noise: 120uV (IHF "A").

Signal To Noise Ratio: 110dB (IHF "A").

Weight: 45 lbs. (20 kgs).

Dimensions: 19"x7"x10"

(48.3cm x 17.8cm x 25.4cm).

Optional Accessories: Solid Oak or Walnut Side panels. E.I.A. standard rack mount configuration.

Phase Linear®

THE POWERFUL DIFFERENCE

PHASE LINEAR CORPORATION, 20121 48TH AVENUE WEST, LYNNWOOD, WASHINGTON 98036
MADE IN U.S.A. DISTRIBUTED IN CANADA BY H. ROY GRAY LTD. AND IN AUSTRALIA BY MEGASOUND PTY. LTD.

Enter No. 60 on Reader Service Card

Behind the scenes

Bert Whyte

Every once in a while I write a "bits and pieces" column to report on some incidental items of audio interest, and this column is of that breed. At this time, the establishment and implementation of standards is very much on my mind, for several reasons. The 61st AES convention at the Waldorf will quite naturally be heavily concerned with digital matters. There will be quite a few papers on various aspects of digital technology, and many anticipate some real progress on the establishment of standards for digital recording. As I have previously noted, there have been indications that we would have two digital recording standards. Very roughly they could be designated as one which favored a "consumer type" helical-scan PCM recorder with a sampling rate of 44.056 per second, tying in with the NTSC color TV signal, and one for "professional" linear digital tape transports operating up to 45 inches per second with a sampling rate of somewhere between 50 to 54 K per second. Most of the helical-scan PCM units have been 13-bit systems, while the "pro" linear drive machines have been 16-bit systems. Well, friends, on the basis of some information I have and a private demonstration of a new digital recording system (which I have sworn not to reveal at this time), the standards situation is going to be newly complicated. I can tell you that it is a major effort by a major company, and therefore the system will command attention in the ongoing deliberations of the digital standards committee of the AES.

At the recent Teresa and Bob Rogers New York Hi-Fi Show at the Statler-Hilton, I encountered a "standards" problem of a very simple nature, but one which needs to be resolved just as much as the digital situation and, in fact, has been a source of irritation for many years. Before going on to this, I should mention that the show itself was reasonably interesting and as well organized as are most of the Rogers' shows, but there wasn't a great deal of really new equipment, with such established giants as Pioneer, Kenwood, and Technics not showing. Some people ventured the opinion that the

dearth of new equipment and the non-participation of the biggies was the imminence of the Winter CES, and this could very well be the case.

One item which caught the eye of many people was a new Hitachi cassette deck, which has the facility of automatically setting the bias and equalization for the various cassette tape formulations. Another thing about the Rogers' shows is that they allow dealers to exhibit, and thus many items of "high end" audio "exotica" not normally on demonstration at other hi-fi shows can be auditioned. McIntosh preamps, amplifiers, and tuners, usually conspicuous by their absence, were there in all their high-styled elegance. The Bedini-Strelieoff 200-watt amplifiers were impressive brutes, with huge capacitors in their power supply and massive heat sinks. The current "darling" in many high-end shops is the Professional Systems Engineering preamp and amplifier, and in the brief audition I had, they were impressively clean sounding. M&K of Beverly Hills were demonstrating their new subwoofer, a fairly small size for this species, but it has its own amplifier and a motional feedback circuit, and when I heard it, it was putting out some floor-shaking low frequencies. As at the Chicago CES, Bowers and Wilkins were presenting a tasteful low-key demonstration of excellent classical recordings through their very accurate and smooth-sounding DM7 and DM2 speakers. Superex, heretofore known as a headphone manufacturer, was showing a new preamp and amplifier, from all places, Israel! The amplifier is said to operate pure Class A up to 40 watts and then in Class AB up to 150 watts per channel at 8 ohms. I had offered to help a friend set up his demonstration system in his room when I ran afoul of the "standards" problem I mentioned earlier.

Mating Mishap

My friend wanted to use a new tonearm with a new cartridge in his phono playback system. The arm is one of the better ones on the market, and the cartridge has also received excellent reviews in the audio press. Good as this combination of arm and

cartridge probably would have been, there was no way I was going to determine this, as the twain were never to meet. The signal pins on the rear of the cartridge were too big for the diameter of the connecting press-on phono leads of the arm. Most of these press-on connections are of the split and crimp type and can be increased or decreased in diameter by careful use of a tiny screwdriver or long-nose pliers. Just by chance, the press-on connectors used on the arm were not of the crimp type, and if the signal pins of the particular cartridge you want to use are appreciably bigger than the connectors, you are out of luck. Understandably, the pins of the arm maker's cartridge fit perfectly with the leads of their arm, and although one tends to become very cynical in this business, I really don't believe the arm was deliberately designed this way — to exclude the use of any cartridge save their own. In the first place, there are so many cartridges on the market, with total non-standardization of signal pin size, that any number of them might fit on a sheer random basis. You also can't fault the arm maker for using the type of press-on lead found in their arm. I'm sure the intent was a secure fit, and, in fact, after several manipulations many crimp type slip off the signal pins far too easily.

There is also the fact that many audiophiles use several different cartridges in their phono systems, and while many have arms with removable headshells and thus do a minimum of pin/press-on adjustment, there are those who have tone arms with non-removeable headshells. Several changes of cartridges and the press-on leads can all too easily become fatigued and break. Of course, you can buy new leads and replace them entirely, and, in general, several spare leads are usually packed in the parts kit.

Phono Frustration

My question is . . . why do we have to go through all of this frustrating work? In an industry that is debating digital recording standards, surely we can agree on such a simple thing as a

If you can find a receiver that does more.

DC configuration
OCL power
amplifier with
fully complemen-
tary output stage

Bi-modal electro-
sensor relay
protection and
delay circuit
with LED
indication

Differential
current mirror
loaded low noise
input stage

Center channel
and signal
strength tuning
meters

18 LED Analog
to digital
logarithmic
power display
indicator
calibrated in
watts and dBW

5 stage IF ampli-
fier incorporating
3 linear phase
ceramic filters
with differential
limiter and
quadrature
detector

LED function
indicators

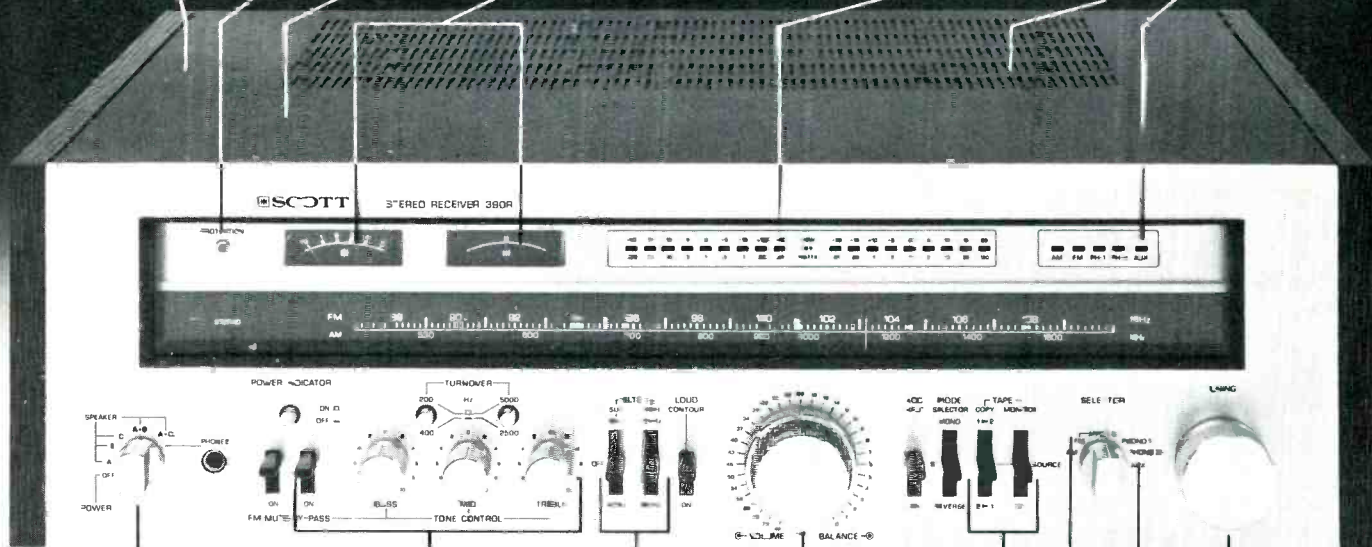

Connections for
3 pair of speakers

11 position
detent bass/
midrange/treble
tone controls
with variable
turnover fre-
quencies and
by-pass

Twin position
active subsonic
and high filters

32 detent loga-
rithmic volume
attenuator cali-
brated in dB

2 tape monitors
with full tape
copy capability

Multiplex filter

2 phono inputs

5 gang FM tun-
ing capacitor
with twin
stage dual gate
MOS FET
TRF amp

Buy it.

warranty is your assurance of lasting
pleasure.

Scott's new 390R is perhaps the
most complete receiver ever made.

A professional control center for
your entire sound system, the 390R delivers a full
120 watts per channel min. RMS, at 8 ohms from 20-20,000 Hz
with no more than 0.03% THD. And it offers more options,
features and flexibility than you'll find on most separates.

Compare the Scott 390R with any other receiver on the market
today. If you can find one that does
more... buy it.

Scott's unique, gold warranty card.
Individualized with your warranty,
model and serial numbers, and expira-
tion date. Scott's fully transferable,
three-year parts and labor-limited

For specifications on our complete line
of audio components, contact your nearest Scott
dealer, or write H.H. Scott, Inc. Corporate
Headquarters, 20 Commerce Way, Dept. JR,
Woburn, MA 01801. In Canada: Paco Electronics,
Ltd., Quebec, Canada.

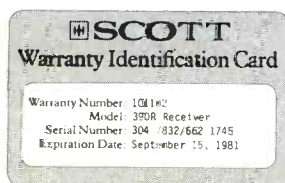

SCOTT
The Name to listen to.
Makers of high quality high fidelity equipment since 1947.

Enter No. 34 on Reader Service Card

standard phono cartridge signal pin/press-on lead interface. The Institute of High Fidelity has done a good job on establishing performance standards for complex equipment like amplifiers and tuners, and I would think they could be the organization to initiate action on this frustrating phono cartridge problem.

While we are on our soapbox, another pet gripe of mine in respect to audio equipment, is the total non-standardization of output terminals on amplifiers and input terminals on loudspeakers. Some amplifiers have simple screw-type barrier strips. Oth-

ers have various spring-loaded wire grabber devices. Still others use wire insertion and screw clamp connectors. Some amplifiers are fitted with what is incontestably the best output connector... the double banana jack and plug. It is by all odds the easiest to use and affords the most secure connections and integrity of the audio signals. Loudspeaker input terminals follow the same ideas as used on the amplifiers. Most have simple screw terminals to accept bare wires or wires with spade lugs. Some have spring clip-on terminals. An enlightened few also use the double banana jack and plug. In

my opinion, the standardization of amplifier output terminals to loudspeaker input terminals is long overdue, and there is absolutely no question that the double banana jack and plug is the connector of choice.

Furthermore, if a speaker system has the capability to be bi- or tri-amplified, there should be banana jacks provided and clearly marked with proper polarities for this purpose. Some people have quite rightly pointed out that the banana jack on loudspeakers might be mistaken for a.c. power input in European countries. I would note that the user would have to make up a lead with a banana plug on one end and a European a.c. lead on the other. An unlikely happenstance and surely a warning in large print in the principal languages pasted to the back of the speaker enclosure would suffice to prevent this from happening. In our country, there would be no problem whatever.

The aforementioned examples of much needed standardization are concerned with mechanical and signal interfaces. There are other areas where standards should be established or updated. The correlation between disc cutting angle and disc playback tracking angle needs more study which should lead to a more precise standard than the rather loose one we have now. For many years, the NAB has not acted on their promised issuance of standard magnetic alignment tapes for playback and subsequent record calibration. In light of new work and new tape formulations, many of their references are obsolete. Fortunately for us, such companies as Ampex, Magnetic Reference Laboratory, and Taber have provided us with the proper tapes in spite of the default by the NAB. Well, I won't prattle on any longer about the lack of standardization. The need for it in the areas I mentioned is obvious, and I hope it will find a place on the agenda of the IHF in the near future.

London Lacquers

I am writing this column in London, where I have been making some direct-to-disc recordings of the London Philharmonic Orchestra. Naturally this entails the use of lacquer recording discs. I had arranged for a supply of lacquers before I left the U.S.A., but when I arrived in London I decided we needed more, just to be on the safe side. That is when I learned how serious the worldwide shortage of lacquers has become. I had wanted to try some French Pyral lacquers and found there had not been a shipment of them to England for several months. A call to the import agent for some

AUDIO • January 1979

22

Soundcraftsmen

the GREAT EQUALIZERS...
the PERFECT PRE-AMPLIFIERS...
the NON-LIMITED CLASS 'H' AMPLIFIERS

Equalizers \$249 to \$550



SE 450 \$249. ▲



RP 2215-R \$379. ▲
RP 2201-R \$299.

TG 3044-R \$550. ▼



EQUALIZER FEATURES:

1. Environmental EQ Test Record and Computone Charts for EQ re-set included
2. EQ Tape Recording
3. Tape Monitor
4. EQ defeat
5. ± 16-22 dB EQ/octave
6. S/N-105 dB
7. Cabinets included as shown
8. Two Master Output Controls.

Pre-amps \$549 to \$699



PE 2217-R \$549.



SP 4002 FEATURES:

1. Variable Cartridge Loading
2. Variable 47 k/100 ohm Phono Impedance
3. Moving Coil Cartridge Inputs
4. Four Mono Phono Preamplifiers
5. ± 20 dB Phono Level Adjustment
6. Sub-Sonic Filtering-15Hz
7. Stepped Level Control
8. Two External Processing Loops
9. Three-way Tape Dubbing
10. Two Amplified Headphone Outputs
11. Front Panel Tape Inputs & Outputs
12. Dual 10-Band ± 15 dB Equalization
13. Zero-Gain/LED Level Balancing
14. Zero-Detent Slide Potentiometers
15. 19" Rack Mounted Brushed Aluminum
16. Computone Charts for "EQ" Setting
17. THD: 0.01%
18. Phono S/N: -97 dB

Class 'H' 250w. Non-Limited Basic Amps, from \$649

The new CLASS "H" ANALOG logic Vari-Portional® circuit with AUTO-CROWBAR protection circuit, input level controls, adjustable range meters, main and remote speaker selection, clipping indicators, VARI-PORTIONAL® indicators and speaker protection. 250 watts RMS minimum p/c 20-20KHz @ 8 ohms, less than 0.1% THD. T.I.M. better than 0.02%. NON-LIMITED output assures crisp clean peaks. 3 models. From \$649.



WHYS & HOWS
of equalization

FREE! 16-page Full-Color Brochure

Includes TEST REPORTS, complete specifications, Class "H" amplifier ENGINEERING REPORT, EQ COMPARISON CHART, and the "WHY'S & HOW'S" of equalization—an easy-to-understand explanation of the relationship of acoustics to your environment. Also contains many unique IDEAS on "How the Soundcraftsmen Equalizer can measurably enhance your listening pleasures;" "How typical room problems can be eliminated by Equalization;" and a 10-POINT "DO-IT-YOURSELF" EQ evaluation checklist so you can FIND OUT FOR YOURSELF WHAT EQ CAN DO FOR YOU!

MADE IN U.S.A. BY SOUNDCRAFTSMEN, INC., 2200 SO. RITCHEY, SANTA ANA, CA 92705

Enter No. 40 on Reader Service Card

CANADA: 5440 Maingate Rd., Mississauga, Ontario

A \$150 cassette?

That's what our FX-I audiocassette has been called, because of the *audible* improvement it makes. Especially on medium-priced decks and automobile cassette players.

People say it's almost unbelievable. Richer, fuller bass. Cleaner, more extended highs. Greater detail than they've ever heard before. (Or even thought their system could provide!)

It's all due to FX-I's Pure-Ferrix formulation: a unique low-noise gamma ferric oxide. With increased output at frequency extremes, to compensate for roll-offs in tape-deck response. And to help good equipment sound even better.

To hear how much better your deck can sound, make your next recording on Fuji FX-I. Our little cassette can make a big difference.

FUJI

Magnetic Tape Division of Fuji Photo Film U.S.A., Inc.
350 Fifth Avenue, New York, New York 10001

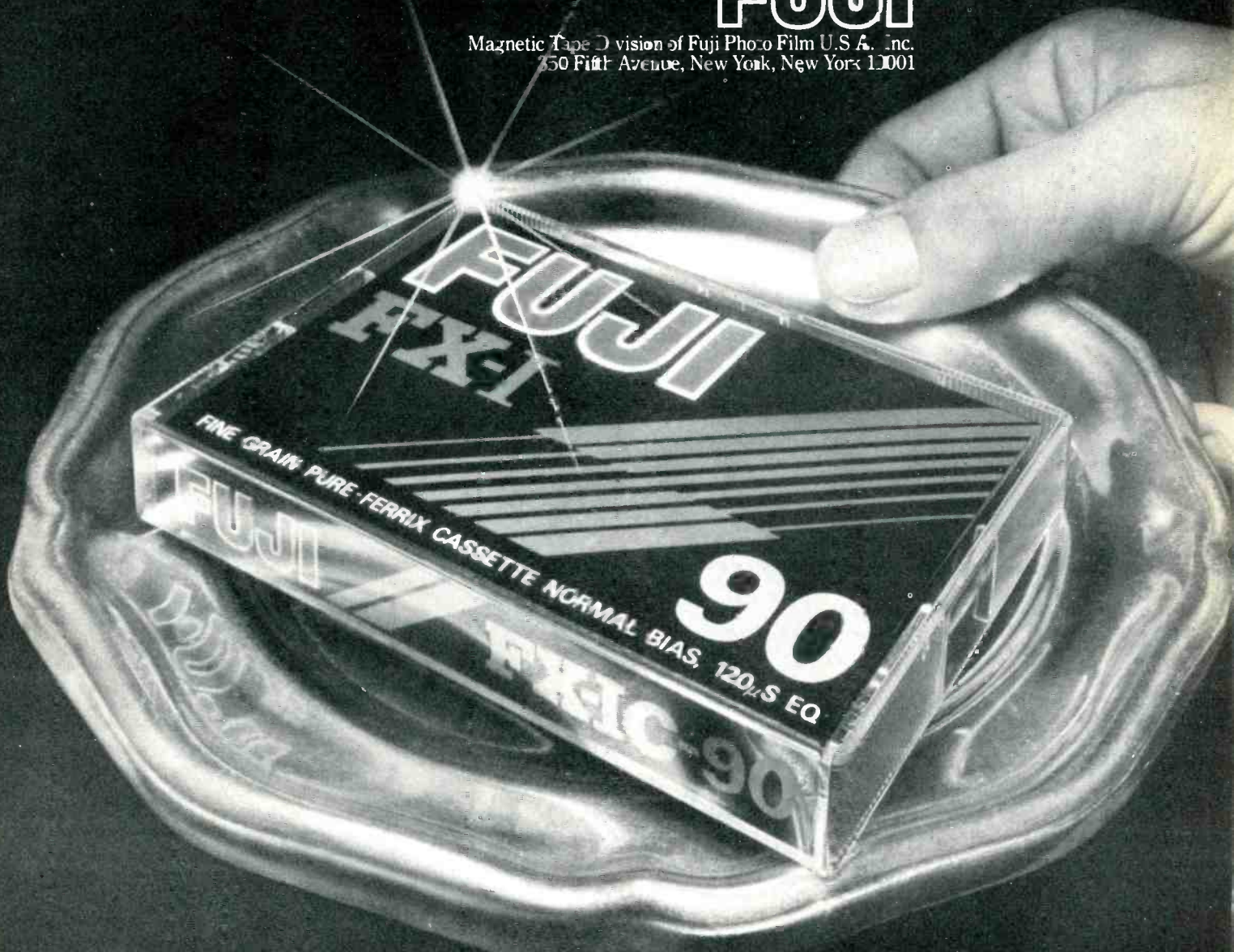

Enter No. 14 on Reader Service Card

Transco lacquers (which are made in the U.S.A.) revealed they had none in stock. Calls to friends in several record companies also verified that their stocks of lacquers were at a low level. Steve Temmer of Gotham Audio in New York, importer of Neumann disc cutting lathes and Pyral lacquers into the U.S.A., has written a "white paper" on the serious threat to the entire record industry posed by the shortage of lacquers. Among other things, he points out that the aluminum discs are made from very special aluminum to very close tolerances, and the alumi-

num companies do not like to make them, as they claim they make no profit on such items.

Here in England, the problem is compounded because EMI, which used to make lacquers, has gone out of the business. So that leaves but three companies in the entire world who make lacquer discs . . . Transco and Audio Devices in the U.S., and Pyral in France. It so happens that EMI owns Capitol Records in the U.S., which in turn owns Audio Devices, so perhaps this is why EMI abandoned the business themselves. It must be

pointed out that there have been many threats to the continued existence of the venerable phonograph record. Tape was going to supplant it, etc.

Such has not been the case, and even now, at the beginning of the digital era, the disc has a role to play in several areas of this technology. For regular analog and for certain digital discs, lacquer recording discs or some variation of them will still be a vitally important part of the entire record business.

Needless to say the companies involved are looking to alternative materials, if the situation with the aluminum companies should worsen. During the War, when there simply was no aluminum available for such luxuries as recording blanks, glass was quite successfully substituted, although breakage could quite obviously ruin a recording. George Konk, the President of Transco, has done some experiments with glass as a substrate.

Substrate Substitute

Actually, modern tempered glass, which is quite resistant to breakage, is nearly an ideal medium for use as recording lacquers. For one thing, obviously it can be polished to optical flatness. The disc needs to be a bit thicker than its aluminum equivalent, and it must be treated with a special compound before the lacquer can be properly "flowed" on the surface. It is an advantage to have the flatness of the glass disc, and one hopes this would produce smoother lacquers. Even with the aluminum discs, which are very highly polished, this does not guarantee every lacquer will be usable. Quite often there are tiny undulations on the surfaces, which can result in rejecting as many as 50 percent or even more of the discs in a given package, if you are doing really critical mastering as in direct-to-disc work.

In America, reject or even used lacquers can be returned to Transco for a certain credit, and then they are stripped of lacquer, and repolished as good as new. With a shortage of blanks, this makes good sense and in no way results in an inferior product. I was a bit shocked to find that in England there is no reclamation system, particularly in view of the lacquer shortage here, which is considerably worse than in the U.S.

The need for alternatives is obvious; glass or otherwise, we have got to find a satisfactory disc recording medium. What was my solution to finding discs in England? Why I had some flown in from Transco, of course, although with customs duties and taxes, they were mighty expensive lacquers! A

24

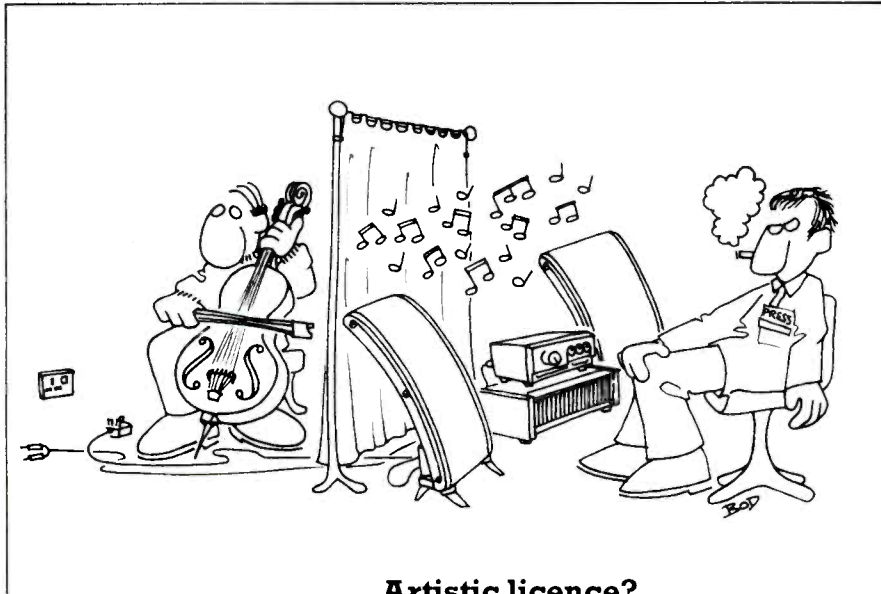

Artistic licence?

We at QUAD go to a very great deal of trouble to ensure that with a QUAD 33 in the Cancel position, the voltage delivered to your loudspeakers is a virtually exact RIAA transfer of the voltage the pickup will produce into a stated passive load. Nothing added - nothing taken away.

A visiting journalist recently suggested that we should not do this. Final adjustment should be done by ear, he said.

What an opportunity!

After all we know that if we add a little warmth with a subtle boost in the lower middle and balance this with an ever so gentle hump in the quack region (2-3kHz), we can make most programmes sound superficially more impressive. Come to that, why not change the 3180uS to 5000uS adding a little more 'heft' that most people will fall for. We could even make a special model for the boom and tizz brigade.

Been to any live concerts recently ?

For further details on the full range of QUAD products write to:
The Acoustical Manufacturing Co. Ltd.,
Huntingdon, Cambs. PE18 7DB, England.
Telephone : (0480) 52561

QUAD 

for the closest approach to the original sound
QUAD is a Registered Trade Mark

What's new

Pioneer Cassette Deck

The Model CT-F900 cassette tape deck is a three-head unit featuring full electronic function control, fluorescent level indicators, four electronic-memory controls, an electronically-controlled d.c. servo motor with a built-in generator for capstan drive, a d.c. high torque motor for fast forward and rewind, an MPX filter, and Sendust-alloy record and playback heads. The fluorescent level indicators offer high speed response at all recording levels from -20 dB to +7 dB, indicate average levels, and can be programmed to hold peak values for reference. The electronic controls allow for memory stop, memory play, coun-



ter repeat, and end repeat. The three-head design enables monitoring during recording. The unit has variable bias control, manual EQ settings for standard and FeCr tapes, and automatic EQ adjustment for CrO₂ tapes. Wow and flutter is 0.05 percent, S/N ratio is 64 dB with Dolby, frequency response of 20-17 kHz (30-15 kHz ± 3 dB) for standard tapes, 20-19 kHz (30-17 kHz ± 3 dB) for CrO₂ tapes, and 20-19 kHz (30-17 kHz ± 3 dB) for FeCr tapes. Price: \$475.00.

Enter No. 61 on Reader Service Card

Mitsubishi Tuner/Preamp

The Mitsubishi DA-C20 dual monaural tuner/preamplifier is built to dock with any of the company's four power amplifiers. The FM tuner section has an S/N ratio (IHF) of 80 dB (mono) and 75 dB (stereo), a frequency response of ± 1 dB from 30 Hz to 15 kHz, and a THD at 1 kHz in mono is 0.05 percent and 0.08 percent (IHF) for stereo. The AM tuner section has a S/N ratio of 50 dB, 30-dB selectivity,



and a THD of 0.8 percent. The preamp section has a S/N ratio of 84 dB phono and 110 dB tuner (IHF), the moving-coil phono preamp section has a S/N ratio of 74 dB, channel separation crosstalk is less than noise level at 1 kHz, and frequency response re: RIAA for phono is ± 0.2 dB from 20 Hz to 20 kHz, while THD for MM phono is 0.003 percent, phono MC is 0.005 percent, and high level is 0.002 percent. Interchannel separation is 80 dB or better at 20 kHz. The unit features a rotary disc tuning dial, signal strength and center channel tuning meters, tape monitor and tape duplicate functions, mode and subsonic filter switches, switchable selectivity, muting-mode controls, and variable attenuator. Price: \$490.00.

Enter No. 62 on Reader Service Card

Apt/Holman Preamplifier

The Apt/Holman phono preamp is designed to eliminate input impedance interactions, which are said to be the single most audible difference between otherwise good designs, by use of a FET differential-pair input configuration and separate, adjustable resistive and capacitive input terminations. Other features include an optional plug-in pre-preamplifier with adjustable gain, input termination, and resonance compensation for all moving-coil cartridges; comparative immunity to r.f.i. resulting from the FET input configuration; a noise level approaching the theoretical minimum



— the noise of the cartridge itself — achieved through design as though a real cartridge were connected and weighted for the effects of noise on listeners, and a frequency response of 20 Hz to 20 kHz, ± 0.5 dB. The infrasonic filter (defeatable) is -3 dB at 15 Hz and more than -30 dB at 4 Hz; ultrasonic filter (defeatable) is -3 dB at 50 kHz; rated output level is 2.5 V rms; THD, at rated output from 20 Hz to 20 kHz, is less than 0.05 percent; IM distortion, SMPTE method, at rated output, is less than 0.05 percent; high frequency difference-tone distortion, 19 + 20 kHz mixed 1:1, is less than 0.05 percent, and transient intermodulation distortion (Otalá method) is less than 0.05 percent. Price: \$447.00.

Enter No. 63 on Reader Service Card



Miller & Kreisel Loudspeaker

The Bass Cube loudspeaker has dual voice coil drivers with a 2nd-order Butterworth (B2) maximally flat ($f_c=f_3$) alignment for the woofer, and is available in three sizes, with an optional built-in selectable crossover. Price: \$160.00.

Enter No. 64 on Reader Service Card

Tape guide

Herman Burstein

Head Quandry

Q. I took my tape deck to a reliable service shop after noticing a considerable loss of high frequencies. The serviceman said that the most probable solution was to have the worn heads replaced with new ones. However, I have read that some heads can be resurfaced and work just like new. Will such resurfacing restore the original high frequency response? — Bill Arnold, Glidden, Iowa

A. I am inclined to be a bit doubtful about lapping (resurfacing) the heads. While the high frequency response of the playback head may be restored, this may only be for a short while unless the gap is fairly deep. It seems, to me, that the best course is to get a new head. Keep in mind that the head which is usually most affected by wear is the playback head . . . so it may only be necessary to replace the playback head, assuming that your deck has separate record and playback heads.

Bass Increase

Q. My cassette deck has generally given me good results. Lately, however, some of my tapes have exhibited higher bass output than when I first recorded them. I'm not alone in this problem as a friend of mine with an identical deck has noticed it also. Is this a function of time, tape, or machine? — Mark Boufford, Cape Canaveral, Fla.

A. It is possible that the gap of the playback head has widened resulting in reduced treble response and, hence, an apparent increase in bass. Dirt may have accumulated on the head, causing poor tape-to-head contact, and therefore, impairment of the treble response.

Deck Connection

Q. I have two tape decks but my amplifier has source and monitor jacks for only one tape deck. Can I use the commonly available Y-connectors for recording on both decks simultaneously without damage to the components? Can I add more Y-connectors

if I purchase a third deck? — David DelVecchio, Whitehall, Pa.

A. Y-connectors may work satisfactorily for two decks without excessive loss of signal level, increase in distortion, or impairment of frequency response. The only way to know is to try, which means a modest investment in Y-connectors.

However, I doubt that you will get satisfactory results with more than two decks. In other words, if you are lucky with two decks, don't press your luck. If you are not lucky with two decks, you'll need to build or buy a switch box so that you can alternately connect the two decks to your amplifier.

Tape Treble

Q. If I use the 1 mil tape there seems to be no noticeable signal loss, but if I use the ½ mil tape of the same brand I lose volume. Also the ½ mil tape seems to have a better high-frequency response. Can you explain this? — George Woodard, Seattle, Wash.

A. The thinner (½ mil) tape has a thinner magnetic coating so that the recorded signal is, therefore, of smaller magnitude. The reason for the better treble response with the ½ mil tape is that with the magnetic coating being thinner, the middle and low frequencies are recorded at a lower level, whereas the treble frequencies are less affected by the thinner coating as they tend to be recorded nearer the surface of the tape, thus treble is emphasized relative to the other frequencies. Further, the thinner tape is more limp and, therefore, conforms better to the shape of the playback head, preserving close tape-to-head contact and better treble response.

Noise Problems

Q. I tape phonograph records using an open-reel deck and an external Dolby N/R unit. My problem is excessive tape noise. How does this happen? — Bill Westheimer, Schnectady, N.Y.

A. The records which you are taping

may have excessive noise to begin with and the Dolby system cannot remedy this. The Dolby recording level may be improperly set. You may be recording at too low a level owing to miscalibration of the deck's VU meters with respect to the tape you're using. It is also possible that you may have picked up noise owing to a magnetized head or other magnetized parts (guides, etc.) contacted by the tape.

Tape Wear

Q. What are the negative effects of tape wear on the quality of music reproduction? Does tape used in an open-reel deck at 7½ ips wear faster than tape used at 1½ ips in a cassette deck? — Allen Moore, Stanford, Cal.

A. The chief effect of tape wear appears to be a loss of the highs. Such loss occurs, principally, during the first five times or so that a recorded tape is played. At high speeds (7½ ips) this effect is negligible, occurring beyond the audible range. At slow speeds (1½ ips) this effect can be appreciable, reducing response by 6 dB or even more at 15 kHz. The extent of this loss depends upon the oxide formulation . . . some oxides may exhibit a loss of only 2 dB, while others may exhibit even greater losses.

Head Explanation

Q. I need an explanation of the cross-field head system. — Terrence McQueen, APO San Francisco

A. The cross-field head is an extra head mounted opposite the record head which contacts the base side of the tape. Its purpose is to supply bias in a manner that reduces the erasing effect of bias, thereby permitting improved treble response, along with the maintenance of low distortion and high signal-to-noise ratio.

If you have a problem or question on tape recording, write to Mr. Herman Burstein at AUDIO, 401 N. Broad Street, Philadelphia, PA 19108. All letters are answered. Please enclose a stamped, self-addressed envelope.

AUDIO • January 1979

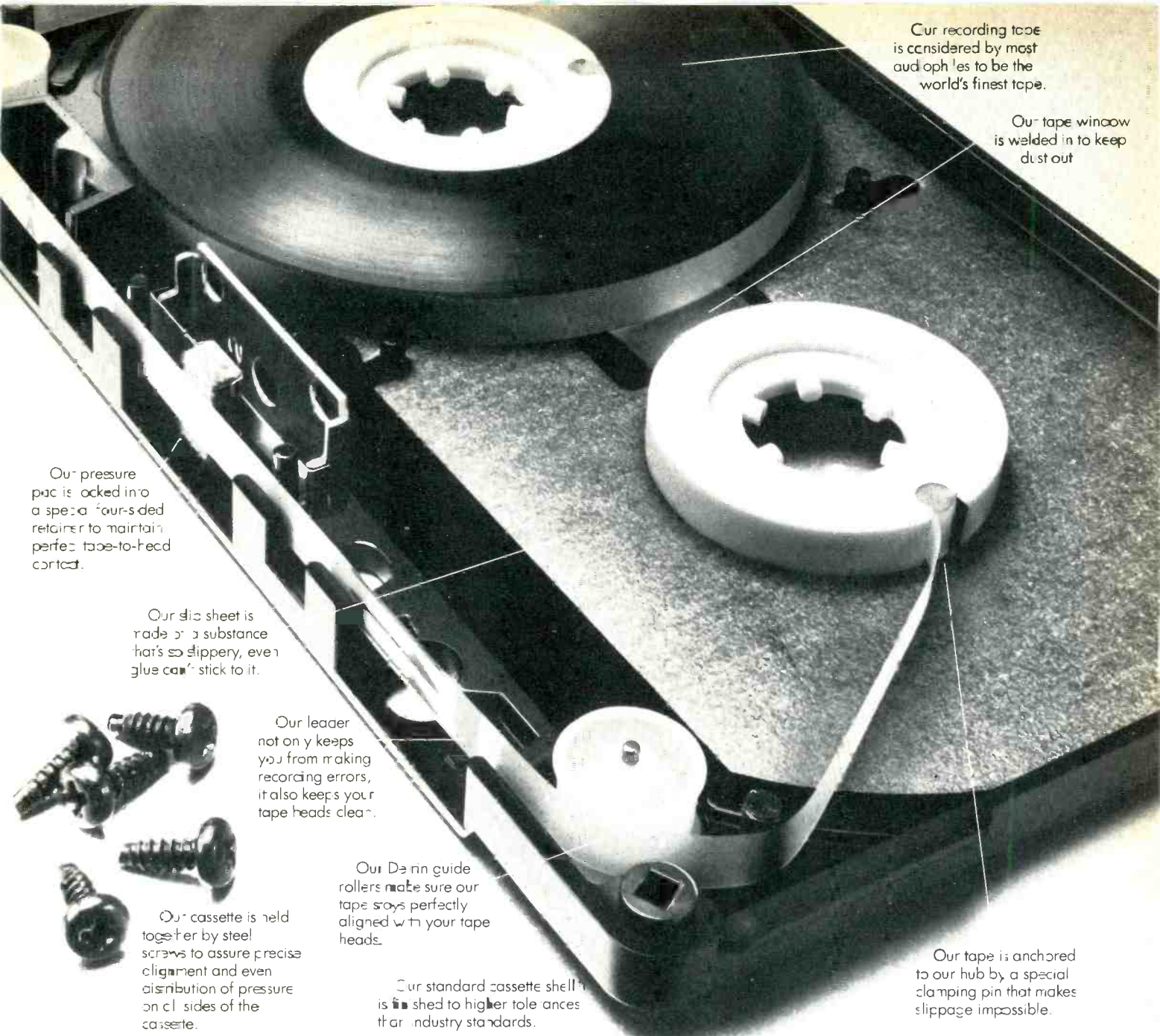

Our recording tape is considered by most audiophiles to be the world's finest tape.

Our tape window is welded in to keep dust out.

Our pressure plate is locked into a special four-sided retainer to maintain perfect tape-to-head contact.

Our die sheet is made of a substance that's so slippery, even glue can't stick to it.



Our leader not only keeps you from making recording errors, it also keeps your tape heads clean.

Our cassette is held together by steel screws to assure precise alignment and even distribution of pressure on all sides of the cassette.

Our Derrin guide rollers make sure our tape stays perfectly aligned with your tape heads.

Our standard cassette shell is finished to higher tolerances than industry standards.

Our tape is anchored to our hub by a special clamping pin that makes slippage impossible.

There's more to the world's best tape than the world's best tape.

Our reputation for making the world's best tape is due in part to making the world's best cassettes.

In fact, we put more thought

and more work into our cassettes than most manufacturers put into their tape.

We do all this, because at Maxell

we believe in a simple philosophy.

To get great sound out of a cassette takes a lot more than just putting great tape into it.



Maxell Corporation of America, 60 Oxford Drive, Mahwah, N.J. 07074.

Enter No. 20 on Reader Service Card

The bookshelf

Honkers and Shouters: The Golden Years of Rhythm & Blues by Arnold Shaw. Macmillan, New York (hardcover), \$19.95; Collier Books, New York (softcover), \$9.95.

If you like pop, rock, jazz, blues or just about any sort of music save classical, then you'll want to read *Honkers and Shouters*, since it's an indispensable reference and guide for anyone who is even mildly serious about their music. Aside from being an exhaustive source of information on R&B, the book is as entertaining with its stories, anecdotes, and interviews of fascinating music people as any historically oriented book could be.

To do it by the numbers, there are seven major chapters, entitled The Roots, The Components, The California Cataclysm, The Midwest Mavericks, East Coast R&B, Down-South R&B, and The Disc Jockey Scene, interlaced with some 25 interviews of important figures covered in each chapter. Among the interviews, or

"grooves" as Shaw calls them, are the last ever done with Louis Jordan and T-Bone Walter. The index goes from A&M Records to the Zion Kings of Harmony and, just to give you an idea of the depth of this book, contains well over 1,000 entries. Aside from a very select bibliography, there are two discographies — one for collections and the other for individual artists.

Associated with several important record and music companies during the "classic" R&B period, Shaw is also an author with several books to his credit, including two on rock, *The Rock Revolution* and *The Rockin' 50s*; two biographies, one on Belafonte and the other on Sinatra; *The World of Soul* and *The Street That Never Slept: N.Y.'s Fabled 52nd St.* He's also composed about half a dozen light classic pieces, mostly for piano.

The tone of the book is a little scholarly in places, though this is easily forgiven for the enormous weight of information, and at times Shaw mildly

criticizes music critics "who sometimes think of their music as if it were an original creation of the Elvis Presley/Pat Boone generation of the 1950s." Save for these two small criticisms, I can only wish the book were longer.

Shaw tends to plead a special meaning for "rhythm & blues," separating it pretty clearly from most all music produced by whites and even from soul. Says Shaw on this last point, "they stem from the same roots, but the expression is different enough to involve a detectable difference of style, the difference between the Isley Brothers' 'Twist and Shout' and their 'Fight the Power.' James Brown is not B.B. King, Aretha Franklin is not Dinah Washington, and Ray Charles is not Muddy Waters." 'Nuff said.

The book is full of fascinating information about musicians most will know only in later contexts, as well as intimate details of groups who had only one or two big records. For example, did you know that Ike Turner was

How to improve your tonearm.

One of the most frequently-asked questions in high fidelity these days is how well a particular tonearm and cartridge work together. Because tonearm/cartridge compatibility is increasingly recognized as vital to accurate record reproduction.

At Micro-Acoustics, we have a unique solution: *the first phono cartridge specifically designed to help any tonearm work at*

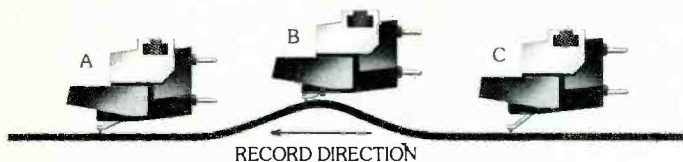

Figure 1. Record warp activates tonearm/cartridge resonance, undesirably reducing and increasing stylus force. (A) Normal position — normal tracking force. (B) Compressed position — increased tracking force. (C) Extended position — decreased tracking force. Record direction is right to left.

its best — whether that tonearm is straight or S-shaped, low- or high-mass, with low to high cable capacity. We call it the 2002-e ... and it offers significant advantages over conventional cartridge designs.

Tonearm/cartridge resonance: a critical problem

Record warp, present to some degree on nearly every disc you play, causes the cartridge to move up and down about the stylus (see Figure 1). This low-frequency up-and-down oscillation — called *tonearm/cartridge resonance* — can be considerable, since the amplitude of record warp can actually be *twelve to fifty times* that of the loudest musical program material.

When the tonearm/cartridge combination, moves upward

relative to the stylus, the stylus tends to be pulled out of the groove, reducing tracking force to a fraction of the tonearm setting. When this lower tracking force coincides with a loud musical passage, the cartridge mistracks, causing audible distortion and sometimes, groove jumping.

There is a common misconception that tonearm/cartridge resonance can be "matched" out of existence. The fact is, it cannot: it must be *controlled* to allow the cartridge to function properly.

Compromised vs. optimized damping

The most important factor in controlling this tonearm/cartridge oscillation is *damping* — a mechanical counterforce precisely applied to suppress resonance. Because the tonearm must be absolutely free to move, virtually all tonearms are totally undamped devices. *So damping must be supplied by the cartridge.*

In conventional cartridges, damping of tonearm/cartridge resonance must be a compromise. Because it is provided by a *single*, multi-purpose elastic bearing (see Figure 2) which must trade off maximum compliance for tracking ability (less damping) with maximum suppression of high-frequency stylus resonance and tonearm/cartridge low-frequency resonance (more damping).

In contrast to this, Micro-Acoustics' 2002-e (Figure 3) has a sophisticated *multiple* damping system utilizing *eight* specialized

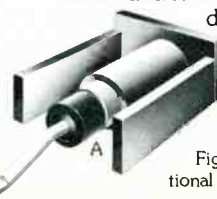

Figure 2. Single multi-purpose elastic bearing (A) on conventional cartridges compromises damping and compliance.

a Memphis talent scout for the Modern Records group, beginning at about age 16? And what about Muddy Waters just walking into the Chess Records storefront office and studio at 71st and Phillips in Chicago? And that one of Ahmet Ertegun's first records for Atlantic was of a jazz band formed by Joe Morris, previously a trumpeter for Lionel Hampton, which included Philly Joe Jones, Percy Heath, and (unbelievably) Ray Charles.

One of the best stories is from Elvis Presley:

"You want to make some blues?" Sam Phillips [of Sun Records] asked, knowing that I'd always been a sucker for that kind of jive. He mentioned Big Boy Crudup's name and maybe others, too. All I know is, I hung up and run fifteen blocks to Sun Records' office before Mr. Phillips had gotten off the line. We talked about all the Crudup records I knew — 'Rock Me, Mama,' 'Everything's A-Right,' 'Hey, Mama,' 'Cool Disposition,' and others, and settled for 'That's All Right'..."

If you want any more, you'll have to go read the book yourself. — E.P.

Walk Away René by Hipgnosis. A&W Visual Library, 1978, \$10.95.

Hipgnosis has been at the vanguard of exciting and innovative graphics,

mostly on the covers of record albums, for more than a decade now. Their clientele regularly includes Pink Floyd, Led Zeppelin, 10 cc, Al Stewart, Wings, and many, many more. *Walk Away René* is a combination retrospective, overview, critique, history, and scrapbook.

The book's layout could easily have been a simple chronological progression, but given the ambitious nature of *The Album Cover Album*, a project Hipgnosis and Roger Dean collaborated on brilliantly and released a year-plus ago, they would obviously not have been pleased with that simple an out. Instead Hipgnosis, which consists of Aubrey "Po" Powell, Peter Christofferson, and Storm Thorgerson, who wrote the text for *René* in association with their oft-times collaborator, and illustrator George Hardie, developed categories to illuminate their work and what goes into it. Typical headings for collected work are Animals, Nostalgia, Rays of Light, Projects (a catch-all for non-record jobs), Record Labels, Dust Sleeves, and Stories. Special sections are devoted to the covers for Led Zeppelin's *Presence* and Pink Floyd's *Wish You Were Here* and *A Nice Pair* albums, exceptional packages all. The How a Sleeve is Done section focuses on their job for 10 cc's *Deceptive*

Bends from conceptualization, false starts, shooting, and design all the way through printing and assembly. Some particularly provocative ideas surface in the *Unsold Ideas* and *Tasteless* sections.

Storm Thorgerson's text is a bit dry but direct and informative about Hipgnosis' techniques and trickery. He is best when relating anecdotes about memorable assignments. There is an appendix with photographer/designer/illustrator credits for the included pieces as well as data on what camera film, lighting, and lens were used, location of the shot, and what special techniques (montage, hand tinting, etc.) were needed.

From cover to cover, reproduction is in full color with stunning, sumptuous reproduction which is all I could have hoped it would be.

Hipgnosis is clearly the best, most exciting design firm doing record cover work and have deserved this kind of volume for a while. What with Roger Dean's *Views* and *The Album Cover Album*, they have had a hand in the three best books examining the graphics that have been so instrumental a part in the music business' explosion in the 70s. The firm may well remain the best for a long while yet.

Michael Tearson

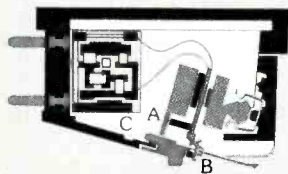

Figure 3. In Micro-Acoustics 2002-e, one pair of dampers—low-frequency warp stabilizers (A)—control tonearm/cartridge resonance. Other dampers optimize other characteristics. Dual bearings (B) provide maximum tracking ability. Microcircuit (C) optimizes cartridge output to any cable capacitance (Only one channel shown.)

dampers. One pair are low-frequency warp stabilizers, specifically designed to control tonearm/cartridge resonance. This is the first effective warp-control system because it suppresses oscillation at the cantilever pivot, rather than ahead of the stylus. The remaining six dampers are optimized for stylus high-frequency damping and other factors, while our exclusive dual-bearing system independently optimizes tracking ability. By designing separate systems for damping and compliance within the 2002-e, we can precisely control tonearm/cartridge resonance without compromising any other aspect of cartridge performance.

High vs. low cartridge body weight

Regardless of the tonearm and damping system utilized, the lower the cartridge body weight, the greater the tonearm's ability to track warped records. This is because lower tonearm/cartridge weight allows damping to more effectively counter tonearm/cartridge resonance. At four grams, the Micro-Acoustics 2002-e is half the weight of many other



high-quality cartridges, yielding two or more times the effective damping.

Cable capacitance capability

Another important limitation of conventional cartridges is their inter-action with cable capacity, which causes a deterioration in high-frequency response and transient ability (see Figure 4). In contrast to this, the 2002-e has a passive microcircuit which automatically matches the cartridge output to any tonearm's cable capacity, providing linear high-frequency response and transient accuracy.

Figure 4. With conventional cartridges (A), low cable capacity causes response to peak; medium-to-high capacity (B) caused high-frequency response to roll off. Response of 2002-e (C) is unaffected.

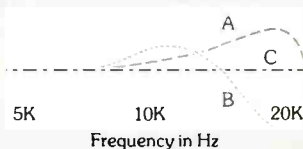

Tonearm optimization made easy

If there were no such thing as tonearm/cartridge resonance or cable capacity, any cartridge would match any tonearm. But in the real world, where these problems exist, the only way to get optimum performance from your tonearm is the Micro-Acoustics 2002-e. Or our other direct-coupled cartridges: the moderately-priced 282-e and top-of-the-line 530-mp. All of them offer advantages you can hear today, at your Micro-Acoustics dealer.

Micro-Acoustics Corporation, 8 Westchester Plaza, Elmsford, NY 10523. 914-592-7627. In Canada, H. Roy Gray, Ltd., Markham, Ontario.



© 1978, Micro-Acoustics Corporation

Until recently, there has existed no simple general method for designing selective minimum-phase, constant time delay filters. Since constant time delay filters are necessary for low distortion FM signal transmission and minimum-phase filters are easy to construct and align, a general method for locating the poles or resonant frequencies of minimum phase constant time delay filters would be useful. The method presented here uses a FORTRAN computer program to realize a new class of highly selective minimum-phase, constant time delay filters. Experimental FM tuners were constructed to test the new filter characteristic and will be discussed first. Two successful commercial designs, the McIntosh MR-77 and MR-78, will then be examined.

With the advent of stereo FM broadcasting, very stringent requirements have been set for the design of a high-fidelity receiver. In particular, one important aspect of FM receiver design, the i.f. amplifier delay characteristic, has been largely compromised in tuners and receivers intended for the consumer market. Typically, these circuits fall into a general stereotype consisting of limiter-amplifier stages separated by tuned circuits of insufficient selectivity, a sacrifice necessary in order to obtain reasonably constant time delay.

In seeking a means to improve upon the performance of FM i.f. amplifiers, a new linear-phase filter, the Rimo filter, has been devised. The filter designs are arrived at by computer solution (1). A brief discussion of the theory behind the computer solution follows,

Rimo FM Tuner Filters

Richard Modafferri

with some applications of this theory to commercial FM tuner designs.

One of these designs, the McIntosh MR-78, became the first tuner to achieve adjacent-channel reception capability. Variable-selectivity FM i.f. systems, including the MR-78, will be discussed in the final part of this paper. We begin with a treatment of some of the basic theoretical aspects of low-distortion, high-selectivity FM receiving systems.

I.f. Amplifier Bandpass Characteristics

First, the ordinary design approaches to the FM i.f. amplifier system were investigated. Both cascaded synchronously tuned and stagger-damped Bessel filter systems were tried and rejected due to poor selectivity. Another design approach effected a compromise by using a selective minimum-phase filter characteristic (Butterworth) which had fair delay performance and enough selectivity to provide good alternate-channel reception. Adjacent-channel reception was not considered as the distortion expected would be too high.

The Butterworth tuner yielded acceptable performance and probably justifies the lack of initiative that has been evident in most commercial designs, which generally use some kind of flat-amplitude, minimum-phase filter amplifier. However, the chronic problems of insufficient selectivity and excessive stereo IM distortion persisted in these designs, and new technology was needed to improve FM i.f. amplifier performance.

One of the well-known properties of a selective, flat-amplitude, minimum-phase filter is that the time delay increases from the midband toward the band edges. If a single-tuned circuit is now placed in cascade with the aforementioned filter and is tuned to its midband frequency, a crude sort of delay equalization will result as shown in Fig. 1.

The concept in Fig. 1 can be expanded. If the poles of a minimum-phase filter can be adjusted to give any desired amplitude shape, might not they also be adjusted to give any desired passband phase response while having high skirt selectivity? Would the passband response still be useful? If the pole locations of useful filters are determined, then a new approach to the FM i.f. amplifier design problem will be found.

The Rimo Filter

Presented here are a new class of minimum-phase FM i.f. filter. Rimo filters have nominally constant time delay within their passbands and rapidly degraded delay characteristics outside their passbands. The amplitude shape is rounded in the passband, with relatively high skirt selectivity. The pole locations for these filters are obtained by computer solution (1) and allow the design of a selective, low distortion, easily aligned FM i.f. amplifier.

The general computer program allows any number of poles from four to 20 to be placed in the upper-left half S-plane. Up to 10 may be fixed, and up to 10 are movable to positions yielding minimum delay error. For example, the designer may select five poles to yield his basic selectivity, add five movable poles, and locate the 10 poles of a "hybrid" Rimo filter. This filter will then have the minimum passband delay error, given the five fixed poles and the desired selectivity.

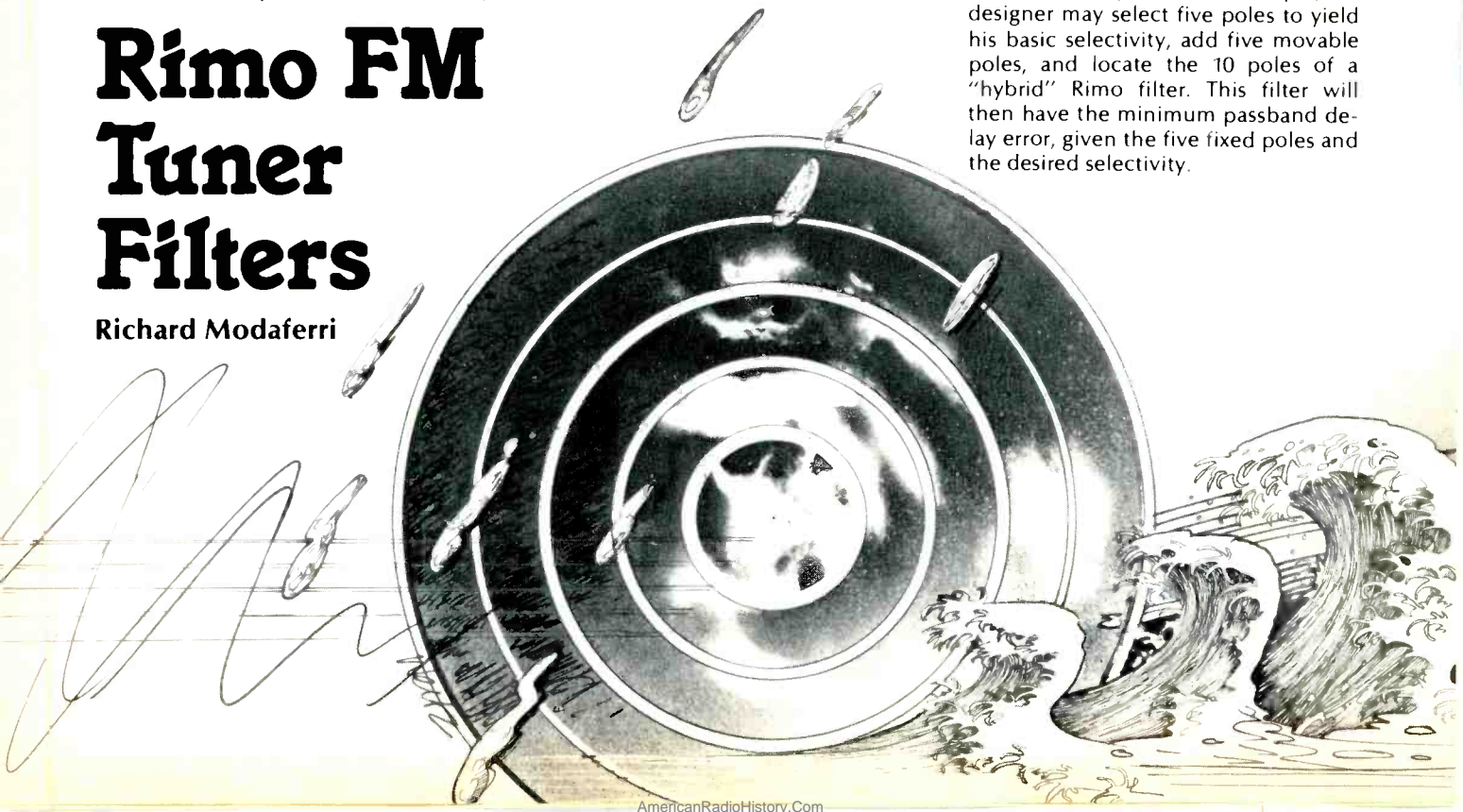



Incredibly smooth, well-defined, powerful. Yet small.

Presenting Yamaha's new NS-10M Mini-Monitor. With wide even dispersion, high sensitivity and accuracy, the sound is distinctively Yamaha: a rich, solid sound with a tight, firm bass that respects every nuance of tonal shading.

What you're going to wonder, is where it's all coming from. Because for the sound, the Mini-Monitor is amazingly small. Weighing in at 13 lbs., the speaker measures only 15.4" high, 8.5" wide. Inside, a 7" cone woofer and a 1.5" dome tweeter produce 90 dB SPL with 1 watt at 1 meter.

The Mini-Monitor was made in the image of the NS-1000. It has an identical finish, and like its bigger brother, is sold in mirror-image matched pairs. At low volume levels the sound is virtually the same. It's a primary monitor with the NS-1000 look and sound, for places the NS-1000 won't fit.

Our new Mini-Monitor with the powerful sound is currently contending with the heavyweights at your Yamaha Audio Specialty Dealer. And holding its own, thank you.



YAMAHA

Audio Division, P.O. Box 6600, Buena Park, CA 90622

If you can't find your nearest Yamaha Audio Specialty Dealer in the Yellow Pages just drop us a line.

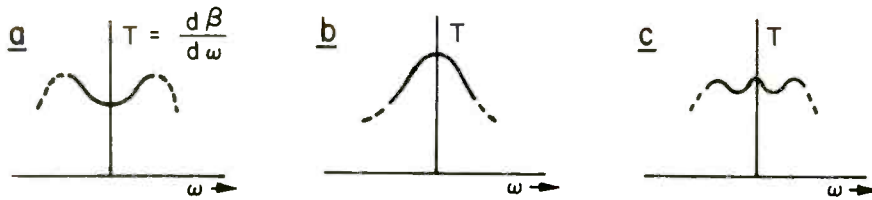

Fig. 1 — Delay equalization of a bandpass filter. A) Time delay for a typical bandpass filter with flat amplitude response. B) Time delay for a single

tuned circuit. C) Time delay with A) and B) connected in cascade. Solid part of curves is the pass band, dotted part is the stopband.

The designer could also choose no fixed poles and eight movable poles. This would yield a "pure" Rimo filter. Pure Rimo filters can give some simple high-performance designs. McIntosh's MR-77 an eight-pole pure Rimo filter made up from just four ordinary double-tuned i.f. transformers!

Basic Theory

In order to obtain a linear-phase characteristic from an arbitrary number of upper-left poles in the S-plane, a computer program is required which will be automatic and convergent, i.e. the computer must place the poles into the one optimum constellation. The upper left poles always occur in conjugate pairs; the lower left poles are assumed, but do not explicitly exist in the computer program.

Given some S-plane poles, one can obtain minimum delay error by simply moving all of them out to infinity — the resulting filter would be a cascade of open and short circuits! One avoids this trivial solution by specifying the mid-band time delay and holding this constant during execution of the program. This insures that the skirt selectivity will remain relatively constant and that the computer's action will concentrate on trading off in-band amplitude flatness with the band-center delay characteristic.

If one plots the phase response of a hypothetical narrow-band, minimum-phase bandpass filter, and superimposes on this curve a straight line drawn tangent to the phase curve at the midband frequency, the results could appear as in Fig. 2. The shaded area between the curves of Fig. 2 is a measure of the delay error of the filter. If one can move the poles of the filter in such a way as to maximally reduce this shaded area, the filter will then have optimum delay characteristics.

With the computer program devised such that the shaded area near the center frequency, in Fig. 2 is minimized as poles are moved, the problem is solved, since a filter with straight line phase shift near its center frequency will also have constant time delay near its center frequency. By not

trying to force the straight phase curve too far from the center frequency, one can hope to preserve the high skirt selectivity of the filter. It's a case of "having your cake and eating it too," and in practice, Rimo filters have remarkably constant time delay in the passband and plenty of selectivity in the skirts. The rounded top in the amplitude response takes some getting used to for those who like their FM tuners with a "square" i.f. passband

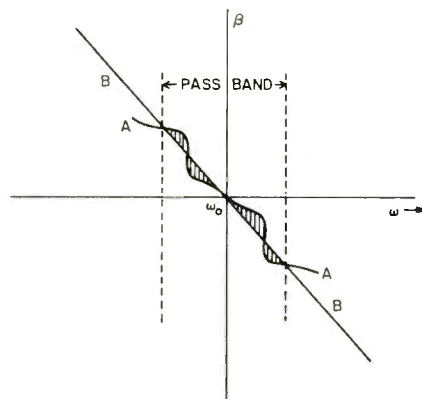

Fig. 2 — Phase response of a bandpass filter having poor phase linearity. Line A-A is the phase characteristic of the filter, B-B is a straight line tangent to phase curve at midband frequency. The shaded area between A-A and B-B is a measure of the phase error.

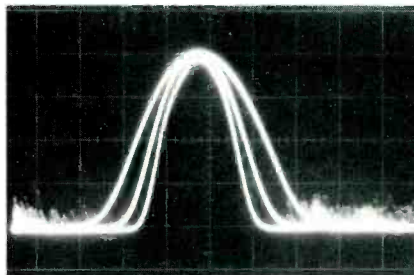

Fig. 3 — I.f. response of an FM tuner using three Rimo filters in a three-choice, variable selectivity scheme (MR-78 prototype No. 1). (Scales are 100 kHz/div., 20 dB/div.)

shape, but when one operates a Rimo-filter receiver, one never notices the i.f. passband shape. (Fig. 3.)

Effect of Nonlinear Phase Shift Upon FM Distortion

In order to establish the need for a linear-phase filter in an FM receiver, it becomes necessary to develop an analytical means for computing the signal distortion which would result from phase nonlinearities in transmission. Accurate computation of FM signal distortion is quite complex (8); this writer has derived a quasi-empirical relation (2) which is simple and gives useful engineering answers for typical FM receiver systems.

Even simplified FM distortion calculations require messy mathematics, so only the results will be discussed here. Table I tabulates the distortion and selectivity for two FM tuners, the author's early five-pole Butterworth (1962) and a later 10-pole Rimo (1965). The i.f. response and delay for these same tuners is shown in Fig. 4.

Besides having double the selectivity of the Butterworth filter, the Rimo has only one-half the distortion. Ten Butterworth poles arranged to yield 60-dB selectivity would have much greater distortion than either of the filters in Table I.

Table I — Computer third-harmonic distortion, before de-emphasis, for two FM i.f. systems.

	Five-Pole Butterworth	Ten-Pole Rimo
5-kHz Distortion	0.67%	0.38%
20-kHz Distortion	2.68%	1.51%
IHF Alternate Channel Selectivity	30 dB	60 dB

Application of the Rimo Filter To the FM I.f. Amplifier

The real usefulness of the Rimo filter lies in its application to FM transmission. Ideal FM signals are sensitive to phase information only, and the linear-phase characteristic of Rimo filters make them particularly well suited to FM amplifier use. If an FM signal is passed through an i.f. system using these filters, the important phase information will suffer negligibly, while a good limiter will easily handle the

Again we turn the world around.

The world's first pure power DC receivers, the Sansui G-line, redefined the limits of musical fidelity. Sansui's capacitor-free DC amplifier design (patent pending) with super-high slew rate, ultra-fast rise time, and full transient response, makes music sound much more true-to-life.

Now Sansui does it again. With the new G-7500 and G-5500. Using the same exclusive DC circuitry all others are trying to imitate, these new models offer more watts per dollar than ever before.

The **G-7500** delivers 90 watts per channel, min. RMS, both channels into 8 ohms from 20 to 20,000Hz with no more than 0.025% total harmonic distortion, at a suggested retail price of only \$620.

The **G-5500**, at a suggested retail price of only \$465, offers 60 watts per channel with no more than 0.03% THD under the same conditions.

From their macro-designed power supplies, for rich, full sound over the widest frequency range, to their micro-sensitive double speaker-protection circuitry, the G-7500 and G-5500 are unbeatable.

The FM sections further enhance Sansui's reputation for tuner excellence. Pinpoint selectivity and ultra-sensitivity to even the weakest signals guarantee pure and clean reception, always. And always with maximum stereo separation.

Let your franchised Sansui dealer demonstrate the comprehensive, human engineered features and controls. There's nothing in the world with quite the same feel as the Sansui click-stop attenuator and ultra-smooth tuning knob.



Now look carefully at the graceful styling, with elegant rosewood veneer cabinet. It is setting the trend for all other receivers.

For the best receiver values, the world is now turning to the newest DC by Sansui, the G-7500 and G-5500. Shouldn't you turn to Sansui, too?



SANSUI ELECTRONICS CORP.

Lynhurst, New Jersey 07071 • Gardena, Ca. 90247
 SANSUI ELECTRIC CO., LTD., Tokyo, Japan
 SANSUI AUDIO EUROPE S.A., Antwerp, Belgium
 In Canada: Electronic Distributors

Sansui

Enter No. 33 on Reader Service Card

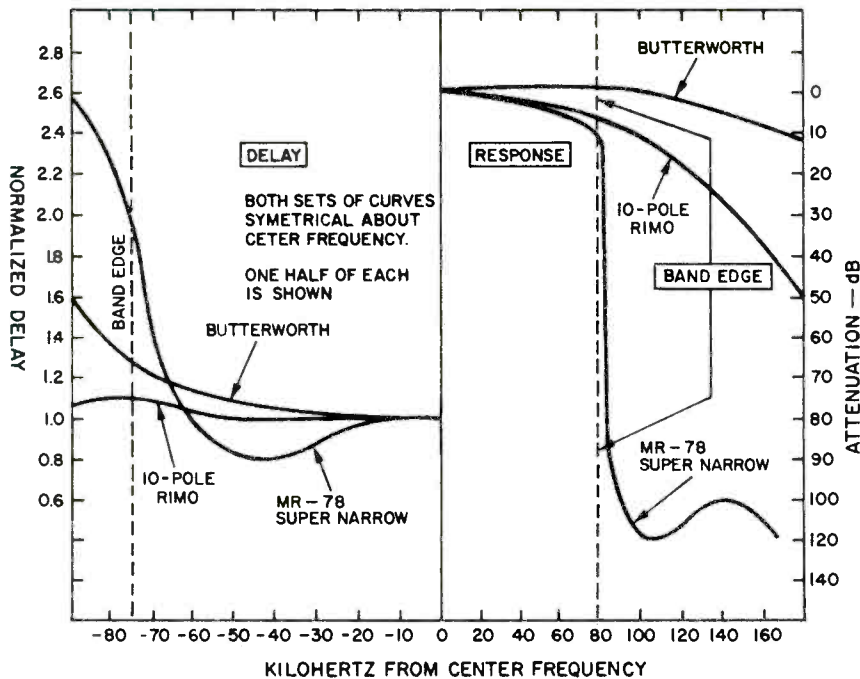

Fig. 4 — Amplitude and delay characteristics for three FM tuner i.f. systems. 1) Author's early Butterworth

tuner, c. 1962. 2) Author's 12-pole Rimo vacuum-tube tuner, c. 1965. 3) MR-78 prototype No. 3, c. 1971.

moderate passband amplitude distortion. The high selectivity will effectively suppress alternate — or even adjacent-channel signals.

Various Rimo filter tuners have been constructed by the author in the last 13 years, beginning with the original vacuum-tube model of 1965 (Fig. 5) and ending with the successful exploitation of the Rimo filter in the McIntosh MR-77 and MR-78 tuners. Also shown in Fig. 5 is an interesting battery-powered "MR-78" AM-FM radio prototype. This battery set has been backpacked and jeepped to mountain-

tops for endless and fascinating DX work. It will be the subject of a later construction article for ambitious readers.

FM Reception Problems and Solutions

FM tuners should be able to accept the r.f. energy from an antenna and convert this energy into usable audio signals. Sounds simple stated this way, but to take each and every signal at the antenna and convert it to a noise- and distortion-free audio output is extraordinarily difficult. Most tuners,

even those costing thousands of dollars, ignore up to half of the theoretically usable signals at their antennas.

This writer's tuner designs have always emphasized the optimization of the tuner's ability to convert each signal present at the antenna into a useful audio signal. Crucial to this end is the proper design of the r.f. and i.f. circuitry. The two essential considerations are front-end dynamic range and i.f. selectivity.

Dynamic range operates in an FM tuner's front end exactly the same as it does in the more familiar phono preamp. Good dynamic range in both implies that tiny signals — the little details — are not obscured by the presence of much stronger signals. Poor dynamic range in a tuner front end yields crossmodulation and spurious responses, which are really a kind of distortion. A phono preamp with the same poor dynamic range would mask orchestral detail and in general sound distorted.

I.f. selectivity is useful only up to the extent of the tuner's front-end dynamic range. For example, if the dynamic range is 100 dB, the useful maximum i.f. selectivity is also 100 dB. If one should graft the 100-dB i.f. filter onto a front end having only 50-dB dynamic range, then all signals 50 dB below the strongest one on the dial will be prone to spurious interference. Putting a poor front end ahead of a good i.f. amplifier is analogous to connecting a noisy and distorted phono preamp to a clean super-power amplifier.

The author's MR-78 prototype uses a special vacuum-tube r.f. front end and an eight-pole, four-zero crystal i.f. filter, along with 16 poles of Rimo i.f. filtering. Specifications are tabulated

36

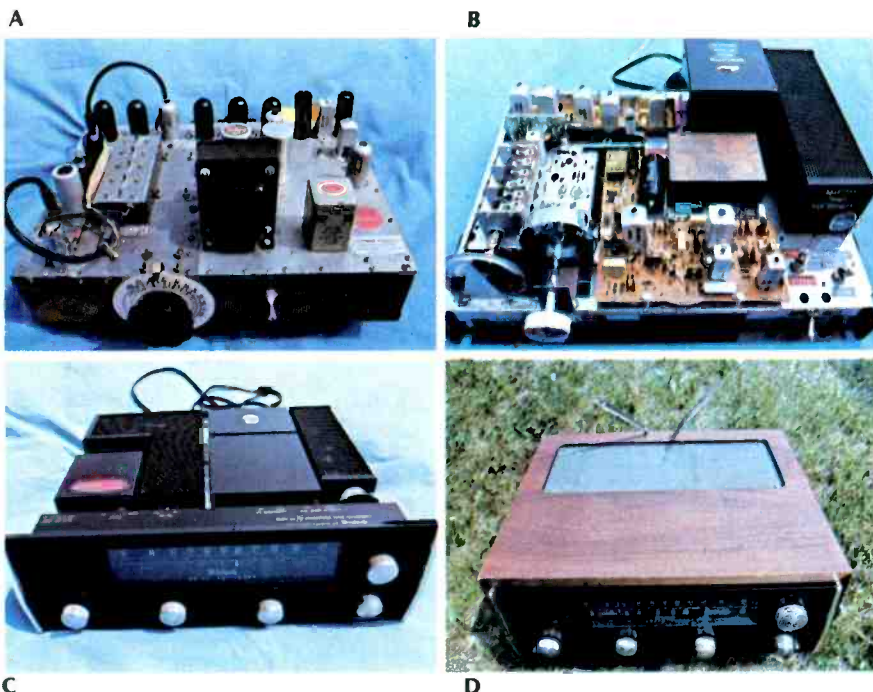

Fig. 5 — Several of the author's experimental tuner prototypes. A) Vacuum tube type, c. 1965, with the first Rimo filter. B) First MR-77. C) MR-77 No. 2, c. 1969, with 10-pole Rimo filter. D) Battery-powered MR-78.



“It’s the ideal stereophone for all types of music from hard rock to classical because of the extreme lows and highs.”

Nancy Knapcik
Audio Saleswoman, Chicago, Illinois

“The sound of the Koss HV/1A is really hearing the natural sound that the record is putting out.”

By substantially reducing the mass of the moving diaphragm assemblies used in the HV/1A, Koss has been able to achieve a wide-range frequency response of unusual fidelity. Delicate overtones, which add to the faithfulness of the reproduction, are retained. Yet, bass response is extended, clean and un-muddied.

“It’s a really distinct, professional sound as if you were listening to a large set of quality speakers in the room.”

Unlike conventional stereophones which contain the sound waves in a sealed acoustical chamber, the Koss HV/1A High Velocity Stereophone vents the back sound waves to the rear without raising the resonance or inhibiting transient response. This unique electroacoustical



design concept provides not only unusual lightness and hear-thru characteristics, but also the exciting, full-range Sound of Koss as well.

“The Koss HV/1A stereophone has a frequency response of 15Hz to 30kHz. That’s a very wide range . . . from the lowest lows you can hear to the highest highs. You can’t hear that in a cheap headphone. There’s no clipping or other types of

distortion.”

Thanks, Nancy! We’re sure that your customers couldn’t agree more . . . or hear more than all 10 of the audible octaves the HV/1A delivers. Nor will they enjoy more listening comfort than with the HV/1A’s glove soft vinyl headband and acoustical sponge ear cushions.

“You can tell they’ve got quality just by looking at them. They’re not a cheap

plastic like so many headphones.”

Designed to fit close to the head, the new Koss HV/1A Stereophone has a stylish, low-silhouette design without the cone-type projections found in other headphones. This slim design permits unusually fine acoustical tuning of the element chamber at the factory.

“I think men and women are all looking for the same thing: a really good sound.”

Why not ask your Audio Dealer for a live demonstration of the Koss HV/1A and HV/1LC with volume-balance controls. And while you’re there listen to the beautiful sound of the new Koss CM Speakers. But by all means, write c/o Virginia Lamm, for our free, full color stereophone and speaker catalog. Once you’ve experienced the Sound of Koss, we think you’ll agree with Nancy: hearing is believing.

© 1978 Koss Corp.

KOSS stereophones/loudspeakers
hearing is believing™

KOSS CORPORATION, 4129 N. Port Washington Ave., Milwaukee, WI 53212 International Headquarters: Milwaukee facilities: Canada · France · Germany · Ireland · Japan

TDK's new one-second, no-headache demagnetizer.



You don't need time or technical expertise to operate TDK's exclusive instant head demagnetizer. Just pop it into your deck and push "Play" to restore musical performance lost through inevitable head magnetization. Other demagnetizers can be less effective, take more time, or actually magnetize your heads and are more difficult to use. Because our HD-01's miniature battery powers sophisticated circuitry built into a standard cassette shell, it solves all of these problems. You will hear the performance improvement in your home, portable or auto system. TDK Electronics Corp., Garden City, NY 11530.

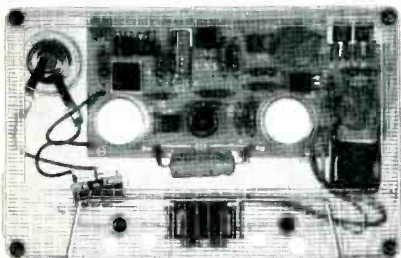

TDK
The Machine for your Machine.®

Table II — R.f. and i.f. specifications for three of the author's tuners.

Specification	Production	Battery	MR-78
	MR-78	MR-78	No. 3
IHF Sensitivity (300 ohms)	1.8 μ V	1.6 μ V	2.3 μ V
50-dB Quieting (Mono, 300 ohms)	2.5 μ V	2.0 μ V	3.0 μ V
IHF Adjacent Channel Selectivity, Normal	7 dB	3 dB	7 dB
Narrow	22 dB	15 dB	25 dB
Super-Narrow	55 dB	45 dB	100 dB
Front-End Dynamic Range (30-dB Quieting to 1-dB gain compression)	90 dB	70 dB	100 dB

in Table II. This tuner has been field tested in some very difficult reception areas. Clear stereo signals come in on this MR-78 which are inaudible or unusable on any other commercially available tuner, even at the date of this writing (11).

McIntosh's commercially available MR-78 is only a little less "hot" than the third prototype. It's a bit more sensitive, with about half the maximum selectivity. The battery set is very sensitive for best results from its "rabbit ears" antenna. Some loss in front-end dynamic range and i.f. selectivity results from tradeoffs which maximize sensitivity and minimize battery drain.

An FM tuner with 100-dB IHF alternate-channel selectivity will not guarantee adjacent-channel reception. FM stations do not always radiate signals which are as much as 100 dB down in their adjacent channels. This is especially true for stations which use an SCA subchannel.

When the FCC adopted the standards concerning signal emissions of FM stations, the minimum adjacent-channel selectivity of any FM receiver was considered to be only 6 dB (ref. 10, p. 785)!

Adjacent-channel reception was believed impossible when the FCC developed its technical standards on FM broadcasting. Today these standards have not been revised to keep up with the advances in receiver design. When surface-wave integratable filters become available in the near future, anyone will be able to market an inexpensive FM receiver with any amount of selectivity. Plastic portable radios with 100-dB adjacent-channel selectivity should cost no more than present-day sets.

Perhaps our call to alarm should be recognized. Adjacent-channel FM reception should be considered when new FM broadcast standards are written. This will become especially important with respect to discrete four-

channel broadcast systems, which will certainly aggravate the adjacent-channel reception problem. These systems contain high-energy, high-frequency modulation components that could spill over into the adjacent channel. Add an SCA subcarrier to a discrete four-channel modulation, and it may be economically and/or technically unfeasible to reduce adjacent-channel energy to a level 100 dB below carrier level.

Fortunately, many FM stations radiate a clean signal well in excess of FCC standards, at least with respect to side-band energy distribution. Owners of selective FM receivers can use high selectivity in many cases. WTIC, 96.5, Hartford, Conn., radiates low adjacent-channel energy, permitting reception of WQXR, 96.3, New York City on an MR-78 (11).

MR-77, Variable Selectivity and the MR-78

We close with a historical treatment of the MR-77 and 78 designs and the application of this design process to the solution of the FM reception problem outlined previously.

The MR-77 grew out of the author's research at New Jersey Institute of Technology in the early 1960s. The MR-77 is a direct descendant of the early vacuum-tube tuner of 1965. Selectivity was not uppermost in the author's mind at this time, so the MR-77 came to be a low-distortion tuner with good spurious response rejection and conventional selectivity. McIntosh customers soon began asking for a tuner which would receive adjacent channels. An MR-77 was taken to a difficult test location to try adjacent-channel reception and it failed (11).

An avid collector of old radios, this writer was inspired by one design concept commonly used in the "super" AM consoles of the 1930s, variable i.f. selectivity. I asked "Would this work in a modern FM tuner?" "Yes, it will,"

Bose® presents the most exciting bookshelf speaker since the Model 301.

The new Model 301. With an improved tweeter that took three years to perfect. An innovative Dual Frequency Crossover™ network that delivers smoother midrange response. A unique tweeter protection circuit that virtually eliminates tweeter burnout. And a subtle exterior modification that makes the Model 301 more elegant than ever.

But even with changes, the Model 301 retains its conventional personality.

It is, after all, a Bose Direct/Reflecting® loud-speaker system. Which means it utilizes a carefully produced balance of reflected and direct sound to give you the spatial realism of a live performance. From nearly every location in your listening room, you hear accurate stereo balance. Accurate location of each instrument, each note. Clearly, precisely. And with a fullness and richness you may have thought

impossible from such a compact enclosure.

As a matter of fact, the Model 301 delivers a level of performance which simply astounds first-time listeners.

It could happen to you. Ask your Bose dealer to demonstrate the Model 301 against any bookshelf speaker, regardless of price.

Then ask him to demonstrate the Model 301 against even much larger speakers. In each case, you will hear an open, spacious sound that expands the confines of your listening room. Suddenly, you are in a larger, more open space, listening to music as if you were hearing it for the first time.

No other bookshelf speaker even approaches the spatial realism of the new Model 301. See your Bose dealer for a demonstration and hear what we mean.

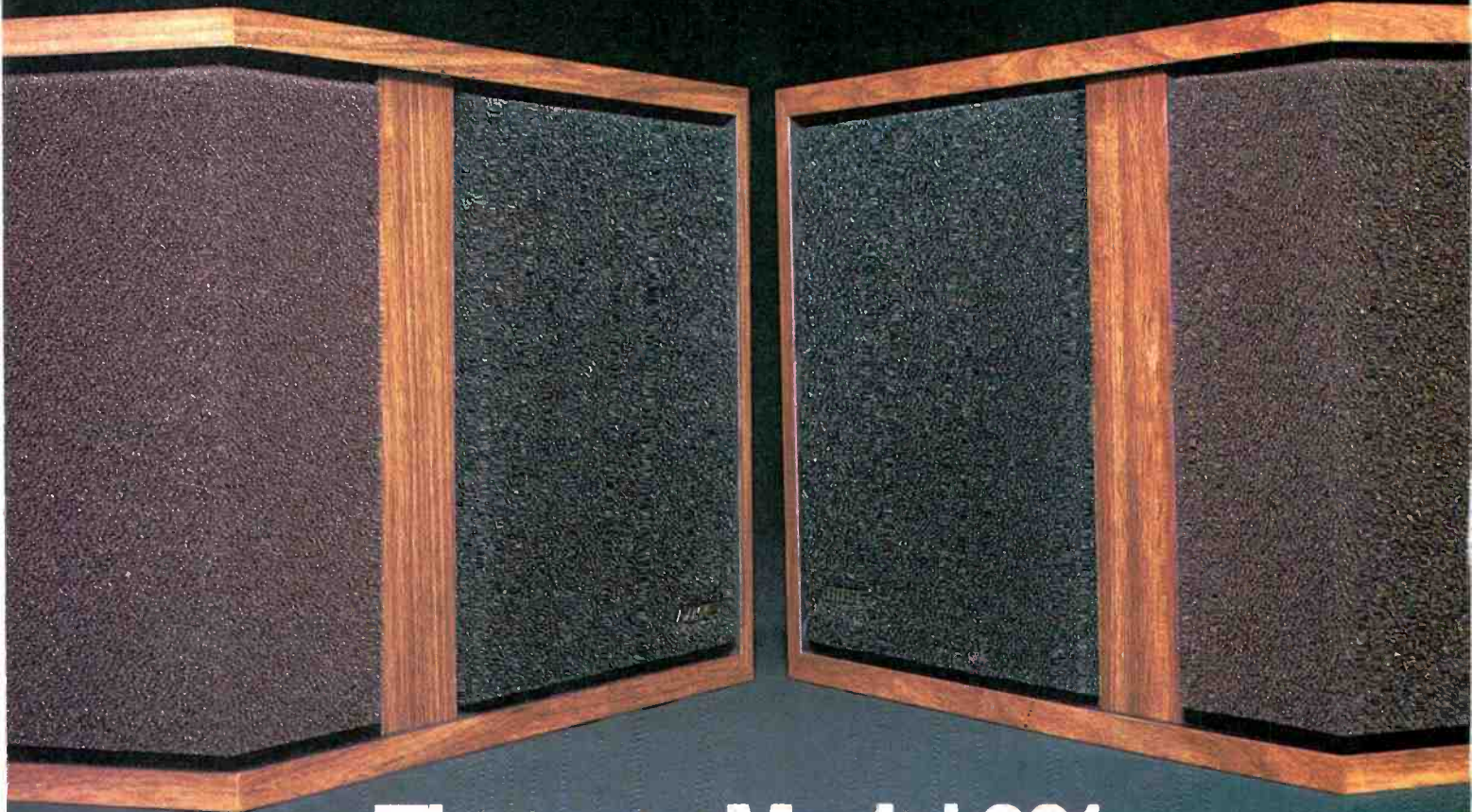
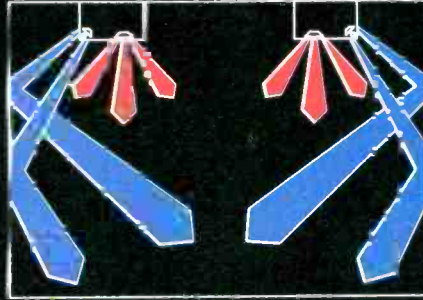

The new Model 301.

BOSE®

For complete technical information on the new Model 301 speaker system, write Bose, Dept. T, The Mountain, Framingham, MA 01701

Covered by patent rights issued and pending.

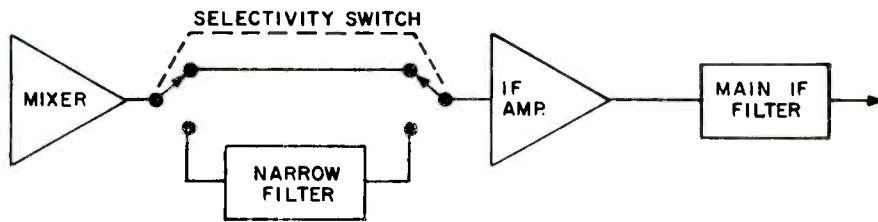

Fig. 6 — Typical i.f. system layout for an FM tuner with two selectivity choices.

came the answer, "after a lot of development work." The McIntosh variable selectivity scheme, now being adapted in most "super" tuners, involves the switching into the signal path i.f. filters which add to the selectivity (Fig. 6).

Figure 6 shows a tuner i.f. system with two choices of selectivity, *Normal* for very low distortion reception of local signals and *Narrow* for DX work. In *Normal* the tuner's main i.f. filter is used alone. In *Narrow*, the main i.f. filter remains in the signal path and a *Narrow* filter is added. Actual switching is done using diodes, transistors, or FETs (or some combination of these) so that only d.c. goes to the selectivity switch.

Figure 7 shows the somewhat more elaborate three-choice selectivity system used in the MR-78. Here, *Normal* selectivity bypasses both narrow filters and the super-narrow filter. *Narrow* selectivity switches in both narrow filters simultaneously. *Super Narrow* leaves both narrow filters still in the signal path, adding the super-narrow filter.

The three selectivity choices on the MR-78 allow the user to trade distor-

Fig. 7 — MR-78 i.f. system. Super-narrow signal path is shown. For *Narrow*, S1 points up, bypassing the super-narrow filter. For *Normal*, all switches point up, leaving only the *Normal* filters in the signal path.

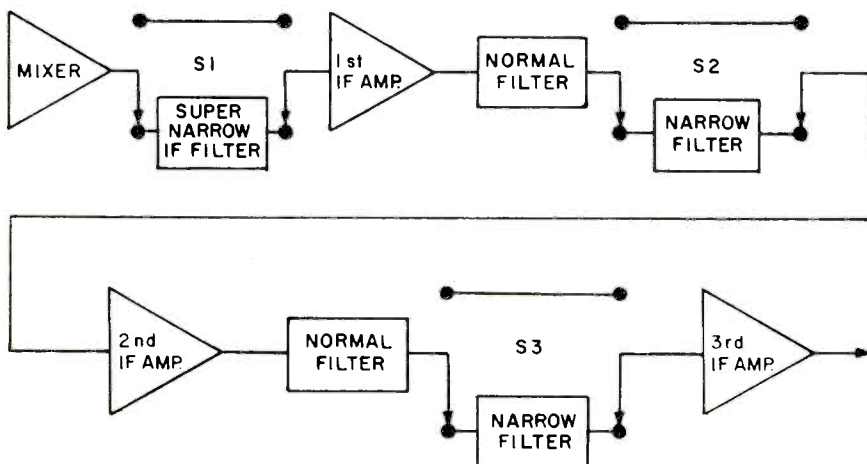

tion for selectivity as required by reception conditions. *Normal* is used for low-distortion (less than 0.1 percent) reception of local stations. *Narrow* will clear up mild interference when receiving stations from near-by cities. *Super-narrow* is used for critical DX work, to pull in those impossible stations. Distortion in super narrow is about 1 percent better than most FM source material.

Summary and Conclusion

We close this discussion by restating a simple premise: The main job of an FM tuner is to tune in FM stations. It sounds almost silly to say this until one reflects upon it for a moment. As mentioned earlier, designing an FM tuner which will receive every signal present at the antenna is not easy. One must pay careful attention to the idea that the tuner must be able to tune to each and every signal.

Return to the year 1970 and place yourself in Hartford, Conn. You want to listen to your old favorite, WQXR New York City, a 30-microvolt signal on 96.3 MHz. You would assume that almost any good FM tuner would suffice, but it isn't so.

Hartford has powerful local station, WTIC, 96.5, adjacent-channel to New York's WQXR. WTIC will obliterate WQXR's feeble signal in Hartford, because no FM tuner available in 1970 had sufficient front-end dynamic range and i.f. selectivity to tune WQXR in the presence of WTIC's overpowering signal.

What do you do about this problem? You want WQXR. You complain to your local McIntosh dealer, who

then yells at the McIntosh sales rep. Finally, I receive the demand, "Design an FM tuner that will pull WQXR in Hartford!"

The MR-78 came to be as a solution to this reception problem. People really wanted those distant, weak, adjacent-channel stations. The MR-77 would not receive them, the 10-B almost did. Needs generate advances in technology and thus the MR-78 became the first tuner to successfully receive adjacent channels. At the date of this writing, it still is the only tuner which will receive WQXR in Hartford. Other successful tuners should follow, perhaps awaiting only the awakening of the Japanese and improvement of the FM broadcast technical standards by the FCC. A

References

- (1) *The Rimo Filter*, Master's thesis, R. Modafferi, N.J.I.T., June, 1965.
- (2) *FM I.f. Filter Design*, R. Modafferi. Unpublished research at N.J.I.T., 1964.
- (3) *A New Low Distortion FM Tuner*, R. Modafferi, IEEE BTR Trans; Nov., 1970.
- (4) *A Receiver Design for Rejecting Interference*, Roy Paananen, MIT, 22 Sept., 1952. (This early paper is a little-known classic work.)
- (5) Tibbs, Johnstone, "Frequency Modulation Engineering," John Wiley, 1956.
- (6) F.F. Kuo, "Network Analysis and Synthesis," John Wiley, 1962.
- (7) Jacob Klapper, ed., "Selected Papers on Frequency Modulation," Dover, 1970.
- (8) P. Panter, "Modulation, Noise, and Spectral Analysis," McGraw-Hill, 1965.
- (9) *MR-77 and MR-78 Service Manuals*, McIntosh Laboratory, Binghamton, N.Y.
- (10) *Reference Data for Radio Engineers*, ITT Inc., New York, 1956.
- (11) "Thanks for the Memories," letter by R. Modafferi to *Audio*, May, 1977, p. 6.

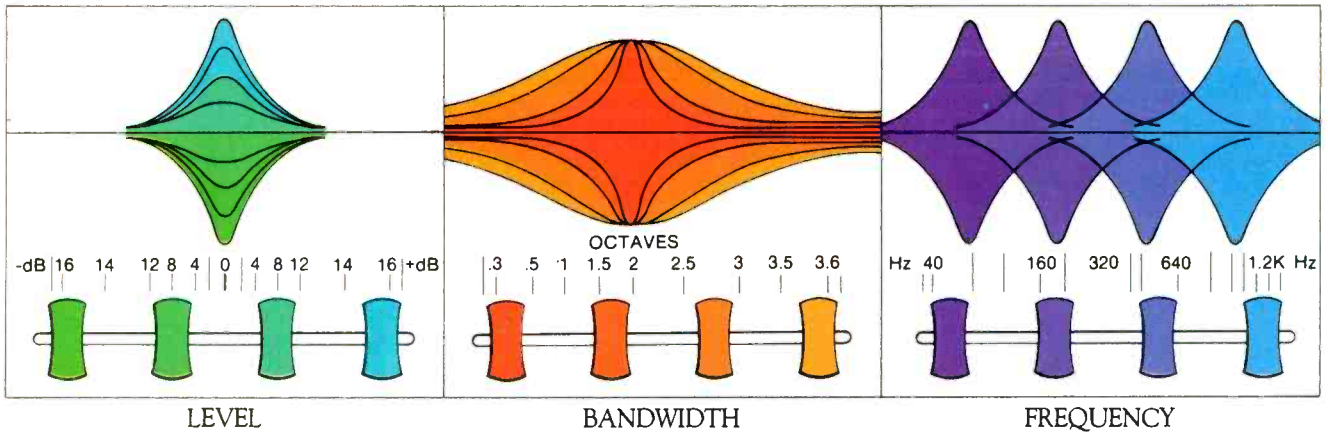

With the graphic equalizer, you have a limited number of chances to correct an infinite number of potential problems in a recording or listening environment. You're dealing with fixed bandwidths and fixed frequencies. You can only increase or decrease the level. When boosting or cutting frequencies,

you have to settle for the nearest one or two octaves. It's a compromise. With the parametric, you're provided an infinite number of solutions. Bandwidth, frequency and level are each determined by you. Any musical problem can be isolated and corrected. And that's what all the excitement's about.

The graphic reason to buy our parametric.

At SAE, the battle has always been for complete musical control. Control that would allow you to correct for any inadequacy in any recording or listening environment.

Now the battle is over. You won.

SAE introduces the 180 Parametric Equalizer.

Actually, if you work for a recording studio, "introducing" would hardly be appropriate. You'd be working with parametrics already. Very simply, it's a matter of flexibility and precision. And very simply, with the SAE 180, the flexibility and precision of your sound control are absolutely limitless.

We should let the parametric speak for itself.

Problem: The lead singer is overpowered by the back-up group.

Solution: Set Level control to +10dB. Sweep Frequency control until the voice is brought

forward. Adjust Bandwidth control to encompass the full voice range. Tailor Level control to exact voice presence desired.

How much does a machine like this cost? How can I afford a component that can acoustically correct a system? How can I buy an electronic box that can fix a listening room and a recording at the same time?

The SAE 180 costs \$250.* That's how.

What we have is a small miracle that is also an attainable reality. Imagine: Complete, precise, musical control for the price of a common graphic.

Remember that word: Parametric. Remember that number: 180. And remember that name: SAE.



I want control. Send information.

Name _____
 Address _____
 City _____ State _____ Zip _____

SEND TO: SAE, P.O. Box 60271, Terminal Annex,
 Los Angeles, California 90060



Scientific Audio Electronics, Inc.

Enter No. 32 on Reader Service Card

*Nationally advertised value, actual retail prices are established by SAE Dealers.

SPECIAL ANTENNA TECHNIQUES

M. J. Salvati

The four-part series on FM antenna systems run last year elicited unusually high reader response. Many wrote in to say how much they liked the series. Many wrote in to say they liked it, but it didn't cover this or that problem they have. Apparently a goodly chunk (or at least a very vocal chunk) of the readers have problems that fall into one or more of the following categories: On-channel interference, severe multipath, or a desire to hear a distant station that is very close in frequency to a local station. These problems have a common characteristic, they are all forms of on-channel interference, hence they cannot be filtered out. The only effective method of rejecting the undesired signal is by extreme antenna directionality, and this is achieved by antenna systems using multiple antennas (arrays). Thus, this final article will deal with esoteric antenna techniques yielding extreme directionality and related techniques for achieving maximum antenna output.

Stacked Arrays

Stacked arrays are combinations of two or more antennas whose outputs are combined in a way that provides nearly double the signal power and an array pattern having characteristics un-

like that of any single antenna. The patterns may be characterized by a very-narrow main lobe with deep nulls alongside or extremely high F/B ratio.

The individual antenna outputs are combined by using a two-way signal splitter backwards. The baluns of the two antennas are connected with equal lengths of coax to the "out" ports of the splitter; the "in" port is connected to the long run of coaxial cable that goes to your tuner. The exact amount of gain increase actually achieved depends mainly on the resistive losses of the splitter; 3 dB is the maximum-possible gain (perfect splitter). The splitter must also be waterproof, since it is generally located on the mast near the antennas. The RMS Electronics MA-2UV or CA-1002/5M described in Part II are ideal for this purpose; the 100 MHz combining gain of these miniature units with die-cast housings was measured at 2.6 to 2.7 dB. Do not attempt stacking at 300-ohms impedance unless gain is of secondary importance; aside from the difficulty of installing the combining lines, the best 300-ohm splitters have a combining gain of only 2.2 dB.

The coax sections from the antennas to the splitter must be equal within 2 inches. The baluns must be connected so the two antennas are phased properly (yes, just like speakers). If the phasing is reversed, the array output will be less than that of a single antenna, and the pattern will be haywire. So make the balun connections to each antenna as alike as possible. This includes having the same side up, and the same transmission line approach.

To check the phasing, point the antenna array toward a moderately weak station whose direction is accurately known. This is very important for horizontally stacked

arrays. Add attenuation between the tuner input and transmission line until the signal-level meter indication is a little less than half of full scale. Then reverse one *balun* connection and check the meter. If the signal level has dropped, the original connection was correct and should be restored. However, if the signal level improved, leave the new connection as is. Do this procedure with the AFC off and at a frequency that has no other stations on it or on the adjacent channels.

The type of array needed depends on the direction (or bearing) of the undesired signal relative to the desired signal. If the undesired station or interference is in the opposite direction (interfering signal A in Fig. 1), a single antenna with very-high F/B ratio may do the job (as was mentioned in Part III, Reception Problems). However, for severe cases the technique known as *stagger stacking* must be used. If the interference is coming from the side (interfering signal B), reorienting a single antenna with deep side nulls may do the job (again, as described in Part III). However, if the angle is very small (as interfering signal C), no single antenna has narrow enough beamwidth to null out the interfering signal and provide maximum output of desired signal. A pair of *horizontally stacked* antennas is needed.

When the interference problem is not one of bearing but of elevation, *vertical stacking* is indicated.

Vertical Stacking. In vertical stacking two identical antennas are mounted one above the other. This is very easy to accomplish mechanically, since both antennas mount on the same mast (Fig. 2). Vertical stacking has no effect on the horizontal-plane beamwidth, it is the same as that of a single antenna. However, the *vertical-plane* beamwidth (or should we say, beam height) is greatly decreased. Deep nulls appear in the pattern

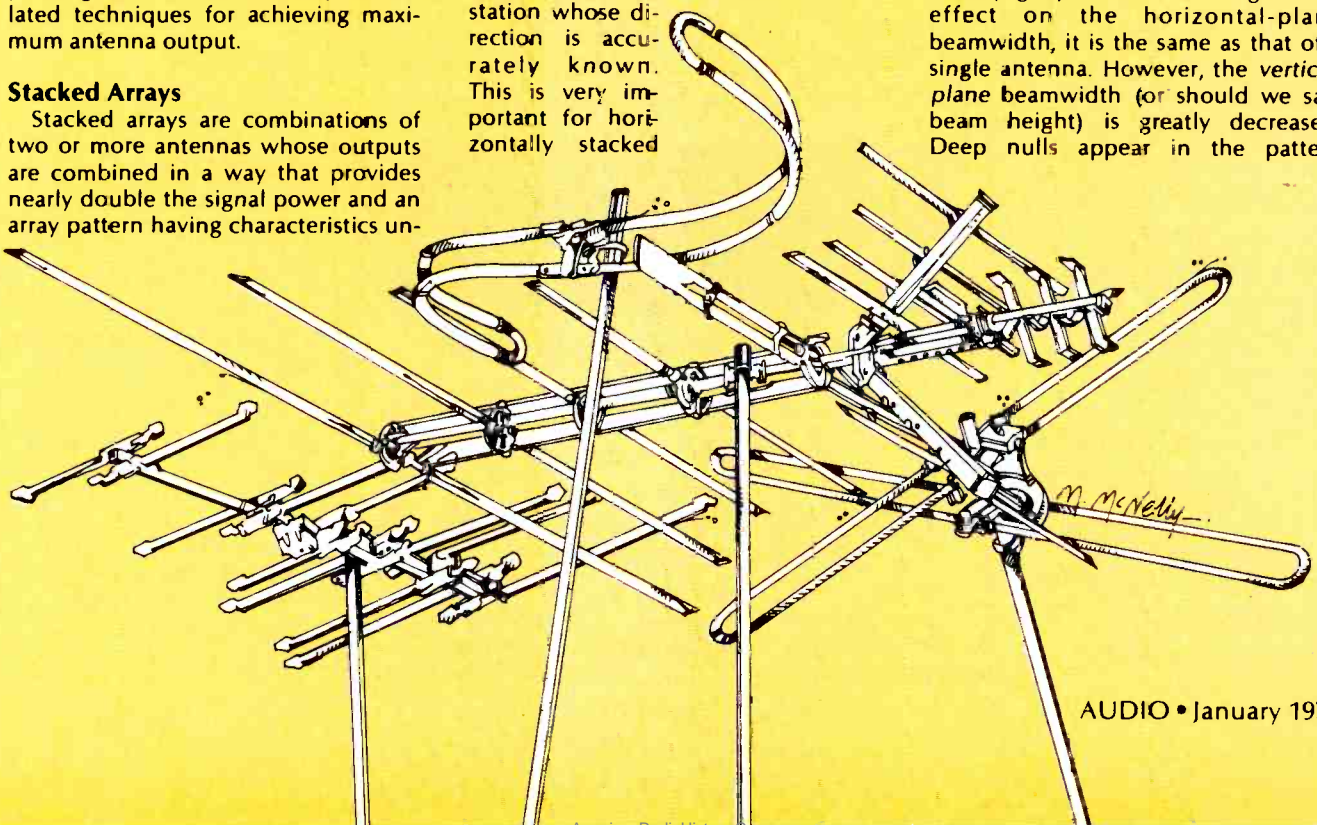



Revolutionary! Sound-shaping taping mike.



Never before — a single microphone that gives you the versatility of 16 microphones! Four tiny frequency filter switches built into the new Shure 516EQ E-Qualidyne Microphone let you tailor sound for studio effects in virtually any recording situation: flick a switch to add sizzle to vocals . . . flick another switch to highlight the sound of a bass drum. You can even compensate for the acoustic response of a room — *right from the microphone!* In all, the 516EQ creates 16 different response variations that can add a new, professional sound to every tape you make. Available singly or in pairs for stereo recording. Ask to hear a recorded demonstration at your participating Shure dealer.

Shure Brothers Inc.
222 Hartrey Ave., Evanston, IL 60204
In Canada: A. C. Simmonds & Sons Limited



Manufacturers of high fidelity components, microphones, sound systems and related circuitry.

Enter No. 36 on Reader Service Card

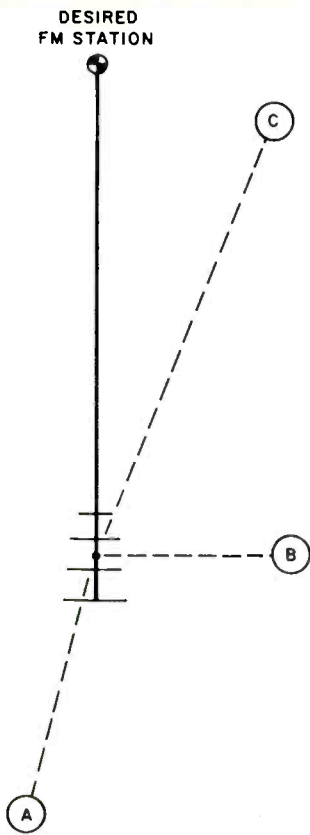

Fig. 1 — Interfering signals.

44

above and below what is now a very narrow front (and rear) lobe. This means a big decrease in the pickup of interfering signals originating above and below the zero elevation mark. This reduces or entirely eliminates pickup of auto ignition and ground- and airplane-reflected multipath. The null angle varies inversely with the spacing between the antennas, so it is possible (but obviously tedious) to adjust the antenna spacing for maximum rejection of a fixed interference source at your favorite FM frequency. For general (broadband) use the spacing is not critical, but six feet is about the minimum amount recommended for good gain and pattern characteristics all the way to the bottom of the FM band. If large, high-gain antennas are used, the minimum recommended spacing is greater, about eight feet.

The wider the spacing, the narrower the vertical-plane pickup pattern. However, very wide spacing is impractical because the lower antenna will be too close to the roof unless the array is mounted atop a tower. To achieve the proper vertical-plane pattern, both antennas must receive equal-strength signals, so the difference in distance from each antenna to the roof should be as small as possible. Never use vertical stacking unless the lowest antenna is at least 20 feet above the roof. This means the 10-foot mast section holding the two antennas

should be mounted on at least an 18-foot well-guyed mast, but preferably a tower. The Oct.-Dec., 1977, issue of the Winegard Dealer News uses captioned photographs showing step-by-step how to vertically stack a pair of their CH-6065 FM antennas on a tower. If you are seriously considering this venture, contact Winegard for a copy.

Stagger Stacking. Stagger stacking is a technique that produces an array with extremely high F/B ratio. The antennas are mounted one above the other, but one antenna is a quarter wavelength closer to the signal source, and its cable section is an electrical quarter wavelength longer than that of the other antenna (Fig. 3). Since this technique is frequency sensitive, the antenna displacement and cable lengths should be optimized for the frequency at which you are having your problem. For example, if fourth harmonic CB radiation is being picked up from a transmitter behind your antenna, use 108 MHz for your calculations. If you want to reject a local station on 89.1 MHz so you can listen to a distant station in the opposite direction, use 89.1 for the displacement and line-length calculations.

If the antennas are mounted so each antenna receives exactly the same signal level, the F/B ratio will approach infinity at the design frequency. In practice, this is impossible (for the same reasons discussed above in *Vertical Stacking*), but the F/B ratio will be very high at the design frequency and higher than that of a single antenna over most of the FM band.

The vertical spacing of the stagger-stacked array should be the same as if it was a vertically stacked array. The amount of antenna displacement for the frequency of interest is calculated from the formula in Fig. 3. Note that a diagonal brace is required to support

Fig. 2 — Vertically stacked antennas. (Photo courtesy Winegard Co.)

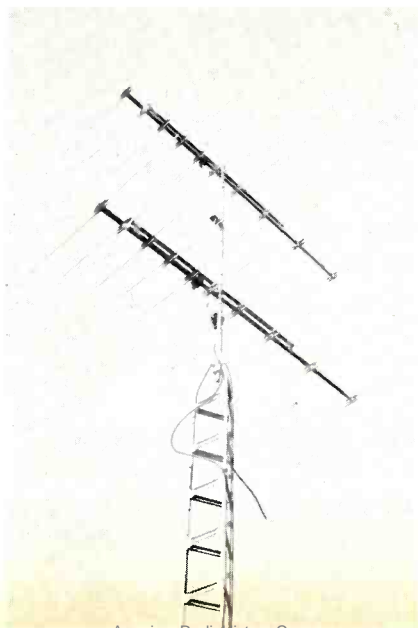

the displaced antenna. Naturally, the mounting bracket and clamp must also be relocated. Before running out and buying a pair of antennas, make sure the antenna's mounting clamp can be moved back by an amount equal to the desired displacement and you do not end up with the mast touching an antenna element.

The difference in cable length can also be calculated from the formula in Fig. 3. This formula is correct only for foam-dielectric coax, either RG59-sized with No. 20 center conductor or RG6-sized No. 14 coax.

Horizontal Stacking. Mounting two antennas side-by-side (Fig. 4) produces an array with the very useful characteristic of being able to reject an undesired signal that lies in almost the same direction as the desired station. Moreover, it also provides nearly three dB more gain on the desired station than a single antenna. As Fig. 5 shows, the horizontal-plane polar pattern has a main lobe much narrower than that of the antennas used in it, with deep

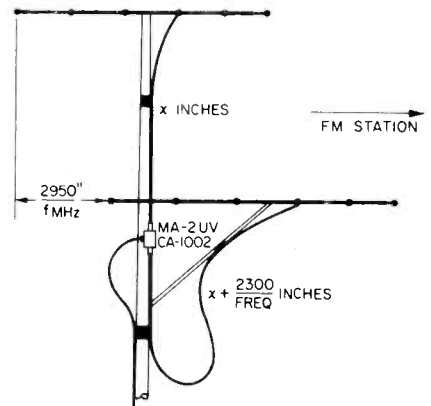

Fig. 3 — Stagger-stacking technique and formulae.

nulls alongside the main lobe. The angle between the nulls and the beamwidth of the main lobe decreases with increasing spacing between the two antennas. This means that if the interfering signal and the desired station are extremely close together (only a 15-20° difference in bearing), very wide spacing can be used to drop the interfering signal into a null while providing very high output of the desired station. Similarly, if the two signals have a fairly large difference in bearing (50-60°), narrow spacing is indicated.

To determine the spacing (in inches) between antennas needed to knock out an interfering signal, proceed as follows:

1. Measure the difference in bearing between the station you want and

SONY IS ALL DECKED OUT.

You're looking at seven of Sony's greatest performances.

A big, bold line of cassette decks that's guaranteed to hold the audience spellbound.

After all, Sony's arresting combination of Year 2000 technology, and common-sense value, is hard to resist.

Our line extends from under \$200, to over \$500. So you won't have to settle for less than you want. Or be forced to pay for more than you need.

And Sony isn't a newcomer to cassette decks. We've been making tape, and tape recorders, for 30 years. That gives us a reservoir of electronic know-how that allows us to be so technically advanced today.

For instance, Sony innovates with our liquid crystal peak program meters. We're the first to utilize this LCC display—a significant improvement in accurate record level setting, and in protection against overload distortion.

You'll also find an auto-reverse function. It automatically flips the head when your cassette is finished...so you can record or playback on the other side. So you don't have to fudge.

To offer you great flexibility, Sony builds in a 3-position tape bias and equalizer switch. With it, you can accom-

modate any tape now available.

At Sony, we look at cassette decks as both mechanical and electrical device. So both our electronics and our transport system are designed to the most challenging specifications a manufacturer can set for itself.

Simplicity is the toughest goal.

All Sony decks are designed with what we call Human Engineering.

It means that our controls are comfortable and convenient. Whether it's a sophisticated LCD display, or an air-cushioned eject system.

Whether it's an advanced auto-reverse function, or a remote control capability, or a conserve automatic shut-off, that disengages all mechanisms.

And there's more, as Human Engineering is the way we operate.

If this is your year to buy a deck, you can do a lot of tiresome shopping. And end up with Sony.

Or you can go directly to Sony.

And start at the place you'd end up anyway.

SONY[®] AUDIO

© 1978 Sony Industries, A Division of Sony Corp. of America.
94 West 57 Street, New York, N.Y. 10019. Sony is a trademark of Sony Corp.

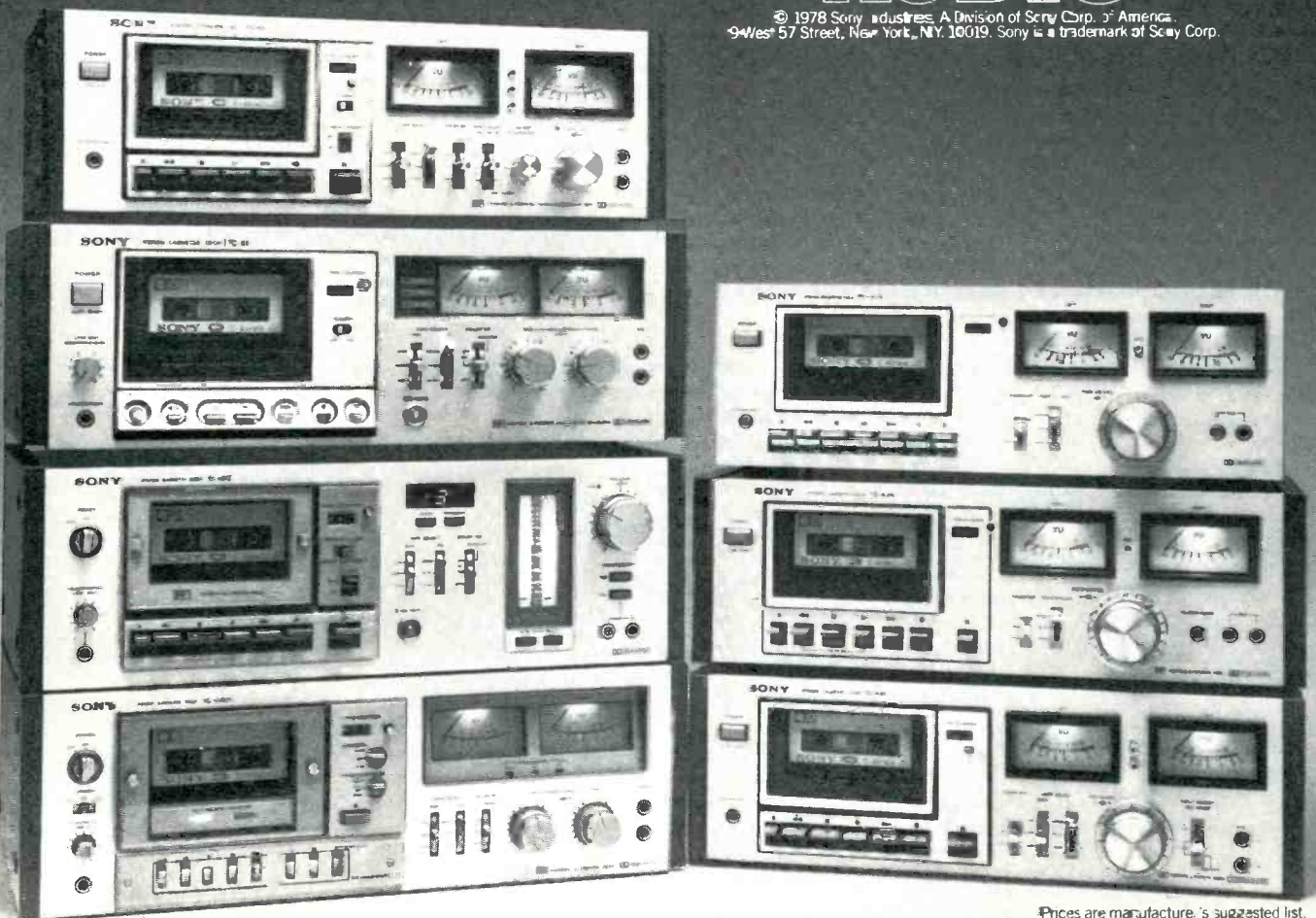

Prices are manufacturer's suggested list.

Enter No. 39 on Reader Service Card

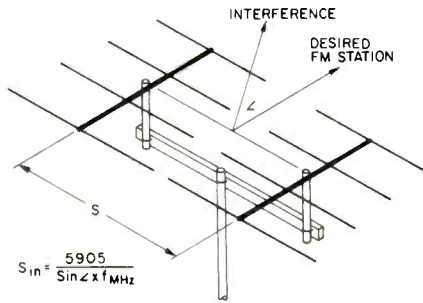

Fig. 4 — Horizontally stacked antennas.

the one you wish to reject, using a local map and a protractor.

2. Determine the spacing in inches at the frequency of interest by the following formula:

$$S_{in} = \frac{5905}{\sin z \times f_{MHz}}$$

This technique is applicable to rejecting CB harmonic radiation and severe multi-path arriving from the front, although the direction of the interference must be fairly well known for this technique to be effective. Its greatest application is for long-distance reception of a station on the same or adjacent channel as a local station, when the desired and the local stations are in almost the same direction. Moreover, this technique can be used as an alternative to stagger stacking if the desired station is almost (but not quite) opposite to the interfering local. This is possible because the nulls also appear in the back lobe!

Horizontal stacking is much harder to accomplish mechanically than vertical or stagger stacking. Two short masts are needed to mount the antennas, and these must be attached to a crosspiece, which is in turn fastened to the tall main mast. This is complicated by the requirement that the crosspiece be non-metallic. Since the crosspiece is parallel to the antenna elements, a metallic crosspiece will interfere with the operation of the antenna. Additionally, the crosspiece may be as much as 20 feet long (2 wavelengths) to achieve the spacing necessary for small null angles. Redwood crosspieces are often used in commercial applications, but the resultant array will be too heavy for a residence. A lighter and cheaper technique is shown in Fig. 6. Plastic pipe (around 1¼-inch outside diameter) is used for the crosspiece. The short mast sections can be slid along the plastic pipe to allow relatively easy readjustment of

the spacing. However, the center of the plastic pipe must be strengthened with braces made by slicing a 12-inch length of steel pipe lengthwise.

The cable sections connecting the antennas to the splitter cannot be run horizontally either. Run the cable down the individual mast sections and from there at a 45° angle to the splitter on the main mast.

Quad Stacks. Two arrays of horizontally stacked antennas can be stacked vertically to produce a *quad array* or *quad stack* (Fig. 7). An array of this type has narrow beamwidth and beam height. This is close to the ultimate in directionality and interference rejection. However, an array of this type is obviously expensive, very difficult for the audiophile to build and erect, and even more difficult to keep aloft! Still, if money is no object (yes, there really are people who can afford it), professionally built and installed quad arrays are available from CATV antenna manufacturers such as SITCO.

Increased Output

An additional requirement for low-noise, long-distance reception is antenna output that is as high as possible. Preamplifiers are of little use unless the transmission-line run is very long and/or several tuners must be served (see Part IV). This is because modern high-quality FM tuners have noise figures as good as, if not better than, broadband FM preamplifiers. However, if the line run is very long (150 feet or over), a *low-noise, mast-mounted* preamp will make a useful contribution to perceived S/N ratio by an amount equal to the transmission-line attenuation. However, in most cases higher antenna output must be achieved by "noiseless" antenna tech-

Fig. 5 — Narrow-beam main lobe and nulls produced by horizontally stacking two Jerrrod QFM-9s one wavelength apart.

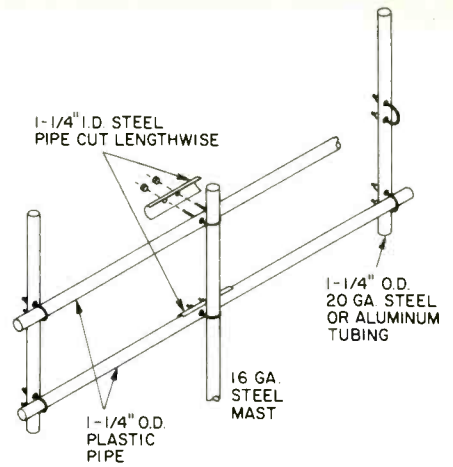
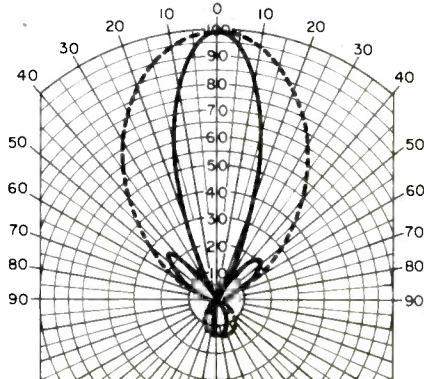

Fig. 6 — Mechanics of horizontal stacking.

niques. Stacking increases output up to 3 dB, but increased antenna height or larger antenna(s) may be needed in extreme cases or if stacking is not used. Each technique has its advantages and disadvantages.

Increased Antenna Heights. The distance between the roof and an antenna mounted on the popular 10-foot mast is small enough in terms of wavelength for the roof (and surrounding objects) to affect the antenna operation to some degree. Experiments conducted by the author on TV Channel 5 (which is not far in frequency from the FM band) indicate that a gain of three to four dB is likely when a medium-sized FM antenna is moved from 10 feet above roof level to 18 feet. The additional spacing removes much of the proximity effect of the roof and allows the antenna to provide maximum output from the signal level available. The only hitch is that an 18-foot mast must be properly installed and guyed — or down it comes!

Larger Antenna. If you are using an omnidirectional antenna, changing to a fairly big yagi will yield a healthy increase in signal strength. Changing from a small (3- or 4-element) yagi to a really big one (10 or 11 elements) will yield a useful increase in output. However, changing to an antenna with just two or three more elements more than your old one will yield just a fraction of a dB increase in average gain, so is hardly worth the trouble. To get about 3 dB more gain, the replacement antenna must be about 2½ times the boom length and element count of the one it is replacing.

Indoor Antenna Techniques

At the beginning of this series, I mentioned that indoor antennas have no place in a discussion of high-quality FM antenna systems. Though I still hold this opinion, many readers point



THE TUNE UP KIT FOR YOUR CAR STEREO. IT'LL GIVE YOU A BETTER HIGH END.

With a Scotch® Master III™ Cassette and a minor change in your recording routine, you can noticeably boost the highs you get from your car stereo.

You see, our Master III Cassette was engineered for use with the ferri-chrome switch position on your cassette recorder. Normally, you'd record and play back in this position, enjoying strong response across the entire frequency spectrum.

But most hi-fi buffs seem to agree it's the high frequency response in particular that adds the details to your sound and makes high fidelity truly high. And this high frequency response is especially critical in car cassette players.

You can boost those highs simply by recording on a Master III ferri-chrome cassette in the normal switch position. Master III records with more highs than standard tapes, so you'll be getting stronger highs on playback

than were really there to begin with.

Give it a try. You might just get hooked on the highs you get with a Master III Cassette.



**SCOTCH RECORDING TAPE.
THE TRUTH COMES OUT.**

Enter No. 54 on Reader Service Card

out that they have *no choice* but to use an indoor antenna, so ask that I please do something to help them. With some misgiving therefore, I will end this article with a few suggestions.

On the premise that residences where outdoor antennas are prohibited are usually located in strong-signal areas, a high-sensitivity tuner can compensate for the low signal levels obtainable from small indoor antennas. The problems therefore are multipath and S/N ratio. Each of these can be alleviated somewhat by antenna directionality. Although the simple dipole (be it the ribbon dipole packed with the receiver or a TV rabbit ears) has essentially zero front-to-back ratio, it does have decent side nulls under the right circumstances. The idea is to orient the antenna (while watching the multipath indicator or listening to the interference) so the undesired signal falls into a side null and thus produces little output from the antenna.

Orientability means that the ribbon dipole cannot be taped on the wall or laid under the rug. The dipole should be taped to a wooden or plastic strip about 6 feet long, and mounted on some sort of device that will allow it to remain in the position you leave it. A clamp-on reflector lamp (which sells

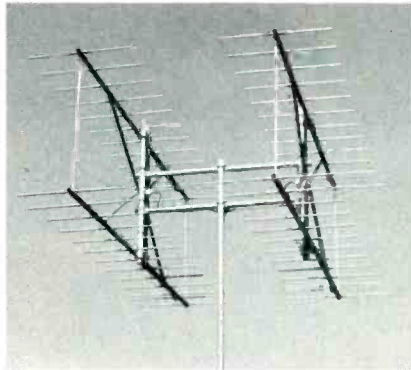

Fig. 7 — SITCO quad-stack array. (Photo courtesy SITCO.)

for about \$2) is a good device to adapt; remove the reflector and lamp socket, and use the clamp with universal joint. The result will not look pretty in your home, but is about the best that can be done under the circumstances. A better-looking alternative is TV rabbit ears, the simple kind having just two telescoping elements. These rods can be adjusted in length to peak the signal, the angle of the two rods can be varied, and the whole antenna rotated. Just make sure the one you buy has rods each that extend to at least 34 inches.

Every so often a very expensive indoor FM antenna is marketed. Some of them do offer performance superior to that of a ribbon dipole or rabbit ears, but none can *outperform* even a small outdoor antenna in terms of directionality and low-noise output level. The amplifiers in the more elaborate models can boost the signal level as high as that from an outdoor antenna, but the output necessarily has relatively poor S/N ratio. Still, if you can't put a good antenna up outdoors, the newer indoor "mini antennas" are worth a try. A

Manufacturer's Directory

For further information on the products mentioned in the article, contact the applicable manufacturer at the following address.

RMS Electronics
50 Antin Pl.
Bronx, NY 10462
SITCO Antennas
Box 20456
Portland, OR 97220
TACO/Jerrold
1 Taco St.
Sherburne, NY 13460
Winegard Co.
3000 Kirkwood St.
Burlington, Iowa 52601

Signet dealers are a breed apart.

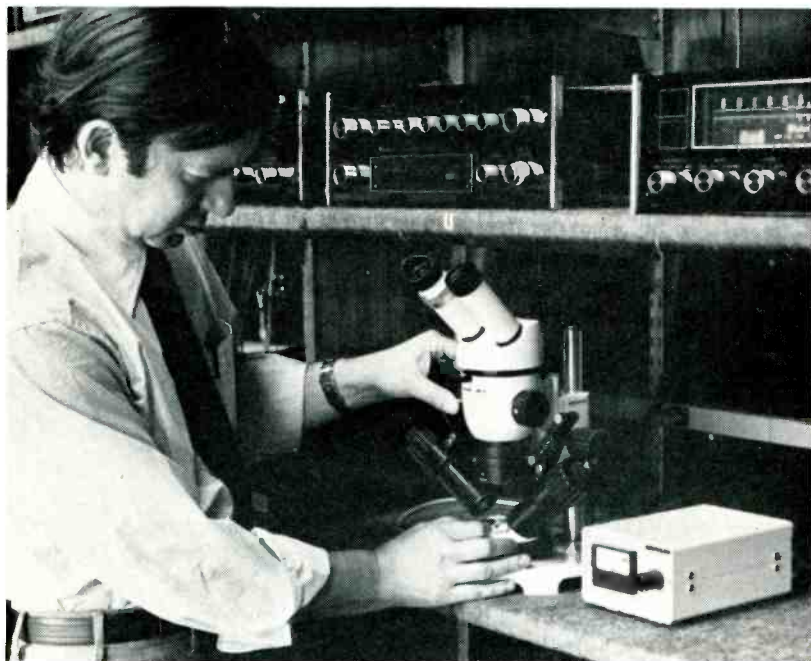

Simon Zreczny, Pres., Audio Consultants, Libertyville and Evanston, IL

They don't just sell merchandise. They get involved. In the how and why of sound reproduction. And they don't take anything for granted.

For instance, to hold a Signet franchise, each dealer must have—and know how to use—a powerful microscope. Like the \$5,500 Wild-Heerbrugg stereo Model AT-M5A we helped to develop. It reveals in intimate 3-dimensional detail the construction and condition of any phono stylus.

We think it's important that your dealer be able to check your stylus for wear, tip geometry, tip polish, damage or dirt. Signet dealers agree.

But they also use their microscope to take a critical look at new cartridge products—ours and others. To see for themselves the quality of this critical component. We wouldn't have it any other way.

If your audio standards are high, your Signet dealer is worth seeking out. Write us and we'll introduce you to him and our current Signet products. We honestly believe you'll appreciate the difference.

SIGNET DIVISION, A.T.U.S., Inc., Dept. 19A-3, 33 Shiawassee Avenue, Fairlawn, Ohio 44313

signet™

The most important piece of audio equipment you'll ever own.

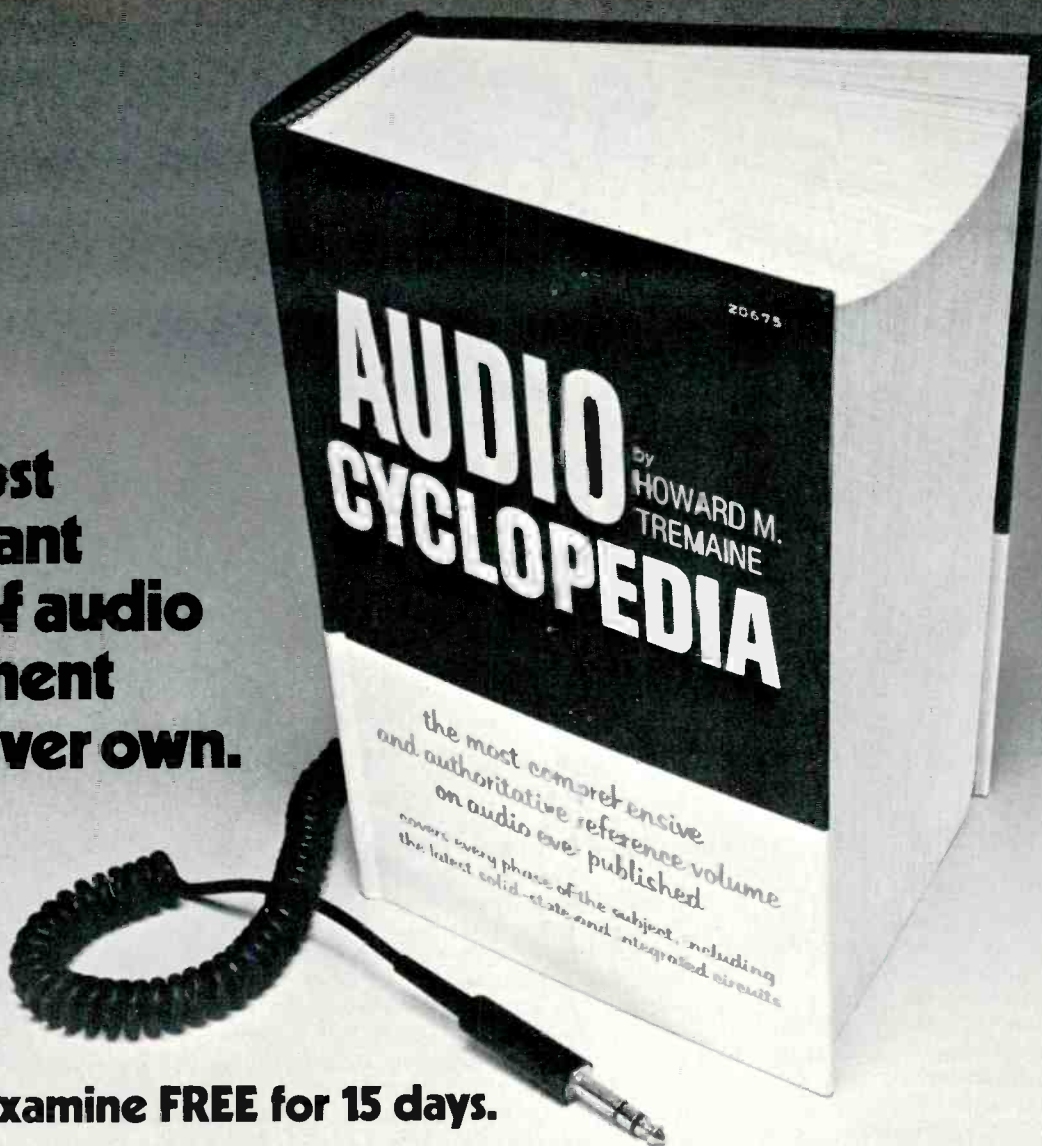

Yours to examine FREE for 15 days.

**25 FACT-FILLED CHAPTERS
ARRANGED IN "EASY-TO-FIND"
QUESTION AND ANSWER FORM**

- Basic Principles of Sound
- Acoustics, Studio techniques, and Equipment
- Constant-Speed Devices, Motors, and Generators
- Microphones
- Attenuators
- Equalizers
- Wave Filters
- Transformers and Coils
- Sound Mixers
- VU and Volume Indicator Meters
- Vacuum Tubes, Transistors, and Diodes
- Audio Amplifiers
- Disc Recording
- Cutting Heads
- Recording and Reproducing Stylis
- Pickups
- Magnetic Recording
- Optical Film Recording
- Motion Picture Projection Equipment
- Loudspeakers, Enclosures, Headphones, and Hearing Aids
- Power Supplies
- Test Equipment
- Audio-Frequency Measurements
- Installation Techniques
- General Information, Charts and Tables

Be our guest. Examine the AUDIO CYCLOPEDIA free for 15 days. You'll find out why it is considered the most comprehensive and authoritative book ever written on the subject. And you'll get a FREE \$3.50 bonus book to keep no matter what!

The AUDIO CYCLOPEDIA is literally a one-book audio library. It has long been considered "the bible" by amateur stereo buffs as well as professional technicians. That's why you'll find it in constant use not only in home workshops and at stereo centers, but also in recording studios, broadcast booths and concert halls.

This giant reference book is over 3" thick,

and packed with 1,757 illustrated pages. It features 3,645 questions and answers and a 50 page "instant-find" index for subject identification. It is truly the big one in audio electronics and it puts all the information you'll ever need right at your fingertips, chapter by chapter.

Send for the AUDIO CYCLOPEDIA today. If you don't agree that it's the most important piece of audio equipment you own, just return it within 15 days. You won't owe a cent. And no matter what you decide, you'll get a free \$3.50 copy of *The ABC's of Tape Recording* to keep just for mailing the coupon.

**FREE-BOOK
FREE-TRIAL COUPON**



Save postage & handling costs. Full payment enclosed (plus tax where applicable). 15-day return privilege still applies.

Yes, please rush me the AUDIO CYCLOPEDIA (#21455) for my free trial. I understand if not completely satisfied, I may return it within 15 days, and owe nothing. Otherwise, it's mine to keep for only \$39.95 plus postage and handling and local taxes (where applicable).

And, whatever I decide, a copy of "The ABC's of Tape Recording" (valued at \$3.50) is mine free!

Name _____
 Address _____
 City _____
 State _____ Zip _____



Mail to Audel
 4300 W. 62nd Street
 Indianapolis, Indiana 46206
 A Division of Howard W. Sams & Co., Inc.

CT49

SCA & Stereo FM

Stephen R. Waldee

50

As the engineer for two stereo FM stations with SCA operations, I was intrigued by Len Feldman's comments in his *Audio* tuner reviews about SCA rejection and crosstalk measurement techniques. One of two audio-conscious stations, for which I act as Technical Consultant, has a classical format, with at least 40-dB dynamic range, and any SCA crosstalk must be kept to an absolute minimum.

"How can a stereo FM station be quality conscious and permit SCA operation?" you might ask. Before I began my career in broadcasting 13 years ago, then being an audiophile and avid radio listener, I was of the opinion that SCA transmission and high fidelity were mutually exclusive. But now, thanks to modern solid-state transmitters and receivers, this is not so! And I am proud to have contributed to cleaning up the transmission end of some marginal SCA operations in the San Francisco Bay Area. The present day use of SCA results in only a very slight (and possibly inaudible) reduction in FM stereo quality, and need not destroy the listening pleasure of the most critical auditors.

Basically, the SCA (for Subsidiary Communications Authorization) is a frequency-modulated subcarrier, centered at 67 kHz, which is transmitted along with the station's "main channel" audio. For stereo stations, the SCA is sent, or "injected," at a maximum of 10 percent of the total modulation and a minimum of 8 percent. This is only a fraction of a decibel loss

and is not noticed even in a direct A-B listening test. Usually there are so many inaccuracies in FM monitor calibration, limiter performance, and differences in station policies on modulation levels that SCA and non-SCA stations cannot be told apart on the basis of loudness alone.

SCA crosstalk is usually, but not always, limited to the receiving end of the broadcasting chain. However, as James Tonne has pointed out in articles in *Broadcast Engineering* magazine, SCA "birdies" are also generated in the transmitter if it has greater than 0.3 percent distortion. Tonne, of Moseley Associates, manufacturers of SCA and stereo generators, characterizes the SCA crosstalk signals as 9- and 10-kHz beat tones occurring from intermodulation between the second and third harmonics of the 19-kHz pilot (at 38 kHz and 57 kHz), the second harmonic of the stereophonic subcarrier (at 76 kHz), and the SCA subcarrier itself (at 67 kHz). Not only are these steady-state tones audible, but also "sizzling" sounds are heard from the sidebands of the 76-kHz harmonics of the stereo subcarrier mixing with the sidebands of the 67-kHz subcarrier. Judging from the deplorable condition of many radio stations, we should expect dreadful interactions, but in reality the results are usually good to excellent, despite the crosstalk which occurs in two ways — from the SCA into the main channel and from the main channel into the SCA! The people who pay the radio station for the use of the

subcarrier for their programming are always the first to complain, speeding up a correction of a bad crosstalk situation.

In 1976, we performed an elaborate series of off-air measurements of the Bay Area's SCA operations, using a Marantz 10B tuner and a Tektronix SL4N spectrum analyzer, and made some significant discoveries. About two-thirds of the FM stations with SCAs were operating correctly, with complete separation of stereo subcarrier and SCA channel and proper injection levels; however, several stations betrayed severe spillage across guardbands between main channel, pilot, stereo subchannel, and SCA region, or improperly high pilot, SCA, or stereo subcarrier levels, or faulty 38-kHz and 76-kHz suppression. The stations with correct basebands had absolutely no audible SCA crosstalk on the Marantz, indicating that conscientious transmissions into a clean receiver produce outstanding stereo results.

Upon further investigation, we learned that the faulty stations had bad SCA and stereo performance due to these major factors: 1) Carelessness or ignorance on the part of the engineers who had not, for example, checked 38-kHz subcarrier null since the last station proof-of-performance measurements, as required by the FCC; 2) use of extremely old and obsolete early-60s stereo generators with no input low-pass filtering; 3) use of miscalibrated modulation monitors with errors causing incorrect pilot and SCA injection levels or overmodulation, and 4) confusion about appropriate SCA deviation levels, resulting in excessive SCA modulation while also engaged in stereo transmission.

In the last-mentioned case, many SCA broadcasters were using 6-kHz carrier deviation or transmitting lots of high frequencies, permitting the 67-kHz subcarrier sidebands to intersect with the upper frequencies of the ster-

Table I — Comparison of mono and stereo noise, with SCA and without SCA, between a Technics ST-9030 and a modulation monitor.

MONO NOISE		STEREO NOISE, SCA OFF				STEREO NOISE, SCA ON			
Mod. Monitor	Technics	Mod. Monitor	Technics	Mod. Monitor	Technics	Mod. Monitor	Technics	Mod. Monitor	Technics
		L CH	R CH	L CH	R CH	L CH	R CH	L CH	R CH
-70	-67	-49	-52	-64	-64	-49	-51	-63	-64

This three-component LRS system may bring the ultimate within your reach.

The Laboratory Reference Series was conceived and designed to appeal specifically to those demanding audiophiles who long ago made the transition from receivers to separates, and who are still seeking "the ultimate." We realized that they would be relatively few, especially those able to spend a considerable amount for just the electronic elements of their system.

With the new 5T10 stereo FM tuner, it is now possible to have authentic LRS performance in a complete three-component system that's priced rather moderately. The other two LRS components are the 5L15 integrated amplifier and the 5F70 tone control unit.

The 5T10 has state-of-the-art sensitivity, selectable i.f. bandwidth, audible multipath monitoring, variable

interstation noise-muting level and adjustable output signal level. FM distortion in the wide-band position is held to no more than 0.1 percent. And a remarkable new tuning aid, "Accutouch", physically locks the tuning at the point of lowest distortion when each strong-signal station is reached.

The 5F70 tone-control module with its exclusive linear equalizer provides an extraordinary range of tonal adjustment. Bass and treble have four turnover frequencies each, plus a defeat switch. This assures precise compensation for high and low-end deficiencies in program material. The separate acoustic-equalizer circuit has an adjustable center frequency and Q, as well as variable attenuation. It pro-

vides precise nulling of bass standing waves in the 75 to 150 Hz range.

The 5L15 is a completely DC direct-coupled integrated amplifier with special LUX-developed IC's that not only achieves remarkably low THD and IM distortion (0.02 percent) at rated output, but also virtually eliminates transient intermodulation distortion. So the purity of sound is purely LRS.

We don't know exactly where you are on your long journey to sonic perfection, but we invite you to make a short stop at one of our very select audiophile/dealers. At the very least, it will be an enlightening and memorable musical experience. And whether or not you go home with the ultimate, you'll at least have met up with it.

LUX Audio of America, Ltd.

160 Dupont Street, Plainview, New York 11803 • In Canada: White Electronics Development Corp., Ontario



Luxman 5T10 Tuner Features Lux's exclusive "Accutouch" tuning system. Has switchable i.f. bandwidth: wide (normal) and narrow. Signal strength indicator has five LEC's. Tuning circuit employs Lux's closed-lock-loop. Audio multipath monitoring through speakers. Output level adjustable from 0 to 1 volt. Usable sensitivity, 10.3 dBf (1.8 μ V); 50-dB quieting sensitivity, 14.2 dBf (2.8 μ V). Capture ratio, 0.8 dB (wide i.f.).

Luxman 5F70 Tone Control: Bass and treble controls, each with four turnover frequencies (125, 250, 500, 1,000 Hz for bass; 1,000, 2,000, 4,000, 8,000 Hz for treble). Unique acoustic equalizer; notch filter with adjustable center frequency, attenuation level, and Q. Attenuation from 0 to -12 dB in 75-to-150 Hz range, with Q adjustable from "wide" to "narrow." Total harmonic and intermodulation distortion under 0.005 percent.

Luxman 5L15 Integrated Amplifier: Direct-coupled, DC integrated amplifier. 80 watts per channel minimum continuous power into 8 ohms, 20-20,000 Hz with no more than 0.02 percent total harmonic or intermodulation distortion. Protective circuits with warning light sense DC levels in the outputs. Two average-reading VU meters with switchable sensitivity (0 and -10 dB). Also: dual tape monitors with adjustable preset level. Phono signal-to-noise, 80 dB (10mv, IHF-A weighted); input sensitivity, 2.7 mV.

eo sidebands out around 53 kHz and slightly beyond. This problem was exacerbated when old or cheap stereo generators without 19-kHz low-pass filters were employed, permitting the stereo sidebands to reach beyond 53 kHz. One mono-and-SCA station, with apparently *no* filtering of any kind, was transmitting as much "junk" out to 100 kHz and beyond as it was broadcasting usable audio. Crosstalk from main-to-sub and sub-to-main was devastating, and any time an announcer's voice sibilant or a cymbal crash was heard, the SCA audio was buried in annoying hash. We spoke to the SCA program people who leased air time on this station, and they said that the station's engineer has disavowed all blame for the problem.

Transmitter tuning and distortion was found to be of minor but noticeable importance. If low-level r.f. stages are not operated fully class C and if bandwidth is not broad, a perfectly clean baseband signal from the station's 10-watt FM exciter or carrier modulator-generator, will be improperly amplified and distorted. One notorious old transmitter, now retired, caused pilot and SCA levels to rise and fall several percent as its driver stage was tuned! The pilot signal recovered off the modulation monitor was no longer a perfect sine wave, but had become a virtual sawtooth. SCA birdies were dreadful unless the transmitter was tuned with a silent main channel while the engineer wore stereo headphones and nulled the crosstalk. Some old tube-type exciters were found to have leakage of their supersonic automatic frequency control signals into the audio, causing intermodulation effects. Stations which used wide-band composite microwave studio-transmitter links also sometimes picked up interference that beat with the pilot, stereo information, and SCA. And, as James Tonne pointed out, antennas with a large number of bays and high gain will encourage multipath and phase distortions which will increase the whistles.

Nevertheless, the stations which looked good on our spectrum analyzer display sounded virtually noise free. As I do not own a Marantz 10B tuner, I went looking for a modern equivalent which would give me equally quiet performance. Like Len Feldman, I was surprised that tuners with excellent published specs differed enormously in their SCA crosstalk rejection. Using one of my own stations as a reference, I listened to many receivers. The Marantz tuner would sound silky silent, while one tuner had a slight whistle, another had fuzz, and still an-

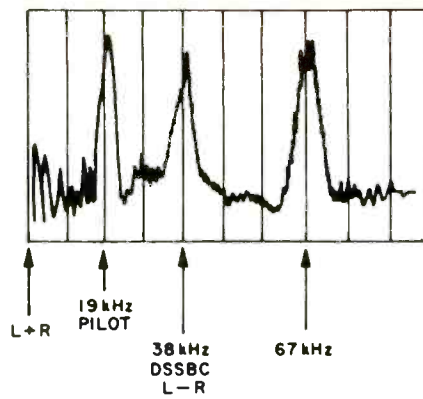

Fig. 1 — Drawing of spectrum analyzer showing location of main and sub channels, pilot, and SCA region.

other reproduced ever-changing "birdies." For a while, I resorted to mating an old H. H. Scott rack-mount Model 335R matrix-type stereo demodulator, c. 1962, to an inexpensive Japanese tuner, and got clean reception with better than 30 dB separation. Then recently I discovered the Technics ST-9030 FM tuner and use it now for all evaluation and measurements. It is so clean that it even surpasses my station's modulation monitors. The table presents recent measurements comparing the station's performance on the \$4000+ modulation monitors to the audio outputs of the Technics tuner, read on a Hewlett-Packard noise and distortion analyzer.

For Figs. 2 through 5, a Tektronix 5L4N spectrum analyzer was connected to the detector output of a Marantz 10B tuner and operated in the 10-dB and 10-kHz per division modes. The top of the screen represents about 10 dB

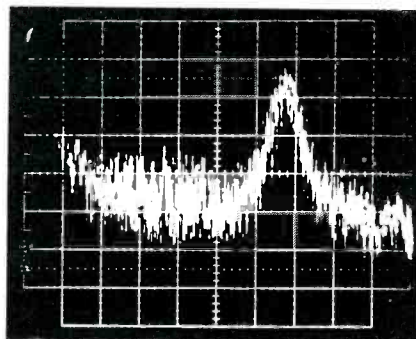

Fig. 2 — Mono FM station with SCA. No filters are employed, and baseband is filled with "junk" consisting of noise and harmonics. Because no stereo subcarrier is used, 6-kHz SCA deviation is permissible.

It is important to note that the FCC requires that FM stations only verify mono noise performance (at -60 or better) during the yearly proof-of-performance, although stereo noise standards have also been established. As you can see, the modulation monitor did not reveal the true station performance, as it did not have adequate filters to null out the pilot and SCA. We spoke to the modulation monitor manufacturer, who quietly acknowledged this flaw and promised that his new model would be much better! So, station engineers should learn not to trust broadcasting equipment merely because it is expensive.

Our tests with spectrum analyzer and a known clean receiver have shown that if the broadcaster meets the following operating requirements, his stereo quality will not be impaired by SCA: 1) The injection level must be no greater than 10 percent; 2) audio frequencies no greater than 5 kHz should be transmitted on the SCA (and James Tonne recommends a special audio filter with stepped rolloff); 3) no greater than 4-kHz frequency deviation of the SCA subcarrier should be attempted; 4) the transmitter itself should have well under 0.5 percent distortion, and 5) the stereo generator should have the proper filters, and its subcarrier null should be *precisely* adjusted and maintained at minimum

down from 100 percent modulation. Because of cable capacitance between the 10B and 5L4N, 67 kHz appears to be down about 5 dB from its actual level. Original photos made May 1, 1976.

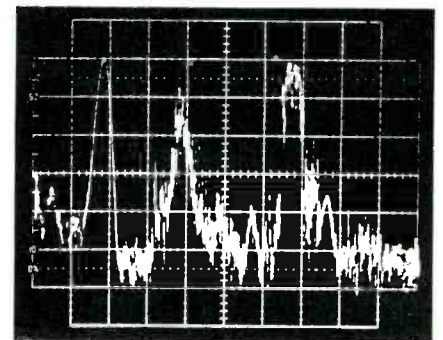
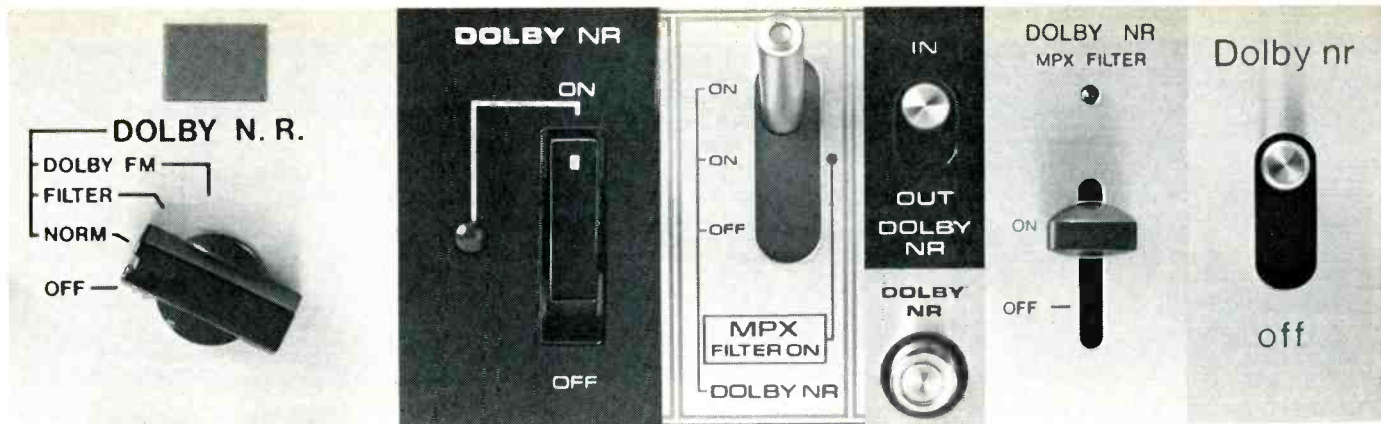

Fig. 3 — Stereo station with SCA. Due to cable capacitance in the test set-up, it was verified that correctly aligned stations showed their SCA carrier injection at -5 dB; however, this station's SCA carrier was high. Noticeable 76-kHz component indicates poor stereo generator performance. SCA crosstalk from this station was quite perceptible.



When what's built-in is not enough.

Still hearing some "SSSSSSSS," even though you're using good tape and the noise reduction system in your deck? Don't blame the tape. Chances are, that noise reduction system doesn't have what it takes to give you totally noise-free recordings.

The answer: a dbx II tape noise reduction unit. All of our models give you 30 dB of noise reduction at all frequencies, plus 10 dB extra recording level headroom. Without altering the sound of your music, either. The best that Dolby* B can offer is 7-10 dB of noise reduction. Besides, Dolby and other typical systems operate only at high frequencies, allowing low frequency noises to remain. And as experts know, they require level matching. dbx II doesn't require any level matching whatsoever, because its true mirror image compression/expansion operates linearly on all frequencies and your music's entire dynamic range.

*Dolby is a registered trademark of Dolby Laboratories, Inc.

This all means that the live performances, FM broadcasts and record albums you tape will have their full dynamic range preserved, with no audible tape noise added. So, if you're unhappy with the noise reduction system in your tape deck, consider a dbx II. We make 3 models: the 122, for two-channel tape noise reduction; the 124 for four-channel tape noise reduction, or simultaneous off-tape monitoring of the noise-reduced signal; and the 128 combination tape noise reduction system/dynamic range expander, which lets you make tape copies of your recordings that sound better than the original.

The dbx difference is the difference between some tape noise and no audible tape noise at all. Hear it at your dbx dealer soon.



UNLOCK YOUR EARS

dbx

dbx, Incorporated
71 Chapel Street
Newton, MA 02195
617/964-3210

Enter No. 9 on Reader Service Card

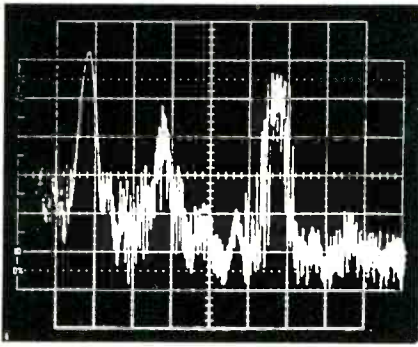
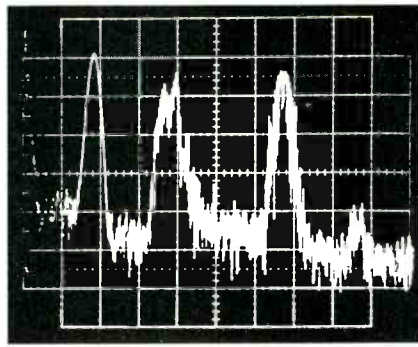

Fig. 4 — Two views of a clean-sounding stereo and SCA station. Fig. 4A was made with very loud, but legal, main channel stereo musical modulation, while 4B shows very little stereo sub-



carrier modulation from an off-balance voice. The 4-kHz subcarrier deviation is used on SCA, and guardbands are maintained between stereo signal and SCA.

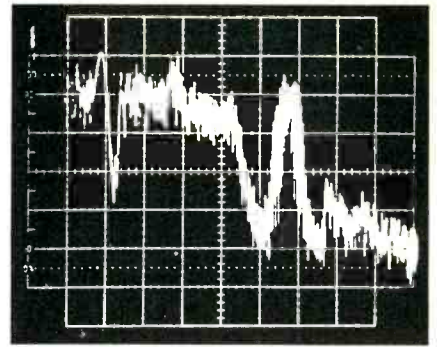

Fig. 5 — Another stereo and SCA station, though not quite as clean as the station in Fig. 4. A 57-kHz harmonic is apparent, which probably accounted for the slight whistle audible in stereo.

(-60 or better is optimal). Under these conditions, we have found that with a good receiver, outdoor antenna properly aimed, and with good antenna feedline, it makes virtually no difference whether the SCA is modulated or not, and usually it may be turned on and off inaudibly.

I understand that the BBC is considering the use of SCA, and I would plead with them to phase-lock the SCA subcarrier to a harmonic of the pilot, out of the way of possible future quadrasonic subcarriers. For those of

us in the United States who are stuck with conventional 67-kHz SCA, the situation is improving with current technology. And I wouldn't be surprised if my remarks encourage the gobbling-up of any classic old Marantz 10B tuners which have fallen into disuse alongside their flashy solid-state brothers.

Finally, a last bit of advice for stereo-philes: If you still have SCA crosstalk on your favorite station, even if your reception is multipath-free and their equipment is fine, try miniscule two-

or three-degree rotations of the cores of the i.f. cans and ratio detector in your tuner. You may be amazed and delighted, as I was, to hear the birdies and whistles fade away completely in many cases. *More radical retuning will, of course, ruin the alignment and will necessitate expensive servicing, so be forewarned!*

I would like to thank Robert Orban of Orban Associates for permission to include off-air spectrum analysis pictures of FM stations that he made for our SCA tests.

WHEN YOU'RE READY TO SPEND OVER \$1,000 ON A STEREO SYSTEM, YOU'RE READY FOR PHASE.

Building a total system in this price range is a step into big league stereo. So why tie yourself down with an integrated amp or high-power receiver, when you can have the power, performance and flexibility of a Phase 2200 Series Two?

The Phase 2200 consists of two great components. The 2000 Series Two preamp, together with the 200 Series Two amp.

The 2000 Series Two preamp gives you the deviation-free control you expect from Phase Linear, with an added dimension: Ambience. With a touch of the controls, you recover the reflected sound captured by the recording microphone, but lost in ordinary preamps and integrated components. So when you put on Horowitz at Carnegie Hall, it sounds like you're in Carnegie Hall.



The 200 Series Two amplifier uses revolutionary "BI-FET" and high-loop gain technology to improve performance. Output power is 120 watts per channel minimum RMS into 8 ohms from 20Hz-20kHz with no more than 0.09% total harmonic distortion.

And don't worry, the full complementary direct coupled (OCL) output stage features an array of protection systems that prevent damage to the amp *and your speakers*.

Stay flexible. Compare the Phase 2200 Series Two to the integrated units. There's more power. Lower distortion. Wider dynamic range. Faster transient response.

If you're ready for big improvements in your system, take the first step. Contact your Phase dealer, and hear the System 2200.

Phase Linear[®]
THE POWERFUL DIFFERENCE

Phase Linear Corporation/20121 48th Avenue West/Lynnwood, Washington 98036
MADE IN U.S.A. DISTRIBUTED IN CANADA BY H. ROY GRAY LTD. AND IN AUSTRALIA BY MEGASOUND PTY. LTD.

Enter No. 61 on Reader Service Card

Small is Beautiful

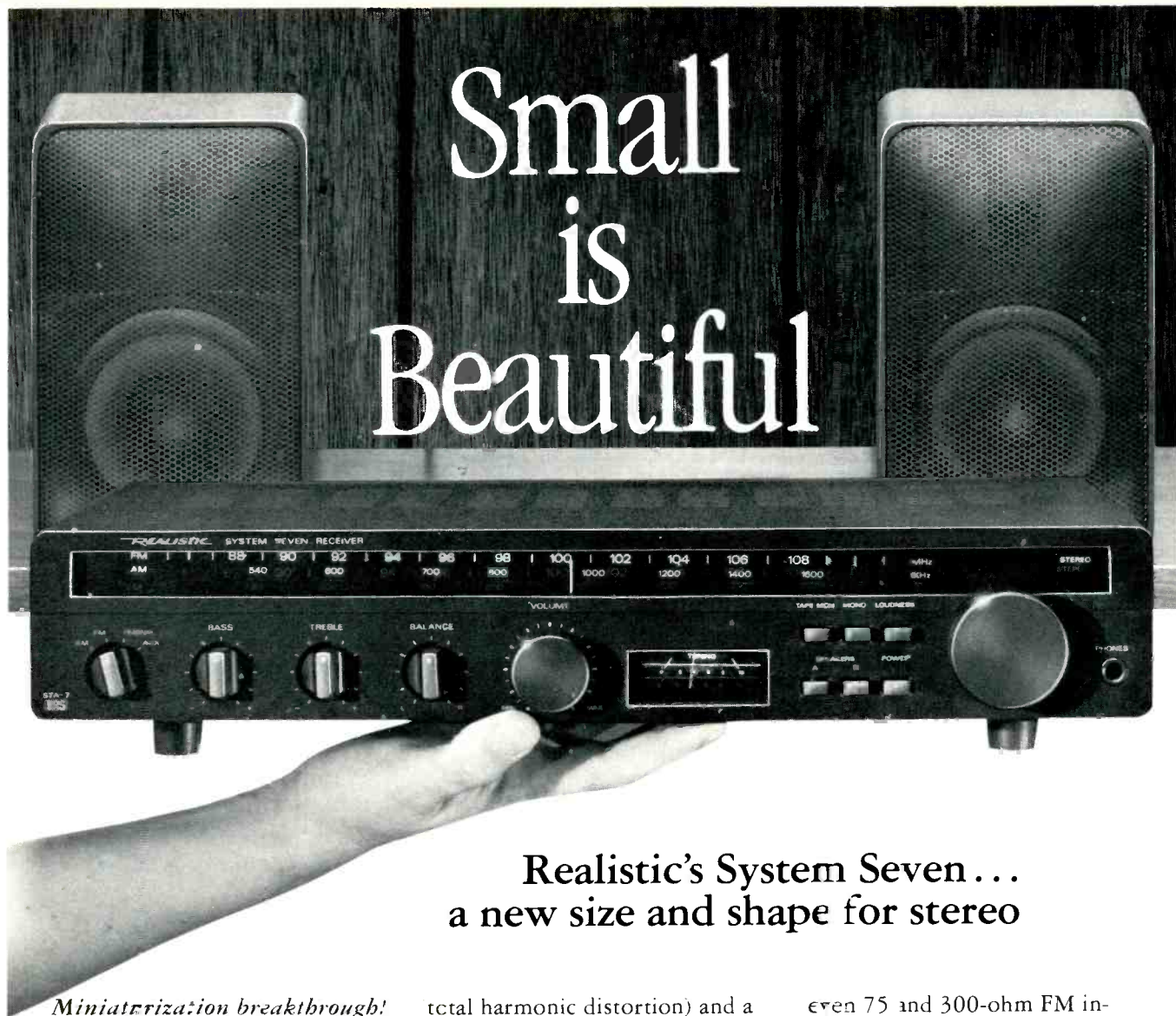

55

Realistic's System Seven... a new size and shape for stereo

Miniaturization breakthrough! Realistic's fabulous new System Seven combines beauty, elegant small size and a level of acoustical quality you've never heard, until now, in low-priced bookshelf stereo.

System Seven includes our new STA-7 AM/FM receiver (10 watts per channel, minimum RMS into 8 ohms, 20-20,000 Hz, with no more than 0.5%



At last — true hi-fi perfectly sized for a bookcase. The 4-1/2-lb. speakers can even be used for bookends!

total harmonic distortion) and a pair of our amazing Minimus[®]-7 speaker systems — featuring large-excursion woofers and soft-dome tweeters in diecast enclosures only 7 1/16" high.

Bass without bulk. Despite its small size, System Seven delivers rich, satisfying bass to 50 Hz and sound levels up to 90 dB for accurate reproduction of anything from classical to rock music.

What's the secret? The receiver has a unique equalization network engineered especially for the speakers. And it's switchable so you can use full-size speakers, if you wish.

Compact, but no compromises. You get "full-size" high-fidelity features with System Seven — magnetic and aux inputs, tape monitor, A/B speaker switching,

even 75 and 300-ohm FM inputs. U.L. listed, of course, and housed in a stunning jet-black metal cabinet with blackout dial.

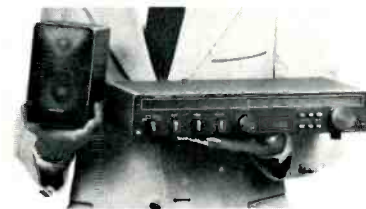

Receiver is briefcase-sized, a little taller than a credit card — just 3-1/2" high. Each speaker is about the size of two average books.

The price for all this may be the surprise of your audio life — only 219.95*, a savings of \$39.90 off the "each" price!

Audition System Seven. Small has never been so beautiful!

*Price may vary at individual stores and dealers.

Sold only at **Radio Shack[®]**
The nationwide supermarket of sound[®]

A Division of Tandy Corporation
Fort Worth, Texas 76102

Open Reel: The format

You're looking for a tape recorder. You've heard from friends and salesmen that cassette is the answer. At TEAC we make both cassette and reel-to-reel tape recorders. Because we make each for a specific person and application, you should depend on fact, not hearsay, before spending your money.

IT'S A MATTER OF PHYSICS

There are immutable reasons why cassettes can't match open reel fidelity.

Take tape speed. Open reel tape running at $7\frac{1}{2}$ ips is running four times faster than a cassette. And speed has more to do with the relationship between frequency response and signal-to-noise than anything else by far.

At $7\frac{1}{2}$ ips all audio frequencies can be recorded at full level

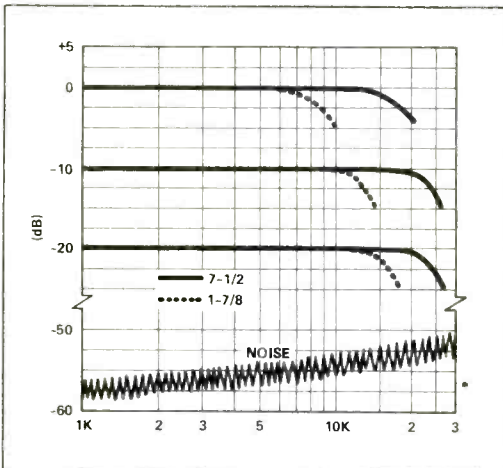

Tape saturation vs. level at $7\frac{1}{2}$ ips and $1\frac{7}{8}$ ips.

without tape saturation. Recording at $1\frac{7}{8}$ ips forces you to make drastic compromises in record levels. The more you have to back off on recording levels, the more you hurt the ratio of signal-to-noise.

In short, with a cassette deck you cannot have high frequency response and good signal-to-noise. So a cassette deck is always operating on the ragged edge of disaster. It's so much easier to get into trouble than out of it because there's a difficulty for every solution.

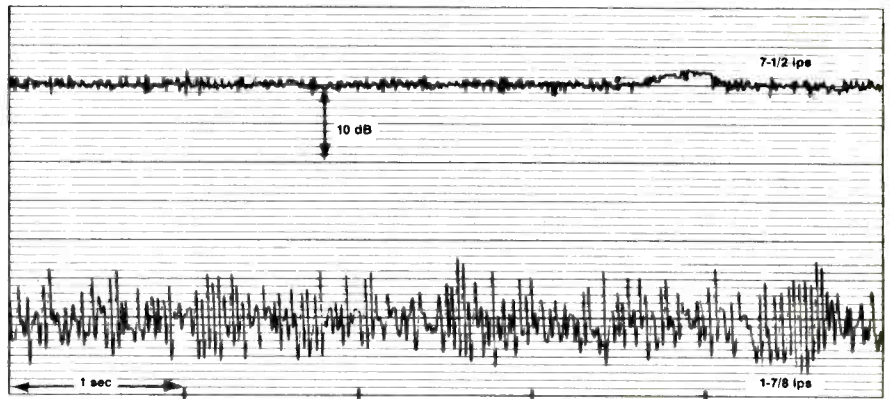

Comparative dropouts between $7\frac{1}{2}$ ips and $1\frac{7}{8}$ ips at 15kHz.

MORE IS MORE

The faster the speed the longer the wavelength, the longer the wavelength the more protection you have against dropouts. You also have an easier job of editing.

Now take track width. Open reel gives you twice the track width of cassettes. The wider

the track width the higher the output, the higher the output the better the signal-to-noise ratio. A wider track is also less sensitive to dropouts and, obviously, a wider track retains more magnetism.

And while we're on the subject of magnetism, an open reel tape has twice the oxide coating of a cassette.

Upshot: A total tape volume 16 times greater than a cassette, which means 16 times more magnetic particles to store and remember music.

If that sounds better to you, if we've convinced you the cassette format is a high price to pay for convenience, then you ought to look at the TEAC lineup of open reel tape recorders.

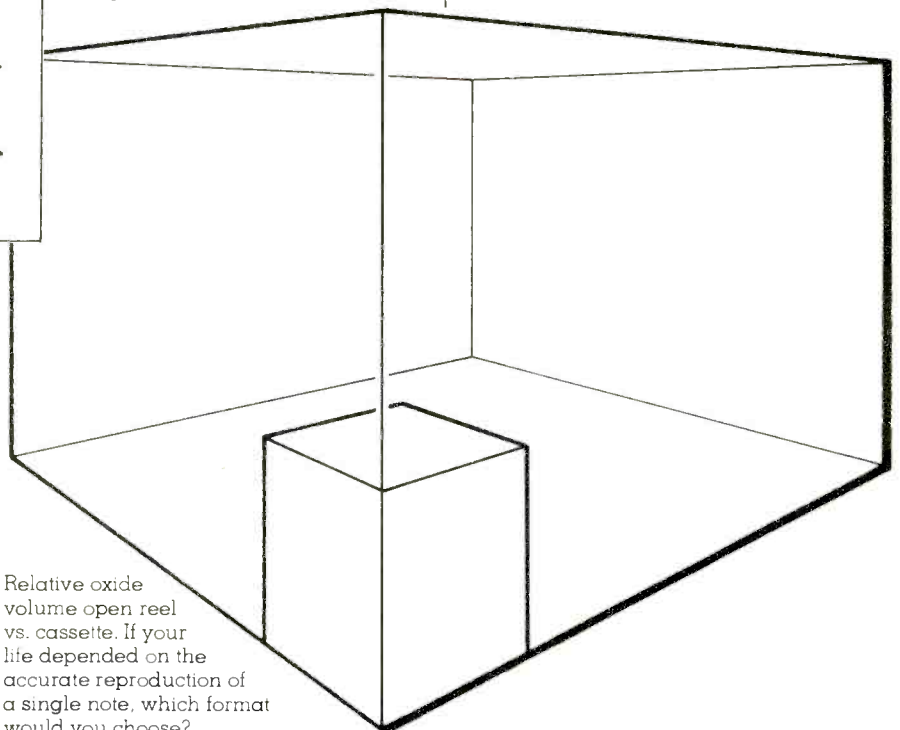

Relative oxide volume open reel vs. cassette. If your life depended on the accurate reproduction of a single note, which format would you choose?

for the informed.

INSIDE INFORMATION

TEAC is a leading designer and manufacturer of computer and instrumentation recorders. In medical centers, for example, physicians depend on special TEAC units to record vital data in life-or-death situations; in remote wilderness areas, scientists depend on TEAC to monitor now-or-never phenomena like earthquakes.

From that experience we've learned that the quality of the transport mechanism is the single most important consideration in a tape recorder. For the computer industry, and for you. That's why many of the same engineers have designed the tape recorders we make for both.

Our entire reel-to-reel line has three motors and micro-switched solenoid operated transport systems, a blend of computer age sophistication and brute strength that nothing else can equal. Ask anyone whose opinion you respect.

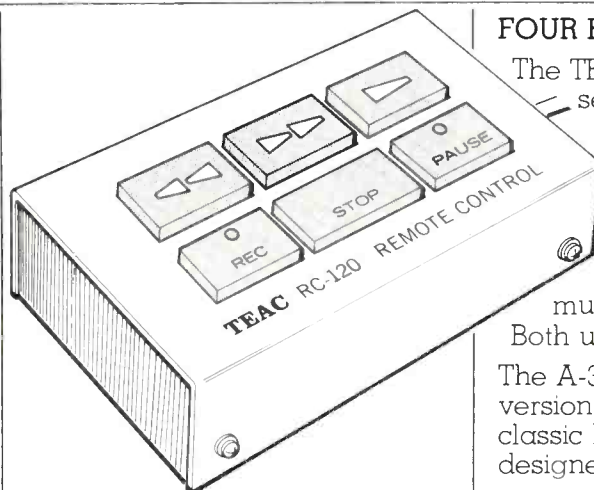

OPTIONAL REMOTE CONTROL

Unlike some reel-to-reel machines, TEAC decks have full-function remote capability. Our optional remote units are the perfect answer for recording sessions where you can't be next to the recorder, or for operational access to a recorder in a custom installation.

TEAC®

First. Because they last.

FOUR EXAMPLES

The TEAC A-2300SX is the best selling, most successful open reel machine ever. Over 300,000 have been sold. The SR version of the A-2300 features an auto-reverse function so you can play music in two directions.

Both use 7" reels.

The A-3300SX and its reversing version, the A-3300SR, are classic heavy-duty machines designed for 10" reels.

Whichever TEAC open reel recorder you choose, you can be sure it will last a long, long time. It was designed and built that way.

FACE IT

In the end, the cassette recorder is for those who are fonder of convenience than fidelity. If you want fidelity you can't ignore open reel.

In all crucial specifications, open reel tape recorders are better than cassette decks. And that message comes from the people who make the best of both. TEAC.



TEAC Corporation of America • 7733 Telegraph Road • Montebello, CA 90640

TDS - a progress report

Don and Carolyn Davis

Paul Klipsch's famous "Ho, hum, another major breakthrough" applies to the majority of "new" ideas in audio, but on rare occasions a new idea does appear on the scene. In the past no conscientious acoustical expert would presume to design a predictable, controlled acoustic environment for the reproduction of music in a small room. However, this can now be done, a situation which truly rates the "major breakthrough" title, thanks to the application of time-delay spectrometry (TDS) techniques to small rooms.

Since writing the article on time delay spectrometry (invented by Dick Heyser) for the January, 1978, issue of *Audio Magazine*, TDS has experienced a literal explosion of growth. This intense activity has stemmed from the availability of apparatus and the discovery of TDS applications that are fundamental to the recording industry.

TDS in the Control Room

After initial exposure to the TDS technique, we included the apparatus in the recording studio control room consulting job we had at hand. A first look at this environment revealed difficulties in the response of the direct sound from the monitor loudspeakers and then an overwhelming mass (or mess) of early reflections as the analyzer's filter looked at the swept signal later and later in time. To be able to return to looking at the "total sound field" by means of our $\frac{1}{3}$ -octave real time analyzer (RTA) was a relief.

In thinking over what had been observed with the TDS apparatus, several "first principles" of acoustics were brought freshly to mind. The first was that two sources emitting sound at the same frequency in the crossover region cause serious difficulty if they do so at different distances from the lis-

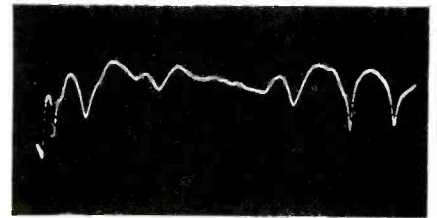
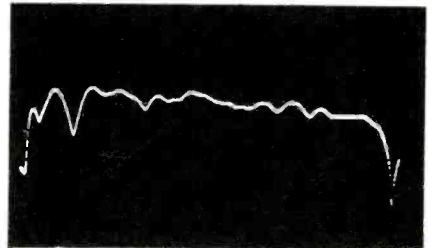

Fig. 2 — Studio monitor with high frequency driver unblocked.

Fig. 3 — Studio monitor with the high frequency unit blocked with a hand.



tener and/or measuring instrument. See Fig. 1 as an illustration of how comb filter effects are generated by the difference distances from two sources. TDS shows that lining up a woofer and a tweeter at exactly the crossover frequency does no good because the apparent acoustic center is changing with frequency throughout the crossover region (at least two octaves). The results on occasion are almost catastrophic. Figure 2 shows the direct response of a very widely used three-way monitor first with its tweeter in normal operation and then (Fig. 3) with a hand placed over the tweeter. The acoustic centers of the midrange and tweeter are over one foot apart at the crossover frequency. The mixer in this particular control room, who has really well trained ears, had been complaining that there was something wrong with the sound in the room. (Once heard, this type of distortion becomes quite intolerable thereafter.)

The second fundamental is that a reflection can serve very adequately as a second source and that the time delay

Fig. 1 — Calculating addition and cancellation of signals. Signals are in phase every (velocity of sound in ft. per sec./separation of sources in ft.) in Hz and add; signals are out of phase at each half wavelength multiple of in-phase points and cancel.

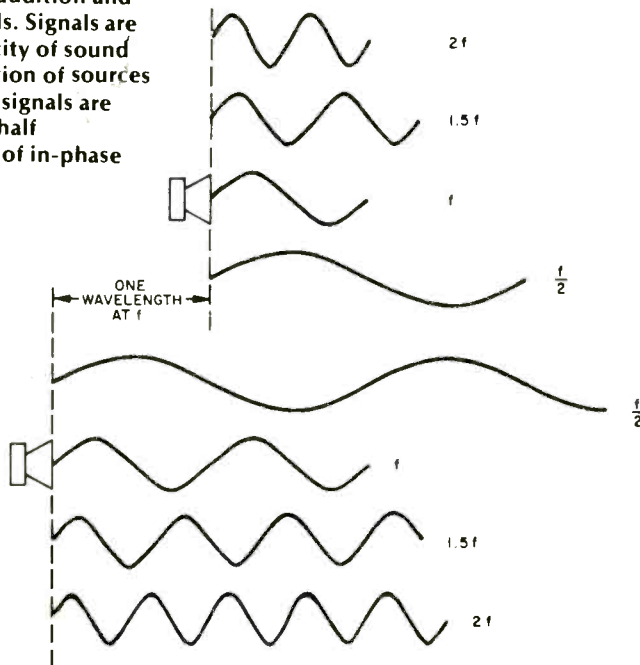

SO WHERE'S THE GUITAR PLAYER?



He vanished right in the middle of a riff. Eliminated by a low definition cartridge.

But ADC could have saved him. The XLM Mk III features the famous ADC tapered cantilever, which when combined with our tiny .004" x .008" rectangular nude diamond results in 50% less mass.

That's less than our previous

lowest mass cartridge, the highly acclaimed XLM Mk II. And because of its ultra linear frequency response, 10Hz to 20kHz ± 1 dB, every instrument sounds alive and natural, all at a record saving tracking force of $\frac{3}{4}$ to 1 $\frac{1}{2}$ grams.

If you'd like the complete facts about the ADC XLM cartridge, simply circle our

reader service number on the reader service card, and we'll send you the ADC brochure and a free record care gift.

So be good to guitar players and other musicians. Invest in something that understands them, and protects them. An ADC cartridge.



Audio Dynamics Corp., Pickett District Rd., New Milford, CN 06776 • Distributed in Canada by BSR (Canada) Ltd., Ont.

Enter No. 49 on Reader Service Card

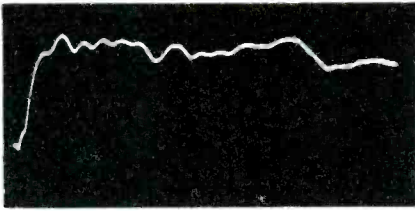

Fig. 4 — Direct sound field of a studio monitor. Response is from 0 to 10,000 Hz.

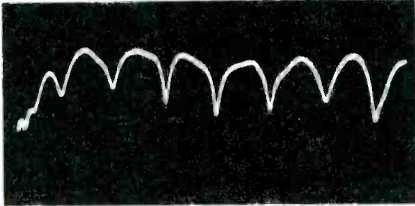

Fig. 5 — Direct and reflected sound field of a studio monitor. Total distance between the direct and reflected sound field is 13.56 feet; response as in Fig. 4.

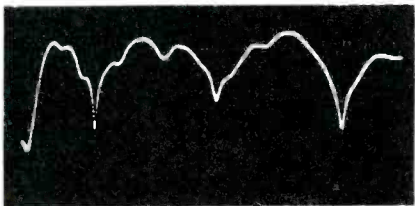

Fig. 6 — Total distance between the direct and the reflected sound field is 6.78 feet.

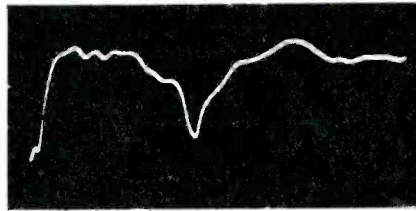

Fig. 7 — Total distance between the direct and reflected sound field is 4.52 feet.

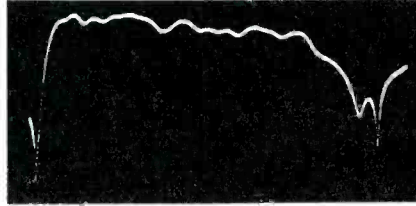

Fig. 8 — Total distance between the direct and the reflected sound field is 1.94 feet.

of the control rooms we were working in had surfaces near the monitors which were hard and the rear wall as dead as it was possible to make it. The evidence indicated that, more than likely, something was awry.

A remark made by Ed Long and Ron Wickersham — more on these two later — put another piece in the puzzle; they revealed they were placing their Pressure Response Pickup (PRP) microphones the so-called Hass distance apart.

Live End, Dead End

In discussing these insights with a Syn-Aud-Con class in Anaheim, Chips Davis (no relation to the authors), co-owner of Las Vegas Recording as well as sound engineer for Wayne Newton, decided to rebuild his control room under the guidance of the principles discussed in class. The results are shown in Figs. 9 and 10.

When Chips called us to come and hear the control room we took with us a knowledgeable control room designer and studio owner, Bill Putnam of United Recording. The hard, diffuse rear wall was *totally inaudible*. If one turned and faced the rear wall and cupped one's ears, not a sound could be heard off the rear walls. Why? Because the mixer's position was squarely in the center of the Henry or Haas effect fusion zone. A remarkable paper written by Professor Joseph Henry for the Smithsonian Institution and presented to them in 1856 (on work done in 1849) discusses the effect:

If . . . we stand at half this distance (half the distance sound travels in 1 sec.) before a wall, the echo will return to us in one second. It is, however, a fact known from general experience, that no echo is perceptible from a near wall, though in all cases one must be sent back to the ear.

Professor Henry went on in experimentation to establish that the effect ran to about 30 feet or 1/16 of a second. Modern researchers have found



Fig. 9 — The dead end of the control room built by Chips Davis at Las Vegas Recording.

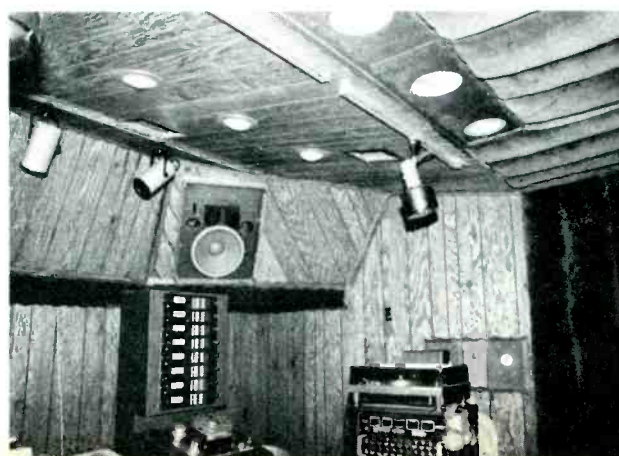

Fig. 10 — The live end of the control room at Las Vegas Recording.

between the direct sound spectrum from a monitor and a reflected sound spectrum can and does combine in violent comb filter effects.

One important parameter instantly observed is that the longer the time delay between arrival of the direct and reflected sound spectrums, the narrower and more frequent the anomalies (the peaks and dips). The shorter the time difference between arrivals, the wider and less frequent the anomalies. See Figs. 4-8.

Triggered no doubt by our experience in the equalization of sound systems, we instantly realized that wide-band anomalies are dangerous because of the power that can be present in that bandwidth. It is today a well-established fact that bandwidths substantially narrower than one-third of an octave are a relatively undetectable entity in a broadband complex signal and that the ear cannot respond to the spectrum shape within such a narrow band (critical bandwidth theory).

We reached the conclusion that *early reflections are not desirable in a playback monitor*. This was an interesting insight, inasmuch as a majority

SOMEDAY, EVERY AMPLIFIER WILL BE HIGH SPEED.



From the people who brought you dual power supplies and DC amplification comes high fidelity's most significant breakthrough in years.

The High Speed Transistor from Kenwood. An improvement so important that it will actually change the way you evaluate amplifiers. An improvement that will be part of every amplifier that claims to be state of the art.

Today, only Kenwood has it. Because Kenwood developed it.

Our engineers discovered that even with exceedingly low harmonic distortion, amplifiers typically lack the ability to react quickly enough to an input signal, particularly at the mid and upper frequencies. This is called transient intermodulation distortion (TIM).

The result can be seen on an oscilloscope as a square wave that's distorted. And heard as poor spatial imaging and loss of detail. While some manufacturers have dealt with a square wave's rise time, only Kenwood High Speed Transistors produce high frequency square waves that decay as fast as they rise.

That's because Kenwood High Speed Transistors

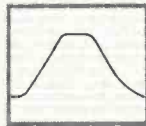

Pulse waveform response of a conventional amplifier.

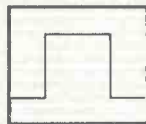

Pulse waveform response of Hi-Speed amplifier.

allow a much faster change in voltage (slew rate) than ever before. So no matter what the music demands, the amplifier can match it exactly.

What this means to you is depth and definition that will take your breath away. High frequencies are completely clear and totally non-fatiguing. You'll hear each violin individually in a string section. Each audible harmonic of a single piano note. Even the separate handclaps in recorded applause.

High Speed Transistors are used for the first time in our Audio Purist Group, shown above. Because it takes a very sophisticated and demanding listener to appreciate this new technology.

We're convinced that in a world of compromise, some people still demand the very latest state of the art. Building high fidelity equipment for them will always be our commitment. For more information and complete technical specifications, please write us.

HI-SPEED™
Hear the future of high fidelity.



KENWOOD®

Kenwood, P.O. Box 6213, Carson, CA 90749. In Canada: Magnasonic Canada, Ltd.

that for spaces with the acoustic characteristics of control rooms that about one-half this time is optimum. Remember Professor Henry's experiments were done outdoors without modern timing apparatus. This effect has had many names, the latest being Haas, and the entire history of the reinvention or rediscovery of this effect was covered thoroughly by Mark B. Gardner's article, "Some Single and Multiple Localization Effects," in the *Journal of the Audio Engineering Society*, July-August, 1973, Vol. 21, No. 6.

Turning around in the Las Vegas Recording control room and facing the anechoic end, it was as if the wall between the studio and the control room had been knocked down. As the mixing engineer remarked, "I now hear exactly what is happening in the studio. Successful mixes are reached in half the usual time since the control room has been reversed."

In essence, the control room is now a controlled acoustic environment without significant coloration of its own and accurately reflecting (within the capabilities of the monitor loudspeakers and the studio microphones) what is happening acoustically in the studio. This approach is referred to as the "live end, dead end" technique (LEDE) and is now underway in a number of control rooms.

Implementing the LEDE Approach

In addition to the usual cares for isolation, etc., necessary in the design of a control room, the LEDE technique requires great care in the following areas:

1. The room geometry must eliminate early reflections and very late reflections.

Fig. 12 — Free-field calibration of a pressure type microphone.

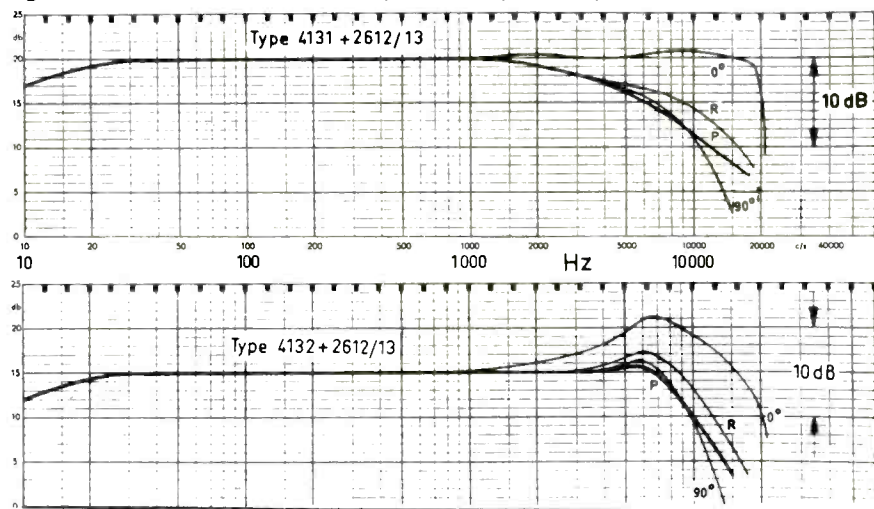

Fig. 13 — Pressure calibration of a pressure type microphone, showing rise in response with 0-degree incidence wave.

2. The hard end must be diffuse, without long paths, and provide relatively equal distances for reflections to the mixer's ears that fall in the 10 to 25 ms range. See Fig. 11 for a rough sketch of the general characteristics. In thinking over the outstanding results Chips received from his efforts, the realization that this approach had been indicated over and over again through the years was increasingly apparent.

An anechoic chamber is eminently unsuited for mixing music primarily due to its unnatural environment and the fact that there are no reflections, early, middle or late, to help smooth out the comb filter effects generated whenever the mixer is not exactly centered between two monitors. A reverberation chamber is quickly discarded

as a control room after one experience.

Therefore, in spite of contemporary attempts to make the mixer's ears location nearly anechoic, it is a diffuse, mixing, semi-reverberant environment that is really desired (note all the nonsense about coherent summing of monitors, +6 dB for combined acoustic signals from monitors). Failure to achieve such an environment is due, in our opinion, to many designers thinking that what works well in a large arena or auditorium, namely dead back walls, could be scaled down to control rooms. It is clearly evident that control room designers minus TDS equipment and experience in its use are like blind men instructing sighted persons in perspective drawing.

Fig. 11 — Rough approximation of how the control room should be set up.

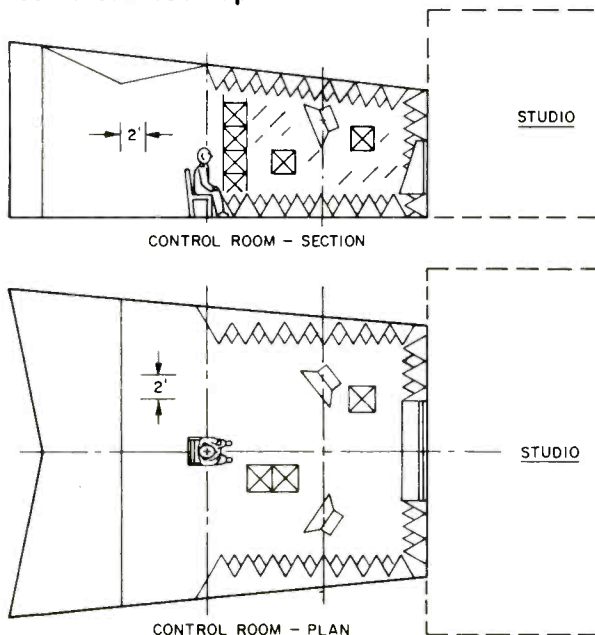

The Pressure Recording Process[®]

An equally dramatic offshoot of TDS and one that will be experienced by most listeners sooner than the LEDE effect is the PRP Technique of Ed Long and Ron Wickersham. Long is the inventor of Time Align[®] loudspeakers wherein electronic networks are employed to keep low frequency and high frequency signals in the crossover region in time alignment through the entire region. Ed later became associated with Ron Wickersham, Chief Engineer and co-owner of Alembic, Inc. Greatly annoyed with multichannel mono records, Ed and Ron set out to make some true stereophonic recordings that retained the amplitude, phase, and time differences present at a live performance — true spatial geometry as well as a solid curtain of sound.

Again TDS demonstrated that a microphone first receives the direct

If the bass isn't as clean as you'd like...

The problem may be your tonearm. Not your amplifier or speakers.

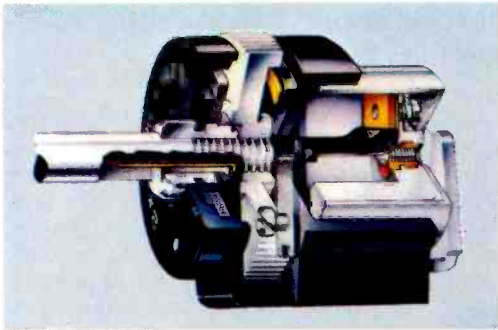

Cutaway view of anti-resonance counterbalance.
(A feature of Dual models 604, 621, 721 and 1246)

Solid lines show effectiveness of anti-resonance filters in damping resonant amplitudes of three different cartridges (compliance 15, 25 and 43 x 10⁻⁶ cm/dyne). Broken lines show higher resonant amplitudes with conventional counterbalance.

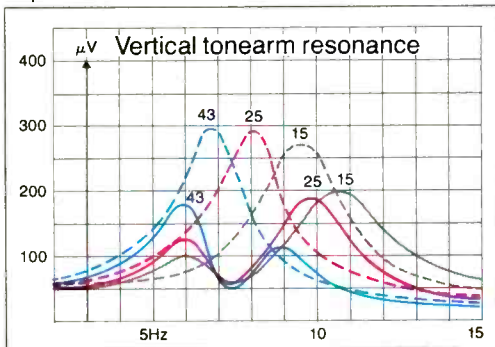

These are specially tuned to damp resonant energy in the tonearm/cartridge system and chassis.

The startling effectiveness of these filters in lowering the resonant amplitude of three cartridges having different compliances can be seen in the graph. Whether the improvement in the bass is subtle or obvious to you depends on the other components and your listening environment.

We've prepared a technical paper on this subject which we'll send to you if you write us directly. You may discover that you don't have to replace your amplifier or speakers after all.

If you've been wondering why your high-powered amplifier and great speaker system don't deliver deep bass as cleanly as you'd like—especially at high listening levels—the problem may well be the effects of resonance on the stylus.

Ideally, the stylus should move only in response to the contours of the record groove. But in reality, the stylus tip also responds to various resonances: its own (with the stylus shank) and the combined resonance of the tonearm/cartridge system.

These subsonic frequencies, though inaudible in themselves, can have very audible effects. Especially with warped records. They can drain amplifier power and cause excessive movements of the low frequency driver. They can cause the tonearm to vibrate and even to momentarily leave the groove. All of which results in audible distortion.

Competent tonearm designers know all this and do their best with materials, masses and compliances to establish the inevitable resonances at the least harmful frequencies, (usually between 8 and 10 Hz) and with the lowest possible amplitudes.

Dual's tonearm designers have taken a significant step beyond this.

The unique counterbalances of our direct-drive models (604, 621 and 721) and our top belt-drive multiple-play model (1246) contain two mechanical anti-resonance filters.



For the life of your records

United Audio, 120 So. Columbus Ave., Mt. Vernon, NY 10553

Enter No. 10 on Reader Service Card

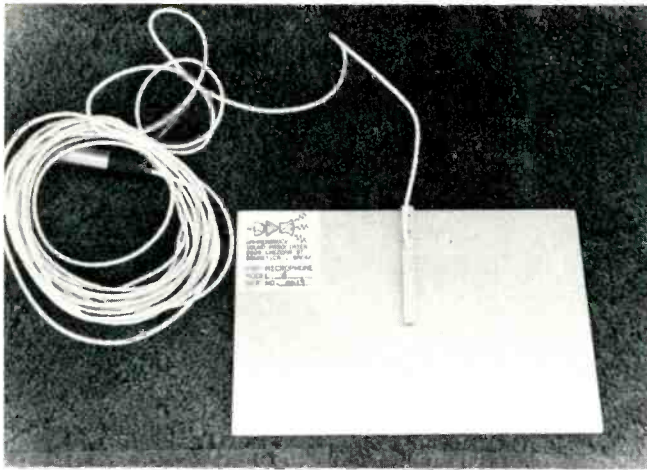

Fig. 14 — A pressure response microphone designed by Ken Wahrenbrock, Downey, CA.

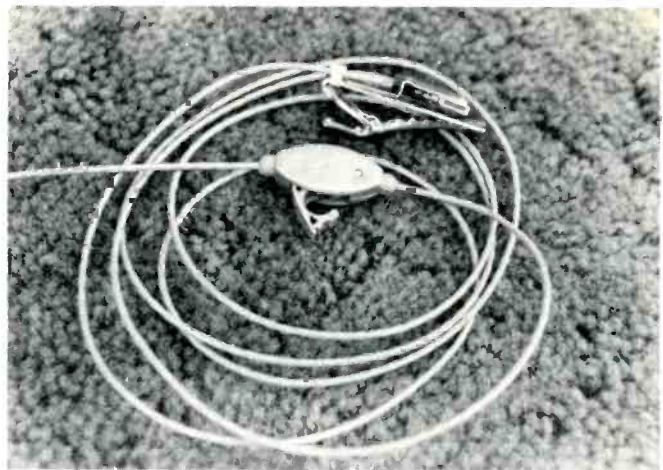

Fig. 15 — A lavalier-type PRP microphone.

64

sound from a musician, followed by the room reflections natural to the musician's location. So far so good, but the microphone also sees (or hears) the early reflections from surfaces near the microphone. Ed and Ron reasoned that a flush-mounted microphone would be free of such anomalies. True, but such a flush-mounted microphone should be a pressure response type (See Figs. 13 and 14), but when a signal arrives at the pressure microphone's 0 degree incidence, an unwanted peak in the response occurs. They then realized that a pressure response microphone placed in opposition to a reflective surface, a few thousandths of an inch away, would never see a 0 degree incidence signal and the pressure response calibration would always be accurate. One of the results has been the special model shown in Figs. 15 and 16 designed by Ken Wahrenbrock of Downey, CA. Wahrenbrock calls his system the Pressure Zone Microphone[®], recognizing that a pressure capsule not in a pressure zone fails to provide the benefits sought.

TDS Equipment

When we first reported to you on TDS last January, TDS apparatus cost over \$12,000. Currently it costs under \$5,000, and it is reasonable to expect it to drop to the \$2,500 range. The equipment can be rented for under \$500 per month. It means that a serious loudspeaker designer, experimenter, or small manufacturer no longer needs a \$100,000-plus anechoic chamber but can actually measure with greater accuracy, in his own living room if he wishes, the direct, reflected, and total sound fields from a loudspeaker. Figure 17 shows the equipment currently used by us. Those wishing a license to practice TDS should send a check for

\$100 made out to the California Institute Research Foundation but mailed to Syn-Aud-Con, and a check for \$25 made out to Syn-Aud-Con for a set of "how to" notes on TDS. (Syn-Aud-Con, P O Box 1134, Tustin, CA 92680)

The list of TDS licensees is growing at a rapid rate, especially considering that until the Spring of 1978 there was only one licensee. The increasing knowledge that comes from the use of TDS is going to have an enormous impact. The licensees are:

Cecil Cable, Cecil Cable Assoc., Edmonton, Alberta; Marshall Buck, Ph.D.; Don Davis, Synergetic Audio Concepts, Tustin, CA; Alan Feierstein, Acoustilog, New York; Richard Jamieson, Jamieson & Assoc., Minneapolis; Walt E. Disney Enterprises, Burbank, CA; K. A. Wahrenbrock, Wahrenbrock Assoc., Downey, CA; Ed Lethert, MTS Northwest, Inc., Minneapolis; Timothy J. Clark, Huntington Beach, CA; William M. Peterson, Jr., Reston, VA; Richard Blinn, Capitol Records, Inc., Hollywood, CA; John E. Payne, Westlake Audio, Los Angeles, CA; D.F. Morris, UREI, Sun Valley, CA; Ed McGee, Acoustic Control Corp, Van Nuys, CA; Nelson Rose, Maple Glen, PA; A. J. Martinson, Martinsound, Alhambra, CA; J. G. Mitchell, Schaumburg, IL; Richard C. Coscia, Heavy Custom Sound & Light, Brooklyn; John W. Kryda, G&T Harris Inc., New York; David M. Andres, Andrews Audio Consultants, New York; Glen Ballou, Southington, Conn.; John J. Klanatsky, Astoria, NY; Brett Cosor, Electronic Marketers, Gaithersburg, MD; Mark Lynch, Quality Sound Enterprises, Fayetteville, NC; Camillo/Barker Enterprises, Somerville, NJ; John Laberdie, Dale Ashby & Father, Basking Ridge, NJ; Robert Brown, J.F.A.

Electronics, Troy, NY; Ray Rayburn, Rayburn Electronics, Glendale, NY; Robert V. Vitale, Pittsfield, MA; Don Mowry, Marguerite's Music, Moorhead, MN; Eugene T. Patronis, Ph.D., Dunwoody, GA; Klipsch & Associates, Hope, Arkansas; Bob Todrank, Valley Audio, Nashville, TN; Farrel M. Becker, Kensington, MD; Robert Daniel, Eleven Ninety One, Inc., Clarksville, TN; Don Heavener, Miami, FL; Bobby Lin and Bjorn Matz, Sound Systems, Inc., Long Island City, NY; Thomas C. King, Walt Disney World, Buena Vista, FL; Robert C. Herrick, Production Consultants, San Antonio, TX; Kenneth L. Hartz, Orlando, FL; Lillian Sarbey, Sarbey Systems Corp., Miami, FL, and Ted L LeTourneau, Acoustic Consultants, Longview, TX.

Syn-Aud-Con is licensed by the California Institute Research Foundation to teach TDS, and those wishing instruction can attend the current Syn-Aud-Con classes. PRP records are available from Sumiko, P.O. Box 5046, Berkeley, CA 94705, \$9.00 each. Time Align[®] loudspeakers are manufactured by UREI and Sonex. Some of you can and will approximate the LEDE approach in your homes. When you have, you will appreciate how many audio engineers are manacled by conventional, large room, statistical acoustic concepts.

It is with genuine pleasure that we share these insights, obtained via TDS, into the "combinational geometry" and practical psychoacoustics underlying successful control of a small room's acoustic environment. The functional truth regarding playback systems in small rooms, such as control rooms and home music rooms, once experienced, is simple to understand, easy to apply, and immediately obvious to anyone who hears the results. Δ

A short course in shelf-improvement.

Hand-rubbed oiled oak and walnut wood finishes add a richness to your room.

Die-cast or injection molded frames on all drivers for a solid, tight sound.

Special controls let you equalize the speaker to your room's acoustics.

Molded port tubes enable more exacting quality control of the tuned enclosure, ensuring total speaker-to-speaker duplication of the lab standard.

Deep, long-throw woofer features high-technology, sintered ceramic magnet structure.

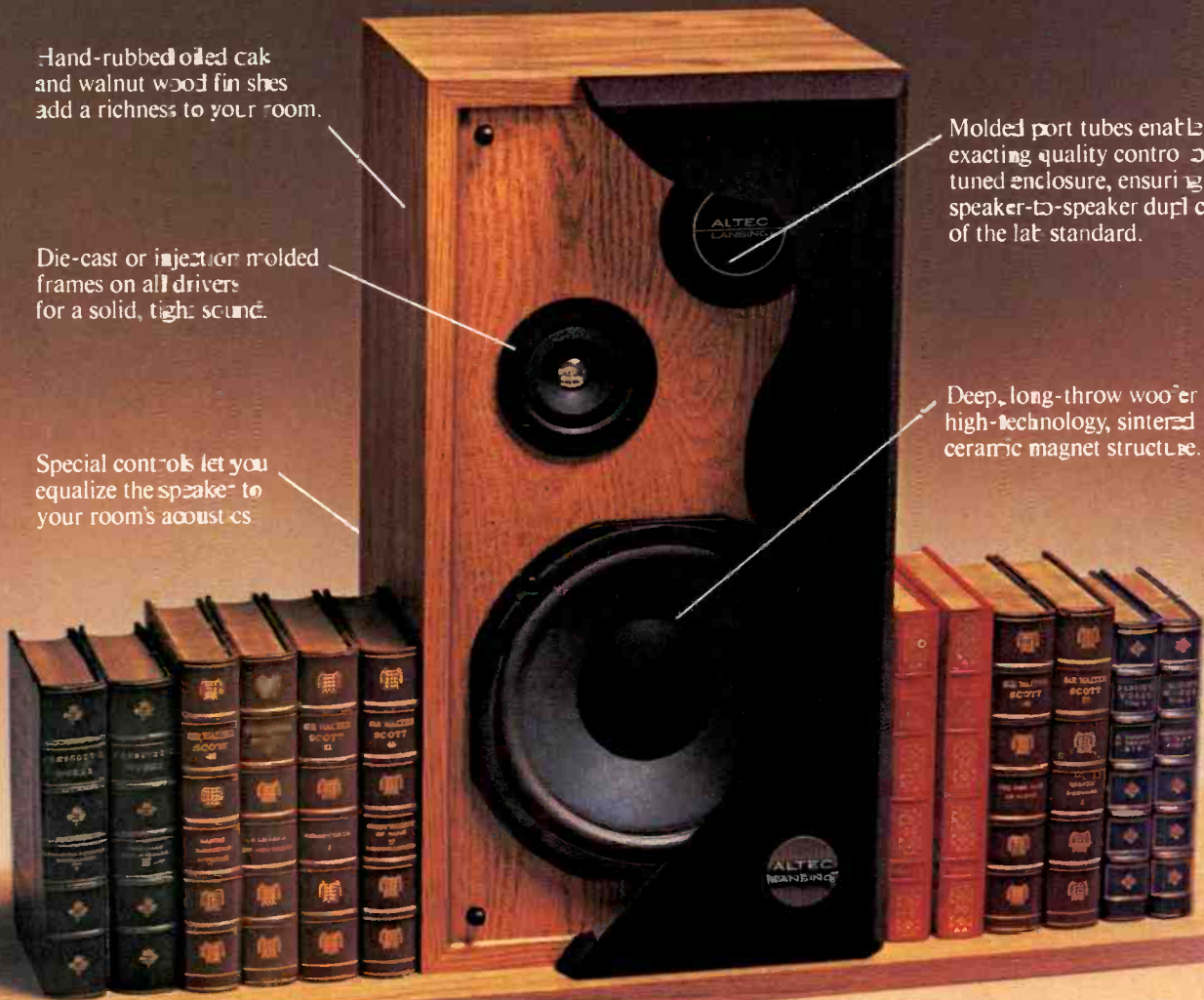

The quickest way to improve your shelf with the new Series II from Altec Lansing. Each speaker in the Series II line combines the best of everything we've learned during the past 40 years of making professional speakers for studios, concerts and theaters.

As you can see, we've given the Series II a lot of features you'd expect only in Altec's most expensive speakers. Items like long-travel woofers with non-degaussing ceramic magnets; equalizing controls; molded port tubes; and real wood finishes.

What you can't see (but you can most assuredly hear) is the Series II's high-efficiency design delivering the fullest sound possible, even with a receiver or amp as small as 10 watts. Also, there's the confidence you'll have in knowing that we make every major component and cabinet ourselves. Then we back it all up with a full, 5-year warranty.

For the full course, send for our free, full-line catalog and the name of your nearest Altec Lansing dealer. Write: Altec Lansing International, 1515 S. Manchester Ave., Anaheim, CA 92803.



Altec Lansing. The #1 name in professional speakers is coming home.

Enter No. 52 on Reader Service Card

ACOUSTIC ROSETTA STONE

Richard C. Heysler

Suppose that Leonardo da Vinci had known about the hologram. And suppose he was aware of a technical clue that he could put onto his paintings allowing future generations to see them as three-dimensional images in untarnished colors, once they developed the technology for proper reproduction. And suppose that because the technology of his time was not sufficiently advanced, Leonardo realized he would never be able to see these images as future generations could. Art style or artistic intention aside, what would be your reaction if he had known about the possibility of these things and chose not to bother adding this clue, even though it was otherwise invisible on his paintings?

Before you chastise the memory of da Vinci in this hypothetical circumstance, consider this: Right now, today, we can record subsidiary information on our master recordings which will allow future generations to reproduce that sound with an accuracy denied us ... and we are not presently doing it.

Rosetta Stone

It is conceptually quite easy to understand what we could do to increase the future value of our present sound recordings. The information we could leave has been likened to that of the Rosetta Stone (1, 2). Found in 1799 near the town of Rosetta in what is now the Arab Republic, this stone bore parallel inscriptions in Greek,

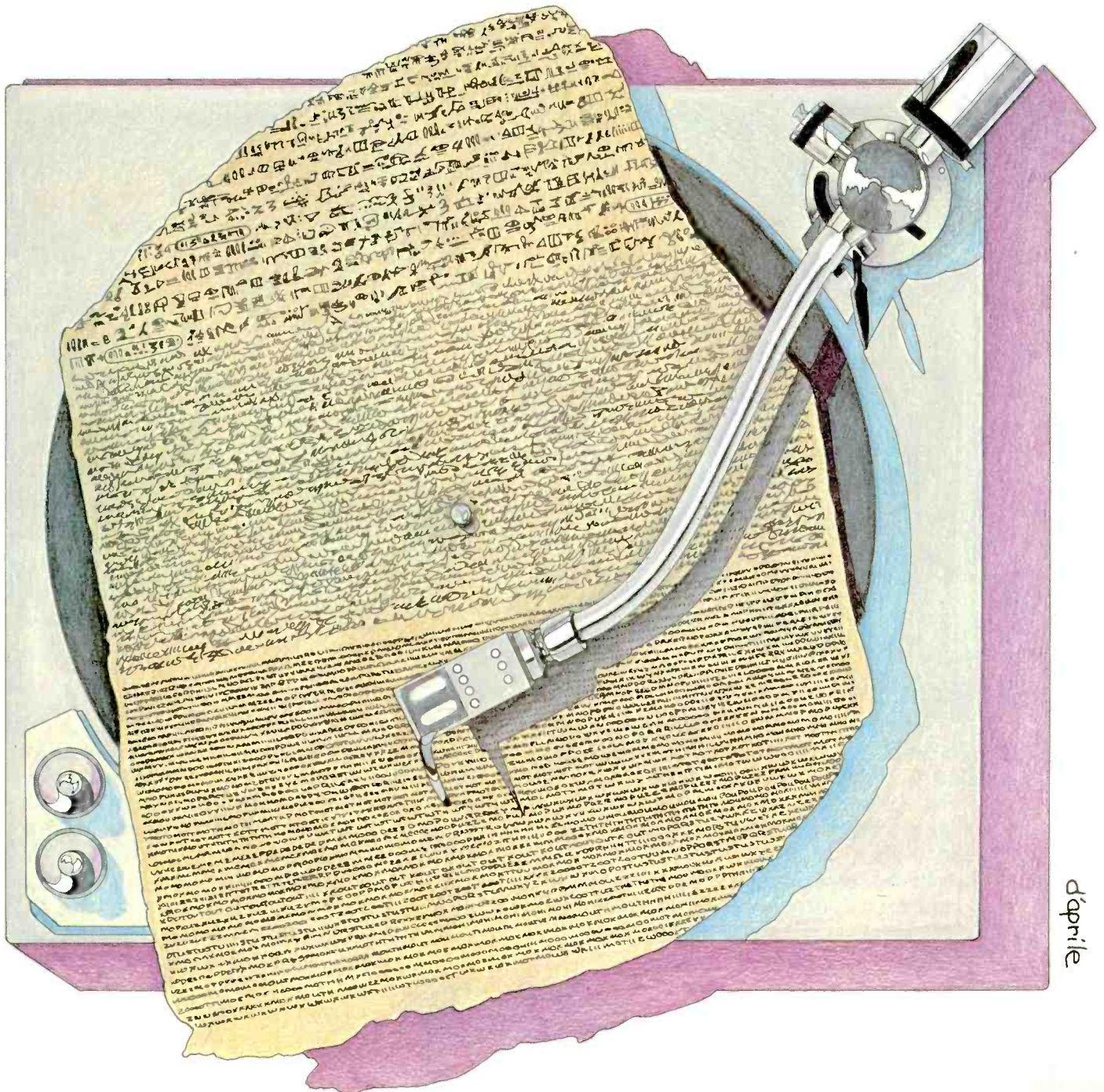

demotic, and Egyptian hieroglyphic characters. Since Greek and demotic were known to scholars, this made it possible to decipher previously unfathomable Egyptian hieroglyphics. If our audio Rosetta Stone contains adequately recorded reference sounds which will be known to future technologies, as well as the sound of the performance, then, like that ancient cipher, this reference can be used to remove the veil of years and technology.

Evolving Technology

Within a decade, the recording and processing of sound will swing almost exclusively over to the digital realm. Several decades after that, the methods by which recordings are made, processed, and reproduced may differ considerably from anything we can now envision. Audio, for example, may not survive as a separate art. Simply "listening" to something may not be considered adequate, no matter how accurate the sound may be.

Regardless of such considerations, it is apparent that the methods of recording and reproduction which we now use will eventually be replaced by something else. I have a personal feeling what one of those "something elses" may be. But nobody can really say what will happen. We see the future only through the window of our imagination . . . and that window is often distorted by our knowledge of present capabilities.

But we do have greater assurance that whatever future generations may do, they probably will not change the laws of nature. This means that if we can preserve sound in a way somehow linked to the laws of nature, we can leave a legacy of great value.

Let me point out that, like my hypothetical da Vinci, we do know how to intercept a sound field in such a way as to contain the major ingredients of an acoustic hologram of that sound field. We can record it, but the rub is that we do not yet have the technology to reproduce it. And the interesting fact is that we can do this for many of our present recording situations *without effecting the present product in any way.*

In addition, we know what actions we might take to provide test signals on our recordings that can be used to correct many of the inherent technical limitations in our present archive preserving techniques.

Think, then, what impact it would create if many years from now the technology was developed to recreate the sound field corresponding to the intercepted dynamic diffraction pattern of some of our present perfor-

mances. Imagine the legacy we could leave if we allowed some future audience to hear the sound of a legendary artist performing in a hall that was no longer in existence.

Past and Present

Perhaps the sound reproduction technology of that future era will bear no resemblance to anything we now consider "necessary." They may chuckle at the history book descriptions of our two-channel "stereo" systems and wonder how in the world we could ever tolerate such distortion. And there might not be many of those ancient magnetic or disc reproducers available in the museums which could be used to play the archive records.

"Imagine Hearing a Legendary Artist Performing in a Hall That was no Longer in Existence."

But if they had dutifully transcribed the record-to-computer bank-to-"whatever," keeping all Rosetta Stone information, much as we do today to preserve 78s by putting them on magnetic tape, they would have it available when the time came. And they could put it into whatever format of reproduction was then in vogue.

And, if they were smart, they would realize that their "present" would again become somebody else's "past." And they would not throw away those old "records" once the wiggles were traced into computer "whatsits." But they would make every effort to preserve our scratches and magnetic domain orientations so that "future-future" technology could squeeze even more out of them.

If that sounds strange to you consider this: In thinking about the concept of an audio Rosetta Stone and what sort of signal previous generations might have inadvertently left on old acoustic records, M. Gerzon, with the mathematical institute of the University of Oxford, postulated that there may be a vestigial stereo signal present in them. (3) The vocalist generally stood directly in front of the recording trumpet, while the stronger instruments were placed off to the side. Although the intent was to produce either a vertical or lateral groove modu-

lation, there was a tiny off-axis motion of the stylus due to acoustic waves coming from the side. Such a component was actually found when an early acoustic recording was traced by a stereo cartridge. It is not clear whether this inadvertent stereo signal can be reasonably lifted off the original recordings by present computer technology, but had recordists of several decades ago "preserved" the signals by simply transcribing the acoustic record monaurally to electrical transcriptions or magnetic tape, then thrown the old records away, this phenomenon would never have been preserved.

Two Aspects

There are two aspects to this concept of leaving a Rosetta Stone. One aspect deals with leaving adequate information so that future processing can remove, or reduce, not only the existing technical problems in our recordings, but correct for the inevitable deterioration effects while in archive storage. The other aspect deals with preserving the spatial configuration of the original sound field through providing enough information to generate the equivalent of a dynamic diffraction pattern.

In some ways both of these aspects can be addressed by the same type of subsidiary signal which we can leave. A key to this is to use some type of acoustic-oriented signal which depends upon first physical principles and can be duplicated by future generations.

Let me give an oversimplified example: If, prior to a recording, we walk through the hall and clap our hands once every several seconds, we are exciting that hall with a localized impulsive source which migrates through the recording environment. A recording of that sound will contain the room response as intercepted by the microphones. If careful annotation is made of the room geometry and location of each clap, we have an acoustic spatial record of the room. If a musical performance is made in that same room and with those same microphones, we can theoretically combine them to determine the spatial position of each instrument in the performance. Even without the recorded hand claps, we have a synthetic aperture situation when there are a number of microphones, spatially separated, which can pick up the sound of the same instrument. The hand claps give us needed polar patterns of the microphones and the nature of reverberation species within the recording environment.

Of course, it is not perfect . . . and it is also a pain in the *gluteus maximus*.

But if this Rosetta Stone signal goes through all of the equalization and processing that the performance does, and if it is subjected to the same storage conditions, and if future generations know how to duplicate a hand clap, then they can crunch on all this data to reconstruct an actual sound field far closer to that of the original recording environment than anything we can get from this same recording today.

I only use the hand clap as an illustration of a type of signal. Actually, a hand clap is far from ideal. But a hand clap is better than nothing at all — which is what we now have.

There are many technical factors that must be addressed if we want to do a good job of enscribing an acoustic Rosetta Stone. The fundamental consideration is to leave some type of signal which can be used to "measure" the technical limitations of the recording medium. Phase-coherent frequency sweeps at different intensity levels would be nice to have.

The next thing would be a signal that could be used to determine the microphone and pickup limitations, once the recording medium aberrations were removed. Even a dumb thing like a child's spring-steel clicker toy could be used to get started. Go up to each microphone and snap the spring for near field and high sound pressure level characteristics. Then back off to the location of each musical instrument that is to be recorded and snap again, always being careful to note where the sound is relative to the microphone. Since it is a test recording we can speak out loud and say where it is located as we walk around. Photograph the hall and mike placement. Make a B & K microphone recording of the sound of that clicker so future generations can get close to the original sound even if they did not know how to physically duplicate the clicker. And be sure to put it all together as an archive package.

I have no intention of going into greater technical detail on what type of signal we could use, nor do I wish to haggle about the fact that many of our recordings are not intended to represent a cohesive spatial-temporal performance. What I want to do is stimulate thought about the concept — to free our mind from the prison of the present.

The Hall in a Can

The acoustic wave propagating outward from each source of sound can be thought of as a signal illuminating the listening environment. The reaction of that environment to this acous-

tic illumination gives rise to the sound field. If we know what the source of sound is and we intercept the resulting sound field, we can use that to recover the "sound" of the environment.

Think what that means. We can conceptually preserve the acoustic "essence" of a great hall (4, 5). And it does not take as much effort to do this as we might imagine. Since an illumination function has a predictable space-time relationship, we can determine most of it by intelligently intercepting selected parts of it. We really should record both the sound pressure (a scalar) and particle velocity (a vector) at a number of different locations. But if we only had one part, such as pressure, we could crunch to determine the probable velocity distribution.

Once we had the "hall in a can" there is no necessity for performers to go to that hall in order to produce a recording "there." Regardless of our esthetic or professional opinion on the ethics involved, it is going to happen — some day. All we need is the appropriate acoustic Rosetta Stone. That sure will stretch the old copyright laws to the limit. Who owns the sound of a great hall?

The Intellectual Trap

Of course, when I mention such things I am falling into the common habit of restricting the future to those things I know can be done today. But future technology will take directions that we cannot predict. For that reason if we ever do get around to recording the subsidiary information which can be used as a Rosetta, we must try to document it as thoroughly as possible.

I close this little mind-stretch discussion with a personal observation . . . there is a fascinating intellectual trap that gets sprung once we know it is possible to leave a Rosetta Stone for future technology. Once we know that something of value can be done for the future, we can never remain intellectually content in the knowledge that it is not being done at present. ▢

References

1. R.C. Heyser, "A Rosetta Stone for Audio?" (editorial), *J. Aud. Eng. Soc.*, Vol 22, No. 4, p. 251 (1974).
2. D. Davis, "A Rosetta Tone?" (Forum), *J. Aud. Eng. Soc.*, Vol 22, No. 6, p. 430 (1974).
3. M. A. Gerzon, "On a 'Rosetta Stone' for Acoustic Recording," (Forum), *J. Aud. Eng. Soc.*, Vol 22, No. 8, p. 638 (1974).
4. M.A. Gerzon, "Recording Concert Hall Acoustics for Posterity," (Forum), *J. Aud. Eng. Soc.*, Vol 23, No. 7, p. 569 (1975).
5. R. C. Heyser, More on "Recording Concert Hall Acoustics for Posterity," (Forum), *J. Aud. Eng. Soc.*, Vol 23, No. 7, p. 571 (1975).

Mitsubishi Car Audio Dealers

ARIZONA
HI-FI SALES COMPANY
Mesa
CALIFORNIA
AUTO RADIO HEADQUARTERS
Oakland
CALIFORNIA CAR STEREO
Hayward
DOW SOUND CITY CAR STEREO
San Diego
RADIO SUPPLY COMPANY
Sacramento
SOUNDWORKS
Emeryville
THE FEDERATED GROUP
West Los Angeles
Hollywood
Westminster
Canoga Park
La Puente
THE GOOD GUYS
South San Francisco
THE SOUND ROOM
Modesto
SAN JOSE STEREO TAPE
San Jose
SOUND COMPANY
San Diego
COLORADO
ESP COMPANY, INC.
Englewood
SOUNDTRONICS
Greeley
CONNECTICUT
P.J.S., INC.
East Hartford
FLORIDA
AUDIO GARAGE, INC.
Winterpark
CONSUMER WAREHOUSE
Jacksonville
ELECTRONIC CENTER
Miami
HART'S APPLIANCE
& STEREO CENTER
Daytona
HI-FI-FO FUM, INC.
Pinellas Park
LUSKINS HIGH FIDELITY
Hollywood
SOUND INVESTMENT
CAR STEREO, INC.
Tampa
GEORGIA
BACK DOOR STEREO, INC.
Atlanta
GODWIN DISTRIBUTING COMPANY
Manetta
IDAHO
ASCENSION STEREO
Sandpoint
LANDMARK DISTRIBUTING
Idaho Falls
ILLINOIS
AUTO SOUND
Skokie
CAR HI-FI
Dowers Grove
CONTROLS UNLIMITED
Arlington Heights
CUSTOM CAR STEREO
Oak Lawn
GLENN POOR'S AUDIO VIDEO
Urbana
R & S AUTOMOTIVE SOUND, INC.
TEAM ELECTRONICS
Capentersville
THE STEREO SYSTEMS CO.
Aurora
UNITED AUDIO CENTERS INC.
Chicago
WILLARD'S AUDIO-TV-CB
Lombard
INDIANA
CLASSIC STEREO
Fort Wayne
HI-FI BUYS
Indianapolis
PRO AUDIO
Lafayette
IOWA
AUDIO ODYSSEY
Davenport
RENIER COMPANY
Dubuque
WALDEN PHOTO & STEREO, INC.
Waterloo
KANSAS
AUDIO SYSTEMS
Wichita
CUSTOM SOUND, INC.
Wichita
HAYES SIGHT & SOUND
Hutchinson
KENTUCKY
AUDIO WAREHOUSE
Louisville
MASSACHUSETTS
K & L SOUND SERVICE CO.
Watertown
MICHIGAN
ALMAS HI FI STEREO
Dearborn
ELECTRONIC SOUND
Grand Rapids
MINNESOTA
AMALGAMATED AUDIO
Wirota
DAYTON'S
Minneapolis
MR. MUSIC MAN
Moonhead
MISSOURI
INDEPENDENCE AUDIO
Independence
NEW JERSEY
ABC WIDE WORLD OF MUSIC
Hackensack
ARMAND'S SOUND ODYSSEY
Cherry Hill
AUDIO DISCOUNT WHSE. SALES
West Long Branch
SOUNDWORKS
Greenbrook
NEW YORK
CLASSIC CAR STEREO
Great Neck
THE AUDIO THRESHOLD, INC.
Webster
NORTH CAROLINA
AUDIO & VIDEO CONCEPTS
Winston Salem
CAR STEREO DISTRIBUTORS
Raleigh
CB ELECTRONICS
Whiteville
SOUND HAUS
Durham
OHIO
GENE SHIPP'S CARLIN AUDIO
Dayton
THE SOUND CONNECTION
Canton
PENNSYLVANIA
TEPPER AUTO SOUND
Philadelphia
TENNESSEE
ADDITION
Kingsport
H & W ELECTRONICS, INC.
Jackson
TEXAS
B & M ELECTRONICS, INC.
Houston
UTAH
INKLEY'S
Salt Lake City
ZCMI
Salt Lake City
WASHINGTON
ERY'S APPLIANCE
Marysville
SPEAKERLAB, INC.
Seattle
WEST VIRGINIA
HIGH FIDELITY COMPANY
Charleston
WISCONSIN
AUTO RADIO STATION
Madison
PORT OF SOUND
Milwaukee
PRO GALLERY
Racine

 **MITSUBISHI®**
CAR AUDIO
SOUND US OUT



Miles Ahead in Car Audio Components

You're aware of Mitsubishi audio component systems for your home as well as the superior quality, performance and design that goes into them. Now Mitsubishi engineers have followed through with that same "separate components" premise, and we now want you to be fully aware of our new component systems for your car.

Start with the CV-21 Power Amplifier and the CJ-20 FM Tuner. Then choose the CX-21 Auto-Reverse Cassette Deck or the CX-20 Cassette Deck. Add up to six speakers including a pair of SX-30 two-way Alumi-Die Cast Enclosed

speakers for a total car audio system worthy of the name Mitsubishi.

Now a word about "specs"...we have always believed in rating our equipment's performance conservatively. Only you benefit from this caution. "Sound us out" before you buy any other car stereo system. You'll be miles ahead with Mitsubishi.



A complete line of components, in-dash/under-dash units and speakers await you at select audio and car audio dealers. Check the list adjacent to this ad for the Mitsubishi Car Audio dealer nearest you.

 **MITSUBISHI®**
CAR AUDIO
SOUND US OUT

© 1978 Melco Sales, Inc.

Dealer inquiries invited: Contact Melco Sales, Inc., 7045 N. Ridgeway Ave., Lincolnwood, Ill. 60645, 800-323-4216 (Outside Ill.), 312-973-2000 (Within Ill.)

Enter No. 22 on Reader Service Card

Equipment profiles

Jensen Model R-430 AM/FM Car Stereo Cassette/Receiver

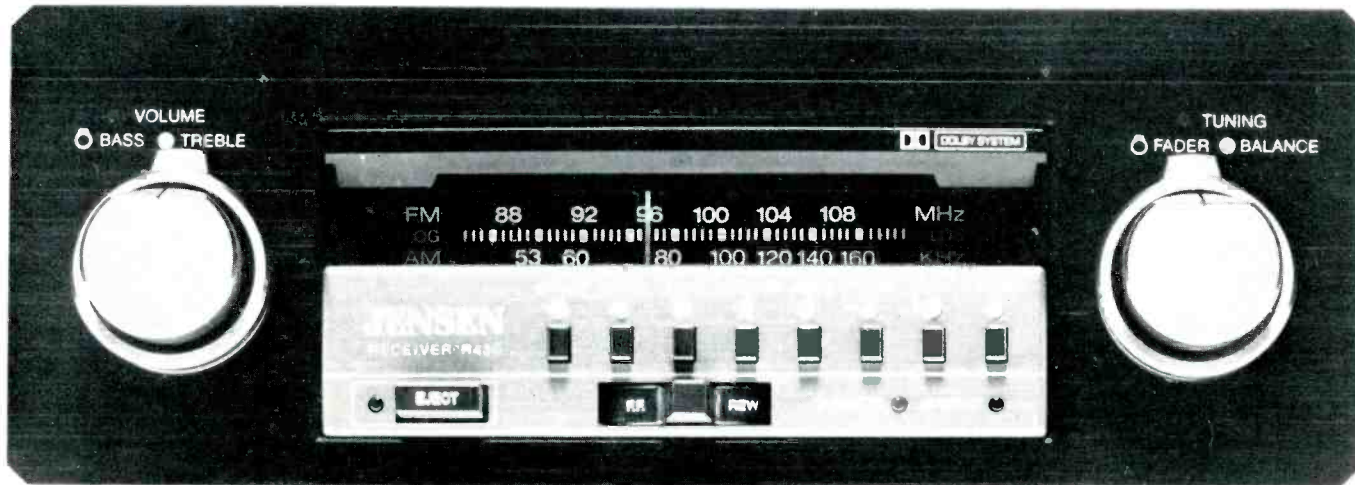

MANUFACTURER'S SPECIFICATIONS

AM Tuner Section

Quieting Sensitivity: 9.0 μ V.
Image Rejection: 80 dB.

FM Tuner Section

Usable Sensitivity: 1.0 μ V (11.2 dBf).
50-dB Quieting: Mono, 2.5 μ V (19.2 dBf).
S/N: Mono 68 dB, 73 dB w/Dolby.
Selectivity: 75 dB.
Capture Ratio: 1.5 dB.
AM Suppression: 52 dB.
I. f. Rejection: 85 dB.
Image Rejection: 65 dB.

Stereo FM Separation at 1 kHz: 32 dB.
Distortion: 0.45 percent.

Amplifier Section

Total System Power: 60 watts.
Rms Output per Channel: 30 watts.
Crossover Frequency for Bi-Amp Operation: 1 kHz w/ 12 dB/octave low-pass filter and 6 dB/octave high-pass filter.
THD: 0.4 percent at 52 watts, 1 kHz.
Frequency Response: 30 Hz to 18 kHz, -3 dB.
Bass & Treble Control Range: \pm 10 dB at 100 Hz and 10 kHz.

Tape Section

S/N: 50 dB, 60 dB w/Dolby.
Separation: 35 dB.
Crosstalk: 45 dB.
Wow & Flutter: 0.2 percent.

General Specifications

Dimensions: Main Chassis: 17 in. (17.8 cm) W x 2.7 in. (6.9 cm) H x 6 in. (15.2 cm) D. Nose: 4.1 in. (10.4 cm) W x 1.8 (4.6 cm) H. Power Amp: 5.6 in. (14.2 cm) W x 2.9 in. (7.4 cm) H x 8.6 in. (21.9 cm) D.
Price: \$579.95

At Audio Research our only business is providing the highest definition in music reproduction.

On the following 11 pages you will find our 9 major products, followed by our authorized dealer listing. Each of these products represents a serious effort to provide quality of two kinds — construction and sound — we do not offer one or two "state-of-the-art products" in order to merchandise some less costly products. No, at Audio Research, quality is our only business, and each of these products is constructed without compromise with quality, each offering different features and/or application.

- 4 Power Amplifiers: D-52, D-100A, D-110, D-350
- 1 Electronic Crossover: EC-5
- 3 Pre-amplifier/Stereo Control Units: SP-4A, SP-5, SP-6
- 1 Moving coil pre-pre-amplifier

Note: The wood cabinets shown on some of the products on the following pages are optional extra cost accessories.

If you desire more information about any of these products a detailed specification sheet is available upon request.

Write:

Dept. A
Audio Research Corporation
Box 6003
Minneapolis, MN 55406

audio research

Jensen Sound Laboratories has been the acknowledged leader in sales of car speakers for some time now and, according to spokesmen for that company, they had been concerned over the poor performance quality of much of the electronics that was sold for use in moving vehicles (not to mention the exaggerated power output claims made by many car stereo equipment manufacturers who, unfortunately, feel they are not bound by the FTC power disclosure rules which apply to home entertainment audio amplifiers). Rather than wait for someone else to come up with a high-fidelity grade car stereo receiver, the Jensen company decided to market several such units on their own, thereby marking this long-lived company's first entry into the electronic area of audio. Accordingly, they have come up with no less than six "car stereo receivers" ranging in total power output (both channels combined) from 10 watts to 60 watts. At each power level (10, 20, and 60 watts), there is a choice of either an 8-track or a cassette model.

We elected to test their top-of-the-line cassette/receiver, Model R-430 which is supplied on two chassis. The in-dash mounted unit, at first glance, looks like many other car-stereo units though we soon discovered that it contains a host of features never before found on car units. The companion chassis is a power amp module, intended for mounting in the trunk space or in any other out-of-the-way storage area. All necessary cables and mounting hardware are supplied, as are front escutcheons and necessary mounting brackets.

Essentially, the R-430 is intended for use with four car speakers. Front-mounted speakers are driven by the lower-powered stereo amplifier contained in the radio/cassette unit, while rear-mounted speakers are driven from the separate, higher-powered amplifier module. In addition, a built-in electronic crossover network enables you to use the system in a bi-amp mode, with frequencies below 1 kHz directed to the rear speakers and those above channeled to the front speakers via the lower-powered amplifier.

We were amazed at the number of control features that Jensen managed to cram onto the standard car stereo-sized front panel of the radio/cassette chassis. Triple concentric major control shafts at the left and right handle volume, bass, treble and tuning, left-right-balance, front-rear fading. The linearly calibrated FM frequency scale and the AM frequency scale and dial pointer hinge backwards to permit insertion of a standard cassette tape. Below the dial area are no less than

eight feather-touch, fully electronic switches, each with an associated LED indicator light. The first of these, when depressed, increases gain of the separate power-amp module for "high powered" operation. The second selects bi-amp operation. Next comes a loudness switch, followed by a Dolby On/Off switch (Dolby works for cassette playback as well as for Dolby-FM signals). An FM muting switch comes next, followed by an FM/AM selector, a Local-Distance switch, and a tuner On/Off switch. The tuner switch is a nice touch in that it allows you to retain pre-set volume level for tuner operation, eliminating the usual "blast" from the radio when retracting a tape.

Along the lower edge of the front panel are a tape eject button, alongside of which is a "tape alarm" LED indicator which flashes (while speakers beep) if you should inadvertently leave a cassette in the cassette slot and turn off the ignition switch. This feature, along with control memory (if unit is turned off and on again, previous button settings are retained), is made possible because there are two connections to the car's power supply: One directly to the car battery (for the memory circuits), the other to the car's ignition switch. A centrally positioned rocker-type level switch provides fast-forward and fast tape rewind functions, while at the lower right of the panel there are two more indicator lights, one of which lights when a cassette tape is engaged, the other for denoting stereo FM reception. Managing to get all of these controls and switches into the small surface area available on a car-stereo front panel was nothing short of miraculous, in our opinion.

Laboratory Measurements

Since Jensen claims that their car "receivers" are in every way comparable in performance to home stereo receivers, we decided to measure the R-430 exactly as we would measure a home stereo receiver. In terms of specification verification, that wasn't completely possible. For one thing, there was no easy way to measure amplifier-performance by itself (we don't normally like to "tear into" any equipment being tested, preferring to use the "black box — input output" approach which is what a consumer would necessarily have to do). Thus, our amplifier performance measurements had to be made using signals generated for reception by the tuner section. Although this did not impose the full distortion limitations of the tuner section upon the amplifier (by reducing

The High Definition™ Approach



In photography, it is the razor-sharp resolution and faithful adherence to hues, tones, and shadings of the subject. In music, it is the strict re-creation of musical transients and subtle tonal structures which give the listener the sensation of "listening through" a music system to the "live" performance. At Audio Research this is our ONLY business — providing the highest definition in music reproduction.

D-52 High Definition™ Power Amplifier

Our smallest wattage amplifier — but of the very highest sound quality for music systems where its power is adequate. Recommended especially for multiway speakers with bi-amplification as well as for the many small high quality speaker systems available.

Rated 50 watts RMS per channel
(180 watts mono mode - 8 ohms)
Internal Impedance .012 ohm

Near "Class A" performance
80 joule energy storage
power supply

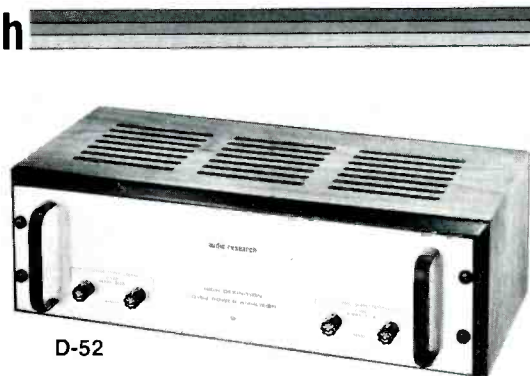

D-52

audio research

2843-26th AVE. SO.
MINNEAPOLIS, MINN. 55406

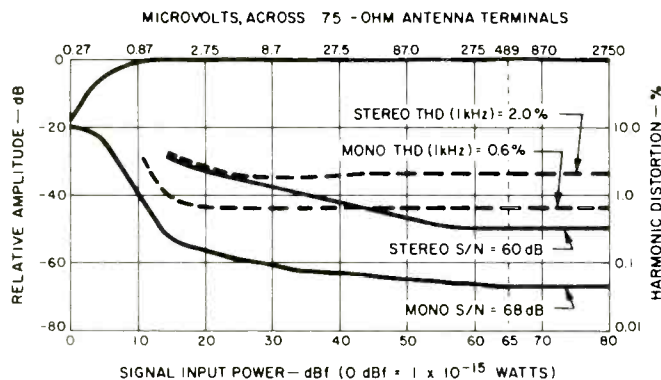

Fig. 1 — Mono and stereo quieting and distortion characteristics in the FM section of the Jensen R-430.

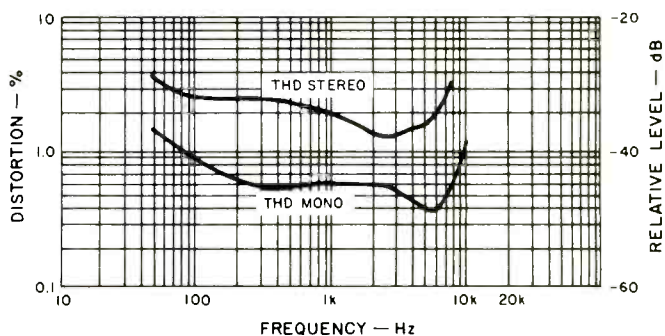

Fig. 2 — Distortion vs. frequency in the FM section.

modulation one can almost always read lower tuner section distortion), some interaction between tuner performance and actual power amplifier performance was inevitable.

Referring to Jensen's own published specifications, we noted that there were omissions as well as some ambiguities which had to be resolved before we could proceed. Setting aside the omissions for the moment (there is no mention of power bandwidth, no stereo sensitivity or quieting figures for FM, etc.), we had to first figure out what the actual power rating of the unit was supposed to be. On the one hand, Jensen speaks of "system power" of 60 watts (presumably, all channels driven and power added up). Individual amplifiers are described as having 25 watt (rear) and 5 watt (front) power output capability, but no distortion level is given. Then, in another specification, we are told that total harmonic distortion is 0.4 percent at 52 watts (presumably at 1 kHz). We soon learned that this, too, was a *total* figure, arrived at by adding together a front and rear channel power output and then doubling it for the final total figure that can be obtained at 0.4 percent THD. There's nothing wrong with all this, of course, once you figure it all out, but wouldn't it have been simpler for Jensen to supply now-standardized power ratings strictly in accordance with FTC home-amplifier requirements? They, and other car stereo makers, have been asking for standards for some time now, and here are recognized

power output standards that they could have used. Admittedly, their "60 watt system" claim would have to be modified, but, as it turned out, the unit performed so much better than any car stereo we have tested that there would really have been no problem as far as the competition is concerned. So much for specification philosophy; on with the actual testing.

FM Performance Measurements

Figure 1 summarizes the more important FM performance characteristics. Ultimate S/N in mono reached 68 dB for strong signals, while in stereo FM the best S/N for strong signals was 60 dB. Harmonic distortion measured 0.6 percent in mono (at 1kHz), a bit short of the 0.45 percent claimed, but much lower than measured on most car FM sets. In stereo, THD measured 2.0 percent and, from the way the set behaved when tuned manually, we suspect a slight misalignment here. Usable sensitivity in mono was a very low $0.95 \mu\text{V}$ (10.8 dBf).

Remember, that referred to a 75-ohm antenna input, it takes fewer microvolts to reach a given *power* level than it does when input impedance at the antenna is 300-ohms. Thus, $0.95 \mu\text{V}$ across 75 ohms is equivalent in power to $1.9 \mu\text{V}$ across 300 ohms. The dBf readings are the same, however, regardless of antenna impedance. Stereo sensitivity measured

72

The Quality Approach

Audio Research products are built FOR perfectionists, BY perfectionists. Basic to the nature of a perfectionist is a love for quality, whether it be in fine automobiles, cameras, or music systems. Simple appreciation of a quality built product can be very satisfying. The extra measure of enjoyment in ownership of an Audio Research product comes from the knowledge that you own a component that not only represents the "state-of-the-art" in music reproduction, but also the "state-of-the-art" in construction quality.

D-100A High Definition™ Power Amplifier

Rated 100 watts RMS per channel
(360 watts mono mode - 8 ohms)
75 joule energy storage power supply

The D-100A shares with all Audio Research amplifiers total stability to drive any kind of load — from electrostatic speaker to induction motor — with complete stability. Built to continuous commercial service standards. Second generation Analog Module™ Technology.



D-100A

audio research

2843-26th AVE. SO.
MINNEAPOLIS, MINN. 55406

Enter No. 2 on Reader Service Card

15.0 dB. The 50-dB quieting point was reached with signal strengths of 12.4 dBf in mono and a rather high 54.7 dBf in stereo. Combined FM frequency response, shown in the spectrum analyzer photo of Fig. 3, was flat from 50 Hz to 10 kHz, and was down 1.0 dB at 30 Hz and 4.0 dB at 15 kHz. Distortion versus frequency is plotted in Fig. 2 and remained fairly uniform over most of the significant audio range. Referring once more to Fig. 3, stereo separation (lower trace) measured better than 40 dB at mid-frequencies, decreasing to 36 dB at 100 Hz, and 35 dB at 10 kHz. The display shown in Fig. 3 is necessarily based upon low modulation levels (because of the built-in pre-emphasis of our test equipment). When "spot" measurements of separation were made at the three test frequencies of 100 Hz, 1 kHz, and 10 kHz, using 100 percent modulation, separation figures were lower, measuring 30 dB, 34 dB, and 25 dB respectively.

Selectivity (alternate channel) measured exactly 75 dB as claimed, while AM suppression, capture ratio, and image rejection all exceeded claims with readings of 54 dB, 1.3 dB, and 68 dB respectively. The i.f. rejection was 85 dB as claimed.

Figure 4 illustrates the action of the Dolby FM circuitry, with sweeps taken at various modulation levels. While there is some evidence of mistracking (at high modulation levels), the basic action of the Dolby circuitry was correct.

As has become our practice in recent receiver test reports, we measured the AM tuner section's frequency response and were pleasantly surprised. Response, as shown in the sweep-frequency photo of Fig. 5, was actually flat right out to 5 kHz (down 3 dB at that frequency), placing the AM section of this car-stereo unit well ahead of most of the AM sections we have measured for some of the most expensive and powerful home stereo receivers currently available.

Amplifier Section Measurements

Figure 6 is a plot of power output of each of the two amplifiers (front and rear) of the R-430. The front amp reached a 1 percent THD distortion level at an output of 5 watts, while the more powerful rear amp delivered 24 watts for that same level of distortion. Thus, if one wants to use lensen's method of power rating, one could add 5 plus 24 (29) and double it (58) to report that the "total system" power was 58 watts for

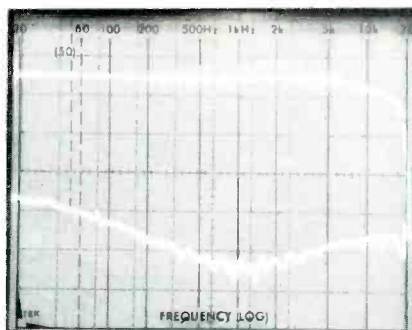

Fig. 3 — Frequency response and stereo FM separation.

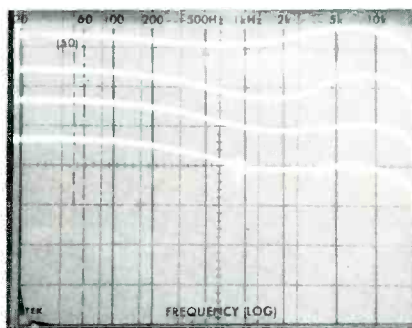

Fig. 4 — Frequency response with the Dolby FM circuit activated.

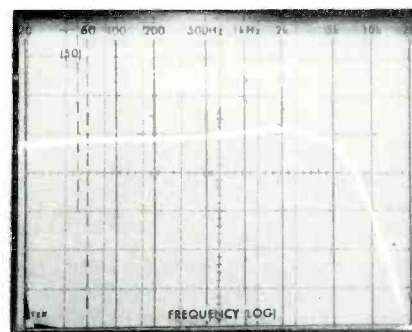
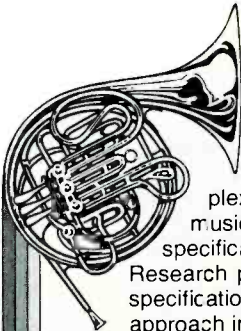

Fig. 5 — AM frequency response.

The Musical Approach



High Definition™ music reproduction is accomplished by a design approach that considers, first and foremost, the complex, constantly changing phenomena of musical waveforms. The musical approach requires designs which go beyond good "static" specifications to perform in actual use — music reproduction. Audio Research products have good "static" specifications which exceed the specifications of many competitive products. However, it is the musical approach in Audio Research products that sets them apart. The musical approach gives Audio Research products a hard-to-define, elusive, musical quality which is difficult to measure but easy to hear.

D-110 High Definition™ Power Amplifier

Rated 100 watts RMS per channel
(360 watts mono mode — 8 ohms)

300 joule energy storage power supply

The D-110 — a combination of the D-100A circuitry with the D-350 power supply — rebiased to higher operating current and fan cooled, provides the highest possible measure of musical quality.



D-110

audio research

2843-26th AVE. SO.
MINNEAPOLIS, MINN. 55406

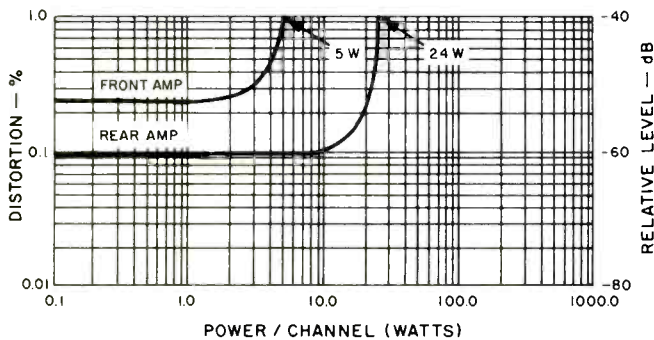
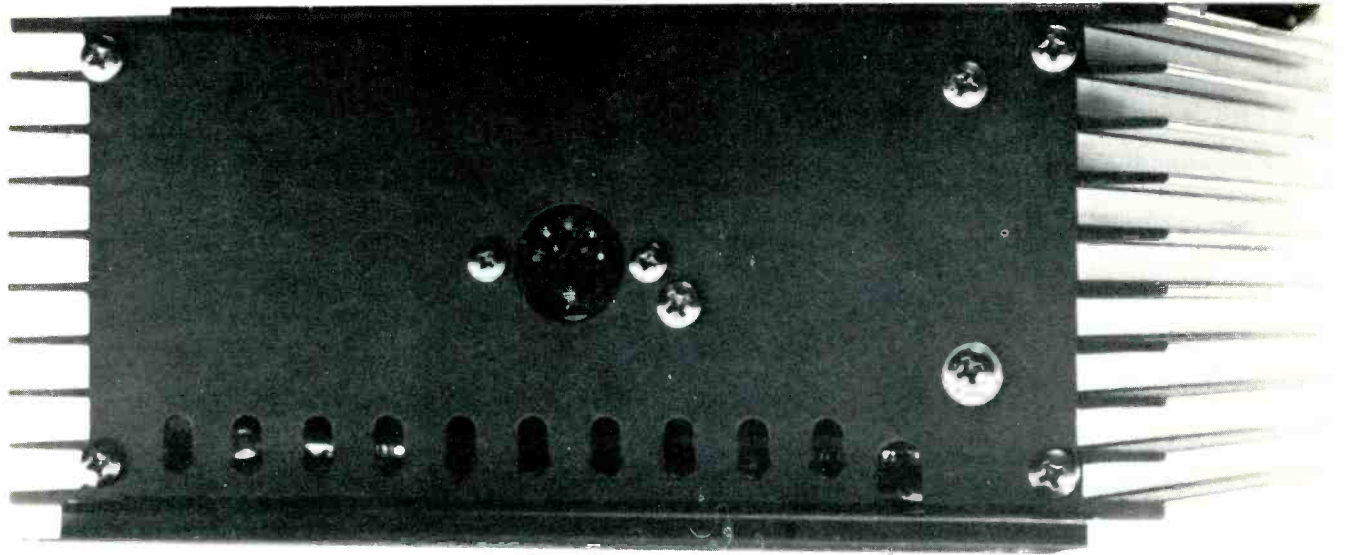

Fig. 6 — Distortion vs. power output at 1 kHz with the power amp.

the R-430. There would be no problem rating the system at 60 watts, as Jensen did, since no associated harmonic distortion figure was provided. Actually, by pushing each amplifier a bit harder, (and trying to keep distortion levels from each the same) we came up with a distortion of just over 2.0 percent

for the "60 watts total system" power. For the 0.4 percent distortion level mentioned by Jensen, the front amp puts out 3.9 watts while the rear amp delivers 23 watts. So, adding it all up and doubling again, you come up with 53.8 watts "total" — or better than the 52 watts claimed by Jensen.

Tone controls behaved pretty much like those of any home stereo receiver, and total range of bass and treble controls is shown in the 'scope photo of Fig. 7. Loudness control action (confined to the bass frequencies) is depicted for various volume control settings in Fig. 8. We checked out the bi-amping feature of the R-430 by depressing the bi-amp button on the front panel and remeasuring frequency response for both the front amplifier and rear amplifier. Through the use of the front-panel fader control, we were able to achieve equal output levels from each of these separate amps, and so were able to plot a composite bi-amp response, shown in the 'scope photo of Fig. 9.

Cassette Player Performance

We prepared a cassette test tape, using our reference Nakamichi Model 1000 deck and TDK type AD tape since the cassette deck in the R-430 is a playback unit only. The tape

The Common Approach

All Audio Research components share a number of things in common.

For example, all have heavy gauge two color anodized aluminum front panels for lasting durability and beauty. Most small parts (capacitors, resistors, transistors, etc.) are selected from quality American vendors for availability and reliability — and of course, all are used at conservative levels to assure long life.

The D-350 High Definition™ Power Amplifier

Rated 350 watts RMS per channel — 8 ohms
(about 1 KW total into 4 ohms)

300 joule energy storage power supply

Speaker line fuses

Logic circuitry with relay for added protection against subsonic or DC output.



D-350

audio research

2843-26th AVE. SO.
MINNEAPOLIS, MINN. 55406

transport mechanism was very quiet in its operation and the end-of-tape stop and "tape alarm" features all worked perfectly. Playback frequency response was flat, within 3 dB, out to 13 kHz — an excellent figure for any car tape player, while wow and flutter measured 0.15 percent W rms, considerably better than claimed by Jensen. Signal-to-noise ratio for our particular tape sample measured 55 dB without Dolby and 65 dB (above 5 kHz) with Dolby.

Use and Listening Tests

Jensen provided us with their J-1001 "Separates" Speaker Systems consisting of a pair of 6 x 9-in. woofers, two 3½-in. midrange units, and two 2-in. tweeters, and a stereo midrange/tweeter control unit. After some un baffled "bench testing" (primarily for checking FM reception, which turned out to be quite good), we concluded that, short of turning all these speakers in one of our cars, the only way to test the system from a listening standpoint would be to connect up the rear amplifiers to a pair of high-efficiency, home-type speaker systems. This we did, and were quite surprised and pleased with the results. Dial calibration was a bit off at the frequency extremes on FM, but right on target from around 92 MHz to 104 MHz and sensitivity (in terms of number of FM stations received) was certainly as good, if not better, than that of most home stereo receivers in similar price categories. The muting is effective in eliminating interstation noise, and stations pop in as one tunes across the dial without any annoying transitional noises. We played back a few of our best cassette recordings too, and although we could detect a difference in treble reproduction between what we heard and the sound of the same program material played back on our Nakamichi deck, the differences were not all that monumental or disturbing. Certainly overall sound seemed well balanced and tight.

In our opinion, Jensen had every right to call this unit a high-fidelity stereo receiver. Certainly, its features surpass anything we have seen available for use in a moving vehicle. Now, if the company would just specify the performance of their new car receivers in a manner that is consistent with the rest of the high-fidelity component industry, they could well establish a new level of performance and credibility in car stereo audio equipment.

Leonard Feldman

Enter No. 90 on Reader Service Card

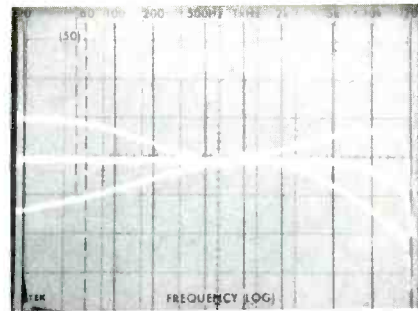

Fig. 7 — Tone control range.

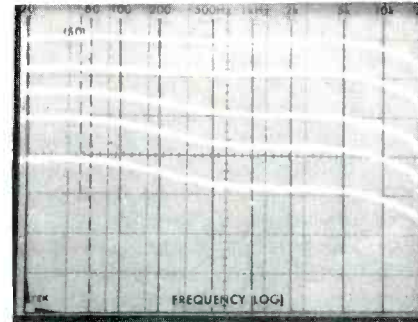

Fig. 8 — Loudness control action.

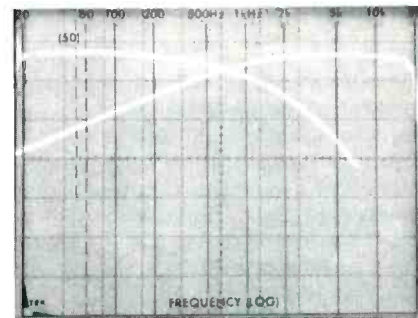
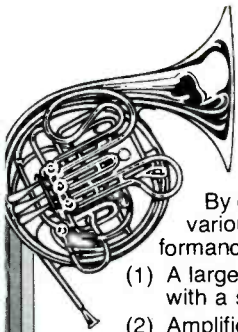

Fig. 9 — Response of the front and rear amplifiers when operated in the bi-amp mode.



How to Make the Best Speaker Systems Even Better

Many of the current state-of-the-art speakers have provision for using more than one amplifier.

By dividing the audio spectrum in two or more sections, various combinations of improved speaker/amplifier performance become possible. For example:

- (1) A large amplifier can be used for bass response, together with a smaller high quality amplifier for the treble.
- (2) Amplifiers of different gain/power specifications can be used together.
- (3) Speakers of different efficiencies can be used together.
- (4) Higher SPL's can be achieved.
- (5) Lower system distortion can be possible from both the improved amplifier performance as well as possible speaker network reduction.

The EC-5 Electronic Crossover

The EC-5 is a two-way fixed frequency electronic crossover featuring two (2) switch selectable crossover slopes, field

changeable crossover frequency with optional "network parts cards" and variable channel gain.

The crossover slopes or rolloff (transfer) characteristics are front panel selectable 6 dB or 18 dB (1st and 3rd order) Butterworth for minimum "summed" channel gain error within the frequency cutoff region.

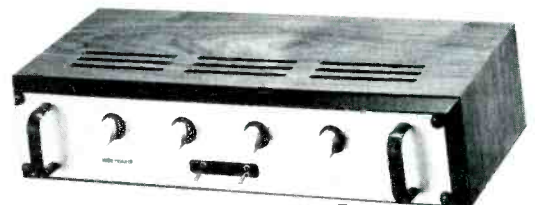

audio research

2843-26th AVE. SO.
MINNEAPOLIS, MINN. 55406

Enter No. 2 on Reader Service Card

Phase Linear Model 3000, Series II Preamplifier

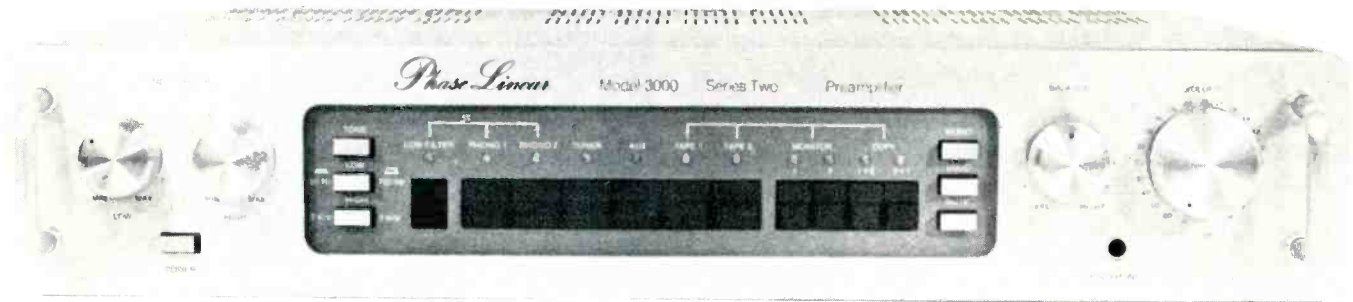

MANUFACTURER'S SPECIFICATIONS

Rated Output Voltage: 2.0 V rms.
THD at Rated Output, 20 Hz to 20 kHz: Less than 0.04 percent.

S/N Ratio (IHF "A" Weighted): Phono 1 (MM), 90 dB re: 10 mV; Phono 2 (MC), 78 dB re: 1 mV, High Level, 91 dB.

Input Impedance: Phono 1, 47 kilohms shunted by selectable 150, 225, or 420 pF; Phono 2, 50, 200, or 500 ohms, selectable, shunted by less than 20 pF; High Level, 50 kilohms.

Input Sensitivity: Phono 1, 2.0 mV; Phono 2, 0.2 mV; High Level, 200 mV.

Frequency Response: Phono 1 & 2, RIAA ± 0.3 dB; High Level, 20 Hz to 20 kHz, ± 0.1 dB.

Maximum Output at Clipping: 10 V into 10 kilohms.

Phono Overload: Phono 1, 120 mV; Phono 2, 12 mV.

Bass Control Range: ± 7 dB or ± 9.5 dB at 20 Hz.

Treble Control Range: ± 8.5 dB or ± 10 dB at 20 kHz.

Low Filter Characteristics: -18 dB per octave, cut off frequency of 15 Hz.

Headphone Amplifier Output: 200 mW into 8 ohms, 20 Hz to 20 kHz, with less than 0.07 percent THD.

Headphone Amp S/N: Better than 90 dB re: 200 mW output.

General Specifications

Power Requirements: 120 V, 60 Hz, 8 watts.

Dimensions: 19-in. (48.3 cm) W x 3½-in. (8.9 cm) H x 8-in. (20.3 cm) D.

Weight: 10 lbs. (4.5 kg).

Price: \$499.95.

76

Just one quick look at the front panel of the new Phase Linear Model 3000-II is enough to tell you that the company has come a long way in terms of industrial design compared with its earlier, rather cumbersome looking units of a few years ago. And, even if you were one of those who admired the technology offered by earlier Phase Linear products (and we can be numbered among such admirers), you'll be pleased to see that improved outward styling has not resulted in any internal circuit compromises. In fact, the preamp circuitry of the 3000-II is better than ever.

The light-colored, two-tone panel of the 3000-II is distinguished by a darker colored recessed area which contains all of the switching facilities built into this unit, with the excep-

tion of the power On/Off button at the lower left of the main panel area. At the left end of the recessed panel area are three pushbuttons. Two of these select turnover frequencies for the tone controls (50 Hz and 150 Hz for the bass, 2 kHz and 5 kHz for treble), while the third serves to bypass the tone circuits entirely. Symmetrically positioned buttons at the right of the recessed panel area handle mono/stereo selection, loudness circuitry, and -20 dB audio muting. Arranged horizontally and still within the recessed area are a low-filter button (with an amber LED above it that lights when the circuit is activated), six tactile pushbutton switches that operate CMOS-logic selector switches for program selection, and four matching pushbutton switches for the two

The Analog Module™ Approach

All of Audio Research's products (except the vacuum-tube SP-6) share in common our exclusive Analog Module™ technology.

Simply stated the Analog Module™ is nothing more than the practical packaging of our proprietary circuitry to employ the bi-polar transistor (and other discreet components) in a linear fashion for low distortion audio applications. The end results include straight-forward designs, easy maintenance, high performance audio products from these basic building blocks.

The SP-4A High Definition™ Stereo Control Preamplifier

The SP-4A is our most deluxe control unit, with ample features to satisfy the most involved "audiophile".

Frequency Response: -3 dB, 5 Hz and 100kHz

Distortion: Less than .005% THD or IMD @ 2V RMS output.

2 dB stepped controls — programmable magnetic inputs



SP-4A

audio research

2843-26th AVE. SO.
 MINNEAPOLIS, MINN. 55406

Enter No. 2 on Reader Service Card

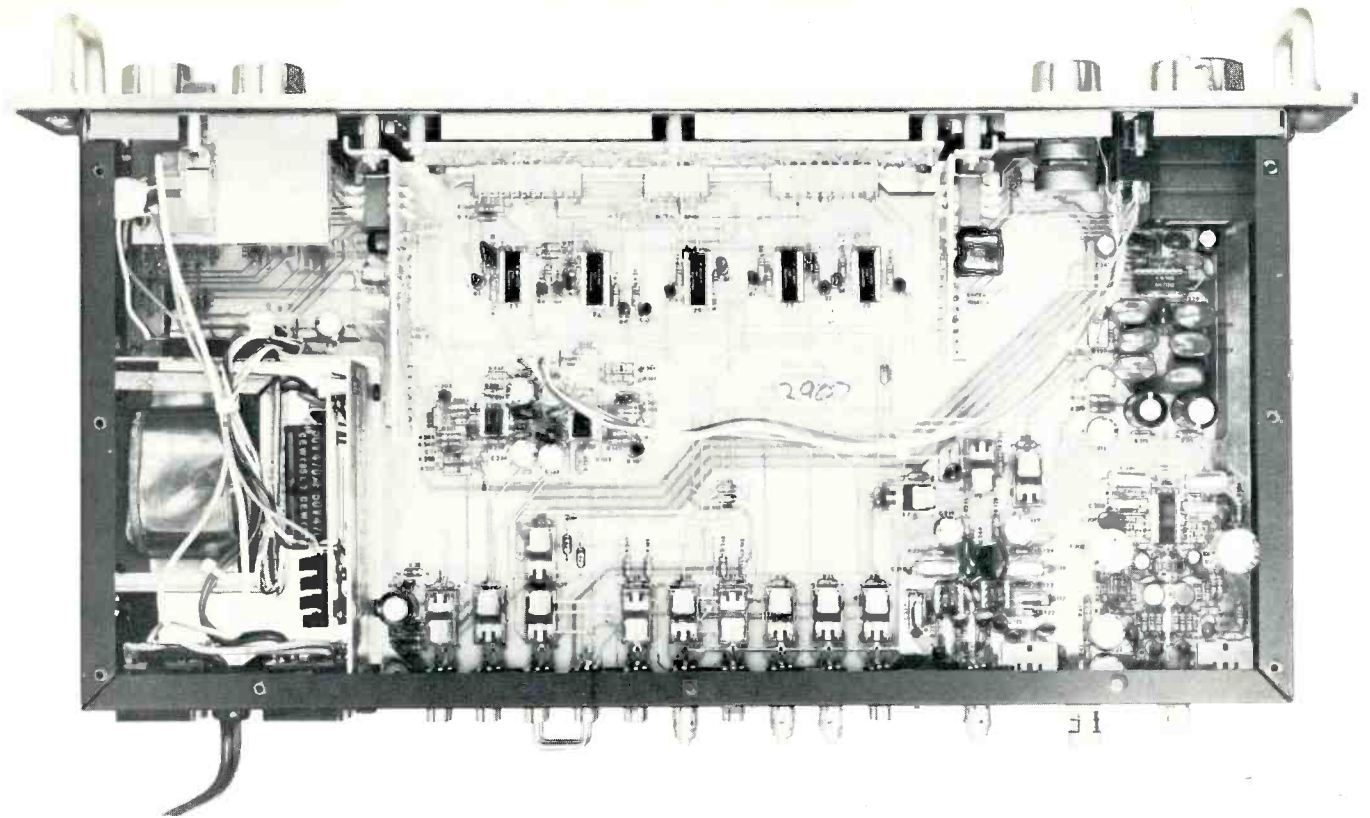

tape monitor circuits and for dubbing from tape 1 to tape 2 or vice versa. Green LED indicators above the program selectors denote program source, while amber LEDs above the monitor and dubbing switches let you know what's happening in that area.

The bass and treble tone controls, step-calibrated, are on the main panel surface at the left, while at the right end of the panel are a balance control and a 22-step volume control calibrated in dB of attenuation. A headphone output jack, powered by its own amplifier, is also located in this area.

Input and output jacks are logically arranged and designated on the rear panel of the 3000-II. The moving-coil (MC) inputs have a slide switch near them which selects the required resistive loading for such cartridges (50, 200, or 500

ohms), while the moving-magnet phono inputs (MM) have an associated slide switch which selects capacitance values of 150, 225, or 420 pF which are then placed in parallel with the 47 kilohm resistive load appearing at these inputs for optimum match of MM cartridges. In addition to the high-level, tape-in, and tape-out jack pairs, there are input and output pairs labeled NR (Noise Reduction) Loop which come with interconnecting jumpers, but which may be used to interpose noise reduction (or other accessory) units such as Dolby, dbx, or, as Phase Linear is quick to point out, their own Model 1000 auto-correlator noise reduction device. Switched and unswitched pairs of output jacks are provided, the former switched off whenever headphones are connected to the front panel phone jack. A total of six a.c. convenience

77

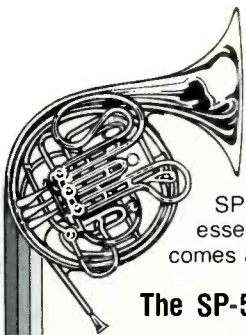

The Simple Approach

In Audio, perhaps more so than in any other electronic discipline, the concept of "simpler is better" proves true. The SP-5, although elegant, is such a product. By eliminating all but essential features, a basic stereo control of the highest quality becomes available at a modest cost.

The SP-5 High Definition™ Stereo Control Preamplifier

Frequency Response: -3 dB, 5 Hz and 10ckHz
 Distortion: Less than .005% THD or IMD
 Segmented controls, 2 dB steps



audio research

2843-26th AVE. SO.
 MINNEAPOLIS, MINN. 55406

Enter No. 2 on Reader Service Card

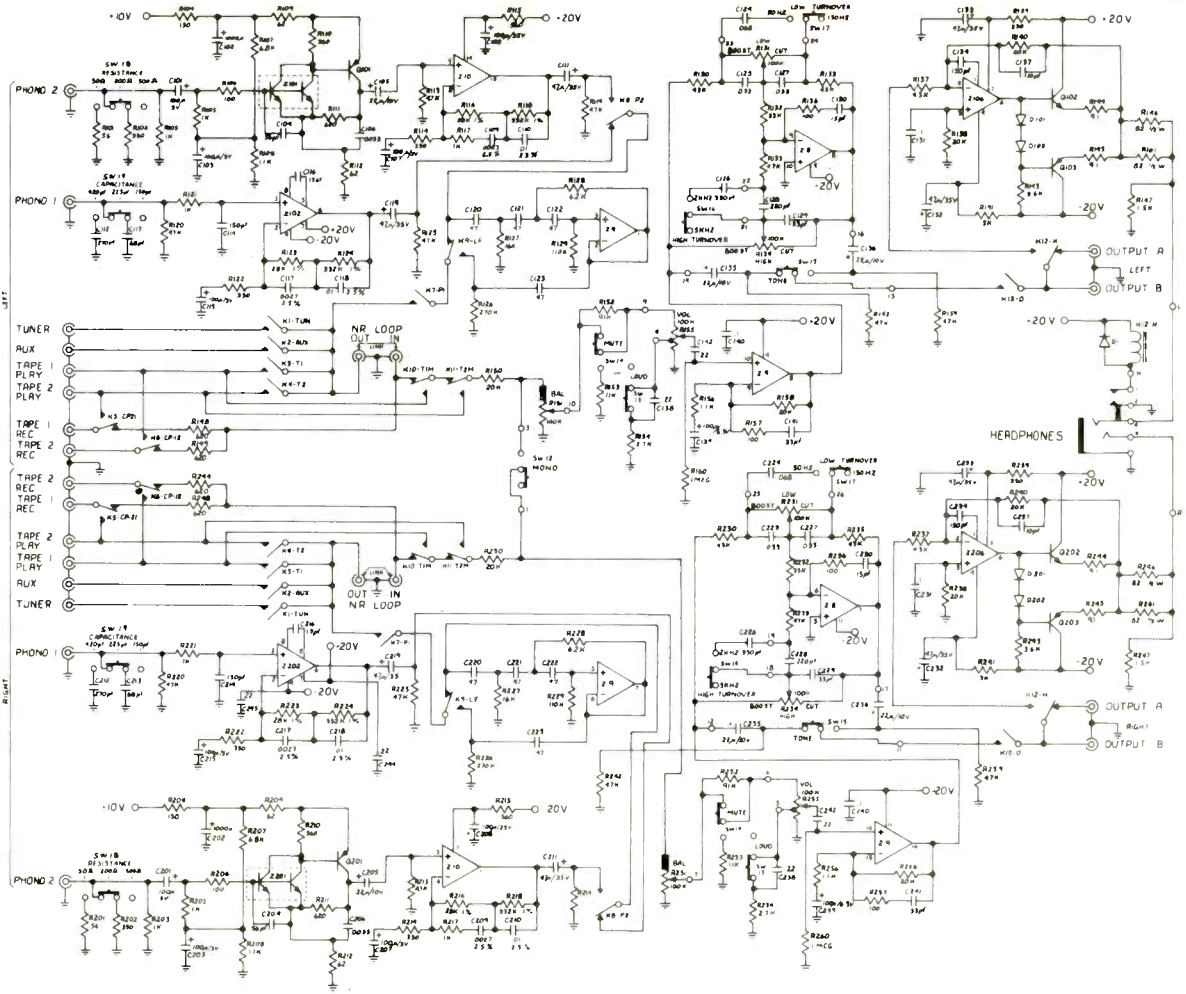

outlets (4 switched, 2 unswitched) and a chassis ground terminal complete the rear panel layout.

Circuit and Construction Highlights

A complete schematic diagram of the 3000-II is reproduced in Fig. 1. Gain and equalization for the MM and MC cartridge

inputs are separately accomplished by ICs Z-102 or Z-10. Active tone controls consist of Z8 and its associated feedback elements which are arranged in a modified form of the classical Baxandall circuitry. Gain of the high-level signal section is 20 dB, provided by a gain block made up of Z9 and its feedback network.

Listen Through the Music System

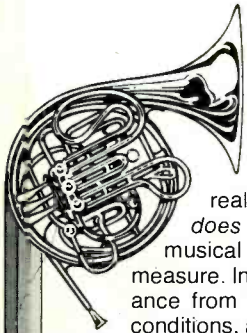

It is very easy, these days, to talk of sophisticated signal processing equipment that purports to do this or that, but the real measure of audio equipment is not what it does, but what it *does not do*. Simply to amplify, without adding to, or taking from the musical signal is *very difficult*, and this is always achieved only in measure. Interestingly enough, you cannot learn that measure of performance from the "specifications" because they relate only to static test conditions, and so we invite you to listen to our only vacuum tube product,

The SP-6 High Definition™ Preamp/Stereo Control

- Some of the specifications:
- Response -3 dB @ .05 Hz and 250kHz
- Output: 75 V RMS (Hi Z) at less than 1/2% THD at 1kHz
- Maximum Input Magnetic Phono without overload: 1 kHz — 700 mV RMS
100kHz — 2 V RMS



SP-6

audio research

2843-26th AVE. SO.
MINNEAPOLIS, MINN. 55406

Fig. 1 — Complete schematic of the Phase Linear 3000-II.

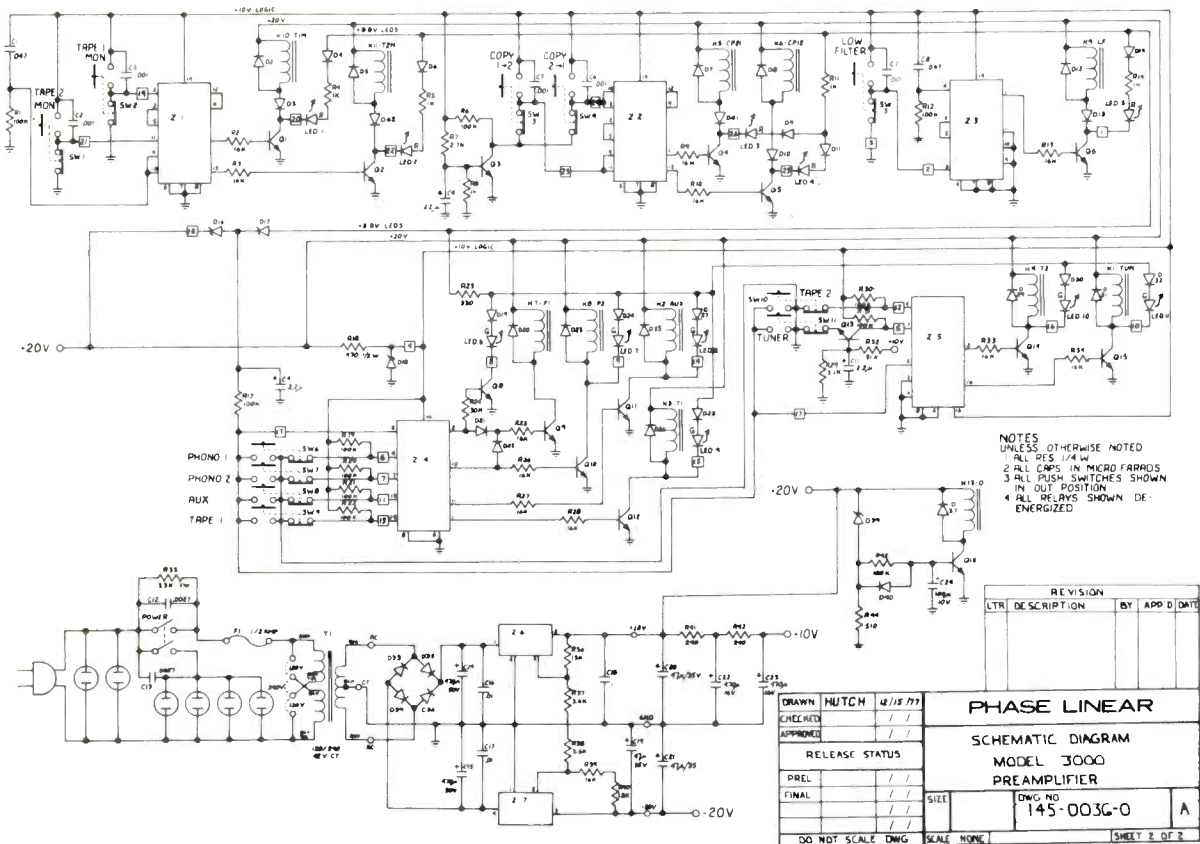

All relays used for signal routing are controlled by CMOS-D flip flops — either dual units Z1, Z2, and Z3 or quad units Z4 and Z5. Tactile pushbuttons (SW1-SW11) are used to control the clock input lines on the dual-Ds and the D-inputs on the quad-Ds. Transistors Q3 and Q13 are used for sequencing during power turn-on, along with networks R1-C1 and

R12-C8. Integrated circuits Z6 and Z7 comprise a dual-tracking regulator system providing ± 20 volts d.c. for all ICs except the CMOS circuitry which operates from -10 V d.c. regulated by Zener diode D18. Delayed turn-on is accomplished by the R-C charge time of R45 and C24, while the quick turn-off time is fixed by discharge time constant R44-C24.

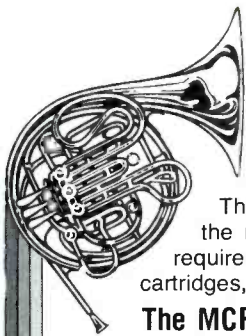

The Specialized Approach Products to Meet a Need

The very best phonograph pick up cartridges include several technologies. One of these is the "moving coil" cartridge.

These cartridges tend to have very small signal output because of the requirement for low moving mass. Most music systems will require a special "step-up" system to obtain the benefits of these cartridges, and for these we offer

The MCP-2 High Definition™ Moving Coil Phono Cartridge Pre-Preamplifier

Features include adjustable gain, adjustable input impedance, selectable inputs and outputs, a muting switch and vanishingly low distortion.

audio research

2843-26th AVE. SO.
MINNEAPOLIS, MINN. 55406



MCP-2

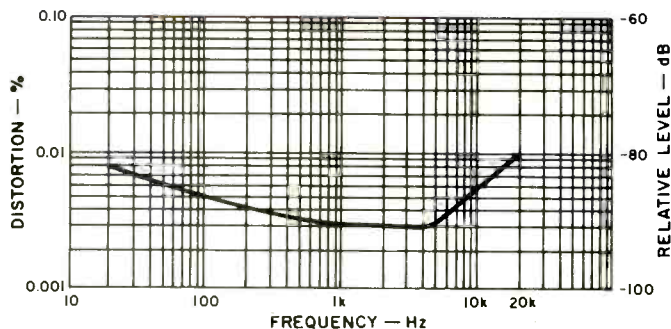

Fig. 2 — Harmonic distortion vs. frequency at 2.0 V rated output.

A major feature of the CMOS-logic selector switch is its ability to remember which functions have been selected even with the power switched off. For the memory circuits to remain active the a.c. power cord must remain connected to an energized outlet, but the power switch need not be on. In situations where control of the 3000-II is to be done by switching power to its a.c. line cord (as, for example when using an external timer), the logic circuits will automatically select *Tuner* as the program source.

Laboratory Measurements

Harmonic distortion, for the high level inputs and with rated output delivered (2.0 volts), as a function of input signal frequency is plotted in Fig. 2. At mid-frequencies, THD was essentially that of the signal source, or around 0.003 percent. Highest observed THD occurred at 20 kHz and was 0.01 percent, well below the 0.04 percent limit published by Phase Linear. IM distortion measured a very insignificant 0.005 percent. Signal-to-noise measurements were made two ways. To

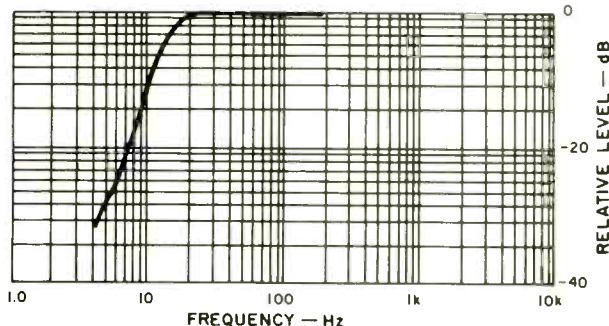
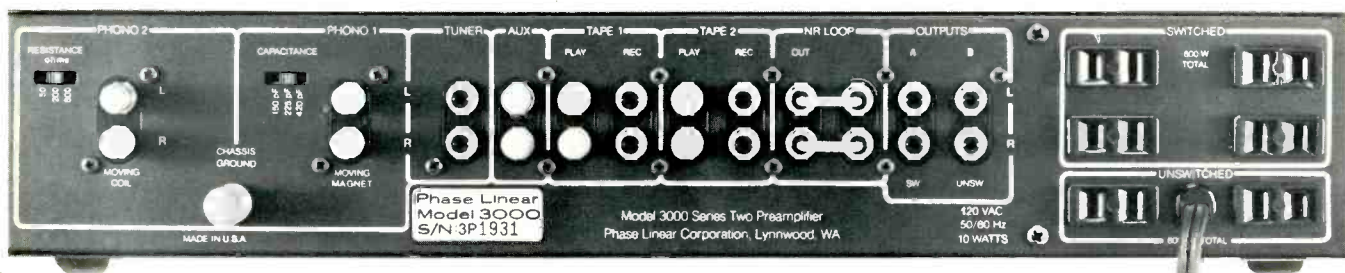

Fig. 3 — Response of the sub-sonic filter.

achieve correlation between published specs and our measured results, we measured S/N using input and output references given by Phase Linear. Then, we also measured S/N for low and high level inputs in accordance with the new IHF Amplifier Measurement Standards, IHF-A-202. Using Phase Linear's measurement techniques, we read an S/N value of 93 dB for the high level inputs ("A" weighted), 90 dB for the MM phono inputs, and 81 dB for the MC phono inputs. Repeating the measurements using IHF Standard input and output reference levels, high level S/N was 81 dB, phono S/N turned out to be 79 dB, and S/N for the higher gain MC inputs was 75 dB. As has been explained before, there is no direct way to calculate S/N results obtained using the new IHF method from those obtained using other S/N measurement and reference methods.

Input sensitivity for the phono inputs was 2.0 mV at the MM inputs and 0.24 mV at the MC inputs. These values can be translated to the new standard and become 0.5 mV for the MM inputs and 0.051 mV for the MC inputs. Phono overload



Authorized Dealers

California

GARLAND AUDIO
San Jose, CA
(408) 244-6724
MISSION BAY
AUDIO
San Diego, CA
(714) 270-9350
STEREO HAVEN,
INC.
Huntington Beach,
CA
(714) 897-0166

Florida

AUDIO ETC., INC.
Gainesville, FL
(904) 377-4107
AUDIO INSIGHT
Fort Lauderdale, FL
(305) 491-7677

Georgia

HI FI BUYS
Atlanta, GA
(404) 266-9643

Hawaii

AUDIO
REFERENCE
SYSTEMS
Honolulu, Hawaii
(808) 732-3303

Idaho

THE STEREO
SHOPPE
Boise, ID
(208) 344-7603

Illinois

PAUL HEATH
AUDIO, LTD.
Chicago, IL
(312) 549-8100

Indiana

AUDIOTREND
Evansville, IN
(812) 477-2121
HI FI GALLERY
Indianapolis, IN
(317) 253-5141

Iowa

THE ECOLOGIC
EAR
Des Moines, IA
(515) 278-5879
THE STEREO
SHOP
Cedar Rapids, IA
(319) 365-1324
THE STEREO
SHOP
Davenport, IA
(319) 386-1478

Kentucky

HI FI BUYS
Louisville, KY
(502) 447-6015

Louisiana

AUDIO CLIMAX
Metairie, LA
(504) 455-4434

Maryland

D.K.L. SOUND LAB
Silver Spring, MD
(301) 588-6257

Michigan

AUDIO
DIMENSIONS
Birmingham, MI
(313) 642-6383

Minnesota

SOUND
ENVIRONMENT
Edina, MN
(612) 926-7674
SOUND
ENVIRONMENT
Minneapolis, MN
(612) 339-4641

Missouri

J.C. GORDON CO.
St. Louis, MO
(314) 647-8866

Nebraska

AUDIO SYSTEMS
& DESIGN
Omaha, NE
(402) 556-7559

AUDIO SYSTEMS
& DESIGN
Lincoln, NE
(402) 423-8733

New Mexico

SOUND IDEAS
Albuquerque, NM
(505) 292-1188

New Jersey

THE AUDIO
ADVOCATE
Millburn, NJ
(201) 467-8988

New York (L.I.)

AUDIO DEN, LTD.
Stony Brook, NY
(516) 751-3350

Alabama

THE
SOUNDTRACK,
INC.
Auburn, AL
(205) 821-7700
THE
SOUNDTRACK,
INC.
Montgomery, AL
(205) 277-8410

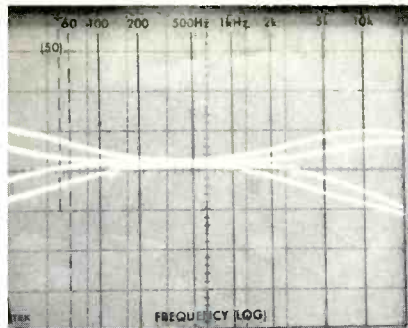

Fig. 4 — Tone control range at each bass and treble turnover frequency. (Each vertical division equals 10 dB.)

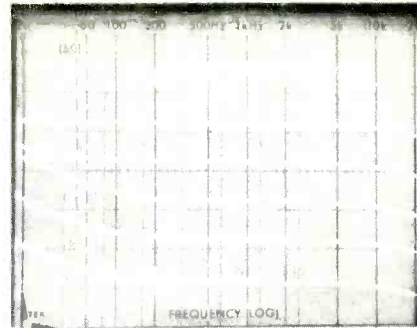

Fig. 5 — Loudness control characteristics.

in the MM inputs occurred with an input signal level of 130 mV at 1 kHz, while for the MC inputs it was 12 mV, exactly as claimed by Phase Linear. Maximum output before clipping measured 12.0 volts rms.

The built-in headphone amplifier delivered a maximum output of 240 milliwatts before clipping (into an 8-ohm load). At its rated output of 200 mW, THD at mid-frequencies measured 0.05 percent.

Frequency response was absolutely flat (via the high level inputs) from 20 Hz to 20 kHz and was down 0.4 dB at 30 kHz. RIAA equalization was also completely accurate from 30 Hz to 10 kHz, and was down 0.2 dB at 15 kHz. The response of the sub-sonic filter is plotted in Fig. 3, since its cut-off and slope are all below frequencies that can be swept and displayed on our spectrum analyzer's scope face. Figure 4 shows the composite range of control of the bass and treble tone controls (Phase Linear prefers to call them tone-contouring controls), and it will be noted that even when the "inboard" turnover frequencies are selected, there is very little change in amplitude of the important mid frequencies. This, to our way of thinking, is a much-preferred approach to tone control design than the more conventional central "hinge point" usually found at 1 kHz or thereabouts.

In keeping with current thinking about loudness compensation, Phase Linear elected to provide progressive bass boost only in their effective loudness compensation circuitry, as illustrated by the several sweeps (taken in 10 dB increments of the master volume control) shown in the 'scope photo of Fig. 5. It should be noted that while this loudness control arrangement does not provide the maximum flexibility that some preamps offer (those that have a separate loudness control and a separate volume control, or individual input

level control adjustments), some additional flexibility is provided over and above that shown in Fig. 5, since it is possible to attenuate high-level input program sources by another fixed 20 dB (using the audio mute switch) for another set of loudness curves each further displaced by that amount of attenuation.

Listening and Use Tests

Aside from its very sophisticated switching circuitry, the Phase Linear 3000-II is a well designed, straightforward unit that offers a high degree of flexibility in use without adding needless embellishments that do little to improve sound quality. During listening tests, the preamp seemed particularly immune from any kind of overloading often caused by either steady-state or transient effects, whether amplitude, frequency, or slew-limit induced. There was a clarity and accuracy of sound reproduction that could not be faulted in any respect. Noise levels were inaudible, even when listening to soft passages of music via the MC phono input, and that includes power-line induced noise as well as random, wide-band noise.

From its rugged cold-rolled steel chassis, to its gold-plated switch contacts, and its liberal use of 1 percent metal-film resistors, 2 percent poly capacitors, and solid tantalum capacitors, it is clear that the folks at Phase Linear were not about to compromise the design of this, their latest preamp, in any conceivable manner. We believe that their attention to detail and quality control, coupled with intelligent circuit design and human engineering, as represented in the Phase Linear 3000 Series Two, will pay off in terms of long-life and excellent sound reproduction for those readers who are fortunate enough to buy and own one.

Leonard Feldman

Enter No. 91 on Reader Service Card



Authorized Dealers

New York

EARDRUM
Nanuet, NY
(914) 623-3983
LYRIC HI FI
New York, NY
(212) 535-5710 & 5711
LYRIC HI FI
White Plains, NY
(914) 949-7500

SOUND ODYSSEY, INC.
Wappingers Falls, NY
(914) 297-6922
THE STEREO EMPORIUM
Buffalo, NY
(716) 874-3372
North Carolina
TAYLOR HOUSE
Denver, NC
(704) 483-5730
Ohio
CUSTOM STEREO ELECTRONICS
Columbus, OH
(614) 235-7575
GOLDEN GRAMOPHONE
Akron, OH
(216) 864-4411

HI FI GALLERY
Terrace Park, OH
(513) 831-4483

Oregon

HAWTHORNE STEREO WEST
Portland, OR
(503) 292-4401
TOAD HALL HI FI
Corvallis, OR
(503) 752-5601
TOAD HALL HI FI
Eugene, OR
(503) 485-1262

Pennsylvania

BARCLAY RECORDING & ELECTRONICS
Wynnewood, PA
(215) 667-3048

D.S. AUDIO
Lancaster, PA
(717) 393-9677

D.S. AUDIO
Wyomissing, PA
(215) 376-4917
SOUND INVESTMENTS
Pittsburgh, PA
(412) 884-4040

Tennessee

OPUS 2
Memphis, TN
(901) 683-0117

Virginia

AUDIO ART
Richmond, VA
(804) 644-8903

Washington

DEFINITIVE AUDIO
Seattle, WA
(206) 524-6633
HAL'S STEREO
Spokane, WA
(509) 327-1541
HAL'S STEREO
Spokane, WA
(509) 747-4268

TIN EAR
Richland, WA
(509) 946-4459

West Virginia

SOUND INVESTMENTS
Morgantown, WV
(304) 292-3292

Wisconsin

THE AUDIO EMPORIUM
Milwaukee, WI
(414) 354-5082
AUDIO SYSTEMS
Kenosha, WI
(414) 658-3796

IN CANADA

ADVANCE TV & STEREO
Winnipeg, Manitoba
(204) 786-6541

BOUTIQUE OF SOUND
Calgary, Alberta
(403) 242-2023
OTTAWA STUDIO SOUND, LTD.
Ottawa, Ontario
(613) 236-1097
SOUND ROOM
Vancouver, BC
(604) 736-7771

audio research

2843-26th AVE. SO.
MINNEAPOLIS, MINN. 55406

Enter No. 2 on Reader Service Card

Yamaha NS-1000 Loudspeaker System

MANUFACTURER'S SPECIFICATIONS:

Type: Three-way acoustic suspension.
Driver Complement: 12-in. (30 cm) cone woofer, 3½-in. (8.8 cm) beryllium dome tweeter, 1-in. (3 cm) beryllium dome tweeter.
Crossover Frequencies: 500 Hz and 6 kHz.
Nominal Impedance: 8 ohms.
Output Sound Pressure Level: 90 dB at one meter for one watt input.
Dimensions: 28 in. (71.1 cm) H x 15½ in. (39.4 cm) W x 14½ in. (36.2 cm) D.
Weight: 89 lbs. (39 kg).
Price: \$1450.00 per pair.

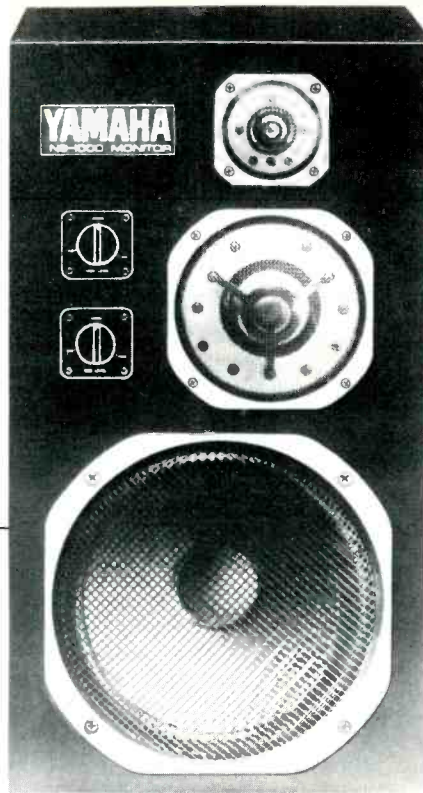

The NS-1000 is a recent addition to the Yamaha Natural Sound series of loudspeakers. This system comes in fairly similar versions, the NS-1000 with decorative grille, and the NS-1000M, a version which Yamaha calls the monitor and which is devoid of a front cover except for a metal grid placed over the woofer.

While of a size that it could be considered a bookshelf-type speaker system, the NS-1000 is exceptionally robust and quite heavy. At 39 kg (89 lbs.) I would never recommend placing this smooth-sided system on any overhead bookshelf, no matter how sturdy the shelf might be. In my opinion this speaker should be floor mounted in consideration of user safety. The robust nature of this speaker can be appreciated by the ratio of its weight to volume, almost 24 pounds per cubic foot. More than normal precautions in lifting and moving this speaker should be employed, particularly in view of the fine furniture finish on all exposed surfaces. Careless attempts to move this speaker around the house can translate into instant hernia or a mar in the finish. And, in my opinion, this speaker should never be placed where a small child could accidentally cause it to topple or slide off a smooth surface.

This is a three-way speaker system, using a 30-cm woofer in a sealed enclosure, complemented by an 8.8 cm midrange and a 3 cm tweeter. The midrange and tweeter are of unusual design since they use a thin beryllium diaphragm which, be-

cause of its higher ratio of stiffness to mass, is considered to offer superior diaphragm performance. Beryllium, however, is quite brittle and protective metal covers are used to protect them against physical contact.

A removable decorative grille covers the front of the NS-1000, and the sides are ebony-wood veneer, hand rubbed to a fine finish with no mounting feet or protuberances. The rear of the enclosure is unfinished black.

Speaker connection is made to push-type terminals mounted in a recessed cavity in the rear of the enclosure. Polarity is clearly marked, and users should have no difficulty hooking these speakers up if the instructions in the accompanying manual are followed. However, there is one important point which may need further clarification. These speakers come as a mirror-image pair — one for left channel and one for right channel. The manual makes a peripheral comment that there is a left and a right speaker but does not say how to identify which is which. In the units delivered for review, there was a smudged letter R following the serial number on

Fig. 1—Magnitude of impedance for the three equalizer settings.

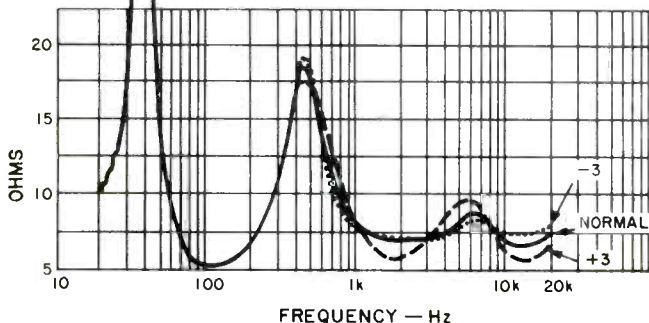
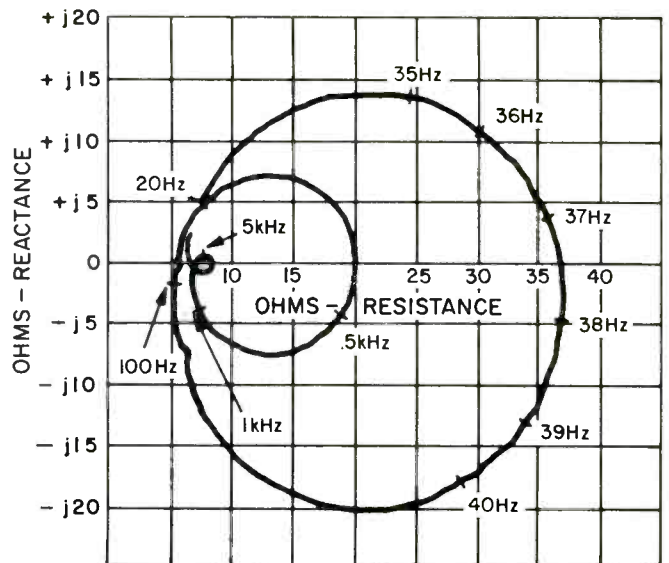
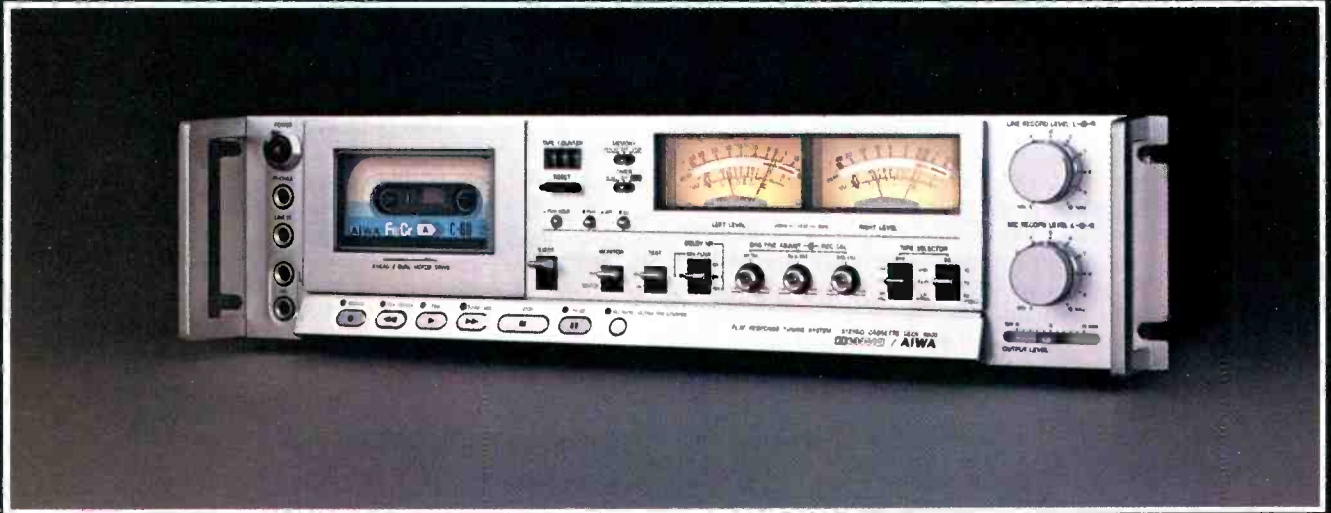

Fig. 2—Polar plot of impedance for Normal equalizer settings.



the unreel deck



The AIWA AD-6900U. Super specs and sound quality we defy any reel-to-reel to beat. Plus a lot of extras.

For openers, the AD-6900U delivers a frequency response of 20 to 20,000 Hz and an S/N Ratio of 68 dB using FeCr tape with Dolby* on. And only 0.04% WOW and FLUTTER (WRMS). Great numbers, but there's more.

The exclusive AIWA Flat Response Tuning System (FRTS) gets sensational sound out of any kind of tape on the market.

With just the push of a button, FRTS will use its own circuitry to measure the precise bias level of any kind of tape and adjust for the flattest possible response. And with the built-



Exclusive AIWA 3 head V-cut design

in 400 Hz and 8 kHz oscillators, the AD-6900U offers the most precise test recording possible, so you know exactly what to expect before you record. Coupled with AIWA's exclusive combination 3-head V-cut design, you can expect absolute optimum results in recording, playback and test.

The AD-6900U features Full Logic operation and exclusive Double Needle Meters.

Full logic feather-touch push button controls and dual motor operation make the going easy, and the feather-touch operation with Cue and Review can't be found on any other cassette deck. And no other reel-to-reel or cassette deck offers Double Needle Meters that combine both VU and Peak functions on each meter.

Plus a full array of extras, including AIWA's exclusive SYNCHRO-RECORD.

When you use the AD-6900U with AIWA's AP-2200 turntable, Synchro-Record activates recording automatically when the record is cued, and stops when the tone arm lifts. Mic/line mixing, oil-damped cassette ejection, Double-Dolby Noise Reduction with fully adjustable calibration, optional RC-10 remote con-

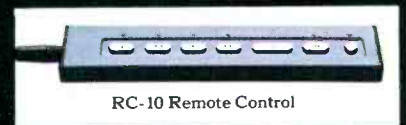

RC-10 Remote Control

trol, low profile design and your choice of rich wood side panels or tough rack-mount handles make this deck an unparalleled value.

The AD-6900U is the absolute deck. When you hear it, when you use it, you'll agree it's UNREEL.

AIWA®

Distributed in the U.S. by: **AIWA AMERICA INC.**, 35 Oxford Drive, Moonachie, New Jersey 07074 • Distributed in Canada by: **SHRIRO (CANADA) LTD.**
*Dolby is a trademark of Dolby Laboratories, Inc.

Enter No. 50 on Reader Service Card

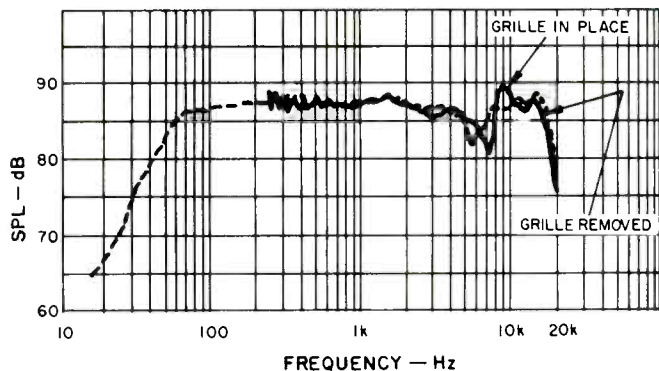

Fig. 3—One-meter axial, anechoic amplitude response for constant voltage drive corresponding to one-watt average power in an 8-ohm resistor with equalizer settings at Normal.

following the serial number on one speaker and a slightly less smudged L on the other speaker. This is quite out of keeping with the neat and explicit construction of these speakers and I hope that is not the case with all NS-1000s.

The midrange and tweeter crossover at 500 Hz and 6000 Hz respectively. Continuous-rotation attenuator controls are mounted on the front panel for the midrange and tweeter, and three positions are marked for suggested settings. These are -3, Normal, and +3, and their effect on frequency response is shown in the owner's manual. The manual itself is moderately sparse in detail, but adequate for proper connection and operation of the speakers.

Technical Measurements

The measured magnitude of impedance as a function of frequency is shown in Fig. 1. In order to show the variation of impedance with various control settings, three measurements are presented. The curve marked *Normal* is the impedance which an amplifier sees when both the mid and high frequency front-panel speaker controls are set to the position which Yamaha indicates as *Normal*. The +3 curve is the impedance when both controls are rotated to their indicated +3 position. Similarly for the -3 curve. Figure 2 is a complex impedance plot for the *Normal* setting.

The bass resonance peak occurs at 38 Hz and has a value around 41 ohms. The lowest impedance for all settings occurs at around 100 Hz and has a value around 5.5 ohms. Both impedance plots show that there should be no difficulty driving the NS-1000 from any good power amplifier. Reactance effects at higher frequencies are minimal, and the worst case reactive value occurs at 700 Hz with a 33-degree lagging phase and a magnitude of impedance of 11 ohms. With the exception of a small glitch at 70 Hz, the smoothness of the complex impedance curve shows the NS-1000 has no

Fig. 5—One-meter axial phase response corrected for air-path delay of the tweeter.

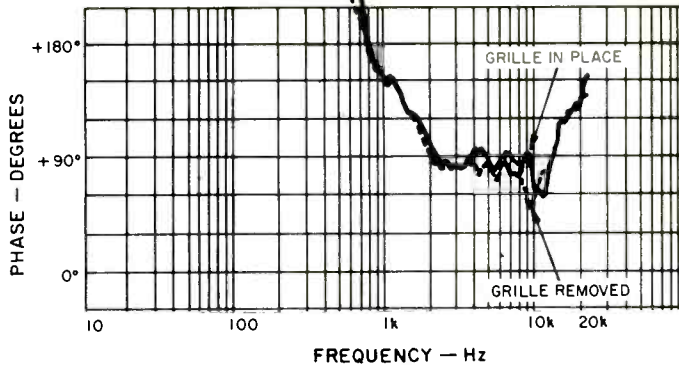
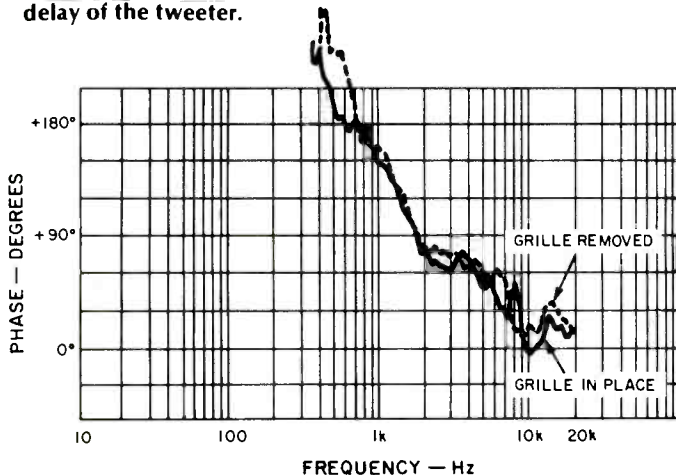

Fig. 4—One-meter axial phase response corrected for the air-path delay of the midrange.

indication of structural resonance in the enclosure. The box is rigid and well built, a fact one can verify by striking the side of the NS-1000 enclosure with the heel of one's hand. There is no drum resonance which is often encountered in less rigidly built enclosures.

The measured one-meter, anechoic, axial sound pressure response is shown in Figs. 3 and 4 for the *Normal* position of both equalizers. The free-field response showed the existence of a small problem which is surprising in a loudspeaker with the overall quality of the NS-1000 — the grille assembly noticeably alters the frequency response. Both the amplitude response of Fig. 3 and the phase response of Fig. 4 are plotted twice, once with the grille firmly in place and once with the grille removed. The problem is not the grille cloth, but the metal frame on which the cloth is placed. The frame extends in front of the drivers and scatters sound. Although the effect is not substantial in this, the axial position, the off-axis measurements, which *Audio* also checks, shows a more considerable perturbation due to the presence of the grille assembly. My personal recommendation for obtaining the very best sound from the NS-1000 is to remove the grille entirely.

Audio's frequency response measurements agree quite well with the response which Yamaha publishes for this type of system. The mild interference dip at 7 kHz and the drop in top end above 19 kHz are effects seen with the sound measurement made on the geometric axis of the system, which is our standard measurement position. Sound pressure measurements made at one meter directly in front of the tweeter are identical to those furnished by Yamaha. Free-field, low-frequency response extends down to 55 Hz with a uniform fall below that frequency. Frequencies up to 5 kHz are handled quite smoothly with a minimum amount of irregularities in sound pressure from 5 kHz to the upper cutoff around 19 kHz.

There is, however, one important technical fact which the *Audio* phase measurements reveal. The phase shift of the

Fig. 6—Three-meter room response.

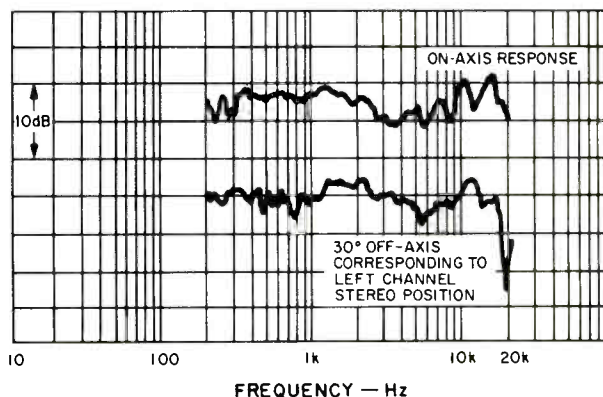

QUALITY IN REVERSE

AKAI introduces automatic reverse record at popular prices.

Now instead of interrupting great moments in music when it's time to flip the cassette, AKAI's two newest decks automatically reverse the tape and continue to record or play back.

In addition, the deluxe GXC-735D is loaded with all the features that make the difference between a good deck and a great one. Things like AKAI's exclusive GX (glass and crystal ferrite) heads, guaranteed for 150,000 hours — the equivalent of playing 24 hours a day for 17½ years. As well as feather-touch controls, Dolby,* memory rewind, quick reverse and dramati-

cally recessed red/green illuminated VU meters. Not to mention the kind of specs serious component buyers all over the world depend on AKAI to deliver. (For the more economy-minded, there's the CS-732D. Same great auto reverse record/playback feature, with Dolby, quick reverse and tape selector — a lot of AKAI quality for not a lot of money.)

Hear them both at your AKAI dealer or write AKAI America, Ltd., 2139 E. Del Amo Blvd., P.O. Box 6010, Compton, CA 90224. And see how they can reverse your thinking about automatic recording.

GXC-735D: Wow/Flutter — less than 0.08% WRMS; S/N Ratio — better than 58 dB, weighted, at FeCr position, with peak level at 3% THD. Dolby on improves up to 10 dB above 5 kHz. Frequency response — 35-17,000 Hz (± 3 dB) using FeCr tape.

CS-732D: Wow/Flutter — less than 0.08% WRMS; S/N Ratio — better than 57 dB, weighted, at FeCr position, with peak level at 3% THD. Dolby on improves up to 10 dB above 5 kHz. Frequency response — 38-16,000 Hz (± 3 dB) using FeCr tape.

AKAI

You never heard it so good.

*TM, Dolby Labs, Inc.



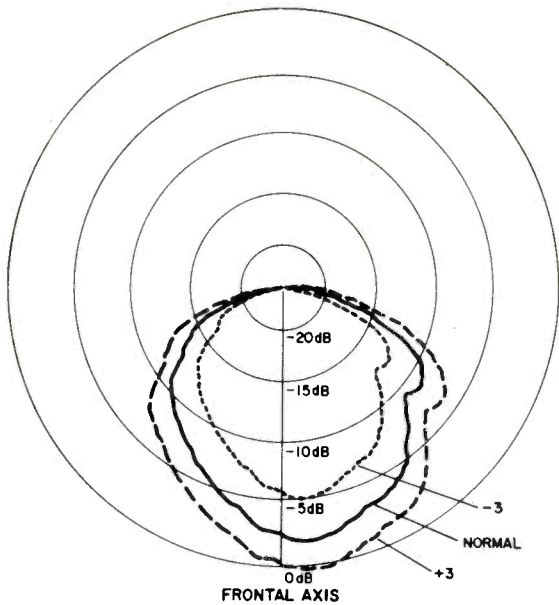

Fig. 7—Horizontal polar energy response with grille in place.

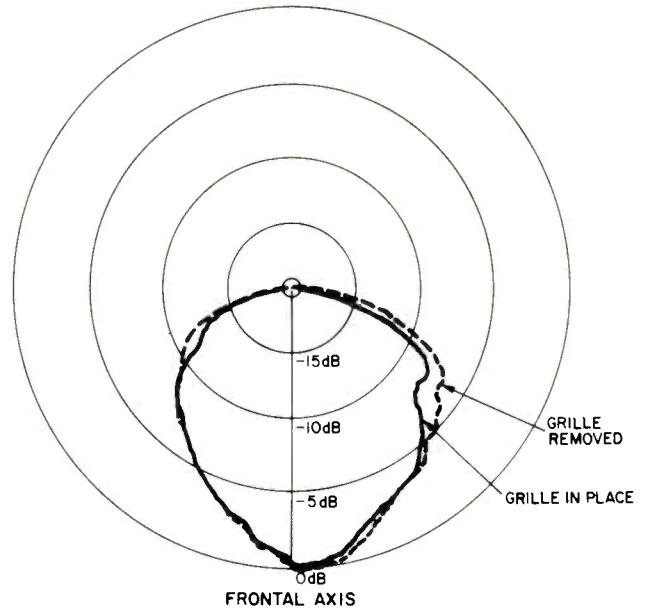

Fig. 9—Effect of grille on horizontal polar energy response.

midrange is neither zero nor 180 degrees, but is 90 degrees leading through the frequency range from 2 to 10 kHz. Figure 4 is the phase measurement made with the air-path time delay corrected for the acoustic position of the NS-1000 in the 2-to-10-kHz range. What this shows is the net phase change due solely to the loudspeaker. The value of this phase is dependent somewhat upon the equalizer control settings, and these plots are made with the controls carefully set to the *Normal* positions. Figure 5 is the phase measurement corrected for the air-path time delay from the tweeter. Here it can be seen that the frequency range above 10 kHz has a sound pressure which is in phase with the driving volt-

age. Low frequency measurements, not shown here, reveal that the woofer is also in phase with the driving voltage.

The effect of this 90-degree phase change in the midrange can also be observed in the impulse response, not included as a standard plot but also routinely made in our *Audio* evaluations. The sound from the tweeter arrives approximately 0.08 milliseconds before the sound from the midrange. But the initial pressure peak due to the tweeter is just completing its first period when the midrange pressure peak arrives. The positive 90-degree frequency response phase of the midrange means that the pressure due to the midrange swings first to an overpressure then to a compar-

Fig. 8—Vertical polar energy response with grille in place.

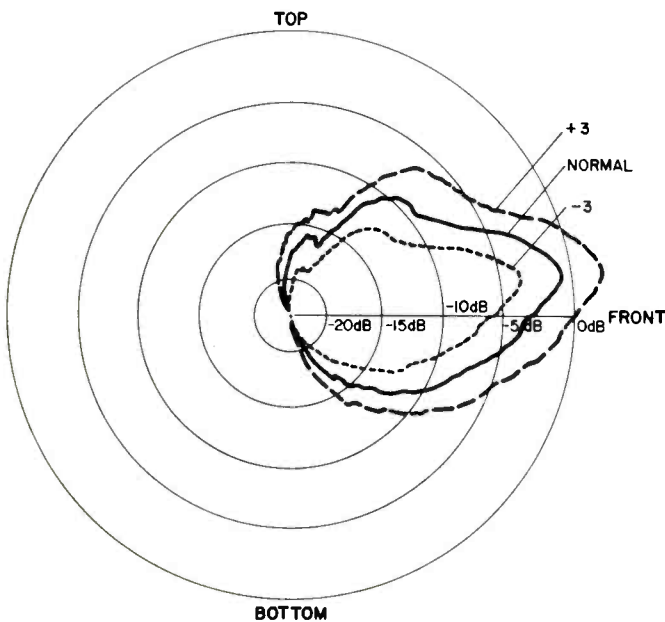
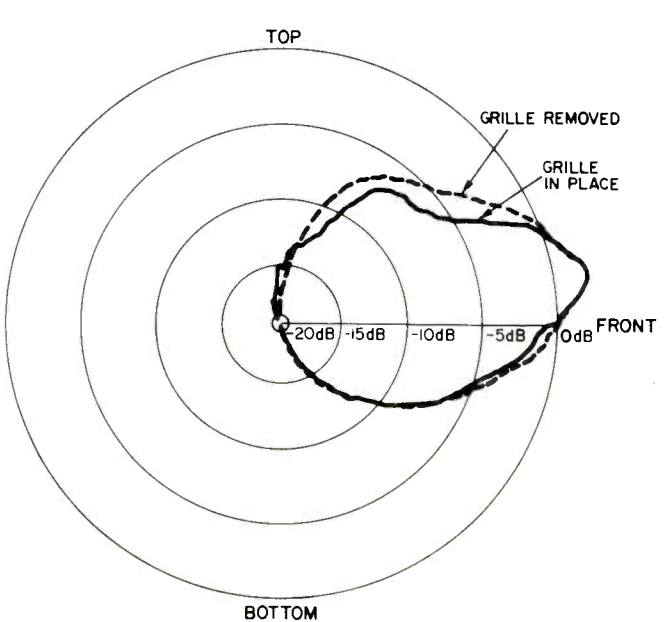

Fig. 10—Effect of grille on vertical polar energy response.



ELECTROSTATICS TURNED INSIDE OUT.

Electrostatics have long been acknowledged as the finest means of audio reproduction. But traditional designs have been too large, too fragile and too expensive.

Now there's a radical new concept in electrostatic sound reproduction that has turned electrostatics inside out. It's called the ElectroStatic Translator.^{®*}

AN INSIDE OUT DESIGN.

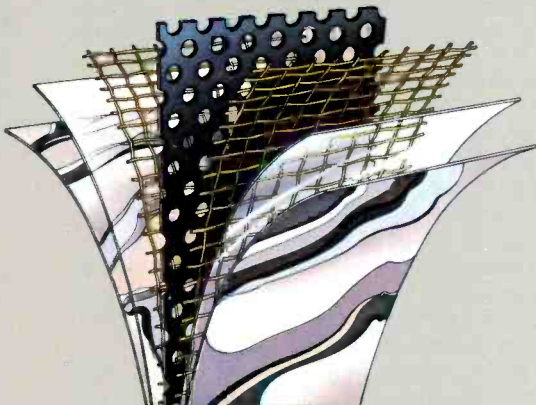

Unlike old electrostatics, the Translator's elements have one fixed plate surrounded by two diaphragms. Each diaphragm works on half the input signal. So the Translators play as loud as you like. Crystal clear. No breakup. With receivers delivering as low as 35 watts per channel. And there's no need for the traditional external power supplies. We've even



solved the old problem of elements burning out by introducing a unique chloride dielectric material.

BOOM-LESS, BOX-LESS REPRODUCTION.

Unlike any other reproducer, the Translators have no acoustic

environment of their own. So there's no cabinet resonance, standing wave interference or echo.

The Translator's woofer is the first of its kind, designed to match the ear's real-life sensitivity to low frequency audio signals. The result is boom-less, box-less bass, midrange and high end.

LISTEN TO OUR PITCH.

The overall Translator design produces near-perfect voicing. An openness and articulation that offer your ears a new criterion of audio perception.



That's why we invite you to compare the Translators to the finest dynamic or electrostatic speakers you can find. We think you'll agree that the Translators are turning today's speaker technology inside out.

For our informative brochure, see your Translator dealer or write BTM Manufacturing Company, 2005 Lincoln Ave. Pasadena, CA 91103. (213) 798-0476.

ESTTranslator
Persistence Makes The Difference



THE TRANSLATORS.

*Manufactured under license by BTM Manufacturing Company with U.S. and foreign patents issued or pending.

Enter No. 7 on Reader Service Card

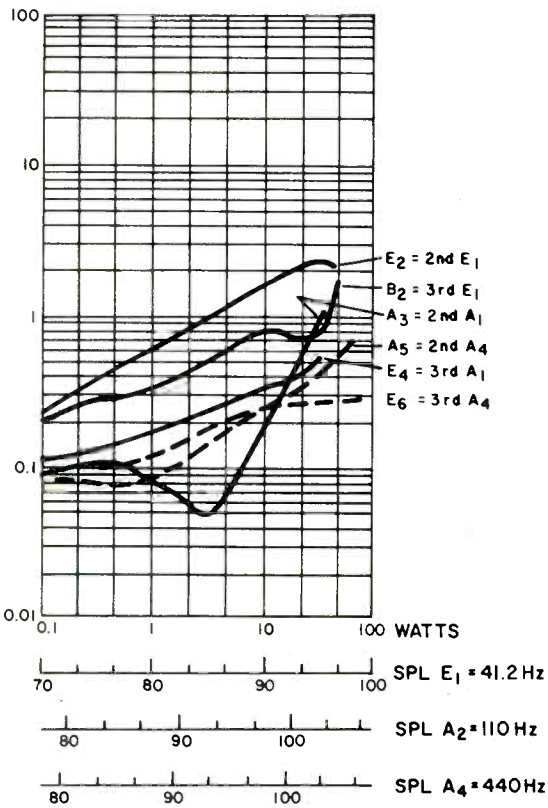
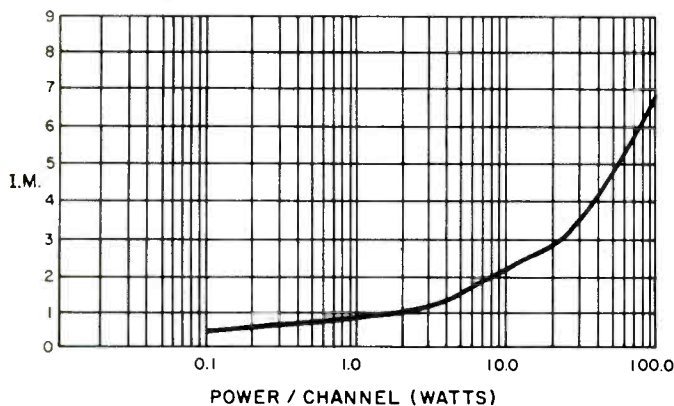

Fig. 11—Harmonic distortion for the tones E_1 (41.2 Hz), A_2 (110 Hz), and A_4 (440 Hz).

ble underpressure before decaying to equilibrium. The result of all this is that the tweeter and midrange complement each other to produce an initial wave packet which is well behaved. Highly technical, but the result is a synergism giving good transient response.

The measured three-meter room response is shown in Fig. 6. Unlike the anechoic response, the room response represents the frequency spectrum of the first 11 milliseconds of sound which one hears from the system when seated three meters away from the front of the speakers and in a typical room. For this measurement the NS-1000 was mounted in the room used for the listening test and in a fashion recommended by Yamaha with the speaker raised slightly off the carpeted floor on cinder blocks. The back of the speaker was placed against a hard wall. Two listening positions are shown

Fig. 12—Intermodulation distortion of A_4 (440 Hz) by E_1 (41.2 Hz) mixed one-to-one.



for this measurement. One position is three meters directly in front of the speaker, and the other is at the same distance but 30 degrees off center, representing a normal stereo listening configuration for this system. The grille was in place and both equalizers set to the *Normal* position.

Both positions provide a very smooth response, with the normal stereo listening position somewhat more uniform. There is some ceiling scatter in evidence, which gives rise to the small irregularities above 4 kHz. A check of the phase response (not shown here) showed an essentially constant average phase about 1 kHz. This indicates a good transient response.

Horizontal and vertical polar energy response is shown in Figs. 7 and 8 respectively. Three curves are shown, corresponding to both equalizer controls set to the *-3*, *Normal*, and *+3* positions. The NS-1000 comes as a set, with one speaker intended for left channel use and the other for right channel use. The left channel speaker was used for this measurement. The horizontal plot shows that indeed the left channel speaker has a more uniform dispersion when heard at a position to the left of its central axis. Similarly, the vertical measurement shows that sound is launched in an upward direction, as befits a floor-mounted system. Horizontal dispersion is quite good, and the measurements indicate that little is to be gained by rotating the speakers toward the listening area. The energy difference between the settings is almost exactly the 3 dB indicated on the controls.

The influence of the grille assembly on both the vertical and horizontal dispersion is strong. Figures 9 and 10 are plots of horizontal and vertical dispersion patterns with and without the grille in place, and it will be seen that the grille structure introduces lobes in both patterns. Again, I recommend removal of the grille assembly for most accurate sound.

Harmonic distortion for the tones of E_1 (41.2 Hz), A_2 (110 Hz), and A_4 (440 Hz) is quite low up to the maximum average level which the speaker is intended to handle. Particularly noteworthy is the low value of harmonic distortion for A_2 and A_4 , though E_1 , 41.2 Hz, has a bit higher level of distortion than I would like to see in a speaker of this overall high quality, particularly at the lower sound pressure levels. Loudspeaker overload became evident with bursts of 60 average watts at the lowest frequency, so the measurements were terminated at this level, even though the second and third harmonic distortion levels were still not excessive.

The NS-1000 is quite good at handling transients at high level. But a frequency dependence, which was puzzling from a technical viewpoint, was evident in the test which we call the crescendo handling test. The 110-Hz and 262-Hz inner musical voices were absolutely unmodified by the presence of broadband random noise at 20 dB higher average level than those tones. This indicates that wandering in the stereo sound image should not be a problem for those tones when other loud signals are present. But 440 Hz was a "worst case" frequency in the crescendo handling test. The 440-Hz tone was acoustically reduced a nearly uniform 0.3 dB when incoherent noise signals were present over the full dynamic range up to noise peaks of 800 watts. This frequency dependence is a bit unusual, although the 0.3 dB effect is most probably low enough not to be audibly troublesome.

The acoustic transfer linearity of the NX-1000 has a slight downward trend with increasing drive level. A one-decibel increase in drive level produces slightly less than one-decibel increase in sound level. The effect was checked at 60 Hz, Middle C (262 Hz), and A_4 (440 Hz) and found to be a decrease of about a hundredth decibel of sound per decibel of electrical drive. This will impart a very small, probably insignificant, amount of signal compression to program material. What this means is that the sound does not get as loud as it should for increases in drive level.

"The Highly Prized Receiver... ONKYO's TX-4500 MKII"

In the beginning

there was only one Quartz-Locked tuning system. Onkyo's TX-4500. While others started building their own versions, Onkyo's innovative genius was improving on the first to produce the finest.

The result. TX-4500MKII, the world's first IC Quartz-Locked tuning system for totally drift-free reception... and in heavy demand nationally. An improvement on the model Hirsch Houck Labs called, "one of the finest receivers available at any price,"* with more power (60 watts per channel minimum RMS, both channels driven at 8 ohms with no more than 0.1% THD from 20Hz to 20,000 Hz), new and convenient styling, wide-ranging flexibility and integrated circuitry for longer life and cooler running.

Check the features.

The all stage DC OCL Power Amp for delivering clean power. Heavy duty 12,000 μ F electrolytic capacitors to reduce transient crosstalk distortion. And 200mV RMS phono overload level ensured by linear 3-stage DC equalizer amp. For minimum overload distortion the dual gate MOS FET front end; for superb FM stereo separation the PLL MPX circuit and for maximum selectivity the FM 4-ganged, AM 2-ganged variable tuning capacitors. All contributing to a quality product.

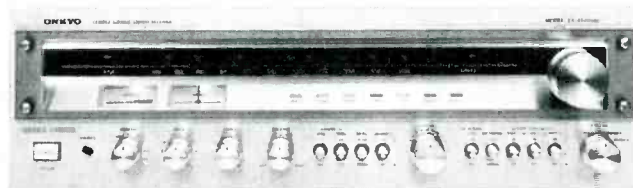

Redesign has resulted in sloping panels for easy observation, group controls for easy operation, and facilities for 2 turntables, 3 tape decks with dubbing and 3 speaker systems. Complete mode, function and tone controls including high and low filters with 12dB oct slope and Dolby** 25 μ s deemphasis switching.

With so much invested, the TX-4500MKII is equipped with an electronic detector circuit sensitive to the slightest malfunction and a shut-off relay to cut off speaker power in case of a short circuit or drop in load impedance.

Nothing has been spared to give you the most for your money. There's nothing finer on the market.

See everything that Onkyo has to offer at your local dealer or write for information and the name of your Onkyo dealer. Find out how Onkyo stays... a step ahead of state-of-the-art.

*STEREO REVIEW, October 1976.

**Dolby is a trademark of Dolby Laboratories, Inc.

Artistry in Sound **ONKYO**

Eastern Office: 42-07 20th Avenue, Long Island City, NY 11105 (212) 728-4639

Midwest Office: 935 Siverl Drive, Wood Dale, IL 60191 (312) 595-2970

West Coast Distribution Center: Darnark Industries, Inc., 20600 Nordhoff Street, Chatsworth, CA 91311 (213) 998-6501

Canada: Sole Distributor, Tri-Tel Industries, Ltd., Ontario, Canada

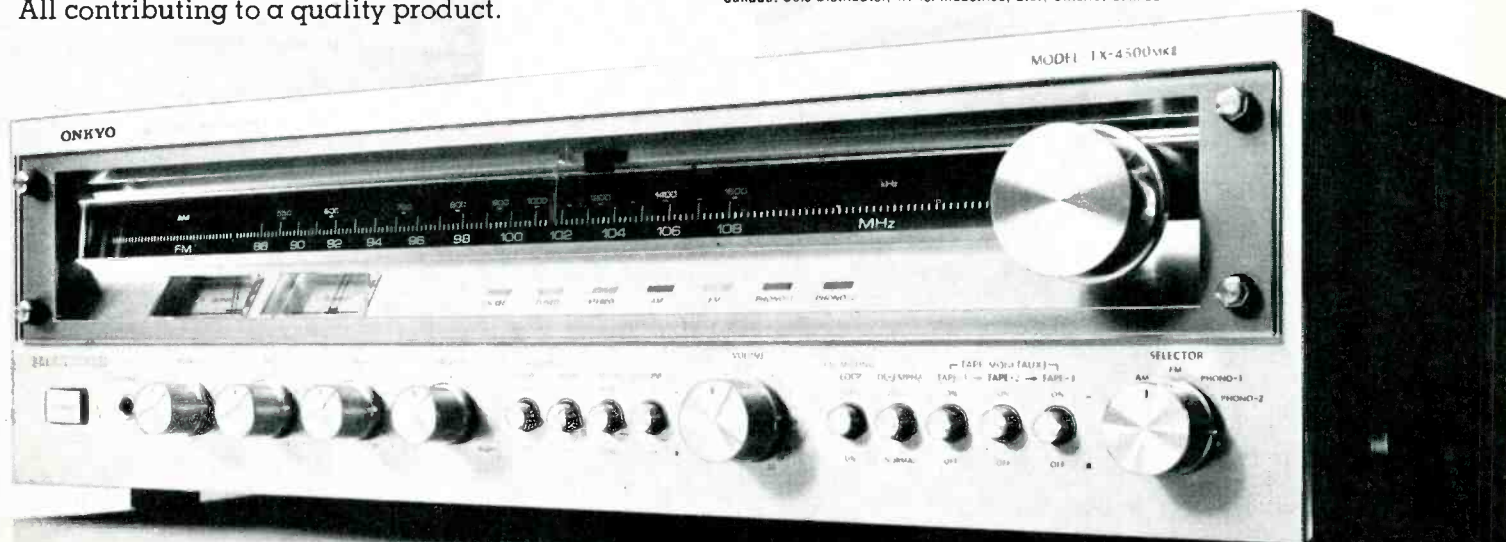

Enter No. 25 on Reader Service Card

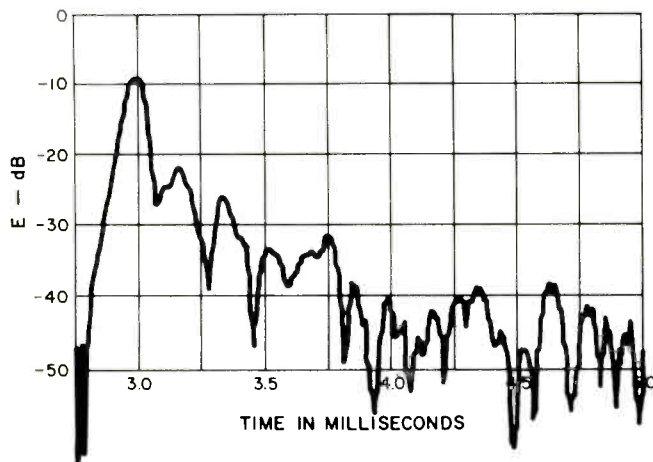

Fig. 13—Energy-time response with grille in place.

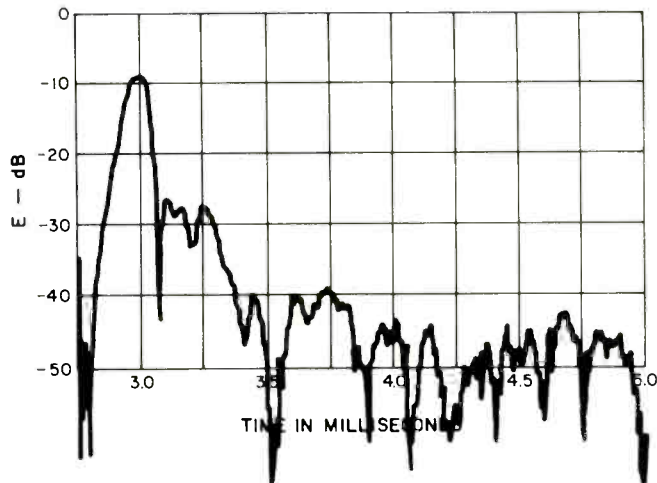

Fig. 14—Energy-time response with the grille removed.

The crossmodulation of A_4 (440 Hz) when a tone of E_1 (41.2 Hz) is present at equal level is shown in Fig. 12. At moderate listening levels, this type of distortion is quite low in the NS-1000 and is composed of both amplitude modulation and phase modulation of the higher tone by the presence of the lower tone. At 10 average watts, the amount of phase modulation is 3 degrees peak to peak and the amplitude modulation is of the order of 2 per cent peak to peak. Even up to the highest tested power of 100 watts, the character of IM remained the same. Net displacement of the average position of the woofer was less than one degree at 440 Hz when 41.2 Hz was present. In other words, the higher frequency tone did not have its arrival time altered by the presence of the lower tone. Many loudspeakers do this; the Yamaha does not. While the harmonic distortion measurement shows that at high sound levels the woofer can create subtle changes of timbre on low bass tones, the IM test shows that the same tones at high level do not substantially intrude on upper register instruments to modify orchestral *tutti*.

The energy-time curve, which is a measure of transient performance, is shown in Figs. 13 and 14. This is the envelope of the impulse response measured one meter on axis. The equalizer controls on the NS-1000 are set to their *Normal* position for both tests. Figure 13 is the energy-time response when the grille is in place, and Fig. 14 is the same test with the grille removed. The better response is clearly obtained when the grille assembly is removed. As discussed in the phase test, the in-phase contribution of the tweeter melds smoothly with the quadrature phase contribution of the midrange driver to produce a smooth wavelet for the first few tenths of millisecond. The first sound from the tweeter begins to arrive at the microphone at 2.85 milliseconds on this scale. The first midrange sound starts at around 2.93 milliseconds. Neither of these facts can be discerned from Figs. 13 or 14 because the amplitudes of these two sounds combine so smoothly. When the grille is removed, there is some internal reverberation in the 3.1 to 3.2 millisecond interval and then the sound energy falls off smoothly to a level some 35 dB down from the peak at 3 milliseconds. The effect of the grille is to create the equivalent of a "slap" echo at a 0.15-millisecond period decaying at a rate of around 30 dB per millisecond. In addition there is a subsidiary reflection component around 3.8 milliseconds caused by the presence of the grille frame. I realize that Yamaha has gone to great pains to create an attractive grille assembly, but it is my opinion that the sound will be more accurate with this particular grille removed.

Listening Test

In accordance with Yamaha's recommendations, the speakers were positioned flat against a hard wall and placed on cinder blocks. This raised the speakers approximately 17 cm off the floor.

In order to get at the mid and high frequency equalizer controls, it is necessary to remove the grille assembly. Removal is quite simple, but both enclosures reacted to my attempts at reinstallation by popping out on the side opposite to the one I was pressing into place. Yamaha's explicit instructions to the contrary, this is a two-hand job.

My initial impression was that the NS-1000 had a bass dominance on percussion but sounded quite natural on pipe organ. After considerable experimentation, I found that a preamplifier tone-control equalization which dropped the 50-Hz level by 2 dB relative to 1 kHz was about right to my ears for bass response. When listening to vocals I sensed a need for a slight increase in level in the upper midrange. Rotating the midrange control on the NS-1000 halfway between *Normal* and *+3* filled the need.

Stereo lateralization is good on the NS-1000. More significantly, the illusion of depth is quite excellent. In order to achieve a good stereo illusion, it is not necessary to sit in one spot; the illusion remains good over a large range of listening positions, though this freedom of position is marred by vertical beaming in these speakers. You can move from side to side and the image remains fixed, but stand up and the image shifts and slightly blurs. The part of the spectrum which is most affected by this vertical change in listening position is that from the higher midrange and on up.

Although these speakers can handle quite a large dynamic range and produce lease-breaking sound levels, I sensed a top end crunch on some clean material which was reproduced at very high level. There is a bite to the top end of this speaker which, to my ears, produces a spectral dominance at around 9 kHz. When driven very hard on sharp percussion, this bite seems to have difficulty relative to the rest of the reproduced spectrum, and appears to overload. Of course, this is at sound levels well above that which most users might demand from their speakers, so that it will rarely, if ever, be encountered.

The Yamaha is an accurate sounding system when properly placed in a room. And although it does benefit from some minor spectrum adjustments in the driving signal, this system requires nothing more than a clean signal to deliver a good, clean sound.

Richard C. Heyser

Enter No. 92 on Reader Service Card

For about \$15 you can buy the only total record care system or something less.

You have a choice. You can buy a fancy handled record cleaner. Or, for about the same money, you can have the only total record care system there is.

That is, our new Sound Guard™ record cleaner and our famous Sound Guard® record preservative. Both in one package.

The Sound Guard™ Total Record Care System.

With it, you do more than clean everything off your favorite records from dust particles to oily fingerprints.

You actually protect your record's life with a microscopically thin, dust-resistant patented lubricant.

If you want the most for your \$15* (and

the best for your records), you have to have the only total record care system there is.

Like all Sound Guard products, the Sound Guard Total Record Care System is sold in audio and record outlets.

*Suggested retail price.



Sound Guard® keeps your good sounds sounding good.



Sound Guard preservative — Sound Guard cleaner — Sound Guard Total Record Care System
Sound Guard is Ball Corporation's registered trademark. Copyright © Ball Corporation, 1978. Muncie, IN 47302

ADC Model LMF-2 Tonearm & ZLM Phono Cartridge

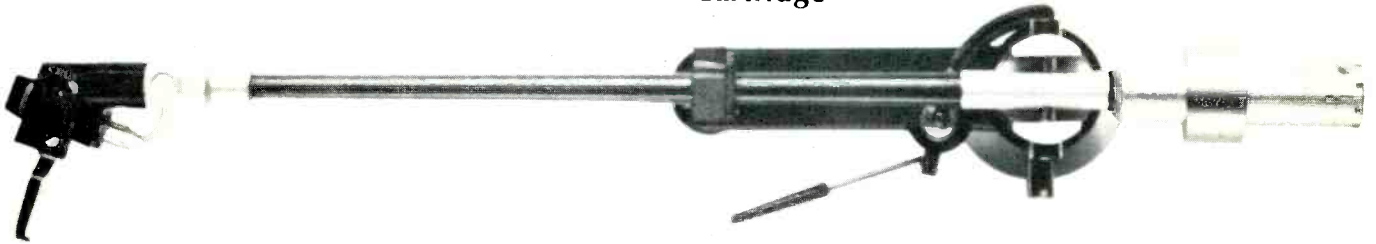

MANUFACTURER'S SPECIFICATIONS

LMF-2 Tonearm

Overall Length: 12.33 in. (31.3 cm).
Pivot-Stylus Distance: 9.33 in. (23.7 cm).
Bearing Type: Ball.
Tracking Forge Range: 0-1.5 gms.
Price: \$215.00.

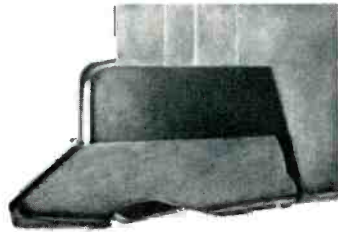

ZLM Phono Cartridge

Frequency Response: 10 Hz to 20 kHz, ± 1 dB.
Channel Separation: 30 dB at 1 kHz.
Stylus Assembly: Nude "Alyptic" with tapered cantilever.
Price: \$135.00.

92

During the long and, I must say, tedious process of preparing methods to test and evaluate phono cartridges and arms in combination, it became apparent that, if correlations were to be made between objective technical measurements and subjective impressions gathered during listening sessions, some new approaches needed to be tried. Many different approaches were investigated including even generating a new test record which would allow tests which are not possible with existing records. It was decided, however, that at least for the present certain available test records could be used to present data in new formats which seem to correlate well with subjective listening impressions. These subjective evaluations were made by a listening panel. This panel auditioned passages from recordings of various types of music. A reference system was used to allow comparative comments to be made. The technical measurements had previously been completed in order that the setup of the phono cartridge-arm combination could be optimized. The data gathered during these technical measurements were inspected

later to see if correlations existed between the data and subjective comments made by panel members during the listening tests regarding various characteristics of sound quality.

Rather than separate the objective technical measurements from the subjective impressions of the listening panel, both aspects of the report are presented concurrently. Since this report deals with a specific phono cartridge and arm combinations, comments pertaining to the mechanical parameters of the arm which would affect its use with other cartridges are presented later.

It should be noted that the reference system consists of an excellent moving-coil phono cartridge, a Swiss-made arm, and a highly regarded turntable. This reference system was used to allow comparisons to be made during the subjective evaluations by the listening panel. The two systems were designated "A" and "B." Comments were elicited from panel members regarding the sound reproducing qualities of each system and comparative comments were made. This format seemed to allow panel members to crystallize their feelings

Measured Data

ADC ZLM Phono Cartridge

Serial No. 7A4147

	Left	Right
Inductance, mH	520	500
Resistance, ohms	843	811
Output, mV/cm/sec at 45 degrees (B&K 2009, band 3)	1.08	1.30
Dynamic Tracking Force, B&K 2010, grams (Gms x 980 = dynes)		
Band 3, +8 dB	Dist., %	Dist., %
Band 4, +6 dB	1.6	1.6
Band 5, +4 dB	1.2	1.2
Band 6, +2 dB	0.9	0.9
Band 7, +0 dB	n0.7	0.7
Tracking vs. Radius, HFS-75, grams		
Outer grooves	1.3	
Middle grooves	1.3	
Inner grooves	1.3	
Cartridge Mass: 5.55 gms.		
Microphony: Low		
Hum Rejection: Good		
High Frequency Resonance: 28.6 kHz.		
Rise Time: 24 μ s.		
Low Frequency Resonance: 10 Hz.		
Low Frequency Resonance Q: 3.3.		
Recommended Load Resistance: 47 kilohms.		
Recommended Load Capacitance: 275 μ F.		
Recommended Tracking Force: 1.6 gms.		

ADC LMF-2 Tonearm

Pivot-to-spindle Distance: 8.75 in. (22.23 cm).
Pivot-to-stylus Distance: 9.33 in. (23.7 cm).
Pivot-to-rear of arm Distance: 3.0 in. (7.62 cm).
Spindle-to-rear of arm Distance: 11.688 in. (29.69 cm).
Overall Height Adjustment: 1.5-3.2 in. (3.8-8.3 cm).
Tracking Force Adjustment Range: 1.7 gms with calibrated scale; more with separate gauge.
Tracking Force Calibration: 0.5 to 1.7 gms.
Tracking Force Accuracy: -0.1 gm at 0.8, 1.0, 1.3 and 1.5 gms settings, but -0.2 at 1.7 gms.
Cartridge Weight Range: 3 to 11 gms.
Counterweights: 15.0 (14.9 actual), 30.0 (30.5), and 45 (44.9) gms.
Counterweight Mounting: Two "O" rings; rubber main rod isolation.
Sidethrust Correction: Marked for 0 to 2 gms, with excellent uniformity.
Lifting Device: Finger lift on headshell and delayed-action damped lever.
Headshell Weight: 4.05 gms.
Headshell Offset: 24 degrees vs. 20 degrees specified.
Overhang Adjustment: Sliding screw mounts in headshell, with template.
Bearing Alignment: Good in both planes.
Bearing Friction: Less than 50 mG in both planes; too low to measure accurately.
Lead Torque: Very little effect.
Arm Lead Capacity: 20 pF internal, 255 pF external, 275 total.
Arm Lead Resistance: 0.89 ohms internal, 0.23 ohms external, 1.12 ohms total.
Lead Length: 48.5 in. (123 cm).
Structural Resonances: Very dead, tight "click" when tapped.
Base Mounting: Single hole, nut on pillar.
General Comments: Effective mass specified as 8 gms.; good fit between headshell and arm with no play; good cueing level with short delay before starting cycle; recommend CD-4 lead wires and added external capacitance as needed.

The Eumig CCD. Opto-electronically engineered for absolute recording excellence.



Eumig, one of the world's leaders in electro-mechanical research and development, has introduced a revolutionary new technology to cassette recording. Its the OPTO-ELECTRONIC SERVO CAPSTAN DRIVE SYSTEM incorporated in the unique Eumig CCD. This technology offers so many advantages that the Eumig CCD will out-perform every other cassette transport.

Ultra-Precision: The unique Eumig photo disc

Other decks use old-fashioned belts and flywheels to control the capstan. In the Eumig design these are replaced by a light-weight disc, photo-etched with 2500 radii, spaced precisely 1/50mm apart. When rotated, these radii create 15,000 pulses per second for instantaneous optically-sensed speed corrections. Wow and flutter is a mere 0.05% WRMS, and speed accuracy is $\pm 1\%$.



The Eumig photo disc weighs about 1/70th as much as a typical flywheel. When combined with an almost inertia-free, coreless drive motor, the CCD offers a startup time of less than 0.04 seconds, which means you never hear the wowing sound after a pause in recording. And the CCD boasts the fastest rewind time in the world—an astonishingly low 40 sec. (C-60).

Rugged reliability

The Opto-Electronic Servo System is only one among many dramatic advantages of the Eumig CCD. It offers three precision heads of our own design, mounted in a die-cast aluminum carrier made at our own facilities (as are virtually all parts of the CCD), for greatest precision. The Eumig CCD is engineered

with circuit boards rather than wires, for utmost reliability.

Advanced technology features

The comprehensive features of the CCD reflect Eumig's innovative technological approach. Two parallel LED displays allow simultaneous monitoring of both channel levels. Full solenoid/MOS logic is operated by feather-touch controls with logic-programmed LED indicators, and the flexible two-input mixing facilities use strictly DC controlled circuitry.

Perfect recording every time

Perfect performance is guaranteed with every type of tape because the Eumig CCD offers virtually flat frequency response to 20,000Hz (chrome); Dolby calibration adjustment for different tape sensitivities; and an azimuth adjustment to optimize high frequency performance with each and every tape.

The Eumig CCD, probably the finest deck in the world, is now available for \$1300, including full-function remote control, at select audio outlets throughout the country. Write to us for the name of the dealer nearest you. Then listen and compare. We believe you'll agree—it's incomparable.

Eumig (USA) Inc., Lake Success Business Park, 225 Community Drive,
Great Neck, New York 11020, (516) 466-6533

Enter No. 13 on Reader Service Card

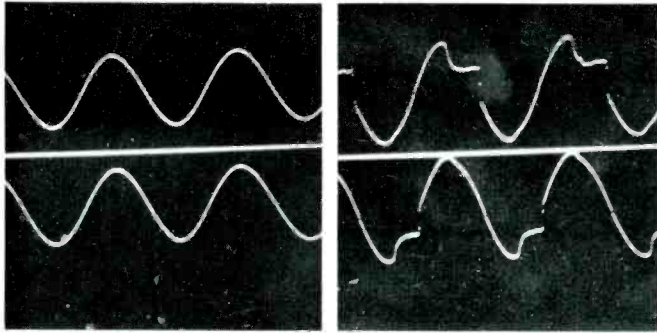

Fig. 1—A, left, is reproduction of CBS STR-112, band 4, which is +15 dB re: 11.2 μ M. B, right, is band 5, +18 dB re: 11.2 μ M. Both bands are 300 Hz tracked at 1.6 gm.

regarding different aspects of the reproduction quality and therefore to make statements which could be correlated to measured technical data. The panel members did not have prior access to the technical data so their comments were based solely upon the listening tests. Two listening formats were utilized. In one format, rapid A vs. B comparisons were made by synchronizing the two turntables, playing copies of the same record, with a delay of about 4 to 5 seconds between them. In a second format, the same record was played with system A and then system B, with relatively long spans for each selection, about 2 to 4 minutes. Both formats were deemed valuable by the members of the listening panel.

This synopsis of the background of the new format adopted for reporting on phono cartridges and arms is intended as a guide for this first review. It is necessarily limited but it is hoped that a more comprehensive article will be forthcoming. We feel very strongly that this new format will be very helpful in correlating at least a few important subjective impressions with specific technical measurements. (Editor's Note: We would like to emphasize that many of these measurement techniques are new and, though carefully done, somewhat experimental — experimental in the sense that we are not yet certain as to the strength of the correlation between subjective observation and technical measurement. We suggest, therefore, that readers do not fully judge the techniques — or the cartridge and arm — on the basis of this single review but rather evaluate them as part of a continuing series of reviews. — E.P.)

The ZLM phono cartridge is the top of the extensive ADC line. It employs a transduction technique originated by Peter Pritchard, who founded ADC. A small permeable sleeve is fitted to the rear of the stylus cantilever. This causes the magnetic field of a rather large, fixed magnet to be varied by the

motion of the stylus. This type of cartridge design was first introduced in 1964 in the ADC Point Four phono cartridge. Many refinements have been made since then.

The ZLM was mounted in the ADC LMF-2 phono arm which features an interchangeable headshell. ADC also makes the LMF-1 without this feature but offering slightly lower effective mass.

The arm was mounted on the Pioneer PLC-590 turntable which is the top of their line and provides an excellent test platform. It has quartz-referenced speed control and excellent isolation from mechanical and acoustical feedback. The 3/4-in. thick, interchangeable arm-mounting blocks are a boon to arm-o-philes and reviewers because arms can be changed in about one minute. The instant stop feature was also a great advantage when cueing different bands of the test records and changing from one record to another.

Figures 1a and 1b show the left (upper) and right (lower) channel outputs to the 300 Hz tone on CBS test record STR-112. This format is followed for all other photos. Figure 1a represents the output when reproducing band 4 which is +15 dB referenced to an amplitude of 11.2 μ M. This is a very high modulation level, and the clean waveform shown is heard as a very pure tone.

Figure 1b is the waveform of the signal from each channel when attempting to reproduce the even higher level on band 5 on STR-112. The modulation level of this band is +18 dB re: 11.2 μ M. Most cartridges have great difficulty trying to reproduce this band. The reproduced tone is not very clean. The symmetry of the mistracking indicates that adjustment of the side thrust correction, also known as bias correction or anti-skating, is quite good. Even though Fig. 1b indicates mistracking at 300 Hz for +18 dB, no comments which could be directly related to mistracking were made by the listening panel when playing musical recordings.

Figure 2a is a graph of the output vs. frequency and inter-channel output, commonly referred to as crosstalk. The balance between the main channel outputs is off by about 1.5 dB which could easily be corrected by adjusting the balance control of the amplifier or receiver. This channel imbalance is corroborated by the unequal measured resistance and impedance of the cartridge coils (see table). It would seem that the channel to channel balance of a top of the line cartridge such as the ZLM, should be quality controlled to be much closer than our sample. We therefore requested two more samples from the firm, and output for both channels of all three are shown in Fig. 2b.

During the listening tests, one panel member commented on the quality of certain piano notes as being a type of resonant coloration. A correlation to the particular timbre of this

Fig. 2—A, left, interchannel output vs. frequency for cartridge number 7A4147. Notches in crosstalk are due to filter switching. Note increase between 250 and 400 Hz.

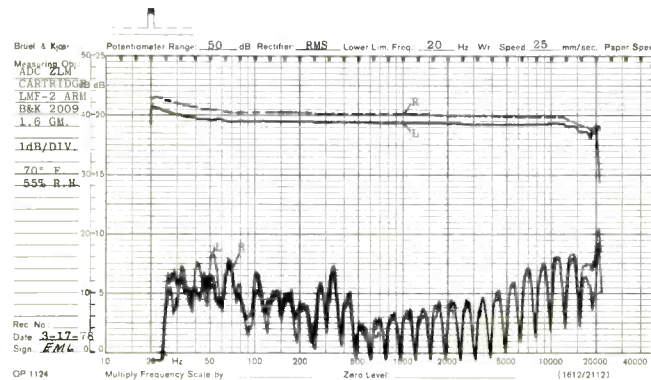

B, right, channel balance for three cartridges. Top curve is for original cartridge, No. 7A4147. Note that separation for No. 7E7021 is much closer.

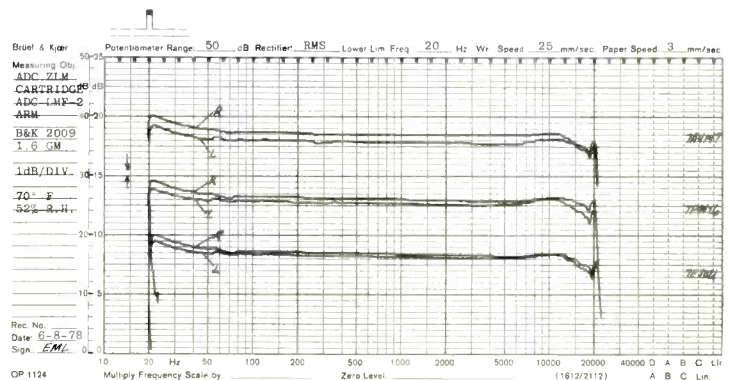

IT TOOK TOSHIBA TO BUILD THE WORLD'S FIRST DIGITAL-SYNTHESIZED RECEIVER.

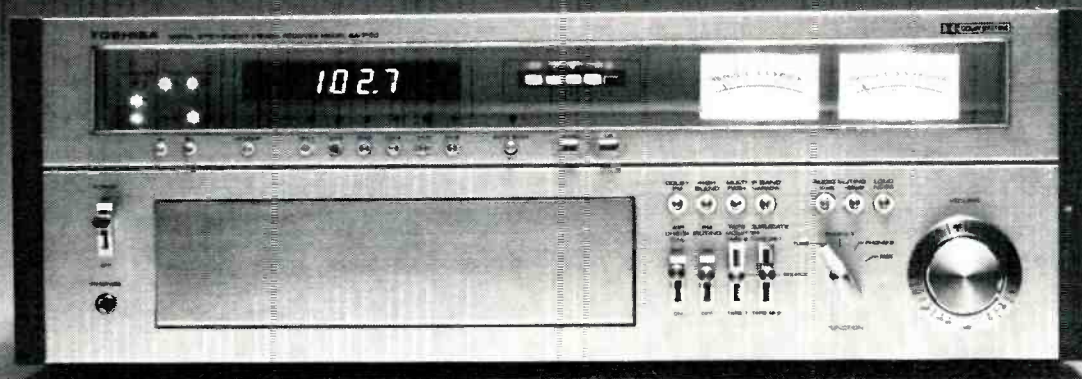

The Toshiba 7150 locks into the center of any station's assigned broadcast frequency and eliminates drift.

95

A few years ago, Toshiba introduced and marketed the first fully electronic digital-synthesized tuner.

Now Toshiba has another first.

We've built a digital-synthesized tuner into a high-powered, low-distortion FM/AM receiver: the Toshiba 7150 with SYNTHETUNE.[™]

SYNTHETUNE is a function that provides tuning so accurate even a center tuning meter is unnecessary. Drift is eliminated.

The 7150's FM tuner section also contains flat group delay IF circuitry. And a quartz crystal oscillator, which automatically locks into the center

of any station's assigned broadcast frequency — as precisely as the station's own transmitter.

Tune the 7150 just by pushing the auto-scan button. It scans the full range of the AM or FM band, stopping precisely at each listenable station.

Bright green LED numerals instantly display all frequencies as they are tuned.

Of course, there's more to the 7150 than SYNTHETUNE.

It also has separate transformers for class A and class B amplifier sections. The toroidal transformer for class B amplification has separate left and right power supplies.

It also has Dolby[®] FM and an air check switch for

accurate tape recording.

Furthermore, the 7150 delivers a minimum of 150 watts per channel into 8 ohms, 20 to 20,000 Hz, with no more than 0.05% THD. And the rest of the specs are just as impressive.

Hear the Toshiba 7150 at better audio dealers. At \$1100.00** it's the top of our line. But every receiver Toshiba makes is engineered just as meticulously.

So they all have one thing in common. Superb sound quality.

TOSHIBA
Again, the first.

Toshiba America Inc., 280 Park Ave., New York, NY 10017

[®]Dolby is a registered trademark of Dolby Laboratories, Inc.

**Suggested retail value solely for purpose of information.

Enter No. 45 on Reader Service Card

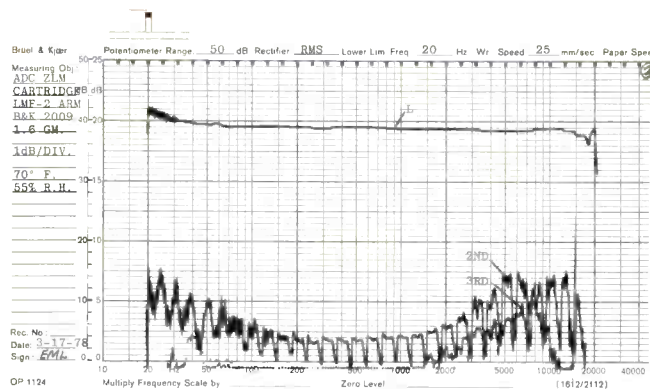
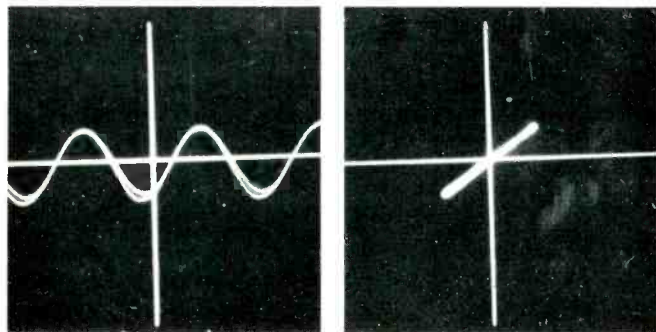

Fig. 3—Second and third harmonic distortion vs. output. Note the increase above about 1.5 kHz. Some and perhaps most of this distortion is probably due to the test record.

coloration was found by looking at the crosstalk data in Fig. 2a. The output in the 1/3-octave band centered at 315 Hz is greater than the general trend, as in the output from the 250 and 400 Hz filters. Barely noticeable in the main output of each channel is a discontinuity at about 250 Hz. These measurements are made with such a slow sweep speed, that for practical purposes, they may be considered to be steady state. Under groove excitation due to the rapid, transient nature of the piano notes, this resonant-produced coloration is more audible than might be supposed. Figure 2 does correlate with listening quality to at least the extent of providing clues to the cause of this perceived effect. The dip at 18 kHz in the main output curves shown in Fig. 2 is documented by B&K as being an anomaly present in all pressings of their test record 2009.

Another aspect of the quality mentioned by all panel members was the bright, forward sound which at the same time lacked the extreme highs of the reference system. It is an interesting point that the ZLM exhibits to a greater degree the very quality for which some moving-coil cartridges are highly praised. It has a more forward quality than usually associated with cartridges of this design type. Part of this quality can be explained by the very tiny amount of droop in output above 2 kHz. This drop in output of only 0.5 dB centered around 5 kHz is less than that exhibited by some cartridges of similar design type. It is felt that the other part of the explanation is found by correlating this forward, bright quality to the rise in distortion, especially third harmonic distortion in the 3 to 10 kHz range. This is shown in Figure 3. No absolute distortion data is available for the B&K 2009 test record, so only relative information can be extrapolated. The disc cutting system used to make these recordings has a reso-

Fig. 4—A, left, amplitude vs. time, and B, left vs. right channel, using B&K 2009 3-kHz band. If both channels were identical, the sine waves in A would be exactly together and B would show a straight line at 45 degrees.



nance at about 2 kHz. Above this frequency, the feedback in the system decreases to avoid instability at high frequencies. It would seem reasonable to assume that the distortion inherent in the B&K 2009 test record would increase in the range above 2 kHz because of the decreasing amount of feedback, but part of the distortion may also be due to the response of the cartridge. Since most commercial records are also cut using this or another similar feedback cutting system, which exhibits a resonance at about 1 kHz, most, if not all, commercial records will exhibit similar distortion characteristics. Further research is being carried out in this area to isolate the distortion inherent in the test records.

During the listening tests another aspect of performance drew comments, which had to be carefully sorted out since two phenomena seemed to be occurring simultaneously. The program material during which these effects were noted was

Fig. 5—Same as in Fig. 4 except that the 5-kHz band is being used.

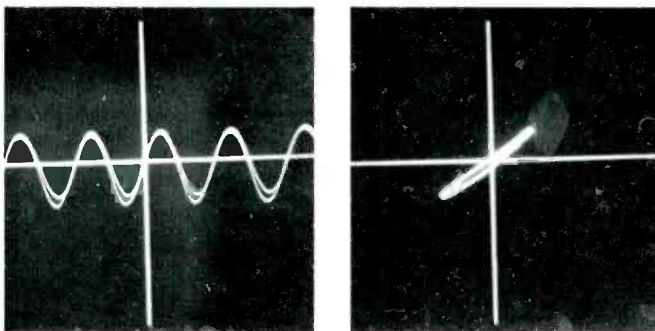
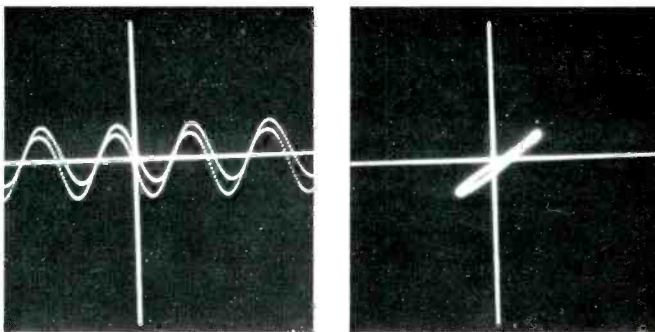
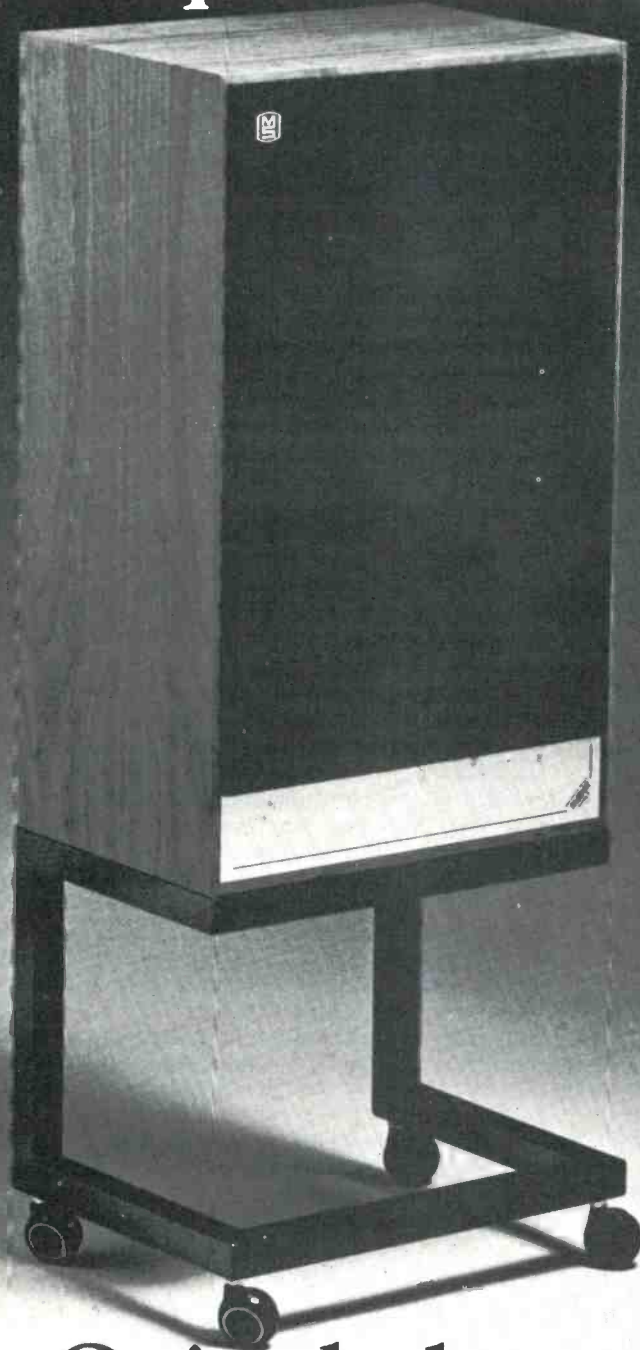

Fig. 6—Same as in Fig. 4 except that the 10-kHz band is being used.



complex, with many instruments playing from various positions in the stereo image. The comments alluded to some lack of precision in positional accuracy and in timbre during these complex musical passages. During less complex passages, the stereo positional accuracy of various sources, heard individually, was quite good. The timbre of each instrument was also good except as previously described. The interchannel crosstalk data shown in Fig. 2 correlates well with the aural impression that the cartridge is excellent in this respect during relatively noncomplex musical passages which approach steady-state measurements. Figures 4 through 7 show essentially the same information as that of Fig. 2 but in a different form. Each figure is divided into a) which shows the amplitude vs. time response of both channels of the cartridge to steady-state sinusoidal signal, and b) which represents the

Not quite the best known name?



"... a well finished system of good performance,
... representing good value for money at its
moderate price."

'GRAMOPHONE'
Review of PAGEANT SERIES 2.

"... the speakers gave a good account of
themselves on almost every type of material, an
initial favourable impression being confirmed
as the length of acquaintance grew."

"... Mordaunt-Short are on to a real winner here."

'HI-FI SOUND'
Review of PAGEANT SERIES 2.

"The impression of excellence is further
enhanced when one looks at the technical test
results."

"... a well-engineered, well-executed design,
where attention has been paid to the end
result — the listening experience — with the
result that (the PAGEANT SERIES 2) out-
performs, by a fair margin, all the other
submitted designs in the important area of
'listenability'."

'PRACTICAL HI-FI & AUDIO'
Comparative review of 6 loudspeaker models.

"Maintaining the high standard set on the live
listening session, the speaker further improved
its ranking relative to the group, assuming the
No.1 position under stereo programme testing."

"... an unquestionable best buy."

"... undoubtedly an example of consumer
engineering at its best."

'HI-FI FOR PLEASURE'
Comparative review of 30 loudspeaker models.

"I not only recommend this speaker very
highly, but rate it excellent value for money."

Angus McKenzie, 'HI-FI CHOICE, LOUSPEAKERS':
84 loudspeaker models reviewed and compared.

Quite the best name to know.



Mordaunt-Short Inc
High-Fidelity Loudspeaker Systems

1919, Middle Country Road, Centereach, N.Y. 11720.
Telephone: (516) 981-0066

I am interested in the best name to know in speakers.
Please send me details.

Name _____
Address _____

Enter No. 24 on Reader Service Card

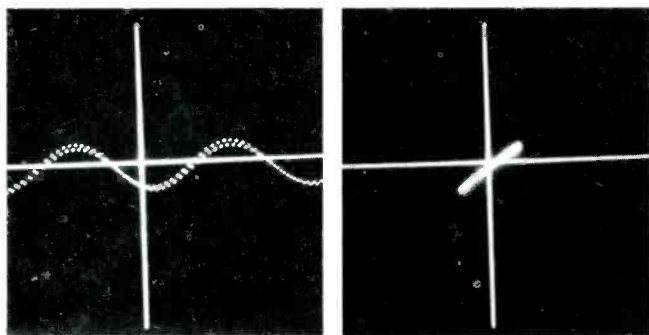
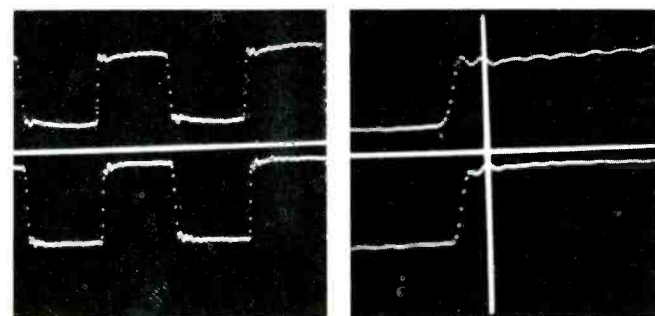

Fig. 7—Same as in Fig. 4 except that the 20-kHz band is being used.

left vs. the right channel. The b) part of each figure could be called the interchannel phase response. The frequency represented by each figure is 3, 5, 10, and 20 kHz, respectively. The slight bowing in the phase response is due to nonlinear distortion components as previously shown in Fig. 3. An absolutely coherent or zero degree phase relationship between the channels would be indicated by a straight line at about a 45° angle. The cursor lines shown are not meant to indicate x-y axes. They are related to the position of the cursor lines in the appropriate "a" part of each figure. The data in Figs. 4 through 7 correlate well with the data of Fig. 2 and also with regard to the image stability and excellent separation provided by the cartridge when reproducing simpler program material.

Figures 8a, b, and c provide the technical data necessary to correlate to the image and timbre quality perceived during complex passages. It should be pointed out that the waveforms shown in all the photos are taken from the screen of a digital storage device, which means that parts a, b, or c of each of the figures are directly related to each other. They are presented in a different format by utilizing computer manipulation. This is important if only because other insights may be drawn from this data, at a later date, which are beyond our capabilities at present. Figure 8a indicates that response to the 1-kHz square wave signal provided by CBS record STR-112 is very good but that each channel is slightly different. Since the square wave represents a complex signal composed of odd-order (i.e. 3rd, 5th, 7th, etc.) harmonics, each with a specific amplitude and phase relationship, it would appear to be a good test signal for determining performance during at least one type of complex signal conditions. Figure 8b which is the same as Fig 8a, but expanded to show the leading edge, indicates the high frequency resonance due to the equivalent tip mass of the stylus and record material compliance. This resonance is at 28.6 kHz with this particular record material. It should be pointed out that this frequency will change according to the stiffness (the reciprocal of compliance) of any given record. The stiffer the material, the higher the frequen-

Fig. 8—Response to 1-kHz square wave from CBS STR-112 at 3.54 cm/Sec. modulation. A, far left, is normal view; B, second left, is expanded view. C, third left, is left vs. right, X vs. Y presentation; if high frequency components were in per-



cy. There is no ringing in the groove modulation of the STR-112 test record, which was examined with a microscope. This high frequency resonance is so well damped that it is not easily determined from amplitude vs. frequency response data taken using a record which provides signals up to 45 or 50 kHz. This will be seen later. Figure 8c shows the same 1-kHz test signal in the left vs. right channel (x vs. y) format. A perfect correlation between the signals in each channel would result in only two bright dots. As can be seen, while there are two bright areas, they are a bit fuzzy and there are intermediate points scattered on an ellipse. The major ellipse indicates some interchannel phase misalignment between certain frequency components in each channel.

This technical information correlates with the perceived spatial smearing or broadening of individual musical instruments during complex passages. The minor ellipses near each bright spot indicate a shift in the relationships between the individual frequencies of the square wave. Such a shift could affect the timbre of instruments when they are producing complex transient musical tones.

Figure 9 shows the effect upon the high frequency response of the cartridge caused by changing the resistive component of the load impedance from the recommended 47 kilohms to 100 kilohms. Only the left channel is shown for the sake of clarity since the effect is the same for the right channel. The capacitive component of the loading was already slightly greater than the maximum recommended which is 275 pF. The capacitance of the leads inside the arm was measured as being 20 pF and the cable supplied which connects the arm to the input of the preamp had a measured capacitance of 255 pF. To this total of 275 pF must be added the input capacitance of the preamp and test switching system which is 60 pF. Thus the total capacitance during our measurements was 60 pF over the value recommended by ADC or 335 pF. Since any preamp will have some value of input capacitance, it would seem that the recommended value of 275 pF will always be exceeded, since the capacitance of the arm and cable supplied total 275 pF. ADC does supply another low capacitance cable, designated CD4W, as an accessory to the arm. Unfortunately we did not have this cable at our disposal during the tests. It is listed as having a capacitance of only 100 pF. We would have liked to have been able to run curves showing the effects of lower capacity upon the output, but it appears that the ADC recommended value of 275 pF is correct. During the listening tests we were able to reduce the capacitance by about 40 pF to a total of 295 pF, since the switching system used for the interchannel tests was eliminated.

During the listening session, a passage with very deep bass was auditioned. The general consensus of the panel was that the ZLM/LMF-2 combination provided a less tight bass than the reference system but that the bass output was also slightly more pronounced. Figure 10 shows the low frequency resonance due to the combination of stylus compliance and

fect alignment, only two bright dots would appear. D is square wave response of the three cartridges as presented in Fig. 2B.

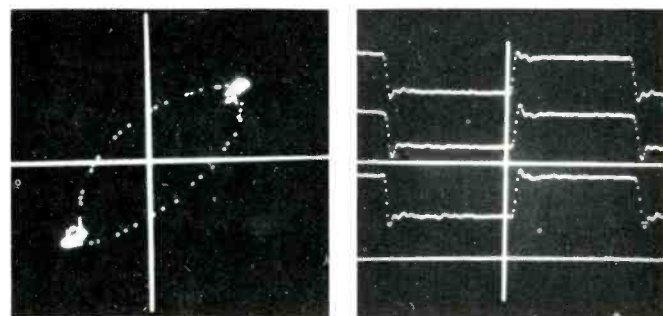

The most sought after loudspeaker in Europe is almost unknown in America.

Until now.

You've probably never heard of Sinus, because until recently, our loudspeakers have been completely unavailable in this country. But on the Continent, the Sinus name has long been synonymous with extraordinary sound reproduction. A sound so pure and true that Sinus of Sweden is now the largest manufacturer of fine loudspeaker systems in Western Europe.

Toward a near-perfect sound.

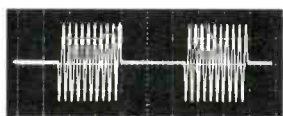

Input signal.

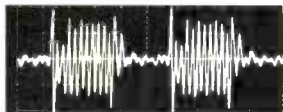

This loudspeaker exaggerates the initial and final sections of the signal. The result is a sharp, distorted sound.

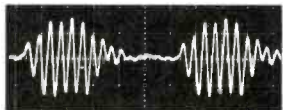

In this case the speaker is unable to reproduce the signal correctly or quickly enough. Here the resultant sound is lifeless and unclear.

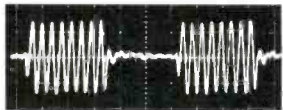

Here the speaker (Sinus 3400) has been able to reproduce the signal with sufficient speed and accuracy; qualities we require in every Sinus loudspeaker.

speaker's capacity to reproduce transient signals quickly and accurately. Transients are rapid sequences of fundamental tones and varying overtones which identify a particular sound or instrument.

The virtual elimination of masking effects, coupled with exceptionally fast and accurate reproduction of transients are the two most important objectives at Sinus laboratories in moving toward the near-perfect sound.

Traditionally, one of the major deterrents to pure sound reproduction has been the "masking effect." Masking effect is experienced as a blending or blurring of sound frequencies and is perceived by the human ear as distortion.

At the most advanced sound laboratories in Europe, Sinus engineers can reduce significantly these masking effects for an unexcelled clarity of sound. Because of all the world's leading speaker manufacturers, we are one of the few to use both free field and reverberant chamber test methods for determining an accurate and truly representative measure of sound quality.

A second important characteristic of fine sound reproduction is in the loud-

Toward a near-perfect loudspeaker.

All loudspeakers in the Sinus line have been perfected to exhibit minimal distortion due to masking effects and to reproduce transients with maximum speed and accuracy.

Sinus offers two basic types of speaker design in five models. Our acoustic suspension loud-

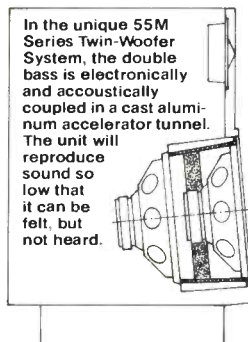

In the unique 55M Series Twin-Woofer System, the double bass is electronically and acoustically coupled in a cast aluminum accelerator tunnel. The unit will reproduce sound so low that it can be felt, but not heard.

speakers, the Sinus 2300 and 3400 Series, boast an unusually open and natural sound. Our bass reflex loudspeakers introduce a number of innovative design and engineering departures. The 44F Series features horizontal placement of midrange and tweeter units to create a more even

reproduction of both direct and reflected sound. The 3000XB Series offers a two-way bass reflex, time-aligned speaker with a specially-constructed 8" woofer.

At the top of the Sinus line, our 55M Series loudspeaker features a truly unique twin-woofer system. The bass reproduction is so astounding that the 55M is frequently compared to systems incorporating sub woofers and costing four times as much.

All Sinus loudspeakers are compact in size, made with natural wood veneers throughout and sold only in matched pairs.

Sinus Loudspeakers.

(Pronounced Seen-us.) Built in Sweden and now available in Canada and America through C.C.L. Enterprises, Inc. Call or write for more detailed information and the address of your nearest Sinus dealer.

In U.S.: C.C.L. Enterprises, Inc.
24 Ledin Drive
Avon, Mass. 02322
(617) 588-1800

C.C.L. Enterprises, Inc.
30682 San Antonio St.
Hayward, Calif. 94544
(415) 487-1144

In Canada:
Durex Marketing Corp.
Streetsville, Ontario, Canada
(416) 826-9400



I'd like more information about your complete line of Sinus loudspeakers. Please send me your free brochure: The New Sound-Philosophy of Sinus.

NAME _____

ADDRESS _____

CITY _____

STATE _____ ZIP _____

Enter No. 38 on Reader Service Card

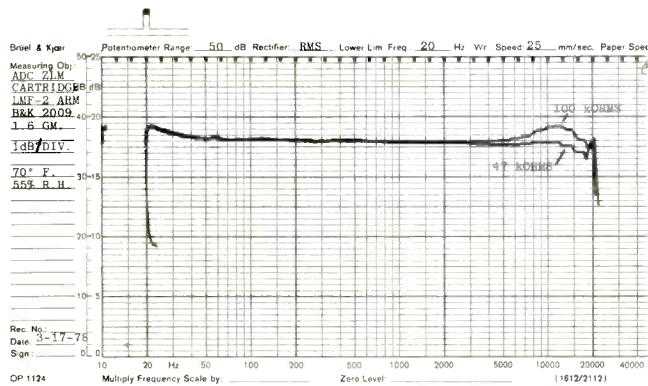

Fig. 9—Effect of load impedance on high frequency output of left channel, 330 pF total capacity.

effective tone arm mass. The Q of this resonance is about 3.3. It is very probable that low frequency bass passage in the recording caused this resonance to be excited, a small amount of which could cause the "blubbery effect" in the bass notes commented on by one panel member. The modulation effects produced by this low frequency resonance have lately come under investigation by a number of researchers. We are investigating the effect of some of the external damping devices which are being offered to reduce the high Q of this low frequency resonance, which is found in all cartridge-arm combinations. The frequency of this resonance with the ZLM/LMF-2 combination is 10 Hz, which, at the present time, has become the generally accepted magic number. Thus, from the standpoint of this criterion, the ZLM/LMF-2 is a very compatible combination.

Figure 11 shown the scanning loss of the ZLM at the inner diameter of a record (3.75 in. or 9.53 cm) vs. the outer diameter 5.625 in. or 14.29 cm) for the left channel. The right channel exhibited a similar characteristic. This scanning loss is a general characteristic of all cartridges. It is a function of the inter-relationship between the dimensions and shape of the stylus and the groove modulation. Since scanning loss data may be new to many, it must be said that the scanning loss of the ZLM is neither worse nor better than most cartridges. No specific tests were devised during the listening session to elicit comments from the panel members regarding this effect.

Figure 12 shows data regarding another situation which is also related to the scanning effect. In this case, a wider frequency test record, the B&K 2010, was used. The change in output is a function of tracking force. When the tracking

Fig. 10—Low frequency resonance due to arm effective mass and cartridge compliance. Q is 3.3.

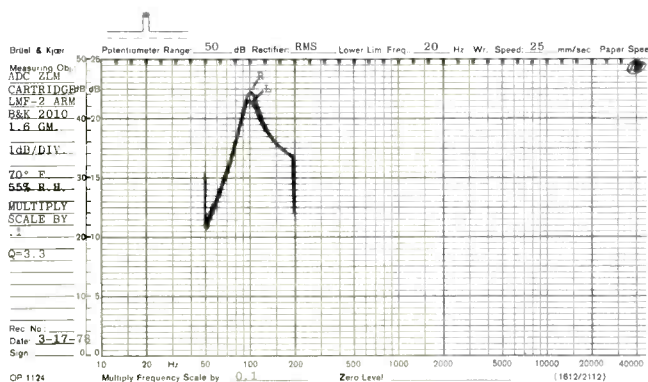

force is reduced from 1.6 to 1.4 grams, the output at high frequencies increases! Actually, this increase in output is due to the addition of distortion products. Once an optimum tracking force is found, no further increase in force causes a change in output during this test, however it should be noted that ADC recommends 1.25 grams, while we found that 1.6 grams gave the best results in our tests.

Since we were very aware of the deleterious effect of acoustical and mechanical feedback upon the audible quality of a turntable-arm-cartridge combination, great pains were taken to secure maximum isolation. Figure 13 shows the effect upon left channel output and crosstalk with and without an external sound field. The sound pressure level (SPL) measured at the cartridge was between 94 and 100 dB from 30 Hz to 200 Hz. This is a very severe test. The effect upon the main output is all but invisible, however the crosstalk does exhibit a change between the sound field being on or off. The sound field was produced by an oscillator which was tracking the chart recorder and was therefore a slowly swept sine wave of the same frequency as being reproduced by the cartridge from the test record. The change in crosstalk at 50 Hz, where the sound field measured 98 dB, was from 23 dB to 20 dB or only 3 dB. During the listening sessions the maximum SPL at the turntable was, at the most, 15 dB lower than during this severe test.

We are trying to develop a standard method for determining the hum rejection which will give a repeatable result which can be given in the form of a number. At this point we can only say that the ZLM/LMF-2 has excellent hum rejection. The microphonic effect of the ZLM/LMF-2 is also very low, so coloration due to this phenomenon should be very small.

Further investigations of the ZLM/LMF-2 combination, using the square wave on CBS STR-112, yielded some interesting information about the relationship between the reproduction of lateral (mono) and vertical (stereo) modulation. The vertical modulation seems to exhibit a time delay vs. frequency which gradually increases at a greater rate than that of the lateral modulation. This could possibly cause an extra sense of spatiality from that actually present in the record grooves. It would seem that more research in this area is warranted.

Figure 14 shows the response of the left and right channels of the ZLM/LMF-2 combination to the 10.7 kHz filtered tone burst of Shure TTR-103 test record. This interesting test signal has more merit than meets the eye and you will see more of it in the future. We have included it in this report for reference so that you may compare it with future reports.

The LMF-2 arm is very easy to use, especially while making adjustments during tests. The mounting of the arm to the

Fig. 11—Scanning loss vs. disc radius. This loss is due to the geometric relationship between the stylus and the modulated groove, and all practical styli will exhibit this effect to varying degrees.

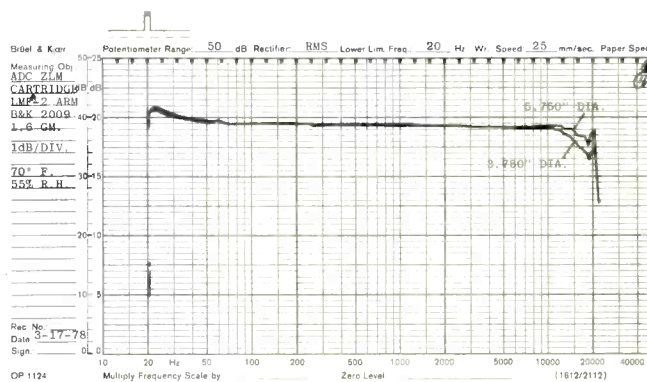

Just for the record.

Audiophile Edition

Just for the record, may we introduce you to the Audiophile Edition from Bib Hi-Fi Accessories, Inc. Already sought in more than 60 countries, the Audiophile Edition comes from England, with the technical and esthetic superiority that have made Bib's a preminent name for more than 25 years.

And, just for those records with which you are most concerned, consider this sampling:

The Record Valet

The elegant, effective remover of damaging substances, pictured above. Note the exclusive reservoir for Bib's anti-static cleaner, to merely humidify the pad rather than coat and smear debris. Note, too, the pad's tensiled edge of bristles.

The Stylus Cleaner

Here is a cleaner which recognizes both the value of your investment and the requirement that it be protected. It removes destructive agents without harm to the stylus tip, while accompanying mildly formulated lotion softens grit and removes glaze, with no danger to cantilevers.

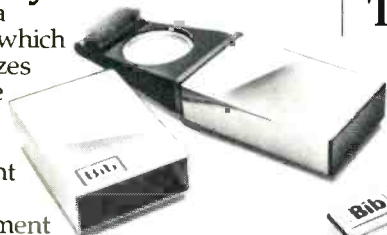

Calibrated for accuracy within 0.25 gram's sensitivity and engineered for just sufficient pressure to prevent excessive stylus and record wear, to say nothing of distortion levels.

The Parallel Tracking Groov Kleen

Compatible with even the lowest profile deck, the unit's roller cleaning brush is augmented by a camel-hair trailer which tracks across grooves in linear fashion.

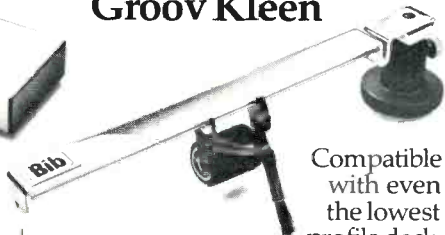

The Stylus Balance and Deck Level



The Groov-Stat Electronic 3000

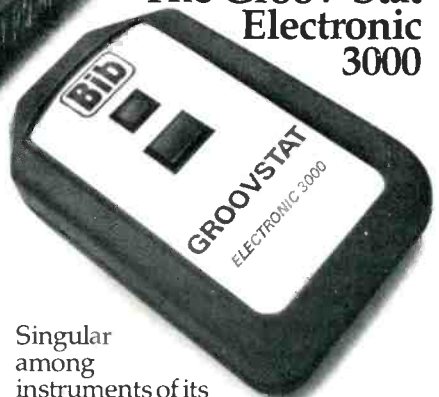

Singular among instruments of its kind, this releases only positive ions and is, therefore, vastly more effective than conventional static guns which also emit negative ions even though all records are negatively charged. While not for the record, here is one more offering from the Edition:

The Tape Head Cleaner



A unique multi-angled tool, for use on every tape recorder made. Plus our inspection mirror, a fluffy brush and the extraordinary cleaning lotion from our own chemists. Consider finally, the Edition's handsome case... Just for the Record. And the tape recorder.



The Audiophile Edition by Bib. The Finest Record and Tape Accessories in the World.

Bib Hi-Fi Accessories, Inc. • 3363 Garden Brook Drive • Dallas, Texas 75234

Enter No. 6 on Reader Service Card

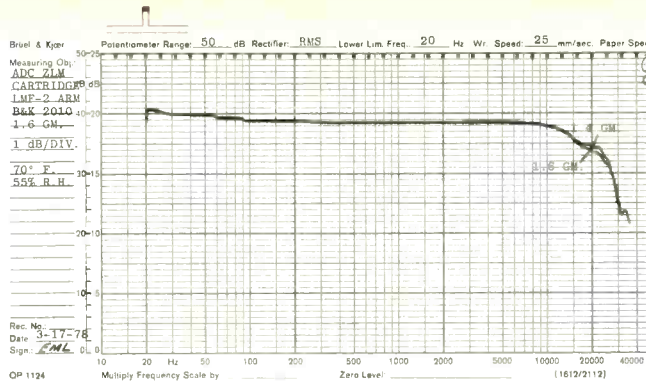

Fig. 12—Scanning error vs. tracking force. Higher output at high frequencies indicates the addition of distortion products due to inadequate tracking force. Wider range of B&K 2010 is used to show output change above 20-kHz limit of 2009 disc. Record grooves at 5.625 inch diameter.

turntable is not difficult compared to some other arms. The main problem will be in using the template supplied to find the proper location of the hole which must be drilled for the arm. Because the template is of cardboard and must be held above the spot on the mounting board to be marked, an error might occur so care is advised during this operation. Because the same template is used to determine the proper stylus overhang, the locating hole in the template is as large as the tone arm pillar which is about 11/16 in. (1.746 cm) in diameter. This is a very nice way to assure correct overhang but it makes locating the exact center of the tonearm pillar hole a bit more difficult. Perhaps later production might include two templates with different size center holes for each operation.

The mechanical aspects of the arm are generally quite good. The lateral and vertical bearing frictions are so low that they defy accurate measurements. Three counterweights of 15, 30, and 45 grams are provided to allow the use of cartridges weighing from 3 to 11 grams. It is always best to use the largest counterweight possible so that the weight may be located close to the arm pivot, rather than further out on the back of the arm. This will reduce the moment of inertia, which is very desirable. The sidethrust correction is not only very effective (see the even results obtained on the outside, middle and inner bands of test record HFS-75), but can be adjusted while playing a record. This is a great feature to have during the optimization of the arm-cartridge system.

The tracking force, which is calibrated in 0.1-gram increments, is off calibration by about 0.1 gram in the middle of the range. At the maximum indicated setting of 1.7 grams,

Fig. 13—Effect on output of external sound field at cartridge position. Good isolation of playback system is shown by small change in crosstalk signal; no change is noted in main channel output.

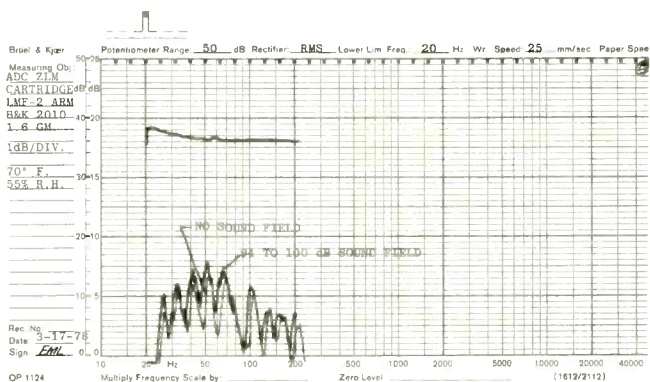

the actual value was 1.5 grams. This error on the low side might possibly cause people who tend to set the tracking force as low as possible to have some tracking and scanning problems (see Fig. 12). A second person was asked to adjust the arm as a check and he came up with a slightly greater error. It can be presumed that most persons who purchase ADC's top of the line ZLM cartridge and LMF-2 arm are doing so with the expectation of achieving super performance. To help achieve this, we recommend that, unless a person has access to an accurate gram gauge, he should have the turntable, arm, cartridge combination set up and adjusted by someone who has such a gauge or set the tracking force just slightly on the high side.

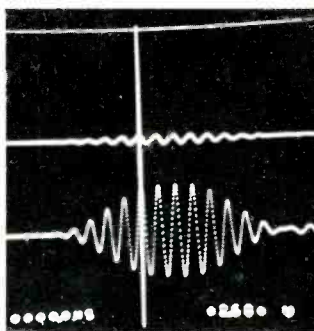

Fig. 14—Effect of 10.7-kHz filtered tone burst from Shure TTR-103, left channel at top. System is tracking at 1.6 gm at 30 cm/Sec.

We have listed other measurement data in tabular form for convenience. This is not because they are less important than some of the data we have mentioned. We have listed some items, such as the headshell offset, without comment and although the risetime of the cartridge was measured as being 24 μ Sec, we reserve comment to such data can be correlated to the perceived aural impressions of listeners. Listing such data does allow determinations to be made at a later date when we are all a little smarter and that includes yours truly.

In conclusion, we are pleased to be able to present some correlation between the subjective comments made by the listening panel and the objective technical measurements performed in the laboratory. The fact that the combination of the ADC ZLM cartridge and LMF-2 arm is of such high quality, makes such correlation appear even more impressive. We are continuing to explore other test procedures which will provide better correlations to subjective impressions of performance.

Edward M. Long

Enter No. 93 on Reader Service Card

Sony Model ECM-56F Electret Condenser Microphone

MANUFACTURER'S SPECIFICATIONS

Capsule: Back-electret condenser.
Directivity: Unidirectional.
Impedance: 250 ohms \pm 20 percent at kHz, balanced.
Frequency Response: 20 Hz to 20 kHz.
Output Level: Effective output level -53.8 dBm. (0 dBm=1 mW/10 μ Bar, 1000 Hz); open circuit voltage, 0.2 mV/ μ Bar at 1000 Hz, output level deviation \pm 2 dB.
Recommended Load Impedance: More than 3 kilohms.
Maximum Input Level: Approximately 134 dB SPL.
Noise Level: Less than 28 dB SPL (0 dB SPL \times 10⁻⁴ μ Bar).
Wind Noise: Less than 40 dB SPL at 2 m/S velocity.
Induction Noise from External Magnetic Field: Less than 5 dB SPL at 1 mil² gauss, 50 Hz.



Power Requirements: 7 to 9 V d.c., 1 mA max. from internal battery or 24 V-54 V d.c. 3.5 mA max. from external power supply.

Battery Life: Approximately 400 hrs. with Eveready 216 manganese, or approx. 600 hrs. with Eveready E146 mercury.

Cable: Attached, 7/32-in. diameter (5.2 mm), 2-conductor shielded cable with Cannon XLR-3-12C plug, 20 ft. (600 cm).

Mounting Thread: PF 1/2

Dimensions: 2 in. (5 cm) x 8 $\frac{1}{4}$ in. (20.7 cm).

Weight: 1.06 lbs. (500 gms).

Finish: Non-reflective satin nickel.

Accessories Supplied: Stand adaptor PF 1/2 to NS 5/8.

Price: \$220.00.

The Sony ECM-56F will appeal to audiophiles who want condenser performance with the simplicity of a dynamic or ribbon mike. Unlike some contemporary condensers, it is not a "system" mike, and has no interchangeable capsules, windscreens, etc. Simplicity is further enhanced by the permanently attached cable compete with an XLR 3-pin plug on the end, so there's no soldering to do if your recorder or mixer has professional-type balanced inputs. We did not, however, escape reading the instructions because the battery is well concealed by a perfectly machined and fitted housing. The lower shell unscrews and drops downward, allowing access to battery and electronics.

We've always preferred a mike with radial sensitivity for distant miking of orchestra and chorus, and Sony has included some calibration marks on the swivel which facilitates duplication of tilt angles. (Radial means you talk into the side, as distinguished from axial sensitive mikes where you talk into the end.)

The advertising literature indicates that Sony has designed the ECM-56F and other mikes in their "back-electret" line as a medium cost substitute for air-condenser microphones in audiophile or professional studio applications. The inclusion of additional electronics inside the mike, as required for remote "phantom powering," opens up a wide variety of applications such as recording or broadcast studios and permanent installations for sound reinforcement or recording. With remote powering, the internal battery is removed, and power is supplied through the standard two-conductor shielded microphone cable. "Phantom powering" is normally found in professional air-condenser mikes and has been discussed in our recent reviews. Sony ECM-56F may be operated into a balanced input with grounded center tap when you're using battery power, without short circuiting the power source. Similarly, it may be used into unbalanced inputs by grounding one output line and replacing the three-pin connector with the desired two-circuit plug.

The "back electret" is a recent development by Sony. The rationale makes a lot of sense to this reviewer who has had considerable experience with the testing and selection of diaphragm materials. The design of an electret capsule has always necessitated a compromise between mechanical and electrical properties of the plastic film which functions both as a diaphragm and as a "permanently" charged dielectric, as in a capacitor. A film such as *Teflon* has good electrical prop-

erties for use as an electret, but it is mechanically very limp and is practically useless as a diaphragm. On the other hand, a polyester film such as *Mylar* is stiff and ideal as a diaphragm, but does poorly as an electret. (*Mylar* is a good dielectric and is used in capacitors but is not suitable for use as an electret.) Instead of going to a different film with compromise properties, Sony has attempted to achieve the "best of both worlds" by utilizing the two ideal types of films in a single capsule. The electret film, which is described only as "high polymer," is placed more or less in contact with the back plate. The diaphragm fill, which is stated to be "polyester," is mounted on top, and separated from the electret film by a small air space. Kubota¹ states that this composite transducer called the back electret performs better than conventional electrets, and presumably equal to air condensers.

The capsule of the ECM-56F, about $\frac{3}{8}$ -inch diameter and $\frac{3}{8}$ -inch thick, perches on top of the lower housing and is surrounded by an open-mesh windscreen. The screen is an elaborate affair consisting of an outer coarse-weave wire mesh which provides mechanical strength, and two layers of fine-weave mesh inside, which does the windscreening. As stated previously, the electronics and battery are in the lower housing. In addition, there is an internal switch providing 8 dB reduction in sensitivity if desired and a battery test lamp visible from the outside on the bottom of the housing. The *Off-M-V* switch is in the middle front of the mike and provides power switching and low frequency attenuation.

The appearance, quality, and durability of the ECM-56F seem to be excellent. We encountered one difficulty in the area of biomechanics. The front and backs of the mike are identical in appearance save for the switch. We had to consult the manual to find that the switch is on the front side. It is our opinion that the switch location does not necessarily denote the front, because on some mikes the switch is on the back. We suggest that Sony add an engraving such as "Front" or "Back."

Laboratory Tests

The impedance with flat response (M) setting (Fig. 1) is satisfactorily close to the 250-ohm nominal value. It is higher than the 180-ohm maximum value recommended by the EIA Standard for 150-ohm mikes, but a 250-ohm mike generally may be used with "unloaded" inputs rated from 150 to 600 ohms.

On bass roll-off (V) setting, the impedance peaks at about 1500 ohms, so the degree of bass rolloff will vary with the

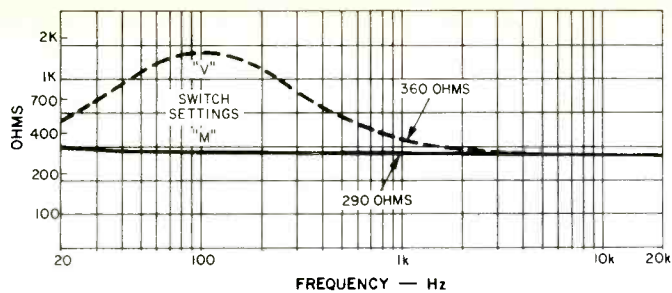

Fig. 1—Impedance with the internal attenuator switch setting at "0" or -8 dB.

actual input impedance of the preamp. The 150-ohm input of our BA-31 Broadcast Microphone Preamp measures about 1500 ohms at 50 Hz, increasing with frequency, and Sony recommends 3000 ohms or greater load impedance.

Figure 2 shows the on-axis frequency response. There is considerable bass rolloff for plane-wave conditions, so equalization may be needed for distant miking. Sony's curve (in the instruction manual, no individual curve supplied) matches our 12-inch curve at low frequencies. It is likely that Sony's curve is not for plane waves but for a finite source distance of about 50 or 100 cm.

We were concerned about the sample mike's 6 dB peak at 7000 Hz, but the manual shows a broad peak having a maximum value of +3 dB at 6000 Hz. Allowing for production tolerances plus variations between labs, our mike seems normal. The narrowness of the peak on our graph, and the magnified dB scale gives the misleading impression that our data is quite different from Sony's.

Of course, a narrow peak is more difficult to equalize than a broad peak, and may be accompanied by "ringing" on high frequency impulse-type sounds (otherwise referred to as "poor transient response"). Our response curve shows more rolloff than Sony above 10,000 Hz but the trace of a peak at 15,000 Hz, correlates with Sony's curve. This is of little concern as the 15,000 Hz response is only -1 dB relative to 1000 Hz response.

Our sensitivity number -54 dBV/Pa agrees very well with Sony's value (-53.8). The internal switch reduces output level by the stated 8 dB, with no change in frequency response. The user is cautioned to reserve this feature for sound sources in excess of 100 dB SPL because the ECM-56F sensitivity will in this case be less than a normal dynamic or ribbon mike, and your recorder or mixer noise may be heard otherwise.

Figure 3 shows the loading effects we encountered at low frequencies, and it is evident that the preamp loading effects are actually desirable for smooth rolloff in "V" switch positions. The rolloff under open circuit conditions is too abrupt and doesn't compensate very well for proximity effects. Compare Figs. 2 and 3. In fact, an open circuit (or very high impedance) load results in a slight bass boost instead of a cut at 250 Hz, and speech at six inches or less might sound "boomy."

The directional frequency response curves, Fig. 4, show that the response at 90° is uniform to at least 10,000 Hz. The 180° response reveals 10 to 13 dB cardioid rejection up to 3000 Hz. Above 6000 Hz, the ECM-56F resembles a bi-direc-

Fig. 2—Frequency response vs. distance.

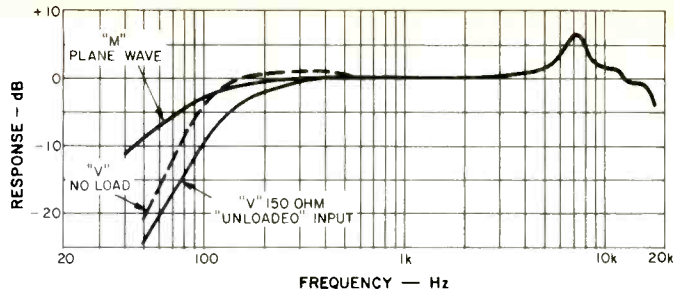
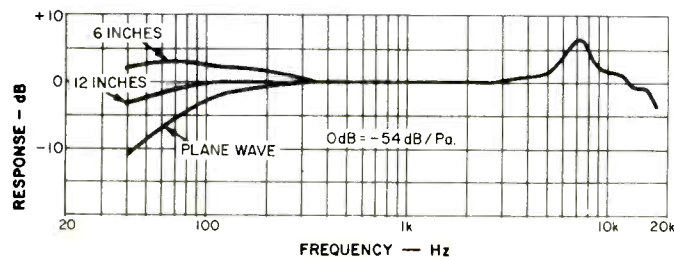

Fig. 3—Effects of load on the low-frequency response compensation.

tional (figure-eight) pattern mike. It seems to us that something strange is happening inside the capsule about 3000 Hz. The directional curves in the manual roughly correlate with our data. The 180° response is -20 dB up to 3000 Hz and the mike is bi-directional at 9000 Hz. A cardioid microphone, in our opinion, should exhibit a minimum of 15 dB at the 180° "null" point. (For super-cardioids the null points are 135° and 225°.) We repeated our tests outdoors at six feet from the source. The results of 0°, 90°, and 180° were confirmed, and additionally we checked 135° for a deeper null which would indicate a super-cardioid pattern. The 135° response was similar to the 180°. Some results of this pattern may include reduction of useable gain before feedback in sound systems, reduction of signal-to-ambient noise, and sound coloration in distant miking where reverberant sound predominates over direct sound.

The one-third octave band noise spectrum² is shown in Fig. 5. Since the ECM-56 sensitivity is similar to a dynamic mike and its noise level is low, the results were slightly influenced by noise from our amplifier. It is safe to say, therefore, that the ECM-56F noise is less than 25 dB "A" weighted and less than 32 dB unweighted. Since most (wide-band) commercial preamp or mikes are noisier than our (restricted bandwidth) OP-6 amplifier, the ECM-56F noise may not always be greater than preamp noise. In most cases, ambient noise will be greater than the mike or preamp/mixer noise, of course. Sony's value of 28 dB, weighting and bandwidth unknown, correlates with our data.

Phasing was measured as pin # 2 positive, in accordance with the proposed revision to the EIA Standard. The overall level of vibration noise was about 15 dB greater than the BK-5B reference mike. The electret capsule is resiliently mounted but the low mass of the capsule may result in the resonance frequency, where vibration is amplified, being in the audible frequency range. Vibration noise could be a problem in some stringent applications, and the user may wish to purchase an accessory shockmount.

Magnetic hum pickup is much less than our BK-5B and for practical purposes is non-existent. The integral windscreen is very effective outdoors in winds up to 10 mph, and "pop" noise is almost as low as the BK-5B with its 4-inch diameter accessory screen. After we finished our tests, we removed the Sony screen and, seeing the two layers of fine-weave wire mesh, we wondered if a tradeoff in frequency response or directional characteristics had been made to obtain the excellent windscreening. It would be interesting to repeat the acoustical tests without the screen.

Our overload test showed indefinite clipping at approximately 138 dB on the 0 dB switch setting. At 138 dB SPL, the Sony ECM-56F might overload your input and in that case it would be appropriate to switch in the integral 8 dB attenuator.

Listening and Use Tests

The ECM-56F on "V" setting was talk-tested and compared to the BK-5B reference microphone on "VI" setting at six inches.

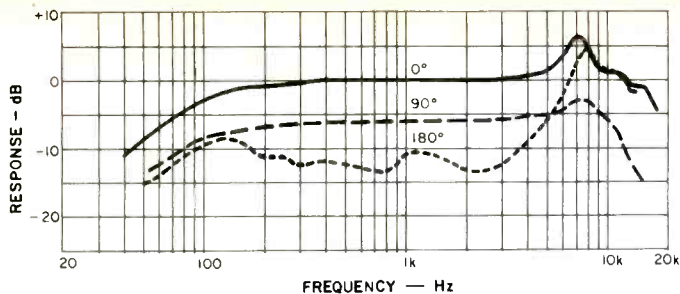

Fig. 4—Frequency response vs. angle, "M" response, plane wave.

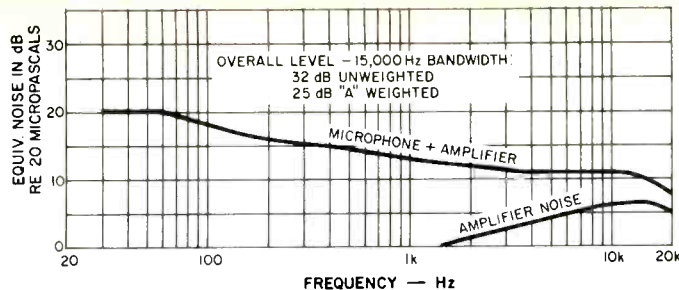

Fig. 5—One-third octave band noise spectrum with the Sony ECM-56F microphone.

The ECM-56F sounded similar to the BK-5B except for a little less "presence." This is the normal result of comparing a mike with ruler-flat response to the BK-5B. The high frequency peak in the Sony's frequency response was not evident.

A comparison test using recorded music and line acoustic guitar yielded results similar to speech. On some selections the ECM-56F sounded "cleaner" than the BK-5B, emphasizing some string overtones. The Sony sound was uniform for on- or off-axis sources out to 90°, whereas, the BK-5B sound varies drastically. For distant on-axis sources in our semi-reverberant studio, both mikes sounded similar at very high and very low frequencies. The Sony did pick up more ambient noise which in this case originated in the rear hemisphere.

We conclude, from both objective and subjective tests, that the Sony ECM-56F may be equal to more expensive air condensers but in a relatively limited range of environments. It appears ideal for close miking of voice or instruments and, perhaps with the addition of a shockmount, is well suited to field recordings of rock, folk, or country music. It is well suited to close or distant miking in acoustically dead and quiet studios or auditoriums. Our tests showed that the ECM-56F is

not particularly outstanding for reducing noise from the rear hemisphere, but we could not show that the non-uniform 180° response adds any coloration to on- or off-axis sources in a semi-reverberant room. Highly reverberant auditoriums are frequently noisy, and we would shy away from distant miking a live concert with ECM-56Fs in these rooms with an audience present.

The Sony has many fine acoustical, electrical, and mechanical features. The small size of the capsule, plus the technical articles, led us to expect uniform response and directivity to 15,000 Hz. Naturally, some design tradeoffs are to be expected to achieve all-around performance in a "non-system" condenser mike. Since it out-performed our \$360.00 ribbon mike in at least one test, we must conclude that the Sony offers a high degree of performance at a moderate cost.

Jon Sank

Enter No. 94 on Reader Service Card

References

- 1) H. Kubota, "Back Electret, A Method to Improve Performance of Condenser Microphones of Electret Design." Paper given at AES Convention in Fall, 1976. AES Preprint 1157 (O-Z).
- 2) "The Compleat Microphone Evaluation . . . An Update," *Audio*, Sept., 1978, pp. 35-40.

KLH/BURWEN RESEARCH Model TNE7000 Transient Noise Eliminator

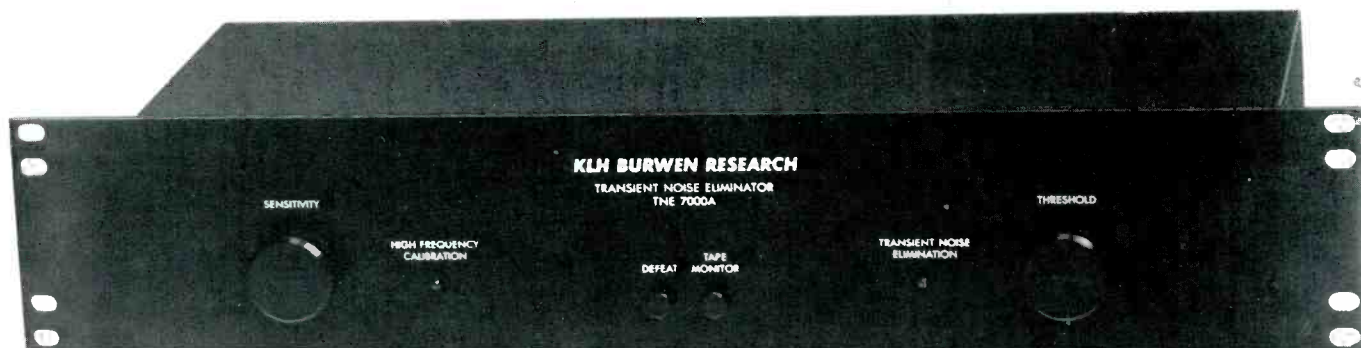

MANUFACTURER'S SPECIFICATIONS

Gain at 1 kHz: 0 dB.
 Maximum Input Level: 6.0 V rms.
 Input Impedance: 40 kilohms.
 Rated Output: 2.5 V rms.
 Clipping Level (Output): 7.0 V rms.

Output Impedance: 1 ohm, d.c. coupled.
 Frequency Response: 20 Hz to 20 kHz ± 0.5 dB.
 THD (20 Hz to 10 kHz): Less than 0.2 percent.
 Internal Noise: 40 μ V maximum rms, 20 Hz to 20 kHz.

Power Requirements: 105-125 V, 50/60 Hz, 8 watts.
 Dimensions: 16 $\frac{3}{4}$ in. (42.5 cm) W x 2 $\frac{7}{8}$ in. (7.3 cm) H x 7 $\frac{1}{2}$ in. (19.4 cm) D.
 Weight: 7 lbs. (3.2 kg).
 Price: \$299.00.

When Dick Burwen comes up with his version of a "click and pop" eliminator, you can be pretty sure that it will have some circuitry approaches that have not been tried before. Burwen is one of the current innovators of the audio industry, and it is always interesting to see what he is going to come up with next. His Model TNE7000 Transient Noise Eliminator (his term, not ours) is simple enough looking on the outside. There are only two rotary controls, one labelled *Sensitivity*, the other *Threshold*. Between them, at panel cen-

ter, are two pushbuttons, one for defeating the noise eliminator circuitry, the other for tape monitoring (which controls appropriate tape-out and tape-in jacks on the rear panel, replacing those that may have been used up in connecting this device to a stereo component system). An indicator light next to the sensitivity control is identified by the words *High Frequency Calibration*, while a symmetrically positioned indicator near the threshold control is identified as a *Transient Noise Elimination* indicator.

The rear panel of the TNE7000 has the required pairs of input and output jacks plus the aforementioned tape-out and tape-in jacks.

Burwen's Approach

As explained in the instruction manual, musical transients and unwanted noise transients are sufficiently different in character so that they can be differentiated from each other even though both are present in a composite signal. According to Burwen, musical transients have an attack time of around 2 milliseconds with a decay time that can last from between 0.1 to several seconds. Transient noise attack time is much faster, varying from 50 to 200 millionths of a second with a duration of no more than 0.002 seconds. Transient noise also contains high energy in the ultrasonic frequency region from 20 kHz to 50 kHz, where there is virtually no musical content.

Transient noise elimination in the TNE7000 consists of two steps, detection and elimination. The system detects pops and clicks by their high energy content in the superaudible region. The entire signal is switched off until the transient has passed and, during the off time, a smoothly varying signal is substituted so that the listener will not detect an absence of signal. Off time is only between 80 and 600 millionths of a second. A time delay of 40 millionths of a second is inserted in the signal path to give the detector time enough to detect the transient and suppress it by means of the signal-off switching circuit.

The TNE7000 uses steep-slope high-pass filtering, full wave rectification, and a high-speed pulse detector. The system involves high-frequency pre-emphasis ahead of the switch, complementary de-emphasis afterwards, sampling and holding of the low frequency content of the music, phase matching and switch spike cancellation.

106

In using the device, one starts out with both the *Threshold* and *Sensitivity* controls at minimum (counterclockwise) positions. The *Threshold* control is then used to adjust the sensitivity of the detector circuit to music and to ticks and pops in the presence of high-frequency program information, while the *Sensitivity* control adjusts the sensitivity of the detector circuit to high-frequency program information. This control is advanced (while program material is playing) first until the high-frequency calibration LED indicator is only dimly lit. The threshold control is then adjusted, primarily by ear, to the maximum setting that does not cause audible distortion. As this control is advanced, the *Transient Noise Elimination* LED will begin to flash on and off each time a tick or pop is "removed." To make the flash appear bright enough to be observed, the duration of the light pulse may be more than 200 times the actual time the audio is turned off internally to eliminate the pulse sound.

Static Measurements

Only a few bench measurements were made on our sample of the TNE7000, since such a device is best evaluated under actual use conditions. We did confirm the following:

Harmonic distortion at 20 Hz measured only 0.01 percent decreasing to 0.006 percent at 1 kHz, and increasing to 0.05 percent at 20 kHz. Response was flat within ± 0.5 dB from 10 Hz to 23 kHz, and gain was indeed 0 dB or unity. Noise at the output measured 90 dB below a referenced level of 0 dBm

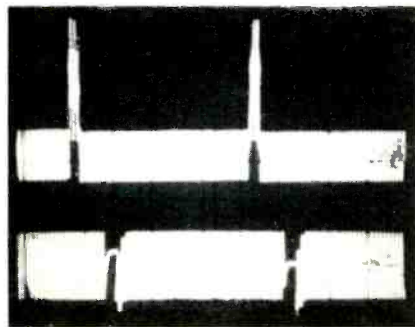

Fig. 1 — Synthesized transient "clicks" in the upper, input waveform, are effectively suppressed by the Burwen TNE7000, as shown by the output waveform (lower trace).

(0.775 volts), and maximum output before encountering clipping distortion was in excess of the 7 volts claimed.

In an effort to demonstrate graphically what the TNE7000 can do, we concocted a repetitive signal with the aid of an audio oscillator and a square-wave pulse generator. The input signal is depicted in the upper trace of the 'scope photo of Fig. 1. The fundamental sinusoidal frequency was 10 kHz, and while we realize that the square wave pulse had a repetition rate which was lower than that (note that a couple of 10 kHz alternations fit inside of each pulse in the upper waveform of the photo), we hoped that the steep rise time of the pulse would confuse the TNE7000 into believing that it was of a higher basic frequency and qualified for "instant removal."

As you can see by the lower trace of Fig. 1, measured at the output of the TNE7000 with absolutely no "doctoring," our hopes were more than justified. The spikes of the pulses are gone, and in their place there appears to be the "smooth transitional waveform" of which Mr. Burwen speaks in his instruction manual. Frankly, we were as proud of our synthesized "ticks and pops" as we think Burwen ought to be concerning his uncannily clever Transient Noise Eliminator.

Listening & Use Tests

Fortunately for us (and for the user), Burwen is honest enough to tell us what the TNE7000 will not do as well as what it can do. Specifically, he warns against trying to clean up records that are heard as broadcast from a stereo FM station. It seems that the sub-carrier products that spew forth from most FM tuners and receivers (19 kHz, 38 kHz, etc.) will confuse the device and desensitize its detecting circuitry. It will also be ineffective with mono signals (such as AM), since it senses the difference between left and right channels as it does its thing. However, plugging into only one channel of the device when listening to mono would solve that problem. Finally, the TNE7000 will not be as effective or sensitive when subjected to program sources played back on a tape deck because of the loss of high frequencies through the tape recorder (the high frequencies that are used to differentiate between musical transients and the unwanted click and pop kind).

That left us pretty much confined to record playing, but we had no trouble at all finding an ample supply of tick and pop-laden discs in our collection. Our available sources of clicks and pops, moreover, were sufficiently diverse to enable us to check out everything from minute "static-sounding" clicks all the way to "knife-blade gouge" types and everything in between.

Let us say at the outset that really severe scratches are not completely eliminated by the TNE7000. They are, however, much diminished in intensity and become devoid of that awful high-frequency splatter that typifies them under ordinary listening conditions. Their diminution is in no way accompanied by any alteration in overall musical tonal balance that is detectable by these ears. While earlier pop and click eliminators were most effective on the knife-gouge type of scratch in record, the TNE7000 is most, in fact, totally effective on the most subtle (and much more prevalent) types of ticks and pops that plague so many of our records. Since these types of pops predominate in my record collection, at least, I would vote for the TNE7000 over earlier models which failed to suppress these disturbances but worked marvelously on the mightier clicks and pops.

One final word about discs . . . If you still own some CD-4 records (left over from the age of four-channel quadraphonic sound), remember that they contain frequencies up to 45 kHz and will not be helped much by the TNE7000, considering its operating principles. Even so, that left me with countless records that were helped by the Burwen device, and I'm quite certain all you readers must own at least a couple — right?

Leonard Feldman

Enter No. 95 on Reader Service Card

Dear editor

Discount Dilemma

Dear Sir:

I read the "Dear Editor" letter in the September, 1978, issue of *Audio* with interest, and I have a similar experience to relate. I used to buy records at a discount department store because they usually ran "Label Sales" at some nice savings.

I bought a number of records that were on sale. One of the nice things was that they would never give me a hassle when I brought back a noisy or warped record for exchange. Well, I finally found out why when I opened a "new" record and found a sales slip in the sleeve from that store dated two months previously.

Well, I don't buy records there anymore! The manufacturers should put some sort of seal right on the cover opening so the consumer can be assured that it's a new record. But, then again, most of the record manufacturers can't seem to make a decent record anyway.

Bill Scavuzzo
Clark, N.J.

Vintage Stereo

Dear Sir:

In the early 1950s, Cook Laboratories in Stamford, Conn. were the first to manufacture stereo records. These records had two bands and required a tonearm fitted with two cartridges spaced 1 11/16 inches apart. One cartridge played the outer band, while the other played the inner band. The frequency response, stereo effect, and dynamic range of these Cook Records is outstanding, even by today's standards.

I have a number of these Cook records and the two-headed tonearm for playing them. There were, however, a sizeable number of records made and I would be interested in locating a purchase source or readers that may have a collection for sale. Any assistance the readers of *Audio* can give me in locating such records will be deeply appreciated.

K.O. Johnson
P.O. Box 011751
Miami, FL 33101

Coincident Congrats

Dear Sir:

I have just finished reading "A Basic Guide to Coincident Mikes" by Charles P. Repka in the November is-

sue of *Audio*, and would like to extend my compliments for a well-written piece on a subject previously thought of as "subversive" in the audio sense. The subject of coincident miking and disclosure of the ORTF approach will, I believe, be invaluable information to your readers who are not already familiar with it.

Many of my colleagues and myself, living in the New York City area, use the ORTF method for stereo recordings with great success. It affords us a simple and relatively inexpensive way to achieve superb stereo imaging and clarity, which is often more effective than the more elaborate multi-mike techniques.

The ORTF miking technique has recently been used in a two album recording of the **Musical Instruments of the Metropolitan Museum of Art** using Schoeps mikes.

Although the author implies that the Schoeps name is not well-known in this country, it is rapidly gaining acceptance in both the film and music recording industries. There are only a few dealers in this country with the American representative being Posthorn Recordings, 185 Avenue C, New York, NY 10009. The service is personal and attentive to the needs of amateur and professional recordists.

Danny Michael
New York, N.Y.

Dealer Dealings

Dear Sir:

I am certain that complaints lodged against audio dealers and manufacturers have validity. I have often wondered, however, why little mention has been made of the exceptional dealer, the unique manufacturer, or special instances of customer service/relations. The only public reference I can recall was that made of Dr. Clay Barclay ("the affable neurosurgeon"), and having spoken with Dr. Barclay on the phone, I can only concur that he is a most welcome dealer/enthusiast.

Two other individuals in the industry bear mentioning in a public forum. Mr. Simon Zreczny of Audio Consultants (Evanston, Illinois) has provided me with exceptional customer service since 1970. I have never met Mr. Zreczny and I feel that his ability to maintain my patronage over the years in such a competitive market place

speaks for itself. Audio Consultants is a retail organization. They offer qualities beyond the selling price.

An unscrupulous dealer sold me a pair of discontinued Infinity QLS-1 speakers. Mr. Arnold Nudell, President of Infinity Systems, exchanged these units for the final versions at the manufacturer's expense. Infinity had absolutely no liability in the original transaction, and Mr. Nudell's gesture was based purely on pride in his product and concern for the consumer. A great company!

Other Audiophiles must have similar stories.

David B. Adams, Ph. D.
Columbia, S.C.

The Editor replies: My guess about why so little editorial mention is made of good service by a dealer or manufacturer is that folks such as yourself rarely write in to tell us of the good things that happen to them. Incidentally, the reason we don't publicize the "bad things" which happen is that almost universally we have found upon investigation that "the worst service in the world" boils down to either an unreasonable expectation or a missed communication, neither of which were necessarily by the dealer/manufacturer. — E.P.

Namesake Number

Dear Sir:

We are looking for a copy of the song *Shoo Shoo Baby*, recorded in 1943 (Decca 18572) by the Andrews Sisters. The U.S. Air Force Reserve unit at Dover AFB is presently restoring a WW II B-17 bomber named "Shoo Shoo Baby." This is one of only two, out of the 12,000 manufactured, that exist today for public display.

Either a record or even the sheet music for the song would be helpful. We will make a copy of it and return the original to the party, or we can display the material with the restoration project and then forward it to the Air Force Museum for permanent display when the project is completed in about two years. If anyone can help us in locating either the record or the sheet music, we would certainly find it a valuable part of our restoration work.

Please contact Mr. Wesley Bell, 512 MAW Information Officer, Dover AFB, Del 19901, or phone (302) 678-6961.

Wesley Bell
Dover, Del.

Top of the pile

The Fox Touch, Vols. 1 & 2: Virgil Fox. Music of Bach, Jongen, Franck, Alain, Widor, Dupre, Gigout, and Verne. **Crystal Clear CSS-7001, 7002**, direct to disc, \$15.98 ea.

There is no doubt in this reviewer's mind that these are the most stunning organ recordings ever made. One may take issue with Fox's highly individualistic treatment of Bach, but there can be no doubt that his approach works for the likes of Vierne, Dupre, and others of the French organ school. All too often, that music is given such dull treatment at the hands of players who are content to merely follow the score literally. Fox addresses the organ as a quasi-orchestral instrument with frequent registrational changes and skillful manipulation of the swell boxes. He has more rhythmic drive and control than most organists will ever know, and his only shortcoming in this quarter is the use of excessive *rubati*.

The organ is a large Ruffatti in the Garden Grove, California, Community Church. Like all Ruffattis, the instrument is a bit raw in sound, not too unlike the typical Cavaille-Coll instruments which normally serve the French repertoire. The church, however, has unusual acoustical characteristics. It is not terribly reverberant, but the prevalence of glass renders its reverberation time somewhat longer at high frequencies than would normally be expected. The result is a pleasant warmth, with the harsh edge removed from the instrument. Again, Whyte has chosen a spaced-apart microphone array, and this approach serves both the instrument and the room in the best way.

It is a pity that our spectrum analyzer only goes down to the 25-Hz 1/3-octave band. The peak energy was flat down to that point — and one suspects that important things are

happening even lower than that! A gross visual examination of the disc will give some indication of just how low the information goes. Hold the disc up to a large, flat light source, the sky, for example, and you will see what appear to be herring bone-like *moiré* patterns in sections of the music where there are long, sustained pedal notes. These patterns result from the near-random phase relationships of the lowest frequencies as they are picked up at the microphones. (It's possible via a few simple equations to translate the spacings in these patterns into the actual frequencies present in the recording.)

The sound, from bottom to top, is clean and brilliant without a trace of distortion. The power required to reach realistic levels will probably shock many audiophiles, and if things do not sound right, make sure your cartridge and amplifier are in proper order.

A minor digression. Many reviewers have assailed direct-to-disc recording on the musical grounds that the all-or-nothing aspect of it engenders tentative, over-cautious performances. These records prove the contrary; where the performer is up to the challenge, as Fox certainly is, the excitement is genuinely that of a live, virtuoso performance. What wrong notes are there are minor, and in no way do they intrude on the music during the first or subsequent replays. *John M. Eargle*

Ralph Sauer Plays Music for Trombone by Milhaud, Persichetti, Basset and Pergolesi. With A. deVeritch, vla., R. Leonard, vc., P. Pitman, pf. **Crystal S381**, stereo, \$7.98.

Special-interest recordings are mostly the bane of a reviewer's existence —

not this one. Here is a trombonist who plays for all of us, not just for other trombones and trombone fanatics! And curiously — it always seems to happen this way — the recorded sound of his instrument is musical, modest, and blends beautifully with the other instruments who play along with him. Rare indeed, I say. Moreover, except for the Pergolesi, early 18th century, the music is actually composed for the trombone. Too many specialty records of this sort are arrangements, largely of music that (for us, on the outside) is far better heard in the original format.

Even Pergolesi has his interest here, though the piece is indeed fixed up for the trombone. It is the same work that Stravinsky manhandled into his delightful *Pulcinella* music, which as I remember also includes a very blatty trombone. Arrangements of old music can be wonderful, given the right arranger.

Sound: A- Recording: A- Surfaces: A-

Check Your Sounds, Vol. 2 (Kouichi Sugiyama: Audio Symphony No. 2; Tampopo Mau Koro; Bridge over Troubled Water). NHK Orchestra, Kamatuzu. **RCA RVL-2**, stereo, available through Audio-Technica dealers.

This and its companion Vol. 1 are curiosities in numerous odd ways, combining wildly different techniques, different media and aesthetics, different approaches, for a sort of multi-faceted median — the series is in fact intended as a halfway point between "software and hardware," music and audio, and indeed goes so far in that direction that it is halfway between almost everything, in all sorts of areas.

The (English) booklet asserts that this meeting of hard and soft has not been accomplished before. A slight exaggeration — what have we in recording been doing all these years? — but it is true, I guess, that few large musical works have been deliberately composed for audio testing. Well, that, if I may say, is like the EPA tests. How about the real thing? But maybe this is the crux of the project for you, even so.

No use trying to describe everything — it was an immense project. This is (more or less) classical music and yet also it is big-sound pop, the Western sort that is currently very much Japanese. The recording technique splits the diff too. Umpteen differences. For instance, the main "symphony" orchestra plays in a live "classical" studio but an auxiliary percussion group, more pop-like, plays *simultaneously* in another studio, dead, via TV monitors and phones. The fi in the result is gratifyingly hi, but by no means in the way we currently expect. Where some of our direct-to-disc people use two or maybe three mikes for sound purity, these people had some 40 mikes all going at once, which will shock a lot of us and intrigue even more. Tape? Of course, and strictly analog! The master is 16-track, pop style, and it is mixed down — horrors — to a *second* tape for stereo mastering. You say it is unthinkable; well, they did it. They also added a bit of reverb, too, via — ugh — head-to-head feedback on an Ampex. Strictly analog. And if *that* isn't enough, there was no noise reduction of any sort, Dolby or dbx or other. Better sound, maybe, but —?? And, of course, no limiters, compression and so on — well, we can all go along with that.

The tape (stereo master mixdown) was cut into a French type of lacquer, Pyral, neither too hard nor too soft, as they put it. And the pressing? Oddly, the detailed account stops rather abruptly at this point. Well, after all,

the label does say RCA (though I think the pressing is out of Japan).

The large, illustrated book goes into every detail of all this and much, much more, with tables and charts and directions. The photos are revealing; the pianist at his enormous classical grand (Yamaha, I'll bet) has on phones. Classical phones? So does the lady singer at her solo mike, not to mention various other soloists, in what seem to be semi-isolation booths or alcoves. Yet the string section is strictly classical in the pickup and playing. All very intriguing but the fanciest aspect I have yet to mention, the complete miniature score of the Audio Symphony, every last note, is printed out in parallel columns with the assorted hi-fi comments under the pages. Not simplified — far from it. You must follow no less than 30 simultaneous lines of music, one above the other, from start to finish.

Now there is one little question — *can you?* To a non-score reader, this is a lot of pretention. In 20 seconds you'll be hopelessly lost, and if you try to count time, you won't be able to follow the hi-fi suggestions. I find that previous use of this score printing, in assorted string quartets, Bach concertos, the Complete Bach Cantatas, has been a very helpful device for a musician with some score training. But for others? You can always try. Practice makes perfect.

The Music? Ah, there's the rub. If only the Japanese had an original and native "Western" style, developed over several centuries and more! They don't and who's to complain? So, inevitably, with their incredible industry and ability, they have synthesized a super-Western style that is a mix of everything and everything, neatly homogenized and wholly derivative; there isn't an original note in a million. You'll hear every Western composer you ever knew — classical *and* pop — and only the mixtures themselves are "original" in that nobody in the West

could possibly think them up! Understandable. You just cannot create a new and vital musical style in a few years, anywhere.

The *Audio Symphony No. 2*, thus, is a massively expert semi-modern "Western" piece of incredible virtuosity in the orchestration, but for my ears sterile and boring. You want a bit of pseudo-Debussy, Hindemith, Stravinsky? All there. Frankly the stuff left me chilled, that so much talent and skill should lead to so little of musical interest. Only the slow movement (out of three) seemed to me to have a bit of real merit *as itself*, in a mildly Bartók style. (Bartók did it so much more powerfully, a long time back.)

The two shorter items are frankly big pop, blown up and slick. The lady croons a ballad, very prettily. Paul Simon's *Bridge* is made into one of those pseudo piano concertos à la Liberace or Montovani. Give me Simon in the original — now *there's* a man who says a lot with a little, and not even in my own field. One unexpected oddity — the obligatory piano cadenza is suddenly Beethoven, for quite a long passage, before sliding back into semi-Simon. Fun. (Simon, in fact, often does quote classical music though many listeners don't know it.) So now you can decide for yourself.

Sound: A Recording: A- Surfaces: A-

109

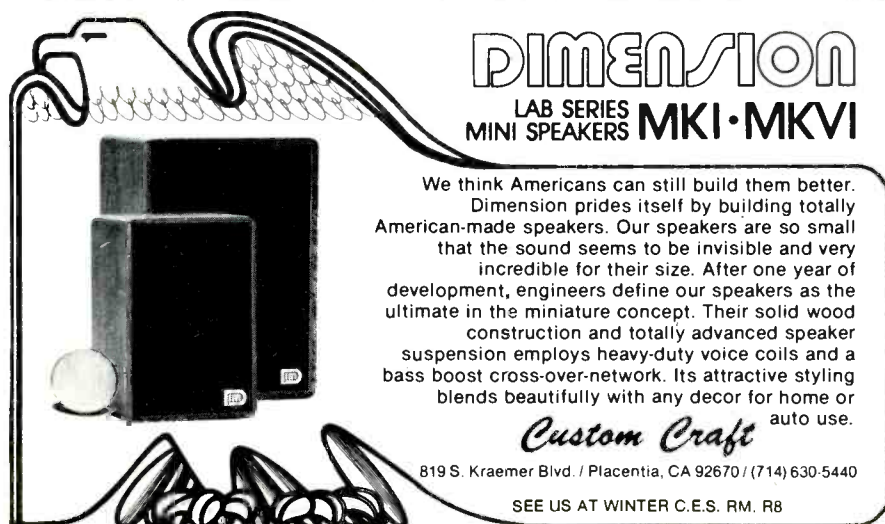

DIMENSION
LAB SERIES
MINI SPEAKERS MKI • MKVI

We think Americans can still build them better. Dimension prides itself by building totally American-made speakers. Our speakers are so small that the sound seems to be invisible and very incredible for their size. After one year of development, engineers define our speakers as the ultimate in the miniature concept. Their solid wood construction and totally advanced speaker suspension employs heavy-duty voice coils and a bass boost cross-over-network. Its attractive styling blends beautifully with any decor for home or auto use.

Custom Craft

819 S. Kraemer Blvd. / Placentia, CA 92670 / (714) 630-5440

SEE US AT WINTER C.E.S. RM. 8R

Enter No. 8 on Reader Service Card



AM Comes Alive

The McKay Dymek DA 5 shielded ferrite loop AM antenna has a solid state preamp with tuning and sensitivity controls.

Overcomes the two most common AM reception problems: strong local stations "hiding" weaker distant stations close on the dial, and interference from TV and electrical sources.

Improves inherent long range capabilities of AM — programs listenable from over a thousand miles.

Increases signal strength 4 to 8 times — really sharpens up AM performance in typical hi-fi receivers and tuners.

Factory direct, 20-day money back guarantee. Exclusive rent/own plan available. For more information call toll free:

Nationwide 800/854-7769
California 800/472-1783



MK McKay Dymek Co.
111 South College Ave.
P.O. Box 5000
Claremont, CA 91711

Enter No. 57 on Reader Service Card

The column

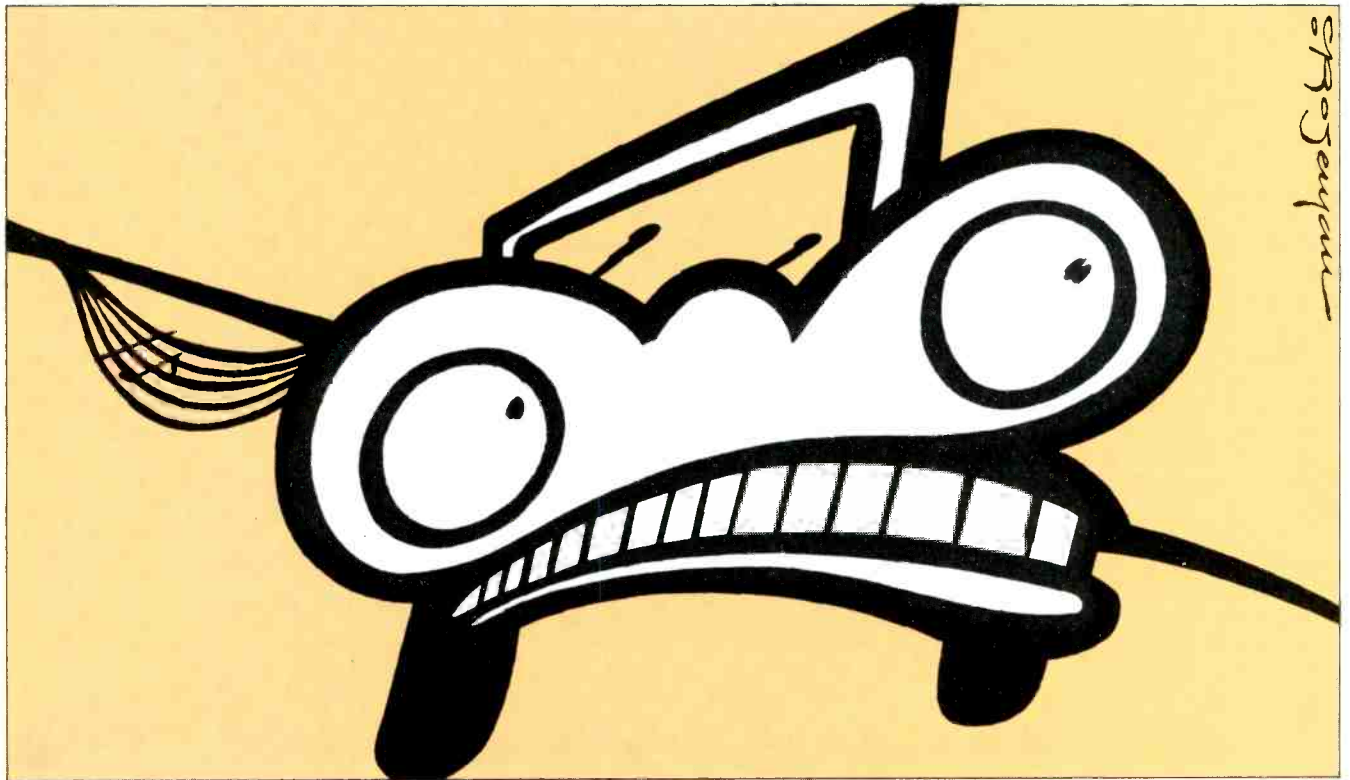

110

The Cars

Elektra 6E-135, stereo, \$7.98.

The Cars (from Boston) may not look like the most exciting thing to hit pop music in the past three minutes, but that's why they put an amusing picture of a cute girl on the cover of their record. It's unfortunate that they had to put a picture of the group anywhere on the cover because their music, which is both attractive and unique, suggest a much snazzier appearance than they actually show. In fact, despite a slightly pretentious edge to their sound (courtesy Roy Thomas Baker, famed for extravaganzas with Queen/Journey/Be-Bop Deluxe) this band's got a straight-ahead approach that puts most so-called metal rockers to shame. Then again, their artistic approach is not to be faulted; early reviews compared lead singer Ric Ocasek to noted intellectual Bryan Ferry, and to my ears the comparison is valid (then again, he doesn't sound totally unlike Mick Jagger). Without being overly mannered or relying solely on brute force, The Cars

have managed to put together a stunning debut album that seems to have a well-rounded appeal.

Not that it's without faults, as producer Roy Thomas Baker (who is extraordinarily talented) seems determined to put his stamp of multiple overdubbed backing vocals way up front instead of referring to his early work with the simplistic but brilliant Free. One would have liked to hear a bit more of guitarist Elliot Easton (who puts out a splendid performance on the album's finest track, *My Best Friend's Girl*) and slightly less of keyboardist Greg Hawkes. Not all of the songs are wonderful, but most of them have something going for them, although I would have liked to guess the lyrics rather than have them printed up for all the world to see. These are minor quibbles, however, since the band is surely a major find for music fans and I highly recommend you pick their album up.

J.T.

Performance: B

Sound: A-

Shots From A Cold Nightmare: Moon Martin

Capitol SW-11787, stereo, \$7.98.

If you've been fortunate enough to hear either of Mink DeVille's two albums or desperate enough to purchase Michelle Phillips last studio outing, the songs of John Moon Martin shouldn't be totally unfamiliar to you. His *Cadillac Walk* was one of the more popular staples of Mink's repertoire, and if you've got a memory for insignificant details, you might recall that sometime around the turn of the decade Mr. Martin was playing with an undistinguished group called Southwind. Southwind rarely gave J.M.M. the chance to sing lead or write songs, so for most of the world, this is his debut, and the guy's got a running start on the wrong foot. **Shots From A Cold Nightmare** passes the test for song demos, but as an artist he's got a long way to go.

First, he's got to find his voice. Martin seems to have left all gusto at home, singing with the spontaneity of Jim Croce's corpse. Perhaps he forgot

to wake up for the sessions, fell victim to the West Coast's idiosyncratic laid-backness, or simply was ingesting the wrong mind-altering substances at the time. Whatever the case, he should either learn how to properly deliver a tune like *Victim of Romance*, *She's A Pretender*, and *Paid Killer* or find someone else to be his frontman. There's no pizzazz in the whole affair, and the fault is not in the songs, for a change.

To my dismay the players he's got backing him sound like a British singles band who also left their verve at home. Fault can easily be placed with the producer, whose lack of expertise and insight ruined many a previous record; the bassist and drummer have graced several records in the past, some of which are suite enjoyable and none of which are as diabolically limp as this number.

There's no getting away from the fact that John Moon Martin is a very talented rock songwriter, but the day is yet to come when he distinguishes himself as an artist. Maybe he should have a talk with Carole King J.T.

Sound: F Performance: C+

The Path: Ralph MacDonald
Marlin 2210, stereo, \$7.98.

Ralph MacDonald is a superb and imaginative percussionist whom I first heard playing with Harry Belafonte some years back. **The Path** is his second album as a leader, and actually it is almost two distinct albums in one.

Side One is the side-long suite that bears the album's name. It is an odyssey of percussion, opening with a recitative and chorale over a hypnotic and captivating African drum bed. Along the way the theme picks up a West Indian steel band and finally a cracker-jack New York rhythm and horn section from which Bob James contributes a surprisingly inventive synthesizer solo. The side is brilliantly recorded with the exotic drum sounds as lively and close as you could want them. *The Path* is thoroughly delightful and absorbing, one of the year's best performances.

Side Two contains music that falls into the realm of pop jazz, not very filling but very well played. With soloists the caliber of Grover Washington and Toots Thielemans, you've got to have good playing. Ultimately, I find myself repeatedly bypassing this side for the other.

Sound: A Performance: B+

Approved By: The Motors
Virgin JZ 35348, stereo, \$7.98.

If The Motors are punk, then Billy Joel has joined the Sex Pistols and James Taylor's next album features Richard Hell and Rat Scabies backing him up on a forty-minute version of *96 Tears*. The group is more pop than power, utilizing every gimmick known to modern man in order to compensate for rather undistinguished vocal talents. They write pleasant songs, they know how to use rhythm in a way that refuses to let the listener go and they've copped every Beatlesque production lick from guitar sounds to use of piano. I liked all this stuff the first time around, and I can't say that I much mind it again (especially as Epic Records isn't particularly well-known for releasing music in this genre), but I can't honestly say that the album's existence is going to make one bit of difference unless they have a hit single.

If Epic Records is worth anything, they should be able to get at least one top-40 seven-incher out of **Approved By**, but as they already blew their chance with *Airport I* doubt that they'll do any better with *Forget About You* (a song with a hook stolen from Sixties top-10 song, usually a guarantee of chart success), *Soul Redeemer* (easily as saccharin as most hits), or *Breathless* (which sounds almost identical to their first album's *Dancin' the Night Away*, a track that did well on the FM waves but never made it to AM). What the Motors are trying to do is not dissimilar to what 10 cc, the Electric Light Orchestra, and Badfinger attempted to get across; they don't have as readily identifiable lead voices, but they aim at a little lower intellect. These limeys have every lyrical cliché and corny riff memorized and manage to regurgitate most of them in a manner which is far more acceptable to "progressive rock" fans than the Monkees or the Foundations ever could be.

It's not bad. In fact if you listen to it one track at a time, it can impress and soothe all your friends who hate New Wave, pub-rock, or whatever is the trend this week. Buy it if you so desire, but certainly not before you've purchased **The White Album** by The Beatles, a complete set of Badfinger LPs, and whatever records are currently in print by the Idle Race — this may be new but not necessarily superior to the originals. I wish this was **Improved By The Motors**, but unfortunately they're looking for approval rather than progress.

Sound: B Performance: B

BGW COMPONENTS: The "Art-of-The-States"

Foreign components dominate the consumer hi-fi marketplace. But when you walk into a pro-recording studio and take a look through the double-glass window, it's mainly American gear you see. And, when it comes to the amplifiers that drive the monitors and musicians' headphones, that usually means BGV.

The matching Model 210 Power Amplifier and the Model 103 Pre-amplifier share this professional heritage. Both have performance and features that define the standards of component audio. Write us or contact your franchised BGV dealer for full technical and feature information.

Get Behind the BGV "Art-of-The-States" Components. The pros already have.



BGW Systems, Inc.
13130 South Yukon Avenue, Hawthorne, California 90250
In Canada: Omnimedia Corp., 9653, Cote de Liesse, Dorval, Quebec H9P 1A3

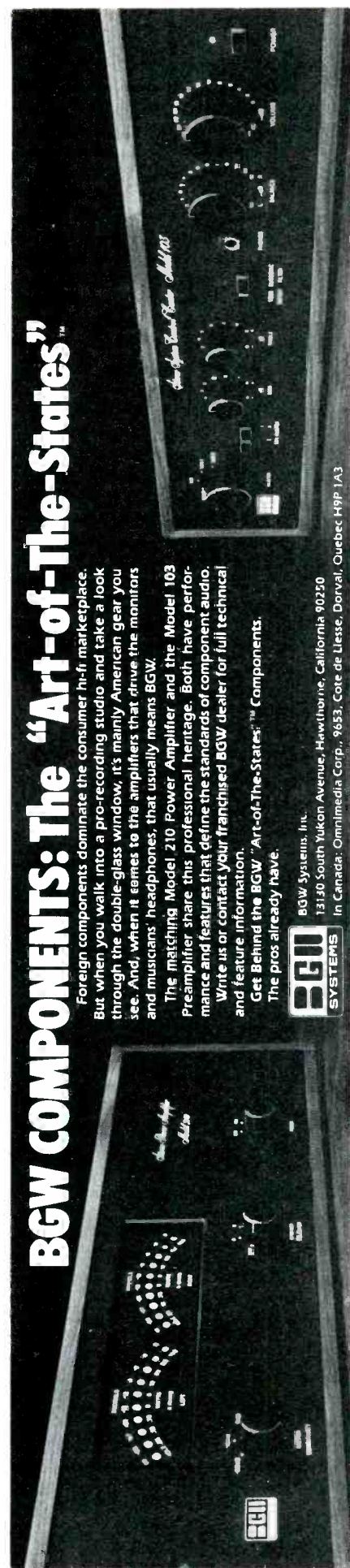

Enter No. 5 on Reader Service Card

Blue Jug

Ariola SW-50028, stereo, \$7.98.

Blue Jug plays Eagle-ized music with spirit. What raises them above the mediocre is their enthusiastic playing and some good tunes. *Memories Are Hard to Come By* is an obvious winner. Their version of Creedence Clearwater's *Lodi* is equally a gas. Sure, sparkly sound helps. M.T.

Performance: B

Sound: B

You're Not Alone: Roy Buchanan
Atlantic SD 19170, stereo, \$7.98.

Loading Zone: Roy Buchanan
Atlantic SD 18129, stereo, \$7.98.

Roy Buchanan is a classic case of a guitarist's guitarist. His prowess is undeniable, but his records have rarely revealed any more than the briefest flashes hidden by the gauze of poor material and uninspired backing.

His two most recent albums go a long way toward correcting the situation. Stanley Clarke produced last year's **Loading Zone**. For that album the number of tracks with vocals was reduced to three from eight, leaving more room for Roy's guitar.

The new album, **You're Not Alone**, opens it up wider yet. Producer Raymond Silva has stripped the band



down to a lean, powerful quartet of Buchanan, rhythm guitarist Ray Gomez who is the only holdover from **Loading Zone**, and the mighty rhythm section of Willie Weeks and Andy Newmark. For the most part the album is a cooker. Following a spacy opening bit is a top track, a hot version of Joe Walsh's *Turn to Stone*. The album's other cover is the only vocal track, a somewhat needless run-through of

Down by the River that is nonetheless convincingly delivered.

Both sets have professional sound and presence and, most important, more of Roy Buchanan's amazing guitar, which after all is his drawing card. He has always been a great player, and it is way overdue for his records to show it. M.T.

Sound: B

Performance: B

CORELLI, CALINDA AND CANTATA

Each of these popular loudspeakers is an excellent example of the KEF total system design approach, whereby the drive units, the cabinets and the electronic circuits are developed together, using the computerised digital analysis techniques which KEF pioneered. The Corelli, designed for shelf mounting, offers remarkable bass performance and surprisingly high power handling from such a compact system. The Calinda and Cantata are tall, elegant floor-standing loudspeakers with a special arrangement of the drive units which give a truer frequency response, greater clarity and a sharper stereo image than any previous speakers of comparable size.

And because we make all our own drive units, we can offer a consistency in manufacture and performance which is unrivalled in the Hi-Fi industry.

Write for literature and the name of your nearest dealer.

KEF Electronics Ltd., US Distributors Intratec,
PO Box 17414, Dulles International Airport,
Washington DC 20041.

KEF 
The Speaker Engineers

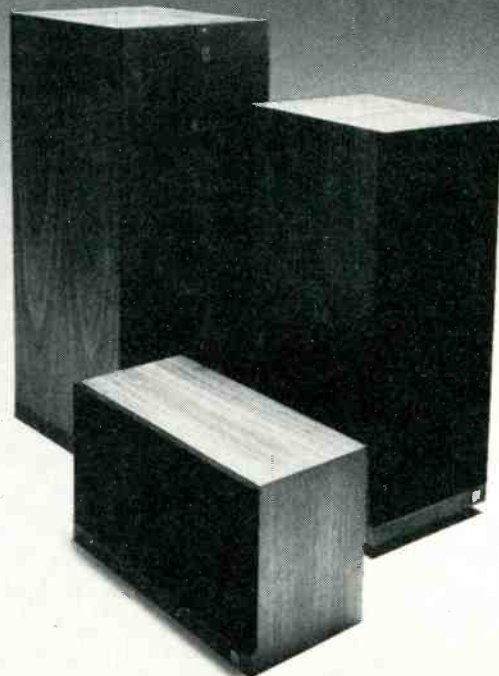

Enter No. 18 on Reader Service Card

Deep in the Night: Etta James
Warner Brothers BSK 3156, stereo,
 \$7.98.

Motion: Allen Toussaint
Warner Brothers BSK 3142, stereo,
 \$7.98.

Classy albums both, but each with a disappointing introspective quality. Jerry Wexler produced both these albums with West Coast session men backing. Etta James' album has some inspired song choices that nearly work. Alice Cooper's *Only Women Bleed* comes real close, and while Kiki Dee's *Sugar on the Floor*, is a difficult song at best, here it's a mismatch. What works best is what is closest to home for both James and Wexler, *Piece of My Heart* modeled after Irma Franklin's original, Bobby "Blue" Bland's *Blind Girl*, and Toussaint's *Sweet Touch of Love*.

Allen Toussaint has always been a shy performer. He plainly is more interested in producing others, and when he has produced himself, he mixes his voice way down. Finally he has turned to an outside ear in Wexler to make the record happen, but alas Toussaint is still a reticent lead voice who has yet to make the record he is so obviously capable of . . . even though he is one of the very best song writers today. *Night People* is as persuasive a song as the Bee Gees *Satur-*

day Night Fever. *With You in Mind* is a gorgeous ballad. I have no doubt that Toussaint will make that killer album someday. He is too good not to. But **Motion** just isn't it. M.T.
James

Sound: B- Performance: C+

Toussaint

Sound: C+ Performance: C+

Voyager: Dexter Wansel
Philadelphia International JZ 34985, stereo, \$7.98.

Since 1975 Dexter Wansel has been a writer, producer and arranger with Gamble, Huff, and Bell, the nucleus of Philadelphia International Records, an organization that has been heralded for its perspective and accomplished treatment of the funk genre. Wansel's third Philadelphia International album, again proves that the organization and the artist have both talent and taste.

Voyager vacillates between disco and jazz, often combining the two. The single most outstanding cut is a song called *Solutions* on which a radio newscaster reports the world's problems from Ireland to South Africa. The

broadcast is interspersed between passages of captivating, rhythmic music. It's difficult to not dance to the music or to be touched by the reality of the lyric.

All of the music is excellent. The album is economical, nary an extraneous syllable or note. **Voyager** travels from earthy disco all the way to synthesizer-infused space-funk.

But Wansel is no ordinary funkmaster. His innovative jazz-funk fusion is well established, and this album further proves the expansive nature of his talents. He wrote all the material, arranged it, produced it, sang all lead vocals, and played pianos, synthesizers, guitar, and percussion. The other musicians are a who's who of Philadelphia players.

Especially outstanding is George Howard whose saxophones punctuate several tunes including the title cut and *Time Is The Teacher*.

Voyager was recorded at Sigma Sound and engineered by Joe Tarsia, Jay Mark, and Jim Gallagher whose reputations precede them and, needless to say, who do an excellent job here.

Dexter Wansel's new album is spacy and spicy and funky and fine, and well worth a good listen. *Janet Melaragni:*

Sound:A Performance:B+

Pair up for perfect reproduction

With Osawa's Dynamic Duos

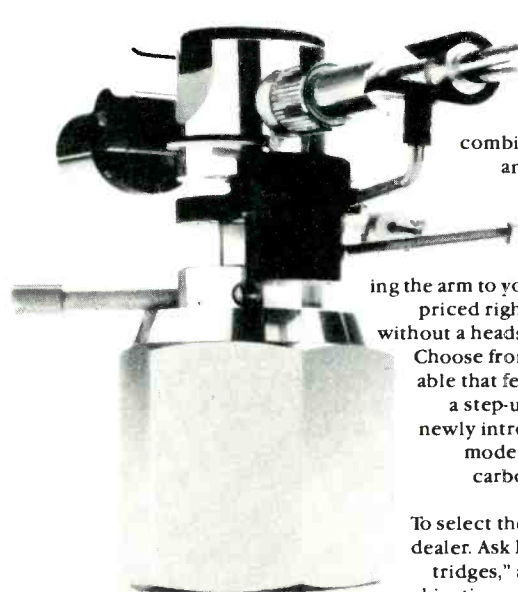
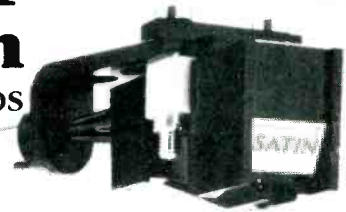

Advanced electronics are just not enough. For the most realistic music reproduction you need a high performance tonearm/cartridge combination to ensure smooth, wide frequency response and highly accurate tracking. The kind of top-quality performance that the **Osawa** duos deliver.

Start with the **Ultracraft AC-300 MK-II** tonearm that features adjustable oil damping. This eliminates resonances by fine tuning the arm to your cartridge. Then select the **Osawa** cartridge that's priced right for you. You can mount it directly on the tonearm without a headshell, thus reducing effective mass to the minimum. Choose from 4 **Satin Moving Coil** models, the only MCs available that feature user-replaceable stylus and that don't require a step-up transformer or pre-preamp. Or choose one of the newly introduced high-compliance **Moving Permalloy (MP)** models by **Osawa**. Top-of-the-line 300 MP offers a unique carbon-fiber cantilever that is extremely lightweight yet extraordinarily strong.

To select the combination that's ideal for you, visit your **Osawa** dealer. Ask him for the **Osawa** "Consumer Guide to Phono Cartridges," and then get a complete demonstration. Whichever combination you select, the name **Osawa** assures you the ultimate in clean and faithful music reproduction.



OSAWA & CO. (USA) Inc./521 Fifth Avenue, New York, N.Y. 10017/Tel. (212) 687-5535-9/TELEX: 23-6593

Enter No. 26 on Reader Service Card

The Audio Critic reports a small breakthrough.

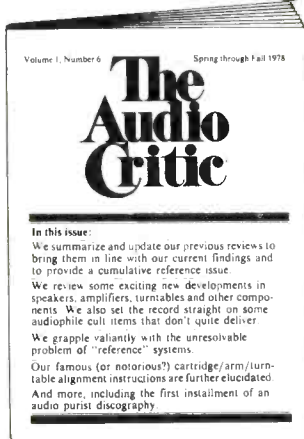

Since there exists a great deal more mediocrity than excellence in high-end audio, the test reports in *The Audio Critic* are more often on the negative than on the positive side and very rarely enthusiastic. That's why the latest issue (Volume 1, Number 6) is special; it hails quite a few impressive new advancements in equipment design.

Specifically we review new developments in speakers, amplifiers, phono systems and peripheral equipment, the sum total of which is greater clarity and definition in sound reproduction than has been obtainable until now, at any price. In combination, these new components constitute a minor breakthrough in audio performance, well short of a revolution but quite audible nonetheless. In this same issue we also summarize and update our previous reviews for the benefit of new subscribers.

As most of you must have heard by now, *The Audio Critic* is the purist's audio review, containing no advertising by either manufacturers or dealers and dedicated to in-depth testing both in the laboratory and in the listening room. Our laboratory is a superbly equipped in-house facility (we don't hire commercial labs to do our testing), and our listening criteria are merciless.

The subscription cost of six consecutive issues (indexed as one volume) is \$30, by first-class mail only. (No Canadian dollars, please!) For overseas airmail, add \$6. No single copies are sold for any reason whatsoever, but the unused portion of canceled subscriptions is refundable on request.

You'll probably want to start with the new reference issue (Volume 1, Number 6); however, you may also be interested in the still current Volume 1, Numbers 4 and 5, which cover certain subjects in greater detail (such as our widely discussed cartridge/arm alignment instructions). Of course, you'll get six consecutive issues no matter which one you start with. Just specify your choice when you subscribe.

Send \$30 for your first six issues today to *The Audio Critic*, Box 392, Bronxville, New York 10708.

Snakebite: David Coverdale's Whitesnake
United Artists UA-LA915H, stereo,
\$7.98.

Champion
Epic 35438, stereo, \$7.98.

It's old home week here, where members of such illustrious dinosaurs as Deep Purple, Humble Pie, The Grease Band, Wings, Rough Diamond, and the Jeff Beck Group have all gathered together to consolidate forces. Now that New Wave has been given the Kiss of Death, the minor league non-stars of yesteryear have come back to haunt us and see if maybe they'll have their day. David Coverdale's project has turned out far better than anyone might have suspected, while the "supergroup" Champion proves that adage about once a loser, always a loser.

Coverdale's Deep Purple days saw him as a stand-in for Paul Rodgers (who turned down the gig), but since that stint, he's matured a great deal and started to discover a voice all his own. One must forgive David for his errant ways, as he was but a mere tot when he joined Purple and hardly in a position to determine musical direction; with Whitesnake, as the group leader, we have an entirely different story. He's slanted toward blues and rhythm, although there is no short supply of heavy riffing by guitarists Mick Moody and Bernie Marsden. His band is hard edged and exciting; songs like *Come On*, *Keep On Giving Me Love*, and *Ain't No Love In The Heart of The City* show off his voice in a proper setting.

Champion were doomed from the start — I thought I smelled something rotten when I heard Clem Clempson, Mr. Tasteless, was playing guitar with the band. My hopes perked up for a minute when I saw Geoff Britton's name on the album cover, and after hearing the first track, *Sha La La*, I optimistically foresaw a group that could at least do a fair imitation of Graham Parker & The Rumour. Much to my dismay, the rest of the album finds Champion floundering for direction, searching high and low for a musical style and coming up empty-handed. Gary Bell's lead vocals are passable Graham Parker mimicry but except for one song, they are positively dismal. If they had three decent songs I'd say that it showed promise but was a duff album, but with only a single track worth hearing more than once. *J. T.*

Coverdale

Sound: B Performance: B+

Champion

Sound: B Performance: F+



Hermit of Mink Hollow: Todd Rundgren

Bearsville BRK 6981, stereo, \$7.98.

A friend, a Rundgren freak, remarked to me about **Hermit of Mink Hollow** that the fewer sidemen Todd uses, the better his work. Also the fewer others, the denser the finished product. Both statements are true here. Todd has again recorded a solo album totally through the magic of studio overdubs playing all instruments and singing all voices himself. And **Hermit** is the best Rundgren in ages, at least since **Something/Anything**, the last time Todd went this solo route.

On **Hermit** Todd has returned to the beautifully crafted melodies that marked his early work. The album rings from the opening of *All the Children Sing* through what he calls *The Easy Side* all the way through the flip *Difficult Side*. Besides melody, the songs have points, social commentary. *Bag Lady* is a powerful portrait. The anthemic *All the Children Sing* is a joy. Other songs lapse occasionally into cutesy-poo, *Onomatopoeia* for instance.

Producer, musician, singer, writer, engineer, and more, Todd Rundgren can be justly proud of **Hermit of Mink Hollow**. *M.T.*

Sound: A

Performance: B+

Watch: Manfred Mann's Earth Band.
Warner Bros. BSK 3157, stereo, \$7.98.

Manfred Mann and his Earth Band tend to run hot and cold. **Watch** does neither, aiming for a middle ground,

but still it's kind of perky and fun, if tepid. There's a new live recording of an old hit *The Mighty Quinn* updated to the current band's style. The album's other nonoriginal cuts are *Davey's on the Road Again* and *Martha's Madman*, both fine, obscure tunes ideal for the Mann concept. **Watch's** freshly generated material is all on side one, standard stuff with a chipper sameness to it.

After a couple of hit singles in a row, it isn't surprising that Manfred Mann would direct his Earth band down the same path, and he has done this well for **Watch** is one of his better efforts. However unsurprising the album may be, it at least adds strong playing and enthusiasm to the formula. M.T.

Sound: B Performance: B

Birchfield Nines: Michael Franks
Warner Brothers BSK 3167, stereo, \$7.98.

Michael Franks is the late 70s Mr. Cool. His soft, breathy voice, a ticklish Mose Allison sounding instrument, is matched to sophisticated, witty songs with delightful results. He sings of perfect shampoos, babies eating and throwing food, wrestling live nude girls, and Vivaldi. **Birchfield Nines** is this Californian's first New York recording with Big Apple sidemen. Not surprisingly, it is still delicately jazzy, though it has a bit more kick than Michael's records have had before.

Wry humor, smart playing, and considered production combine for a heady album of light, fun-yet-durable music. M.T.

Sound: B- Performance: B

Aliens: Horslips
DJM DJLPA-16, stereo, \$7.98.

More than ever before, Horslips emulates the sound of Jethro Tull on **Aliens**, and that ain't so bad. The flute sound and jig-like melodies are the keys. It is a spritely, even charming, album.

Horslips has always used their native Irish traditional music for melodic underpinning and conceptual inspiration, and this element gives them their magical lilt. On **Aliens** the connections are more tenuous and implied than before, but the magic is intact.

The album relates the journey of Irish immigrants to New York City and a new life. Their restlessness and yearning thematically tie the album together.

Destiny was kind to the immigrants and if right be done, it should be no less so to Horslips. M.T.

Sound: B+ Performance: B+

AUDIO • January 1979

Q • How close can hi-fi get to an authentic musical experience?

A • Slip on new Audio-Technica Stereophones and hear for yourself.

If you want to find out how good the new Audio-Technica Stereophones really are, don't just compare them with other headphones. Put them up against the very finest *speaker* systems. But don't just listen to the equipment. Listen to the *music*. And be ready for a surprise!

Judged on the basis of flatness of response, freedom from distortion, transient response, sensitivity, and independence from room acoustics, these new dynamic and electret condenser models are perceptibly better sounding than speaker systems costing hundreds of dollars more.

And if you think that great performance can only come from heavy, bulky stereophones, get ready for another surprise. Our heaviest model is less than 7½ ozs. and our lightest is an incredible 4¾ ounces light. Comfort that lasts an entire opera if you wish.

For all the facts, send for our catalog. But for the revealing truth about stereophone performance, listen and compare at your nearby Audio-Technica showroom. It will be a great *musical* experience.



Model ATH-7
 Our finest Electret Condenser with LED peak level indicators
 \$149.95

Model ATH-1
 The moving coil dynamic stereophone that weighs just 4¾ oz.
 \$29.95



audio-technica
 INNOVATION □ PRECISION □ INTEGRITY

AUDIO-TECHNICA U.S., INC., Dept. 19A-2, 33 Shiawassee Avenue, Fairlawn, Ohio 44313
 Available in Canada from Superior Electronics

Jazz & blues

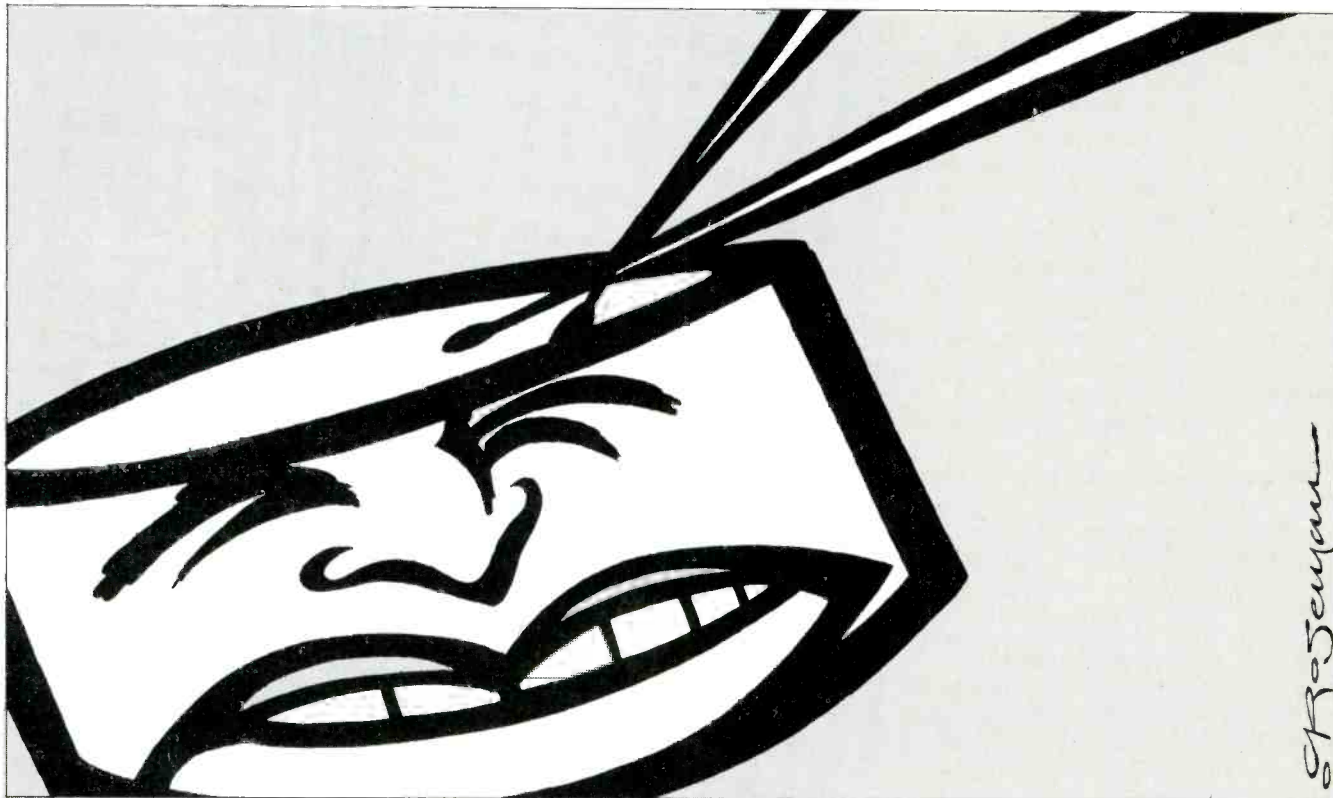

116

Plays & Plays & Plays: Buddy Rich
RCA CPL 2273, stereo, \$7.98.

Class of '78: Buddy Rich

Great American Gramophone 1030,
stereo, \$14.95.

Buddy Rich is one of the greatest of big band drummers—I don't think you'll find many who will disagree with that statement. At 60-going-on-61, it is incredible that Rich's playing has lost none of its strength and intensity. As a matter of fact, his attack now seems more virile and supercharged than in the heyday of the big bands, when he played with Artie Shaw, Tommy Dorsey, and Harry James. Yet the contemporary music produced by Rich's big bands in the past decade and a half has none of the characteristics that gave his swing bands a measure of authentic greatness. These two recent Rich LPs lack the easy-going ebullience of Shaw's big band music, the warmth and mellowness of Tommy Dorsey's, or the distinction of Harry James.

Rich has stated over and over again how he hates nostalgia, and how he is not going to rewarm Swing Era standards. Deliberately turning his back on his Swing Era roots, he has, on all of

his recent recordings, made strenuous efforts to come to terms with the music, rhythm, and sounds preferred by today's young people. But much as he may put down some of the swing band leaders and their music, Rich's big band, unlike that of Glenn Miller, Harry James, Tommy Dorsey, or Artie Shaw, has never come up with arrangements sufficiently original to give his contemporary ensembles a character of their own. His recordings, including these two releases, sound as if they were played by a powerful, impeccably rehearsed group of studio pros.

Of the two albums, I prefer RCA's **Plays & Plays & Plays**; there is a furious unrelenting drive to numbers like *You Gotta Try*, *Tales of Rhoda Rat*, and *No Jive*; solos are glib, virtuosic, with Steve Marcus' tenor sax choruses careening along with a slashing, cutting power. Marcus on *Round Midnight* proves he is an outstanding contemporary jazz soloist, as he heats up Monk's angular melodic lines with a volatile, passionate solo. The Monk tune is provided with a lustrous arrangement by Dick Leib who is not adverse to using the soprano sax lead voicing that was a

trademark of Charlie Barnet's beautifully scored sax sections of yesteryear. Billy Strayhorn's *Lush Life*, the only other ballad in the album, is enhanced by a fine Phil Wilson arrangement that stresses tonal elegance. (Too bad that Rich doesn't feature more music with the easy, coasting mid-tempos of the Swing Era bands; he seems to favor the frantic and strident.) A number called *Party Time* is a dull, shuffle-rhythm tune that features tenor man Robert Mintzer in an abrasive, squeaking solo; something called *King Kong* is pseudo-rock nonsense, with Rich's band trying to sound like Rufus with Chaka Khan (complete with a dreadful "soul" singing group giving out with shrieking falsettos in the background). Rich doesn't have to play this type of garbage; he has impressed the younger generation with his virtuosity, vitality, and impeccable musicianship.

Buddy Rich, **Class of '78**, the Great American Gramophone direct disc, takes an unrelenting, hyper approach to a series of modern and contemporary jazz tunes—Joe Zawinul's *Birdland*, which he created for his Weather Report repertoire, not surprisingly emphasizes electronic textures with some

intense squealing from tenor man Marcus. The Rich band also slams its way through Bud Powell's *Bouncin' with Bud*, Horace Silver's *Cape Verde Blues*, Chick Corea's *Fiesta*, and an original called *Funk Ola*. Rich is a powerful force up in the drummer's seat, his pulsing, rhythmic drive propels his 14 musicians as they punch out crisp, cohesive ensembles and broil along at a dizzying pace with tense, hard-edged solos.

Hard-charging is, perhaps, the best way to describe Rich's current big band sounds, and, after listening to these two releases, I felt like I had been through a weeklong practice session with the Dallas Cowboys. The sonic quality of both these recordings is excellent—the RCA LP has the full-bodied clarity one has come to expect from RCA, and the direct-disc process is attractively utilized on the Great American Gramophone collection—the electricity of the Rich band really jumps direct to disc with the full presence of Rich's cymbals and Marcus' searing, soaring sax vividly showcased.

John Lissner

Plays & Plays & Plays

Sound: B Performance: B+

Class of '78

Sound: A+ Performance: B+

Fat Girl: Fats Navarro

Savoy SJL 2216, mono, \$7.98

Prime Source: Fats Navarro

Blue Note NB LA 507-H2, mono, \$7.98

Fats Navarro, wide of girth with a high-pitched voice (hence the **Fat Girl** title of the Savoy album), was a bop trumpet player with a brassy, fluent sound, one of the most exciting musicians to come out of the be-bop movement, and the only trumpet player from early bop days considered a match for Dizzy Gillespie. Indeed, although his recording career was sparse, reissues like the Savoy and Blue Note double discs indicate that his dazzling technique could even exceed Dizzy's.

His incredibly clean articulation, stamina, accuracy, and wealth of ideas, set him apart from most of the frenetic be-bop trumpet players attempting to mimic Gillespie. That his playing was less flamboyant than most of his fellow boppers, that he emphasized purity of tone and melodic conception, is no doubt due to his starting from a swing era base, as a trumpet player with the Snookum Russell and Andy Kirk bands. On the Savoy reissue, made up of a number of 78-rpm, 1946-47 dates with Navarro in a sideman

role, the 21-year-old trumpet player holds his own with such formidable talents as saxophonists Dexter Gordon and Sonny Stitt. Selections like *Fat Girl*, *Be Bop Carol*, and *Tadd Walk* are bop/jump numbers delivered by the soloists and ensembles in short, taut bursts. Over the fast, surging be-bop beat, Navarro is mercurially inventive, delivering brilliant improvisations, evolving complex solo lines that move unerringly over his instrument's entire register. **Prime Source**, the Blue Note set, contains just about all the material he recorded for that independent jazz label. On such numbers as *Ice Freezes Red* and *Double Talk* (where he's teamed with another talented bop trumpet player, Howard McGhee), Navarro's biting attack and skillful dynamics help create the kind of bristling excitement and emotional power associated with great jazz musicians. His playing on a 1949 Bud Powell Blue Note date is documented with four brilliant pieces — *Wail*, *Bouncing With Bud*, *52nd St.*, and *Dance of the Infidels*; here the agility and ebullience of his well-turned trumpet phrases stokes the five already sparked by Powell and by young tenor man Sonny Rollins.

Navarro came to a premature end at age 26; had he lived and continued to develop, his admirers believe he would be bracketed with such trumpet geniuses as Armstrong, Gillespie, and Eldridge. If you are a buff of jazz's be-bop period, these recordings are recommended. Arista, which now owns the Savoy catalog, has done an admirable job of cleaning up the sometimes muddy sound of the original 78s; Jerry Valburn and Jack Towers did the fine transfer and editing job. The Blue Note set preserves the clarity and resonance of the original 10-inch mono LPs and has a consistently good sound level.

John Lissner

Fat Girl

Sound B+ Performance: A

Prime Source

Sound: A- Performance: A+

Developing an American Orchestra 1923-37: Fletcher Henderson
Smithsonian Collection R 006, mono, \$6.98

Fletcher Henderson, whose music launched the Swing Era by way of Benny Goodman, never fully shared in the commercial rewards of that resonant period when jazz musicians were being rewarded as popular entertainers. Henderson's was, of course, the

MEET



Now you don't want to make



MAD!

For complete details on how not to make



MAD!

SEE YOUR SUMO DEALER.

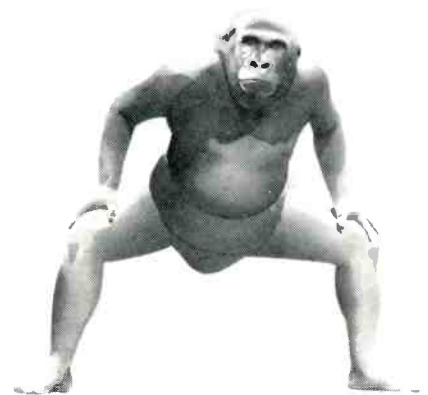

SUTO
SUMO ELECTRIC COMPANY LIMITED
1230 N. HORN AVE., W. HOLLYWOOD, CA. 90069
213-659-4370

ground-breaking band, establishing the Swing Era format — choirs of brass phrased against reed ensembles, with open spaces for hot-jazz solos, the band playing a surging four beats to the bar. This classic fusion of arranged section work with solos was achieved by Henderson and his chief arranger Don Redmen and brought to fruition by the Henderson band in the early 30s.

It is said, what distinguished Henderson's band from the white swing orchestras that followed was that it played his arrangements mainly as vehicles to launch the jazz soloists, while a Goodman or Shaw thought of the swing arrangements in terms of overall ensemble execution.

The Smithsonian has put together an excellent chronological history of the Henderson band, starting in 1923 and going to 1937. In the band's formative years, from about 1923-27, ensemble execution was not one of its strong points, but there is a rhythmic intensity, energy, and enthusiasm that offsets the band's raggedness and outright clumsiness. As the years advance, the album reveals an increasing improvement in overall technical skill and polish. By 1936-37, Henderson had a brief moment of Swing Era glory and was recording hits that have become classics such as *Christopher Columbus* and *Stealin' Apples* (both arrangements also became big numbers for Benny Goodman.) These arrangements were by brother Horace Henderson, and they have the sleekness and clarity of a Benny Goodman performance. In terms of solo talent, neither Goodman's nor any white band could match Henderson's — he was knee deep in tremendous jazz players; there were outstanding soloists in every section.

One of the most interesting points to note in this Smithsonian album is how Henderson slowly built his sonorities over the years. The earliest tune, *Dirty Blues*, recorded in 1923, has an instrumentation of two saxes, one trumpet, one trombone, and rhythm (piano and banjo). Devices like clarinet trios were added as time went by until his 1937 recording of *Sing You Sinners* boasts five saxes, three trumpets, three trombones, and rhythm (piano, guitar, bass, and drums).

The Smithsonian has, as usual, done an impeccable sound transfer job. Records on the Smithsonian label are only available by mail. Write Smithsonian Customer Services, P.O. Box 10230, Des Moines, Iowa 50336.

John Lissner

Sound: A- Performance: A-



Carter, Gillespie, Inc.: Benny Carter & Dizzy Gillespie
Pablo 2310-781, stereo, \$6.98.

Absolutely super. Norman Granz issues a lot of records on Pablo, maintaining a consistently high level of accomplishment, and this pairing of Carter and Gillespie is one of his finest ever.

The blending of the swing alto saxist and the bop trumpeter is an inspiration. The collaboration is remarkably successful, resulting in a beautifully balanced production recorded by Grant in RCA's Los Angeles studios.

From the first note of the first cut, *Sweet and Lovely*, you know you are hearing something special. *Sweet & Lovely* is taken at an elegant samba tempo with Diz varying his attack neatly with both muted and open horn, and Carter offering suave and stylish responses. *Broadway*, the Basie Swing Era opus, canters along in solid 4/4 as Diz and Carter jump in with driving choruses and end with a tricky unison-voiced coda. *Courtship* is an attractive original by Carter that features his luxuriant alto, which makes for a neat contrast with Gillespie's swoops and dives.

Nobody Knows the Trouble I've Seen is the only weak cut here as it features drummer Mickey Roker's simply awful singing. *Night in Tunisia* makes up for this lapse, as this is a fresh, pungent version of Gillespie's jazz standard, and it's fascinating to note how swing giant Carter interprets the bop classic, moving through the changes with complete ease and authority. At 67, Carter remains a master with total command of the jazz idiom, having lost nothing over the years. His articulation, clear, penetrating tone, and swinging attack bear repeated listening.

The interaction of these two giants is fascinating to hear. Mention should also be made of guitarist Joe Pass who has some nice moments on *Broadway and Sweet and Lovely*. The LP is cleanly recorded and well balanced.

John Lissner

Sound: A Performance: A

Lenny White Presents the Adventures of Astral Pirates: Lenny White
Elektra 6E-121, stereo, \$7.98.

The Adventures of Astral Pirates is drummer Lenny White's third solo outing after leaving the metal fusion of Chick Corea's *Return To Forever*. His present format of guitar, bass, drums, and multi-keyboardist, along with his heavy electric sound and intense rhythms, is obviously indebted to Corea, but his compositions and arrangements are more organic and immediate.

Melodies lash out across cascading rhythms and with this immediacy comes a sense of superficiality that's heightened by the packaging which surrounds the record in a science-fiction tale. It often comes off as being designed to fit someone's marketing concept rather than the White's own music. This pretentiousness comes from his time with Chick Corea and *Hymn to the Seventh Galaxy* up through White's own debut, *Venusian Summers*.

There's no doubting the technical flash and visceral impact of White's group however. Their music careens out of the speakers in a constant high-energy attack. Don Blackman's ornamental keyboards drape over Nick Moroch's fuzzed guitars. At the core is Alex Blake (bass) and Lenny White's driving rhythms. Music like this requires crisp production to work and

White gets it when he combines with coproducer Al Kooper. The sound of this album is brilliant. The bass drum kicks out the bottom while the guitars and keyboards are distinctly recorded in the high end for a very dynamic aural experience. *John Diliberto*

Sound: B Performance: B+

The Lester Young Story, Vol. 1
Columbia CG 33502, mono, \$7.98.
The Lester Young Story, Vol. 2.
Columbia JG 34837, mono, \$7.98.
The Lester Young Story, Vol. 3.
Columbia JG 34840, mono, \$7.98.
Lester Young, Pres/Complete Savoy Recordings.
Savoy SJL 2202, mono, \$6.98.
Lester Young/Pres Lives.
Savoy SJL 1109, mono, \$6.98.
Lester Swings: Lester Young.
Verve VE-2-2516, mono, \$7.98.

Lester Young, the "Pres," one of jazz's martyred hipsters, is an icon in jazz mythology accorded the same reverence as Charlie "Bird" Parker and Billie Holiday. Young's musical prowess is amply documented in recordings, and these six selections, all recent releases, offer a comprehensive view of Young's career from his days of glory with Count Basie and with swing groups accompanying Billie Holiday to his slow post-World War II decline.

Tenor saxist Lester Young came into prominence with a cool sound at a time when jazz was "hot." The style of Coleman Hawkins was the dominant influence — Hawk's sound was big, warm, and emotional. By contrast, Young's music appeared detached, oblique, almost dispassionate. His tone was pale where Hawkins had been rich; he phrased leanly where Hawkins was fat and florid. Though his detached style and smaller tone tied in with the concepts emerging in bop, he was part of the Swing Era and primarily a melody player. The ease and relaxation of his improvising arose from his ability to anticipate, to phrase ahead, preparing for and leading into the next chord change several beats before he reached it.

Young's serenely floating swing is magnificently showcased on the three Columbia double-sets in the label's new Jazz Contemporary Masters series. The three albums encompass 122 sides; Volume One consisting of small group dates including his very first recordings — four sides made with Jones-Smith, Inc., a quintet drawn from within the Basie band with Basie on piano — as well as various combos accompanying Lady Day. Jazz aficionados, particularly Young admirers, will welcome Columbia's largess —

not only the original masters have been reissued, but also second takes. There is an interesting alternate take of the Smith-Jones *Shoe Shine Boy*, as well as half a dozen alternates of the Holiday classics. The three collections put everything in proper sequence.

While Billie Holiday was singing in Basie's band in 1937, she started using Young on her Vocalion sessions, produced by John Hammond, and also on the Brunswick recordings she made with Teddy Wilson. Holiday and Young had a remarkable rapport, and it is evident on all these sessions. Young was one of those musicians unusually sensitive to his surroundings, and one notices how the intimate, lyrical playing on the small band dates with Billie Holiday contrast with his more aggressive, flamboyant style on such Basie orchestral stompers as *Taxi War Dance*, *Pound Cake*, and *Miss Thing*.

After Young left Basie in 1942 things were never quite the same. It is this writer's firm conviction that Young was at his best with Basie; happiest with the Basie band in back of him. There was a vast difference between making lengthy solo appearances as a star accompanied by a rhythm section, and making occasional appearances as one of several soloists featured with Basie's band. Young's later efforts as found on the early 50s sides in the Verve doubleset are sometimes sluggish, often joyless. This is not to discount the Verve collection, for there are also many moments of swinging invention and some fine ballads. The eight cuts recorded in 1945 in Los Angeles with Nat King Cole on piano and Buddy Rich on drums are perfectly splendid. There is also some sparkling work by pianists John Lewis and Hank Jones with those 1950-51 groups led by Young.

Savoy's double-set, **Pres/Complete Savoy Recordings**, is mostly in the Basie orbit. Young had rejoined Basie briefly in 1943. Early in 1944, the Basie band under the guise of Earle Warren and His Orchestra recorded several sides for the Savoy label which had made peace with the striking musicians union. Basie could not record with Savoy because he was under contract to Columbia, and that company was still in disagreement with the AFM. On numbers like *Circus in Rhythm* and *Tish*, we get Young with the full Basie band (with the excellent Clyde Hart on piano in lieu of Basie). The headlong drive and rocking pulse of the Basie ensemble seems to inspire Young who plays with the sinewy, flashing style that marked his earlier days with Basie. On the same day he



TM
 "The Magic of Neutrality"

Neutrality is the quality or state of being free of distortion or any coloration. A neutral speaker is one which can reproduce all types of music just as recorded. It must also perform well in all the varieties of acoustic environments, particularly in the critical mid-bass range.

To date, all existing forms of speaker technology have been unable to deliver this most important criteria.

With Qysonics development of the Critical Alignment* system and the Laminar Flow Vent,** Neutrality finally becomes a reality.

Please write us for additional information of Qysonics technical developments.

We invite retailers to visit us in the Jockey Club exhibit area at C E S in Las Vegas.



Qysonic Research Corporation
 920 S. Placentia Ave./Placentia, CA 92670
 (714)630-5321

**Pat. Pend. *U.S. Pat. No. 4119799

Enter No. 30 on Reader Service Card

recorded with the Basie band, Young made several Savoy sides with a fine combo led by Johnny Guarneri, a good swing pianist who could sound like Basie, Fats Waller, or Art Tatum. Not surprisingly, Guarneri makes like Basie on *Basie English* and *Exercise in Swing* and Lester cooks along with him. A few months later, with contractual problems overcome, Basie led into the Savoy studios a casual group that featured Young on tenor. All six sides are included here with Lester sounding laid back and increasingly languid even with the pulsing Basie rhythm. On the last two Savoy sides Young appears with a 1949 bop group and the languid approach is accentuated, with Pres displaying less and less of the old verve and elan.

Savoy's **Pres Lives!** is a total disaster sonically and musically. Taken from 1950 tapes of Young leading an unknown rhythm section at what sounds like a neighborhood dance, his playing, is, for the most part, listless, and his tone is often rancid. The recording's dreadful sound quality doesn't help. There are abrupt fades, unpredictable volume changes, and terrible balance. Unless you are a Lester Young nut, you can skip it.

The sound of the Columbia reissues is first rate. Engineer Doug Pomeroy is

responsible for the reprocessing; the clarity and detail of these 40-year-old recordings is remarkable. Young's Verve recordings were made 10 to 15 years later than the Columbia's, and they presumably had the advantage of advanced recording techniques, yet they are not as lively and vivid; sonically acceptable, but that's all. The sound of the Savoy double set, made up of transfers from 78 rpms, is adequate. *John Lissner*

Young Story, Vols. 5-3

Sound: A- Performance: A+

Pres/Complete

Sound: B- Performance: A-

Pres Lives

Sound: D Performance: C-

Lester Swings

Sound: B Performance: B+

Love Will Find A Way: Pharoah Sanders

Arista AB 4161, stereo, \$7.98.

With the commercial pressures that are brought to bear on musicians today, it's not hard to understand why so many flee the music they've been playing for years and search for more marketable sounds. For some, it is a



genuine attempt to bring their message to a wider audience or to incorporate a greater variety of elements into their music. A few, such as Miles Davis and John McLaughlin, succeed in making music that is honest and complex while at the same time having an element of accessibility. Others churn out music whose transparency only reveals the truth that "those who abuse their talent, lose it." Pharoah Sanders has entered the legions of the lost.

Pharoah was never a ballad player. His message came screeching in

Don't make a decision on speakers until you've heard all sides.

There are literally hundreds of high fidelity speakers to choose from. But before you make a purchase decision, you should listen to our speakers. And the reasoning behind them.

We pioneered the concept of omnidirectional sound radiation. That means we arrange multiple drivers so that they radiate sound in virtually all directions.

This results in a number of benefits.

First of all, high frequency sound waves travel in a beam along a fairly direct axis. So with conventional directional speakers, you have to be sitting on or very near this axis to really get the full impact of the highs. But with an omni-directional speaker, the sound is much more uniform throughout the entire listening area.

Secondly, in a concert hall environment, the listener hears a high ratio of indirect or reverberant sound to direct sound. Since omni-directional speakers radiate sound in many

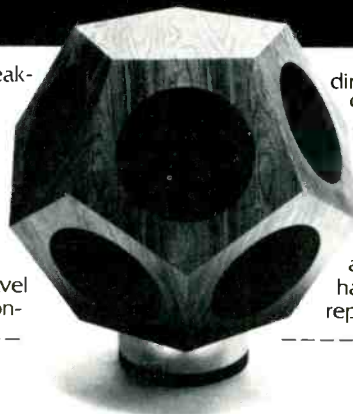

directions, they can more closely duplicate this concert hall ratio of indirect to direct sound.

Naturally, we think that the easiest way to appreciate the difference is to listen to our speakers for yourself. However, we'd like to warn you that our speakers are designed to impart as little coloration as possible. So don't expect "bigger than life" sounds with artificially sweetened highs or especially enhanced lows. Our speakers are designed to reproduce just what's been recorded. Nothing more and nothing less. We think that makes them nicer to live with in the long run.

So before you choose any speaker, listen to ours. And we think we'll win you over to our sides.

DA
DESIGN ACOUSTICS
Speakers with an all-around better sound.

Please send me more information on your omni-directional speakers.

Name _____
Address _____
City _____ State _____ Zip _____

send to:
Design Acoustics, Inc.
2426 Amsler St., Torrance, CA 90505

1A-79

honks, growls, and careening runs. **Thembi**, an earlier recording, showed that he could be lyrically elevating to the point of tears, but never smoothly sentimental. **Love Will Find a Way** deposits Pharoah in the hands of Norman Connors, another of the lost, who gained notoriety in Pharoah's inspired early 70s groups. But Norman has found the commercial keys . . . with his slick production and accompanying hordes of studio musicians, he's ready to open the door for Pharoah.

Love Will Find A Way leaves behind Pharoah's frantic improvisatory talents and finds him blowing breathy melodies. The few times he begins to take off, he flounders in a series of R&B clichés. The lack of vitality in this recording is only emphasized by drawing a comparison between Pharoah's listless version of *Got To Give It Up* and Marvin Gaye's energetic original. Marvin's been singing soul and R&B for years. He knows it and believes in it so that his authority makes it work. Pharoah has no such authority, and his subsequent performance is gutless.

Love Will Find A Way is dressed in exquisite MOR production with sensuous strings, the torched voice of Phyllis Hyman, and all the session names this type of disc requires for that brilliant, superficial sheen. *John Diliberto*

Sound: B Performance: D-

A Dream Without Reason: Heldon
Inner City IC 1021, stereo, \$7.98.

Heldon comes from that new circle of French avant-garde that includes Magma and Clearlight. Though all these groups share musicians, they each have a clearly distinct area of sound exploration. Heldon just happens to be one of the most unique groups on the planet, performing music that few would dare touch. As it evolves out of the mind of Heldon's director, Richard Pinhas, this is music of the machine. It screams with clashing factories, belching chimneys, and mechanical drones.

Heldon's music is largely based in the minimalism of Terry Riley and Philip Glass strained through rock mutants, Robert Fripp and Brian Eno. Earlier albums were dedicated to the pair whose combination of passive musical functions combined with controlled free improvisation informs much of Heldon's work. The flow of minimalism is used as a sheet through which Heldon cuts jagged edges inspired by John Cage, Karlheinz Stockhausen and electric Miles Davis.

Synthesizers moan like Tibetan trumpets while temple percussion is slashed in the background. A medita-

tive intensity is established which crescendoes in the turbulent drums of Francois Auger. Pinhas and synthesist Patrick Gauthier spin twisting, clashing lines of feedback and electronic howls. Occasionally the improvisations meander into a numbing hum, as in the sequencer-dominated *Toward the Red Line*, but more often the performance is sharply integrated with multiple pyrotechnic displays.

A Dream Without Reason is the fifth Heldon album but only the first to come out stateside. In many ways it is their best and most uncompromising release as they further their exposure of sound as music. John Cage used to hear music in the sound of commonplace machinery. Richard Pinhas, in the vehicle of Heldon, has taken the activation of those machines into his own hands and lifted it to a piercing cerebrality.

A Dream Without Reason is mixed with a dark harshness that emphasizes the edge in the music but blends the distortion of the instruments. Inner City Records, 43 W. 61st St., New York, N.Y. 10023. *John Diliberto*

Sound: B+ Performance: A-

Charred Earth: Sunny Murray & The Untouchable Factor

Karma PK-1, stereo, \$7.98.

Doctor To-Much: Frank Lowe

Karma PK-2, stereo, \$7.98.

These records by two leading *avant-gardists* show them in their worst possible light. Sunny Murray is the leading innovator of Free-jazz drumming and has been playing his exciting, rhythmless style for nearly two decades. He hasn't done a lot of recording under his own name since his '60s work for ESP and Actuel, but his prominence as one of jazz's most daring conceptualists was recently reassessed in the **Wildflower** recordings of New York's loft jazz scene (already out of print). The Untouchable Factor dominated the five discs with their energy-laden improvisations, especially the twin saxes of David Murray and Byard Lancaster which whirled around the locus of Sunny's floating pulse.

On **Charred Earth** Sunny is featured with a stripped-down version of the Untouchable Factor. Lancaster is the only holdover from the **Wildflower** group. Dave Burrell sits in on piano and Bob Reid has the bass chair. Their performance is completely uninvolved, with little of the intuitive exchange needed to make this type of performance work. Burrell and Reid seem completely out of it, with bland solos and no support or cohesiveness between them. Byard tries to funnel

McIntosh

"A Technological Masterpiece..."



McIntosh C 32

"More Than a Preamplifier"

McIntosh has received peerless acclaim from prominent product testing laboratories and outstanding international recognition! You can learn why the "more than a preamplifier" C 32 has been selected for these unique honors.

Send us your name and address and we'll send you the complete product reviews and data on all McIntosh products, copies of the international awards, and a North American FM directory. You will understand why McIntosh product research and development always has the appearance and technological look to the future.

Keep up to date.
Send now - - -

McIntosh Laboratory Inc.
Box 96 East Side Station
Binghamton, NY 13904

Name _____

Address _____

City _____ State _____ Zip _____

If you are in a hurry for your catalog please send the coupon to McIntosh. For non-rush service send the Reader Service Card to the magazine.

Enter No. 21 on Reader Service Card

some energy into the set, recorded January 1st, 1978, but no one can follow the few flights he takes. When the ensemble is not behind their principal soloist, it's got to fall apart. Murray himself is content to hover in the background, never taking control.

Frank Lowe's album suffers from the same listlessness. He's accompanied by Olu Dara and Leo Smith on trumpets, Philip Wilson on drums, and Fred Williams playing bass. If they had taken the opening and closing pieces, tenor solos by Lowe, it would've made a great single. *Trombone* finds Lowe imitating the intervallic jumps that a

trombone must make, in a stutter of choked energy. On *Future Memories* he creates a misty balladic reminiscence. In between the band meanders in a series of short underdeveloped performances. The lack of direction is emphasized by *Parts* a string of solo pieces which are spliced together with a butter knife.

Both performances are filtered through some of the most technically deficient recordings I've heard this side of bootlegs. The Murray work sounds like it was done on a forty-dollar cassette deck. There's an audible buzz in the left channel throughout

with a mix that comes up like sludge. Frank Lowe is plagued by a similar mix coupled with poor editing and lots of tape hiss.

Karma has released records by two vital, provocative musicians accompanied by some master sidemen of the *avant-garde*... yet they have managed to make almost completely worthless records.

Write to Karma, Inc, 165 William St., New York, N.Y. 10038. *John Diliberto*

Sound: D

Performance: C

Out of the Blue: "Blue" Gene Tyranny **Lovely Music, Ltd LML 1061, Stereo, \$6.98.**

I have no idea where he comes from or what the true origins of his name might be, but "Blue" Gene Tyranny has surfaced with a quirky, enigmatic album called **Out of the Blue**. The centerpiece of the album is a sound collage with narration that takes the form of a letter to "Blue" Gene and appears to be partially autobiographical. *Out of the Blue/A Letter From Home About Sound And Consciousness* begins with a train passing through, accompanied by some *Orange Blossom Special* fiddles. It dissolves into a sound pastiche that uses sustained strings and tremulous synthesizer lines to tie together the narration of a letter from home. After each section of narration the versifying chorus of two lightheaded female sopranos rephrase the narration as if they were "Blue" Gene's conscience speaking to himself. The cyclic flow of the music with the continual appearance of certain lines, the train which opens and closes the side, the blend of folk, jazz, and electronic music, along with the narration, purport an "all is one, one is all, and all is you" conceptualization.

The first side doesn't fare as well. Its three songs fail to sustain interest with their overly cute tunes and contrived arrangements. *Next Time Might Be Your Time* and *Leading a Double Life* come off as rough drafts for *Out of the Blue* while *David Kopay (Portrait)* is fusion dance filler.

Out of the Blue is an ambitious work from a label that seems to specialize in music that is unclassifiable. "Blue" Gene's process is a unique one. While certain aspects of his music are carefully worked out, he also strives for a natural or "real" feeling in his choice of a narrator who sounds like a real person, rather than a trained narrator. His attempts at pop, however, are forced and stilted, hence the split rating for the sides.

In terms of sound, the album is well-produced, in the case of *Next Time*... and *David Kopay* the sound tends

THE Gale® LOUDSPEAKER

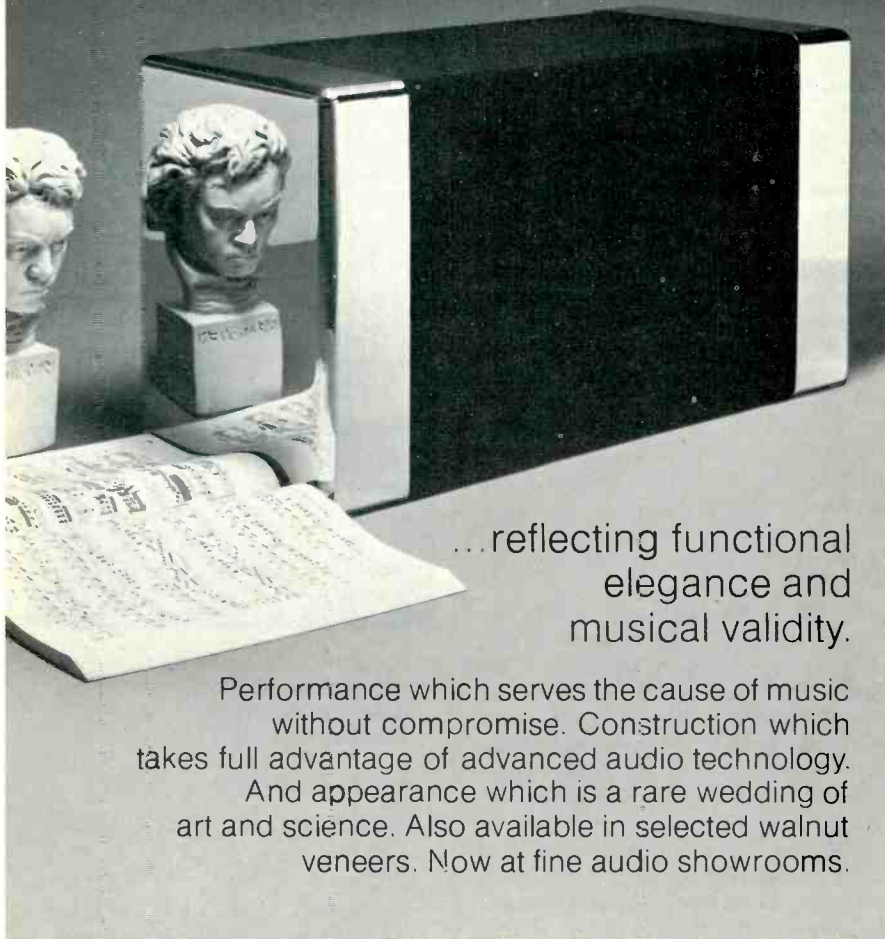

...reflecting functional
elegance and
musical validity.

Performance which serves the cause of music
without compromise. Construction which
takes full advantage of advanced audio technology.
And appearance which is a rare wedding of
art and science. Also available in selected walnut
veneers. Now at fine audio showrooms.



Imported from England by
AUDIO POTENTIALS, INC., P. O. Box 5367, Dept. G179A, Akron, Ohio 44313

Enter No. 1 on Reader Service Card

to be too clean, with the clear definition emphasizing the lameness of the arrangements. Available from Lovely Music, Ltd. 463 West St. N.Y., NY 10014. *John Diliberto*

Sound: A- Performance: D+/B+

Waiting For The Moment: Stanley Cowell

Galaxy GXY-5104, stereo, \$7.98.

Waiting For The Moment is the second solo Cowell album. On the surface it seems radically different from the sparse solo piano of **Musa: Ancestral Streams** since the second side features Cowell playing multiple keyboards. But that same sense of space and directness which marked **Musa** is also found in this work. *Sienna: Welcome my Darling* and *Sienna: Waiting for the Moment* are the most elaborate pieces. Twin rhythms are set up on the electric keyboards, harmonic shadings by the synthesizers and the improvisations and melodies are played on the grands, whether electric or acoustic. For the final pieces he strips down to a pair of keyboards. *Coup de Grass* rollicks through a two-handed rhythm section. *Today, What a Beautiful Day* is the most fully realized piece, employing the contrasting ambience of acoustic and electric instruments. It places Stanley's delicate and lyrical piano line against the tremulous sustain of an electric grand.

While side two maintains a mild interest, it seems like an intellectual exercise coming after the first side, which is a work of passion. Stanley traces the history of jazz piano from ragtime up through post bop, finally ending with the new awareness of its African roots. Cowell's piano style seems particularly suited to this sort of excursion. It's very personal, but lacks the idiosyncracies and flourishes that would turn this into a gross reinterpretation for most pianists. But Cowell's understanding of these styles and his own virtuosity is served. He easily makes the transition through each phase and draws a line of continuity from *Ragtime*, written by Jimmy Heath, through Bud Powell's dense filigree on *Parisian Thoroughfare*, and concluding with the breezy melody of *Spanish Dancers* played on African thumb piano.

Waiting For The Moment is well recorded in both the acoustic properties of the piano and the warmth it brings out of Cowell's playing of the electric instruments. Cowell has made a clear statement of his influences, even if expression of these influences in the more contemporary setting is often distant and mechanized. *John Diliberto*

Sound: B Performance: B

AUDIO • January 1979

Q • Where should you start in your search for better sound?

A • At the beginning. With a new Audio-Technica Dual Magnet™ stereo phono cartridge.

Our AT12XE, for instance. Tracking smoothly at 1 to 1-3/4 grams, depending on your record player. Delivers smooth, peak-free response from 15 Hz to 28,000 Hz (better than most speakers available). With a minimum 24 dB of honest stereo separation at important mid frequencies, and 18 dB minimum separation even at the standard high-frequency 10 kHz test point. At just \$65 suggested list price, it's an outstanding value in these days of inflated prices.

Audio-Technica cartridges have been widely-acclaimed for their great sound, and for good reason. Our unique, patented* Dual Magnet construction provides a *separate* magnetic system for each stereo channel. A concept that insures excellent stereo separation, while lowering magnet mass. And the AT12XE features a tiny 0.3 x 0.7-mil nude-mounted elliptical diamond stylus on a thin-wall cantilever to further reduce moving mass where it counts. Each cartridge is individually

assembled and tested to meet or exceed our rigid performance standards. As a result, the AT12XE is one of the great bargains of modern technology ...and a significant head start toward more beautiful sound.

Listen carefully at your Audio-Technica dealer's today.

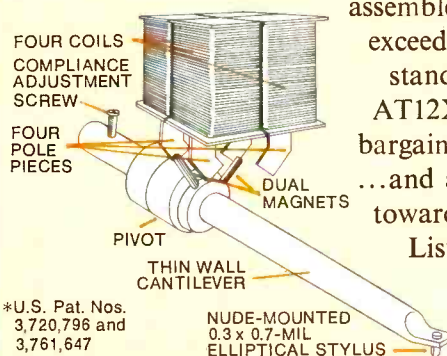

audio-technica
INNOVATION □ PRECISION □ INTEGRITY

AUDIO-TECHNICA U.S., INC., Dept. 19A-1, 33 Shawassee Avenue, Fairlawn, Ohio 44313
In Canada Superior Electronics, Inc.

Enter No. 3 on Reader Service Card

Classical reviews

Edward Tatnall Canby

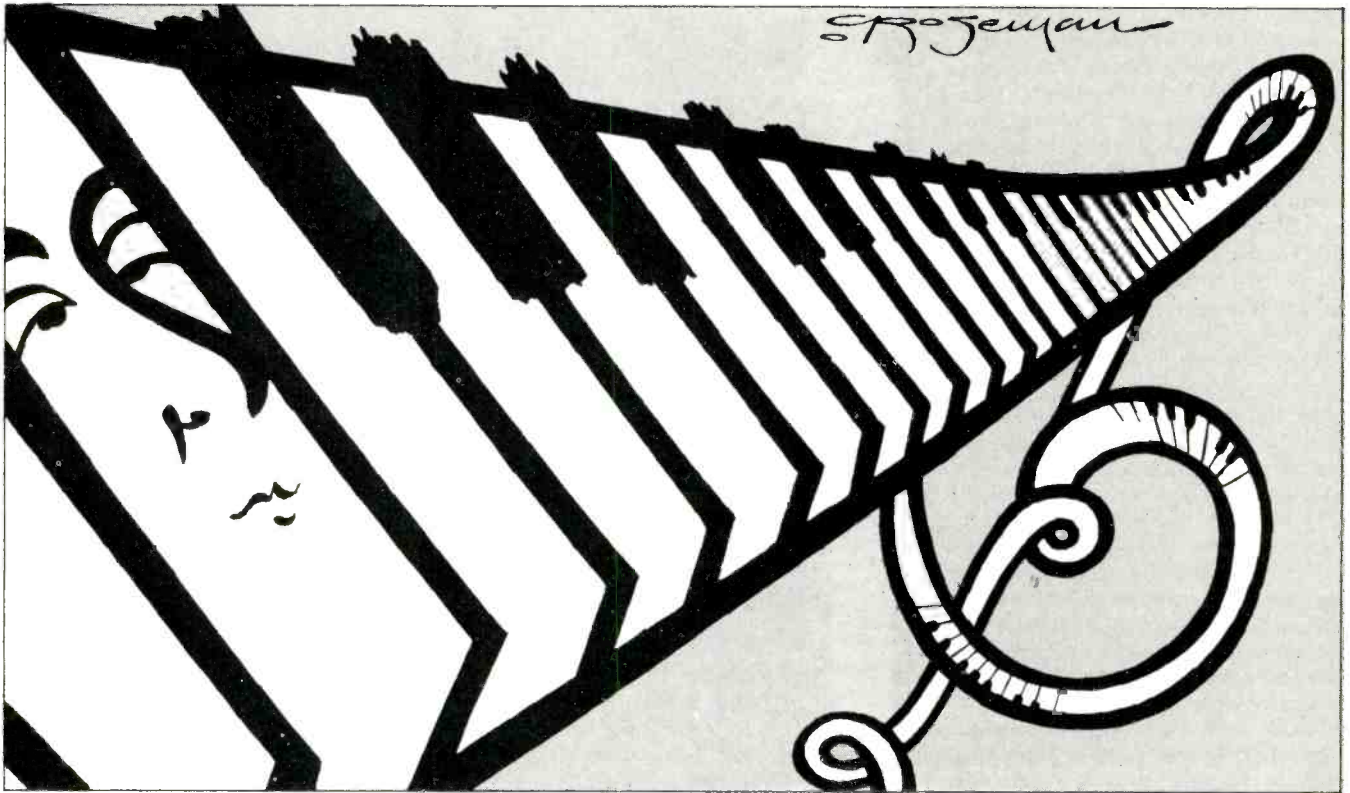

124

Hummel: Piano Quintet in D minor, Op. 74; Concerto for Piano, Violin, and Orch., Op. 17. Eugene List, pf., Carroll Glenn, vl., Vermont Festival Players, Vienna Chamb. Orch., Marzendorfer. **Monitor MCS 2155**, stereo, \$6.95.

If you are partial to the "Viennese classics" — from Mozart and Haydn through Beethoven and Schubert — this Johann Nepomuk Hummel should give you a good time. A great man in his day, student of Mozart and Haydn too, he lived about a decade later than Beethoven and went through the same period, from elegance and polish in the late 18th century into passionate Romanticism in the early 19th. You get 'em both on this record, but it is the later work, the *Quintet* for piano and strings, that really jells. You will not be sorry you bought it, both for the music and performance, and for David Hancock's excellent recording in New York.

Guiding spirit here is the once fair-haired boy of pianism, Eugene List. Now, he is a vast, jowly gentleman with a portly smile, but his playing is electric and his enthusiasm for this music almost speaks itself . . . superb.

His violin colleague, veteran Carroll Glenn, is agreeable too, if sometimes a bit shaky in pitch and coldy-in-the-head in tone. The Vermont Festival Players, unnamed, are lively and sympathetic — altogether a real musical session, and you will long remember a good many of the Hummel ideas even if the whole is a bit on the long side, and for a *Quintet* almost orchestral in intensity.

As for the "double concerto," recorded in Vienna, it is much earlier in time and almost a farce in content as we hear it today — sort of exaggerated Mozart, padded out to absurd lengths. Well, maybe not in its day! I could not decide whether Hummel was just trying to be cute and funny or just didn't know any better. It's a remarkably interesting commentary on Mozart, incidentally — shows you ever so clearly why he is so good. The *Concerto's* orchestra, Viennese or no, is just barely adequate, perhaps sight reading its way. Most likely, since this was a first performance since the beginning.

Producer for the *Concerto* in Vienna was, of all people, Kurt List (no rela-

tive, I think), once the general *factotum* of the original Westminster records hereabouts. Hadn't heard of him in years.

Sound: B+, B Recording: B+,
B- Surfaces: B

Eternal Father, Vol II. Chapel Music from the United States Naval Academy (Bach, Franck, Gretchaninoff, Hassler, Langlais, Riegger). Chapel Choir and Glee Club, Talley. **Richardson Records (1938 Old Annapolis Blvd., Annapolis, MD 21401)**, \$7.98.

Very small company recording remains a fascination for me, as it surely must for you, if you listen widely enough. Here is the variety and spice of everyday life, to set off the endless celebrity discs from the Majors and even the ultra-various recordings of the bigger small labels. Definitely part of our scene.

This outfit sets up its recorder on the local scene, in Annapolis and around Baltimore. The U.S. Navy is a good source! This is a very fine choral recording of a marvelously disciplined

and enthusiastic group of young men — one would think that maybe the rest of the life in the good old Navy must be pretty dreary, the way they button down to their singing. It isn't very sophisticated, but it is highly musical and the voices are carefully chosen, the best. The recording itself is excellent, too. Choral music is not easy to record by any means.

The last disc I tried from this source had no proper label name, no address, no price, no nothing. Well, they're learning. Still no label, unless "Eternal Father" is a label name. But a rubber-stamped address (above) and inked-in price; note that postage is 75¢ via lame old Uncle Sam or \$1.50 if you want it UPS.

Sound: A- Recording: A- Surfaces: B+

Holst: Suites No. 1 & 2 for Symphonic Wind Band. Bach: Fantasia in G. Handel: Music for the Royal Fireworks. Cleveland Symphonic Winds, Frederick Fennell. **Telarc 5038, digital.**

Here it is. The audiophile disc resulting from the digital recording session I wrote about in our July issue. I was there — now I listen. Always intensely interesting to compare the original and the final recorded product! This one lives up to high expectations. In one fell swoop, it effectively disposes of direct-to-disc as state-of-the-art for fi on discs. Standard-play LP stereo discs, of course. That's what this is.

The winning combo of technology here is that of the Soundstream digital recorder and the well-known half-speed cutting process developed by JVC, along with various ancillary benefits therefrom. In the disc cutting, absolutely no limiting of any kind nor any doctoring at all. And an almost total lack of transformers right through the electronic chain — from the Scheopps/Studer omni mikes through the transformerless disc-cutting circuit by Neumann — for unprecedented cleanness and accuracy. A glance at Soundstream's main recording specs, like signal to noise of 90 dB and the same figure for dynamic range (all of it preserved on the disc!), plus total harmonic distortion of 0.004 percent, wow and flutter unmeasurable, should predict for any of us what sort of a signal is involved to begin with. Enough said. Telarc would really have had to botch this job in order to avoid a winner.

Ah, yes, the pressing. There we have the element common with other disc recordings, and it could be the Achilles heel. When we get to digital disc playback, pressing will no longer

be a significant problem. In a digital-to-analog operation, such as this by Telarc, it remains crucial, and Telarc was well aware of it. I gather that the lacquers were plated up by Europadisc (American). And, alas, and as usual, the pressing is imported. Thanks are given to Teldec, presumably for this service, though the record itself is "manufactured" by Victor of Japan, alias JVC. Anyhow, we still must send overseas for really adequate pressings, which is an affront, if you ask me, to the technical prestige of our good old U.S. of A. Can't somebody meet the challenge? The pressing, need I say it, is excellent. I noticed maybe a very small increment of rumble (with volume turned up high, of course) and a remarkable paucity of ticks and pops. A good record. As the Beatles said of the sun, it's OK!

The music. Not that anybody else cares very much, but I do. I still firmly believe that the business of audio is music, one way or another, wherever we may go. Fennell has long been my own favorite conductor of band music, which is his specialty, I would say. He does the two virtuoso Holst pieces with superb vigor and understanding, as was obvious at the recording session itself. These works, fancy symphonic settings of English folk tunes, are in the high Edwardian manner of 1910, a more exuberant Elgar, and you can't help liking them in spite of the highly dated approach to folk idiom. So what! It sounds nice.

When it comes to Handel, Fennell's genial instincts are still 1910, only moderately modified. I have a feeling that my wry faces at some of the gigantic *ritards* at the endings of movements may have resulted in at least one retake with a "normal" ending — that is, as things are done today, rather than 1910! It's good, bouncy Handel, if hardly the latest thing in authenticity in spite of one "improvised" trumpet cadenza. As for Bach, this grotesquely post-Romantic arrangement outdoes old Bach-Stokowski of a couple of generations ago in its vast sighings and heavings and dyings-away. I didn't even recognize it as Bach for several hearings at the recording session; I thought it must be more Holst. Well, I suppose that's the right idea, at least for this particular disc.

Sound: A Recordings: A- Surfaces: A-

Mainline to Panther (Sounds of Steam Railroading Vol. 65). O. Winston Link Railway Productions, (381 Park Av. South, New York, N.Y. 10016)

As some readers will remember, O. Winston Link was the Beethoven of



Get A GNOME
the original micro-synthesizer

John Simonton's time-proven design provides two envelope generators VCA, VCO & VCF in a low cost, easy to use package.

Use alone with its built-in ribbon controller or modify to use with guitar, electronic piano, polytonic keyboards, etc.

The perfect introduction to electronic music and best of all, the Gnome is only \$59.95 in easy to assemble kit form. Is it any wonder why we've sold thousands?

- () Send GNOME MICRO-SYNTHESIZER Kit (\$59.95 plus \$2.00 postage)
- () GNOME MICRO-SYNTHESIZER (Fully Assembled) \$100.00 plus \$2 postage
- () Send FREE CATALOG

name: _____

address: _____

city: _____ state: _____ zip: _____

BAC/VISA MC card no. _____

B&F DEPT. 1 a
1020 W. WILSHIRE, OKLAHOMA CITY, OK 73116

Enter No. 27 on Reader Service Card

125

PRICE BUSTERS

FAMOUS NAME SPEAKER SYSTEM
Mfg. close-out - Famous Name Mfg. had model change & close-out of production run. They might have slight blemishes, or 2nds on the finish. Only we saved big for you. (Sample picture shown) - most are ducted port 3 & 4 way with pop off grills tweeters, midrange controls on front.

	Your Price
8" . . . 35wt. . . 3 way . . . \$198.00 . . . \$118.88/Pr.	
10" . . . 50wt. . . 3 way . . . \$279.50 . . . \$179.88/Pr.	
12" . . . 70wt. . . 3 way . . . \$349.50 . . . \$199.88/Pr.	
12" . . . 90wt. . . 4 way . . . \$399.50 . . . \$248.88/Pr.	

Ultrasonic REMOTE CONTROL SET
Brand New! Originally for TV use — you can use it to control stereo — on/off tape, on/off power, volume & more. All are controlled from across the room with a hand held xmitter. For the serious custom designer. Includes transmitter & receiver & will control 3 circuits. Includes DATA.

Sh. Wt. 1 Lb. . . 8C30372 . . . \$25.00/set

Neat assembled board contains all solid state components. Contains a DARTINGTON drive, push-pull output, all with complementary power tab transistors & mounted to lg. heat sinks. Accepts input from tape decks, magnetic or ceramic phono cartridges, mikes, etc. Requires a 48V transformer & 1 meg volume control. (not supplied). Output 8 into 8 ohms. (Supplied with data).

Sh. Wt. 1 Lb. . . 8Y0513 . . . \$5.78
* Stereo Xformer . . . 8G0530 . . . \$2.88
* Stereo Pkg. 16 watts W/xformer & cont. SAVE!
Sh. Wt. 4 Lbs. . . 8E0544 . . . \$13.88

16/8 WATT STEREO AMP

BOOKSHELF/FLOOR SPEAKER SYSTEM
Big enough to utilize full size speakers, small enough to fit on a bookshelf. Big enough to handle 50 watts & small enough to fit your budget.

Sh. Wt. 60 Lbs. 8Y0542 . . . \$88.88/Pair (Allow for 2-30 Lb. Packages)

50 WATTS Power Capacity * Cabinet Size 20x11x9 1/2" dp
FREQ. RESP. 30-22,000 Hz. * Ferro-Fluid Damping
10" Woofer * 5" Midrange * 4" Super Tweeter

B&F ENTERPRISES Dept. A-1
119 Foster Street Peabody, MA. 01960
Phone Orders: (617) 531-5774

VISIT OUR NEW STORE - "THE TOWNE DUMPE"
777 So. Willow St. (Woolco Plaza) Manchester, N.H.

TERMS: Add postage. No C.O.D.'s please.
MasterCharge, Visa & American Express Charges Welcome!

Enter No. 4 on Reader Service Card

I-AD

name _____

address _____

city _____ state _____

zip _____

MAIL THIS COUPON AND WE'LL SEND YOU THE BEST SPEAKER CATALOG YOU EVER READ!

No kidding. Speakerlab's catalog took longer to write than some of our competitors have been in business. In fact, we created an industry by "building great kits so you can afford great speakers." Our catalog is an invaluable

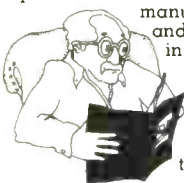

manual of speaker function and design. And, it will introduce you to the finest speaker kits made anywhere...with the strongest money-back guarantee. Find out for yourself...FREE. FREE, that is. Mail the coupon now.



Dept. I-AD, 735 N. Northlake Way
Seattle, WA 98103

126

8 IMPORTANT REASONS WHY MORE PEOPLE BUY TOP QUALITY EQUIPMENT FROM INTERNATIONAL HI-FI THAN ANY OTHER MAIL ORDER COMPANY

MORE THAN 80,000 CUSTOMERS NATIONWIDE

1. Guaranteed lowest price... you pay same price many dealers pay.
2. No-risk, no-deposit... phone orders shipped C.O.D. or Credit Card.
3. Same day shipping when ordered by 1 p.m.
4. Seven audio advisors provide professional help for the inexperienced buyer.
5. Fully insured shipments plus full manufacturers' warranty.
6. Exclusive "no lemon" guarantee.
7. Fully staffed customer service department.
8. Over 70 top name brands... equipment most mail order and discount dealers can't supply.



CALL NOW
(301) 488-9600
Mon.-Fri. 9-9, Sat. 9-4

Write for: • Brochure with prices and lines
• Tips on buying by mail



**International
Hi-Fi Distributors**

Moravia Center
Industrial Park, Dept. A1
Baltimore, Maryland 21206

Enter No. 15 on Reader Service Card

steam railroad recording men. I say "was" because by 1960 he had lost his me eater; there was no more steam. Not worth his talent, anyhow. It's been a long time since we have heard from O. Winston; his last offering was a lovely little 45-rpm disc of "The General" in action, a loco from the Civil War running just like new.

Not only the departure of steam but, coincidentally, the arrival of stereo, undid Mr. Link. His earlier work was a model of hi fi and still is, but it came in mono except for volume 3, **Thunder on Blue Ridge**. This new disc, after so long, is indeed in a species of stereo, of course, being that strange kind that you get from the top of a caboose traveling at 50 mph or at a rail crossing as a train goes by from miles on the right to miles on the left. It's very odd, but, I guess, an improvement on mono if only for the acoustic ambience it provides.

Anyhow, this new release (older material) is splendid, after a somewhat lame start on that caboose with O. Winston making laconic comments into the 50-mph gale. The man knows his drama. The peak of suspense — and of rhythm — comes at the end of side 1 when the huge loco, hauling no less than 86 freight cars, tries to make the long, long grade up the Blue Ridge and fails. Slower and slower — what a panting, pulsing rhythm! Any musician, any dancer for that matter, should be entranced. O. Winston knows enough not to break *that* sequence.

Sound: A- Recording: A Surfaces: B+

Haydn: String Quartets Op. 76 No. 3, 'Emperor'; Op. 76 No. 4, 'Sunrise', Quartetto Italiano. Philips 9500 157, stereo, \$8.95.

For Haydn, the originator of the string quartet, there is at present no more wonderful playing group than these four Italians, three men and a woman. I have never heard such consummately *right* playing of this powerful, elegant music, two of the later quartets and, particularly, the superb piece that includes those ineffable variations on the melody Haydn himself composed as a national patriotic hymn, later to be borrowed as *Deutschland uber alles*, but first called in 1797 the *Emperor's Hymn* in the wars with the French.

It is somehow just and fitting that these Italians should do so much for Haydn; in the composer's own day, Italian influence on music to the North was enormous but in Italy itself not

much of importance was composed after the end of the Baroque. Now, it seems to take the Italian spirit to bring out that curious mixture of North and South that was centered in the region of Vienna.

Marvelous quartet sound. So big! So dynamic and forceful in the recording. This Quartet, of course, has made quantities of other records for Philips, all the Brahms and Schumann, all the Mozart, all the Beethoven, some 22 LPs right here. Help yourself.

Sound: B+ Recording: A Surfaces: B+

Votapek Playing the Music of Gershwin and Chopin. Ralph Votapek, piano. **MSU (Mich. State Univ.) ATP 1387, stereo, \$6.95. (MSU Alumni Assn. Box 551 E. Lansing MI 48823.)**

An interesting disc from a State University piano prof., a super virtuoso. I played the Gershwin first, mainly those transcribed songs Gershwin the pianist used to improvise at endless parties in the 1920s. he wrote down 18, more or less as played, no more than brief sketches, one "chorus" only, mostly, all over in moments — but such an incredible wealth of music in them! No wonder Ravel was impressed, no wonder these two, out of different worlds, got on so well and not surprising that Ravel's two piano concerti have so much Gershwin in them. The similarity in thinking, notably in the acute sense of complex harmonies, was never so striking as here.

Ralph Votapek's Gershwin is all-out and chrome steel, so that your pickup may mistrack if you aren't careful — but he has the right idea, thank the Lord! No precious parlor intellectualism here. Just Gershwin's own enthusiasm, glorying in the thing he could do best. Everything is crystal clear and easy to hear, the high-speed rhythms, the crowding inner harmonies. Very good.

I almost skipped the Chopin. Too many people play Chopin. I didn't skip and was retarded. That earlier and very different parlor performer is rightly given a more melodious, even a gentler sound with an excellent feel for rubato, the Romantic flexibility of rhythm. This Chopin is natural and unselfconscious, which is something, these days! Yet the showy spots are properly dazzling. Also very good.

One minor technical problem, a low-pitch rumble and throb, maybe in the cutting lathe, rather than the tape or the pressing. It won't bother.

Sound: B+ Recording: B+ Surfaces: B

Folk bag

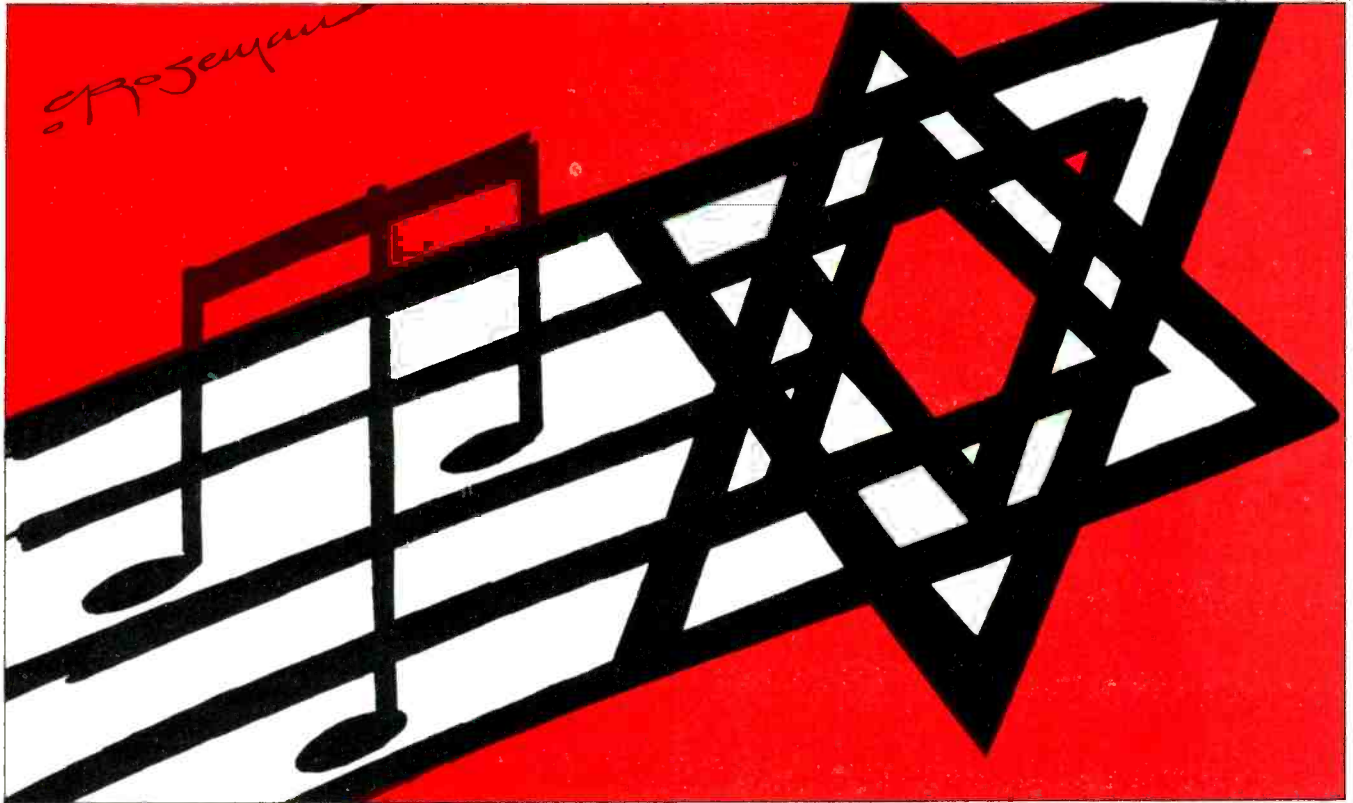

Morasha: Traditional Jewish Musical Heritage

Folkways FE 4203, mono, \$8.95.

Morasha examines the musical traditions of the Jews who immigrated to Israel from different nations. The album's emphasis is on songs and rituals brought from their former homes. Thus, the music is not necessarily Jewish per se, but reflects — wholly or in part — the ethnic idioms of their countries of origin.

It's worth noting that most of the settlers heard here came from Arab countries. Listeners who think in primarily political terms may be temporarily thrown offguard by an album of Israeli field recordings which opens with an oud *taqsim*, followed by an emotional, melismatic vocal improvisation in a classic Arabic mode, yet sung in Hebrew. As the swaying North African rhythm suggests, this is one of several performances by artists from Moroccan Jewish communities. *Song of Maimunah*, on side two, is an uninhibited Southern Moroccan ritual piece with hand-clapping in a Berber rhythm often encountered in Jajouka. *Shir Tahfif* is a Moroccan bar mitzvah

song done in a folk variation on the classical Moorish *andaluzidion* which so greatly influenced flamenco singing elsewhere.

Several tracks are devoted to Yemenite Jews. *Rahbidu Bildayf* is sung in unison over an intriguing rhythm background supplied by a drum and a copper tray. *Song of the Henna*, from a different area of Yemen, is harsher, more abandoned, with wilder drumming, and falsetto yelps. Three modern songs by Yememite-Israeli singer-composers are included, though one suspects that there is little Israeli influence on their melodies.

The similarities between Jewish and Muslim musical traditions is most clear on a Psalm and *peeyoot* (liturgical song) from Aleppo, Syria. Passionately sung in an unaffected Cantorial manner, it nonetheless betrays the singers' Syrian origins, especially after the full chorus enters. *I Will Sing Thy Might*, from a similar ceremony by Syrian Jews from Damascus, is in a far less intense style.

Four of the songs come from outside the Arab world. *Mujer La Mi Mujer* and *Una Noche* are sung in Ladino by

a singer from Yugoslavia, though like the Ladino language itself, the songs are more Spanish than anything else. *Love Song* is an affecting Turkish air given a strong, husky-voiced interpretation. *The Heroic Feats of Hamu Museo* is a curious Kurdish ballad, sometimes more like pitched conversation than music.

We have no way of knowing, of course, what the "original" Jewish music sounded like, but the melody and antiphonal form of the Samaritan *Song of the Angels* are so archaic one is tempted to speculate that it must be a remnant of an ancient Hebrew religious song. Regardless of this, the rest of the album reveals an absorbing blend of Semitic cultures, a Jewish heritage as variegated as it is abundant.

Folkways' address is 43 W. 61st St., New York, NY 10023. *Tom Bingham*

Sound: C- to B- Performance: B to A

Easy and Slow: David Jones
Minstrel JD-201, stereo, \$5.50.

David Jones is a British folksinger with a tremulous, nasal, yet robust

TOP Discount AUDIO

Your NATIONAL HEADQUARTERS

For Famous Brand Electronics By Mail

1150 N. Powis Rd., West Chicago, Ill. 60185 • (312) 293-1825

All Orders Shipped In Factory-Sealed Cartons

Write Or Call For The Lowest Prices Anywhere!

MILLION \$\$\$ INVENTORY

LOWEST PRICES ON

RECEIVERS TURNTABLES TUNERS
SPEAKERS CHANGERS CARTRIDGES
TAPE DECKS AMPLIFIERS HEADPHONES
CALCULATORS COMPACTS CAR AUDIO

Top Discount Audio 1150 N. Powis Rd. West Chicago, Ill. 60185 (312) 293-1825

We honor Master Charge and Bank Americard. Date _____ AU1

Please send me a quote on _____

MR (First) (Initial) (Last)
 MS (Number And Street)

(City) (State) (Zip Code)

Enter No. 28 on Reader Service Card

J&R BLANK TAPES & ACCESSORIES AT WHOLESALE PRICES!

BLANK TAPES CASSETTE TAPES

Ampex Grand Master I C-60	\$2.14
Ampex Grand Master I C-90	\$2.79
BA5F Studio C-90	\$2.69
BA5F Professional II or III C-90	\$2.99
Maxell UD C-60	\$1.99
Maxell UD C-90	\$2.84
Maxell UDXL I or II C-60	\$2.47
Maxell UDXL I or II C-90	\$3.47
Scotch low noise C-90 / 2 pk.	\$4.99 for 3 (10%)
Scotch Master I C-90	\$2.84
Scotch Master II or III C-90	\$3.29
Sony Ferrichrome C-90	\$3.68

Minimum Order 12 Tapes — 100% Guaranteed.

CARTRIDGES audio-technica

AT-20 SLA	\$119.00
AT-18 SA	\$82.50
AT-14 SA	\$46.50
AT-12 SA	\$34.50
AT-10	\$12.00

SHURE

V15 TYPE IV	\$89.90
V15 TYPE III	\$63.50
M95C	\$26.50
M91D	\$21.00
M24H (QUAD)	\$36.50
M70E	\$9.90

PICKERING

XUV/4500G (QUAD)	\$66.00
XSV/3000	\$45.95
PRO 4 AAA	\$33.00
XV15/750E	\$30.00
XV15/625E	\$20.98
XV15/400E	\$17.95

HEADPHONES

PIONEER

SE 205	\$19.95
SE 505	\$46.70
SE 7	\$33.50
SE 500	\$39.95
SE-700	\$59.95

KOSS

PRO 4 AA	\$37.95
PRO 4 AAA	\$45.00
HV/1	\$26.97
HV/1LC	\$35.97
PHASE/242	\$83.00
TECHNICIAN/VFR	\$48.00
K/6A	\$14.97

SENNHEISER

HD 400	\$24.99
HD 414	\$39.97
HD 424	\$59.95

PICKERING

OA-7	\$41.90
------	---------

HOW TO ORDER For shipment within 48 hours, send money order or certified check. Two weeks delay on personal checks. Please add \$3.50 per order for shipping & handling. (\$5.50 for orders outside U.S.). N.Y.S. residents add tax. No C.O.D.'s. All merchandise 100% guaranteed, brand new & factory fresh.

J&R MUSIC WORLD

Dept. A, 33 Park Row, N.Y.C. 10038 (212) 732-8600

WRITE FOR FREE CATALOG

Enter No. 16 on Reader Service Card

voice that's perfectly suited for songs of the sea, comic ditties, and bawdy ballads. On **Easy and Slow**, his debut album, Jones sings songs from each of these categories, along with several other stirring traditional British and Irish songs.

Sailors seem to figure in several of the album's best songs, whether or not they can rightly be termed "sea songs." *The Golden Vanity* is a well-known account of treachery at sea, with a memorable singalong refrain. *Yarmouth Town* is the ribald tale of a vigorous young lady with an insatiable appetite for sailors. *Young Edwin in the Lowlands* is an affecting a cappella ballad which recounts a sailor's grisly fate at the hands of his true-love's parents, subsequently leading to her degradation — not a very pleasant narrative, to be sure, yet Jones puts it across very convincingly.

Indeed, Jones has an uncommon ability for presenting a tragic ballad and a broad comic parody with equal conviction and authority. Compare, for example, the spellbinding *The Three Knights* with the facetious *General Guinness*. He also sings a couple tradition-rooted contemporary songs by Cyril Tawney. *The Oggy Man* is a particularly touching lament which ties together the end of a romance with the passing of a Cornish social institution.

Jones, who plays guitar and tin whistle, is joined by John Roberts (of Roberts and Barrand), whose concertina adds an appropriately funereal touch to *The Trooper Cut Down In His Prime* (a British antecedent of *Streets of Laredo*), while lending a carnival atmosphere to *Weyhill Fair* (Morris dancing, anyone?). Ed Trickett's hammered dulcimer helps enliven *Yarmouth Town*, while he plays guitar on several other unspecified cuts.

The recording has a metallic bite, though Jones' singing comes across clearly and with a lot of body, even though some of the accompaniments are mixed rather distantly.

Available from Collegium Sound Systems, 35-41 72nd St., Jackson Heights, NY 11372. *Tom Bingham*

Sound: C+ Performance: A-

All In One Evening: Ola Belle Reed & Bud Reed with Kevin Roth
Folkways FA 2329, stereo, \$7.95.

Ola Belle Reed is a feisty old girl with mischief in her manner, the kind of woman legends are written about. Born in another time and place, she might have blazed a trail across a wilderness or been the matriarch of an empire, but, having been born in the

Appalachian mountains of North Carolina and gifted with a fine, strong voice, she learned to play guitar and banjo and has spent most of her sixty-plus years making music.

Music is around her all the time. Her husband, Bud, plays harmonica and guitar (their son David plays, too), and what music the family can't make, friends come by to create.

Kevin Roth is one such friend. A dulcimer virtuoso and master of piano with a rich voice, Kevin has spent many an evening in the Reed's parlor making music. Those evenings inspired this album.

All this sounds very romantic, and it's a shame that this session didn't have quite the expected results. Roth produced the album, and it almost sounds like two albums got mixed up somewhere along the line—one of the "pickin' session" variety and the other, a pop balladeer's offering. Of the dozen original and traditional tunes on the album, one is by Ola Belle, two by Bud, four are performed by all three players, and the final five were conceived, written, performed, and produced by Kevin Roth. These tunes by Roth, although excellent, belong on a solo Kevin Roth album, not on this group session.

When one picks up an album with Ola Belle Reed's name on top of the billing, one hopes to hear Ola Belle sing. On this disc, you have to wait until the fourth cut to hear her, and when you do, something is missing. In live performances Ola Belle is animated, rambunctious, very funny, and bursting with the good time feeling of her music; on this album Ola Belle just sings. Although that's something, it's not quite enough. Roth's performance is far more engaging than hers. Even her classic, *Tear Down The Fences* with Bud and Kevin singing along (which usually brings down the house in concert), falls short of her usual vibrancy.

Most of the album was actually recorded in one evening in Emmet Robinson's living room above his recording studio. Robinson's back-ground includes a long stint as head sound engineer at the Main Point, the well-known suburban Philadelphia folk club. Although never put under much strain, his equipment and technique didn't make it for this parlor recording task. As for the three Roth songs recorded elsewhere, the engineering fares a bit better, but next time out Folkways would do well to do two albums, one for Roth and the other for the Reeds. *Janet Melaragni*

Sound: C— Performance: C

Others don't stack up against the books from Audio

No. 607, This volume is a handbook on the broad aspects of the practice and principles of multitrack recording.

No. 618, Covers both the advantages and disadvantages of each enclosure type.

No. 617, This is a thorough learning manual about microphones and how they work.

No. 622, Directed toward both the theory and the practical applications of audio circuits.

No. 619, The book attempts to address the considerations in applying the IC op-amp with maximum effectiveness in a wide variety of circuits.

No. 620, This book explains the operation of unique IC op-amp applications.

No. 608, Here is the whole event-filled story of the phonograph's first century.

No. 903, This new modern publication discusses the audio-system as a whole.

No. 609, This book has become a bible for serious scholars of the technical and legal aspects of the development of the audio-visual industry.

No. 623, This text tells and shows practically and authoritatively the uses of the microphone.

No. 621, The book discusses all types of timers, using representative industry standard devices as examples.

No. 612, This extensive survey of sound should be required reading for every recording engineer and audiophile.

No. 616, This book presents important information for those who want to, and should understand the performance characteristics of the room itself.

No. 613, This is the most up-to-date, complete, and accurate single volume on the development of television and radio now available.

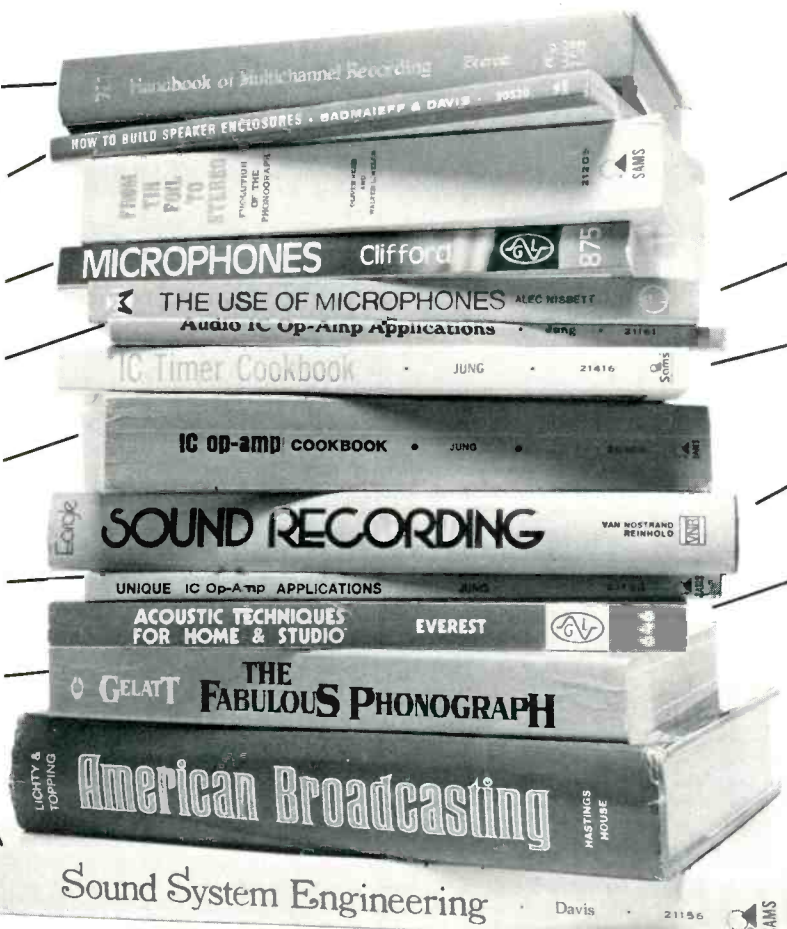

Please send me the book(s) I have checked.
Enclosed is my proper remittance for \$ _____.
I understand if I am not fully satisfied I may return my selection(s) in undamaged condition within 10 days for a full refund.

- 607, HANDBOOK OF MULTICHANNEL RECORDING, \$10.95
- 608, THE FABULOUS PHONOGRAPH, 1877-1977, (softback) \$6.95
- 609, FROM TIN FOIL TO STEREO, (softback) \$9.95
- 612, SOUND RECORDING, \$16.95
- 613, AMERICAN BROADCASTING, \$26.50
- 616, ACOUSTIC TECHNIQUES FOR HOME AND STUDIO, \$8.95
- 617, MICROPHONES—How They Work and How to Use Them, \$8.95
- 618, HOW TO BUILD SPEAKER ENCLOSURES, (softback) \$4.95

- 619, IC op-amp COOKBOOK, (softback) \$12.95
- 620, UNIQUE IC op-amp APPLICATION, (softback) \$4.95
- 621, IC TIMER COOKBOOK, (softback) \$9.95
- 622, AUDIO IC op-amp APPLICATIONS, (softback) \$4.95
- 623, THE USE OF MICROPHONES, (softback) \$6.95
- 903, SOUND SYSTEM ENGINEERING, \$19.95

Name (please print) _____

Address _____

City/State _____ Zip _____

Please allow 4-6 weeks for delivery

Audio

Book and Learning Systems Division

North American Publishing Company, North American Building, 401 N. Broad Street, Philadelphia, PA 19108

Audio Magazine is published by North American Publishing Company, leaders in editorial excellence.

AAM1

Classified

FOR SALE

CLASSIFIED ADVERTISING RATES

BUSINESS ADS- For Sale, Help Wanted, Services, Business Opportunities, Tape Recordings, etc. etc. \$4.80 per line. First line set in bold face type at no extra charge. Extra lines \$9.60 per line. One point ruled box, extra charge \$8.00. Full payment must accompany order.

NON BUSINESS ADS- Situations Wanted, used equipment for sale by private individuals \$2.80 per line. First line set in bold face type at no extra charge. Extra lines set in bold face type \$5.60 per line. Full payment must accompany order.

FREQUENCY DISCOUNT- 3 times, less 10%. 6 times, less 15%. 12 times, less 20%. (line copy ads only)

DEADLINE- 1st of two preceding months. (Dec. 1 for Feb. issue).

BLIND ADS- Box numbers may be used at \$5.00 extra for handling and postage.

MAIL ORDER AND DISPLAY CLASSIFIED RATE

1 col x 1"	\$125
1 col x 2"	\$180
1 col x 3"	\$250
2 col x 1"	\$180
2 col x 2"	\$320

Advertiser must supply complete film negative ready for printing for display ads.

AUDIO Magazine
401 North Broad Street
Philadelphia, Penna 19108

HOW TO ANSWER BOX NUMBER ADS

When replying to an Audio Box Number Ad, please use this address Box No. — c/o Audio, 401 No. Broad Street, Philadelphia, Pa. 19108

A BARGAIN: RAPPAPORT Pre 1 \$325. Phase Linear 400 with case \$300. Phase Linear 1000 with case \$170. (914) 967-4708 days.

ANOTHER FIRST FROM PARAGON

If you own a sub-woofer you need the System-E5 sub-woofer amp from PARAGON. Your bass can be articulate, clear and have more impact, with an amplifier specifically designed for bass. The E5 is your key to cost effective biamping because it comes in single channel modules. You buy only what you need when you need it. Single modules come in a stereo chassis for later addition of another module for use with stereo sub-woofers. Naturally, each module has its own mammoth 52 joules power supply capable of driving 2 ohm loads at full output, and naturally, it's from PARAGON. The people who lead with innovation, rather than follow with imitation. Write to me, Diana Graeber, for complete information on this exciting and innovative new amplifier. System-E5 single \$249.00, System-E5 dual \$449.00 Paragon, 997 east San Carlos Ave., San Carlos, Ca 94070 8.9

ELECTRONICS

GAS • Nakamichi • Mitsubishi • AGI
Spectro Acoustics • APT • Audiopulse • ADS
Burwen • Audionics • Denon • Seton • NAD

Audiocom HIGH TECHNOLOGY AUDIO
177 Sound Beach Ave Old Greenwich CT
Phone (203) 637-3621

FOR SALE

AMPEX TAPE—NEW 1800 on 7" reel 12 for \$18 POST-PAID, 1200" 12 for \$13 POSTPAID—free list—WIDE RESPONSE, 6114A, SANTA MONICA BLVD., HOLLYWOOD, CA 90038 TF

AMPEX 350 AMPS \$125 each. Ampex 600 ½ tr. \$275. Ampex ¾ \$100. Tannoy 15" coax (no xover) \$100 each. RCA LC 1A \$65. Heath AR-15 RCVR. \$125. Reply to Box A911, c/o Audio.

AT LAST! THE ULTIMATE CABINET DESIGN FOR HOUSING STEREO COMPONENTS - THE CUSTOM SOUND MODULAR EQUIPMENT CABINET. EARLY TWO YEARS IN DEVELOPMENT FEATURING:

- Flexible modular design expandable to suit any size installation.
- Accommodate any size components including the largest.
- Totally enclosed design with locks prevents dust buildup, tampering, or theft of valuable equipment.
- Bottom casters for mobility and rear door for easy rear access.
- High grade furniture design and construction.
- Very attractively priced.

Before you invest in a rack, call or write for our free illustrated information. Custom Sound Service, 8460 Marsh Road, Algonac, Michigan 48001. (313) 794-5400. 11.8

ACCUPHASE P-300 \$450. Soundcraftsmen PE 2217 \$275. Trevor Lees preamp, latest mods \$175. Trevor Less high level gain stage \$95. all excellent condition. (707) 938-1131.

ADS/BRAUN 810's European walnut cabinets, very good condition \$435. DYNA PAS-3, ST70, ST35, very good, \$80, \$85, \$45. (802) 387-5966.

AEA 630-MINT, hardly used. (802) 462-2668 eves.

THE CRITICAL RECORD REVIEW

A critical review newsletter of high quality discs, SOTA and D to D with emphasis on sound quality. \$6/year (6 issues): P.O. Box 8766, Jacksonville, FL. 23311.

THE NEW YORK AUDIO SOCIETY, INC. is a non-profit member-supported Hi-Fi Club. Come and hobnob with others like yourself to widen your knowledge of Audio Products and Systems and make new acquaintances. Informative monthly meetings feature new product demonstrations, lectures on latest Hi-Fi developments and exchange of information. All Audiophiles are invited to attend one session as your guest. Details about meetings and membership available. Write Box 125 Whitestone Sta., Flushing, N.Y. 11357 or call (516) 593-6538.

The perfect Christmas gift is THE HI-FI GAME: a board game for everyone! And, as a Christmas special, buy one game at our regular price of \$11.95 and get a second game at half price. Order now; immediate delivery from PENIJON GAMES, Box 2129, Martinez, CA 94553. 12.8

THE SOUND WORKS, Green Brook Shopping Village 221A Route 22, Green Brook NJ 968-7200 REMEMBER we will meet their price but they can't beat our service. 1.9

WANTED: MACINTOSH OR MARANTZ tube and pre-amps. P.O. Box 962, Hollywood, CA 90028. (213) 851-1107.

THRILLING DIGITAL TELARC RECORDING!

Fredrick Fennell, Cleveland Symphonic Winds, with new Soundstream process. Bach, Handel, Holst as never before. \$14.95 plus \$1.00 P.&H. MasterCharge. VISA. Write for free catalog Direct-to-Disc and other audiophile recordings on RCA-Japan, Sonic Arts, Toshiba-EMI, Umbrella Labels, as well as quality audio accessories. Interstate 80 Marketing P.O. Box 5367, Akron, OH 44313 12.8

FOR SALE

TIME-DELAY-SYSTEMS

Analog and digital. Low Prices! Efficient, Personalized Service. Buy with confidence! AudioAmerica, Box 445A, Lexington Park, Maryland 20653. (311) 862-3088

TONEARMS-CARTRIDGES-TURNABLES at lowest prices. Most brands available, including MC cartridges. Other quality brands available. Send # 10 SASE for quotes. Audio Unlimited, 401 Reynolds Circle # 12-D, San Jose, CA 95112 (408) 289-8875 1-6 M-F. 5.9

TOP QUALITY SPEAKER CABLES with banana plugs, 25 ft. only \$24.95. "SNAKE CABLES" P.O. Box 242 Littlerock, CA 93543. 1.9

TOURING SOUND SYSTEMS, 2, 4 and 8 Track Studios, Disco Sound, Cerwin Vega BGW, Altec, Shure, AKG, Tapco, Dyna, Revox, EV, Beyer, Cetec, etc. K & L Sound Service, 75 North Beacon At., Watertown, Mass. 02172. (617) 787-4072. Att: Ken Berger. TF

Tube Equipment: ARC D-51 \$500. ARC D-75 \$600. ARC EC-3 Xover \$300. Electronic Industries subsequently ARC, D-75 prototype with separate power chassis and user controls. A classic behemoth of unequalled quality. \$500. All mint. 612-475-1271 evenings.

TUBES - GENALEX, TELEFUNKEN, VALVO for audiophiles who demand premium quality European replacements for ARC, Dyna, Marantz, McIntosh and other preamps, amps, & tuners.

Just a few popular types include:

	Matched Prs.	Each
GENALEX:		
KT88/6550	\$67.00	\$29.50
TELEFUNKEN:		
ECC83/12AX7	\$4.95	4.95
ECC82/12AU7	\$23.95	10.95
EL34/6CA7		
VALVO:		
ECC83/12AX7	\$4.95	7.95
GZ34/5AR4		

Tube price lists are not available due to frequent stock/price changes. Quotes provided on request for other than advertised tubes. Save 10% and get a complete Retube Kit for and specific unit.

Now! HARTLEY 8", 10", 18", 24" drivers and complete systems. Send orders and inquiries to: SOUND SERVICES, Lake Walton Road, Wappingers Falls, NY, 12590. Telephone: 914-226-5414.

WANTED: WE 594A OR 555 DRIVER and other WE, Speakers, Amps, horns. P.O. Box 962, Hollywood, CA 90028. (213) 851-1107.

WHERE THE BEST IS CLEARLY A BARGAIN

If you're wondering which way to go, try advice that has evolved from hundreds of mistakes. Through trial and error we have finally resolved most compatibility issues, and we can tell you just what works and what doesn't.

We currently stock a complete selection of audio gourmet items including virtually everything called "best" by the audio guru crowd, or by our own golden eared staff.

Unless a sealed box is requested we audition and check all equipment prior to shipment, and we prepay freight to any of the 48 contiguous states.

We offer Acoustat...Beveridge...Bryston...Dahlquist...Dayton Wright...DB Systems...DCM...Denon...Dynavec...G.A.S...Grado Signature...Hill Plasmatronics...JR 149...KEF (105s drivers)...Linn Sondek...Lux LSS...Paragon...RH Labs...Promethean...Rogers...Spatial Coherence...Stax...Tangent...Threshold...Verion...Win Labs...and more!

AUDIO DIRECTIONS

8898 Claremont Mesa Blvd. San Diego, Calif. 92123 (714) 278-3310 Visa/Mastercharge orders accepted.

FOR SALE

ULTIMATE REFERENCE COMPONENTS: UPDATE
At Audio one, we are proud to present a new standard in electronics:

THE SPATIAL COHERENCE PREAMPLIFIER

Designer Richard Knapp, has developed a new amplification process utilizing the TFET-Valve (also developed by Mr. Knapp). The sonic result of which, reaches a new frontier of reproduction quality. In particular, the spatial relationships (e.g. depth, localization, etc.) and musical timbres are reproduced with a degree of realism that is absolutely astonishing! The Spatial Coherence preamplifier will make a *MAJOR* sonic improvement in *ANY* system regardless of the preamplifier currently used. One audition will spoil you for anything else. The way the information from disc is suspended in space, the retrieval of ambience, the dynamic range, the correctness of timbre and the incredible definition are all parameters that you will hear for the first time on the Spatial. Literature and technical details of this new technology are available and a backlog of orders has already begun. We suggest you contact us immediately for further information.

We have a rash of new and exciting products for the audiophile. From Britain, the Tangent loudspeakers ranging from \$99.95 to \$499.95, featuring bextrene cones and time corrected crossovers. The superb Armstrong 602 speaker in mirror-imaged rosewood pairs. The first table to sonically surpass the Linn, the STD 305D. From America, the time and pulse aligned MZ Mod 3 speakers. Audionics new belt drive turntable (we have excellent delivery on Audionics CC-2 amplifiers). The Promethean Phase II A cartridge. Additionally, we have a new reference speaker cable. The Lenco-clean "wet" record playing system that doubles both record and stylus life, for \$24.95! The Stylift. The Grace 707 mkII tonearm. Our incredible selection of direct and reference discs (well over 50 titles) and much more. When it comes to musical accuracy, Audio one is not just another alternative. Audio one . . . is the answer!

AUDIO ONE

167 N. Woodward Birmingham, MI 48011 (313) 646-6666

TF

VAN ALSTINE DYNA MODS FOR ST-400, ST-416, ST-410, ST-150, PAT-5, PAT-5 BIFET FM-5 are still the best. New \$10.00 improvement kit for Dyna PAT-5 BIFET. Double 400 conversions for both ST-400 and ST-416. Free mod instructions for ST-70, MK-111 and PAS-3X. \$100 audio circuit mods for ARC SP3-A1 All new DC coupled VAN ALSTINE MODEL 1 preamp and MODEL 2 power amp. Crown tape electronic mods coming soon. Jensens Stereo Shop, 2202 River Hills Dr., Burnsville, Minnesota 55337 612-890-3517 12-8

VACUUM TUBES

and tube-peculiar parts. We offer a complete inventory of high voltage capacitors, precision resistors and tubes. Kits or separate parts available for building circuitries described in our 220 + page Audio Modification Manual. Write for parts list and literature. AUDIO DIMENSIONS, 8898 Clairemont Mesa Blvd., San Diego, Calif. 92123. 12-9

ZERO NEGATIVE FEEDBACK

It is now possible for you to drive your favorite speaker system with electronics that do not require the crutch of negative feedback. The RAPPAPORT PRE-3 preamplifier and RAPPAPORT AMP-1 class A power amplifier do not use any negative feedback. AUDITION the RAPPAPORT REAL TIME ELECTRONICS at

AMERICAN AUDIOPHILE
5 SUNRISE PLAZA, VALLEY STREAM, NY 11581
FOR APPT. 516-561-7114

ALL SHIPMENTS PREPAID AND INSURED
FREE THROUGHOUT CONTINENTAL U.S.

120W TUBE!!

ADI now offers a limited number of new Dyna MKVI amplifiers, kit or assembled, plus a remarkable modification for that circuit which converts it into an edge-of-the-art tube powerhouse suitable for anything from Rogers to Dahlquist speakers. Innovative biasing system eliminates need for matched sets of output tubes. Basic kit \$435. Assembled \$645. Mod kit \$75. AUDIO DIMENSIONS, 8898 Clairemont Mesa Blvd., San Diego, CA 92123. Visa/Mastercharge orders accepted. (714) 278-3310.

AUDIO • January 1979

FOR SALE

"We believe the PRECISION FIDELITY C4 to be the finest sounding and finest built tube preamplifier we have been able to find to this date. Anyone that does not avail himself of the privilege to compare the C4 with the unit of his choice may be remiss in making a proper judgement."

Jonas Miller,
Jonas Miller Sound, Inc.

Peter McGrath
Sound Components, Inc.

Introducing the PRECISION FIDELITY C4 vacuum tube preamplifier. Write for more information and your nearest dealer to: Precision Fidelity, 1169E Chess Dr., Foster City, CA 94404.

WE'VE SPENT MORE THAN TWO YEARS DESIGNING AND DEVELOPING THE VERY BEST DESIGNED AND BUILT CABINETS AND RACKS FOR HOUSING STEREO COMPONENTS. FEATURES INCLUDE: —Flexible modular design expandable to suit any size system. —Accommodates any size components including the largest. — Totally enclosed design with locks prevents dust buildup, unauthorized tampering, or theft of valuable equipment. — Bottom casters for mobility and rear door for easy rear access. Special separate record or tape storage module. — High grade furniture design, materials, and construction. — Low prices because you buy direct from the manufacturer. Send 25¢ (stamps O.K.) for our latest illustrated brochure. Custom Sound Service, Algonac, Mich. 48001. (313) 794-5400.

WHAT COSTS LESS than a direct-to-disc recording, is more fun, plays longer, and never wears out? The Hi-Fi Game! Immediate delivery. \$11.95 to Penijon Games, Box 2129, Martinez, CA 94553. 8-9

YAMAHA RECEIVER, CR800 built in noise reduction on phono & FM, mint \$375 (215) 843-2576

FOR SALE

WISCONSIN HAS: Audionics, Denon, Luxman, Hafler, Polk, Soundcable, Mayware, STAX, Mirco-Acoustics, Infinity, Connoisseur, Lit. and prices on request: The Sound Seller, 1706 Main St., Marinette, WI 54143. 715-735-9002. 1-9

WORLD AUDIO WESTCHESTER, INC.

Westchester's finest audio sales and service dealer is proud to announce the addition of:

Celestion Speaker Systems

to the already fine lines of Lux, Soundcraftsmen, Thorens, Audio-technica, ADC-BSR, AR, AKG, CM LABS, DBX, DECCA, JVC, Jensen, M.A., Optonica, Phillips, Pickering, Pioneer, Stanton, Supex, Sonab, Tandberg. Direct to disc records. Shipping is free in continental U.S.

WORLD AUDIO WESTCHESTER, INC.

211 North Avenue
New Rochelle, NY 10801
914-576-3230

1-9

Bob Heenan Sells Great Used Equipment

Tel: 617-734-2727
Sound Advice
Box 782
Brookline Village
MA 02147

AR	Marantz (Tubes)	SAE
DB	Magneplanar	Sony
EPI	McIntosh	Stax
Bose	Levinson	Quad
B & W	LS3/5A	Revox
Crown	H - K	Yamaha
Advent	Linn	Thorens
Dahlquist	GAS	Tandberg
Dyna (Tubes)	JBL	Nakamichi
Audio Research	Lux	Phase Linear

Money Back Guarantee

**Sound Advice, Box 782,
Brookline Village, MA 02147**
Equipment bought, sold, traded & brokered.

poor

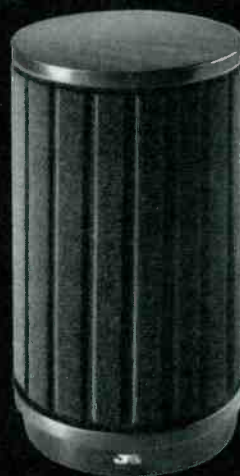

little speaker. He's just come from England, and someone mean told him that Americans think good loudspeakers should be large and come in boxes. But he's little and cylindrical, and he wants to let everybody know how outstanding he really is. Won't you help him make friends here?



H & H International, 354 State St., Rochester, N.Y. 14608 • 716/325-5275

FOR SALE

AUDIO HORIZONS

P. O. BOX 10973
St. Louis, Missouri 63135

Our first issue, which is now available, contains reviews of thirty-four audio-ophile-grade components. Featured in this first issue is a survey of ten moving-coil step-up devices, which include the AUDIONOTE, DENON and VERION transformers, and the DB SYSTEMS, DENON, LENTEK, LEVINSON (AC and DC), LINN/NAIM, and MARCOF pre-amplifiers.

The second issue of AUDIO HORIZONS™ is nearing completion and should be available shortly. It contains the largest survey of esoteric/high-end phono cartridges ever assembled by any American review publication. Included are in-depth reviews of the G.A.S. Sleeping Beauty Shibata, SIGNET MK-111E, NAGATRONICS HV-9100, DYNAVECTOR 2BA, 20B, 20C, and 1DX, JVC MC-1 and MC-2, ORTOFON MC-20 and MC-10, SONY XL-55 and over twenty other moving-coil and induced-/moving-magnet cartridges.

Subscription rates to AUDIO HORIZONS for six issues are: U.S.A. \$18 (sent First Class), Canada \$20 (sent First Class), and outside North America \$24 (sent Air Mail).

FOR SALE

FOR SALE

ANTI-SKATING for AR TURNTABLES!! Proven counter-weight design of nickels steel & aluminum construction. Install yourself in minutes. \$7.95 postpaid. (Dealer inquiries invited.) AUDIO INNOVATIONAL PRODUCTS, P.O. Box 1607, Portsmouth, N.H. 03801.

• **APT-HOLMAN PREAMPLIFIER** • Hafler Preamplifier • Dahlquist • Satin • Chartwell • Signet • Nakamichi • McIntosh • IMF • B & W • Crown • Quad • Bryston • Revox • Lux • Verion • Audio Consultants, Inc., 517 Davis Street, Evanston, IL 60201, (312) 864-9565 Audio Consultants, Inc., 757 N. Milwaukee Ave., Libertyville, IL (312) 362-5594. Write for our monthly list of used equipment bargains.

APT/HOLMAN PREAMPLIFIERS BY MAIL

Tom Holman rocked the audio world with his new preamplifier designed for the Advent receiver. Now he's taken his work to the ultimate refinement in the APT preamplifier. The APT is the on State of the Art and has more flexibility and unique features than preamplifiers 3X the price. The APT lets you control BOTH resistance and capacitance for any cartridge. Now you can own an APT no matter where you live in the continental U.S.A. Write for quote to Designatron 260 Old Country Road Hicksville NY 11801. (516) 822-5277. Master charge/Visa.

ATTN: LEACH AMP BUILDERS: news letter & hard to find parts sources. Prebuilt details. TA, BOX 90 RRI, Surry, ME 04684. 12-8

ARC D-150 \$1800, SP3A-2 \$400, BRAUN TG-1000 DECK W/REMOTE \$500 (50 HRS), AKG D224E MIKES \$275/PR TUBES GE 6550 ARC MATCHED QUADS \$75/4

702-293-4795

ARIZONA AUDIOPHILES

Dahlquist, S.A.E., Revox, Rabco, Nakamichi, Yamaha, Crown, Grace, Stax, Tandberg, Sonab, Supex, Gale, Klipsch, Phase Linear, Uher, Burwen, J.B.L., Harmon-Kardon Citation, A.D.S., Spectro Acoustics, Beveridge, Sennheiser, Teac, Thorens, Stanton, Aiwa, Stax, Micro-Seiki, Fidelity-Research, Genesis, Optonica, R.T.R., B&W, Toshiba, DBX, Signet, Mitsubishi and Mitsubishi V.S.S.

JERRY'S AUDIO EXCHANGE

PHOENIX—334 E. Cambridge Rd. (602) 263-9410
TEMPE—130 E. University Dr. (602) 968-3491
TUCSON—5750 E. Broadway. (602) 622-7407
MAIL ORDER HOT LINE—MR. WOZ (602) 265-7841

TF

AT LAST! A HYPE-FREE SPEAKER AD!

The VMPS TOWER II guarantees the following performance specifications: less than 0.7% THD 22Hz-20kHz/1W drive; anechoic response -3dB at 22Hz; 250W power handling; high efficiency (103db/1W). ALSO: biamping w/o ext. xover. THREE 12" woofers, butyl-sulround midrange, top&forward-firing tweeters in a slim 5 ft walnut cabinet. The sound! With good electronics, that of live music. The TOWER II costs \$549 ea; easy-to-assemble KIT available factory-direct \$369 ea incl. shipping. ITONE AUDIO 7301 Rockway El Cerri to Cal 94530 (415) 526-7084; dealer enquiries invited

AUDIO MODIFICATION MANUAL

220+ pages of priceless information. Step-by-step procedures for many common components, general information applicable to almost anything you own. Emphasis on tube circuitry. **AUDIO:** "... a wealth of ideas. ..." **STEREOPUS:** "... easy to read, entertaining. ... a painless education. ..." **HIGH FIDELITY:** "... chock full of goodies. ..." This unique book provides information available nowhere else. Includes one year's free consultation service. \$25. U.S.A., \$27. elsewhere. California residents add \$1.50 tax. M/C, Visa orders accepted: (714) 278-3310. AUDIO DIMENSIONS, 8898 Clairemont Mesa Blvd., San Diego, Calif. 92123. TF

AUDIO-RESEARCH D-350 (Save \$1,000 on latest model) \$1995 206-325-1948.

ATTN: LEACH AMP BUILDERS: news of hard to find parts sources and news letter. Also prebuilt models. Transcendental Audio, Box 927, W. Cornwall, CT. 06796 41c stamps please *

Audio and TV tubes factory boxed, speakers, semiconductors—low prices, free price list. Transisletronic Inc., 1365-39th St. Brooklyn, N.Y. 11218 212-633-2800 TF

AUDIO BARGAINS — FREE LIST. Closeout/Bankrupt specials Stereo Cost Cutters, Box 8014A, Canton, OH 44711 2-9

AUDIO DEN LTD.

Long Island's leading audio store has on demonstration,

THE STATE OF THE ART

AUDIO RESEARCH ELECTRONICS

(THE NEW SP6 TUBE PREAMP)

THE NEW ACOUSTAT MONITORS

EMT & GREADD SIGNATURE CARTRIDGES

(AUDIO CRAFT) ULTRA CRAFT UNI-PIVOT TONEARM

We also have the following lines, B&O, Chartwell and new Chartwell woofer, CM, Denon, Fulton, Grace, Koss, Luxman, Magneplaner (including Tympani series), M&K woofers, Nakamichi, Polk, (Quad ESL and electronics), Rappaport, Rogers, RTR, Sonus, Thorens, Yamaha, largest selection of direct discs on Long Island.

FREE INSTALLATION IN NEW YORK AREA

WITH IVIE SPECTRUM ANALYZER.

ALL GOODS SHIPPED PREPAID AND INSURED — COME SEE THE WORLD'S FINEST RECORD CLEANING MACHINE BY KEITH MONKS.

AUDIO DEN LTD.

1320-34 Stony Brook Road
Stony Brook, New York 11790
516-751-3350 TF

AUDIONICS in Eastern Pennsylvania, at **AUDIOWORKS**, Box 4314, Harrisburg, PA 17111. Tel. (717) 652-6996 for info and appointment to hear.

AUDIOPHILE CLEARANCE

Pyramid Metranome 2 speakers	demos	\$1200.00 pr.
Phase Linear A III (latest) speakers	new	799.00 set
Db 1 & 2 preamp	demo	399.00
G A S Thalia preamp	demo	199.00
G A S Thoebe preamp	demo	349.00
Marantz 3300 preamp	used	149.00
Marantz 7T preamp	used	119.00
Van Alstine 1 preamp	new	360.00
Van Alstine 2 amp	new	600.00
SAE 2B amp	used	299.00
Gately EK 6 echo wired	demo	199.00
Gately SM 6 mixer wired	used	249.00
ADC LMF 1 tonearm	new	135.00
ADC LMF 2 tonearm	new	142.00
Grace 704 tonearm	new	135.00
SME 3009 II tonearm	new	99.00

all items subject to prior sale

Send check, VISA, MC

Stereo Lab

2244 Neil Avenue

Columbus, Ohio 43201

(614) 294-4743

132

TASCAM by Teac

... we've got the line in stock at the old prices.

CALL OR WRITE TODAY

CUSTOM STEREO

1391 S. Hamilton Rd. Columbus OH 43227
614/235-7575

AT SOUND COMPONENTS, INC. WE'VE GOT IT ALL.

Audionics Bang & Olufsen Beveridge Cylindrical Bryston DCM . . . Denon . . . Dynavector . . . Fidelity Research . . . Fulton . . . Grace . . . Great American Sound . . . Hafler . . . H.Q.D. Reference System . . . Janis . . . KEF . . . Kenwood Purist . . . Linn Sondek . . . Magnepan . . . Mark Levinson . . . Paragon . . . Pyramid Metronome . . . Quad . . . Rega . . . Rogers . . . Sonex . . . Sendor . . . Stax . . . Verion . . . Yamaha . . .

Master Charge & Visa accepted

We ship prepaid within U.S.

SOUND COMPONENTS, INC.

2710 Ponce de Leon Blvd., Coral Gables, Fla. 33134
(305) 446-1659

BUILD YOUR OWN SPEAKERS

Save 50% or more...



FREE KIT BROCHURE I'm interested—send me your free brochure (kits from \$59.00 each)

\$1.00 catalog/manual Give me all the details send me your comprehensive speaker manual on kits, x-overs, raw components and engineering data \$1.00 enclosed.

Acusta Craft

Dept. AU P.O. Box 12030 Shawnee Mission, Ks 66212

FOR SALE

AUDIO RESEARCH D-76A amplifier, mint cond. \$750 Eves. (312) 327-9792, Days (312) 621-4156.

AUDIO RESEARCH D76A gold panel amp and SP3AI preamp \$1100 pair quad. ESL speakers \$750, mint 212-859-0228.

AUDIO RESEARCH D76A. Gold Panel Amp and SP3AI preamp. \$1100. Pair Quad ESL speakers \$750. Mint. (212) 859-0228.

AT PARAGON OF SOUND: New & Superb Conrad-Johnson tube amp and Berning FT 10 tube transistor preamp; Paragon 12A preamp, subwoofer amp, and now Integrated amp; In Speakers-M2 MOD 3, Rogers LS 3/5A, Snell Acoustic, and Acoustic Concept A19; Mrk and Fundamental Research subwoofers; Armstrong. 624 FNE tuner; Denon, Grace, Super and Dynauctor Products. Also used AFI preamp. Call 301-229-2676 (Bethesda, MD) or write P.O. Box 189 Cabin John, MD 20731 4-9

ATTENTION SOUTHERN AUDIOPHILES

Yamaha	Crown
Dahlquist	Polk
Audio	Denon
Bang & Olufson	Klipsch
Advent	Technics
M & K	Visonik
Aiwa	Sonus
Philips	Maxwell

Available at Sound Advice

Village Plaza Ruston LA. 71270 (318) 255-8000. 9-9

AWARD WINNING SONY XL-55 MOVING COIL CARTRIDGE This one is a sleeper. Hear the pure sound of coreless coil uncontaminated with iron hysteresis. \$175.00 incl. post. and ins. Also, SONY HA-55 super performance pre-amp. \$275.00. Send money order or specify Visa or Master Charge Number and Expiry to Western Sound — 619 Erin Street, Winnipeg, Canada, R3G 2W1, one of the largest hi-fi specialists in North America. 1-9

BACK ISSUE MAGAZINES. Over 200 titles. 1890 to 1978. Send stamped Envelope. Free List. Everybody's Bookshop, Dept. AU, 317 West 6th, Los Angeles, Calif. 90014. TF

BGW-1000 (2). Mint R. Bailey 216 Slade Ave. Balto., Md. 21208 (301) 486-4323. 3-9

BOULDER SOUND GALLERY, LTD. - COLORADO'S AUDIO DEALER WITH A POINT OF VIEW. WE CARRY LUX L.R.S., B&W, MARK LEVINSON, DAHLQUIST, POLK, CONRAD-JOHNSON, K-M SYSTEM, VAN ALSTINE, QUAD, ULTRA-PHASE, SUPEX, STAX, DENON, ADC TONEARMS, SIGNET, ENTRE, REVOX, B & O, JANIS, AND CHARTWELL LS 3/5 A. IF YOUR GOAL IS TO GET FROM THE SOURCE MATERIAL BACK INTO THE AIR WITH THE LEAST POSSIBLE CHANGE, WE CAN HELP. 1200 PEARL, BOULDER, COLORADO 80302, 303-444-2626.

B & O 4002 USES "ANY" CARTRIDGE with standard mounting centers after our modification. Effective mass 2.5 grams. Adjustable silicone damping. \$199.00 with money-back guarantee. JML Company, 39,000 Highway 128, Cloverdale, CA 95425 8-9

SPECIAL PURCHASE!



Sansui

Model QC-04 CD4 Four-Channel QUAD RECORD DEMODULATOR!

12⁹⁵ EA.

\$9.95 ea., lots of 3.
\$8.95 ea., lots of 100.

Sensational Factory Surplus purchase! A goldmine of parts and circuitry! 1500 in stock. With schematic. (5 lb.) 025HP099.

FREE! EXCITING CATALOG!

Hundreds of surplus & unusual items — Write today!

ETCO ELECTRONICS

Dept. 044,
NORTH COUNTRY SHOPPING CENTER
PLATTSBURGH, N.Y. 12901

FOR SALE

LEGENDARY.

Mark Levinson. Threshold. Grado Signature. Janis. Pyramid. Grace. Spendor. Rogers. DCM. Paragon. DB. Bryston. Paoli. Linn-Sondek. Bowers & Wilkins. Denon. Verion. Dunlap-Clarke. All these legends at Chestnut Hill Audio, 2302 Lombard Street, Philadelphia, Pa. 19146. (215) KI 6-6178.

CHESTNUT HILL AUDIO.

"BONGIORNO IS BACK"

After more than 1 1/2 yrs of absence we are proud to announce the new Sumo Amplifier. It is different in every way - and consistent with the advancements of designs by James Bongiorno.

In the past, Mr. Bongiorno has designed the Dynaco 400, the entire line of S.A.E. amps, and more recently the products from G.A.S. These were and still are great products. But time moves on and new progress and new ideas must be born.

The new Sumo amplifier will be at your dealer soon along with the Sumo preamp. They will also have features that are new and original, but at prices that can be afforded, in the Bongiorno tradition.

The Sumo cartridge
The Sumo Bridge
The Very Clever Little Crossover
The Sumo Preamp
The Sumo Amplifier

See Them Soon
SUMO ELECTRIC CO. LTD.
1230 N. Horn Ave.
W. Hollywood, CA 90069
(213) 659-4370

FOR SALE

B&W DM6 Rosewood evenings after 7 est (201) 447-0391

CAMPUS AUDIO. Lowest prices. All brands. for rates and catalogue P.O. Box 2232, Boulder, CO 80306.

COLORADO AND WYOMING! The area's finest specialty audio store. Grado, Winn Labs, Promethean, Supex; Connoisseur, Denon, J.A. Mitchell, Grace, Hadcock; Rogers BBC Monitors, J R 149, Allison, Shahinian, Spatial, Grafyx. Demonstrations, sales by appointment. Audio Alternative, 1124 East Elizabeth, Fort Collins, Colorado 80524. Mail order inquiries promptly answered. (303) 221-1496, Call 9-5. 1-9

AUDIO RESEARCH • JANIS • GALE • BREUER
• TECHNICS • **Audio Reference Systems** • MAGNEPAN •
808 • 732-3303 • Kahala Office Center
Suite 201 • Honolulu, Hawaii 96816
ROGERS • GREAT AMERICAN SOUND • SONEX

lower

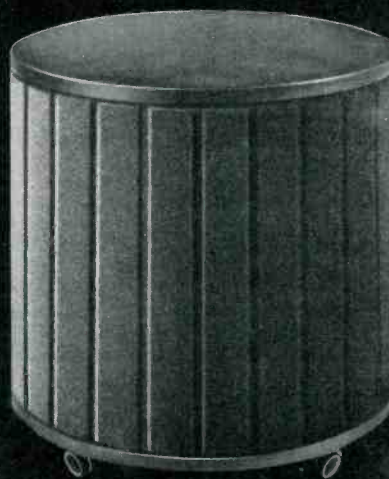

the response of your speaker system with the JR Super Woofer and LPA unit—our little brown box that segregates and amplifies the low frequencies. By the way, our LPA (Low Pass Amplified) unit can be used with other sub-woofers, too.



H & H International, 354 State St., Rochester, N.Y. 14608 • 716/325-5275

FOR SALE

COLLEGIATE RESEARCH PAPERS. ALL SUBJECTS. 10,250 ON FILE. IMPROVE YOUR GRADES! SEND \$1.00 TODAY FOR 256-PAGE CATALOG. RAPID DELIVERY. BOX 25918-AD, LOS ANGELES, CALIF. 90025. (213) 477-8226. 4-9

CONCRETE TURNTABLES BY MAIL

You won't get any feedback with Kenwood Concrete Resin Direct Drive turntables. Available "armed and armless" from Designatron. 260 Old Country Road Hicksville NY 11801. In stock. U.P.S. to continental U.S.A. Write for quote or call (516) 822-5277.

CROWN D150A AMP IC150 preamp. Mint. original boxes. manuals \$595 both. Walnut cases. \$50. (801) 486-6285

CROWN D60 amp, mint \$225. D150A amp, mint \$400 IC 150A preamp, mint \$295. Under warranty. (219) 293-7230

YES, KITS!

Glue, Screw & Goo Your Way To
The World's Finest Speakers



JANSZEN Z-40
BI-POLAR
ELECTROSTATIC

\$628 a pair
SEMI-KIT
(If Factory Assembled, \$940)

The legendary performance of electrostats is now affordable in this easy-to-assemble kit. The top of JansZen's new line is a 3-way hybrid system using separate, dual-electrostatic elements for the mid-range and tweeter.

These fourth generation, high power, ultra-low distortion, bi-polar units are loaded into carbon fiber based lenses to provide virtually omnidirectional dispersion for pinpoint imaging. A low crossover point is used to insure exceptionally clean, taut bass. Power handling: 20-100W.

Specs & prices subject to change without notice.

Fried, Dalesford Bextrene. Others from \$150 a pair.

NEW CATALOG

"The Speaker Specialists"

Sonikit 1173 C - 65th Street
Oakland, CA 94608

Here's my \$1 check—please send me your new catalog.

Name _____

A6

Address _____

City _____

State _____

Zip _____

FOR SALE

CONNECTICUT: A.D.S., Advent, A.P.T., Holman Audio Pulse, B&O, B.I.C., Citation, Dahlquist, D.C.M., Time Windows Epicure, Hafler Harman/Kardon, J.B.L., Mitsubishi, Nakamichi, Ortofon, Phase Linear, Micro-Acoustics, N.A.D., Stax, Tandberg, Yamaha, Cizek, Sonus. Will ship prepaid. Sounds incredible. 226 White St., Danbury, Conn., 06810. (203) 748-3889—phone quotes only. TF

CROWN I.O.C. BY MAIL ORDER

Now you can own Crown Professional I.O.C. Electronics no matter where you live in the continental U.S. It's available by mail order from Designation Stereo Store 260 Old Country Road, Hicksville NY 11801. (516) 822-5277. Write for quote.

DAHLQUIST DQ-1W subwoofer with DQ-MX1 crossover \$325. Sleeping Beauty cartridge new \$125. Microacoustics 2002e \$45. Sheffield S-10 \$85. 901-754-3010 1-3 p.m. C.S.T.

DAVID HAFLER IS BACK!

The man behind the original Dynakit is back with his own company and a new state-of-the-art preamplifier at a bargain price! Available as a KIT or CUSTOM ASSEMBLED by expertly trained wirers—each performance certified. For further details write or call AUDIOKIT—260 Old Country Road, Hicksville, N.Y. 11801 (516) 822-5749

DBX 129, 20 HRS. use. as new, under warranty, \$335. G. Litsey, 3900 Lomaland, San Diego CA 92106

DBX 3BX DYNAMIC RANGE EXPANDER — exc. cond., \$400 (203) 848-3318

DENON

Audition the superb line of DENON direct drive turntables, tuners, amplifiers, tape decks, cartridges, transformers, arms, pre-preamps and equipment racks at: G-B ELECTRONICS P.O. Box 385 Hawthorne, N.J. 07507 (201) 427-8885 anytime for appointment.

DESIGN ACOUSTICS DEMONSTRATED NEW YORK AND NEW JERSEY

All Models in Stock

Phone your "MUSIC MAN" for demo appointment
212-463-1208 OR 516-621-2126

Custom Audio Systems Designed and Installed

the audio advocate

SME
AVID
POLK
ONKYO
SHURE
DECCA
DENON
QUATRA
LS 35 A
ARISTON
PARAGON
ACOUSTAT
MAGNEPAN
FORMULA 4
DAHLQUIST
NAKAMICHI
AUDIO RESEARCH

505 Millburn Avenue Millburn, NJ
(201) 467-8988

FOR SALE

DIAMOND NEEDLES and Stereo Cartridges at Discount prices for Shure, Pickering, Stanton, Empire, Grado and ADC. Send for free catalog. LYLE CARTRIDGES, Dept. A, Box 69, Kensington Station, Brooklyn New York 11218. For fast service call toll free 800-221-0906. TF

DISCO: MOBILE OR FIXED = CASH

START YOUR OWN DISCO BUSINESS. Complete 25 page start-up manual explaining sound and lighting systems installation written by Professional Disco DJ's and Designers. \$10.00 J.C. ENTERPRISES, P.O. Box 243, Apalachin, NY 13732 1-9

DOLBY NOISE REDUCTION KITS

Switchable or simultaneous encode/decode. Finest quality precision components, based on latest IC LM1011A, as seen in Audio articles. Also Dolby test tapes. Complete information from AJ INTEGRAX, Box 747, Havertown, Pa. 19083.

DYNA PAS 3X PRE-AMP, \$80. Dyna Mark III 60-watt power, \$80; SME 3009 S. II arm, with Spure III, \$85. All mint. 1-617-666-8386

DYNAVECTOR 505 \$295 206-325-1948

EAST BAY CITY JAZZ BAND. Indirect Disc. \$15 ppd. Free catalog. Decibel Records, P.O. Box 631 Lexington, Massachusetts 02173.

ELECTRONIC BARGAINS, CLOSEOUT, SURPLUS! Parts, equipment, stereo, industrial, educational. Amazing values! Fascinating items unavailable in stores or catalogs anywhere! Unusual FREE catalog. ETCO-008, Box 762, Plattsburgh, NY 12901 TF

ELECTRONIC CROSSOVERS—ALL TYPES. Updated definitive booklet describes applications, how to improve speaker systems. \$5.00 postpaid, credited to first purchase. Huntington Electronics, Box 2009A, Huntington, Conn. 06484 TF

Enjoy Better Music!! Detail analysis of acoustic performance of your room. Report shows how to improve sound quality. Send room and furniture description (measurement and material) with \$10 to Giotech Box 714-A.

ESOTERIC RECORDS

Direct-to-disc, super-disc and Film Music. Comprehensive, free catalog will astound and amaze! Cosmic Chords P.O. Box 4873 Boulder, Colo. 80302 3-9

FACTORY DIRECT SAVES YOU MONEY. We can help satisfy your needs for quality, performance, and style. From our small monitor (with KEF or AUDAX drivers) to our largest (KEF loaded) subwoofer. You would like your music better (not only for the sound but also the savings).

Crossover network, electronic or passive, capacitors and air core chokes are also available for your own projects. Do write soon. Common Wealth Electronics, 822 South Victory, Burbank, CA. 91502 846-6336

FALL-WINTER SALE

Audio Research SP-4A preamp., \$675; D76A amp., \$725; Tandberg TR2075 Releiver, \$750; 10X tape deck, \$825; KEF 105 speakers, \$980 pr.; GAS thoebe preamp., \$395; tin ear, 704 Symons, Richland, WA 99352 (509) 946-4459 2-9

FAMOUS FRIED SPEAKERS IN KITS

Now you can build your own Fried speakers from kits. Model B-II, Satellite kits, Model T subwoofer kits at bargain prices. Ship U.P.S. to continental U.S.A. Write for quote to AUDIOKIT 260 Old Country Road, Hicksville NY 11801. (516) 822-5749.

FLINT-MICHIGAN Mordaunt-Short, Audionics, Linn Sondek, M&K Subwoofers, Bryston, Sound Concepts, Watson Labs, Rogers, Visonik-David, Conrad-Johnson, Spectro-Acoustics, Supex, Grace. Rice paper record covers 25 for \$7.50. Gonza speaker wire. 40 per ft. Samples \$1.00 Audio House, 5232 Sagamore Dr., Swartz Creek, Mich. 48473 (313) 732-4670 by appoint. only.

FREE CATALOG ... CLASSICAL. Cassettes. Stereo Dolby ... Quality Guaranteed ... Discounted ... Credit Cards Accepted ... EKR Classics. GPO Box 1977AL, New York, NY 10001

ONLY THREE THINGS REALLY MATTER IN A PREAMP'S PERFORMANCE

1. Accuracy of frequency response
2. Low noise
3. Low distortion

The DB Systems DB-1A has...

1. The most accurate phono equalization available (± 0.07 dB 10Hz - 40kHz).
2. Noise as low as any on the market with actual cartridge attached (moving magnet type).
3. The lowest distortion of any preamp available (less than 0.0008%, 20Hz - 20kHz).

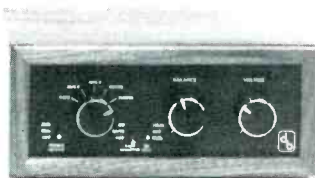

DB SYSTEMS • P.O. Box 187 • Jaffrey Center, NH 03454

FOR SALE

FM ANTENNA TESTS 6 FM, one TV antenna by Finco, JFD channel master, and winegard tested. FM sensitivity and directive patterns all compared to outdoor folded dipole. Signal loss due to leadin wires baluns, and signal splitters. Stacking of antennas. Send \$3.00 to Engineering Design Lab (antennas) Ca. State University, Sacramento, CA 95819

FORGET YOUR TROUBLE C'MON GET HAPI

The HAPI ONE (HPR/HCU) is a preamplifier and control unit featuring wide bandwidths, extremely low noise and distortion. Stu Hegeman has used op-amp techniques with flat gain and passive equalization to assure equal time delay for all elements in the musical spectrum. Audition the HEGEMAN AUDIO PRODUCTS preamplifier along with our other fine products by AUDIONICS, AGI, AUDIO TECHNOLOGY, CIZEK, DCM, DECCA, DENON, HADCOCK, HAFLER, HEGEMAN, JANIS, NEXUS, PEDERSON ACOUSTICS, RAPPAPORT SERIES 20, SHURE, SIGNET, SME, STD, SYMDEX, TANGENT.

AMERICAN AUDIOPHILE
5 SUN RISE PLAZA, VALLEY STREAM, NY 11581
for appt. 516-561-7114
ALL SHIPMENTS PREPAID AND INSURED
FREE THROUGHOUT CONTINENTAL U.S.

FORMULA 4 Universal Alignment Protractor, enables correct setting up of all tone arm assemblies and measuring tracking accuracy over entire disc surface. Original Hi Fi News review \$1. Protractor \$5 Bills only. Mayware Ltd. 15 Heather Walk, Edgware, Middlesex England. 12-8

FRIED "SIGNATURE" LOUDSPEAKERS

Featuring the B/2 mini monitor with higher SPL levels than its English counterparts through the world famous transmission line monitors H/2 and M/2. Southern California's only complete FRIED dealer Interface Communications Group 8489 West Third Street, Suite 54 Los Angeles, CA 90048 (213) 653-5696 11-8

FULTON J. MODULARS, 1½ yrs, \$1600.00. Sony TC-880-2 \$1450.00. Dynaco MK VI (Monotube), 219-432-2124. 1-9 p.m.

FUTTERMAN HANDCRAFTED tube amplifiers. Golden Ear Reference Loudspeaker system. Levinson JC-2 preamplifier, new \$1,250, another pristine \$1,175.00. Advent # 300 Receiver, new \$250. DBX # 122 Noise Reducer, new \$259.00. PML Professional stereo mikes ST-6 w/power supply, cables, etc. \$1,500 value, only \$900. Thaedra # 301 preamp, pristine \$600.00. C/M 607 Disco Mixer, new \$185.00. **WANTED:** Audio Research D-150's; Marantz 5's, 7c's, 8B's, 9's; McIntosh 275's, C-22's, MC-3500's; MC-2300's; Rabco tonearms. GOLDEN EAR, Box 2189, Riverview, Michigan 48192. (313) 479-1234.

G-B ELECTRONICS

Is pleased to offer:

The complete line of DENON turntables, electronics, cartridges, step-up devices and equipment cabinets. Come see and hear the direct-drive tables, cassette decks, tuners, integrated amps and moving coil cartridges.

The SNELL ACOUSTICS Type A Loudspeaker. Audition these superb full-range speakers proclaimed by review after review as the best speaker system currently available. reasonable priced too.

The GALE Loudspeaker. Come hear the 401 in either chrome or walnut. For those who want state of the art performance but are limited in space the GALE offers the only alternative.

Please phone for an appointment. **G-B ELECTRONICS** P.O. Box 385 Hawthorne, New Jersey 07507 (201) 427-8885. Sales & Service since 1945. 2-9

GO TO BED WITH MUSIC CONTROL-1 automatically switches your system off. Works with tapes or records. \$60.00. Electromedia, P.O. Box 265., Livingston, N.J. 07039. 12-8

FOR SALE

G-B ELECTRONICS

Components and custom service since 1945 for those who know live music.
Snell Acoustics Threshold
Spendor Denon Turntables
Symdex Denon Electronics
Gale Linn-Sondek
J. R. Connoisseur
Sonex Haddock
Thiel Audio Audio Source
Conrad Johnson Decca Products
Rappaport Stax
AGI Levinson
Leach Sheffield
Promethean Crystal Clear
Audition these and other fine components in our custom sound studios.
G-B ELECTRONICS
P.O. Box 38
Hawthorne, New Jersey 07507
(201) 427-8885 for audition appointment

G-B ELECTRONICS Components for those who know live music: Snell Acoustics, Spendor, Sonex, Symdex, JR, Threshold, Rappaport, Conrad-Johnson, AGI, Leach, Linn-Sondek, Ariston, Connoisseur, Promethean II Grace, Haddock, Levinson, Decca, Crystal Clear, Sheffield, Columbia Cable & many others. **G-B ELECTRONICS, BOX 385, HAWTHORNE NEW JERSEY 07507 (201) 427-8885 for appointment. Sales & Service Since 1945. 1-9**

HAFLER PREAMP HEADQUARTERS IN N.E. OHIO — THE LISTENING ROOM. CANTON, OHIO. (216) 452-6332, 9AM-7PM. 2-9

HAFLER — PREAMP, HEAD AMP, RACK MOUNT & KNOB KITS

We have in stock the DH-101K \$199.95, the DH-101A, custom or factory assembled, \$299.95, the DH-102 head amp \$74.95, the DH-103 black knob set \$19.95 and the DH-104 rack mount kit \$24.95. DH-101A with DH-102 installed by OAC \$375. Free shipping. Visa & Master Charge honored. Demonstration by appointment. OXFORD AUDIO CONSULTANTS, P.O. Box 145, Oxford, OH 45056. 513-523-3895. Also open evenings and weekends.

HADCOCK GH228: A NEW STANDARD IN TONEARMS

Judged by the English journals to be the finest-sounding tonearm irrespective of cost, the Haddock has become the new reference standard. Noted for its sense of openness and clarity and its consistent freedom from coloration, this arm comes complete with unilift cuing platform.

The Haddock features a low mass, viscous-damped unipivot design. It is now available in this country from **H & H INTERNATIONAL, 354 State St., Rochester, N.Y. 14608.**

FOR SALE

HAFLER DH-101 PREAMP

We expect to be in stock on this exciting new preamp by Dec. 12th. Kit price is \$199.95. Custom wired and tested, \$299.95. Immediate prepaid shipment shipment via UPS. **THE AUDIBLE DIFFERENCE**, 435 Tasso, Palo Alto, California 94301. (415) 328-1081. TF

Hafler DH-101 preamp \$200, Accuphase P-300 \$450, Trevor Lees preamp \$200, high level stage \$95. (707) 938-1131. 1-9

HAFLER PREAMP CABINETS. Literature. GEOMETRIX, Box 612, Mexico, MO 65265 7-9

HALF PRICE DAYTON WRIGHT XG 8 III speakers. 18 mos. old, Threshold Mod., Rosewood & white, mint condition., \$1450 plus shipping. Also Dynavector Arm \$350, Grado Signature I \$75. (312) 335-4011 evenings.

HARTLEY 24 in. transmission line. Equalizer below 40 hz. Wanigo Tacoma (206) 857-6635 evenings. 3-9

Western Pennsylvania's FINEST AUDIO

Mark Levinson
Bryston
Dayton Wright
Watson Lab
Snell Acoustics
Rogers LS3/5A
Van Alstine
Hegeman Hapi One
Hafler
Magneplanar
Dahlquist
Janis Woofers
M&K Woofers
Denon
Ariston
Connoisseur
Thorns
Fidelity Research

Supex
Grace
Black Widow
J.H. Formula 4
Decca
dbx
Verion
Nikko
S.A.E.
Luxman
Accuphase
Marantz
Armstrong
Sherwood Micro CPU
Infinity
AR
AEI
Visonik



PLUS MUCH MORE
Shipping Prepaid & Insured



OVATION

6019 Broad St. Mall Pittsburgh, Pa. 15206

412-441-4550



THE LABYRINTH™

What Ted Roger Karson of KA has done for the tapered acoustical trapezoidal line/labyrinth—Mike Wright and Harold Beveridge have done for the electrostat, Arthur Radford has done for the transmission line, and Paul Klipsch has done for the folded horn enclosure. All KA products now have trade marks and patents are pending.

KA/KUSTOM ACOUSTICS Inc.
6624 W. Irving Park Road, Chicago, Illinois 60634
(312) 685-6609

REFINED STEREO SPEAKER SYSTEMS SINCE 1968
MADE IN USA



Labyrinth—Left Channel

Labyrinth—Right Channel

FOR SALE

FOR SALE

FOR SALE

THE \$ENSIBLE SOUND

NEW—ISSUE #6—WE REVIEW THE FOLLOWING, PLUS MORE!!
 AGI 511A, Conrad-Johnson, Series 20 (Pioneer) C-21, Kenwood L-07C, Grado G1+ and F3E+, Ortofon MC-10 with STM-72, Pickering XUV-4500Q, Stanton 881S, Onkyo T-9 and Yamaha T-1 tuners, Dahlquist DQ-LP1, Audioplate, Allison 3, AR 15, Cizek 2, Fried H/2, Essence 8a, Micro-Acoustics MS-1, Sponder BC-1, Rogers Compact Monitor, ESS 10b, Kustom Impulse and Imp, Isophon DIA-2000, PSU II, Warpknott, Pixoff, Audio Technology 510, Nortronics QM4, Sound Guard, Uni-Sync PMS-1, Setton TS-11, Epicure 14, Denon DP-790, Onkyo T-4, Monitor Audio MA-4, Reviews of over 40 audiophile discs, a \$25 product that will improve the sound of your system, and our usual zero cost tips and inside industry info. **SUBSCRIBE TODAY: \$12 (4 issues) 3rd class mail, \$14 first class & Canada, \$17 foreign air mail.**
 403 DARWIN DR., SNYDER, NY 14226

HAVING TROUBLE FINDING DIRECT-TO-DISC AND SOTA RECORDINGS? WE HAVE THEM ALL. SEND FOR FREE CATALOGUE. KNOT SO CHEAP RECORDS, 7505 BIG BEND, DEPT. AM12, WEBSTER GROVES, MO. 63119. 1-8

HI-FI ENTHUSIASTS WANTED!!! Earn more than just spare money in your spare time. We need campus representatives to sell name brand stereo components at discount prices in your area. No investment required. Serious inquiries only please. Contact: Mail Order Dept., K&L Sound Services Co., 75 N. Beacon St., Watertown, Mass. 02172 **TF**

HIGH END FINALLY COMES TO SOUTH CAROLINA
 The finest audiophile equipment: British American Sound, P.O. Box 1247, 186 King St., Charleston, SC 29402 **1-9**

HIGHEST QUALITY USED EQUIPMENT: Stax SRA-12 preamp, \$275; Dahlquist DQ 10 spkrs, \$325 ea; Infinity Quantum Line Source Speakers, \$140 pr; Audio Pulse Model One, \$500; Audio Research SP 5, \$425; Yamaha C2 preamp, \$450; McIntosh 1900 receiver, \$600; Sony TA 3200 F amp, \$225; McIntosh C 28 preamp, \$450; Tandberg 2075 receiver, \$750; Sony 2251 turntable w/ SME arm, \$300; Phase Linear 2000 preamp, \$200; Tandberg 9200 XD deck, \$800; B & O 1900 receiver, \$395; B & O 3000 turntable, \$210; Marantz 3600 preamp, \$250; Marantz 250 amp \$295; Nakamichi 700 cassette deck \$650; Thorens TD 125 AB turntable, \$275. All used equipment guaranteed 90 days parts and labor. Audio Consultants, Inc. 517 Davis Street, Evans-ton, IL 60201. (312) 864-9565.

How is it that the inefficient, noisy, distortion prone, archaic vacuum tube can retain any acceptance among serious audiophiles? Why do manufacturers, large & small still expend enormous creative energy in designing and making tube equipment? Who cares? We do... **MR. AUDIO'S BIMONTHLY** expounds the gospel of tube equipment but not at the exclusion of all else. We concede to permit solid state MC head amps, xovers, bass amps & the like in a music system. The tenacity with which tubes cling in spite of advanced solid state technology is a mystery to some — but not to us. **MR. AUDIO'S BIMONTHLY** — 6 issues 1st class \$15. Overseas \$18 — P.O. Box 3022, Monterey, Ca. 93940.

IS YOUR PREAMPLIFIER "STATE OF THE ART"?
 The new Crown DL-2 preamplifier is the result of a totally uncompromised effort to design the quintessential preamp. Only Crown has the engineering expertise to conceive and construct a preamplifier whose sound quality surpasses its superior specifications.

Discerning audiophiles know that **BARCLAY** is also dedicated to satisfying those listeners who strive for the finest musical reproduction attainable. We feature the complete Crown "Distinction Series," including the new SA-2 amplifier (500 watts/4 ohms) and the EQ-2 equalizer (unquestionably the world's best). Visit our showrooms to see and hear the Crown DL-2 preamplifier: tomorrow's "state-of-the-art" preamp available today.

BARCLAY RECORDING & ELECTRONICS
 233 East Lancaster Avenue
 Wynnewood, Pa. 19096
 (215) 649-2965 **1-9**

In Central Illinois
AUDIO LTD brings you the finest in components:
 KEF David Hafler GAS
 Quad DB Systems Cizek
 Grace Quatre Dynaco
 Rogers JVC Allison
 Tangent JR Ampzilla
 Direct disc too. 115 N. Walnut, Champaign 61820 **3-9**

PHONO INPUT FILTER
 Don't let interference from CB, ham radio, broadcast stations, TV games, hobby computers bug your Hi-fi system. Just plug **PHONO INPUT FILTERS** directly into phone input jacks for interference-free enjoyment. Send **SASE** for free interference cures. At your dealer or order direct.
ELECTRONIC SPECIALISTS, INC., Dept A
 171 South Main St., Natick, Mass. 01760
 **SET OF 2 \$8.95**

STEREO COMPONENT Video Tape Equipment
AKAI • B-I-C • Harman Kardon Phase Linear • ALTEC • Kenwood • TEAC • Marantz • Sony • Technics • Sanyo • JVC • JBL • Pioneer • Dual • RCA Photographic Equipment Too!
TO ORDER CALL TOLL FREE (800) 421-8537

Henry's
CAMERA • HI-FI • VIDEO
 516 W. 8th St. Downtown L.A., Ca. 90014 Tel. 488-0341

The Apt/Holman Preamplifier

For literature, the name of your local dealer, and ordering information, please check the box.

For a collection of five technical papers by Tom Holman, please check the box and send \$2.00.

Name _____
 Address _____

Apt Corporation Box 512 Cambridge, Massachusetts 02139

IMF TLS-80 MON. SPEAKERS. Will accept reas. offer. Alex (215) 335-1926 Alt. 6:00.

INFINITY QLS best cash or trade. Dr. Adams (803) 765-6116. **1-9**

INFINITY QLS-1 speakers, newest model \$1600.00 Tom (216) 524-1185.

INFINITY SERVO STATICS in mint condition with transferrable warranty. Call (617) 648-4191 before 8 p.m. EST.

INSIDERS know that **AUDIO FORUM MAGAZINE** provides the most extensive coverage of the esoteric audio market. . . . **DO YOU!?** Audio Professionals know how **AFM** helps them keep in touch with the ever-changing audio market with vital information — often exclusive, always first, months before the others. Audiophiles like the first reports on new equipment, ways to improve their systems, and increasing their understanding of some of audio's most complex and controversial topics. You should subscribe today. Send \$18 (1st class) or \$22 U.S. (overseas air) for six bi-monthly issues to **AFM**, Box 22544, Portland, OR 97222. **BAC/MC** honored. Full **MONEY BACK GUARANTEE** if not satisfied.

IS THIS TOO GOOD A DEAL?
 After listening at length to the many moving coil step-up devices currently on the market, we are convinced that the **Marcof PPA-1** pre-preamplifier is sonically superior to all of them regardless of price. The **PPA-1** is cleaner, faster, more transparent, and less colored than any transformer or pre-preamplifier from any other manufacturer. Simply put, the **Marcof PPA-1** is the most musically accurate step-up device currently available.

We invite you to try your favorite moving-coil cartridge with the **PPA-1**. We guarantee that you will be pleasantly surprised with its unbelievable clarity and transparency. We also guarantee that until you have auditioned the **Marcof PPA-1** you have never really heard your moving-coil cartridge. You will find, after comparing the **PPA-1** to your previous step-up device, that a significant portion of your cartridge's "Sound" was actually coloration contributed by the previous step-up device.

Agreed, at our introductory price of \$89.95, the **PPA-1** is grossly underpriced, compared to its overpriced competition. However, we felt it necessary to introduce a unique combination of quality and price. With our two-year limited warranty and 30-day money-back guarantee, you can't lose. Unfortunately, even introductory prices can't last forever. As of January 1, 1979 the **PPA-1** will cost \$119.95. So take advantage of a good deal now. Certainly you will find, as others have, that the **Marcof PPA-1** is not only the best sounding step-up device available, but that it is also one of the biggest bargains in audio history. Check with your favorite audio dealer. If he is not yet stocking the **PPA-1** you may order direct, postage paid.
Marcof Electronics, 7509 Big Bend Blvd., Webster Groves, Mo. 63119 (314) 968-2170

IT'S THE UNEXCELLED FM REFERENCE! The **FM Atlas** and **Station Directory**, with 112 pages of programming, technical data on nearly 5,000 stations of North America. It's a must for the traveler and the audiophile! \$3.95. **FM Atlas**, Adolf MN 55701. **1-9**

JDS SOUND, E.E.T.— 212 2.2 Speaker Cable, Nonreactive, for all class amps. \$70 per ft. Call for info. 5 p.m. to 9 p.m. Det area, 313-545-6892.

J. E. SUGDEN A48 Integrated Stereo Amplifier \$350. P51 Mono/stereo power amplifier \$300. C51 Control unit \$225. In factory sealed cartons. Complete array of printed boards and spares for Quad 33 & 303. R. Bernavides, 630 Sun Valley Ct. Indianapolis, IN 46217

TURNTABLES
 Denon • Visonic • Supex • Linn • Sondek
 Transcriber • SAEC • Grace • Sleeping Beauty
 AKG • Formula 4 • Dynavector • Mitsubishi

Audiocom HIGH TECHNOLOGY AUDIO
 177 Sound Beach Ave. • Old Greenwich CT
 Phone: (203) 637-3621

FOR SALE

JBL S&R SOVEREIGN - externally BI-AMPLIFIED or select internal cross-over network (JBL's newest Model LX-80). Dark solid oak cabinets — JBL's best speaker. As modified — \$2700. Will sell for \$1250. SAE Mark I-B preamp (W/wty) \$425; Mark III 144 wrms/ch amplifier w/meters \$425; Mark VI Digital tuner w/oscilloscope \$750. All SAE with solid walnut SAE cabinets and remainder of warranty.

ELECTROCOMPANET Two Channel preamp (from Norway) — \$600 **ROGERS LS3/5A** in ROSEWOOD (brand new) only ones here — \$675. P.O. Box 346 Wall St., Sta., NY, NY 10005; (212) 255-9076

JH FORMULAR 4 unipivot tonearm. New improved version. \$100 shipped anywhere. Dealers invited. Moonlighter Electronics, 117 Inverness, San Francisco, CA 94132 (415) 664-6703.

JH Formula Tone arms, new, \$110. **YAMAHA B-2** amp, demo, \$700. **YAMAHA C-2** pre-amp, demo, \$500. Both for \$1150 **SOUNDCRAFTSMAN MA 5002** Pwr. amp 250 w. per ch., demo, \$550; **LINN NAG20** Moving coil pre-amp, used, \$100. All demo equip. with new warranties. Vere Smith Audio, 16 W. Union St., Athens, Ohio 45701. Ph. 614-592-7708.

KEF B110, T 27 Celestion HF 5000. Crossover (2700, 7000 HZ), and enclosure. 919-832-2284. Leave message.

KENWOOD LO7M amps \$599 pr. DB 1&2 preamp \$299, both like new, call eve 614-882-2077

KLH 9 ELECTROSTATIC LOUDSPEAKERS, 2½ years old, excellent condition, \$1000. Marantz 8B, no cage, \$225. 603-749-2558.

LEACH LNF 1-A amp, \$395. SAE 1800 parametric equalizer, new, \$165. Mike, (608) 835-5580

LED POWER LEVEL DISPLAY plans, easy and inexpensive to build (about \$25). Send Only \$3.50 for complete plans and schematics to: P.O. Box 19686, San Diego, CA 92119

Levinson-Cartridge Pre-amp JC-AC-Mint condition. Bozak Woofers (8) -45- each. Also the following Cartridges-Sleeping Beauty, Decca 5, Denon 103 s. -75- yp 125- Grad Signature II -250-, all hardly used. 212 -HO 5-4717 or Buonocore 80-30 235 St., Queens Village, N.Y. 11427

LINN PRE-AMP FOR MOVING COIL CARTRIDGES: Audition this highly acclaimed step-up device and discover the incredible improvements it can make with your moving coil cartridge. The model PNAG is AC powered, and sells for \$250. Contact us to arrange a one week trial period. **AUDIO REPRODUCTION**, 217 College Ave., Blacksburg, VA 24060 (703) 552-6850. 1-9

LINN SONDEK — LINN NAIM — LINN MODIFICATIONS
We offer the remarkable Linn Sondek LP12. Hear it in an A-B demonstration and make your own decision. We also offer the 45 rpm adapters & friction hinged covers for the LP12, the superb Linn Naim dc & ac head amps and the Linn mods for the Grace 707 MK1 & MK2. By appt. Free shipping. **OXFORD AUDIO CONSULTANTS**, PO Box 145, Oxford, OH 45056. 513-523-3895.

LINN SONDEK OWNERS play 45 rpm records. 45rpm adapter finally available. Send \$50 to MH Audio Group Box 628 Orange, CA 92666. CA resid. add \$3 tax. Money back if not satisfied. 1-9

LOWEST PRICES: BOSE, SAE, NAKAMICHI, PHASE LINEAR, DBX, ADS, HK, JBL, AND MANY MORE. QUOTE FROM DYNAMIC SOUND, BOX 168, STARKVILLE, MS 39759.

LUX PD-121 turntable mint, (401) 847-8476.

LUX PD 121. Like New. \$350. (512) 892-1120 Nights. 1-9

SpeakerKit, Lambda Series

Charles Graham reports in American Record Guide, "The Model 5 (speaker) is probably the finest sounding and best buy for home listening available today, provided you assemble it yourself". Send 25¢ for details.



SpeakerKit Box 12A, Route 2, Menomonie, WI 54751

AUDIO • January 1979

FOR SALE

LOWEST DISCOUNT PRICES ANYWHERE on audio equipment. All major brands discounted. Write for quotes, K&L Sound Services, 75 N. Beacon St., Watertown, Mass. 02172. TF

LOWEST PRICES ON STEREO-ESOTERIC COMPONENTS & Tapes! Over 150 brands. Send #10 SASE for quotes. Audio Unlimited, 401 Reynolds Circle #12-C. San Jose, CA 95112 (408) 289-8875 1-6 Monday-Friday. 5-9

L.A.—SOUTHERN CALIFORNIA

STAX	KOSS ELECTRONICS
B & W	LINN SONDEK
DENON	ULTRACRAFT
OSAWA	AUDIONICS
ROGERS	TUNGSRAM
HOTWIRE	MERIDIAN

PROFESSIONAL SYSTEMS ENGINEERING

Executive Audio is of course a stereo store. However, in many ways it is more like a private practice than a normal store. We deal with people individually, on an appointment basis. This allows us to devote much more attention to individual needs than would be possible in an open-door environment. We know that no matter what you are used to you will appreciate the difference.

EXECUTIVE AUDIO

by appointment only (213) 394-6463
2210 Wilshire Blvd. suite 207 Santa Monica, Ca. 90403
Shipping prepaid, insured in U.S. 6-9

MAGNEPLANAR Tympani I, \$550. Dukane Ionovac tweeters, \$250. Mark Zenon, 2301 S. Jeff. Davis Hwy., Apt. 1231, Arlington, VA 22202 (702) 521-0836 evenings.

MAGNEPLANAR I-D, \$1000; MG-II w/MK subwfr. \$625; ARC SP-5, \$400; D-100, \$550. 703-378-4779

MARANTZ 10B, perfect \$725. Pain Ionofane tweeters \$200. (612) 922-7106.

Marantz 240 amp, \$240; Soundcraftsmen PE 2217 \$295. 919-832-2284. Leave Message.

MARK LEVINSON JC-2 systems D, complete update to ML-1 specs except power supply. (919) 787-0211 after 7 p.m.

McIntosh C-11 preamp, factory case, \$185; MC-225 power amp \$125. Heathkit XO-1 crossovers. \$1751 pair. 404-289-5374

McIntosh C-28 in mint condition, \$390. McIntosh 2105 in mint condition: \$500. Sherwood Micro/CPU-100 with warranty card: \$1000. Heath AD-1304 expander \$100. David -212-586-6030.

FREE details. A DIFFERENT KIND OF RECORD CLUB

Discounts up to 73%, no "agree-to-purchase" obligations. All labels, Schwann catalog of thousands of titles; classical, pop, jazz, country, etc. Discount dividend certificates. Newsletter; accessories; quick service. 100% iron-clad guarantees. Write for free details.

DISCOUNT MUSIC CLUB, INC. DEPT. 14-179
650 Main Street, New Rochelle, N.Y. 10801

FOR SALE

MONTANA AUDIOPHILES DISCOVER ROCKY MOUNTAIN HI FI

DAHLQUIST	NAKAMICHI	SONUS
ACOUSTAT	GAS / AMPZILLA	GRACE
BEVERIDGE	AUDIONICS	VERION
DCM TIME WINDOW	HEGEMAN	STAX
FULTON/FMI	SONY	POLK

812 Central Ave., Great Falls, Montana 59401
Phone (406) 761-8683

MUM'S THE WORD

ON THE QE1 CP-1 PREAMPLIFIER. WE WON'T OVERWHELM YOU WITH THEORIES AND GRAPHS EXPLAINING WHY THE CP-1 IS "TECHNICALLY ACCURATE" YET JOYOUSLY MUSICAL. WOULD YOU BELIEVE US IF WE CLAIMED TO HAVE FOUND "THE ANSWER"? IF ANYONE DID FIND IT, DO YOU THINK THEY'D RUSH OUT TO TELL THE WORLD THE SECRET? THEORIES AND GRAPHS MAY STIMULATE INTERESTING DEBATE BUT THE REAL ANSWER EXISTS ONLY BETWEEN YOUR EARS.

AT QE1. WE STRIVE TO RECREATE AN AUDITORY HOLOGRAM THAT IS INDISTINGUISHABLE FROM THE ORIGINAL EVENT. IT'S ALL AN ILLUSION! WE ADMIT THAT BEFORE WE START, HAVE WE RECREATED A PERFECT ILLUSION? NOT YET. BUT WE WON'T TRY TO INVENT ILLUSIONS IN YOUR MIND WITH GRAPHS AND DATA. WE JUST COULDN'T COME UP WITH ANY COMBINATION OF INK AND PAPER THAT COULD RECREATE A CONVINCING AUDITORY HOLOGRAM. SO WE BUILT THE CP-1. FORGET EVERYTHING THAT'S IN BLACK AND WHITE AND COLOR GLOSSY. FIND OUT WHAT THE CP-1 CAN PUT BETWEEN YOUR EARS, BUT REMEMBER, IT'S JUST AN ILLUSION.

QE1
300 AUDUBON PARKWAY #80
SYRACUSE, NY 13224
(315) 446-8315

ACTIVE ELECTRONIC CROSSOVERS

Plug-in Butterworth (maximally flat) filters in 6 db., 12 db., or 18 db. per octave attenuation, any specified frequency. Complete crossover in attractive cabinet with all terminations and regulated power supply.

MONAURAL BI AMP	\$ 92.00
STEREO BI AMP	\$126.00
STEREO TRI-AMP	\$209.00
STEREO QUAD AMP	\$279.50

Suggested added features: Summer for "Single Woofer" systems, sub-sonic noise elimination filters; level controls.

FOR OEM'S AND HOME ASSEMBLERS
500 Series dual filters and/or plug-in filters; regulated power supplies.

WRITE FOR FREE BROCHURE AND PRICE SHEET

DeCoursey ENGINEERING LABORATORY

11828 Jefferson Bl. • Culver City, CA 90230
Phone: (213) 397-9668

BREATHLESS



Patented circuitry eliminates pumping and breathing.

For information write: RG Dynamics
4448 W. Howard St., Skokie, IL 60076



THE RG PRO-16W DYNAMIC PROCESSOR

Advertising Index

Advertiser	Page	Advertiser	Page	Advertiser	Page
Acoustical Manufacturing	24	Audio Research	70, 71, 72, 73, 74, 75, 76, 77, 78, 79, 80, 81	Discount Music Club, Inc.	137
Quad Speaker		Hi-Fi Components		Record Club	
Enter No. 48 on Reader Service Card		Enter No. 2 on Reader Service Card		Write Direct to Advertiser	
Acusta Craft	132	Audio Technica	115, 123	Discwasher	2
Speaker Kits		Stereophones		SC-1 Stylus Cleaner	
Write Direct to Advertiser		Write Direct to Advertiser		Write Direct to Advertiser	
ADC	59	Stereo Phono Cartridge		Dual (United Audio)	63
ADC Cartridges		Enter No. 3 on Reader Service Card		Tonearms	
Enter No. 49 on Reader Service Card		Ball	91	Enter No. 10 on Reader Service Card	
AIWA	83	Record Preservation Kit		Electronic Specialists Inc.	136, 147
Hi-Fi Components		Write Direct to Advertiser		Hi-Fi Components	
Enter No. 50 on Reader Service Card		B & F Enterprises	125	Write Direct to Advertiser	
Akai America	85	Hi-Fi Components		Electro-Voice	6
Hi-Fi Components		Enter No. 4 on Reader Service Card		Speakers	
Write Direct to Advertiser		BGW	111	Enter No. 11 on Reader Service Card	
Allison Acoustics	4	Hi-Fi Components		Empire Scientific	7
Used Loudspeakers		Enter No. 5 on Reader Service Card		698 Turntable	
Enter No. 51 on Reader Service Card		Bib	101	Enter No. 12 on Reader Service Card	
Altec	65	Hi-Fi Components		EMS, Inc.	144
Series-II Speakers		Enter No. 6 on Reader Service Card		Speakers	
Enter No. 52 on Reader Service Card		Bose	39	Write Direct to Advertiser	
Apt Cooperation	4, 136	Speakers		Etco	133
Preamplifiers		Write Direct to Advertiser		Quad Record Demodulator	
Write Direct to Advertiser		BTM Corporation	87	Write Direct to Advertiser	
Apt/Holman Preamplifier		Electrostatic Translator		Eumig	93
Enter No. 53 on Reader Service Card		Enter No. 7 on Reader Service Card		Cassette Decks	
The Audio Advocate	134	Chestnut Hill Audio	133	Enter No. 13 on Reader Service Card	
Hi-Fi Components		Audio Store		Fuji	23
Write Direct to Advertiser		Write Direct to Advertiser		FX-1 Audiotape	
Audiocom	131, 136, 147	Contemporary Sound Associates	149	Enter No. 14 on Reader Service Card	
Hi-Fi Components		Audio Components		Garland Audio, Inc.	146
Write Direct to Advertiser		Write Direct to Advertiser		Audio Store	
Audio Concepts Arcadia	146	Crown	15	Write Direct to Advertiser	
Hi-Fi Components		Preamplifier		Golden Gramophone	145
Write Direct to Advertiser		Write Direct to Advertiser		Hi-Fi Components	
Audio Critic	114	Custom Craft	109	Write Direct to Advertiser	
Publication		Loudspeaker Systems		Harman-Kardon	13
Write Direct to Advertiser		Enter No. 8 on Reader Service Card		Cassette Decks	
Audio Excellence	144	Custom Stereo	132	Write Direct to Advertiser	
Hi-Fi Components		Hi-Fi Components		Henry's Camera Store	136
Write Direct to Advertiser		DB Systems	134	Hi-Fi Components	
Audio Horizon	132	Preamplifiers		Write Direct to Advertiser	
Publication		Write Direct to Advertiser		H & H International	131, 133
Write Direct to Advertiser		DBX	53	Speakers	
Audio Insight	147	Noise Reduction Unit		Write Direct to Advertiser	
Stereo Equipment		Enter No. 9 on Reader Service Card		High Definition Recordings	145
Write Direct to Advertiser		Decoursey Engineering Lab	137	Direct-to-Disc Recording	
Audiophiles Sound Studio	144	Electronic Crossovers		Write Direct to Advertiser	
Sound Recording Studio		Write Direct to Advertiser		International Hi-Fi	126
Write Direct to Advertiser		Denon	Cover IV	Mail Order Hi-Fi Store	
Audio Potential	122	Hi-Fi Components		Enter No. 15 on Reader Service Card	
Gale Loudspeakers		Write Direct to Advertiser		J&R Music World	128
Enter No. 1 on Reader Service Card		Design Acoustics	120	Hi-Fi Components	
Audio Reference Systems	133	Speakers		Enter No. 16 on Reader Service Card	
Speaker Kit		Write Direct to Advertiser			
Write Direct to Advertiser					

Advertising Index

Advertiser	Page	Advertiser	Page	Advertiser	Page
JVC	16, 17	Phase Linear	19, 54	Sinus	99
Speakers		700 Series Two Amplifier		Loudspeakers	
Enter No. 17 on Reader Service Card		Enter No. 60 on Reader Service Card		Enter No. 38 on Reader Service Card	
KA Acoustics	135	2200 Series Two Preamplifier		Sonikit	134
Speakers		Enter No. 61 on Reader Service Card		Hi-Fi Components	
Write Direct to Advertiser		Pioneer	Cover II, 1	Write Direct to Advertiser	
KEF	112	PL-518 Turntable		Sony	45
Speaker Systems		Enter No. 55 on Reader Service Card		Hi-Fi Components	
Enter No. 18 on Reader Service Card		Playback	128	Enter No. 39 on Reader Service Card	
Kenwood	61	Discount Catalog		Sound Advice	131
KR-8010 Receiver		Enter No. 28 on Reader Service Card		Used Stereo Equipment	
Write Direct to Advertiser		PS Audio	18	Write Direct to Advertiser	
Koss	37	PS-3 Preamplifier		Sound Components, Inc.	132
HV/1A Stereophones		Enter No. 29 on Reader Service Card		Hi-Fi Components	
Enter No. 19 on Reader Service Card		Qysonic	119	Write Direct to Advertiser	
LT Sound	146	Array Speaker System		Soundcraftsmen	22
Hi-Fi Components		Enter No. 30 on Reader Service Card		Hi-Fi Components	
Write Direct to Advertiser		Radio Shack	55	Enter No. 40 on Reader Service Card	
Lux	51	Realistic's System Seven		Speakerkit Ltd.	137
LRS Components		Write Direct to Advertiser		Speaker kits	
Write Direct to Advertiser		RG Dynamics	137, 145	Write Direct to Advertiser	
3 M	47	Dynamic Processor		Speakerlab	126, 145
Master III Cassette		Write Direct to Advertiser		Speaker Catalog	
Enter No. 54 on Reader Service Card		RST Audio Products	144	Write Direct to Advertiser	
Marantz	150, Cover III	Precision Turntable Levels		Speaker Kit	
Hi-Fi Components		Write Direct to Advertiser		Write Direct to Advertiser	
Write Direct to Advertiser		SAE	41	Stanton	3
Maxell	27	180 Parametric Equalizer		Hi-Fi Components	
Hi-Fi Components		Enter No. 32 on Reader Service Card		Enter No. 41 on Reader Service Card	
Enter No. 20 on Reader Service Card		Howard W. Sams	49	Sumo	117
McIntosh	121	Audio Cyclopeda		Hi-Fi Components	
MX-113 Tuner Preamplifier		Write Direct to Advertiser		Enter No. 42 on Reader Service Card	
Enter No. 21 on Reader Service Card		Sansui	35	Take 5	144
McKay Dymek	109	Hi-Fi Components		Hi-Fi Components	
AM Antenna		Enter No. 33 on Reader Service Card		Write Direct to Advertiser	
Enter No. 57 on Reader Service Card		Saxitone Tape Sales	149	TDK	11, 38
Micro-Acoustics	28, 29	Magnetic Tape		Hi-Fi Components	
Phono cartridge 2002-e		Write Direct to Advertiser		Enter No. 43 on Reader Service Card	
Write Direct to Advertiser		Scott	21	Teac	56, 57
Mitsubishi	68, 69	Receiver		Hi-Fi Components	
Car Audio Components		Enter No. 34 on Reader Service Card		Write Direct to Advertiser	
Enter No. 22 on Reader Service Card		The Sensible Sound	136	Technics	5
Mordaunt Short	97	Hi-Fi Components		The RS-1500 4-track	
Speakers		Write Direct to Advertiser		Enter No. 44 on Reader Service Card	
Enter No. 24 on Reader Service Card		Series 20	14	Toshiba	95
Onkyo	89	Hi-Fi Components		Hi-Fi Components	
TX-4500 MKII Receiver		Enter No. 35 on Reader Service Card		Enter No. 45 on Reader Service Card	
Enter No. 25 on Reader Service Card		Shure	43	Trusonic	12
Osawa	113	Microphone		Hi-Fi Components	
Tonearm/Cartridge Combination		Enter No. 36 on Reader Service Card		Enter No. 46 on Reader Service Card	
Enter No. 26 on Reader Service Card		Signet	48	Wisconsin Discount	18
Ovation Audio	135	Phono Cartridges		Discount Hi-Fi Store	
Audio Components		Enter No. 37 on Reader Service Card		Enter No. 47 on Reader Service Card	
Write Direct to Advertiser		Yamaha	33	NS-10M Mini-Monitor	
PAIA	125	Write Direct to Advertiser		Write Direct to Advertiser	
Gnome Micro-Synthesizer					
Enter No. 27 on Reader Service Card					

FOR SALE

FOR SALE

FOR SALE

Audiophile's Sound Studio

7521 KENWOOD AVE.
CINCINNATI, OH. 45236
PHONE 513-984-0355

Handling only the finest in domestic and imported components, from B&O to the incomparable MARK LEVINSON HQD SYSTEM

7459 ELMWOOD AVE.
MIDDLETON, WI. 53562
PHONE 608-831-5955

A complete selection of "limited edition" records is available. Each store has private listening rooms, also professional sales and service staff. Delivery and set-up can be easily arranged. Send for a FREE copy of our BROCHURE and NEWSLETTER.

MIDWEST AUDIOPHILES

ELECTRONICS: Levinson, Lux, Apt Holman, Stax, Denon
SPEAKERS: B&W, Quad ESL, Magneplanar, Rogers, Dahlquist, B&O, Visonik, R.H. Labs
TURNTABLES: Denon, Lux, Micro Seiki, B&O, Connoisseur
TONEARMS/CARTRIDGES: Denon, Stax (CPY), Grado Signature, ADC, Nakamichi, Grace, Supex
TAPE DECKS: Revox, Nakamichi, Tascam
SOUND PROCESSORS: Ivie, DBX, Burwen, Audio Pulse, Advent
MICROPHONES: Neumann, Sennheiser, Beyer, Nakamichi
We ship, insured, at no charge to any address within the U.S.

David Beatty Stereo

1616 W. 43 St Kansas City, Mo. 64111 (816) 531-3109
7105 W. 105th St. Overland Park, Ks 66212 (913) 341-3500

**WOOFERS • MIDRANGES • TWEETER
ZERO PHASE ERROR CROSSOVERS**

High power handling 4 1/2" & 5 1/4" midrange units with 2.7 lb. magnet structures • One hundred watt 6", 8", 10" & 12" woofers with 4.7 lb. or 7.6 lb. magnet structures • High quality 1" cloth dome tweeter with 3lb. magnet structure • Wide dispersion, low distortion piezoelectric tweeter handling 150 watts r.m.s. • Revolutionary new ZERO PHASE ERROR CROSSOVER built on glass epoxy printed circuit boards for 2, 3 & 4-way systems • Crossovers are matched to system utilizing our drivers or systems utilizing the high quality POLYDAX units mfg. by AUDAX in France • Large inventory of nonpolar capacitors, non-inductive wire wound resistors & air-core coils.

SEND \$3.00 for prices & CATALOG of complete engineering data, application notes and simplified procedures for measuring Theile and Small's parameters — refundable with first order.

EMS, Inc. • P. O. Box 5301 • Knoxville, TN 37918

McINTOSH MC-2100, \$425.00. Two McIntosh MC-240 \$160.00 each • McIntosh MX-110, \$150.00 • Call (313) 525-4673 days after 6:00 est.

McINTOSH ML4C • Bos 901 II + chains - mint, \$1400 pr. • \$375 pr., ph. 504-346-1278 evenings. 2-9

MEASURE FREQUENCY RESPONSE OF ROOMS, SPEAKERS, electronic components, live instruments, etc. Hand-held Real Time Analyzer and Sound Level Meter with built-in professional quality condenser microphone can be used for recording. Reads to ± 0.5 dB. Ivie Octave Analyzer IE-10A, \$650.00. 1/2 Octave Analyzer IE-30A—with lots of extra goodies—\$2,800.00. Pink Noise Generator, \$175.00. Prices postpaid with money-back guarantee. JML Company. 39.000 Highway 128, Cloverdale, CA 95425 6-9

METAL FILM RESISTORS, RN55, 1%, 70 values from 10 ohms to 1 Meg., 12c ea. Send Stamped self addressed envelope for list of values. Gold plated panel mount phono jacks, 90c ea. Nylon panel insulators for jacks, 10 for \$1.00. Gold plated shielded metal phono plugs, \$1.00 ea. All ppd. Component Systems, 5556 Personality Court, Indianapolis, Indiana 46227 1-9

METRO—NEW YORK CITY

G.A.S., FR, Dahlquist, Bang & Olutson, Lux, Linn Sondel, AVID, Janis, Bauree & Wilkens, Grace, many others. Also issues of Absolute Sound.

UNIVERSITY STEREO—Ridgewood, N.J.
57 E. Ridgewood Ave—(201) 447-5700
20 minutes from G.W. Bridge 7-9

MICRO CPU 100 FM TUNER Retail \$2000, will sacrifice for \$900 with warranty. For information and laboratory test results, phone (219) 875-8123.

PRECISION TURNTABLE LEVELS

It is an established fact that record playback equipment must be installed perfectly level if optimum performance is to be obtained. The RST 301 is a precision made circular level enclosed in a chrome plated solid brass base. It is extremely accurate, simple to use and small enough to fit on virtually any turntable. (Can be used unmounted with equally good results.) Mounting screws and instructions supplied.



Accuracy: 0.1 inch bubble
travel per 0.945 of tilt
Base diameter: 1.25 inch
Price: \$10.95 ppd.
BAC VISA and MC accepted
N.J. residents add 5% Sales Tax
Send check, money order to:
RST Audio Products, Dept. A
361 Shore Rd.
Cape May Court House,
New Jersey 08210

DEALER INQUIRIES INVITED

MILWAUKEE! THE AUDIO EMPORIUM, where ears and minds are open! We're expanding! ARC, B&O, Connoisseur, Dahlquist, Decca, GAS, Genesis, Grace, Grado, Grafyx, Hafler, Kenwood Pro, Lux, M&K, Magneplanar, Polk Audio, Revox, Rogers, Shreve-Rabco, Sonus, Sumo Electric Co., Sulex Technics-Platter Pad, Audio Perfectionist Cables and the best selection of direct disks in town. OPEN Tues. thru Sat. 10-6, 6900 W. Brown Deer Rd., 354-5082.

**MILWAUKEE & WISCONSIN'S ONLY
TRUE AUDIOPHILE DEALER**

Specialists in components by Audio Research, Dahlquist, Transcriptors, SAE, Nakamichi, Bozak, MSE, DBX, Revox, Infinity, RTR, Phase-Linear, Tandberg, G.A.S., London-Decca, Stax, Sonus and over 50 others. Wisconsin's ONLY Audio Research dealer with their new product line on demonstration. Plus one of the truly largest displays of tape decks & accessories in the entire country. Over 130 machines on display. WACK ELECTRONICS, INC. 5722 W. NORTH AVE. MILWAUKEE, WI 53208 TF

MIXER made especially for tape duplication. Will produce enhanced high quality second generation tapes. KUHN ELECTRONICS, 1801 Mills Ave., Norwood, OH 45212. TF

NAKAMICHI 500 TAPE DECK \$185.00

Infinity ES-1 headphones \$135.00
PS audio preamp \$40.00
ADC XLM cart. \$25.00

All mint. (614) 464-0810

NEW - ALLISONS ONES. TRANS WARRANTEE 2 MONTHS OLD \$675. (212) 341-4213.

NEW LOW DISTORTION HIGH DETAIL VACUUM TUBES NOW BEING IMPORTED BY PENINSULA CUSTOM AUDIO, 971 Hillcrest Drive, Redwood City, Cal. 94062. Dealer Welcome.

NEW QLS-1 DISCOUNT 20-25% (803) 781-4638 6-8 pm EST.

NORTHERN CALIFORNIANS

It is our goal to make the joy of music possible for everyone. At any price we offer solid value, superior performance, and traditional service.

We operate on the theory that you as our customer will achieve the greatest long term satisfaction only through a careful analysis of your audio requirements. We strive to offer sober highly cost effective solutions to meet your specific needs.

OUR SELECTION INCLUDES:

Tandberg	Denon	B&W
Onkyo	Micro	Chartwell
JCV	Sonus	Avid
PSE	Grace	Cizek
Audire	Shure	Aiwa
Audionics	Stanton	M&K
Hafler	Grado	Ram

HIGH FIDELITY SHOPPE
1511 North Main
Walnut Creek, CA 94596
(415) 932-2242

"WE TAKE PRIDE IN WHAT WE DO"

9-8

Audio Excellence
A UNIQUE STEREO SHOWROOM DEDICATED TO THE PERFECTIONIST

Presenting Components from the Prestigious Companies of

**THRESHOLD GAS SNELL ACOUST CIZEK
BEVERIDGE LUX VAN ALSTINE ROGERS
PARAGON DCM FULTON CART. EPA 100
BRYSTON GALE GRADO SIG. HARBETH**

AT LAST, AN AUDIO SALON IN NORTHERN CALIF. ADVANCING THE ART IN THE ATMOSPHERE OF OUR ELEGANT SOUNDROOMS!

584 Washington Street, San Francisco 94111 415-433-1335

TAKE 5 AUDIO

CONN.'S HIGH-END AUDIO SHOP

Bryston	Verion	DCM
Denon	Signet	NAD
Hafler	Symdex	ADC
Pyramid	Rappaport	M & K
Cizek	Watson Lab	AT
Tangent	Promethean	DAC
LS-3/5A	Sound Cable	KMAL
Supex	Platter Pad	JR 149
Cybele	Discwasher	Grado

* 4 private sound rooms
* East Coast's largest direct-disc dealer
* Keith Monk's record cleaning

105 WHITNEY AVE.
NEW HAVEN, CT. 06511
203-777-1750



FOR SALE

Northern N.J.'s finest store—Lux, Mod DQ-10, IMF, Grace, B&W, G.A.S. Sleeping Beauty, FR, B&O, Linn Sondex, Janis and more. University Stereo, 57 E. Ridgewood Ave., Ridgewood, N.J. 07450. 20 minutes from the G.W. bridge. 201-447-5700. TF

OHM F—drivers unused, cabinets clean. (802) 462-2668 eves.

"ONE OF THE MOST POWERFUL MEN IN SOUND," R. Guss, will custom-build 7-way 15 inch speaker system with 3-D control, Awesome fidelity. Only \$1200. (212) 580-7401. 1-9

OPEN REEL TAPES. 7½ips. Dolbyized releases from RCA, London, DG, Warner and others. Airline tapes, quad. Catalog and updates, \$1. THE REEL SOCIETY, P.O. Box 9337-A, N. Hollywood, CA 91609. 9-9

PARAGON LIVES!!

If you have a Paragon preamplifier, it can be made into something very special. ANY model can be converted to ADI's no-feedback, passive EQ circuit. Results of this modification are impressive to the most dedicated nitpicker. \$100 plus shipping, one week turnaround. AUDIO DIMENSIONS, 8898 Clairemont Mesa Blvd., San Diego, CA 92123. Visa/Mastercharge orders accepted. (714) 278-3310.

AUDIO DEN AND POLK AUDIO

The Audio Den is proud to have on display and demonstration the amazing Polk Audio Monitor Series. Our customers say "Fantastic! Compares with the finest loudspeakers I have heard. Probably the best value in the history of Audio!!!" Audiogram™, from the Audio Advisor said, "We were so impressed that we could not believe the prices . . . Other \$200 speakers simply do not come close to the standards set by the Model 10 . . . And at their price, they are simply a steal." Come in for an audition or write us for information on Polk or our other state-of-the-art products. Polk is shipped free in the continental U.S. Audio Den Ltd., 1320-34 Stony Brook Rd., Stony Brook L.I., N.Y. 11790, 516-751-3350. TF

SOUND ADVICE AND POLK AUDIO LOUSPEAKERS

We have the incredible Polk Audio Monitor Series loudspeakers in stock. The Polks are definitely the best performance per dollar value ever offered in a truly accurate inexpensive loudspeaker. State of the art sound is now available from less than \$200 per pair. We ship freight prepaid anywhere in the U.S. within 24 hours upon receipt of order. Write or call for information on the Polk Audio Monitor Loudspeakers.

SOUND ADVICE

Village Plaza Ruston, LA 71270
(318) 255-8000 9-9

THE MONITOR SERIES FROM POLK AUDIO AUDIO BREAKTHROUGHS now has on demonstration the remarkable new Polk loudspeakers priced from less than \$200 per pair. Compare them to the finest loudspeakers in the world. All Polk Audio Monitors utilize high definition polymer laminate bass-midrange drivers, wide dispersion soft dome tweeters and fluid coupled sub-bass radiators. They are capable of reproducing a highly defined phase accurate three dimensional sonic image which rivals the thousand dollar super speakers. They sound great with a small receiver, yet reveal the fine subtleties of state of the art electronics. Shipped free in U.S. Send for free brochures on Polk or our other fine lines. AUDIO BREAKTHROUGHS, 1534 Northern Blvd., Manhasset, LI, NY 11030 (516) 627-7333. TF



GOLDEN gramophone®

2858 W. Market Street
Akron, Ohio 44313
Phone (216) 864-4411

Direct Discs	Hafler	Grace	Rogers
Audio Research	DynaVector	Kenwood	Setton
Advent	Electro Research	LinnSondex	Shure III
ADS	E. M. T.	Magneplanar	Sonus
Armstrong	FMI (Fulton J.)	Nakamichi	Stax
Bravura	Grado Signature	Rappaport	Technics
Connoisseur	GAS Ampzilla II	Revox	Threshold
Denon			

FOR SALE



the weakest link . . . in your sound system is probably the record itself. HIGH DEFINITION RECORDINGS offers the most complete mail order service of direct-to-disk recordings. We carry Sheffield, Crystal Clear, Umbrella, East Wind, G.A.G., Nautilus, and others. We also stock French EMI, Fresh Aire, Gale, Denon PCM, Crescent, Audio Labs, Three Blind Mice, assorted European pressings and more! Send for our free catalogue.

high definition recordings P.O. Box 82566
San Diego, CA 92138

PARAGON 12 PREAMP \$495, Janis Decoursey xover \$145, Kenwood KD500 w/Aud. Tech. Ft + Platter Pd \$195, Infinity Blk Widow w/warranty crd \$125, T.L. Tube Hd amp \$165, Entre EC-1 \$95, GAS Slping Bty Sph. \$75, Denon 103D \$155, Denon AU320 \$65 - ship. prepd. (408) 373-4411.

PASSIVE CROSSOVERS! CUSTOM BUILT TO YOUR SPECS. LOW NOISE PRECISION COMPONENTS. BI-AMP OR TRI-AMP ABSOLUTELY NO DISTORTION. \$89 EACH. C. O. G. ELECTRONICS 1-313-294-8715. 19027 ROSEGARDEN, ROSEVILLE MICHIGAN 48066 4-9

PERFECTIONISTS PREFER DYNAKITS

Before Purchase You Owe Yourself Our Quote Mainline 11a 971 Fronheiser, Johnstown, PA 15902 TF.

PHASE LINEAR 5000 TUNER with expander \$275 or best offer, SAE 5000 Impulse Noise Reduction Unit \$125, SME 3009S/2 Tonearm \$95. (218) 326-1992 evenings.

PHILIPS AND AUDAX LOUSPEAKERS in stock at good prices with competent service. Madisound Speaker Components 537 Holly Ave., Madison, Wisc. 53711 (608) 238-1517.

Pioneer QX-949 \$275, 2 JBL D131 \$100/each, 2-Attec 811B horns & 806 drivers \$150/each, 2-Speakerlab 800HZ Xover \$12.50/each, 4-AR3ax \$125/each, Marantz 8B \$250, Heathkit IM58 harmonic distortion meter \$75, Brother phone answerer \$75, Keyser TV projector 40" x 54" screen \$1350, call John (317) 962-7270.

POINT 3 SPEAKER SYSTEMS, Now available. These are a unique 3-cabinet design that uses a time-aligned tweeter and mid-range in the upper unit. And 2-10" drivers in the subwoofer. Comes with its own crossover. And has a flat response from 20 to 20KHz. With the ability to handle any power from 20 to 200 watts. And more importantly the sound is very clean, detailed, and open. With no coloration. What is the cost? Hard to believe? Write or call: — E. Smith, 2941 N. Gransback St., Phila., Penna. 19134. Phone: (215) 427-1359. 10 to 10.

PRECISION FIDELITY C4. The new generation tube preamplifier with innovative cascode circuitry and solid state regulation and your nearest dealer. Precision Fidelity, 1169E Chess Drive, Foster City, CA 94404 (415) 572-1811

POLYDAX (AUDAX) Bextrenes, soft domes etc., Decca Ribbon tweeters Leach Amplifiers. Catalog: TA Box 97A, W. Cornwall CT. 06796. Postage now 40c, please help with stamps. 9-8

POLYDAX (AUDAX) Bextrenes, woofers, soft domes, Decca Ribbon Tweeters, x'over parts, Mylar caps. inovative designs coming. TA, Box 927, W. Cornwall, CT 06796 41c stamps please.

FOR SALE

PIONEER HPM-60 SPEAKERS \$190. PIONEER REVERB \$90 Electro-Voice SEQ equalizer, (215) 678-3885.

Professional Hi-Fi Home Study Course —Instructors include Len Feldman, Julian Hirsch, Larry Klein, and Larry Zide. Send \$2.00 for full color AUDIO PRIMER and information on joining (SAC) Society Audio Consultants, Dept. A. 19 W. 34th Street, Suite 1208. New York, N.Y. 10001 TF

PROFESSIONAL AUDIO EQUIPMENT In stock: AMPEX, CROWN, DBX, TECHNICS, JBL, OTARI, SOUND WORKSHOP, TASCAM, ASI, P.O. Box 6520, San Antonio, TX 78209. CALL TOLL FREE: 800-531-7392

PROPER TONEARM GEOMETRY!! Optimum offset angle, overhang, vertical pivot height and angle. Resonance damping construction. Jewelled pivots. Height adjustable while playing records. Effective mass 2.5 grams. Damped cueing. Anti-skate bias. TA-3A with silicone damping, \$249.00. "Universal" nylon hardware, \$1.00; alignment protractor, \$3.00. Prices include postage and money-back guarantee. JML Company, 39,000 Highway 128, Cloverdale, CA 95425-9

PROTECT YOUR LPs. POLY SLEEVES FOR JACKET 9", ROUND BOTTOM INNER SLEEVES 8", SQUARE BOTTOMS 6". POLY LINED PAPER SLEEVES 15", while jackets 35". POSTAGE \$1.50. HOUSE OF RECORDS, HILLBURN, NEW YORK. 10931. TF

RABCO OWNERS — Ultimate modification features adjustable 15-gram tone arm gimble in jewels. Effective mass 2½ grams. \$295.00. Complete modification \$395.00. Wheaton Music, 2503 Ennalls Ave, Wheaton, MD 20902-301-949-115. Photos etc \$1.00. 1-9

RAM 512 AMP \$600.00 (513) 751-6879

WRITE US AND WE'LL SEND YOU THE BEST CATALOG YOU EVER READ!

No kidding. Speakerlab's catalog took longer to write than some of our competitors have been in business. In fact, we created an industry by

"building great kits so you can afford great speakers." Our catalog is an invaluable manual of speaker function and design. And

it will introduce you to the finest speaker kits made anywhere . . . with the strongest money-back guarantee. Find out for yourself . . . FREE, FREE, that is. Write now. Right now.

Speakerlab®
Dept. C-AD, 735 N. Northlake Way
Seattle, WA 98103

ACCURATE



The only expander to accurately invert both compression and peak limiting.

For information write: RG Dynamics
4448 W. Howard St., Skokie, IL 60076

THE RG PRO-20W DYNAMIC PROCESSOR

FOR SALE

RAPPAPORT AMP-1 REAL TIME POWER AMPLIFIER PRE-3 preamplifier now may be heard, with the newly improved **SNELL TYPE A** speaker at our studio. A marvelous listening experience awaits you! Phone for appointment.

AUDIOWORKS

Box 4314, Harrisburg, PA 17111 Tel. (717) 652-6996

RAPPAPORT PRE IA; Mel: PS-1 \$550 Paragon 12: 600. All Pristine 914-769-4659 Eves.

Reels, Cassettes, 8-Tracks. MAXELL, TDK, BASF, SCOTCH. New Guaranteed. Listing: YELTA HOUSE, 2007 Wilshire Blvd., AD-530, Los Angeles, Ca. 90057 1-9

RENOUNCE ROTTEN RECORDINGS! Read selected British reviews in the bi-monthly EURO-DISC GAZETTE, then order these European discs judged the finest in technical and musical excellence. Selections mainly classical. Send for free sample issue. No obligation. EURO-DISC GAZETTE, PO Box 337-A, Peterborough, NH 03458. TF

REVOX A-77 (1104 or 1304) AT LOW, LOW PRICE \$695. Brand new batch just received in manufacturers sealed cartons, manufacturers warranty. It's a steal. Other models available including a few reworked but top performance A-700's at \$1350. Write for full listing or make checks or money order (\$695 & \$15 freight & handling A-77, NY residents add appropriate sales tax) payable to Entertainment Sound Services, Inc., 78 North Franklin St., Hempstead, NY 11550 (518) 538-2220. tf

ROGERS REFERENCE MONITOR SYSTEM

This is a biamplified system designed by Rogers using the incredible LS3/5a's. Hear this system as well as the Rogers Monitor II's, Compact Monitor's, LS3/5a's, A75 amp and T75 tuner at OXFORD AUDIO CONSULTANTS, P.O. Box 145, Oxford, OH 45056. By appointment. Free shipping. 513-523-3895.

FOR SALE

RAPPAPORT

Amp-1 Realtime Class A Power Amplifier. The first amplifier using absolutely no negative feedback for an unsmearing, phase coherent sound. It will vastly improve the performance of all speaker systems, the difference is amazing. Audition this and the Rappaport preamps at G-B ELECTRONICS P.O. Box 385 Hawthorne, N.J. 07507 (201) 427-8885 anytime for appointment.

SAVE UP TO 40% ON DIRECT DISCS

Select from over 250 different direct discs, PCM, and Japanese Audiophile records. Over 30 labels to choose from. Send \$1 for complete list and prices. DYNAMIC DISCS, P.O. BOX 0, Tarzana Ca. 91356. 2-9

SAVE UP TO 69% ON OVER 100 TOP BRAND AUDIO COMPONENTS FROM CARSTON STUDIOS. NEW ENGLAND'S AUDIO SUPERMARKET ONE OF THE OLDEST MAIL ORDER FIRMS (EST 1952) AND CERTAINLY ONE OF THE MOST RELIABLE. ALL ORDERS SHIPPED FROM STOCKED WAREHOUSE. SEND FOR PRICE QUOTE AND PRICE LIST. CARSTON STUDIOS, OLD BROOKFIELD ROAD, DANBURY, CONN. 06810. TF

SEMI-PRO AND CONSUMER TAPE EQUIPMENT, HEADPHONES. TEAC/Tascam, Technics, Dbx, MAXELL. Best Prices! Prompt Delivery! WDI P.O. Box 340, Cary NC 27511. 919-467-8122. 1-9

SEMI-PRO AND CONSUMER AUDIO EQUIPMENT: TEAC/Tascam, Dbx, AKG, Maxell, Delta-Lab, Technics, JBL, Others. Best Prices! Prompt Delivery! WDI, P.O. Box 340, Cary NC 27511. 919-467-8122

SEX is not a part of The Hi-Fi game. But it's great fun anyway. A board game for the non-bored. Immediate delivery. \$11.95 to PENIION GAMES, Box 2129, Martinez, CA 94553. tf

SIEMENS, TELEFUNKEN, GENALEX AND AMPEREX and other top quality audio tubes available at very competitive prices. Contact Jim Wallace at 1203 Success St., Pittsburg, PA 15212 or (412) 322-4706 TF

SNELL ACOUSTICS

Type A Loudspeaker. Proclaimed superior to all others by review after review. All serious music lovers should audition the Type A for these reasons:

1. Linear amplitude response 32-22, 500 hz \pm 2 db.
2. Extremely open sound, excellent dispersion
3. Low coloration, musically accurate
4. Precise imaging
5. Outstanding dynamic range
6. Magnificent construction and appearance
7. Affordably priced.

G-B Electronics P.O. Box 385 Hawthorne, N.J. 07507 (201) 427-8885 for audition appointment. Sales & Service in New Jersey Since 1945.

FOR SALE

ROTEL QUALITY AUDIO COMPONENTS: Immediate delivery all Rotel products including RB-5000, RX-1603 RX-1203, RA-1412, RA-1312, RT-1024. National Sound Company, Ft. Lauderdale, Florida. (305) 462-6862.

SAVE ON PRO EQUIPMENT

BGW, CROWN, SHURE, JBL-PRO, TASCAM TEAC VEGA, EV, SENNHEISER, TECHNICS, ESS, HME, STL, WHITE, TAPCO AND MUCH MORE. CALL OR WRITE FOR YOUR QUOTE. AN-TECH LABS, INC. 8144 BIG BEND, ST. LOUIS, MO 63119

SOUND COMPONENTS INC.

EXCLUSIVE SOUTHEAST DEALER FOR THE INCOMPARABLE MARK LEVINSON H.Q.D. REFERENCE SYSTEM

The H.Q.D. reference playback system consists of the following components:

- 2 Hartley 24 in sub-woofers
- 4 Quad ESL loudspeakers
- 2 Decca ribbon tweeters (modified)
- 2 Levinson LNC-2 Crossovers (100 hz & 7 Khz)
- 1 Levinson ML-1 (LEMO) preamp
- 6 Levinson ML-2 amplifiers
- 1pr. Hand-crafted oak or ash trestle stands (for Quads & Decca)

THE H.Q.D. SYSTEM WITH GOOD SOURCE MATERIAL, WILL REPRODUCE A MUSICAL EVENT BETTER THAN ANY SYSTEM WE KNOW OF.

For more information, please write or call:
SOUND COMPONENTS
2710 Ponce de Leon Boulevard
Coral Gables, Florida, 33134
305-446-1659

TXW 812-848-7627

tf

SNELL ACOUSTICS TYPE A LOUDSPEAKER sets a new standard for music reproduction. Hear it with the finest electronics at **AUDIOWORKS**, Box 4314, Harrisburg, PA. 17111. Tel. (717) 652-6996 for appointment and consultation.

SOMEDAY THERE WILL BE A PASSIVE LOW FILTER DEVICE THAT COST LESS THAN \$20.00, NEVER WEARS OUT, INSTALLS IN SECONDS, AND REMOVES THE WARP, (BUT NOT THE BASS) FROM VIRTUALLY ANY RECORDING. "ITS HERE TODAY!" ITS THE WARP-KNOT. FOR \$14.95 A PAIR, POSTAGE PAID. FOR INFORMATION WRITE: WARP-KNOT, 7505 BIG BEND, WEBSTER GROVES, MO. 63119. DEALER INQUIRIES INVITED.

SONY TTS 3000A 195.00, Decca int. tone arm (old style) 95.00, Fulton Gold spkr. Cables 42' 125.00, Audio Research D-150 1.950. Make offers 1-216-658-4675.

SOUTHERN OREGON AUDIOPHILES

Advent, Bang & Olufsen, Cizek, G.A.S. Haffler, Harman-Kardon, Magneplanar, Onkyo Polk Audio, Rogers & More! Visit our listening rooms or write for information. Riverside Sound, 114 So. Riverside, Medford Oregon 97501 (503) 779-0114. Prepaid shipping U.S.A.

SPENDOR BC-1 SPEAKERS at **AUDIOWORKS**, Box 4314, Harrisburg, PA 17111, Tel. (717) 652-6996 for info and appointment to hear.

Get QUALITY HI-FI with PROFESSIONAL ADVICE

call the Pros at Audio Concepts

Franchised Dealers For:

JBL, AR, TECHNICS PRO, GREAT AMERICAN SOUND, MICRO-SEIKI, BOSE, DAHLQUIST, AVID, ADS/NAKAMICHI, MAXELL, DISCWASHER, MXR, YAMAHA, ONKYO, OPTONICA, SATIN ADC, AC-CUPHASE, PHASE LINEAR, TANDBERG, AKG DBX, WIN LABS, SONUS, MICRO ACOUSTICS, HARMAN KARDON, AUDIOPULSE, VISONIK, STAX, DENNON, HAFFLER, G.A.S., OTHERS.

Free freight on most items.

Call us TOLL FREE. It's worth it!!!

(800) 423-4170

AUDIO CONCEPTS

1127 W. Huntington Dr., Arcadia, CA 91006
(213) 445-3663

146

A SINGER'S DREAM!



REMOVES VOCAL FROM MOST STEREO DISCS
The Thompson Vocal Eliminator can actually remove most or all of a solo vocalist from a standard stereo record and yet leave the background music virtually untouched! Not an equalizer! We can prove it works over the phone. Write for a brochure and demo record below. COST: \$195.00

ECHO Ambiance

We do it BETTER for LESS
Whether your interest is in using ambiance for a concert hall effect or as an echo chamber for studio recording use, we manufacture a broad line of sophisticated analog delay Echo and Reverberation devices at prices which only direct sales make possible. Prices range from \$159 to \$495.

Write for a brochure and demo record. Include \$1 to cover costs (refundable with order.)

Write to: **LT Sound**, Dept AU, P.O. Box 1061, Decatur, GA 30031 (404) 284-5155

GA GARLAND AUDIO, INC.

WHERE ONLY THE FINEST IS GOOD ENOUGH

AUDIO RESEARCH
MAGNEPAN
LUXMAN
DENON
GALE
F.M.I.

B & W
ROGERS
NAKAMICHI
MITCH COTTER
FIDELITY RESEARCH
R.H. LABORATORY

MARK LEVINSON
SEQUERRA
QUATRE
GRACE
QUAD
G.A.S.

Call or write for a FREE subscription to our quarterly newsletter!

GARLAND AUDIO
2960 Stevens Creek Blvd. • San Jose • (408) 244-6724

Tues/Thurs, 11-8 — Wed/Fri, 11-6 — Sat, 10-5 — and by appointment—

FOR SALE

STATE OF THE ART IN N. CALIFORNIA

is now on demonstration at The Audible Difference. Hear the superb Threshold NS-10 preamp/400A power amp through Dick Sequerra's stunning Metronome loudspeakers. Audition Peter Snell's superb Snell Acoustics Type A loudspeaker system with Threshold's new medium power CAS-1 amplifier. For the ultimate in high-power amplification, audition the Threshold 8000A mono amplifiers. Hear how good a bi-amp system can be with John Curl's new transient perfect crossover from Symmetry, the ACS-1, plus Paragon's 125 watt solid state bass amp. Experience the beautiful new Paragon 12A preamp, plus Thaedra II from G.A.S.

Hear the ultimate direct drive turntable, the Denon DP-6000, plus the audiophile reference Linn Sondek with Linn-modified Grace 707 tonearm. Examine the precisely machined bearing of the new glass platter, belt drive Planar tables from Rega Research. Hear the ultra-musical Paragon System E preamp, plus the new high performance, moderate cost Thalia/grandson combination from G.A.S. Audition a new generation of compact high performance loudspeakers from Polk and Cizek, plus BBC minimonitors from Spondor and Rogers. For the music listener who demands the best, we offer the Breuer Dynamic Tonearm, plus the EMT cartridge with Verion transformer.

For that extra measure of sonic purity so important to the critical audiophile, we recommend and stock Polk Sound Cables; Mogami wire; the anti-resonant Platter Pad, \$24.95; Audio Perfection audio interconnect low capacitance cables, \$15/pr; plus the Stylift at \$19.95 and a wide selection of audiophile quality recordings including Gale Maximum, Fidelity and Denon PCM.

We ship all products prepaid throughout the United States.

THE AUDIBLE DIFFERENCE

435 Tasso, Palo Alto, CA 94301
(415) 328-1081

TF

STEREO REPRESENTATIVES NEEDED!!

Sell 100 brands!! Lowest Possible Prices!! Krasco—REP DEPT. —998 Orange Ave. West Haven, Conn. 06516

TF

SUPLEX—ORTOFON—DENON—OTHER MOVING COIL

CARTRIDGE OWNERS: Send for free literature on our Micro Preamp Superb performance at \$129.95 Huntington Electronics, Box 2009A, Huntington, Conn. 06484

TF

SYMDEX SPEAKERS

state-of-the-art. At AUDIOWORKS, by appointment. Tel. (717) 652-6996, Box 4314, Harrisburg, PA 17111.

TACTILE MASS MEDIA

A new recording industry is beginning, not for the eyes or ears, but for the skin. You touch a new patented invention and feel different images. You can identify objects and different people, and touching music is a unique and highly entertaining experience. The basic transducer is available separately and can be connected to any audio system. You can now feel your records. For more information contact: How Wachspress, AUDITAC, 1940 Washington, San Francisco, CA 94109. (415) 885-3138.

TAPCO and ELECTRO-VOICE, mixers, equalizers, amps, mics, and raw loudspeakers. Write for low mail order prices, Sonix Co., P.O. Box 58, Indian Head, MD 20640

8-9

TEAC AN 180 Dolby \$195. 714-281-7097

TEAC 7010 GSL \$520; Matant 4400 \$410; Thorens TD-125/SL-8/AT-15 \$325; Advent Dolby \$125. All mint! 213-382-7428.

THAEDRA G.A.S. PRE-AMP \$625, Coral 777 EX-moving Coil Cartridge, \$99, Both new. 512-854-2486, work 512-883-2551 Wayne.

Unexplained buzz, pops, hash?

Power line surges and hash could be the culprit! Line Cord Surge Suppressor/Hash Filter curbs damaging surges & disruptive hash. Protects valuable equipment. Strips away annoying hash from tools, appliances. Send SASE for free interference cures. At your dealer or order direct.



S/F-KW-3

\$22.50

ELECTRONIC SPECIALISTS, INC., DEPT. A2
171 SOUTH MAIN ST. • NANTICK, MASS. 01760

FOR SALE

THAEDRA II, excellent condition \$625 Call evs. or week ends. (703) 620-2912

THE ABSOLUTE SOUND™, in its new issue, reviews the Audio Research SP-6 (tubes, no less), the Grado Signature III, the Acoustat Monitor, the (new) Quatre gain cell, the Threshold CAS-1; the ReVox straight-line turntable. Three cartridges: the Es'Ans, the Sumo, and the Stanton 881S; the Phase Linear 500 amp; the Soundcraftsmen Class H amp; the Visonik speaker system; the Promethean cartridge; the Mordaunt Short Pageant speaker system. Also: There are sneak previews of the Threshold 4000 and the Signet moving coil cartridge, plus an interim report on the Spatial Coherence preamp. And, finally, (surprise), a state-of-the-art speaker system — though you'll never guess what. Plus: Reference Recordings; Technical Tips; Updated Reports, and a bevy of other special articles. Do yourself a favor. Subscribe. Prices: \$16 (first class; four issues); \$17 (Canada); \$24 (outside North America; (air mail). Checks go to The Absolute Sound, Box L, Drawer A, Sea Cliff, New York, 11579.

THE AUDIOGRAM™ a pithy independent newsletter now in its third year, provides timely, money saving reports on the latest products and techniques. Our critical integrity and realistic sense of proportion fill the gap between the commercial magazines and the neurotic underground press. Our June issue contains capsule reviews of:

—Denon 103D, Signet Tk7E, Onlife 20B, Supex 900E Super Cartridges

—The two best headphones

—The three best tonearms

—The best tube preamp

—As well as substantial reports on the Polk Sound Cable and Verion pick-up transformer.

\$15/16 issues. Free information. AUDIOGRAM, Box 27406, St. Louis, MO 63141.

TF

THE AUDIONICS

LK1 TURNTABLE

MOTOR—24 pole precision synchronous motor,

BELT—circular belt to reduce energy transmission.

BEARING—graphite impregnated material originally developed for aerospace applications.

PLATTER—precision machined and dynamically balanced aluminum alloy.

MAT—a special material which eliminates resonance interaction.

BASE—two one-inch thicknesses of high density sandwiched material (with inset motor mount/platter suspension).

FEET—spring loaded, air cushioned feet isolate the base from the support.

DUSTCOVER—an acrylic chosen for minimum vibration.

OPTION—electronic speed control for 45 rpm use and vernier adjustments.

AMERICAN AUDIOPHILE

5 SUNRISE PLAZA, VALLEY STREAM, NY 11581

FOR APPT 516-561-7114

ALL SHIPMENTS PREPAID AND INSURED

FREE THROUGHOUT CONTINENTAL U.S.

THE NEW REFERENCE — CROWN DL-2 — Using the latest technology is the most accurate, flexible system controller available. The DL-2 may be critically auditioned along with the SA-2 power amp and EQ-2 equalizer at Sounds Good To Me! 60 Shawnee Ave. Akron, O; 44313

1-9

FOR SALE

The BERKSHIRE MATCH-MAKER is the perfect method to correctly match your cartridge to its preamp. It is a switchable adapter that plugs into the preamp and offers 18 different loading conditions, from 50 to 350 pF. Also permits varying resistive loading and as an added plus includes an RF filter. \$49.95/set of 2.

The Berkshire MODEL CCM CAPACITANCE METER is a hand-held precision capacitance meter that measures the capacitance of your tonearm cables and preamp phono input. For the ultimate in cartridge/preamp matching, \$89.95 Order directly. Immediate delivery. Fully guaranteed. Literature available. BERKSHIRE AUDIO Products, P.O. Box 35, Great Neck, N.Y. 11021.

THE LISTENING ROOM INC.

590 Central Park Avenue
Scarsdale, N.Y. 10583
(914) 472-4558

Cordially invites you to audition our fine line of equipment. THRESHOLD • BRYSTON • GREAT AMERICAN SOUND • PYR • AMID METRONOME 2 + 2 • DAYTON WRIGHT ESL • QUAD ESL • SNELL ACOUSTICS • DAHLQUIST • DYNAVECTOR • DENON • YAMAHA • TANDBERG • POLK AUDIO • LUX REF. • KEF • GRACE • NAKAMICHI • STAX • R.H. LAB • LS3/5A BBC MINI MONITOR BY CHARTWELL • SEQUERRA • PHASE MATRIX • HAFLER • JANIS • FONTEK HEADPHONE • AUDIO PULSE • SPATIAL • OASIS • EMT • VERION • DIRECT TO DISK RECORDS •

Visit our private studios. We ship free anywhere in the U.S. We invite inquiries. 12-8

THOUSANDS OF LIKE NEW LP's and prerecorded tapes. Catalogue—\$1.50. House of Records, Hillburn, New York 10931.

TF

THE JANIS BASS SYSTEM

—A JANIS WOOFER

—A JANIS INTERPHASE 1 CROSSOVER/AMPLIFIER

—A SST-1WR SET UP TAPE

The JANIS BASS SYSTEM brings a sense of bass detail, range, and ambience unmatched by any full range speaker system or other add on woofer. Set up is simple and unambiguous requiring no instrumentation yet achieving 1 db. Audition the JANIS BASS SYSTEM at American Audiophile along with our other fine products by AUDIONICS, AGI, AUDIO TECHNOLOGY, CIZEK, DCM, DECCA, DENON, HADCOCK, HAFLER, HEGEMAN, NEXUS, PEDERSEN ACCOUSTICS, RAPPAPORT, SERIES 20, SHURE, SIGNET, SME, STD, SYMDEX, TANGENT.

AMERICAN AUDIOPHILE

5 SUNRISE PLAZA, VALLEY STREAM, NY 11581

For Appt 516-561-7114

ALL SHIPMENTS PREPAID AND INSURED
FREE THROUGHOUT CONTINENTAL U.S.

SPEAKER SYSTEMS

Beveridge • Rogers L35A • JR Rogers 149
DCM • Snell Acoustics • Dahlquist • ADS
Allison • Mitsubishi • BW • Janis

AUDIOCOM HIGH TECHNOLOGY AUDIO

177 Sound Beach Ave. Old Greenwich CT
Phone: (203) 637-3621

Now in Fort Lauderdale...
State of the art components for the
audio perfectionist and serious listener.

Audio Research • Acoustat • Denon • B & W • Armstrong • Chartwell • Lux
Tangent • Polk • GAS • Conrad Johnson • Audire • Ariston • Connoisseur
ADC • Grace • Supex • Grado • Goldring • DB Systems • Quatre • Stax
Sonex • Plasmatronics • Transcriptors • Dynavector

Complete selection of direct to disc recordings.

AUDIO INSIGHT

The Promenade at Bay Colony
6286 N. Federal Hwy., Ft. Lauderdale, FL 33308 • 305/491-7677

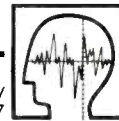

FOR SALE

1978 AUDIO EQUIPMENT PROFILES has just been published by AUDIO magazine. Order a copy by sending \$3.95 to: AUDIO EQUIPMENT PROFILES, 401 N. Broad St., Philadelphia, PA 19108. Over 50 pages of equipment specifications and nearly 100 pages of test reports. Supply is limited, so order now.

24 Channel Sound Reinforcement Mixer, 100 foot snake, balanced input, 3 band EQ submixers, monitor, echo, solo... includes UREI Model 527A graphic equalizer. Must sell! Asking Price: \$2,950.00 B C & G Enterprises, P.O. Box 708, Arvada, Colorado 80001. (303) 751-5991 or (303) 42406151. 1-9

75 year old **EDISON** cylinder records on cassettes, operatic-band-comic-personalities, etc. 45 minute sampler and lists. \$5.00, postpaid. Mendershausen, 1441 Alta, Reno, Nv 89503

RECORDS

DIRECT TO DISC RECORDINGS: All labels including Sheffield, Crystal Clear, M&K, Umbrella. Send \$1.00 for catalog. Disconnection, 4201 Jetton Ave., Tampa, FL 33609. TF

FREE SOUNDTRACKS & CASTS CATALOG! Personalities! ST/OC Valuebook: \$4. RTSA 711 W. 17th G-1 Costa Mesa, CA 92627. TF

JIMMY'S RARE RECORDS/ Buy & Sell Busy Flea Market/Sunyside /Queens 43rd Ave. 784/9040 4-9

MILWAUKEE! — The Audio Emporium-Audio Perfectionist Cables, Audio Research, Bang & Olufsen, Connoisseur, Dahlquist, Decca, Genesis, Grace, Grado, Grafyx, Great American Sound, Haller, Kenwood Pro, Linn, Lux Magnepan, Polk, Revox, Rogers, Sonus, Supex, Technics, many direct discs. 6900 W. Brown Deer Rd., Open Tues. thru Sat. 10-6. 414-354. 5082. tf

RARE OUT-OF-PRINT LP's. Factory Sealed — 99c to \$3.99 ea. Over 25,000 in stock. List — \$1.00 Record Warehouse, Box 4617, Dept. AO, Rochester, New York 14613.

RARE OUT-OF-PRINT LP's. Factory Sealed — 99c to \$3.99 ea. Over 25,000 in stock. List — \$1.00 Record Warehouse, Box 4617, Dept. AO, Rochester, New York 14613.

"RECORD JACKETS. Replace old, torn, LP jackets with clean, glossy, pure white or black jackets. Plastic lined inner sleeves, 78 sleeves, opera boxes. Free catalog. CABCO A6, Box 8212, Columbus, Ohio 43201." TF

RECORDS, RECORDS, RECORDS

Old, New & Direct Disc too! Send \$1. for Complete Info, S.E.O.J., 519 Wheat, Johnstown, PA 15902. 4-9

STEREO LP's \$1.50 each and Record Cleaning device. Details LPLTD 3205 Caithness, Savannah, GA 3145.

WORLD'S LARGEST, computerized, catalogue of rare records. 18,000 entries. Classical, Showbiz, Popular, Jazz, Comedy, Spoken. \$2.50 refundable. Round Sound West, P.O. Box 2248 Leucadia, CA 92024. 1-9

SPEAKERS

**HIGH FIDELITY SPEAKERS REPAIRED
AMPRITE SPEAKERS SERVICE**
655 Sixth Avenue, New York, N.Y. 10010
212-CH3-4812

TF

WANTED TO BUY OR TRADE

ALL SPEAKERS REPAIRED

FAST SPEAKER RECONING SERVICE ON ALL TYPES OF TRANSDUCERS, FACTORY AUTHORIZED SERVICE FOR JBL, ALTEC, CETEC AND ELECTROVOICE, ESS. DEALERS DISCOUNTS AVAILABLE. ANTECH LABS, INC. 8144 BIG BEND, ST. LOUIS, MISSOURI 63119 (314) 962-5656

MATANTZ 7C, 9, McIntosh C22, Mc275. State price and condition. J. Fong, 1238 Green St., San Francisco, CA 94010 (415) 572-1812 10-9

WANTED TO BUY OR TRADE

CASH FOR your unwanted LPs & reel to reel tapes. Records, Box 323, Hillburn, New York 10931. TF

JBL SG-520, SE400S, SE460. State Price condition. P.O. Box 962, Hollywood, CA 90028. 213-851-1107 1-9

MACINTOSH OR MARANTZ tube and pre-amps. P.O. Box 962, Hollywood, CA 90028. (213) 851-1107.

OPEN REEL pre-recorded tapes. Rock, folk, jazz, classical stereo, quad (8-track quad also). A few of each for sale too. SSAE, Ray, 1293 French Ave., Lakewood, Ohio 44107. 11-9

RABCO-SL-8E, Infinity Menolumia Electr-Voice EV-2's (circa 1965) D. Slindee, box 55, Lansing, IA 52151.

Used vacuum tube Electronics, classic speakers and esoteric products. State price and condition. Sound Advice Box 782 Brookline Village, MA 03247. Tel. 617-734-2727 1-9

WANTED - Harman Kardon citation "B" amplifier working or not. Greg, 788 Cdooni Ave. Modesto, Calif. 95351.

WANTED: PAIR ALTEC 100A Bass energizers. Write: R. V. Marchbank, 1626 East 54th St., Tulsa, OK 74105.

WANTED: PIONEER SD-1100 Audiophile type Blue Oscilloscope exc. cond. Steve Tylicki, Box 225 Milville, Mass. 01529

WANTED: Recording gear of all ages and variety. Microphones, outboard gear, etc. Dan Alexander, 6026 Bernhard, Richmond, CA 94805. (415) 232-7933.

WANTED: WESTERN ELECTRIC PRODUCTS - 954A, 555 (W) drivers and diaphragms, 22A or large multicellular horns. 10A cartridges, etc. H. Ohtsuka, 450 22nd Avenue, San Francisco, CA 94122.

WESTERN ELECTRIC 594A Driver. 21 Holly Hill Dr. WA98040. 1-9

WE 594A OR 555 DRIVER and other WE. Speakers, amps, horns. P.O. Box 962, Hollywood, CA 90028. (213) 851-1107

PLANS & KITS

FM-1, FM-3 FANS: Phase Locked Loop Multiplex Demodulator-center channel Meter Kit featuring the LM1800AN (THD 0.1%) Demodulator and custom made Meter is now available for \$29.95 post paid.

LT-110 FANS: Same as above but without meter plus separate instruction sheet for \$22.50. Send for free info. VSM Audio P.O. Box 114, Maspeth, NY 11378.

HOW TO CREATE BEAUTIFULLY Veneered Furniture Quickly, Easily! Illustrated Veneering Manual/Catalog FREE. Exotic Veneers, Inlays, Supplies. Morgan, A11K1, 1123 Bardstown Road, Louisville, Kentucky 40204.

LOW TIM PREAMP AND POWERAMP KITS OR ASSEMBLED. Free 30-page manual. Write Moonlighter Electronics, 117 Inverness, San Francisco, CA 94132 (415) 664-6703. 10-9

TAPE-SLIDE SYNCHRONIZER, multiprojector lap dissolve plans, \$5.50. With mixer, compressor, preamp schematics, \$8.50. The Millers, 1896 Maywood, S. Euclid, OH 44121. TF

BUSINESS OPPORTUNITIES

CAMPUS REPS - High Performance Loudspeakers, Box 18009, Seattle, WN 98118 TF

EARN \$500.00/THOUSAND IMMEDIATELY STUFFING ENVELOPES! FREE DETAILS: MONTEREY PLACE P.O. Box 33147-CI, Coon Rapids, Minn. 55433. 4-9

EXCEPTIONAL PROFITS. Must know electronics. Send \$2.00 (or business letterhead). Box 809, Boyton Beach, Fla. 33435. 2-9

\$600/THOUSAND PROFIT!!! Guaranteed Earnings, stuffing envelopes, RX, DGWING, Box 311, Novato, California 94947

BUSINESS OPPORTUNITIES

BADGE and BUTTON Machines. 7 Sized, 12 Models - Supplies Photo Mug Machines - Supplies Literature - Sample \$1.00, National Co. 1565-D, West Bruce, Milwaukee, WI 53204

CABLE FM BROADCAST STATION. Unique no investment/experience business makes money! Others work for you! Free details. "CAFM", Box 5516-N9, Walnut Creek, CA 94596 TF

CAMPUS REPRESENTATIVES - Earn big money as a QSI Campus Rep! For info, contact **QUADRAPHONIC STUDIOS INTERNATIONAL, 4151 Emerson St., Skokie, IL 60076.**

HELP WANTED

Expert Hi-Fi technicians wanted for responsible positions in well-equipped service specialty organization. Send complete resume (confidential) to Westronix, 3312 Silverton Rd. N.E., Salem, OR 97303.

OVERSEAS JOBS - Now hiring all Occupations. High pay. Transportation. Computerized Reports. \$2.00 **TRANSWORLD, International Airport, Box 90802-K, Los Angeles 90009** TF

RADIO-TV Jobs... Stations hiring nationwide! Free details: "Job Leads," 1680-PH Vine Hollywood, CA 90028

TAPE RECORDINGS

FREE CATALOG. Classical Cassettes... Stereo-Dolby... Quality Guaranteed... Credit Cards Accepted. EKR Classics, GPO Box 1977AX, New York, New York 10001.

MUSICAL INSTRUMENTS

UP TO 60% DISCOUNT. Name brand instruments. Catalog Freeport Music, 114R Mahan St., W. Babylon, N.Y. 11704. TF

RADIO PROGRAMS

CATALOGS. Broadcasts, soundtracks, Personalities of Thirties, Forties. Box 225, New York, N.Y. 10028. TF

RENT RADIO SHOWS: Make your own copies or just listen. Great way to build your collection reasonably. Catalog \$1 refundable. OTR Rental, Box 1146, Livermore, Ca. 94550 TF

VINTAGE RADIO: Lowest rates, post free. Traders welcome. Also trading for comics, films, pulps, etc., video tapes, too. SIGNALS, Box 5063, Sta. E. Edmonton, Alta., CANADA. 3-9

VINTAGE RADIO PROGRAMS on Cassette. Catalog \$1.00. MB/JB Enterprises Box 724 Spencer, Iowa 51301

WHILE YOU WERE LOOKING for out-of-print records, you should've been looking for us. DISContinued. 444 S. Victory Blvd., Burbank, Ca. 91502 TF

YESTERDAYS RADIO ON TAPE. Reels-Cassettes. Quality Sound. Reliable Service. Catalog \$1.00 refundable with first order. ADVENTURES, Box 4822-A, Inglewood, California 90302. TF

1930-1962 RADIO PROGRAMS. Beats television!! Tapes. \$1.00 hour! Established esteemed dealer, informative 200 page catalog \$1.25. Cassette samples \$2.00. AM Treasures, Box 192AU, Babylon, N.Y. 11702 TF

INSTRUCTION & EDUCATION

CLASSES IN MUSIC RECORDING. Record Production, publishing, disc mastering, film recording. Taught by famous engineers and producers. Held in 16/24 track recording studios. Contact: University of Sound Arts, 1508 Crossroads of the World, Hollywood, CA 90028. (213) 467-5256. 3-9

GET INTO BROADCASTING! Learn how to receive free records, tapes, get an FCC broadcast license, start your own station. Free details. "Broadcasting", Box 5516-N9, Walnut Creek, CA 94596 TF

INSTRUCTION & EDUCATION

NEW AUDIO MODIFICATION MANUAL

Everything you need to know to modify your equipment. Use it to its best advantage, and let it help you select components for your system. More than 220 pages of valuable information, with emphasis on vacuum tube circuitry. Step-by-step procedures for many common components. Strongly recommended by experts for both the amateur kitbuilder and the advanced audiophile. Proprietary modifications presented in detail. This unique book provides information available nowhere else. Purchase includes one year's free consultation service. \$25 U.S.A., \$27 other countries. California residents add \$1.50 tax. Telephone orders accepted (M/C, Visa): (714) 278-3310. AUDIO DIMENSIONS, 8898 Clairemont Mesa Blvd. San Diego, Calif. 92123. tf

HIGH FIDELITY

UNZOO OBFASCATION OF SALON AUDIO. STATE-OF-THE-ART: PHASELIN-EAR II, ANALOG, TECHNICS PRO, NAKAMI-CHI, LENWOOD PURIST, PSE, NIKKO, PRO DENON, RTR, MARK LEVINSON, VAN ALSTINE, DYNA, TANDBERG, KIRK-SAETER, LECSON. OTHERS: ADS, BOSE, B & O, MCINTOSH, KLIPSCH, AUDIO PULSE, BRYSTON, THRESHOLD, DAHLQUIST, KEF, SAE, YAMAHA, LUX, AND OVER 141 MORE. INCREDIBLE DISCOUNTS, PROFESSIONAL ENGINEER AVAILABLE TO GIVE FREE, NO B.S. ADVICE AND INFORMATION. SEND \$3.00 FOR NEW 17 1/2 PAGE CATALOG CONTAINING 2,500 HIGH-END AUDIO ITEMS; EVALUATED: G.E.A./E., P.O.B. 296 (DEPT: A.), IDAHO SPRINGS, COLORADO, 80452. OR CALL: (303) 582-5200, 1:00 p.m. until 9:00 p.m. (MST) GOLDEN EAR AUDIO/ELECTRONICS ACCEPTS: MC, VISA, BANK, CHECKS. TRADE-INS AND HOME TRIALS.

TAPE AND TAPE RECORDERS

BARGAINS! RECORDS, TAPES: blank, prerecorded. Close-out prices! Catalog \$1.00 (refundable). Tower, Box 12, Lewes, Del. 19958. 7-9

CUSTOMIZED TAPES, Jazz, Big-Band. Over 900 standard tracks. 80 minute cassettes or 8-tracks, \$8.00. Open reel, \$10.00, catalog \$1.00 (refundable). Tapes Unlimited Box 163 Portsmouth RI 02871 T.F.

Direct-Mastered Records — Free 20-page catalog. Low prices, large selection. Phone orders accepted. (805) 773-1855 The Essentials, 761 Shell Beach Rd., Pismo Beach, CA 93449

FREE PROFESSIONAL CASSETTE w/specs. Save direct-air-mail. Discover LARKSONG, Box 468F, Point Arena, CA 95468 tf

SCOTCH RECORDING TAPE, lowest prices TAPE CENTER Box 4305B Washington, D.C. 20012. USA, APO, FPO 5-9

DON'T BUY MAXELL, UDXL II or TDK SA. Try our tested and proven superior quality low-cost equivalents. C-60 \$1.25, C-90 \$1.55. A. BLANK, Box 621, Forest Hills, NY 11375.

BLANK TAPE SALE

MAXELL RECORDING PRODUCTS. Lowest prices on complete line of Maxell's quality products. We also stock complete line of TDK products. Write or call for prices.
Ampex Grandmaster-C60 \$2.29 Discwasher Cmpit Sys \$13.50
Ampex Grandmaster-C90 2.75 BASF Studio or CRO-C90 2.49
Scotch Master I-C90 2.79 BASF Prof I-C90 2.79
Scotch Master II or III-C90 2.4 BASF Prof II or III-C90 2.95
Minimum order 12 pieces. All tapes can be assorted. PA add sales tax. Shipping \$2.50 per order. Or write for complete catalog (412) 283-8621
Tape World, 220 Spring St. Butler PA 16001

SAVE up to 80% BY MAIL on: SCOTCH, TDK, BASF, MAXELL, MEMOREX, CAPITOL MUSIC TAPE, CERTRON (over 180 different reel & cassette tapes to choose from); top brand recorders; America's largest collection of taping accessories, too. Same day service. **FREE catalog.**

America's Recording Tape Specialists
SAXITONE TAPE SALES
1776 a Columbia Rd., Washington, D.C. 20009
(202) 462-0800

TAPE AND TAPE RECORDERS

IF LATIN MUSIC TURNS YOU ON, let us send you our free brochure. We specialize in 8-track, cassettes and reels of Salsa and Tipica. SOULSOUNDS, P.O. Box 312, New York, NY 10471

LOWEST PRICES ON MAXELL, BASF, TDK, FUJI TAPES!!! Send # 10 SASE for free catalog. All new, guaranteed!! Audio Unlimited, 401 Reynolds Circle # 12-E, San Jose, CA 95112 5-9

MXR's 10 Band equalizer, Dynamic processor, Comander. Disc-washer products, Maxell tape discounted. N.A.B. AUDIO, Box 7, Ottawa, IL 61350. 4-9

OLDIES ON OPEN REEL TAPE. Rock n' Roll songs by their year of release. Free Brochure. Rock n' Reel Rental, 38 Fairland Dr., Wethersfield, CT 06109.

TDK, MAXELL, MEMOREX, BASF, cassettes, reels 8-tracks. Lowest prices. New, Guaranteed. FREE CATALOG S&S Audio, P.O. Box 94485, Schaumburg, IL 60194 TF

SERVICES

CUSTOM RECORDING SERVICE, Tapes, discs, and cassettes. Stereo and mono. Live and copies. Editing. Masters and pressings. High quality at reasonable rates. Joseph Giovannelli, Audio-Tech Laboratories, 2819 Newkirk Ave., Brooklyn, N.Y. IN9-7134 TF

NASHVILLE RECORD PRODUCTIONS WILL PRESS HIGH QUALITY PURE VINYL RECORDS FROM YOUR TAPES. SEND FOR SAMPLE RECORD AND PRICE LIST. ALSO FINEST DISC MASTERING. 469 Chestnut St., NASHVILLE TENNESSEE 37203 TF

PRO-SOUND ASSOCIATES Professional Sound reinforcement, top of line equipment only. Use for our installations. (Professional only) Call Pro Sound Associates, 44 Trinity Place, New York, NY 10006 Toll free (800) 221-3235, (212) 747-0600. 12-8

TAPE HEAD REFINISHING — Precision method restores full frequency response. \$15.00 ea. One day service. E. Maher, 5 Evans Place, Orinda, CA 94563. TF

WALNUT CABINETS BUILTS FOR YOUR STEREO COMPONENT. FOR PRICE. SEND SKETCH AND DIMENSIONS OF REQUIRED ENCLOSURE TO GEOMETRIX, BOX 612, MEXICO, MO. 65265 1-9

MISCELLANEOUS

CUSTOM LABELS Printed to order. Send ideas we will submit suggestions. P.O. Box 73 Sarasota, Fl. 33578 1-9

MISCELLANEOUS

ADVANCED TITLES/DEGREES, Ministers, Honorary Doctorates, other Services available. Omnidenominational. Free Details. Acquarian Church, 432-D PCH, Hermosa Beach, California 90254. TF

ELECTRONIC BARGAINS, CLOSEOUT, SURPLUS! Parts, equipment, stereo, industrial, educational. Amazing values! Fascinating items unavailable in stores or catalogs anywhere! Unusual FREE catalog. ETCO-008, Box 762, Plattsburgh, N.Y. 12901 TF

JEEPS — \$59.30!! CARS — \$33.50!! 450,000 Items! — Government Surplus — Most comprehensive directory available tells how, where to buy — Your Area! — \$2.00 — Moneyback Guarantee — Government Information Services, Department SA-1, Box 99249, San Francisco, CA 94109 2-9

MOTOR treatment saves engine, pays you. Box 1271, Platina, CA 96076

YELLOW PAGES OF AUDIO—\$3.95
Sourcebook to 1,100 periodicals. 250 books, 7,500 products! Future Publications, 137 Valley Park S. Bethlehem, PA 18018 1-9

50 DIFF. OLD U.S. Stamps between 1861 and 1939 \$1.00. Ed Roush, 423 Shepard, Mansfield, OH 44907. tf

RECORDING

MINI-STUDIO PACKAGE SYSTEMS FROM \$2599. Using Pro-Recording equipment from Revox. Otari, Lamb Labs, Trident Beyer. Write for full details of offer to ENTERTAINMENT SOUND SERVICES, INC., 78 N. Franklin St., Hempstead, NY 11550. (516) 538-2220. 1-9

Records For Collectors: Busy flea market. Jimmy 43 St. & 43rd Ave. Sunnyside, Queens, N.Y.

REVOX MODIFICATION variable pitch for A-77. In-Sync for A-77 or A-700. Programmer for A-77. Rack Mounts, Slow Speed, 1 1/2 Full Track. Auto Rewind, High Speed 15 IPS for A-77, Slidematic for A-77. Machines available with or without mods at low cost (A-77 from \$695). All mods professionally performed by Revox trained technicians. ENTERTAINMENT SOUND SERVICES, INC., 78 N. Franklin St. Hempstead, NY 11550 (516) 538-2220. 1-9

NOTICE: RECORD RATERS WANTED

(No experience required) Each month you will receive nationally released albums to rate. THERE IS NO EXTRA CHARGE for the LP's you receive. You pay a small membership fee which covers all costs of the LP's. We pay postage. In return for your opinion, build your LP collection. "First come basis." For application write: EARS, DEPT. A, Box 10245, 5521 Center St., Milwaukee, WI 53210.

THE AUDIO ALTERNATIVE

FINE AUDIO COMPONENTS FOR THE DISCRIMINATING LISTENER **CSA AUDIO**

WE HAND PICK THE FINEST IN STATE OF THE ART HIGH FIDELITY COMPONENTS AND SCRUPULOUSLY EVALUATE THE CURRENT TECHNOLOGIES TO ENSURE THE MAXIMUM SOUND PERFORMANCE FOR YOUR AUDIO DOLLAR

Designs featured by CSA:

REFERENCE SYSTEM:
SME MKIII
Beveridge ZSW1
Linn Sondek LP-12
Grado Signature III
Van Alstine Model 1

PRIVATE LISTENING AUDITIONS BY APPOINTMENT PREFERRED CLIENT LIMO SERVICE

35 LITTLE FALLS ROAD, FAIRFIELD, N. J. 07006 201/575-1135
30 min. from G.W. Bridge, Rt. 46W to Passaic Ave. exit: left, then first right beyond overpass.

17 MARANTZ COMPONENT WHATEVER THE MIX IT'S ALWA

Now there's a Marantz component system for everyone! From our most affordable to our finest—with 223 systems priced in between—Marantz delivers the same top Marantz quality and the same stunning Marantz look. There's never a compromise! And with so many systems to choose from, you'll be able to find the exact match for your listening requirements and budget.

A MARANTZ EXCLUSIVE: MIXED SYSTEMS THAT REALLY MATCH.

From the least expensive to the most expensive, all Marantz Pre-Amps, Power Amps, Console Amps, Tuners and Front-Load Cassette Decks feature the same front panel size, the same striking cosmetics, the same top quality design philosophy. So whatever component combination you choose, you'll have a perfect match. Only with Marantz.

BRINGING IT ALL TOGETHER.

Once you have selected a system, only one question



The RM-3700 STACK RACK contains three Marantz components on fixed-positioned shelves, an accessory shelf and divided record compartment behind its full-length smoked-glass door. The Marantz system shown includes the 6170Q Turntable, 2110 Tuner, 1180DC Integrated Amplifier, 5010B Cassette Deck and Design Series 930 Speakers.

remains: Where do you put it? With a Marantz STACK RACK you can bring it all together—with style. The RM-3100 "Professional" STACK RACK (at right) will accommodate up to four Marantz components equipped with optional rack handle adaptors. Or you may prefer the RM-3700 "Decorator" STACK RACK (above) which encloses three Marantz components behind its full-length smoked glass door. A perfect fit in either rack, your entire system will be at your fingertips.

BUILD NOW. ADD LATER.

Once you see and hear what Marantz components have to offer by way of more performance per dollar, striking appearance and unheard of flexibility, you'll be sold. You'll have a perfectly matched system tailored to your specific needs from as little as \$650* to \$2100.* And don't hesitate when you want to upgrade any part of your system. Any Marantz component you upgrade to will match what you already have.

MIX AND MATCH BY MARANTZ—IT'S ALL FOR YOU.

17 separate components from Marantz. Designed to mix and match into 225 different systems to give you unprecedented flexibility. Whoever you are, Marantz has the perfect system for you.

The three unit Marantz system shown at right includes the 2100 Tuner, 1090 Integrated Amplifier and the 5000 Cassette Deck with 6270Q Turntable. The four unit Marantz system shown at the far right includes the 2130 Tuner, 3650 Pre-amplifier, 5030B Cassette Deck and the 300DC Amplifier with a 6370Q Turntable.

25th Anniversary **marantz**®

*These prices are for informational value only (actual prices are set by Marantz retail dealers) and do not include turntables, racks, optional rack handles or speakers. ©1978 Copyright Marantz Co., Inc., a subsidiary of Superscope, Inc., 20525 Nordhoff St., Chatsworth, CA 91311. All Rights Reserved.

S. 225 MARANTZ SYSTEMS. EASY A MATCH - FROM \$650* TO \$2100.*



NEW PRODUCTS FROM DENON



TU-850

PMA-850



TU-501

PMA-501

The 850 Series—Perfectionist equipment for serious listeners. 85/85 watts of DC amplification, tuner performance, and meaningful meters make the 850 Series an exceptional set of "separates", that defy comparison.

The 501 Series—Amplifier and tuner that defy performance/value comparisons. 50/50 watts of coupled accuracy.



DR-750

DR-750—The first innovative transport and head system in five years make the DR-750 the lowest distortion and highest performance cassette deck you can physically carry! Wow & flutter are under 0.045% with a literal 20 to 20kHz capability. Ask for literature and a listening test.

DR-350—The engineering of the DR-750 in a scaled-down package. Servo-monitored transport and fine-tune bias control make the DR-350 an outstanding bargain (you will know in a comparison with any comparably-priced cassette deck).

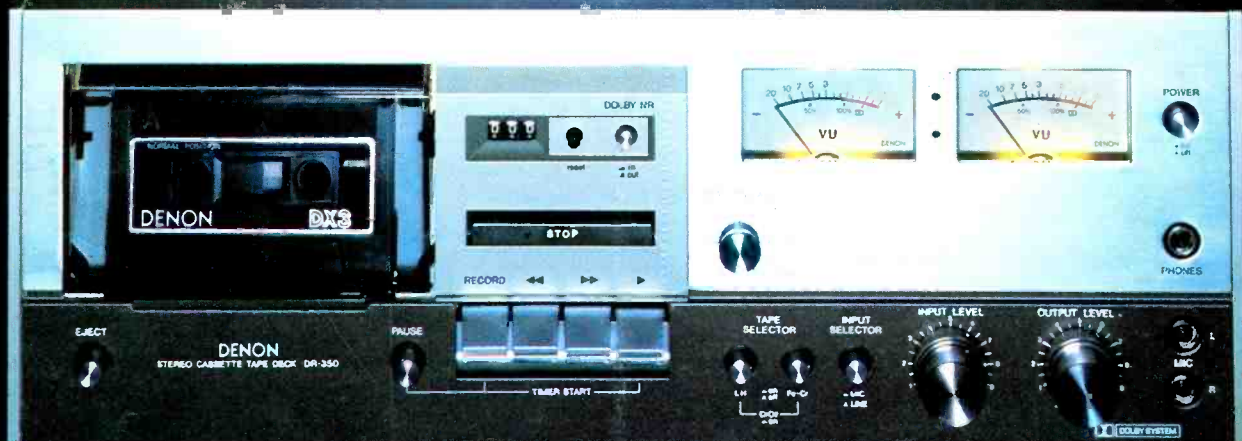

DR-350

DENON Available from authorized dealers of American Audioport, Inc.
1407 N. Providence Rd., Columbia, MO 65201.