

# Audio

Car Stereo  
& Speaker Directory

THE AUTHORITATIVE MAGAZINE ABOUT HIGH

JULY 1977

\$1.00

47425



Dynamic  
Requirements Of  
Phono  
Preamps -  
Holman

Heyser on  
Frequency  
& Time  
In Loudspeaker  
Measurement



U0803760 0280 70620015P0101312  
DON L HUNTER  
2608 CENTRAL BLVD OR 97403  
EUGENE

# WHEN YOU'RE NOT IN A RUSH TO CATCH UP, YOU'VE GOT THE TIME TO BUILD THINGS RIGHT.



\* 160 watts per channel minimum RMS continuous power output at 8 ohms, from 20 to 20,000 Hz, with no more than 0.1% total harmonic distortion.

Enter No. 26 on Reader Service Card

# WHY THE FIRST HIGH POWERED RECEIVER IS STILL THE BEST HIGH POWERED RECEIVER.



When Pioneer first introduced the 160 watt\* SX1250 last year, it prompted our competitors to hastily introduce a bevy of high powered receivers.

Unlike the others, however, the SX1250 wasn't a rush job. And the time and care that went into it can both be seen and heard.

### EVERY SECTION SHIELDED.

Unlike most high powered receivers, every critical section in the SX1250 is shielded. Enveloped in aluminum. So spurious signals from one section can't leak into another. And dirt and dust can't slowly build up to affect performance. So the receiver not only produces crisp, interference-free sound when it's new, but still sounds great as it grows old.

### A 22 POUND TRANSFORMER.

In our power supply, instead of finding a conventional transformer, you'll find a heavier, more advanced toroidal-core transformer. It's less susceptible to voltage fluctuations. And less likely to leak noise. Which means you get cleaner, clearer sound. And instead of finding the usual two electrolytic capacitors in the power supply, you'll find four. Because we've found that the two extra capacitors help improve low frequency response. And protect against tone burst distortion.

### THE FM SECTION: A FIVE GANG VARIABLE CAPACITOR.

The average high powered (and low powered) receiver comes with a three, or four gang variable capacitor for FM tuning. Not the SX1250. It comes with a *five* gang zinc plated variable capacitor that cleans up FM reception much better. And helps to pull in stations that some three or four gang capacitors can't touch.

This same kind of thinking even went into things like our heat sinks. They're massive, and located around the outside of the 1250 to dissipate heat away from the innards, instead of into them. (In the Technics SA 5760, by comparison, the heat sinks are located right in the middle of the receiver.) And where many manufacturers choose to solve the heat problem with fans, we choose not to. Simply because electrical fans can cause noise and vibration. While our heat sinks can't.



Massive heat sinks to keep the heat off delicate electronics.

### OTHER POWERFUL ARGUMENTS FOR THE SX1250.

Our pre-amp circuit was designed with an unheard-of phono overload level of 500 millivolts. Which means that no magnetic

cartridge in the world can make it distort. It was also designed to follow the RIAA curve (the recording standard of the record industry), to within 0.2 decibels. A figure that competes favorably with even the costliest separate pre-amps.

And where some high powered receivers give you two or three tone controls, the SX1250 gives you four. Two for regular treble and bass, and two for extended treble and bass. They're calibrated in 2 decibel click stops; which give you a total of 3,024 ways to make the most out of your music.

Given all this, it should come as no surprise that the SX1250 even weighs more than most of our competitors' high-powered offerings.

So before you run out and buy just any high powered receiver, consider all the time and engineering that went into the SX1250. And weigh your decision carefully.

High Fidelity Components  
**PIONEER**  
WE BRING IT BACK ALIVE.

©1977 U.S. Pioneer Electronics, 85 Oxford Drive, Moonachie, New Jersey 07074



An extraordinary power supply, for an extraordinary amount of power.

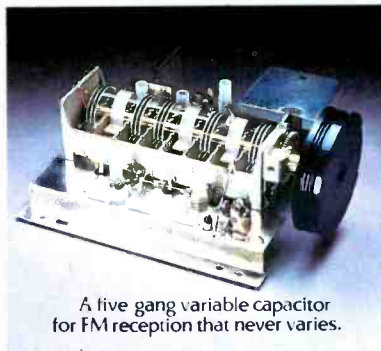

A five gang variable capacitor for FM reception that never varies.

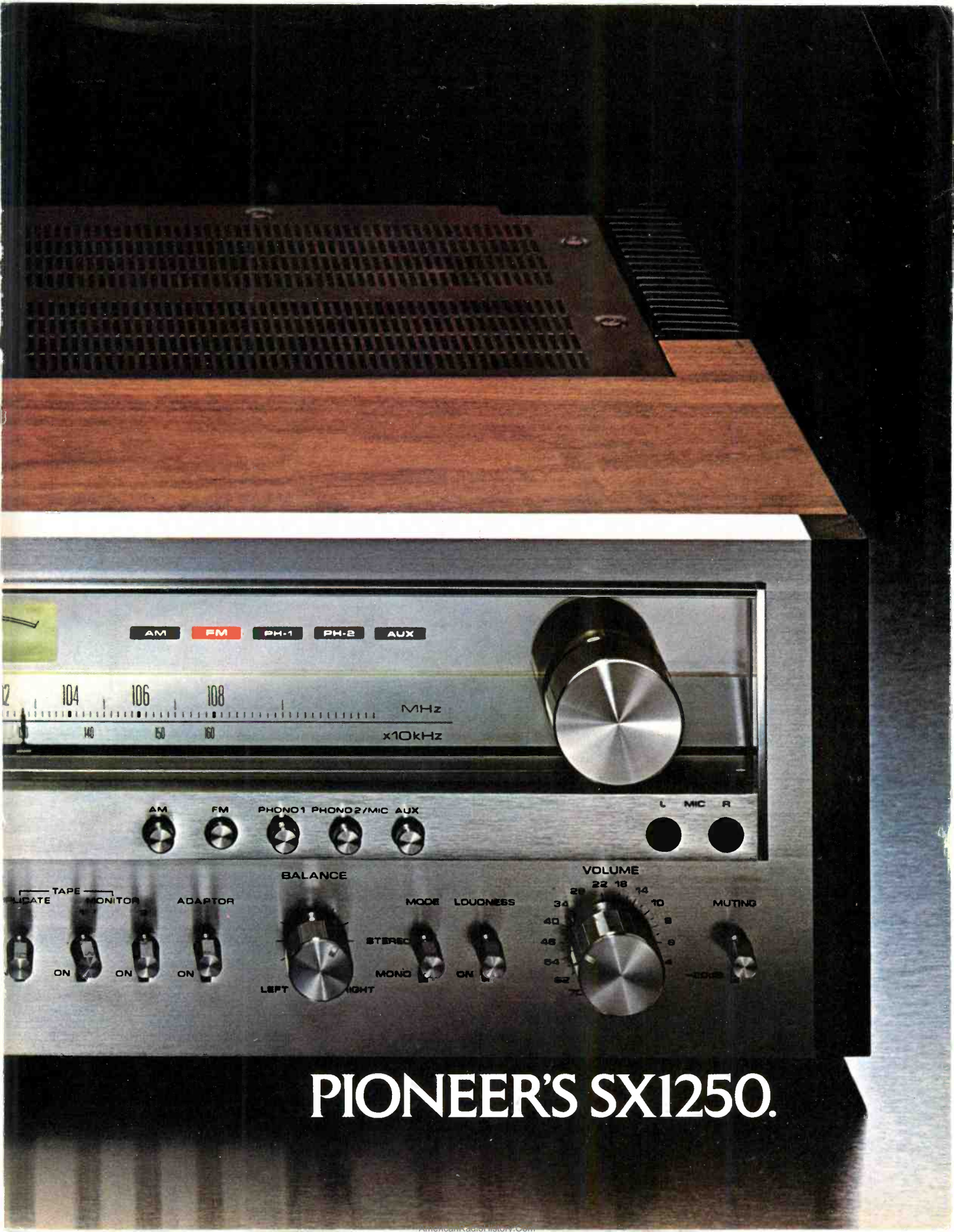

AM FM PH-1 PH-2 AUX

104 106 108 MHz  
140 150 160 x10kHz

AM FM PHONO1 PHONO2/MIC AUX L MIC R

TAPE MONITOR ADAPTOR  
DELICATE ON ON ON

BALANCE LEFT RIGHT  
MODE STEREO MONO  
LOUDNESS ON

VOLUME 20 22 18 14 10 8 6 4  
MUTING

# PIONEER'S SX1250.

DISCWASHER®

presents

# RECORD CARE BASICS

The finest record care system is Discwasher, and the research of the Discwasher labs shows four ways to dramatically extend the fidelity of your discs:

1. Beware of the heat monster. Taking records from very cold conditions to hot conditions, or playing records at temperatures in excess of 90° F, accelerates record wear and distortion.
2. Beware of a "clean" stylus. A stylus may look clean, but can be glazed with contamination after playing two or three records. This glaze holds dust which abrasively destroys records. Discwasher's SC-1 Stylus Cleaner is the best way to keep your clean-but-dirty stylus really clean.
3. Do not replay records quickly. Playing a record more than once every hour causes chemical and physical stress to the vinyl that will eventually destroy the album.
4. Clean micro-dust before playing. Micro-dust is attracted to records and may not be noticeable. Playing a dust-contaminated record welds this micro-dust into the grooves. The Discwasher brush with a few drops of D3 fluid is the finest, most convenient way to remove this threat to your valuable record collection.

For technical information on the complete line of Discwasher products, see your hi-fi specialist or discriminating record store.



**d** discwasher inc.

1407 N. Providence Rd.  
Columbia, Missouri 65201

# Audio

July 1977

"Successor to RADIO Est. 1917"

Vol. 61, No. 7

## Feature Articles

- 22 Turntables & Noise/Joseph F. Grado
- 28 Sound on Wheels
- 34 Car Stereo Directory
- 56 Three Car Components Tested/Leonard Feldman
- 72 Dynamic Range Requirements of Phonograph Preamplifiers/Tomlinson Holman

## Equipment Profiles

- 84 Jensen Model 530 Loudspeaker/Richard C. Heyser

## Record Reviews

- 89 The Column/Michael Tearson & Jon Tiven
- 99 Jazz & Blues
- 103 Classical/Edward Tatnall Canby

## Audio In General

- 4 Tape Guide/Herman Burstein
- 8 Audio ETC/Edward Tatnall Canby
- 16 Audioclinic/Joseph Giovanelli
- 18 Behind the Scenes/Bert Whyte
- 104 Classified Advertising
- 106 Advertising Index

**Editor** Eugene Pitts III

**Associate Editors:** Edward Tatnall Canby, Bert Whyte

**Assistant Editor** Eugene J. Garvin Jr.

**Marketing Director** Sanford L. Cahn

**Design** Frank Moore

**Design Assistant** Debbie DePietro

**Circulation Manager** Jean Davis

**Advertising Production** Gloria Klaiman

**Senior Editors:** Richard C. Heyser, Bascom H. King, B.V. Pisha

**Contributing Editors:** Tom Bingham, Herman Burstein, Leonard Feldman, Joseph Giovanelli, C.G. McProud, Dan Morgenstern, George Pontis, Howard A. Roberson, Jon Sank, Donald M. Spoto, Michael Tearson, George W. Tillet, Jon Tiven.

**Publisher** Jay L. Butler

**About the Cover:** It seems like everyone is getting into car stereo these days, even those who measure their mobility in pedal power rather than horsepower.

**EDITORIAL CONTRIBUTIONS** are welcomed but should be accompanied by return postage. Submissions will be handled with reasonable care, but the publisher assumes no responsibility for return or safety of manuscripts, photographs, or artwork.

**AUDIO** (title registered U.S. Pat. Off.) is published monthly by North American Publishing Co., Irvin J. Borowsky, President; Frank Nemeyer and Jay L. Butler, Vice Presidents; Harry Feld, Treasurer; Joseph Florentine, Chief Financial Officer; Mary Claffey, Secretary & Circulation Director; R. Kenneth Baxter, Vice President/Manufacturing; Sanford L. Cahn, Marketing Director; Mary Anderson, Production Director; John Nolan, Corporate Art Director; Vic Brody, Promotion Director.

**Subscription Rates:** United States only, 1 year for \$8.00, 2 years for \$14.00, 3 years for \$20.00, outside the U.S., 1 year for \$10.00, 2 years for \$18.00, 3 years for \$26.00. Printed in U.S.A. at Columbus, Ohio. All rights reserved. Entire contents copyrighted 1977 by North American Publishing Co. Second class postage paid at Philadelphia, PA and additional mailing office. Back issues, \$2.00 each.

**World Library Congress Number:** ISSN 0004-752X

**Dewey Decimal Number:** 621.381 or 778.5

**National Sales Office:** Jay L. Butler, Publisher, 545 Madison Ave., New York, NY 10022. Telephone (212) 371-4100.

**West Coast Sales Office:** Jay Martin, 2525 West 8th St., Los Angeles, CA 90057. Telephone (213) 385-2917.

**Continental European Representative:** V.B. Sanders, International Publishers Advertising Service, Raadhuisstraat 24, P.O. Box 25, Graf-De Ryp, Holland. Telephone, 02997-1303; telegrams, Euradteam—Amsterdam.

**England:** The Paul Singer-Lawrence Media Group, 54 Burton Court, London SW3, SY4, England. Phone, 01-730 3592.



**AUDIO Publishing, Editorial, Subscription and Advertising Production offices,** North American Building, 401 No Broad St., Philadelphia, PA 19108. Telephone: (215) 574-9600. Postmaster: Send Form 3579 to above address.



# Disco goes portable... and portable disco pros make Stanton their first choice!



Jack Marsh and an associate load equipment on their van, preparing to go on location.

If people can't get to Discos, then why not bring Disco to the people? Bring it to their Church Halls . . . to their School auditoriums . . . to a banquet hall in a nearby Motel . . . that's just what Murray the K's DISCO ON WHEELS is doing.

At last count, there were numerous franchised Murray the K DISCO ON WHEELS rolling across America, bringing Disco to the people. And, every last one of them has a STANTON CARTRIDGE as part of the system; in this case, the Stanton 500AL, a truly tough performer that is also known as the "work horse" of the broadcast industry. The Stanton 500AL does a fine job of playback while withstanding the rigors of back cueing, slip cueing, heavy tracking

forces, vibration and potential mishandling. This cartridge can take it under circumstances where a damaged stylus means even more than lost music . . . it means lost business.

For those Disco Operators who prefer a more sophisticated sound quality, Stanton has created the 680EL, the top quality performer for both Disco or Radio broadcasting.

So, Stanton, world famous for its top-of-the-line cartridge, the Calibrated 681 Triple-E, also serves the professionals in an interesting new branch of the Disco industry.

Whether *your* usage involves Recording, Broadcasting, Archives, Disco, or home entertainment, your choice should be the overwhelming choice of the professionals in every field . . . STANTON CARTRIDGES!

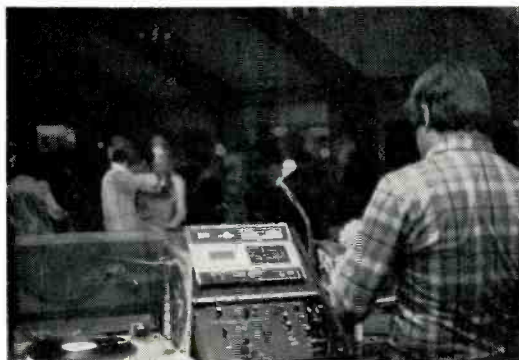

Close-up of the portable disco console.



Dancers in the Syosset (L.I.) High School gym.



Write today for further information to Stanton Magnetics Inc., Terminal Drive, Plainview, New York 11803.

© Stanton Magnetics, Inc., 1977

Enter No. 38 on Reader Service Card

## Empire's Blueprint For Better Listening

No matter what system you own, a new Empire phono cartridge is certain to improve its performance.

The advantages of Empire are threefold.

One, your records will last longer. Unlike other magnetic cartridges, Empire's moving iron design allows our diamond stylus to float free of its magnets and coils. This imposes much less weight on the record surface and insures longer record life.

Two, you get better separation. The small, hollow iron armature we use allows for a tighter fit in its positioning among the poles. So, even the most minute movement is accurately reproduced to give you the space and depth of the original recording.

Three, Empire uses 4 poles, 4 coils, and 3 magnets (more than any other cartridge) for better balance and hum rejection.

The end result is great listening. Audition one for yourself or write for our free brochure, "How To Get The Most Out Of Your Records." After you compare our performance specifications we think you'll agree that, for the money, you can't do better than Empire.



# EMPIRE

Already your system sounds better.

Empire Scientific Corp.  
Garden City, New York 11530

# Tape guide

Herman Burstein

### Cassette Monitoring

*Q. I want to re-record some cassette tapes, using two machines. But I want to be able to monitor the material through a speaker while the signal is going from one recorder to the other. Please tell me how this is done. Why doesn't using a patch cord from the external speaker jack of one recorder to the Aux In jack of the other recorder work?—Happy Gee, Jackson, Miss.*

*A.* Most receivers, and integrated amplifiers and preamplifiers that rate as high fidelity equipment, permit you to monitor the incoming sound and at the same time feed it to a tape recorder. You would play your cassette into such equipment, listen to the sound through your amplifier and speaker equipment, and simultaneously feed the amplifier output (via the jack usually marked *Tape Out*) into another cassette for recording.

It seems that your connection from *External Speaker* to *Aux In* should work, and I don't know why it doesn't work in your case. Perhaps the signal voltage available at the *External Speaker* jack is too low, perhaps the jack is defective, or perhaps you are putting the wrong kind of plug, or a defective plug into this jack. Another possibility is that the *Aux In* jack is defective, or the cable might be defective. You should check all of these.

### Impedance Mismatch

*Q. How important is microphone-tape recorder impedance matching? I am interested in using a 600-ohm microphone for a tape deck with an input impedance of 10 kilohms.—Frank Greene, Kerley, Cal.*

*A.* Microphone impedance is important from the viewpoint of avoiding treble loss, possibly hum, and other noise pickup owing to cable length between the microphone and the tape deck. If you have a cable run of

more than 15 feet, a mike with low impedance is desirable. Ordinarily, an upward mismatch will have no adverse effects in terms of treble response and distortion, thus a 600-ohm mike could be fed into a 10-kilohm input. However, there remains a question as to whether the 600-ohm mike will deliver sufficient signal for a satisfactory signal-to-noise ratio. If not, then you require a step-up transformer mounted on the tape deck side of the cable whose output should approximately match the impedance of the deck's mike input.

### 8-Track to Open-Reel

*Q. I have an extensive collection of 8-track cartridges which I am planning to transfer to open-reel tape. I would like to know what speed to use on the open-reel deck, 7½ or 3¾ ips? I would also like to know the frequency response of an average 8-track tape and if there will be any improvement if I use a Dolby unit?—William Kenney, Ridgewood, N.J.*

*A.* With an open-reel deck of moderate or better quality, the 3¾ ips speed should be quite adequate for copying your 8-track cartridges. These cartridges tend to have little response above 10,000 Hz, while good open-reel machines should go well beyond that at 3¾ ips. These open-reel machines have quite high signal-to-noise ratios, so they add very little noise compared with the noise already on an 8-track cartridge. Therefore, I doubt that the use of a Dolby unit in the copying process would make any significant difference.

### Tape Preservation

*Q. I have a large collection of recorded tapes that I want to save intact. I am designing my own storage cabinets and would like to know if there is any way I can shield my tapes*



# “I’ve always wanted Bose 901’s, but won’t I need a 100-watt amplifier?”

The original Direct/Reflecting® Bose 901® was one of the most acclaimed loudspeakers ever. But many people who admired the 901’s didn’t buy them because they thought they demanded a big, expensive amplifier.

## The New Bose 901 Series III

Now comes the new Bose 901 Series III. It is a revolutionary speaker that combines proven Bose design concepts with startling new technology to achieve performance that is superior to the original 901 in every dimension—including even the spatial realism and spectral accuracy for which the 901 was justly famous.

Yet the 901 Series III requires less than one-third the amplifier power of the original 901. That means it can produce the same sound volume with a 15-watts-per-channel receiver as the original 901 with 50 watts. In fact, we suggest that anything over 70 watts is simply unnecessary.

No advertisement can describe fully the 901 Series III and the technology behind it. So we’ve put together a comprehensive literature package that includes a detailed 16-page color brochure, a 20-page owner’s manual, and a copy of Dr. Amar Bose’s paper on “Sound Recording and Reproduction,” reprinted from *Technology Review*. To receive this literature, send \$1.00 to Bose, Dept. AU7, The Mountain, Framingham, Mass. 01701.

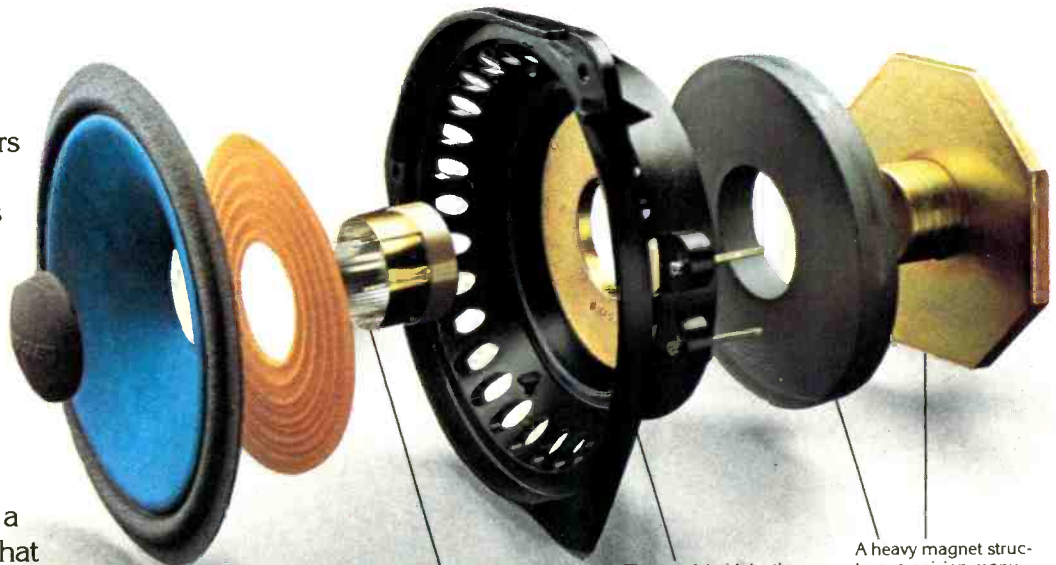

The helically-wound, all aluminum voice coil.

The precision injection-molded plastic frame eliminates energy-wasting clearances.

A heavy magnet structure, precision manufactured and assembled, minimizes loss of magnetic energy.

## The New Driver

The key to the remarkable efficiency of the 901 Series III is a totally new, high performance



The voice coil consists of flat aluminum conductor wire wound on-edge on an aluminum core, eliminating the inefficient air gaps between the round copper windings of a conventional voice coil.

driver—a driver so advanced we had to build our own state-of-the-art driver manufacturing facility to produce it. It combines a light-weight, ultra-high-efficiency, helically-wound voice coil with a precision injection-molded plastic frame that practically eliminates loss of magnetic energy. Just as important, this strong plastic frame allows computer controlled assembly to tolerances far tighter than those imposed on conventional drivers.

## The Payoff

This efficiency lets you enjoy the spectacular performance of the 901 Series III without a large investment in something you can’t hear: pure power. And that might make the difference between getting just good speakers, and the speakers you’ve really wanted all along.

“A speaker unlike any other.”



**BOSE**®

Better sound through research

Cabinets are walnut veneer. Patents issued and pending.

# Introducing New Quantum by Memorex. Four Reasons It Sounds So Good.

1. Quantum offers low distortion. You get a true recording of any type of music at high output, with virtually no distortion.

2. Quantum has very high sensitivity. This maximizes output and allows you to effectively capture all signals at a greater level.

3. Quantum provides an excellent signal-to-noise ratio because its high sensitivity is obtained with no increase in noise level. This means a pure, brilliant sound.

4. Quantum gives you high saturation, resulting in a wide dynamic range and broad recording flexibility.

Quantum achieves improved recording performance while maintaining a high degree of mechanical excellence. With long life, durability, precision edge quality and excellent oxide adhesion.

The best way to hear the Quantum difference is to try it out for yourself. Available in 7" x 1800', 7" x 2400' and 10½" x 3600' reels.

**MEMOREX** Recording Tape.  
Is it live or is it Memorex?

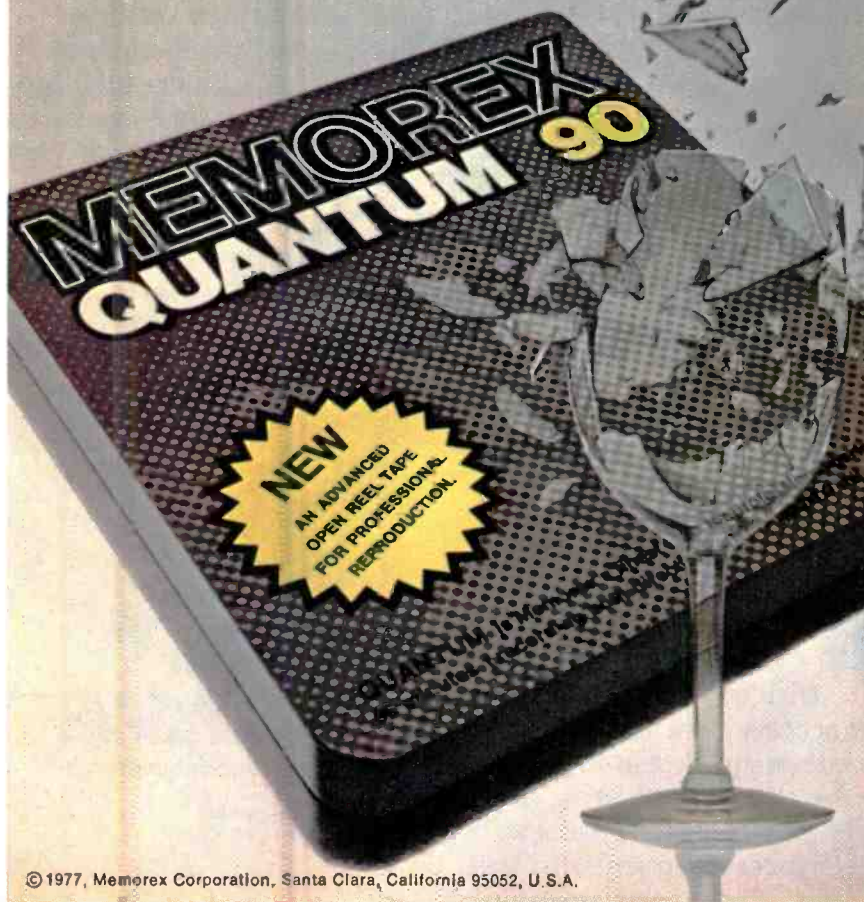

© 1977, Memorex Corporation, Santa Clara, California 95052, U.S.A.

Enter No. 19 on Reader Service Card

against magnetic fields.—Barry Schwartz, Phila., Pa.

A. Tapes are pretty safe if you keep them at least a foot or so from strong magnetic fields. However, you might consider lining your storage cabinets with magnetic shielding material, which is rather expensive. You can get information about such material from Magnetic Shield Division, Perfection Mica Co., 1322 N. Elston Ave., Chicago, Ill.

## Deck Modification

*Q. I have an old tape deck and would like to know if you recommend having it adjusted to take advantage of the low noise, high output tapes. If so, please explain how this should be done.—Peter Lombardo, Gary, Ind.*

A. As low noise tapes are pretty much universally used now, it seems like a good idea to adjust your machine for them. These adjustments apply only to recording, and they entail approximately a 15 per cent increase in bias, about a 3-dB reduction in treble boost at 15 kHz, and about a 2-dB increase in record drive current. It would be best to make these adjustments when using the specific brand of tape you plan to use in the future. When these adjustments are properly made, you should be able to get flat response within about 2 dB out to at least 15 kHz, and when recording a 400-Hz signal at a level that produces one per cent harmonic distortion, the VU meter should read zero. If your machine has a magic eye tube, the recording reference level should be three per cent harmonic distortion.

## Stereo from Mono

*Q. I have a mono cassette recorder. I can't afford a stereo system, so could I use two microphones, two level meters, and a microphone mixer to get stereo?—John Soliday, Mattoon, Ill.*

A. Inasmuch as yours is a mono machine, the use of several mikes and a mixer will not enable you to stimulate a stereo effect. However, several mikes and a mixer would enable you to obtain better sound coverage and thereby a much more pleasing effect.

If you have a problem or question on tape recording, write to Mr. Herman Burstein at AUDIO, 401 North Broad Street, Philadelphia, Pa. 19108. All letters are answered. Please enclose a stamped, self-addressed envelope.

AUDIO • July 1977

# Soundcraftsmen presents the NEW MA5002

## a NEW CLASS super-amp

250 WATTS RMS PER CHANNEL 20 HZ-20KHZ BOTH CHANNELS DRIVEN INTO 8 OHMS, LESS THAN 0.1 % THD—\$699.00



### FANTASTIC PERFORMANCE BECAUSE IT HAS ITS OWN ANALOG LOGIC CIRCUIT!

Soundcraftsmen's revolutionary new Patent Pending "VARI-POR-TIONAL" system uses Analog Logic Cir-cuity to anticipate power demands, then supplies only a proportional amount of power, as required by varying input signal voltages. This new power-con-servating and energy-saving circuitry was invented by Soundcraftsmen's Chief Engineer, Paul Rolles, holder of seven patents in the field of solid state electronic power circuitry, together with his assistant, John Holyoake.

The advantages of the "VARI-POR-TIONAL" system are obtained through its continuous monitoring of output power requirements for optimum efficiency. This results in direct and measurable energy savings by reducing the amount of energy dissipated as heat loss, yet with controlled full power always available,

standing by, and supplied as needed. This higher powered amp can be sold at a price even lower than ordinary Class AB amplifiers through cost savings made possible by the Patent Pending "VARI-POR-TIONAL" circuitry. For example, no fan is needed even under most severe operating conditions.

An added advantage is a substantial savings in power consumption. Class AB amplifiers of the same power rating, operating at 1/3 power in accordance with FTC test requirements, will consume over 40% more energy than the Soundcraftsmen "NEW CLASS" amplifier. Thus, the "NEW CLASS" amp provides sav-ings in heat dissipation of approximately 200 watts. Progressively greater percentages of savings may be obtained at lower power levels.

Other outstanding PERFORMANCE FEATURES of the Soundcraftsmen "NEW CLASS" amplifier are its uniquely designed exclusive all solid-state CROWBAR fail-safe overload protection circuitry with automatic reset, (no circuit breakers or fuses), for 100% protection in the event of shorted speaker leads, etc. Totally NON-LIMITING output circuitry eliminates any possibility of limiter-caused distor-tion due to excessive current demands.

**SPECIFICATIONS:** 250 watts per channel RMS 20HZ-20KHz both channels driven into 8 ohms, less than 0.1% THD. Noise—105dB, Damping factor 100, Slew rate 25, Frequency response 0.25dB 20Hz-20KHz. Size 7 in. x 19 in. x 15 in. deep. Side panels included. Suggested price \$699.00.

### CIRCLE READER CARD FOR COMPLETE ENGINEERING AND TECHNICAL REPORT



### THE PERFECT MATCHING PREAMP-EQUALIZER

Now the PE2217 rated "State-of-the-Art" and "Best-Buy" in magazine Test Reports is available as the PE2217-R in rack silver-black form as a matching mate for our new amplifier. With the control flexibility of pushbutton-patching for tape monitoring and tape dubbing between two or three machines together with tape and program discrete-octave equalization, the PE2217-R is still the **MOST POWERFUL** and **FLEXIBLE** Preamp available at **\$549.00** 1721 Newport Circle, Santa Ana, California, 92705/Telephone (714) 556-6191

### PE2217-R SPECIFICATIONS

FREQ. RESPONSE—Hi-level:  $\pm 1/4$  db, 5 Hz to 100 KHz  
 FREQ. RESPONSE—Phono:  $\pm 1/2$  db, 20 Hz to 20 KHz  
 THD: less than .05% at 1 volt (Typ. .01% at 1 volt)  
 IM: less than .05% at 1 volt (Typ. .01% at 1 volt)  
 PHONO INPUT CAPABILITY: 105mv  
 SIGNAL-TO-NOISE—Hi-level: 100 db below full output  
 SIGNAL-TO-NOISE—Phono: 84 db below a 10mv input  
 SIGNAL-TO-NOISE—Equalizer: 106 db @ full output  
 GAIN—Phono: 63 db 96 db @ 2 v. RMS  
 GAIN—Hi-level: 21 db 90 db @ 1 v. RMS  
 OUTPUT IMPEDANCE: 600 ohms  
 EQUALIZER LEVEL: Zero-gain controls for left and right continuously variable, for unity gain compensation  
 INDIVIDUAL OCTAVE-CONTROL RANGE: Minimum:  $\pm 12$  db (Typ.  $\pm 14$  db), each octave centered at 30, 60, 120, 240, 480, 960, 1920, 3840, 7680, and 15,360 Hz  
 MAX. OUTPUT SIGNAL: Variable master volume control allows adjustment of optimum output to match amplifier  
 GOLD SWITCHES: All contacts are gold plated for low-noise, long life, and resistance to oxidation and corrosion  
 CIRCUIT BOARDS: Military grade G-10 glass epoxy  
 RESISTORS: Low-noise selected carbon-film  
 Enter No. 37 on Reader Service Card

### FREE BROCHURE

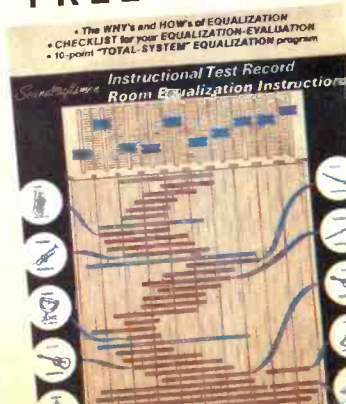

# Audio etc.

Edward Tatnall Canby

With all these anniversaries sailing past, the 200th, the 100th, our own 30th and 60th, I'm feeling retrospective—which means, with me, looking forward in the light of the past. Perspective! I have a sense that this is a good time for all of us to do just that. We are in a sort of interim in spite of all the excitement generated by new developments, early-digital and otherwise. We need some new names, I think.

I am not referring to sales efforts. Nor to new models. The biggest sales tend to be rung up, like on Wall Street, when there is an era of profit taking. It is the fully matured and developed product that sells, not the Latest Revolution—though we're always talking about revolution. A few revolutions catch on quick but most don't. More often, the latest sensation, if it has any solid worth, soon finds itself falling flat on its face, snarled into every imaginable kind of unforeseen trouble and hassle, and doesn't pull itself out and into the clear for an agonizingly long time. You know what I mean! Like with stereo. Not stereo now. Back when stereo was the revolution. Or the LP disc, which had its problems and before it was a year old ran smack into the 45 and the all-too-familiar wars of the rival systems.

But now conventional stereo is the fully matured product, as well as the LP disc. A matchless pair! Next year, the stereo disc has its 20th anniversary and the LP its 30th. Wow! Old geezers like us can scarcely believe it.

## Silly Revolutions Succeed

Only the silly revolutions succeed right away. Instant miracles. Frisbies, hula hoops, bubble gum, the Great T-Shirt Explosion. And, of course, George.

Now don't run down George. In terms of purpose and utility, George has to be the most frivolous (and expensive) gadget in recent memory,



but George is indeed a miracle, the very embodiment in a van-like shape of current technological know-how. And George works by audio. Totally minus complications like, say, decoders, demodulators, Shibata styli and four speakers in the living room. George just *is*, and *does*. What more do you want for sales?

What we need in the hi fi biz is James, which I'm inventing. James is the pint-sized electronic robot who turns on your hi fi when you smile. And turns it off the instant you frown. So your system becomes subliminal

and is subconsciously automated. You need merely *think*, positively, and it goes on. Howzat? James isn't quite yet perfected but I'm working on the digital circuitry and the smile/frown chip. Any day now and I expect to make millions.

Meanwhile, that slightly larger Sensation with the name that begins with a Q has done it. Predictably fallen flat

on its face. What else? As I say, it never fails. As usual, this once-Latest Revolution turned out to be a bit more complex and profound than previously thought, and took a wee bit longer to fall on its fizz than most. That's where it is now, and the ardent people who once promoted it are pretending it isn't there any more, nor ever was. OK—par for the course! So now in all the stores there are stereo records and stereo records, the former two-channel, old tried-and-true, the latter, shall I say, discreetly four. Look for the fine print on the back side.

All in all, this isn't a bad idea. I am not about to deplore the present situation, as you may have thought. Indeed, I think that in a way this is a healthy reaction after eight-odd years of overpromotion, ill-digested technology and the sort of war between systems that merely bores most of us, to the tune of million \$ wasted. I am—as one of the proponents of the new idea right from the beginning—*not* backing down, just revaluating as we all must. Because from here on out we must take a new tack altogether and maybe our very first

# WE'RE ALL EARS

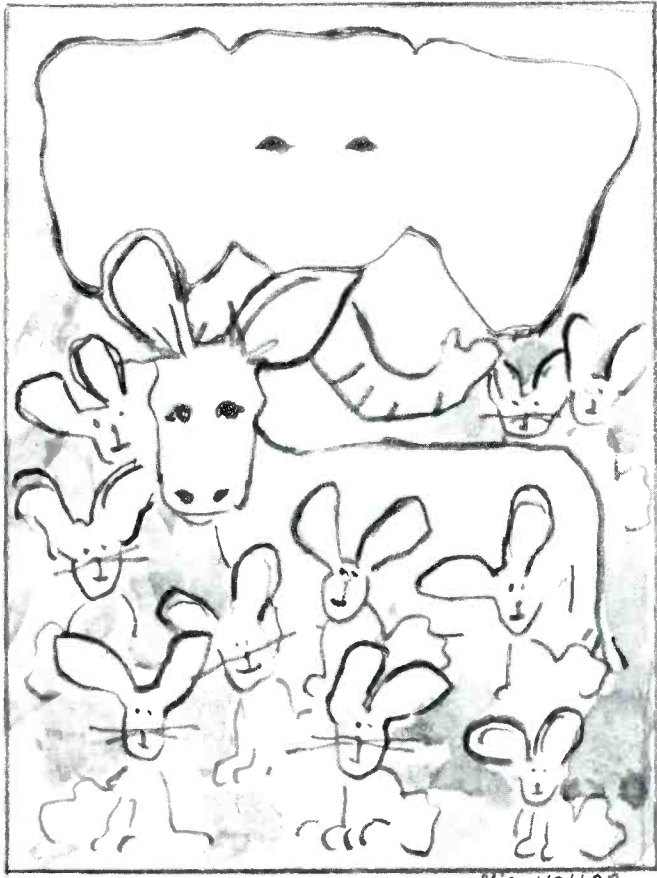

# WE WANT TO HEAR FROM YOU

You will notice that several pages in AUDIO each month are heavy duty stock.

And, as you can see, there are cards here that help us serve you better.

You can subscribe to AUDIO. (With the card, we pay the postage and all you have to do is fill in your name and address.)

There is even a card for placing classified advertising.

You can order '76 bound copies, or the HI-FI HANDBOOK.

There is a free literature card. . . get information from manufacturers. . . no cost.

Or, just write and tell us what you think of us. . . good or bad. We like praise, but criticism is of use to us too, since we can then serve you better, and change to meet the needs of the audiophile.

# SUBSCRIBE

Don't wait until your subscription runs out. Renew now and insure uninterrupted service. The remaining issues on your current subscription will be added. Postage will be paid.

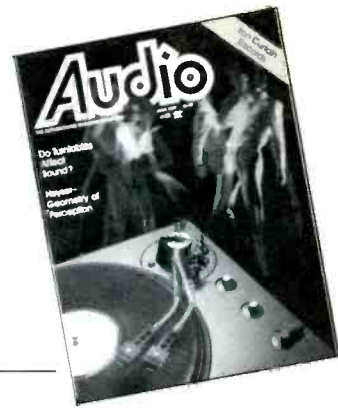

Gentlemen: Please enter my subscription to **AUDIO**.

Name \_\_\_\_\_  
 Address \_\_\_\_\_  
 City \_\_\_\_\_  
 State \_\_\_\_\_ Zip \_\_\_\_\_

New Subscription     Renewal     Payment Enclosed     Bill me

3 Years — \$20     2 Years — \$14.     1 Year — \$8.  
 (Foreign — \$26.)     (Foreign — \$18.)     (Foreign — \$10.)

You may pay for your subscription on your credit card.

Credit Card No. \_\_\_\_\_  American Express  
 Diners Club  
 Card expires \_\_\_\_\_  Master Charge  
 Bank No. \_\_\_\_\_

Signature \_\_\_\_\_  
 For office use \_\_\_\_\_

# READER INQUIRY CARD

JULY 1977—This card expires September, 1977

ENTER NUMBERS IN BOXES BELOW

- A to help me make an immediate decision to purchase  
 B to explore a new method or to keep my files on the subject to date

Name \_\_\_\_\_  
 Address \_\_\_\_\_  
 City \_\_\_\_\_  
 State \_\_\_\_\_ Zip \_\_\_\_\_

Are you a subscriber to AUDIO Magazine?  Yes  No  
 I buy an average of \_\_\_\_\_ records a year Age \_\_\_\_\_  
 I have purchased the following equipment after seeing it advertised in AUDIO Magazine \_\_\_\_\_

I am planning to purchase the following equipment in the next year \_\_\_\_\_

Comments \_\_\_\_\_

### READER INTEREST INFORMATION:

- 1  High Fidelity Enthusiast
  - 2  Home Recordist
  - 3  Professional Recordist
  - 4  Broadcast Engineer / Mgr
  - 5  Audio Service Technician
  - 6  Audio Mfg. or Dealer
  - 7  Other
- I would like to see more
- Technical articles
  - Articles for beginners
  - Construction projects
  - Articles on music
  - Music reviews
  - Classical
  - Jazz
  - Rock
  - Other

FIRST CLASS  
Permit No. 22,489  
Philadelphia, Pa.

BUSINESS REPLY MAIL—No Postage Necessary if Mailed in the United States

Postage will be paid by

**Audio**

North American Building  
401 North Broad Street  
Philadelphia, Pa. 19108

FIRST CLASS  
Permit No. 22,489  
Philadelphia, Pa.

BUSINESS REPLY MAIL—No Postage Necessary if Mailed in the United States

Postage will be paid by

**Audio**

P.O. Box 13892  
Philadelphia, Pa. 19101

**READER INQUIRY CARD**

Fill in other side to get more information on advertised products

SUBSCRIPTION ORDER CARD Fill in other side to order a new subscription

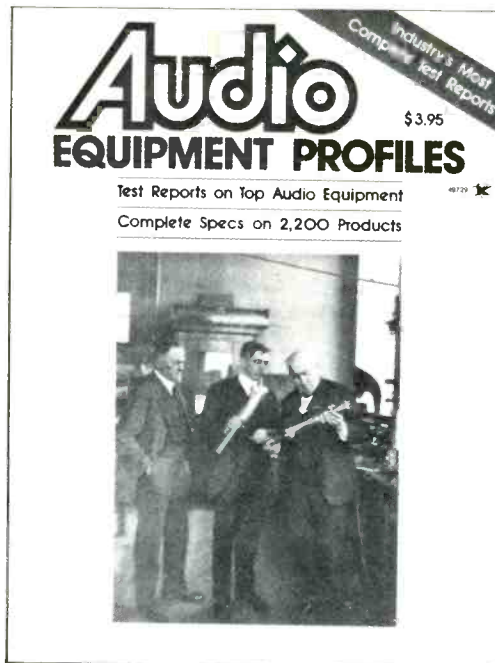

# Now Available...the 1977 Equipment Profiles

## With The Industry's Most Complete Test Reports

The 1977 EQUIPMENT PROFILES, published by AUDIO magazine, contains nearly 100 pages of test reports... the industry's most complete, in-depth reviews.

To receive your copy send in this card. You will get a large (8½" x 11"), 160-page, illustrated book.

Then you have, not only the test reports, but over 50 pages of equipment specifications... speakers, tuners, amplifiers, all are listed, over 2200 products in all.

To order your copy of the 1977 AUDIO EQUIPMENT PROFILES, just fill out the form below and enclose it, with your check for \$3.95 (we pay mailing costs), in an envelope and send it to us at the address below.

----- CLIP AND MAIL -----

**Yes...** send me \_\_\_\_\_ copy (copies) of the 1977 EQUIPMENT PROFILES. My check for \$3.95 is enclosed. I understand that payment must accompany order. And, the book is guaranteed. If I don't like it, I can return it in 30 days (in good condition) for a full, unquestioned refund.

Name \_\_\_\_\_

Address \_\_\_\_\_

City/State \_\_\_\_\_ Zip \_\_\_\_\_

**Rush this coupon... with payment to:  
AUDIO**

401 N. Broad St., Philadelphia, PA 19108

# The Dolby System in FM Broadcasting – April 1977



In June 1973 Dolby Laboratories proposed an improvement in FM broadcasting which would overcome high-frequency overmodulation problems and at the same time reduce receiver noise. The technique combines a reduction in the pre-emphasis time constant to 25 microseconds and the use of the Dolby B-Type noise reduction system. In May 1974 the new method was approved by the Federal Communications Commission for optional use in the U.S.A. A number of other countries either have approved the system or are considering it.

## Transmitters

Since 1974, 160 FM stations in the U.S.A., in addition to 25 in other countries, have purchased the Dolby Model 334 FM broadcast encoder unit.



## Receivers

Concurrently, Dolby consumer product licensees have been preparing tuner and receiver models incorporating Dolby FM decoder circuits. At the present time there are 51 different models of such receivers from 22 manufacturers. About 300,000 units are in use, increasing by some 30,000 units per month.

## Listening Advantages Gained

1. High-level high-frequency signal recoverability.
2. Noise reduction.

The Dolby FM process works at both extremes of the dynamic range. The maximum permissible level of high frequency signals is

increased, while low level noise is reduced. The 10 dB action of the Dolby B system is split in an optimum way between these two equally important areas of operation. The net result is an FM system which can pass signals from transmitter input to receiver output with high integrity.

## Information Available

To find out more about this new development, please write to us for further details.

### A NOTE ON DOLBY LABORATORIES

Founded in 1965, Dolby Laboratories specializes in complementary noise reduction methods and systems. In London the company manufactures equipment for professional use by recording studios, broadcasters, and the motion picture industry. In the consumer field, Dolby Laboratories functions purely as an R & D and licensing organization, based in San Francisco, California. Licensing is handled by a subsidiary, Dolby Laboratories Licensing Corporation, which has world-wide non-exclusive agreements with about 60 manufacturers for the incorporation of the Dolby B-Type noise reduction system into consumer audio products. A uniform royalty rate is applied on a sliding scale based on circuit quantities; the average royalty paid is about \$0.21 per circuit (two circuits for stereo). All Dolby circuits are manufactured to meet standardized performance requirements for universal interchangeability of hardware and software; 20 million such circuits have been made since 1968. Software products (duplicated tapes and FM broadcasts) are produced on a royalty-free basis.



## Dolby Laboratories

'Dolby' and the double-D symbol are trademarks of Dolby Laboratories

731 Sansome Street  
San Francisco CA 94111  
Telephone (415) 392-0300  
Telex 34409  
Cable Dolbylabs

346 Clapham Road  
London SW9  
Telephone 01-720 1111  
Telex 919109  
Cable Dolbylabs London

move should be to get rid of that word itself, which begins with a Q and goes on to an i, an a or an o, depending. (Look—we couldn't even agree how to spell it, let alone sell it!)

That word was just as misleading, I think, as the word we once used for stereo, back at its beginning—binaural. In case you are too young, you should know that two-channel recording, tried before WWII, first broke into our audio news around 1950 but not as stereo. We called

it binaural, even though intended for loudspeakers, and the term stuck for a number of years until the more accurate "stereo" took over, just in time for commercialization. In those days I used to refer to "loudspeaker binaural," to make it clear that I wasn't talking about headphones. But it was such a clumsy term that, as I now note, I often left the matter in doubt and can't even tell at this late date whether I meant loudspeakers or phones, just referring to

binaural. Stereo was much better.

So, I say, we might as well call Q----- what it really is, which is indeed a form of loudspeaker stereo. Stereo—old Greek, meaning solid, or with shape. An excellent description of the sound we hear out of multiple speakers and more than one channel of information. And the useful minimal number of channels, plural, is of course two. Q----- is stereo out of four sources, set variably around the listener rather than up-front, and from four channels of info. The basic idea remains not only a valuable modification of the original stereo but—in spite of present problems—an increasingly practical concept as multiple circuits become progressively easier and tinier. The important modification, then, is that the number four, as indicated by that obsolete letter Q, is arbitrary. We will have even more varieties of stereo, before we are finished, and in numerous channels too, as Dyna (3), Audio Pulse (6), AR (16) and Entity I (40) continue to remind us.

### The Limiting Letter

Indeed, the letter Q is much too limited itself. The most we can squeeze out of it is Quintaphonic, which doesn't even satisfy existing commercializations. So please, down with Q, as well as Q-----, and let's start talking. We need new names, more accurate names, to clear the air before we go much further. Until we find them, the name of the present game is emphatically STEREO. In two, four, or more channels.

Speaking of that, I must remind again that the basic idea of our standard stereo is not the limitation to two channels but a much more important aspect, stereo up front. It could be out of twenty channels and still be up front. This was the original concept and you have heard of the U.S. debut of this type of sound with the aid of Leopold Stokowski back in the Thirties, when music by a "live" orchestra was transmitted directly from one hall to another via microphones and loudspeakers. Two channels? If I remember, not having the data before me, there are many more than two. But all of them were reproduced up front.

And yes, you have anticipated me: next (in the U.S.) came the movie "Fantasia," again with Leopold S., and this time we had—what? No, not Q----- but the more important concept behind Q-----, which is multiple sound sources (x in number) distribu-

## The beginning of the end

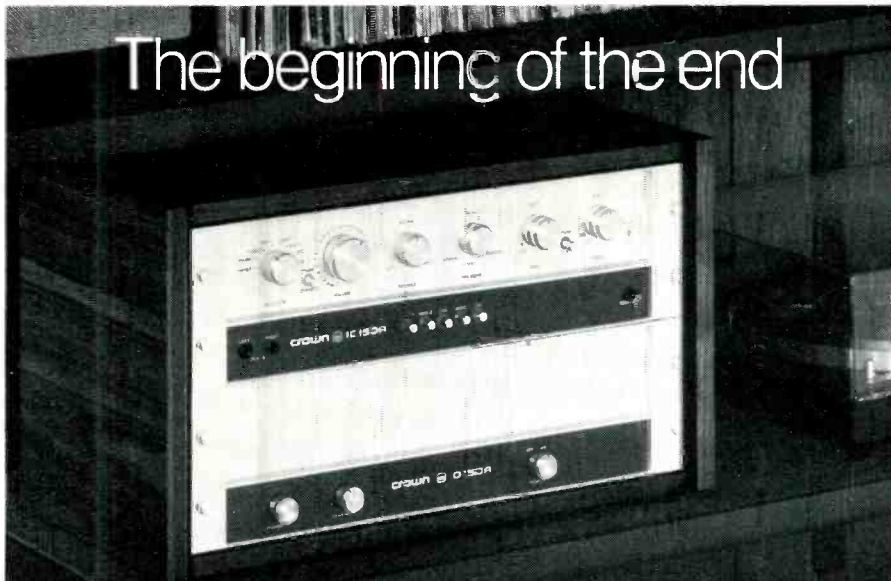

The Crown IC-150A/D-150A stereo combination pre-amp/amp is a good place to begin building your ultimate system. This Crown approach to the design of an "integrated" amp offers some unusual advantages.

**Power now** 80 watts per channel minimum RMS into 8 ohms, 1 Hz-20 KHz, total harmonic distortion of 0.05%.

**More power later** The D-150A amp converts instantly to mono. Delivers 250 RMS watts into 8 ohms in mono. The D-150A's could be the way to big power without big instant money.

**Reliability** Drives almost any speaker. Can't be hurt by hookup problems. Three-year full warranty includes round-trip shipping.

**Total control** Eight inputs, switch selectable. Front panel jack. "Panorama" control.

**Future expansion** Add other D-150A's or IC-150A's for more power, for quad, for pre-amp.

Start your ultimate system with a good foundation: the Crown IC-150A/D-150A combination. You may never outgrow its specs.

**Write.** We'll send brochure, specs and test reports. Check it out at your nearest Crown Dealer.



Enter No. 9 on Reader Service Card

AUDIO • July 1977





# Our new AD cassette takes the normal bias position to extremes.

We made a name for ourselves by creating the world's first non-chrome, "high" (CrO<sub>2</sub>) bias/EQ cassette tape, TDK Super Avilyn (SA). The state-of-the-art tape that has quickly become the standard of reference for cassette tape performance.

Our latest innovation is called AD (ay-dee), and we predict it will soon become the standard of performance and economy in the "normal" bias/EQ position.

We produced the first high fidelity ferric oxide cassette tape some ten years ago, and we've been perfecting the formulation ever since. Our new AD delivers superior performance, especially at the critical high-frequency range (7kHz to 20kHz), where many mid-priced cassette decks and even premium-priced cassettes tend to fall off too quickly.

AD is our ultimate ferric oxide tape designed for the "normal" bias/EQ position. Overall, it provides the lowest noise, highest frequency response and widest dynamic range of any pure ferric oxide cassette tape. In 45, 60, 90 and 120 minute lengths, AD has the same super-precision cassette mechanism found in TDK SA, in a new blue-gray shell.

And AD brings its audible benefits to all cassette decks, with and without switchable bias/EQ, including those found in cars, portables and home stereo systems. So the music you love can travel with you, with all of the clear, crisp, brilliant sounds that make music so enjoyable.

AD is the finest pure ferric oxide cassette tape you can buy at any price. And it has TDK's full life time warranty. Give our new high-fidelity, moderately-priced AD a try—it's anything but normal.

TDK Electronics Corp., 755 Eastgate Boulevard, Garden City, New York 11530. In Canada: Superior Electronics Industries, Ltd.

 **TDK**  
The machine for your machine.

Enter No. 41 on Reader Service Card

# Defog your ears

## with a Decca



14

Cartridge makers are talking about how their shorter cantilevers reduce tip mass for better transient response. But just shortening the cantilever won't help much if it still pivots in the standard seesaw manner. Pivoting cantilevers cannot help but *add* their own friction and unwanted back-and-forth movement, to the vibrations of the stylus. These "cantilever haze" factors result in substantial loss of definition and transients available from all good recordings.

Decca MKVI cartridges use Decca's "Positive Scanning" system, meaning *no* cantilever in the conventional sense. The stylus is mounted on an incredibly light but strong "super-cooled" armature. Its vibrations are scanned by stationary pickup coils *directly above* the stylus, rather than at the far end of a pivoting cantilever. "Cantilever haze" is eliminated for unmatched realism and transient response. The difference from other cartridges is audible enough to make the discerning audiophile feel he is *really* listening to his records for the first time.

Decca MKVI's also feature extra quality control to ensure excellent uniform tracking, separation and channel balance as well as flat frequency response on every unit shipped. Two models to choose between: the Gold Elliptical (tracks at 1.5 grams) at \$149.50\*, and the Plum Spherical (tracks at 2 grams) at \$129.50\*. Gold or Plum, you'll defog your ears with a Decca.

\*Suggested List Price

Sole North American Distributor:

**ROCELCO INC.,**

160 Ronald Dr., Montreal,  
Canada H4X 1M8  
Phone: (514)-489-6841

Enter No. 31 on Reader Service Card

ted around the listening space. Will I ever forget, in the original production, the big choral number, Schubert's *Ave Maria* blown up to enormous size, spread out in enormous stereo, which then proceeded to flop back and forth, oscillating between the front and the back of the theatre! In those days it was an impressive sonic fantasy. I suspect that in recent replays, even with speakers in the rear, it has been modified. Nowadays that sort of thing sounds a bit corny. Anyhow—you see that we had both of the fundamental types of stereo, the up-front kind and the surround or semi-surround kind, 'way back in the pre-war years. And you also see that the limitation to two channels or four channels did not exist; it was the *placement* of the available channels that counted.

It is still the same today, and will be as we expand into our destined future in living-room sound.

I must add one minor story, as of a week or so ago. That wealthy lady in my neighborhood who owns an estate in Antigua and another in France, plus a considerable hunk of my Connecticut home town, came up to my place one recent afternoon in her old clothes to give me a book she had found, my mother's writing as of 1932, and stayed on to talk once more about the vast stereo system her husband had installed in Antigua back around 1959—he's dead (leaving his millions) and she wants out. The trouble is, she says, every time she leaves Antigua those big speakers, all three of them, have to be hauled by truck into a special dry room, to avoid rot and mildew. She wanted my recommendation for three little speakers, to replace them.

Get my point? *Three* speakers, for stereo in 1959. Of course! In that year, with stereo discs just beginning, the whole idea of stereo was untrustworthy, not yet settled down, and people generally didn't like what they called "the hole in the middle," which was clearly—as we now see it—due to faulty procedures in recording, in phasing, even in listening to a new and unfamiliar medium. So you bought yourself a third and essentially mono speaker as a kind of insurance, to blend the sides into the middle and so fill up the hole. This lady, now in 1977, still wants three speakers, to replace the original trio. She hadn't heard about four.

I never fell for the center channel idea myself, though for a time it was even built into many amplifiers (and

maybe still is), with a third set of output terminals to accommodate the extra speaker. I tried it, and quickly found that all I was doing was in fact diluting the very stereo I was trying to create with all that equipment. If there was an absence of sound in the middle, the answer was elsewhere and, most of all, it was in phasing—which at that time could be reversed in the darndest places. Not only your own pair of speakers (or between woofer and tweeter) but anywhere in dozens of points within the electronic equipment (they hadn't yet gotten used to the idea of phase continuity as between channels, now taken for granted) and even, occasionally in some records. I still have a few marked in grease pencil *OUT OF PHASE!*

Also, to be sure, in terms of ping pong, which exaggerated channel separation in various crude ways, for greater sales impact. I can tell you, no center speaker ever cured a case of ping pong. All it could do was to make the pingpong table a bit narrower. Which you could do just as well by sliding your two speakers closer together.

### Hard Experience

I will allow the abundant analogies between all this and our recent experiences with Q----- to fall where they may. So clear! The same has happened all over again but worse, since the surround type of sound was a very much unexplored concept in terms of the living room and few recording people or audio engineers really had much of a positive idea as to what would work out for useful *listening*. We blundered, and argued, and we still blunder. It's a long road into pioneer territory, and in no way comfortable for such as record and hi fi dealers, we might add. But we have learned. As we did for up-front stereo. The new stereos to come, whatever their names, will be the better for it. And even the old stereo records, two-way or four-way, will sound better and better as we improve our knowledge of multiple-channel reproduction.

As I've said before, and even if Q----- as such remains on its flat face for some time to come, we have not dropped the idea of more-than-up-front, nor the idea of more-than-two. Whether the shape of the sound is triangular, quadrangular or multi-polygonous, there will be a lot more of it coming up for the next batch of anniversaries. A

AUDIO • July 1977

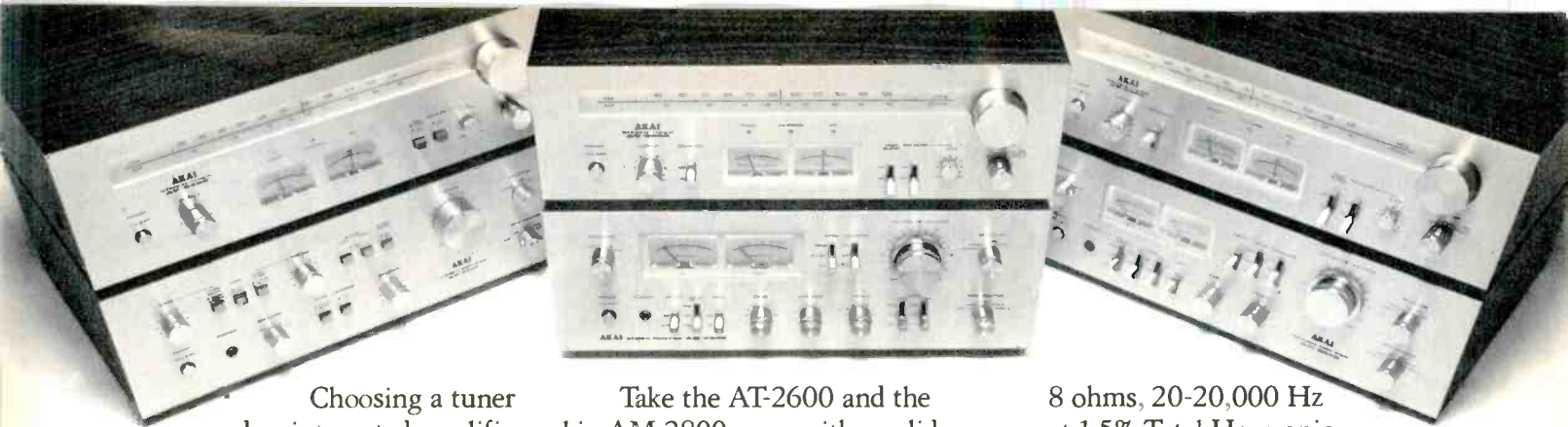

Choosing a tuner and an integrated amplifier is a lot like choosing a mate. You look for things like compatibility, performance, appearance and, of course, fidelity.

AKAI just made the process of matching component separates foolproof with a new line of tuners and integrated amplifiers. Paired on the grounds of total compatibility. And priced to be affordable.

Take the AT-2600 and the big AM-2800 amp, with a solid 80 watts, RMS per channel, 8 ohms, 20-20,000 Hz at .08% Total Harmonic Distortion.

Or the AM-2600 amp at 60 watts, RMS per channel, 8 ohms, 20-20,000 Hz at .1% Total Harmonic Distortion. And match it with the AT-2600 tuner.

Or maybe the AM-2400 amp at 40 watts, RMS per channel,

8 ohms, 20-20,000 Hz at 1.5% Total Harmonic Distortion. And the AT-2400 tuner.

No matter which of the perfect AKAI couples you choose, you get specs and features not found on all-in-one receivers in the same price category. Improvements you can hear. With clean, clear power per channel.

To hear the new separates, see your AKAI dealer. And live in perfect harmony.



For a 18" x 24" poster of this Charles Bragg etching, send \$2 to AKAI, Dept. A, 2139 E. Del Amo Blvd., P.O. Box 6010, Compton, CA 90224, ATTN: Couples.

# AKAI INTRODUCES THE PERFECT COUPLES.

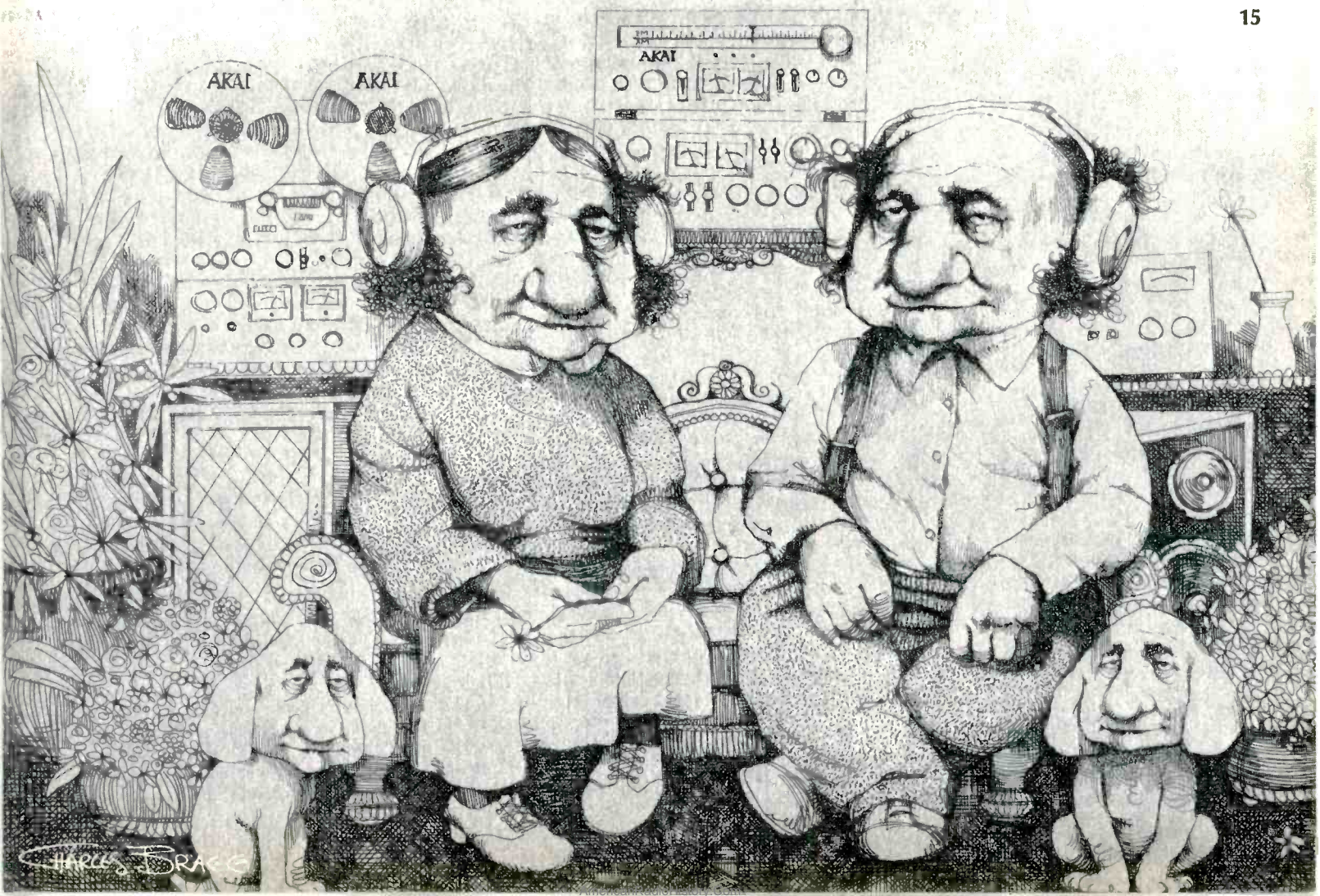



## 3009+FD200

The FD200 is a new accessory from SME: a fluid damping device which can be fitted, easily and quickly, to any Series II or Series II Improved arm. The benefits of fluid damping have long been known: resistance to external shock, audibly improved bass, and reduction of spurious low frequencies; but these are not fully realised when the damping is applied at the bearings. For this reason the FD200 is designed to be fitted at a point along the length of the arm.

The FD200 design overcomes the usual problems of leakage and low efficiency. It offers a choice of two damping rates, to suit a wide range of cartridge compliances. The attractively presented kit includes viscous fluid and full instructions.

16

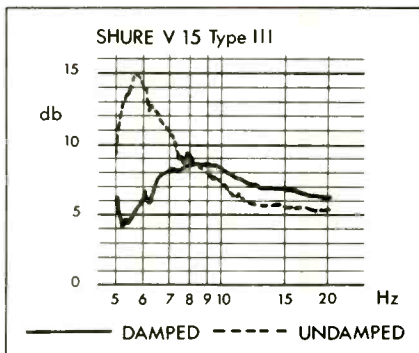

The illustration shows the extreme low frequency response characteristics of a typical high-quality cartridge in the Series II Improved arm.

Note the substantial reduction in the Q of the low frequency resonance. Although these frequencies are themselves outside the range of human hearing they give rise to undesirable side-effects which are audible.

Write to Dept 1443A, SME Limited  
Steving, Sussex, BN4 3GY, England

Exclusive distributors for the U.S.:

Shure Brothers Incorporated  
222 Hartrey Avenue  
Evanston, Illinois 60204

and in Canada:

A. C. Simmonds and Sons Ltd  
975 Dillingham Road  
Pickering, Ontario, L1W 3B2

# SME

Enter No. 35 on Reader Service Card

# Audioclinic

Joseph Giovanelli

## FM Antennas

**Q.** This is a request for your help in setting up the best antenna system for my location. Most of the stations I would like to receive are from Montreal, Canada, 120 miles up the Champlain Valley. Should I use a stacked or an unstacked antenna, how many in the stack? Tower, rooftop, or mast; how high? How about getting the last microvolt of signal down to the ground; are there commercial amplifiers as well as super cables and connections to do the job?—Ronald McKinnon, Middlebury, Vt.

**A.** It is often quite possible to obtain satisfactory FM reception from stations which are more than 200 miles from the receiving site, but if the terrain is not favorable, no antenna system, no matter how great its gain, will ever help. If the antenna cannot be erected high enough to clear obstructions you stand little chance of obtaining reliable reception. You may, at times, hear these signals, but this will be a matter of weather conditions rather than solid groundwave reception.

Where obstructions are not present, you should experience no problem, especially with today's tuners which are far better than the best commercial units available 10 years ago.

The FM band covers a wide portion of the r.f. spectrum and in order for the antenna to encompass such a range, its Q must be rather low which results in a decrease in available gain. However, if you are not concerned with tuning in the entire FM band, but want only to hear some specific station or cluster of stations within a certain section of the dial, an antenna could be cut to resonate at this area of the dial. The response over the rest of the band would not be optimum, but you would have gain where you need it.

By stacking antennas, gain can be increased, regardless of the Q of the antenna systems used. Adding a second antenna will add 3 dB gain. Adding two or more antennas will add another 3 dB gain, for a total gain of 6 dB.

While it is possible to buy ready-made or custom cut commercial antennas, it is also possible to make your own if you know the formulas involved. This may be obtained from "The Antenna Handbook" by Krauss, a classic in the field. Also, "The VHF Handbook" by the American Radio Relay League in Newington, Conn. is another good source of information.

No matter what kind of antenna you use, the higher you erect it the better your reception will be. However, any antenna mounted in the open, high above surrounding objects, must be protected against lightning. A competent person must do this work. Also such an antenna must be protected against the force of high winds. The more complex the antenna system, the greater will be the effect of the wind upon it.

If the run of cable between the receiver and antenna is great you will best be served by what is known as an "open wire feeder" which resembles a chain ladder—two parallel conductors are separated by insulators spaced about 18 inches apart, running at right angles to the conductors. The distance between the conductors determines the impedance of the feed line.

Where the need exists for use of coaxial cable, there may be a need for using antenna booster amplifiers, which are located right at the antenna and make up for cable losses. However no significant improvement in the signal-to-noise ratio can be expected from the use of such amplifiers, even though there is more signal. If there are strong local signals in your area, the amplifier will boost them also and their added strength can possibly overload your tuner. However, this condition can also occur by virtue of having a better antenna system than previously. In this event, band-pass or band-reject filters may have to be used to reject the effects of these strong signals. A

If you have a problem or question on audio, write to Mr. Joseph Giovanelli, at AUDIO, 401 North Broad Street, Philadelphia, Pa. 19108. All letters are answered. Please enclose a stamped, self-addressed envelope.

AUDIO • July 1977

# There Are Bigger, Chromier, Knobier, More Expensive Cassette Machines Than The Advent 201A. But...



If you are going to buy a high-performance cassette deck, you ought to know that no cassette machine will make more satisfying recordings (and keep on making them for year after year) than the Advent 201A.

The Advent 201A is a new version of the machine that made cassettes the high-fidelity medium they are today.

It is a uniquely simple, precise, and durable piece of recording machinery that will make cassette tapes that sound essentially identical to the best material you will find to put on them—with an ease (and repeatability) that is approached by very few cassette decks at any price and surpassed by none.

The 201A is designed to be *used*, not worshipped. Its unique single VU meter (which continuously scans both stereo channels and reads out the louder at any given moment) and its precise recording controls make it the same kind of day-after-day joy to operate as a fine camera.

If you will send us the coupon, we will be

happy to send full information on the Advent 201A (including a description of the new features, such as the Sendust tape head, that distinguish it from the original 201).

In the meantime, we suggest that before you buy *any* tape machine, cassette or open reel, you give the 201A the performance test it deserves. And check with anyone who owns an Advent on the kind of satisfaction it gives year after year.

Thank you.

TO: Advent Corporation, 195 Albany Street, Cambridge, Massachusetts 02139.

Please send information on the Advent 201A, including a list of your dealers.

Name \_\_\_\_\_

Address \_\_\_\_\_

City \_\_\_\_\_

State \_\_\_\_\_ Zip \_\_\_\_\_

**Advent Corporation, 195 Albany Street, Cambridge, Massachusetts 02139.**

# Behind the scenes

A little over 10 years ago, Philips introduced their compact cassette system, which stripped to essentials, was a tape recording system utilizing tape slightly over 1/7th inch in width, which operated at a speed of 1-7/8 ips, and was enclosed in a plastic shell which could be easily inserted and withdrawn from the record/playback mechanism, thus eliminating tape threading. The cassette was intended to be an inexpensive, convenient, portable speech recorder, suitable for dictation purposes. Within the Philips company, I'm sure that even the most wildly optimistic advocate of the cassette system never envisioned it becoming a high-fidelity stereo recording medium; in terms of prerecorded cassettes and in the opinion of many people the cassette is now a viable alternative to the phonograph disc. The advent of high-energy oxide formulations, new types of high-efficiency magnetic heads, Dolby-B noise reduction, advanced solid-state record/playback circuitry ... all have contributed to the establishment of the cassette as a truly high quality means of magnetic tape recording.

The high quality, versatility, and relatively modest cost of the cassette resulted in a veritable sales explosion, with literally hundreds of models of cassette recorders on the market. While the cassette drove "low-end" open-reel magnetic tape recorders off the market, open-reel aficionados with the wherewithal supported the

"high-end" recorder market and pointed out the technical shortcomings of the compact cassette. They said that cassette tape was lacking in headroom ... it couldn't handle a wide enough dynamic range ... the tape went into saturation too fast and caused distortion ... tape motion wasn't stable, because guidance was a function of the shell, and the shells were inconsistent in construction. While acknowledging all this, there were many tape enthusiasts who idly speculated on what a good thing it would be if someone could combine the best features of both systems.

## Japanese Ingenuity

The ever-industrious, ever-ingenious Japanese evidently had just this sort of thing in mind when they announced the Elcaset tape recording system early last year. In essence, the Elcaset is a scaled-up version of the compact cassette, some 2½ times larger in size, and it uses standard quarter-inch magnetic tape, operating at 3¾ ips ... double the speed of the cassette. Besides these obvious points, the Elcaset is considerably more sophisticated than the regular cassette. For instance, in the Elcaset the tape is pulled out of the plastic shell and onto the tape heads, eliminating the guidance problems inherent in the cassette system. The Elcaset shell was designed from the first to accept three heads, so true "off-the-tape" monitoring is possible. Sensing notches are moulded into the Elcaset to automatically program the recorder for such things as Dolby-B noise reduction and proper bias and equalization for the three specially formulated tapes designated Type One ... a low noise/high output gamma ferric oxide, Type Two ... a ferri-chrome tape, and Type 3 ... chromium dioxide tape. While the Elcaset

comes in C-60 and C-90 lengths and is stereo/mono compatible, a third "pilot" track between the stereo tracks can be used for such things as slide show synchronization and pre-set program selection. With the quarter-inch wide tape, 3¾ ips speed, and special tapes, the Elcaset is capable of a much wider dynamic range, wider frequency response, less distortion, and a better signal-to-noise ratio than the cassette.

The Elcaset was a joint development of Sony, Matsushita, and Teac, and they were soon joined by JVC and Akai. There were some previews of the system for the audio press corps, who learned there were models of the Elcaset to be shown at the 1976 summer CES. As it turned out, to a limited extent, this did indeed happen. I was "button-holed" by the public relations minions of one company, who gave me very positive promises that an Elcaset unit would be sent to me in short order for my evaluation. Well, tempus fugited, I fidgeted, and no Elcaset appeared. During this period, it seemed that some internecine unpleasanties were going on within the Elcaset consortium.

One of the things the group had to contend with was a certain amount of apathy and indifference to the Elcaset concept on the part of some audio dealers and some of the press. There were the usual expressions of "who needs it?"—common to many new developments in audio. These nay-sayers are entitled to their opinions, but to voice such ideas before they ever got to see or hear an Elcaset is patently unfair. If the ideas of these people prevailed, we would still be sharpening cactus needles and playing our music through "morning glory" horns!

## Licensing Lethargy

Eventually, the reason for the reduced activity and nonappearance of Elcaset models from the various companies became apparent. It appears that Sony, probably the prime-mover in the Elcaset project and sole manufacturer of the special Elcaset tapes, wanted other tape companies like TDK and 3M, to pay a fee for a license



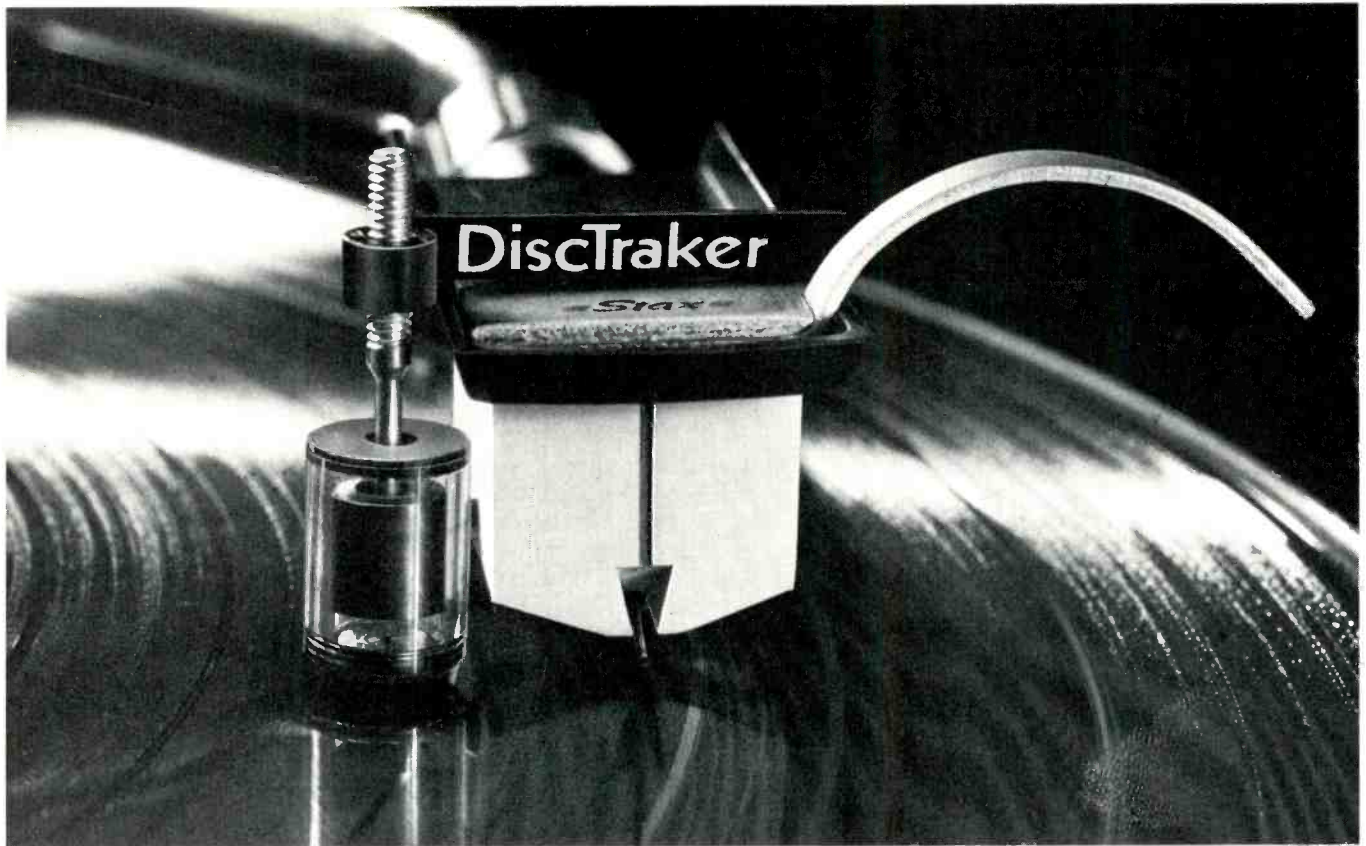

# THE NEW REVOLUTION FROM DISCWASHER.

DiscTraker is a revolutionary pneumatic damping device that provides a critical protective cushion so badly needed with state-of-the-art tonearms and cartridges.

- effectively reduces tonearm/cartridge resonance at low frequencies.
- drastically and listenably reduces record-warp resonance (woofer flutter).
- allows badly warped records to be played with fidelity and without record wear or stylus damage.
- applicable to any tonearm.
- patented in all industrialized countries.

DiscTraker greatly enhances the performance of fine record playback systems; another example of Discwasher's leadership and innovative technology.



## DiscTraker™

 discwasher®, inc.  
1407 N. Providence Rd.  
Columbia, Missouri 65201

to manufacture these tapes. They are, of course, perfectly within their rights in making such a request, and one cannot castigate them for so doing. However, might we gently suggest they take a leaf from Philips' book and offer their technology free of any license fees? There is little doubt that this Philips gesture was of inestimable value in the rapid proliferation and establishment of the cassette format. As of now, negotiations are still going on, and one hopes that the issue will soon be resolved. One hopes that there may be some movement in this direction from the announcement by Teac that their Elcaset deck will soon be available. Superscope has begun to market the Sony decks, and the Sony decks are on the market in England, and have, in fact, been glowingly reviewed in the prestigious *Hi-Fi News and Record Review*. Technics demonstrated their Model RS-7500US Elcaset deck at the New York AES convention and at the recent Washington and Philadelphia Hi-Fi Shows. In December of last year, I was with a group of audio writers at the Technics plant

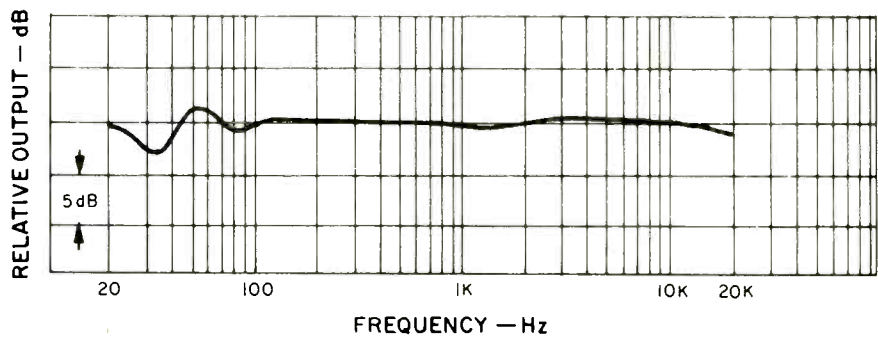

back heads, permitting off-the-tape monitoring. The tape drive is via a frequency generator servo-controlled d.c. motor, with a connecting belt driving the take-up reel. Wow and flutter is claimed to be 0.06 per cent rms, and while I did not test it with a flutter bridge, sustained piano chords (piano is a fixed-pitch instrument) sounded quite clean and stable. Tape motion and record/play functions are controlled by the usual mechanical "finger" leverage system. The unit has two good-sized VU meters (peak in-

important? I personally feel the answer is self-evident . . . both machines should have the combination of three heads and Dolby B noise reduction. Both Sony and Technics do have higher priced Elcaset units with both facilities. Frequency response of the Technics RS-7500US is rated at 25-18,000 Hz  $\pm 3$  dB with Type One tape and 25-20,000 Hz with Type Two or Three tape.

#### Testing Tells . . .

I have a great new device for measuring overall record/playback response with three-head tape machines. This is the United Recording Equipment Industries (UREI) Model 2000 automatic X/Y response plotter. This sweeps from 20 to 20 kHz, and a pen recorder plots the curve on log audio paper. I will be bringing you a detailed report on this unit in an upcoming column . . . I am awaiting a new UREI module 2010, which can plot amplitude and frequency from test tapes and records, etc. so I can give a full report. Anyway, the curve I obtained speaks for itself!

I hooked up a Dolby 505 Type B noise reduction unit to the Technics Elcaset, and at 9-10 dB better than the claimed 63 dB S/N ratio, hiss was no problem. I played a 15-ips master with Dolby-A noise reduction through an Ampex 440C and recorded it on Type One Elcaset tape. On A/B comparison, it was almost impossible to consistently tell one from the other. The Elcaset handled the wide dynamics of Prokofiev's *Lt. Kije* suite with no strain, and the S/N was quite good. I played quite a few Elcaset tapes I had recorded from master copies, and without exception, people who have heard them have been singularly impressed, not the least of which were some ladies, who loved the simplicity of the loading. It is early in the game, but on the basis of my experience and the fine reviews from England, the Elcaset deserves a hearing (no pun intended). A



in Osaka, where we got a thorough rundown on this Technics Elcaset unit. Now I finally have a RS-7500US Elcaset unit and a supply of Type One and Type Two blank Elcaset tapes. It seems that the chromium dioxide Type Three Elcaset tapes are not yet available.

The RS-7500US Elcaset recorder is a very rugged-looking unit, in the "rack mount with large handles" configuration and the currently popular "black look." It is a front-loading unit, and there is an ingenious mechanism which automatically pulls the tape out of the Elcaset when the shell is inserted and locked in place. There is a double-gap ferrite erase head and separate permalloy record and play-

dications with an LED would be helpful), tape-monitor switch, memory rewind, and separate pots for mike/line mixing. As noted previously, bias and equalization are automatically set by the sensing notches on the Elcaset shell, and front panel lights indicate what type of tape is being used. A panel covering the three heads unscrews for easy cleaning. There is no Dolby-B noise reduction furnished in this \$599.00 Elcaset deck, and this brings up a marketing point . . . The Sony EL5 Elcaset deck is the same price as the Technics and has Dolby B noise reduction . . . but it only has two heads and does not permit off-the-tape monitoring! Which is the more



# A New Dimension



Two new electronic products from Nakamichi may be just what you've been waiting for. The 410 Preamplifier and 420 Power Amplifier are indeed compact, beautifully styled and decidedly affordable. Measuring less than 9" x 16" and barely 3/4" thick, both are timeless design expressions... pure Nakamichi in quality and performance.



The 410 approaches the theoretical limits of error-free amplification. A superb phono section, inherited from Nakamichi's amazing 610 Control Preamplifier, utilizes unique circuitry to minimize noise and distortion while maximizing dynamic range. Three phono input sensitivities accommodate a wide variety of cartridges. There is even a switchable active subsonic filter that keeps rumble and tonearm resonances from degrading sound quality. Additional features include fully defeatable tone control circuits, variable contour compensation, high-output headphone jack, and a 2 dB-stepped precision volume attenuator.

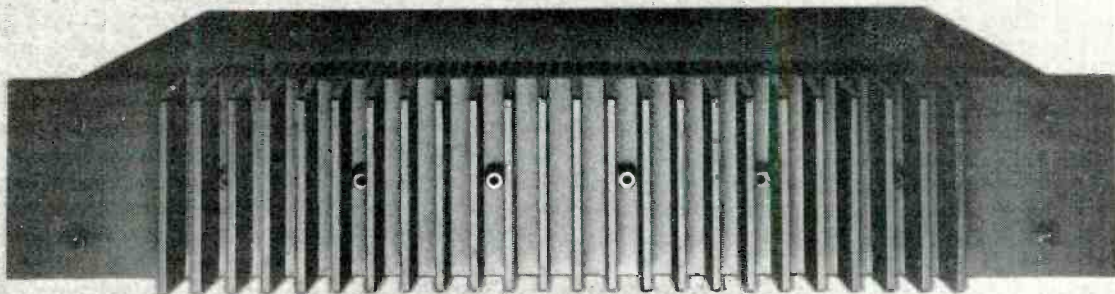

The 420 Power Amplifier is a neat, efficient unit for perfectionists with moderate power requirements. The unique output circuitry originally developed for the Nakamichi 620 virtually eliminates crossover and switching distortions without high idling current. The resulting low operating temperatures ensure long-term reliability. And, like the 620, the 420 employs a super-efficient toroidal power transformer, low negative feedback and foolproof protection circuitry—all of which add up to exemplary performance specifications and an effortless sound quality that belies its conservative power rating.

Let the 410 and 420 add new dimensions to your listening pleasure. See and hear them at a Nakamichi dealer soon. Your ears will thank you. For further information, write Nakamichi Research (U.S.A.), Inc., 220 Westbury Avenue, Carle Place, New York 11514

  
from Nakamichi

**410 Preamplifier:** Phono S/N (IHF-A): Better than 80 dB ref. 1 mV  
RIAA Deviation: Within 0.3 dB  
Subsonic Filter: -45 dB @ 10 Hz  
Distortion: Less than 0.003%  
Frequency Response: 20-50,000 Hz + 0, -1 5dB

**420 Power Amplifier:** Power Output: 50 watts per channel min. rms @ 8 brms,  
5-20,000 Hz, with less than 0.02% THD  
S/N Ratio (IHF-A): Better than 110 dB @ rated output  
THD @ 1 KHz: Less than 0.0008% at any power level below clipping  
Frequency Response: 5-50,000 Hz + 0, -1dB

# TURNTABLES

## Turntables and Noise

Joseph F. Grado\*

22

In my first article I discussed the various types of noise one might encounter in a phono playback system, and particularly the fact that the pickup sees mechanical motion and converts it into an electrical signal. Unfortunately, the pickup cannot discriminate one mechanical motion from another, and therefore if an extraneous mechanical motion is added to the signal on the record, a distorted playback will result. The two general classifications of extraneous noise are those resulting from poor turntable design and those created by external sources, the latter problem being feedback. The first article ended by describing a mechanical-energy decoupler, consisting of a series of springs and a special dense board, designed to isolate the turntable from both mechanical and acoustical environmental energy. The description of this energy decoupler was simplified considerably for purposes of illustration. It was shown that a vertical spring action was effective for decoupling mechanical energy to the turntable, and this is true to a degree. However, the problem of completely decoupling the turntable from environmental energy is considerably more complex. Environmental energy does not reach the turntable in only the vertical direction. It arrives at the turntable from several major directions and an almost infinite number of integrated directions. A damping unit must therefore be capable of isolating the turntable environmental energy arriving from all directions. The mechanical energy caused by

poor turntable design is yet another story. It cannot be controlled by the user, yet it is important that he be aware of it when making his initial purchase.

As we discussed earlier, a turntable's design may be classified into several basic sections: 1, the drive system (motor); 2, the transmission system (motor-to-turntable coupling); 3, the platter and/or flywheel system, and 4, the main chassis.

The drive system in early turntables generally consisted of a motor shock mounted to the main chassis by means of rubber supports, a turntable platter, and a rubber idler. When the turntable was switched off, the rubber idler wheel was automatically disengaged from contact with the motor shaft and the turntable platter. When the turntable was switched on, the rubber idler wheel would swing into its operating position and the mechanical operation was as follows—the rotating motor shaft contacted the rubber idler wheel, which in turn rotated against the inner rim of the turntable platter which rotated.

There were two methods used to keep the rubber idler in contact with the motor shaft and platter. One method was to use a spring-loaded lever to hold the idler in position, and the other was to use the rotational direction of the motor shaft to actually jam the idler into its operating position. Needless to say, both approaches are inadequate for a state-of-the-art design. If we examine this basic design approach, it becomes immediately obvious that the high-stress contact between the motor shaft and the idler wheel forces the motor shaft to rotate eccentrically in its upper

bearing, with a counter rotating action in its lower bearing. This motor shaft and bearing action is intolerable since it creates high-stress mechanical vibrations easily within the audible range. The rubber idler wheel, being compressed against the inner rim of the turntable, forces the turntable platter shaft to rotate off center in its upper bearing contact and, at the same time, counter rotating in its lower bearing area. This creates a second mechanical vibration condition within the turntable system. The rubber idler wheel, being compressed between the motor shaft and the inner rim of the turntable platter, has now become distorted in shape and produces multi-directional rippling motions intermittently in and out of mechanical phase with the motions of the motor shaft and the turntable platter. This is a third mechanical vibration, and when you add these three mechanical vibrations together, you can see how monstrous the situation is beginning to get. But wait a minute, I'm not finished yet!

As was mentioned, the idler wheel's operating position is maintained by either a spring-tension device or by the rotational operating pressures of the motor shaft driving force and the resistive force of the inner rim of the turntable platter. If the spring-tension system is used, you may add spring oscillation to the list of problems. If you use the system of rotational contact, considerable force is applied to the rubber idler, thereby increasing the mechanical vibration level. This general system is still being used today. In all fairness, however, I must add that it has been refined to a reasonably acceptable performance level.

\*Grado Laboratories, Inc.,  
4614 Seventh Ave., Brooklyn, N.Y. 11220

# THE TAPE THAT'S TOO GOOD FOR MOST EQUIPMENT.

Maxell tapes are not cheap.

In fact, a single reel of our most expensive tape costs more than many inexpensive tape recorders.

Our tape is expensive because it's designed specifically to get the most out of good high fidelity components.

So it makes no sense to invest in Maxell unless you have

no one gets into our manufacturing area until he's been washed, dressed in a special dust-free uniform and vacuumed.

## WE CLEAN OFF THE CRUD OTHER TAPES LEAVE BEHIND.

After all the work we put into our tape, we're not about to let it go to waste on a dirty tape recorder head. So we put special non-abrasive head cleaner

## OUR TAPE COMES WITH A BETTER GUARANTEE THAN YOUR TAPE RECORDER.

Nothing is guaranteed to last forever. Nothing we know of, except our tape.

So our guarantee is simplicity itself: any-time you ever have a problem with any Maxell cassette, 8-track or reel-to-reel tape, you can send it back and get a new one.

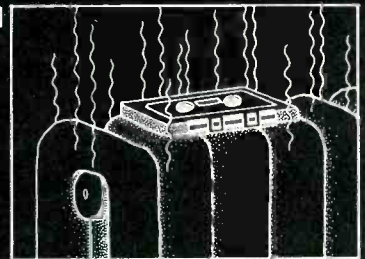

Our guarantee even covers acts of negligence.

sounds at your nearby audio dealer.

(Chances are, it's what he uses to demonstrate his best tape decks.)

equipment that can put it to good use.

## THE REASON OUR TAPE SOUNDS SO GOOD IS BECAUSE IT'S MADE SO CAREFULLY.

Every batch of magnetic oxide we use gets run through an electron microscope. Because if every particle isn't perfect, the sound you hear won't be either.

And since even a little speck of dust can put a dropout in tape,



Every employee, vacuumed.

## No other tape starts off by cleaning off your tape recorder.

on all our cassettes and reel-to-reel tapes. Which is something no other tape company bothers to do.

## OUR CASSETTES ARE PUT TOGETHER AS CAREFULLY AS OUR TAPE.

Other companies are willing to use wax paper and plastic rollers in their cassettes. We're not. We use carbon-impregnated material. And Delrin rollers. Because nothing sticks to them.

A lot of companies weld their cassettes together. We use screws. Screws are more expensive. But they also make for stronger cassettes.

## GIVE OUR TAPE A FAIR HEARING.

You can hear just how good Maxell tape

You'll be surprised to hear how much more music good equipment can produce when it's equipped with good tape.



Maxell Corporation of America, 130 West Commercial Ave., Moonachie, New Jersey, 07074.

## Tonearm Vibration

Now that we've seen where mechanical vibrations occur within the turntable itself, let us also examine their influence upon the tonearm. The direction the above mechanical vibrations follow to reach the tonearm and upset its function are as follows. The mechanical vibrations from the turntable platter and shaft are transmitted to the record, added to the recorded signal and picked up directly by the phono stylus. The other mechanical vibrations are transmitted from the drive mechanism to the turntable chassis, then to the rear tonearm support, continuing up into the tonearm tube itself, and finally into the phono pickup. It can be easily seen that this second vibration reaches the phono pickup much later than the first, creating phase, delay, and decay problems in the recorded signal. (Please keep in mind that I am only glossing over highlights of turntable problems. To do a complete analysis of turntable design would be a very complex affair and could not be completed even in several articles like this.) The two remaining turntable designs are the belt drive and the center motor or direct drive. Since the belt drive is next in the evolutionary cycle, I will discuss it first.

A belt-drive turntable is just that, a turntable driven by the motor via a flexible belt. The belt is simply used in place of the rubber idler wheel. Figures 5, 6, and 7, show three variations of the belt-drive system. In Fig. 5, you see the basic belt drive, a motor with its shaft positioned outside the turntable perimeter and a flexible belt stretched around the outer diameters of the motor shaft and the turntable platter. Figure 6 shows the double-motor drive system in which a motor is positioned on each side of the turntable platter with a single belt stretched around the two motors and the turntable. In the first belt-drive system the belt tension is between the motor shaft and the platter. This belt tension causes both the motor shaft and the turntable shaft to be pulled toward each other, resulting in an erratic shaft and bearing action identical to that which I described in the idler wheel system. In the double-motor belt-drive system, the belt pressures on the platter are equalized, however, we now have two motor shafts being pulled together by belt tensions. This of course results in an erratic motion between the motor shafts and their respective bearings.

The third example of the belt-drive

system has two belts and an intermediate idler wheel pulley. The motor shaft drives the pulley by means of the first belt, and the pulley drives the turntable by means of the second belt. The theory of the belt drive is that it will drive the turntable and at the same time absorb mechanical vibrations from the motor. The big drawback here is that the filtering of the belt is accomplished through its flexibility, and this very same flexibility creates its performance limitations. When the belt system was first introduced, a belt that was highly flexible, and had long term elastomeric stability simply did not exist. At the present time, the technology of flexible belt design and manufacture has become highly sophisticated, and the net result is that a good belt drive system may easily compete with the best direct-drive systems.

## Direct Drive Systems

The last system to be discussed is the center motor or direct drive. In the direct-drive system, both the belt and the rubber idler wheel are eliminated, and the turntable platter is mounted directly onto the motor shaft. One could assume that this would be the ideal system, but, alas, it too has problems. Since we have now mounted the platter directly to the motor shaft, we no longer have either the belt or the idler wheel to filter motor vibrations. In the center-drive system, every mechanical inaccuracy and vibration of the motor is directly transmitted to the turntable platter! Fortunately, the motors designed for the direct-drive system are superbly built, but there are some electronic control problems of a minor nature which are being corrected at a very fast rate. There are already digital controls which are beginning to approach quartz crystal control accuracy and yet still afford the ease of manual speed variation. There is very little doubt that future turntable design will continue in the direction of the direct-drive system, considering the potential sophistication it is capable of providing.

Although the turntable drive systems are improving at a fairly rapid rate, one problem basic to all turntables still exists—I call it the teeter-totter of the turntable platter. Figure 9 shows a conventional platter and shaft standing on the end of the shaft. It is obvious that the weight of the platter will cause the platter to topple over if it were to stand by itself. When the

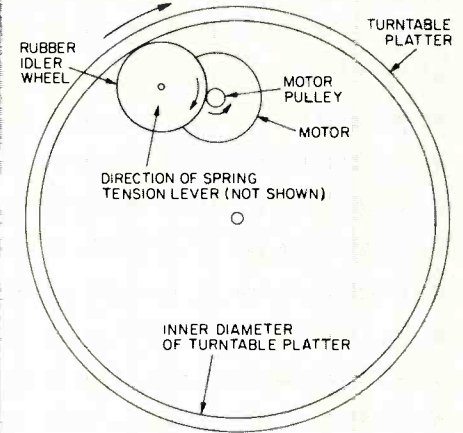

Fig. 1—Drive system of early turntables.

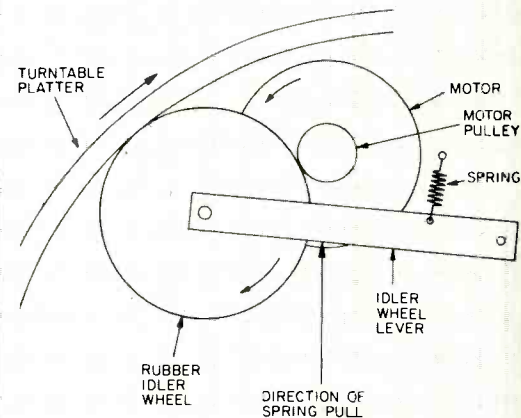

Fig. 2—This drive system uses a spring-loaded lever to keep the idler wheel in contact with the motor pulley and the platter rim.

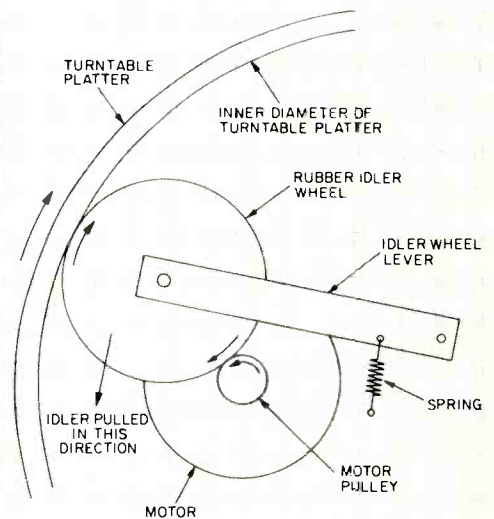
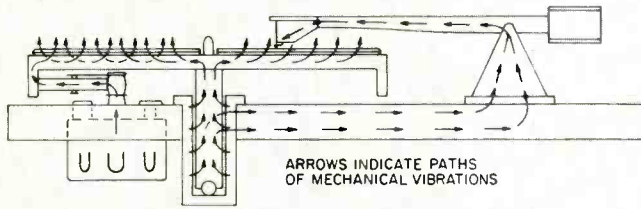
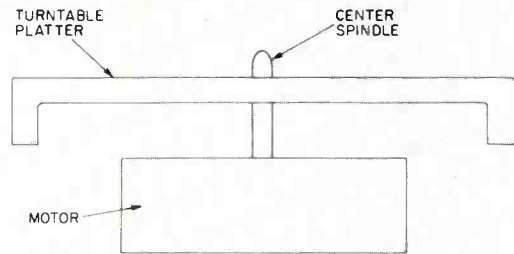

Fig. 3—This variation of the lever system jams the idler wheel between the motor pulley and the platter rim.



**Fig. 4—The arrows indicate the paths that mechanical vibrations take to reach the tonearm and cartridge.**



**Fig. 8—Direct-drive system.**

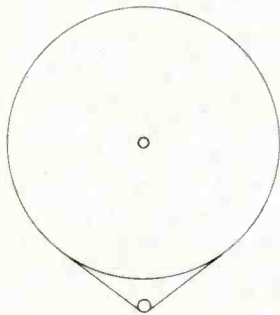

**Fig. 5—Single-motor belt-drive system.**

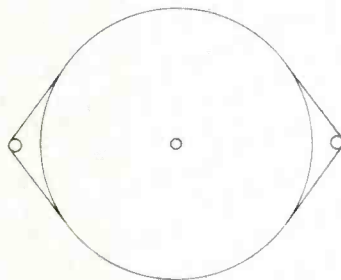

**Fig. 6—Dual-motor belt-drive system.**

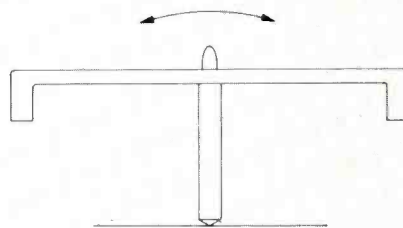

**Fig. 9—Basic "teeter-totter" motion of platter and spindle.**

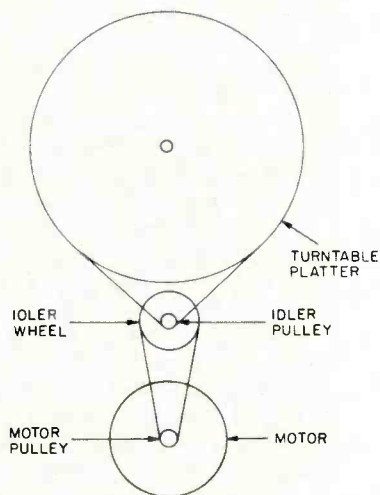

**Fig. 7—Belt-drive system using an intermediate idler.**

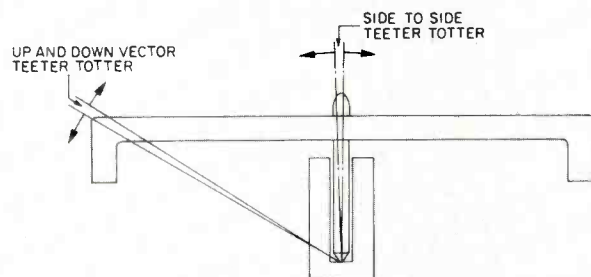

**Fig. 10—The amount of "teeter-totter" motion is the product of the side-to-side motion of the spindle times the ratio of spindle length to platter radius.**

# The AUDIBLE JUSTICE of the RAM512 power amplifier.

Specifications: 300hp, dual overhead cam, 180 WATTS CONTINUOUS PER CHANNEL BOTH CHANNELS DRIVEN INTO 8 ohms, 20 TO 20KHz WITH LESS THAN .08% I.M. AND T.H.D. 0 to 100 mph to 0 in 23 sec., SLEWING BETTER THAN 20 VOLTS PER MICROSECOND. Four wheel disc brakes, DAMPING FACTOR 1000 OR GREATER 20-20KHz. 5 speed gear box, PROPAGATION DELAY LESS THAN 0.2 MICROSECONDS. 140 mph speed indicator, 43dB RANGE AVERAGE POWER READING METERS, WITH -20dB PEAK RESPONDING INDICATORS.

SPECIFICATIONS ARE NOT THE WHOLE STORY, TEST DRIVE YOUR SPEAKERS WITH THE RAM512.

## RAM audio systems inc. 17 JANSEN ST., DANBURY, CT. 06810

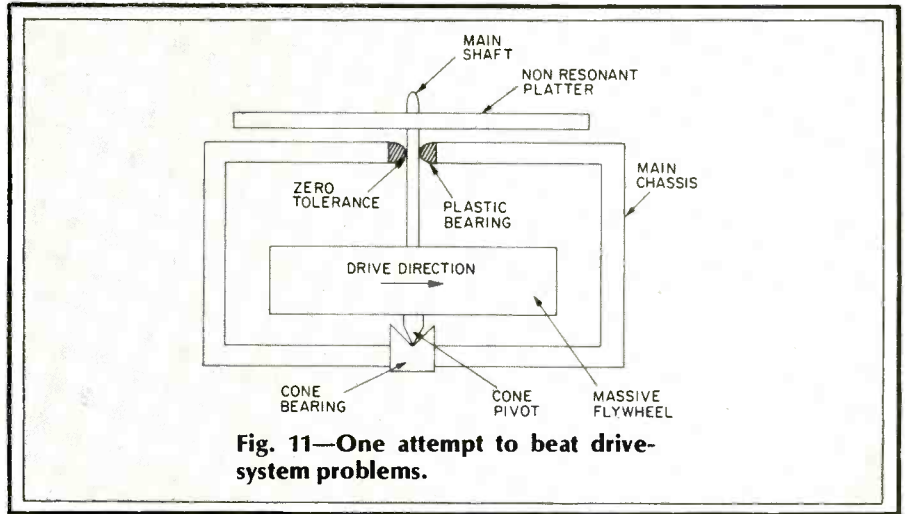
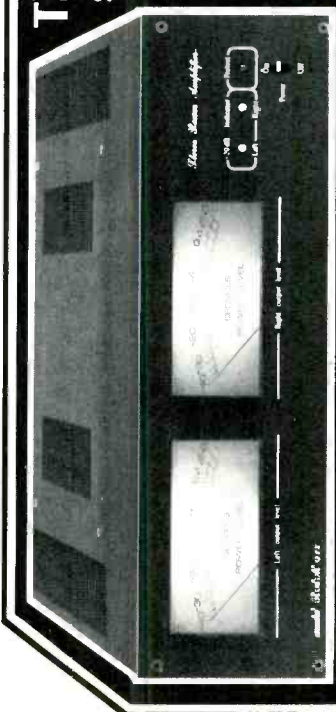

Fig. 11—One attempt to beat drive-system problems.

platter is in the turntable bearing assembly, it tries to do the very same thing—it tilts. The result is that one side of the platter shaft contacts the upper bearing and the opposite side of the shaft contacts the lower bearing. When the shaft rotates, then, it does not rotate on axis. The weight of the platter high above the shaft and bearings creates a sideward thrust and a counter rotating of the platter shaft in its bearing assembly. This counter rotation of the shaft causes a vibratory action in the shaft which is transmitted directly to the turntable platter and then to the phono pickup. The above condition exists in all conventional turntables, regardless of the drive system employed.

It can be seen in Fig. 10, that if the turntable radius is six inches and the bearing length is three inches, a two-to-one ratio exists between the shaft and bearing clearance and the platter teeter-totter. The additional vertical signal generated by the pickup due to the vertical teeter-totter is added to the recorded signal as distortion! This condition exists in all turntables regardless of the drive system employed in them.

Many years ago, in an effort to combat these problems, I designed a turntable which had a massive flywheel mounted in the lowest possible position on the shaft (Fig. 11) and a very light platter on the top of the shaft. The upper platter was made of a non-resonant material and was used to carry the record. The shaft was as long as the turntable radius, the lower support bearing was a cone type, and the shaft made a single point contact with the cone bearing. The upper bearing was a sleeve bearing of self-lubricating plastic. The elastomeric qualities of the plastic allowed a zero tolerance between the shaft and the bear-

ing. The shaft and bearing friction was so low that the eight pounds of flywheel could be driven beautifully by two tiny clock motors. The stylus force could be increased to 50 grams without slowing the turntable. Needless to say, the flutter and wow were extremely low, but more important the rumble figure was better than -85 dB.

### Granite-Epoxy Platters

In my first article I discussed the problem of acoustic feedback in turntable platters. This, as I said, is caused by acoustic energy creating mechanical energy in the platter itself, much the same as wind in a church bell causes it to hum or resonate. The only way to overcome this condition is to damp the platter or to make the platter of a dense, non-resonant material. I, for one, would like to see platters made of the granite-epoxy presently being used for turntable chassis. A turntable platter of this material would make an excellent flywheel and be dense and massive enough to effectively mass damp mechanical vibrations from either design or environmental sources.

The turntable chassis should also be as massive and as dense as possible since it must perform two important functions, mass-damp acoustical energy coming to the turntable from room sources and mass-damp mechanical energy created by the turntable drive system before it can reach the tonearm base.

As we have seen, turntables and their extraneous mechanical vibrations may affect a change in the sound of a phono pickup, but the turntable itself does not "sound." In my next article, I will discuss tonearm design and how the tonearm manages to affect the sound of pickups.

If you take a creative approach to recording, you'll appreciate the special versatility of the new Dual C919 cassette deck. Four separate slide controls for the line-level and microphone inputs allow you to mix and record signals from disc, tape or FM with live voices and instruments. Output level controls eliminate the need to readjust your amplifier's volume when switching programs, such as to tuner or record player. (These and additional features are shown below.)

# The Dual C919 is so versatile, you might think of it as a miniature recording console.

What about performance? The C919 uses the highly reliable Continuous Pole/synchronous motor, tapeheads, electronics and a uni-directional version of the transport system of our new Auto/Reverse deck, which *Audio* magazine reported as "...another outstanding example of the great strides in cassette deck technology in recent years. Wow and flutter

was indeed extremely low, measuring 0.065% (WRMS)...total harmonic distortion...well below the 1.5% claimed...about the fastest and smoothest [wind] we have encountered...we also found that the Dual deck was able to handle [C-120 cassettes] smoothly...A distinct feeling of quality...seems well worth the price."

Thus, whether you have special program-mixing requirements, or simply want superb overall performance, both are available in the C919 cassette deck. Less than \$450.00.

United Audio Products, 120 So. Columbus Ave., Mt. Vernon, N.Y. 10553

Exclusive U.S. Distribution Agency for Dual

Enter No. 12 on Reader Service Card



Output level controls.

Memory for locating pre-selected passages on tape.

Headphone level control for precise stereo monitoring.

Bias and equalization for ferric-oxide, chromium-dioxide, and ferrichrome tapes.

Wow and flutter; 0.07%. Frequency response ( $\pm 3\text{dB}$ ): ferric-oxide, 20-16,500 Hz, chromium-dioxide, ferrichrome, 20-17000 Hz.

Level meters with VU characterstics; meters tilt for optimum viewing angle.

Level controls for microphones and line inputs.

Dolby system with calibrators; can be switched to decode Dolbyized FM broadcasts too.

Dolby is a trademark of Dolby Laboratories, Inc.



# SOUND ON WHEELS

There's no reason to leave good sound at home just because it's an hour commute to the office or you're going to the shore for the weekend—no reason at all, not when a good custom shop can outfit you with a rolling listening room complete with a sound system approaching the quality of the multi-kilo-buck rig you've got at home.

28

The sound studios on wheels shown here were done by Vandango, Pembroke Park, Fla., who specialize in "customizing any means of transportation anyone wants" and have already done just about everything from motorcycles to yachts. Their specialty is the custom van, but they've even done an ambulance!

If you're looking for good ways to get good sound into your van or car, feast your eyes on the jewels these pros have produced and in particular the paint work by Vandango's mural artist, Shelby Goode.



**Wyatt Fuller, Vandango's President, owns this '76 Ford Econoline; close-ups of its murals are shown below. Two entertainment consoles feature a Pioneer FM supertuner/cassette; Panasonic CB; and Audiovox digital clock, FM booster, and weatherband receiver; a B-W TV, and a computer-driven CRT which flashes true random patterns of colored squares. Other goodies include black plexiglas dash with micorswitch control panel, bedroom area with fiber-optic display of night sky complete with Milky Way and comets, and portholes showing deep space. Six Pioneer TS-167 speakers were hidden throughout the van.**







Installing speakers and other components isn't hard — so long as you take your time and use common sense. Several makers, including Pioneer and JIL, have produced self-help booklets, and "Auto Stereo Service & Installation" by Dorweiler & Hansen (Tab #694) provides more information for the advanced do-it-yourself-er. Above we see two of the steps in speaker installation, while at left an overhead console is being prepared for final assembly.

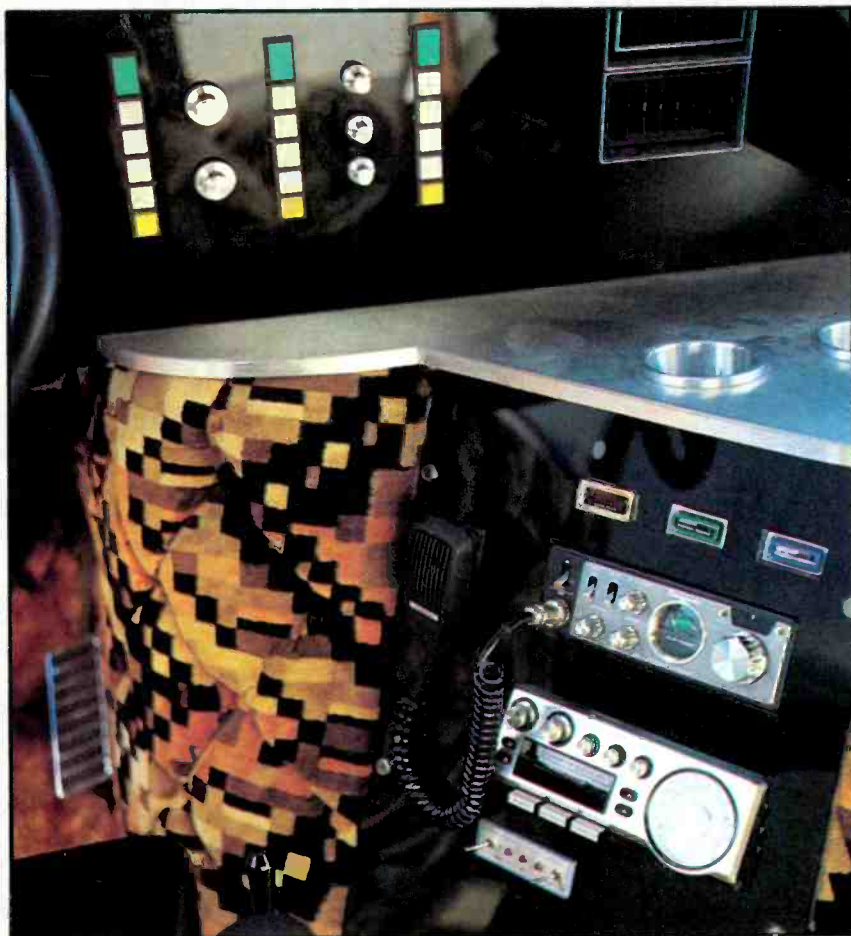

This 1971 Cadillac ambulance was designed and built as an executive limousine for the city of Sunrise, Fla., as transportation for entertainers performing at the Sunrise Music Theater. The sound system features a Pioneer FM supertuner cassette unit driving four Pioneer TS-167 speakers located in the four corners of the passenger compartment.



# FOUND ON WHEELS



**WSHE / WSRF, radio stations in Fort Lauderdale, own this 1975 silver Dodge maxi-van. An overhead console in the driver's compartment contains a Superscope AM / FM stereo / cassette unit and hides two Pioneer speakers, while two more Pioneer 6x9 speakers are hidden in the front of the couch. The murals again are by Shelby Goode and topped by 50 coats of clear lacquer. The interior features four captain's chairs in vinyl with velvet inserts. Buttoned vinyl covers the door panels, dash, engine cover, console, walls and overhead liner.**



# Tannoy

## INTEGRATED SPEAKER SYSTEMS

At first glance, the Tannoy appears to be a loudspeaker. *It is more.* It is in fact a completely integrated loudspeaker system. Sound is reproduced, phase coherent throughout the entire audio range, from one transducer matrix. The high frequency (HF) tweeter and low frequency (LF) woofer are combined within a single, powerful magnetic structure. Sound is collected by a unique multi-throated phase compensating unit and fed into a short exponential horn. The curvilinear LF diaphragm ensures wide dispersion of high frequencies and an unbroken audio spectrum.

□ The LF diaphragm acts as a true piston from the lowest bass up to 1kHz. The tweeter handles frequencies from 1kHz to beyond 20kHz. The crossover network ensures smooth transition between the woofer and horn-loaded tweeter. A superb, level response curve is achieved throughout the low, mid-range and high frequencies by an ingenious combination of the extended LF direct radiator, crossover network and wide range HF driver. A dynamic balance and roll-off control is incorporated for adjustments to personal taste or room acoustics. The Tannoy is exceptionally efficient. It can handle high powered amplifiers with ease, yet can be driven to high levels by moderately powered units. Equally important, music can be played at low volume without any compromise of musical quality.

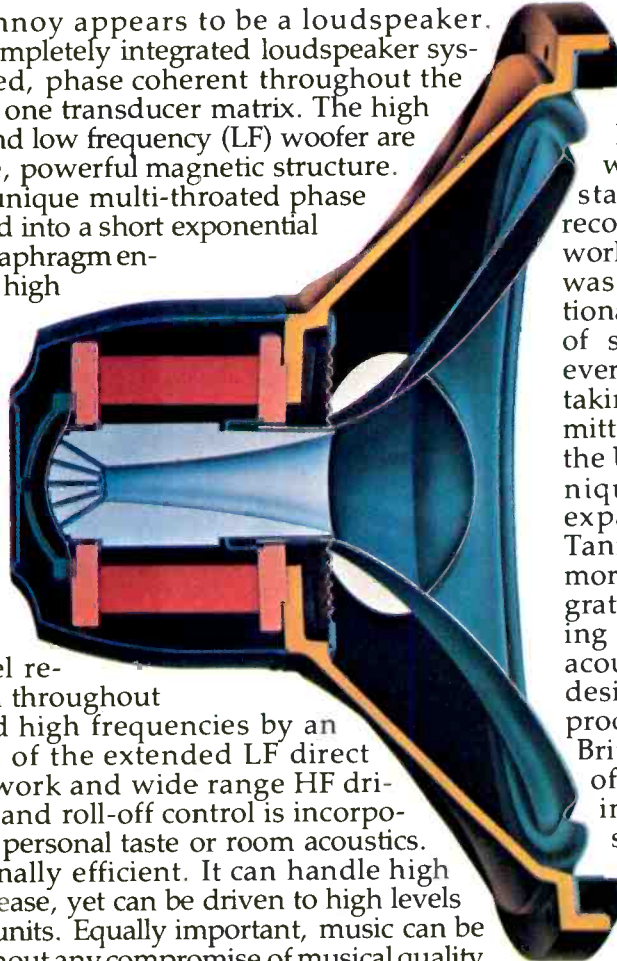

Tannoy has been engaged in continuous research and production of high quality transducers for half a century. From the outset, its products were adopted as a listening standard by broadcasting and recording companies all over the world. By 1968, the term, "Tannoy" was in the Chambers English Dictionary as synonymous with the art of sound reproduction. □ However, modest facilities and painstaking standards of production permitted only limited distribution in the United States. Now... new techniques and materials, as well as expanded facilities have made Tannoy systems available to many more listeners. □ The Tannoy integrated speaker system is the crowning achievement of generations of acoustic consultants, researchers, designers, sound engineers, and produced in the best traditions of British craftsmanship. The hand of the master cabinetmaker is immediately apparent in the system's exquisitely finished enclosure. The Tannoy will provide the maximum quality your electronic equipment is capable of delivering.

31

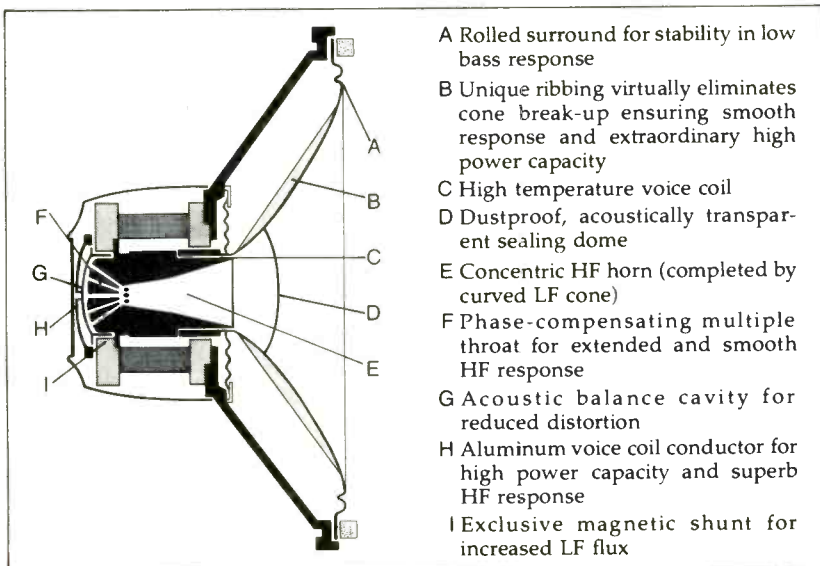

For additional information:

# TANNOY®

122 Dupont Street, Plainview, N.Y. 11803

Enter No. 40 on Reader Service Card

# FOUND ON WHEELS



Terry Messer's 1975 orange Ford Econoline E-300 was a work van before Vandango did its number. The sound system is mounted in an overhead console and includes a Pioneer AM/FM/cassette unit and a Lafayette CB radio, with a Bearcat police band scanner mounted in the dash. Paint work includes a candy apple tangerine lacquer over a gold base coat and custom murals by Shelby Goode topped with some 60 coats of clear lacquer.



**The engineers who conceived the state-of-the-art DDX 1000 are pleased to announce the MB 15.**

**At less than one fourth the price.**

With its three-tonearm capability, its \$600 nationally advertised value,\* and its optional highly-acclaimed MA 505 tonearms, the Micro Seiki DDX 1000 has been accepted as one of the unique advances in turntable concept and design.

Using the same technology, our engineering team has crafted the MB 15 to achieve economy, while preserving musical accuracy.

Elegant and understated, its economy of design reveals not one extra line—contains

not one unnecessary part.

An electronic sensor controls shutoff and arm-lift operation: a Hall-effect IC sensor detects a change in tonearm speed at the end of the record and activates a viscous-damped device which lifts the tonearm and shuts off power.

Its diecast aluminum platter is driven by a 4-pole synchronous motor coupled with a precision-polished belt that effectively acts as a damping device; wow and flutter is less than 0.06%.

A solenoid-activated cueing system and an easy-to-adjust anti-skating control are among its attractions. The MB 15 tonearm headshell is detachable for ease in mounting cartridges.



DDX 1000



MB-15

At \$150 (nationally advertised value)\* you can considerably enhance the enjoyment of your records with Micro Seiki purity of sound.

Isn't it time to upgrade your pleasure?

**MICRO SEIKI**

Advanced engineering in turntables.

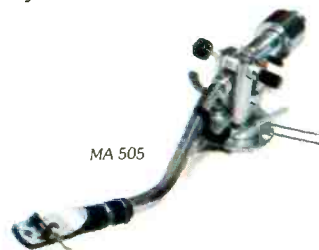

MA 505

Distributed by TEAC Corporation of America, 7733 Telegraph Road, Montebello, California 90640. ©TEAC 1977.  
\*Actual resale prices will be determined individually and at the sole discretion of authorized Micro Seiki dealers.



# Car Stereo Directory

34

Car stereo equipment is proliferating, particularly in the wide variety of AM/FM radio, cassette, and eight-track tape gear available for post-sale or add-on installation.

In this issue *Audio* presents a directory of add-on equipment in many different configurations. It should be

added that car manufacturers use some of these same suppliers to construct sets to fit the contours of their particular automobile for original equipment installation. Loudspeakers are listed in their own specific section.

It must be noted that the data in

these listings are supplied to *Audio* by the manufacturers for this directory and are not the results of *Audio's* own laboratory tests.

This listing is not complete as some manufacturers failed to return the forms sent them.

## Directory of Manufacturers

**Acoustic Fiber Sound Systems, Inc.**  
7999 Knue Rd., Suite 116  
Indianapolis, Ind. 46250

**ADS**  
64 Industrial Way  
Wilmington, Mass. 01887

**Astrosonix/Boman**  
9300 Hall Rd.  
Downey, Cal. 90241

**Audiovox Corp.**  
150 Marcus Blvd.  
Hauppauge, N.Y. 11787

**Automatic Radio**  
2 Main St.  
Melrose, Mass. 02176

**B&B Import-Export, Inc.**  
185 Park St.  
Troy, Mich. 48084

**Blaupunkt**  
Robert Bosch Corp.  
2800 S. 25th Ave.  
Broadview, Ill. 60153

**Car Tapes, Inc./Jet Sounds**  
Caltron  
9180 Kelvin Ave.  
Chatsworth, Cal. 91311

**Cerwin-Vega**  
12250 Montague St.  
Arleta, Cal. 91331

**Clarion Corp. of America**  
5500 Rosecrans Ave.  
Lawndale, Cal. 90260

**Comm Industries, Inc.**  
1 Gateway Center  
Newton, Mass. 02158

**Components Specialties, Inc.**  
393 S. Franklin St.  
P.O. Box 398  
Hempstead, N.Y. 11550

**Craig Corp.**  
921 W. Artesia Blvd.  
Compton, Cal. 90220

**Electronic Industries**  
333 Taft Dr.  
S. Holland, Ill. 60473

**Far Eastern Research Labs**  
8749 Shirley Ave.  
Northridge, Cal. 91324

**Hanabashiya Ltd.**  
39 W. 28th St.  
New York, N.Y. 10001

**Hart Acoustics**  
4423 Saltillo St.  
Woodland Hills, Cal. 91364

**Herald Electronics**  
6611 N. Lincoln Ave.  
Lincolnwood, Ill. 60645

**Inland Dynatronics, Inc.**  
10 Horizon Blvd.  
S. Hackensack, N.J. 07606

**Jensen Sound Laboratories**  
4136 N. United Parkway  
Schiller Park, Ill. 60176

**Kraco Enterprises, Inc.**  
505 E. Euclid St.  
Compton, Cal. 90505

**Lake Communications, Inc.**  
1948 E. Lehigh Ave.  
Glenview, Ill. 60025

**Magitran Co.**  
311 E. Park St.  
Moonachie, N.J. 07074

**Medallion**  
Div. Midland International Corp.  
P.O. Box 1903  
Kansas City, Mo. 64141

**Metro Sound**  
11144 Wedington St.  
N. Hollywood, Cal. 91601

**Motorola, Inc.**  
1299 E. Algonquin Rd.  
Schaumburg, Ill. 60196

**Neosonic Corp. of America**  
57 Old Country Rd.  
Westbury, N.Y. 11590

**Nuvox Electronics Corp.**  
150 Fifth Ave.  
New York, N.Y. 10011

**Panasonic**  
1 Panasonic Way  
Secaucus, N.J. 07094

**Pioneer Electronics of America**  
1925 E. Dominguez St.  
Long Beach, Cal. 90810

**Polk Audio**  
4900 Wetheredsville Rd.  
Baltimore, Md. 21207

**Rogersound Labs**  
6319 Van Nuys Blvd.  
Van Nuys, Cal. 91401

**Royal Sound Co.**  
409 N. Main St.  
Freeport, N.Y. 11520

**Sankyo Seiki**  
149 Fifth Ave.  
New York, N.Y. 10010

**Solar Sound Systems**  
339 Fifth Ave.  
New York, N.Y. 10016

**Sparkomatic Corp.**  
Milford, Pa. 18337

**Superscope, Inc.**  
20525 Nordhoff St.  
Chatsworth, Cal. 91311

**Utah Electronics**  
1124 E. Franklin St.  
Huntington, Ind. 46750

**Visonik of America**  
1177 65th St.  
Oakland, Cal. 94608

# Car Radio / Tape Players

MANUFACTURER	Model	Price	Stereo (S) Mono (M) or 4-channel (D)?	FM Separation, uv? (for 50-dB quieting)	Average Watts (channel, 50-10 KHz, at rated distortion)	% Distortion @ rated watts	Local/Distance Switch?	Pushbutton? If Yes, Number, AM, Number, FM	Bass Control?	Treble Control?	Cassette?	B. Tweak?	Auto Reverse?	Fast Forward?	Tape Rewind?	Includes Speakers?	In Dash (I) or Under Dash (U)?	Control Shaft Spacing, inches?	Dimensions, inches, H x W x D?
ASTROSONIX/BOMAN	305-PB	57.95	M	—	2.5	No	5AM	No	No	No	No	No	No	No	No	No	U	Adj.	1 1/2 x 6 1/4 x 3 3/4
	BM-290MPX	179.95	S	10	2.5	No	5FM	No	No	No	No	No	No	No	No	No	U	Adj.	3 x 6 1/4 x 3 3/4
	BM-260FM	139.95	M	10	2.5	No	5FM	No	No	No	No	No	No	No	No	No	U	Adj.	3 x 6 1/4 x 3 3/4
	BM-230PB	79.95	M	—	2.5	No	5AM	No	No	No	No	No	No	No	No	No	U	Adj.	3 x 6 1/4 x 3 3/4
	50-M	29.95	M	—	2.5	No	—	No	No	No	No	No	No	No	No	No	U	Adj.	2 x 6 1/4 x 4 1/4
	BM-911	84.95	S/Q	N/A	5	No	No	No	No	No	Yes	No	No	No	No	No	U	Adj.	2 1/4 x 4 1/4 x 8 1/4
	AP-16	46.95	S	N/A	2.5	No	No	No	No	No	Yes	No	No	No	No	No	U	Adj.	2 1/2 x 5 1/2 x 7 1/2
	CT-2200	144.95	S	N/A	3	No	No	No	No	Yes	No	No	No	No	No	No	U	Adj.	2 1/2 x 7 1/2 x 7 1/2
	BM-590	89.95	S	N/A	2.5	No	No	No	No	Yes	No	No	No	No	No	No	U	Adj.	1 1/2 x 5 1/2 x 7 1/2
	BM-1312	64.95	S	N/A	3	No	No	No	No	No	No	No	No	No	No	No	U	Adj.	—
	OP-5000	199.90	S	10	5	No	No	No	No	No	No	No	No	No	No	No	U	Adj.	2 x 7 x 6 1/4
	605-MPX	139.95	S	10	5	No	No	3FM	No	No	No	No	No	No	No	No	U	Adj.	2 x 6 1/4 x 5 1/4
	405-FM	99.95	M	10	2.5	No	No	2AM	No	No	No	No	No	No	No	No	U	Adj.	1 1/2 x 6 1/4 x 4 1/2
	BM-2980	299.95	Q	13	4	Yes	5FM	2AM	No	No	No	Yes	No	No	No	No	I	Adj.	2 1/4 x 7 x 5 1/4
	BM-294	299.95	S	10	4	Yes	5FM	5AM	No	No	No	Yes	No	No	No	No	I	Adj.	2 1/4 x 7 x 5 1/4
	BM-1150B	199.95	S	10	4	Yes	5FM	5AM	No	No	No	Yes	No	No	No	No	I	Adj.	2 1/4 x 7 1/2 x 6 1/2
	BM-1335	229.95	S	6	6	No	No	No	No	No	Yes	No	Yes	Yes	Yes	No	I	Adj.	2 1/4 x 7 1/2 x 6 1/2
	BM-1332	159.95	S	10	2.5	No	No	No	No	No	Yes	No	Yes	No	No	No	I	Adj.	2 1/4 x 7 1/2 x 5 1/2
	BM-1339	199.95	S	10	3	No	No	No	No	No	Yes	No	No	No	No	No	I	Adj.	2 1/4 x 6 1/4 x 5 1/2
	BM-13300	129.95	S	6	5	No	No	No	No	No	Yes	No	No	No	No	No	I	Adj.	2 1/4 x 6 1/4 x 6 1/4
BM-1126	224.95	S	10	4	No	No	No	No	No	No	Yes	No	No	No	No	I	Adj.	2 1/4 x 7 1/2 x 6 1/4	
BM-1129	189.95	S	10	4	No	No	No	No	No	Yes	No	No	No	No	No	I	Adj.	2 1/4 x 7 x 6 1/4	
BM-1125	189.95	S	10	6	Yes	No	No	No	No	No	Yes	No	No	No	No	I	Adj.	2 1/4 x 6 1/4 x 5 1/4	
BM-1123	159.95	S	10	3	No	No	No	No	No	Yes	No	No	No	No	No	I	Adj.	2 x 6 1/4 x 5 1/4	
BM-1120	199.95	S	10	2.5	Yes	No	No	No	No	No	Yes	No	No	No	No	I	Adj.	2 1/4 x 7 x 4 1/4	
BM-1115	119.95	S	10	5	No	No	No	No	No	No	Yes	No	No	No	No	I	Adj.	1 1/4 x 7 x 6 1/4	
AUDIOVOX CORPORATION	QD-500	209.95	Q	5	4	10	Yes	No	Yes	Yes	No	Yes	No	No	No	No	I	Adj.	2 1/4 x 7 x 6
	CAS-300	149.95	S	5	5	10	Yes	No	Yes	Yes	Yes	No	Yes	Yes	Yes	No	I	Adj.	2 1/4 x 7 x 5 1/2
	C-981	119.95	S	N/A	5	10	N/A	No	Yes	Yes	Yes	No	Yes	Yes	Yes	No	U	N/A	1 1/2 x 5 1/2 x 6 1/4
	C-992	119.95	S	5	4	10	Yes	No	Yes	Yes	Yes	No	No	Yes	No	No	U	N/A	2 x 6 1/4 x 6 1/4
	C-993	109.95	S	5	4	10	Yes	No	Yes	Yes	No	Yes	No	No	No	No	U	N/A	2 x 6 1/4 x 6 1/4
	C-977	131.25	S	5	5	10	Yes	No	Yes	Yes	No	Yes	No	No	No	No	I	Adj.	6 1/4 x 7 x 6 1/4
	CM-4000	174.95	S	5	5	10	Yes	No	Yes	Yes	Yes	No	Yes	Yes	Yes	No	I	Adj.	2 1/4 x 6 1/4 x 5 1/2
	TM-2000	159.95	S	5	5	10	Yes	No	Yes	Yes	No	Yes	No	No	No	No	I	Adj.	2 1/2 x 7 x 5 1/4
	CP-650	262.50	S	5	6	10	Yes	Yes	Yes	Yes	Yes	No	No	Yes	No	No	I	Adj.	3 3/8 x 7 1/2 x 6
	AUTOMATIC RADIO	SPA-5000	62.95	S	N/A		No	No	Tone	Tone	No	Yes	No	No	No	No	No	U	N/A
SPB-5001		71.95	S	N/A		No	No	Tone	Tone	No	Yes	No	No	No	No	No	U	N/A	2 x 5 1/2 x 8
SPC-5002		82.95	S	N/A		No	No	Tone	Tone	No	Yes	No	Yes	No	No	No	U	N/A	2 x 7 1/2 x 8 1/4
SPE-5004		135.95	S			No	No	Tone	Tone	No	Yes	No	Yes	No	No	No	U	N/A	2 x 7 1/2 x 8 1/4
SPG-5006		76.95	S	No		No	No	Tone	Tone	Yes	No	No	Yes	No	No	No	U	N/A	2 1/4 x 6 1/4 x 8
SPK-5008		133.95	S			Yes	No	Tone	Tone	Yes	No	No	Yes	No	No	No	U	N/A	2 1/4 x 6 1/4 x 8
SST-1179		41.95	S	No		No	No	Tone	Tone	No	Yes	No	No	No	No	No	U	N/A	2 1/2 x 5 1/2 x 7
SSS-2595		52.95	S	No		No	No	Tone	Tone	No	Yes	No	No	No	No	No	U	N/A	2 1/2 x 5 x 7 1/4
STS-2450		34.50	S	No		No	No	Tone	Tone	No	Yes	No	No	No	No	No	U	N/A	2 1/2 x 5 1/2 x 6 1/4
TFF-1082		80.95	S			Yes	No	Tone	Tone	No	Yes	No	No	No	No	No	I	Adj.	2 1/2 x 7 1/4 x 7 1/2
UPX-2354		121.50	S			Yes	No	Tone	Tone	No	Yes	No	No	No	No	No	I	Adj.	2 x 7 x 6 1/2
IDC-3224		121.50	S			Yes	No	Tone	Tone	Yes	No	Yes	No	No	No	No	I	Adj.	2 1/2 x 7 x 6 1/2
UPB-3200		151.95	S			Yes	No	Tone	Tone	No	Yes	No	No	No	No	No	I	Adj.	2 1/2 x 6 1/4 x 7 1/4
CUD-3230		50.50	S			No	No	No	No	Tone	Tone	Yes	No	Yes	No	No	U	N/A	2 1/2 x 5 x 7 1/2
CSA-9985E		121.95	S			No	No	No	No	Tone	Tone	Yes	No	Yes	No	No	U	N/A	2 1/2 x 6 1/4 x 7

Craig T631



Clarion RE-676A



Automatic Radio UPB-3200



Jet Sounds JS-9600



# Car Radio / Tape Players

MANUFACTURER	Model	Price	Stereo (S) Mono (M) or 4-channel (D)?	FM Separation, dB (for 30-dB weighting)	Average Watt. channel, 50-10 kHz	% Distortion @ rated watts	Local/Distance Switch?	Pushbutton? If Yes, Number AM, Number FM	Bass Control?	Treble Control?	Cassette?	2-Track?	Auto Reverse?	Fast Forward?	Tape Rewind?	Includes Speakers?	In-Dash (I) or Under-Dash (U)?	Control Shift Spacing, Inches	Dimensions, Inches H x W x D?
B & B IMPORT-EXPORT INC.	RY-879	24.95	S	3		No		Yes	Yes	No	Yes	No	No	No	No	U	N/A	2x5 1/2 x 7 1/4	
	RY-700	26.95	S	3		No		Yes	Yes	Yes	No	No	Yes	No	No	U	N/A	2x6 1/2 x 6 1/4	
	RY-861	71.95	S	5	6	3	Yes	Yes	Yes	No	Yes	No	No	No	No	I	Adj.	2 1/2 x 6 1/2 x 7	
	RY-702	69.95	S	5	6	3	No	Yes	Yes	Yes	No	No	Yes	No	No	I	Adj.	2 1/2 x 6 1/2 x 7	
BLAUPUNKT	1071	35.00	M		3.5	No		5 AM	Yes	Yes	No	No	No	No	No	I	5.1		
	2072	89.90	M	4	3.5	No		5 AM & FM	Yes	Yes	No	No	No	No	No	I	5.1		
	Frankfurt Mono	107.00	M	2.5	4	5.3	Yes	4 AM & FM	Yes	Yes	No	No	No	No	No	I	5.1	1 1/2 x 7 x 5	
	Frankfurt Stereo	185.00	S	2	4	5.3	Yes	4 AM & FM	Yes	Yes	No	No	No	No	No	I	5.1	1 1/2 x 7 x 4.4	
	CR4091	155.00	S	3	4	5.8	Yes	No	Yes	Yes	No	Yes	No	No	No	I	Adj.	1 3/4 x 7 x 6	
	CR4094	219.50	S	3	4	5.8	Yes	No	Yes	Yes	No	No	Yes	No	No	I	Adj.	2 x 6 1/2 x 7	
	CR4096	213.00	S	3	4	5.8	Yes	No	Yes	Yes	Yes	No	Yes	Yes	Yes	I	Adj.	1 3/4 x 7 x 5 1/2	
	Bamberg U.S. Electronic	785.00	Q	2	4	5.8	Yes	2 AM 2 FM 1 SW	Yes	Yes	Yes	No	No	Yes	Yes	No	I	5.1	1 1/4 x 4 1/2 x 2 1/2
	Berlin U.S. Electronic	836.60	Q	2	4	5.8	Yes	3 FM 2 AM 1 SW	Yes	Yes		No	No	-	-	No	None		
	CAR TAPES, INC./JET SOUNDS	JS-8120	89.95	S	10	4.5	3	Yes	-	No	Yes	No	Yes	-	No	No	I	Adj.	1 3/4 x 6 1/2 x 4 1/4
CT-4310		79.95	S	10	4	3	No	-	No	Yes	No	Yes	-	No	No	I	Adj.	2 1/2 x 7 x 4 1/4	
CT-4355		89.95	S	10	4.5	3	Yes	-	No	Yes	No	Yes	-	No	No	I	Adj.	2 1/2 x 7 x 4 1/4	
CT-9300		89.95	S	10	4	3	Yes	-	No	Yes	Yes	No	No	Yes	No	I	Adj.	1 3/4 x 7 x 5 1/2	
JS-220		34.95	S	-	5	3	-	-	No	Yes	Yes	No	No	Yes	No	U	-	1 3/4 x 5 x 5 1/2	
JS-400		39.95	S	-	5	3	-	-	No	Yes	Yes	No	No	Yes	No	U	-	1 3/4 x 5 x 5 1/2	
JS-600		69.95	S	-	5	3	-	-	No	Yes	Yes	No	No	Yes	Yes	U	-	1 3/4 x 5 x 6 1/4	
JS-3500		99.95	S	8	5	3	Yes	-	No	Yes	Yes	No	Yes	Yes	Yes	U	-	2 x 7 x 6 1/2	
JS-8001		149.95	S	8	8	3	Yes	-	No	Yes	Yes	No	Yes	Yes	Yes	I	Adj.	2 x 7 x 6 1/2	
JS-8550		139.95	S	10	4.5	3	Yes	5 FM or 5 AM	No	Yes	Yes	No	Yes	-	No	No	I	Adj.	2 1/2 x 7 x 4 1/4
JS-9200		149.95	S	8	8	3	Yes	-	No	Yes	Yes	No	Yes	Yes	Yes	No	I	Adj.	2 1/2 x 7 x 6 1/4
JS-9600		159.95	S	8	8	3	Yes	5 FM or 5 AM	No	Yes	Yes	No	Yes	Yes	Yes	No	I	Adj.	2 1/2 x 7 x 6 1/4
CLARION CORP.		450	49.95	S	-	3.5	10.0	-	-	No	Yes	No	Yes	No	No	No	U	-	2x5 1/2 x 6
	452	74.95	S	-	3.5	10.0	-	-	No	Yes	No	Yes	No	No	No	I/U	-	2x5 1/2 x 6	
	423	119.95	S	-	8.0	10.0	-	-	No	Yes	No	Yes	No	No	No	U	-	2 1/2 x 8 x 7 1/2	
	PE-618A	159.95	S	5	4.0	8.0	Yes	No	No	Yes	No	Yes	No	No	No	I	Adj.	2 x 7 x 4 1/4	
	PE-702	229.95	S	5	4.0	-	Yes	4 AM or FM	No	Yes	No	Yes	No	No	No	I	Adj.	2 1/2 x 7 x 4 1/4	
	826	59.95	S	-	2.5	10.0	-	-	No	Yes	Yes	No	No	Yes	No	U	-	2x5 1/2 x 6	
	827	84.95	S	-	3.5	10.0	-	-	No	Yes	Yes	No	No	Yes	No	U	-	2x5 1/2 x 6	
	829	99.95	S	-	3.5	10.0	-	-	No	Yes	Yes	No	No	Yes	Yes	U	-	2x5 1/2 x 6	
	828	139.95	S	-	3.5	10.0	-	-	No	Yes	Yes	No	Yes	Yes	Yes	U	-	2x5 1/2 x 6	
	PE-676A	159.95	S	5	4.0	8.0	No	No	No	Yes	Yes	No	No	Yes	No	I	Adj.	2 x 7 1/4 x 5 1/2	
	PE-666A	239.95	S	5	4.0	8.0	No	No	No	Yes	Yes	No	Yes	Yes	Yes	I	Adj.	2 x 7 1/4 x 5 1/2	
	PE-662B	279.95	S	5	5.0	-	No	No	No	Yes	Yes	No	Yes	Yes	Yes	I	Adj.	1 3/4 x 6 1/2 x 7	
	RE-338C	159.95	S	5	4.0	10.0	No	3 FM 2 AM 5 AM or FM	No	Yes	No	No	No	No	No	I	5-1/8	2x6 1/2 x 4 1/4	
	RE-351B	179.95	S	5	4.0	10.0	No	5 AM or FM	No	Yes	No	No	No	No	No	I	Adj.	2x7 1/2 x 4 1/4	
RE-361A	209.95	S	5	4.0	10.0	No	5 FM 5 AM	No	Yes	No	No	No	No	No	I	Adj.	2x7 1/2 x 4 1/4		
100-EQB equal.	129.95	S	-	10.0 15.0	1.0 3.0	No	-	-	-	No	No	No	No	No	U	-	2 1/2 x 6 1/2 x 6		
CRAIG CORP.	3149	159.95		4														7 1/2 x 3 x 6 1/2	
	S630	169.95		4														2 1/2 x 7 1/4 x 5 1/4	
	S681	199.95		12														2 1/2 x 7 1/4 x 5 1/4	
	T180	139.95		12														2 1/2 x 6 1/2 x 6 1/4	
	3515	49.95		3.5														1 3/4 x 5 1/2 x 6	
	T100	79.95		4														2 1/2 x 6 x 7 1/4	
	3517	79.95		3.5														2 x 7 1/2 x 6 1/2	
	T200	119.95		4														2 1/2 x 7 1/2 x 7 1/4	
	3519	119.95		12														2 1/2 x 6 1/2 x 8 1/4	
	3152	39.95		3														2 1/2 x 6 x 7	
	3144A	49.95		3.5														2 1/2 x 6 x 6 1/4	

(Continued)



"at their price, they are simply a steal"

*The* AUDIO ADVISOR

# AUDIOGRAM

VOLUME I, NUMBER 7

1976

*This is the full text of the review of the Polk 10's which appeared in the AUDIOGRAM, a discerning and independent audiophile journal which is entirely supported by its readers and accepts no manufacturers' advertisements. Subscriptions are available for \$15.00 per year.*

## POLK MODEL 10 LOUDSPEAKER

POLK AUDIO  
4900 Wetheredsville Rd.  
Baltimore, MD 21207  
\$199.95 - suggest retail

When we heard the Polk speakers at Summer CES we knew we had to test them. We were so impressed that we could not believe the prices. But first let us say that there are a few factors that might make us prejudiced in their favor. The Polk people use the Sendor as a reference. They like the sound of ARC tubes. They are the East coast distributors of the Formula 4 tone arm. We, at AUDIOGRAM, share so many likes with the folks at Polk that it is hard for us not to like their speakers. And the company is a local one that has made good - the pride of Baltimore and Washington.

Nonetheless, the sound coming forth from the Model 10 "monitors" is something really special. It is a sound that is open, well defined and very low in coloration. One does not generally expect such low coloration in a modestly priced box speaker, and certainly not anything like the definition exhibited by these speakers. How does Polk do it? We think it is mostly execution. They hear very well and they care.

The Model 10 uses a 1-inch soft dome tweeter, two 6 1/2-inch plasticized midrange drivers and one 10-inch sub-bass radiator (which is really a passive radiator). Polk calls the crossover between the bass and midrange drivers "fluid-coupling". It occurs at 60 Hz and provides fourth order Butterworth loading for the energizing cones.

We auditioned the speaker on the optional stand which Polk sells. The stand, or one like it, is highly recommended. It tilts the front of the speaker slightly back from the listener, providing better phasing between drivers and reducing undesirable floor-coupled resonant effects. We would say that the sound of most bookshelf speakers currently placed on the floor would certainly be improved by such a stand.

Inasmuch as Polk had indicated that they use the Sendor as a reference and inasmuch as we had one on hand, we compared the Model 10 to this speaker. In fact, we have compared many speakers to the Sendor and most of them have sounded extremely colored by comparison. (The only speaker systems that have been able to make the Sendor sound colored have been a well-tuned Fulton J and the Rogers LS3/5A's.) Although the Sendor did manage to make the Model 10 Sound a trifle nasal, we were amazed at the similarity of sound - and that's good!

But the Sendors cost upwards from \$700 a pair (if one can find them), will not handle much power and cannot reproduce the bass of the Polks. It really isn't fair to compare the Model 10 to a reference monitor. It should be compared with other modestly priced speakers. However, such a comparison is no fairer than the Sendor comparison. Other \$200 speakers simply do not come close to the standards set by the Model 10. In fact the Polks compare very favorably with the Magnepan and Dahlquist DQ 10's. Bass response of the Model 10 surpasses that of the DQ 10. Definition is almost on the par with the Magnepan (stereo imaging is better). Driver blending is excellent, the midrange is open and exceptionally clear, and there is much less hint of boxiness than that which is found in most box speakers.

If we had to fault the Model 10's, we would say that they are slightly bright and just a little fat in the low end. However, they are extremely neutral throughout most of their range. Only in comparison with some of the world's best speaker systems do they sound the least bit colored. They are a high definition speaker system deserving the very best associated electronics. And at their price, they are simply a steal.

AUDIOGRAM is published by The Audio Advisor  
Dulles International Airport P.O. Box 17202  
Washington D.C. 20041

## THE POLK AUDIO MONITOR SERIES



Polk Audio products are available at the finest audio salons. Write us to find out your nearest dealer.

**polkaudio**

4900 Wetheredsville Road  
Baltimore, Maryland 21207

**NEW STATE OF THE ART COMPONENTS FROM POLK AUDIO SPECIAL PRODUCTS**  
**Cobra cable, The First True High Definition Speaker Wire**  
**The Mayware Formula Four      The Best Sounding Universal Tonearm**



Astrosonix/Bowman SK-1010



Acoustic Fiber Sound Systems KK-6069

# Car Speakers

MANUFACTURER	Model	Price, \$ (if sold individually)	Price, \$ (if sold in pairs)	Recommended Power, Watts	Driver Size, inches?	Magnet Size, Dia.?	Impedance, Ohms?	Frequency Response 7 Hz to 7 kHz ± 2 dB	Ceiling (C) or Tie-Back (T)?	Flush Mount (F) or Surface Mount (S)?	Overall Dimensions	Notes
ACOUSTIC FIBER SOUND SYSTEMS, INC.	8972	39.95	79.95	30	6x9	20	8	40-18k	C	F		
	8971	29.95	59.95	30	6x9	20	8	40-15k	F	F		air suspension dual cone speaker
	8932	34.95	69.95	18	6x9	10	8	45-18k	C	F		
	8931	24.95	49.95	18	6x9	10	8	45-15k	F	F		air suspension dual cone speaker
	8531	22.95	44.95	10	5	10	8	65-15k	F	F		air suspension dual cone speaker
	8232	32.95	64.95	12	5 1/2	10	8	55-17.5k	C	F		
	8231	22.95	44.95	12	5 1/2	10	8	55-15k	F	F		air suspension dual cone speaker
	6049	29.95	59.95	25	5 1/2	10	8	60-15,000 ±5dB	F/S	F/S	5 1/2 x 11 x 9 1/2	air suspension dual cone speaker
	6059	39.95	79.95	25	5 1/2	10	8	60-20,000 ±5dB	C	F/S	5 1/2 x 11 x 9 1/2	
	6069	49.95	99.95	36	6x9	10	8	50-15,000 ±5dB	F	F/S	5 1/2 x 11 x 9 1/2	air suspension dual cone speaker
6079	59.95	119.95	36	6x9	10	8	50-18,000 ±5dB	C	F/S	5 1/2 x 11 x 9 1/2		
AOS	ADS200C	115.00	230.00	5	1 dome 4 cone	12 16	4	50-22k ±5	*	S F(opt)	4 1/2 x 7 x 4 1/4	*two-way
	ADS300	140.00	280.00	5	1 dome 5 1/2 cone	13 20	4	40-23k ±5	*	S **	5 x 8 1/2 x 5 1/4	*two-way **cus. inst.
	ADS2001A		570.00	160*	1 dome 4 cone	12 16	43k 350k	50-22k ±5	**	S F(opt)	4 1/2 x 7 x 4 1/4	**bi-amp **two-way
	ADS2002		448.00	80*	1 dome 4 cone	12 16	47k	55-22 ±5	**	S F(opt)	4 1/2 x 7 x 4 1/4	**bi-amp **two-way
ASTROSONIX/BOMAN	SK-885	34.95	20	—	—	20	4	—	—	F	5 1/2 dia.	
	SK-880	29.95	10	—	—	12	4	—	—	F	5 1/2 dia.	
	SK-860	22.95	10	—	—	6	4	—	—	F	5 1/2 dia.	
	SK-300	16.95	5	—	—	3	8	—	—	F	5 1/2 dia.	
	SK-450	18.95	—	—	—	2.5	4	—	—	F	5 1/2 dia.	
	SK-1010	22.95	8	5	—	10	4	—	—	S	4 dia.	
	SK-1055	24.95	8	5	—	10	4	—	—	S	—	
	SK-75	18.95	8	5	—	3	4	—	—	S	—	
	SK-55	14.95	8	5	—	3	4	—	—	F	—	
	SK-34	13.95	5	5 1/2	—	3.5	4	—	—	S	—	
	SK-690	16.95	10	6x9	—	6	8	—	—	F	—	
	SK-69TR-40	88.95	10	6x9	—	20	8	—	*	F	—	*Tri-sonic
	SK-525CX-20	39.95	10	5 1/2 & 2	—	20	8	—	C	F	—	
	SK-69CX-20	24.95	10	6x9	—	20	8	—	C	F	—	
AUDIOVOX CORPORATION	CO1D-69/10	20.95	44.95	15	6x9	10	4/8	60-16k Hz	C	F		
	CO1D-69/20	24.95	53.95	20	6x9	20	4/8	60-18k Hz	T	F		
	TRYVOX-20		89.95	30	6x9	20	4/8			F		
	CO5C-10		34.95	20	5 1/2 rd.	10	4/8	60-18k Hz		F		
	CO5C-20		44.95	25	5 1/2 rd.	20	4/8	50-20k Hz	C	F		
	OSW-30		28.95	10	5 1/2 rd.	10	4/8	85-17k Hz		S		
	ID-35		20.95	5	4 rd.	3.57	4/8					
	ID-36		29.95	10	—	10	4/8	70-13k Hz		F		
	MRS-10		18.95	5	2 1/2 rd.	—	—					
	MSS-10		18.95	10	—	10	8			F		
	SC-15		33.95	10	5 1/2 rd.	15	4/8	60-10k				
	SC-20		37.95	15	—	20	4/8	60-17k Hz		F		
	AUTOMATIC RADIO	SET 5482	8.95	5	5	3	8	—	—	—	F	
FMT 6396		8.50	5	5	3	8	—	—	—	S		
SK-300		12.95	5	5	3	Dual 4&8	—	—	—	S		
SK-500		13.50	5	5	3	Dual 4&8	—	—	—	F		
SK-600		14.95	—	—	3	8	—	—	—	S		Wedge
SK-625		17.95	—	5 1/2	3	Dual 4&8	—	—	—	F		
SK-550		17.95	—	5 1/2 x 5 1/2	3	Dual 4&8	—	—	—	S/F		
SK-675		23.50	—	—	3	Dual 4&8	—	—	—	S		Wedge
SK-750		25.95	—	5 1/2	6.8	8	—	—	—	F		
SK-800		24.95	—	—	6.8	Dual 4&8	—	—	—	S/F		
SK-900		29.95	20	5 1/2	12	Dual 4&8	—	—	—	F		
SK-950		29.95	20	5 1/2 x 5 1/2	12	Dual 4&8	—	—	—	F		
SK-975		29.95	—	5 1/2 x 5 1/2	12	Dual 4&8	—	—	—	S/F		
SK-1010		39.95	25	5 1/2	20	8	—	—	C	F		
SK-6090		42.95	25	6x9	20	8	—	—	C	F		
JR-690		14.95	—	6x9	6.8	8	—	—		F		
SH-570	13.95	—	5x7	6.8	8	—	—		F			

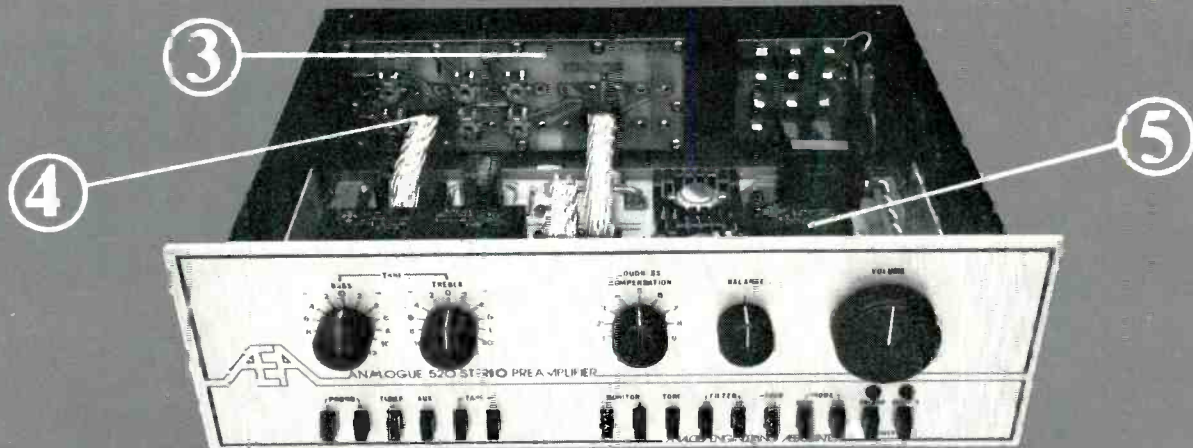

## If you're buying components, and you want performance,

- ① All original circuit design, Pure Class A/Multi-path loop with lowest S/N ever 84 dB unweighted, 92 dB A weighted).
- ② 95% of all circuit components are hermetically encapsulated in 6 Epoxy plug-in modules for the ultimate in facility of service and stabilized component protection.
- ③ *Integral Back-plane interface system* allows true integral jack to board wiring for constant impedance

- and consequent elimination of losses
- ④ NASA and Mil. Spec. throughout — with all highest grade parts available/24k. gold-plated cable connectors, 35 pin/24k. gold-plated phono jacks/silver plated and 24k. gold-plated mode switch contacts
- ⑤ Continuously variable loudness compensator uses precise *Summation Filter* design for infinite combination of room/amp/speakers.

"on the cutting edge of technology — where nothing matters but the music"



**ANALOG ENGINEERING ASSOCIATES**

520 PARK AVENUE SOUTH, WINTER PARK, FLORIDA U.S.A. 32789

For more information on A.E.A. and their products, write or call 315-628-1665.

© Copyright and all rights reserved Analog Engineering Associates, Inc., 1977

45

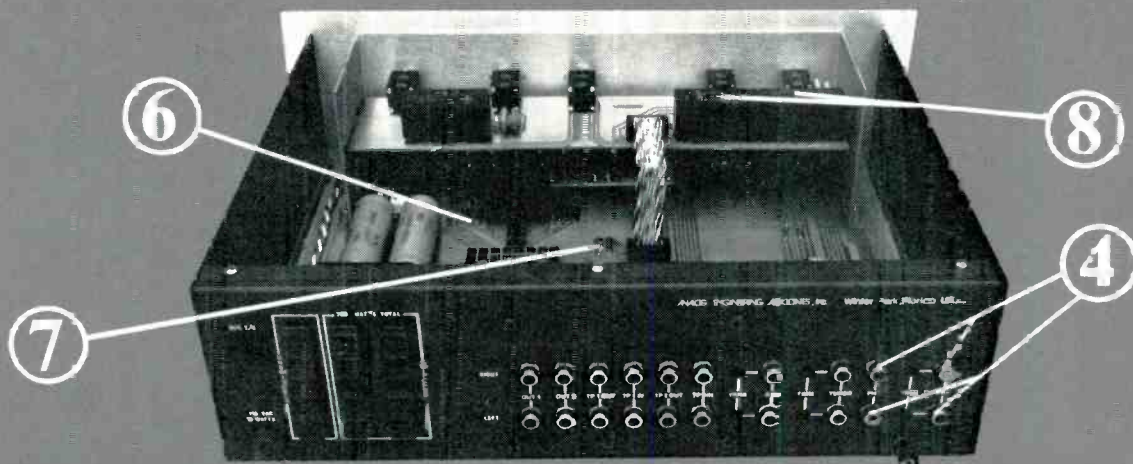

## look into the Analogue 520 with ANA-MOD engineering exclusives.

- ⑥ All interconnections, all controls, all circuitry, all input/output jacks are mounted directly on printed circuit *Blue-Boards*.
- ⑦ Aerospace parts throughout, all resistors are 1%/capacitors, mica, metalized polycarbonate or solid tantalum for unvarying specs.
- ⑧ *Integrated Equalizer* tone control circuit with psychoacoustically computed slopes and non-ringing hi-cut filter.

- \*\*⑨ *Low transient error rating*, below 0.001% under actual dynamic conditions (while using music as a test signal) TTE Method using proprietary A.E.A. Inc. Transient Error Detection System in Q.C. and circuit design.
- ⑩ 1000% overrated, ultra-regulated power supply with high thermal stability.

\*\*Tech paper on total Transient Error detection techniques is available on request from the factory.

"on the cutting edge of technology — where nothing matters but the music"



**ANALOG ENGINEERING ASSOCIATES**

520 PARK AVENUE SOUTH, WINTER PARK, FLORIDA U.S.A. 32789

For more information on A.E.A. and their products, write or call 315-628-1665.

© Copyright and all rights reserved Analog Engineering Associates, Inc., 1977

Enter No. 4 on Reader Service Card

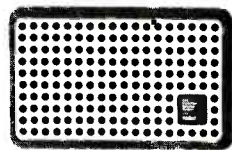
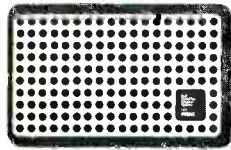

Sparkomatic SK-6922T

# Car Speakers

MANUFACTURER	Model	Price \$ (if sold individually)	Price \$ (if sold in pairs)	Recommended Power, Watts	Driver Size, inches?	Magnet Size, Oz.?	Impedance, Ohms?	Frequency Response Hz to kHz ± dB	Coaxial (C), or Tr. Axial (T)?	High Mount (H) or Surface Mount (S)?	Overall Dimensions	Notes
CRAIG CORP. (Continued)	9432	59.95		6x9	10	4			C	F	9x6x1/2	
	V400	34.95		4	8	8			F	F	5 1/2 x 4 1/2 x 1/2	
	9426	24.95		4	5.4	4			F	F	5 1/2 x 5 x 1/2	
	9427	26.95		5 1/4	5.4	4			F	F	6 1/2 x 1/2	
	9428	29.95		5 1/4	2.9	4			F/S	F	6 1/2 x 6 x 1	
	9429	57.95		6x9	30.0	4 1/8			F	F		
	V140	29.95		6x9	8	8			F	F		
	9433	22.95		3x5	3.6	4			S	F	7 1/2 x 3 1/4 x 5 1/4	
	9414	21.95		5 1/4	3.6	4			F	F	6 1/2 x 1	
	9413	19.95		4	3.6	4			F	F	5 1/2 x 4 1/4 x 1	
9405	18.95		5 1/4	2.9	4			F	F	6 1/2 x 1/2		
ELECTRONIC INDUSTRIES	990X	69.95	30	3 1/8	10	4-8	50-18k	C	F		9x6x5	
	KE-2	79.95	30	3 1/8	10	4-8	50-18k ±1	C	F		9x6x5	
	KE-3	99.95	30	6x9 1/8	10	4-8	25-20k ±1	T	F		9x6x5	
	6W20XR	49.95	15	5 1/4	20	4-8	55-15k	C	S/F		7x6x6	
	6L20XR	39.95	15	5 1/4	20	4-8	55-15k	C	F		6x6x4 1/2	
	9L20X	51.95	20	6x9	20	4-8	45-18k	C	F		9x6x4	
	9G10	29.95	10	6x9	10	4-8	55-17k	F	F		9x6x4	
6L10R	24.95	10	5 1/4	10	4-8	60-17k	F	F		6x6x4		
5SF5	19.95	8	5	5	4-8	70-17k	F	S/F		6x5x3		
FAREASTERN RESEARCH LABS	XS-8D	11.95	5	5	2	8	100-18k±3		S		4 1/2 x 6 1/2 x 6 1/2	
	XS-12C	14.95	10	5	5.3	8	100-20k±3		F		6x5 1/2 x 2	
	XS-18D	24.95	10	5 1/4 x 2 1/2	5	8	60-20k±3	2-way	S		4x5 1/2 x 9 1/2	
	XS-1W	9.95	5	3x5 1/2	3	8	100-18k±3		S		6x4	
	XS-4Dr	11.95	5	5	3	8	100-18k±3		F		5 1/2 x 2 1/2	
	XS-6Dr	29.95	40	5 1/4	20	4 1/8	20-20k±3	C	F		6x4	
	XS-9H	11.95	5	5	3	8	100-20k±3		S		3x7 1/2 x 5	
HART ACOUSTICS	RVS-1	100.00	4-25	6in woofer 3in tweeter	12	4-8	90-10k±2		S		13 1/2 x 9 x 6 1/2	All models incorporate separate (not coaxial) Woofer and Tweeter.
	RVS-2	75.00	4-25	6in woofer 3in tweeter	12	4-8	90-10k±2		F		11 1/2 x 7 1/2	
	RVS-3	65.00	4-25	6in woofer 3in tweeter	12	4-8	90-10k±2		F		3 1/2 dia. 6 1/4 dia.	
	RVS-4	55.00	4-25	6in woofer 3in tweeter	12	4-8	90-10k±2		F		10 1/2 x 6 1/4	
HERALO ELECTRONICS		12.98	25	6x9	10	8	Whizzer	S	S			
		14.98	30	6x9	20	8	Whizzer	S	S			
		23.95	30	6x9	20	8	C	S	S			
		39.95	50	6x9	30	8	C	S	S			
INLAND DYNATRONICS, INC.	AX3-2096	89.95	25	6x9	20	8		T	F			
	CX-2096	43.95	20	6x9	20	8	N/A	C	F			
	CX-1096	37.95	15	6x9	10	8	N/A	C	F			
	CX-1052	30.95	15	5 1/4	10	8	N/A	C	F			
	CX-2052	34.95	20	5 1/4	20	8	N/A	C	F			
	RM-755	12.95	8	6 1/4	5	8	N/A		F			
	SK-1069	21.00	15	6x9	10	8	N/A		F			
JENSEN SOUND LABORATORIES	C9945	119.95	30	6x9	20	4-8	40-20	T	C			
	C9740	73.95	25	6x9	20	4-8	40-18	C	C			
	C9943	72.95	25	5x7	20	4-8	50-15	C	C			
	C9852	71.95	25	5 1/4	20	4-8	60-15	C	C			
	C9853	61.95	25	5 1/4	10	4-8	60-15	C	C			
	C9851	60.95	20	4	10	4-8	70-15	C	C			
	C9729	49.95	25	6x9	20	4-8	40-14		C			
	C9940	48.95	25	5x7	20	4-8	50-12					
	C9862	47.95	25	5 1/4	20	4-8	60-12					
	C9728	42.95	25	6x9	10	4-8	40-14					
	C9937	41.95	25	5x7	10	4-8	50-12					
	C9863	40.95	25	5 1/4	10	4-8	60-12					
	C9860	39.95	20	4	10	4-8	70-12					
	C9927	89.95	25	5 1/4	10	4-8	50-15	C	S			
	C9926	58.95	25	5 1/4	10	4-8	60-12		S			
	C9809	56.95	25	5 1/4	20	4-8	60-12		S			
C9814	32.95	20	5	5.4	4-8	90-10		S				

# "..a pair of 66's may sound unspectacular, even disappointing.."

This is not the sort of quote that manufacturers usually select from equipment reviews. However, we did it for one reason: to get your attention. That's not an easy task, considering the hundreds of other speaker manufacturers clamoring for your ear and your dollar.

The complete excerpt (from *Canadian Stereo Guide*) reads: "To the untrained ear, a pair of 66's may sound unspectacular, even disappointing. There's no thump and sizzle which many equate with good frequency response. No spectacular effects, just the neutral sound of musical instruments playing with nothing added by the speakers. Purity of tone and cleanness of reproduction is particularly noticeable."

The Ditton 66 was in fact developed by Celestion to serve as an authentic monitor speaker, which means

that it was designed to neither add nor subtract anything from the original program material. Recording engineers aren't interested in "hi-fi effects"—they want to hear exactly what's on the master disc or tape with minimum sonic contribution by the speaker.

When the British publication, *Hi-Fi Answers* needed a concert monitor they found the Ditton 66's "... sufficient to cope with the loudest orchestral climaxes available (or even required) ... when we wanted to provide concert levels in a large hall, 110 feet x 55 feet with a 25-foot ceiling. A most impressive performance ..."

Since most listening rooms are somewhat smaller, the shape of the Ditton 66 should be of special interest. Though its internal volume is three cubic feet, it needs only 1.2 square feet of floor space. It is 15" wide, 11" deep and 39½" high.

Another thoughtful aspect of the enclosure: the drivers are mounted on a finished baffle board. So those who like to operate their speakers with the grille off, for whatever reason, can do so happily.

Now, if you'll drop us a card, we'll send you a list of our carefully selected dealers by return mail. We believe you'll be impressed by the exceptionally "unspectacular" sound of the Ditton Monitor 66.



The  
Ditton  
66  
by Celestion.  
\$499.50



Loudspeakers for the perfectionist

Celestion Industries, Inc., Kuniholm Drive, Holliston, Mass. 01746

In Canada: ROCELCO INC., Montreal

The HF-2000 soft-dome tweeter operates from 5,000 to 20,000 Hz. Its exceptionally smooth extended response and wide dispersion achieve an open, airy quality and accurate stereo imaging.

The MD-500 2½" soft-dome mid-range operates from 500 to 5,000 Hz with very low distortion, wide dispersion and correct phase relationships. An extremely powerful magnetic assembly ensures critical damping and high power handling capability.

The FC-12 woofer has a heavy plasticized diaphragm that effectively suppresses resonances. The neoprene roll suspension permits considerable cone excursions without non-linear effects. A massive Feroba II magnet provides critical damping.

The Auxiliary Bass Radiator (ABR) is a highly effective proprietary Celestion device that operates in conjunction with the woofer/enclosure acoustic circuitry. The critically-damped moving system of the ABR has a carefully chosen mass and compliance, acoustically coupled to the woofer and enclosure to control the lower range of the woofer excursion. It takes over completely at the very lowest frequencies. Result: exceptionally smooth reproduction to well under 40 Hz.

Neosonic SP-12



Polk Audio Mini-Monitor

# Car Speakers

50

MANUFACTURER	Model	Price \$ (If sold individually)	Price \$ (If sold in pairs)	Recommended Power, Watts	Driver Size, inches?	Mounting Size Dia.?	Impedance, Ohms?	Frequency Response, Hz to ? kHz ± ? dB	Control (C) or T/Auxial (T)?	Finish Mount (F) or Surface Mount (S)?	Overall Dimensions	Notes
KRACO	TRI-369	99.95	20	6x9	20	8	60-17k ±6	T	F	3¼x6¼x9¼	Speaker set w/built-in 45 watt RMS/CH amplifiers	
	CX-269-20F	74.07	12	6x9	20	8	160-15k ±6	C	F	3¼x6x9¼		
	CX-1-20F	55.43	8	5¼	20	8	190-6.5k ±6	C	S	2½x6¼		
	CX-2-20CF	66.27	10	5¼	20	8	200-13k ±6	C	S/F	4¼x7x6¼		
	PBS 90	122.75	-	6x9	10	8	200-4.5k ±6	-	F	-		
	K-269-20F	62.77	12	6x9	20	8	160-10k ±6	-	F	3x6¼x9¼		
	SS-1-20F	49.85	15	5¼	20	8	180-4.5k ±6	-	F	2½x6¼		
SS-2-20F	59.63	15	5¼	20	8	170-10k ±6	-	S	4x7x6¼			
MAGITRAN CO.	A2000V	11.50	22.95	10	5¼	4-8	70-20	-	F	6¼x1		
	A500	22.95	10	4¼x8¼	-	4-8	80-20	-	F/S	6x10x1		
	A4000S	29.95	10	4¼x8¼	-	4-8	90-20	-	S	5¼x9¼x1½		
	A3000S	24.95	10	5¼	-	4-8	80-20	-	S	7 dia. wedge		
MEDALLION	60-070	-	20	6x9	10	4or8	-	C	F	-		
	60-071	-	25	6x9	20	4or8	-	C	F	-		
	60-073	-	25	5¼	20	4or8	-	C	F	-		
	60-074	-	20	5¼	10	4or8	-	C	F	-		
	60-090	-	-	6x9	10	-	-	-	F	-		
	60-091	-	-	6x9	10	-	-	-	C	-		
	60-157	8	8	5x7	3	8	-	-	-	F		
	60-169	8	8	6x9	3	8	-	-	-	F		
	60-170	12	12	6x9	10	8	-	-	-	F		
	60-171	20	20	6x9	20	8	-	-	-	F		
	60-173	20	20	5¼	-	8	-	-	-	F		
	60-174	15	15	5¼	-	8	-	-	-	F		
	60-175A	5	5	5	2	8	-	-	-	F		
	60-178	5	5	5¼	3	8	-	-	-	F		
	60-179	5	5	5	5	8	-	-	-	F		
	60-182	5	5	3x5½	3	8	-	-	-	F/S		
	60-187P	5	5	3x5½	3	8	-	-	-	F/S		
60-189	15	15	5	10	8	-	-	-	F/S			
60-257B	8	8	5x7	3	8	-	-	-	F/S			
60-269B	8	8	6x9	3	8	-	-	-	F			
60-270B	12	12	6x9	10	8	-	-	-	F			
60-282B	-	-	3	-	-	-	-	-	F			
60-290B	8	8	4x10	3	8	-	-	-	F			
METRO SOUND	MS-69-202-3X	14.95	69.95	35	6x9	20	4/8	-	T	F	wedge	
	MS-69-120	16.95	20	6x9	12	4/8	-	C	F			
	MS-69-200	-	35	6x9	20	4/8	-	C	F			
	MS-525-120	26.95	20	5¼	12	4/8	-	C	F			
	MS-525-202	29.95	35	5¼	20	4/8	-	C	F			
	MS-514	18.95	20	5¼	12	4/8	-	-	F			
	MS-516	25.95	35	5¼	20	4/8	-	-	F			
	MS-712	20.95	20	4	12	4/8	-	-	S			
	MS-452	19.95	20	5¼	12	4/8	-	-	S			
	MS-830	19.75	45	8	30	4/8	-	-	F			
NEOSONIC CORP. OF AMERICA	SPR-12	26.95	10	3¼	5	4	100-16	-	S	4¼ Dia.	Filtered for CB use	
	FS-10	14.95	10	3¼	5	8	300-4	-	S	3¼x4		
PANASONIC	EAB-151	19.95	N/A	3x5	N/A	8	N/A	-	S	-	rear speaker rear speaker door speaker door speaker	
	EAB-551	19.95	N/A	5	N/A	8	N/A	-	S	-		
	EAB-303	19.95	N/A	5	N/A	4or8	N/A	-	S	-		
	EAB-751	19.95	N/A	6	N/A	8	N/A	-	F	-		
	EAB-755	29.95	N/A	6	N/A	8	N/A	-	F	-		
	EAB-951	19.95	N/A	6x9	N/A	8	N/A	-	F	-		
	EAB-752	34.95	20W	6x9	20	4	N/A	-	C	F		
EAB-753	49.95	max. 20W	5¼	10	4	N/A	-	C	F			
EAB-754	57.95	max. 20W	5¼	20	4	N/A	-	C	F			

(Continued)

# The Precision Decision. We made it. Now it's your turn.



QL-7

We believe that precision is the most important factor in turntable design and performance. Which is why we've built such a high degree of precision into our advanced new line of turntables. So you'll need a whole new set of reasons to choose the one that's right for you. And when it comes to value, all seven will play second to none.

Take our new QL-7 Quartz-Locked and JL-F50 Fully Automatic direct drive, shown above. They're both unusually close when it comes to some important specs, but what will surprise you most is that they're also both in the same price range.

For instance, the JL-F50 checks in with 0.03% wow and flutter (WRMS); 70dB signal-to-noise ratio (DIN B). And it offers a host of convenience features as well, with most controls up front so you can operate them without lifting the dust cover. Its fully automatic operation gentles your favorite records, and lets you repeat them from one to six times, or infinitely. A built-in strobe makes speed adjustments easy and accurate. And the JL-F50's looks are in keeping with its precision design.



JL-F50

The QL-7's looks are equally great. And in its electronic heart, it's a tiger. All business, with the incredible accuracy only a Quartz-Locked machine can boast. Truly for a perfectionist, the QL-7's wow and flutter measures only 0.025% (WRMS); S/N is more than 74dB (DIN B). Figures that no other QL turntable we've seen in its category can touch. It's totally manual, with strobe speed indicator, and priced less than any other QL machine on the market.

The way we see it, you're left with a superb decision: our JL-F50 at less than \$250\*, with all the convenience and performance most people could ever want, or our QL-7, the finest under \$300\* turntable available today for the discriminating audiophile.

Either JVC you choose, you'll Enter No. 14 on Reader Service Card

have made the right decision.

JVC America Company,  
Division of US JVC Corp., 58-75  
Queens Midtown Expressway,  
Maspeth, N.Y. 11378 (212)  
476-8300. Canada: JVC Electronics  
of Canada, Ltd., Scarborough, Ont.

For your nearest JVC dealer, call  
toll-free (outside N.Y.) 800-221-7502

\*Approximate retail value

# JVC

We build in what the others  
leave out.

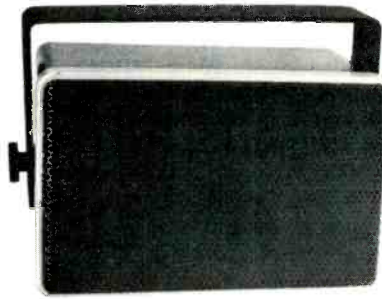

Visonik D-30MO



Rogersound Labs RSL-44

# Car Speakers

MANUFACTURER	Model	Price \$ (if sold individually)	Price \$ (if sold in pairs)	Recommended Power - Watts	Driver Size - inches?	Magnet Size - D?	Impedance - Ohms?	Frequency Response Hz to ? kHz ± ? dB	Coaxial (C) or Tri-Axial (T)?	Flush Mount (F) or Surface Mount (S)?	Overall Dimensions	Notes
PANASONIC (Continued)	EAB-771	19.95		20W max.	6x9	10	4	N/A	-	F		rear speaker
	EAB-772	29.95		25W max.	6x9	20	4	N/A	-	F		rear speaker
	EAB-773		37.95	20W max.	5 1/2	10	4	N/A	-	F		door speaker
	EAB-774		44.95	20W max.	5 1/2	20	4	N/A	-	F		door speaker
PIONEER	TS35		36.95	40	5 1/2	5	4	80-13k	-	S	N/A	
	TS22		36.95	8	4.2 1/2	4	4	100-15k	-	S	N/A	
	TS5		19.95	8	5 1/2	3	4	70-10k	-	S	N/A	
	TS570	17.95		20	5x7	10	4	50-16k	D*	F	N/A	*dual cone
	TS571	24.95		20	5x7	10	4	50-18k	C	F	N/A	
	TSM2		38.95	20	2 1/2	3	4	450-20k	-	S	N/A	tweeter
	TS120		29.95	8	5 1/2	3	4	80-16k	-	F	N/A	thin type
	TS167		59.95	20	6 1/2	10	4	30-20k	C	F	N/A	exponential horn on tweeter
	TS165		54.95	20	6 1/2	20	4	30-16k	C	F	N/A	
	TS164		44.95	20	6 1/2	10	4	40-16k	C	F	N/A	
	TS161		32.95	20	6 1/2	10	4	40-16k	D*	F	N/A	*dual cone
	TS101		25.95	8	4	7	4	60-14k	-	F	N/A	
	TS160		29.95	20	6 1/2	10	4	40-16k	D*	F	N/A	*dual cone
	TS100		21.95	8	4	7	4	60-14k	-	F	N/A	
	P15L		19.95	8	6 1/2	3.7	4	50-10k	-	F	N/A	
	P10L		16.95	8	4	3.7	4	100-10k	-	F	N/A	
	TS694	34.95		20	6x9	20	4	35-18k	C	F	N/A	
TS693	29.95		20	6x9	10	4	40-18k	C	F	N/A		
TS692	24.95		20	6x9	20	4	35-16k	D*	F	N/A	*dual cone	
TS691	19.95		20	6x9	10	4	40-16k	D*	F	N/A	*dual cone	
TS690	9.95		10	6x9	10	4	50-16k	D*	F	N/A	*dual cone	
POLK AUDIO	Mini Monitor	89.95		5-30	4 1/2 bass mid 4 1/2 sub bass 1 dome		5	60-25k -2			15 1/2x6x4 1/2	
ROGERSOUND LABS	RSL44		60.00	10	6x9	10	8	50-22k	C	F/S	6x9x3 1/4	
ROYAL SOUND CO., INC.	RS-705 RS-805 RS-6040		52.00 64.00 200.00	10 10 30 max.	4&2 6 1/2 4 2 1/2	5 10	4 4 4-8	80-10k 80-10k 50-22k	C C C	S S S	6 1/2x4 1/4 x4 1/3	
SPARKOMATIC CORPORATION	SK-6922T	59.95		20	6x9	20	8	30-20k±3	T	F	9 1/2x6 1/2x3 1/2	
	SK-622T	49.95		15	6	20	8	55-20k±3	T	F	6 1/2x2 1/2	
	LC-100			20	6x9	10	3	40-18k±3	C	F	9 1/2x6 1/2x3 1/2	
	SK-313	11.95		5	3	3	8	100-8k±3	with amp.	S	4x4x4	
	SK-6920C	49.95		20	6x9	20	8	40-18k±3	C	F	9 1/2x6 1/2x3 1/2	
	SK-620C	29.95		15	6	20	8	55-18k±3	C	F	6 1/2x2 1/2	
SK-520C	39.95		10	5	20	8	80-18k±3	C	F	4 1/2x2 5/8		
UTAH ELECTRONICS	CS5JFC-W	19.66	-	10	5	10	4.8	-	-	S	5x2 1/2	whizzer
	CS57JC-WCR	21.14	-	10	5x7	10	4.8	-	-	S	5 1/4x2 1/2	whizzer
	C52JC-WFR	20.30	-	10	5 1/2	10	4.8	-	-	S	5 1/2x2 1/2	whizzer
	CS6JC-W	21.23	-	10	6	10	4.8	-	-	S	6 1/2x2 1/2	whizzer
	C63JC-W	21.14	-	15	6x9	10	4.8	-	-	S	6 1/2x9 1/2x3	whizzer
	C63JC-WCR	21.85	-	15	6x9	10	4.8	-	-	S	6 1/2x9 1/2x3	whizzer
	C63JC-CR3	29.69	-	15	6x9	10	4.8	-	C	S	6 1/2x9 1/2x3	whizzer
	C69LXC-WFR	34.22	-	30	6x9	20	4.8	-	-	S	6 1/2x9 1/2x3 1/2	whizzer
	C69LXC-WFR	44.75	-	30	6x9	20	4.8	-	C	S	6 1/2x9 1/2x3 1/2	whizzer
	C69RC-FR3	75.86	-	50	6x9	39	4.8	-	T	S	6 1/2x9 1/2x4	
	SP410CPS-8	15.12	-	8	4x10	1.73	4.8	-	-	S	4 1/2x10x2 1/2	Alnico replacement type
	SP410CPS-8A	15.12	-	10	4x10	1.73	4.8	-	-	S	4 1/2x10x2 1/2	Alnico replacement type
	SA52-10P	50.49	-	10	5 1/2	10	8	-	-	S	5 1/2x2 1/2	
	SA69-10N	58.30	-	12	6x9	10	8	-	-	S	6 1/2x9 1/2x3	
	SA69-10N/T	66.29	-	12	6x9	10	8	-	C	S	6 1/2x9 1/2x3	
SA69-20N	72.62	-	30	6x9	20	8	-	-	S	6 1/2x9 1/2x3 1/2		
SA69-20N/T	100.24	-	30	6x9	20	8	-	C	S	6 1/2x9 1/2x3 1/2		
SA-H100	54.32	-	10	5 1/2	10	8	-	-	F	7 1/2x6 1/2x3		
VISONIK OF AMERICA	David 30 MD	115.50	231.00	8-30	3 1/2 woofer 1/2 tweeter	4-8	55-25 k ±3		2-way	S	6 1/2x4 1/2x4 1/4	



# “ ‘Super’ FM tuners are usually priced from \$1000 up. Sansui’s new model TU-9900 tuner, at (under) \$450\*, matches (their) performance..., at least in the most important respects”.

Julian Hirsch, Hirsch/Houck Laboratories

These are excerpts from the Julian Hirsch test report on Sansui’s new Model TU-9900 as it appeared in Popular Electronics, January 1977.

“The Model TU-9900 ... is an ideal mate for the highest quality amplifiers and speaker systems ..... [It is] esthetically impressive ..... The S/N at 65 dBf (1000 $\mu$ V) was 74 dB in mono and 71.5 dB in stereo while distortion measured an incredible 0.021% and 0.052% respectively. (These figures ... leave no doubt that the tuner has stretched the capabilities of our test equipment to its limits) ..... Image rejection was unmeasurable, exceeding the 100 dB range of our test equipment ..... Stereo channel separation was almost as unbelievable as the distortion figures, exceeding 60 dB from 60 – 600 Hz ... The alternate

channel selectivity [narrow mode] was unmeasurable (greater than 100 dB) and the adjacent-channel selectivity of 17 dB was one of the best we have ever measured on a tuner ...

“Clearly, the Sansui Model TU-9900 tuner is a very superior performer ... [and] any untoward sounds heard via this tuner originate from the FM station ..... In sum, this separate tuner excels in virtually every area of FM performance ..... It’s a top value unit.”

Visit your nearest Sansui franchised dealer today for a demonstration of the TU-9900 or any of the other models in Sansui’s impressive line of amplifiers and matched tuners, the AU/TU series.

**A whole new world of beautiful music.**



**Sansui**

**SANSUI ELECTRONICS CORP.**

Woodside, New York 11377 • Gardena, California 90247

SANSUI ELECTRIC CO., LTD., Tokyo, Japan

SANSUI AUDIO EUROPE S.A., Antwerp, Belgium • In Canada: Electronic Distributors

\* Approximate nationally advertised value. The actual retail price will be set by the individual dealer at his option.

Enter No. 33 on Reader Service Card

AmericanRadioHistory.Com

# V-Fets are the new generation of transistors.



# And you know how hard it is to understand the new generation.

Remember the phrase "generation gap"? Well it's not only true for generations of men, but generations of machines, too.

V-Fet devices are a major advancement, needing major explanation. And nobody is more equipped to offer it, than Sony.

Sony pioneered the first generation of transistors, some 25 years ago.

Today, Sony is predictably innovative again, being: the first to offer V-Fet equipment commercially. And the only ones to bedazzle you with a whole line of it.

So with these credentials behind us, we will begin our explanation of the new generation.

## First came the Fets.

The new generation really began many generations ago. Fets—or field effect transistors—were first conceived in the 1920's. But the concept was so far ahead of its time that nobody quite knew how to execute it.

Fet's work quite differently than the bipolar transistor; the transistor you're familiar with. The bipolar transistor works by conducting a small amount of current, which then induces a high level of current. With the Fet a small amount of voltage (rather than current) controls the high level of current.

This bestows a Fet with high speed reaction time. Regular transistors have a delay in reaction time, creating problems like notch distortion and TIM (transient intermodulation) distortion.

This high speed reaction means also that Fets are extremely efficient and accurate in the high frequency range. Therefore they allow more precise and stable nega-

tive feedback, and minimal distortion.

And, to heat up the argument, a Fet will never be afflicted by thermal runaway. High temperature does not induce the self-destructive current surge that you'll find in the regular transistor.

## V-Fets. Or, bye, bye, bipolar.

Wondering why Fets have not taken over, with the transistor

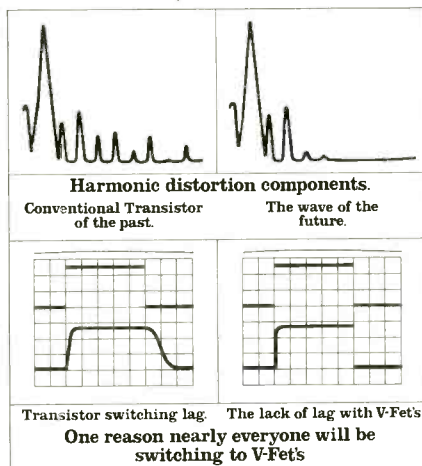

becoming a part of history?

Well, for one reason, a Fet will not allow high currents to pass through it. And today's loudspeakers demand high currents to drive them.

Enter the V-Fet. Vertical field effect transistor. In this structure, thousands of Fets are ordered in a parallel orientation. The current passes through the silicone chips vertically.

Thus, the ability of the V-Fet to handle a lot of current is many times greater than that of small signal Fets—like the kind found in FM tuners and pre-amps.

Sony made it possible for this complex network to be mass produced, by devising the "Selec-

tive Oxidation Process." A new technology originally developed for manufacturing large scale integrated circuits.

## Sony's V-Fets. A full line, from A to V.

Sony makes both integrated amps and power amps with V-Fet circuitry. The TA-4650, TA-5650, TA-8650, TAN-5550 and TAN-8550.

But if you rest your purchase decision on specs alone, V-Fets will disappoint you.

For example, Sony makes two amps, one V-Fet, one not, with identical specs. Yet the V-Fet amp costs more than a spec more.

Obviously, the true measure of V-Fets can't be measured by anything except the human ear.

## Now that you've listened to us, really listen to us.

So go ahead and measure it! Bring your favorite record to your V-Fet dealer. Ask him to play it. You'll find your favorite record will become even more of a favorite, as the sound opens up to you like never before.

And, if you want to open up a brochure on V-Fets, we'll send you one. Write to SONY, 9 West 57th Street, New York, New York 10019.

We have one note to add. V-Fet equipment is not cheap. So if you've appreciated our explanation, you'll find that a little knowledge can be an expensive thing.

# SONY® V-FETS

Enter No. 36 on Reader Service Card

# Three Car Components

## TESTED

# 1

### Fosgate Electronics Model PR-7000 "Power Punch" Audio Amplifier

The quest for higher audio power and better fidelity on the road (in cars, vans, trailers, boats and even trucks) has prompted a good many manufacturers to come up with separate audio amplifiers that can be added to any vehicular sound system operating from a standard 12-volt car battery. Fosgate Electronics, Inc., of Phoenix, Arizona offers a line of such amplifiers, the more powerful of which is their Model PR-7000 Power Punch, shown here. More than just a two-channel power amplifier, the unit provides five degrees of bass boost and five degrees of treble boost in addition to a flat response setting.

The front panel of the PR-7000 contains two rocker switches, one for power on-off switching, the other for selecting radio or tape inputs. Six-position rotary switches to either side of these switches take care of the aforementioned equalization or boost positions.

The rear panel of the PR-7000 is equipped with a slide switch which varies input sensitivity of the amplifier, high and low impedance inputs for radio and tape (in the form of

standard phono tip jacks for the high impedance inputs, and screw terminals for the low impedance inputs) and speaker output terminals. The two types of inputs are provided so that a user who does not wish to "tap into" the earlier stages of an existing car radio or tape machine can connect directly from the "speaker" output terminals of those program sources to the low-impedance inputs provided on the PR-7000. Of course, doing so (as Fosgate mentions in their manual) will result in poorer fidelity, since the higher-distortion signals appearing at the output of your present equipment will be fed as an input voltage to the new amplifier.

The entire underside of the Fosgate PR-7000 is one giant heat sink to dissipate the heat produced by the high-level outputs this unit is able to deliver. The mathematically inclined reader, having noted the power output specifications of this product, may be wondering how it is possible to obtain 20 watts of output across an 8-ohm load, using a 12-volt car battery supply. After all, the rms voltage corresponding to that power level equals 12.65 volts which means the peak-to-peak voltage must be able to reach a value of approximately 30.4 volts! The answer is that Fosgate uses a d.c.-to-d.c. converter type of power supply which includes a super-audible frequency power oscillator (operating at 35 kHz), whose voltage is then stepped up and rectified to provide a



# MANUFACTURER'S SPECIFICATIONS

## Fosgate Electronics Model PR-7000 "Power Punch" Audio Amplifier

**Maximum Continuous Power Output @ 1 kHz:** 20 watts, 8 ohm load; 35 watts, 4 ohm load.

**Distortion:** 0.3 per cent, 20 Hz to 20 kHz at half-power; 0.75 per cent, 20 Hz to 20 kHz at full power, 8 ohms.

**Frequency Response:** Within 0.5 dB, 20 Hz to 20 kHz at half-power into 8 ohms.

**Load Impedance:** 4 to 16 ohms.

**S/N Ratio:** 65 dB below full output.

**Input Sensitivity:** High impedance, 0.25 V; low impedance, 3.0 V.

**Maximum Equalizer Boost:** +18 dB @ 55 Hz, +12 dB @ 20 kHz.

**Power Requirements:** 12 to 14.5 V d.c., negative ground.

**Current Drain:** 3 amperes "average listening level," 11 amperes, full output, both channels @ 4 ohms.

**Input Impedance:** Low, 47 ohms; High, 10 kilohms.

**Dimensions:** 5 3/4 in. (14.6 cm) x 5 (12.7 cm) x 2 1/2 in. (7.3 cm) H.

**Price:** \$199.95.

## J.I.L. Model 615CB/AM/FM/MPX Radio/Stereo Cassette Player

### Cassette & Amplifier Section

**Power Output:** 6 watts rms per channel, 4 ohms, 10 per cent THD.

**Frequency Response:** 50 Hz to 10 kHz.

**Cassette Playback THD:** Less than 3.0 per cent.

**S/N Ratio:** 50 dB.

**Separation:** Cassette, 35 dB.

**Wow & Flutter:** Less than 0.35 per cent.

### AM/FM/MPX Tuner Section

**Usable Sensitivity:** Less than 10 dB.

**Stereo Separation:** 25 dB.

**AFC Holding Range:**  $\pm 350$  kHz.

### CB Receiver Section

**Frequency Range:** 29.965 to 27.405 MHz (40 channels).

**Sensitivity:** 1.0  $\mu$ V for 10 dB S/N.

**Selectivity:** -6 dB @ 4 kHz.

**Adjacent Channel Rejection:** 65 dB.

**Audio Output:** 5 watts @ 10 per cent THD.

**Audio Fidelity:** 400 Hz to 2 kHz.

**Spurich Sensitivity:** 1.0  $\mu$ V.

**Spurious Response:** 65 dB.

### CB Transmitter Section

**Frequency Range:** 26.965 to 27.405 MHz (40 Channels).

**R.F. Output:** 4 W maximum.

**Modulation Capability:** 90 per cent.

**Spurious Suppression:** 60 dB.

**Frequency Accuracy:**  $\pm 0.005$  per cent.

### General Specifications

**Current Drain:** 3 amperes.

**Power Requirements:** 11.0 to 16.0 V d.c.

**Loudspeaker Impedance:** 4 to 8 ohms.

**Dimensions:** 7 1/2 in. (19 cm) W x 2 in. (5 cm) H x 7 in. (17.8 cm) D.

**Price:** \$369.95.

## Clarion Model PE-666A Cassette/ AM/FM Car Stereo

### Radio Section

**Maximum Sensitivity:** AM, better than 20 dB; FM, better than 12 dB.

**Selectivity:** AM, 20 dB.

**Image Rejection:** AM & FM, more than 40 dB.

**I.F. Rejection:** AM, 45 dB; FM, 65 dB.

**Stereo Separation:** More than 20 dB.

**"Electrical Fidelity":** AM, -12 dB @ 4 kHz; FM, -15 dB @ 7 kHz.

### Tape Section

**S/N Ratio:** Better than 40 dB.

**Wow & Flutter:** Less than 0.44 per cent.

**Crosstalk:** Less than 30 dB.

**Playback Frequency Range:** 50 Hz to 10 kHz.

### Amplifier Section

**Maximum Output:** 5.0 watts per channel.

**"Effective Maximum Output":** 3.5 W/channel @ 10 per cent THD.

**Load Impedance:** 8 ohms x 4.

### General Specifications

**Dimensions:** 7.09 in. (18 cm) W x 1.97 (5 cm) H x 5.51 in. (14 cm) D.

**Weight:** 3.97 lbs (1.8 kg).

**Power Requirements:** 10.8 to 15.6 V d.c. (14.0 V nominal), less than 1.5 amperes at maximum output (less than 5 amperes during program switching).

**Price:** \$229.95.

# Technics knows there's more to Linear Phase than staggered speakers.

If staggered speakers were all it took to achieve phase linearity, other staggered speaker systems would sound like ours. But Technics knows it takes more. Much more. Like a phase-controlled crossover network that takes into account the phase characteristics of each driver. Like extremely wide-range drivers, each with a frequency response that's as flat as it is wide. And finally, aligning the acoustic center of each for the optimum acoustic position.

But just as important, Technics knows that to achieve phase linearity as well as a wide and flat frequency response is also to achieve the ultimate in high fidelity: waveform fidelity. With it the output waveform of any component or speaker will be a mirror image of the waveform put into it. And that sounds better than good. It sounds live.

And if seeing is believing, look at the waveforms. On top is the oscilloscope reading (the fingerprint) of a live piano waveform. The other, the piano as reproduced by Technics Linear Phase SB-7000A. That's waveform fidelity you can see, as well as hear.

How did we do it? By designing a crossover network that would provide an overall linear phase characteristic for the entire

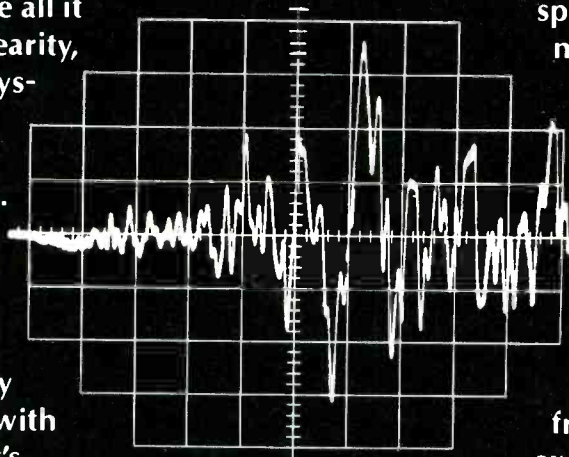

Live Piano Waveform.

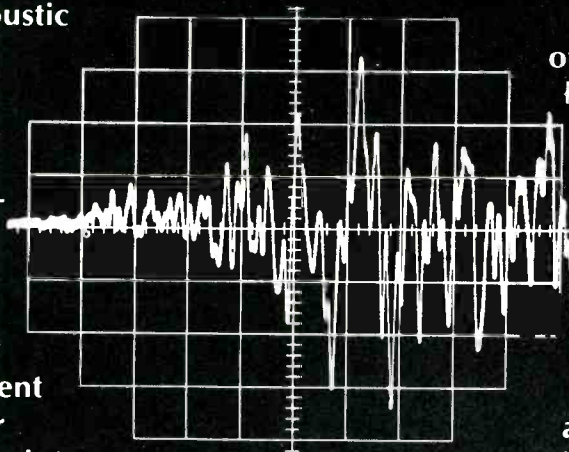

Piano Waveform  
Reproduced by SB-7000A.

speaker system, while simultaneously compensating for the different acoustic pressures of the individual drivers.

When we finished we ended up with a unique phase-controlled crossover network consisting of 6 dB and 18 dB/octave cut-off slopes. It not only eliminates "audible dip" at the crossover frequencies, but also assures excellent localization of the original sound source within the acoustic field.

But as important as the crossover network is in achieving linear phase, so are the individual driver units. That's why we designed and manufactured the speaker drivers with the flattest amplitude, widest frequency response and lowest distortion possible. A goal we achieved only after exhaustive amplitude and phase studies in anechoic chambers.

Our final step was aligning the acoustic center of each driver in precisely the same vertical plane. But it took more than anechoic chambers. Technics had to develop a new time-delay system using BBD (Bucket Brigade Device).

Only then could we locate the optimum acoustic position for each driver. In addition, each unit is positioned vertically for the best horizontal dispersion and then spaced as

# Much more.

closely as possible for the best vertical dispersion of all audio frequencies. What's more, after alignment each unit is fine-tuned to assure precise linearity.

The result, with the SB-7000A for example, is an overall phase response, linear between  $0^\circ \pm 45^\circ$  between 100Hz and 15kHz. A figure that's virtually flat and definitely unsurpassed by any other multi-range speaker system.

As the graphs prove, even staggered speaker systems with seemingly "linear phase" characteristics show moderate to

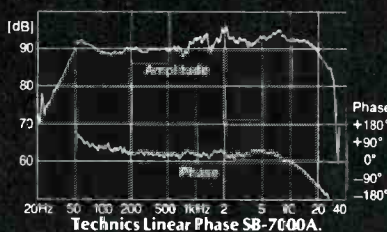
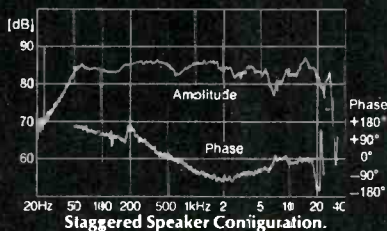

severe phase shifts at different frequencies. But as you can see, the Technics SB-7000A has an unprecedented flat amplitude/frequency response and linear phase response.

But we don't expect you to buy any speaker system based on how good it sounds on paper. Audition the world's most linear phase speaker systems: the Technics SB-7000A, SB-6000A, SB-5000A. You'll find out just how much more there is to Technics

Linear Phase than staggered speakers.

## Technics

by Panasonic

Enter No. 42 on Reader Service Card



SB-6000A

SB-7000A

SB-5000A

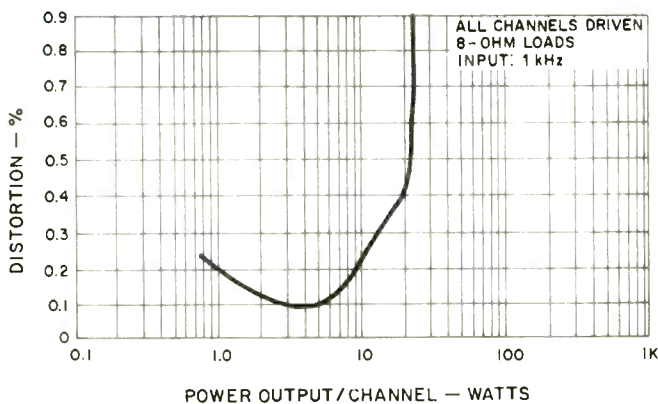

**Fig. 1—Harmonic distortion characteristics of the Fosgate "Power Punch," all channels driven with 8 ohm loads at 1 kHz.**

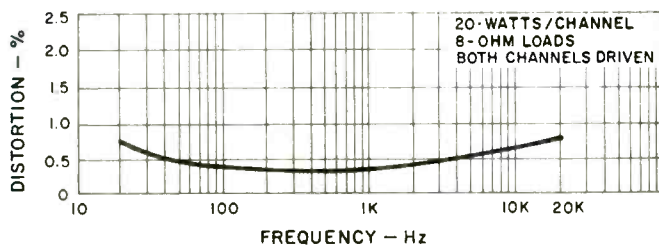

**Fig. 2—Distortion vs. frequency.**

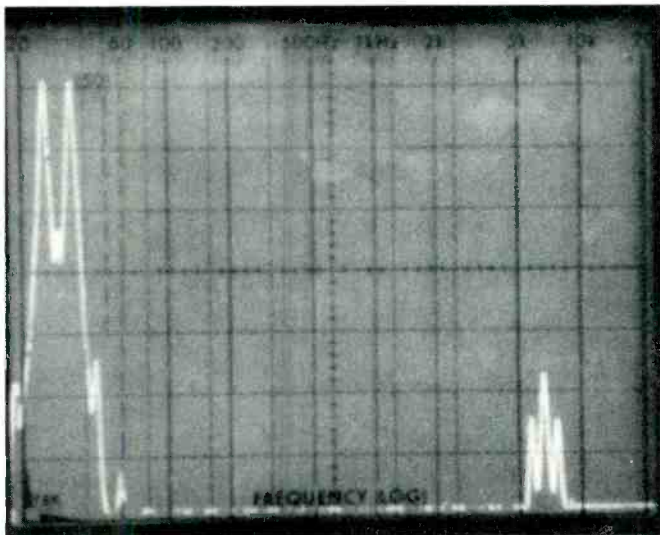

**Fig. 3—Spectrum analysis shows presence of power supply switching frequency (35 kHz) in audio output signal.**

dual-polarity 21 volt powering source for the output stages of this compact unit.

### Laboratory Measurements

The use of this high-frequency power supply, as well as certain grounding considerations of the PR-7000 (which would pose no problem when used with actual loudspeaker loads, each of which is separately wired) made it impossible for us to use our distortion analyzer in the usual manner. Fortunately, we were able to measure outputs and distortion by substituting our spectrum analyzer and interpreting distortion components indirectly. As shown in the graph of Fig. 1, at 20 watts output, into 8 ohm loads, the amplifier exhibited a distortion level of 0.4 per cent. The 1.0 per cent THD level was reached with an output of 22.0 watts, both channels driven. At 4 ohms, output was 37 watts for the same 1.0 per cent THD level. All of these measurements were, of course, made with the equalizer switches set to their "0" or flat response positions.

Figure 2 is a plot of distortion versus frequency for 20 watts output into 8 ohm loads. While Fosgate chose not to specify their rated power output in FTC-approved terms (evidently, the FTC power rule does not apply to amplifiers not intended for "home use"), it is obvious from this graph that they might well have done so, for the distortion at any frequency within the audio spectrum did not exceed 0.75 per cent at this 20-watt power output level.

We referred earlier to the influence of the high-frequency power supply on our test measurements. In carefully examining the sine-wave output waveforms monitored by our 'scope, we noted that there was a small amount of 35 kHz switching voltage present in the waveform. Since this high frequency signal is not audible, it in no way affects the quality of sound reproduced using the PR-7000, but its presence did set a bottom "floor" or limit on distortion readings using a conventional meter-type distortion analyzer. To determine the amount of residual 35 kHz present in the output, we altered the sweep mode of our spectrum analyzer so that it sweeps linearly from 0 to 50 kHz. In Fig. 3, the tall spike at the left represents a full-output audio signal, while at the right of the 'scope face we see the switching-frequency content, some 48 dB lower in amplitude (each vertical division on the scope face equals 10 dB and upper frequency notations should be ignored, as they apply to log-sweep mode).

For the Fig. 4 'scope photo, we returned to our usual log-sweep mode, applying frequencies from 20 Hz to 20 kHz to the input of the PR-7000. Successive sweeps were made using the six available equalization settings (including the "flat response" setting) of the bass and treble switches on the front panel of the PR-7000. Note, that unlike ordinary bass and treble tone controls found on most home hi-fi equipment, the turnover points of these bass and treble equalizer controls are set far away from the mid-range area and are designed to compensate for the roll-off at the frequency extremes encountered with most car speaker systems. The 36 possible combinations of settings permits you to tailor overall response of your car system so that lows, middles, and highs will be heard in their proper perspective at a variety of listening levels.

### Summary

The PR-7000 is extremely simple to install under the dashboard and is suspended by means of a single supplied bracket. While it naturally draws a considerable amount of current from your car battery when operated at high levels, under no-signal conditions, current drain was about 1/3 of an ampere. By itself, the unit had a signal-to-noise ratio of 65 dB as claimed, far better than most program sources that



# You've got to be serious.

If you're interested in Phase Linear, you've got to be serious. Serious about music. Serious about enjoying the most realistic sound possible from a home stereo system. Serious about acquiring quality state-of-the-art components built to deliver a lifetime of top performance.

The three components featured here represent the very finest technical achievements of the Phase Linear Corporation:

**The Phase Linear 5000 FM Tuner:** An advanced tuner with a Dynamic Range Expander that restores FM broadcast signals to rival your records and tapes.

**The Phase Linear 4000 Preamplifier:** An incredibly sophisticated preamp and control center that actually compensates for limitations inherent in the recording and playback process through noise reduction and dynamic range expansion.

**The Phase Linear 700B Power Amplifier:** The most powerful, most dependable stereo amplifier you can buy, at any price.

Phase Linear manufactures a complete line of amplifiers and preamplifiers, a noise reduction unit, and a speaker system. Ask your dealer for an audition. If you're serious.

Enter No. 25 on Reader Service Card

*Phase Linear*  
The Powerful Difference

Manufactured in the USA. Distributed in Canada by H. Roy Gray, LTC.

AmericanRadioHistory.com

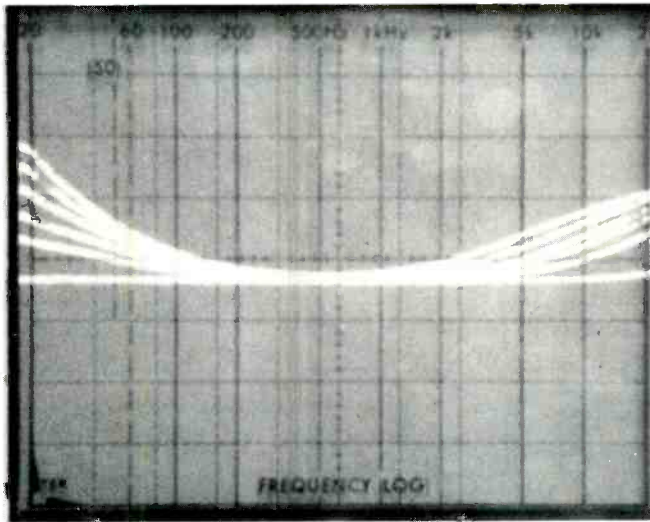

Fig. 4—Composite plot of possible response curves available with the Fosgate PR-7000 auto amplifier.

would be connected to it. This noise (disregarding the 35 kHz switching component) is primarily of a random nature and, as might be expected from a d.c. operated device, totally free of hum components.

While the orders of distortion produced by the PR-7000 are not nearly as low as those produced by home high fidelity amplifiers, they were far better than those observed on most mini-powered all-in-one car stereo units. If you crave good, big sound in your car or van or boat, this high powered amplifier can deliver it. Fosgate claims that in the close environment of a car, SPL levels of 115 dB have been obtained using the PR-7000. Much, of course, will depend upon the quality of associated speakers used with the amp and with their ability to handle such levels of power. Given a good set of speakers and reasonably good program sources, even with the equalization controls set for full boost (in most cases you won't need that much compensation), mid-range average sound levels of 100 dB should be obtainable without taxing the power output capability of the PR-7000—and that's really quite a lot of sound when you're on the road.

Leonard Feldman

Enter No. 75 on Reader Service Card

## 2

### J.I.L. Model 615 CB/AM/FM/MPX Radio/Stereo Cassette Player

62

Sooner or later, someone was bound to combine an AM/FM stereo radio-cassette car unit with a 40-channel CB transceiver in a single, compact, behind-the-dash unit for car use, and the distinction of having accomplished that feat belongs to J.I.L. Corporation of America, whose broad line of auto electronic products is probably well known to readers of this magazine. Even more amazing is the fact that all of these electronic goodies are contained in a cubic volume no greater than that occupied by ordinary AM-FM cassette car units. Like so many other late-model CB units which include all of the newly approved CB frequencies (now totalling 40), the hand-held microphone serves many important functions other than just being a transducer. A thumbwheel at the right of the microphone assembly changes channels,

whose numbers are displayed on the front face of the mike by means of illuminated LED digital readouts. A push-to-talk switch is located on the left of the microphone case, and above it is an r.f. gain control. Needless to say, there's a pretty thick cable running down from this microphone assembly to the chassis proper but that cable terminates in a multi-pin plug so that it can be easily disconnected and stored when not in use, or removed from the car to prevent possible theft. The chassis proper, intended for behind-the-dash permanent mounting, features dual concentric controls at either end of the front panel. The pair of controls at the left turn on the unit and control volume, and serve as a tone control. Those at the right take care of station tuning and left-right speaker balance. A cassette cartridge door flap is centered above the stationary dial scale area and permits insertion of a cassette tape only when it is properly oriented. At the left is a fast-forward tape transport button which also serves as an eject button for the inserted cassette. To the right of the cassette/dial scale area is a continuously variable squelch control used to eliminate noise when no CB channel is being received. Below the dial area, to the right, are the AM/FM selector button, a mono-stereo selector button, and a special standby switch which activates an unusual circuit developed by the people at J.I.L. and patented by them. With this button depressed, if you are listening to music via any of the available program sources and a CB signal is received on the channel you have selected, the circuit automatically switches over to CB reception, returning to your previous program source once the received signal goes off the air!

Additional features at the lower left of the panel's center area are a CB button (depressed for continuous CB operation), a "transmit" light, and a dual-purpose indicator light that illuminates when CB signals are received (so long as squelch is overcome) or, in the case of FM reception, when a stereo FM signal is tuned to. Another indicator light centered below the dial area tells you that you are listening to a tape cassette program. All of this on a panel surface that measures only 2 in. by 7 1/2 in. wide!

#### Circuit Highlights

A complete schematic diagram is supplied in the owner's manual accompanying the J.I.L. 615CB and, while it does not

Fig. 1—FM quieting and distortion characteristics of the J.I.L. 615CB.

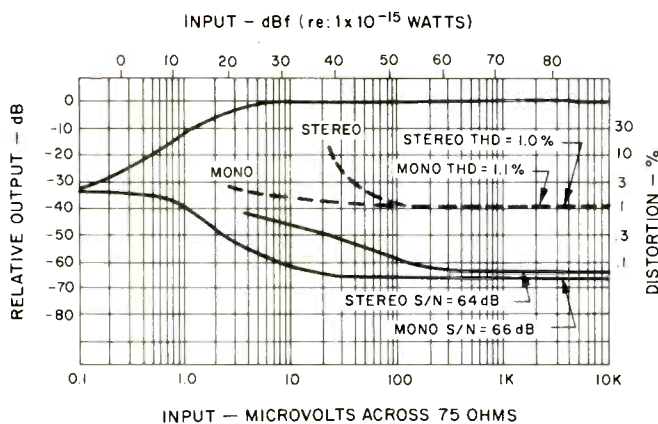

# Credentials Like These Are Worth Reading



When you're buying speakers, you want to talk specs. And we don't blame you. In fact, we encourage it. Because when you invest your good money in a pair of speakers, you want more than just a pretty cabinet.

Consider the new Jensen Spectrums. These good sounds didn't just happen. They're the result of extensive engineering efforts and exhaustive testing. Testing that ranged from exacting measurements in laboratory "live" rooms and anechoic chambers to in-depth consumer surveys.

Examine our Spectrum Model 540. It's an excellent example of the superb specs you'll find throughout the Jensen Spectrum Series.

The Spectrum 540 is a 3-way, 4 element system that is so efficient it can be driven with as little as 10 watts continuous power. Its maximum power rating is 75 watts continuous.

The woofer is a 12" long-throw, high compliance design. Special acoustic suspension and infinite baffle enclosure give you extremely low distortion. And a high temperature voice coil affords high power handling. Magnet structure weight is a hefty 4½ lbs. with a Gap Flux Density of 10,000 Gauss.

Two 3½" cone midranges give excellent power handling and eliminate break-up in the critical midrange region. Tuned isolation chambers control response at the low end of the midrange spectrum. They also provide acoustical isolation in the cabinet between the midranges and the woofer. An edge damped rim suspension with specially treated molded cone offers sharp, clear, midrange reproduction.

A 1½" Mylar<sup>®</sup> rear damped hemispherical dome tweeter offers a disper-

sion of 170°. Its large, lightweight voice coil gives high power handling, yet maintains a low mass for good high frequency reproduction.



Tweeter and midrange controls allow you to adjust your Spectrum System to room conditions and listening preferences; controls are front mounted for convenience, continuously variable, calibrated in db attenuation from a maximum, or flat, response.

## FREQUENCY RESPONSE

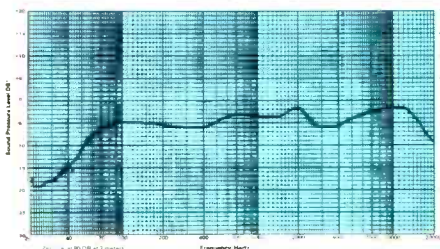

About as flat as you can get... and that's good. The Frequency Response Range is an admirable 25 to 25,000 Hz.

## TONE BURSTS



"Blurring" and "Overshoot" are reduced to a minimum in this acid test of transient response. The Spectrum 540 re-

produces each waveform accurately with low distortion.

## TOTAL HARMONIC DISTORTION

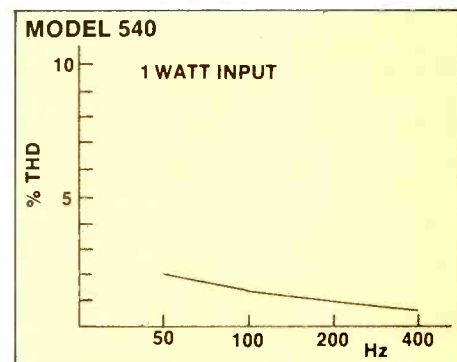

Distortion is kept to a minimum in Jensen Spectrum Speaker systems.

The cabinet is built with solid walnut front moldings and walnut veneer on wood composition panels. All walnut surfaces are hand rubbed for a rich luster and beauty. The baffle is finished in an attractive, durable black pebble grain.

In short, Jensen Spectrum speakers aren't designed to put out the most amount of bass or the most amount of treble. They're designed to put out the right amount. We consider them to be the best speakers we've produced in 50 years. Simply because when it comes to sound reproduction, they're extraordinarily accurate. And that's what specs are all about.

For further information and name of your nearest authorized Spectrum Dealer, write to: Jensen Sound Laboratories, Dept. AM-774136 United Parkway, Schiller Park, Illinois 60176.

# JENSEN

## SOUND LABORATORIES

Division of Pemcor, Inc. Schiller Park, Illinois 60176

detail construction of the FM front end of the unit, we did note that the i.f. section uses an IC amplifier, plus a second IC limiter-quadrature detector circuit followed by an IC phase-lock-loop multiplex decoder section. The AM circuitry uses three bi-polar transistor stages in a fairly conventional circuit arrangement. Tape head signal pre-amplification is accomplished by means of a single dual-channel IC, while the main amplifier module contains a pair of IC power circuits, one for each speaker channel plus two additional voltage amplifier bi-polar transistor stages. The novel tone control arrangement used in this amplifier circuit combines the action of a conventional treble control with that of bass-boost loudness compensation, so that rotation of the control clockwise (when the volume control is at less than maximum settings) results in simultaneous bass boost and treble attenuation. A separate module board is used for the CB transmit circuitry with another p.c. assembly used for the CB-receive section. CB frequencies are determined by the now-popular phase-lock-loop method which requires only a pair of quartz crystals, one cut to a frequency of 9.785 MHz, the other tuned to 10.240 MHz. Total solid state complement of the 615CB includes 10 IC's, 33 transistors and 31 diodes.

### FM Section Measurement

Figure 1 details mono and stereo FM quieting and distortion characteristics of the FM tuner section of the 615CB. At strong signal levels, THD in both mono and stereo were virtually identical, at around 1.0 per cent. Mono usable sen-

sitivity measured 2.5  $\mu\text{V}$  (15.2 dBf) while in stereo (largely because of increased levels of distortion), usable sensitivity was 40  $\mu\text{V}$  (43.3 dBf). The 50 dB quieting point in mono occurred with an input of 3.0  $\mu\text{V}$  (4.7 dBf) and in stereo the corresponding signal strength measured 50  $\mu\text{V}$  (45.2 dBf). Distortion in mono was governed by the inability of the detector circuit to handle full, 100 per cent modulation in a linear fashion. For our separation and distortion versus frequency measurements we therefore "backed off" the signal generator to 75 per cent modulation and results are plotted in Fig. 2. Note, that with this slight reduction in deviation of the audio modulating signal, mono THD decreased to 0.6 per cent at 1 kHz, a not unreasonable figure in a unit of this type. Frequency response (upper curve of Fig. 2) conformed nicely to the required 75 microsecond de-emphasis curve from around 100 Hz to 8 kHz, but rolled off a bit too quickly beyond those limits. Stereo switching threshold takes place with a signal input of 3.0  $\mu\text{V}$  (20.76 dBf) but considerably stronger signals are needed before stereo listening becomes completely acceptable.

Overall frequency response (including FM de-emphasis) in FM, at extreme settings of the front panel tone control, are plotted by means of a spectrum analyzer in the 'scope photo of Fig. 3.

### Amplifier Measurements

In view of the low power output claimed for the amplifier section of the 615CB, instead of plotting a curve of distortion versus power output, we measured power output capability





## THE INTEGRATED DC AMPLIFIER HAS ARRIVED.

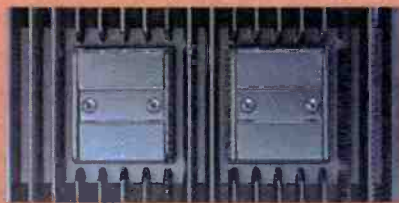

Gone is phase distortion. Gone is time-delay distortion.

The Kenwood KA-9100 integrated DC amplifier is here.

Its response is flat down to 0 Hz. It has three power supplies. The Total Harmonic Distortion is 0.03% over the full frequency range of 20-20k Hz. The Signal-to-Noise ratio is 83 dB at 2.5 mV. It has the best phono sensitivity (0.8 mV) of any integrated amplifier. For better heat dissipation, the KA-9100 has large heat sinks on either side.



It is an amplifier so advanced even the pre-amp has its own power supply.

It is the next generation Kenwood. The unit all others will be measured against. Just as they were when we pioneered dual power supplies.

The KA-9100 integrated DC amplifier. With 90 watts per channel, minimum RMS, at 8 ohms from 20 to 20,000 Hz with no more than 0.03% Total Harmonic Distortion.

And, as if all that wasn't enough, it costs less than \$500.\*

# KENWOOD

15777 S. Broadway, Gardena, CA 90248 · 72-02 Fifty-First Avenue, Woodside, NY 11377

Handles optional.

\*Suggested resale price. Actual prices are established by Kenwood dealers.

Enter No. 18 on Reader Service Card

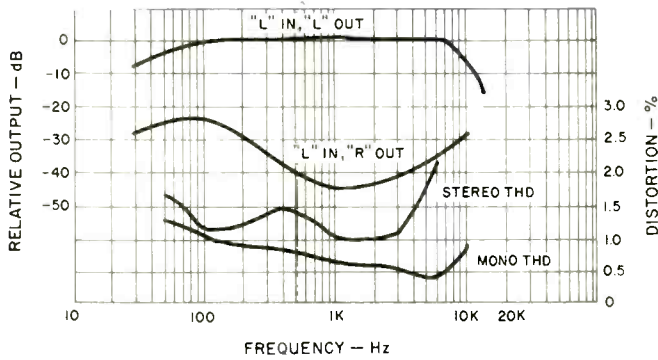

**Fig. 2—Stereo FM separation and distortion vs. frequency. (Distortion measurement at 75 per cent modulation.)**

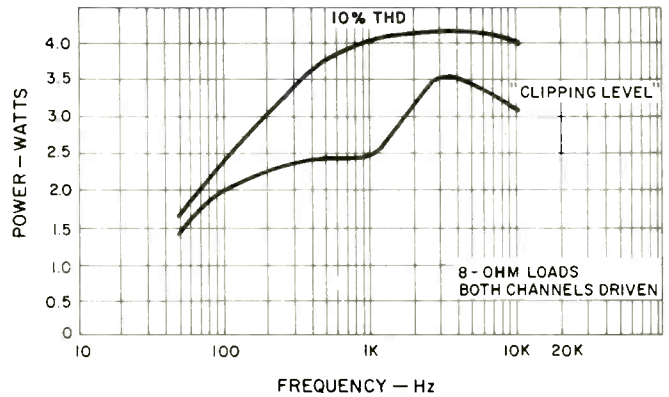

**Fig. 4—Power output vs. frequency.**

for 10 per cent THD and for clipping level at a variety of audio frequencies and plotted results in Fig. 4. At mid-frequencies, the unit delivered 4.0 watts per channel, both channels driven, into 8 ohm loads before the 10 per cent THD level was reached. Evidence of clipping was seen at considerably lower power levels, as plotted in the lower curve of Fig. 4.

### Cassette Section Measurements

Using our test tape prepared on a reference Nakamichi 1000 cassette deck, at -20 dB recording level, we plotted playback response of the cassette section of the 615CB. Results are shown in Fig. 5, and response was off by 3 dB at 60 Hz and 9 kHz. Wow-and-flutter measured an acceptable 0.18 per cent W rms. If J.I.L. had had a bit more room in this compact model, a fast-reverse tape transport mode would have been a welcome addition to the features incorporated for the cassette playback section of the product.

### CB Tests

Since our laboratory is not equipped to perform definitive measurements on CB equipment (and such tests are available in publications devoted to CB equipment), all we could do regarding the CB section was put it through its paces and listen to signals picked up on the various channels. There were plenty of these, even with only a rudimentary whip-

antenna hooked up to the CB-antenna connector, including music re-broadcast from a radio (illegal), a fair amount of profanity (illegal) and even one or two serious conversations which were obviously intended primarily for communication between citizens in our immediate area (legal). Since we are totally against illegal use of CB, our attempts to transmit were limited to a quick call, using our self-assigned call letters (KLF-11023) as instructed on the "temporary license form" provided with the unit. After establishing contact with a youngster down the block, we were satisfied that the CB portion of the 615CB was, indeed, operative in both modes. Fearful of possible wrath from the FCC, that concluded our base-station operation for the evening.

### Summary

J.I.L.'s 615CB offers a great deal of entertainment-on-wheels for its not unreasonable price. Since its FM tuner section is a cut above the average units found in "car radios" and its cassette deck section is certainly no poorer than those offered by most of the competition, the incorporation of CB in this all-around unit makes it an extremely attractive package for those who want to communicate while driving and still want to enjoy a bit of music without having to usurp all available under-the-dash leg room by the addition of separate add-on boxes.

*Leonard Feldman*

Enter No. 76 on Reader Service Card

**Fig. 3—Frequency response in FM (including deemphasis) at extreme settings of combination tone control.**

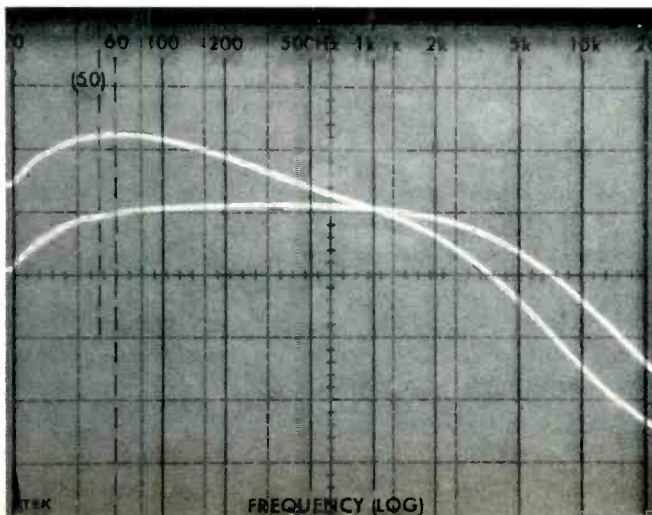

**Fig. 5—Playback response for the cassette section of the J.I.L. 615CB.**

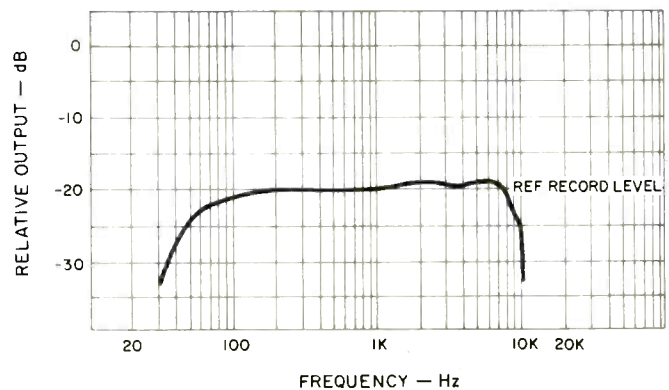

*Now we've mastered  
a Scotch® cassette for every switch position.*



**Introducing the Master Series.** Three totally different tapes. Each developed to deliver the truest, clearest sound possible at each tape selector switch position.

Our Master I cassette is for normal bias recording. It features an excellent dynamic range, low distortion, uniform high frequency sensitivity and output that's 10 dB more than standard tapes.

Our new Master II replaces chrome cassettes and is designed for use on hi-fi stereo systems with chrome bias (70 microsecond equalization). It features some spectacular performance characteristics, including a special coating that gives it a 3 dB better signal-to-noise ratio at low and high frequencies than chrome cassettes, yet it's less abrasive.

Our new Master III is for the ferri-chrome setting. It's formulated with the most advanced technology available, giving a 3 dB output improvement at low frequencies and 2 dB at high frequencies. And the unique dual layer construction increases both low and high frequency sensitivity over chromium dioxide and ferric oxides.

**All this, plus unique inner workings you can actually see.** Our new Master line has a special bonus feature. A precision molded clear shell that allows you to monitor the inner workings of the cassette. You can actually see the recorder head penetration and the unique roller guides in action. Look closely at the transparent shells above and you'll see the water wheels which were specially designed to move the tape evenly across the head, reducing friction and noise. And two radially creased shims insure smoother wind, improved mechanical reliability and reduced wow and flutter.

Enough said. Now it's time for you to take the true test. Match up the right Master cassette with the bias you prefer. Then just listen.

You'll find that whichever switch position you use, a Scotch Master is the way to get the most out of it.



**Scotch Recording Tape.  
The truth comes out.**

Enter No. 43 on Reader Service Card



# 3

## Clarion Model PE-666A Cassette/AM/FM Car Stereo

68

Here is another of those multi-function, add-on, behind the dash-board, AM-FM cassette units, this one by Clarion. The published specifications shown above are reproduced here exactly as shown on that company's single-sheet "owner's guide," and if you don't understand all of them, well, you're not alone. We will, however, check the unit out in accordance with our accepted procedures, so you can judge against our usual "standards."

The front panel of Clarion's PE-666A features dual concentric knobs at each end, one pair for volume/power and tone control, the other for station tuning and speaker fading (front to rear pair). A push of the volume control reverses tape direction, and the unit also features automatic reversal of cassettes at end of play (as indicated by a pair of illuminated arrows near the volume control). A fast forward/rewind lever is located below the dial area, but its lever must be manually held to engage the fast transport modes. The dial area and pointer swing away to permit insertion of the cas-

sette which then drops into correct positioning, and can only be ejected by means of an eject button located at the upper right, near the dial area. A stereo indicator light and an FM/AM band switch complete the front panel layout. The connection diagram of Fig. 1 illustrates how front and rear stereo speaker pairs may be wired to the PE-666A, and necessary leads and hardware are supplied with the unit.

### Circuit Features

The FM front end of the PE-666A is inductance tuned and utilizes bi-polar r.f., mixer and oscillator stages. Four bi-polar transistors are used in the FM i.f. section, followed by an IC multiplex decoder. The AM tuner section utilizes a total of four transistors and is also inductively tuned. ICs are used to amplify low-level tape signals as well as for the power amplifier sections of the unit, which connect, via the fader control, to the pairs of speaker terminals. A power board containing four transistors is used to drive the d.c. tape transport motor. A separate illumination lead can be connected to the car's dash illumination system so that the PE-666A's dial can be dimmed with the rest of the dash illumination. Powering a motorized car antenna is also made possible by connecting it to yet another lead emanating from the PE-666A.

Fig. 1—Speaker wiring diagram for the Clarion PE-666A car stereo unit.

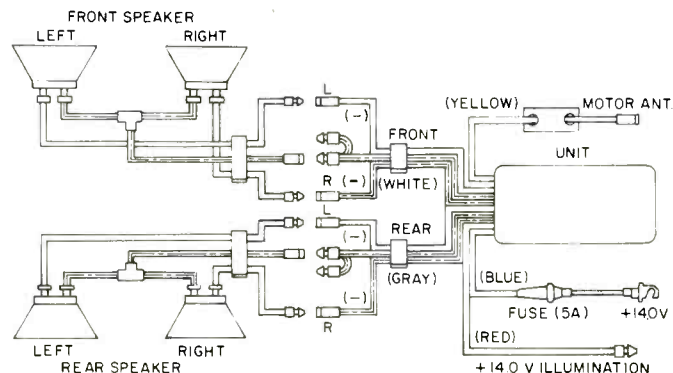



**“The Ohm F  
may well be the  
finest speaker  
on the market  
and is certainly  
without a doubt  
among the  
top few.”**

Reprinted from the 1977 edition of THE  
COMPLETE BUYER'S GUIDE TO STEREO/HI-FI  
EQUIPMENT.

If you'd like to find out what hi-fi experts from all  
around the world have to say about the patented  
Ohm F coherent sound loudspeaker, please visit  
your Ohm dealer or write to us at the address  
below. An informative full-line brochure that  
explains how the Ohm F works is also available.



**Ohm Acoustics Corp.**

241 Taaffe Place, Brooklyn, N.Y. 11205

**Ohm Canada Ltd.**

9 Oriole Crescent, Toronto, Ontario M5P 1L6

Enter No. 23 on Reader Service Card



# Dynamic Range Requirements of Phonographic Preamplifiers

Tomlinson Holman\*

The task facing the phonograph preamplifier is a complex one.<sup>1</sup> It must interface properly with high source-impedance cartridges, follow the RIAA equalization curve precisely, and be immune from overload and nonlinearity from any signals present at the input, singly or in any combination. Over the last several years detailed information has become available on the range of signals to be expected from cartridges, and both musical signals and undesired warp and distortion signals have been quantified.<sup>2,3</sup> Consequences of the undesired signals on the program material may now be studied analytically and criteria set for phonograph preamplifiers. At the other end of the range, noise present in the system has received increasingly more sophisticated treatment, so that now a psychometrically correct comparison may be made between the noise level achieved by design and the theoretical limit.

## Sonic Range Signals

In the low audio frequency range from 20 Hz to 800 Hz, the maximum allowable groove velocity is set by the physical amplitude of the groove width.<sup>4</sup> The criteria is set for LPs by the cutterhead's standard two-mil excursion, which is mechanically limited by stops and practically determined by playing time requirements. When played with a conventional cartridge having 1 mV/cm/sec sensitivity through an RIAA equalized preamplifier with 40 dB of gain at 1 kHz, the output overload level varies with frequency as shown in Fig. 1. For other sensitivities or gain, the curve may be translated up or down as appropriate.

In the range from 800 Hz to ultrasonic, the maximum velocity is set by the geometry of the cutting stylus. If the maximum velocity limit were exceeded in this range, the back facet of the stylus (required for a smooth groove wall) would interfere with the

just-cut groove, causing high distortion by deforming it.

At the audio frequencies above 2 kHz, the playback stylus' dimensions become the dominant mechanical limitation. The maximum curvature of the groove wall cannot exceed the contact radius of the stylus for low distortion. Two curves are shown for this region. For spherical styli with 0.7 mil diameter, curve 2 applies, and for elliptical styli of 0.2 mil minor diameter, curve 3 applies. The maximum undistorted playback velocity at high frequencies is extended by the elliptical and other special styli. Special styli developed for CD-4 have smaller contact radii with the groove wall and consequent greater high frequency tracking capability—all other things being equal.

The curve in figure 1 then gives the sine-wave low-distortion power response of the cutterhead and cutting stylus, cartridge, preamplifier combination. That is, no single-frequency component of program material may exceed the limits for low reproduced distortion. But, because overload is a peak phenomenon for which all frequency components instantaneously add, the actual spectral output of the preamplifier must run substantially below the sine-wave limit line. The amount below is determined by the frequency and phase characteristics of the program material; since the energy distribution of orchestral music falls off with increasing frequency, it is less likely to produce high frequency overload than modern popular or jazz recordings, with their increased high frequency energy content.<sup>5</sup> The overall record level should be adjusted downwards so that every peak fits under the curve if low distortion is important. In such cases, the overall record level may need to be lowered so much that noise becomes apparent, or the disc plays back at a noticeably lower level than others. Since these are not commercially acceptable alternatives, peak levels beyond the

modulation limits do occur at high frequencies. Good data exists for the highest recorded velocities—some "worst case" points are plotted on Fig. 1.<sup>6</sup> The 105 cm/sec peak is from a Woody Herman recording, Verve V-8558, side 1, band 2. The 40 cm/sec peak is from the Sheffield **Pressure Cooker** recording; it is the sibilance on the beginning of side 1 with a center of 11 kHz. Notice that the 80 cm/sec peak imposes a more severe output requirement than the 105 cm/sec peak due to its lower frequency and consequent greater amplification. From this and earlier studies one may draw the conclusion that this high frequency stylus limit called curvature overload is a dominant one to dynamic range with modern program material.

"Low distortion" keeps repeating itself above as a criteria. Small, infrequent high-frequency overload of the system probably goes unnoticed since the high-frequency components are often broad-band, which offers built-in distortion masking. For example, sibilance or cymbal crashes to some degree contain their own source of distortion masking by their nature. Taken too far, however, sibilance overload can turn a clean "s" sound into one akin to rubbing two blocks of sandpaper together; "tish" becomes "tush." Although low distortion reproduction is limited by the cutter and playback stylus' mechanical overload, the preamplifier should be capable of reproducing these overloads (and their corresponding distortion components) cleanly without intermodulation.

## Ultrasonic and Infrasonic Signals

In the ultrasonic spectrum, a wide survey of peaks from records has not yet been made. Recently however, information has become available on one well-known "hot" record. The ultrasonic range output is shown in Table 1 and plotted on Fig. 2. A moving-coil cartridge was used for this measurement, since moving-magnet cartridges driving cable capacitance in

\*Apt Corp.,  
BOX 512, Cambridge, Mass. 02139

**1976: ADC CLAIMS THE XLM MK II SHOWS "NO PERCEIVABLE WEAR OVER THE LIFE OF A RECORD." AND PROVES IT.**

**1977: ADC CLAIMS THE NEW ZLM WITH THE ALIPTIC™ STYLUS HAS EVEN LOWER WEAR AND BETTER PERFORMANCE. AND PROVES IT AGAIN.**

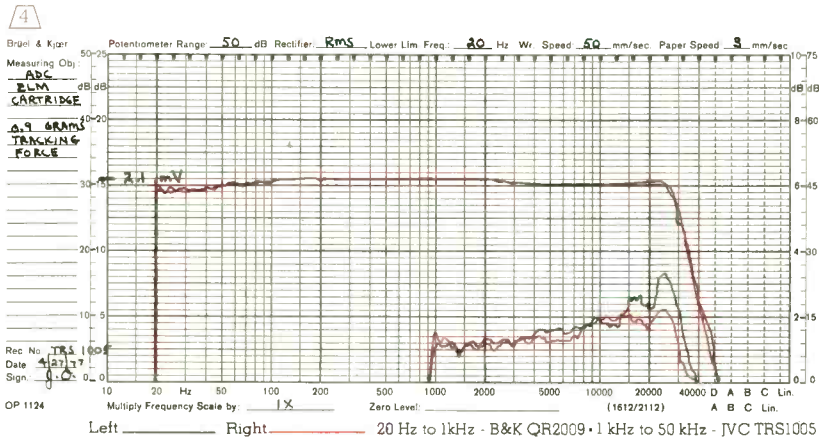
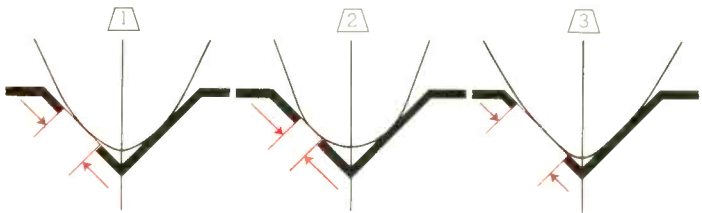

Introducing the ADC ZLM cartridge with the ALIPTIC <sup>1</sup> stylus. It's a revolutionary new cartridge design that has taken the state of the art a giant step closer to the state of perfection.

Because of last year's XLM MK II record wear test results, we confirmed our thinking on how to design the perfect stylus tip shape. It combines the better stereo reproduction of the elliptical <sup>2</sup> stylus shape with the longer, lower wearing, vertical bearing radius of the Shibata <sup>3</sup> shape. The result is our revolutionary new ALIPTIC stylus.

And that's only the beginning. The ALIPTIC shape is polished onto a tiny .004" x .008" rectangular nude diamond shank, which has reduced the tip mass of the XLM MK II by an incredible 50%. This tiny stone is mounted on our new, tapered cantilever, which reduces effective tip mass even further.

The XLM MK II tests also proved the importance of tip polish in reducing record wear. So the ZLM is polished with a new, more expensive, more effective patented polishing method.

The ADC XLM MK II has long been known for its uncolored, true sound reproduction. The ZLM goes even further. Sound reproduction is completely open and spatial. And individual instrument placement can now be identified with even greater ease.

The ZLM tracks between 1/2 and 1 1/4 grams. Frequency response is ± 1dB to 20kHz and is flat to even higher frequencies; out to 26kHz ± 1 1/2dB.

As you can see, by reducing the tip mass even further, we've come closer to the ultimate in pure sound reproduction. To prove it, every ZLM comes with its own individual frequency response curve <sup>4</sup>, signed by the ADC technician who tested it.

This means that the ZLM cartridge will reach every sound lying dormant in your records, transmitting them faithfully through your hi-fi system without altering the sound or the health of your records.

Not only do we think the ZLM is one of the most exciting cartridge designs to come along in years, but we can prove it.

Superior performance we can prove.

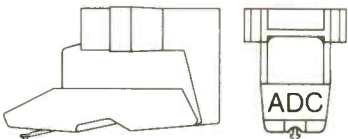

ADC  
 A BSR  
 COMPANY

CARTRIDGES

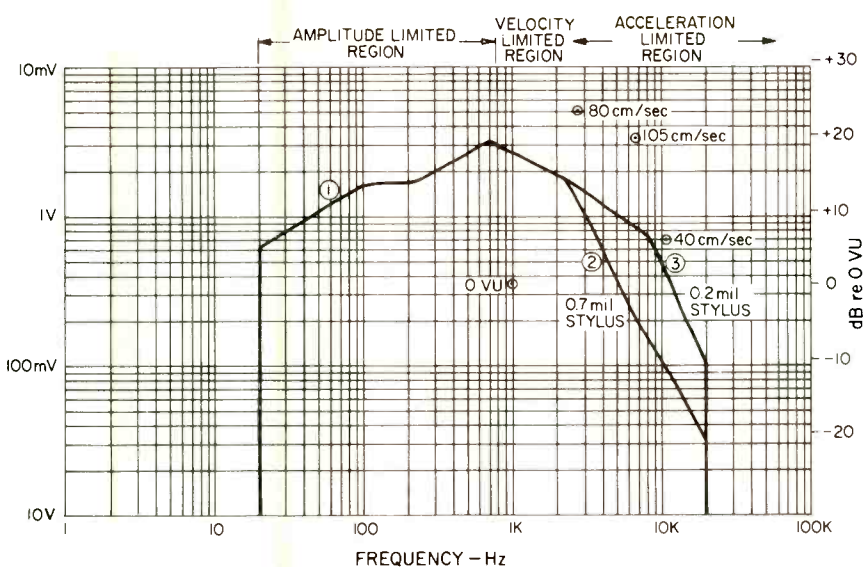

**Fig. 1—Sonic cutting limits for low distortion playback. Uses 1 mV/cm/sec cartridge with 40 dB/1 kHz gain RIAA equalized preamplifier.**

74

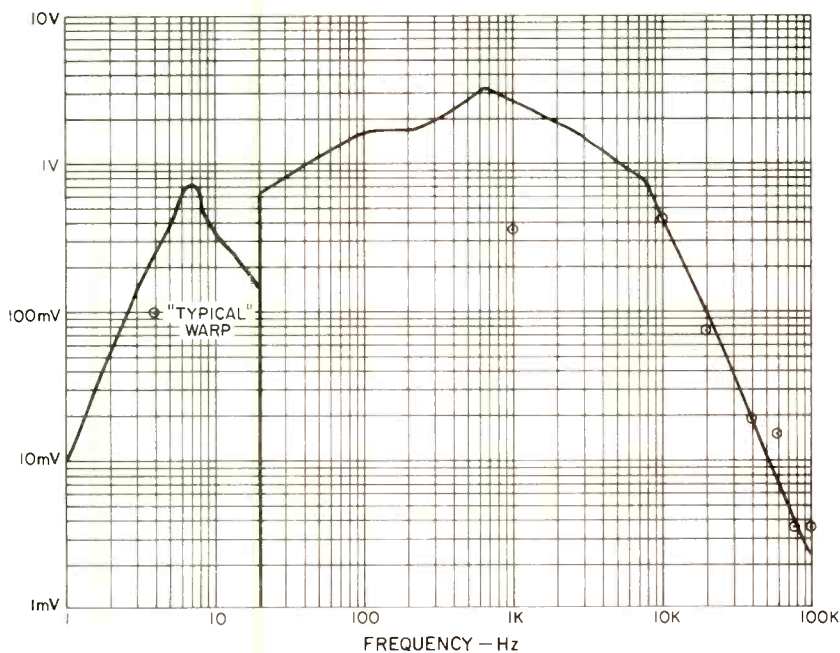

**Fig. 2—Ultrasonic and infrasonic range signals measured from records (same conditions as Fig. 1). No infrasonic rolloff in preamp. Average tone-arm/cartridge combination,  $f = 7$  Hz, 5 dB peak. Worst warp envelope shown.**

parallel with the input impedance of phonograph preamps form a low-pass filter which attenuates response in the ultrasonic range.<sup>7</sup> The low source impedance of moving-magnet cartridges provides flat electrical response throughout the ultrasonic region. While it may be argued that the output from a cartridge at these frequencies probably consists of distortion products that need not be reproduced cleanly, difference tone intermodulation, i.e., distortion products appearing as  $f_2 - f_1$ , may become audibly important. Any nonlinearity in the phonograph preamplifier at these frequencies and levels will act as a detector and will thus produce output in the audio range. Difference tone intermodulation of two strong, inband signals to produce a third has been noticed in preamplifiers. "One word of caution is in order. The preamplifier used to amplify the reproduced signal must be an extraordinarily good one. Even some highly respected amplifiers were found to introduce sufficient IM with high-level signals to partially obscure the contribution of the pickup."<sup>8</sup> Ultrasonic signals could produce similar problems. The ultrasonic output voltage requirement is ameliorated by the RIAA equalization; still, the preamplifier should clearly be capable of handling signals shown in the table with low distortion.

The infrasonic range signals are generated by warps on records interacting with tone-arm/cartridge resonance. Fortunately, a large amount of data is available characterizing the warps which occur on commercially acceptable records which met the 1964 N.A.B. standards for record warp.<sup>9</sup> The records in the survey were not particularly badly warped. Instead, they were from a conventional collection of records. The effect of much more severely warped records has not been included because of the inherent difficulties of playing such records, e.g. tracking them and their severe warp-induced wow. Most warps occur below 5 Hz (70 per cent) with 95 per cent occurring below 8 Hz. The envelope encompassing all the measured warps, corrected for cartridge sensitivity and preamplifier gain and equalization, is shown in Fig. 3 as curve 1. This maximum envelope has not been corrected for the effect of tone-arm and cartridge mass/cartridge compliance peaking and roll-off. Also shown is a single warp at 4 Hz with a peak amplitude of 0.003 in. which was chosen from the data to illustrate a "typical" warp. This

warp will be used to project the practical consequences of average warps on system performance. Also shown in Fig. 3 are the overall response of two tone-arm/cartridge systems. The two systems chosen represent quite reasonable best and worst case tone-arm/cartridge systems—the “good” system has a resonant frequency of 10 Hz with a Q of 3; the “bad” system has a resonant frequency of 4 Hz with a Q of 3. The criteria of “good” and “bad” are set by the fact that having a resonance where there are few disturbances with a rapid rolloff below is preferable to a resonant system having a peak coincident with many disturbances. Since many more warps lie around 4 Hz than around 10 Hz, the difference in the maximum peaks do not tell the whole story—the statistical distribution of warps must be considered as well. The plotted points above and below the “typical” warp show the range of possible responses to that warp from the best system upwards to the worst. This shows that a 4 Hz warp may be reproduced over a 24 dB span by the range of available tone-arm/cartridge combinations. Another interesting phenomena is seen in the difference between undamped systems and ones with pivot or arm damping, such as has been advocated among audiophiles. In the case of the 10 Hz,  $Q = 3$  system, damping of the arm motion relative to the turntable base is seen to substantially increase the output on warps below resonance, even though this moderate degree of damping does not cause the system to mistrack warps.<sup>10</sup> Since this form of damping increases the output in the warp region, it is causing the arm to behave rigidly and therefore there is net motion between the stylus and the cartridge body; the arm is no longer following the warps. This can lead to frequency and amplitude intermodulation effects in the cartridge. Therefore, damping of optimum systems is not recommended; it may, however, prove useful in a system with resonance in the 4 Hz region. For the composite whole range curve of Fig. 2, an average tone-arm/cartridge system has been used with the typical resonant frequency of 7 Hz with 5 dB peaking.

An example of cartridge/arm limits is given in Fig. 4. The overall playback system trackability has been modified by the frequency response of the tone-arm/cartridge system and by the gain and equalization of the pre-amplifier. The upper curve shows the capability of this arm/cartridge combination. The lower curve shows the

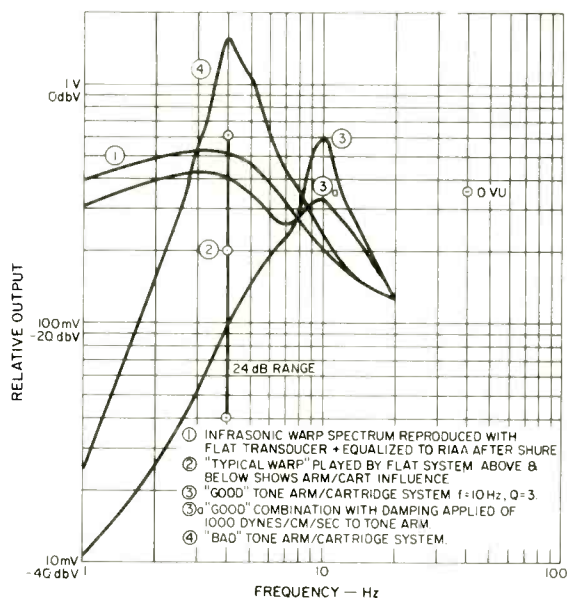

Fig. 3—Infrasonic region responses.

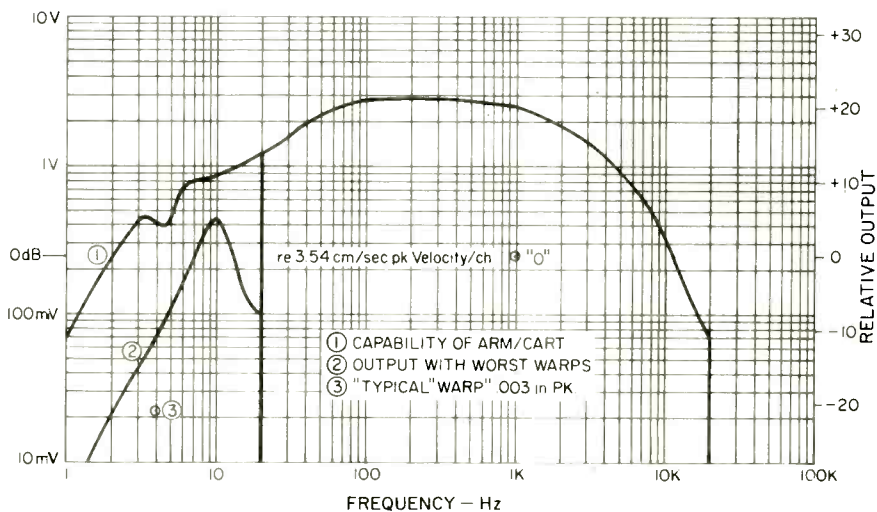

Fig. 4—Trackability vs. frequency referred to output of RIAA equalized preamp. No infrasonic cutoff. Adjusted for 0.7 mV/cm/sec cartridge sensitivity with 40 dB/1 kHz gain preamp. Example: Shure V-15 III.

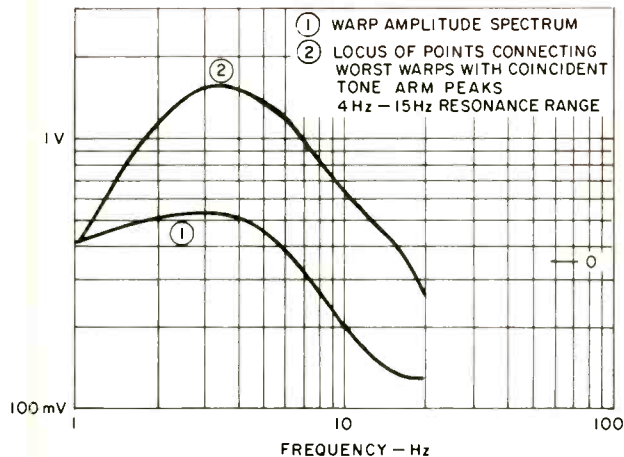

Fig. 5—1 mV/cm/sec cartridge sensitivity, RIAA equalized.

maximum output of this combination from the worst warps. Once again, it should be remembered that there are statistically far fewer warps at 10 Hz than at 4 Hz. The plotted point represents the response of this overall system to our "typical" warp.

Figure 5 gives the warp amplitude spectrum from Fig. 3 as curve 1 while curve 2 represents the maximum output possible at each frequency by combining worst case warps with tone-arm/cartridge systems peaks. The capability of handling these warp signals from records combined with the range of the possible tone-arm/cartridge peaks is a clear-cut performance requirement for phono preamps. And these signals must be handled in the presence of sonic range signals without cross-modulation.

All the information up to this point has assumed no electrical low frequency roll-off in the system. Previous work has shown the usefulness of infrasonic rolloff.<sup>11</sup> The degree of rolloff was set empirically by observation of loudspeaker cones while playing moderately warped records. Once the criteria were set, group delay effects associated with such rolloff were studied<sup>12</sup> and were shown to be inaudible on program material. The consequences of passing warp range information to the loudspeakers has not been studied analytically. The presence of very low frequency warp components coincident with program material is expected to produce distortion in loudspeakers.

A loudspeaker driven simultaneously with mid-band and infrasonic signals will produce both amplitude

and frequency modulation sidebands around the mid-band signal. Although a spectrum analyzer will read both kinds of modulation equally, the ear is much more sensitive to frequency modulation distortion than amplitude modulation distortion. Figure 6 shows the average threshold of subjects listening to slow piano music played in rooms to pitch and amplitude fluctuations.<sup>13</sup> Note that the pitch fluctuation threshold is lowest in the range of 4 to 10 Hz, which unhappily corresponds to the range of warps and tone-arm/cartridge system peaks. Also, the threshold for amplitude modulation is more than an order of magnitude greater than for frequency modulation in this range.

Frequency modulation distortion arises from the Doppler effect. Although the audibility of F.M.D. is debatable on low-frequency program material cross-modulating with high frequency material,<sup>14</sup> the effect of warp range signals with their attendant high excursions intermodulating with mid-range material is worth study.

A simple equation for F.M.D. exists:<sup>15</sup>

$$d.f. = 0.033 A_1 F_2 \quad 1)$$

where  $A_1$  = amplitude of cone motion, each side of rest, in inches;  $F_2$  = modulated frequency, and d.f. = distortion factor in per cent. Since this distortion arises from cone motion and is not due to acoustic output, the relationship should hold for infrasonic signals present at the woofer. It has been shown that the predicted F.M.D. occurs in loudspeakers by separate measurements of AM and FM sidebands.<sup>16</sup>

Since this problem quickly becomes overpowering if one tries to examine all possible combinations of loudspeaker, playing level, system rolloff, etc., a reasonably chosen example seems in order. A good acoustic suspension, two-way loudspeaker, with a 10 in. woofer, was set up in an ordinary listening position in a 2,000 cu. ft. living room. One-third octave noise, centered at 800 Hz, was fed the loudspeaker, and the drive level was adjusted to produce an average 90 dB sound pressure level in listening positions. The noise was then removed and replaced by an 800 Hz sine wave at the same drive level. Various frequencies and amounts of infrasonic signals were superimposed on the 800 Hz tone, representing a range of possible warp conditions assuming no electrical rolloff in the system. The results are given in Table 2. The woofer displacements corresponding with the warps were measured and are

Fig. 6—Subjective pitch and amplitude fluctuation thresholds, after Stott and Axon.

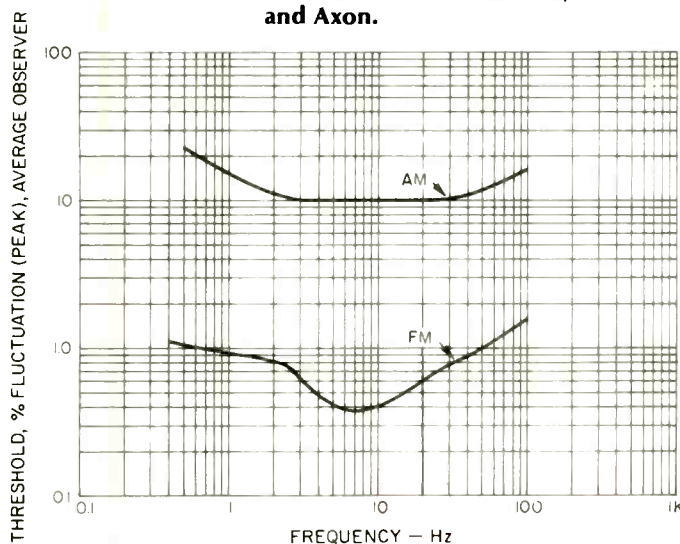

Table 1—Ultrasonic content from a record. Moving-coil cartridge playing cymbal crash on opening of Sheffield Vol. 3, Lab 1. Ref. 3.54 cm/sec peak velocity = 0 dB. Direct measurement of cartridge output before RIAA equalization. Measurement made by Dave Hadaway of DB Systems.

1 kHz.....	0dB
10 kHz.....	+16dB
20 kHz.....	+6dB
40 kHz.....	0dB
60 kHz.....	+2dB
80 kHz.....	-7dB
100 kHz.....	-5dB

shown in the table. Distortion was measured with a spectrum analyzer, and under one set of conditions the AM and FM distortions could be separated due to a sideband null. Equation 1 checked for these conditions indicating that Doppler distortion was present in the amounts predicted by theory.

The percentage of distortion arising from these cone motions on the 800 Hz tone are given in the table. These percentages correspond to the same phenomena as flutter in tape recorders or turntables, but because of the multiplicity of flutter standards in use, they may not correspond with the specified flutter numbers. Specifications weighted to the DIN peak standard should correspond fairly well, however. The threshold for flutter is given in Fig. 6. At 4 Hz, where the worst warp velocities occur, the threshold for an average listener is about 0.4 per cent peak. Setting a critical flutter standard at two standard deviations from the mean, so that fewer than 5 per cent of listeners will perceive the flutter, yields a criteria of 0.14 per cent peak flutter at 4 Hz. These two flutter criteria are represented in Table 2 by the amount of attenuation required to meet the stated limit.

In order to make the problem manageable, one set of conditions was analyzed to produce the numbers in the table. While this set of conditions represents a reasonable average, different amounts of distortion will occur under other conditions. As the playback level is raised, the cone amplitude increases while the modulated frequency stays constant so the distortion will increase and vice-versa. A one-way speaker will be more susceptible since a wider spectrum will be handled simultaneously and the modulated frequency goes up; conversely,

a lower crossover from the woofer to a midrange or tweeter driver will ameliorate the effect. Piano music threshold represents a practical worst case, in other real-world instruments, vibrato in the production of sound will more or less mask flutter sources in the system. In addition, the random nature of warp-induced flutter superimposed on complex musical signals, where the influence of the flutter stops at the top end of the woofer's range, complicates the problem further.

The built-in stochastic nature of the problem, along with these difficulties, prevents an absolute solution to the problem. As may be seen in Fig. 3 and Table 2, the tone-arm/cartridge system has a strong influence on the performance of the system. Infrasonic fil-

should be suspected for their distortion contribution.

It is clear from Table 2 that some amount of infrasonic attenuation is desirable in nearly every circumstance. Larger amounts of attenuation are useful to limit the modulation distortion generated in loudspeakers. However, the practical upper limit on infrasonic attenuation is set by the group delay characteristics of the filter in combination with the tone-arm/cartridge system. Ideally, the group delay should be a small fraction of the audible limits. Figure 7 gives the data on limits of audibility and on the standards of the Federal German Post Office and West German broadcasting companies.<sup>16A</sup> Also shown is the group delay of the infrasonic filter with and without the influence of a

Table 2—Consequences of Infrasonic Drive on F.M. Distortion generation by loudspeakers. Conditions: Midband output 90dB SPL in 2,000 cu. ft. room; acoustic suspension 2-way loudspeaker with 1.5kHz crossover.

Warp Freq./Amplitude Arm resonant frequency, peaking in dB	4Hz, typ.		4Hz, max.		4Hz, max.	
	10Hz/ +10dB "best"	7Hz/ +5dB "typ"	4Hz/ +10dB "worst"	10Hz/ +10dB "best"	7Hz/ +5dB "typ"	4Hz/ +10dB "worst"
± displacement, inches	± 0.008"	± 0.022"	± 0.090"	± 0.022"	± 0.055"	± 0.170"
Flutter, % peak due to loudspeaker at 800Hz.	0.21%	0.6%	2.4%	0.6%	1.4%	4.5%
Attenuation@4Hz required to suppress flutter to threshold of 50% of population (0.4% peak)	none	3.5dB	16dB	3.5dB	11dB	21dB
Attenuation@4Hz required to suppress flutter to threshold of 5% most critical listeners (0.14% pk)	3.5dB	13dB	25dB	13dB	20dB	30dB
Flutter, % peak due to loud- speaker with 3-pole infra- sonic filter @ -3dB = 15.5Hz; 4Hz, -36dB	0.003	0.009	0.04	0.009	0.02	0.07

tering should not be used as a "band-aid" for bad tone-arm/cartridge systems since the bad system is likely to be producing modulation distortion in the cartridge, which no filter can take out. Still, even the best tone-arm/cartridge system requires 13 dB of 4 Hz attenuation to make the warps from the survey produce inaudible flutter for 95 per cent of the population.

It had been previously supposed that vented box loudspeakers, unloaded below resonance, would exhibit worse distortion on warps due to longer cone excursions on warp signals. This theory was tested on one vented box design. The unit tested had distortion at about the same level as the acoustic suspension design due to a quite stiff driver suspension. Speakers that exhibit long, uncontrolled motion visible on warp signals

worst case tone-arm/cartridge system. At 50 Hz the group delay of the playback system is about one-fortieth of the audible limit on program material.<sup>17,18</sup> This makes mental sense if one remembers that events happening at low frequencies take a relatively long time by definition. The "low-frequency transient" is practically a contradiction in terms. Furthermore, low-frequency group delay is unavoidable in high-fidelity systems; the low-end rolloff of the loudspeaker system, combined with the response of the room, will always cause a delay. However, even most of the vented-box system alignments, with their relatively long delays, fall under the limit of perception even when aligned to the relatively high frequency of 50 Hz.<sup>19</sup> And the high-quality acoustic-suspension design used in the distortion experiment adds only about 4 ms of 50

# Time & Frequency in Loudspeaker Measurements

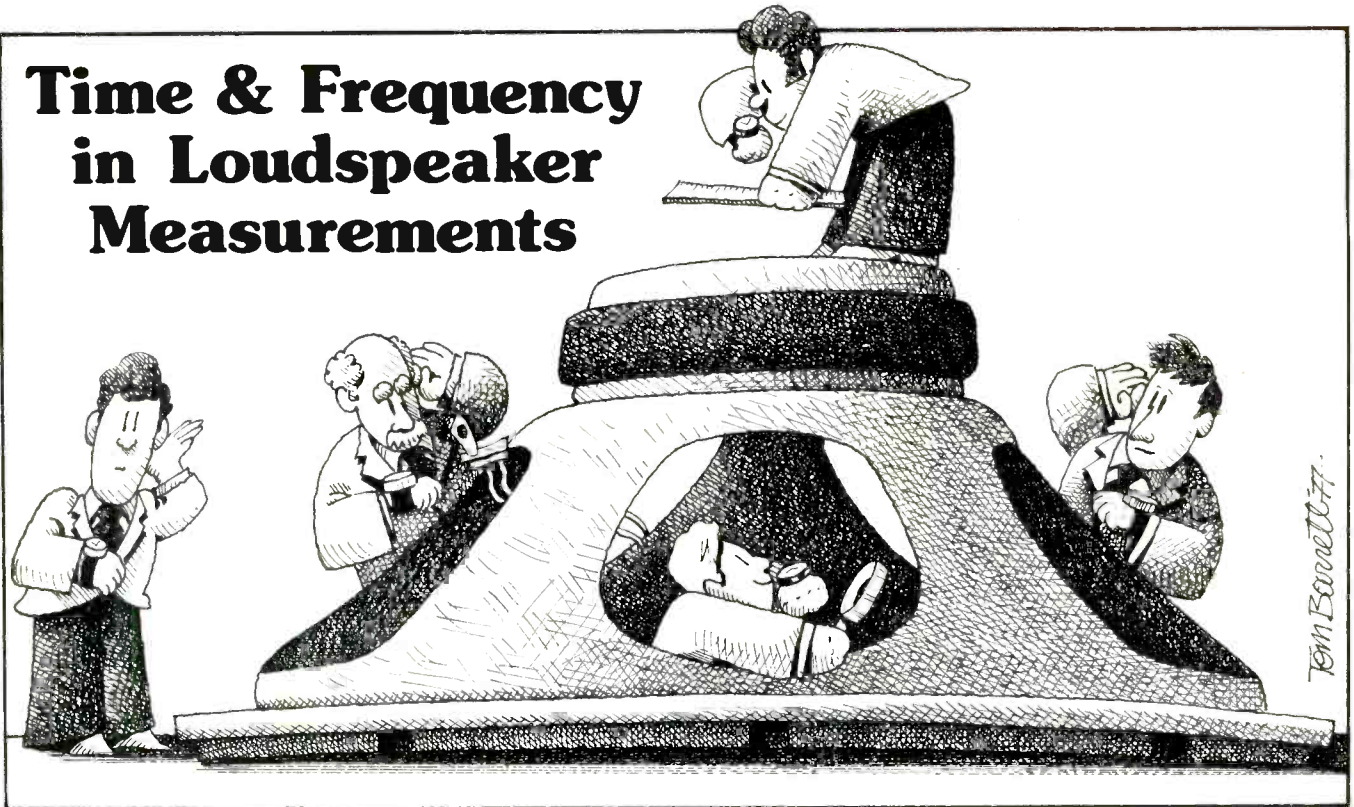

80

## Richard C. Heyser

I claim that it should be possible to measure audio systems and have those measurements correlate with what we hear out of those systems. We are not doing that now. Our measurements are more precise than ever, but our understanding of what those measurements mean to the way a system "sounds" is still hazy.

I further assert that we are locked into that dilemma because we do not truly understand the meaning of those technical concepts which we now use. I don't think I can be more blunt about the matter.

OK. So having shot my mouth off, what am I going to do about it? Well, what I would like to do is present the readers of *Audio* with my personal view of the meaning of some of the more important terms we use in audio. These are some of the results from my own continuing research into the problem of finding out how to bring subjective and objective audio together. What I present here is my own work. I'm laying it out, in a put up or shut up fashion.

But I am not asking you to accept these things blindly. Question it, think about it, because what we really need to do is dig down to these underlying principles, the philosophy of the

problem. In these discussions we go below the equation's mechanical formalism and question what the meaning is behind the equations. Then when we come up to the equations of audio we find that, while there may be no change in form, we often have a completely new perspective on just what they mean, not only to the pedestrian task of measuring components, but to the possible link with subjective perception.

In a previous article, I started out at ground zero and gave my interpretation of the meaning behind a technical term that is commonplace in audio, the term we call frequency. In this article I would like to carry this point further and apply it to the interpretation of certain loudspeaker measurements.

But before I get technical, let me put one thing into perspective. The end product of this whole multi-billion dollar audio industry is the listening experience. It is what we "hear," in the abstract sense of this word, that is important.

It is not the oscilloscope pattern but the listener's perception that is paramount. This does not mean that we should reject technology... quite the contrary. We know that most persons have the same general impressions of the realism and quality of a performance when listening to identical sound reproduction. There is some-

thing that is used by all of us in making our judgment, and that something is tied to the ingredients making up the reproduced sound. If this something is there but not specifically outlined in our present technical measurements, then we need to get even more technical and find out why. We need a Renaissance out of what may prove to be the "middle ages" of audio. The winner, if there is to be a winner, would be the listener, for we would know how to make his enjoyment of sound far better.

In my last article, I pointed out that when we do become very technical and poke around at the precise meaning of terms, a startling fact emerges. Even as fundamental a term as frequency turns out to have a meaning quite different from that which most of us employ in audio.

It is a subtle thing, but sometimes subtle things topple kingdoms. Let me recap. We know that at present there are two major ways of describing an audio signal. There is a time-domain representation and there is a frequency-domain representation. The time-domain representation and the frequency-domain representation are Fourier transforms of each other.

Now what the heck is a Fourier transform? A conventional textbook answer to that question is to write out a certain hairy integral equation and state... "that is a Fourier transform."



Simply writing down some equation, as though it were a Machine of the Gods, doesn't answer anything. Nature does not solve equations, people solve equations. Nature works in spite of us, and at best the equation is some sort of model for the way in which nature works.

In the previous article, therefore, I suggested a different approach. Suppose we have a signal which we agree is a legitimate time-domain representation. And suppose we ask ourselves what form that signal will take if it is observed by a being who uses some other coordinate instead of time. In particular, what would the form of that signal be if it has the same dimensionality but is somehow measured in units that are the reciprocal of the units of time we use?

Remember, we would both be seeing the same signal, but would be using different frames of reference.

Pursuing the point further, we asked what recipe we could use to take our time-domain view and see it within the framework of this other being's coordinate system. We derived the recipe, which turned out to be the Fourier transform. And the coordinate system which this other being uses turned out to be the parameter we call frequency. Exactly the same equation you will find in a textbook, but with a totally new interpretation.

The thing we call time in audio measurements and the thing we call frequency are different coordinates for describing precisely the same signal.

### Subjective Descriptions

Oh, yes... ho hum, technicalia. But if we begin to think what this means to audio it gets a bit exciting, because this means that frequency and time are only two out of an infinite number of coordinate systems we can use to characterize a signal. We don't have to go just from time to frequency, we can go from time to some other coordinate. And even more stunning is that since we can have *either* time or frequency, but never both together in a meaningful description, this means that those properties of sound which we perceive and relate to the

words "time" and "frequency" are *not those parameters at all*.

Now, think for a moment about those words we often use to characterize the sound of imperfect reproduction. Words such as "grainy" and "forward." These words do not seem to fit in with either an exclusive time description or frequency description. Is it possible that these words belong to some other, as yet unrecognized, coordinate system which is a legitimate mathematical alternative to time and frequency? I claim the answer to this question is yes.

Putting it in blunt language, if we measure the frequency response of a system, and do it correctly, then we know everything about the response of that system. We have all the technical information needed to describe how that system will "sound." But the information we have is not in a system of coordinates that will be recognizable by a subjectively oriented listener. Everything is there, but the language is wrong.

That is the root cause of the continuing fight between subjective and objective audio. It is *not* that *either* is more correct than the other... rather it is due to the fact they do not speak the *same language*. And when I say language, I do not mean just the descriptive words, but the very frame of reference upon which these words are based.

Sticking my neck out further, I assert that the reason technical people (and I am one of them) did not recognize the root cause of this problem was due to the fact we did *not* realize there *could* be other meaningful frames of reference besides time and frequency.

And, as a matter of fact, not too many technical people are aware that time and frequency are themselves alternate frames of reference, rather

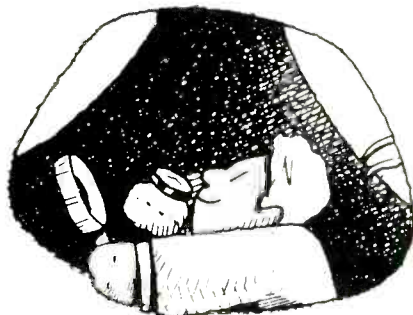

**"And, as a matter of fact, not too many technical people are aware that time and frequency are themselves alternate frames of reference..."**

than just two terms to be applied haphazardly to measurement.

There! How's that for tipping over icons?

### Loudspeaker Tests

As a reader of *Audio*, you've probably noticed that our loudspeaker reviews have been a bit more technical than is normal industry practice. There's a reason for this. These tests are a first attempt to relate measurement to subjective perception. The various tests we perform did not just happen; each is in some way related to simple mathematical results in the type of geometric structure which we might use in perception. It is a first attempt, and very crude at that. But somebody's got to start the process, so let it be here.

In the remainder of this discussion I would like to explain the technical aspects of spectrum sampling and apodization as they relate to the loudspeaker tests we perform in *Audio*.

Let me begin by recapping a very important concept which I flogged to death in the previous article. That is this mysterious and seemingly sinister thing called the uncertainty principle. There is nothing mysterious about the uncertainty principle at all. It is not something nature does to us, but something we do to ourselves through the definitions we give things.

Here is the point. It makes absolutely no difference whether we start out by defining parameters as being related by the Fourier transform, or somehow discover well along the road that two properties happen to be related through Fourier transformation: when two properties are Fourier transforms of each other, they represent different ways of describing the same thing and hence cannot be thrown together into one common description. The Fourier transform is a map, you see, which converts one coordinate system into another coordinate system.

It is a property of changing from one view to another that each part of one view becomes somehow spread over the entirety of the other view. In particular, the Fourier transformation takes a single coordinate location in

## **“Nature’s clocks always run forward; at least, the most diligent searching has failed to reveal any experimental results to the contrary.”**



one view and makes it into a very special geometric figure in the other view, a figure which we call a wave and which extends over the entire range of coordinates in the other view. If we try to take a restricted range of coordinates in both views, we cannot do so and be precisely accurate. But what we can do is ask what the minimum ranges of coordinates are in both views such that “most” of the same information is contained in each. The form this takes for a popular measure of “mostness” is such that the product of these two ranges is greater than or equal to some number. This is called the uncertainty principle.

Let’s see what this means in audio terms. Suppose we are testing a loudspeaker. We kick it with a voltage and the loudspeaker produces some sort of sound. Let’s pick that sound up with a microphone and convert it back to voltage. Now let’s put a switch in the output of the microphone. Suppose the switch is initially open, so that we do not have any sound signal to analyze. Some time after the loudspeaker puts out a pressure wave, we close the switch for one second and then open the switch.

What do we have? In the coordinate of time we have a signal that only has a sound-related value over a period of one second. We have created a one-second chunk of time... a time-domain representation.

Imagine, if you will, how that voltage would appear to some being who does not live in a coordinate called time, but whose frame of reference is something we call frequency.

In fact, if we want to see what he sees, we can convert to his coordinate system by making what we call a spectrum analysis. In order to do this, we have to give up the thing we call time. Time will show in this frequency spectrum, but it will be in the form of the relationship of phase and amplitude of waves in the frequency spectrum.

When we look at the frequency representation, we will see that there is some energy spread over the whole of the frequency coordinate. But the effect of having taken a frequency spectrum from a small chunk of time is that the frequency spectrum will be

very slightly out of focus. The edges will not be sharp, but somehow smeared. The amount of this smear will be on the order of one Hertz, which is the name we give to the unit of measurement in this other being’s coordinate system.

If we had only closed the switch for one-thousandth of a second, and then seen what our frequency-domain friend saw, we would find that the smear was of the order of one thousand Hertz units (I’m only talking in ballpark figures).

That is the manifestation of what is called the uncertainty principle. In performing *Audio’s* loudspeaker tests, I use a 13-millisecond time window to make the three-meter or room test. I want to find out what spectral components are found in that important time period which can establish some measure of timbre or tonal balance of the sound heard from that loudspeaker when placed in a room. This time duration derives from psychoacoustic tests. I cannot legitimately present any frequency measurements focused to an accuracy of better than about 100 Hz, including the range from d.c. to 100 Hz, because of the chunk of time which the data represents. To be safe, therefore, I only give data from about 200 Hz upward.

### **Apodization**

Now there’s this problem called apodization, which literally means “the process of removing feet.”

When we hack off sharp edges, such as closing and opening a switch on a voltage, the equivalent transformed view will be blurred in a most unpleasant manner. There will be foot-like appendages, or sidelobes, which extend outward from each place where there should be a solitary frequency value standing apart from its neighbors.

Again, I must stress this is not due to some caprice of nature, it is due to our definition. If we hack off edges, and if we take a Fourier transform view, then we will find sidelobes. And I don’t give a darn whether we measure the equivalent frequency response with sharp filters or with a computer FFT, our definition requires they be there. The theory determines what we will observe.

In order to minimize (we can never remove) them, it is necessary to do some sort of blurring or defocussing in the hacked-off parameter. The process of removing spectral feet by operating on the original data is called apodization. There are an infinity of apodization processes available, depending upon the type of corresponding blurring we are willing to tolerate in the apodized spectrum. Apodization usually consists of smoothing the sharp edges by using more of what is in the middle of the hacked-off distribution than at the sharp edges. *Audio’s* loudspeaker data is apodized with a nearly raised-cosine weight function when frequency response is plotted, and with a Hamming weight function when time-domain response is plotted.

### **Time Measurements**

Nature’s clocks always run forward; at least, the most diligent searching has failed to reveal any experimental results to the contrary. Where we poor humans get into trouble is when we start out from a frequency measurement and compute the corresponding time-domain response. If we have a *chunk* of frequency response, for example if we have no data above 20 kHz, then the time-domain response will be blurred.

In nature, the sharpest edge of all is at “now.” A computed time-domain response will therefore spread before and after “now.” The computed time-domain response will appear to predict the future... that is not really a prediction, but a blurred edge.

The energy-time loudspeaker measurement we make is a computation from the anechoic frequency response. We band limit from zero frequency to 20 kHz. In order to get the sharpest definition of discrete signal arrivals, such as due to diffraction

from the edge of the enclosure, with the least amount of predictive "feet," we use an apodization function called Hamming weighting. Our measured sidelobes are actually down close to 40 dB below the peak giving rise to them. But you will still see what appears to be a predictive risetime prior to extremely sharp pulses.

As a matter of professionalism, we also check the loudspeaker impulse response by using a raised cosine pulse of voltage that has a 10 micro-second half-width. The loudspeaker impulse response is viewed on an oscilloscope and compared against the computed energy-time response to make sure all is kosher.

The reason for this belts-and-suspenders approach is due to a fact of apodization that, unfortunately, very few professional people seem to be aware of. Apodization, or a weight kernel, or whatever you choose to call it, has all the properties of the data to which it is applied. This includes the properties of amplitude and phase. In fact, we could take a converse view that the data is actually a weight kernel on the apodizing function.

Now, you know what happens when we take a Fourier transform of a product of two functions in frequency. The result is a time-domain convolution of what would have been the time-domain representation of each by themselves. They get all mixed up.

They get tangled up in phase as well as amplitude. And quite often a messy data signal will "unsmooth" even a good apodizing function. In short, this means that sometimes the computed response is lumpier than we think it should be. But, and computer people take note, unless you have a cross check or precise knowledge of the amplitude and phase of the data being transformed, you don't know it happened.

The geometry of this is too lengthy to go into here, but most apodizing functions used in Fourier transform analysis are non-minimum phase. Mostly they change the amplitude without changing phase. This includes Hamming, Hanning, and the rest. Historically, this is because the interest usually lays in the power spectrum (phase, what's that?). That works swell when the data is minimum phase. But when the data (in our case loudspeaker frequency response) has a maverick phase term, it can unsmooth a good apodizing function. Look at it this way, the effect is as though the loudspeaker response was minimum phase and the excess phase term was thrown into the weight kernel.

I realize that such talk might be highly confusing if you're not in the FFT business, but computer people ought to know what I mean. Other than my own comments in technical journals, I don't believe this fact has been pointed out before.

What it boils down to is that *Audio* makes every effort to be technically accurate, even if we are not terribly popular among some manufacturers when we do so.

### Wrap Up

Let me wrap up this little discussion with two observations. First, if we real-

ly want to bring subjective and objective audio together, we need to get down to the fundamentals which can be highly technical. Second, with the editor's permission, I am trying an experiment with these discussions—in using words rather than mathematical symbolism, but I am not watering down the technical level.

*Audio's* readership covers the full range of involvement in the sound industry, from listener to researcher. Reader survey cards (yes, we do read them) indicate that many of you want more technical articles. And you like straight talk. All right, this was a trial balloon. Want more? 

## If you missed the first two issues, it's still not too late.

We've reprinted Volume 1, Number 1 of *The Audio Critic* and have printed enough of Number 2 to keep up with the ever-increasing demand. Our phenomenal growth seems to indicate that noncommercial, consumer-oriented audio journalism has come of age.

One subscriber writes that *The Audio Critic* is as good as the four best-known "underground" audiophile reviews combined. Another calls it the new Bible of high fidelity. Even if you ascribe such reactions to fanaticism, the fact remains that *The Audio Critic* is unlike any other publication or service.

Six times a year, by subscription only, *The Audio Critic* tells you in print what has so far been only spoken of in private among a few enlightened professionals. What's the best. What isn't. What's smart. What's dumb. And why.

Since *The Audio Critic* accepts no commercial advertising, not even by retail stores, and since it has no connections with the audio industry, it has nothing to gain from being kind to unscrupulous or incompetent manufacturers. It names names, calls bluffs, praises and criticizes without restraint.

What's more, *The Audio Critic* doesn't just blithely inform you that the highs are "grainy" or the midrange is "liquid." It makes a serious effort to correlate its listening tests with measurements taken in its own, superbly equipped laboratory.

One year's subscription to *The Audio Critic* (six issues) costs \$28, first-class mail only. For overseas

airmail, add \$5. No single copies are sold for any reason whatsoever, but the unused portion of canceled subscriptions is refundable on request.

The first two issues cover close to thirty preamplifiers, as well as power amps, speakers, subwoofers, tone arms and other subjects. The third issue (May/June) is devoted mainly to speaker systems with state-of-the-art pretensions. We strongly suggest that you begin your subscription with Volume 1, Number 1, in order to own a complete set and be thoroughly familiar with our approach.

Send your \$28 for the first six issues today to *The Audio Critic*, Box 392, Bronxville, New York 10708.



# Equipment profiles

## Jensen Model 530 Three-Way Loudspeaker System



84

### MANUFACTURER'S SPECIFICATIONS

**Speaker Complement:** 10-in. woofer, 3-in. mid-range, 1½-in. tweeter.

**Frequency Range:** 27 Hz to 25 kHz.

**Impedance:** 8 ohms, nominal.

**Crossovers:** 1&5 kHz.

**Dispersion:** 170°.

**Minimum Power:** 10 watts.

**Maximum Power:** 60 watts.

**Dimensions:** 24½ in. (62.2 cm) Hx 14 in. (35.6 cm) Wx 12 in. (30.5 cm) D.

**Shipping Weight:** 42 lbs (19 kg).

**Price:** \$189.95 (west of the Rockies \$199.95).

The Jensen Model 530 is a three-way loudspeaker system using a 25 cm (10-in.) woofer, 9 cm (3-1/2 in.) cone mid-range, and a 4 cm (1-1/2 in.) dome tweeter. Mounted in an attractive walnut finished enclosure measuring 35.5 cm (14 in.) by 31 cm (12-1/2 in.) by 62 cm (24-1/2 in.), this system reproduces the audio range from 50 Hz to 18 kHz.

The sound may be balanced, to user satisfaction, by means of midrange and tweeter level controls, which are reached by pulling off the front grille. After adjusting these controls, the grille may be re-attached by simply pressing it back in place.

Electrical connection is made to binding posts mounted in a recessed cavity at the rear of the enclosure. Instructions supplied with the system, while not overly detailed, are sufficient to allow proper setup with little chance for mistake.

### Technical Measurements

The magnitude of the impedance which the Jensen Model 530 presents to a power amplifier is shown in Fig. 1. In this measurement the two front-panel equalizer controls, which set the middle and high frequency balance, are adjusted to their mid-rotation values. Following a bass rise at 58 Hz, the

impedance reaches a second peak near 1 kHz. The lowest impedance is reached at around 10 kHz and lies slightly over 6 ohms.

A polar plot of the impedance for the same equalizer settings is shown in Fig. 2. The nature of this plot indicates a smooth impedance variation throughout the audio frequency range. There is, however, a potential problem which some amplifiers may have when driving this loudspeaker near their peak limit. The phase angle of impedance has a 42 degree lag at 1.8 kHz with a net impedance around 12 ohms. While this impedance should cause no problems with quality amplifiers, it could possibly trigger the protection circuitry of some amplifiers into audible distress when these amps are driven near their limit on musical material with wide dynamics such as voice and piano. The solution is to use quality amplifiers with the Jensen 530.

Measurements made on the frequency response demonstrate that the equalizer controls have a strong influence. Figure 3 is a plot of the one-meter axial response for three equalizer positions: both at maximum, both at minimum, and both at a halfway position, shown as -10 on the calibrated panel markings. There is very little effect below 1 kHz, but substantial influence above that frequency.

Bass response extends down to 55 Hz, then falls uniformly below that frequency. Midrange is relatively smooth, with a broad peak around 600 Hz, while the response above 1 kHz is most uniform only for the maximum equalizer positions.

Figure 4 is the phase plot corresponding to the maximum equalizer measurement of Fig. 3. The Jensen Model 530 is a three-way loudspeaker system, and the acoustic time delay is different for each driver comprising this system. For this measurement, as with the anechoic test, the microphone is always placed one meter in front of the loudspeaker front panel and directly on the system's central axis. Three measurements were made to show the complete phase response of this system. A time delay corresponding to a path length of 1.028 meters is needed to give the measurement corrected for the tweeter acoustic position. The midrange measurement from 200 Hz to 20 kHz is made with a path length of 1.05 meters. And the lowest frequency needs a path delay of 1.40 meters to yield the phase plot shown here. In short, this means that the sound from the three drivers arrives at the listening location at slightly different times.

The woofer and tweeter are in phase with the voltage waveform, while the midrange unit is shifted 190 degrees. A positive-going speaker voltage applied to the speaker terminal indicated by the red post will arrive at the listening location as a pressure increase when the sound is due to the woofer and tweeter.

**Fig. 3—Magnitude of sound pressure level, anechoic response one meter on axis with one watt average drive.**

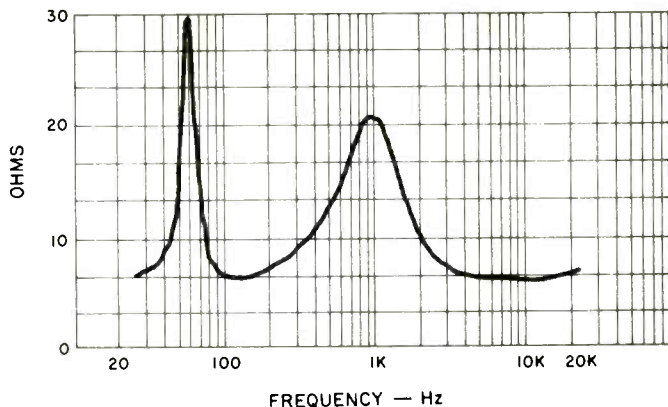
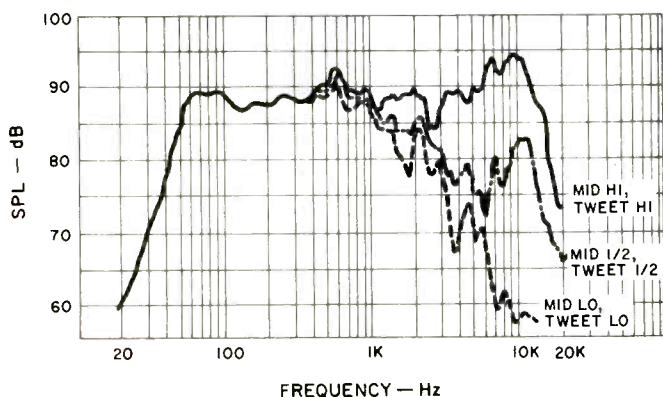

**Fig. 1—Magnitude of impedance.**

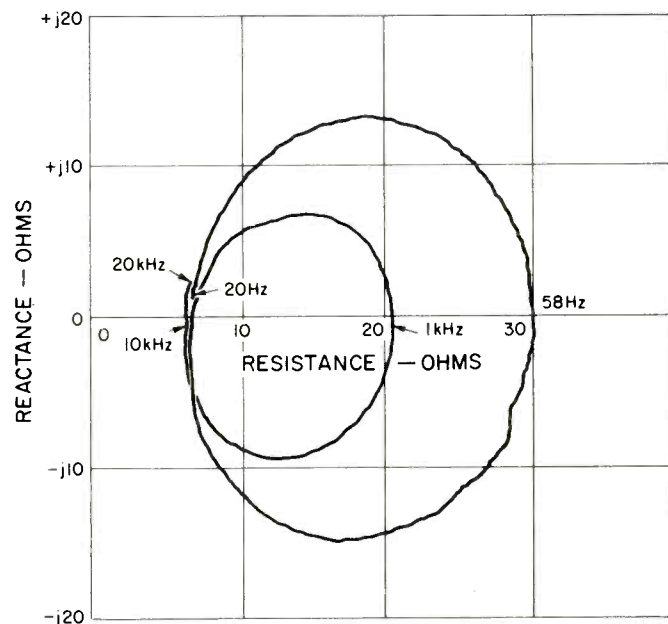

**Fig. 2—Complex impedance.**

The acoustic crossover frequencies are indicated to be around 600 Hz and 11 kHz by this phase measurement. In general, the response due to each driver is of minimum phase type, although the complete system must be classed as nonminimum phase due to the time delay differences.

The three-meter room test is shown in Fig. 5. This is the spectral distribution for the first 13 milliseconds of sound which is heard when the Jensen Model 530 is placed in a room. The physical placement of the speaker for this test is against a wall and raised off the floor by an amount which places the center of the enclosure one meter from the floor. The measurement position is one meter above the floor and three meters away from the front of the speaker. The room has a floor-to-ceiling height of 2.5 meters, and there's a rug on the floor. No furniture reflections are allowed within the time window of this measurement, which is mathematically changed (apodized) to prevent clipped transients interfering with the frequency measurement. The speaker is placed directly in front of the microphone for one measurement and 30 degrees to the left of the microphone in the other measurement to simulate probable stereo listening locations. Both the tweeter and midrange controls were placed in their maximum clockwise position for this measurement.

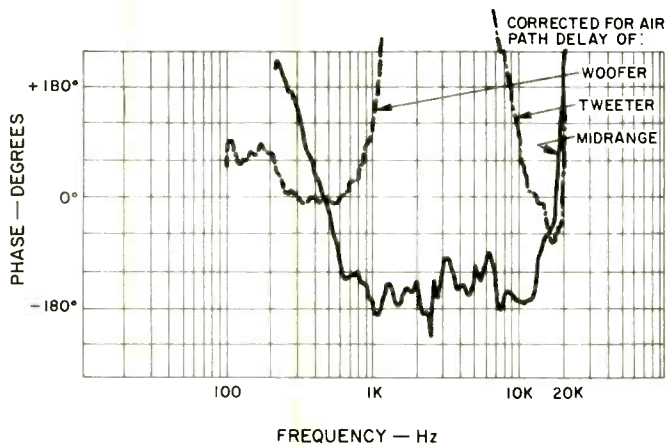

Fig. 4—Phase of sound pressure level.

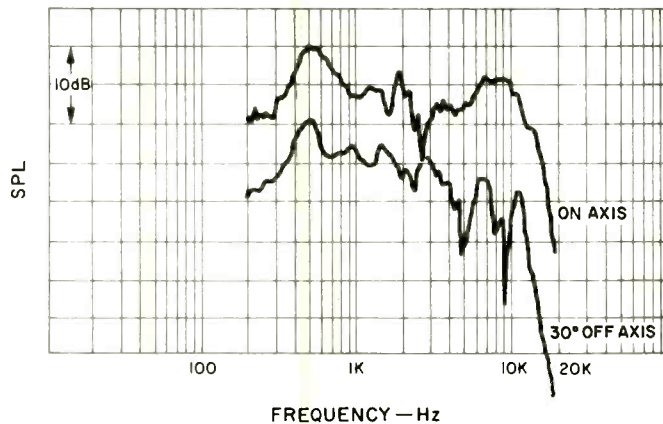

Fig. 5—Three-meter room response, plots displaced 10 dB for clarity.

86

The room response is similar to the anechoic response in that there is an emphasis of frequencies around 500 Hz and 9 kHz. This measurement indicates that the speakers should be rotated toward the listening position for a more uniform balance of high frequency energy.

The polar energy response is shown in Figs. 6 and 7 for the horizontal and vertical dispersion of sound around the Jensen Model 530. This is a measure of the total energy in the full 20 Hz to 20 kHz band, and five equalizer positions were used for each measurement.

The most uniform polar response is obtained with the midrange set *Low* and the tweeter set to its *High* position, with other combinations of equalizer position resulting in some polar "fingering" which indicates a change of sound timbre with seating position. The polar measurements verify the suitability of rotating the speakers toward the listening area. The strong upward projection of sound energy indicates that the Model 530 should not be placed immediately beneath a ceiling or shelf that projects beyond the front of the enclosure and this speaker will sound best placed in an open unconfined space.

The measured harmonic distortion for the musical tones E1 (41.2 Hz), A2 (110 Hz), and A4 (440 Hz) is shown in Fig. 8. This type of distortion is moderately low in the Jensen for the middle and upper tones but rapidly rises with increasing drive power for extremely low bass.

Intermodulation distortion is plotted in Fig. 9 for the effect of E1 on A4, or 41.2 Hz on 440 Hz, mixed one to one. At 10 watts average power, the modulation of A4 by E1 amounts to 4 degrees peak-to-peak phase modulation and 3

per cent amplitude modulation. As with all loudspeakers, there is a small but measurable migration of the cone away from its rest position when signal is applied. This is a d.c. effect which shifts the average position of the acoustic source. For the Jensen Model 530, the mean average position of the woofer moves inward by an amount corresponding to 4 degrees phase shift of 440 Hz when 10 watts average drive is sustained with combined E1 and A4. Percussive bass will therefore cause a small time smear of the higher musical frequencies carried by the woofer.

A perfect loudspeaker will cause an increase in sound pressure level which precisely matches the increase in electrical drive causing that sound, hence a one dB increase in drive should cause a one dB increase in sound pressure. In the real world, however, no loudspeaker is perfect. This transfer function linearity is measured by starting from a reference level of 0.1 watts and measuring the sound pressure level change as drive power is stepped upward. The amount by which the sound pressure level is greater or less than what it should be at a given power is a measure of transfer linearity.

The musical tones of A2, middle C, and A4 (110, 261.6, and 440 Hz) were used for checking the transfer gain of the Jensen. Relative to 0.1 watt, the gain first increases above unity by a small amount as power increases, then drops below unity for the two lower tones. The higher frequency of A4 (440 Hz) does not behave in this manner but gradually drops in gain with increasing drive. The greatest spread in gain occurs at 10 watts average drive with unity gain for A2, negative 0.3 dB for middle C, and negative 0.8 dB for A4. This indicates there will be a small change in timbre as a function of drive level with higher partials becoming relatively reduced.

In the crescendo test neither middle C nor A4 were changed by greater than 0.5 dB when incoherent signals 20 dB larger were superimposed, even up to peak power levels of 250 watts. Thus, the Jensen Model 530 can be rated as handling massed sounds very well.

Fig. 6—Horizontal polar energy.

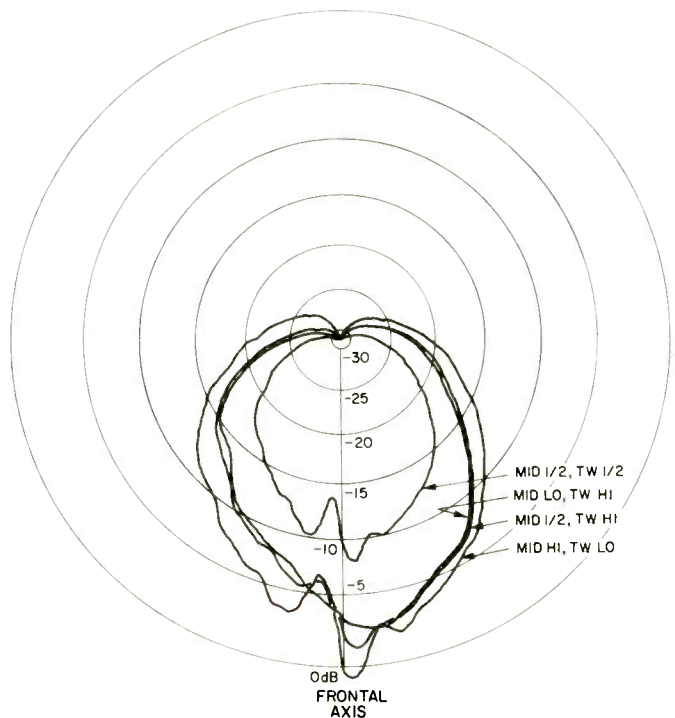

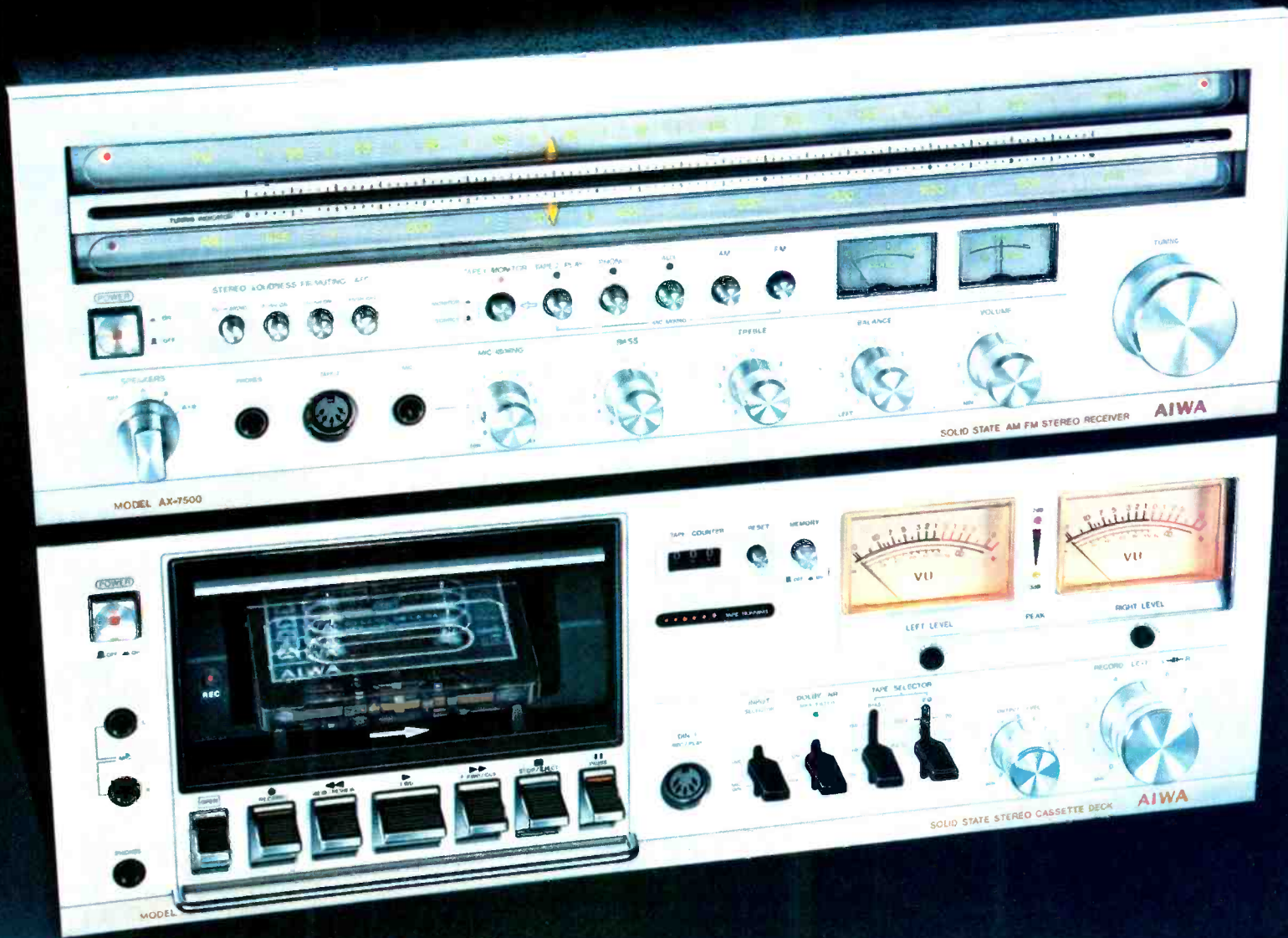

# Meant for each other.

From the beginning it was a love match, each bringing out the best in the other. The AIWA AD-6500 cassette deck and the powerful AIWA AX-7500 receiver.

The AD-6500 cassette deck with its exclusive automatic front loading has been the belle of the ball since coming out. The separate transport system automatically loads the cassette into place. Added to this exclusive feature are those famous AIWA specs that impress even the most discriminating audiophile. The built-in Dolby<sup>®</sup> N.R. allows the S/N ratio of 62dB (Fe-Cr tape); the wow and flutter is kept to 0.07% (WRMS); the frequency response from 30 to 17,000Hz; the 2 step peak level indicator (+3dB, +7dB); the quick

cue and review; the Ferrite guard head and the 3 step bias and equalizer tape selector insures that the AD-6500 will always be out front.

The AX-7500 is a high powered, low distortion AM/FM stereo receiver that can hold its own with the best. Even the toughest engineers have nodded their approval. It boasts 30 watts per channel minimum RMS at 8 ohms from 20 to 20,000Hz with no more than 0.2% total harmonic distortion. The advanced 3-stage direct coupled OCL and differential amplifier circuitry equalizer assures stability and excellent transient response.

The AIWA AD-6500 and the AIWA AX-7500. The perfect sound relationship.

# AIWA<sup>®</sup>

\*Dolby is a Trademark of Dolby Laboratories, Inc.

Distributed in the U.S. by: **MERITON ELECTRONICS, INC.**, 35 Oxford Drive, Moonachie, N.J. 07074

Distributed in Canada by: **SHRIRO (CANADA) LTD.**, Montreal 256, P.Q. Canada

Enter No. 2 on Reader Service Card

The final measurement performed on this speaker is the plot of total sound energy as a function of time following excitation by an impulse. This is the envelope of impulse response, and the measurement is shown in Fig. 10. The equalizer controls were both set to their high position.

The first large peak is due to the sound arriving from the tweeter, while the energy extending out to 4 milliseconds is principally due to the midrange speaker. Some evidence of diffraction scattering is seen in this measurement and this is

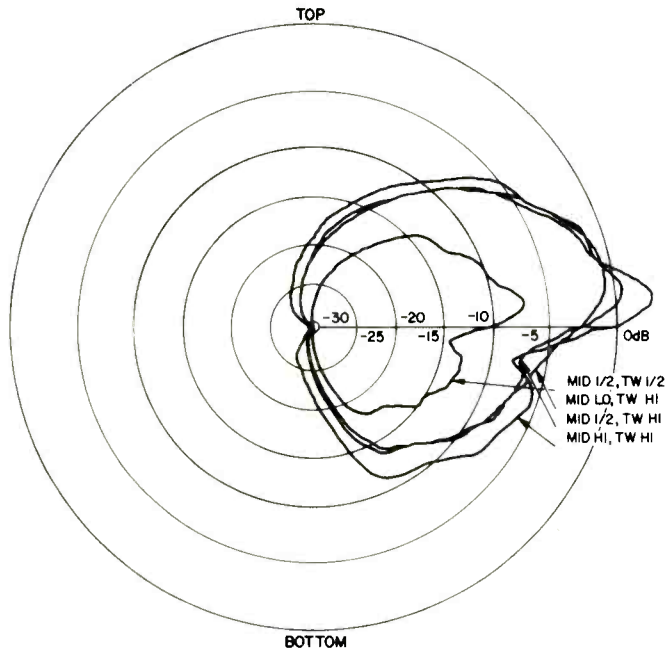

Fig. 7—Vertical polar energy response.

Fig. 8—Harmonic distortion for the tones E1 (41.2 Hz), A2 (110 Hz), and A4 (440 Hz).

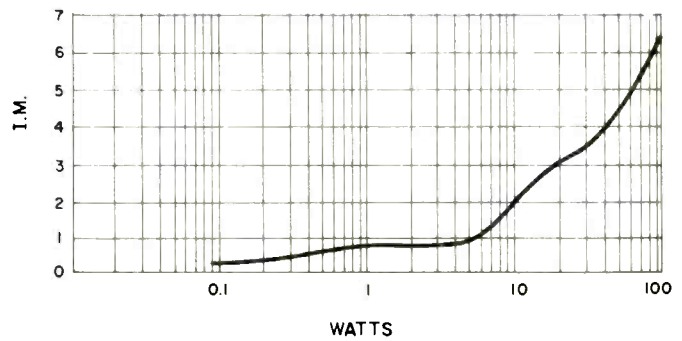
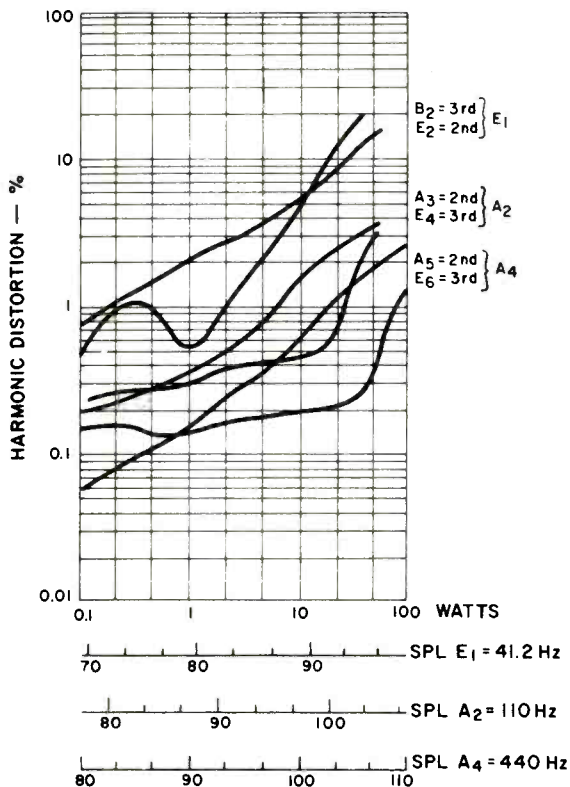
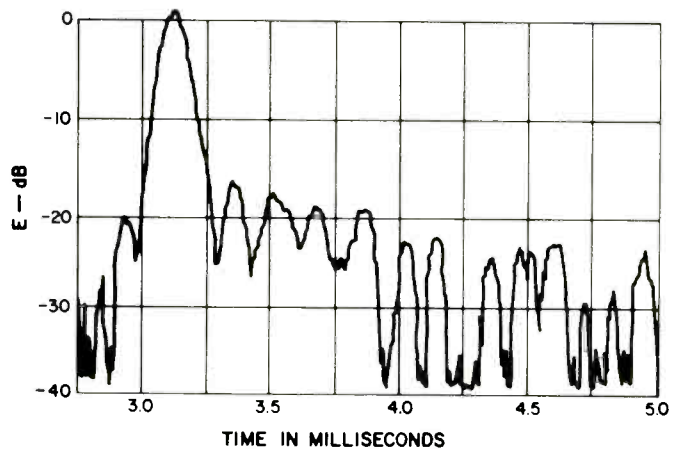

Fig. 9—Intermodulation distortion of A4 (440 Hz) by E1 (41 Hz) mixed one-to-one.

Fig. 10—Energy time response.



possibly due to the physically attractive, but acoustically difficult wood structure on the front of the enclosure. An otherwise good transient response appears to be marred by some time delay and acoustic scattering effects.

### Listening Test

The Jensen Model 530 was auditioned against a wall and clear of the floor by about 2/3 meter (2.2 ft). This, to my personal tastes, gave a more balanced sound than other positions I tried.

One problem I found on setting up this system was that both the tweeter and midrange potentiometers were intermittent. Fortunately a standard solution exists—you rapidly rotate the shafts back and forth to burnish off the contact corrosion. This worked with the Jensen, and I recommend it be done as the unit is set up, particularly in this area. Use off-station FM receiver noise, at low level, and listen to the speakers as the pots are turned.

My personal preference on balance was that the midrange potentiometer be set to the mark indicated as —5 and the tweeter set to its maximum position.

My overall impression of the sound of the Jensen was that there was no super low bass, there was coloration at the bottom end, and the top end needed some boost with preamp tone controls. I also found that I preferred having the speakers rotated towards my listening area.

With the human voice, I had the impression that some vocalists were farther back from the stereo stage center than they should be, and I was not particularly pleased with reproduction of the piano, which is, of course, a very difficult instrument to make sound lifelike.

On the positive side, I felt that electronic music sounded pretty good on the Jensen.

*Richard C. Heyser*

Enter No. 70 on Reader Service Card



# The column



**Sweet Forgiveness:** Bonnie Raitt  
Warner Bros. BS 2990, stereo, \$6.98.

**Sweet Forgiveness** is one of Bonnie Raitt's best albums despite some flaws. Bonnie is in terrific voice, and Paul Rothchild's down-to-basics production lets the band play without cluttering the tracks with frilly horns or any more backing vocals than needed.

The album allows a place for all the different Bonnie Raitts. Funky Bonnie shines on *About to Make Me Leave Home*, *Boy* and Eric Kaz's *Gamblin' Man*. Driving, thoughtful Bonnie's outlets are a Little Feat oldie *Takin' My Time* and Daniel Moore's *Sweet Forgiveness*. Good-time Bonnie rocks out on Don Covay's *Three Time Loser* and a lively new version of Del Shannon's *Runaway*. Soft Bonnie does Paul Siebel's *Louise*, new friend Kara Bonhoff's lovely *Home* and old friend Mark Jordan's *Two Lives*. The surprise killer track is a definitive version of Jackson Browne's *My Opening Farewell*, beautifully textured by Bonnie's finger-picked electric guitar and played loftily by her band.

As a whole **Sweet Forgiveness** is a fine, engaging album that took a lot of obvious effort. It comes closest to the spirit Bonnie exudes in concert since her second album **Give It Up**. A primarily spontaneous artist, one who does not sing a song the same way twice, she's often had a rough time in a studio getting the precision the situ-

ation demands without sacrificing her personal touch. This is still true on the new album, though less so than most of her earlier efforts. Additionally on **Sweet Forgiveness** Bonnie's voice is quite far back in the mix which leaves a vaguely icy feel in the sound.

Talking with Bonnie about the material, she said that to find the 10 songs on the album, she sifted through more than 400, and still wound up at the same sources she often has in the past, a Kaz, a Mark Jordan, an old Browne, an old Siebel, Little Feat, Bonhoff, and Dan Moore, all close-to-home sources. Clearly, finding songs from new sources has been a problem, but it is to Bonnie's taste that the album still sounds fresh and lively and free of annoying *déjà vu*.

Bonnie Raitt's is a genuine and very real talent. She breathes life into songs with the very best. The big public response is still to come and is long overdue at that. If it doesn't come this time, it may well the next. **Sweet Forgiveness** may have flaws but they only result from the rare combination of conscience, effort, and positive movement. You just can't ignore the lady forever.

Sound: B — Performance: A —

**Hard Travelin':** Ramblin' Jack Elliott  
Fantasy F-24720, stereo, \$8.98.

As a double-pocket reissue of Ramblin' Jack Elliott's first two Prestige albums, **Ramblin' Jack Elliott** and **Jack**



The B&W DM 6 linear phase dynamic loudspeaker is new, English, strange-looking (for a good reason), controllable, indestructible, powerful, "outstandingly good," "clean," "natural," "smooth," "silky," has an excellent pedigree, and requires at least six pages to explain fully. We'd like to send you copies of those pages. Write, please.

## B & W Loudspeakers

c/o Anglo-American Audio Co., Inc.  
P. O. Box 653  
Buffalo, N. Y. 14240 U.S.A.

Enter No. 7 on Reader Service Card



## "G" LINE

Offers Full-Range Components For  
**Professional  
Sound Reinforcement**

### Preamplifiers-Mixers



G5TA • G12T • G11T

Versatile, expandable, top-notch mixing components, perfect for large areas such as auditoriums and churches, as well as recording, broadcast, and other commercial sound applications. Ultra-low distortion, full-range performance.

### Power-Amplifiers

50, 100, 200 RMS WATTS



G52 • G102 • G200

Tops in continuous performance reliability for serious professional audio usage.

### POWER-AMPLIFIERS

35, 50, 100 RMS WATTS



GT-35 • GT-50 • GT-100

Choose from a flexible line of solid state integrated units that will control, mix, and amplify four low impedance microphones and two auxiliary inputs. Satisfies even the most critical demands.

### Background Music at Its Best



G-109B

Special high performance FM-AM monaural tuners can be used with any amplifier, since volume control is located on front panel.

To Order, Call Toll Free,  
800-323-0228

or, write for complete information today.

### Precision Electronics, Inc.

9101 King Street • Franklin Park, Illinois 60131

In Canada, Superior Electronics

In Caribbean, E. D. Magnus, Chicago, Ill.

Foreign, Morhan Exports, New York, N.Y.

**Elliott Sings the Songs of Woody Guthrie, *Hard Travelin'*** is no less than an essential reissue. The music is among the best Jack ever recorded. He is at the peak of his prodigious talents on these discs.

David Bromberg's enthusiastic notes along with the reprint of John Greenway's original notes for **Ramblin' Jack Elliott** give a vivid picture of one of the great characters in folk music, a veritable one-man treasure trove of Americana.

**Hard Travelin'** is way overdue, but it's finally out. M.T.

Sound: B+ Performance: A

**Fundamental Roll:** Walter Egan  
Columbia PC 34679, stereo, \$6.98.

Surely, the co-production credit of Fleetwood Mac's Lindsey Buckingham and Stevie Nicks has gotten Walter Egan a whole lot of attention he'd not have gotten otherwise. They've also conspicuously added vocals and Lindsey's guitar, so if Egan's album sounds like a top-heavy version of Fleetwood Mac, it's no surprise. One thing very obviously missing is that big bottom Mick Fleetwood and John McVie give their namesake.

Egan's a far more American Big Mac with some dandy songs and some filler. *Only the Lucky; Won't You Say You Will; Yes, I Guess I Am*, and the Buddy Holly-like anthem *When I Get My Wheels* are fine stuff. Not too coincidentally, they are four of the five songs graced by the instantly recognizable voice of Stevie Nicks.

What **Fundamental** has in abundance is the right forms. His songs are very catchy and commercial so that even if there's very little beneath, it still sounds good. What the album lacks, though, is stick-to-the-ribs substance.

It's shaped right, played right, and it'll probably sell. The cover photography of Moshe Brakha (also of Boz Scaggs' **Silk Degrees**) of those young cheerleaders backsides won't hurt sales either. **Fundamental Roll** is calculated. M.T.

Sound: B Performance: B

**The Beach Boys Love You:** Beach Boys  
Reprise MSX 2258, stereo, \$7.98.

As the first full album of Brian Wilson songs in many years, **The Beach Boys Love You** is good to see, the childlike genius was at least working again. Granted his appearances on TV on "Saturday Night Live" and "The Mike Douglas Show" were outright disasters, showing a once feathery voice gone to leather.

Give the album a chance, I says. I do but it confirms my worst expectations. Brian's new songs are turkeys, ill-conceived, not played too well, and even lacking the recording excellence that has always been a Beach Boys hallmark.

Despite the good intentions of dedicating the album to Brian, **The Beach Boys Love You** can only be interpreted as patronizing and disastrous, the kind of record to get out of a contract with. And that they have done.

M.T.

Sound: D Performance: F



**Chirpin':** The Persuasions  
Elektra 7E-1099, stereo, \$6.98.

With **Chirpin'** the Persuasions return to what they do best, a capella, leaving behind the unfortunate studio backing their last several albums employed.

**Chirpin'** is a joy. The sound is very bright and present. The four voices just ring out. However, the bottom line is the songs; if they're good choices the album will likely be a good one. **Chirpin'** has good songs, from the Rivertons' *Papa oo Mow Mow* and Billy Ward & the Dominoes' *60 Minute Man* to their own *Women and Drinkin'* and the brilliant a capella anthem *Looking for an Echo* the material is solid.

Down from five voices to four, the Persuasions have tightened up their singing more than ever. They carry on a tradition that's important in places like Philadelphia where I live, the great sound of street corner harmony in an expressway world. May they sing forever. M.T.

Sound: A Performance: A

**Full House:** Frankie Miller  
**Chrysalis CHR-1128**, stereo, \$6.98.

Somewhere around the time of the breakup of legendary British rockers Free, many were speculating as to whether Robert Palmer or one relatively unknown Frankie Miller would succeed Paul Rodgers as the premier soulful U.K. singer. As it turned out, Rodgers himself was not so anxious to give up his throne and continued as a major force, fronting Bad Company, while Palmer allowed his music to stray so far from rock music that he was no longer in the running. Mr. Miller, however, is not so anxious to deny his skin color, and though his music is r&b influenced to say the least, he retains the basic rock band on his latest album **Full House**. While the entire album is not a total success, there is at least one side's worth of *incredible* music here.

Most notable is Andy Fraser's song *Be Good To Yourself*, as Frankie's voice is the perfect instrument to sing the tunes written by Free's bassist, and Mr. Fraser is perhaps the best contemporary rock songwriter alive. Buoyed by Chris Spedding's guitar and the crystalline production of Chris Thomas, the song doesn't have a losing moment from start to finish. Also more than just listenable are *Love Letters* (but the final few notes are awful), John Lennon's *Jealous Guy* (fine keyboards), *The Doodle Song* (very Otis Redding but no less respectable because of it), and *Take Good Care of Yourself*. The band, which includes Chrissy Stewart (bass), Graham Deacon (drums), James Hall (keyboards), and Ray Minhinnet (guitar), is a bit laid back in their efforts to support Frankie, but plays crisp r&b-rock that feels good most of the time. Side two, which is made almost entirely of Frankie's own songs lags a bit, but for *Be Good To Yourself* alone the album is certainly worth your while, certainly a lot more satisfying than either of Robert Palmer's last two records. Hopefully, Frankie will soon find the audience which will be able to appreciate his music, and also find a suitable songwriting partner so that the original compositions will be as interesting as the covers. J.T.

Sound: A      Performance: B+

**Nite City**  
**20th Century T-528**, stereo, \$6.98.

Ray Manzarek has got to be the best writer of spooky, creepy, and spine-tingling rock music alive today; he consistently comes up with the most memorable melodies when it comes

# If your cartridge is more than three years old, don't replace your stylus!

Don't get us wrong. There is nothing worse than playing your records with a worn stylus. And no better way to restore your old unit to its original glory than a new diamond.

But frankly, there have been significant strides made recently in the phono cartridge field. And the new cartridges of today stand head and shoulders above even the finest of a few short years ago.

Here's the choice: Get fresh—but outdated—performance with a replacement stylus, or enjoy all the benefits of modern cartridge research and development for just a few dollars more. You'll find that you can update your system for far less than you might imagine. It's probably the most dramatic single improvement you can make.

For instance, Audio-Technica offers Universal™ cartridges equipped with a genuine Shibata stylus and our unique y effective Dual Magnet™ system beginning at just \$75.00 list. Or you can replace your present cartridge with a fresh new Audio-Technica cartridge with highly-polished elliptical tip for as little as \$45.00 list.



AT11E \$45.00      AT12Se \$75.00      AT19Ea \$65.00      AT-5Sa \$125.00

Are these new models worth the difference? Absolutely. You'll be amazed at what you hear from today's generation of phono cartridges. Improved frequency response. Lower distortion. Better separation. Less record wear. Truly better sound.

**A new Audio-Technica cartridge.  
Your best value in hi-fi.**



AUDIO-TECHNICA U.S., INC., Dept. 77A, 33 Shawassee Avenue, Fairlawn, Ohio 44313  
Available in Canada from Superior Electronics, Inc.

# Nakamichi New Standards 1000 II for the World Nakamichi 700 II

The course of cassette history was irreversibly changed four years ago with introduction of the Nakamichi 1000. It generated an unprecedented wave of reaction, from enthusiasm to outright disbelief. But today, the 1000 and the equally phenomenal 700 are standards of the industry, the logical choice of recording studios, independent testing laboratories, leading cassette tape manufacturers and discriminating audiophiles the world over.



to that sort of stuff that would be equally comfortable behind a Roger Corman film or somebody like, for example, Jim Morrison. The Doors have been emulated recently by performers such as John Cale and Iggy Pop, but none can equal The Door's legacy. Manzarek tried for years to satisfy the audience which The Doors had created before Jim Morrison's untimely exit, carrying the lead vocal chores himself though he wasn't quite adequately equipped to do it. Now he's part of this group which prominently features Ray's keyboards and musical compositions, but with the added plus of being a real band—there are five individuals contributing to what goes on in Nite City (at least), and the album is a highly impressive debut effort from this quintet.

Although, Noah James may have a few bridges to cross when it comes to onstage presentation—he has a hard time living in the shadow of Morrison—as a singer/poet he comes across on disc, especially on the title track and *Bittersky Blue*. The entire group, as a matter of fact, seems like a disciplined bunch of individuals who know well how to pool their talents into a cohesive meld, coming across

like gangbusters on *Caught in a Panic* and *Summer Eyes*. There is a trace of The Doors sound, but with all due respect to John Densmore and Robbie Krieger, their successors are far more able to play rock music—it's nice to have a bassist in the band as well.

All things considered, it would be no surprise to me if Nite City became one of the biggest groups to come out of America in the Seventies. Their intelligence never gets in the way of their visceral impulses, and they seem to know a great deal about how to present their songs in the most immediate way possible. They've got something to say and they know how to say it—I can only wish them all the best.

J.T.

Sound: A — Performance: A

### Kate and Anna McGarrigle

Warner BS 2862, stereo, \$6.98.

**Dancer With Bruised Knees:** Kate and Anna McGarrigle

Warner BS 3014, stereo, \$6.98.

Kate & Anna McGarrigle's debut album was one of 1976's quiet pieces of brilliance. Each sister writes songs at once contemporary and sounding centuries old. Take Anna's *Heart Like a Wheel*, the first song she ever wrote.

The McGarrigles' version is far more sorrowful, far less melodramatic, simpler and much more emotional, than the brilliant Linda Ronstadt version. A common thread through their work is that uncharacteristically direct and honest emotion, as if the songs were tapped directly from the heart. Anna's *My Town* and *Jigsaw Puzzle of Life* and Kate's *Talk to Me of Mendocino* and *Tell My Sister* are wrenching experiences, all of them songs that deserve the attention of others, and will likely find cover versions. If **Kate and Anna McGarrigle** has a flaw, it is that it is so shy and understated an album, easily understandable for a debut album.



No other manufacturer has equalled the original 1000 and 700. And yet, these remarkable decks have undergone a constant evolution. Nakamichi innovations are most often subtle, but important improvements not reflected in published specifications alone.

The latest refinements have produced the 1000II and 700II—cassette decks that in no uncertain terms restate the state of the art. The audible improvement is dramatic. Recordings have an openness and breadth which elude all but the very best open reel decks.

Immediately noticeable are level meters that indicate program peaks from -40dB to an unheard of +10dB! Other new features include front panel access to the record level calibration controls, and independent tape bias and equalization switches.



But the real news is *inside*. Nakamichi's famous dual capstan DC Servomotor transport now has fewer moving parts with enviably low wow and flutter (under 0.1% DIN, 0.05% Wrms). New electronics yield lower noise and distortion than ever before; the mic preamps have increased dynamic range. The addition of phase correction ensures total reproduction accuracy, while a newly refined Crystal Permalloy playback head boasts even longer life. And both decks are designed and factory-calibrated for optimum performance with today's most advanced cassette tape formulations, such as Nakamichi SX and EXII.

Cassette history marches on. Visit your Nakamichi dealer and ask him to demonstrate the *new* world standards. For more information, write Nakamichi Research (USA), Inc. 220 Westbury Ave, Carle Place, New York 11514.



**Nakamichi**

Enter No. 22 on Reader Service Card

**Dancer With Bruised Knees** corrects all that. It is both livelier and brighter. Anna's title track, with its unlikely spoken intro, is a touching account of a prospective ballet career that ended with a crash and "blue knees." Kate's *Southern Boys* is a striking, candid picture of a Northern girl's infatuation with Southern affection. The track includes some outstanding bowed bass work by Richard Davis. Her *Come a Long Way* is another wonderful traditional sounding song. *Walking Song* is a disarming person-to-person appeal. Anna's *Be My Baby* almost aches to be a hit. Her *Naufragee du Tendre*, written with occasional collaborator Phillippe Tatarcheff, is the unlikely combination of a song in French with a distinctive reggae beat.

The album's most soaring moments are during a pair of traditional French Canadian songs, the sorrowful tale of false love *Blanche Comme la Neige* and the rollicking *Perrine Etait Servante* are segued ingeniously, and the sisters' two-part harmonies are magical.

**Dancer** has an impressive support cast, including Davis, Dave Mattacks, Pat Donaldson and John Cale among others. Joe Boyd's production is high-

ly empathetic to the McGarrigles' songs.

Kate and Anna McGarrigle occupy a very special musical space. Their songs are devoid of funk and tricks, opting for the straightforward and true. Their two albums have yet to stray very far from my turntable. Their calm is a welcome treat. *M.T.*

Sound: B Performance: A

**LIVE!** Rough Trade **Umbrella UMB DD1**, stereo, \$12.95 (see text).

Rough Trade's album is one of the best *sounding* albums I can remember hearing. In fact, the sound is the star of the album. It was recorded direct-to-disc which means the way they played it in the studio is the way the record sounds. The process allows no overdubs or remixing. It has to be right or the whole side has to be re-cut. These results sound particularly spectacular in the bass end, and the process accounts for the record's remarkable presence and clarity. There are no in-between generations in which to lose sound.

The band itself is only a little better than average. Carole Pope's songs are good but not spectacular and the

band is game, so they make the most possible out of them. But as I said the raw sound is what matters most.

The record sleeve contains information about the direct-to-disc recording process used for this album. Copies of the disc may be obtained through Audio-technica dealers in the U.S. *M.T.*

Sound: A+ Performance: B

**Rumours:** Fleetwood Mac **Warner Brothers BSK 3010**, stereo, \$7.98.

The extraordinary breakout success of **Fleetwood Mac** in 1976 has made **Rumours** one of early 1977's most eagerly awaited items. That kind of expectation can lead to an anticlimactic let-down feeling once the disc is in your hands, but **Rumours** avoids that trap. Constructed very much like its predecessor, it delivers song after song of catchy, quality material. As with **Fleetwood Mac**, the blues band origins of the group several incarnations back has become completely obscured as they have evolved into a front-line pop band.

Stevie Nicks and Lindsay Buckingham, who joined up only last album, dominate **Rumours** just as they

# Reintroducing A World Standard...

## CBS Laboratories' STR Professional Test Records



For over ten years, the original series of these high-precision test records set a standard for the audio industry. Now the new series sets an even higher standard. It's been revised, recut and expanded.

The new series consists of eight records for professionals and one for non-professional audiophiles.

Each record contains a complete series of easy-to-use tests to help you rapidly and accurately evaluate components and systems. Even one of these records can eliminate the need for costly, additional equipment. Each will find productive use and save you hours in the laboratory, on the production line and in field testing.

Take a look at what this essential testing series contains:

**SEVEN STEPS TO BETTER LISTENING**—For only \$6.98, you can improve your system with CBS Laboratories' "Seven Steps to Better Listening." This high-precision test record enables you to make sure that your equipment functions properly . . . to tune your system to your ears and your room acoustics. Included is a detailed 16-page booklet by Audio's Edward Tatnall Canby explaining how to use the record to improve the performance of your system. With the record you can perform the following "ears alone" tests: left-right identification, phasing, loudspeaker balance, tone control setting, alternate phasing, buzz and rattle elimination, lateral tracking, and vertical tracking.

★ **STEREOPHONIC FREQUENCY TEST RECORD STR 100** Designed for the evaluation of pickups and systems. Provides a constant amplitude characteristic below 500 Hz and a constant velocity characteristic above 500 Hz. Tests include: Sweep Frequency—with the sweep rate synchronized for use with a graphic level recorder; Spot Frequency—with voice announcements; Channel Separation; Wavelength Loss and Stylus Wear—to pinpoint oversize or worn-out stylus, and excessive pickup tracking force; Compliance; Phasing; Vertical and Lateral Tracking; Tone Arm Resonance—to check system performance at low and subaudible frequencies and thus reveal undamped resonance which may cause equipment overloading.

★ **318 MICROSECOND FREQUENCY RESPONSE TEST RECORD STR 170** Provides pickup designers and recording studios with a high-level, easily-equalized signal for frequency response and channel separation measurements. The STR 170 employs a 318 microsecond characteristic corresponding to the "test" or "flat" mode common to most disc recording equipment. Constant amplitude recording is employed in the region below 500 Hz with constant velocity recording in the region above. The transition is smooth, in contrast with the STR 100 which employs a sharp breakpoint at 500 Hz. The record is suitable for use with a graphic level recorder to provide permanent, visible records for precise evaluation.

★ **SQUARE WAVE, TRACKING AND INTERMODULATION TEST RECORD STR 112** Enables detailed study of tracking capabilities of stereophonic phonograph pickups. The square wave modulation allows a rapid appraisal of stylus-tip mass, damping, and tracking. Low frequency compliance and tracking are determined by means of 300-Hz bands of progressively increasing amplitude. Intermodulation distortion measurements are made possible by graduated 200-Hz intermodulation test bands. The Str 112 has been cut with vertical angle approximating 15°, which is representative of current recording practice.

★ **WIDE RANGE PICKUP RESPONSE TEST RECORD STR 120** Makes possible the measurement of pickup response at frequencies far beyond the audible range, where elusive distortion elements can cause audible distortion. The low-frequency range includes glide-tones at twice normal level for the detection and elimination of arm resonance, loudspeaker cone and cabinet rattles. Other tests include: silent grooves for measuring rumble and surface noise characteristics; and standard level bands at 0 dB for overall system S/N measurements. This record is suitable for use with a graphic level recorder to provide permanent, visible records for precise evaluation.

★ **BROADCAST TEST RECORD STR 151** Developed especially to meet the needs of broadcast engineers, audiophiles, and other professionals seeking a convenient signal source for the testing and adjustment of all audio equipment. Tests include: phonograph pickup response and separation, speed accuracy at 33 1/3 and 45 rpm, wow and flutter, rumble and hum detection, ballistic test of V.U. meters and many others."

★ **QUADRAPHONIC TEST RECORD SQT 1100** Designed for calibration, verification, and adjustment of SQ™ decoding equipment. The record provides test bands for pickup measurements, for adjustment of decoder electronics and for channel identification and balance. Each band is described in terms of recorded characteristics and its intended use.

★ **RIAA FREQUENCY RESPONSE TEST RECORD STR 130** Provides RIAA frequency characteristics for the calibration of professional recording equipment and for testing the response of professional and consumer record reproduction equipment. This record is suitable for use with a graphic level recorder to provide permanent, visible records for precise evaluation. Spot frequency bands for use without automatic equipment are included.

★ **RIAA PINK NOISE ACOUSTICAL TEST RECORD STR 140** Designed for acoustical testing of systems and loudspeakers and for psychoacoustic tests on reproduction equipment. With the STR 140 it becomes possible to test loudspeakers in the room in which they will be used. Spot frequency tones with voice announcements facilitate the testing procedure. Continuous glide-tones in 1/3-octave bands cover the frequency range from 30 to 15,000 Hz and are synchronized with a graphic level recorder.

The original series has been unavailable for many years. Quantities of the new and improved series are also limited. So make sure you have perfect copies on hand for years to come by ordering duplicates. Fill out and mail the coupon now for immediate action.

SQ is a Trademark of CBS Inc.

Only a limited quantity are available. Be sure to order enough for many years of use.

SEND TO:  
AUDIO TEST RECORDS  
401 N. Broad Street  
Philadelphia, Pa. 19108

AU/7/77

Send me the following test records:

- Seven Steps to Better Listening (STR 101) \$6.98 each. Quantity \_\_\_\_\_
- Stereophonic Frequency (STR 100) \$10.00 each. Quantity \_\_\_\_\_
- Square Wave, Tracking and Intermodulation (STR 112) \$15.00 each. Quantity \_\_\_\_\_
- Wide Range Pickup Response (STR 120) \$15.00 each. Quantity \_\_\_\_\_
- RIAA Frequency Response (STR 130) \$15.00 each. Quantity \_\_\_\_\_
- RIAA Pink Noise Acoustical (STR 140) \$15.00 each. Quantity \_\_\_\_\_
- Broadcast test (STR 151) \$15.00 each. Quantity \_\_\_\_\_
- 318 Microsecond Frequency Response (STR 170) \$15.00 each. Quantity \_\_\_\_\_
- Quadraphonic Test (SQT 1100) \$15.00 each. Quantity \_\_\_\_\_

Amount Enclosed \$ \_\_\_\_\_  
(Payment must accompany order)

Name \_\_\_\_\_

Address \_\_\_\_\_

City \_\_\_\_\_

State \_\_\_\_\_ Zip \_\_\_\_\_

did the last one. Lindsay's *Go Your Own Way* is an unforgettable cooker, eminently hummable, and *Second Hand News* is another. While neither *Dreams* nor *Gold Dust Woman* has quite the impact of Stevie's chilling *Rhiannon*, they do convey that compelling aura of mystery. Christine McVie continues to mine the vein she has successfully tapped earlier as in *Heroes are Hard to Find* and *Say You Love Me* with *Don't Stop* and *You Make Loving Fun*, both appealing, pleading little songs.

The breakthrough of Fleetwood Mac with a bag of smooth, absolutely non-mediciney songs is very probably a serious indication of where the rock/pop of the late 70s and into the 80s will go, to songs of a pleasing and non-incendiary manner. Fleetwood Mac makes it so easy to swallow that you never stop to realize that it's really syrup after all. And they do it with nothing but quality and staggering consistence. M. I.

Sound: B+                      Performance: A-

**I'm Everyone I've Ever Loved:** Martin Mull

ABC AB-997, stereo, \$6.98.

Garth Gimble is dead. He was the character Martin Mull played in the "Mary Hartman Mary Hartman" TV series, and he doesn't have a damned thing to do with Mull's new album which first appeared two weeks after Garth's demise.

**I'm Everyone** is the best studio album Mull has recorded. It's laced liberally with a biting humor, devastating yet understated. The bridges between the songs are loaded with guest stars; the breaks are clever and sharply cut. The songs between the bridges are acerbic and funny. They are well braced with the cynical, skeptical slant that Mull always uses, something he shares with producer Michael Cuscuna who has been *that way* since he and I were in college together.

Part of the album's concept is Mull's stated refusal to let himself be "bagged"—take my style, please. So his songs range from a token folkie of the mock sea shanty *Men* to a disco piece—"that's where the big money is"—*Get Up Get Down to Boogie Man's Philly Soul* to the cocktailed spirits of *Bombed Anyway* and *Buy Me a Drink*, and the erotic bossa nova of *The Humming Song*. The man somehow covers his bases, probably to his own surprise.

Mull's humor is, most of all, based on a very carefully constructed and warped yet thoroughly personal set of



## Revolutionary! Sound-shaping taping mike.

Never before — a single microphone that gives you the versatility of 16 microphones! Four tiny frequency filter switches built into the new Shure 516EQ E-Qualidyne Microphone let you tailor sound for studio effects in virtually any recording situation: flick a switch to add sizzle to vocals . . . flick another switch to highlight the sound of a bass drum. You can even compensate for the acoustic response of a room — *right from the microphone!* In all, the 516EQ creates 16 different response variations that can add a new, professional sound to every tape you make. Available singly or in pairs for stereo recording. Ask to hear a recorded demonstration at your participating Shure dealer.

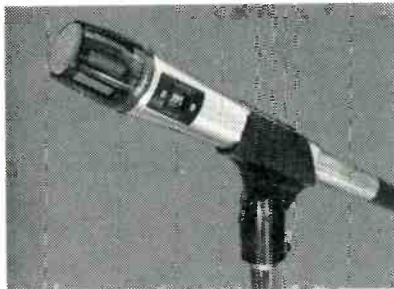

Shure Brothers Inc.  
222 Hartrey Ave., Evanston, IL 60204  
In Canada: A. C. Simmonds & Sons Limited



Manufacturers of high fidelity components, microphones, sound systems and related circuitry.

Enter No. 34 on Reader Service Card

**FREE**

# McIntosh CATALOG and FM DIRECTORY

Get all the newest and latest information on the new McIntosh Solid State equipment in the McIntosh catalog. In addition you will receive an FM station directory that covers all of North America.



## MX 113

FM/FM STEREO - AM TUNER AND PREAMPLIFIER

**SEND  
TODAY!**

McIntosh Laboratory, Inc.  
East Side Station P.O. Box 96  
Binghamton, N.Y. 13904  
Dept. 1

NAME \_\_\_\_\_  
ADDRESS \_\_\_\_\_  
CITY \_\_\_\_\_ STATE \_\_\_\_\_ ZIP \_\_\_\_\_

If you are in a hurry for your catalog please send the coupon to McIntosh.  
For non rush service send the *Reader Service Card* to the magazine.

Enter No. 18 on Reader Service Card

perceptions. **I'm Everyone I've Ever Loved** is simply more cleverly conceived and more fully realized than anything Martin has yet done. Besides it made me laugh. Often. *M.T.*

Sound: B+ Performance: A-

**Something Magic:** Procol Harum Warner/Chrysalis CHR 1130, stereo, \$6.98.

After nine albums and gradually diminishing returns it looked like Procol Harum had literally faded into some middle-aged shade of pale.

As a long-term devotee I can't escape the let-down feeling that **Something Magic** just doesn't cut the mustard. A fairy tale called *The Worm and the Tree* completely takes up side two. It is plenty majestic in the musical segments, but Gary Brooker's recital of Keith Reid's words only recall to me his comment in *In Held Twas In I* on the classic **Shine on Brightly**, "Tho the words I use are pretentious and make me cringe with embarrassment..." I may not have then, but I cringe this time.

The five songs on the first side are a downbeat collection, standard Procol but mostly lacking that magical transcendence they are capable of. The truly outstanding song is the one Brooker didn't compose music for, *Year of the Claw* with music by guitarist Mick Grabham. *Claw* sports a thoroughly menacing rape story in which the prisoner goes free to a screaming synthesizer solo.

They sound more confident than the withdrawn and uncertain unit of **Procol's Ninth**. With **Something Magic** Procol Harum serves notice that they don't intend to simply vanish. Flawed as it is *Something Magic* is not hey day Procol, but at least they are moving in the right direction. *M.T.*

Sound: B- Performance: C+

**Wind and Wuthering:** Genesis Atco SD 36-144, stereo, \$6.98.

**Peter Gabriel** Atco SD-36-147, stereo, \$6.98.

**The Geese & The Ghost:** Anthony Phillips

Passport PP-98020, stereo, \$6.98.

The music of Genesis has always been highly plotted stuff. They've always told stories in song, often with more than a nod to the bizarre. Front man Peter Gabriel's departure didn't cripple the band as many expected. Instead the survivors regrouped around drummer Phil Collins' very Gabrielesque vocals, debuting their

AUDIO • July 1977

**PAIA**  
WE'RE FAMOUS FOR OUR  
SYNTHESIZERS

but did you know we also have ....

"OZ" MINI-ORGAN, PHLANGER, ARTICULATORS (FOR "TALKING" GUITAR), COMPUTER MUSIC INTERFACES, PROGRAMMABLE RHYTHM UNITS, ENCEPHALO GRATIFICATION GENERATOR (EGG), COMPUTER BASED MUSIC SYNTHESIS SYSTEMS, PLUS.....

"POLYPHONY" THE MAGAZINE FOR THE ELECTRONIC MUSIC ENTHUSIAST...  
... AND MORE IN OUR FREE CATALOG

PAIA ELECTRONICS DEPT. 7-A  
BOX 14369, OKLAHOMA CITY, OK 73114

Enter No. 24 on Reader Service Card

**DIXIE HI-FI SAVE ON**  
Brand Name Audio Components  
BY MAIL

Write Today for Our  
FREE Audio Catalog

DIXIE is one of the oldest and largest stereo mail order houses in the country. Our lower prices on brand name components can save you real money. Call us today for a price quote, toll free (800)446-7925, in Virginia call (804) 257-4241. Everything shipped in factory sealed cartons with manufacturer's warranty.

Major Charge Cards Honored on Mail Orders	
PIONEER	SHURE
VENTURI	TECHNICS
TEAC	DUAL

**DIXIE HI-FI** AM-7  
P.O. Box 6496  
Richmond, Va. 23230

Please rush me your FREE Audio Catalog and complete information. I understand there is no obligation.

Name \_\_\_\_\_  
Address \_\_\_\_\_  
City \_\_\_\_\_ State \_\_\_\_\_ Zip \_\_\_\_\_  
Phone (\_\_\_\_) \_\_\_\_\_  
A.C.

Enter No. 10 on Reader Service Card



new look with last year's **Trick of the Tail**, arguably Genesis' finest moment. The album sold very well, and the supporting tour was both an artistic and financial success. Somehow they manage to take their four or five not terribly visual members and, with well-planned lighting, keep the show from being a visual bore, even if it's without a focal point.

The second post-Gabriel album is a good one, but not a great one. Their production and presentation are much like **Trick**, but a shade less bright, and, of course, the first side's 28-minute length was bound to affect the recorded sound. Good work has gone into the new collection of story/songs. *Eleventh Earl of May*, the psychodrama of the young heir, has a melody more than a bit like the early segment of *The Battle of Epping Forest* from the **Selling England by the Pound** album. Michael Rutherford's ballad *Your Own Special Way* is simply gorgeous. *All in a Mouse's Night* is a delightful tale of extermination told from several views, from the alarmed human couple in bed, their hungry cat, and naturally, the unfortunate mouse's place on the floor. *Mouse* is Genesis at its most charming.

Ultimately, what **Wind and Wuthering** is about is Genesis' continued

dedication to the group format. They don't overlay strings and horns. They lean on their considerable battery of sounds available from guitars, keyboards and synthesizers. Their aims are at once ambitious and modestly self-contained.

Peter Gabriel's self-titled debut solo effort is a declaration of independence from exactly that group reliance. Clearly Peter felt a rest was needed after his long association with the band, particularly in the light of the mixed success of the show and album of **The Lamb Lies Down on Broadway**, his double-pocket Genesis swan song. His reappearance was produced by Bob Ezrin, long associated with the razzle dazzle show biz of Alice Cooper. Ezrin's work on Alice's **Welcome to My Nightmare**, Cooper's own escape from group limitations, was certainly an influence on **Peter Gabriel**. Ezrin lavishes individual attention to each song's arrangement, and Gabriel's album has even more extreme dynamics than does Genesis'. Gabriel ranges from the metallic *Modern Love* through the music hall antics of *Excuse Me* to the extra-soft *Humdrum*, which last gives an excellent example of the intricate nature of these arrangements. After a dreamy verse, backed mostly by soft Fender

# Top Discount AUDIO

**Your NATIONAL HEADQUARTERS**

**For Famous Brand Electronics By Mail**

1150 N. Powis Rd., West Chicago, Ill. 60185 • (312) 293-1825

All Orders Shipped In Factory-Sealed Cartons

Write Or Call For The Lowest Prices Anywhere!

**MILLION \$\$\$ INVENTORY**

**LOWEST PRICES ON**

RECEIVERS	TURNTABLES	TUNERS
SPEAKERS	CHANGERS	CARTRIDGES
TAPE DECKS	AMPLIFIERS	HEADPHONES
CALCULATORS	COMPACTS	CAR AUDIO

Top Discount Audio 1150 N. Powis Rd. West Chicago, Ill. 60185 AU-7 (312) 293-1825

We honor Master Charge and Bank Americard. Date \_\_\_\_\_

Please send me a quote on: \_\_\_\_\_

MR.  MS. (First) (Initial) (Last)

(Number And Street)

(City) (State) (Zip Code)

**Enter No. 27 on Reader Service Card**



Not a win on the pools, a trip to a Pacific paradise, or a reduction in income tax, but distortionless "current dumping"

Z's 1 to 4 are the four passive components which interconnect the current dumpers, (the output transistors which supply the power), to the small high quality amplifier which provides the error signal, so that when the above condition is met the current in the load, the loudspeaker, is independent of the current in the dumpers and hence distortion is solely dependent on the quality of the error amplifier, which because it is small can be very good.

Wonderful indeed.

For further details on current dumping and other Quad products write to Dept. A

The Acoustical Manufacturing Co. Ltd., Huntingdon, Cambs., PE18 7DB England

\* Elektor Electronics Magazine No. 8, Dec. 1975

## QUAD

**for the closest approach to the original sound**

QUAD is a Registered Trade Mark

**Enter No. 1 on Reader Service Card**

# BREAK THE SOUND BARRIER...

... in your car or van. Until now, even with the best 12V stereo or cassette player, you had to accept distortion, flutter, intermodulation, low power and poor fidelity. The ADS 2002 music system opens up a whole new era: for the first time ever, you now can enjoy in your automobile or van the same high fidelity music reproduction that you have come to expect from the finest home component stereos.

Analog and Digital Systems and Nakamichi search, both famous for their superb home and professional audio equipment, have jointly developed this precision stereo system which converts your car or cabin into a small concert hall. You can even remove the entire set in seconds and take it to your summer cottage, office, or wherever you like; the optional AC power supply gives you worldwide 110V/220V flexibility!



The ADS 2002 system is so small, it easily fits into your briefcase or its own handsome travel-pack (optional).

ADS 2002 CARRYING CASE

It consists of two precision 2-way loudspeakers with six built-in ultra modern solid state power amplifiers and a tiny studio quality cassette player equipped with Dolby® circuits.

Mail us the coupon below for a data sheet and a list of our knowledgeable, franchised dealers where you can listen to this milestone in miniature audio technology.

You will hear a dream come true.

## ADS 2002

ADS manufactures a complete line of loudspeaker systems, active and passive, for home, mobile and studio applications, priced between \$100 and \$700 (approximately). For catalogs and a dealer list send this coupon to

**ADS, ANALOG & DIGITAL SYSTEMS**  
64 INDUSTRIAL WAY  
WILMINGTON, MASSACHUSETTS 01887.

NAME _____	
STREET _____	
CITY & STATE _____	ZIP _____
2002C/77V	

Enter No. 3 on Reader Service Card

Rhodes piano, the song dances through four bars of bossa nova followed by an eight-bar jazz flute break before turning into a tarantella for the next verse. *Down the Dolce Vita* goes to the other extreme, effectively using the London Symphony Orchestra.

The band assembled by Gabriel and Ezrin is all-star quality. It includes guitarist Steve Hunter and keyboardist Josef Chirkowski from the **Nightmare** album's band, former King Crimson leader Robert Fripp and Larry Fast (aka Synergy) on synthesizers with the solid New York studio rhythm base of Allan Schwartzberg and Tony Levin. The production and sound are sterling. The only major fault with the album is the omission of a lyric sheet which would have made Gabriel's often murky intentions clearer. In all probability, much of Gabriel's clever wordplay is lost in this dense, complicated mix without printed lyrics.

Anthony Phillips was Genesis' charter guitarist. He left after 1970's **Trespass** album, just as the group began to take off in England. **The Geese & The Ghost** is his first recorded work since then, and not surprisingly it occupies a place in the musical landscape near that of his former compatriots. The first tipoff to this fact is the presence of Phil Collins for a pair of vocals, and Michael Rutherford on guitars and sundries as well as being cocreator of more than half the album, in addition to coproducing it. **The Geese & The Ghost** is mostly instrumental. The title suite and *Henry, Portraits from Tudor Times* are a pair of lengthy, sweeping, episodic works which dominate their respective sides, each without vocals, a musical mural with grandeur and abundant detail. Listening, I couldn't help drifting back in memory to the first time I heard Mike Oldfield's **Tubular Bells**. Phillips' shares Oldfield's sense of the rustic.

Perhaps the most apt comment about the album came from Phillips himself in an interview when he observed, "Even if Genesis and I are miles apart, there is that same thread in our music." This thought applies equally to all three albums. M.T.

### Genesis

Sound: B+ Performance: A-

### Gabriel

Sound: B- Performance: A

### Phillips

Sound: B+ Performance: B+

**Shouts Across the Street:** Alan Price  
Polydor 2383 410 (import), stereo,  
\$6.98.

Only occasionally meeting with commercial success in the United States, Alan Price's latest record is available only as an import, which means you'll pay a dollar more for it (at most) but get a better quality pressing and a flimsier cover. Spend the buck, record buyers, because Alan Price is one of the true original songwriters, and although I can't say that I like the entire album, he covers such a wide variety of styles that he's bound not to strike a resounding chord with everyone 100 per cent of the time. But when he connects, it's with a punch 10 times as effective as his peers.

A little background on Price: he was the original leader of The Animals, went off to make records with a strong r&b background, rose to fame by doing the soundtrack to the movie "O Lucky Man," and then quickly sank back into obscurity with rumors of an Animals reformation featuring Price and Burdon. This is the first studio album from Price in some time, and to tell you the truth, I didn't expect miracles. The cover credits Price with writing all the songs, playing all keyboards, all the lead vocals, and the production—quite a responsibility for an artist in this genre, because production is so important in a singer/songwriter album, and even people like Randy Newman, Harry Nilsson, Leo Sayer, and such don't do it themselves.

Side two is better than side one, with *The World's Going Down On Me*, a splendid tune performed exquisitely and a likely candidate for a single. Also appealing are rockers like *Cherie*, *I Just Got Love*, *Hungry For Love*, and a song which Roger Chapman could cover with ease, *The Wasteland*. There are some lighter, semi-acoustic tunes here which are pleasing to the ear, like *Leave It All To Me*, but the five I already mentioned to me seem the most immediate and stupefying. I highly recommend **Shouts Across the Street** to anyone who appreciates singer/songwriters, contemporary rhythm & blues, bar room brawls, or a night on the town without a whole lot of money to spend. Me, I'll take all of the above, especially the track *The World's Going Down On Me*, because it's one of the best records out all year. J.T.

Sound: A Performance: A

# Jazz & blues



**Heavy Weather:** Weather Report  
**Musicians:** Joe Zawinul, piano, Rhodes Piano, Arp 2600, Oberheim Polyphonic, etc.; Wayne Shorter, soprano and tenor saxes; Jaco Pastorius, bass, mandocello; Acuna, drums; Badrena, percussion, vocals.

**Songs:** *Birdland*, *A Remark You Made*, *Teen Town*, *Harlequin*, *Rumba Mama*, *Palladium*, *The Juggler*, *Havana*.

**Columbia PC 34418**, stereo, \$6.98.

Musically, *Weather Report* is and represents everything at once and yet nothing in particular. This is a compliment, however paradoxical, to a group of eclectic musicians who continue to dare comparison and defy categorization.

*Birdland*, for example, is a Zawinul composition that highlights this very asset. Energetic rhythms derived from rock, disco, Latin and who knows what else dominate the percussion. The recurrent theme is stated by soprano sax and polyphonic synthesizer. The broad and unique sound produced is no less than that of a full brass section, plus strings, in counterpoint with the solo sax. What makes this exciting is the sparing use of the effect, and the tasty big band-type entrances Zawinul sets up. Remember, this is all done with just a couple of keyboards. Incidentally, the vocals permeating the cut possess the soft Latin air captured so successfully by Shorter on his *Native Dancer* LP.

Tension without release is some-

thing that occurs too often within the repertoire and live performances of too many groups. Not here! Shorter, on tenor sax, leads the ensemble in a convincing performance of Zawinul's tender and serene composition *A Remark You Made*. Shorter's instrumental inflections and the mood of the melody itself are reminiscent of Keith Jarrett's timeless composition *In Your Quiet Place*. It's reassuring to know that *Weather Report*, which has a blizzard of electronics at their disposal, has regard for good taste, as evidenced by the inclusion of *Remark*, as an element to preserve from being snowed under.

Zawinul's talents on acoustic piano are given breathing space on Shorter's *Harlequin*. Here Zawinul's linear excursions, behind Shorter's introverted soprano work, clearly represent his most articulate playing on *Heavy Weather*. The end of *Harlequin* features the rhythm section building in rhythmic and electronic intensity, as Shorter's soul searching soprano voice serves as the ideal foil to this burst of energy.

Rivaling *Birdland* as the most memorable composition on this LP is Shorter's *Palladium*. Pastorius' throbbing melodic bass lines and the vivacious Latin rhythms which abound launch this indelible theme (as stated by Shorter on soprano in unison with Zawinul on Arp several octaves above) and Shorter's solo on a foot-stomping journey. My only qualm

## Because good tracking isn't enough.

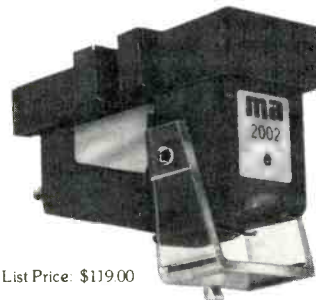

List Price: \$119.00

### The Micro-Acoustics 2002-e Cartridge.\*

No matter how much you hear about tracking ability, it can't tell you everything about cartridge performance. Because tracking ability only tells how well a stylus stays in the groove on loud passages, at low pressures. Transient ability is just as important. Without it, no cartridge can reproduce music with really lifelike clarity—because music is mostly transients.

The problem was, no cartridge offered both. So you had to choose between low record wear (tracking ability) and accurate reproduction (transient ability). Until now.

For the first time, superb transient and tracking ability are available in the same cartridge—the Micro-Acoustics 2002-e.

Designed by the world's leading manufacturer of record-mastering styli, with direct-coupled electrets and low-mass beryllium stylus bar that offer the most transparent sound your critical ears have ever heard. Tracking at only one gram.

But don't take our word for it. We've prepared a unique demonstration record to help you evaluate and compare cartridge transient and tracking ability. Just send \$3.95, and we'll mail you one postpaid. For free information, and the name of your nearest dealer, just write.

Micro-Acoustics Corporation,  
8 Westchester Plaza, Elmsford, NY 10523.  
In Canada, H. Roy Gray Ltd., Markham, Ont.

**ma**<sup>®</sup>  
Micro-Acoustics  
"The high-end phono cartridge line."

\* U.S. Pat. #3952171. ©1977 Micro-Acoustics Corp.



# Enjoy Music More

If the recorded music you purchase and listen to is important in the way you enjoy life . . . you ought to know about a goldmine of helpful information for every record collector.

## Schwann Record & Tape Guide

is a compilation of information about records and tapes of many classifications. This wonderfully useful catalog uncovers titles you didn't know were available, helps you select versions by conductors and artists whose work you prefer . . . shows you money-saving reprints on budget labels . . . and much, much more.

More than 65,000 records and 8-track and cassette tapes are listed in the monthly *Schwann-1* and its semi-annual companion, *Schwann-2*. All are available through your record dealer if you ask for them by Schwann title and number. Schwann opens up rich rewards in your record collecting hobby. See your record dealer for latest copies.

**Schwann-1** Monthly. Lists the month's new releases in every category. Also nearly 45,000 available recordings on 702 record labels, 231 tape labels, 82 quadraphonic labels, in classical, recent popular, rock, jazz, musical shows, country, opera, ballet, electronic, etc. \$1.00 at your dealer's.

**Schwann-2** The semi-annual companion catalog for specialized categories: pop more than two years old, classic jazz, classical classics of the pre-stereo era, also the great re-issue catalogs; international pop & folk on domestic labels, spoken, educational, religious, etc. 95c at your dealer's.

### SPECIAL PRICE SAMPLE OFFER

If your favorite store doesn't carry Schwann, order samples by mail, but please try your dealer first. Prices include postage and handling.

- Latest Schwann-1 (monthly).....\$1.60
- Latest Schwann-2 (sem-annual).....\$1.40
- Combination Offer: latest Schwann-1 (monthly) and latest Schwann-2 (semi-annual).....\$2.75
- Basic Record Library booklet.  
Lists 1,000 suggestions in classical music by musical periods for your enjoyment. Send 50c for cost of handling and postage.

I enclose \$.....for the items checked above.

Name \_\_\_\_\_

Address \_\_\_\_\_

City \_\_\_\_\_ State \_\_\_\_\_ Zip \_\_\_\_\_

Dealer's Name & Address \_\_\_\_\_

## Schwann Record & Tape Guide

137 Newbury Street, Boston, Mass. 02116

AU

about this cut, as with the rest of **Heavy Weather**, is that there isn't enough of Shorter soloing.

Pastorius is a powerfully melodic bassist, whose solo concept within the ensemble is the ideal one for a group whose success is concerned with the dimension of space. While not a time-keeper, his directing melodies imply the time, allowing Zawinul to mix big, spacey, keyboard chord potions and concoctions as the drummer fills the time with multi-directional sounds, rhythms, and percussive offshoots. All of this is the case on Pastorius' *Havona*. Pastorius almost serves as another horn soloist while maintaining his role of steering the group into one storm and out another. Also, noteworthy here is Zawinul on acoustic piano again.

All in all, one listen to **Heavy Weather** is not enough. There is so much being vaulted at the listener, that only successive hearings will reveal the brilliant intricacies hidden deep within the group's core. Underlying basslines jump out and say, "here I am." The roots and origins and diverse experiences of each member rumble on the horizon. Perhaps, because there is so much in the music of WR that lies just below the surface, adding body to the whole, many "one-listen" listeners are not aware that this is much more than a group dabbling in electronics!

Eric Henry

Sound: A— Performance: A—

**The Toughest Tenor:** Johnny Griffin and Eddie "Lockjaw" Davis  
**Milestone M 47035**, mono, \$7.98.

This is toe-tapping modern jazz full of zest and swagger. From the opening number, Count Basie's *Tickletoe* on side one, through swingers like *Funky Flute* and *Good Bait*, this two record set really moves. The two boss tenor men play music that gets you on your feet; you might want to even dance around the room a bit.

Honors are equally divided between Davis and Griffin who frolic through these 1960 and 1961 sessions like a couple of frisky sea otters. The selections are a potpourri of tracks from five out-of-print LPs on the old Jazzland label.

"Jaws" Davis' robust, driving sax style has never been heard to better advantage, and Griffin, playing with lightning speed and with a lighter tone, matches him chorus for chorus. Griffin's treatment of Monk selections

in the collection like *Epistrophy* are of special interest; he attacks them in a straightforward, bluesy manner; never being intimidated by the Monk "mysterioso."

Backup personnel include pianists Horace Paran and the lively, strutting Junior Mance who almost steals the show on *Tickle Toe*, *Save Your Love For Me*, *Funky Flute* and *Good Bait* with tautly controlled, yet rollicking solos that build to peaks of intensity.

The sound is good, clean monaural, and it has been beautifully remastered by David Turner at the Fantasy studio in Berkeley.

John Lissner

Sound: A

Performance: A

**The Jimmy Guiffre 3, Music for People, Birds, Butterflies & Mosquitoes**

Choice 1001, stereo, \$6.98.

For some years, Jimmy Guiffre has been probing the jazz frontiers with-out much success. His jazz playing appears to be an aesthetic adventure and listeners can join in or reject it; Guiffre makes no effort to win them over.

Most of Guiffre's free jazz, recorded over the past 15 years, sounds more like modern chamber music than jazz. His most recent collection, recorded for Choice, a small Long Island label, does at least seem to have the feel of jazz; there appear to be tonal centers and established keys from which the musicians can improvise. Each selection is extremely well played, and the interaction and empathy between Guiffre, on flute or tenor sax, and bassist Kiyoshi Takunga and percussionist Randy Kaye, is impressive.

There are some interesting cuts, particularly the *Mosquito Dance*, *Night Song* and *Flute Song*, where Guiffre's solos take on the dreamy, hypnotic quality of Eastern music, or where Guiffre chisels probing, Sonny Rollins-like saxophone passages, yet the album lacks the particular kind of driving momentum and movement that makes for the very most satisfying jazz performance. Cleanly recorded, **The Jimmy Guiffre 3, Music for People, Birds, Butterflies & Mosquitoes** is, for this listener, an adventure in jazz esotericism and perhaps a bit of self-indulgence by a very gifted musician.

The album may be obtained from Choice Records, 245 Tilley Place, Sea Cliff, NY 11579.

John Lissner

Sound: A

Performance: A

# NUMBER ONE

The new Grace G707  
is the largest selling tonearm in America  
for a reason:



Its ultra-low mass  
enables cartridges to sound better.

The name is Grace.  
The tonearm: The G-707

It establishes new standards of cartridge performance and craftsmanship excellence. Critics and audio experts worldwide enthusiastically agree. About \$130 at the prestige audio specialist nearest you.

Contact: Sumiko, Inc., P.O. Box 5046, Berkeley, Ca 94705

Even our own!



Enter No. 39 on Reader Service Card

## Is your name and address correct?

Please check the address label on this issue of Audio. If not accurate, please send corrected label, with this notice, to:



AFFIX  
LABEL  
HERE



Circulation Department  
Audio  
North American Building  
401 N. Broad St., Philadelphia, PA 19108

## Zero Cartridge Interaction

Now you don't have to buy a "special" receiver or other expensive electronics simply to improve your present phono section.

Check this out

- First sophisticated outboard phono pre-amp
- All class A, low TIM design
- Complete freedom from cartridge interaction
- High voltage, all discrete construction
- Totally unique circuit topology, featuring non-ringing passive RIAA equalization.

All this plus a 10 day money back guarantee that puts our showroom into your livingroom. Our pre-amp will sound better than yours or it will cost you nothing. Write for details.



**\$89.95**



AUDIO  
2734 Industrial Parkway, Santa Maria Calif. 93454

Enter No. 29 on Reader Service Card

# CONTROL CONTROL



## YOUR CAR STEREO SYSTEM!

Get your sound together  
with an equalizer from Audio Kinetics Corp.

It's available in pre amplified or  
amplified models, and allows you to tune  
your music to fit your personality.

It's compact and compatible with all car  
stereo systems and  
gives you that "studio sound" in your car.

**QUALITY AND DEPENDABILITY IN ADVANCED  
ELECTRONIC COMPONENTS & ACCESSORIES**

**AK AUDIO KINETICS CORP.**  
THE POWER COMPANY

1900 S. QUINCE, SUITE D • DENVER, COLORADO 80231 • 303/755-9876

5/11/77

### Thelonious Monk in Person

Prestige 47033, mono, \$7.98.

Prestige's **Monk in Person** collects the pianist's two live recordings from the old Riverside catalog, the 1959 Thelonious Monk Orchestra at Town Hall and sides made by his small band at San Francisco's Blackhawk club. The Town Hall concert was well received at the time, but it wasn't well received by this writer then and still isn't. I find much to admire in Monk's lean, spare, and usually swinging piano, but when his piano harmonies and solos are orchestrated for a full band as they were at this concert, the whole effect is sour and lumpy. It's a small big band with little rhythmic impact: trumpet, trombone, french horn, tuba, and three saxes. Each instrument was orchestrated by Hal Overton as if it were a finger of one of Monk's dissonant-tinged chords. The sinewy solos by trumpeter Donald Byrd and alto saxist Phil Woods on *Little Rootie Tootie* are very good.

More to my liking is the laid-back Blackhawk set. Outstanding is Monk's long-time tenor sax man Charlie Rouse, who blows with a hard jauntiness on *Let's Call This*, *Four in One*, and *Getting Sentimental Over You*; but trumpeter Joe Gordon's solos are over-oblique and unnecessarily shrill. Monk's piano is lively and tartly swinging; I was patting my feet throughout *Getting Sentimental*. *Round Midnight*, a Monk classic and the one slow piece in the Blackhawk set, is 12 minutes long and a tour-de-force for Monk who plays a sad, angular solo. Monk's strong chording on *Midnight* gives Rouse splendid support as the tenor man precedes the pianist with a choppy, introspective chorus.

Record two of the Prestige double-set is, indeed, very good Monk, probably the closest you can get to one of his legendary night club stands during the "Beat" era. The music is quirky, offbeat; so original it compels attention. The quality of this live recording is, unfortunately, somewhat murky.

John Lissner

Sound: B

Performance: A -



AUDIO • July 1977

# Classical reviews

Edward Tatnall Canby

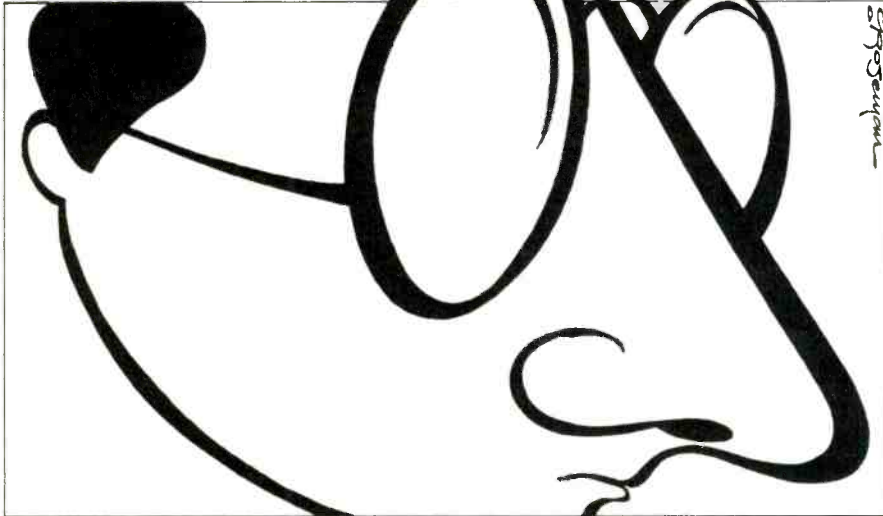

**Shostakovich: The New Babylon (1928-29).** Ensemble from the Moscow Philharmonic, Roshdestvensky. **Columbia-Melodiya X698**, stereo, \$6.98.

**Shostakovich: Age of Gold Ballet Suite (1930).** Glière: **Red Poppy Ballet Suite.** Rimsky-Korsakov: **"Sadko" Suite.** Seattle Symphony Orch., Katis.

**Vox Turnabout TV-S 34644**, stereo, \$3.98.

I nominate *The New Babylon* as the recorded discovery of the year, even if we have several months yet to go in 1977. A superbly made recording from Russia of a hitherto unknown early Shostakovich score which was produced for, of all things, a silent film. (Imagine the sync problems—a live orchestra and a film on the screen overhead!) It was actually used with the film but inevitably, as the talkies took over, it became outdated and vanished. What a loss! And what a gain, on recovery.

The music is all snazzy jazzy late-20s Shostakovich in his early period, full of youth and enthusiasm, sardonic, satirical, but not yet either long-winded or introspective. If you have heard his delightful *First Symphony* of the same period, you know the approach (and a lot, of the well known *Fifth Symphony* a few years later). The pay-off, here, is that the film was set in Paris of 1871, the brief commune after the Franco-Prussian War, and though this is hardly a Westerner's idea of a

time for fun, it gave the Russians a fine chance to do the usual, make fun of Capitalism and French decadence (which, I suspect, maybe they liked just a wee little bit). So—marvelously slaphappy can-cans, all blatty and squawky and full of brass, cute French folk tunes, even the Marseillaise cleverly hinted at. And a quote or two from Offenbach himself. Such a delightful sound, and so perfectly adapted for recording in its spare, solo-instrument configuration! I've played the thing a dozen times already and all that has happened is that each playing brings out more subtlety and more sophistication.

After awhile, by the way, you will begin to recognize Shostakovich himself, even as of his much later work. A very typical way of writing, and here at its most felicitous. I'd put this ahead of dozens of later scores.

A good companion disc is the Turnabout item, which includes the somewhat similar Suite from *The Age of Gold*, another Shostakovich satire on Capitalism (gold, of course, meaning Wall Street). The familiar Polka, that zany, staggering, out-of-tune dance we all have heard, is here surrounded with a more substantial excerpting from the complete work. With it go Glière and Rimsky, these pieces in the easygoing pop Romantic vein even though Glière wrote as late as the post-revolution period. Recording is a bit distant for my taste, lacking sonic bite, the playing...straight-forward.



## FRM-3. Because one good listening spot in a room isn't enough.

With all you invest in quality components, why shortchange yourself by confining your listening to a limited area? Unfortunately, no matter how much you spend, that's what conventional speakers force you to do: accommodate your room to your speakers, instead of vice-versa.

Micro-Acoustics' new FRM-3\* puts *more* listening room in your listening room. Thanks to its easily-accessible *Vari-Axis*™ tweeter control that lets you rotate tweeter angle to optimize high-frequency dispersion, maintaining precise instrumental definition, tonal balance and stereo separation regardless of speaker placement.

But the *Vari-Axis* high-frequency assembly is only half the story. The other half is an efficient, long-throw woofer operating into a balanced *twin-ducted-port* enclosure, which produces rich, fundamental bass.

The result: 'expensive' sound at a very modest price, even from low-powered receivers, backed by a warranty that's *twice* as long as the industry standard.

The proof is waiting at your Micro-Acoustics dealer... or write for our 8-page brochure, which also includes information on the FRM-1A (\$200) and FRM-2A (\$159).

Micro-Acoustics Corporation, 8 Westchester Plaza, Elmsford, New York, 10523. In Canada, H. Roy Gray Ltd., Markham, Ont.

\$125. All prices are manufacturer's suggested list. Prices slightly higher in West.



"Quality worth a 10-year warranty."

# Classified

## FOR SALE

**LOWEST DISCOUNT PRICES ANYWHERE** on audio equipment. All major brands discounted. Write for quotes, K&L Sound Services, 75 N. Beacon St., Watertown, Mass. 02172.

**DIAMOND NEEDLES** and Stereo Cartridges at Discount prices for Shure, Pickering, Stanton, Empire, Grado and ADC. Send for free catalog. LYLE CARTRIDGES, Dept. A, Box 69, Kensington Station, Brooklyn, New York 11218.

**MODIFICATION MANUAL FOR VACUUM TUBE AUDIO EQUIPMENT** 190+ pages of audio philosophy, design criteria, general instructions for all tubed equipment, and step-by-step procedures for optimizing performance of many components. "Proprietary" modifications detailed. If you can build a kit, this will enable you to upgrade hardware once doomed to garage sales. Latest printing includes new information, including a construction project for a **QUIET** Nuvistor sub-preamplifier...and more! Includes free consultation service - \$25.00. California residents add \$1.50. **AUDIO DIMENSIONS**, 8898 Clairemont Mesa, San Diego, Cal. 92123.

**CAMPUS REPS! CONSUMERS! DEALERS!** Most medium and many high end lines available at lowest wholesale. Make 10%/40% Repping/Demonstrating high quality loudspeaker line. Prices, info. \$1 (refundable w/order) + SASE (812) 332-4252 **AUDIO 1010 S** Dunn, Bloomington, Indiana 47401.

**ELECTRONIC CROSSOVERS—ALL TYPES.** Updated definitive booklet describes applications, how to improve speaker systems, \$5.00 postpaid, credited to first purchase. **Huntington Electronics**, Box 2009A, Huntington, Conn. 06484.

**SUPEX — ORTOFON — DENON — OTHER MOVING COIL CARTRIDGE OWNERS:** Send for free literature on our Micro Preamp Superb performance at \$99.95. **Huntington Electronics**, Box 2009A, Huntington, Conn. 06484

**ANTI-SKATING for AR TURNTABLES!!** Proven counter-weight design of nickel steel & aluminum construction. Install yourself in minutes. \$7.00 postpaid. (Dealer inquiries invited.) **AUDIO INNOVATIONAL PRODUCTS**, P.O. Box 1607, Portsmouth, N.H. 03801.

**OUR TA-1 TOMEAR™ IMPROVES RECORD SOUND** with low effective mass (<2.5 grams with most cartridges) and pivot friction (all pivots jeweled), optimum silicone damping, vertical pivots at record level, anti-skate bias, damped cueing, and low capacitance cables. Money-back guarantee. \$149.00 postpaid. **JML Company**, 39.000 Highway 128, Cloverdale, CA 95425

**BUY DIRECT** from England's Hi Fi mail order specialists! Save on B&O, Celestion, Tandberg, Revox, Transcriptors, Jordan Watts, Lowther, KEF Rogers, SME, Ariston, HPD, Sugden, Radford, Neal, Technics, Sony, Aiwa, Yamaha, Pioneer, etc. Shipping list free or send \$3 bills to include literature. Goodwins, 7 The Broadway WoodGreen, London N22 Phone 888 0077 Visitors welcome

**McINTOSH MC-240 AMP. \$150.** McIntosh MX-112 AM/FM Tuner-Preamp Mint \$450. Marantz 2220 Receiver \$140. C/M Labs. 2 channel solid state Power Amp \$110. Twenty years of **AUDIO \$40.** Call 201-625-0432 Evenings.

## FOR SALE

**TOURING SOUND SYSTEMS**, 2, 4, and 8 Track Studios, Disco Sound, Cerwin Vega BGW, Altec, Shure, AKG, Tapco, Dyna, Revox, EV, Beyer, Ceteq, etc. K & L Sound Service, 75 North Beacon At., Watertown, Mass. 02172. (617) 787 4072-Att Ken Berger

**ATTENTION DYNA OWNERS:** Our Dyna Double 400 modification with 16 output transistors, front end bypass, and 80,000 mfd power supply is twice as fast and twice as strong as a stock ST-400. Our Super PAT-5 has lightning fast ICs and improved high gain phono section. With a Denon DL103S straight in, these Super Dynakits show you just how great our Fulton Js and Magneplanars will play. **JENSEN STEREO SHOP**, where State of the Art is affordable. 2202 River Hills Drive, Burnsville, Minnesota, 55337. 612-890-3517.

## SEATTLE, WASHINGTON

—Seriously Pursuing The State of the Art—

Audio Research  
G.A.S./Ampzilla  
Quatre  
Mark Levinson  
Bravura  
Dynaco (MODIFIED)  
Connoisseur  
Linn Sondek  
Formula 4  
Denon

Magneplanar  
Fulton/FMI  
Quad ESL  
Beveridge  
Yamaha  
Nakamichi  
AKG  
ERA Mk6  
Grace  
Shure IIIIG

**DEFINITIVE AUDIO**  
3414 NE 55th  
Seattle, Washington  
(206) 524-6633  
Tuesday-Saturday

**SAVE UP TO 69% ON OVER 100 TOP BRAND AUDIO COMPONENTS FROM CARSTON STUDIOS.** NEW ENGLAND'S AUDIO SUPERMARKET. ONE OF THE OLDEST MAIL ORDER FIRMS (EST 1952) AND CERTAINLY ONE OF THE MOST RELIABLE. ALL ORDERS SHIPPED FROM STOCKED WAREHOUSE. SEND FOR PRICE QUOTE AND PRICE LIST. **CARSTON STUDIOS**, OLD BROOKFIELD ROAD, DANBURY, CONN. 06810.

**ACOUSTAT FULL-RANGE** electrostatic speakers with integral amps, latest version, new, teakwood with off-white linen grill. Call 919-449-4132. Days only.

**4 - ELECTRO-VOICE 15W's**, 1-SP12, 1-30W woofer, 1-"E.V. Patrician 800" x-over various Patrician drivers and horns. Various E.V. x-overs. Chas. W. Hopkins, 1613 Highland, Kalamazoo, Mich. 49001

**CITATION A PREAMP**, B&O 3000 new SP-12, Cerwin Vega 26 speakers \$600 or best offer. Bill Rollins, Rt. 2, Box 1288, Madison, Fla. (904) 971-5429.

**LUX TUBE** stereo system, perfect, \$1150. Arnold Feyh, 21 Steel St., Eureka Springs, Ark. 72632; (501) 253-9483.

**TEAC 3340-S.** ARP synthesizers, Sunn Concert Slave and Mixer, Dan Keen, RD # 1, Box 21, Cape May Court House, New Jersey 08210.

**VAN ALSTINE'S JENSEN STEREO SHOP.** Custom wired modified PAT 5 preamp \$295. Will take Decca cartridge as partial trade. (612) 789-1222.

## FOR SALE

### ENGLISH HI-FI

B&W, Celestion, Decca, Tannoy, Garrard, Radford, SME, KEF, and very famous Transmission Line speakers for sale. Also, AEL Mini Monitors at £ 110.00 pair; Zeppa Anti-Static Gun at £ 6.50 & p/p £ 2.50, Zeppa Record Dust-Lifter at £ 4.00 & p/p £ 2.00, Linn Sondek, Saec arms. All from stock. Write for immediate airmail reply on all prices. Mrs. Ling, Southern Audio Services Ltd., 43 High Street, Kingston, Surrey, UK. Tel: 01-549-3194. Telex 929679 AEL G.

**STEREO REPRESENTATIVES NEEDED!!!** Sell 100 brands!! Lowest Possible Prices!! **Krasco**, 623 Campbell Ave., West Haven, Connecticut 06516

**MXR's 10 Band** equalizer, Discwasher Systems, Maxell Tape Discounted. **N.A.B. Audio**, Box 7 Ottawa, IL 61350

**MICHIGAN AREA AUDIOPHILES:** Perfectionist Stereo now on display at the **EQUINOX STUDIO**. Fulton FMI, Magneplanar, Magnepan, Rogers Monitors, Great American Sound GAS, Ampzilla, Paoli, DB Systems, Linn Sondek, KMAL, Grace, Win Labs, Denon, Fidelity Research, Promethean and more. 2763B, 44th St. S.E., Wyoming, Mi. 49508; 616-531-4530, 313-482-4801.

**CANADIANS — DYNACO COMPONENTS AT TREMENDOUS DISCOUNTS.** Write En Jay Sales Hornepayne Ontario.

## CLASSIFIED ADVERTISING RATES

**BUSINESS ADS** - For Sale, Help Wanted, Services, Business Opportunities, Shortwave, Tape Recordings, etc. etc. 60c per word (minimum charge for eight words per line, \$4.80 per line.) First line set in bold face type at no extra charge. Extra lines set in bold face type \$1.20 per word (minimum charge for eight words per line, \$9.60 per line) One point ruled box, extra charge \$8.00. Full payment must accompany order.

**NON BUSINESS ADS** - Situations Wanted, used equipment for sale by private individuals. 35c per word (minimum charge for eight words per line, \$2.80 per line) First line set in bold face type at no extra charge. Extra lines set in bold face type 70c per word (minimum charge for eight words per line, \$5.60 per line). Full payment must accompany order.

**FREQUENCY DISCOUNT** - 3 times, less 10% 6 times, less 15% 12 times, less 20%

**BLIND ADS** - Box numbers may be used at \$2.00 extra for handling and postage

### MAIL ORDER AND DISPLAY CLASSIFIED RATE

1 col x 1"	\$85
1 col x 2"	\$125
1 col x 3"	\$175
2 col x 1"	\$125
2 col x 2"	\$225

Advertiser must supply complete firm negative ready for printing for mail order and display ads.

**AUDIO Magazine**  
401 North Broad Street  
Philadelphia, Penna 19108

### HOW TO ANSWER BOX NUMBER ADS

When replying to an Audio Box Number Ad, please use this address **Box No. .... c/o Audio, 401 No. Broad Street, Philadelphia, Pa 19108.**



## FOR SALE

**COLORADO'S AUDIO ALTERNATIVE** — Boulder Sound Gallery, Ltd. — Purveyors of unusually fine audio systems and service to meet the needs of all serious music lovers. Our product selection includes the Acoustat X ESL, Allison, B & O, B & W, Dahlquist, dbx, Dynavector, Fidelity Research, Fons, Luxman, Magneplanar, Mark Levinson, M & K Sound, Quad Acoustical, Quatre, RAM Sound Concepts, Stax, Supex/Sumiko, Yamaha, and Ultraphase. Demo Lux M-6000 amp with new warranty available. 1200 Pearl, Boulder, Colorado 80302; 1-303-444-2626

**DECOURSEY ACTIVE ELECTRONIC CROSSOVERS**  
Model 110 dividing network: complete with regulated power supply, for bi-amp, tri-amp, or quad-amp. Custom assembled to meet your specifications. Monaural, stereo or with derived third channel. Plug-in Butterworth (maximally flat) filters; 6, 12, or 18 db per octave at any desired audio frequency. OPTIONS: Summer for single woofer systems, VLF hi-pass filters for elimination of subsonic noise, derived third channel. **FOR OEM OR HOME ASSEMBLERS:** Model 500 or 600 dual filters. Regulated power supplies. Write for new brochure. **DECOURSEY ENGINEERING LABORATORY**, 11828 Jefferson Blvd., Culver City, CA 90230. Ph. (213) 397-9668

### THE SENSIBLE SOUND

In issue No. 2, reviews for the first time anywhere - DCM Time Windows, Grafyx SP-10, and Marjen I speakers. \$35 August systems Mod for Dyna PAS3x, Quatre B0D-1B pre-amp, AKG K140 and Superex PEP-70E headphones, Hegeman Probe, Bigston and Technics 677 cassette decks. Also - Audio Pulse, Onkyo TX4500, Decca Brush, Shure M95, Phase Linear 400, four new direct discs, and much more. Subscribe - \$10, \$11 Canada, \$16 Foreign. 403 Darwin, Snyder, NY 14226.

**THE SENSIBLE SOUND: ONLY** audio equipment testing publication with a "best sound for the money" philosophy - for perfectionists on a budget. Subscribe. \$10, 11 Canada, 16 foreign. 403 Darwin, Snyder, NY 14226.

**KLIPSCH CORNWALLS**, \$800 pair B&O 4002 \$550, SAE 2400 \$600 shipped prepaid, 305-857-0279.

**TRUSONIC** top of the line superb raw speakers: 12" - \$50.00. 8" - \$30.00. (615) 622-6182.

**SPEAKER KITS** in San Francisco. 39 to 149 pair. Listen before you buy. All Philips. 647-6538.

**CANADIANS MARANTZ 500 AMP**. Factory tweaked 340 watts per channel, pristine, \$1,200. Technics SL-110, S.M.E. and V15, \$575. (204) 256-6329.

**TYMPANI-IC WITH** two M&K bottom ends and crossover - \$1150; D76-A - \$750; D-100 - \$800; EC-2A - \$150; TD-125 MkII - \$150; Grace 707 - \$85; two JBL-S8R (dark oak) \$1200; Excellent condition; 301-692-6782.

**AMPLIFIERS KITS AND ELECTRONICS PARTS** - specialists in advanced audio design. Computronics, Box 531, Station "H", Montreal, Canada.

### INTRODUCING THE PERFECTIONIST AUDIO SUB WOOFER

We have featured our own augmented stereo transmission line woofer for our clients who wanted the most accurate, natural bass response available regardless of cost. Each unit is meticulously built and finished to the client's specifications. For this, we charge a fee of \$1400. Response: ±1 dB 8Hz to 240Hz.

Complete construction manual now available for you to build this same unit for about \$300 and your labor. Send \$15 first class mail (\$20 outside U.S.)

#### PERFECTIONIST AUDIO LTD.

P.O. Box 174  
Pleasant Gap, Pennsylvania 16823  
Calls eves. (814) 238-4071

## FOR SALE

**ROGERS LS35A's**, \$340; ADS 810's, \$490; Linn-Sondek, \$285; Grace 940 arm, \$100; Micro-Acoustics QOCle, \$39; Grace f8c, \$50; Tandberg TR 1055, \$495. All equipment shipped prepaid - C.O.D. Call (703) 552-5568.

**MARANTZ:** 10B Tuner, 7 Preamp, 8 Power Amp. Also Sony SDD-2000 (modified), TEAC AN-180. All excellent operating condition. D. Littler, 49 King St., NYC 10014. 212/242-6297.

**SEQUERRA TUNER**, Dunlap-Clarke 500 amp, Dayton-Wright SPL preamp virtually new; 201-746-2794.

**ALTEC DRIVERS, TWO 411-8A 15"**, Two 807-8A with 811B horns, excellent, 1/2 cost \$200. Box A77-1, Audio.

**AUDIO EXOTICA** cordially invites the discerning audiophile to partake in a unique opportunity. A monthly presentation of previously owned esoteric exotica will be delivered to those persons who submit an annual membership tariff of \$20. Advertisements are presently being solicited for the un-negotiable fee of \$50; acceptance contingent upon editor's approval. Division of Geffen Industries, 797 Industrial Court, Bloomfield Hills, MI 48013, (313) 858-7773.

**CITATION 16**, McIntosh 2100, JVC VT 900 dig. tuner, Soundcraftsmen PE 2217. Best offers 516-757-1386.

**AUDIO RESEARCH D75A** \$435; Linn Sondek with SME arm \$285 (504) 241-4277.

**IN CONNECTICUT AUDIO RESEARCH** is available at FRED LOCKE STEREO Hear the *incomparable new D 100, SP 4* and Tympani I-0 in acoustically designed rooms! FRED LOCKE STEREO, 216 W. Main St., Avon (203-678-1797), and 1533 State St., New Haven (203-787-3469)

### Avant-garde

14583 Big Basin Way  
Suite 2B, Saratoga, CA 95070  
(408) 867-6677

**LOW NOISE RESISTORS**—1/4W, 5% from 1 to 4M7 ohms for 3 1/2c ea. 50 per value \$.85 Postage & handling \$1. Send 25c for catalog, sample & specs. Components Center, Box 134A, NY, NY 10038

### INNOVATIVE AUDIO

Audio Instruments & Service for the music lover & audiophile. Drop in to experience us. You will experience a home-like atmosphere as much as you need honest & concise information, unmatched service, superb facilities & a good time. Mark Levinson, Sequerra, Dunlap Clark, IMF Intl, Innotech, Audio, Acoustat, Quatre, Spendor, AGI, DB Systems, Yamaha, SAE, Accuphase, Stax, BGW, DBX, Klipsch, ADS, OHM, Micro-seiki, Linn Sondek, Teac, Revox, Ortofon, Denon, Supex, Gale.

#### INNOVATIVE AUDIO

129 Degraw Street, Brooklyn, NY  
(212) 596-0888

### WESTCHESTER, FAIRFIELD COUNTY

#### THE LISTENING ROOM INC.

590 Central Park Avenue  
Scarsdale, NY. 10583

Cordially invites you to audition our line of equipment.  
AMPZILLA II ● SON OF AMPZILLA ● AUDIOANALYST ●  
THRESHOLD ● DAYTON WRIGHT ● ESL ● DAHLQUIST  
● DENDON ● DUNLAP CLARKE ● GRACE ● JANIS ●  
KEF ● LUXMAN ● M & K ● NAKAMICHI ● PARAGON  
12 ● S A E C ● SEQUERRA ● STAX ● TANDBERG ●  
THAEOIRA ● THOEBE ● ANTHEM ARRAY ● QUAD ESL  
● YAMAHA ●

AUDIO PULSE DIGITAL DELAY SYSTEM  
DYNAVECTOR TONE ARM DV 505

## FOR SALE

### CENTRAL OHIO Audiophile Art Headquarters

GAS • AUDIO RESEARCH  
SAE • LINN SONDEK • FONS  
TASCAM • MAGNEPLANAR  
MAGNEPLANAR • KLIPSCH  
GRACE • KIETH MONKS  
SUPEX • FIDELITY RESEARCH  
STAX • ROGERS • LUXMAN  
AUDIO PULSE

**Custom Stereo**

1391 S. Hamilton Rd. Columbus, OH 43227  
235-7575

**AMPEX TAPE**—NEW 1800' on 7" reel 12 for \$18 POST-PAID, 1200' 12 for \$13 POSTPAID—free list—WIDE RESPONSE, 6114A, SANTA MONICA BLVD., HOLLYWOOD, CA. 90038.

### NORTHWEST AUDIOPHILES

THE TIN EAR presents high definition audio components for the discriminating music lover

AUDIO RESEARCH	NAKAMICHI	MARK LEVINSON
BEVERIDGE	MAGNEPLANAR	TREVOR LEE
YAMAHA	FULTON	AUDIOANALYST
ROGERS	AKG	TECHNICS
LUXMAN	GRACE	DAHLQUIST
SUPEX	LINN SONDEK	QUAD
FORMULA 4	QUATRE	SONEX

Also: Audio Lab, Levinson, Pathi Marconi, Sheffield recordings.

### THE TIN EAR STEREO CENTER

704 SYMONS, RICHLAND, WA. 99352  
(509) 946-4459 Tues-Sat.

### OPAMP POWER SUPPLY

For Opamp filters, amplifiers, etc. Delivers ±15 volts at 50 ma, regulated. Compact; suitable for PC board mounting. Each \$27.50. DeCoursey Engineering Laboratory, 11828 Jefferson Blvd., Culver City, CA 90230. Ph. (213) 397-9668.

**CORNER HORN SPEAKER ENCLOSURE KITS** Send for free brochure. Kneller Audio Cabinets Dept "A", 6428 W. 27th Pl. Berwyn, Illinois 60402

**CYBERACOUSTIC LABORATORY** is a research and development center combined with the most scientifically advanced audio acoustics lab. Exciting new product lines for 76-77 including: Audio Pulse Home Digital Delay Line, Acoustat Direct Tube Drive Electrostatic Spkr., Crown's New High Definition Series of Amps and Preamps, Fulton Systems, Infinity's New Quantum Spkr. Series, Luxman Ultra-High Fidelity Solid State & Tubes, IMF International Spkrs., RTR Point Source Direct Drive Electrostatic Spkrs., IM Fried Models H, M, D, R II, L, Q, & S Spkrs., Denon Blk. & Wht. Carts., Stax Electrostatic Spkrs., Nakamichi's Recording Director Series of Electronics, Source Engineering's New Noise Reduction System, EMT Moving Coil Cartridges, Transcriptors TT, Sonus Carts., Otari Decks., KEF Spkrs., Spendor Spkrs., Formula 4 Tonearms, Polk Spkrs., Fons TT AND MUCH MORE!!!! 233 E Lancaster Ave., Wynnewood, PA 19096; 215-667-3048.

**SAVE ON SACRED COWS**—Bose, SAE, JBL, Thorens, Philips. Over 50 top brands. Write for quotes. SOUTHBOUND SOUND, P.O. Box 52508, Atlanta, Georgia 30355.

**CB INTERFERENCE** in your audio system? 3 pc. filter system guaranteed to reduce interference or your money back. Send \$11.95 + \$1.00 shipping and handling to: Fantasy House Dept. A, P.O. Box 3395 Fox Valley Station, Aurora, Illinois 60505

## FOR SALE

### BUILD YOUR OWN SPEAKERS AND SAVE UP TO 50%

Send for our free fact-packed 44-page catalog manual and learn how to assemble your own multi-element stereo speakers from scratch or from kits. Our catalog includes chapters on design, construction, drivers, enclosures, midranges, woofers, tweeters and horns. Write us today.

SPEAKERLAB  
Dept. AD-A 5500 35th N E  
Seattle, Washington 98105



**NEW GENERATION** Crown Amplifiers. Cleanest, Smoothest sound ever produced - Crown D1200/HP1200, on demo only at Barclay Recordings, 233 E. Lancaster Ave., Wyne-wood, PA 19096; (215) 667-3048.

### JOSEPH GRADO ATTENTION!!

#### READERS OF AUDIO REVIEW PUBLICATIONS (STEREOPHILE, SOUND ADVICE, ABSOLUTE SOUND, ETC.) AND AUDIOPHILES.

Joseph Grado of Grado Laboratories, Inc. is contemplating an educational audio newsletter for the sole benefit of the audiophile.

During recent lecture tours it became obvious that important audio information was badly needed by the Audiophile. Lecturing simply does not reach enough people, so a new method is being planned.

This newsletter will be non commercial and will deal primarily with the problems of setting up, listening to and evaluating what you hear through your high fidelity system.

It will further explain such things as why different tone arms "sound" different. What makes a turntable perform? How to evaluate a turntable properly. Why do phono pickups sound different even though they all measure flat? What to look for in loudspeakers.

It will also act as a communicator between Audiophiles. The publication will be sent free upon request and will be issued monthly.

Send now and list the publications to which you already subscribe.

Joseph Grado  
4614 7th Avenue  
Brooklyn, N.Y. 11220

**AUDIOGRAM, THE BI-MONTHLY** newsletter that brings you reviews, news, and our views of today's audio world. \$15.00/6 issues. Free information - Write - Audiogram, P.O. Box 17202, Dept. AM, Wash., D.C. 20041.

#### POLK AUDIO and AUDIO DEN

The Audio Den is proud to have on display and demonstration the amazing Polk Audio Monitor Series. Our customers say, "Fantastic! Compares with the finest loudspeakers I have heard. Probably the best value in the history of audio!!" Audiogram™, from the Audio Advisor said, "We were so impressed that we could not believe the prices. Other \$200 speakers simply do not come close to the standards set by the Model 10. . . And at their price, they are simply a steal." Come in for an audition or write us for information on Polk or our other state-of-the-art products. Polk is shipped free in the continental U.S. Monitor 10<sup>S</sup> - 199.95 ea. Monitor 7<sup>S</sup> 129.95 ea. and the incredible Mini Monitor 79.95 ea. Audio Den Ltd. 1320-34 Stony Brook Rd., Stony Brook L.I., N.Y. 11790, 516-751-3350.

**CABINETS FOR DYNACO** preamps, tuners, Quadaptor, Stereo 120, Literature, Geometrix, Box 612, Mexico, MO 65265

**SHOP AROUND** — Listen to every speaker available — then come to Cyberacoustic Laboratory and hear RTR's New Direct Drive Electrostatic DR-1 speaker system at Philadelphia's exclusive distributor — by appointment — 233 E. Lancaster Ave., Wyne-wood, PA 19096; (215) 667-3048.

# Advertising Index

ADVERTISER	PAGE	ADVERTISER	PAGE
Ace Audio.....	118	Discount Music.....	111
Catalog of Kits		Record Club	
Write Direct to Advertiser		Write Direct to Advertiser	
Acoustical Mfg.....	97	Discwasher.....	2, 19
Hi-Fi Components		Record Care System	
Enter No. 1 on Reader Service Card		Write Direct to Advertiser	
ADC.....	73	Discracker	
Phono Cartridge		Write Direct to Advertiser	
Write Direct to Advertiser		Dixie Hi-Fi.....	96
Advent Corp.....	17	Audio Mail Order	
Loudspeaker Systems		Enter No. 10 on Reader Service Card	
Write Direct to Advertiser		Dokorder.....	43
Aiwa.....	87	Reel-to-Reel Tape Deck	
Hi-Fi Components		Enter No. 11 on Reader Service Card	
Enter No. 2 on Reader Service Card		Dolby Labs.....	11
Akai.....	15	FM	
Hi-Fi Components		Write Direct to Advertiser	
Write Direct to Advertiser		Dual (United Audio).....	27
Analog Digital Systems.....	98	Turntables	
Loudspeaker Systems		Enter No. 12 on Reader Service Card	
Enter No. 3 on Reader Service Card		Dynamic Specialties.....	113
Analog Engineering.....	45	Audio Store	
Loudspeaker Systems		Write Direct to Advertiser	
Enter No. 4 on Reader Service Card		Empire.....	4
Appalachia Sound.....	114	Phono Cartridge	
Recording Workshop		Enter No. 13 on Reader Service Card	
Write Direct to Advertiser		Garland Audio.....	115
The Audio Critic.....	83	Audio Store	
Publication		Write Direct to Advertiser	
Write Direct to Advertiser		Jensen.....	63
Audio Kinetics.....	102	Loudspeaker Systems	
Hi-Fi Components		Write Direct to Advertiser	
Enter No. 5 on Reader Service Card		JVC.....	51
Audio-technica.....	91	Hi-Fi Components	
Phono Cartridge		Enter No. 14 on Reader Service Card	
Write Direct to Advertiser		KEF.....	71
Bose.....	5	Hi-Fi Components	
Loudspeaker System		Enter No. 15 on Reader Service Card	
Write Direct to Advertiser		Kenwood.....	65
B&W.....	89	Amplifier	
Loudspeaker Systems		Enter No. 16 on Reader Service Card	
Enter No. 7 on Reader Service Card		Marantz.....	Cov. III
Celestion.....	49	Turntables	
Loudspeaker Systems		Write Direct to Advertiser	
Enter No. 8 on Reader Service Card		Maxell.....	23
Crown.....	12	Magnetic Tape	
Hi-Fi Components		Enter No. 17 on Reader Service Card	
Enter No. 9 on Reader Service Card		McIntosh.....	96
Custom Stereo.....	105	Catalog	
Audio Store		Enter No. 18 on Reader Service Card	
Write Direct to Advertiser		McK Sales.....	116
		Audio Mail Order	
		Write Direct to Advertiser	

# Advertising Index

ADVERTISER	PAGE	ADVERTISER	PAGE
Memorex.....	6	SAE.....	47
Magnetic Tapes		Impulse Noise Reduction System	
Enter No. 19 on Reader Service Card		Enter No. 32 on Reader Service Card	
Micro-Acoustics.....	99, 103	Sansui.....	53
Phono Cartridge		FM Tuners	
Write Direct to Advertiser		Enter No. 33 on Reader Service Card	
Loudspeaker Systems		Schwann.....	100
Write Direct to Advertiser		Catalog	
Musical Heritage Society.....	39	Write Direct to Advertiser	
Music Society		Shure.....	95
Enter No. 20 on Reader Service Card		Hi-Fi Components	
Nakamichi.....	21, 92, 93	Enter No. 34 on Reader Service Card	
Hi-Fi Components		SME.....	16
Enter No. 21 on Reader Service Card		Damping Device	
Hi-Fi Components		Enter No. 35 on Reader Service Card	
Enter No. 22 on Reader Service Card		Sonic Research.....	79
Ohm.....	69	Phono Cartridge	
Loudspeaker Systems		Write Direct to Advertiser	
Enter No. 23 on Reader Service Card		Sony Corp.....	54, 55
Ovation Audio.....	112	Transistors	
Audio Store		Enter No. 36 on Reader Service Card	
Write Direct to Advertiser		Soundcraftsmen.....	7
PAIA.....	96	Hi-Fi Components	
Synthesizer		Enter No. 37 on Reader Service Card	
Enter No. 24 on Reader Service Card		Speakerlab.....	106
Phase Linear.....	61	Speaker Kit	
Hi-Fi Components		Write Direct to Advertiser	
Enter No. 25 on Reader Service Card		Stanton.....	3
Pioneer.....	Cov. II, Pg. 1	Hi-Fi Components	
Hi-Fi Components		Enter No. 38 on Reader Service Card	
Enter No. 26 on Reader Service Card		Sumiko.....	101
Playback.....	97	Tonearm	
Audio Mail Order		Enter No. 39 on Reader Service Card	
Enter No. 27 on Reader Service Card		Tannoy.....	31
Polk Audio.....	37	Hi-Fi Components	
Loudspeaker Systems		Enter No. 40 on Reader Service Card	
Write Direct to Advertiser		TDK.....	13
Precision Electronics.....	90	Cassette Tapes	
Hi-Fi Electronics		Enter No. 41 on Reader Service Card	
Enter No. 28 on Reader Service Card		Teac.....	33, Cov. IV
PS Audio.....	101	Hi-Fi Components	
Hi-Fi Components		Write Direct to Advertiser	
Enter No. 29 on Reader Service Card		Technics.....	58, 59
Ram.....	26	Hi-Fi Components	
Amplifier		Enter No. 42 on Reader Service Card	
Enter No. 30 on Reader Service Card		3M.....	67
Rhoades.....	117	Magnetic Audio Video	
Teledapter T.V. Sound Tuner		Enter No. 43 on Reader Service Card	
Write Direct to Advertiser		Yamaha.....	41
Rocelco.....	14	Hi-Fi Components	
Phono Cartridge		Write Direct to Advertiser	
Enter No. 31 on Reader Service Card			

## FOR SALE

### FREE details... A DIFFERENT KIND OF RECORD CLUB

Discounts up to 73%, no "agree-to-purchase" obligations. All labels, Schwann catalog of thousands of titles; classical, pop, jazz, country, etc. Discount dividend certificates. Newsletter; accessories; quick service. 100% iron-clad guarantees. Write for free details.

**dmc** DISCOUNT MUSIC CLUB, INC. DEPT. 14-0777  
650 Main Street, New Rochelle, N.Y. 10801

### ATTENTION AUDIO-PHILES SPECIAL PURCHASE CLOSE OUT SALE

PREAMPS	SPEAKERS
MARANTZ 3600	ACOUSTAT X70 + 69
NAKAMICHI 610	ARC TIC MAGNEPLANARS
QUAD 33-303	CROWN ES 212B
STAX SRA 125	ESS AMT 1
	FRIED H KIT
	FRIED RII
<b>AMPS</b>	IMF SUPER COMPACT
AUDIO RESEARCH ST70C3	IMF TLS 80
CROWN 060	INFINITY COLUMN
CROWN DC 300	INFINITY MONITOR II
CROWN IC 150	INFINITY SERVO STATIC
PAOLI MODEL 60 M	INFINITY 1001A
QUAD 303	INFINITY 2000 II
<b>TUNERS</b>	JBL AQUARIUS S109WX
QUAD FM3	KOSS MODEL ONE
SAE VIB	RODGERS BBC MONITORS
	SPENDER BC-1

TURNTABLES	MISC.
AUDIO RETROFLEX LT-76	AMPEX 456-273111 1/2" TAPE
CONNOISSEUR BD-2	BURWEN 1201 NOISE SUPPRESSOR
LINN SONDEK LP-12	CROWN DC 150 SELECTOR
RABCO ST-4	ORBAN/PARASOUND EQUALIZER
RABCO ST-7	ORTOFON STM 720 TRANSFORMERS
THORENS 125 II	TANOBERG 10XD TAPE RECORDER

USED	TANOBERG 10XD
ADVENT 101 DOLBY	TANOBERG TR 1040 RECEIVER
BRAUN TURNTABLE	TANOBERG TR 1055 RECEIVER
DAYTON WRIGHT-	TEAC MODEL II AUDIOMIXER
SPM SPEAKERS	
KLH 9 SPEAKERS	
SHERWOOD SEL 300 TUNER	
MARANTZ 3300 PREAMP	
YAMAHA B1/UCI	
MCINTOSH MC30	

SOME IN ORIGINAL CARTONS - SOME DEMOS -  
MANY LIMITED QUANTITIES  
BARNETT BRDS.  
932 ARCH ST.  
PHILA, PA. 19107  
215-925-9780

### SP4 — SP4 — SP4

New analog module preamp from Audio Research with their new D100 amp, more need not be said! Barclay Rec. & Electronics, 233 E. Lancaster Ave., Wynwood, Pa. 215-667-3048.

## We Deliver!

This magazine was mailed on

June 6, 1977

and, hopefully, delivered five to  
seven days later.

**FOR SALE**

**Western Pennsylvania's  
FINEST AUDIO  
DEALER**

Mark Levinson Audio Systems Lux Fulton Music J. System Great American Sound Ampzilla, Thaedra Rodgers Magnapan Audire Stax Radford IMF International Revox Scott Infinity Dahlquist LS3/5A Ariston Fons	Diponica Decca Denon Supex Fidelity Research Win Labs ADC Grace Bryston Dunlap-Clarke Janis Woofers M & K Woofers SAE dbx Connoisseur Dynaco SME Audioanalyst
--	--

"Headquarters for Reference Recording"

PLUS MUCH MORE

Shipping Prepaid & Insured

**OVATION**

6019 Broad St. Mall  
Pittsburgh, Pa.



412-441-4550

**TECHNIARTS**

Professional Audio Equipment Showroom, Ampex, AKG, DBX, Crown International, Malatchi, Urban Parasound, SESCO on display and in stock for immediate delivery. 8555 Fenton Street, Silver Spring, MD 20910; 301-585-1118.

**RENOUNCE ROTTEN RECORDINGS!** Read selected British reviews in the bi-monthly EURO-DISC GAZETTE, then order these European discs judged the finest in technical and musical excellence. Selections mainly classical. Send for free sample issue. No obligation. EURO-DISC GAZETTE, PO Box 337-A, Peterborough, NH 03458.

**AMBIENCE DECODER FOR REAR CHANNELS.** \$149.95. Free literature. Huntington Electronics, Box 2009-A, Huntington, Conn. 06484.

**ELECTRO-VOICE** Patrician speaker. Make offer. Call 614-837-3868 evenings.

**SIEMENS, TELEFUNKEN AND AMPEREX** and other top quality audio tubes available at very competitive prices. Contact Jim Wallace at 201 McMasters Drive, Monroeville, Penna. 15146 or (412) 373-2602.

**CROWN CX844** tape machine 4 channel/reel-to-reel, 2 trac. sync. boards, 2 mike boards, tape counter, wooden case/black portable case, 10 hours use-\$3400 new \$2600. Phone 212-582-3824, 9-5 Mr. Blumenberg.

**DAYTON WRIGHT, SPS MK 3** - Mint, six months old, factory carton and literature, \$300. (402) 331-7580, 5820 S. 100 Plaza 3B, Omaha, NE 68127, ask for Bill.

**FOR SALE**

**DYNAMIC VOLUME EXPANDER.** Puts the "live" back into your program material. See Hirsch review of our product in Popular Electronics, Nov. '75. Immediate delivery for \$197.50 direct from manufacturer. Dealer inquiries invited. B-Cubed Eng. Inc. P.O. Box 95102, Schaumburg, Ill. 60196

**QUALITY USED AND DEMO EQUIPMENT**

Dunlap Clarke 500 amp \$595; Radford 2022 preamp \$199; Sony 2000F preamp \$199; Dayton Wright 535 preamp \$195; Levinson JC-1AC preamp \$150; Tandberg 10XD tape deck \$995; Fidelity Research FRMKII \$69; Nakamichi MCB100 \$69; Nakamichi MC1000 \$179; IMF ALS40A speakers \$195; formula 4 Arm \$95; Yamaha B1/UC1 \$895; plus new Celestion HF2000 \$149 ea.

**THE TIN EAR STEREO CENTER**

704 Symons  
Richland, Wa. 99352  
(509) 946-4459

**MAKING HIS MOVE** — Mel Schilling, formerly of Willow Grove, Pa. has taken his knowledge of music and sound to California, where he will continue to serve a select nationwide clientele devoted to ultra state-of-the-art stereo. All shipments prepaid and insured. Write or call — 20929 Ventura Blvd., Woodland Hills, Calif. (213) 348-4600.

**NEWLY ARRIVED!**

Breuer Dynamic Tonearm  
Rappaport PRE-1  
Spendor BC-1  
Audionics BT-2  
M&K Bottom End

**THE AUDIBLE DIFFERENCE**

435 Tasso, Palo Alto, Ca. 94301  
(415) 328-1081

**FLINT MICHIGAN:** DB Systems, Leach LNF-1, DCM "Time Windows", Connoisseur, Audio House, 5232 Sagamore Dr., Swartz Creek, Mich. 48473. 313-732-4670.

**NOW ALMOST 14 YEARS OLD, STEREOPHILE** has become the most widely-copied audio publication of them all. It should be: We pioneered subjective testing (by ear), devised a unique vocabulary for describing nuances of reproduced sound, proved that a subscriber-supported magazine could be blunt without being churlish, and led the industry by demanding higher standards of reproduced fidelity than it could provide. STEREOPHILE is not for the neurotic compulsive who must own the Best On the Block, but for the listener who wants the most natural possible reproduction of music. Send \$12 for 4 issues, or write to STEREOPHILE, Box 49S, Elwyn, Pa. 19063 for details.

**DISGUSTED WITH AMERICAN RECORDINGS?** Tired of paying import prices? Join us at STEREOPHILE in mounting a campaign to bring US record companies back to the view that high fidelity means musical realism, not tick, boom and screech. For information about this lively, literate publication that is still leading the audio industry since 1962, write STEREOPHILE, Box 49S, Elwyn, Pa. 19063, or send \$12 for 4 issues.

**STEREO SYSTEM** - Hartley 24" Concertmasters, Stax SRA12S, Phase Linear 400, Micro-Seiki MB-10, Shure V15III. Complete \$1600. (916) 927-2653. J. Lynch, P.O. Box 214073, Sacto., Ca. 95821.

**AMPEX 350 DECK** with Nortronics 4-track plus original full track heads, Capstan motors for 3 3/4/7 1/2, 7 1/2/15 ips. reel motors just overhauled, \$400.

**MARANTZ 10B-\$500 - 7T - \$175** Dynaco stereo 120 - \$150 Concertone 5054R \$150. All \$825. All perfect. F. Aquilino, 1107 S.E. 8th Ave., Okeechobee, Fla. 33472; 813-763-5232 Evenings.

**FOR SALE**

**DYNA STEREO 70 MOD KIT.** Tighter bass, improved transient response, higher definition. Complete instructions, schematics, parts list, \$5.00. With parts kit, including all new tubes, \$75 all postpaid. Audio Designers, Box 122, Ledyard, Conn. 06339.

**WISCONSIN AND THE MIDWEST**

AUDIOPHILE'S SOUND STUDIO IS AN ESTABLISHED DEALER IN SOPHISTICATED COMPONENTS FOR THE SERIOUS MUSIC LISTENER. WE OFFER FIVE INDEPENDENT AND FULLY-EQUIPPED LISTENING ROOMS, AND A TECHNICALLY COMPETENT STAFF WHO ARE WILLING TO APPRAISE HONESTLY ANY AND ALL EQUIPMENT. ALL OUR PRODUCTS ARE BACKED BY OUR SUPERB, PROFESSIONALLY EQUIPPED, AND STAFFED, SERVICE DEPARTMENT.

We are exclusive Wisconsin Dealers for: Mark Levinson \* Great American Sound Co. \* Bower & Wilkins \* Dayton Wright \* Quad.

Our carefully selected product lines also include: Denon \* I.M. Fried \* Fulton \* Lux Audio \* B&O \* Dahlquist \* Magnapan \* and many more outstanding products.

ALL OUR EQUIPMENT IS PRETESTED AND GUARANTEED TO MEET SPECIFICATIONS. WE ALSO SHIP PREPAID AND INSURED WITHIN THE CONTINENTAL U.S.

AUDIOPHILE'S SOUND STUDIO  
7459 Elmwood Avenue  
Middleton, Wisconsin 53562  
Phone 608-836-3807

**TDK SUPER AVILYN C-90 CASSETTES** \$3.19 ea. 10 or more \$3.06 ea. SHIPPING & HANDLING 10% under \$20.00 7% over \$20.00. Free Catalog. SAXTONE TAPE SALES, 1776 Columbia Rd., N.W., Dept. A, Washington, DC 20009

**LUX DEMOS** - 20% off, 3 yr. manufacturer's warranty. Power amps, preamps, tuners, Marshall's Sound Shop, 245 Ann, E. Lansing, Mich. 48823 (517) 351-7830

**UHER CG-360** Auto reverse cassette. New in box \$760. JBL-L-120's, factory sealed. List \$684 ea./now \$456.

**THE NEW PARAGON-E PREAMP.** Startling, musical reproduction at the right price. Also the highly acclaimed Paragon Model 12 preamp. Both at Paragon of Sound. Call 301-229-2676 (Bethesda, Maryland) (On weekdays call after 6:30 P.M.) or write to Paragon of Sound, P.O. Box 189, Cabin John, MD 20731

**DYNAKITS, DYNASPEAKERS, SHURE, SME**—lowest prices. FRIED LOUDSPEAKERS (not discounted). Perfectionist modifications. Underground HiFi Sales, 324c Broadwater Road, Arnold, Md. 21012. (301) 647-0919

**QUICK AIRMAIL SERVICE FROM TOKYO.** All brands of Cartridges and Tone-Arms. Great money-saving. Write us today!! JAPAN AUDIO TRADING CO., Saikaen Bldg., 4-33-21, Kamimeguro, Meguro-ku, Tokyo.

**MINNESOTA—GREAT AMERICAN SOUND,** FMI, Bravura, Electro Research, Sequerra, Janis woofer, DB Systems, Paoli, Grace, Linn-Sondek, Shreve Rabco, more. AUDIO PERFECTION, 822 Regent Drive, Apple Valley, MN 55124, (612) 432-3222.

**ATTENTION DYNACO PAT 5 OWNERS!** Our Pat 5 phono board update kit will convert your Pat 5 into a stunning state-of-the-art contender. We invite comparison to any pre-amp. Parts list and instructions - \$5.00. Kit - \$55.00, postpaid. Musical Sound Lab, Box 5503, Preston King Station, Arlington, Virginia 22205.

**ASTOUNDINGLY LOW PRICES AND FRIENDLY ADVICE** All Quality Brands. Factory Sealed. Campus Representatives Needed. Please write to us at: "HIGH CLASS STEREO" P.O. Box 1089, FLUSHING N.Y. 11352.

**FOR SALE**

**ATTENTION AUDIOPHILES**

James Bongiorno and Oki Sugano are proud to announce the introduction of Audio Lab records to the American market. In the past some of these superb recordings have been available through limited sources at very high prices.

A-Train Ltd. is now offering the entire Audio Lab library of 35 albums with more new releases coming every month.

These superb recordings are made with advanced processing techniques and DBX noise reduction processing which is equal and in many ways superior to direct disc recording. Records are treated for static, absolutely noise free with dead silent surfaces, and of course—no tape hiss.

In addition to quality, the musical selections are much wider in scope as compared with the terribly limited musicality of other so-called state-of-the-art recordings.

The records are divided equally between classical and jazz with many variations in groups and styles to suit a wide variety of tastes.

A complete descriptive brochure is available from A-Train Ltd., 8719 Wilshire Blvd., Beverly Hills, CA 90211.

You may order direct from A-Train or visit your local dealer.

**FREE SAMPLE!** World's first and only FREE AD Audio Newsletter. AUDIOMART, Box 821, Stratford, Connecticut 06497.

**JAMES B. LANSING C40-001** mint pair large colonial fruitwood speakers. Best offer over \$450. Adler. (201)-381-2788.

**AMPZILLA-THAEDRA  
SON OF AMPZILLA**

Sound Advice, 536 State Road, Emmaus, Pa. 18049. Hours Mon., Tues., Thur., Fr., 12-9:30, Wed. 6-9:30, Sat. 10-6. (215) 967-4418.

**RARE CHANCE AT THE ULTIMATE.** Experienced audio connoisseurs agree the old tube-type STAX SRA-3S operating the Stax SRX headphone to be absolutely the audio ultimate. I have one of those very rare units. Perfect, seldom used condition. Originally \$185. Mine for \$175. (Do not confuse with later transistor model SRA-125) R. Weir, RR 1, Box 18, South Holland, IL 60473.

**VERION. ULTIMATE TRANSFORMER FOR MOVING COIL CARTRIDGE.** VERION absolute hum and interference cables. Improves your system dramatically! DENNON. We are California BRYSTON headquarters featuring the amazing BRYSTON 3B and 4B amplifiers. GALE improved loudspeaker, 2101 turntable and GALE maximum fidelity records. ROGERS LS35/a monitor speaker on display, in stock.

GARLAND AUDIO  
3101 Telegraph Ave.  
Berkeley, California 94705  
(415) 841-1591

2960 Stevens Creek Blvd.  
San Jose, California 95128  
(408) 244-6724

**GOLD PLATED SHIELDED METAL PHONO PLUGS** 90c ea. Ultra low capacitance (12 pf/ft.) stereo connecting cable, 50c/ft. All ppd. Low mass nylon cartridge mounting hardware, 18 pc. set, \$2.50 ppd. Component Systems 5556 Personality Ct., Indianapolis, IN. 46227

**KOSS MODEL ONE** electrostatic speakers. Mint. Original cartons. 6 months old. \$1700. Andy Malone, 2524 N.W. 28th Okla. City, Okla. 73107 (405) 947-8925

**AUDIO RESEARCH SP-3A1 OWNERS:** New modification tightens bass and extends high frequency response. \$40 Williamson Laboratories, 135 N. 183rd, Seattle, WA 98133 (206) 546-1316

**FOR SALE**

~ SAN FRANCISCO BAY AREA ~  
~ DYNAMIC SPECIALTIES ~ AUDIOPHILE ITEMS DIV. ~  
PARAGON, ANALOG ENG, LEES, AUDIONICS, SOUNDCRAFTSMEN,  
FUTTERMAN, DYNACO, DAHLQUIST, F.M.I., M.E.K., RTR, HARTLEY,  
ERA, FR, GRACE, SUPEX, PROMETHEAN, SHURE, ALSO QUALITY,  
USED EQUIPMENT VINTAGE # CURRENT: MARANTZ, QUAD,  
AUDIO RESEARCH, CITATION, MCINTOSH ETC. VACUUM TUBES:  
TELEFUNKEN, AMPEREX, MULLARD, VALVO, SIEMENS, GENELEX ETC.  
BANKAMERICARD ~ BUY ~ SELL ~ TRADE ~ MASTERCHARGE  
2261 SPRING ST., REDWOOD CITY, CA 94063  
415 - 364-6634 364-2494

**CONNECTICUT:** ADC-Accutrac, Advent, Audio Pulse, B&O, B.I.C., Citation, Epicure, Harman/Kardon, J.B.L., McIntosh, Nakamichi, Ortofon, Phase Linear, Sony, Stax, Tandberg, Yamaha. Will ship prepaid. Sounds Incredible, 226 White St., Danbury, Conn., 06810. (203) 748-3889 - phone quotes only.

**RAW SPEAKERS,** High Quality, Low Prices. Free informative catalog. Please include information about types of speakers needed. Speaker Warehouse, Dept. Albert 23316 Locust Way, Bothell, Washington 98011

**SONY PRE-AMP 2000-F** w/cabinet 3 yrs old Mint cond. \$225 516-289-6828

**TDK SUPER AVILYN C-90 CASSETTES** \$3.19 ea. 10 or more \$3.06 ea. SHIPPING & HANDLING 10% under \$20.00 7% over \$20.00. Free Catalog. SAXITONE TAPE SALES, 1776 COLUMBIA RD. N.W., Dept. A, WASHINGTON, D.C. 20009.

**LEACH LNF-1A:** 100 Watt/Channel Stereo Power Amp Low TIM (Transient Intermodulation Distortion) Amplifier Available from your local dealer or from Electronics One, Inc., P. O. Box 13835, Atlanta, Georgia 30324

**FOR SALE**

MARK LEVINSON	DAYTON WRIGHT
KEITH MONKS	LINN SONDEK
DAHLQUIST	MAGNEPAN
AMPZILLA	THAEDRA
POLK	STAX
FR	MK

**ABSOLUTE SOUND  
ABSOLUTE SOUND  
ABSOLUTE SOUND**

SAE	ESS
AVID	GALE
RABCO	GRACE
DENON	REVOX
LUXMAN	LESCON
TANDBERG	KOSS ESL
DUNLAP CLARK	SONY V-FET
HARMAN KARDON	SOUNDCRAFTSMAN

**ABSOLUTE SOUND - HIGH ACCURACY AUDIO CDM-  
PONENTS**  
(313) 527-2244 12400 Morang Detroit, Mich 48224  
(313) 549-7550 4354 N Woodward Rd. Mich 48072  
(313) 662-2026 312 S State St Ann Arbor 48104

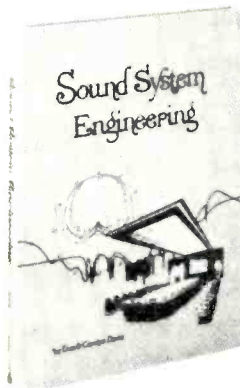

# Sound System Engineering

by Don and Carolyn Davis

A new, completely up-to-date book discussing audio systems as a whole. The decibel notation system, loudspeaker directivity and coverage, the acoustic environment, designing for acoustic gain, and interfacing the electrical and acoustical systems are reviewed. Circuit levels, grounding and shielding, servicing cable, useful wiring concepts, impedance matching, fundamentals of time delay, and proofing the installed system are explained in depth. The authors discuss equalizing the sound system, instrumentation, sample design application, and specifications. The many appendices give symbols and abbreviations, recommended installation practices, priority systems, definitions of terms, test questions and answers, and other valuable reference information.

AUDIO Book & Learning Systems Div.  
401 N. Broad St.  
Philadelphia, Pa. 19108

Enclosed is check for \$19.95. Send me, postage prepaid,  
Sound System Engineering.

NAME \_\_\_\_\_

ADDRESS \_\_\_\_\_

CITY/STATE/ZIP \_\_\_\_\_

## FOR SALE

### THE SUMMER RECORDING STUDIO WORKSHOP

- an 8 week practical experience in;
- how to record and mix music on professional 16 and 8 track equipment.
  - how to produce music and be a record producer.
  - how to understand the business of music.

No previous experience necessary • Limited enrollment • Call or write immediately for details • July 11 - Sept. 2

The Recording Workshop, Appalachia Sound, Route 8, Box 525, Chillicothe, Ohio 45601 (614) 663-2544

## FOR SALE

**CROWN DC300A** and case in mint condition. \$550, Bob (603) 837-9320

**HIGHEST QUALITY USED EQUIPMENT:** Yamaha C-1 pre-amp, \$1000; Yamaha YP-800 tt, \$360; Sony TTS-3000A tt, \$150; Beogram 4002 tt, \$525; Marantz 33 pre-amp, \$260; Marantz 1200B amp, \$275; Marantz 16 amp, \$280; Marantz 20B tuner, \$400; IMF TLS 80 spks, \$640 ea; IMF Studio 3B spks, \$300 ea; McIntosh ML1C spks, \$500 pr; McIntosh ML2M spks, \$425 ea; McIntosh MX110 tuner/pre-amp, \$250; Audio Research SP3 pre-amp, \$450; Audio Research EC2 X-over, \$189; Revox A77II deck, \$600; Four (4) Dayton-Wright XG8 MKII spks w/power supply, \$2000 complete; Crown DC300 amp, \$475; Phase Linear 2000 pre-amp, \$200; Phase Linear 700 amp, \$525; JBL SE401 amp, \$150; JBL SA600 amp, \$250; Marantz 3600 pre-amp, \$350; Marantz 18 rec, \$475; Nakamichi 1000 deck, \$900; Tandberg TCD310, \$250; AR 11 spks, \$200 ea; Soundcraftsman 20-12 eq, \$195. All used equipment guaranteed 90 days parts & labor. Audio Consultants, Inc., 517 Davis Street, Evanston, IL 60201. (312) 864-9565.

**GOLDEN EAR'S** Reference Loudspeaker system using KEF drivers. Rare find, C/M CC-2A preamp, no nonsense, exceptionally quiet, \$250. C/M RR805 professional rack-mount receiver, \$600. Lux #3045 tubed amplifiers, new pair \$885. Crown SS824 tapedeck, mint \$900. All-Test #25 Phono Preamplifier \$145. Pioneer SF-850 Electronic Crossover \$205. Rare Brociner mono tubed amp \$150. **WANTED:** Marantz tubed equipment. GOLDEN EAR, Box 2189, Riverview, Michigan 48192. (313) 479-1234.

**REPLACEMENT STYLII.** Diafix, Box 762 Hightstown NJ 08520

**IN ILLINOIS,** the Sonex Two speaker is available at AUDIO LTD., where you will find the finest in stereo components. 115 N. Walnut, Champaign, 217-359-3774

**ARC D-100, SP-3A-4;** Dahlquist's DQ10a; Denon transformer; Entré-1 cartridge; Thorens 125 MK II; Teac auto-reverse A1500 tape deck. 319-354-1196 evenings.

**MARANTZ 10B \$550, 7T \$225, B0TH \$675** with cabinets, all original paperwork Revox A77 \$375, G36III in custom cabinet \$195 Thorens TD224 (rare changer) Shure V15 \$225. All plus shipping. Whitson, 6827 Rosemary Lane, Charlotte, NC 28210 (704) 366-8787.

**LOWEST PRICES ON STEREO-ESOTERIC COMPONENTS!!!** Over 150 brands. Write for quotes. Audio Unlimited, 3386 Golf, San Jose, CA 95127. (408) 251-8776 S-Th 6-10.

**JBL HARTSFIELDS** (375, SE402 building 1504C, etc.) Oiled walnut. Original owner (1965). Near St. Louis. \$1250 pair. 6-9PM Central. 618-566-4383

## FOR SALE

**10 1/2" Recorder Specialists:** Fresh Scotch L/N 3600 ft. on new 1/4" NAB metal reels five for \$35.00. New low noise, high output Ampex tape on 10 1/2" metal reel, six for \$35.00. Reconditioned NAB metal 10 1/2" reels, \$24.00 per dozen. 10% on above for postage. Other tapes also on special, write for catalog: Sound, POB 88338, Atlanta, GA 30338.

**THOUSANDS OF LIKE NEW LP's** and prerecorded tapes. Catalogue - \$1.50. House of Records, Hillburn, New York 10931.

### AUDIO'S HI-FI HANDBOOK

Complete reference guide to over 1,000 components including prices and specs. All arranged in tabular form for easy comparison. Plus over 30 outstanding articles on audio topics, trends and advances. State-of-the-art reading for audiophiles. Only a limited quantity available. Over 200 pages. Send \$4.50 (including shipping and handling) to: Jean Davis, Audio Hi-Fi Handbook, 401 N. Broad St., Phila., Pa. 19108.

**NAME BRAND RECORDING TAPE,** custom loaded. Available in cassettes, reels, and cartridges. Huge savings direct from manufacturer. New catalogue now available, MJS, 516 Brooks, San Jose, Calif. 95125 (408) 998-2693.

**HI-FI ENTHUSIASTS WANTED!!** Earn more than just spare money in your spare time. We need campus representatives to sell name brand stereo components at discount prices in your area. High commission, no investment required. Serious inquiries only, please. Contact: Alan Weisberg, K&L Sound Services Co. 75 N. Beacon St., Watertown, Mass. 02172

**CANADIANS:** Best Hi-Fi discounts on over 96 leading Hi-Fi brands. Many exclusive factory closeout and special deals. Quotations via return mail. Nationwide mailorder service. FREE catalogs jam packed with bargains in Hi-Fi equipment, tape and recording accessories, calculators, telephones and accessories, kits, parts, etc. Hundreds of factory and government surplus specials too! American inquiries welcome. Rush free catalog request to: ETCO, Dept. AUA, Box 741, Montreal H3C 2V2

**TANNOY SPEAKERS** all models, Quad-405 amplifier, 33 pre-amplifier. Write to Nat, 423 South Sixth Ave., Mount Vernon, NY 10550.

**PROTECT YOUR LP's.** Poly sleeves for jackets 8c round bottom inner sleeves 7c Poly lined paper sleeves 15c White jackets 35c Postage \$1.50 House of Records, Hillburn, New York 10931

**Professional Hi-Fi Home Study Course**—Instructors include Len Feldman, Julian Hirsch, Larry Klein and Larry Zide. Send \$2.00 for full color AUDIO PRIMER and information on joining (SAC) Society Audio Consultants, Dept. A, 49 East 34th St., New York, N.Y. 10016.

### CONN. AND WESTERN MASS.'S LARGEST STEREO DEALER

• Accuphase • Audio Technica • Epicure • Dahlquist • B&W • dB Systems • Crown • Quatre • Phase Linear • SAE • ESS • Soundcraftsmen • Magneplanar • Magneplanar • Mayware • Grace • Tandberg • Technics • SME • Ortofon • Revox • TEAC • OBX • Beyer • Stax • AKG • Nakamichi • Sequerra • Hartley Woofers • Harman-Kardon • Rabco • Avid and more.

### FRED LOCKE STEREO

Avon	East Hartford	New Haven
203-678-1797	203-289-3231	203-787-3469
Newington	Waterbury	Orange
203-666-0555	203-757-9296	203-795-5757
Springfield, MA,	Professional Products Division	
413-782-7111	203-828-1124	

**ROGERS LS III-5A BBC** Monitor speakers. Unbelievable but hearing is believing. Now at Paragon of Sound. Call 301-229-2676 (Bethesda, Maryland) (On weekdays call after 6:30 P.M.) or write to Paragon of Sound, P.O. Box 189, Cabin John, MD 20731

### POLK AUDIO MONITOR SERIES

**AUDIO BREAKTHROUGHS** now has on demonstration the remarkable new Polk loudspeakers. Compare them to the finest loudspeakers in the world. Both the Seven (\$129.95 ea.) and the Ten (\$199.95 ea.) utilize high definition polymer laminate bass-midrange drivers, wide dispersion soft dome tweeters and fluid coupled sub-bass radiators. They are capable of reproducing a highly defined phase accurate three dimensional sonic image which rivals the thousand dollar super speakers. They sound great with a small receiver, yet reveal the fine subtleties of state of the art electronics like Levinson and G.A.S. Shipped free in U.S. Send for free brochures on Polk or our other fine lines. **AUDIO BREAKTHROUGHS**, 1681 Northern Blvd., Manhasset L.I., N.Y. 11030 516-627-7333

**SOUND ADVICE MAGAZINE OFFERS EDITORIAL JUDGMENTS ABOUT AUDIO COMPONENTS UNADULTERATED BY THE INFLUENCE OF EQUIPMENT MANUFACTURER ADVERTISING. THE FORMAT COMBINES OBJECTIVE TESTING PROCEDURES WITH SUBJECTIVE LISTENING EVALUATION TO GIVE YOU A BALANCED PICTURE OF THE PERFORMANCE CHARACTERISTICS OF AUDIO COMPONENTS. THE RESULTS ARE MUCH LIKE THE BEST EFFORTS OF TRUE WINE CONNOISSEURS. THEY CAN USE LABORATORY TESTING DEVICES WHICH PROVIDE THE POTENTIAL PURCHASER WITH MEASUREMENTS OF THE PERCENTAGE OF ALCOHOL, THE AMOUNT OF SEDIMENT PRESENT, AND SO FORTH, BUT NONE OF THESE ACCURATE TESTS CAN TELL THE CONSUMER HOW THE WINE WILL TASTE. SO IT IS WITH THE EVALUATION OF HIGH QUALITY AUDIO COMPONENTS. OBJECTIVE TESTS CAN YIELD SOME USEFUL DATA, SUCH AS THE PERCENTAGE OF DISTORTION PRODUCED, FREQUENCY RESPONSE UNDER TEST CONDITIONS, ETC. AND YET EVEN THE MOST SOPHISTICATED TESTS CANNOT SUBSTITUTE FOR THAT MARVELOUS INSTRUMENT—THE HUMAN EAR. THEN, THERE ARE THE PRACTICAL JUDGMENTS REGARDING RELIABILITY, QUALITY OF CONSTRUCTION, PHYSICAL APPEARANCE, THE PRESENCE OR ABSENCE OF FEATURES WHICH ARE ALSO SUBJECTIVE CONSIDERATIONS. IF YOU AGREE, LET US GIVE YOU SOUND ADVICE. FOR \$12.00 IT'S THE BEST AUDIO INVESTMENT YOU WILL EVER MAKE. BECAUSE SOUND ADVICE IS PUBLISHED FOR THE LOVE OF LISTENING RATHER THAN THE PURSUIT OF PROFIT, WE NEED FINANCIAL SUPPORT THROUGH YOUR SUBSCRIPTIONS. WE FEEL A STRONG NEED TO CONTINUE TO PROVIDE YOU WITH OBJECTIVE JUDGMENTS AND RECOMMENDATIONS. YOU WON'T FIND THEM IN OTHER PUBLICATIONS. SOUND ADVICE-4 ISSUES FOR \$12.00 (\$15.00 FIRST CLASS, \$18.00 FOREIGN, SENT AIR MAIL). NEW ADDRESS: 68 POST STREET, SUITE 226, SAN FRANCISCO, CA. 94104.**

**FOR SALE**

**DON'T BE PUZZLED**

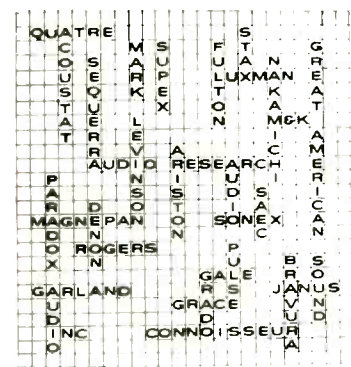

**WE'LL FIT THE PIECES**



**GARLAND AUDIO, INC.**  
 BERKELEY SAN JOSE  
 3101 TELEGRAPH 2960 STEVENS CRK  
 (415) 841-1591 (408) 244-6724  
 TUES - FRI 11-6 SAT 10-5 CLOSED - SUN MON

**DON'T MISS THE BIG ISSUE NO. 2 OF THE  
 AUDIO FORUM**

Our 2nd (on-time!) issue features a massive 20+ page report on this years giant CES Trade Show. The rumors of all the super new gear are running wild! AUDIO FORUM will be there bringing you the behind the scenes story of ALL the new audiophile products and the people behind them. And this big plus: The magazine can be in your hands in early July—months before anyone else can (or will) publish the story. So don't wait. Subscribe today by sending \$15 (\$20 overseas) to: AUDIO FORUM, BOX 578, Fairfax, CA 94930.

**AUDIO FORUM: The ONLY on-time audiophile journal!**

**STEREO ONE  
 FAIRFIELD, CONN.**

For the exceptional listener who demands purity and fidelity of sound, we have carefully evaluated and offer:

- |                |                |
|----------------|----------------|
| MARK LEVINSON  | STEREOTECH     |
| MCINTOSH       | ROTEL          |
| JECKLIN FLOATS | DAHLQUIST      |
| NAKAMICHI      | CELESTION      |
| ADS            | AKG            |
| SETTON INT     | STAX           |
| BANG & OLUFSEN | TDK            |
| DENON          | MAXELL         |
| SUPEX-GRACE    | DISCWASHER     |
| ORTOFON        | M-K 80TTOM END |
| AGI            | AMPEX-TAPE     |
| ARISTON        | HARTLEY        |
| REVOX          | WATTS          |

We pay freight.

**STEREO ONE INC.**

1229 POST RD. FAIRFIELD, CONN. 06430  
 PHONE 203-255-5939

**ROSEWOOD INFINITY SERVO-STATIC I's**, with Audio Research SP3 preamplifier, 2 Dynaco stereo 70 power amplifiers (with Infinity mod.) and Thorens TD - 160 turntable with Shure V-15 type III cartridge, all in excellent condition, sounds and looks fantastic, total system price: \$2100. Call Lee Marston, 313-971-8988, after 8:00 P.M.

**SHERWOOD STEREO** four components, over 1000 classical records and tapes. Four speakers, earphones, extras. \$750. 212-H04-1363.

**MARANTZ 7T PREAMP - MINT CONDITION.** Best offer in next few weeks. 914-834-8888.

**FOR SALE**

**THE ABSOLUTE SOUND™**, in its current issue (#9), reviews Audio Research's solid state pre-amp and amplifier; Infinity's Black Widow tone arm and FET pre-amp; the much-discussed Van Alstine Double Dyna 400; Ampzilla II; the Goldring 900 SE cartridge; the Dahlquist sub-woofer and electronic low-pass filter; the ReVox A 700; the Heath AA-1640 amplifier; the Hegeman Input Probe; the Janis sub-woofer; the Sony MX 20 mixer; Yamaha's C-1 and C-2 pre-amplifiers; the Luxman PD-121 turntable; the Yamaha B-2 amplifier; the Acoustat-X full-range electrostatic (again, no less); the Fulton J. Modular speaker system; the AGI-511 pre-amplifier; the Fidelity Research Mk III moving-coil cartridge; the Empire 2000z cartridge; the Dyna 410 amplifier; the Grado Signature cartridge; the Koss Pro-4aa headphones; the Yamaha HP-1 headphones; the Stax tone arm — and, would you believe it, much more. And, then, there's the beginning of our investigation into why American records sound so awful: The president of a small high-quality U.S. company tells the truth about his frustrations trying to get good-sounding, reliable discs. Furthermore, we give you a guide to imported records, how to get them and where. The record review sections have been expanded and our listing of super discs is back, now replete with film music. As a further enticement (to get you to subscribe, of course), we will be reviewing, in upcoming issues Dick Sequerra's first loud-speaker, the Metronome 2; a new generation of solid-state devices that are supposed to reduce or eliminate transient intermodulation distortion, including amplifiers from Kenwood and FM Acoustics (of Switzerland). There's big news in pre-amps as well, including the Rappaport Pre-la, an all-new venture from Infinity, and the improved JC-2 from Levinson. You get all this and more for \$12 (four issues)—plus \$2 if you wish the magazine sent first class. Canada, \$13 (plus \$2, for first class); outside North America, \$16 (air). Back issues (1-8), \$3 each. Send your checks to The Absolute Sound, Box 5z, Northport, New York, 11768.

**QUALITY VACUUM TUBE PREAMPLIFIER**

The **CONRAD-JOHNSON** stereo preamplifier offers breathtaking impact, clarity, and definition. The unit combines low noise, precision audio circuitry with the finest available switches and controls and is finished with an elegant and durable gold anodized faceplate and knobs. The result is lasting beauty, both sonic and visual. Offered directly to the audiophile at \$335 delivered. Write for our brochure and specifications sheet. **CONRAD-JOHNSON DESIGN**, 1474 Pathfinder Lane, McLean, Virginia 22101.

**TYPE YOUR SLIDES!** Sizes 3 1/4 x 4 \$2.35 per 50 and 2 x 2 \$2.85 per 100 plus postage. Radio Mat Slide Co., 444 N. Peninsula Drive, Daytona Beach, Fla. 32018

**DENON! DENON! DENON!** D/D turntables, tuners, I-amps, 103 S&C cartridges, 320 transformer, 307 tonearm. Available to U.S. audiophiles with insured prepaid shipments and duty discounted. Write: 20/20 AUDIO, Box 24, Aurora, Ontario, Canada L493A3

**ARIZONA AUDIOPHILES**

- MARK LEVINSON • DAHLQUIST • S.A.E. • SE-  
 QUERRA • REVOX • RABCO • NAKAMICHI •  
 YAMAHA • TRANSCRIPTOR • CROWN • GRACE  
 • STAX • TANDBERG • ACCUPHASE • SONAB  
 • SUPEX • GALE • KLIPSCH • PHASE LINEAR •  
 UHER • E.S.A. • BURWEN • SONY V-FET • J.B.L.  
 • HARMON-KARDON CITATION • A.D.S. • SPECTRO  
 ACOUSTICS • JENNINGS RESEARCH • BEVERIDGE  
 • SENNHEISER • TEAC • THORENS • STANTON  
 • AIWA • STAX • A.K.G. • ARISTON • MICRO-  
 SEIKI • FIDELITY RESEARCH •

**JERRY'S AUDIO EXCHANGE**

PHOENIX - 334 E. CAMELBACK RD. (602) 263-9410  
 TEMPE - 130 E. UNIVERSITY DR. (602) 968-3491  
 TUCSON - 1037 N. PARK AVE. (602) 622-7407  
 MAIL ORDER HOT LINE - MR. WOZ (602) 265-7841

**S.A.E. Mk30 pre-amp, \$150; S.A.E. Mk31B amplifier, \$200;**  
 Marantz 150 tuner, \$450. Hank Batts, 2104 Lakeside Drive,  
 Lexington, Kentucky 40502. (606) 266-5581.

**FOR SALE**

**IN PURSUIT OF EXCELLENCE WE OFFER:** Luxman, Dayton-Wright, Nakamichi, I. M. Fried, ADS, Stax, BGW, Revox, Philips, Ortofon, SAE Beyer, DBX, McIntosh, JBL, Klipsch, Harman Kardon, Decca, SME, Dahlquist, Yamaha, Soundcraftsmen, Teac and more... Also custom room equalization, individually damped Altec and JBL Monitors and an ongoing equipment evaluation program. **THE HOUSE OF SOUND**, 821 Kent Avenue, Baltimore, Maryland, 21228, Tel: 301-747-5260

**THE WAREHOUSE — LOWEST PRICES ON TYPEWRITERS, MANUAL AND ELECTRIC.** All brand new, factory sealed, and fully warranted. Free catalog and prices. **YOU CAN'T BUY IT ANYWHERE FOR LESS!** Fast service. **THE WAREHOUSE, DEPT 18**, 187 North Main Street, Milltown, New Jersey 08850

**MILWAUKEE & WISCONSIN'S ONLY  
 TRUE AUDIOPHILE DEALER**

Specialists in components by Audio Research, Dahlquist, Transcriptors, SAE, Nakamichi, Bozak, SME, OBX, Revox, Infinity, RTR, Phase-Linear, Tandberg, G.A.S., London-Decca, Stax, Sonus and over 50 others. Wisconsin's ONLY Audio Research dealer with their new product line on demonstration. Plus one of the truly largest displays of tape decks & accessories in the entire country. Over 130 machines on display. **WACK ELECTRONICS, INC.** 5722 W. NORTH AVE. MILWAUKEE, WI. 53208

**BACK ISSUE MAGAZINES.** Over 200 titles. 1890 to 1977. Send Stamped Envelope. Free List. Everybody's Bookshop, Dept. AU, 317 West 6th, Los Angeles, Calif. 90014

**—NORTHERN OHIO AUDIOPHILES—**

Akron's **GOLDEN GRAMOPHONE** (owned by audio systems)—Audio Research, Nakamichi, Magneplan, Great American Sound, Linn Sondek, ADS, Advent, SAE, Grace, Oenon, Stax, Sonus, Grado Signature I, Vestigal, and many other fine audio components. 2858 W. Market St., Akron, Ohio 44313. 216-864-4411.

**RECORDING TAPE - Money saving values!** Maxell, TDK, Scotch. Cassettes, 8 tracks, reels. Free price list. Northhill Sales, Box 98014-A, Des Moines, Wa. 98188.

**PERFECTIONISTS PREFER DYNAKITS**

Before Purchase You Owe Yourself Our Quote Mainline 11a 971 Fronheiser Johnstown, PA 15902

**STEREO REPRESENTATIVES NEEDED!!!**

Sell 100 Brands!! Lowest Possible Prices!! Krasco - REP DEPT - 998 Orange Ave., West Haven, Conn. 06516.

**needle in a haystack** specializes in stereo styli and cartridge-ridges, accessories, special records. All major brands and many hard-to-find replacements available. Free catalog. Dept. A, P.O. Box 17436, Washington, DC 20041.

**SAN DIEGO, CALIFORNIA**

**FULTON/FMI - BRAVURA - PRO MUSICA, AUDIO RESEARCH, MAGNEPLANAR, KMAL** record cleaning, Audio Pulse and other state-of-the-art components. Mission Bay Audio, 4501 E. Mission Bay Dr., San Diego 92109.

**DYNACO, HEATH BARGAINS.** Only one of each. STEREO 300 kit \$275; wired \$360; PAT-5 \$175; wired \$230; AJ 1515 tuner with Dolby, wired \$400; AA 1515 amplifier kit \$190, wired \$265. All brand new, full warranties. Box A77-2 Audio.

**INFINITY MONITOR II A's** Mint Condition \$600 Call (313) 694-0236 Evenings.

## FOR SALE

**SOUND GUARD \$5.75.** Refills two for \$7.35. All postpaid USA. Coastal Cinema, 1428 San Marco, Blvd., Jacksonville, FL 32207

Discounts on most high-end lines. Free shipping.

### AUDIOBROKERS

909 W. 77th Street, So. Drive.  
Indianapolis, Indiana 46260

**AKG, AMPZILLA, ARISTON, BEYER, CIZEK, CROWN, Dahlquist, DB Systems, Denon Electronics, Entre, Fons, Grace, Grado Signature, Infinity, Nakamichi, Ortofon, PHASE LIN-EAR, PMI, REVOX, SAE, SAEC, Sennheiser, Sequerra, Sony, Stanton, Stax, Supex, TASCAM, Technics, Thorens, etc.**

### HI-FI HAVEN

28 Easton Ave.  
New Brunswick, N.J. 08901  
201-249-5130

**AN AUDIO SALON** for discriminating music lovers and audiophiles. Yamaha V. FET - McIntosh, Mitsubishi, Tandberg, B&O, Hermary's, 386 El Camino Real, San Carlos, Ca. 415-591-7194

**ESOTERIC PRODUCTS** - New and used. Audio Research, Nakamichi, Ampzilla, Luxman, B&O, Dahlquist, Quatre. Write for list. STEREO SHOP, 107 Third Ave SE, Cedar Rapids, Iowa 52401

**FOR SALE:** 6 Switchcraft Quadswitchers (2 630-4A Program Selectors, 2 631-4 Amp. Selectors, 2 632-4 sprk. selectors), \$99, \$189 & \$149 resp. or best offer. Call (203) 637-9824.

116

**AUDIO RESEARCH D-150** best offer over \$2000; ESS 504 amp with FAN \$520; Jensen stereo Dyna preamp FET-5 MKII \$325; Radford ZD-22 preamp \$375; EMT XSD-15 cart. only used a few hours \$200; Formula 4 arm \$85; Rabco SLB-E \$150; Audio Craft AC300C arm \$110; Grado Signature One cartridge \$150; McIntosh MC240 power amp \$250; McIntosh MC-75 mono power amp \$175; Thorens TD-125 turntable no arm \$100; 4 ea. Electrovoice RE20 microphones \$140 ea.; 2 ea. Shure SM53 microphones \$150 ea.; Shibaden video tape recorder model SV700VC \$500; Panasonic strain gauge cartridge Model EPC 450C-II \$60 ea.; custom demodulator power supply for strain gauge cartridge, plugs in to preamp aux input \$100 ea.; J.P. Sammut, P.O. Box 186, San Bruno, Ca. 94066

**CANADIANS: ASSEMBLED DYNACO** components, hardly used, mint condition. Stereo 400, \$615; PAT-5, \$300; AF-6, \$340. Will cover shipping C.O.D. within Ontario, Quebec and Maritimes. Shipped fully insured. P.D., 1262 Lemoine, Sillery, P.O., G1S 1A2

### ATTENTION!

Owners of SONUS; B&D; V-151II; DECCA and other high quality cartridges. Experience true clarity and openness in the high end. The HEGEMAN PROBE is now available. For info and/or orders contact: C.S.A., 35 Little Falls Rd., Fairfield, NJ 07006. (201) 256-3636.

**BOB HEENAN SELLS QUALITY USED EQUIPMENT ONLY.** Almost anything available, from KLH compacts to Quad ESL's. Everything unconditionally guaranteed. Send \$1 for newsletter, handwritten. Sound Advice, 1906 Beacon Street, Brookline, Mass. 02146 or Tel.: 617-734-2727.

**CROWN DC300A** - One year old \$575, D-150 \$300, D-60 \$200, IC-150 \$225 & all perfect with cases. Bose Series I equalizer \$35. (912) 876-4681.

**BOSE SUPERAMP** - L.E.D. power readout & meters. Used very little in a year. Great buy at \$625. Nites 404-857-3336.

## FOR SALE

**M&K BOTTOM END SUB-WOOFERS**  
**POWERFUL, DETAILED, TIGHT, LOW BASS FOR THE BOTTOM TWO OCTAVES 80-20HZ.**

If you have an ear for detailed sounds in bass, and a dislike for "tubby" sound, we invite you to listen to the new BE-1A, BE-1V and the DBE-1A. We believe they are the finest available sub-woofers.

A speaker for long sustained organ notes is easy to make and the M&K BOTTOM ENDS are excellent in this regard; but, for the discriminating audiophile, the BOTTOM ENDS also have:

- Superb detail on drum skin sounds and the ability to distinguish between various bass instruments.
- Solid feel of floor shock on Flamenco
- Exceptionally smooth transition to Quads ESL's, Acoustats, Magneplanars including T/M panels, Magnepan MG-II's, Dahlquists, Dayton-Wrights, KLH-9's, and other fine audiophile speakers.
- The lowest mid-bass & mid-range coloration of any sub-woofer we have heard.
- New M&K universal matrixing & non-matrixing crossover networks allow the use of one or two woofers, no bi-amping necessary, your present stereo amp does it all.
- Extended frequency response, superb tone burst & pulse response, high power handling capacity.
- The new DOUBLE BOTTOM END DBE-1A, our finest audiophile super sub-woofer produces extremely high level deep bass waveforms with thrilling detail & definition.
- New M&K BASS RAMP to allow BOTTOM ENDS to be used with high efficiency speakers such as Altec, JBL, Klipsch, Tannoy, etc. The ramp is passive, works out of your pre-amp tape in - tape out, and allows the full power of your amplifier to be available. Front knob adjustable up to 20 db. of correction.

### NEW BASS & TRANSIENT MUSICAL TEST RECORD VOLUME II

● The new Bass & Transient Test Record, Volume II, contains a brilliant array of musical sounds in classical, jazz, marching bands, organ and opera passages.

● Each one is specifically designed to show and test improvements you can make to your system, as well as being enjoyable on their own. A description of each of the twenty bands tells what to listen for and its significance to audiophile equipment.

● A few critical passages are excerpted and repeated several times to avoid needle lifting and plastic deformation distortion in A-B comparisons or component evaluation.

● It is having an exceptional order rate from high-end audio dealers and manufacturers. Really demonstrates tubby vs. tight bass, very low frequencies and extremely high transient peaks in high frequency crescendos. Available at your M&K Dealer or by direct mail. (\$7.50-mail orders add \$1.00 for postage.)

● Includes: 1812 Overture Finale with live cannons; Pipe Organ and Orchestra; Bells; Flamenco Dancers; Xylophone; Harp; Steam Locomotive

### BE-1V "DAVID AND GOLIATH" - THE ALMOST INVISIBLE SYSTEM THAT SOUNDS LIKE A HUGE SPEAKER SYSTEM

● The BE-1V is a super sub-woofer with an internally integrated matrixing crossover network designed to work with the new generation of small super speakers such as the "Visonic "David" 50's & 60's, B&W DM 5's, Roger's LS3/5A, Jim Rogers JR-149, Polk's, ADS, KEF's, etc.

● The above mentioned small super speakers permit excellent decorator effects & when used in conjunction with the BE-1V yield dynamic range, imaging, low distortion, definition and frequency response hard to distinguish from large audiophile systems.

● Write for full descriptive literature on specifications and principles involved. Of course, we don't expect you to believe until you hear one of these systems at your M&K dealer. Please come in and hear it. We have been enjoying watching that expression of disbelief disappear.

Send for literature and dealer list  
MILLER AND KREISEL SOUND CORPORATION  
8719 Wilshire Boulevard  
Beverly Hills, California 90211  
213-652-8318

**SHOPPERS' GUIDE TO AUDIO MAIL ORDER DISTRIBUTORS**—\$3.95 Hundreds of audio distributors worldwide surveyed! Box 94-A, Colmar, PA 18915.

**BUY HI-FI COMPONENTS THE MODERN WAY:**

ADC • AKAI • AR  
DUAL • KOSS • SONY  
SHERWOOD • SHURE  
TEAC • TDK • HY-GAIN

MANY OTHERS

## PHONE & MAIL

Call TOLL FREE or write for LOW PRICES

Nationwide **800/854-7769**  
California **800/472-1783**

Approved by Phone

### MCK SALES

250 N THOMAS, PO BOX 2100  
POMONA CA 91766

**SONY MODEL 360** reel to reel exc. condition, Pioneer SX1500T (170 watts) receiver needs minor adjustments, must sell, make offer now. John Guardiani, RD # 3 Box 44-0A, Felton, DE 19943

## HELP WANTED

**RECORDISTS** interested in a high paying career. No experience necessary. No traveling. Modest investment required. Send resume to DGI, 551 NW 42nd Ave., Suite 304, Ft. Lauderdale, Fla. 33317.

## PHOTOGRAPHY

**WOMEN WRESTLING - BOXING.** Films - Photos. Details \$1. ASF Enterprises (AU), P.O. Box 14, Bognor Regis, Sussex, England.

## SITUATION WANTED

**DUTCH IMPORTER SEEKS TO REPRESENT** High quality Audio equipment and accessories for starting on the Dutch market. Write Farlake Audio Postbox 6672 Rotterdam-Holland.

## RADIO PROGRAMS

**OLD RADIO ON TAPE AND CASSETTES.** THOUSANDS AVAILABLE. 6 HOURS \$8.00 Immediate Service Catalogue 50c. Nostalgic Radio, Box 29K, Peoria, IL 61601

**VINTAGE RADIO:** Lowest rates, post free, traders welcome; shows for comics, etc. signals. Box 5063, Station E, Edmonton, Alta., Canada

**NATIONAL RADIO TRADER** quarterly publication for old radio hobbyists. Sample issue \$1.00 Box 1147A Mount Vernon, Washington 98273.

**50,000 WATT U.S. AM** nighttime radio stations cross referenced by frequency, call letter, and location. \$2. Dept. A, Box 2647, Boston, Mass. 02208

**1930-1962 RADIO PROGRAMS.** Tapes \$1.00 hour!! Established esteemed dealer. Informative 175 page catalog. \$1.25. AM Treasures, Box 192 AU, Babylon, N.Y. 11702

**GOLDEN AGE RADIO** - your best source for radio tapes Box 25215-0, Portland, Oregon 97225

**YESTERDAY'S RADIO PROGRAMS ON TAPE.** Reels, Cassettes. Fast-Reliable Service. Catalog \$1.00 - refundable with first order. ADVENTURES, Box 4822 A, Inglewood, California 90302

**RENT RADIO SHOWS** Make your own copies or just listen. Great way to build your collection reasonably. Catalog \$1 re fundable OTR Rental, Box 1146, Livermore, Ca. 94550



## TAPE & TAPE RECORDERS

**SCOTCH RECORDING TAPE.** lowest prices TAPE CENTER Box 4305B, Washington, D.C. 20012

**EVERYTHING ON OPEN REEL!** Classical, Popular, Dolby, Quadraphonic. Latest releases. For "Reel News," send \$1.00. Barclay-Crocker, Room 857 A, 11 Broadway, New York 10004.

**CASSETTES, 8-TRK & REEL TAPES.** lowest prices, name brands and custom loaded w/BASF or SCOTCH. Super mastering computer cassettes loaded with LAB SERIES TAPE. Prepaid shipment. FREE catalog STANFORD INTERNATIONAL, Box 609A, San Carlos, CA 94070

**WE WILL BEAT** any price sheet in America. Featuring TDK, MAXELL, and others. Tape World International, 220 Spring St., Butler, PA 16001.

**BLANK TAPE BONANZA.** TDK: 10 SAC-90 \$30.57, 10 SAC-60 \$21.57. MAXELL: 12 UDC-90 \$35.03, 10 UD35-90 \$49.74, 12 UDXL-C90 (I or II) \$41.15. All prices include shipping. (PA add 6% sales tax). Give us a try! Tape World International, 220 Spring St., Butler, PA 16001.

## RECORDS

**SOUNDTRACKS - JAZZ - POP.** Vincent, Box 5202, Long Island City, N.Y. 11105

**COLLECTORS RECORDS** - 50,000 LPs - Sold @ Auction - International Service Since 1971 - Specify category or artists - Lists From: Ray Macknic (or) Theo's, P.O. Box 7511, Van Nuys, Calif. 91406, U.S.A.

**OPERA TAPES-DISCS** - Fantastic rare live performances. Superb quality, fast service. Free catalog. Historical Recording Enterprises, Box 12, Kew Gardens, N.Y. 11415.

**NEW LINE LPs 30s & 40s SWING BANDS, SWEET BANDS.** Selections never before released. Send for catalog. Hindsight Records, Inc., P.O. Box 480306-A, Los Angeles, CA 90048.

**SOUNDTRACK RECORD ALBUMS**—Mail Auction—Free List Whalon 2321A Hill, Redondo Beach, Calif. 90278

**CATALOGS.** Broadcasts, soundtracks Personalities of Thirties, Forties. Box 225, New York, N.Y. 10028

**WHILE YOU WERE LOOKING** for out-of-print records, you should've been looking for us. DISContinued, 444 S. Victory Blvd., Burbank, Ca. 91502

**QUADRAPHONIC RECORDS AND TAPES** - World's largest selection - all labels, over 1000 titles - at discount prices! For your free illustrated quad catalog, write: SOUND CONCEPTS, Box 654-C, Peoria, Illinois 61652

**DISCOUNTS ON LP's, Tapes, Cutouts, Imports.** Huge Catalogs. One Dollar, Record Finder Services NERT, Box 268, Lawrence, Mass. 01842

**SOUNDTRACKS, CASTS, personalities!** Free newsletter! RTSA, 3700 Plaza, F211, Santa Ana, Calif. 92704.

**SHOW ALBUMS**—Rare Out of Print LP's. 64 page list \$1.00. ROBBER BRIDEGRROOM 7" STEREO, 33-1/3, & songs Jerry Orbach; Virginia Vestoff \$3.95; La Strada, Mata Hari EP \$3.95; Bakers Wife cast LP \$9.95. Broadway/ Hollywood Recordings, Georgetown, Conn. 06829.

## RECORDS

**RECORD JACKETS.** Replace old, torn, 12" or 10" LP jackets with new, pure white, cardboard jackets, 35c. Postage \$1.25. 78 sleeves and opera boxes, all sizes. Free catalog. CABCD A6, Box 8212, Columbus, Ohio 43201.

**78 RPM RECORD LISTS.** (1) Popular & Jazz, (2) Americana, (3) Classical, (4) Country-Western. State category, AUCTION ONLY. Write, S.A. Langkammerer, RECORD LISTS, 3238 Stoddard, San Bernardino, Ca. 92405.

**HARD TO FIND** Soundtracks, Disco, Rock. Some set price. Periodic auctions — Send \$1.00 for auction list. The Vinyl Junkie, P.O. Box 3598, L.A., CA 90028.

**QUASI-RATIONAL PRODUCTS** has everything in record protection; Liners @ \$13.50/100 incl. shipping, jackets, containers, Discwasher, Watts, Maxell, Nortronics, Jensen and Pioneer auto, etcetera. Swift and Reliable. Free catalog. QUASI-RATIONAL PRODUCTS, P.O. Box 171, Prospect Heights, Illinois 60070.

## SPEAKERS

**HIGH FIDELITY SPEAKERS REPAIRED**  
AMPRITE SPEAKERS SERVICE  
655 Sixth Avenue, New York, N.Y. 10010  
212-CH3-4812

**ELECTRO-VOICE SENTRY PRODUCTS.** In stock: Sentry IV-B, Sentry III, and Sentry V monitor loudspeaker systems for professional monitoring and sound reinforcement. Immediate air freight shipment to any N. American destination. National Sound Company, Ft. Lauderdale, Florida. (305) 462-6862.

**5,000 SPEAKER CABINETS**  
"Builders delight" finished, ready for speakers. OHIO MERCHANTISE, 2825 S. Main St. - Akron OH. 44319

## PERSONALS

**RECORDING STUDIO ENGINEER CAREER?** Degree unnecessary. Send two 13c stamps to Attainment Research, Box 45333AU, Dallas, Tex. 75245.

## HIGH FIDELITY

**PINK NOISE TAPES.** Measure loudspeaker response accurately with a microphone and voltmeter. 1/3 octave bands +1dB 31.5Hz to 16KHz, 15 ips-\$28 ppd 7 1/2 ips-\$23 ppd. Both 1/4" halftrack. Cassette available. Instructions included for stereo system or P.A. application. AUDIOLECTRO Audio Division, Box 5334-A, San Antonio, Texas 78201. QUALITY PRODUCTS SINCE 1929.

## MUSICAL INSTRUMENTS

**UP TO 50% DISCOUNT.** Name brand instruments. Catalog Freeport Music, 114R Mahan St., W. Babylon, N.Y. 11704.

"LUDWIG" 24" BRASS SYMBOL set on foot pedal stand. \$60. T. McClure, Rt-2, Princeton, Kentucky 42445.

## GOVT. SURPLUS

**JEeps, TRUCKS,** Typically from \$52.40 ... Automobiles, Boats, Motorcycles, Airplanes, Cameras, Tools, Clothing, Sports, Camping, Photographic, Electronics Equipment ... 200,000 Bid Bargains Direct from Government Nationwide ... Low as 2c on Dollar! Surplus Catalog and Sales Directory \$1.00 (refundable). National Surplus Center, 240 Eastcass-AUD, Joliet, Ill. 60432.

### STEREO TV



The TE-200 TELEADAPTER EASILY CONNECTS TO ANY TV & STEREO SYSTEM. Using our coupling and matrix circuit, teleadapter takes a low impedance output from the television and delivers two HIGH IMPEDANCE CHANNELS OF SIMULATED STEREO, to drive any amplifier. Frequency response is maintained so you can hear the tinkle of bells or booming bass sounds as it happens on TV. With service warranty and hookup instructions \$19.95 ppd. Guaranteed to make your TV 100% more enjoyable.

OUR NEW TE-300 VHF UHF TELEVISION High Fidelity AUDIO TUNER is now available. Completely solid-state Recording and amp output jacks. Anodized Aluminum front panel and simulated Walnut Cabinet. 110 volt operation. \$169.95 ppd.

SEND CHECK, M.O. MASTERCHARGE, or BANKAMERICARD NO and Expiration date TO: RHOADES NATIONAL CORP. DEPT NO 5C BOX 817, HENDERSONVILLE, TENNESSEE 37075

NAME \_\_\_\_\_

ADDRESS \_\_\_\_\_

CITY \_\_\_\_\_ STATE \_\_\_\_\_ ZIP \_\_\_\_\_

SEND COMPLETE CATALOG

## INSTRUCTION & EDUCATION

**PIANO LESSONS** by mail using cassette tapes. Free details. Home Music Co., Box 13113, Louisville, KY 40213.

**DEGREES,** experience/credits: EMI, Inc. Box 4277, Inglewood, CA. 90309

**GET INTO BROADCASTING!** Become a DJ, earn big money! Start your own station! Free details. Broadcasting, Box 5516-N7, Walnut Creek, CA 94596.

## BUSINESS OPPORTUNITIES

**CAMPUS REPRESENTATIVES** - Double your profits! Contact TOKYO AUDIO LTD., Box 3241, Los Angeles, Ca. 90028

**OWNER'S HEALTH FORCES SALE!!**  
Well-established California audiophile store, five year national reputation, top lines, superb opportunity for diversified eccentric audiophile, priced for immediate bargain sale, terms negotiable, for details write: P.O. Box 637, San Carlos, CA. 94070.

**OUR PORTABLE DISCO SYSTEMS** could make you rich. Earn \$150 night and more, playing records for parties, bars, weddings. Get in on one of the fastest growing best paying jobs. Free information. American Audio 103 Ohio Ave Fremont, Ohio 43420 419-334-3326

**\$500/THOUSAND IMMEDIATELY,** Stuffing Envelopes, Free Supplies, Rush Stamped, Self-Addressed Envelope, HOFFMAN ENTERPRISES, 1935 Bellevue Drive, Whitehall, Pa. 18052.

**GOLDEN EAR** owns famous Futterman capacitor-coupled vacuum tube amplifier patent. Joint venture/partnership sought with firm having manufacturing/marketing expertise. Serious businesslike proposals only. GOLDEN EAR, Box 2189, Riverview, Michigan 48192. (313) 479-1234.

## PLANS & KITS

**LINEAR AMPLIFIER,** 2—30 MHz, 140 watt mobile. Construction plans, \$3.00. IGOR, Box 5516-N5, Walnut Creek, CA 94596

**TAPE-SLIDE SYNCHRONIZER,** lap-dissolve plans, \$5.50. With mixer, compressor, preamp schematics, \$8.50. The Millers, 1896 Maywood, S. Euclid, OH 44121.

# Kit

● zero-distortion  
on preamps

● equalizer

● power amp  
lifiers

● electronic  
x-over

● new "Pancake"  
Preamp

free catalog:

**ACE** AUDIO CO.,  
#532 5th Street,  
East Northport,  
New York 11731

## SERVICES

**HISTORICAL RADIO-ELECTRONICS DIRECTORY** - Services - Almanac, Tubes, Parts, Museums, Appraising, Collectors, Restoring, Covers A-Z, \$9.95 in Color, \$5.00 Standard, HRS, Box 15370-B, Long Beach, Ca. 90815.

**POLK AUDIO PIONEER, DYNA SALES** - Expert service - The Stereo Shop, 3907 Washington Rd., Martinez, GA., 30907 (404) 863-9143

**TAPE RECORDER HEADS** re-lapped \$15.00 ea. Removed from machine or stack. One day service. E. Maher, 5 Evans Place, Orinda, Calif. 94563

**DISCO SOUND SYSTEMS** - Installations, sales, service & rentals. Mobile DJ available. King Cobra Sound Co., 291 Kings Highway, Brooklyn, N.Y. 11223. Tel: 212-375-4062.

**8 1/2x11 CIRCULAR PRINTING.** One side. Non conflicting ads on back. \$8.00 per 500 postpaid! Immediate shipment. We both save money. JEPAG9, 18 Seafoam Ave., Boston, MA 02152.

**STEREO AND GUITAR SPEAKERS REBUILT** Fast economical service. Dealer discounts. SRS 2409 1/2 Colo. Ave., Colorado Springs, Co. 80904

**NASHVILLE RECORD PRODUCTIONS WILL PRESS HIGH QUALITY PURE VINYL RECORDS FROM YOUR TAPES. SEND FOR SAMPLE RECORD AND PRICE LIST. ALSO FINEST DISC MASTERING.** 469 Chestnut St., NASHVILLE TENNESSEE 37203

### STEREO SOUND LABS

Factory specs or better by 10% on all repairs on major brands. Warranty 90 days parts and labor. Ship us your gear properly packed and insured. 4419 John Marr Drive, Annandale, Virginia 22003 (703) 941-5707.

## SERVICES

**CUSTOM RECORDING SERVICE.** Tapes, discs, and cassettes. Stereo and mono. Live and copies. Editing. Masters and pressings. High quality at reasonable rates. Joseph Giovanelli, Audio-Tech Laboratories, 2819 Newkirk Ave., Brooklyn, N.Y. IN9 7134

### CROWN INTERNATIONAL

Complete repair, overhaul, and rebuilding service for current and early model Crown tape recorders and amplifiers. New Crown recorders in stock for immediate delivery. Excellent selection of reconditioned Crown recorders for sale. Used Crown recorders purchased and accepted for trade in. TECHNARTS 8555 Fenton Street, Silver Spring, MD 20910 301-585-1118

**STEREO MASTERS, RECORDS AND ALBUMS.** Check our prices. Newest type high level cutting equipment featuring: Neumann VMS 70 Computer control lathe, Parametric Equalization, Dolby, DBX, and the new SX74 Cutting System by Neumann. Special package prices on pure vinyl album and single record production. 1000 45 RPM stereo singles \$199.00 including mastering. 100 LP albums \$325.00 including printed jackets. Write or call for brochure. A & R Record Manufacturing Corp., 902 N. Industrial Blvd., Dallas, Texas 75207 Toll Free 1-800-527-3260.

**CONSUMER ELECTRONICS SHOW NEWSLETTER:** In June all the latest audio goodies were shown in Chicago. Readers of StereoPlus will soon be learning about them. Even if you're not a subscriber, we'd like to send you, free, a summary of the latest products. Simply send stamped, self-addressed envelope. StereoPlus, P.O. Box 509, Shalimar, Florida 32579.

## TAPE RECORDINGS

**RECORDING TAPE SPECIALIST OFFERS LOW PRICES. FAST SERVICE, WIDE VARIETY OF BRANDS, UNUSUAL CATALOG.** SAXITONE TAPE SHOP, 1776 COLUMBIA RDAD, N.W. WASHINGTON, D.C. 20009.

**RARE OPERA TAPES.** Over 3000 on reels from all over the world. Some available on cassettes too. Write: Cory, Box 1123, Malibu, California, 90265.

**HEAR THE ROAR OF WIND AND SURF ANYTIME!** Soothing windchimes program also included. Great for relaxation or parties. Electronically synthesized, better than the real thing. Send \$5.95 for C-60 cassette to Victoria, Box D, Louisville, KY 40219.

## WANTED TO BUY OR TRADE

**TANNOY: IMPERIAL or AUTOGRAPH PROFESSIONAL** (two 15" Monitor gold speakers) Kazuo Takishima, 33-7-1421, Takashimadaira 2 Chome, Itabashi-ku, Tokyo, 175 Japan.

**WANTED - DIAPHRAM ASSEMBLIES** for Pioneer PT-100 tweeters & PM-100 Midrange speakers. Jorgensen, 2241 Woodlawn, Erie, PA. 16510.

**WANTED SONY 850-2 & 650-4** Head Assy. Call Collect 904-476-6816

**QUAD** electrostatic speakers (any condition), electronics (including Model II). Mention lowest price. OMS, 619 Addison, Chicago, IL 60613.

## WANTED TO BUY OR TRADE

**E.V. GEORGIAN OR TWO PATRICIAN IV's or 600's and T350's** 16 ohms. John Wynn, 4836 Old Post Circle, Boulder, Colo. 80301: 303-443-2996.

**WANTED: TEAC 7030GSL, JBL Hartfields, J. Wolff, 15228 Mettetal, Det., Mi. 48227**

**USED COMPONENTS WANTED:** SAE: IM, 2200 or 2400L, MkVIB; Ohm Fs, preferably rosewood; Sony 177SD; dbx 119; Akai 400DSS. Fred Schmidt, 12129 Botkins Road, Botkins, Ohio, 45306, 1-519-662-3298.

**OPEN REEL, pre-recorded tapes.** Rock, folk, jazz, classical, stereo, quad. Ray, 2282 Woodward, Lakewood, Ohio 44107.

**MARANTZ 7C, Z, 9.** J. Fong, 1238 Green St., San Francisco, CA 94109.

**CASH FOR** your unwanted LPs & reel to reel tapes. Records. Box 323, Hillburn, New York 10931

## TAPE & TAPE RECORDERS

**CAVEAT EMPTOR!** Microphone comparison tape auditions popular mikes before you buy, presents chorus and orchestra recorded in true stereo. Cassette or reel, \$6.50. Millers, 1896 Maywood, S. Euclid, OH 44121.

**WE WILL BEAT** any price sheet in America. Featuring TDK, MAXELL, and others. Tape World International, 220 Spring St., Butler, PA 16001.

**SONAR'S OPEN REEL TAPES** Duped one to one from the master. All formats. Highest quality available anywhere! Send \$1.00 for catalog and stereo sampler 1/4 track, 7 1/2ips tape. Sonar, P.O. Box 455A, Kingsbridge Station, Bronx, NY 10463

**RECORDING TAPE—OUTSTANDING VALUES CASSETTES—8 TRACKS—OPEN REEL—ACCESSORIES.** New, Fully Guaranteed. FREE CATALOG. Write: MAGNE HOUSE  
2015-17th Street, San Francisco, CA 94103

**PRE-RECORDED CLASSICAL CASSETTES.** Complete inventory of quality imported and domestic selections, all dolbyized. Fair prices. Latest catalogue available 50c. B&W Sound 5521 La Cienega, L.A., Cal. 90056

**OLDIES TAPES ON OPEN REEL TAPE.** Rock n' Roll songs by their year of release. Over 100 songs per year. Free brochure. Rock N' Reel Rental, Dept. C, 4 Prescott Ave., Dix Hills, NY 11746.

**MAXELL, AMPEX, CAPITOL,** Columbia Tape Bulk & Custom Loaded reels, cassettes. Reels, boxes, leader, splicers. For complete catalog write Omega Audio, Box 39253-B, Redford, MI 48239

**TDK, MAXELL, MEMOREX, BASF,** cassettes, reels 8-tracks. Lowest prices. New. Guaranteed. FREE CATALOG S & S Audio, P.O. Box 56039, Harwood Hts., IL 60656

**CUSTOMIZED TAPES.** Jazz, Big Band. Select standard tracks or available artists. Free catalog. 80 minute reel cassette or 8 track. \$8.00. Tapes Unlimited, Box 163, Portsmouth, RI 02871



# I AM MUSIC.

No one can duplicate the vital ingredient that sets Marantz stereo apart from the others. Its true musical sound. You experience it with Marantz turntables because wow and flutter and rumble are reduced to imperceptible levels. The only sound you hear is the music on the record.

Like a fine musical instrument, Marantz is designed to be at one with the music. For instance, the Marantz 6300 Turntable has a direct drive, DC servo motor for absolutely consistent speed. Automatic lift and shut-off that's opto-coupled for optimum tracking accuracy.

Some manufacturers can match some of the Marantz features. But none can deliver the true musical sound of Marantz. Not for more money. And certainly not for less. Marantz is music. It's the truth.

**marantz®**  
We sound better.

The Marantz 6300 Turntable comes complete with S-shaped tone arm with viscous-damped cueing, vertical/lateral counter-balancing and anti-skate, anti-static turntable mat, hinged plastic dust cover, and base enclosure constructed of laminated plywood, finished in genuine walnut veneer. ©1977 Marantz Co., Inc., a subsidiary of Superscope, Inc., 20525 Nordhoff St., Chatsworth, CA 91311.



**Now  
you can help  
your music  
for a song.**

As an imaginative tool for overdub sessions, for demos and for experimentation, the TEAC A-3340S is the most popular multi-track tape recorder in the world.

Since it was designed to expand your imagination, imagine this: participating TEAC dealers are having a special sale on the A-3340S.

**THE  
FIRST & ONLY  
A-3340S SALE!**

So for everyone who's ever dreamed of owning an A-3340S, it's now priced lower than you ever dreamed possible. But you have to hurry. You have to get into your TEAC dealer before he's out of the A-3340S.

And while you're there, check his prices on the Model 2 Mixer and other multitrack studio accessories.

**TEAC®**

The leader. Always has been.

TEAC Corporation of America  
7733 Telegraph Road  
Montebello, California 90640

In Canada TEAC is distributed by White  
Electronic Development Corporation (1986) Ltd.  
©TEAC 1977

MB-20



Model 2