

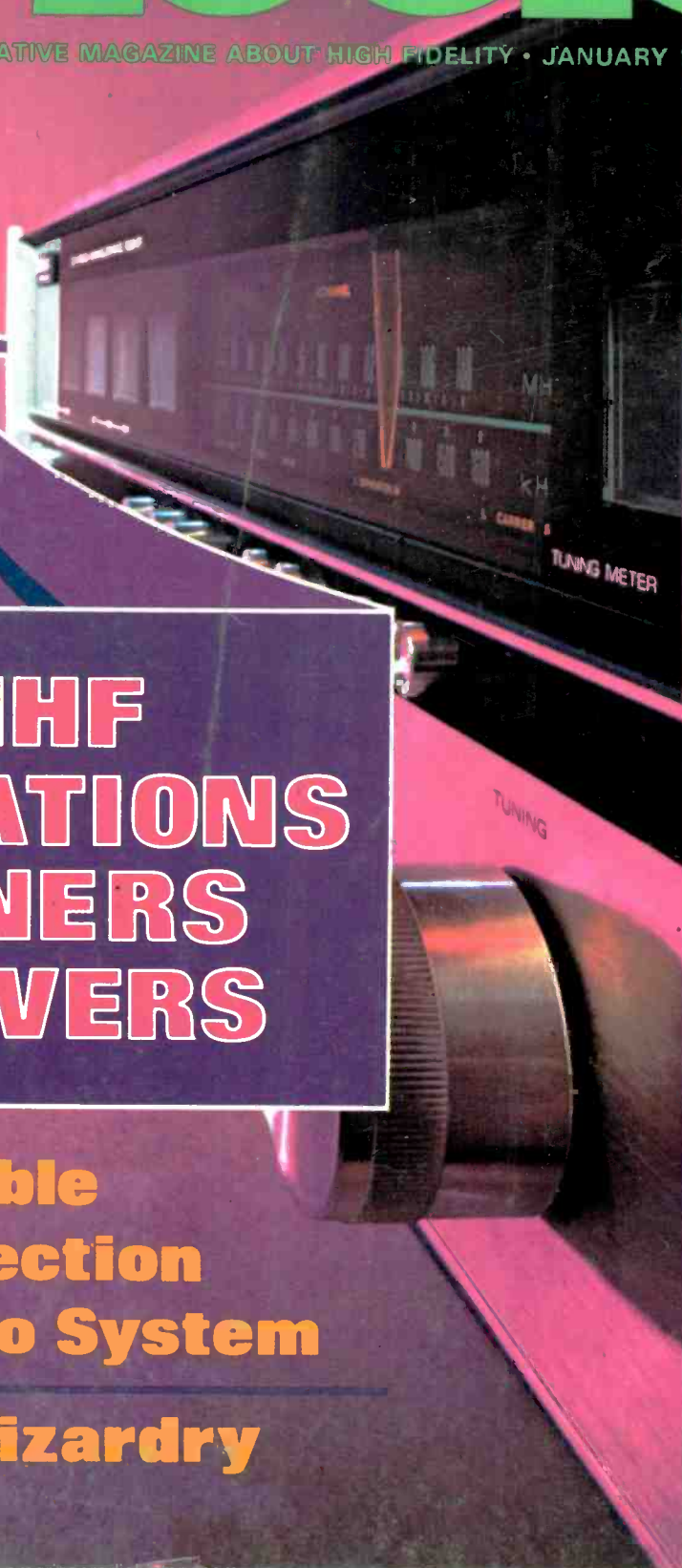

Audio

THE AUTHORITATIVE MAGAZINE ABOUT HIGH FIDELITY • JANUARY 1974 75¢

47425

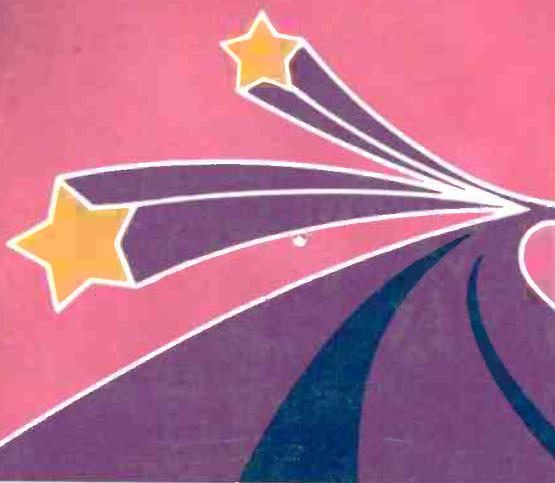

NEW IHF SPECIFICATIONS FOR TUNERS RECEIVERS

U0803760 0476 30725005P0101212 * *
DON L HUNTER
2608 CENTRAL BLVD
EUGENE OR 97403

Compatible
Quadra-Direction
Complete Stereo System

Watergate Wizardry

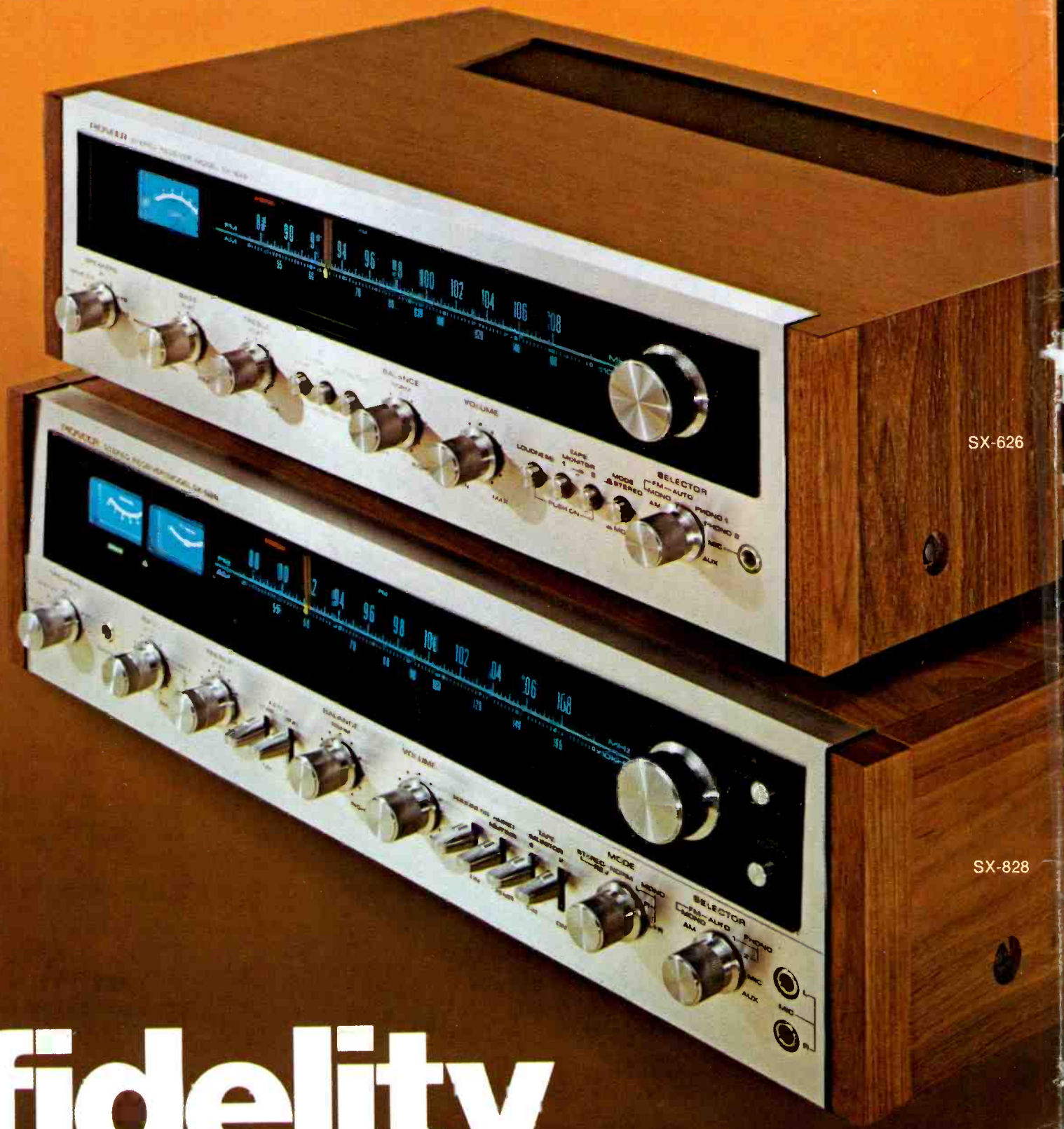

SX-626

SX-828

fidelity
s Pioneer.

SX-525

SX-727

in high
the best i

Critics Agree

AUDIO: "We find the SX-727 to be a rugged, reliable instrument that certainly represents state-of-the-art receiver technology in its design and performance."

HIGH FIDELITY: "... Solid quality ... Pioneer has avoided a make-do approach in the SX-626; we wish we could say the same for all under \$350 receivers."

HI-FI STEREO BUYERS' GUIDE: "This (SX-828) excellent performer features full power output at all frequencies ... excellent reception of weak FM signals ... selectivity was excellent."

STEREO REVIEW: "... We were especially impressed by the solidity and precise 'feel' of the SX-626's controls. Clearly, nothing has been skimped in the mechanical design and construction of this receiver. It is a joy to use, a very good value in every respect."

STEREO REVIEW: "Pioneer's moderately priced SX-727 has a degree of operating flexibility and electrical performance previously found only in some of the most expensive receivers ... The array of operating features is impressive ... In its flexibility and in many areas of its measured performance it is somewhat better than much of the competition at its price level."



Complete reprints available upon request

You, too, will reach the inevitable conclusion...

Long before the current wave of consumerism, Pioneer had established its reputation for superior quality craftsmanship. This reputation has been continuously augmented by our commitment to building high fidelity components with a measurable extra margin of value. Our four versatile receivers — SX-828, SX-727, SX-626, SX-525 — are designed to meet a wide range of requirements and budgets. Yet each unit incorporates a significant array of features and refinements built into the top model — the SX-828. Regardless which Pioneer receiver you finally select, you are assured it represents the finest at its price.

Conceptual diagram

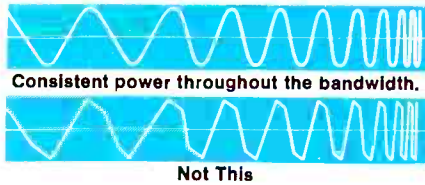

More meaningful power.

When it comes to power, each model provides the most watts for your money. This is meaningful power. Power that is consistent throughout the 20-20,000 Hz bandwidth (not just when measured at 1,000 Hz.) Especially noticeable at the low end of the spectrum with improved bass response, the overall effect is greater frequency response and low, low distortion.

Model	IHF Music Power 4 ohms	RMS @ 8 ohms Both channels driven @ 1KHz
SX-828	270 watts	60+60 watts
SX-727	195 watts	40+40 watts
SX-626	110 watts	27+27 watts
SX-525	72 watts	17+17 watts

Direct-coupled amplifier circuitry and twin power supplies improve responses.

Of course, having power to spare is important; but directing it for maximum performance is even more vital. In the SX-828 and SX-727, you will find direct-coupled circuitry in the power amplifier combined with two separate power supplies to maintain consistent high power output with positive stability. This means transient, damping and frequency responses are enhanced, while distortion is minimized. In fact, it's less than 0.5% across the 20-20,000 Hz. bandwidth.

Ultra wide linear FM dial scale takes the squint out of tuning.



You can't expect great music without great specifications.

Pioneer's reputation for high performance capability is thoroughly reinforced in these four receivers. Listening to them substantiates it; the specifications tell the reasons why. Since Field Effect Transistors increase sensitivity, they're incorporated into the FM tuner section of each unit. For example, the SX-828 uses 4 FET's. You get greater selectivity and capture ratio with Integrated Circuits and Ceramic Filters in the IF stage. Here's a mini spec list.

	SX-828	SX-727	SX-626	SX-525
FM Sensitivity (IHF) (the lower the better)	1.7uV	1.8uV	2.0uV	2.2uV
Selectivity (the higher the better)	+75dB	+70dB	+70dB	+45dB
Capture Ratio (the lower the better)	1.5dB	2.0dB	2.5dB	3.0dB
Power Bandwidth	All exceed by a wide margin the usable sound frequency spectrum			

Inputs and outputs for every purpose including 4-channel sound.

Depending on your listening interests and desire to experiment in sound, each receiver provides terminals for a wide range of program sources.

Inputs:	SX-828	SX-727	SX-626	SX-525
Tape monitor	2	2	2	2
Phono	2	2	2	Phono/Mic.
Auxiliary	1	1	1	1
Microphone	2	1	1	Phono/Mic. (as above)

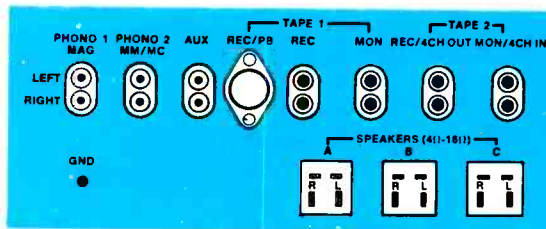

Outputs:	SX-828	SX-727	SX-626	SX-525
Speakers	3	3	3	2
Headsets	2	1	1	1
Tape Rec.	2	2	2	2

Some day, if you want 4-channel sound, all models have 2 inputs and 2 outputs to accommodate a 4-channel adapter unit. By simply attaching it and two additional speakers, perfect 4-channel sound reproduction is simply achieved.



Exclusive protector circuit for speakers.

Another example of Pioneer's advanced engineering is the automatic electronic trigger relay system designed into the SX-828 and SX-727. Since the signal is transmitted directly to the speakers because of the direct-coupled amplifier, this fail-safe circuit protects your speakers against damage and DC leakage, which can cause distortion. It also guards against short circuits in the power transistors. It's absolutely foolproof.

Versatile features increase your listening enjoyment.

Our engineers have outdone themselves with a host of easy-to-use features. All four units include: loudness contour, FM muting, mode lights, click stop bass/treble tone controls with oversize knurled knobs, and an ultra wide linear FM dial scale that takes the squint out of tuning. Except for the SX-525, they all employ high and low filters. Enlarged signal strength meters make tuning easier than ever. Center tuning meters

are included as well in the SX-828 and SX-727. Further sophistication is offered on the top two models with a 20dB audio muting switch — the perfect answer to controlling background music. As the senior member of the family, the SX-828 is

endowed with speaker indicator lights (A,B,C,A+B,A+C) and a tuning dial dimmer for creating a more intimate lighting atmosphere.

Some day other stereo receivers will strive for this total combination of power, performance, features, precision and versatility. Why wait? Pioneer has more of everything now.

See and hear these magnificent receivers at your local Pioneer dealer. SX-828—\$499.95; SX-727—\$399.95; SX-626—\$339.95; SX-525—\$259.95 Prices include walnut cabinets.

U.S. Pioneer Electronics Corp., 75 Oxford Drive, Moonachie, New Jersey, 07074

Check No. 33 on Reader Service Card

PIONEER
when you want something better

You're
reading
this page
for the
same
reasons
we build
our
speakers.

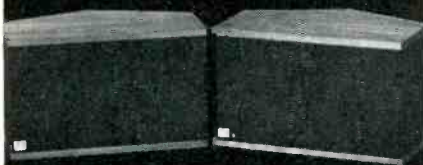

Better music, wherever you listen. Real fundamental bass, including the attack of tympani and organ. An almost tactile feeling of presence. And transparent highs, providing unusual instrumental definition.

First and foremost, we built the LDL 749A to satisfy our own desire for musical enjoyment. Including the spatial sensations, from the intimacy of small groups to the awesomeness of full orchestra.

With their precise combination of forward-radiated sound and panoramic reflection, LDL 749A are a compact elegant way to put the concert hall in your listening room. And the price is as realistic as the sound!

**Linear
Design
Labs** Inc.

20 Willeff Avenue, Port Chester, N.Y. 10573

Audio

JANUARY 1974 Successor to **RADIO** Est. 1917

Vol. 58, No. 1

FEATURE ARTICLES

- | | | |
|----|--|--------------------------|
| 20 | New IHF Tuner Standards—An Interim Report | <i>Leonard Feldman</i> |
| 30 | Compatible Quadra-Direction Discrete Stereo System | <i>Fumitaka Nagamura</i> |
| 40 | 20th Century Witchcraft—Electronic Surveillance | <i>Daniel Queen</i> |

EQUIPMENT PROFILES

- | | | |
|----|------------------------|-----------------|
| 44 | JVC 4-Channel Receiver | <i>4VR-5446</i> |
| 55 | Audioanalyst Speaker | <i>A-200</i> |
| 60 | Bose Amplifier | <i>1801</i> |

RECORD AND RECORDED TAPE REVIEWS

- | | | |
|----|--------------------------|-------------------------------|
| 66 | Classical Record Reviews | <i>Edward Tatnall Canby</i> |
| 72 | Sherwood's Forest | <i>Sherwood L. Weingarten</i> |
| 76 | Jazz & Blues | <i>Martha Sanders Gilmore</i> |
| 78 | Tape and Turntable | <i>Bert Whyte</i> |

AUDIO IN GENERAL

- | | | | | | |
|----|-------------------|--------------------------|----|------------------------|-----------------------------|
| 4 | Audioclinic | <i>Joseph Giovanelli</i> | 14 | Audio Etc | <i>Edward Tatnall Canby</i> |
| 6 | Tape Guide | <i>Herman Burstein</i> | 18 | Editorial | |
| 8 | From the Lab | <i>George W. Tillet</i> | 50 | Advertising Index | |
| 10 | Behind the Scenes | <i>Bert Whyte</i> | 80 | Classified Advertising | |



EDITOR *Eugene Pitts III* PUBLISHER *Jay L. Butler*
ASSOCIATE EDITOR *Edward Tatnall Canby* MARKETING DIRECTOR *Sanford L. Cahn*
ASSOCIATE EDITOR *Bert Whyte* COVER DESIGN *John Kwasizur*
ASSISTANT EDITOR *Peggy Bicknell* CIRCULATION MANAGER *Jean Davis*

CONTRIBUTING EDITORS: *Herman Burstein, Martin Clifford, Leonard Feldman, Richard Freed, Martha Sanders Gilmore, Joseph Giovanelli, C. G. McProud, Harry E. Maynard, Alexander Rosner, George W. Tillet, Sherwood L. Weingarten.*

AUDIO (title registered U.S. Pat. Off.) is published monthly by North American Publishing Co., Irvin J. Borowsky, President; Frank Nemeyer, Jay L. Butler and Roger Damio, Vice Presidents; R. Kenneth Baxter, Vice President/Production; Nate Rosenblatt, Promotion Director; Mary Claffey, Circulation Director.

RATES—U.S. Possessions, Canada, Mexico, \$6.00 for one year; \$10.00 for two years; all other countries, \$9.00 per year. Printed in U.S.A. at Columbus, Ohio. All rights reserved. Entire contents copyrighted 1973 by North American Publishing Co. Second class postage paid at Philadelphia, Pa. and additional mailing office. Back issues, \$2.00 each.

REGIONAL SALES OFFICES: Jay L. Butler, Publisher and Sanford L. Cahn, Marketing Director, 41 East 42nd St., New York, N.Y. 10017, telephone (212) 687-8924.

Jay Martin, 15010 Ventura Blvd., Sherman Oaks, Calif. 91403, telephone (213) 981-7852.

REPRESENTATIVES: Continental Europe: John Ashcraft, 12 Bear St., Leicester Square, London W.C. 2, telephone 930-0525. For Benelux and Germany, W.J.M. Saunders, Mgr., Herengracht 365, Amsterdam, Holland, telephone 24.09.08.

Japan: Japan Printing News Co., Ltd., No. 13, 2 Chome Ginza Higashi, Chuo-ku, Tokyo, telephone 541-5795.

AUDIO Editorial and Publishing Offices, 134 N. 13th St., Philadelphia, Penna. 19107

Postmaster: Send Form 3579 to the above address

Garrard introduces its new models.

ZERO 100c



The Zero Tracking Error Tonearm

True tangent tracking geometry. Zero 100c and Zero 92 tonearms.

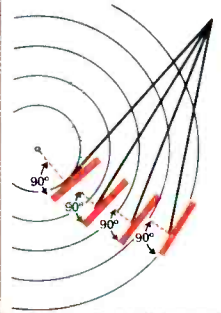

ZERO 92



MODEL 82



MODEL 70



MODEL 62

This season, we have brought out four entirely new units in the Component line, and refined the already famous ZERO 100, now in its third year of production. This unique Zero Tracking Error automatic turntable, which has earned the overwhelming regard of the critics, now becomes the ZERO 100c, and includes further advancements; including a built-in, automatic record counter . . . making the ZERO 100c the finest automatic turntable available at any price.

The Garrard policy of pursuing useful technical innovations and resisting "change for the sake of change," has paid off handsomely this year. Most notably, the articulating Zero Tracking Error Tonearm, Garrard's revolutionary patented design, has been incorporated in the ZERO 92, a new model at lower cost than the ZERO 100c. In addition, three other models, the 82, 70 and 62 have been introduced. The entire series, both in styling and features, reflects the ZERO 100c design philosophy.

This year, more than ever, there is a Garrard automatic turntable to suit your specific needs. Your dealer will help you select the model that will best complement your system . . . whether that system is mono, stereo, 4-channel, matrix or discreet.

ZERO 100c

Two speed Automatic Turntable with articulated computer-designed Zero Tracking Error Tonearm. Features: Variable speed $\pm 3\%$; Illuminated Stroboscope; Built-in automatic record counter; Magnetic anti-skating control; Sliding weight stylus force setting; 15° vertical tracking and cartridge overhang adjustment; Damped Cueing/Pausing in both directions; Patented Synchro-Lab Synchronous Motor. \$209.95*

ZERO 92

Three speed Automatic Turntable with articulated Zero Tracking Error Tonearm. Features: Lever type anti-skating adjustment; Sliding weight stylus force setting; 15° vertical tracking and cartridge overhang adjustments; Cueing/Pausing control, Damped in both directions; Patented Synchro-Lab Motor. \$169.95*

MODEL 82

Three speed Automatic Turntable with low-mass extruded aluminum tonearm. Features: Lever type sliding weight anti-skating adjustment; Sliding weight stylus force setting; 15° vertical tracking and cartridge overhang adjustments; Cueing/Pausing control, Damped in both directions; Patented Synchro-Lab Motor. \$119.95*

MODEL 70

Three speed Automatic Turntable with low-mass aluminum tonearm and fully adjustable stylus pressure setting. Features: Torsion spring anti-skating control; Cueing/Pausing control; 2 point record support; Patented Synchro-Lab Motor. \$89.95*

MODEL 62

Three speed Automatic Turntable with low-mass aluminum tonearm, fixed counterweight, and adjustable stylus pressure. Features: Torsion spring anti-skating control; Cueing/Pausing control; 2 point record support; Heavy duty four-pole Induction Surge Motor. \$69.95*

*Less base and cartridge.

Dist. by British Industries Company, Westbury, New York 11590 / A Div. of Avnet, Inc.
Mfg. by Plessey Ltd.

GARRARD

Check No. 14 on Reader Service Card

VERSATILE IS enjoyable



This IC150 . . . is the finest and most versatile control unit I have ever used. For the first time I can hook all my equipment together at once. I find many semi-pro operations possible with it that I have never before been able to pull off, including a first-class equalization of old tapes via the smooth and distortionless tone controls. I have rescued some of my earliest broadcast tapes by this means, recopying them to sound better than they ever did before.

-- Ed Canby, AUDIO

Among the things you can do with an IC150:

Produce your own taped programs! Record from any of seven inputs: 2 phono, 2 tape, 1 tuner, 2 auxiliary (tape player, cassette deck, guitar, microphone, etc.)

Clean up record scratch, tape hiss and turntable rumble with filters which scarcely alter program material.

Improve frequency response with bass and treble controls for each channel.

Enhance stereo image with the IC150's exclusive panorama control.

Record two copies of a program at once, and monitor source and tape for each.

Correct ping-pong effect for more enjoyable headphone listening.

The IC150 performs all these functions and more with lower distortion and noise than any other preamplifier.

This combination of clean sound and versatility cannot be bought anywhere else for less than \$600. But you can buy it for only \$299 at your **Crown** dealer. See him today to make your own comparison. (For independent lab test reports on the IC150, write CROWN, Box 1000, Elkhart, Indiana, 46514.)



CROWN

Made Only in America

Check No. 16 on Reader Service Card

Audioclinic

Joseph Giovanelli

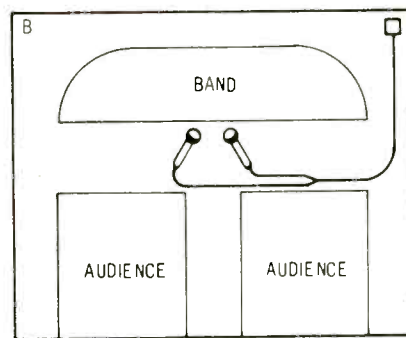
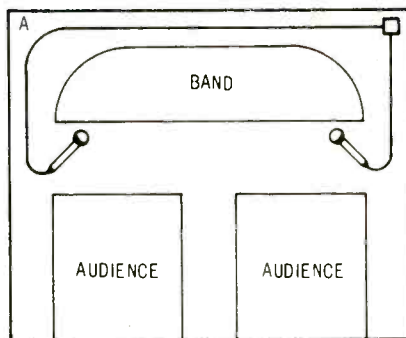
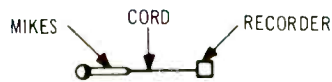

Micing a Band

Q. I would think that ideal microphone placement for recording a band concert (approximately 40-65 pieces) would be as in "A," but I have seen people with equipment costing about three times as much as mine arranging mics as in "B." Please tell me what position would be better in this case.—Jim Spellmeyer, Afton, Missouri

A. Mic placement for a band or any other musical group must be determined experimentally most of the time. Room acoustics play a major role.

I think that your Fig. B would represent the better approach of the two drawings you have shown. If the mics are too close to the band, you may tend to emphasize the instruments closest to the mics. Further, you can possibly overload the preamplifiers in your recorder.

Locate the recorder as far from the musicians as possible in order

that you can monitor what you are taping with a minimum of "live" sound entering your ears. I am assuming that you are using omnidirectional microphones for your recording. If you use cardioid mics, they must be mounted close together, forming an angle of 90 degrees to each other and aimed at the band in such a manner that each one points to the band at 45 degrees. For my own use I made up a bar on which both mics can be mounted. This bar, in turn, can be mounted on the mic stand. I believe that such devices are sold commercially as "stereo rails."

This micing technique is the simplest approach. It guarantees good results where you cannot become involved with numerous mics for accenting the various instrumental sections of the band.

Oscilloscopes in a Recording Studio

Q. I recently attended a recording session here in Montreal. I noticed that the engineers were using oscilloscopes to make sure that the incoming signal or the recorded signal was free from distortion. My questions are: Is this a good technique? Is it better than the use of a VU meter?—Louis Hone, Montreal, Canada

A. That 'scope might be used for a purpose other than level reading. It might be on the line to indicate a possible out-of-place condition which could result in a poor quality final disc when it is reproduced in mono. It is possible that the 'scope was on the line as a level indicator, just as you indicated. If so, it would work better than the VU meter. The 'scope will respond to signal peaks which the meter would not "see."

An additional use of the 'scope might have been to set up an exact phase relationship during tape head azimuth adjustment. This would provide a maximum high frequency response when the master tape is reproduced.

If you have a problem or question on audio, write to Mr. Joseph Giovanelli, at AUDIO, 134 North Thirteenth Street, Philadelphia, Pa. 19107. All letters are answered. Please enclose a stamped self-addressed envelope.



Incredible.

Sorry, but when it comes to our new Phase Linear 4000, modesty fails us. How else would you describe a preamplifier that actually:

- *Puts back in what recording studios take out.*
- *Restores dynamics lost in recording to closely approximate the original.*
- *Vanishes into virtual inaudibility all hum, noise and hiss inherent in most tapes, records, and FM broadcasts.*
- *Lets your music (at last) reach a life-like level where cymbals sound like cymbals, kettle drums like kettle drums.*
- *Lets you . . . for the first time . . . hear your music from a silent background.*

Since its introduction follows the Phase Linear 700 and 400 power amps, the 4000 pre-amp *had* to be good. Consider these features:

The Peak Unlimiter

To prevent overload in recording equipment, studios today "peak limit" high-level explosive transients of the source material. Incorporated in the Phase Linear 4000 is a highly-advanced circuit that reads peak limiting, immediately routes the signal through a lead network, and restores dynamics lost in recording to closely approximate the original.

The Downward Expander

Gain riding, a recording technique used to improve low level signal to noise on phonograph discs, unfortunately compresses dynamic range that would otherwise be available. The 4000 senses when gain riding has been used and immediately expands the dynamics reciprocally downward to precisely the intended level.

The AutoCorrelator

The advanced *Autocorrelation Noise Reduction System* in the 4000 makes record/tape hiss and FM broadcast noise virtually vanish . . . without effecting musical content of the source material. Over-all noise reduction is -10 dB from 20 Hz to 20 kHz. Your music comes from a background that is silent.

Plus . . .

. . . the 4000 is an advanced stereo preamp with SQ* and Phase Linear differential logic . . . its *Active Equalizer* gives you a truly flat energy distribution over the full audio spectrum . . . completely passive, independent *Step-Tone Controls* allow precise tailoring of the music to your listening environment. It is, in a word, incredible. Ask your dealer for an audition.

PHASE LINEAR 4000 SPECIFICATIONS

Total Distortion: Less than .25%. Typically .02%.

Total Noise: High level: 95 dB below full output. Phono: 82 dB below full output.

Tone Controls: Bass: Monotonically increasing and decreasing, dual hinge points, ± 8 dB @ 20 Hz. Hinge points switch selectable beginning at 40 Hz or 150 Hz. Treble: Monotonically increasing and decreasing, dual hinge points, ± 8 dB @ 20 kHz. Hinge points switch selectable beginning at 2 kHz and 8 kHz.

Active Equalizer: 6 dB/octave boost below 50 Hz.

Peak Unlimiter: (Nominal peak unlimiter rate attack threshold, front panel variable) .5 dB/micro second for + 6 dB peak unlimited operation.

Downward Expander: Downward expansion commences at -35 dB. Ultimate limit is -41 dB. Unlimiter window is 35 dB wide, upper and lower thresholds are simultaneously variable.

Auto Correlator (Noise Reduction Systems): High frequency noise reduction commences at 2 kHz and is 3 dB, reaching 10 dB from 4 kHz to 20 kHz. Weighted overall noise reduction is -10 dB from 20 Hz to 20 kHz.

Size: 19" x 7" x 10" — **Weight:** 18 lbs.

Price: \$599 — **Cabinet:** \$37

Warranty: Three years, parts and labor.

Check No. 31 on Reader Service Card

Phase Linear 4000
THE POWERFUL DIFFERENCE

*SQ is a trademark of CBS Labs, Inc.

PHASE LINEAR CORPORATION, P.O. BOX 549, EDMONDS, WASHINGTON 98020

Tape Guide

Herman Burstein

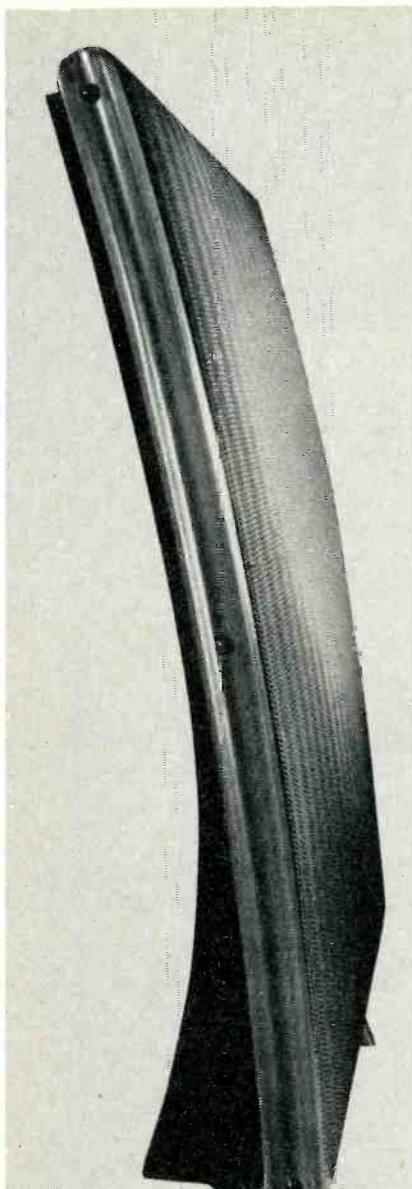

The QUAD Electrostatic was the first full range electrostatic loudspeaker produced commercially and is still the standard by which all others are judged. Using closely coupled moving elements some two hundred times lighter than the diaphragms of moving coil loudspeakers and being entirely free of cabinet resonances and colouration, this loudspeaker overcomes the usual major problems of loudspeaker design and provides remarkably natural reproduction of sound. This explains why the QUAD electrostatic loudspeaker is used by broadcasting and recording organisations all over the world, in applications where quality is of prime importance, and as a standard of reference by the majority of loudspeaker manufacturers.

QUAD for the closest approach to the original sound.

QUAD

is a registered trade mark

For details of your nearest dealer write to Acoustical Manufacturing Co. Ltd., Huntingdon PE17 7DB, England.

Check No. 2 on Reader Service Card

Records to Tape

Q. I have of late been transferring many of my records onto tape, some at 7½ ips and some at 15 ips. My questions are these: Is it possible that my tape reproduction can sound better than the original record? I notice that at loud volume, playing back the tape in comparison with the record, the tape sounds better! Yet how can one get more than what is on the record? I do notice a slight increase in hiss as I A-B the record and tape at 15 ips, which is puzzling since the hiss is less at 7½ ips. Why is that? Also, I have a Dave Brubeck stereo record, which is much quieter than the prerecorded tape version of this record. Is this the usual case?—Jeff De Carlo, Demarest, New Jersey

A. If your tape machine has perfectly flat frequency response, then a tape copy cannot in logic sound better than the disc original. On the other hand, if the tape machine deviates somewhat from flat response, in doing so it may reduce some noise frequencies and thereby sound better.

Hiss should be less at 15 ips than at 7½ ips. A possible explanation for your getting less hiss at 7½ ips is a deviation from correct equalization. Another possible explanation is that the hiss you speak of is not from your tape system but is reproduced hiss from the disc. Likely, your tape machine is a more faithful reproducer at 15 ips than at 7½ ips, so that the disc hiss is more faithfully reproduced at the higher speed.

A tape goes through several generations of copying and recopying before it is issued as a prerecorded tape. With each generation, hiss increases. Hence discs often sound better than their tape counterparts. However, use of the Dolby noise reduction system should result in quieter prerecorded tapes.

Cassette Maintenance

Q. Do cassette tape players need to be demagnetized as do tape recorder/players? Are the cassette tape head cleaners damaging to the tape heads? Is it possible to damage a tape recorder and/or player by demagnetizing and cleaning it too frequently? Do the recorder heads need to be replaced after much use as phono cartridges do? If so, can they be replaced by the consumer, or do they have to be replaced by a serviceman?—Frank J. Valence, Upper

Darby, Pennsylvania

A. Cassette tape players should be regularly demagnetized. Consult the cassette manufacturer as to what may or may not be used for cleaning. I doubt that one can clean and demagnetize excessively in terms of damaging a tape recorder. Yes, heads need replacement. The frequency of replacement depends on the quality of the head. A good head may last about 1,000 to 2,000 hours of use. Claims of much longer life have recently been made for some heads of new material. Heads should be replaced by a qualified technician.

Tape Lubrication

Q. I would appreciate your opinion regarding the use of tape lubrication kits. Do you feel that these are desirable, or that they may be an unnecessary gimmick? Do low-priced tapes and/or white box tapes necessarily require lubrication more than high-priced tapes?—C. J. Hill, San Francisco, California

A. The advisability of tape lubricating devices depends a good deal on the tape and on the machine you are using. If you have no problem of squeal, then you might not find these devices useful. If you do have a squeal problem, they might help, or they might not. Similar comments apply to oxide shedding. There is the possibility that if the lubricant has not completely dried by the time it reaches the capstan, the capstan may become slippery, resulting in tape slippage and therefore in wow. There is a strong tendency for the higher-priced tapes to be more carefully lubricated than the lower-priced ones. This means not a maximum of lubricant but the optimum amount—enough to move the tape easily past the heads, but little enough so that the capstan grabs the tape firmly.

Loss of High Frequencies

Q. I have a Viking 433 deck. A review of this machine showed a record-playback curve, at 3¼ ips, of 40 to 15,000 Hz, within 4 dB, with a rising high end. This seemed to indicate very good high-end response at the slower speed. Using Scotch 203 tape, I have sought to optimize bias by recording a 1 kHz signal at 3¼ ips and setting bias for maximum

(Continued on page 65)

I bought a Marantz 4 channel receiver because I refuse to be stuck with an electronic antique.



Not one to tolerate obsolescence (planned or unplanned), I considered the stereo vs. 4-channel question carefully, then purchased a Marantz receiver for three compelling reasons.

One. Marantz has Dual Power. This means you get full power of four discrete amplifiers working all the time. When you're listening to regular 2-channel tapes and records you can combine the power of all four channels into the front speakers. This means even if you're not ready to commit yourself to a complete 4-channel system, you can buy Marantz now and when you get the other two speakers just flip a switch. You have 4-channel. Meanwhile, you're not compromising 2-channel because you're getting more than twice the power for super stereo.

Reason number two. Marantz receivers feature the exclusive snap-in snap-out adaptability to any 4-channel matrix decoder. This means that your Marantz stereo will never be made obsolete by any future 4-channel technology because the Marantz snap-in SQ[®] module is designed to keep up with the changing state of the art. What's more, Marantz receivers have Vari-Matrix—a built-in circuit that will synthesize 4-channel sound from any stereo source (including your stereo records and tapes) and will also decode any matrix encoded 4-channel disc or FM broadcast.

Reason number three. Marantz receivers, from the Model 4230 up, feature built-in Dolby[®] noise reduction to bring you the quietest FM reception ever. And you can switch the built-in Dolby into your tape deck for noise-free, no-hiss recording from any source. A real Marantz exclusive.

I chose the Marantz Model 4270 because it suits my needs perfectly. It delivers 140 watts continuous power with under 0.3% distortion. And it's literally loaded with features. However, your requirements may be more modest than mine. In which case you can own the Marantz Model 4220 which delivers 40 watts with Dual Power. Or you can go all the way and get the Marantz Model 4300 with 200 watts. It is the very best. Choose from five Marantz 4-channel receivers from \$299 to \$899.95.

The point to remember is this—whichever model Marantz 4-channel receiver you do buy, you can buy it today without worrying about its being obsolete tomorrow. Look over the Marantz line of superb quality receivers, components and speaker systems at your Marantz dealer. You'll find him listed in the Yellow Pages. Think forward. Think Marantz.

marantz.
We sound better.

*SQ is a trademark of Columbia Broadcasting System, Inc.
**TM Dolby Labs, Inc.



©1973 Marantz Co., Inc., a subsidiary of Superscope Inc., P.O. Box 99A, Sun Valley, Calif. 91352. In Europe: Superscope Europe, S.A., Brussels, Belgium. Available in Canada. Prices and models subject to change without notice. Consult the Yellow Pages for your nearest Marantz dealer. Send for free catalog.

Check No. 43 on Reader Service Card

From The Lab

George W. Tillett

Who invented quadrasonic sound? Dr. Murry of Chicago tells me that he had "what is now called quadrasonic sound" in his listening room in 1965 and the special corner speakers were the subject of a 1966 patent.* But the concept is really much older; in fact, it goes back to 1931 at least. I am referring here to the well-known Blumlein patent (394350, 1931) which says "... vertical displacement of the source will in this arrangement give phase differences to the outputs while lateral displacements give amplitude differences and these can be separated, the phase differences converted to intensity differences by modifying networks, as described and the resulting impulses employed to operate four or more loudspeakers ... the transmission in such a system occupies only two channels up to a point in the system where each of these channels is divided into two parallel channels, thus providing four channels." The patent was described in a letter to the "Wireless World" (August, 1973) by a B.J. Shelley to whom I am indebted for the reminder.

* * *

Most of our present day phono cartridges give best results with an amplifier input capacity of about 200 pf which is normally supplied by the screened leads. But what happens with CD-4 cartridges which must perform up to 50 kHz? The shunt capacity is obviously too high and so the leads have to be changed for low-capacity cables having a capacity of no more than 10 to 12 pf per foot at most. Now the problem is this: How to supply the extra capacitance when using a standard cartridge? Well, of course, CD-4 protagonists will say—keep the CD-4 cartridge for both stereo and 4-channel Quadradiscs—but try telling this to someone who has just invested \$70 or so in a Shure M-15 Mk III or a Pickering 1200! At the moment, I am playing all my records—SQ, Quadradisc and stereo—with an Audio-technica 20SL cartridge which has a Shibata stylus and I find it to be very satisfactory although I have not had the chance to A-B it against my trusty ADC XLM or London Professional.

And now for two books, both of which I can highly recommend. The first is *Modern Sound Reproduction*

* A subsequent patent shows 4 phono cartridges mounted on an arm—a most impracticable concept!

by Harry F. Olson who needs no introduction (sorry for the cliché!). There are 328 pages plus index and no less than 250 illustrations covering binaural, stereo and quadrasonic reproducing systems, room design and acoustics. There are 17 chapters with sections on earphones, tape recorders, microphones, acoustical measurements, and loudspeakers. The last chapter is probably the most interesting as it deals with little-known data concerning the human hearing mechanism, subjective response to non-linear distortion and similar subjects. With such a wide range, it is inevitable that some subjects can be discussed only superficially but the author *does* recommend books for further study and it is remarkable just how much information is crammed into those 300 or so pages. The "blurb" on the ornate red and black cover describes Harry Olson as the retired staff Vice President of RCA Laboratories with 45 years service and the Library of Congress publication data reads: "Olson, Harry Ferdinand 1901— . . . May we wait a good many years before the next date. . . ." The publishers are Van Nostrand Reinhold and the price is \$17.50.

The second book is entitled *The Liberation of Sound* and the author is Herbert Rosscol. It is nothing to do with Germaine Greer or Bella Abzug, but it deals with electronic music and the various composers (if that is the right word). Varese is discussed at some length and there is a comprehensive chronology and bibliography as well as a list of recordings. The author's point of view can best be summed up by his remarks in the preface: "The argument of noise is always irrelevant. The true question is, does this noise, when familiar, fall into intelligible forms and convey notable contents? To supply the answer takes time. One hearing, two, three hearings are not enough. Something must change in one's sensibility as a whole, in just the way that permits a foreign language suddenly to break into meaning and melody after months or years of its being mere noise. As a veteran of the premier of Stravinsky's *Sacre du Printemps* in Paris, I can testify to the reality of the transformation. At the end of the work, in 1913, the conductor, Pierre Monteux, turned around amid furious howls of the audience and said that since they liked the piece so much he would play it again. The response

was no better, and the police had to be called in to quell the tumult. But now, sixty years after, the young accept those hammering rhythms and dissonant chords as if they were lullabies." The book is very readable—even if you don't like Varese, Stockhausen, Cage, Babbitt et al. . . . Publishers are Prentice Hall and the price is \$10. (315 pp.).

Cassette Tests

A couple of notes to put with the cassette tape tests which appeared in the October issue.

Advent tells us that they no longer use the Advocate brand name and have changed to screw construction. Ampex cassettes are of welded construction, while Maxell UD and LN cassettes are screw assembled. TDK LN cassettes will be available only until dealer supplies run out.

The statements on frequency response and headroom should not be compared between the chromium dioxide and ferric oxide portions of the tests, as some readers are reportedly doing. They were meant for comparison only within their respective sections. As we have stated a number of times in the past, CrO₂ tape is superior to FeO₂ tape in frequency response and S/N. This margin appears to be decreasing with the recent developments in ferric oxide.

Several readers were concerned because response of some cassettes was not as high as specified by the makers. For example, Maxell claims a 3 dB point of 15.7 kHz for the LN tape and 17 kHz for the UD. These tests place a great premium on the recorder, as we have often said, and a small change in set-up, bias (if adjustable), or test method can make a large difference in results. However, while absolute response of the tapes might vary, relative ranking would remain the same.

In the future, we will include tests of new brands and formulations as part of our tape recorder tests.

Audio Fallacy

Tape is a better medium than records. Wrong—at least in terms of *absolute* fidelity. Records made by the direct-disc method (e.g. the Sheffield series) are superior to those made with a tape intermediary. The difference is mainly in transient response but it can definitely be heard in an A-B test. **Æ**

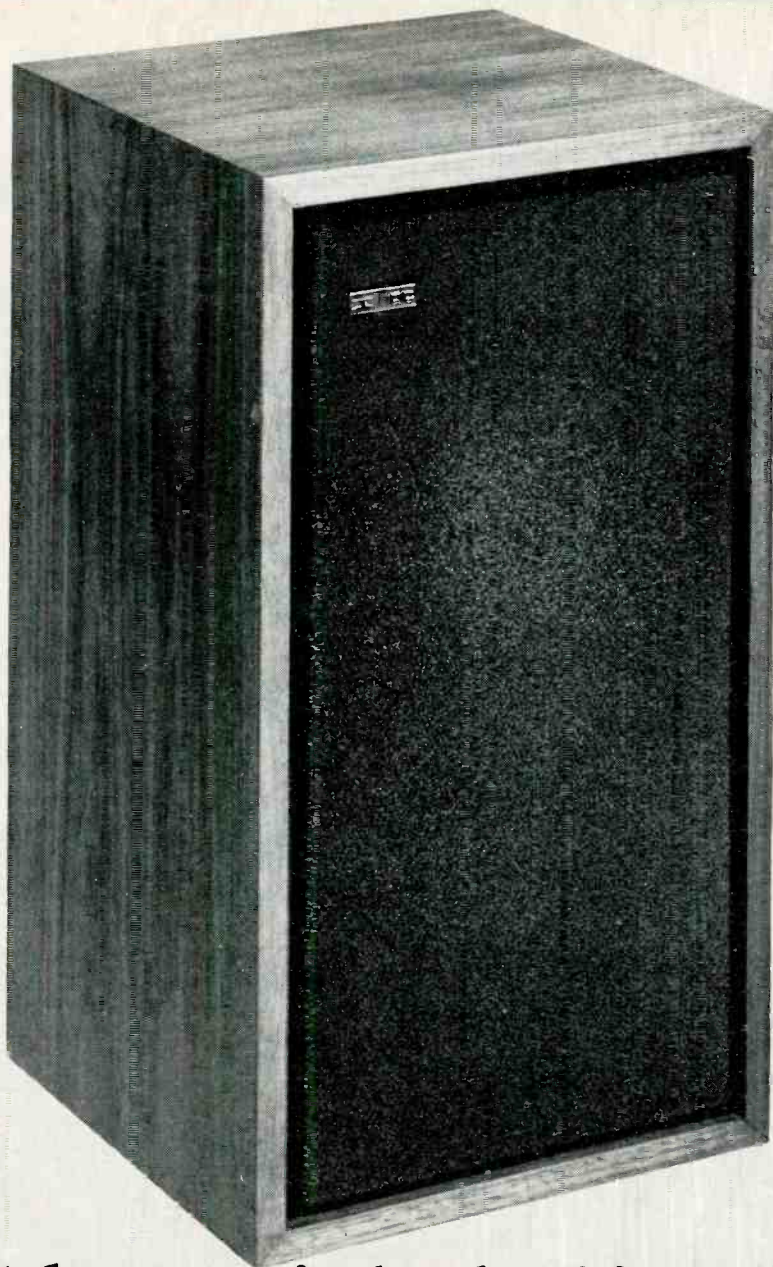

The new ADC-XT 10.

If you believe, as we do, that the ultimate test of any speaker is its ability to produce a true audible analog of the electrical signal fed to it, you'll be very impressed with the new XT 10.

The XT 10 is a two way, three driver, system employing a newly developed ten inch, acoustic suspension woofer with an extremely rigid, light weight cone and a specially treated surround that permit exceptionally linear excursions.

Matching the XT 10's outstanding low frequency performance are two wide dispersion tweeters that extend flat frequency response to the limits of audibility (see accompanying frequency response curve) and significantly improve power handling capacity.

All three drivers are mounted in a beautifully finished, non-resonant, walnut enclosure. And in place of the conventional grille cloth is an elegant new foam grille.

An extraordinarily accurate transducer, the XT 10 is characterized by very flat frequency response, excellent high frequency dispersion and extremely low distortion. Finally, it is distinguished by outstanding transient response assuring exceptional clarity and definition.

As a result, the ADC-XT 10 rivals and in many instances, surpasses the performance of units costing several times as much.

But why not experience for yourself what a truly well behaved speaker sounds like. Audition the XT 10 at your ADC dealer now.

For more detailed information on the ADC-XT 10 write: Audio Dynamics Corporation, Pickett District Road, New Milford, Conn. 06776.

It does precisely what it's told.

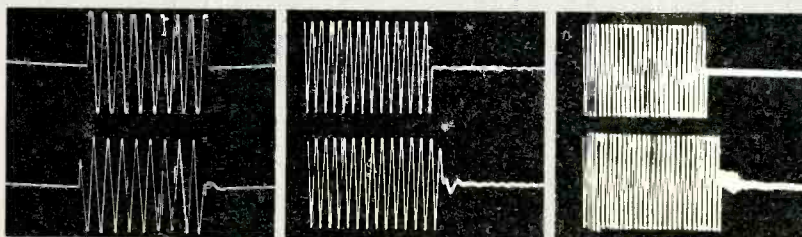
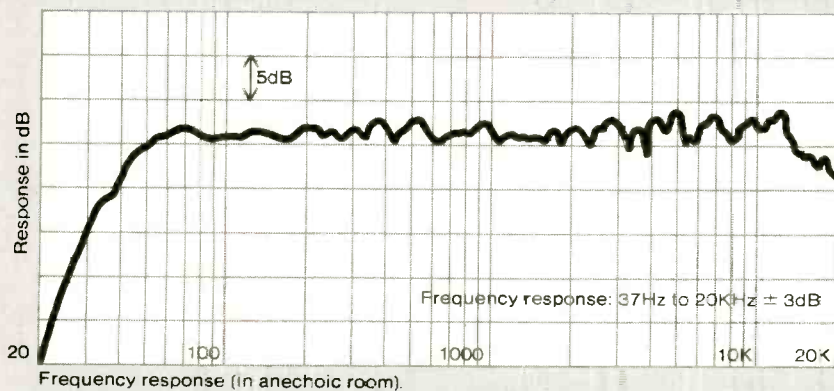

Tone bursts at 500Hz, 1200Hz, 15,000Hz
Virtually identical waveforms from signal generator above
and speaker below demonstrate superior transient response.

ADC Audio Dynamics
Corporation

Check No. 5 on Reader Service Card

... noise from the air conditioning system. Our mics were faithfully picking up a hum and a low frequency rumble from the ducts of the system. It wasn't loud, but it was pervasive. In the tropical climate of San Juan in June, the air conditioning would be used for the concerts. We would just have to live with it for the present.

When we finally met Don Pablo, it was quite a thrill. It isn't often you meet a living legend! The photographs of Casals that I had seen, turned out to be a fairly accurate reflection of the man. He was a short, rotund little man, with a benign, cherubic countenance and with the omnipresent Oom

Paul pipe between his lips. His manner was very courtly, very old-world Spanish, and while an occasional smile would illuminate his face, for the most part he seemed to turn a solemn visage to the world. At the time we met, Don Pablo was 83, and though he moved slowly, he had remarkable vitality for his age. In support of this, we noted with some amusement that it was Don Pablo's habit to take long walks on the beach every morning, parasol shading him from the sun, with his 26-year-old wife, Martita, at his side. But she would tire, and then keep pace with him in a car on the road above the beach!

When we finally heard Don Pablo play his cello, it was a revelation. It would be foolish not to admit that other, younger artists now surpass him in sheer technical virtuosity. But what sumptuously rich tone this old man coaxed from his magnificent instrument! The sound was pure, lambent and always "cantabile" . . . singing, heartfelt.

The final concert of the month-long Festival featured Don Pablo performing the Dvorak Cello Concerto, with his friend "Sasha" Schneider on the podium. As it turned out, this was to be the last time that Pablo Casals would play any of the great concertos for his instrument, the rigors of performance making too great a demand on his physical resources.

Mics all in the proper place, tape rolling, the Concerto was under way. All went fairly smoothly . . . some ragged ensemble playing here and there, Don Pablo producing miracles of tone in a very moving performance, until he reached the cadenzas. Obviously tiring, he was a bit shaky and his intonation and fingering were off. But he got through them and gave us some poignantly beautiful playing to the rousing conclusion of the work.

After all the congratulations and social amenities were over, Don Pablo asked for a playback of the tapes, especially the cadenza section. He listened, nodding approval, but when we reached the cadenzas he obviously was distressed. He asked me if it would be possible to record the cadenzas again and splice them into the master. I agreed, of course, and the next morning, apparently refreshed and under less tension, Don Pablo played quite smoothly and the results were considerably better than during the concert. At the conclusion of the session, Don Pablo shook hands with everyone, and when he reached me, grasped me with both hands and said, "Thank you, thank you, young man, for a wonderful recording."

Now, a sad footnote to the whole affair. Because of certain legal and financial problems, the Festival recordings were never released. The tapes are somewhere either in San Juan, or Washington, D.C. I made a copy of the Dvorak Concerto, and when Don Pablo passed away at 96, I played the tape in his memory. There is hiss on the copy, and there is that damnable low frequency junk from the air conditioning system in the concert hall. Happily, I have found a way to cope with this problem, and with similar problems on other tapes. There is a splendid "sonic bandaid" that can be applied, known as the Burwen Dynamic Noise Filter. A report on this remarkable device next month. **AE**

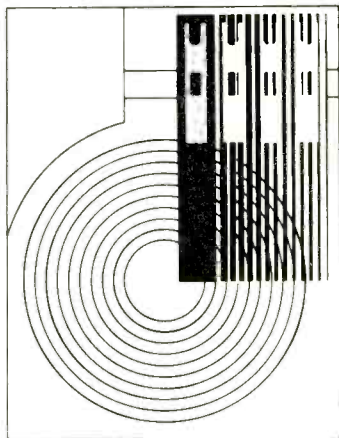

We've got the best anti-skating device ever... none at all

Master records are made by machines that drive the cutting head *in a straight line* across the record. But when you play *your* disc with a conventional pivoted arm system, the revolving groove pulls the stylus towards the center. This is called "skating force."

Skating force causes wear on the inner wall of the groove and the stylus.

and results in a loss of separation as well as distortion levels simply not acceptable to the serious listener

Most good pivoted arm systems *do* have anti-skating devices. But they can only be set for *average* skating force and an anti-skating device that remains *constant* cannot fully compensate for all of the *varying* forces exerted during the playing of a record. Even the *total* elimination of tracking error does not eliminate the *inherent* problem of the pivoted arm skating force.

The RABCO pickup moves in a straight line. The record is played precisely as it was originally cut. There is no anti-skating device for one simple reason: The RABCO system eliminates skating force.

We want to tell you more about how we eliminate both skating force *and* tracking error. Drop us a note and we'll send full information straight away

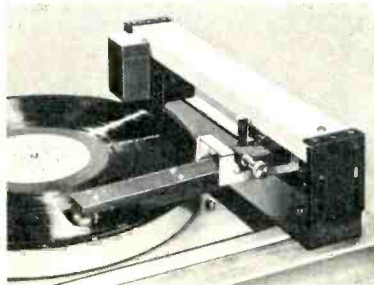

The RABCO SL-8E
A straight tracking tone arm
for your turntable



The RABCO ST-4...
A professional turntable
with the RABCO tone arm system

Check No. 34 on Reader Service Card



In Quest of Perfection...

Neil Diamond is an artist who creates scenes with music. So when he decided that state-of-the-art sound systems be used during press premières to reproduce his original music score for the film *ONATHAN LIVINGSTON SEAGULL*,* realism in terms of spectral balance, spatial character, and lifelike sound-power levels were mandatory requirements.

To reproduce the music he created, Neil Diamond personally selected BOSE 901 Speakers, commenting: "After auditioning what were reputed to be the best high fidelity speakers on the market today, I chose BOSE 901 Speakers because they offer the ultimate in theatre music reproduction." This will come as no surprise to thousands of BOSE 901 owners around the world who believe they have the ultimate in music reproduction in the home.

In our continued quest of audible perfection, we have introduced the new BOSE 901 SERIES II Speakers -- a product of over 15 years of research in musical acoustics.† We invite you to compare the 901s with any speaker on the market today, regardless of size or price. And judge for yourself if you agree with Neil Diamond's selection and with the rave reviews of the music and equipment critics.

For information on the 901 SERIES II, complimentary copies of the reviews, and a report on the theatre sound system competition, circle your reader service card or write Dept. A1.

*Original motion picture soundtrack recording available on Columbia records and tapes.

†This research is presented in the article "Sound Recording and Reproduction" published in *TECHNOLOGY REVIEW* (MIT), Vol. 75, No. 7, June '73. Reprints are available from BOSE for fifty cents a copy.

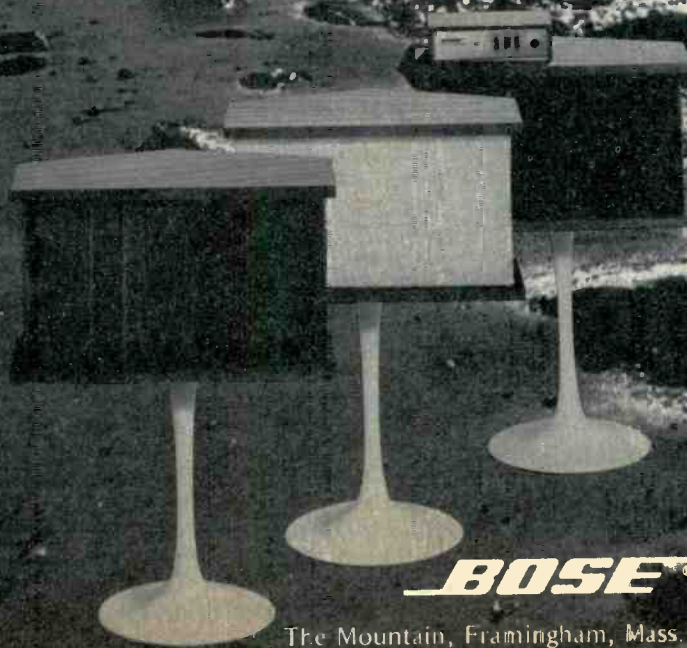

BOSE

The Mountain, Framingham, Mass. 01701

Check No. 13 on Reader Service Card

summit at 30 kHz and its sides—both sides—nicely symmetrical, is what the doctor is really looking for. That could be the ideal response maybe? I'm beginning to get that idea, anyhow. Not flat but gracefully contoured.

Down in the audio band, this would be a "presence peak" and we could rightly object to it in loud, strident tones. But not above! FM is different.

And so—some interesting conclusions. It is quite possible, you see, to get results far out in the sonic stratosphere

even with cartridges wildly unintended for the purpose. If you are not too fussy, that is, and don't mind scaling a few heavy mountain peaks. A good strong Pike's Peak in response, for instance, perhaps generated by the combination of a Shibata-like stylus and a tougher, harder record material (the two have roughly the same effect), could make a passable CD-4 cartridge even out of a real dog.

If your CD-4 pilot "radar" light flicks on in your demodulator, you have

some response up there and you'll get some semblance of quadrasonic sound, even if the cartridge is acting like the Matterhorn itself and all its associated peaks in a line, the Breithorn, Monte Rosa, Mont Blanc, the Gornergrat and what have you. Some curve! But the 30 kHz point gets tweaked. The demodulator hears something—and turns it into recognizable audio.

Of course the CD-4 manufacturers sure can't talk out loud this way. They can admit to nothing less than the fi-est. But you get the implication, and it is important. Note the early RCA demo in which a species of "discrete" sound was produced from a very ordinary and cheap standard magnetic cartridge. Did they know what they were doing! We talk about the ideal and super-fi CD-4 response but what really matters (alas) is whether we can get some response out of a low-cost mass-production CD-4 system.

Well, we got some stereo, and still do, out of a hundred million unmentionably awful commercial stereo rigs, didn't we and don't we? The fact is, I think, that you can tweak that supersonic pair of signals well enough with a very ordinary and inexpensive cartridge. Just dicker around with the triple determinants, play with the stylus and with the disc itself, juggle your outlandish peaks, until you hit the right bit of stratosphere. You have it! A supersonic cartridge for \$1.98! Am I looking into the future?

To be sure, there are a few other bugs to be doused with electronic aerosol, but let that pass. . . I'm just playing with what I suspect is canny CD-4 thinking right now, well behind the scenes. What with miracle chips and all that, the system is adaptable, I'd say, to cheap mass production though maybe it'll take a really agonizing while to get things down to the basic mediocre level. Don't laugh. The lower that level, my friends, the higher can we afford to make (and sell) our hifi.

Curious. In this sense, you see, the rival matrix quadrasonic system is a blessing, not even in disguise, because it is holding things together with its relatively simple and already advanced home equipment while the difficult research in the CD-4 area continues at full pressure. (Well, it was continuing when I wrote this.) I've long ago decided for myself that these two systems are, in spite of rivalry, curiously complementary. Isn't it odd to think that, maybe, neither one of them could continue to exist without the other? Could be. Æ



what is a JR-200M to an audiophile?

Sound is to the audiophile what salt is to pepper, diamond's to a girl, or an oasis to a desert. Each has a most important relationship. That's why an audiophile, a real sound expert prefers TRUSONIC JR-200M's magnificent studio quality reproduction. Clean, undistorted sound from this 12" 3-way speaker system again demonstrates the incomparable electronic technology of TRUSONIC. THE PRICE? You

can pay twice as much, but you won't find a better studio quality system. Write TRUSONIC for complete information on JR-200M.

Just a few of JR-200M's impressive engineering features are 12" woofer for distortion-free low frequency bass performance 5" mid-range speaker for clean voice and horn reproduction, and a horn-loaded dome radiator tweeter for high frequency. A carefully engineered crossover network, plus individual level controls to adjust midrange and tweeter sound independently, are included. Size is: 24" x 15 1/4" x 12" deep. Finish: Hand-rubbed oil finish, Walnut veneer.

NET \$149.95



TRUSONIC
1100 E. Franklin Street
Huntington, Indiana 46750

Export: Morhan Exporting Co.
270-78 Newton Road
Plainview, N.Y. 11803

Check No. 48 on Reader Service Card



If you're seriously into music or sound reinforcement you want more than hi-fi products can give you. But full professional studio gear costs an arm and a leg, and you pay for a lot of things you may not really need.

You pay for what you need

up to four additional input modules and other optional accessories including talkback, remote transport control, quad paner, and headphone monitor.

That's why there's a TASCAM Model 10. It's an 8-in, 4-out mixing console, and it's just \$1890.

With the Model 10 you get what you have to have. Without sacrificing a single necessary function.

Each input module gives you mic and line attenuation, three bands of peak and dip equalization (two with frequency selection), pre- and post-echo send and receive circuitry, pan function, and a unique straight-line fader.

Each of the four submasters has a meter control switch (line/echo), independent monitor level control, echo receive level control, and a straight-line fader. You also get a master gain module and 4" VU meters with LED peak indicators. Plus pre-wired facilities for

That's what you need and that's what you pay for. Some things, however, you may or may not need, and we leave that choice up to you. For instance, the basic Model 10 is high impedance in and out, but studio line impedances are available optionally. You'll probably want low impedance mic inputs, but you may not need all low impedance line inputs. So we don't make you pay for them. You can order any combination of high and low input/output impedances according to your application.

Details and specs on the Model 10 are available for the asking. At the same time we'll tell you about our new Series 70 Recorder/reproducers.

We've got what you need.

TASCAM CORPORATION

5440 McConnell Avenue
Los Angeles, California 90066

Check No. 45 on Reader Service Card

Editor's Review

LAST MONTH we spoke of anniversaries on this page, and again this month there are some we should not let pass without at least a brief mention.

Deutsche Grammophon Gesellschaft celebrated its 75th anniversary with a monster birthday party in Hamburg's new Congress Center. In attendance with some 1600 other figures from politics, entertainment, and the press were Dr. Gustav Heinemann, President of Germany; the Mayor of Hamburg, and Germany's Minister of Culture.

The entire celebration was devoted to honoring Emile Berliner, who invented the disc record and player—the gramophone—and the method of mass producing discs from a single master. Berliner also invented the microphone and the famous "His Master's Voice" trade mark, which was taken from a painting by Francis Barraud.

Capping the evening was the presentation to the Berliner family of DGG's Golden Gramophone award. Normally given to an outstanding entertainer, the award was made in honor of the founder of DGG and of today's record industry. Oliver Berliner, Emile's grandson, accepted the 1/3-size gold replica of the first disc player and is shown below with his children, Tracy and Todd.

A Decade Ago

Another European anniversary, this time from Philips, is that of the cassette system, which was introduced at the Berlin *Funkausstellung* in 1963. The original machine, designated the EL 3300 (shown below), was a portable unit, with only moderate fidelity but having a distinct "personality" in its battery operation and ending of "fumble-fingered" tape handling through introduction of the cassette.

Philips, of course, had competitors in the development of easy-handling tape formats. Grundig, 3M, and Philips each had produced different types of

cassettes, while Muntz, Lear Jet, and Ortronic had produced endless-loop cartridges. To explain the success of the system, Philips credits its design abilities in producing the relatively foolproof cassette player system and the marketing decision to allow any manufacturer to make the system so long as they used Philips' standards.

What is most astonishing about the intervening 10 years, to me at least, is the extremely wide variety of machines available now which are generically "cassette player/recorders." There is a discount operation down the street where I can buy a cassette player for just less than \$20.00, while at the other end of the scale there are the "pro" machines such as the TEAC 850 at \$580.00 and the Nakamichi 1000 at \$1100.00 (which I can't afford at all). Needless to say, there are machines at almost every price level in between and they offer all sorts of features—noise reduction systems, timers, memory rewind systems, bias and equalization switching, etc. The cassette player/recorder has come a very long way from that first model; who knows where it will be 10 years hence?

CD-4 Chip

JVC has announced that an integrated circuit version of the CD-4 demodulator circuit has been developed in cooperation with Signetics. The chip, Model CD4-392, will be available from Signetics in this country and its representative, Asahi Glass Co., Ltd., in Japan beginning early this year. JVC will also be offering two demodulator circuit boards, Models TDM-18A and TDM-19A, each using two of the chips. The latter is intended for high quality components. It is reported that new circuitry allows use of any type of four-channel pick-up combination without the need for carrier adjustment even when styli or cartridges are changed. The IC also is said to automatically switch between two and four channels. *E.P.*



To fulfill the requirements of the most critical listening and auditioning... Stanton is the professional standard.

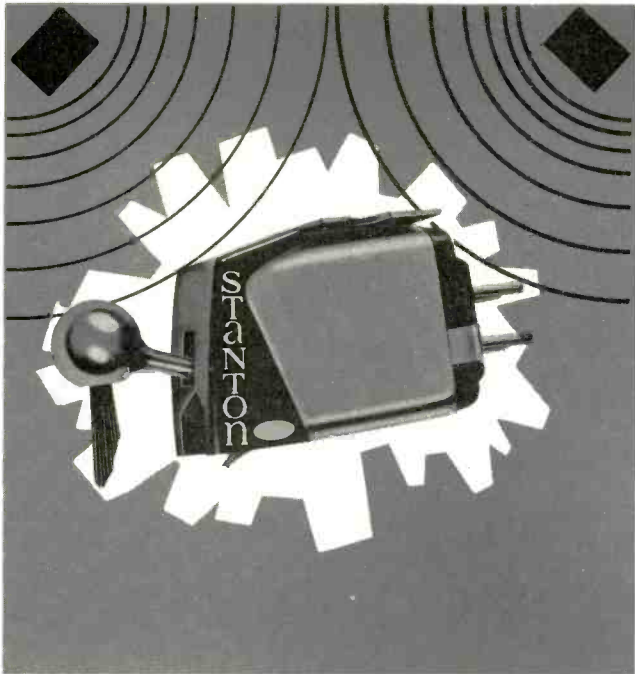

in STEREO— The Stanton 681EE

If critical listening is to be unbiased, it must begin with a stereo cartridge whose frequency response characteristics are as flat as possible. One that introduces no extraneous coloration as it reproduces recorded material. For anyone who listens "professionally," the 681EE offers the highest audio quality obtainable at the present 'State of the Art.'

Many record critics do their auditioning with Stanton 681EE. Recording engineers have long used the Stanton 681A to check recording channel calibration. The 681EE provides that logical continuation of the Stanton Calibration Concept. High compliance and low tracking force assure minimum record wear. Its low-mass, moving magnetic system produces virtually straightline frequency response across the entire audio spectrum. Its built-in longhair brush keeps the stylus dust-free, and protects record grooves, thus reducing noise and wear. Each 681EE is individually calibrated, and the results of these calibration tests are included with each cartridge.

The Stanton 681EE—used by recording engineers, broadcasters, critics and audio professionals—the cartridge that sounds like the record sounds, always.

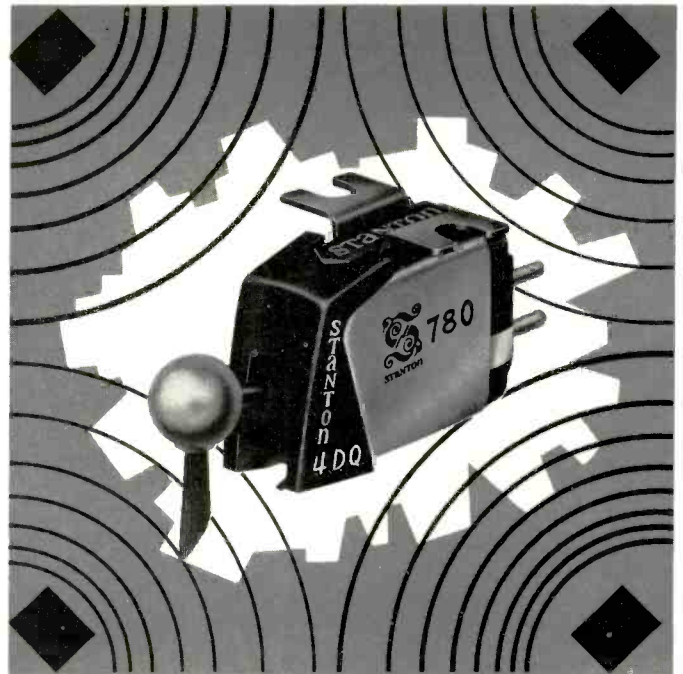

in DISCRETE 4-CHANNEL— The Stanton 780/4DQ



QUADRAHEDRAL

A totally revolutionary stylus design concept proves to be the best solution for discrete playback. It's the Quadrahedral—all tests and in-use demonstrations authenticate the value of the discovery. Stanton has this new stylus in its four channel cartridge.

This is the first American designed and manufactured stylus developed for discrete four-channel records. It was especially engineered for the Stanton 780/4DQ cartridge which is already the first choice of professional record reviewers, anxious to evaluate the new discrete 4-channel discs coming on the market.

The performance of the stylus (and cartridge) fulfills all the extensive demands and sophisticated requirements necessary for playback and review of all the material recorded on discrete discs. And while performing brilliantly, it is actually very kind to records in terms of wear. Stanton's own engineers, whose professional products are the standards of the industry, tested and proved its characteristics, and report that it functions with total reliability in every measurable aspect.

This new cartridge, the 780/4DQ is available at your franchised Stanton dealer.



For further information, write: Stanton Magnetics, Inc. Terminal Drive, Plainview, N.Y. 11803.

Check No. 32 on Reader Service Card

NEW IHF TUNER SPECS

Leonard Feldman

IF YOU ARE a regular subscriber to AUDIO, you may remember that in the January 1973 issue I wrote an article in which I pointed out how obsolete the tuner measurements we use in describing FM products had become since their original issuance by the Institute of High Fidelity way back in 1958. In that article, I also suggested a number of additional measurements that I thought should be published by manufacturers, as well as the revision of a few existing specifications and their method of measurement.

Since then, the IHF has been engaged in the preparation of new proposals for measurement standards, and the first draft of Tuner Measurement Standards is currently being analyzed by the Board of Directors of that organization, as well as by members of the sub-committee that had volunteered to come up with such new standards. As is true of many industry organizations, trying to agree upon standards is a difficult task. Comments on the first draft of the proposed tuner standards have ranged all the way from "It's not tough enough" to "It's much too complicated and there are too many measurements called for." There is, however, unanimity of agreement that new standards *are* needed and that new emphasis must be given to stereo performance measurements. The old 1958 standards were confined to monophonic performance only—simply because stereophonic FM did not become a commercial reality until 1961—three years after the standards were issued!

Here, then, is a summary of the measurements, old and new, that would be required if a manufacturer were to go along with the new proposal for Tuner Measurement Standards.

IHF Sensitivity

In the old standards, this spec combined the effects of residual noise and residual harmonic distortion in one meaningful number, as illustrated in Fig. 1. With 100 per cent modulation applied at an audio frequency of 400 Hz, a suitable 400 Hz null filter was inserted between the output

and the output meter and signal input was reduced until a difference of 30 dB was observed between readings with and without the filter in place. The number of microvolts applied to the antenna terminals to fulfill this requirement was then called IHF sensitivity, or "least usable IHF sensitivity." In Fig. 1 the value for this measurement is 2.0 microvolts.

Today, variations in this reading are minimal. While manufacturers continue to quibble over whether their product achieves an IHF sensitivity of 2.0 μ V, 1.9 μ V or 1.8 μ V, from the consumer's point of view there is little audible difference between the performance of tuners at such low input signal levels. No high fidelity enthusiast is likely to be content with a signal-to-noise ratio of 30 dB today, nor is harmonic distortion of 3 percent a satisfactory figure by today's standards. The newly proposed measurement standard for tuners introduces two new measurements to supplement this all but meaningless number. A "50 dB quieting sensitivity" specification has been proposed in recognition of the fact that a 50 dB signal-to-noise ratio constitutes reasonably good listening quality by today's standards. As seen in Fig. 1, the reading for this new measurement, in this example, turns out to be about 5.0 microvolts. The new measurement also provides the prospective purchaser with an indication of how rapidly, or steeply, the quieting curve approaches its maximum value, which in this case turns out to be about 65 dB, a reading identified as the ultimate S/N ratio in both the old and newly proposed measurement specifications.

Since the new measurement does not combine residual distortion with residual noise, a separate measurement should be made of total harmonic distortion when the signal applied is that required for the 50 dB quieting result. A plot of THD versus signal input is shown in Fig. 2 and at 5 microvolts the hypothetical tuner produces about 1.2 per cent distortion, still measured with full modulation applied to the r.f. signal. In the interest of uniformity, it has been suggested that 1000 Hz be used as the modulating frequency for all single tone measurements instead of the 400 Hz previously used. At

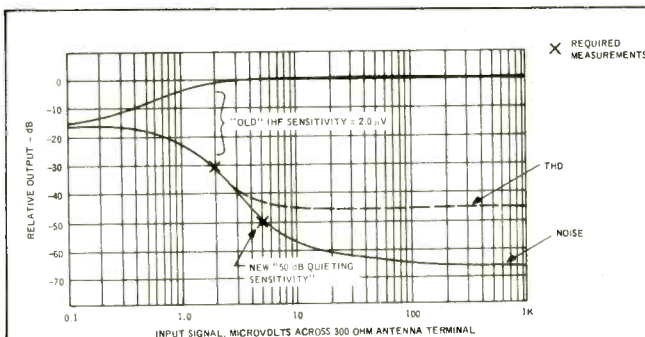

Fig. 1—Existing IHF sensitivity measurement would be augmented by "50 dB quieting sensitivity" measurement.

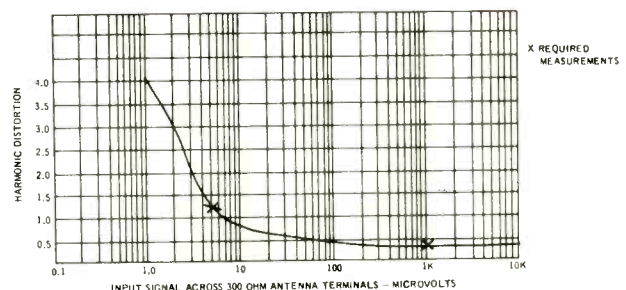

Fig. 2—Total harmonic distortion decreases with increasing r.f. signal input, until "ultimate" THD is reached.

so much power



for so much less

Sansui's new 661 and 771 stereo receivers give you more power for less money. New IC chips and CBM (Circuit Board Module) technology make better and more reliable electronic circuitry and make it possible to offer these receivers at less cost than any other comparable quality units.

For example our new 771 AM/FM receiver puts a full 40 watts RMS per channel into 8 ohm speakers with both channels driven. That's enough power to drive two pairs of most any-

body's speakers. And at \$339.95 that's value. But power is not the only story behind our technology. CBMs mean that individual sections are more compact and built to closer tolerances. Our new IC equipped FM multiplex demodulator gives you better separation with less distortion. Hear the 771 or the 661 with 27 watts per channel, for \$289.95 at your nearest franchised Sansui dealer.



SANSUI ELECTRONICS CORP.

Woodside, New York 11377 • Gardena, California 90247

SANSUI ELECTRIC CO., LTD., Tokyo, Japan

SANSUI AUDIO EUROPE S. A., Antwerp, Belgium • ELECTRONIC DISTRIBUTORS (Canada) Vancouver 9, B.C.

Check No. 39 on Reader Service Card

this frequency, the de-emphasis characteristic having a time constant of 75 microseconds will influence the reading by about 1 dB, but this is considered negligible, and since it has become standard practice to quote stereo separation and other related measurements referenced to 1000 Hz, the switch to this frequency for a majority of required measurements would simplify procedures somewhat.

Most manufacturers have, up to now, listed distortion for a single mid-band audio frequency. It is now suggested that frequencies of 100 Hz, 1000 Hz, and 7.5 kHz be used to measure THD and that at least the results of these three measurements be listed in the specifications. The curve of Fig. 3 is a complete plot of THD in monophonic mode versus frequency and the three required points are designated, both for the THD at 50 dB quieting sensitivity and for the "ultimate" THD readings, one of which was required to be published in the old standards.

While measurement of capture ratio was a requirement of the older standards, it has been found that capture ratio varies considerably with input signal strength on many tuner products. The newly proposed standards therefore require that the results of this measurement be published for input signal strengths of 100 microvolts as well as 1000 microvolts.

A completely new measurement applicable to the monophonic portion of the tuner is "adjacent channel selectivity." The older Standards outlined the means for making this measurement but required only that alternate channel selectivity figures be published. Today it is not at all uncommon to detect interference of the desired channel by an adjacent channel displaced in frequency by only 200 kHz rather than 400 kHz, and so both measurements of selectivity should be stated, and each should be properly identified. There has been a tendency on the part of manufacturers to abbreviate the "alternate channel selectivity" measurement and to simply call it "selectivity."

AM suppression, or the ability of an FM tuner or receiver to reject AM modulation of the received r.f. signal, was a required measurement in the case of the older Standards. Only one measurement was required, with an r.f. input signal strength of 100 microvolts. Again, recognizing that this parameter varies considerably with input signal strength on most tuners, it has been proposed that the results of this measurement be presented or published for input signal strengths of 100 microvolts and the 50 dB quieting sensitivity value of microvolts determined in the earlier measurement. It should be noted that the AM suppression capability of a product is directly related to its response to multipath signals and the distortion and other adverse effects noted in the presence of such reflected signals—particularly in the case of stereo reception.

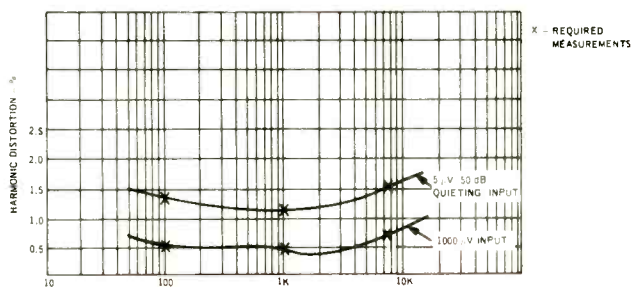

Fig. 3—Harmonic distortion vs. frequency, plotted for monophonic operation at signal input levels of 1000 microvolts and "50 dB quieting sensitivity."

Stereo Measurements

As noted earlier, the old tuner standards did not concern themselves with measurements of stereophonic performance. The newly proposed standards attempt to rectify this situation by adopting and standardizing many of the measurements that some manufacturers have voluntarily published in their advertising literature over the past few years. In the high fidelity component field at least, much of the FM listening done is in the stereophonic mode. Signal-to-noise ratios in this listening mode are considerably poorer than when listening to monophonic transmission because of the greater bandwidth employed by the stereophonic composite signal and because of the AM modulation used to modulate the suppressed 38 kHz sub-carrier used.

The newly proposed standards require that "least usable sensitivity," measured in much the same manner as it was in monophonic units, be measured for stereophonic reception as well. In order that residual carrier products not be included in the residual noise and distortion reading, this measurement (and several related stereophonic measurements) should be made with a suitable band-pass filter inserted between the outputs of the stereophonic tuner and the metering instruments and null filter or distortion analyzer. The two curves plotted in Fig. 4 show a typical comparison between monophonic least usable sensitivity and stereophonic least usable sensitivity.

For the reasons stated earlier, the new "50 dB quieting sensitivity" measurements should be repeated for stereo reception and the total harmonic distortion observed at that quieting sensitivity should also be measured and published. In general, harmonic distortion at almost every signal input level is higher when operating the tuner in the stereo mode than when it is operated monophonically. A typical pair of curves comparing distortion for monophonic and stereophonic operation of our mythical tuner is plotted in Fig. 5 for frequencies of 100 Hz and 7.5 kHz (in the case of monophonic), or 5 kHz in the case of stereophonic. The lower 5

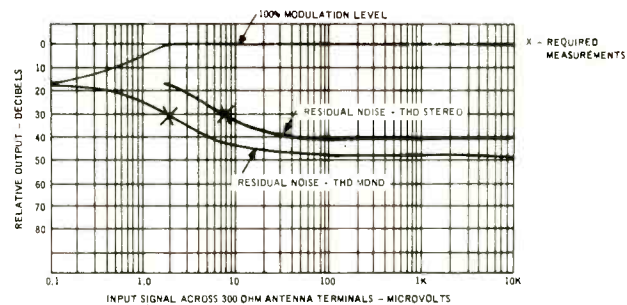

Fig. 4—Typical measurements of "least usable sensitivity" in mono and stereo modes of a tuner.

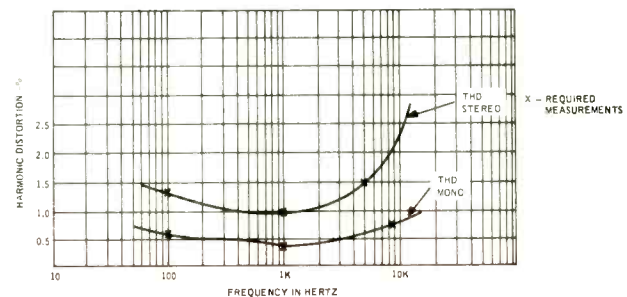

Fig. 5—Harmonic distortion vs. frequency at mono and stereo outputs of tuner under test, with 1000 microvolt input signal.

Now BIC VENTURI™ puts to rest some of the fables, fairytales, folklore, hearsay and humbug about speakers.

Fable

Extended bass with low distortion requires a big cabinet.

Some conventional designs are relatively efficient, but are large. Others are small, capable of good bass response, but extremely inefficient. The principle of the BIC VENTURI systems (pat. pend.) transforms air motion velocity within the enclosure to realize amplified magnitudes of bass energy at the BIC VENTURI coupled duct as much as 140 times that normally derived from a woofer

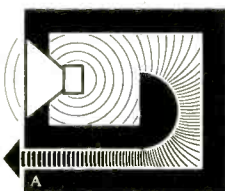

(Fig. A). And the filtering action achieves phenomenally pure signal (Scope photos B & C). Result: pure extended bass from a small enclosure.

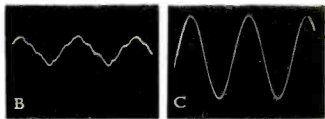

B—Shows output of low frequency driver when driven at a freq. of 22 Hz. Sound pressure reading, 90 dB. Note poor waveform.
C—Output of venturi coupled duct, (under the same conditions as Fig. B.) Sound pressure reading 111.5 dB, (140 times more output than Fig. B.) Note sinusoidal (nondistorted) appearance.

Fairytale

It's okay for midrange speakers to cross over to a tweeter at any frequency.

Midrange speakers cover from about 800 Hz to 6000 Hz. However, the ear is most sensitive to midrange frequencies. Distortion created in this range from crossover network action reduces articulation and musical definition. BIC VENTURI BICONEX horn (pat. pend.) was designed to match the high efficiency of the bass section and operates smoothly all the way up to 15,000 Hz, without interruption. A newly designed super tweeter extends response to 23,000 Hz, preserving the original sonic balance and musical timbre of the instruments originating in the lower frequencies.



Humbug

You can't retain balanced tonal response at all listening levels.

We hear far less of the bass and treble ranges at moderate to low listening levels than at very loud levels. Amplifier "loudness" or "contour" switches are fixed rate devices which in practice are defeated by the differences in speaker efficiency. The solution: Dynamic Tonal Compensation™ This circuit (patents pending) adjusts speaker response as its sound pressure output changes with amplifier volume control settings. You hear aurally "flat" musical reproduction at background, average, or ear-shattering discoteque levels — automatically.

Folklore

Wide dispersion only in one plane is sufficient.

Conventional horns suffer from musical coloration and are limited to wide-

angle dispersion in one plane. Since speakers can be positioned horizontally or vertically, you can miss those frequencies so necessary for musical accuracy. Metallic coloration is eliminated in the BICONEX horn by making it of a special inert substance. The combination of conical and exponential horn flares with a square diffraction mouth results in measurably wider dispersion, equally in all planes.



Hearsay

A speaker can't achieve high efficiency with high power handling in a small cabinet.

It can't, if its design is governed by such limiting factors as a soft-suspension, limited cone excursion capability, trapped air masses, etc. Freed from these limitations by the unique venturi action, BIC VENTURI speakers use rugged drivers capable of great excursion and equipped with voice coil assemblies that handle high power without "bottoming" or danger of destruction. The combination of increased efficiency and high power handling expands the useful dynamic range of your music system. Loud musical passages are reproduced faithfully, without strain; quieter moments, effortlessly.

A system for every requirement

FORMULA 2. The most sensitive, highest power handling speaker system of its size (19¼ x 12 x 11½)!" Heavy duty 8" woofer, BICONEX mid range, super tweeter. Use with amplifiers rated from 15 watts to as much as 75 watts RMS per channel. Response: 30 Hz to 23,000 Hz. Dispersion: 120° x 120°. \$98 each

FORMULA 4. Extends pure bass to 25 Hz. Has 10" woofer, BICONEX mid-range, super tweeter. Even greater efficiency and will handle amplifiers rated up to 100 watts. Dispersion: 120° x 120°. Size: 25 x 13¼ x 13" \$136 each.

FORMULA 6. Reaches very limits of bass and treble perception (20 to 23,000 Hz). Six elements: 12" woofer complemented by 5" cone for upper bass/lower midrange; pair of BICONEX horns and pair of super tweeter angularly positioned to increase high frequency dispersion (160° x 160°). Size: 26¼ x 15¼ x 14¾" \$239 each.

Sturdily constructed enclosures. Removable grilles in choice of 6 colors. Optional bases for floor standing placement. Write for brochure A-1.

Audition today's most advanced speakers at your BIC VENTURI dealer.



BRITISH INDUSTRIES Co., Inc.
Westbury, New York 11590.
A division of Avnet, Inc.,
Canada: C.W. Pointon, Ont.

BIC VENTURI™

Check No. 3 on Reader Service Card

IT'S AS FAR AS YOU CAN GO.

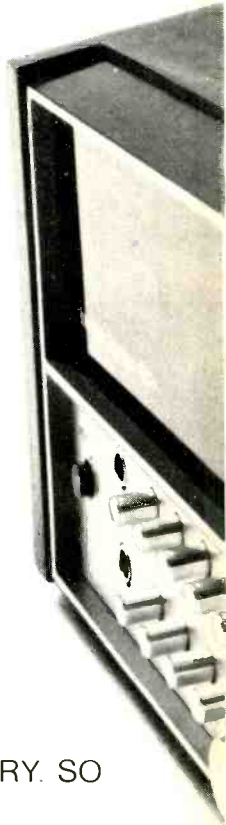

IF YOU'RE UP WITH WHAT'S HAPPENING IN THE HIGH-FIDELITY INDUSTRY YOU'LL KNOW HARMAN/KARDON IS CURRENTLY PRODUCING THE WORLD'S MOST ADVANCED RECEIVER LINE.

THIS 900+ IS THE CREAM OF THAT LINE.

IT CARRIES BOTH DISCRETE AND MATRIX FOUR-CHANNEL CIRCUITRY. SO IT WILL REPRODUCE EVERY TYPE OF QUADRIPHONIC MUSIC AVAILABLE. MOST FOUR-CHANNEL RECEIVERS CARRY ONLY ONE.

THE 900+ PUTS OUT AN ASTONISHING 32 WATTS PER CHANNEL, CONTINUOUS, WITH ALL CHANNELS DRIVEN SIMULTANEOUSLY. THAT'S A GOOD DEAL MORE POWER PER CHANNEL THAN MANY STEREO RECIVERS CAN MUSTER.

THE 900+ DOES NOT WEASEL THROUGH THE PROBLEM OF STEREO RECORD REPRODUCTION BY MERELY SHUTTING OFF THE TWO REAR SPEAKERS. INSTEAD, IT USES A UNIQUE PHASE SHIFT NETWORK TO PRODUCE AN ENHANCED STEREO SOUND THROUGH ALL FOUR SPEAKERS. YOUR STEREO RECORD LIBRARY WILL SOUND BETTER THAN EVER.

BUILT INTO THIS REMARKABLE MACHINE IS AN ANALOG COMPUTER THAT DISTINGUISHES BETWEEN MUSIC AND NOISE ON FM SIGNALS. NO OTHER RECEIVER

CAN PIN DOWN A STATION WITH SUCH HAIR-SPLITTING ACCURACY.

AND LIKE OTHER HARMAN/KARDON PRODUCTS, THE 900+ CARRIES ULTRA WIDEBAND CIRCUITRY. THIS ABILITY TO REPRODUCE FREQUENCIES YOU CANNOT HEAR, SIGNIFICANTLY IMPROVES THE CHARACTERISTICS OF THOSE FREQUENCIES YOU CAN HEAR. HARMAN/KARDON PRODUCTS ARE WORLD FAMOUS FOR THEIR FIDELITY.

IF YOU ARE IN QUEST OF THE PERFECT SOUND, THIS COULD BE WHAT YOU'RE LOOKING FOR

harman/kardon

55 AMES COURT, PLAINVIEW, N.Y. 11803, U.S.A. ALSO AVAILABLE IN CANADA

Check No. 23 on Reader Service Card

IHF Tuner Specs (Continued from page 23)

kHz figure is chosen for the highest frequency to be measured in stereo because many tuners with less than perfect multiplex decoding circuitry often produce sizable "beats" between high-frequency modulating frequencies and internally generated 19 kHz and 38 kHz pilot and subcarrier signals. These beats, while not truly in the realm of "harmonic distortion" would, nevertheless, be summed and read on the meter of a typical distortion analyzer. If readings of harmonic distortion at higher frequencies than the 5 kHz recommended for the stereophonic mode of a tuner are desired, the only practical way to do this is with a spectrum analyzer with which actual harmonic contributions related to the fundamental desired audio modulation can be individually measured and summed up to yield a meaningful total harmonic distortion figure.

In any case, by providing distortion figures at the three frequencies suggested for mono and stereo, the customer will be provided with a better basis of comparison of this quality than if THD is quoted for mono only—and at a mid-frequency at that. Again, it is suggested that distortion

figures for stereo operation be provided at the 50 dB quieting sensitivity signal input and at 1000 microvolt input.

Although a statement of frequency response was required by the old standards, a separate stereophonic frequency response measurement and specification should be recorded and published for stereo operation, since the results will often differ from those obtained and recorded for monophonic operation.

While most manufacturers of stereophonic tuners and receivers have been publishing the separation capability of their stereo circuitry, statements of this parameter have been largely confined to the dB figure measured at a midband modulating frequency of 1000 Hz, where separation is apt to be greatest. The newly proposed standard requires that separation capability be stated for frequencies of 100 Hz, 1000 Hz, and 10,000 Hz or that a complete plot of separation, such as that shown in Fig. 6, be made of this characteristic. The three required figures in this illustration would be 25, 40, and 22 dB, for 100 Hz, 1 kHz, and 10 kHz, respectively.

When a tuner is operated in the stereo mode, its ability to reject high frequency carrier signals is important for at least two reasons: A large amount of residual 19 kHz signal observed at the output of the tuner may be amplified by the high fidelity component amplifier with which it is used and may cause harm to high-frequency drivers in loudspeaker systems even though the listener may not be bothered by the presence of such a signal. Multiples of 19 kHz or residual products of the 38 kHz restored subcarrier may also "beat" with bias frequencies used in tape recorders and may therefore severely affect tape recordings of FM broadcasts made by the user. Accordingly, the new standards offer procedures for measuring rejection of such subcarrier signals by the product and define the manner in which such rejection capability is to be stated in published specifications.

Finally, standard means of measuring SCA rejection are proposed and a statement of this rejection capability, in dB, is made mandatory in published specifications.

The old standards required that certain specifications be published for a "minimum" description of product performance and that additional specifications of somewhat lesser importance be included if the specifications were to be

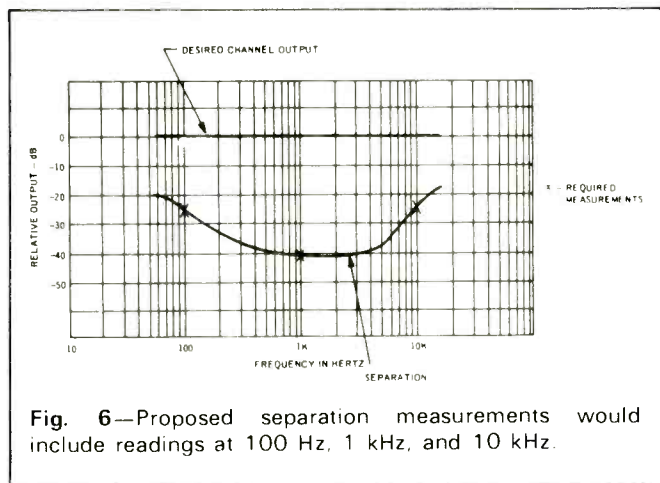

Fig. 6—Proposed separation measurements would include readings at 100 Hz, 1 kHz, and 10 kHz.

TABLE I
MINIMUM REQUIRED TUNER MEASUREMENTS

SPECIFICATION	MONO	STEREO
1. LEAST USABLE SENSITIVITY	UNCHANGED	NEW
2. 50 DB QUIETING SENSITIVITY	NEW	NEW
3. HARMONIC DISTORTION AT 50 DB QUIETING	NEW	NEW
4. ULTIMATE SIGNAL-TO-NOISE RATIO	UNCHANGED	NEW
5. ULTIMATE HARMONIC DISTORTION	REVISED	NEW
6. DRIFT	UNCHANGED	NOT REQUIRED
7. FREQUENCY RESPONSE	UNCHANGED	NEW
8. STEREO SEPARATION	---	NEW
9. SUB-CARRIER REJECTION	---	NEW
10. S.C.A. REJECTION	---	NEW

TABLE II
ADDITIONAL MEASUREMENTS REQUIRED FOR COMPLETE TUNER SPECIFICATIONS

11. INTERMODULATION DISTORTION	UNCHANGED	---
12. CAPTURE RATIO	REVISED	---
13. ALTERNATE CHANNEL SELECTIVITY	UNCHANGED	---
14. ADJACENT CHANNEL SELECTIVITY	NEW	---
15. SPURIOUS RESPONSE REJECTION	UNCHANGED	---
16. STEREO THRESHOLD	---	NEW
17. AUDIO HUM	UNCHANGED	---
18. AM SUPPRESSION	REVISED	---

People who are really serious about their records are the best ones to ask about turntables.

Most people who decide they want components turn to a friend who knows something about high fidelity equipment. If the friend is a reader of this magazine, that's good. And if the friend happens to be someone who reviews recordings, that's even better.

Record reviewers must select their equipment with great care, since they must listen with great care. To such things as the interpretation of the artist. To the recording and microphone techniques. And to the quality of the record surface itself.

All this is why the professional listeners select their turntables so carefully.

What most serious listeners know.

Professional listeners know that what they hear (or don't hear) often depends on the turntable.

After all, the turntable is the one component that actually handles records, spinning them on a platter and tracking their impressionable grooves with the unyielding hardness of a diamond. And the professional realizes that much depends on how well all this is done.

Which is why so many record reviewers listen to their records on a Dual. And why the readers of the leading music magazines buy more Duals than any other quality turntable.

They know that a record on a Dual will rotate at precisely the right speed, to give precisely the right pitch. (If a record happens to be off pitch a Dual can compensate for it.)

They know that a Dual tonearm will let the most sensitive stylus track the

wildest curves ever impressed on a record groove, and not leave a trace of its passage.

And they know that a Dual will perform smoothly, quietly, and reliably year after year after year. Despite all the precision built into a Dual, they know it's one turntable that doesn't have to be handled with undue concern. (Even if the tonearm is locked when play is started, or if the tonearm is restrained in mid-air while cycling no damage will result.)

If you'd like to know more.

A few examples of Dual precision engineering are shown in the illustrations. But if you would like to know what several independent test labs say about Dual we'll send you complete reprints of their reports. Plus a reprint of an article from a leading music magazine that tells you what to look for in record playing equipment.

Better yet, just visit your franchised United Audio dealer and ask for a demonstration.

Dual turntables may seem expensive at first, but not when you consider your present and future investment in records. And now that you know what the professional listeners know, doesn't it make sense to own what they own?

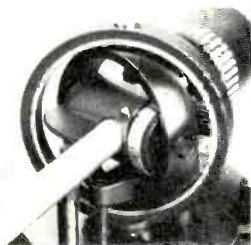

The gyrosopic gimbal suspension of the Dual 1218 and 1229 tonearms is the best known scientific means for balancing a precision instrument in all planes.

The 1218 and 1229 tonearms track records at the original cutting angle. The 1229 parallels single records, moves up for changer stack. A similar adjustment is in the 1218's cartridge housing.

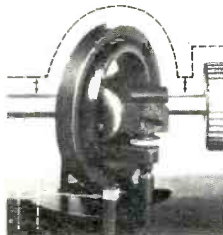

In all Dual models, stylus pressure is applied around the pivot maintaining perfect dynamic balance of the tonearm.

Separate anti-skating calibrations for conical and elliptical styli achieve perfect tracking balance in each wall of the stereo groove.



United Audio Products, Inc., 120 So. Columbus Ave., Mt. Vernon, N.Y. 10553

Exclusive U.S. Distribution Agency for Dual.

Check No. 47 on Reader Service Card

considered a "complete" statement of product performance. The newly proposed Tuner Measurement Standards have followed this same procedure and there are 10 specifications required to be published for "minimum" product description, as are shown in Table I. In the case of monophonic performance, some specifications, as noted in the Table, remain essentially unchanged from the old standard. Those listed as "revised" are specifications in which the method of measurement or the published requirements have been altered or increased, while the dash notation means that the particular specification is not applicable to monophonic performance. Totally new measurements, not previously called for in either the stereo or monophonic categories, are so noted.

Secondary specifications required for a "complete" presentation of product performance are shown in Table II. To fully specify the performance of a stereo tuner product, it would now be necessary to publish 14 specifications relating to monophonic performance and ten specifications relating to stereophonic performance.

It should also be noted that the old standards described measurements for AM tuners, or the AM section of combination tuner-receivers. The new standards make no new proposals with regard to these AM measurements and required published specifications.

As mentioned at the outset, comments have ranged from one extreme to the other. It has been suggested by some that recent findings in the field of psychoacoustics show that a simple measurement of harmonic distortion does not indicate how good (or how poor) a tuner will sound and that it is more important to specify what the harmonic contribution consists of. It is well known that high order harmonics are more disturbing than, say, simple third harmonic contribution which is at least musically related to the program material.

On the other hand, if one takes into account the deemphasis characteristic of FM tuners and receivers, the 7th harmonic of 400 Hz (12,800 Hz), for example, will be so far down that even if present, its contribution is not likely to alter the perceived program significantly.

It has also been suggested by some that, "A few meaningful numbers will be easier to understand than the many measurements suggested by this first draft." No doubt true, but how much further can the specifications be "boiled down" and still provide the knowledgeable customer with a basis of comparison between competing products? And if some measurements are to be eliminated from the published specifications, which ones should be dropped?

On the whole, however, comments thus far received have been helpful and the second draft, now in preparation, will reflect many of these suggestions, most of which have to do with the actual method of measurement rather than with the substantive information to be derived from those measurements. It is to be hoped that the second draft will be granted rapid acceptance by the membership of the IHF. Upon its acceptance, the next job will be to formulate new amplifier standards—a task which non-industry agencies such as the Federal Trade Commission and local consumer affairs bureaus have assumed and one which, in my opinion, the high fidelity component segment of the home entertainment industry is eminently more qualified to accomplish.

(Editor's Note: Much of the material covered by Len Feldman in this article was presented by him as a paper at the 46th Annual Convention of the Audio Engineering Society in September, 1973. In this article, Len has included some additional thoughts on the subject of tuner specifications, in the light of comments he received following that original presentation.)

AE

What's the gimmick with new Avid Speaker Systems?



Check No. 11 on Reader Service Card

There isn't any. Just quality design and thorough engineering. That's what makes the difference.

Avid's Series 100 Speaker Systems are the premium quality products of extensive research and testing by a team of audio experts whose knowledge and experience is unsurpassed in the field today (Avid has pioneered in the design of quality audio components for broadcasting, industry and education for the past 20 years). Each Series 100 model is unrivaled for performance and value in its class.

Superlatives come easy, but the only way you'll be convinced is to visit your Avid dealer, listen to the accuracy of sound reproduction and see the innovative styling for yourself. We're confident of your favorable verdict.

Avid Corporation, 10 Tripps Lane, East Providence, R.I. 02914 Tel. (401) 438-5400.

AVID

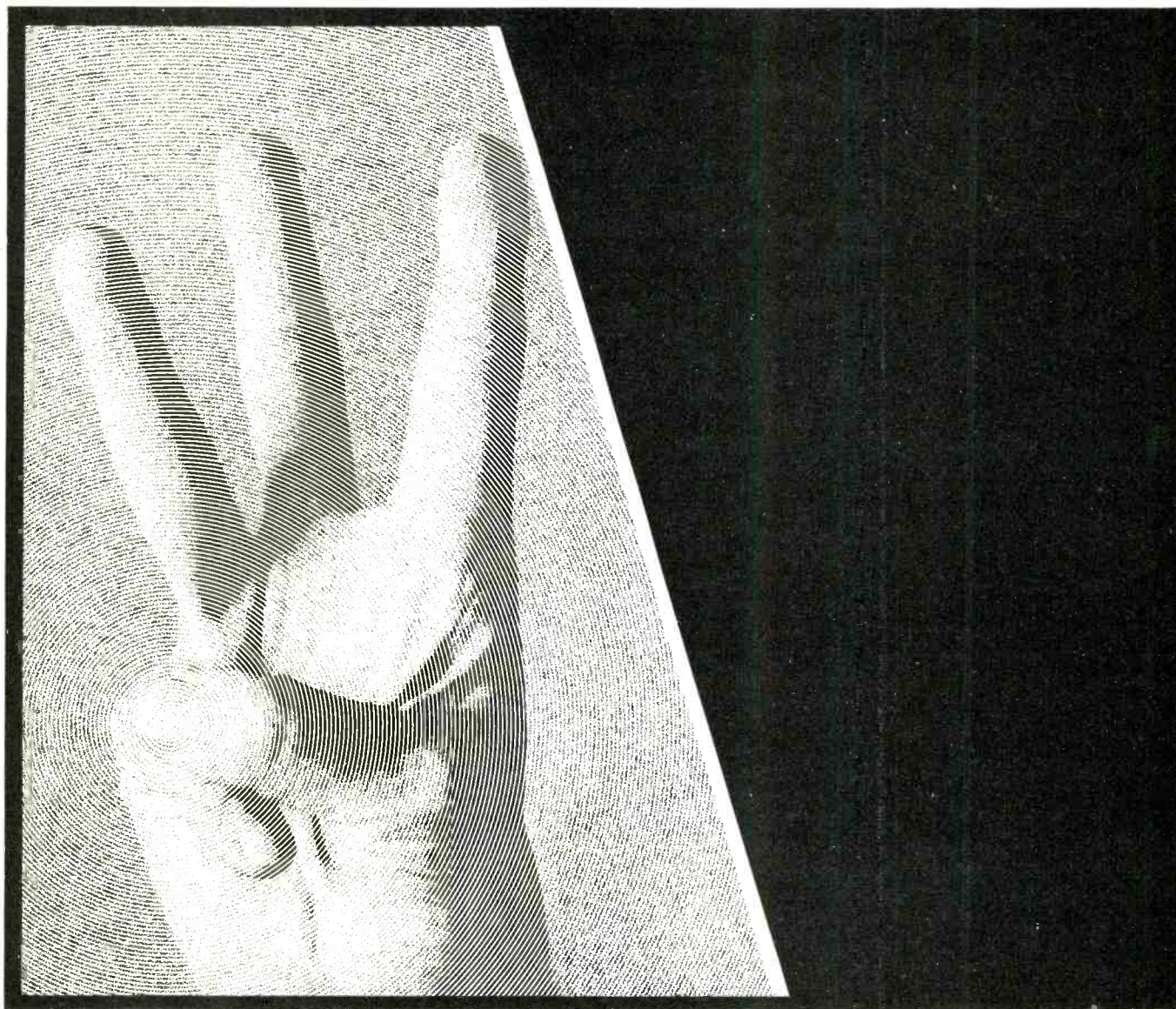

Best. Best. Best.

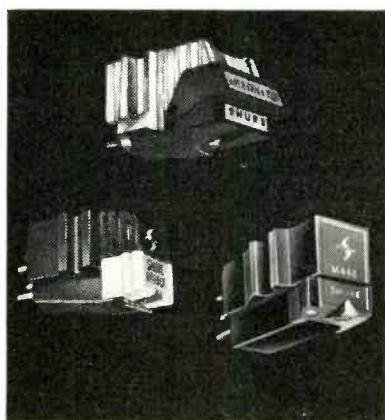

Permit us this momentary bit of self-indulgence, because our intentions are pure: to assist you in choosing the best phono cartridge for your hi-fi system, within the practical limitations of your audio budget. To begin, if you feel uncomfortable with anything less than state-of-the-art playback perfection, we heartily recommend the Shure V-15 Type III, a cartridge of such flawless performance it is the perfect companion to the finest turntables and tone arms available today — and those coming tomorrow. At a more moderate level of performance and price, we suggest the Shure M91ED, a superb performer second in trackability only to the Type III. Finally, for optimum performance under a budget austerity program, the yeoman Shure M44E is for you. All in all, these are three great ways to enjoy music with the kind of system you have decided is best for you.

Shure Brothers Inc.
222 Hartrey Ave., Evanston, Ill. 60204
In Canada: A. C. Simmonds & Sons Ltd.

Check No. 40 on Reader Service Card



Compatible Quadra-Direction Discrete Stereo System

Part I

Fumitaka Nagamura*

Initiated by T.A. Edison in 1877 in his cylindrical records with vertically cut sound grooves, and then developed by E.B. Berliner to disc records with laterally cut sound grooves, recorded discs have continued to prosper on a truly firm basis.

Furthermore, though changed little in appearance, improved materials have contributed to the tremendously advanced record cutting technology of today which, after a long period of monaural cutting, developed the binaural (dual groove) and V/L systems, and since 1957 has standardized the 45/45 system stereo discs. In this historical process of changes and selections, it is felt that the direction of future developments has been indicated, though unrecognized.

Against such a background, recorded discs, though at one time appearing to have achieved the ultimate in develop-

ment, were required to be advanced again when four-channel sound reproduction became the object of such inventors as D. Hafler, P. Scheiber in 1969, and B.B. Bauer in 1970, who developed purely electronic approaches in the form of matrices. On another plane, with the same objective, Inoue and others developed the CD-4 system in 1970 based on innovation in record cutting technique using subcarriers.

It now became obvious that the future direction of recorded discs lay in four or more channel sound reproduction. However, as of this writing, it is felt that the best approach has not necessarily been taken.

Anticipation of New Systems

Considering that recorded discs basically rely on physical and mechanical transducing, a thorough analysis of anticipated future technologies has led to creation of the "QDCS" system to be explained here.

First assigning specific nomenclatures

to disc systems that appeared in the history of multi-channelization as well as those that are contemporary, and then reclassifying them according to their sound-groove cutting and detecting channels of direction defined as the number of spatial directions of relative vectors, have resulted in Fig. 1.

With discs as recording media, a direct analysis of transducers used in cutting and tracing sound grooves has suggested a totally new possibility.

Figure 1 shows transducer innovations as horizontal lines, (A) indicating the time in history when monaural discs were perfected, and (B) that when 45/45 two-channel stereo discs made their debut. Both these times coincided with initiation of complete standardization and popularization of the two systems.

(b) in Fig. 1 represents a forerunner or an indication of the 45/45 system soon to emerge, and is a proof that 45/45 discs were not developed independently of prior arts. Similarly, line (c) is drawn to coincide with an innova-

*President, N.F. Farrd Systems Corp.

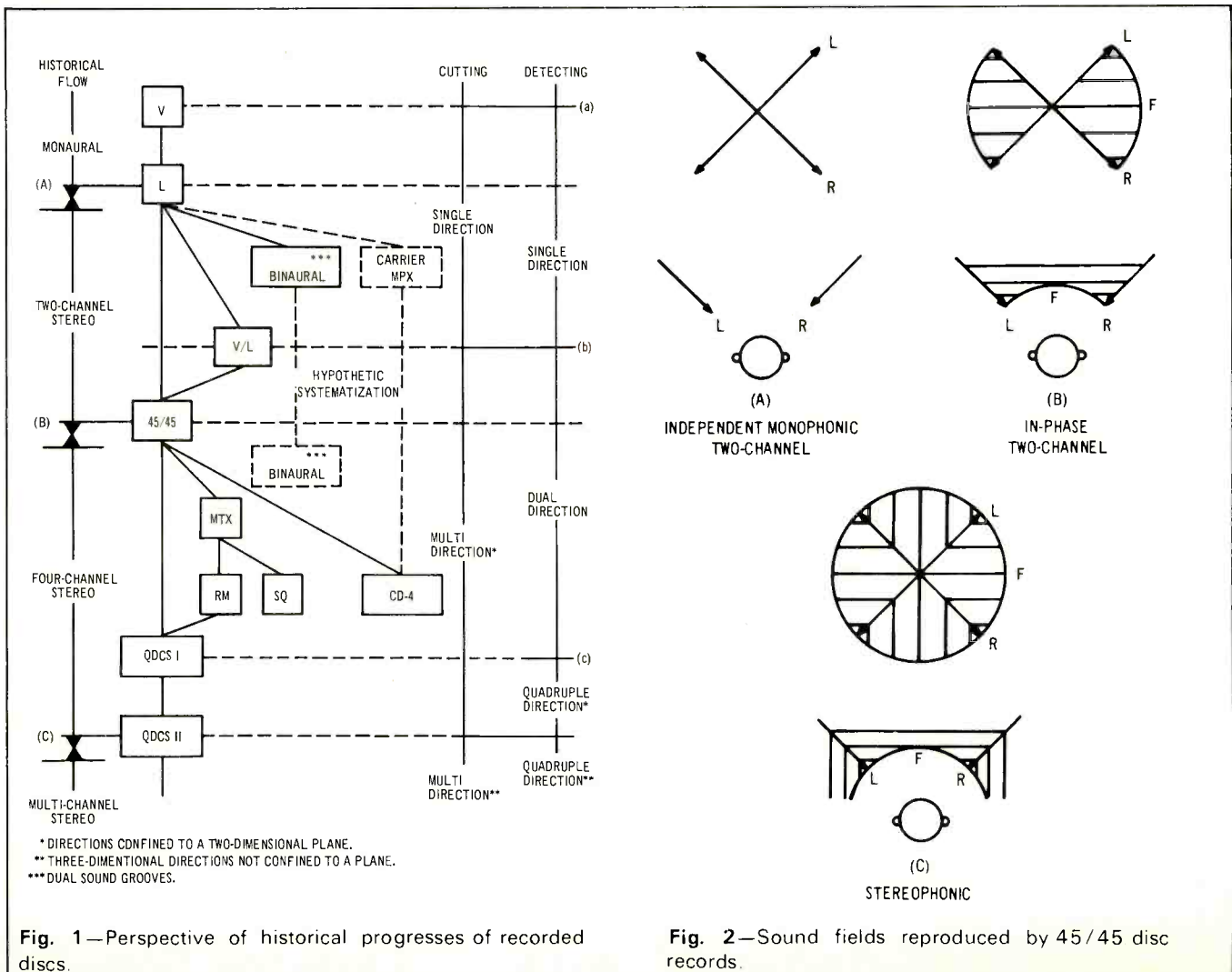
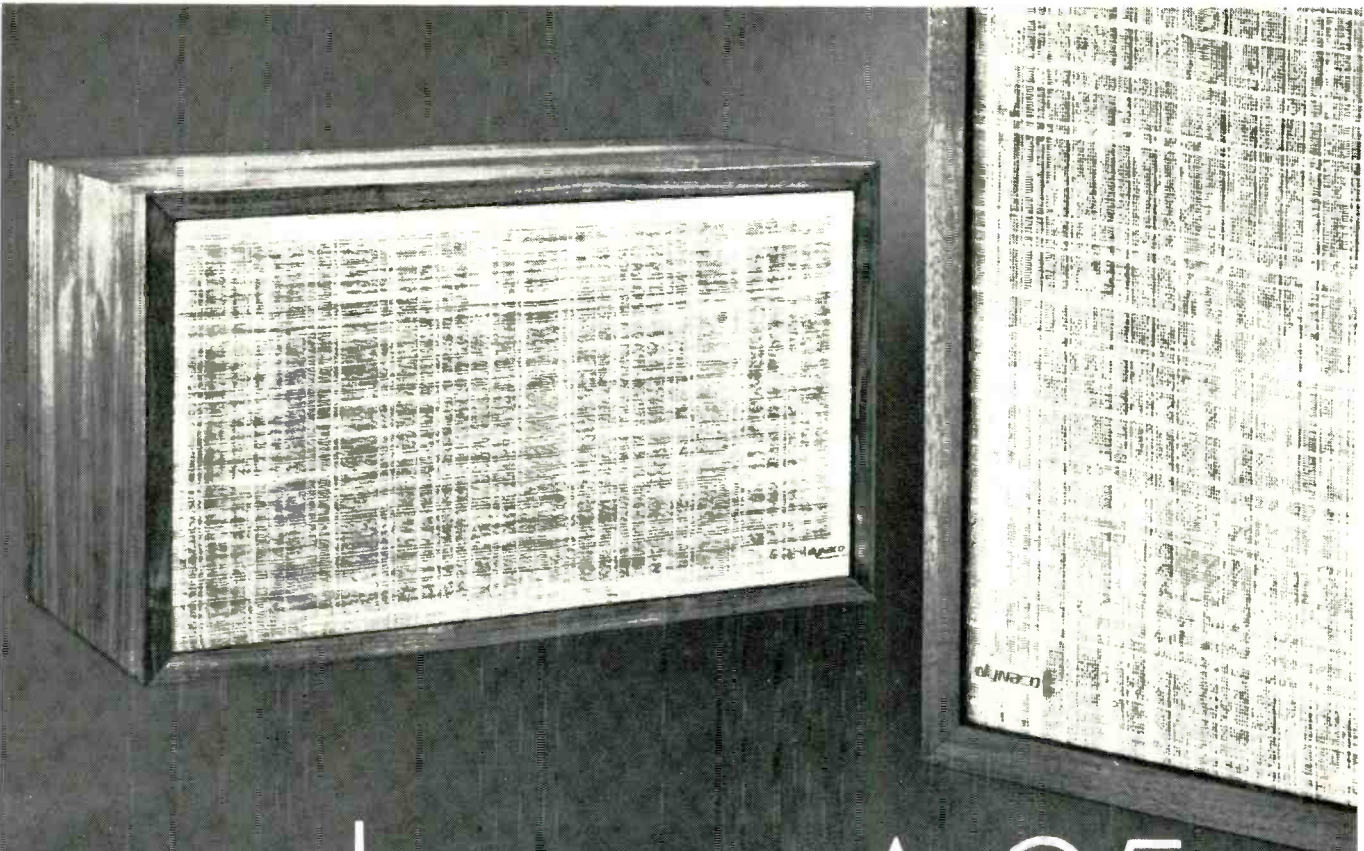

Fig. 1—Perspective of historical progresses of recorded discs.

Fig. 2—Sound fields reproduced by 45/45 disc records.



dynaco A-25 loudspeakers

Fidelity—the A-25 has earned the accolades of audiophiles and critics the world over for natural, lucid, uncolored reproduction of every program source—at a far lower cost than any alternatives. Very nearly the ideal loudspeaker—unobtrusive yet overwhelming in its authenticity—the A-25 can accommodate powerhouse amplifiers, or may be driven adequately by a 15 watt receiver. Dynaco's exclusive aperiodic design assures a uniform impedance which achieves the most from your amplifier, and contributes to the articulate deep bass which rivals systems several times its cost. A unique soft-dome tweeter radiates definitive, widely-dispersed highs for faithful "big sound". 5-step tweeter control and hidden wall mounts included.

\$89.00 in wall mount

DYNACO INC.

Division Tyco

3060 JEFFERSON ST., PHILADELPHIA, PA. 19121

Also available in Canada from DYNACO OF CANADA, LTD.

DYNACO, INC.
3060 Jefferson Street, Phila., Pa. 19121

Gentlemen:

Please send your new full color Dynaco catalog of speakers and components.

Name _____

Address _____

City _____

State _____

Zip _____

A1

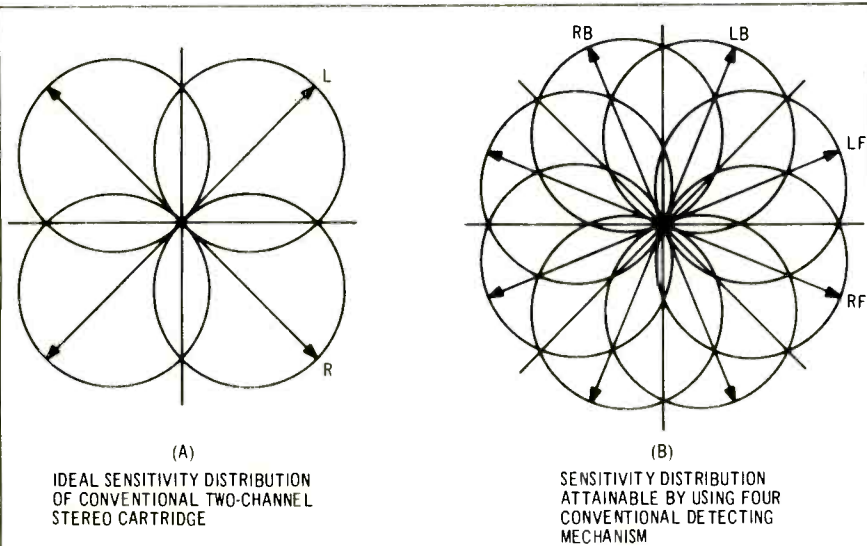

Fig. 3—Directional sensitivity of detection by conventional cartridges.

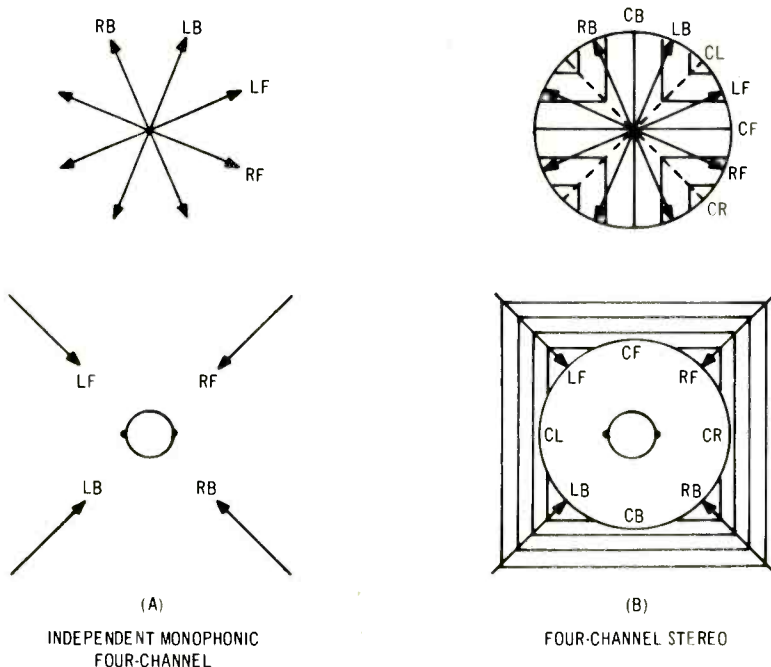

Fig. 4—Sound fields ideally reproduced by four-channel disc records.

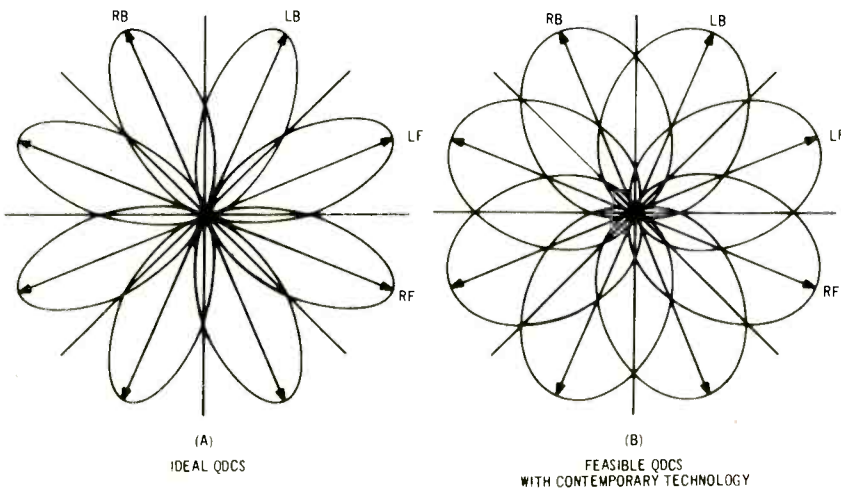

Fig. 5—Directional sensitivity of detection by QDCS cartridges.

tion in transducers for transition to four-channel stereo systems, and the "QDCS" system has newly been developed to fulfill this anticipation.

(c) thus represents an innovation in sound detection or playback, and another line (C) is drawn below it to coincide with perfection of the new total system which includes innovations in the sound-groove cutting technology, in a manner resembling (A) and (B) in the past.

To summarize, an innovation in transducers has led to creation of the "QDCS" system which, as anticipated, has proven to be an advanced and generalized form of the 45/45 system.

Disc Cutting and Reproduced Sound Fields

As 45/45 system disc cutters were adopted, mobility of cutter tips encompassed all of the 360 angles around its stationary point of origin. Expression by vectors of these cutter tip motions is convenient, and will be used in the rest of this article.

Relations among sound sources, recorded motional vectors, and reproduced sound fields may be classified into three types, as shown in Fig. 2, for all two-channel recordings.

(A) may be termed monophonic two-channel and represents two independently recorded channels that are unrelated to each other. In this case, two independent sound fields are reproduced but these do not intermingle in listening space to produce localized sound image.

(B) with closely related channels which are in phase with each other reproduces a sound field stably localized in the space between the two speakers.

(C) whose channels are further expanded to include out-of-phase relationships can reproduce a sound field that extends beyond the speakers, and a wider special coverage, even though with some inherent ambiguity of sound image localization. Thus with (C), the 360 mobility of cutter tips was at last fully exploited.

The above is based on two-channel playback cartridges whose directional detection sensitivity is distributed as shown in Fig. 3 (A), which means that all motional vectors driving cutting tips are picked up, i.e. detected, without loss, regardless of their direction. A very satisfactory, fully rational system has thus been perfected for two channels.

However, freely selectable angular directions of disc cutting vectors should readily suggest that they need not be confined to two-channel recordings.

Scheiber did succeed in increasing recording channels beyond two, but as he declared no need for improvement of playback cartridges, these were not



Soundcraftsmen PE2217—the NEWEST Preamp ...

... the most controls... the most flexibility... the most functions...
the most useability... a \$1,000 worth of control for \$499.50!

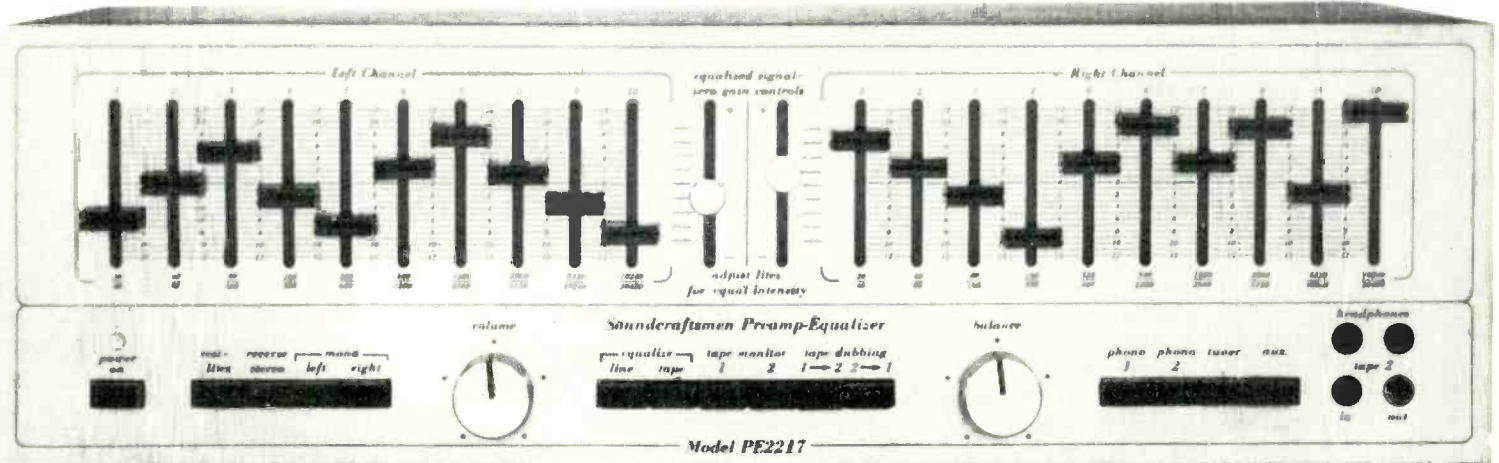

Audio engineers agree that the ultimate Preamp must have all the CONTROL flexibility of a patch panel... our new PE2217 has pushbutton-patching, plus 22 more MUST features...

• All pushbuttons interlocked to prevent inadvertent program destruction • Discrete-octave equalization control of ten octaves on each channel, $\pm 12\text{db}$ each octave • Full-spectrum level control for each channel • Automatic continuous monitoring by light-emitting-diodes for visual warning of overload in output circuits • Light-emitting-diodes for visual zero-gain balancing on music, white noise or pink noise • Push button selection of test-lites on or off • Tape dubbing between two machines, with optional simultaneous equalizing and monitoring • Double-dubbing into two recorders simultaneously • Separate system-selection enables full use of all other functions during the tape dubbing operation • Selection of either line or tape equalization • Automatic

equalizer-defeat when line or tape equalizer is not in use • Front panel tape input-output jacks for easy 2nd or 3rd tape recorder hookup access • Tape monitoring of either tape at any time • Two stereo headphone jacks • Mono selectors for left, right or both channels to both outputs • Reverse-stereo mode • Two low-level phono inputs • Four independent phono preamps • Six A/C outlets, 4 switched, 2 unswitched • Electro-plated ferrous chassis—(eight sections)—provides optimum shielding to minimize magnetic field-coupling • Single-point system ground connector minimizes ground-loops • Regulated power supply.

\$499.50
includes walnut-grain cabinet, or rack-mount.

Check No. 42 on Reader Service Card



Soundcraftsmen SC-12ES Reflectrostatic™

**New W-Type Reflectrostatic™
Doubler Dispersion Element
1KHz-30KHz Bi-Polar Radiators
500Hz-1KHz Dynamic Midrange
20Hz-500Hz Acoustic Suspension
15KHz-100KHz Ultrasonic Limiter
20Hz-30KHz 4-Way Equalization**

The Soundcraftsmen SC-12ES is our latest "State of the Art" product to be introduced for the critical audio connoisseur. The unique REFLECTROSTATIC™ design, combined with low distortion acoustic suspension transducers, provide exceptionally smooth frequency response over the entire spectrum, with unprecedented power handling capabilities. The exclusive Protection-Logic circuitry allows the SC-12ES to be used with amplifiers of modest power capacity, as well as with the latest, high-wattage units available. Designed as a bookshelf or floorstanding speaker in 18 x 28 x 14" Walnut cabinet.

Electrostatic Transducers are universally acknowledged to be the very finest available source for perfect audio reproduction. The 12ES utilizes both the front and rear radiation through the Soundcraftsmen engineered Reflectrostatic™ rear-wave doubler. Only by experimentation and use of the controls can the listener realize the optimum results of any speaker system, and that is why the 12ES includes a control for each segment of the frequency spectrum.

The compactness, control versatility, power-handling capacity, and low price represent a major breakthrough in optimum performance/size/price specifications for sophisticated home high fidelity.

\$399.50 each
in matched pairs

SPECIFICATIONS and SPECIAL FEATURES

FREQUENCY RESPONSE: -3 db, 30 Hz - 20 KHz
RMS POWER REQUIRED: Min. 20 watts
RMS POWER HANDLING: Peak - 200 watts, Cont. - 150 watts
CROSSOVER POINTS: 500 Hz, 1,000 Hz
CROSSOVER DESIGN: 4 LC Networks
ULTRASONIC LIMITER: 15 KHz to 100 KHz
NOMINAL IMPEDANCE: 8 ohms

WOOFER: 12" Acoustic Suspension dynamic with Alnico magnet, neoprene surround.
MIDRANGE: 5" sealed back, controlled resonance, damped surround
TWEETERS: Reflectrostatic™ elements 144 sq. inches of bi-polar radiation with back-wave doubling. Polarization over 1000 volts d.c. Distortion less than .5%
CABINET SIZE: 28" x 18" x 14"
SHIPPING WEIGHT: 76 lbs.

Check No. 59 on Reader Service Card

Soundcraftsmen

1310 E. Wakeham Avenue, Santa Ana, California 92705 Telephone: 714-836-8375



and still remain unaltered. Perhaps his reasons were that the Fig. 3 (A) sensitivity distribution of conventional cartridges lent itself to his matrix reproduction of four channels, and that furthermore arranging four conventional detection mechanisms along the four-channel vector axes merely would have produced a sensitivity distribution like Fig. 3 (B), which represents no improvement whatsoever.

Basically, sound fields reproduced by an ideal system from discs recorded along the foregoing philosophy should be as shown in Fig. 4 (B). However, under contemporary systems, i.e. in matrix reproduction, even when recorded as four monophonic channels as shown in Fig. 4 (A), reproduced sound fields are blended together by

cross-talk, and only a 3 dB adjacent channel separation is attainable.

We can conclude from the above analysis that while multichannel sounds can be recorded on a disc independently and without interference with each other, i.e. discretely, only up to two channels can be reproduced discretely as long as contemporary cartridge construction and detecting mechanisms are used. It should also be noted in passing that the Fig. 3 (A) sensitivity distribution is what is necessary and sufficient for two-channel reproduction, and therefore must be maintained unaltered.

Is discrete four-channel reproduction as shown in Fig. 4 (B), then, impossible? No, not if cartridges with sensitivity distribution shown in Fig. 5 (A) are

made available. However, as comparison of Fig. 3 (B) and Fig. 5 (A) discloses, it is not possible to build such cartridge using conventional detecting mechanisms. Only by adoption of different vector transmission mechanisms is it feasible to realize a near ideal distribution, such as shown in Fig. 5 (B).

"QDCS" cartridges have been developed under the forgoing philosophy, and to maximally enhance their performance, an electronic circuitry entitled "Crosstalk Eliminator" has also been developed. Together they constitute the new reproducing system, "QDCS Mark I".

"Matrix" and "Discrete" as Viewed with 45/45 Disc Cutting

It might be argued that QDCS is a form of matrix and therefore cannot be termed discrete, but in reality, in the 45/45 disc cutting any localized sound within the 360° angle can be represented by an independent motional vector of the cutter tip, and this one-to-one correspondence is complete and continuous without any discontinuity, fully circularly distributed around the center of the tip motion. In other words, by combination of two independent variables as vector projections on coordinate axes, theoretically an infinite number of channels can be recorded discretely in the sound groove.

Therefore the only portion of this process that may be termed "matrixed" is transmission of signals combined and grouped into 2 channels for feeding to the cutter to drive the record cutting tip, plus playback if two or less channel cartridges are used. Records thus cut are discrete discs in themselves, and if vectors thus independently cut into the sound groove can be directly detected without duplication along three or more spatial directions, it can constitute a discrete reproduction. For instance, if detection and reproduction using a cartridge with Fig. 5(A) sensitivity distribution can be effected along four spatial directions, it may be termed a discrete 4-channel reproduction.

To elaborate further through a comparison with tape recording, each channel in recorded tapes is fundamentally independent and unrelated, so that the number of discrete channels cannot exceed that of recorded tracks, and addition of playback heads does not produce any additional channel. With recorded discs, on the other hand, two channels of mutually independent signals, Lt and Rt in Fig. 6(A), that are fed into the record cutter with two mechanical motional axes at right angles to each other, get vectorially added to form a single vector T to drive the cutter tip, and are recorded as such with the T spatial direction. In conven-

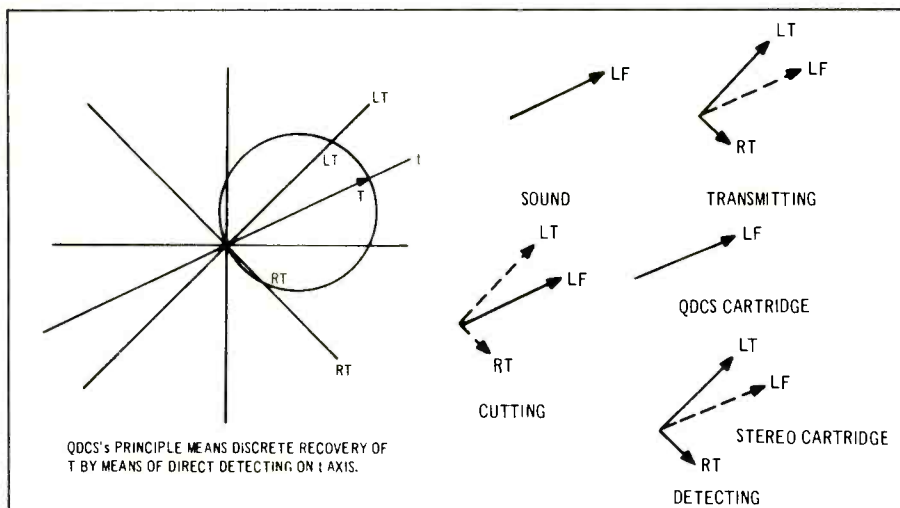

Fig. 6A—Stylus motion T and its driving vectors Lt and Rt.

Fig. 6B—Vectors in disc recording and playback.

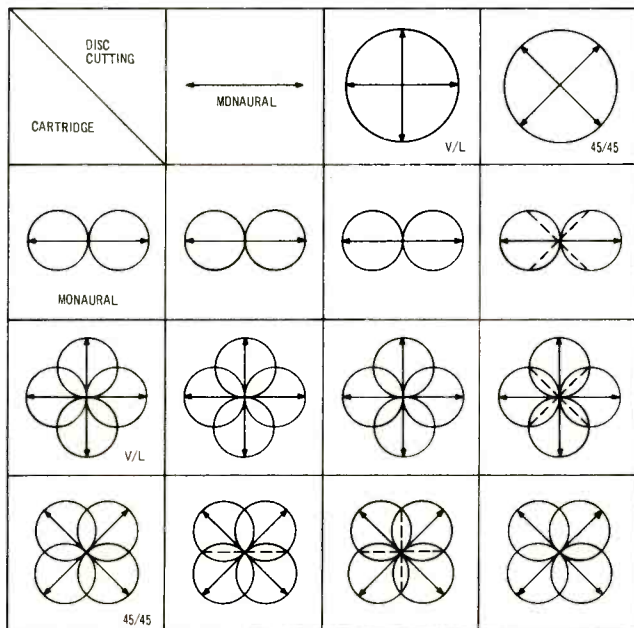

Fig. 7—Disc cutting vectors and vectors detected in playback. Solid line shows directly detectable signals; dotted line shows indirectly detectable signals.

Instead of talking about a cassette deck with 3 heads we make one.

The RS-279US.

It has an HPF™ monitor head. So every recording you make will be as sharp and clean as it should be. That's recording insurance. The kind of insurance that great specs alone can't give. Only a monitor head can.

The monitor is more important in cassette than it ever was in reel-to-reel. Because the cassette can drag or jam without warning. And it's prone to recording overload. Which can ruin a potentially great recording if it isn't detected.

The RS-279US also has many other desirable design and convenience features. Like a dual motor system. With a DC motor for the reel-to-reel drive and our exclusive direct drive DC motor for the capstan. Adjustable Dolby*. Switchable bias for CrO₂ tapes. Solenoid-operated function controls. Locking pause. Memory rewind. And Auto-Stop.

And the specs are just what you'd expect from a deck with those credentials. The signal-to-noise ratio is better than 59dB. Frequency response is from 20-16,000Hz. And wow and flutter are less than 0.10%.

The RS-279US has the hallmarks of a great cassette deck. Plus one that puts it ahead of other decks. Our patented HPF™ monitor head.

The concept is simple. The execution is precise. The performance is outstanding. The name is Technics.

*Dolby is a trademark of Dolby Laboratories Inc.

200 PARK AVE., NEW YORK, N.Y. 10017
FOR YOUR NEAREST AUTHORIZED
TECHNICS DEALER, CALL TOLL FREE
800 447-4700. IN ILLINOIS, 800 322-4400.

Technics

by Panasonic

Check No. 46 on Reader Service Card

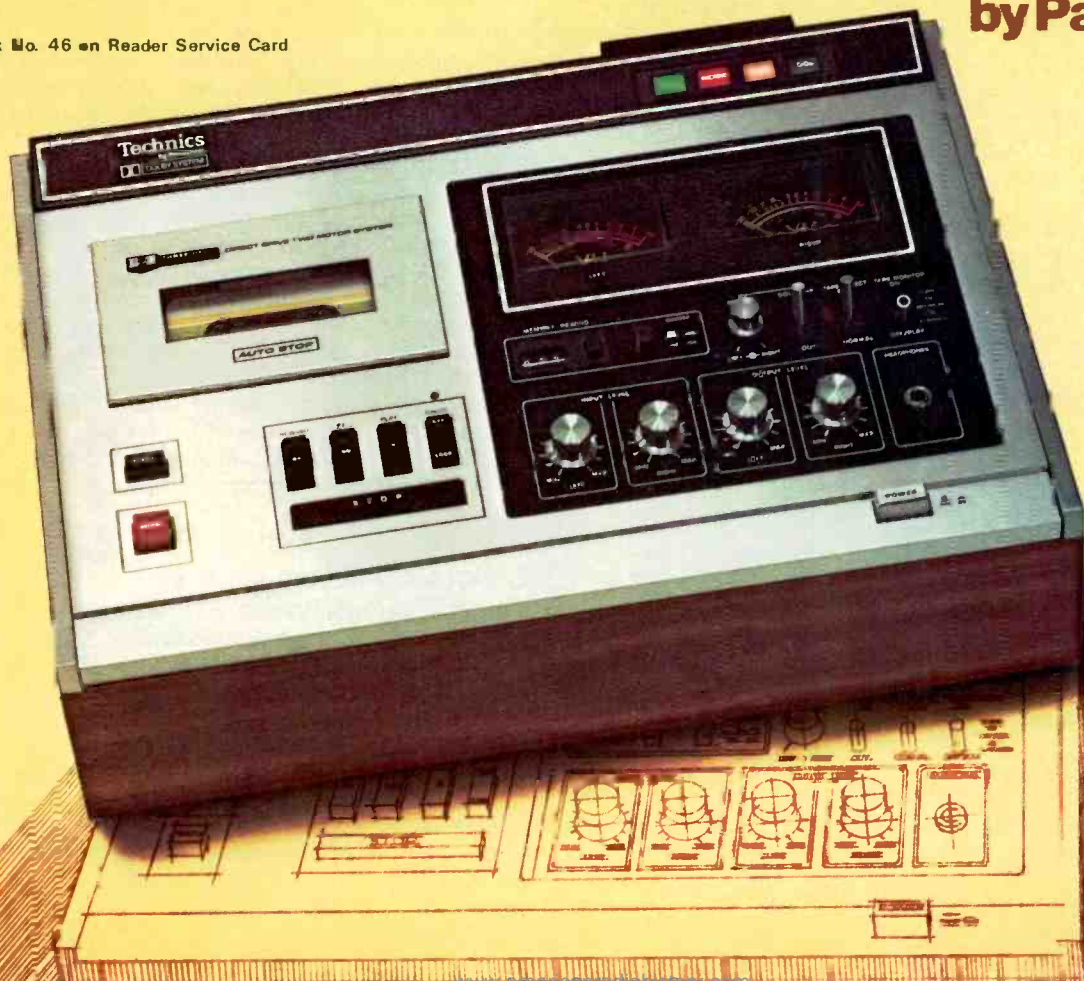

tional stereo reproduction, this single vector is again decomposed into vector projections, or component vectors, Lt and Rt, and detected as such by a 2-channel cartridge.

The principle of QDCS is to detect the vector T directly either by one element conforming with the spatial direction of T, or two elements aligned along different axes from those designed in for recording input signals. This latter approach is not feasible in tape recording as vector T or its equivalent does not exist, and playback heads in other than predetermined configurations do not afford correct reproduction.

In the case of 4-channel stereo, as shown in Fig. 6(B), signal LF is decomposed into component vectors, Lt and Rt, during 2-channel transmission, but in disc cutting these are recomposed and form the original single vector LF which drives the cutter tip. Conventional 2-channel stereo cartridges detect this vector as two component vectors, Lt and Rt, which are then electrically combined for 4-channel outputs, and thus constitute a matrixed reproduction.

QDCS cartridges either detect LF directly by one element, or by two elements whose detection axes do not coincide with LF but lie closest to it. In the latter case, the elements detect vector projections of LF but these are not electrically combined as in matrixed reproduction, but fed individually to respective speakers. It is the acoustical outputs of these speakers that are spatially combined for proper localization of reproduced sound.

Restriction to two channels applies only to the transmission stages of recording signals, and when these are over, i.e. when disc records are made, the restriction no longer holds. Interaction between more than two channels of information is sometimes inevitable while such information is transmitted via two channels, but disc cutting vectors themselves are independent and do not interact among themselves, as long as the two-channel input signals to recording heads are kept either in phase or in opposite phase. It is detection of these vectors that determines whether it is a matrixed reproduction or discrete.

Axes of input when recording and those of detection in playback do not need to coincide, as seen in the above, and also as has been proven during transition from the V/L to 45/45 system of disc recording. Rather, selection of different sets of axes led to new developments. Classification of monaural and two-channel stereo discs and cartridges, as shown in Fig. 7, should aid this comprehension of compatibility among the various systems.

Taking up the relationship between V/L and 45/45, for instance, signals fed to the V and L axes through additive and subtractive matrices are recorded as discrete vectors, L and R, along axes removed 45 in angle. 45/45 picks up L and R vectors directly, an advantage over V/L where both recording and playback must employ add/subtract matrices, which was sufficient for 45/45 to completely replace V/L systems. It should now be evident that similarly QDCS represents full rationalization and simplification of matrix systems.

In Fig. 8, an attempt has been made to illustrate some of the systems employed during transition from two-

channel to multichannel stereo that may be corroborative to the QDCS principle. Vectors drawn in straight lines represent those that are directly detected from discs, and others in dotted lines, those that are indirectly detected by means of composite vectors. The former may be termed discrete and the latter matrix.

Klipsch's system was the first matrix, Hafler's a simple matrixial combination of 45/45 and V/L, and Scheiber's a further advanced form based on additional rationalized interpretation in which, however, all the four detecting axes ended up being indirect axes, constituting a pure matrix system.

QDCS, through similar analysis as that described in the foregoing when comparing V/L and 45/45, attained rationalization and simplification by adopting detection axes coinciding with four discrete vectors recorded on the disc. In Fig. 9, these direct detection axes of QDCS are represented in straight lines, and besides five or more channels can be reproduced by incorporating additional indirect detection axes represented by the dotted lines.

Returning to the disc-tape comparison, as shown in Fig. 10, if M number of original sound sources are picked up by X numbers of microphones, in disc recording M' number of independent vectors are recorded on the disc, even though only two channels are employed to transmit the recording signals to the cutter head, so that depending on the recorded program any number (variable X') of channels can be reproduced by using X' pieces of detection mechanisms in the playback cartridge. However, in tape recording, reproduction of more channels than those employed in recording, fixed X', is feasible only through matrices.

The above basic difference constitutes the real value and future potential of discs in the writer's opinion, so that at the expense of discarding compatibility with two-channel tapes as is feasible in the case of matrix systems, four-direction detection has been adopted. Selection of the four, when any number (X') is feasible, has been made for the sake of symmetry and maximum efficiency in crosstalk reduction and other similar considerations. **AE**

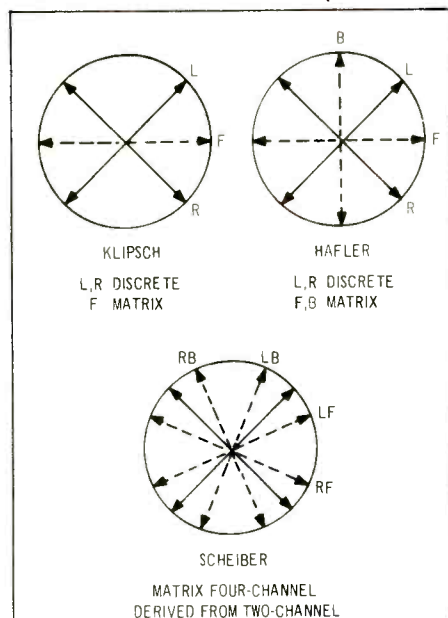

Fig. 8—Examples of conventional multi-channel systems represented by vectors.

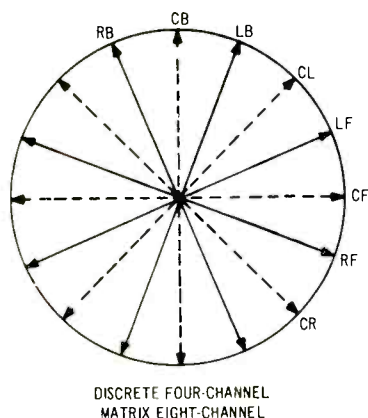

Fig. 9—QDCS multi-channel system.

DISCS

M	LOCALIZATION OF SOUND SOURCES
X	PICKUP MICROPHONES
2	RECORDING CHANNELS (TRANSMISSION)
M'	RECORDED REAL IMAGES OF SOUND LOCALIZATION
X'	PLAYBACK TRANSDUCER CHANNELS (DETECTION)
N	SPEAKERS
M''	LOCALIZED SOUND IMAGES (REPRODUCTION)

TAPES

M
X
X'
X'
N
M''

Fig. 10—Comparison of discs and tapes.

Radio Shack puts more into its Realistic speakers by leaving a few things out!

We leave out things like distributor profits . . . trade shows . . . sales contests. Because we design our own speakers . . . have them made to our specs . . . and market them through our own 2000 stores. This eliminates waste. Which lets us put "in" things like strict quality control . . . unique features . . . and a *Lifetime Guarantee. Because we've left out costs other brands must pass on to the Consumer. We think this is the way you want us to be. Only at Radio Shack — *the famous Realistic Optimus series.*

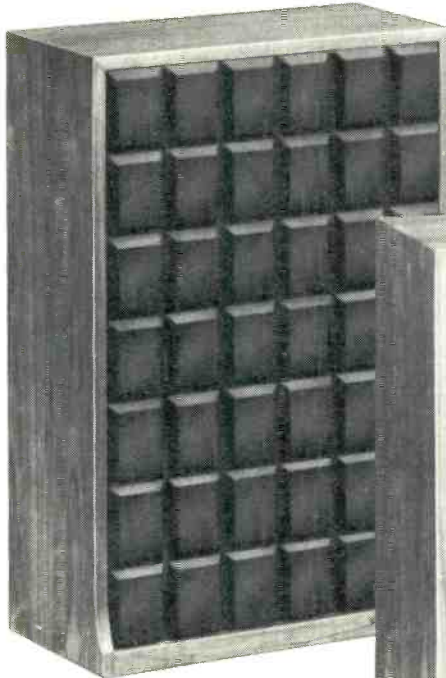

Optimus-9.
Radiates from front and rear for enhanced midrange. 5 speakers including 12" woofer. 28x19x9". 159.50

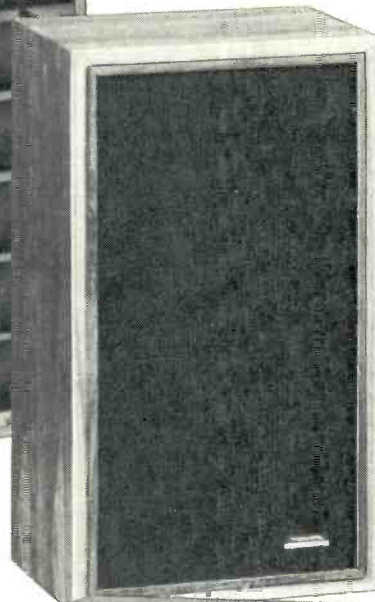

Optimus-5.
Tens of thousands in use. Acoustic suspension 12" woofer, 3 midrange /tweeter units. 25x14x11 1/2". 109.50



Optimus-7.
The best! Acoustic suspension 12" woofer, 6 1/2" midrange, 2 1/2" tweeter, sound "tailoring" controls. 27x24x15 3/4". 198.50

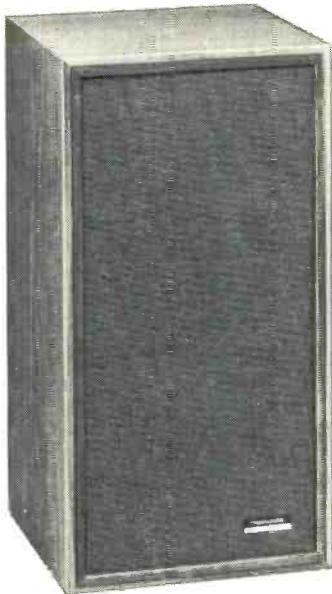

Optimus-1.
The original — the one that cut the cost of uncolored audio 30%. Acoustic suspension 10" woofer, 2 tweeters. 23x12x11 1/2". 89.95

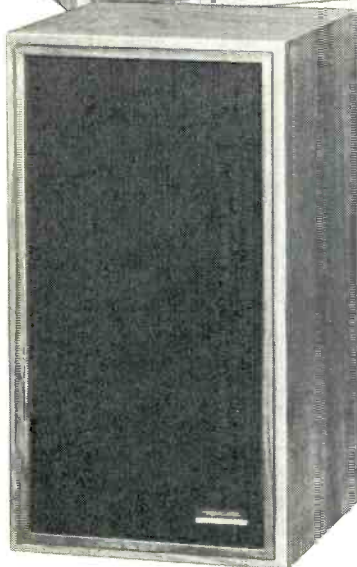

Optimus-2.
Bookshelf size. Acoustic suspension 8" woofer, tweeter, removable grille. 20x11x10". 69.95

*Lifetime Guarantee

Radio Shack guarantees without time limitation the proper electro-mechanical function of all Realistic Optimus speaker systems in original unopened factory enclosures, providing that the system has not been physically abused (our determination is final) and that the owner provides transportation to and from the repair site. Your system must function properly or Radio Shack will repair it **FREE OF PARTS & LABOR COSTS** — today, tomorrow, forever! This guarantee is honored at all Radio Shack stores from coast to coast. Your receipt is all you need to obtain **LIFETIME** free service!



REALISTIC®
Radio at Shack®

and ALLIED RADIO STORES
A TANDY CORPORATION COMPANY 329
P. O. Box 1052, Fort Worth, Texas 76107

FREE! 1974 CATALOG

AT YOUR NEARBY STORE OR MAIL COUPON
180 Pages . . . Full Color! Hi-Fi, Recorders, Radios, CB, Kits, Antennas, Parts, More!

PLEASE PRINT CLEARLY

Name _____ Apt. # _____
Street _____
City _____ State _____ ZIP _____

— Retail prices may vary at individual stores. —

Check No. 35 on Reader Service Card

20th Century Witchcraft— Electronic Surveillance

Daniel Queen

DURING THE LAST few years there has been much said, written, and done concerning electronics for surveillance. Most common are the electronic bugging methods, but following close behind are methods for voice identification, computer data storage, and “psychological” testing. Since the Watergate disclosures, all have been dealt with in sensationalistic terms, both as to their effectiveness and protection from them.

The most familiar is “electronic bugging,” which takes several forms: The wired-in tap on a telephone line; a mic placed in an area of conversation; and the use of mics to pick up conversations from a distance. With all of these, there is much misunderstanding, often promoted by groups who do the tapping and by persons who profit from allegedly “de-bugging” a premises.

Telephone Taps

The simplest way to tap a telephone is to attach another telephone to the same line. This is rarely done, because simple methods can be used to detect the instrument, as each set added draws power. However, a more effective method of tapping a phone line—“bridging”—can be undetectable, since its effect on the line can be less than ordinary day-to-day changes due to electrical variations and temperature. The only way to detect a tap wired directly to the clandestine receiver is to find it—physically. If the tapping has been done on the premises, one must carry out a painstaking search for any wiring not part of the regular equipment. There are no instruments which can be attached to a phone set to detect such a tap and no such instrument will be physically possible with any contemplated technology.

Sometimes a phone will be tapped with the wires leading to a hidden transmitter. In such a case the tapper has been unable to run wire all the way from the phone to his receiver and therefore uses a radio transmission link. Such a tap can be detected, as will be discussed later.

The difficulty of detection of wired-in taps on phones also exists with wired-in bugs. If the wires from a mic placed on the premises run all the way to the receiver, the bug cannot be detected by any method except a painstaking physical search. This search must be carried out in a systematic manner, by looking for unidentified wiring; looking for fresh plaster, or other evidence of recent changes in construction details on the premises; using metal-detectors to find wiring buried in walls, under rugs, etc., and checking adjacent premises to find microphones on adjoining walls. This search must be carried out square foot by square foot on floors, walls, and ceilings. In older buildings, there is often unused telephone and low voltage wiring which must be examined to determine if it is being used to carry information from a hidden mic. Telephone wiring boxes, electrical wiring boxes, and fixtures must all be opened and examined.

If any unidentifiable suspect wiring is found, a properly designed high-gain amplifier driving a loudspeaker should be connected to it so that feedback to a hidden microphone will cause howl from the loudspeaker. It is wise to use a radio-frequency detector on the amplifier when doing this in case the microphone is equipped with an r.f. converter to help elude detection. Moreover, this detector must be capable of detecting all forms of r.f. modulation—AM, FM, suppressed carrier, etc. Remember that this type of bug cannot be detected with any type of non-contact scanning instrument, unless that instrument is one equipped to pick up the very small electro-magnetic fields that could be produced by the wires. Such instruments, besides being expensive, must be used in extremely close proximity

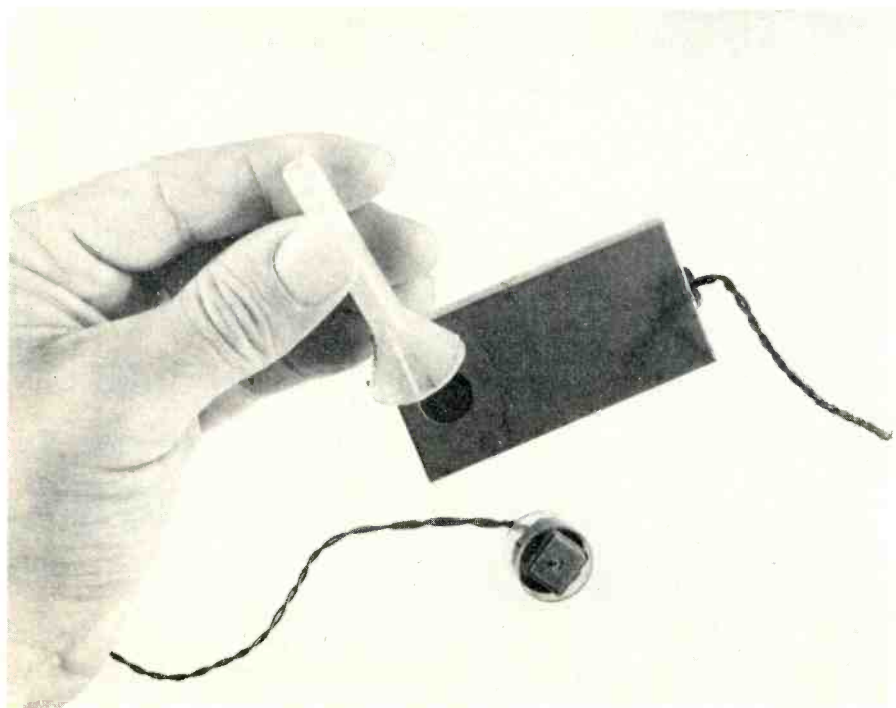

These two clandestine mics were dug out of a wall a few years ago.

Note that they require only a small opening into the room.

TDK's ED has more of what audiophiles want...

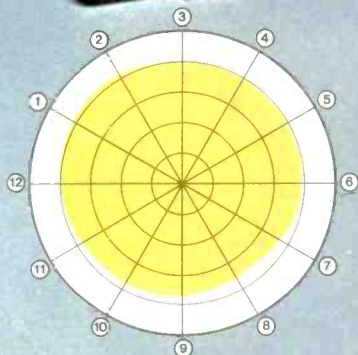

TDK EXTRA DYNAMIC (ED)

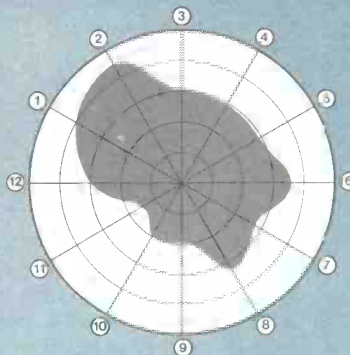

Competitor A

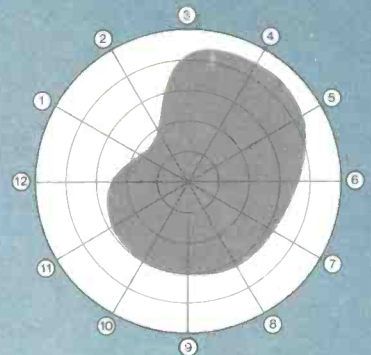

Competitor B

If you're an audiophile, you know what you want — the best cassette there is. That's why you'll insist on TDK's new top-of-the-line EXTRA DYNAMIC (ED). Once you discover ED's superior total performance, you won't settle for anything less than the cassette with more of everything.

Judged on TDK's Circle of Tape Performance for each of the twelve most important tape characteristics as shown in the diagrams above, EXTRA DYNAMIC offers you an entirely new dimension in cassette recording fidelity. Its performance characteristics, represented by

the larger, more circular pattern, approach those of the ideal tape. They are better balanced and superior to those of any other cassette on the market, including the two competitive so-called "hi-fi" cassettes also shown above.

ED's superior total performance results from use of TDK's unique new "Stagnetite"® (stabilized magnetite) coating plus a special binder and other exclusive manufacturing techniques. ED cassettes also have the industry's highest MOL (maximum output level), broader dynamic range, extended frequency

tape performance characteristics			
1-MOL @ 333Hz	7-Bias Noise		
2-Sensitivity @ 333Hz	8-Print-Through		
3-Sensitivity @ 8kHz	9-Modulation Noise		
4-Sensitivity @ 12.5kHz	10-Output Uniformity		
5-MOL @ 8kHz	11-Uniform Sensitivity		
6-Erasability	12-Bias Range		

response and a higher signal-to-noise ratio. The result is incomparably fresh, rich, full-bodied sound on *any* recorder, without need for special bias.

Ask your dealer today for TDK's new EXTRA DYNAMIC cassettes. For sound you *feel* as well as hear... discover the dynamic new world of TDK.



TDK's EXTRA DYNAMIC (ED), SUPER DYNAMIC (SD) and DYNAMIC (D) cassettes are available in 45, 60, 90, 120 (SD & D) and even 180-minute (D only) lengths, TDK KROM (KR) chromium-dioxide cassettes are available in 60 and 90-minute lengths. At quality sound shops and other fine stores.

the new dynamic world of



TDK ELECTRONICS CORP.
755 Eastgate Boulevard, Garden City, New York 11530
Check No. 44 on Reader Service Card

to the wires in question, and so are not usually practical for detection. The power line itself must also be checked with the high-gain amplifier, since r.f. signals can be sent out on it.

Bug Transmitters

The most publicized type of "bug" (although perhaps one least used by Watergate-implicated agencies) is the hidden transmitter. It is this type of bug *and only this type of bug* for which the highly publicized detective agencies attempt to sweep a room "clean." Such transmitters obtain their power in various ways. Some are operated on batteries and therefore, have a limited transmitting life. Others are connected to a source of power such as a telephone line or the house-current power line.

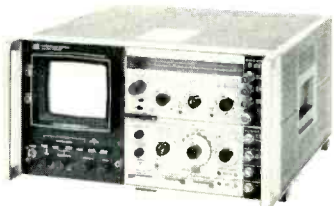

Detection of clandestine transmitters requires costly test equipment including spectrum analyzers, such as this one from Hewlett-Packard

Some of those that operate on house current may also utilize the power lines to send out signals; they must be regarded as wired-in. But those which have to transmit through the air by means of an antenna can be detected by tuning to their transmissions. Nevertheless, the task is not simple, for these bugs may be set to transmit anywhere from 10,000 Hz to 2 GHz with a transmission band as little as 3 kHz wide. There is space in the radio spectrum for six hundred thousand such transmitters to transmit at the same time. Of course, much of this space is taken up with other kinds of transmission such as broadcast and communications and cannot be used. However, it is not difficult to find a little space in the radio frequency spectrum to fit in a short range transmission without serious interference.

Therefore, it is necessary, in order to detect these transmitters, to have a receiver which can receive all frequencies from 10,000 Hz to 2 GHz. There are some instruments on the market which claim to do this without tuning. However, they simultaneously pick up high strength signals, such as broadcast and TV, which overwhelm the signal from that little transmitter. It is necessary, therefore, that the receiver be tunable.

However, since one has to sweep the walls with the receiving antenna of this receiver at the same time that one is tuning, using such a receiver would be a tedious job, to say the least. The task is alleviated by an instrument which automatically scans through all frequencies. Thus, every couple of seconds it examines every frequency of concern. Such devices can be tied in with a loudspeaker to excite the microphone, making the job semi-automatic. Such a convenient instrument might cost you over \$10,000.

Even with this instrument, the task is further complicated because radio waves travel through the air differently at different frequencies. The higher the frequency, the shorter the length of its waves, and therefore, the shorter the transmitting and receiving antenna must be to pick up in the same way that a lower frequency is picked up. This is because the shorter the wavelength is compared to the antenna, the more the antenna is sensitive to the direction from which the signal originates. Consequently, as the instrument scans through frequencies, one would have to constantly change the orientation of the antenna or its size.

However, there is a method to solve this problem; one that improves the ability to separate the nearby transmitter from transmitters far from the premises. The method takes advantage of a qualitative difference in the electromagnetic field near an antenna and that far from an antenna. Each is best picked up with a different type of device. The device for the "near field" will pick up well only when held very close to a transmitter and does not have to change with frequency.

Thus, the de-bugging instrument must sweep through a wide frequency range, have a way of exciting the hidden microphone, and rely on a close-proximity type of antenna to pick up the transmission. Therefore, in order to sweep a room for such a hidden transmitter, it is necessary to systematically sweep closely along entire surfaces and areas where transmitters may be hidden, using the type of equipment described.

Debugging Hoaxes

Knowing this, one can view with enlightened suspicion anyone who claims he can debug a room. Indications of chicanery include:

1. connection of an instrument to a telephone line to see if it is clear of taps;
2. setting up a receiver in the middle of a room, turning a dial quickly to see

if the room is clear of hidden transmitters (Sometimes a variation on this involves producing a single tone from a loudspeaker and listening for that tone on the receiver which is set in the middle of the room; besides the fact that many transmitters will be missed by this procedure, the single tone in the room may actually produce a dead spot where the receiver is; any attempt to excite an acoustic field in a room must use bands of noise or warbled tones to avoid such dead spots.);

3. completion of a survey and certification that a room is clean of taps and bugs after less than 10 hours survey.

Parabolic Mikes

A final type of audio surveillance involves the use of methods to pick out voices from a distance. A favorite of feature writers is the method for picking up speech from vibration of a window pane excited by the sound. The method utilizes a laser beam reflected back to a receiver which detects the modulation of the beam due to the vibration. Such vibrations are often of amplitudes less than the diameter of an atom, so great care must be used in setting up the laser and the receiver. While the tedious task can be accomplished, a slight repositioning of the window would cancel the effort. A more likely method uses a line microphone (sometimes called a "shotgun" microphone) which is able to pick up speech with reasonable intelligibility



This "shotgun" mic, E-V's DL-42, can be used to pick up conversations as far away as 200 feet through open air.

at greater than 200-foot distances through open air. The predecessor to the line microphone was the cumbersome and less effective "parabolic" microphone which erroneously tried to use a reflector to treat sound like light. These are seldom seen now.

Voice Identification

During the past few years an attempt has been made by police agencies and the media to equate the reliability of spectrograph "prints" of the human voice with fingerprints. Little has been

pointed out to the public concerning the probability of correct identification using this method. At present, the most carefully controlled experiments with voice identification have produced a 97 percent correct identification—compared to virtually 100 percent for fingerprints. However, even these controlled experiments (which used computers, not spectrographs) were taken when the number of choices of different voices were in the vicinity of 50. Each of these people spoke the same words and each of these people was recorded on exactly the same high quality equipment in the same acoustical environment. When any of these factors are changed—for instance, the number of people is increased to hundreds or thousands, or the transmission channel is different for each voice (such as different microphones, recorders, or telephone transmission), or the words and sentences spoken are different—the probability of correct identification turns around and becomes far less than 10 percent. Thus, for voice identification with any accuracy one must use a computer, have a small number of people involved, and they all must speak the same words into the same microphones on the same recorder. Yet, even under these ideal conditions, the best accuracy that has been achieved is about 97 percent—still indicating “reasonable doubt” in our courts.

Psychological Testing

Related to the pseudo-science of voice identification by spectrograph are the various methods of psychological testing by electronic instrumentation (called by Senator Ervin “Twentieth Century witchcraft”). The most well-known is the so-called “polygraph” or lie-detector. It is called a polygraph because it plots the changes of several human body functions with time simultaneously on a piece of graph paper, together with an indication of the time a question is asked. The operator asks a question, then interprets the effects of the question on the combination of body functions. No single function, such as pulse rate, can be used—all must be used. This is called, technically, “stress correlation.”

Another claimed “stress correlate” to truthfulness has surfaced in a recent commercial product now being sold to police departments. The company selling it claims that a sub-audible waivering of the voice occurs when a person lies—and the company has a meter to measure it.

Most psychological activity in the human being is “related” to body

changes which can be measured electronically. This relation is used for medical encephalographs as well as for monitoring men in space. However, the key is the “correlating,” that is: what changes correspond to what activity? In the lie-detection process, the “trained operator” does the correlating (called “interpreting”)—and many questions have been raised concerning his qualifications.

As a result, both government and private research funds are now being spent to use computers for such correlation. In the course of this research, it has been recognized that additional information about the habits and personality of the individual are needed to supplement the measurements being made. The computer's memory storage must be called upon.

We often allow ourselves to think that computers are unreliable; that you “put garbage in, get garbage out,” and this is the fault of the hardware. This myth is fed particularly by mistakes in consumer credit billings. However, such error is not inherent in the computer—it is only reflective of the budget of the user of the computer. The present development of a government storage facility based on social security numbers is well-funded and far more fool-proof. It is possible to link this bank with the similarly well-funded National Crime Information Center, a Dept. of Justice data bank. Storage elements are now available which can put the vital statistics of every person in the United States on one disc about 16 inches in diameter; that is one disc 16 inches in diameter for all the people in the United States. Obviously a small room containing such memories could contain large amounts of information on large numbers of people and be readily accessible. While the access methods to information stored in such densely packed memory elements are not completely developed at this time, they are easily within a couple of years of “going on-line.” The technical capability for correlating many details of information on individuals, from bugged conversations to appropriated medical records, is now becoming available to both private and government agencies.

Can One Talk in Confidence?

To protect oneself, one could start with a program for detection of hidden microphones—but it would be an expensive program. A less expensive approach would make the bugs ineffective.

Speech is very similar in its physical

characteristics to random noise. When speech is mixed with an equal energy of random noise, it is nearly impossible to understand without visual cues, such as movement of the lips of the speaker. Furthermore, such a mix is impossible to decipher electronically by any methods known today (although a new computer-based technique called “linear prediction” may make it possible in the near future). If noise equal to or louder than the speech reaches a hidden microphone, the speech will be effectively “masked.” The problem, then, becomes how to create this level of noise while still being able to carry on conversation.

The simple solution to this problem is to bring one's mouth close to the ear of the listener. Since this is physically inconvenient, it can be simulated by placing a noise-cancelling microphone close to the mouth of the talker and headphones on the listener. For a conference, all participants would be interconnected. Today, such multiple microphone and headphone systems are widely available for use in classroom education. With such equipment, a relatively low level of noise can be generated in the room so, with people speaking softly into the microphones, private discussions can be carried on without fear of detection. Care must be taken that at any point where a microphone may be hidden, the noise is always louder than the speech. While this may be a relatively inexpensive way to circumvent the bug, it conjures a frightening picture of the living room or office of the future. Excessive use of data banks will be less yielding to technical gimmickry. Perhaps the gimmick must give way to legislation.

Beginning July 1, this year, Sweden began an official Data Inspection Board which is empowered to severely restrict programming of private data banks and to play an advisory role regarding government banks. Meanwhile, here in the U.S.A., according to *Electronics*, July 19, 1973, “limits are still fuzzy on what the Department of Justice and its FBI can do with arrest records and other data in the National Crime Information Center.”

It is easy for the investigator to perform the illegal act necessary to bug a room or tap a phone; but difficult to detect and remove is the intrusive device. It is easy to enter information in the data bank; but difficult to get it removed or corrected. Shall it be as easy to lose our right to privacy—and as difficult to regain it?

Æ

Equipment Profiles

JVC 4VR-5446 Four-Channel Receiver



MANUFACTURER'S SPECIFICATIONS

FM TUNER SECTION IHF Sensitivity: 2.0 μ V. THD: Mono, 0.5%; Stereo 0.8%. S/N: 65 dB. Selectivity: 65 dB. Capture Ratio: 2 dB. AM Suppression: 50 dB. Image Rejection: 55 dB. I.F. and Spurious Rejection: 80 dB. Stereo Separation: 35 dB.

AM TUNER SECTION Sensitivity: 30 μ V (200 μ V/M, internal antenna). S/N: 50 dB. Selectivity: 30 dB. Image Rejection: 45 dB. I.F. Rejection: 50 dB.

AMPLIFIER SECTION Power Output: 22 watts/channel (quadraphonic); 44 watts/channel (stereo, "strapped mode"). IHF Power Bandwidth: 20 Hz to 30 kHz. Rated THD: 0.5%. Rated IM: 0.8%. Frequency Response: 20 Hz to 20 kHz \pm 1 dB. Input Sensitivity: Phono low, 3 mV; high, 1.5 mV; Aux 1, 2 and Tape Mon., 200 mV. Tone Control Range (rear channels): \pm 10 dB at 100 Hz and 10,000 Hz. S.E.A. (multiple tone controls) Center Frequencies (front channels only): 40 Hz, 250 Hz, 1 kHz, 5 kHz and 15 kHz. S.E.A. Range: \pm 12 dB at frequencies listed. Hum and Noise: Phono low, 70 dB; high, 65 dB; Aux 1, 2 and Tape Play, 75 dB. Low Filter: -10 dB @ 50 Hz. High Filter: -10 dB @ kHz.

GENERAL SPECIFICATIONS. Power Consumption: 280 watts (maximum). Dimensions: 20 in. W x 6 $\frac{3}{8}$ in. H x 15 $\frac{3}{8}$ in. D. Weight: 34 $\frac{1}{2}$ lbs. Price: \$599.95.

It seems altogether appropriate that the first quadraphonic receiver with completely *built-in* CD-4 demodulator circuitry to be reviewed by AUDIO is this JVC unit. (Last month's Kenwood 6340 had a slide-in demodulator.) After all, Japan Victor Company must be credited with the development of the "discrete" form of four-channel records, known in this country as Quadradiscs. After a late start, the number of

Quadradiscs available is on the upswing, and many manufacturers are now marketing equipment capable of demodulating the complex information contained in these discs and separating it into four channels of program information.

The Model 4VR-5446, shown in the photo above, is one step below the highest priced, highest powered 4-channel receiver made by JVC and is one of several which include the built-in CD-4 feature. The massive gold and blacked-out front panel has enough controls and features to delight the most demanding four-channel enthusiast. At the lower left, a rugged power ON-OFF switch is surrounded by a remote control plug (which is removed when an optionally available remote control "joystick plus master volume control" accessory is used) and a pair of headphone jacks (one for front channels, one for rear). The speaker switch does double duty, choosing main, remote or both sets of speakers and switching to the "strapped" amplifier mode for higher-powered two-channel operation, if desired. The adjacent mode switch chooses mono, stereo, discrete four-channel and a pair of matrix decode positions. If the switch is placed in the DISCRETE 4-CHANNEL position, demodulation of CD-4 records takes place automatically. If an SQ record is played with the mode switch still in the CD-4 position, sensing circuits substitute the proper matrix circuitry for this kind of decoding. Alternatively, the mode switch can be placed in MATRIX 1 which closely corresponds to SQ decoding, while the MATRIX 2 position is intended for QS (Regular Matrix) or E-V encoded discs.

Two tape monitor switches come next, followed by a program selector switch, low and high cut filter switch, an S.E.A. switch which enables you to add segmented tonal effects to recordings, the usual loudness switch, a dual-concentric volume control (one section for front channels, the other for rear channels), a dual-section concentric balance control (again, for front and rear), and separate bass and treble controls for the rear channels.

The upper right section of the panel contains five slide controls, each of which controls the tonal response of one segment of the audio spectrum. JVC calls this feature S.E.A.

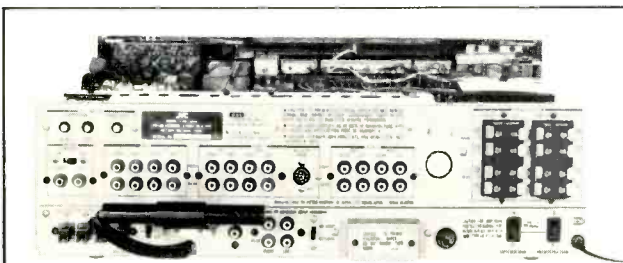

Fig. 1—View of back panel.

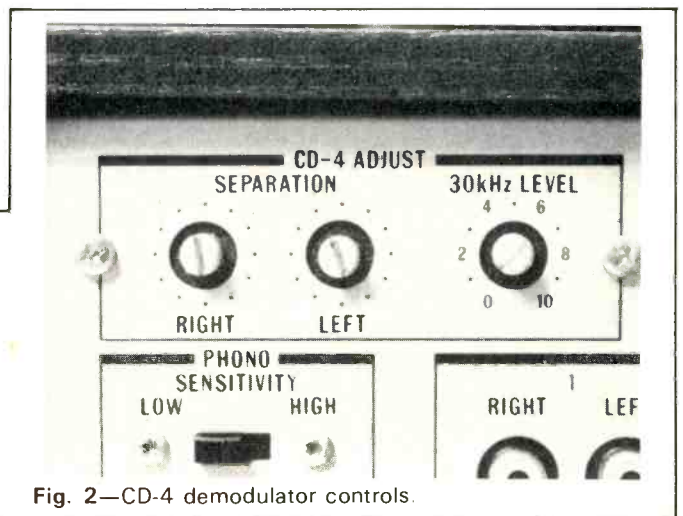

Fig. 2—CD-4 demodulator controls.

(for Sound Effects Amplifier) and it constitutes a miniature "graphic equalizer" similar in performance to separate accessory units sold by other manufacturers. More about S.E.A. and how it works later. A large tuning knob, coupled to an effective flywheel, moves the well-illuminated dial pointer across the well-calibrated AM and FM dial scales, above which are a series of illuminated words which indicate program source, mode, reception of an FM stereo broadcast and the fact that a CD-4 record is being played. The CD-4 indication is larger than the rest and lights up in bright yellow. A pair of illuminated tuning meters (signal strength and center-of-channel) at the extreme left completes the front-panel layout.

The back-panel layout of this receiver is shown in Fig. 1, and a closeup of three important new controls, located at the upper left of the rear panel is shown in Fig. 2. These three controls adjust the CD-4 demodulator so that it works optimally with the phono cartridge of your choice. Of course, a cartridge capable of response to 45,000 Hz or so is required. A 7-in. test record, recorded at 45 rpm, is supplied with the receiver and provides the necessary tones to enable you to adjust CD-4 circuitry for best separation and proper carrier level, since this may vary from cartridge to cartridge. Once adjusted, these controls need not be touched again unless a new cartridge is employed at some future date. Phono input jacks are associated with a slide switch which selects the two phono input sensitivity levels. The required jacks for AUX and both TAPE MONITOR circuits are centrally located on the back panel, as is a DIN socket to fit stereo tape recorders equipped with a DIN connector. Antenna connections as well as speaker connections (enough for eight speakers—two full quadraphonic sets) are made by means of short-proof spring-loaded terminals which permit you to slip the stripped end of a wire in a small hole when the terminal is depressed. Antenna terminals include 300-ohm and 75-ohm connections as well as external AM. Just below the ferritebar antenna are five more jacks. One of these is an FM-detector output jack, intended for future connection of a quadraphonic FM adaptor, if and when the FCC approves a system for discrete quadraphonic broadcasting. The other four jacks will accept the four signals reconstituted from such an adapter, so that you don't have to use up one set of "tape in" jacks for this purpose. A little slide switch adjacent to these jacks will provide the necessary "circuit interruption" point. For the moment, this switch comes with a locking plate to prevent its accidental use. One switched and one unswitched A.C. receptacle and a line fuseholder complete the back panel layout.

Circuitry

An internal view of the chassis is shown in Fig. 3. Considering the amount of circuitry contained in the 4VR-5446, the layout is amazingly neat and orderly. Circuit-board modules are screened with complete parts identification, corresponding to schematic symbols for ease of servicing. The only module that is not detailed in the schematic is the CD-4 demodulator board itself—and who can blame JVC for wanting to protect their licensing arrangement with other manufacturers? The front-end has an FET r.f. amplifier, while two IC's are used together with ceramic 10.7 MHz filters in the i.f. section. Stereo multiplex decoding is accomplished by a single 14-pin dual in-line IC. All tuner functions are arranged on a rather large, single p.c. board, onto which is mounted the shielded front-end. Matrix decoding circuitry uses discrete parts, and there is no logic or gain riding for either the MATRIX 1 or MATRIX 2 switch positions. Tone controls (both the simple bass and treble used for the rear channels and the multiple S.E.A. arrangement used for the front channels) are of the feedback type, and dual positive

and negative voltage supplies of 30 volts d.c. are used to power the pure complementary symmetry, direct-coupled output stages of all four power amplifier sections. An electronic protection circuit activates a relay in the event of overloads and also provides a turn-on delay to prevent popping sounds from being heard at turn-on.

FM Performance

Although the emphasis in this receiver is obviously placed on its four-channel flexibility and capability, FM performance proved to be consistently better than claimed by the manufacturer, as shown in Fig. 4. IHF sensitivity on the unit tested was 1.8 μ V while ultimate S/N reached a level of -67 dB for all input levels above 20 microvolts or so. Harmonic distortion (in mono) reached a low of 0.3%.

Capture ratio, measured at 100 μ V, was 1.5 dB while AM rejection at the same input level was 65 dB. Alternate channel selectivity measured close to 70 dB as opposed to the 65 dB claimed.

THD for stereo FM at mid frequencies measured 0.6%, and a plot of distortion for both mono and stereo at all audible frequencies is shown in Fig. 5 along with stereo FM separation. Muting on this receiver was adjusted for an input signal level of about 10 μ V—a bit high for our taste, but very positive in its action with no audible transitional effects.

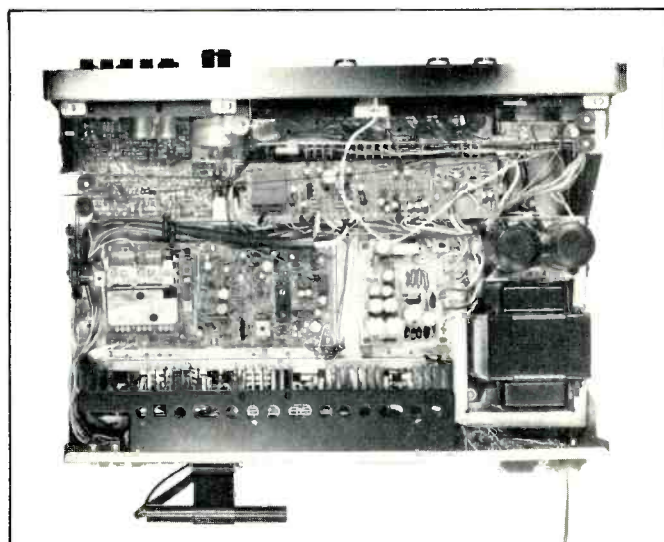

Fig. 3—Internal view of chassis.

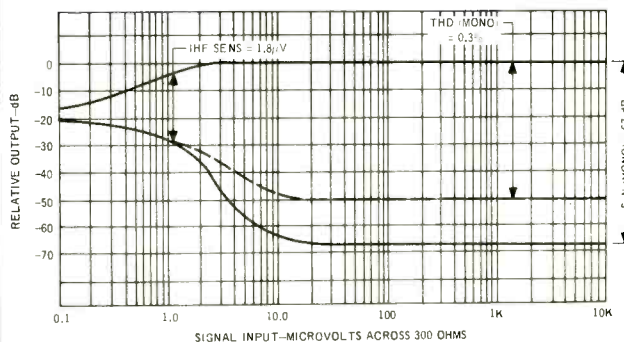

Fig. 4—FM characteristics.

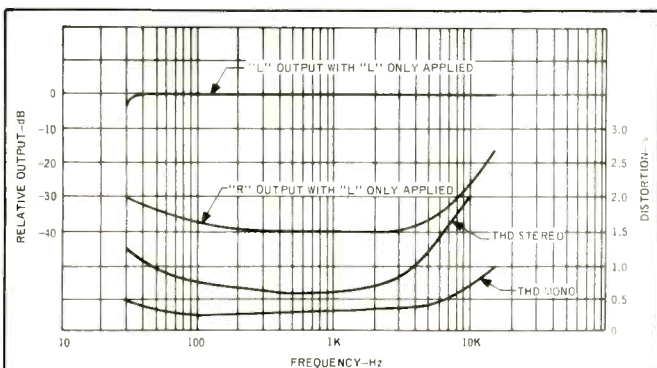

Fig. 5—Separation and distortion characteristics.

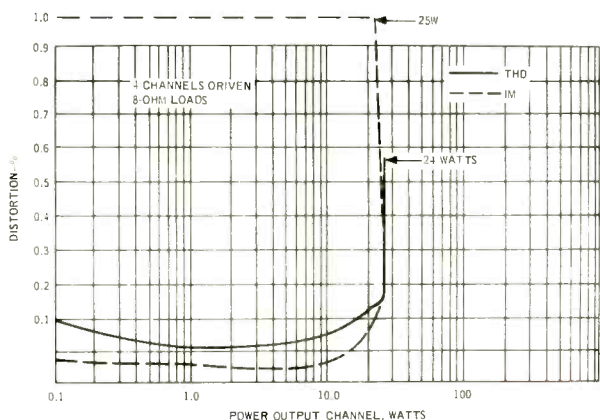

Fig. 6—THD and IM characteristics at 1kHz.

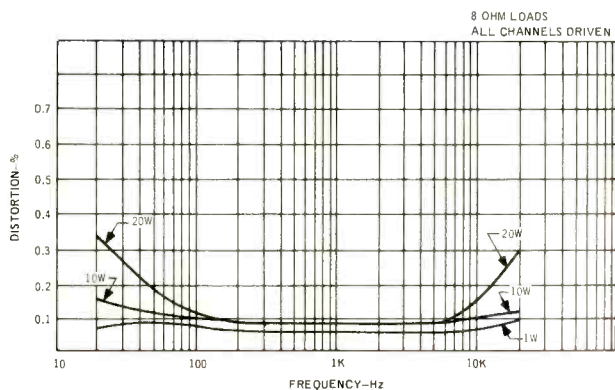

Fig. 7—Distortion vs. frequency at various power output levels.

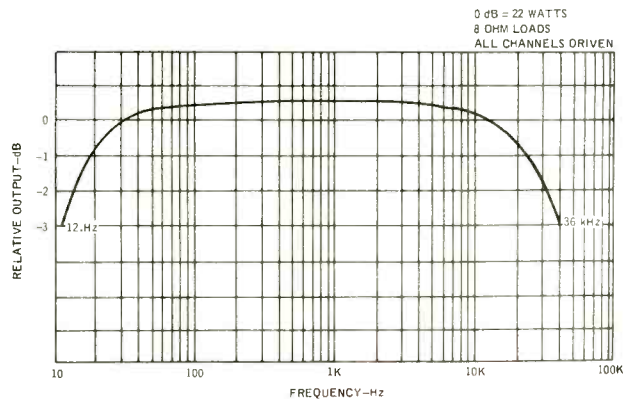

Fig. 8—Power bandwidth.

Amplifier Measurements

At rated output (22 watts per channel, with all four channels driven), harmonic distortion reached 0.2% while rated THD of 0.5% occurred at an output of 24 watts per channel. IM distortion, under the same conditions of measurements, reached 1.0% at 25 watts of power output per channel and remained well below 0.1% for all power output levels below 20 watts. Results of these measurements are shown in Fig. 6.

JVC claims only 20 watts per channel for this receiver if all frequencies from 20 Hz to 20,000 Hz are considered, but that claim, too, is somewhat conservative, as can be seen from the graphs of Fig. 7. At the 20 watt level, THD at 20 Hz and 20 kHz measured 0.24% and 0.3% respectively. In the strapped mode (not plotted graphically), maximum power per channel at mid-frequencies measured 48 watts for rated distortion of 0.5%. Power bandwidth is shown in Fig. 8.

Tone control range for the back channels is plotted in Fig. 9, while the multiple tone control arrangement of the front channels can provide the degrees of tonal adjustment plotted in Fig. 10.

Listening Tests

Since our laboratory is now equipped with a separate CD-4 demodulator (also made by JVC) and a full-logic separate SQ decoder, this provided us with good reference points from which to judge the four-channel performance of the 4VR-5446 in both matrix and discrete modes. To begin with, the built-in CD-4 demodulator of the receiver works fully as well as the separately available demodulator from that firm. We tried cartridges from JVC (their model 4MD-20X), Audio-technica (their AT15S) and experimental models of CD-4 cartridges from Shure and Pickering. All of them performed satisfactorily and apparently had enough 30 kHz output to be well within the range of adjustment of the "carrier adjust" control on the back of the receiver. As suggested by JVC, we did find it necessary to readjust separation controls for each cartridge, though the amount of adjustment was very slight. Residual noise heard when playing CD-4 records is still a bit higher than one expects in stereo, but this is probably more a problem of the software which keeps getting better all the time. As for separation, you just can't beat CD-4, and most of the records now available take full advantage of that fact.

By comparison, the MATRIX 1 and MATRIX 2 settings, when used to play SQ or other matrixed discs come off second best, since the 4VR-5446 has no built-in logic or gain riding circuitry. In fact, even the MATRIX 1 position, which is supposed to be used with SQ encoded discs, sounded to us as though it's decoding coefficients were *not quite* those recommended by SQ proponents. The four-channel effects were there, alright, but instrument directionality was different from that observed using a bona fide SQ decoder with dual logic included. In other words, we detected not just *decreased* localization, but altered instrument locations. Bear in mind that if you did not have other decoding equipment with which to compare these results, you'd probably never know the difference, since in every case, instrument location is a product of the imagination of the record producer or recording engineer in the first place and is often quite arbitrary.

As for the usual things we listen for, power output was clean and quite adequate for our medium efficiency air-suspension systems in a room measuring about 15 feet by 20 feet. We were able to overdrive the amplifier sections, but only at levels that most listeners would deem far too loud for the listening room in which we played the receiver. Because of the tricky requirements of four-channel balancing, we did not particularly like the dual volume control/dual

The classics from KLH. Four bookshelf loudspeakers of such extraordinary quality that each has set the standard of excellence in its price range. Pictured to the far left, our popular little Thirty-Two (\$55.00[†]). Next, one of the best selling loudspeakers in the country, the Seventeen (\$79.95[†]). Up front, everybody's favorite, the Six (\$139.95[†]). And finally, our most spectacular bookshelf model, the Five (\$199.95[†]). If you really want to know what KLH is all about, we suggest you listen to any one or all of these fine

loudspeakers. And when you do, also look for our other bestsellers—the KLH stereo receivers. The Model Fifty-Five (\$219.95[†]); the Model Fifty-Two (\$319.95[†]); and our newest receiver, the stereophonic/quadrasonic Model Fifty-Four (\$525.00[†]). KLH—the best thing to happen to bookshelves since books.

For more information, visit your KLH dealer or write to KLH Research and Development Corp., 30 Cross Street, Cambridge, Mass. 02139.

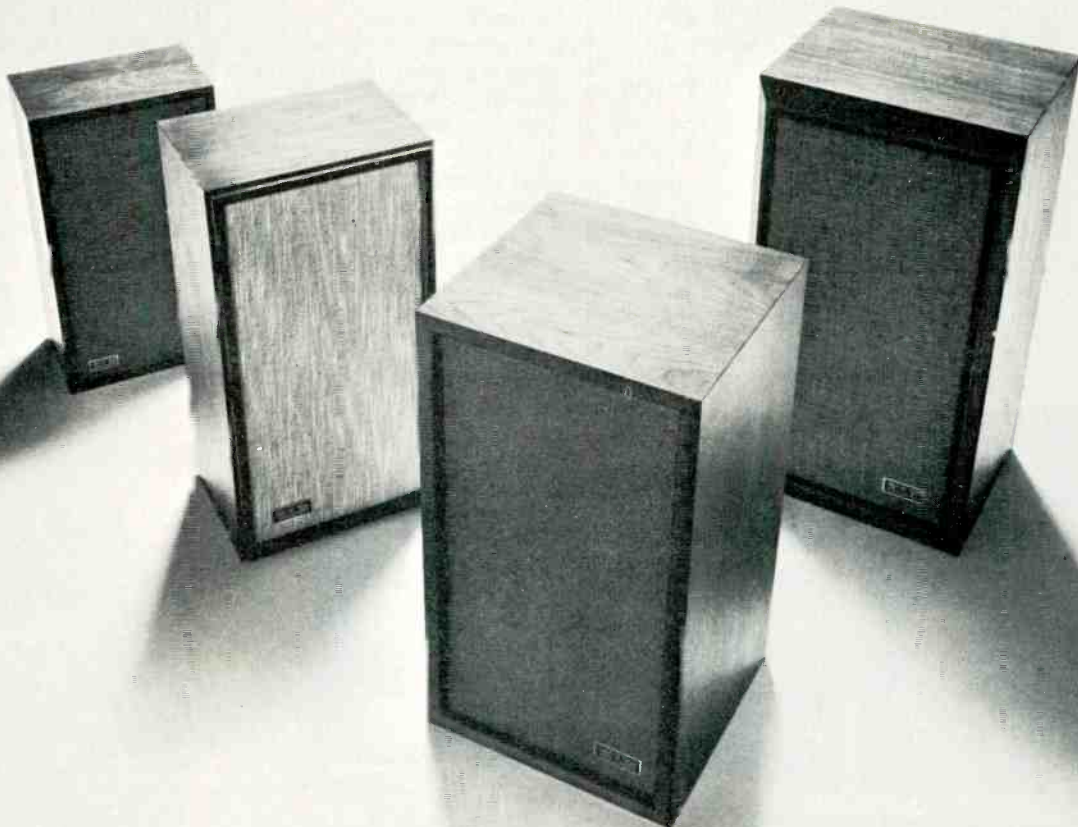

**What's a bookshelf
without the classics?**



KLH RESEARCH AND DEVELOPMENT CORP.
30 Cross St., Cambridge, Mass. 02139

[†]Suggested retail prices—slightly higher in the South and West.

Check No. 22 on Reader Service Card

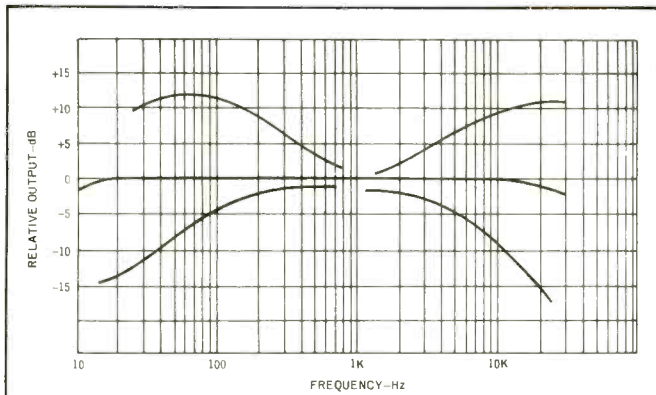

Fig. 9—Rear channels tone control range.

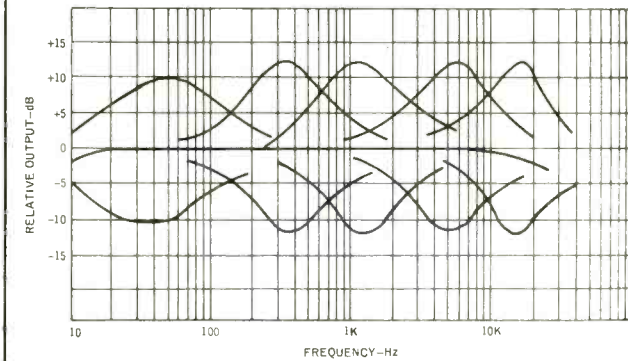

Fig. 10—Control range of 5-section "S.E.A." feature on front channels.

balance control arrangement on the 4VR-5446. These controls, as well as the tone controls, have nice "click-stops" for easy repeatability, but the clutch arrangement between front and rear sections makes it a little difficult to offset these sections in attempting to balance the levels of front and rear to suit our listening position. In other words, front-to-rear balance (most often required in typical four-channel listening situations) is accomplished by the settings of front and rear volume controls, which are concentrically mounted, while left/right balance is done by another pair of concentrically mounted controls. In the absence of a "joystick" type of balance control (which is included on the available remote control option), an easier-to-use arrangement would have been a front-rear balance control and a master volume control concentric to a left-right overall balance control. No more knobs, but an easier arrangement for the consumer to use. While it may be argued that settings need be made only at the outset, the fact is that we found different settings required when listening to CD-4 compared with four-channel tapes or matrix records.

FM performance was every bit as good as we would have expected from the lab-measured results, although stereo switching threshold might have been set a bit lower. Currently, stereo is received only if incoming signals are above 20 microvolts in strength which limited our number of logged stereo transmissions to about 15 out of the 46 usable signals received.

Overall gain of the receiver remains constant when switching from the four-channel mode to the stereo or strapped mode. Incidentally, because of the particular paralleling approach used by JVC in "strapping" the amplifiers, the instruction booklet cautions against using speakers of less than 8 ohms if the receiver is to be used for two-speaker



the
standard
of
comparison

Among audio experts, the SP-3 Preamplifier has become the standard by which other preamplifiers are judged. "The Stereophile" magazine calls the SP-3 "the closest thing yet to the ideal straight wire with gain." We could give you a lot of impressive specifications and numbers, but there's only one way to fully appreciate what the SP-3 can do. Install it in your audio system — put on your very best music source material — and get ready for the most satisfying listening experience of your life.

You'll discover musical subtleties you didn't know existed. Greater depth than you've ever heard before. Tone and color of all instrumentation revealed with unequalled accuracy. You'll also discover a few things are missing. Like hiss, distortion, hum, graininess—all the "bugs" that degrade sound quality.

More and more audiophiles are learning that the SP-3 makes a good system even better. Arrange for a demonstration at your Audio Research dealer. No matter how high your standards, you'll find the musical satisfaction you've been looking for.

audio research corporation

P.O. Box 6003 / Minneapolis, Minnesota 55406 / Tel: (612) 721-2961

*The Stereophile, Box 49, Elwyn, Pa. 19063

Check No. 6 on Reader Service Card

AKAI's 4-Channel Challenge

We challenge any other manufacturer in the world to surpass the performance of AKAI's new 4-channel component combination. You can pay more. But you can't buy better.

Here they are.

First is AKAI's new AS-980 4-channel receiver. Endowed with sophisticated features for unparalleled performance. Sensitive and powerful, the AS-980 provides a continuous output of 120W (30 x 4). Plus 4 separate 4-channel modes: Discrete, SQ, RM, and built-in CD-4 with individual separation controls ... It's everything you'd expect AKAI's ultimate receiver to be.

Unexcelled reproduction quality is yours with AKAI's new GX-280D-SS. It's a fully discrete 4-channel tape deck that's also 2-channel compatible. The utilization of 4 individual heads—including AKAI's exclusive GX glass and crystal heads (dust free and virtually wear free)—and 3 superbly engineered and balanced motors make this unit the professional 4-channel tape deck for recording and playback.

Together, these units are AKAI's unbeatable 4-channel challenge—providing professional 4-channel capabilities that no other equipment combination can match.

Both the AS-980 receiver and the GX-280D-SS tape deck are available at your nearest AKAI Dealer ... Whenever you're ready to make that ultimate step up. That's AKAI's 4-channel challenge.



From

AKAITM

The Innovators

Advertising Index

ADVERTISER	PAGE	ADVERTISER	PAGE	ADVERTISER	PAGE
Acoustic Research	65	Elpa Marketing	15	Radio Shack	39
AR-3a Speaker		Thorens Turntables		1974 Catalog	
Check No. 1 on Reader Service Card		Check No. 18 on Reader Service Card		Check No. 35 on Reader Service Card	
Acoustical Mfg.	6	Empire Scientific	11	Revox Corp.	71
Quad Speakers		Cartridges		Beyer Mics	
Check No. 2 on Reader Service Card		Check No. 19 on Reader Service Card		Check No. 36 on Reader Service Card	
AKAI America	49	Epicure Products	65	Rhoads & Co.	80
4-Channel Components		Loudspeakers		Teledaptor	
Write Direct to Advertiser		Write Direct to Advertiser		Write Direct to Advertiser	
Audio Devices	74	Fairfax Industries	63	Rogersound Labs	66
Magnetic Tape		Loudspeakers		Loudspeakers	
Check No. 4 on Reader Service Card		Check No. 21 on Reader Service Card		Check No. 37 on Reader Service Card	
Audio Dynamics Corp.	9	Frazier	71	S.A.E.	68
ADC XT-10 Speaker		Model 7 Speaker		High Fidelity Components	
Check No. 5 on Reader Service Card		Check No. 20 on Reader Service Card		Check No. 38 on Reader Service Card	
Audio Research Corp.	48	Harman/Kardon	24, 25	Sansui Electronics	21
High Fidelity Components		High Fidelity Components		Models 661 and 771	
Check No. 6 on Reader Service Card		Check No. 23 on Reader Service Card		Check No. 39 on Reader Service Card	
Audio-technica, U.S., Inc.	68	KLH Research and Development	47	Saxitone Tape Sales	82
AT 12S Cartridge		Bookshelf Speakers		Magnetic Tape	
Check No. 7 on Reader Service Card		Check No. 22 on Reader Service Card		Write Direct to Advertiser	
Audio Warehouse	83	Kenwood Electronics	Back Cover	Schwann Record and Tape Guide	79
Mail Order Discounts		KT-8005/KA-8004		Current Listings	
Check No. 10 on Reader Service Card		Check No. 24 on Reader Service Card		Write Direct to Advertiser	
Audioanalyst	76	Lafayette	73	Shure Bros.	29
Loudspeakers		1974 Catalog		High Fidelity Components	
Check No. 9 on Reader Service Card		Check No. 25 on Reader Service Card		Check No. 40 on Reader Service Card	
Audionics	72	Linear Design Labs	2	Sony Corp.	57
Loudspeakers		749A Loudspeaker		Sound Lab	
Check No. 8 on Reader Service Card		Write Direct to Advertiser		Check No. 27 on Reader Service Card	
Avid Corp.	28	Logic Newsletter	80	Sound Technology Research	78
Series 100 Loudspeakers		Sample Copy		P-3 Add-On Tweeter	
Check No. 11 on Reader Service Card		Write Direct to Advertiser		Check No. 41 on Reader Service Card	
BSR	67	Magnepan, Inc.	78	Soundcraftsmen	35
710 Turntable		Loudspeakers and Dealers		Equalizer	
Check No. 12 on Reader Service Card		Check No. 26 on Reader Service Card		Check No. 42 on Reader Service Card	
Bose Corp.	13, 72	Marantz	7	Stanton Magnetics	19
High Fidelity Components		4-Channel Receivers		High Fidelity Components	
Check No. 13 on Reader Service Card		Check No. 43 on Reader Service Card		Check No. 32 on Reader Service Card	
1800 Amplifier		Maxell Corp.	70	Superscope, Inc.	86, Cover 3
Write Direct to Advertiser		Magnetic Tape		High Fidelity Components	
Bozak	59	Check No. 28 on Reader Service Card		Check No. 63 on Reader Service Card	
Loudspeakers		McIntosh	69	TDK Electronics	41
Write Direct to Advertiser		Free Catalog		Cassette Tape	
British Industries	3, 23	Check No. 29 on Reader Service Card		Check No. 44 on Reader Service Card	
Garrard Turntables		McKay Dymek	80	Tascam Corp.	17
Check No. 14 on Reader Service Card		DA3 Antenna		Mixing Console	
Columbia Magnetics	77	Check No. 60 on Reader Service Card		Check No. 45 on Reader Service Card	
Cassette Tapes		PAIA Electronics	81	Technics by Panasonic	37
Check No. 15 on Reader Service Card		Synthesizer Kits		RS-279US Cassette Deck	
Crown International	4	Check No. 30 on Reader Service Card		Check No. 46 on Reader Service Card	
High Fidelity Components		Phase Linear	5	Trusonic	16
Check No. 16 on Reader Service Card		400 Amplifier		JR-200M Speaker	
dbx, Inc.	67	Check No. 31 on Reader Service Card		Check No. 48 on Reader Service Card	
Audio Accessories		U.S. Pioneer Electronics	Cover 2, 1	United Audio	27
Check No. 17 on Reader Service Card		High Fidelity Components		Dual Turntables	
Design Acoustics	69	Check No. 33 on Reader Service Card		Check No. 47 on Reader Service Card	
High Fidelity Components		Rabco	12	Yamaha	61
Check No. 56 on Reader Service Card		ST-4 and SL-8E		High Fidelity Components	
Dynaco	31	Check No. 34 on Reader Service Card		Check No. 49 on Reader Service Card	
A-25 Loudspeaker					
Write Direct to Advertiser					

stereo setups. In the four-channel mode, of course, any impedance from 4 ohms to 16 ohms will be satisfactory.

JVC's S.E.A. tone control system, supplied for the front channels only in this receiver, is effective in tailoring the response to the needs of the speakers or room acoustics. However, since it is only provided for front channels in this model, we would recommend leaving all the five levers in the "flat response" position if you're going to be listening to "matrix" quadraphonic discs through this receiver. The separation afforded by matrix discs when no logic circuitry is provided can be upset if extreme tonal compensation is inserted in part of the spectrum for the front channels without similar tonal compensation inserted for the rear channels. Under those circumstances, instruments have a way

of "drifting" as they play up and down the musical scale.

At just under \$600.00, the JVC 4VR-5446 is representative of many current receiver designs which pack lots of four-channel circuitry into a single chassis together with moderate power output when compared with stereo-only receivers costing considerably less. If the very most sophisticated in matrix technology or huge amounts of power are what you desire, you may have to wait a while, opt for one of the higher-powered, more expensive all-in-one receivers (such as JVC's 4VR-5456) or build your system of separate components (also more expensive). But if CD-4 and matrix reproduction in a single-unit, reasonably-priced receiver is what you're after, the 4VR-5446 will most certainly provide you with good reproduction.

Leonard Feldman

Check No. 53 on Reader Service Card

Audioanalyst Model A-200

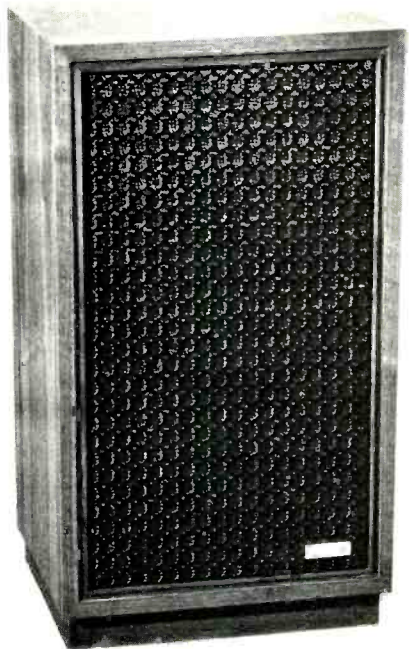

MANUFACTURER'S SPECIFICATIONS

Recommended power input: 20 W. min., 100 W. max. **Nominal Impedance:** 8 ohms. **Drivers:** 12-in. high-compliance woofer, 5-in. midrange (enclosed in separate sub-chamber), 3½-in. tweeter, 2 angle-mounted 2-in. super tweeters. **Crossover Frequencies:** 500 Hz, 2000 Hz, 7500 Hz. **Crossover Type:** L/C. **Controls:** Mid switch (3 dB change 500 Hz to 2000 Hz), tweeter switch (4 dB change 2000 Hz to 20,000 Hz). **Grille Cloth:** Dark, open weave fabric. **Enclosure:** Completely sealed oiled walnut, filled with resonance damping material. **Dimensions:** 27 in. H x 15 in. W x 12¾ in. D. **Weight:** 53 lbs. **Price:** \$225.00.

Audioanalyst's Model A-200 is a four-way speaker system using five direct radiators mounted in a sealed enclosure. A 12-in. high-compliance woofer provides the bass foundation for frequencies up to 500 Hz. A front-mounted 5-in. midrange direct radiator, sealed in a separate sub-chamber, carries the 500 Hz-2 kHz range, and a sealed 3½-in. tweeter augmented by two 2-in. super tweeters covers the range above 2 kHz to beyond audibility. The two super tweeters are slightly angled relative to the frontal axis to provide adequate dispersion at the higher frequencies.

Hookup is made by two widely spaced and well-marked binding posts on the back side. Two toggle switches marked

HIGH and LOW and TWEET and MID provide the only adjustment with which the purchaser need concern himself. The likelihood of improper connection with hazardous loose wire strands that could short when moving the speaker is all but eliminated by this configuration. Nylon runners are provided for the bottom of the enclosure.

A short but reasonably concise instructive brochure is supplied with the speaker. A six-year warranty is provided to the original purchaser.

Technical Measurements

Figure 1 is the measured impedance for three switch combinations. Minimum impedance occurs at 6 kHz when both tweeter and midrange units are in the HIGH switch position. Since this is slightly above 6 ohms, it is not recommended that two A-200's be paralleled on the same amplifier terminal, such as might be anticipated for an extension speaker. Basic system resonance occurs at 50 Hz with a higher impedance resonance peak in the 1-2 kHz range depending upon equalizer switch setting.

The one-meter free field response is shown in Fig. 2 for on-axis sound pressure level at the same equalizer positions as that of Fig. 1. The tweeter switch changes the level by about 4 dB as stated by the manufacturer, but the midrange switch was relatively less effectual. Because certain portions of the midrange response actually dropped when the switch was placed to HIGH, it appears that some phase cancellation is taking place in the range from about 600 Hz to 3 kHz. For small angles off-axis, the extreme high frequency response was extended to beyond 20 kHz by the super tweeters. A general mid-frequency dip of some 3 dB is evident from

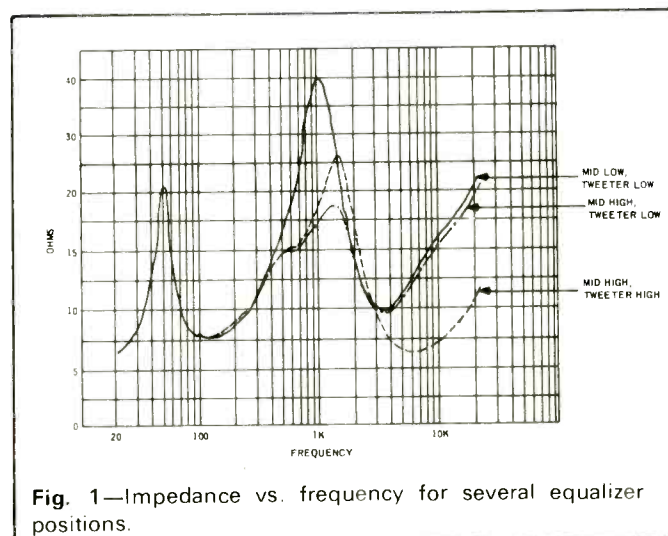

Fig. 1—Impedance vs. frequency for several equalizer positions.

700 Hz to 2 kHz even at the best response position which is, as Audioanalyst claims, with both switches in the "down" position. Bass response is quite smooth and well behaved down to 60 Hz with a 12 dB per octave roll off below 50 Hz.

Phase response is plotted in Fig. 3. Non-minimum phase breaks occur at about 900 Hz, 2 kHz, and 8 kHz. The display of Fig. 3 is the phase response corrected for a time slightly after the arrival of the first sound. This was done in order to get the entire plot on one display with reasonably small phase coordinates. This phase plot is the normal response with both switches "down."

The three-meter room response is shown in Fig. 4. The A-200 was placed in a room in the position recommended by Audioanalyst, on the floor and flat against a wall. Measurement was made at a typical listening position three meters in front of the speaker and one meter above a carpeted floor. Figure 4 shows the frequency response for the first ten milliseconds of sound for both a direct on-axis position and thirty degree off-axis position. The off-axis position corresponds to the left channel of a stereo configuration. For clarity of presentation, the plots are displaced ten decibels apart.

Harmonic distortion measured for the musical tones E_1 , A_2 , and A_4 are shown in Fig. 5. Although the low bass distortion is not high for this speaker, the increase above 95 dB SPL warns against equalization to bring the 41 Hz level up to that of 110 Hz if you like to play your music loud. It is far better to get the good clean bass down to 60 Hz which the unequalized speaker provides. The A-200 did not evidence any sonic discomfort for even the most severe subsonic components of a badly warped record when played at a high level.

The measured intermodulation of 440 Hz by 41 Hz mixed in equal ratio is shown in Fig. 6. The indicated power is that of a single sine wave with the same peak level as the mixed tones. IM for this speaker is primarily due to amplitude modulation.

The crescendo handling capability of the A-200 is extremely good. An 8 watt inner musical voice is not measurably suppressed when an 80 watt average noise burst is superimposed, even though this corresponds to close to an 800 watt instantaneous peak level.

Figure 7 is the 20 Hz-20 kHz polar energy plot and the orientation is that of looking down on the speaker. The two small "fingers" on each side of the frontal axis are due to the angled super tweeters. The apparent horizontal imbalance is probably due to the side-by-side midrange drivers. The tweeter is on the left center of the A-200 as you face the front. The polar plot does not mean that the sound is inaudible from the back, only that the energy contribution from the back is more than 25 dB below that from the front. The polar plot implies that a wall-mounted position would

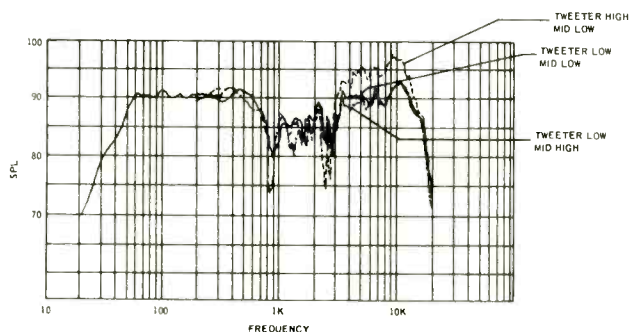

Fig. 2—One-meter pressure amplitude frequency response.

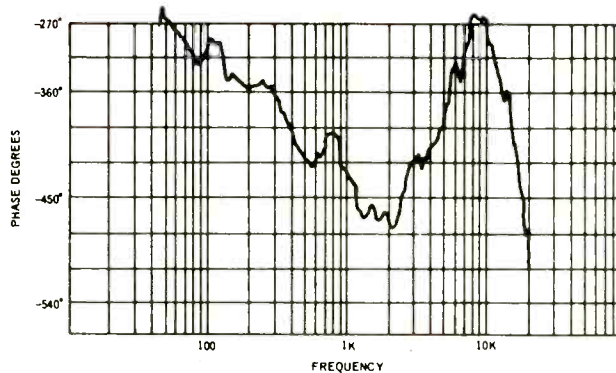

Fig. 3—One-meter pressure phase response.

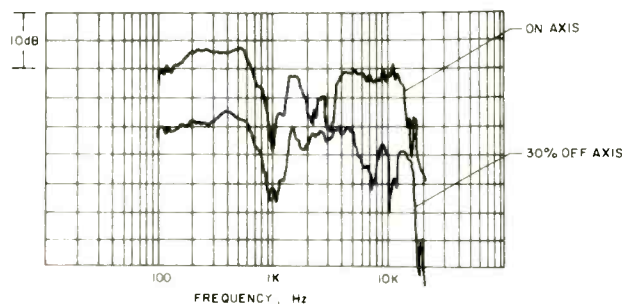

Fig. 4—Three-meter pressure amplitude and phase response.

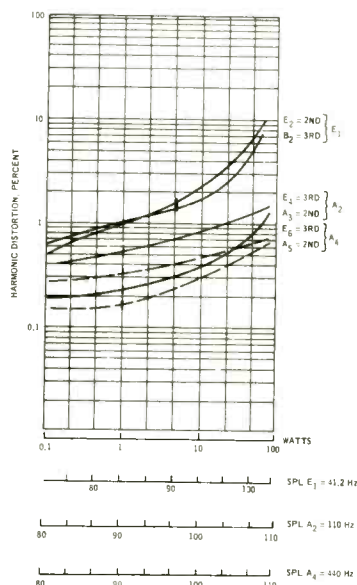

Fig. 5—Harmonic distortion for musical tones E_1 , A_2 , and A_4 .

THE SONY SOUND LAB

Even if you can't afford it, you should know about it.

Knowing about a system like this gives you more than just a hook to hang your dreams on. It's also a benchmark that the system you have (or the one you plan to buy) can be measured against.

It exists because engineers dream, too. And because, at Sony, they turn their dreams into reality.

One dreamed of a turntable whose mechanical performance would approach an electronic circuit's level of perfection. The result was the PS-2251, in which electronic circuits perform the formerly mechanical functions of speed selection, speed regulation and pitch control. The single moving part...the turntable/servomotor assembly.

Other Sony engineers wouldn't settle for anything less than a tuner with

absolute interference rejection. So they added to an already interference-free tuner, a circuit that could cut through even the most persistent impulse noises of men and machines.

More dreams: A preamplifier with the control flexibility of nearly 2,000 precisely repeatable response settings and precisely 42 levers, meters, knobs and jacks. A quadraphonic decoder with dual logic circuits that can make your system realize the full potential of four channel SQ discs and FM broadcasts, with decoder circuits for other matrix recordings, and a full complement of quadraphonic monitoring and control facilities. Plus power amplifiers so clean that they approach the maximum dynamic range of a live symphony orchestra while delivering 100 contin-

uous watts of power per channel at all frequencies from 20 to 20,000 Hz, with less than 0.1% distortion.

Dreams, once. Realities, today.

And new realities to come. For after the dream levels of performance are achieved, our engineers re-scale their visions, asking: "What if we could adapt these new techniques, approach these levels of performance and sophistication, in less costly equipment?"

Some of the answers are on your Sony dealer's shelf already.

The complete Sony Sound Lab described above sells for \$2,247.00: PS-2251 turntable, \$349.50; ST-5130 tuner, \$349.50; TA-2000F pre-amplifier, \$579.50; SQD-2020 full logic SQ decoder, \$229.50; (2) TA-3200F stereo amplifiers, \$369.50 each. All prices suggested retail.

Sony Corporation of America, 9 West 57th Street, New York, N.Y. 10019.

SONY®

Check No. 27 on Reader Service Card



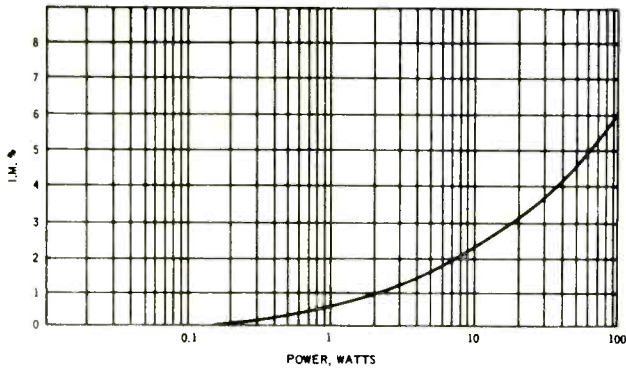

Fig. 6—Intermodulation distortion of 440 Hz by 41 Hz mixed 1:1.

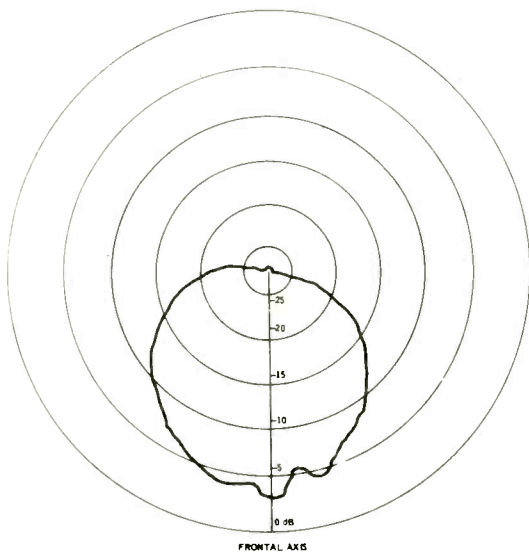

Fig. 7—Polar energy response.

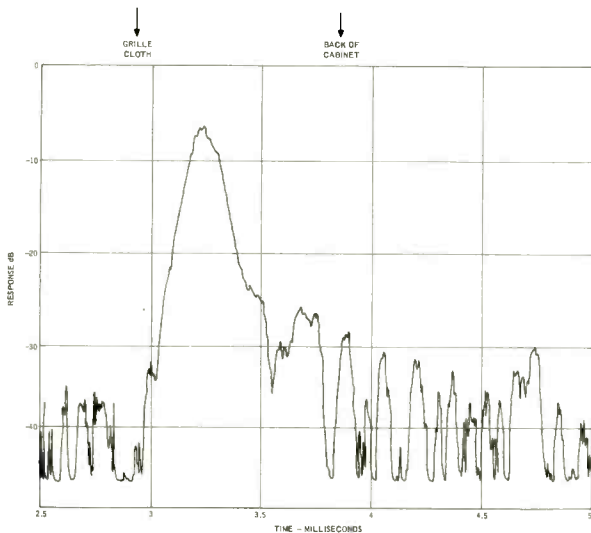

Fig. 8—On-axis energy time response.

be an excellent location for the A-200. There is no appreciable beaming of sound, however if these speakers are used in a stereo configuration with an included angle greater than 60 degrees a slight rotation of the speakers toward the listening area can be helpful in keeping high frequency balance. Even though the A-200 is fairly efficient, yielding 90 dB SPL at one meter for a one watt input, the "direct sound" property of the polar plot suggests that amplifiers rated less than 30 watts might not be satisfactory if you like to play your music loud.

The energy-time plot for a one meter on-axis position is shown in Fig. 8. The physical location of the grille and back of cabinet are indicated to identify the position of acoustic sources. Figure 9 is a plot made for a 30 degree off-axis angle.

Listening Test

Even without checking the manufacturer's mailing address, the sound of the Audioanalyst A-200 would classify it as "New England." The bass does not go *all* the way downstairs, but does go down a quite respectable distance with a sound that is firm but not boomy. The top end is clean and smooth with some sibilant emphasis, but not spitty as one might expect for a speaker system in this price range. The mid frequencies, starting at around an octave above middle C, have a shallow dip which tends to move vocals back in the sound image. A close-miced "breathy" vocal would be particularly bothered by this effect and some rock instruments could benefit from a midrange boost. In this reviewer's opinion, high level percussive sound may lack some punch, even though everything is there and in its place.

The best sound was obtained with the A-200 flat against a wall as the manufacturer recommends. After a good deal of listening with various positions of the tweeter and midrange switches, it was this reviewer's opinion that the "down" position was best for musical balance. It was our impression that although a slight change in timbre was noted for a HIGH midrange control, the mid frequency dip was not adequately filled and indeed a better sonic balance was obtained with this switch down, as the maker says. It was not until the frequency response measurements were made much later that we saw what was happening.

It is this reviewer's opinion that a proper midrange boost would bring the A-200 performance up to that of some highly respected speakers selling for 50 percent more. As it stands, the performance is *certainly* quite acceptable for a speaker in this price range.

Richard C. Heysler

Check No. 55 on Reader Service Card

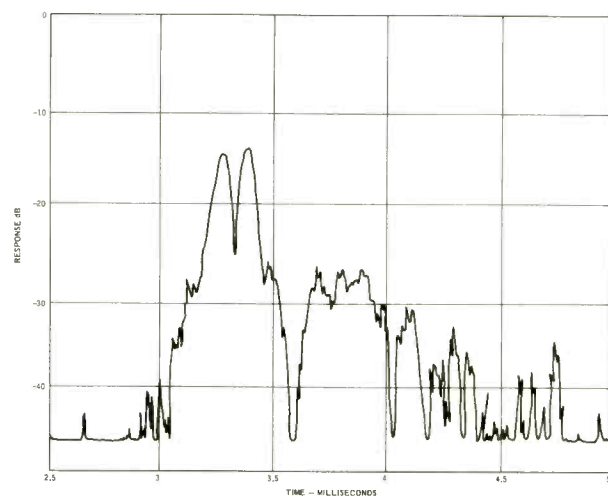
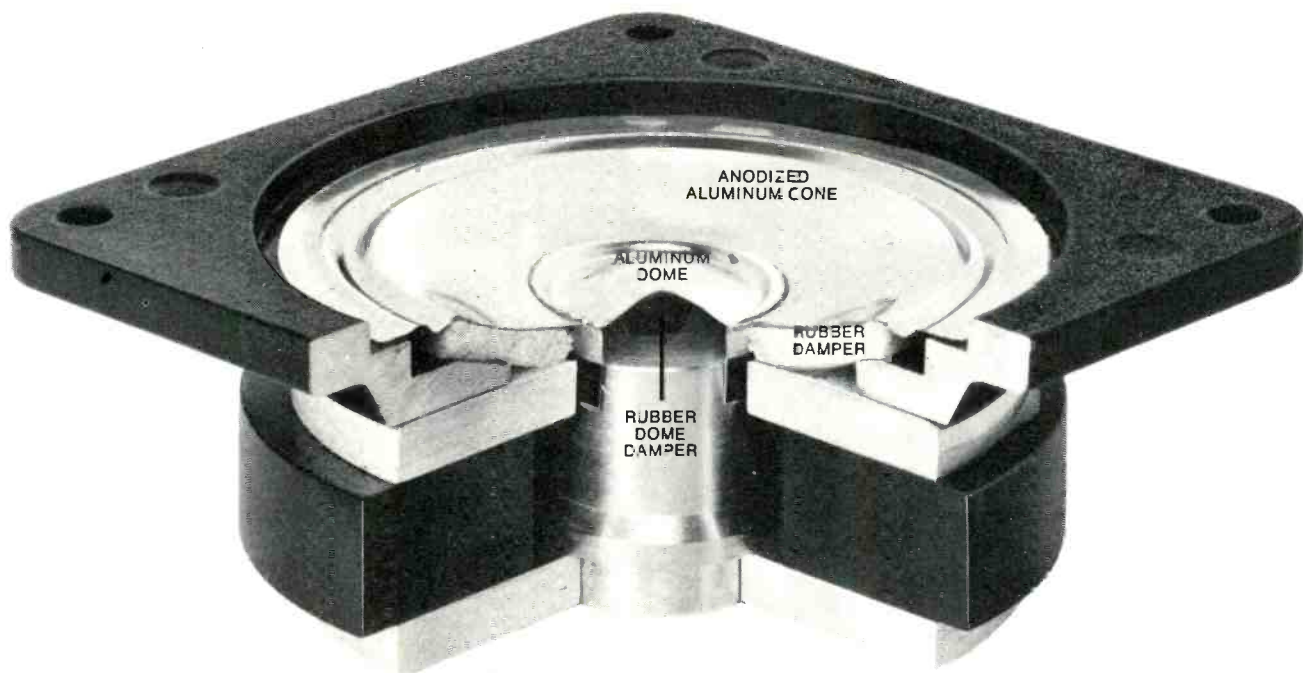

Fig. 9—Off-axis energy time response.



Our tweeter. Like no other.



A cross-section cutting of the ruggedly constructed Bozak B-200Y Tweeter shows some of the reasons why velvet-smooth treble with no hint of shrillness is characteristic only with Bozak.

Bozak's aluminum diaphragm (only .002 inch thick) and a central aluminum dome (providing dual radiation) are nested in a bed of foam rubber which dampens the peaks and resonances usually characteristic of other "tweeters." No other tweeter has such complete damping. This time-tested, 2-inch tweeter is a part of every Bozak speaker system . . . book-shelf to the famed Concert Grand.

Our new, informative booklet, "Evaluating a Speaker System" covers not only tweeter design, but tells what to look for in midrange and woofer design, cabinetry, lots more too. It's free on request. Write: Bozak, Inc., Box 1166, Darien, Conn. 06820.

**It's tough
to compare something
in a class by
itself.**

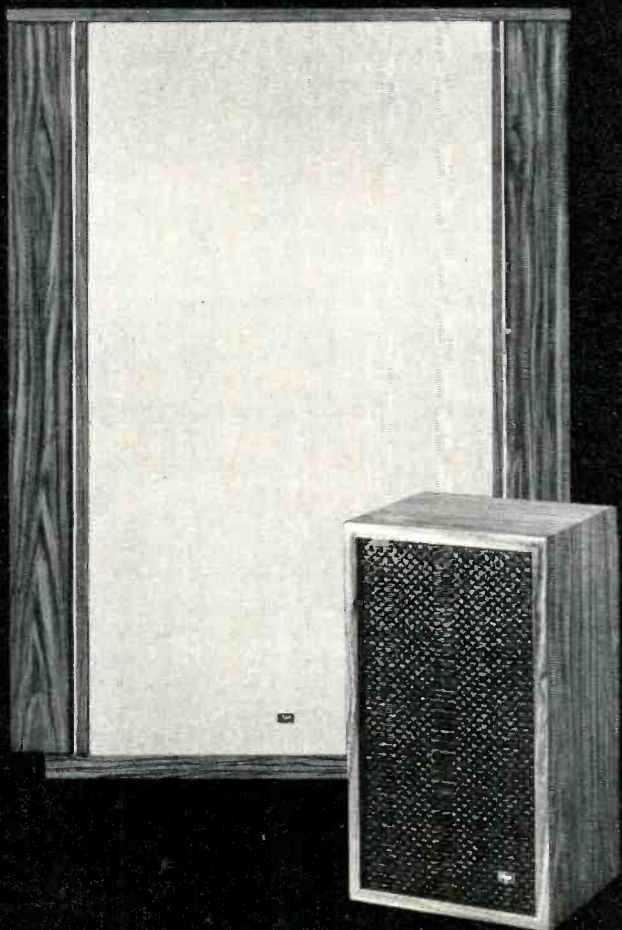

Bose Model 1801 Stereo Amplifier

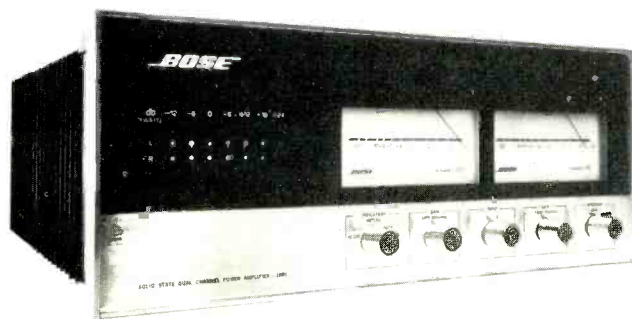

MANUFACTURER'S SPECIFICATIONS

(See text.) **Dimensions:** 7 $\frac{3}{16}$ in. H x 18 in. W x 18 $\frac{1}{2}$ in. D. **Weight:** 82 lbs. **Prices:** \$986.00, as tested; less LED and VU monitor display option, \$799.00.

Discussions of amplifier design have heated up a bit since the introduction of the Bose 1801. In addition to employing a number of new design techniques and some devices not previously seen in this area, the 1801 is an example of the Bose Corporation's highly individualistic approach to design. As with the 901 and 501 speaker systems, it's just not possible to say that the Bose folks let anyone else do their design thinking for them. Again, as with the 901 and 501 speakers, they have rethought the basic problems and questioned the basic assumptions that lay behind previous designs and approaches. Whether or not you agree with their concepts and conclusions, either on individual questions or overall approach, you must agree that they are radicals—in the old sense of the word, that they go to the root of things.

Rather than try to be a spokesman for the firm, through analysis of the amp, let us turn to a copyrighted booklet on the 1801 put out by Bose. This booklet is not a spec sheet in the usual sense but rather deals with the background and philosophy of design and specification mentioned above. Because Bose takes a rather unusual approach to these items, we have dispensed with our usual "Manufacturer's Specifications" block and will simply quote from the booklet. These are not verbatim quotes, but are, we feel, in context, accurate, and pretty well speak for themselves.

"Specification Philosophy

"We have reached a stage where consumers pay more for 'better' numbers in specifications without any knowledge of whether these 'better' numbers give better performance—in many cases they don't.

"In each case when we quote a specification for the 1801, we will quote not the actual specification but only the minimum necessary to achieve audible perfection with respect to the specified parameter.

"Setting aside the measurements for a moment, there is really only one specification that is meaningful. . . . When the 1801 is used within its ratings . . . [it] contributes no audible distortion or coloration of any kind on any music signals. It serves purely to amplify the power level of the musical signals."

"Power Rating

" . . . the characteristics of the human auditory process are such that a large increase in amplifier power produces only a small increase in perceived listening level. For example, it is necessary to *double* the amplifier power to produce a 3 dB increase in sound level which is the first significantly discernible increase in listening level. And the amplifier power

must be increased by ten times to only double the subjective listening level . . . !

"There is no point in designing an amplifier to deliver more power than the loudspeaker can handle. . . . Even the best designed speakers should not be used with amplifiers delivering significantly greater than 250 watts rms per channel.

"Therefore, we elected to design the 1801 to deliver 250 watts rms per channel into an 8 ohm load. For four ohm loads, however, there are significant applications that can benefit from more than 250 watts. In particular, many 4 ohm loads will consist of two pairs of 8 ohm speakers connected in parallel. Hence, we have designed the 1801 to deliver 400 watts rms per channel into 4 ohm loads."

"Frequency Response

"Of all the specifications that have been traditionally used to measure amplifier performance, frequency response is perhaps the most important . . . our research indicates that in order to assure no audible coloration on any music signals, the frequency response in the range from 30 Hz to 10 kHz should be flat within ± 0.25 dB and the frequency response from 10 kHz to 15 kHz should be flat within ± 0.7 dB. In the extremes of the spectrum, from 20 to 30 Hz and from 15 kHz to 20 kHz, a tolerance of ± 1.0 dB is easily sufficient to guarantee no audible coloration."

"Transient Response

"This may come as a shock, but transient response is the most overrated specification parameter in the industry today. The facts are that if the frequency response is tightly controlled as discussed above, then, except for purely pathological cases involving specially designed phase shift networks, the transient response is irrelevant to the audible performance of the amplifier. If a design decision is made to specifically optimize, for example, the 10 kHz square wave transient response, then wide-bandwidth power transistors are required leading to increased cost, marginal stability circuits, and reduced reliability because of voltage breakdown problems associated with high-bandwidth transistors. This is a prime example of how the consumer pays for 'specsmanship.'"

"Overload Recovery

"This parameter is often confused with transient response because pulses are sometimes used to observe the overload characteristics. This difference is that transient response relates to normal operation of an amplifier while the pulses that are used to investigate the overload characteristics are such that they cause the amplifier to be driven beyond its design limits. . . .

"A well designed amplifier should recover from an overload in less than 25 microseconds."

"Input Impedance

"This is actually a very important parameter of an amplifier and one which has interesting design tradeoffs. The lower the input impedance, the more impressive the noise specifications become. However, low input impedances can interact with preamplifiers and other equipment to cause audible changes in the frequency response of the combined units—a factor that does not show up in any amplifier specification. To avoid this deterioration, the input impedance of an amplifier should be greater than 50,000 ohms."

"Noise and Hum

"The amplifier/speaker combination of the best music system should be capable of producing 115 dB instantaneous sound levels on musical passages when the amplifier is

WHILE OTHER STEREO MANUFACTURERS WERE BUILDING MORE POWER INTO THEIR COMPONENTS, WE WERE BUILDING LESS DISTORTION INTO OURS.



The engineers of this new receiver were ordered to give it more watts than ever before. "Power's what turns 'em on today" the engineers were told.

It even features a switch for breaking windowpane and other household glass.



Our engineers gave the new Yamaha stereo receivers 20% less power than competing models.

Why would they do a thing like that?

In order to give you 80% less distortion for the same money.

They know the importance of lower distortion compared to higher power ratings.

Distortion can make you tired of listening.

It fouls up good sounds, can cause headaches, and drive neighbors bananas.

And if you're worried about missing that 20% "extra" power, our engineers say it's less than 1 dB, which can barely be heard.

What can be heard is the clean difference Yamaha's typically .08%* distortion amplification can make.

Especially after listening for a while (people become more critical as time goes on).

Avoid distortion.

Hear our new components at your Yamaha Audio dealer soon.

*Report substantiating low Yamaha distortion is on file. For a free copy, write:

YAMAHA AUDIO DIVISION
Box 6600, Buena Park, California 90620

Check No. 49 on Reader Service Card

fully driven. If the amplifier has a signal-to-noise ratio of 100 dB, then the noise level in the room caused by the amplifier will be only 15 dB—well below the ambient noise of *any* room and therefore inaudible.”

Distortion

“Distortion is a performance parameter frequently subject to specsmanship, to the detriment of amplifier reliability . . . one can achieve impressively low values of distortion at the high end of the audio spectrum (above 10 kHz). Unfortunately, this is accomplished at the expense of increased vulnerability to transistor second breakdown (a form of voltage breakdown) and greater susceptibility to internal oscillations that can destroy the amplifier—quite a price to pay for inaudible improvements in distortion.

“Harmonic distortion actually is significant in a practical sense only in the frequency range up to 10 kHz because above this range the harmonic distortion components all fall above 20 kHz and are inaudible. Basic psychoacoustic tests will show that total harmonic distortion less than 0.5 percent below 5 kHz and less than 1.0 percent between 5 and 10 kHz is inaudible on music or speech signals.

“Intermodulation distortion is a measure of unwanted signals generated by the interaction of two input signals of different frequencies that are applied simultaneously. IM distortion less than 0.5 percent (as measured according to IHF standards) is inaudible on music or speech signals.”

Whether or not you agree with this design philosophy and approach to specifications, you probably agree that Bose has made a rather broad reappraisal of what's needed currently in amplifiers. And having said that, let's turn to the unit itself.

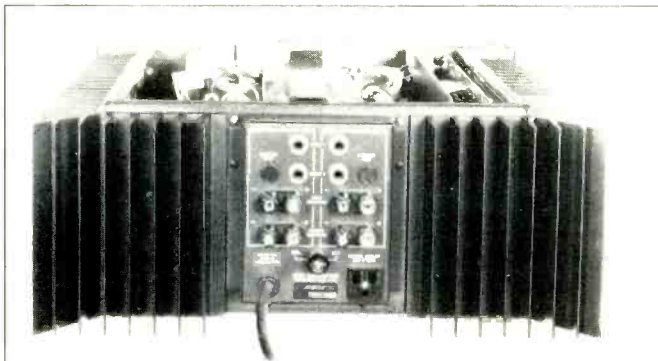

Fig. 1—Back panel of the Bose 1801

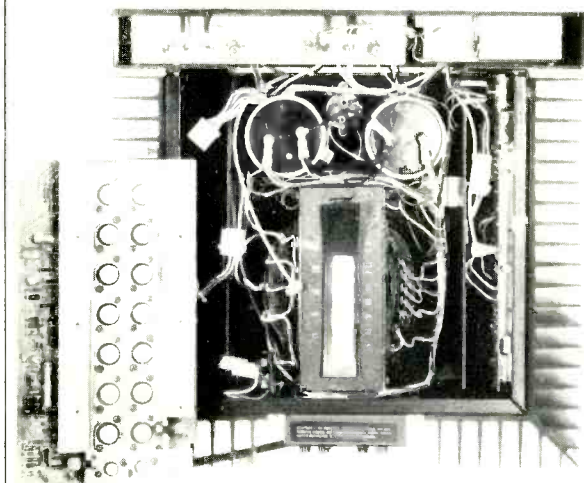

Fig. 2—Top view of the 1801, with one board removed.

Physical Description

After unpacking the amplifier, our first impression was to note the unusually large array of heat sinks extending around three sides. (Some 1300 square inches of radiating surface, according to the booklet.) To be strictly accurate, our first impression was conditioned by the *actual weight* of the amplifier—82 lbs.—and lifting it from the floor to a bench was no easy task. The power transformer alone turns the scales at 41 lbs.—a two kilowatt monster! On the left of the nicely finished front panel is an array of LEDs (Light Emitting Diodes) used as power indicators and to their right are two large VU meters. Underneath are five control knobs, the first being a combined a.c. power switch and meter/LED selector. Next comes the gain control for the left channel and then a two-position input switch. Next to that is the gain control for the right channel, and a speaker switch ends the line. The VU meters have a longer time constant than usual and are calibrated to read in *integrated power*. Fast transient peaks are handled by the LEDs which respond almost instantaneously. Each channel has a row of seven LED indicators calibrated from -12 dB to +24 dB referred to 1 watt (at 4 ohms). Thus, the +24 dB corresponds to a power of 256 watts and the next vertical line of four LEDs to the right indicates clipping. The selector switch gives a choice of LED display, VU meters or both together. The input and output connections are at the rear, phone jacks being used for the inputs and heavy-duty binding posts for the loudspeakers. A single a.c. outlet socket is provided, and a 10-amp fuse is also on the rear panel.

Mechanically, the 1801 is very solidly constructed—built like the proverbial battleship, in fact. All the components are of excellent quality—top-grade fiberglass circuitboards, heavy-duty connectors, 85° C. capacitors, and so on. There are two main boards, each of which contains a complete channel of amplification, including the power transistors and temperature protection circuits. The power transistors are placed on an aluminum alloy “heat coupler,” as Bose calls it, which is in turn connected to the heat sinks via six screws. Circuitry on the board is connected up with three connectors. All this allows easy removal of the boards, if necessary, as we did for our top-side photo.

Circuit Description

The circuit arrangement is fairly conventional with the exception of the first stage which uses an op amp instead of the usual differential pair. Input impedance is higher than usual at 50 Kohms. A differential pair is actually used in the second stage. This is followed by the predriver stages and NPN silicon power drivers connected to two parallel sets of six power transistors—a total of 24 output transistors (32 counting the drivers) for both channels. A current-sensing protection circuit is employed—plus a thermal cutout. A relay in the power circuit switches on full power after a one-second delay, thus eliminating surges.

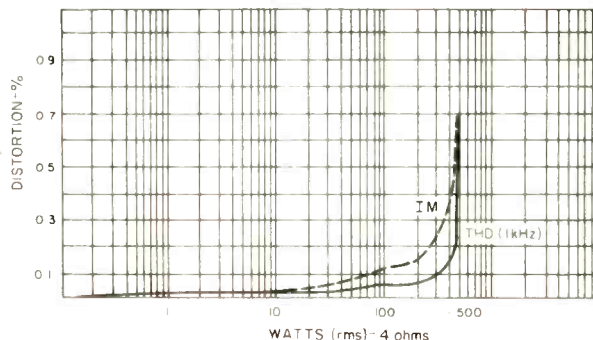
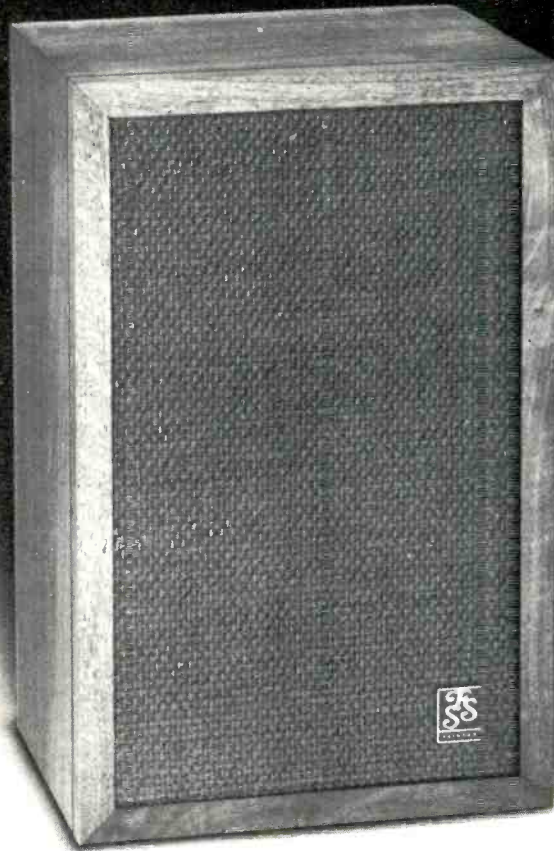

Fig. 3—Power output versus harmonic and IM distortion, 4 ohm loads, both channels driven.

NOT FOR SALE

AT ANY PRICE



We Earned Our Top-Rating

The **Fairfax FX-300** was recently top-rated over 20 leading medium-priced speakers by one of the most respected consumer reporting organizations in the world.

That's something money can't buy! Like any of the nationally advertised brands we topped, we could make all sorts of claims and super-claims for Fairfax speakers, including a number of SPEAKER FIRSTS we have to our credit. We could follow the pack and excerpt reviews or we could spend lots of money to buy endorsements.

However, at Fairfax, our money goes into the speaker. And we think you will agree with "The Report Money Can't Buy"—the investment is well worth it. But in order for you to agree that the **FX-300** is the most accurate sounding speaker (rated at 8 ohms with a minimum of seven watts RMS required) you will have to listen to ours and compare it to theirs—any of the 20 other speakers we topped and then some.

Visit your nearest audio dealer and ask to hear the **Fairfax FX-300**, and compare it to any other speaker in its price range—even some costing considerably more.

If your dealer is not a Franchised Fairfax Dealer, have him contact us and we will send him a pair of **FX-300** speakers for your evaluation—at our expense. Only Fairfax has the confidence in their product, and your judgment, to make such an offer.

FAIRFAX INDUSTRIES, INC.
900 Passaic Avenue, East Newark, New Jersey



Check No. 21 on Reader Service Card

Measurements

Figure 3 shows the power output versus harmonic and IM distortion for 4 ohm loads, both channels driven. It will be seen that the output for 0.5 percent THD is some 470 watts. This fell to 280 watts for 8 ohm loads—both figures exceeding the design goals by a comfortable margin. Distortion versus frequency is shown in Fig. 4, and frequency response is shown in Fig. 5. The response is 3 dB down at 53 kHz and 10 dB down at 100 kHz. Square wave response at 40 Hz, 1 kHz, and 10 kHz is shown in Figs. 6A, B, and C; note that there is no sign of overshoot.

Figure 7 shows symmetrical clipping at the overload point, which is no less than 625 watts! Power bandwidth extended from below 10 Hz to about 30 kHz (it was difficult to measure exactly owing to the action of the thermal cutout). Distortion does not increase at lower levels, and no trace of crossover distortion can be seen in the 10 milliwatt signal shown in Fig. 8. Hum and noise came out at 96 dB for one channel and 98 dB for the other. Sensitivity for full output was 1.7 volts.

The LEDs gave a very positive indication and were remarkably accurate. It was noted that a 100 watt (rms) signal produced a VU deflection of 0 VU—corresponding to about 250 watts of music power. Finally, stability was checked with various capacitive and reactive loads with no untoward effects.

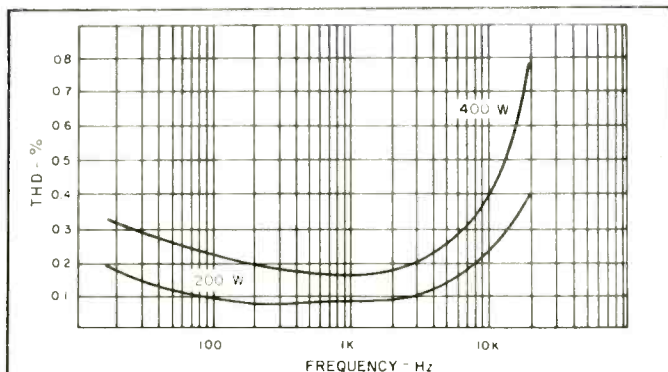

Fig. 4—Frequency versus harmonic distortion at two power levels.

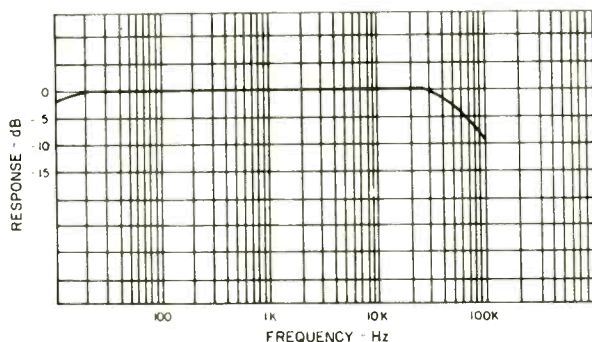

Fig. 5—Frequency response, 1 watt level.

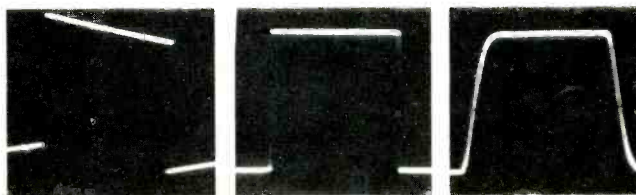

Fig. 6—Square wave response at A, 40 Hz; B, 1 kHz, and C, 10 kHz.

Listening Tests

Listening tests were carried out over a period of several weeks using a wide variety of equipment including AR LST speakers, EPI 400s, a Crown IC-150 preamp, and three phono cartridges—a Shure V-15 Mk III, Decca Professional, and an Audio-technica 20. The turntable was a Thorens 125 Mk II. The sound was as clean and transparent as that produced by any of the other top-quality, high-power amplifiers.

This is certainly not surprising as the only noticeable difference is the slightly inferior (if that is the right word) square wave response at frequencies above 6 kHz. This is, however, a rather academic point, and no difference could be heard in listening tests between it and other amplifiers having a wider bandwidth. To amplify on this point a bit, there are two schools of thought on amplifier design, the narrowband and wideband groups^{1,2,3,4}. The former argue that a 10 kHz square wave needs a bandwidth of ten times the 10 kHz (or 100 kHz) to reproduce it properly; ergo, since music has a much more complex waveform, a response of up to 200 kHz is needed. The narrowband school says that the argument is fallacious and that a response up to 20 kHz is quite adequate. However, the evidence is not conclusive, and more work certainly needs to be done to determine just what bandwidth really is necessary for the accurate reproduction of music waveforms—regardless of the present limitations of tapes, records, and broadcast transmissions.

Irrespective of where the 1801 stands regarding these bandwidth discussions, the sound is completely neutral—like the proverbial piece of wire with gain. Or as the booklet has it: "... the amplifier contributes no audible distortion or coloration of any kind on any musical signals. It serves purely to amplify the power level of the musical signals."

Summing up: The Bose 1801 is a well-engineered, beautifully made piece of equipment using high grade components, which should ensure a higher than average reliability. Power output is high enough for the most insensitive loudspeaker systems—even for rock *aficionados*. It is not particularly cheap, but then this high level of product quality rarely is. But don't forget, there is a version without the LED and VU meter displays which sells for less than \$800.00.

Check No. 54 on Reader Service Card

George W. Tillett

¹Amplifiers, George W. Tillett, *British Audio Annual*, *Hi-Fi News*, 1965; reprinted *Audio*, April, 1971, p. 32.

²"Why Solid-State Amplifiers Can Sound Better," Morley Kahn, *Acoustec* publication.

³"Transistors for Hi-Fi," Myers and Kahn, *Electronics World*, April, 1964, p. 42.

⁴Audio Quality, G. Slot, Philips, Eindhoven, The Netherlands.

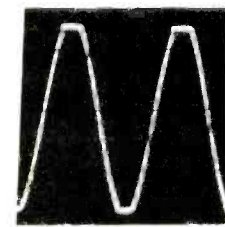

Fig. 7—Symmetrical clipping at 625 watts, 1 kHz.

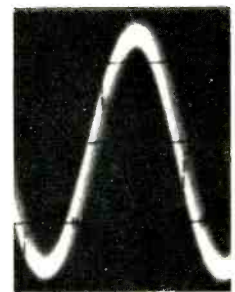

Fig. 8—10 milliwatt sine wave signal.



Fig. 9—Hum and noise.

(Continued from page 6)

output as read in playback on the VU meter. However, instead of my recordings sounding overly-bright, as expected, there is a very definite loss of high frequencies. I have tried under-biasing, but without success. My questions are: (1) How could I adjust playback equalization for optimum performance with Scotch 203, and do you think it would make a significant difference? (2) On occasion I have pinned my VU meters by some sort of feedback when, while listening to my tape through Koss ESP-7 electrostatic headphones, I pass my hand near the playback head of my deck. Is a feedback loop of this nature possible? Could such levels have magnetized my heads beyond the ability of my demagnetizer to remove it? (3) Is it possible, by feeding different frequencies into the recorder and monitoring their respective playback levels on my VU meters, to get some idea of my recorder's frequency response?—Bruce Schwartz, Philadelphia, Pa.

A. (1) At 3¾ ips, your machine should probably be somewhat underbiased in order to maintain frequency response out to 15,000 Hz. If underbiasing results in dull sound, this suggests something else is wrong, such as a playback head with a worn gap, a magnetized playback head, faulty record equalization, or faulty playback equalization. If tapes recorded on other machines sound satisfactory when played back on yours, then neither the playback head nor playback equalization is at fault. When going from conventional to low-noise tape, the adjustments required are in recording (bias, record equalization, and record drive), *not in playback.*

(2) Your hand is a source of hum, and apparently the playback head picked up enough to pin the meter. Whether this may have magnetized your head beyond redemption is something that I doubt. Have you tried using a bulk eraser to demagnetize the head?

(3) Yes, you can get a substantial idea of your recorder's overall response by feeding in various frequencies at a constant level and measuring their playback level on your meter. This assumes you have a true VU meter with substantially flat frequency response. Not all meters found in tape recorders are true VU meters with flat audio response.

If you have a problem or question on tape recording, write to Mr. Herman Burstein at AUDIO, 134 North Thirteenth Street, Philadelphia, Pa. 19107. All letters are answered. Please enclose a stamped, self-addressed envelope.



3 good reasons for owning the AR-3a.

The AR-3a is the best home speaker system that we know how to make. And professional audio critics and musicians agree that it is probably the best speaker system you could own. It has the lowest distortion, the widest and flattest frequency response and broad dispersion. No matter what kind of music you favor, or what form you prefer for playing it . . . if you want to clearly hear what the composer, the musicians and the engineers put on the recording you will be satisfied and thrilled with the fidelity of the AR-3a.

In addition to the 12" bass frequency driver with which AR introduced the acoustic suspension system to home music listeners, the AR-3a was the first speaker system to use two miniature hemispherical dome drivers for mid-range and high frequencies. For detailed specifications, please write.

Acoustics Research, Inc., 10 American Drive, Norwood, Mass. 02145

Check No. 1 on Reader Service Card



EPI'S LINEAR SOUND. NOW YOU CAN HEAR IT BY CALLING A TOLL-FREE NUMBER:

800-447-4700.*

When you call our toll-free number, you won't hear EPI's Linear Sound.

What you will hear, however, is a very pleasant voice telling you the name of the EPI dealer nearest you where you can hear EPI's Linear Sound.

And that's good to hear.



*In Illinois, the toll-free number is 800-322-4400.

imagine:

THAT A MANUFACTURER
COULD EQUAL OR EXCEED
THE \$275 STUDIO
MONITOR SPEAKERS FOR:

\$199 but



RSL STUDIO MONITOR
(IN Walnut Cabinet Optional)

imagine:

YOU COULD BUY IT
WHOLESALE FOR

\$105

ROGERSOUND

LABS

A REALITY!

MANY MODELS TO CHOOSE
FROM—ALL FACTORY DIRECT.

FREE TRIAL ON ALL
RSL SPEAKERS!



6319 VAN NUYS BLVD.
VAN NUYS, CA. 91401
Phone: (213)78-SOUND

Check No. 37 on Reader Service Card

Classical Reviews

Edward Tatnall Canby

The Complete Rachmaninoff, Vol. 2. (mono electric piano solos). RCA ARM3 0261 (3 discs), \$17.96.

Sergei Rachmaninoff plays Concert III. (misc. piano solos). Klavier KS 123, stereo, \$5.98.

Two notable series, both sparked by the 100th anniversary of the pianist's birth, and the two together make more than either by itself. RCA's recordings, of course, are direct disc, via the old 78 system, first acoustic, then later (as in this volume) the electrical method. Klavier has become rather coy, I should say, as to the origins of their recordings. In very small type, back bottom, we read "Recorded from Mason-Hamlin Ampico reproducing piano." Not a word anywhere in the notes. True, the player piano mechanism got itself a tarnished reputation in the old days of front parlor wang-bang uprights—mostly used by the kids of the family for lots of fun. But the really good systems, Welte, Ampico, Duo Art, achieved an almost miraculous fidelity to the original performance at a time when the disc-type recorder and its reproducer produced tiny, tinny noises at best (much as we all loved them).

Yes, there are a number of different works by Rachmaninoff that appear in both of these albums! Very first thing I looked for. But what a curious comparison, odd to inexplicability! We can assume that the piano-roll versions are earlier than the electrical versions. Even so, they are utterly different in each case—so different that the differing machinery could not possibly account for it all. Different tempi, but more important, radically different details in the ever-present rubato (artistically uneven rhythm, a hallmark of Rachmaninoff's type of playing). Curiously, the RCA versions are invariably much faster. In the same key (except for one) and so it isn't a mis-copying of the 78 rpm master. But where one flows liquidly, the other hops along maneredly. Several times I could scarcely believe it was the same piece, and went back again to be sure. *The Polka de V.R. (W.R.)* for instance. Incredibly different!

I have always been fascinated by these automatic piano recordings, because it is so difficult, at least at a distance, to pin down the variables that define the degree of accuracy. On the spot, with a highly trained mechanic and a thorough investigation of each mechanism, one could come out fairly sure. Tempo, maybe, is variable in the whole. (Did they have any way of fixing the speed rigidly?) But details of rhythm, punched into paper, are surely accurate. Loud and soft tones, for each individual note, were recorded—but are they *to scale*? Or can the range of loud-to-soft be varied? I question some of the violent shifts from loud to soft in this Klavier job. In this case, my ear tends to blame the piano, which is hard-voiced and percussively recorded, a twangy, unpleasant sound that has nothing to do with R.'s own sound. Rachmaninoff played a Steinway, and—if the "real" recordings are any evidence—he played it smoothly, with a mellifluous gradation of tone, even up to the loudest poundings. The Mason-Hamlin instrument is utterly different in sound, even allowing for the vast difference in recording technique. Wide-range stereo today and no-highs mono back then, blunting the transients.

RCA's Volume 2 contains a wealth of short pieces by R. himself and this is much the best material, so intelligently and poetically played, so completely *understood*. The Rachmaninoff versions of various other works now seem pretty strange and old fashioned in styling; his transcriptions for piano, from Gluck and Bach through Schubert and Rimsky Korsakoff (that Bumble Bee) are positively 19th century. Klavier's miscellany of short pieces covers similar interesting ground, but the hard-toned bangy recording does not help. Klavier, why not listen to RCA (and to other similar disc originals) for some hints as to the "live" sound of the pianists on paper rolls? True, the "live" recordings are themselves pretty forced and artificial—even, perhaps, to the tempo, fast in order to get through in time. Not to mention the prevailing stone-dead acoustics of the old re-

coding days. Nevertheless, it would be good if there were a better correlation between these two series. There was, after all, only One Original!

RCA has a Vol. 3, the orchestral works with Rachmaninoff as solo, and a Vol. 1, the acoustic recordings. Klavier has two other LPs of their material, as recorded by Rachmaninoff for the re-producing piano.

Piano Music by George Gershwin. William Bolcom. **Nonesuch Quadradisc HQ 1284**, \$3.98. (Also stereo, H 71284.)

A terrific recording! This pianist, out of Seattle, who looks like a prep school English teacher with his drooping pipe and turtle-neck sweater, is about as unlike Gershwin himself as you can imagine but he has the Gershwin *feel*. His playing is *exactly* right, ever so musical, easily fluent (like Gershwin himself), expertly projected, yet not in the least pretentious or mannered. No self-conscious classical here! And a wonder, too, considering what has happened to such as Scott Joplin, the black rag-time man, who has been elevated to super highbrow state and now sounds like hot house Chopin or something. Gershwin was a more complex individual than Joplin, of course, but he, too, can be ruined by pretentious playing and often is. Not here. It's wonderful.

Not that Mr. Bolcom uses a tinny piano as an "authentic" prop, or any other show biz sort of musical tricks. Not a bit. He plays on an impeccable grand, by the sound of it, and in the most sophisticated fashion—but then, Gershwin in his own medium *was* highly sophisticated, if never highbrow. This is the way he ought to sound. The music is entirely little tidbits, short tunes, many less than a minute long, taken from dozens of Gershwin shows and "transcribed" for fabulous fingers by the master himself. He did a million more, ad lib, without ever writing them down. Couldn't stop.

Performances: A— Sound: B—

Edgard Varèse: Offrandes, Intégrales, Octandre, Ecuatorial. The Contemporary Chamber Ensemble, Jan deGaetani, mezzo, Thomas Paul, Bass, dir, Weisberg. **Nonesuch Quadradisc HQ-1269**, \$3.98. (Also H-71269, stereo, \$2.98.)

This was Nonesuch/Elektra's main entry in the early CD-4 sweepstakes on the classical side, and it is a splendid beginning. Amiable old Varèse, who

BSR 710.

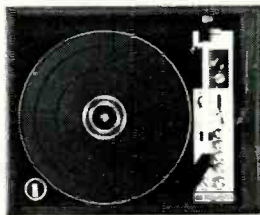

Shaft craft.



The BSR 710 has its brain in its shaft. A carefully machined metal rod holding eight precision-molded cams. When the cam shaft turns, the cams make things happen. A lock is released, an arm raises and swings, a record drops, a platter starts spinning, the arm is lowered, the arm stops, the arm raises again, it swings back, another record is dropped onto the platter, the arm is lowered again, and so on, for as many hours as you like.

Deluxe turntables from other companies do much the same thing, but they use many more parts—scads of separate swinging arms, gears, plates, and springs—in an arrangement that is not nearly as mechanically elegant, or as quiet or reliable; that produces considerably more vibration, and is much more susceptible to mechanical shock than the BSR sequential cam shaft system.

When you buy a turntable, make sure you get the shaft. The BSR 710. From the world's largest manufacturer of automatic turntables.



BSR (USA) LTD.,
BLAUVELT, NEW YORK 10913

Check No. 12 on Reader Service Card

dbx 117 expansion gives your records 20 db more dynamic range

Ever wondered why records seem to have less dynamic range than live performances? Commercial record producers typically sacrifice as much as 20 db of dynamic range through compression (for reasons we explain in our literature).

The dbx 117 Decilinear Expander restores up to 20 db of the dynamics missing from records, tapes, and FM broadcasts. The Model 117 also lets you make professionally noise-free, full range recordings on even a modestly priced tape recorder.

The stereo dbx 117 is sold by better audio dealers at \$159. dbx, Incorporated, 296 Newton Street, Waltham, Massachusetts 02154



dbx inc.

Check No. 17 on Reader Service Card

While others struggle to meet the demands of discrete four channel sound...

AUDIO-TECHNICA introduces its 2nd generation 4-channel phono cartridges.

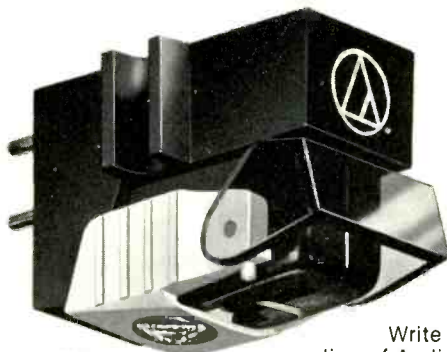

Now you can play any kind of stereo or 4-channel record, including the most demanding discrete 4-channel discs. Audio-Technica Model AT14S with Shibata stylus provides 5-45,000 Hz response. Unique Dual Magnet* design and ultra-precise fabrication sets new performance standards for others to copy. From Japan's most advanced phono cartridge manufacturer with a 10-year history of innovation and design leadership.

Write today for technical data on the entire line of Audio-Technica Dual Magnet cartridges for every high fidelity system.



MODEL AT14S
\$75.00

*Patents pending.

audio-technica®

AUDIO-TECHNICA U.S., INC., Dept. 14A, 1655 W. Market St., Fairlawn, Ohio 44313

Check No. 7 on Reader Service Card

SAE

The most respected name in electronics introduces state-of-the-art loudspeakers.

MARK X Dynamic Transducer Three-way Speaker System, utilizing four drivers (1—12", 1—5", 2—2"), with low and mid-frequency control. Oiled walnut

MARK XI Dynamic Transducer Three-way Speaker System, utilizing seven drivers (1—12", 2—5", 4—2"), with low, mid and high frequency control. Oiled walnut

MARK XII Solid State Electrostatic Transducer, three panel array of electrostatic elements, 1—12" low frequency driver, 1—5" driver, for lower mid-frequencies, electronic protection circuit, with low, mid and high frequency control. Oiled walnut

MARK XIV Solid State Electrostatic Transducer, six panel array of electrostatic elements, 1—12" low frequency driver, 2—5" mid-frequency drivers, with low, mid and high frequency control. Oiled walnut or rosewood.



MARK XIV

Scientific Audio Electronics, Inc.
P.O. Box 60271, Terminal Annex, Dept. A-14
Los Angeles, California 90060

Please send comprehensive data on SAE state-of-the-art loudspeakers.

Name _____

Address _____

City _____

State _____

Zip _____

Check No. 38 on Reader Service Card

lived for years in New York's Greenwich Village, was the granddaddy and patron saint of electronic music, a man who composed "electronic" sounds for live instruments long before those sounds even existed. Somehow, genius does see ahead—or steer things ahead, anyhow. These four ruggedly acid pieces are his major work before he went into actual electronic music in the mid-50s after the war; these all date from the 1920s, composed for standard musical instruments, except for the pioneer Ondes Martenot, a wailing electronic affair tuned by the capacitance of a hand held near an upright metal element. (Have I got the right instrument? In any case, it definitely wails and it is ever so electronic, especially two of them.)

What lovely sounds, at least for our ears! They were unthinkable, and rarely performed, in the 1920s. Even so, they persisted through sheer ruggedness and I have known all but *Ecuatorial* already for decades, in various live and recorded performances. The striking thing, today, is how well suited this harsh, rigorous chamber-type ensemble is to the recorded art. Perfect, in size, in clarity of detail and in variety of tone color—though the music dates from before that art existed in its modern form. That is how things work.

Two soloists assist with soprano and bass lines in *Offrandes* and *Ecuatorial*. They just sing, quite reasonably; this is not the time when singers were asked to do anything else, like shout or talk or groan or stand on their heads. Maybe they were lucky, though they probably didn't think so then.

Performances: A— Sound: A—

Kurt Weill: Kleine Dreigroschenmusik (Suite from the Threepenny Opera).
Darius Milhaud: La Création du Monde. The Contemporary Chamber Ensemble, Arthur Weisberg. **Nonesuch Quadradisc HQ 1281, \$3.98.** (Also stereo, H-71281).

Here is the companion quadradisc to the excellent Varèse recording, the two together the major "classical" element in Nonesuch's first quadrasonic release. Same artists, same fine performance and good sound. Two of my long time favorite pieces from the Twenties! I have the original 78 rpm shellac recording of *La Création* which was Milhaud's big try at classical jazz and Afro-American folklore—it was a ballet, with décor by Fernand Léger. As for Kurt Weill, his familiar *Threepenny Opera* music was beautifully rendered into this snazzy little Suite for small

orchestra and the performance here has all the instrumentation and flavor of the original sound, pure 1920s. The two pieces, with Varèse's four, give a splendid sonic picture of what was going on in those heady days, when the European composers came over and visited Harlem, got to know Gershwin and generally reveled in Afro-American sounds, which they took back home with them to titillate the Parisians, who never had it so great. Or, like Varèse, settled in the New World for good and made pictures of a skyscraper society in music that sounded just the way things looked. It's all there in these two records.

Performances: A- Sound: A-

Luciano Berio: Recital I (For Cathy). Cathy Berberian; London Sinfonietta. Berio. **RCA ARLI 0036**, stereo, \$5.98.

Luciano Berio is one of our most talented international operators in music, ever so Italian in his outlook, even so, and one of the most original and humorous constructors of sonic art forms today. Phew! Just try this. You'll laugh. If you don't scream. It's fun.

What the man asks his people to do, and Cathy to do! They all do it willingly for him. Awhile back it was the famed Swingle Singers in *Sinfonia* (Columbia), who made every noise a human throat can produce and a lot you didn't know about. Now it's Cathy Berberian's turn—she is an excellent pro soprano and a favorite with many composers, a special favorite of Berio's. She goes to town.

It's a recital, all right. The works, including the music and all of Cathy's thoughts, emotions and what-not, produced in groans, speeches, everything. The music is Berio's special kind, an incredible melange of familiar bits from the repertoire of a recital singer all mixed into a matrix of total modernity via the orchestra. Cathy acts the whole thing out, alternating between music and talking, shouting, hysteria, anything and everything. She begins most sedately with a bit of a Monteverdi aria, then a lovely bit of the same composer's *Lamento della Ninfa*, which stops with a loud OOF, right in the middle of a note. She is furious because her pianist is late. More side remarks, to modern noises in the orchestra, and more bits of music—you really should know your soprano repertory if you want to love *this* thing! Such a mixture. By side 2, things get very raucous—a solo instrumental quintet is playing rings around bits of her songs, she waxes ecstatic, then pompous, there are rude shouts and blats, twisty bits of tape-ish music, a

"Box Populi"

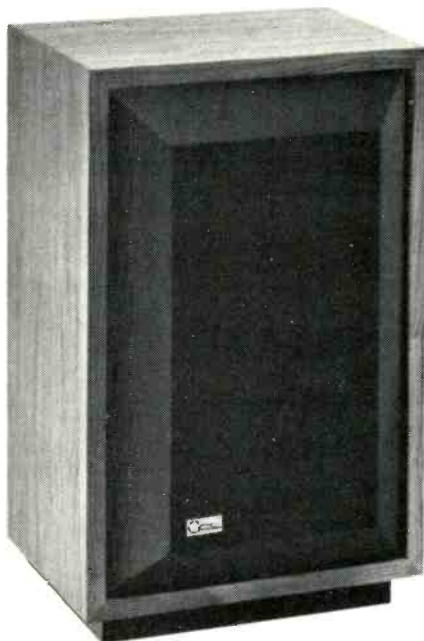

We were wondering how to tell you how great this speaker is. Stereo Review said it for us in September.

"In our simulated live vs. recorded listening test, the D-6 (with controls in the up position) was 100 per cent perfect at any point in the listening room! The D-6 is the *only* speaker in our experience to achieve this." Stereo Review, September, 1973

The D-6. At the better sound stores. In walnut veneer with black, azure, cocoa or mandarin grille. 24½" x 16½" x 13¾". 45 lbs. \$249.00.

If you can't find it, write:
Design Acoustics Inc.
P.O. Box 2722,
Palos Verdes, California, 90274.
Or phone 213-531-7841.



Check No. 56 on Reader Service Card

FREE McIntosh CATALOG and FM DIRECTORY

Get all the newest and latest information on the new McIntosh Solid State equipment in the McIntosh catalog. In addition you will receive an FM station directory that covers all of North America.



MX 113

FM/FM STEREO - AM TUNER AND PREAMPLIFIER

SEND TODAY!

McIntosh Laboratory, Inc.
East Side Station P.O. Box 96
Binghamton, N.Y. 13904
Dept. 1

NAME _____
ADDRESS _____
CITY _____ STATE _____ ZIP _____

If you are in a hurry for your catalog please send the coupon to McIntosh.
For non rush service send the *Reader Service Card* to the magazine.

Check No. 29 on Reader Service Card

Maxell offers a huge improvement in cassette tape. Magnified 10,000x so you can see it.

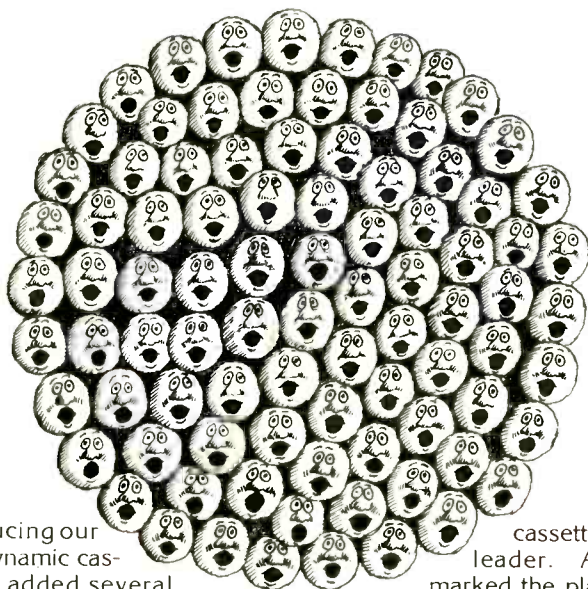

Introducing our new Ultra Dynamic cassette. We've added several new improvements to the cassette. And a little more Ultra to the Dynamic.

Our smallest improvement is our biggest improvement.

We reduced the size of the tiny PX gamma ferric oxide particles on the surface of our tape. The Hz now go up to 22,000 Hz so you get even higher highs. The signal-to-noise ratio's now 8 dB more than ordinary cassettes—which means you get less noise from your cassette player and cleaner, clearer sound from your cassette. And the dynamic range is wider so you can turn the sound up loud enough to disturb the neighbors without worrying about distortion.

Little pad finally gets grip on self.

Every cassette has a little pressure pad to keep the tape pressed firmly against the tape head. Other cassettes keep their pads in place with glue—or rather don't keep their pads in place with glue. So we've designed a little metal frame that holds the pad in a grip of steel. And now the tape can't push the little pad out of place—and you don't need to worry about signal fluctuations and loss of response any more.

An improvement you can see but can't hear.

The first five seconds of our new

cassette is a timing leader. And we've marked the place where it starts with three little arrows so you'll always know exactly where you are.

Amazing new miracle ingredient fights dirt fast!!!

But the leader's also a head-cleaner and what's amazing, new and miraculous about it is that it doesn't rub as it scrubs as it cleans. Because it's non-abrasive. So it keeps your tape heads clean without wearing them down.

Our new long-playing cassette is shorter.

Our new UDC-46 is twenty-three minutes per side. Which very conveniently just happens to be the approximate playing time of your average long-playing record. (Our other cassettes are 60, 90 and 120.)

And that's our new improved Ultra Dynamic cassette.

And its ultra dynamic new improvements.



maxell

The answer to all your tape needs.

Check No. 28 on Reader Service Card

Maxell Corporation of America, 130 West Commercial Avenue, Moonachie, N.J. 07074

tantalizing quote by Cathy from Richard Strauss ("I'm so tired!") and then a serious and quiet lyric coda. It's all an incredible hodge podge; and yet it is Berio's genius to weld the helter-skelter bits into *something* that, you will begin to perceive, exists for itself. Amazing. Good party piece. too.

Performance: A

Sound: B

René Kollo Sings Wagner. Staatskapelle Berlin, Otmar Suitner. **Columbia MG 32302**, stereo, \$5.98.

A new Heldentenor! They are indeed ultra-rare, those golden-brazen tenors with vocal cords of tempered steel, who can outsing 100 orchestral players and do it for hours on end. We haven't had much of a Heldentenor ("hero-tenor") since the great Lauritz Melchior, who, fortunately, is well preserved on records for all of us to hear, the man who dominated the big Wagnerian roles for a whole generation of great opera singing. His successors have been vocally weak in comparison and, all too often, musically enfeebled as well.

Two whole LP records, four sides, on the Columbia label. Somebody must think this young singer is *good*. (He obviously does himself; just study that pose on the album cover.) And indeed he has the right type of voice, one in a thousand. It is in fact all chrome steel, powerful, with an edge that cuts unmercifully and a volume that doesn't need any close-up mics to build its presence. Definitely, a Heldentenor type, at last.

Ah youth. This Kollo, who is 36, they say, is only a calf-like Heldentenor. Much of his singing is superb in color, in diction, in pitch. But he is unstable. When he is bad he is awful. Like so many German tenors, he projects that curious sense of impending disaster, as though the voice were going to break, or collapse, or slide off pitch or just squawk—but it doesn't. Not in any way comparable to the great Melchior, who could flat very effectively and often did, but never, *never* sounded unstable.

Moreover, this man mostly just sings. He hasn't much subtlety. In the earlier Wagner he does best, where the subtlety is less. In *Die Meistersinger*, where Wagner's late and marvelous sense of changing inner thoughts comes through so beautifully, Kollo is lost. The Prize Song is just so much sounding brass. The man has a lyric, gentle voice projection, but he hasn't learned to use it. Maybe he doesn't think he needs to. He'll learn—we hope.

The local Berlin orchestra, in contrast, does a rather nice job with the

Wagnerian expression and, indeed, carries Herr Kollo along on the grand wave as often as he carries it. It's not a great orchestra but it knows its business. So do the recording engineers. The credit goes to VEB Deutsche Schallplatten, Berlin.

Performances: B- Sound: B+

People Past and Present. Thomas Hardy; John Donne, the Duke of Wellington; Queen Victoria. Recorded in association with the National Gallery, London. **Argo ZPL 1164; 1167; 1158; 1159**, stereo, \$5.95 ea. (Many others).

Argo in England has long specialised (let's spell it in English) in speech recordings, but not so much the solo variety, as with our Caedmon, as in various types of ensemble, and/or dramatics, often including music. Some of their readings of poetry, alternating several voices, are superb examples of the recorded art form at its best. Some Argo offerings suffer from a certain British stiffness, including the two—at least—of this series that I have listened to, Queen Victoria and the Duke of Wellington.

The originals were live programs, done before an audience in the National Gallery, and the recording is live, with audience in place. The technique is simple enough. Two or three actor voices and a "narrator" share the running script, divided up between them as a sort of half-play. A stage reading, in other words, though whether with costume or no I could not say.

On records, the thing works only moderately well. The fault is not in the very British accents, which are entirely to be expected! Nor in the material, which is well organized if awfully quick and spotty. What bothered me mainly was the *acting*, which is done strictly in stage style with all the projection and exaggeration required for that challenging medium. Before the close-up mics, this styling very soon grates on the ear. Too forced, too projected, too highly colored. You can see the sonic make-up. You are much, *much* too close. The rapid-fire survey of the continuity, with the quoted excerpts invariably no more than a few words long, gives a hop-skip-and-jump quality to the show, which is not good on records, either.

I enjoyed the records and found the shows informative and entertaining, within the above reservations. Argo, as you see, has lots of them—and hundreds of other speech records, also music, all of which I'd like to review if we had vast quantities of space.

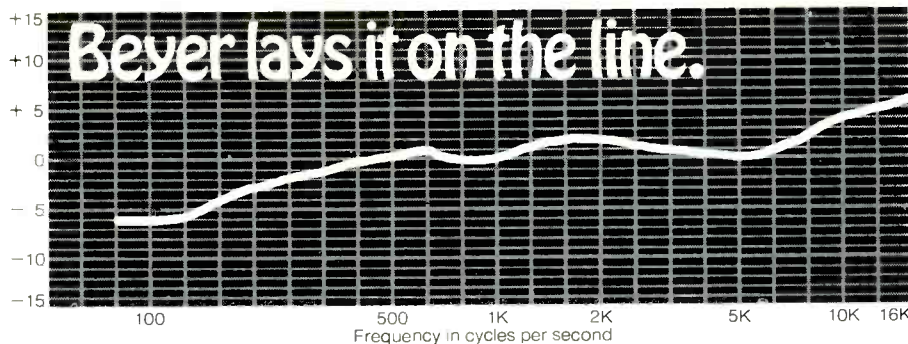

For the demanding professional, some mike manufacturers furnish a frequency print out as proof of performance.

Unfortunately, when it comes to low cost mikes for home use that practice is not only costly, but could prove embarrassing. Besides, you shouldn't expect a guarantee with an inexpensive mike.



Or should you?

You can if you buy the new Beyer 550.

At only \$37.50, the Beyer 550 provides authenticated performance at a price you can afford.

And what performance. In one elegant package you get smooth, wide frequency response, omnidirectional pickup pattern, low distortion and high signal-to-noise ratio.

Finally, you get the most generous warranty in the industry and that's another way Beyer lays it on the line.

Another innovation from Beyer Dynamic, the microphone people. Revox Corporation, 155 Michael Drive, Syosset, N.Y. 11791

Check No. 36 on Reader Service Card

Frazier Seven



Newest Sound In The Frazier Tradition Of Fine Speakers

The Frazier SEVEN gives you incomparable sound because the cabinet itself is acoustically tuned, and components are carefully isolated to stop unwanted intermodulation distortion.

This speaker has a handsome sculptured grille that comes in burnt orange, rich brown or black on black. The oil walnut cabinet reflects Frazier's superb craftsmanship. And the SEVEN has a unique new base that gives you the freedom to set the speaker vertically or horizontally.

The Frazier SEVEN. The kind of speaker it takes 30 years experience to build. When you hear it, you'll understand why.

FRAZIER Incorporated
1930 Valley View Lane
Dallas, Texas 75234
(214) 241-3441

Check No. 20 on Reader Service Card



RUGGED!

The BOSE name and a full FIVE YEAR WARRANTY are your assurances of reliability and performance with the BOSE 1800™ Professional Power Amplifier.

- 800 Watts rms
- LED Displays
- Over 1,300 Square Inches of Heat Sinks
- Sturdy Packaging
- Rack Mountable

Please send complete information on the BOSE 1800 to:

Name _____
 Address _____
 City _____ State _____ Zip _____

Mail to: BOSE, Dept. AP,
 The Mountain, Framingham, Mass. 01701

Introducing the TL-90

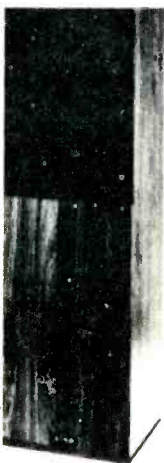

The TL-90 by Audionics* incorporates a full complement of RADFORD components with transmission line bass loading. The TL-90 is one of four high performance transmission loudspeakers from Audionics. Write or call for the name of your nearest dealer.

*Assembled in U.S. under license by Radford Audio Ltd.

AUDIONICS, INC.

8600 NE Sandy Blvd.
 Portland, Oregon 97220
 503-254-8224

Check No. 8 on Reader Service Card

Sherwood's Forest

Sherwood L. Weingarten



I'm irresponsible. Besides that, I'm befuddled. How'd I reach age 36 without ever compiling a set of New Year's resolutions? Enough mind-messing, Weingarten. No longer shall I ignore that integral part of the American Way—setting impossible goals and then feeling guilty about not reaching them. Quick, then, to the task at hand; no looking back and, especially, no second thoughts.

Heading my list of resolves is to quit smoking, with, as the Supreme Court once decreed, all due haste and deliberate speed. Two decades of coughing at the sunrise, of wheezing after climbing a step and a half, is sufficient.

But now that I think of it, I should stick to what I'm best at—quitting quitting, having practiced for years.

Next is to talk gently with my kids, instead of howling at them, after minor irritations—a resolution that also can curtail wardrobe expenses since, presently, I own nothing to match the purple my skin turns.

But the problem is that my children are so accustomed to my tirades, they'll think I've stopped loving them.

Next resolution is to stop offering my shoulder to all who request it, a martyr-like tendency of mine triggered by only the largest of troubles, ranging from marital tremors hitting 7.2 on the Richter scale to someone's worry about excess freckles.

But I wouldn't know where to dispose of the lumber from the cross I've been carrying so long.

Then comes a resolve to avoid being with persons I dislike, to accept no

invitations to places I don't want to be, and to remove a polite-plastic social grin from a mouth that cost my parents a wee fortune in orthodontia fees.

But I abhor being alone.

Next is to, like history, give President Nixon every benefit of the doubt in the post-Watergate era.

But I still can't find my way clear to buy a used tape from him.

Another resolution is to halt the pressure on my otherwise delightful wife to meet my physical needs with greater frequency—hourly, for instance.

But I'd never get her to allow me to consort with shrinks, bartenders or hookers to compensate.

Next is to keep my shaggy beard and long hair trimmed neatly to conform with the demands of a skin-crazy society.

But such blatant nakedness always embarrasses and threatens me.

Then comes a resolve to write columns plainly, without ambiguity or frivolity.

But that'll have to wait for the surgeon to remove my tongue from my cheek.

More to the point of this column, the next resolution is to, like Marc Antony, appear to praise—not bury—the Rolling Stones.

But Mick Jagger & Co., all-too-often acclaimed as the world's top rock 'n' roll outfit, seem to be doing everything in their power to destroy their old image—and perhaps themselves. Their latest outing, **GOAT'S HEAD SOUP** (Rolling Stones Records, COC 59101), is an attempt to broaden their scope, via ballads, and fill the gap in progres-

sive rock left by the disintegration of the Beatles. Won't work, even if one of the slower things. *Angie* is the No. 1 song on the airwaves. You can only fool all the people some of the time.

The tune, a melancholy piece that strongly suggests vulnerability, is complicated because of several factors: its view of romance is a downer ("They can't say we never tried" is offset by "Can they?"); Jagger sings as if he means it, but there's a second, subtle vocal track that simply doesn't fit; and, finally, the strings and electric guitar acting as a dramatic backdrop are jarring rather than soothing, contrasting rather than blending. Some critics undoubtedly will say that all that's intentional, that there's great depth of meaning there, but my view is that it's a fraud, a pretentious failure.

Winter and Coming Down Again, the other ballads, are equally flawed. The latter, in particular, is elongated (nearly six minutes) and dull.

The remainder of the LP, distributed by Atlantic, is without the ranchy rock energy on which the group built its fame—with the exception of *Star Star*. Everything else, somehow, seems watered down, almost as if the Stones are seeking a direction but can't move away from the crossroads.

Dancing With Mr. D, a mediocre opener, lacks the spark of *Sympathy for the Devil*. Jagger's last hymn to Satan. *100 Years Ago* breaks into two separate entities, a touch of violent rock and an isolated touch of moody slowness, never adequately merging the diverse elements.

Silver Train does have some good boogie riffs and a fair chorus line, but it almost seems to reach too far back in rock history to be a Stones' song. *Can You Hear the Music*, also getting a good share of airplay, tends to be excessively repetitious as it traces musical power (with unclenched fist).

Hide Your Love features Jagger on a heavy-handed keyboard, with an equally rough vocal: the song, nonetheless, keeps cooking throughout, mainly assisted by sterling guitar work.

Highlight of the album, though, is *Star Star*. The euphemistic title is the only holding back, for the lyrics are gritty, gutsy and real, telling of the groupie mentality, and the music is classic Stones rock, driving, energetic, frantic. One full-fledged winner per album gets a little expensive, however, not to mention disappointing to the ear.

Not incidentally, the Stones are backed by some standout musicians, each of which can claim a few moments of solo virtuosity on the disc. But the presence of Nicky Hopkins, Billy

Preston and Jim Horn are only more disturbing: Do the Stones really *need* the help? Have they stopped rolling and started gathering the moss that many deemed inevitable? Was **EXILE ON MAIN STREET** the beginning of just that?

Next resolution is to avoid making comparisons of new performers and top stars—particularly when the stars are dead (and can't defend themselves).

But *Judi Pulver*, who's been the object of the heaviest publicity cam-

paign since Karen Wyman (and don't ask what happened to *her*; it shames the flacks), has an album out on MGM that gives everyone a chance to take pot shots.

The truth, however, is that we'd be smarter to praise the chords and pass the ammunition: She's marvelous. **PULVER RISING** (SE-4904) is the showcase for the hoarse voice colored by a drawl that defies an audiophile not to compare her with Janis Joplin. And Rod Stewart must do an aural

FREE



LAFAYETTE 1974 CATALOG



The World's Largest Consumer Electronics Catalog

The world's Foremost consumer electronics catalog is yours for the asking! Over 25,000 items . . . jampacked with illustrations and descriptions of the very latest in Hi-Fi, CB, Tape recorders, Radios, Television, Electronic Parts, Technical Publications.

Your Complete Electronics Buying Guide

**Electronics For Home, Business, Industry
PLUS The Latest in 4-Channel Stereo!**

LAFAYETTE 1974 CATALOG 740

Our 53rd Year **Stores From Coast-to-Coast**

MAIL
THE
COUPON
TODAY

Lafayette Radio Electronics

P.O. Box 10, Dept. 27014

Syosset, L.I., N.Y. 11791

Send For Your Free Lafayette Catalog Today!

Send me the **FREE** 1974 Lafayette Catalog 740 27014

Name

Address

City State Zip

Check No. 25 on Reader Service Card

double-take too, for the resemblance is sometimes uncanny. Let's not, to make Ms. Pulver a triple-threat, forget the occasions when she out-Streisands Barbra.

Her pulver-izing voice is a throbbing instrument that provides bare soul, pure emotion. All of it is raw, earthy, together. A rare experience for the listener.

Unfortunately, her writing talent pales, and the material isn't equal to the singing performance. Her music and lyrics each leave more than a little to

be desired, both stretching to their limits to hit mediocrity. Still, watch the songstress, for you'll soon spell her name J-U-D-I S-U-P-E-R-S-T-A-R.

Resolution No. 829 (the damned thing's habit-forming, like eating potato chips) is to eliminate reviews of groups that have been together too long for their own good.

But would you believe the **Four Tops** have been singing as a foursome 19 years and recording for 15 of them? I would, for they've managed to drain most of the life from themselves and their repertoire. As for their soul, that's

eroded over the decades to the point where they now offer only straight pop (and that's usually only good as a chaser, man).

On **MAIN STREET PEOPLE** (Dunhill-ABC, DSX-50144), the ex-Motown quartet offers 11 cuts, including a brief musical introduction via the title tune. There's plenty of good harmony, but basically it's all ho-hum stuff that instead of coloring black, you can color ennui.

Are You Man Enough, the hit single from the flick "Shaft in Africa," will sell the LP; that's good, for Levi Stubbs, Renaldo "Obie" Benson, Abdul "Duke" Fakir and Lawrence Payton will need the royalties if they keep coming up with records as bland as this one.

Next resolve is to wipe out those capsule critiques that don't have enough room to say anything substantial.

But . . .

COSMIC WHEELS (Epic, KE 32156) is folk-rock from **Donovan**, who 10 years after, is still trying to be mystical and arty-poetic. He succeeds, but the effort is dated. *The Music Makers* has received some good airplay, but it sounds too much like the title tune and so many other Donovan ditties. *I Like You* is a lovely, tender ballad, but the best cut is *The Intergalactic Laxative*, humorous doggerel. The LP, by the way, is distributed by Abkco, which may have forgotten that the '60s have ended.

CYAN (Dunhill-ABC, DSX 50158) is a rock extravaganza by **Three Dog Night** that ranges from soft to soul to hard. *Shambala*, the chartbuster, is best, *Happy Song*, a strong, uptempo thing, a close runnerup. There are nine cuts in all from a seven-member group that gives the listener the feeling that the music is vastly more important than the lyrics.

BUCKINGHAM NICKS (Polydor, PD 5058) marks the record debut of a folk rock duo, Stephanie (Stevie) Nicks and Lindsey Buckingham. Alumni of a Frisco rock group, Fritz, they provide variety by means of a good together sound. Highlight is *Long Distance Winner*, an intricate work that starts slowly and builds to a musical crescendo, reminiscent of some early Gracie Slick. Also good are *Don't Let Me Down Again*, hard rock with a heavy driving sound; *Lola My Love*, a gritty blues, and *Stephanie*, a pleasant instrumental.

One final resolution, now having tried what so many have tried before me: No more resolutions.

But, of course . . .



Capitol 2. The cassette that reaches not only new highs, but new lows.

Most cassettes have trouble reproducing the extreme high and low ends of the audio spectrum. So you miss the upper harmonics of that piccolo, or the fundamental note of the bullfrog's "needit," "needit." Capitol 2 cassettes, however, reproduce these sounds clearly, without distortion. Their Cushion-Aire® backcoating improves the handling and wind of the tape, makes it jam-proof and greatly extends its life.

It's nice to use a tape that lasts a long time, when you're recording something as unusual as a bullfrog. You wouldn't want to have to do it more than once.

Everybody's talking about **Capitol 2 cassettes**



© 1973 Audio Devices, Inc. a Capitol Industries Co. Glenbrook, Conn. 06906

Check No. 4 on Reader Service Card



If it doesn't say Hitachi on the receiver, it won't say three years on the warranty.

The last thing you look at in a stereo receiver should be one of the first.

If you're like most people, you never glance at your receiver's warranty until you get the set home.

Which could be unfortunate, since a major repair could be a major expense. (Funny how people always ask about price, but not about repairs.)

But you don't have to worry when you buy a Hitachi receiver. Because Hitachi gives you one of the longest warranties in the industry: three years, parts and labor, with a five year guarantee on the transistors.

Frankly we can give such a warranty because we don't expect you to use it. That's because almost everything that goes into a Hitachi is made by Hitachi—to our standards, not to some sub-contractor's.

This holds true even for our most modestly priced receivers. Like the Hitachi SR-5200 shown above.

It gives you 20 watts of power per channel (RMS at 8 ohms), along with such features as dual meters for more accurate FM tuning, and four-channel speaker matrix connections.

Incorporated into it are Hitachi-developed LTP (Low Temperature Passivation) transistors which reduce amplifier noise to practically nil.

Not shown is the lower-priced Hitachi SR-3200, identical in every way to the SR-5200 except it gives you one tuning meter and 13 watts of power per channel—so the sound won't overwhelm you in a small room.

Like all Hitachi components, the SR-5200 and SR-3200 produce rich, clear, true sound.

Hear the complete line of Hitachi Maxi-Fi® components, priced to \$600, at your Hitachi stereo dealer's. Or for more information, write Dept. A-6, Hitachi Corp. of America, 48-50 34th Street, Long Island City, N.Y. 11101.

Quality always comes first at
 **HITACHI**



Check No. 58 on Reader Service Card

Jazz & Blues

Martha Sanders Gilmore

DEXTER GORDON: *The Jumpin' Blues*
Prestige PR 10020, \$4.98.

Musicians: Dexter Gordon—tenor sax,
Wynton Kelly—piano, Sam Jones—
bass, Roy Brooks—drums.

Songs: *Evergreenish; For Sentimental
Reasons; Star Eyes; Straight, No*

*Chaser; If You Could See Me Now;
The Jumpin' Blues.*

Another in Prestige's releases out of the fantastic Fantasy catalog, this has a quartet of jazz veterans led by tenor man Dexter Gordon and featuring pianist Wynton Kelly, bassist Sam Jones, and drummer Roy Brooks.

Audioanalyst

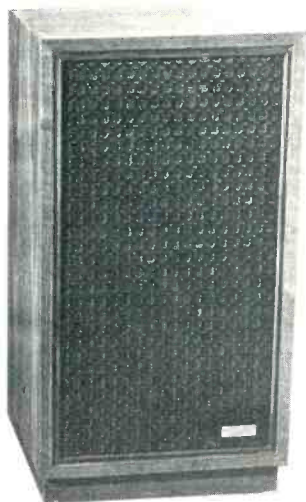

ACCEPT OUR INVITATION TO THE MODEL A-200 EXPERIENCE

If you want to hear trumpets that "sting" you, bass instruments that "stab" your viscera, ensemble clarity that is always perfectly sorted out—ask your dealer to pull out everything he's got for comparison!

No, we're not kidding. You'll find this is the one that makes it in every way: balance, dispersion, overall clarity, frequency response . . . you name it!

So if you want to hear your music and not just your loudspeakers, give the model A-200 accuracy a hearing.

You demand state-of-the-art performance in your other components, now you can have it in your loudspeakers.

6-year warranty.

Audioanalyst

P.O. BOX 262, BROOKFIELD, CT. 06804

**SPECIALISTS IN ENVIRONMENTAL
SOUND RESEARCH**

Distributed in Canada by Kairon Electronics, Montreal.

Check No. 9 on Reader Service Card

It is clear from the outset that these jazzmen have more than paid their dues, Gordon having been strongly influenced by Lester Young and going forward to influence such stalwarts as John Coltrane and Sonny Rollins, and Wynton Kelly, who actually worked with Young and having played with Dizzy Gillespie and Miles Davis in the late fifties. Add to that the impeccable bassist Sam Jones who has sat in with Gillespie, Thelonious Monk, and Cannonball Adderley among others. So it is a rip-snorting group!

Dexter Gordon plays straight-forward tenor, being given to a no-nonsense style that bespeaks authority and totally lacks superfluity. He employs a minimum of vibrato except occasionally at the end of a phrase. Gordon puts his signature on his own composition *Evergreenish*, quoting humorously from *Pop Goes the Weasel* and playing long lines of notes without taking a breath, screaming on the high ones, twisting them to his purpose.

The quartet takes the ballad *For Sentimental Reasons* at a slow gait, Gordon playing a droll understated solo in which there is no excess of notes, easily accomplishing his intervals and tapering it all off to a whisper.

Wynton Kelly is a linear pianist who sticks mainly to single-note lines and dotted eighths. He sprinkles well-chosen note clusters about the keyboard. In *Star Eyes*, which the group converts into a stellar jazz vehicle, beginning it with a Latin rhythm via Roy Brooks' tom-tom, we have a good opportunity to hear Jones' clever notation as he plucks notes that are as round as lemon drops and every bit as tasty and full-flavored.

The quartet, which is truly sympatico, really gets hot in Monks' *Straight, No Chaser*, a boppish piece with puckish, darting lines, punctuated periodically by Gordon's note-holding and low-slung honks. Gordon and Brooks' trading fours indicates their concordance and Kelly romps up and down the scale on triplets. Gordon gives Tadd Dameron's *If You Could See Me Now* a very thoughtful rendering, now floating ahead of the beat, then lingering just behind it.

And, lest I forget, *The Jumpin' Blues* is strident, funky, and familiar, an up-tempo number which zigzags and swings and in which Jones is superb!

The music of Dexter Gordon conveys a sense of immediacy and integrity. It does not bow to the commercial. The quartet could be right in your living room as the reproduction is crystal clear.

This is decidedly Gordon's LP.

It could be yours, too.

Performance A-

Sound A-

Chick Corea and Return To Forever:
Light As A Feather

Musicians: Chick Corea, electric piano; Joe Farrell, flute, saxophone; Stanley Clarke, bass; Flora Purim, vocals; Airto Moreira, drums, percussion.

Songs: *You're Everything*; *Light As A Feather*; *Captain Marvel*; *500 Miles High*; *Children's Song*; *Spain*.

Polydor PD 5525, stereo, \$4.98.

Since the talented young pianist Chick Corea abandoned his highly acclaimed and introspective group Circle, he has gone forth to form still another affable association with three foremost musicians: bassist Stanley Clarke, percussionist Airto Moreira, and vocalist Flora Purim; and on this recording reedman Joe Farrell makes a guest appearance.

Moreira and Purim are married to one another, thus further espousing their musical cause. Both hailing from Argentina, they infuse Corea's group with the samba-like syndrome of South America. Flora scats and sings, her beautifully accented voice earthy, close, given to intimacy, bringing us closer to her.

Corea's group, whose intent it is to communicate, does indeed reach out in these six exhilarating cuts on Polydor, bridging the gap nicely between jazz and pop. The material, save for *Light As a Feather* (the work of bassist Stanley Clarke), is all composed by Corea. Corea is a rather awesome pianist, the son of Armando Corea who was the leader of a Dixieland band in the Thirties and still gigs around Boston playing concert dates. Corea combines the lyricism and Debussyesque quality of a Bill Evans with the jagged turns of phrase of a Cecil Taylor. He disseminates running triplets here on electric piano, funky, free, airborne.

Feather proves to be the lightest and best developed of the bunch, an impressionistic percussive rendering which has a light, wavy, undulating air about it. Clarke, a phenomenal bassist—this past summer at Newport can testify to that—roves up and down his bass fiddle plink, plank, plunk. He emits messages in Morse code. His style has telephone wire frequency. But Farrell's lovely entrée on saxophone sounds far away and remote. In fact it might be said that Farrell's talent is not as well reproduced as it should be throughout the disc. *Feather* ends with some dazzling counterpoint between Clarke, Corea, and Moreira in a stunning sequence.

The mellifluous combination flies along like sixty on *You're Everything*, Corea making a beautifully lyrical statement while Purim floats rhythmically topside, a true jazz singer with

an ease of delivery that is captivating. *Captain Marvel* is dapper and quick, featuring Farrell on a very facile flute, an exhaustive feather-light composition with lots of interplay among the instruments.

Children's Song recreates the sound of children playing with wooden blocks—the work of Airto Moreira. It is an ingenious model of clockwork precision, Corea playing few but selected notes on piano, Clarke bowing his bass. Airto utilizes a mass of percussive effects in *Spain*, digging deep into his bag of tricks, emerging res-

onant and clear. The highly rhythmic excursion has Clarke playing a graceful singing, stinging bass with Airto cymbal-wise behind him against Corea's light and quick comping—a great segment, and did I fail to mention Farrell's bouncing flute?

The sound is clearly demarcated but the recording is not entirely noise free.

This is a record you will find yourself playing over and over for the sheer joy of it. You'll keep returning to *Return To Forever*.

Sound B+

Performance A-

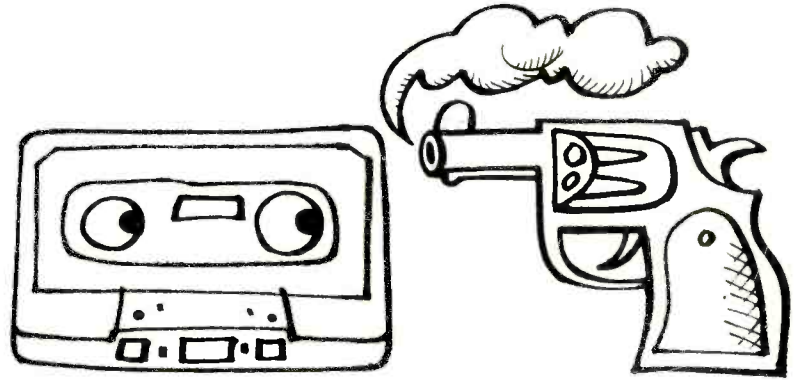

Our cassettes don't self-destruct!

Columbia cassettes are made to stay alive for a long time. In fact, they're the only fail-safe cassettes on the market.

We have low noise/high output gamma-ferric oxide tape. And thanks to a 20-20,000 Hz frequency range, what you hear is what you get.

We use oversized Mylar slip sheets; impregnated with graphite. So there's no friction. Then the tape is guided along by Delrin rollers, mounted in metal pins. You can't find a more sure-footed cassette.

And to top it off, each cassette comes with two extra self-sticking recording labels, an index and a bonus coupon. That gives you one free C-60 cassette after you've bought 11.

Our cassettes are something special. We call them fail-safe. You'll call them fantastic.



COLUMBIA
THE FAIL-SAFE TAPE



Check No. 15 on Reader Service Card

MAGNEPLANAR™ loudspeakers are . . .

extremely realistic sounding — and they're only 1" thick. Our top-of-the-line Tympani series which look like folding floor screens are sold through Audio Research dealers. We now have smaller, less expensive models available at the following dealers:

University Stereo / Ridgewood, N.J.
Transcendental Audio / Buffalo, N.Y.
Hi-Fi Gallery / Indianapolis, Ind.
Hi-Fi Gallery / Evansville, Ind.
Audio Unlimited / Arlington Hts., Ill.
The Stereo Shop / Cedar Rapids, Ia.
The Gramophone Ltd. / Norman, Ok.
Audio Uncommon / Portland, Or.
Sound Center / Beverly Hills, Ca.
Stereo Hi-Fi Center / Gardena, Ca.
Garland Audio / San Jose, Ca.

Contact us if there is no dealer in your area.

MAGNEPLANAR
MAGNEPLANAR™ PRODUCTS
P.O. BOX 8642, WHITE BEAR LAKE, MINNESOTA 55110

Dealer inquiries welcome.

Check No. 26 on Reader Service Card

INTRODUCING the STR P-3

an add-on tweeter

NO MATTER WHEN YOU BOUGHT
YOUR SPEAKER, OUR STR P-3
ADD-ON TWEETER

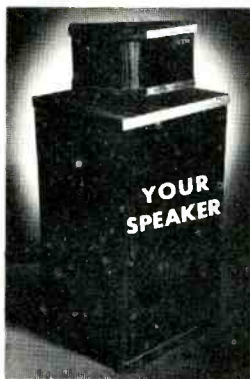

WILL GIVE YOU 1974 SOUND.
COMPARE YOUR SPEAKERS WITH
THE BEST PRODUCED TODAY. THEN
ADD THE STR P-3 — THE SAME SOUND
AT A FRACTION OF THE COST.

SOUND TECHNOLOGY RESEARCH
3516 LAGRANDE BOULEVARD
SACRAMENTO, CA 95823

916 / 422-0440

DEALER INQUIRIES INVITED

Check No. 41 on Reader Service Card

Tape & Turntable

Bert Whyte

Smetana—Ma Vlast (My Fatherland)

Rafael Kubelik cond. the Boston Symphony Orch. **Ampex/DDG-K47054**, Dolby B, open reel, 7½ ips, \$11.95.

This is one of the first fruits of my campaign to induce Ampex Stereo Tapes to issue open reel Dolby B tapes. *Ma Vlast* can best be described as a huge symphonic poem, and includes such familiar sections as *Die Moldau* and *In Bohemia's Fields and Forests*, along with the less familiar but tremendously dynamic and exciting *Vysehrad*, *Tabor*, *Sarka*, and *Blanik*. Much of these latter works are rather thick-textured in scoring and ultra-clean recording is a must. I recorded maestro Kubelik and the Chicago Symphony doing *Ma Vlast*, in stereo, way back in 1951, when Orchestra Hall was one of the most magnificent recording halls in the world. In this piece, the brass and percussion sounds were so real, so overwhelming they were almost palpable. This Boston recording is very fine indeed, and with the blissful freedom from tape hiss with the Dolby B processing, is a far cry from the 48 dB SNR on the tape I made on the old Magnecord! The Kubelik performance is as powerful and convincing as ever, and the Boston men play the work magnificently. The balance between hall reverb and orchestral definition is deftly handled and makes for excellent presence. Ampex did not put a Dolby tone at the beginning of the tape . . . which is really needed . . . for a warned, the tape is recorded at very high level. You will have to use the Dolby level set tape furnished with your Dolby B unit, and set your playback gain at minus 3. Outside of this, an exemplary tape and a most auspicious debut for a much desired product.

Oh! Coward - Original cast album **Ampex/Bell J59001**, Dolby B, cassette, \$6.95.

This cassette arrived a few days after the death of Sir Noel Coward, and it is a fitting musical memorial to him. Currently enjoying "hit" status on

Broadway, this is essentially a compendium of his witty songs, satirical musical skits and lovely music. The cast has many typical Broadway voices, and although there are some difficulties with the British accents, they handle Sir Noel's tricky "patter" songs very well. Sir Noel was a paragon of wit, urbanity and world-weary sophistication, which is reflected in many of his hilarious songs. You don't have to be British to enjoy his wit, but some of the situations and word usage will seem strange to American ears. There is so much on this double-play cassette, that it would be difficult to list all the numbers, but I commend to your attention such items as *Saturday Night At The Rose and Crown*, *Why Do The Wrong People Travel?*, *Don't Put Your Daughter on the Stage Mrs. Worthington* and last but hardly least, the classic *Mad Dogs and Englishmen*. The recording is a bit coarse-textured and bass heavy, but otherwise quite acceptable.

Hindemith: "Mathis Der Maler"
Concert Music For Strings and Brass.

William Steinberg cond.
the Boston Symphony Orch.

Ampex/DDG, L3246,
open reel, 7½ ips,
\$7.95.

The Deutsche Grammophon recordings of the Boston Symphony have been somewhat variable in sonic qualities, with some just fair, others quite good. On that basis this recording of two Hindemith staples must be judged superb. This is a winner all around with Steinberg making a powerful statement on the massive sonorities of these works. His reading is taut, incisive, and he elicits from the magnificent orchestra playing of transcendental brilliance. The sound displays the best qualities of the Symphony Hall, a vast panorama, with reverb balanced just right with good instrumental definition. Good dynamic range, excellent bass response and

great, almost palpable, brass sonorities. The only quibble is that tape hiss is a bit higher than usual. I am pretty certain this was recorded with Dolby, so it would be a likely candidate for the new Ampex open reel B Dolby series.

Bartok: Music for Strings, Percussion, and Celesta. Kodaly: Suite from Háry János. Bernard Haitink cond. the Amsterdam Concertgebouw Orch. Ampex/Philips PHI-L-5015, open reel, 7½ ips, \$7.95.

Haitink is rapidly becoming one of our premier conductors, noted especially for his fine work in the Mahler/Bruckner idiom. I frankly felt he would not be too comfortable with this Bartok/Kodaly combination, but the performances are basically good. He is a bit too fussy over detail in spots, and he has ideas of tempo at variance with the work of other conductors of these scores. One can accept these minor shortcomings in return for the absolutely glorious sound and playing of his great Concertgebouw orchestra. The first strings are positively glowing in the Bartok. The superb acoustics of the Concertgebouw hall permit a lovely spacious sound, yet the most intimate details of percussion, the delicate tracery and texture in much of the Bartok and in sections of the Háry János Suite are never swamped or out of balance. For all this, the sound has power. Note in the opening of the battle scene in the Háry János Suite, the weight and authority of the bass drum and the massive sonority of the bass trombones and tuba. Their presence is almost palpable. Here we have the bonus of less tape hiss than usual, although not as little as a Dolby recording. A little print-through was evident, but all in all, a clean production and worth your attention.

Three Hours of Stereo Stardust Ampex/London Astrostereo W-79, open reel, 3¾ ips, \$27.95

The title is sure corny, but don't let that stop you from acquiring one of the best of these long-playing tapes in some time. The program is culled from such London pop favorites as Mantovani, Frank Chacksfield, Ronnie Aldrich, Stanley Black, etc. They offer a potpourri of many new numbers along with "golden standards". All are robed in clean, wide range sound, outstanding for 3¾ ips, and with surprisingly little tape hiss. A good bet for winter cocktail parties.

STOP

**BEFORE YOU BUY
THAT RECORD . . .**

WAIT A MINUTE!

**IS IT REALLY A BARGAIN?
IS IT THE PERFORMANCE YOU REALLY WANT?**

Check the other performances and recordings in the latest Schwann Record & Tape Guide.

If it saves you disappointment over one poor purchase, it's well worth the time to look in Schwann first.

Schwann-1 Monthly. Special new listing section has latest releases: records, 8-track cartridge and cassette tapes. Nearly 45,000 total listings on 773 labels in classical, recent popular, rock, jazz, musical shows, country, opera, ballet, electronic, quadrasonic, etc.

Schwann-2 Semi-annual catalog for specialized categories: pop more than two years old, classic jazz, older and re-released mono and reprocessed stereo classical recordings, classical on lesser-known labels, international pop & folk on domestic labels, spoken, educational, religious, etc.



SPECIAL PRICE SAMPLE OFFER

If your favorite store doesn't carry Schwann, order samples by mail. Prices include postage and handling.

- Schwann Sampler one Schwann-1 (monthly) and one Schwann-2 (semi-annual) \$2.25
- Latest Schwann-1 (monthly) \$1.25
- Latest Schwann-2 (semi-annual) \$1.25
- Newly revised Basic Record Library booklet.

Lists 1,000 suggestions in classical music by musical periods for your enjoyment. Send 15¢ for cost of handling, also 8¢ stamped self-addressed long envelope.

I enclose \$.....for the items checked above.

Name _____

Address _____

City _____ State _____ Zip _____

Dealer's Name & Address _____

Schwann Record & Tape Guide

137 Newbury Street, Boston, Mass. 02116

AU

Classified

Rates: 25¢ per word per insertion for noncommercial advertisements; 50¢ per word for commercial advertisements. Frequency discounts as follows: 3 times, less 10%; 6 times, less 15%; 12 times, less 20%. Closing date is the FIRST of the second month preceding the date of issue. *Payment must accompany all orders under \$10.00.* Use the handy self-addressed, postage paid card at the back of this issue. When replying to AUDIO box number ads, send letters c/o AUDIO, 134 No. 13th St., Phila., Pa. 19107. For more information about classified advertising, circle Reader Service Card #135.

FOR SALE

TRANSCENDENTAL AUDIO, LTD. BUFFALO, N.Y. 716-897-3984.

AUDIO RESEARCH. Magneplanar, Crown, McIntosh, Thorens, Decca, Stax, Revox on display. Free List used equipment. Stereo Shop, 107 3rd Ave. SE, Cedar Rapids, Iowa 52401. 319-365-1324.

SENSIBLE SYSTEMS & PRICES: Hegeman, LTD, ARP Synth AR-LST, JVC, Citation, Marantz, BGW, Thorens, B&O, Connoisseur, Equa, Akai, Dokorder, Tandberg, Revox-Beyer, Soundcraftsmen, Hartley, JansZen, Design Acoustics, Kirksaeter, Audio Technica, 54 other makes. Trades, 89 Day Speaker Approvals. By appointment only (404) 252-8569. Write for famous "Blue Sheet" ATLANTA AUDIO PROJECT Ltd. 2126 Faulkner Road, Atlanta, Ga. 30324.

DIGITAL THEORY DESIGN
CONSTRUCTION

LOGIC NEWSLETTER

SAMPLE COPY \$ 1.00
LOGIC NEWSLETTER
POB 252AA
WALDWICK, N.J. 07463

LISTEN TO TV THROUGH YOUR STEREO WITH TELEDAPTER!



Works with any television & stereo. No wiring, just takes a minute to plug in. Now enjoy all TV programming with a full new sound. Complete and ready to use with instructions. 10 day money back guarantee. SEND ONLY \$2.00 for C.O.D. or save C.O.D. charges and send \$16.95 in check, cash or mastercharge No. to:

RHOADES & CO.

P.O. Box 817 Hendersonville, TN. 37075

-Dealer inquiry invited-

FOR SALE

SPEAKER SPECIALIST TOBY Corporation of America: 4620 Camp Bowie, Fort Worth, Texas 76107.

PROTECT YOUR LPs. Poly sleeves for jackets 6¢ round bottom inner sleeves 5¢ Poly lined paper sleeves 12¢ White jackets 27¢ Postage \$1.00. House of Records, Hillburn, New York 10931.

ATTENTION ALL SERIOUS CASSETTE ENTHUSIASTS—At last—No nonsense cassette labels. Send for free samples. Joe Bly Enterprises, 339 W. 88th St., N.Y. 10024.

CYBERACOUSTIC AND EQUIPMENT TESTING laboratory. CROWN tape recorders, amps, AURLINEARS, warranty service station, IMF and Infinity monitors, AKG, Rabco, Decca, UREI, Fairchild and more. Barclay, 503 Haverford Avenue, Narberth, PA 19072 (215) 667-3048 or 120 Villa Crest Drive, State College, PA 16801 (814) 466-6500.

FREE 64 PAGE CATALOG offers hundreds of recordings of rare Renaissance, Baroque and Classical music. Some records priced as low as \$1.00 each! All late recordings. In stereo only. Musical Heritage Society, Box 932-AU, New York, N.Y. 10023.

WORLD'S LARGEST, DEEPEST, MOST POWERFUL SUB WOOFER SYSTEM can be had only at Music and Sound Ltd. 11½ Old York Road, Willow Grove, Pa. 19090. 215-659-9251. From \$1,000. Bandpass 16 Hz.

FIREWORKS NEWS—Monthly magazine covering Fireworks, Construction, Sources of Supplies, New Firms—Products. FREE Fireworks Catalogs with Subscriptions! \$9.00 per calendar year. Pyro Press, Box 1202P, Lexington, Kentucky 40501.

ONE OF FLORIDA'S ONLY AUDIO RESEARCH DEALERS. Complete Audio Research on demonstration. SP-3/Dual 75/Dual 51/Magneplanars and Bass Panel (Tri-amped). Plus Phase Linear, Crown, McIntosh, Hartley, Decca, Stax, S.A.E. Braun, Tandberg, Advent, B&O, Rabco, J.B.L. Thorens, E.S.S. (Heil). Complete audio counselling. Sound & Sight, 20 N. Federal Highway, Boca Raton, Fla. 33432. (305) 391-1843.

For the best on AM



AM? Right! With the Dymek DA3 shielded ferrite rod antenna you may think you're listening to an FM broadcast. It greatly reduces electrical interference and nulls out interfering signals through tilting and tuning. Greatly increases the sensitivity of your tuner's AM section. Especially suited for use in offices, homes, recording studios and fringe areas. Range 1000 miles or more.

Try a McKay Dymek DA3 antenna on a 10 day free trial basis. Lease or buy. \$127.00.

For more information call toll free: Nationwide 800/854-7769, California 800/472-7782, or write:



McKay Dymek
675 North Park Avenue
Pomona, California 91766

Check No. 60 on Reader Service Card

FOR SALE

AUDIO RESEARCH, AUDIONICS TRANSMISSION LINE SPEAKERS, B&O, BOZAK, BRAUN, CROWN, KLIPSCH, LINN SONDEL TURNTABLE, PHASE LINEAR, QUAD, RADFORD, REVOX, SAE. Others. Custom designed and constructed music reproduction systems. Each component analyzed and optimized. Demonstration by appointment. Phone or mail consultations AUDIO SYSTEMS & DESIGN. 5421 South 84th St., Lincoln, Nebraska 68516. (402) 489-9888.

SEQUERRA TUNER, QUINTESSENCE preamp. PHASE LINEAR power amps. NORMAN acoustic equalizer. CONNOISSEUR turntables, JANSZEN electrostatics. Also, Soundcraftsmen, P&M Electronics, B&O, ERA, CM Labs, Tannoy, Hartley Design Acoustics and Braun components. More. Units shipped from stock prepaid freight. ADVANCED ELECTRO ACOUSTICS 1610 South Park Avenue, Buffalo, N.Y. 14220 716-826-5832.

THOUSANDS OF LIKE NEW LPs and pre-recorded tapes. Catalogue \$1.00 House of Records, Hillburn, New York 10931.

AUDIO RESEARCH, RADFORD, PHASE LINEAR, CROWN, QUAD, ALTEC, INFINITY, DECCA, GRACE, AKG, REVOX, BRAUN, PANASONIC SP-10, ESS, TANDBERG and many more. Hartley Electronics (Audio Consultants) 1502 Butternut, Richland, Wa. 99352. (509) 947-5026 after 5 p.m. weekdays, all day weekends.

SPEAKERS CUSTOM BUILT Folded or straight axis horns for the perfectionist. These horns will provide the finest sound in the world. Duluth Electronics Co., 24 East 1st, Duluth, Minnesota 55801. 218-624-4153.

FOR SALE

AUDIO RESEARCH CORP'S Magneplanars IA, II, and III, Woofer Screen*, SP-3 Preamp*, EC-2,3 and 4 Crossovers*, Dual-51, 75, and 400 Amps, Tone Arm*. Normally shipped from stock, pre-paid insured. Music & Sound Ltd., 11 1/2 Old York Road, Willow Grove, Pa. 19090. 215-659-9251.

THE INVENTORS, ENGINEERS, COLLEGE INSTRUCTORS AND PROFESSIONAL MUSICIANS at Music & Sound Ltd. offer their clients a new standard of technical competence, certain proprietary testing procedures, a mind bogging research laboratory, and a host of the most advanced professional services, including hand picked component matching/customization/assembly/alignment, room acoustical design and treatment, calibrated environmental equalization, ± 1 dB at your ears, total "A" warranty station service, and the most flexible demonstration facilities anywhere for the distinguished array of products from: Sequerra, Dayton-Wright, Dahlquist, Infinity, Crown, Decca, I.M.F., Quad, Rogers, Spendor, B.B.C. Monitors, Stax, E.S.S., B&O, J.B.L. and Altec Professional, Schoeps, S.S.I., Beyer, Custom Radco, Gately, Braun, Tascam, Ohm, Damped S.M.E., Ortofon QL-15, Tandberg, shipped pre-paid insured. Music & Sound Ltd., 11 1/2 Old York Rd., Willow Grove, Pa. 19090 215-659-9251.

TWO (2) WHARFEDALE W-90 loudspeaker systems, a stereo pair. Must sacrifice, moving out of state. Very reasonable. Call (201) 941-1768-AM ONLY.

CANADIANS: Brand name audio at warehouse prices. FREE price list. Baltimore Audio Inc., 2385 Eglinton Ave. E., Scarborough, Ontario, Canada M1K 2M5.

THE AUDIO RESEARCH ROOM. The complete range of Audio Research equipment on display under ideal listening conditions. By appointment. C.M. Santmire, AUDIO SYSTEMS & DESIGN 5421 South 84th St., Lincoln, Nebraska 68516 (402) 489-9888.

!!OUR RABCO SL-8E SOUNDS BETTER THAN YOUR SL-8E!! For \$100 we'll convert "yours" to "ours." Professional Products Div., Music and Sound Ltd., 11 1/2 Old York Road, Willow Grove, Pa. 19090. 215-659-9251. Dealer inquiries invited, Customized S.M.E. Damping Mods.

!!HAND-PICKED DECCA LONDON EXPORT SERIES & MK VII! At long last the ultimate cartridges, guaranteed from Music and Sound Ltd., 11 1/2 Old York Road, Willow Grove, Pa. 19090. 215-659-9251. Individually calibrated response and separation curves included.

JAPAN HONG KONG DIRECTORY. World Products information. \$1.00 today World Trade Inquiries, Hillyard, Washington 99207.

MAGNEPLANAR, CELESTION, EPI, OHM, RTR, Audionics (transmission line), ERA and Connoisseur perfection turntables, BGW, Sony, B&O Crown, Transcripator, Stax, Decca, Intregal Systems, many others. Hear our Magneplanar & Audionics super speaker system for \$1,100. High definition Audio specialists. The Gramophone, Ltd., 757 Asp St., Norman, Okla. 73069, 405-364-9477.

E. V. PATRICIAN 800 CONTEMPORARY PR. MINT EDMOND HAMMITT BOX 96 WILLISTON, OHIO 43468 419-836-6011.

PROFESSIONAL AUDIO EQUIPMENT: Microphones, recorders, equalizers, limiters, turntables, lathes, cutterheads, disc mastering systems, portable mixers, consoles, alignment tapes. Package deals and installations. Request Flyer. Wiegand Audio, Middleburg, Pa. 17842 717-837-1444.

FOR SALE

CIZEK LOUDSPEAKERS Lowest price in the country. Quotes on your favorite system. Sound Center, Box 1242, Bloomington, Indiana 47401. 812-332-4252.

AUDIO RESEARCH, BRAUN, CERWIN-VEGA, DECCA, ESS, HEGEMAN, IMF, MAGNUM OPUS, PHASE LINEAR, QUAD, QUINTESSENCE, RABCO, RADFORD, SAE, STAX. Paul Heath Audio, 354 State Street, Rochester, N.Y. 14608 (716) 232-2828.

FLORIDA AUDIOPHILES! E.S.S. AMT 1: Phase Linear, Klipsch, Sony, Marantz, B & O, Quad, Revox, Barzilay. **INTERIORS PLUS SOUND** 3038 N. Federal Hwy. Ft. Lauderdale, Fla. 33306. (305) 566-3511.

NEUMANN MICS & ACCESSORIES. Gately Pro kits and mixers. Most models in stock. Immediate prepaid shipment. Mastercharge. Write or call Dick McGrew Recording Service, 7027 Twin Hills, Dallas, Texas 75231. 214-691-5107.

DIAMOND NEEDLES and Stereo Cartridges at Discount prices for Shure, Pickering, Stanton, Empire, Grado and ADC. Send for free catalog. All merchandise brand new and factory sealed **LYLE CARTRIDGES**, Dept. A, P.O. Box 69 Kensington Station Brooklyn, New York 11218.

MEMORIES SEMICONDUCTORS FREE FLYER, UTI, P.O. Box 252, Waldwick, N.J. 07463.

ELECTROENCEPHALOPHONE: brainwave monitor. Professional biofeedback instruments J&J, Rt. 8, Box 8102, Bainbridge Island, Wash. 98110.

CONNECTICUT AREA Audio Research speaker and amps. Dyna-mod kit and Transcripator turntables. The Stereo Lab, 168 State St., New London, Conn. (203) 447-9802.

STEREO COMPONENTS Lowest discounts \$1.00 for catalog. Defa Electronics, 2209 Broadway, N.Y., N.Y. 10024, Tel.: 212-874-0900.

PROTECT YOUR RECORDS. Cardboard replacement covers, plastic lined sleeves, 78 and 45 heavy sleeves, hinged record set boxes, 12", 10", 7". Cabco, A-4, 89 East Woodruff, Columbus, Ohio 43201.

SCOTCH MAGNETIC TAPE, discount Box 167A, Orwigsburg, Pa.

10 1/2" RECORDER SPECIALISTS: Used boxed 10 1/2" metal and fiberglass recording reels NAB center Metal \$2.00 each fiberglass \$1.25 each. New 1 mil quality tape on above metal reel 5 for \$24.00 on fiberglass 5 for \$19.00. Replacement content labels for 10 1/2" tape box samples \$.25. Soundd Investment Co., POB 88338, Dunwoody, Ga. 30338.

FLAT FREQUENCY RESPONSE TO 18 Hz. Sound Systems presents its new Earthshaker One woofer system. The system includes an electronic crossover variable from 20 to 300 Hz and 100 watt rms amplifier.

SOUND SYSTEMS

Palo Alto, Calif. (415) 328-3761.
Mill Valley, Calif. (415) 383-6556.

SCOTCH 150 STUDIO TAPE—1800' on 7" reel degaussed and boxed. 12 for \$12 POSTPAID. Free price list. **WIDE RESPONSE, 6114A SANTA MONICA BLVD., HOLLYWOOD, CALIF. 90038.**

ARE YOUR TAPES BEING SPOILED by recording or playback on equipment that may be magnetized? The magnetic signal "printed" on tape is quite sensitive to subsequent magnetic field exposure. You can now actually measure such damaging residuals and really demagnetize offending components using an Annis Audiophile Han-D-Kit. Write for bulletin & copy of article "Notes On Demagnetizing" R. B. Annis Co. 1103 N. Delaware, Indianapolis, Ind. 46202.

PAIA HAS...

synthesizer KITS

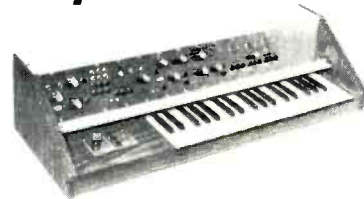

MODELS PRICED FROM \$139

FREE BROCHURE AND CATALOG OF THE COMPLETE PAIA LINE

**PAIA ELECTRONICS
BOX M14359, OKLAHOMA CITY, OK 73114**

Check No. 30 on Free Information Card

FOR SALE

WORLD'S FINEST LOUDSPEAKERS on DEMONSTRATION—AUDIO RESEARCH CORPORATION'S NEW T-1A, T-II, T-III; IMF MONITOR III, STUDIO III, ALS 40, ESS AMT-1, RTR 280DR, ESR-6 CERWIN VEGA 320 MT—320C, HEGEMAN, QUAD. BROCHURES AVAILABLE. PAUL HEATH AUDIO, 354 STATE, ROCHESTER, N.Y. 14608 (716) 232-2828.

MAKE A SOUND CHOICE. Our switching equipment allows instant comparing of all our products Audio Research, Magneplanar, B&O, Braun, Crown, DBX, Decca, Infinity, Phase Linear, Rabco, SAE, Soundcraftsmen and many more **SOUND SYSTEMS** Palo Alto, Calif. (415) 328-3761. Mill Valley, Calif. (415) 383-6556.

SENSATIONAL NEW VACUUM RECORD CLEANER removes dust and pollution for better sound. Battery operated. Satisfaction guaranteed or money refunded \$10.95 postpaid. Calif. residents add sales tax. Ruxton Electronics, PO Box 30312, Santa Barbara, Calif. 93105.

DECCA MK V EXPORT—HAND SELECTED. Custom lateral damping for SME tone arms (for maximum performance).

SOUND SYSTEMS

Palo Alto, Calif. (415) 328-3761.
Mill Valley, Calif. (415) 383-6556.

LOWEST DISCOUNT PRICES ANYWHERE on audio equipment. All major brands discounted. Write for quotes: K&L Sound Services, 264 N. Beacon St., Watertown, Mass. 02172.

BUY DIRECT FROM ENGLAND'S HI FI MAIL ORDER SPECIALISTS! SAVE ON SME, LEAK, DECCA, TANDBERG, REVOX, GOLD SPEAKERS, ELECTROSTATIC SPEAKERS, B&O, CELESTION, TRANSCRIPTOR, CAMBRIDGE, AUDIO DESIGN, ORTOFON, LOWTHER, GOLDRING, KEF. INSURED SHIPPING QUOTES FREE OR SEND \$2.00 BILLS TO INCLUDE LITERATURE GOODWIN LIMITED, 7 BROADWAY, WOOD GREEN, LONDON N. 22. VISITORS WELCOME TO SHOWROOMS PHONE 888-0077

SCOTCH RECORDING TAPE, lowest prices. TAPE CENTER, Box 4305B, Washington, D.C. 20012.

QRK AND REK-O-KUT professional turntables, tone arms, accessories. Isostatic Audio Systems, 66 Dale Drive, Tonawanda, New York 14150. (716) 695-1535.

SCOTCH BRAND CASSETTES

LOW NOISE HIGH DENSITY (LN/HO)
or HIGH ENERGY/COBALT (HE)

QUANTITY	1-9	10	48
SC-45-LN/HO, 45 min	1.35	1.21	1.15
SC-45-HE, 45 min	1.55	1.48	1.40
*SC-60-LN/HO, 1 hour	1.48	1.35	1.21
*SC-60-HE, 1 hour	1.65	1.57	1.49
*SC-90-LN/HO, 1½ hrs	2.16	2.02	1.92
*SC-90-HE, 1½ hours	2.48	2.32	2.22
SC-120-LN/HO, 2 hours	3.00	2.57	2.49

*Buy 2, 60 or 90's. GET ONE FREE

OPEN REEL TAPE RIOT

NEW FACTORY FRESH SCOTCH LOW NOISE 212-R90: #207-R90 (7" REELS 1800 FT. 1 MIL POLYESTER); SCOTCH #203 (3600 FOOT 10-½ METAL REEL); OR AMPEX #641, 1800 FT. 7 INCH REEL

QUANTITY	1-9	10	36
#212-R90 SCOTCH 7"	3.32	2.92	2.77
#207-R90 SCOTCH 7"	3.83	3.34	3.17
#641-18AMPEX 7", 1800 FT.	1.95	1.83	1.69
203-36 SCOTCH 10-½" METAL NAB	7.95	7.00	6.79

CASSETTES & REELS ASSORTABLE FOR BEST QUANTITY PRICE
SHIPPING/HANDLING +10%, 7% OVER \$20.00, 5% OVER \$70.00

SCOTCH MAGNETIC TAPE (USED)

#150, 1800 ft., 7 inch reel, 1 mil polyester, recorded once, bulk erased (no box), 99¢ plus 10% shipping & handling (min. order \$10.00); slightly used 10-½ inch fiberglass reels, ¾ hole, 50¢, metal, NAB, \$1.00 each (plus shipping by weight and zone)



SAXITONE TAPE SALES

1776 Columbia Rd., N.W., Washington, D.C. 20009

FOR SALE

HAND-D-MAGS, Audiophile Han-D-Kits and Magnetometers—Free Data. R. B. Annis Company, 1103 N. Delaware, Indianapolis, Indiana 46202.

SONY TA-3120A, \$120 R.C. Nuebling, 519 Sixth, Ann Arbor, Mich. 48103.

LOUDSPEAKERS—BOSE 901 REPLACEMENTS, \$7.98 postpaid. Quantity Discounts. Moneyback guarantee. Auratone, Box 580-4, Del Mar, California 92014.

THE LARGEST OLDIES CATALOGUE. Over 6000 records for sale 50¢ to \$150.00 covering years 1948-1972. Cost of 60 page catalogue is \$3.00 refundable with the first order. Send to Collectors Records, Box 44017 Dallas, Texas 75234.

OPERA TAPES. Historical performances of past 40 years. Unbelievable treasures and rarities. ALSO LP RECORDS. Free catalog. Ed Rosen, Box 97, Freeport, N.Y. 11520.

ALTEC'S FINEST SYSTEM. 724A Tuner-Preamp with two 2873A Barcelona Biamp speaker systems. \$1,400.00 Thorens TD-125B Turntable with Rabco SL-8E Arm and B&O SP-12 Cartridge. \$350.00 Soundcraftsmen 20-12 equalizer. \$200.00. All units in superb condition. Bob Eastwood 3725 Garfield, Lincoln, Nebr. 68506. Call anytime (402) 489-4158.

CANADIANS—DEEP DISCOUNT PRICES. Name Brand Hi-Fi components. All "Canadian Warranty" protection. No Duty. Send quotation requests to Cartronic, Box 783, Hazeldean, Ontario.

LOW NOISE RESISTORS—¼W, 5%, carbon film for 3.5¢ each. Fifty of one value for \$1.25. All 5% values from 10 to 3.3M in stock. Specifications upon request. 75¢ postage and handling charge per order. Deduct 10% on orders over \$50. COMPONENTS CENTER P.O. Box 134, N.Y., N.Y. 10038.

AT LAST—an ultra-high definition record playing system for the audiophile! Discover far greater **DETAIL** and **RESOLUTION** in your system. Information available from the **DKL LAB**, Box 683, Severna Park, Maryland 21146.

WE ARE INFINITY, SERVO-STATIK AND MONITOR SPECIALISTS, offering components specifically designed for these speakers. The finest components are **LAB-TESTED** and **MATCHED** for the most **LIFE-LIKE**, uncompromising sound available. For information write the **DKL LAB** Box 683, Severna Park, Maryland 21146.

FOR SALE

MAGNEPLANAR® LOUDSPEAKERS are extremely realistic sounding. Our top quality models are sold thru **AUDIO RESEARCH** dealers, some of which advertise on these pages. We now have two less expensive models for sale. They are the **MG1672-P** Room Divider and the **MG2167-F** Floor Standing model. You may buy direct from the manufacturer until there is a dealer in your area. Write us for details. Magneplanar Inc., P.O. Box 8642, White Bear Lake, Minn. 55110.

RECORDING STUDIO AND TUNED ROCK PA'S, 100's of professional products (J.B.L. and Altec Professional, Tascam, D.B.X., U.R.E.I., Gately, etc.) and customized touring sound systems, including feedback suppression, narrow band (5HZ!) acousta-voicing/equalization (± 1 dB at your ears), room design/measurement/treatment. All shipped prepaid insured from Music and Sound Ltd., 1½ Old York Road, Willow Grove, Pa. 19090.

INVENTORS—ENGINEERS

UNBELIEVABLE SAVINGS on 8 track cartridges. Latest list 25¢. Bob Musial, Box 11907-A Chicago, 60611.

KLH-9 ELECTROSTATIC SPEAKERS. Pair list \$1395.00. Pair absolutely factory sealed for \$990. New Pioneer SE100/. electrostatic headphones, \$89. Also available: Rabco, Thorens, Ortofon, Marantz, Revox, Ohm, Soundcraftsmen, DBX, Microstatic, Quad, JansZen, Park Radio, 202 W. Fayette St., Baltimore, Md. 21201 (301) 727-1134.

ENGLAND'S LEADING MAIL ORDER AND DISCOUNT SPECIALIST OFFER—SME, Tannoy, B&W, TEAC, Sansui, KEF, Cambridge, Armstrong, Celestion, Decca, London MK V and Decca Tone-arm at very competitive price. Please send for quotes. Reply by airmail. Shipped immediately Freight collect. Southern Audio Services LTD. @43 High Street, Kingston upon Thames, Surrey, England.

ATTENTION

WESTERN NEW YORK AUDIOPHILES—A new store specializing in personalized, friendly service is now open. We carry Infinity, RTR, Thorens, Sony, B&O, Phillips, Harman Kardon, Sherwood, Soundcraftsmen, Dokorder and others. The Stereo Emporium, Inc. 3407 Delaware Ave. Buffalo, New York. 716-874-3372.

AG 350-2 AMPEX RECORDER. Please call for complete description Scott Kent, BKM Associates, area code 617-658-6565.

ONE STOP for all your professional audio requirements. Bottom line oriented. F. T. C. Brewer Company, P.O. Box 8057, Pensacola, Florida 32505.

OPEN REEL TAPES, CASSETTES, VIDEO, BASF, others. Lowest prices. Acoustic Dynamics, Box 205A Hewlett, N.Y. 11557.

PORTLAND'S OWN HAWTHORNE STEREO now offers the finest in nationally known and esoteric audio components. We stock Advent, Braun, EPI, ESS, Harman-Kardon, Infinity, Klipsch, McIntosh, Quatre, Rabco, Revox, SAE, Stax, and Phase Linear among others. Home trials available as well as complete back-up service. Mail and phone inquires welcomed. **HAWTHORNE STEREO**, 3580 S.E. Hawthorne Blvd., Portland, Oregon 97214.

ELECTRONIC CROSSOVERS—ALL TYPES. Definitive booklet describes applications; how to improve all types speaker systems—\$5.00, credited to first purchase. Huntington Electronics, Box 2009, Huntington, Conn. 06484.

THE MONEY SAVER! Write **STEREO SPECTRUM**, Box 1818, Miami Beach, FL 33139.

FOR SALE

NORTHERN N.J.'S FINEST AUDIO STORE, 20 minutes from N.Y.C. Bozak, B&O, Hartley, Infinity, Magneplanar, Marantz, Phase Linear, Quintessence, SAE, Thorens. Write or Call **UNIVERSITY STORE** 57 E. RIDGEWOOD AVE. RIDGEWOOD, N.J. 201-447-5700.

NORTHWEST AUDIOPHILES; Radford, Decca, Magneplanar, Crown Stax, BGW, SME, Lenn-Sondek, Braun, ERA, Connoisseur, Audionics, JBL-Professional. Other Uncommonly good things—Audio Uncommon, 8600 N.E. Sandy Blvd., Portland, Oregon 97220 503-254-6202.

REVOX A77-1104 SPARE PRE-AMP C/B's, shop manual & stainless steel face plate. Less than fifty hours operation since new. Best offer over \$500.00. Beekman, Box 302, Beeville, Texas 78102.

WEST'S LEADING SPECIALISTS in high definition sound systems offer Celestion, B&O, EPI tower, Klipsch, Phase Linear, Crown, Citation, Pioneer, Connoisseur, Phillips, Braun TG-1000, Thorens, DBX, Rabco, and more—shipped prepaid IMF Studio III and IMF ALS 40 shipped from stock prepaid. ListenUp, Inc., 685 South Pearl, Denver, Colorado 80209. 303/778-0780.

IMF MONITOR MK II SPEAKER SYSTEMS (2), excellent condition. Mk III crossovers. Must sacrifice, very reasonable. D. Magnan, P.O. Box 892, Port Hueueme, Calif. 93041. (805) 486-9593.

TWO MCINTOSH 3500 AMPLIFIERS, SAE Mark I Preamp/ifier Excellent condition Will ship anywhere Roger Egan, Box 540, Sun Valley, Idaho 83353.

CANADIANS: FREE BARGAIN HiFi and Electronics Catalogs. Etco (Au), Box 741, Montreal H3C 2V2.

NAB HUB ADAPTERS—Fit Revox, Crown, TEAC, Robert. \$3/pair postpaid. No C.O.D. Quantity prices available. John Kountz, 1065 Van Dyke Dr., Laguna Beach, Calif. 92651.

SCOTCH CASSETTES, CARTRIDGES, REELS. Discount prices. Lawson's, Box 510, Livermore, Ca. 94550.

AR, KLH, ADVENT, DYNACO, RECTILINEAR, ADC OWNERS—Our low cost electronic equalizer adds a full octave of new bass, provides three broadband tone controls. Three reviews, literature, from **NORMAN LABORATORIES**, 520 Highland Parkway, Norman, Oklahoma 73069.

SCHOEPS CMT34 CARDIOID CONDENSER MIKE. Never used \$350 (new \$450). Rauskolb. 3766 Cass Way, Palo Alto, Calif. 94306. (415) 493-6654.

IMF STUDIO, ALS40, Infinity Monitor, EPI, Marantz, Phillips, Ortofon, Audio Technica Shibata, Stax, Discwasher . . . Stop in and chat . . . The Sound Shop, 96 Seneca Street, Geneva, NY 14456 315-781-0215.

MCINTOSH, AUDIO RESEARCH, CROWN, ESS, QUINTESSENCE, HEGEMAN, BOSE, ADVENT, EPI, STAX, REVOX, RABCO, CITATION, PIONEER, TEAC, FISHER STUDIO-STANDARD and many more. Finest Service on premises. Stereo Designs, Mercury Mall, Hampton, Va. 23666. (804) 838-6394.

AUDIO RESEARCH, TRANSCRIPTORS, INFINITY, SAE, Ortofon, KLH, Thorens, B & O. Phase Linear, Stax. Florida's only state-of-the-art audio shop. Stereo Stuff, 650 W. Tennessee Street, Tallahassee, Florida 32304. (904) 222-0812.

DON'T PAY THE HIGH MAIL ORDER PRICES THIEVES WAREHOUSE OF TAMPA, 1531 SOUTH DALE MABRY, TAMPA, FLORIDA 33609.

FOR SALE

INDUCTORS, MYLAR CAPACITORS, networks & raw speakers plus, new 4 channel (commode/satellite) speaker system component kits. Custom networks (manufacturers inquiries invited). New catalog. Mike Lewis, 3673 W. 113th St., Inglewood, Ca. 90303.

GROMMES-STARCK COMPONENTS, featuring Masterpiece Music Table. Lee Music Chamber and Love Seat. IMF Loudspeakers. Hadley 622 demo amplifier, \$210.00. We trade. Audio-craft, South Rockwood, Michigan 48179. Telephone: (313) 379-9945.

THE ULTIMATE HIGH DEFINITION CARTRIDGE combines Decca transparency and Grace smoothness. Supex moving-coil cartridge \$125. Transformers \$35. and \$135. Levinson cartridge preamp \$210 (super-quiet, sweet, transparent). Supply limited. THE AUDIO SHOP, 2985 College Ave., Berkeley, Calif. 94705. T-W-Th-F 2-8; Sat 12-6—(415) 549-0206.

PHASE LINEAR 700 \$695, MARANTZ 7T \$175, CITATION 12 \$250, RADFORD SPA50 \$250, BRAUN TG 1000 \$735, BOSE 901's \$365 pr., BRAUN 810 Walnut \$595 pr., RABCO SL8E \$145, SAE Mk I \$425, & MK III \$440, HADLEY Power amp \$250, ADVENT DOLBY model 100 \$145, RABCO ST4/ADC 26 \$145 INFINITY SS-I (Improved) \$1295, CROWN DC 300 \$500, AR TURNTABLE with SL8 arm \$165, TANDBERG 6000 \$400, THORENS TD 125BD Mk II/Stax arm \$375, SAE MK IIB \$360, SONY 2000F \$350, REVOX A77 MKII 1104 \$590, EMPIRE Turntable \$150. AUDIO SYSTEMS AND DESIGN 5421 South 84th St., Lincoln, Nebraska 68516. (402) 489-9888.

AUDIO RESEARCH modified Dynaco electronics. Dual 75A, BRAUN 15 ips., Select DECCA Export Mk. 5, IMF, H-K CITATION, ESS-HIEL, MAGNEPLANAR Tympani I \$795 (limited quantities), THORENS, ORTOFON, RABCO, STAX—and other rare and unusual goodies for the serious audiophile at the South's only state-of-the-art stereo shop. BACK DOOR STEREO, 2065 Piedmont, Atlanta, Georgia 30324. (404) 874-9493.

CROWN CONSOLE—714C Recorder plus Mus-O-Matic deck—including console w/cut outs for turntable—tuner amp. Also Sony ST 5000F tuner, TA2000 PreAmp, JBL 50/50 watt energizer. Best offer. J. Barnett, 749 Rt. 35, Middletown, N.J. (201) 671-1161.

ANTIQUES—700 CYLINDER RECORDS. \$3500 the lot. Birnbom, 3655 Ridgewood, Montreal.

CROWN SX824 \$1095. Brello 999-98th Ave. Oakland Cal.

INFINITY HALOSONICS (MODIFIED), Beautiful—like new. Cost \$450.00 plus. F.O.B. Charlotte \$275.00 Early-late—1-704-375-6991

BUILD YOUR OWN highest quality microphone mixers, consoles, phono preamps, crossovers, equalizers, or voltage controlled devices, using modules. Free catalog. Burwen Laboratories, 209 Middlesex Turnpike, Burlington, Mass. 01803. Tel. 617-273-1488.

ASTROCOM-MARLUX 407 tape deck, S/N 900288, needs minor transport repair, schematics; \$150, Mark Casstevens, 3813 Rolland, Nashville, Tenn. 37205.

COMPARE AND SAVE \$50, \$100 AND MORE. Send \$1.50 for complete list of major component discount houses in U.S. to—Component Discounts, P.O. Box 937, Sunnyvale, Calif. 94086.

MARANTZ 8B, MAC C20. Citation 3X, Bell 6060, Freeman 200, Best Offer. George Davis, Rt. 1, Box 366, Solsberry, Ind. 47459.

FOR SALE

PHASE LINEAR AMPLIFIER—Model 700 (with cabinet), 4 mos. old. Mint condition. Best offer. Evenings 516-751-3526.

GRAPHIC EQUALIZER PLANS: Novel circuit very effective/inexpensive, requires no inductors. Ten knobs (octave bands) compensate your Hi-Fi/Tape providing better listening. Complete plans rushed only \$3.00 GREEN BANK SCIENTIFIC, Box 100C, Green Bank, WVa. 24944.

TESLA COIL—40" SPARKS! Plans \$7.50; information 75c. Huntington Electronics, Box 2009-A, Huntington, Conn. 06484.

ORTOFON OWNERS—IMPROVE SOUND with our Micro-Preamp, which replaces Ortofon transformer. Send for free literature. Huntington Electronics, Box 2009, Huntington, Conn. 06484.

RABCO SL-8E TONEARM—½ yr. old, still under warranty. Greg Larsen, 362 Crest Rd., Ridge-wood, N.J. (201) 444-1981.

AR TUNER WITH WALNUT CASE, 6 months old, \$140, postpaid. Nick Lombardi, 2203 Plaster Rd. NE, Atlanta, Ga. 30345.

BSR McDONALD 810X TURNTABLE with base and dust cover, Shure M91ED cartridge. Factory sealed. Selling ad used, \$180. Jim Lowery, 116P Northgate Apts., Cranbury, N.J. 08512. (609) 443-6829.

CUSTOM LOADED MAXELL UDC-90 CASSETTES AS LOW AS \$1.00. PRIVATE LABELING AND OTHER CUSTOM LENGTHS AND TAPES AVAILABLE FOR ALL NEEDS. MJS 1126 Cobb St., San Mateo, Calif. 94401.

BRAUN TG-1000/4 Tape Deck. Remote control. Latest, all black. Less than 10 hours use. \$650. L. Markoff, 21 Talcott Glen Rd., Farmington, Conn. 203-677-0822.

!!OUR HAND PICKED DAHLQUIST & ORTOFON MOVING COIL CARTRIDGES AND MICRO PREAMPS ARE INCOMPARABLE IN OUR CUSTOMIZED DAMPED S.M.E.'S!! Music & Sound Ltd., 11½ Old York Road, Willow Grove, Pa. 19090. (215) 659-9251.

REVOX 1104 MK III Tape Deck. Excellent Condition. ¾ and 7½, plus Advent Dolby 101, many accessories. \$650. Call Richard, 215-233-1702.

THORENS TD-125 with Modified Rabco arm and Decca Mk5 cartridge, Magnaplanar Tympani-1 speakers, ESS amplifier and preamplifier, TEAC 450 cassette deck. All perfect. C. Oliver, 424 N. Van Buren, Iowa City, Iowa 52240. (319) 351-8500.

KENWOOD KF-8011 multiband dynamic noise filter with carton and manuals \$125. ELECTRO-VOICE SENTRY IV MONITORS \$600/pair. Orban, 2000 Cedar Ave., Menlo Park, Ca. 94025.

OHM A SPEAKERS, as new, \$1000; Phase Linear 400, new, warranty blank, \$390. Pope, 51 Hillside, Roxbury, Mass. 02120. (617) 427-8449.

BEST OFFER: McIntosh MR77, KLH Nines, Crown SS724 & SP824, Magnaplanar I, Audio Research Dual 75, Thorens 125 MKII, Decca V, Stax SR3/5. 319-365-6418 after 6 pm CST.

OLDIES 45rpm. Free catalog. Corny's Record Shop, Box 335R, Mason, Ohio 45040.

MARANTZ 22 RECEIVER, \$300. TEAC A7010 deck, \$425. Advent 100 outboard Dolby, \$150. Pair JBL L75WX speakers, \$80 each. Offers considered. (312) 878-8984.

CAPITOL STACK-PACKS. Blank cassettes, cartridges, reels. Discount prices. Lawson's, Box 510, Livermore, Ca. 94550.

HUGE SAVINGS ON FAMOUS BRAND STEREO COMPONENTS

DISCOUNTS ON NATIONALLY ADVERTISED TURNTABLES • CARTRIDGES COMPACTS • RECEIVERS AMPLIFIERS • TAPE RECORDERS

Wholesale Prices! Audio Warehouse Sales, One of the Capitol's largest stereo wholesalers will fill and deliver all your mail orders promptly in factory sealed cartons, at prices that will amaze you.

Write for quote on Famous Brand, Stereo Components. We guarantee satisfaction.

AUDIO WAREHOUSE SALES 3310 NEW YORK AVE. N.E. WASHINGTON, D.C. 20002 (202) 832-1616

Check No. 10 on Reader Service Card

FOR SALE

DAYTON WRIGHT XG8 Mk II; Marantz 500 Amp. Brand new—Must sell. (919) 467-9198.

ROGERS B.B.C. MONITOR, IMF, B&W Ltd., Celestion, Radford, Decca, ERA, Connoisseur, Audionics TL-90, Goldring, Revox, Beyer, Lamb and more. Custom design and modifications. SUFFOLK AUDIO, INC., 120 Boylston St., Suite 220, Boston, Mass. 02116. (617) 423-2051.

RADFORD 360—Dual Transmission line speakers, RADFORD 180, IMF MONITORS MkIII, IMF ALS40, IMF bookshelf, ESS Transtatic, ESS/KEF bottoms. TANNOY Autograph professionals. Futterman's amp. Best offers. TRANSCENDENTAL AUDIO LTD. 1214 Walden Ave., Buffalo, N.Y. 14211 716—897-3984.

HOW TO GET THE BEST AUDIO/TAPE BUYS, SAFELY. Insider's information by leading equipment reviewer lists models and pitfalls. Tells how, where to buy intelligently for greatest savings. 20 pages \$1.00 or send stamped envelope for details. US Audio Testing Laboratories, Box 1570 LICNY, 11101.

KLH-7 SPEAKERS, pair \$225.00. Hadley 621 & 622, \$325.00. R. Williams, 14711 Gandesa Rd., La Mirada, Ca. 90638.

HELP WANTED

ASSISTANT EDITOR

Popular home entertainment magazine needs experienced editor with good background in audio or electronics. Send resume or call F. Nemeyer, 134 No. 13th St., Phila., Pa. 19107 (215) 564-5170.

HELP WANTED

AUDIOPHILES OVERSEAS

EUROPEAN RESIDENCE—3-YEAR CONTRACT—EARNINGS MATCH QUALITY OF LIVING—For qualified HI-FI enthusiasts promoting exclusive products BASF, DUAL, MARANTZ, SUPERSCOPE to Americans overseas, residence STUTTGART/NAPLES. Submit resumé and snapshot to John Suter CH-4023 BASEL.

SERIOUS RECORDISTS NEEDED. Excellent remuneration. We train and equip. Modest investment required. Write Box 278, Englewood, Ohio 45322.

SERVICES

DON'T PAY the high mail order prices. Thieves Warehouse is coming up to your area. Franchises available Thieves Warehouse, P.O. Box 8057, Pensacola, Florida 32505.

HIGH FIDELITY SPEAKERS REPAIRED AMPHRITE SPEAKERS SERVICE

655 Sixth Avenue, New York 10, N.Y.
212-CH3-4812

THE NEW YORK AUDIO SOCIETY is a hi-fi club with a comprehensive activities program and numerous member benefits. Come and be our guest at one of our meetings and see what we have to offer. For details write N.Y. Audio Soc., Dept. A, Box 5889, Grand Central Sta., N.Y., N.Y. 10017 or call M-Fri. 10AM-6PM (212) 242-3900.

RECORDS MADE FROM YOUR TAPES. Also, editing and mastering. Send for free brochure. Nashville Record Productions, Inc., Dept. AM 204 19th Ave., So., Nashville, Tennessee 37203.

CUSTOM RECORDING SERVICE Tape and disc. Stereo and mono. Live and copies. Editing. Masters and pressings. High quality at reasonable rates. Joseph Giovanelli, Audio Tech Laboratories, 2819 Newkirk Ave., Brooklyn, N.Y. IN9-7134.

MULTI-CHANNEL TAPES Processed from YOUR Mono Records Tapes. Demo Tape \$1.50 R. R. Faulkner, Box 26, Redondo Beach, Calif. 90277.

LOW PRICED PROFESSIONAL QUALITY Location Recording in Illinois and Indiana. Send for free price information. N. Beer, 515 Fourth Ave. Ottawa, Ill. 61350.

THE ABSOLUTE SOUND, in its upcoming issue, will review the Dahlquist Phased Array speaker; the Supex moving coil cartridge; the Grace arm and cartridge; the Marantz 500; the Ohm F, the Sendor BBC Monitor (among other things). This magazine is a quarterly (4 issues, \$8) about music and sound. In its first three issues (which you get if you subscribe now); it has reviewed the Dayton-Wright electrostatics; the Magneplanar I and Ia; the Hegeman Model One; Mark Levinson's pre-amp; the improved Heil amt-Ia; Audio Research's SP-3 (and more) The Absolute Sound, Box 115T, Sea Cliff, N.Y. 11579.

EXCITING ANNOUNCEMENT

UNIQUE APPROACH TO AUDIO REPORTING
AUDIO REVIEW QUARTERLY, a unique publication featuring revealing, in-depth discussions of controversial issues, EQUIPMENT REVIEWS, ratings, recommendations, audio highlights and more. **AUDIO REVIEW QUARTERLY** reports issues and ideas other magazines ignore by exposing factual "behind-the-scenes" information. Upcoming issues feature **PROFESSIONAL EQUIPMENT REVIEWS**, exciting exposes, **BUYERS DISCOUNT SERVICE** with so much more! Special Introductory Subscription Rate: \$7.50/year. Write **AUDIO REVIEW** for exciting details on many new services available to subscribers. Take advantage of this offer and mail your subscription TODAY! **AUDIO REVIEW**, Box 175, North Branford, Conn. 06471.

SERVICES

TAPE RECORDER HEADS brought back to spec. Wear removed. Brilliant finish. \$10.00 each. One day service. E. Maher, 5 Evans Place, Orinda, Calif. 94563.

QUADRAPHONIC RECORDING SPECIALIST Will convert stereo material to four channel reel or Q8 cartridge. Custom dubbing & matrix encoding. Reel, 8 track cartridge or cassette. Editing & 2 channel services also available. George Bostwick Custom Recording Box 329, Jasper, Indiana 47546.

JAMMED CARTRIDGES? The Audio doctor will save them. Send \$1.50 with your tape. Satisfaction guaranteed. Box 354, Central Islip, N.Y. 11722.

BUSINESS OPPORTUNITIES

\$25.00 HUNDRED stuffing envelopes. Immediate earnings. Beginner's Kit, \$1.00 (refundable). Lewcard. A392 DU, Brea, California 92621.

MONEY AVAILABLE NOW! Both Personal. Business Uses . . . \$500 to Millions. Finance Anything . . . Get Rich Techniques . . . Thousands Actual Sources. Free Details. AIDS, Box 725-AUD, Holland, Michigan 49423.

MAILORDER MILLIONAIRE helps beginners make \$500 weekly. Free report reveals secret plan! Executive (1Q12). 333 N. Michigan, Chicago 60601.

FREE Collection Agency Details!! \$1,000.00 Monthly Possible. Master-4, Drawer 77009, Atlanta, Georgia 30309.

\$10 DAILY WRITING SHORT ARTICLES at home. Begin immediately! Copyrighted report reveals how and where. Send \$1.00. Specialty Merchandise Co., 7659 So. 42nd St., Omaha, Neb. 68147.

AUTO ACCESSORIES

LOW PRICES ON CAR ELECTRICITY adapters. One wire hook-up. \$8.45. Paul Livingstone, St. Marys, Ontario.

FANTASTIC New Spark Plug Installation Tool. Save Those Burnt-Fingers. Only \$2.00 Postpaid. J & J Mfg., Box 5265, Lincoln, Nebraska 68505.

CAPACITIVE DISCHARGE IGNITIONS DISCOUNTED. Rodgers, Son (AM), Box 3583, Anaheim, California 92803.

MUSICAL INSTRUMENTS

WHOLESALE! Professional Guitars, PA Systems, Altec Speakers, 240W RMS Amplifiers. Free Catalog. Carvin, Escondido, Calif. 92019.

EQUIPMENT WANTED

CASH FOR YOUR unwanted stereo LP's and reel to reel tapes. Record House, Hillburn, New York 10931.

WANTED: CROWN, R.O.M. Write Jim Hollinger, Galen Hall Rd., Rt. #3, Wernersville, Pa. 19565.

LOOKING FOR AN AMPEX MICRO 155 which came out of last year (1972 model). Anyone owning one and willing to sell—must be in excellent shape—please call me. Willing to pay fair price for unit. A Licata, 85 Livingston St., Apt 56 Brooklyn, N.Y. 11207.

MOOG SYNTHESIZER. Prefer portable configuration but will consider console models #1 or #2. Must be in perfect working order. Send complete details and firm price to Stephen Blair, 35 Moseley Av., Newburyport, Mass. 01950.

45 AND 33 1/2 IDLERS for REK-O-CUT TR43H turntables. ETS Record Co., P.O. Box 1299, Wahiawa, Hawaii 96786.

EQUIPMENT WANTED

WANTED: SONY 124 STEREO Portable Cassette Recorder in Good Condition. Gary Bourgois, Box 146, Ishpeming, Michigan 49849. (906) 486-8235.

WANTED: SOUNDCRAFTSMEN OR ADVENT Equalizer in perfect condition, state price, serial number, and age. MJS 1126 Cobb, San Mateo, Calif. 94401.

WANTED: WEATHERS ML66 TURNTABLE W/UNIVERSAL (WOOD) ARM. Andrew Marshall, 279 King Street West, Kingston, Ontario, CANADA. or (613)-546-2466, evenings only.

WANT AKG D-202EI AND D-244E Microphones. George Paight, 194 Joffre Ave., Stamford, Conn. 06905.

WANTED: JBL SE460 OR SE400S Energizer. Wm. J. Riese, 16163 E. Brunswick, Aurora, Colo. 80013.

WANTED—WHARFEDALE SUPER 12 SPEAKER. L. Stecklow, 70 East 8th St., Brooklyn, N.Y. (212) 871-4958.

WANTED SCHEMATIC OF MOOG SYNTHESIZER models 10, 12, IIC, IC, IIIc, or portable models, and all ARP models. Write what you've got and price for original or copies to: B. Allan Taylor, 123 S. 65th Ave. W., Duluth, Minn. 55807.

INSTRUCTION & EDUCATION

BIBLE Degrees—Correspondence—Fundamental Bible Seminary. P.O. Box 942, Elk City, Oklahoma 73644.

LOGIC trainers catalogs 50¢. UTI, POB 252, Waldwick, N.J. 07463.

BE A CREDIT-COLLECTION SPECIALIST. Jobs waiting for novice, advancement for experienced collectors. Information—Scalo Ltd., P. O. Box 377, Millbrae, California 94030.

PHOTOGRAPHY

16MM FILMS, ACCESSORIES—Collectors paradise—Gaines (AM) 15207 Stagg, Van Nuys Calif. 91405.

DISCOUNT PRICES on all photographic equipment, send for price quote of exact items you want, instant reply. Hope Camera Stores 27179 Chagrin Blvd., Cleveland, Ohio 44122.

GOVERNMENT SURPLUS

JEEPS Typically From \$53.90 . . . Trucks from \$78.40. Boats, Typewriters, Knives, Airplanes, Clothing, Multimeters, Oscilloscopes Transceivers, Photographic Electronics Equipment, Wide Variety Condition 100,000 Bid Bargains Direct from Government Nationwide. Complete Sales Directory and Surplus Catalog \$1.00 (Deductible on Orders From Separate Included Catalog) Surplus Service, Box 820-AUD Holland, Michigan 49423.

JEEPS, TRUCKS, Cars From \$31.50. Airplanes, Typewriters, Clothing, Multimeters, Transceivers, Oscilloscopes, Photographic-Electronics Equipment . . . 100,000 Surplus Bid Bargains Direct From Government Nationwide Typically Low as 2¢ on Dollar! Complete Sales Directory and Surplus Catalog \$1.00 (Deductible First \$10 Order From Included Catalog) U.S. Surplus Disposal, 2200 Fuller 601-B-AUD Ann Arbor, Michigan 48105.

MANUALS for Gov't. Surplus Radios, Test Sets, Scopes. List 50¢. **BOOKS**, 7218 Roanne Drive, Washington, D.C. 20021.

MUSIC

BRAZILIAN—Latest hits from Brazil. Not Sergio Mendes. Not available in the U.S. Write Braziliansound, Box 1280, Bellaire, Tx. 77401.

RARE ROMANTIC PIANO SCORES—Moscheles, Henselt, Herz, Litolff, Scharwenka, Scriabin, etc. Free catalog. **MUSIC TREASURE PUBLICATIONS**, Box 127, Highbridge Station, Bronx, New York 10452.

RECORDS

CATALOGS Broadcasts, soundtracks. Personalities of Thirties, Forties. Box 225, New York, N.Y. 10028.

RARE Deleted Motion Picture Soundtrack and Show Albums Steiner, North, Goldsmith, Waxman, Young, Bernstein, Styne, etc. "ONLY THE BEST." Send 25¢ for new quality catalog to ReCollections, P.O. Box 197, Roselle Park, New Jersey 07204.

SHOW ALBUMS—Rare Out of Print Lp's. Free large list. Broadway/Hollywood Recordings, Georgetown, Conn. 06829.

FILM-STAGE SOUNDTRACKS. Large free list. A. Lutsky, Box 7342, Miami, Fla. 33155.

OLDIES—45 RPM Original hits. Catalog 50¢ C&S Record Sales, Box 197, Wampsville, N.Y. 13163.

RARE RECORDS—Send wants. Box 410 Bronx, N.Y. 10469.

FREE LP CATALOG—Deleted Soundtracks Shows, Nostalgia. A. Roseman, P.O. Box 16083, Phila., Pa. 19114.

FREE 200-PAGE CATALOG. 1,400 New Stereo Recordings. Renaissance, Baroque, Classical, Romantic, Modern Music. Not sold in stores. Not listed in Schwann's Highest quality! Budget label prices! Available only by mail **MUSICAL HERITAGE SOCIETY**, Box 932 AU, New York N.Y. 10023.

PILITA CORRALES—Winner 1973 International Music Festival—Tokyo sings about "LOVE." Stereo \$6.00 AIRMAILED!! Record-Handicraft catalog \$1.00 (Refundable). ARABELL CO PITOGO, QUEZON E-327, PHILIPPINES.

WANTED: JOHNNY WESTERN RECORDS. ETS Record Co., P.O. Box 1299, Waihiwa, Hawaii 96786.

HISTORIC JAZZ AND SWING RECORDINGS. Many broadcasts, rare cuts. Catalog for 10 cents from Tulip Records, P.O. Box 6277, San Francisco, Calif. 94101.

TAPE RECORDINGS

RENT 4-TRACK open reel tapes—all major labels. 3,000 different. Free brochure. Stereo-Parti. 55 St. James Drive, Santa Rosa, Cal. 95401.

KENNEDY/TIPPIT/OSWALD Murders! Actual episodes & police recordings! Reels/ cassettes: \$10. Majestic, 9651 Foxbury, Pico-Rivera, California.

SPLICE FASTER BETTER BY SHEARING. Replaces razor. Specify 1/4" or cassette, \$16.95, with attached splicing tape mechanism, \$24.95. Details—NRPA, Box 289, McLean, Va. 22101.

EVERYTHING ON OPEN REEL! Prerecorded classical/popular tapes. Latest releases. Dolby. Quad. 96-page catalogue \$1. Barclay-Crocker, Room 857A, 11 Broadway, NYC 10004.

OPERA TAPES, RECORDS. "live" performances, broadcast. Free catalog. Hathaway, 49A Merbrook, Merion, Pa. 19066.

TAPE RECORDINGS

OVER 16,000 OLD RADIO SHOWS ON TAPE. Latest supplement 50¢, complete catalog \$2.00. Hart Enterprises, 1329E George Washington, Richland, Washington 99352.

ENTERTAINMENT WEST—Opera, (Many West Coast). Old Radio Concerts. Catalogue, \$2.00. 690 Rockdale Dr., San Francisco 94127.

MATHEMATICS CASSETTE TAPES CORRELATED WITH PRINTED TEXTS. A new series that simplifies knowledge required by modern technology. Narrated by William R. Parks, a community college mathematics professor in the State University of New York System. Designed for interest and understanding: Introduction to Statistics \$7.95; Sets and Numbers \$5.95; Computer Number Bases \$6.95; our popular Introduction to Gambling Theory \$7.95; Sets and Flowcharts \$6.95; Algebraic Expressions \$5.95; Linear Equations and Graphs \$6.95. Send check or money order to: Williams-ville Publishing Company, Inc., Dept. DK Box 237, Williamsville, New York 14221.

RECORDS

RECORDS—soundtracks, show, cut-outs. Send wants—we'll quote. Lesco, 2205 Marylane, Broomall, Pa. 19008.

SOUNDTRACKS, original casts and personality recordings—Many hard-to-find titles at reasonable prices. Send for large, new catalog free. Robert Hiott, Box 471, Miami, Florida 33144.

MIDWEST'S LARGEST SELECTION of rare mint soundtracks—Band of Angels, Destination Moon, Etc. Free catalog. Old Record Warehouse 5516 N. Kimball, Chicago, Ill. 60625.

MUSIC GAZETTE (RARE SOUNDTRACK NEWSLETTER)—Hundreds of soundtracks on sale monthly—lowest prices! Free Sample. RTSA 1111 S. Benito Avenue, Suite F. Alhambra, California 91803.

PSYCHIC MEDITATION—WITCHCRAFT MUSIC RECORDS. Free Brochure! (Dealers Welcome) Brotherhood, Box 1363, Spring Valley, California 92077.

SOUNDTRACKS—O.C.—Personalities & Jazz Auction Lists From: Theo's P.O. Box 4994 Panaroma City, Ca. 91412.

SOUNDTRACK RECORD ALBUMS—Mail Auction. Free List—Whalon, 2321A Hill—Redondo Beach, Calif. 90278.

OLD RADIO SHOW

OLD RADIO SHOW Monthly Special Club—TBOR Box 1692A, F.D.R. Station, New York 10022.

REAL ESTATE

IDEAL 5-ACRE RANCH. Lake Conchas, New Mexico, \$5,475. No Down. No Interest \$40/mo. Vacation Paradise. Good investment. Free Brochure. Ranchos, Box 2006 JF Alameda, California 94501.

SONGWRITERS

GET IN ON THE MONEY to be had in the booming song and music world as a lyric writer. Co-write with me on a 50-50 basis. Publishers contract guaranteed. Recording promotion. Send lyrics with stamp: Paul Jackson, Rt. 9, Box 292-cr, Athens, Ala. 35611.

INVENTIONS WANTED

PROSECUTE YOUR OWN Patent Application. All Material Necessary—Write Inventors Service, Box 3574, Washington, D.C. 20007.

TAPE & TAPE RECORDERS

8-TRACK Tapes 3/\$10, to \$1.50 wholesale quantities. 4000 titles. Box 4733 Columbus, O 43202.

SENSE TAPES—Specially-programmed 3 hour continuous stereophonic environments. Reel or cassette. Free brochure. Sunier Productions, Box 814, Kentfield, CA 94904.

8 TRACK CARTRIDGES AT GREAT SAVINGS. Latest catalog 25¢. Bob Musial, Box 11907-A, Chicago, 60611.

RENT CASSETTE or Open Reel Prerecorded tape. All Labels. Catalog 75¢. Tape & Time, P.O. Box 740, Hopkins, Minn. 55343.

RADIO PROGRAMS

REMEMBER RADIO? On cassettes or reels. Amos & Andy, Inner Sanctum, Jack Armstrong, Fred Allen, I Love a Mystery, Your Hit Parade, Grand Ole Opry. All your Favorites live again. High quality, low prices Catalog only 50¢. Remember Radio, Inc., 2513-B, Norman, Okla. 73069.

1930-1962 RADIO PROGRAMS ON TAPE Huge catalog! Hour samples!! \$1.24, Refundable!! AM Treasures, Box 192M, Babylon, N.Y. 11702.

RADIO PROGRAMS. CATALOGUE OF THOUSANDS. \$1.00 (Refundable). THE RADIO VAULT, BOX 9032-TV WYOMING, MICHIGAN. 49509.

NOSTALGIA RADIO PROGRAMS traded. Private collection. Drawer 3226, Newport, Delaware 19804.

THOUSANDS OF OLD RADIO COMEDIES, Dramas, Band Remotes, Mysteries, etc., \$6.00 for 6 Hour Reels Catalogue. \$1.00 (Refundable). Cassettes also available. RADIOVOX 1756 Washtenaw, Ypsilanti, Michigan 48197.

WANTED—"GRAND CENTRAL STATION" radio dramas written by Roger Gallagher 1946-1950. Contact Gallagher, RFD2, Amherst, Mass. 01002.

PLANS & KITS

WAVEFORM Generator Kit \$10.00. Stereo Multiplex Kit \$19.95. Free Kit Catalog. Photolume Corp. Box 139, N.Y., N.Y. 10016.

PYROTECHNICAL chemicals, casings, tools, suppliers, fuse, literature. Giant, illustrated catalogue/handbook includes formulas, instructions—50¢ with samples—\$1.00. Westech, Box 593, Logan, Utah 84321.

ELECTRONIC PARTS, semiconductors, kits. FREE FLYER. Large catalog \$1.00 deposit. BIGELOW ELECTRONICS, Bluffton, Ohio 45817.

REPAIRS & SERVICES

AMPEX AUDIO & VIDEO PARTS-SERVICE-TAPE. Jones Electronic Service Co. 947 Old York Road, Abington, Pa. 19001. (215) 887-1522 or 568-7711. Expert Service on all brands of Audio & Video Equipment.

HIGHER INCOME

SECURITY AND POWER. 256-page book "Thinking Big" reveals secrets that make men rich! Send \$2.00. Byron Dupree, 1272 Penn St., N.E., Washington, D.C. 20002.

SPEAKERS

SPEAKERS OUR SPECIALTY: Quality speakers, crossovers and associated components. For \$1.00 (refunded with first order) we send you a catalog guaranteed to have new speaker items. Century Audio-Electronics, Inc., Box 1471, Tucson, Arizona, 85702.

first came the word...



And then there was music.
And then came Sony tape recorders
to capture the words and music
with perfect fidelity. Right from the
start, Sony has always been first with
the best, the newest and the broadest

selection of tape recording equip-
ment in the world. Sony tape
recorders, Sony accessories, Sony
microphones, Sony recording tape.
We could go on and on and on.
We are. **SONY** Ask anyone.

Brought to you by **SUPERSCOPE**

Check No. 63 on Reader Service Card



HIRSCH-HOUCK LABS report on the KENWOOD KA-8004 STEREO AMPLIFIER

“A deluxe, highly flexible and powerful unit rated conservatively at 60 watts per channel from 20 to 20,000 Hz with both channels driven into 8-ohm loads”



—STEREO REVIEW, November 1973,
“Equipment Test Reports”

Here are some further comments from the Hirsch-Houck Test Report on one of KENWOOD's finest stereo amplifiers:

“...With both channels driven to the clipping point, with a 1,000-Hz test signal, the KENWOOD KA-8004 delivered 72 watts per channel to 8-ohm loads.”

“...Over much of the power range from 1 watt to more than 70 watts the distortion was typically about 0.05 per cent, and always less than 0.1 per cent.”

“...The KA-8004 has the extensive input facilities we have come to expect from KENWOOD... two magnetic phono cartridge inputs, three high-level inputs, paired microphone inputs, and dubbing/monitoring facilities for two tape recorders.”

“...The tone controls were truly excellent. With the ‘normal’ turnover frequencies of 400 and 3,000 Hz, their characteristics were similar to some of the better tone-control circuits we have encountered.”

“...As any fine amplifier should be, it was completely self-effacing, sonically adding or subtracting nothing of its own to the program unless called upon to do so.”

Like the KA-8004, the matching KT-8005 Stereo Tuner is a state-of-the-art unit with unsurpassed performance characteristics: Sensitivity 1.5 μ V; selectivity 100 dB, capture ratio 1.0 dB. The multiplex stage features KENWOOD's exclusive Double-Switching Demodulator (DSD) circuit that delivers an incredible stereo separation of at least 35 dB throughout the frequency spectrum (50-15k Hz).



For reprints of the complete Hirsch-Houck Test Report, as well as complete specifications for both the KA-8004 Amplifier and KT-8005 Tuner, write...



the sound approach to quality
15777 So. Broadway, Gardena, Calif. 90248
72-02 Fifty-first Ave., Woodside, N.Y. 11377
In Canada: Magnasonic Canada, Ltd.

Check No. 24 on Reader Service Card

www.americanradiohistory.com