

Part 2
Behind
The scenes in
JAPAN

Audio

THE AUTHORITATIVE MAGAZINE ABOUT HIGH FIDELITY • MAY 1973 60¢ © A

23602

BASF

AMPEX

Capitol

Tracs

DAK

IRISH

TDK

Scotch

maxell

SONY

MEMOREX

**AUDIO
LOOKS AT
THE NEW
TAPES**



Announcing a major breakthrough
that will have universal impact
on all future high fidelity
components and their
performance.

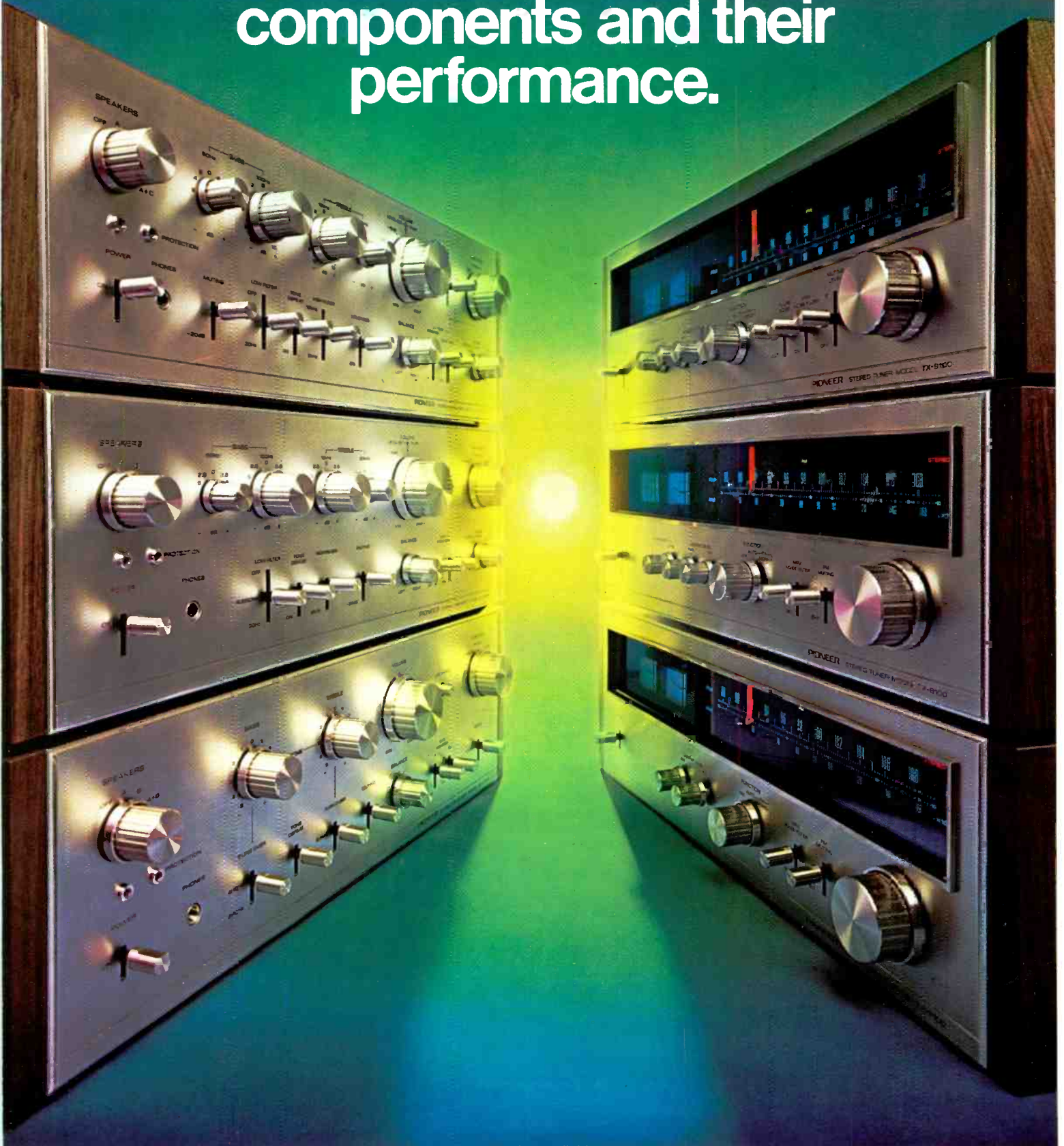

stabilization, special electronic regulator circuits are used. Transient response is also improved with a superb damping factor of 70.

The unique equalizer amplifier

To make certain that extraneous signals do not interfere with the input signal, the equalizer amp is totally enclosed and sealed to shield it against leakage.

There's also extra assurance of precision with special low noise metal film resistors and styrol capacitors. Both are manufactured under continuous computer control to highest laboratory test equipment tolerances: $\pm 1\%$ for resistors; $\pm 2\%$ for capacitors. Until now such precision has been unheard of in hi-fi equipment. Deviation from the ideal RIAA curve is only $\pm 0.2\text{dB}$.

Since a direct-coupled SEPP complementary circuit is used in the equalizer amplifier, virtually any dynamic phono cartridge can be accommodated without overloading or distortion. For example, with 2.5 mV sensitivity, the overload at 1KHz is an unbelievable 250mV, and 1200mV at 10KHz!

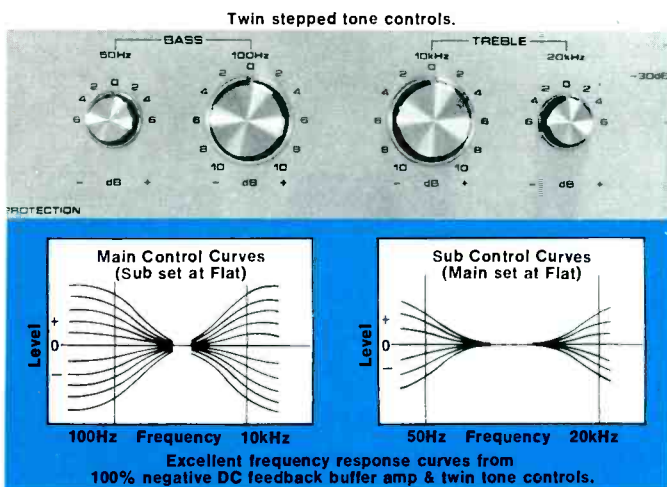

The control amplifier: Twin stepped tone controls custom tailor your listening.

Now you can make the most critical bass and treble adjustments with supreme ease. In fact, there are 5,929 tonal combinations to suit your listening room acoustics and to compare or compensate for component frequency response.

On the SA-9100 and SA-8100 four tone controls (two for bass, two for treble) make 2dB (2.5dB with SA-8100) step adjustments for the entire audio spectrum. Working together with the tone controls is a buffer amplifier with 100% negative DC feedback. The main bass control governs $\pm 10\text{dB}$ at 100 Hz; the sub-bass, $\pm 6\text{dB}$ at 50 Hz. The main treble control governs $\pm 10\text{dB}$ at 10KHz and the sub-treble, $\pm 6\text{dB}$ at 20 KHz. This, plus the tone defeat control (described in the next paragraph) makes the SA-9100 the most exciting-to-use amplifier that has ever powered any hi-fi system.

New tone defeat switch

Because of the extremely wide variety (5,929) of frequency adjustments made possible by the twin tone controls, the tone defeat switch adds extra flexibility. Adjusting the tone controls to your satisfaction, you can flip the tone defeat switch. Bass and treble responses instantly become flat. When it is switched off you return to the original tone control settings.

The power amplifier

To sustain the ultra sophistication of the equalizer and control amp sections, the power amp has a direct-coupled pure complementary SEPP circuit, double differential amplifiers and two constant current loads. The combined effect is the achievement of wide power frequency range and excellent transient response. 100% negative DC feedback is supplemented by 66dB dynamic negative feedback for minimum distortion and absolute stability. The pre and power amps can be used independently with a separation switch.

Exclusive direct-coupling in all stages

Until now direct-coupling has been used only with the power amplifier. Pioneer takes it a dramatic step further in the SA-9100 and SA-8100. Direct-coupling in all stages from the equalizer amp to the control amp to the power amp. More effective? Absolutely. It achieves the finest transient response, wider dynamic range, THD and IM distortion of only 0.04% (1 watt). It's an incredible achievement.

Level set, volume and loudness contour controls adjust to listening preference

Three controls working together adjust to any degree of loudness. The level set control is the primary volume control. Its maximum loudness setting is 0dB.

Successive settings of -15dB and -30dB result in lower gain. Once the desired volume is obtained, the volume control is used for fine adjustments within the given

range. While the loudness contour boosts bass and treble, it may also be used with the level set control. The more advanced the position of the level set control, the lower the effective range of the loudness contour.

The original and positive speaker protector circuit

Since the signal is fed directly to the speakers because of direct-coupling, an automatic electronic trigger relay system is incorporated into the power amplifier. This protects the speakers against damage from DC leakage which can also cause distortion. It also prevents short circuits in the power transistors.

Maximum convenience for program source selection

While there is a multiple function rotary switch for microphone, phono 2 and two auxiliaries, Pioneer has included an

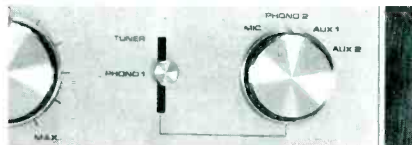

Convenient program source selection switch & control lever.

PIONEER
when you want something better

additional convenience. A separate flip type lever control for instant switching between the more widely used tuner and phono 1 and any other single program source. Incidentally, both switches are shielded to protect the input against undesirable extraneous signal pickups.

Two-way tape duplicating and monitoring

There are two separate flip type switches on the front panel of the SA-9100 for tape-to-tape duplicating and monitoring. Two tape decks can be connected for recording, playback and duplicating in either direction, with simultaneous monitoring.

Level controls for phono 2, aux 2

In order to match the level of various inputs, individual level controls are provided for phono 2 and aux 2.

Speaker B control

This special control helps in the use of two pairs of speaker systems of different efficiencies. There is no sacrifice of damping or distortion when switching from one pair to the other.

Impedance selector for phono 2

An easy-to-use switch allows you to employ any phono cartridge input (25K, 50K, 100K ohms).

Two-position high & low filters

The low filter switch on the SA-9100 and SA-8100 has subsonic (below 8Hz) and 30Hz positions. The high filter switch has 12KHz and 8KHz positions.

Maximum versatility in program sources

Inputs	SA-9100	SA-8100	SA-7100
Tape monitor—S/N	2-90dB	2-90dB	2-90dB
Phono—S/N	2-80dB	2-80dB	2-80dB
Auxiliary—S/N	2-90dB	2-90dB	2-90dB
Microphone—S/N	2-70dB	2-70dB	1-70dB
Tuner—S/N	1-90dB	1-90dB	1-90dB
Outputs			
Speakers	3	2	2
Headsets	1	1	1
Tape Rec.	2	2	2

Consistent power for every requirement

RMS power both channels driven 20-20KHz	RMS @ 8 ohms both channels driven @ 1KHz	RMS @ 4 ohms single channel driven @ 1KHz
SA-9100 60+60 watts	65+65 watts	100+100 watts
SA-8100 40+40 watts	44+44 watts	60+60 watts
SA-7100 20+20 watts	22+22 watts	36+36 watts

This new lineup of Pioneer tuners and amplifiers is unquestionably the most advanced available today. Yet despite this overwhelming sophistication, they're sensibly priced.

See your Pioneer dealer. He'll show you how this series of fine instruments can outperform any units in their price range. All prices include walnut cabinets. SA-9100—\$399.95; SA-8100—\$299.95; SA-7100—\$229.95. TX-9100—\$299.95; TX-8100—\$229.95; TX-7100—\$179.95.

While not discussed here, Pioneer is also introducing the SA-5200 stereo amplifier and the TX-6200 stereo tuner for high quality hi-fi on a low budget. Only \$129.95 each, with walnut cabinet.

U.S. Pioneer Electronics Corp.,
178 Commerce Rd., Carlstadt, New Jersey 07072

West: 13300 S. Estrella, Los Angeles 90248 / Midwest: 1500 Greenleaf, Elk Grove Village, Ill. 60007 / Canada: S. H. Parker Co., Ont.

You're
reading
this page
for the
same
reasons
we build
our
speakers.

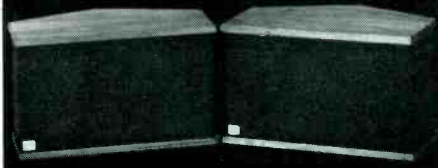

Better music, wherever you listen. Real fundamental, bass, including the attack of tympani and organ. An almost tactile feeling of presence. And transparent highs, providing unusual instrumental definition.

First and foremost, we built the LDL 749 to satisfy our own desire for musical enjoyment. Including the spatial sensations: from the intimacy of small groups to the awesomeness of full orchestra.

With their precise combination of forward-radiated sound and panoramic reflection, LDL 749's are a compact, elegant way to put the concert hall in your listening room. At \$300 per pair,* the price is as realistic as the sound!

*Prices slightly higher in south and west. Dealer inquiries invited.

**Linear
Design
Labs Inc.**

114 Wilkins Avenue, Port Chester, N.Y. 10573

Audio

MAY 1973

Successor to **RADIO** Est. 1917

Vol. 57, No. 5

FEATURE ARTICLES

- | | | |
|----|----------------------------|--------------------------|
| 20 | Tape Survey | |
| 26 | A Simple Volume Compressor | <i>Daniel Shanefield</i> |
| 28 | Language of Hi Fi, Part X | <i>Martin Clifford</i> |
| 38 | Audio-Reader | <i>Billy G. Brant</i> |
| 55 | An Inexpensive Microphone | <i>Roland H. Reiss</i> |

EQUIPMENT PROFILES

- | | | |
|----|---------------------|----------------|
| 40 | Marantz Amplifier | <i>1120</i> |
| 42 | SAE Speaker System | <i>Mk. XII</i> |
| 46 | Sherwood Receiver | <i>S-7200</i> |
| 56 | Leader Oscilloscope | <i>LBO-301</i> |

RECORD AND TAPE REVIEWS

- | | | |
|----|--------------------------|-------------------------------|
| 59 | Classical Record Reviews | <i>Edward Tatnall Canby</i> |
| 62 | Off the Record | <i>Sherwood L. Weingarten</i> |
| 64 | Jazz & Blues | <i>Martha Sanders Gilmore</i> |

AUDIO IN GENERAL

- | | | | |
|----|--------------------------------------|----|-------------------------------------|
| 4 | Coming in June | 12 | Editor's Review |
| 4 | Audioclinic <i>Joseph Giovanelli</i> | 14 | Behind the Scenes <i>Bert Whyte</i> |
| 6 | Tape Guide <i>Herman Burstein</i> | 50 | Advertising Index |
| 8 | Dear Editor | 55 | Workbench |
| 10 | What's New in Audio | 66 | Classified Advertising |



EDITOR *George W. Tillet*

ASSOCIATE EDITOR *Edward Tatnall Canby*

ASSISTANT EDITOR *Peggy Bicknell*

DESIGN *David Adams*

PUBLISHER *Jay L. Butler*

MARKETING DIRECTOR *Sanford L. Cahn*

COVER DESIGN *John Kwasizur*

SUBSCRIPTION MANAGER *Jean Davis*

ADVERTISING PRODUCTION *Peggy Bicknell*

CONTRIBUTING EDITORS: *Herman Burstein, Martin Clifford, Leonard Feldman, Richard Freed, Joseph Giovanelli, C. G. McProud, Harry E. Maynard, Alexander Rosner, Sherwood L. Weingarten, Bert Whyte*

AUDIO (title registered U.S. Pat. Off.) is published monthly by North American Publishing Co., Irvin J. Borowsky, President; Frank Nemeyer, Jay L. Butler and Roger Damio, Vice Presidents; R. Kenneth Baxter, Vice President/Production; Nate Rosenblatt, Promotion Director; Mary Claffey, Circulation Director.

RATES—U.S. Possessions, Canada, Mexico, \$6.00 for one year; \$10.00 for two years; all other countries, \$9.00 per year. Printed in U.S.A. at Columbus, Ohio. All rights reserved. Entire contents copyrighted 1973 by North American Publishing Co. Second class postage paid at Philadelphia, Pa. and additional mailing office. Back issues, \$2.00 each.

REGIONAL SALES OFFICES: Jay L. Butler, Publisher and Sanford L. Cahn, Marketing Director, 41 East 42nd St., New York, N.Y. 10017, telephone (212) 687-8924.

Jay Martin, 15010 Ventura Blvd., Sherman Oaks, Calif. 91403, telephone (213) 981-7852.

REPRESENTATIVES, United Kingdom: The American Magazine Group, 9 Warwick St., London, W 1, England. Continental Europe: John Ashcraft, 12 Bear St., Leicester Square, London W.C. 2, telephone 930-0525. For Benelux and Germany: W.J.M. Saunders, Mgr., Herengracht 365, Amsterdam, Holland, telephone 24.09.08.

Japan: Japan Printing News Co., Ltd., No. 13, 2 Chome Ginza Higasi, Chuo-ku, Tokyo, telephone 541-5795.

AUDIO Editorial and Publishing Offices, 134 N. 13th St., Philadelphia, Penna. 19107

Postmaster: Send Form 3579 to the above address

IMPROVE YOUR HEARING FOR \$200.

Sometimes high fidelity people lose sight of what it's all about: Sound.

The ultimate test of any piece of high fidelity equipment is what you hear.

That's why, of all the statements made by equipment reviewers about our Garrard Zero 100, the most significant were these:

"Using identical virgin records, and virgin styli in identical good cartridges, the Zero 100 on occasion sounded markedly 'crisper' than other turntables." *Rolling Stone*.

"A listening test proves to bring new life to many records, noticeably reducing distortion on the inner grooves." *Radio Electronics*.

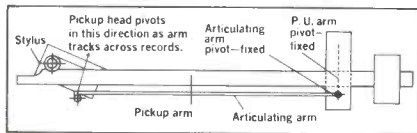

"From about 7 in. diameter to runout, the Zero 100 delivers considerably less distortion and greater definition than with the same pickup mounted in a standard arm. The improvement in sound quality is notably impressive."

Elementary Electronics.

"The articulated arm of the Zero 100 produced less distortion, and therefore greater definition, on high-level, musically complex passages, from the inner grooves."

Hi-Fi Stereo Buyers' Guide.

That's what reviewers actually

heard when they tested the first automatic turntable with Zero Tracking Error. This is, to our knowledge, the first time a turntable has been given credit for making records sound better.

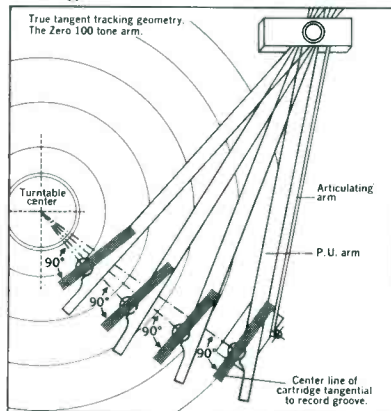

Cartridges and other components, yes. But never a turntable — until the Zero 100.

By this time you probably know how we achieve Zero Tracking Error. The principle of the articulating arm, continually adjusting the angle of the cartridge so it is always at a 90° tangent to the grooves, is a simple one. But the ingenious engineering and the development of the precision pivots to make the principle work, took several years.

But enough from us. Let's go back to what the reviewers say about the Zero 100.

"It probably is the best arm yet

offered as an integral part of an automatic player." *High Fidelity*.

"All of these features combined into one automatic turntable make news, even though some are found on other units. Only in the Zero 100 are they all put together." *Audio*.

When *Audio* talks about "all of these features" they're referring to such things as our magnetic anti-skating, variable speed control, illuminated strobe, viscous-damped cueing, 15° vertical tracking adjustment, patented Garrard Synchro-Lab synchronous motor and our exclusive two-point record support in automatic play.

But all of this gets back to our original point. It is the sound that makes the difference. After all, a \$200 record player should give you a really meaningful difference. And the high fidelity experts agree that people who own a Zero 100 will hear better than people who don't.

If you'd like to read the reviews in full detail, we'll send them to you along with a complete brochure on the Zero 100 and the Garrard line. Write to: British Industries Company, Dept. E 13, Westbury, N.Y. 11590.

GARRARD ZERO 100

The only automatic turntable with Zero Tracking Error.

Dist. By British Industries Co., A Division Of Anet, Inc.
Mfg. By Plessey Ltd.

coming in
June

AUDIO tests 13 Quadraphonic Headphones
The Language of High Fidelity—Part 11 of Martin Clifford's guide for beginners.

Equipment Reviews Include:
Microstatic Speaker System

TEAC FM 100 Tuner

Dynaco A-35 Loudspeaker

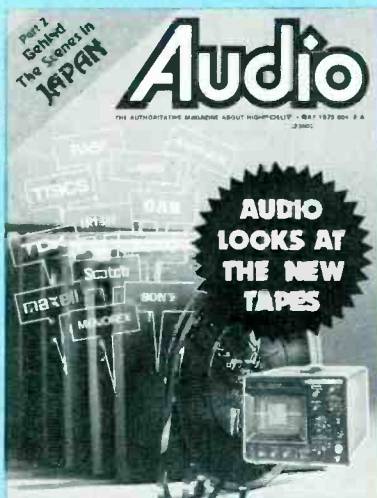

About the cover: Open-reel recorders are still very popular among enthusiasts in spite of the convenience of cassettes. Both types have benefited by the introduction of special low-noise tapes, but cassette recorders still need a Dolby system to come near the performance of open-reel. Shown are some of the low-noise tapes tested. The 'scope is a B & K Model 1440, with "Calibrain"

Audioclinic

Joseph Giovanelli

Low Front-Channel Gain

Q. I recently converted my stereo system (which includes a McIntosh 1700) to quad by adding an EV decoder and a Dynaco SCA-80. I have noticed that, when using the decoder, there is a tremendous loss of gain in the front amplifier, as opposed to its stereo performance. Is this expected? If not, what can I do to receive more gain?—Ed Willner, Clarksville, Indiana

A. The EV decoder has no insertion loss. This means that the front channel performance of your equipment should be substantially the same as it was before the conversion to four-channel.

To determine what is wrong, temporarily connect your front channel amplifier for conventional stereo by bypassing the decoder. Note if gain has been restored. If it has, you will know that

restored. If it has, you will know that nothing has gone wrong with the front channel amplifier.

Recheck your wiring to the decoder to be sure that all cables are in their proper places. Check that all cables are in good condition.

It is possible that something is wrong with your particular decoder. If all other checks have proved negative, this becomes a likely possibility. To determine that you do have a problem in the decoder, feed a 1 kHz audio signal into the two inputs of the decoder. Measure the resulting output voltage appearing at the two output terminals. If this measurement does not yield substantially the same voltage as does the input from the oscillator, the decoder is defective.

Be sure to check the tape switches of the decoder and receiver to see that they are in their correct positions.

Groove Echo

Q. I recently put together a system consisting of a Marantz 2270, Dual 1229 with a Pickering V-15/750E cartridge. When played at full listening volume, I have noted what appears to be an echo for one revolution of the disc prior to the onset of any loud music. This occurs both at the beginning of the record and in appropriate spots within a recording.

I presume this may be due to some irregularity in the first groove because

of the side impressions of the subsequent groove.

I would appreciate your opinion on the cause of this and what, if anything, can be done to prevent it. I am also interested in knowing why I do not hear this on records which are transmitted on FM.—Jack R. Harnes, M.D., New York, New York.

A. When playing a phonograph record, it is not at all unusual for a slight echo to be heard either before or after a given passage is heard. (When the echo precedes the actual signal, we often call this a "ghost"; when it follows the music, we call this an "echo".) There are a number of contributing factors. The modulation being impressed on a given groove during the cutting process can cause the sufficient deformation of the surrounding area of the disc so that this information will be "printed" on either the groove preceding or the groove following the actual modulation. The degree of audibility of the "echo" depends on the level of modulation, the spacing between grooves, the level of the modulation in the adjacent grooves, and the evenness of the deposition of metal during the plating process involved with producing the stampers used to press phonograph records.

While I have not tested this theory, it does appear that some types of styli bring out more of this unwanted signal than do others.

If you have a record on which groove echo is heard, and if this same disc is played on an FM station, you should hear this same groove echo unless it is masked by the noise generated within the tuner or by man-made interference.

Check to see that your stylus is clean.

In addition, check for proper tracking force. Excessive tracking force can deform the surface of a disc, thus causing an increase in unwanted echo.

If you have a problem or question on audio, write to Mr. Joseph Giovanelli, at AUDIO, 134 North Thirteenth Street, Philadelphia, Pa. 19107. All letters are answered. Please enclose a stamped self-addressed envelope.



if you are
serious about
music
use the tape
of the pro.
TDK

When it comes to tape, do like the pros do — use TDK.

TDK, renowned among artists and producers the world over for unmatched purity and fidelity, gives you greater dynamic range and maximum output levels for "real life" sound.

TDK offers the widest choice of formulations and lengths in cassettes, 8-track cartridges and open-reel tape.

If you're into music, use the tape that's in with the pros — TDK.



Purity in Sound

Make recordings like a pro. Get TDK's Better Recording Kit FREE when you buy any 5 TDK cassettes:

- Free "Guide to Better Recordings"
 - Free TDK C-60SD Super Dynamic cassette
- See your TDK dealer for details.



Check No. 2 on Reader Service Card

TDK **TDK ELECTRONICS CORP**
23-73 48TH STREET, LONG ISLAND CITY, N.Y. 11103 • 212-721-6881
In Canada, contact: SUPERIOR ELECTRONICS INC



IMAGINE:

THAT A MANUFACTURER PERFECTED AN ABSORPTION-TYPE ENCLOSURE THAT ALLOWED A SPEAKER TO SOUND SO CLEAN AS TO OUTPERFORM MANY \$600 "STATE OF THE ART" SPEAKERS FOR ONLY:

\$299 BUT.....



RSL Max

IMAGINE:

YOU COULD BUY IT WHOLESALE FROM THE MANUFACTURER FOR:

\$160

**ROGERSOUND
LABORATORIES
A REALITY!**

There are 14 models in the RSL speaker line—
All at wholesale.



6319 VAN NUYS BLVD.
VAN NUYS, CALIF. 91401
(213) 787-6863 (213) 873-3345

Check No. 28 on Reader Service Card

Tape Guide

Herman Burstein

Prerecorded Tape Noise

Q. I have a question with regard to a peculiar noise problem in prerecorded tapes. In some instances I have noted suddenly that a previously satisfactory tape gives very loud clicking noises. There is no periodicity, but the points at which noise occurs are constant. The volume of the noise at its worst is far more than the loudest recorded level on the tape. The noise does not appear to be erasable. Otherwise, the sound quality is not impaired.—D. A. Berlincourt, Chagrin Falls, Ohio

A. I suspect that the clicking sounds you describe were put on the tape as the result of a static discharge. Perhaps this happened during rapid wind or rewind. It may be best for you to consult on this problem with the manufacturer of your tape machine.

Twisted Tapes

Q. Some of my tapes tend to become somewhat twisted or distorted so that they do not go smoothly over the playback head. This happens even when the tapes are handled very carefully, and involves only a small percentage of the tapes.—D. A. Berlincourt, Chagrin Falls, Ohio

A. Plastic substances often have memory, and this might account for the physical twist developed by some of your tapes. The twist might develop during storage as the result of a portion of the tape being under high stress, particularly if it was rapidly wound or rewound just prior to storage. Tapes tend to keep best if they are stored after being run at normal operating speed. If a tape has long been in storage, stress can perhaps be relieved by winding and rewinding the tape before using it again.

Plastic Cap for Heads

Q. It occurs to me that people with three or more heads on their machines might benefit by some type of plastic cap that would fit over the heads that are not in use. Sometimes I use my recorder in the playback mode for 50 to 100 hours without recording. I'm getting just as much wear on the record and erase heads as if I were using them. Wouldn't one benefit from some kind of plastic shield to slip over the heads?—L. N. Norman, Winthrop, Iowa

A. Your thought about a plastic cap is an interesting one. I'm wondering if one could achieve about the same effect with a thin piece of celluloid (or similar material) attached with tape to the heads in question. I am not sure whether this would or would not significantly

disturb the tape path. Where tape tension rather than pressure pads is used to maintain tape to head contact, the use of a plastic cap or device such as I have suggested might interfere with good contact between the tape and the desired head.

Dolby System Function

Q. A friend of mine has told me that the Dolby system will not reduce the hiss on tapes that have been previously recorded. Rather, he says, the Dolby will prevent any new amounts of hiss from being added to a tape when it is being recorded. This, it seems to me, runs counter to what I have read about the performance of the Dolby. Thus one report stated that "a played-back signal . . . is identical with the original in frequency response, but with a reduction of tape hiss of the order of 10 db." To me this means that if I re-record one of my own tapes through the Dolby, the hiss level in playback will be reduced 10 db. Am I correct?—David J. Churchill, APO San Francisco.

A. Your friend is correct. The Dolby will not reduce noise of already recorded materials—unless you are willing to accept a drop in treble response along with a drop in noise. If flat response is to be maintained, the Dolby keeps noise to a minimum only in making a new recording, whether off the air, live, or of a disc or another tape.

Chromium Dioxide Tape

Q. If chromium dioxide tape is so good for cassettes, why has it taken so long to appear in open reel tapes?—Charles Novitski, Pasadena, California

A. As with any new product, a new tape formulation has its problems in terms of compatibility with already existing equipment. These problems include amount of bias, amount of audio drive current, and record equalization. Thus, existing tape machines would have to be adjusted or modified, in all probability, in order to work satisfactorily with the new formulation. However, a new cassette machine can be designed from the start to work properly with a new tape formulation.

If you have a problem or question on tape recording, write to Mr. Herman Burstein at AUDIO, 134 North Thirteenth Street, Philadelphia, Pa. 19107. All letters are answered. Please enclose a stamped, self-addressed envelope.

Albeit an expensive bargain, but a bargain nevertheless. For the Model Fifty-Four is without question the finest stereo receiver we have ever made. Indeed, it may well be the finest stereo receiver anyone has ever made. And if that wasn't enough, the Fifty-Four is also an absolutely incredible four-channel receiver. With 60 watts (RMS) per side in the two channel mode and 25 watts (RMS) per side in the four-channel mode, the Fifty-Four is an extraordinary power package. It's considerably more compact and sleeker than competitive models, yet it will outperform the biggest and bulkiest of

them with ease.

And it's so very easy to use.

All the controls are clearly indicated and conveniently located on the front panel. You can change from one format to another—two channel, Stereo 4, SQ, etc.—with the simple flip of a switch. In addition, there's a neat "joy stick" for absolutely perfect balance control.

The Fifty-Four also features an exclusive automatic power control circuit (patent pending) that turns the receiver on and off to coincide with the operation of your automatic turntable.

All in all, we think the Fifty-Four is

quite in a class by itself.

But don't take our word for it. Not for \$525.† Go listen for yourself. And if the price still seems a bit rich, consider this: Buy the Fifty-Four and you'll never have to buy another receiver again.

Now *that's* a bargain!

For more technical information, write to KLH Research and Development, 30 Cross Street, Cambridge, Mass. 02139. Or visit your KLH dealer.



KLH RESEARCH DEVELOPMENT CORP.
30 Cross Street, Cambridge, Mass. 02139

†Suggested retail price—slightly higher in the South and West.



**The
new
KLH-Model
Fifty-Four
Stereophonic/Quadraphonic
Dual Function Receiver.
Our \$525 bargain.**

Check No. 3 on Reader Service Card

Dear Editor

Loudspeaker Issue

Dear Sir,

I was prepared to let my subscription expire until I read John Crabbe's article. If you promise to include more articles by him and his colleagues, I promise to renew my subscription. In order to make more intelligent purchases American audio consumers must be armed with more knowledge of the kind John Crabbe can disseminate.

H. K. Appleman
Brighton, Mass.

I promise—and there will be more controversial articles in the future—ED.

Dear Sir,

The March issue was great, these are the kind of articles we want. Keep them coming, you may offend some advertisers but you will have a better magazine. The same applies to equipment reviews—keep them objective.

R. L. Brown
Boston, Mass.

As we publish all points of view there is no reason why advertisers should be offended. A magazine that simply repeated manufacturers' claims without criticism, praised every loudspeaker or amplifier as the best, would soon lose credibility—and advertisers too for that matter—ED.

From Percy Wilson

Dear Sir,

I largely agree with Ben Bauer but disagree with John Crabbe regarding column speakers. I find great virtue in columns provided they are properly designed acoustically, which most are not. They are all too short and do not match the units. Thus for a 60 Hertz resonance, the column ought to be 4 ft. 3 inches long.

Percy Wilson,
Oxford, Great Britain

Next time Percy leaves the fleshpots of Oxford and comes over to visit us, I must introduce him to the EPI column which must be over 6 ft. high. To be exact: 6 ft. and 3 inches—I just checked. Seriously, Percy is an expert on column speakers and I hope he can be persuaded to write an article on the subject soon.
—ED.

And from Gilbert Briggs

... I rather like your summing up on page 36 and I agree with your findings.

Gilbert Briggs
Ikley, Yorkshire
England

Help

Dear Sir,

Will you please tell us where we can purchase fine tape dubbings from first generation Master tapes?

J. E. Cade
Casonic Foundation
Ft. Lauderdale, Fla.

Lee Kuby of Harman-Kardon is also anxious to get some prime quality tapes. Can anyone help?

Dear Sir,

I do agree with Editorial observations on the widespread use of clippers, limiters, AGC's etc. The sad part is that many broadcasters install these devices not realizing that you don't get something for nothing! The mad race to get more effective transmitted energy by making the audio more "dense" does cost something aside from the outlay for the AGC amplifier... subtle things like the ease with which listeners can tolerate one station versus another over a given period of time.

Recently, I watched a nearby out-state FM on a VU meter with modulation varying from 0 to -3 dB! How's that for dynamic range? There was plenty of record noise, tape hiss and studio noise all transmitted at "4 times the station's rated power" as the AGC amplifier ads say! This could well be a station who will add Dolby to top off their string of squashing, squeezing and shaping devices.

The high frequency clippers and dynamic treble controls are even more interesting. One area metropolitan FM sends out a special signal on top of the music for me at all times (apparently unknown to the station) so I can instantly evaluate their high frequency response! They constantly transmit a high frequency RF buzz (RF getting into the audio circuits). Every time a muted trumpet plays or the castanets begin, my special "spy tone" disappears along with record scratch, tape hiss and high frequency content of the music.

The bulk of FM broadcasters would probably state quite boldly that their facilities well meet FCC proof-of-

performance standards. I would dare over half of them to allow proof of performance measurements to be made actually through their microphone (not the mic input) or through their cartridge or reel-to-reel tape equipment or their turntable pickups. Very few would pass!

Most of these stations buy good equipment. How it is used is quite another story. Many times, the vocalists on the records played sound more 'live' than the live studio announcer. This is usually when the station uses public address grade microphones while ironically, their listeners sport super fidelity condenser microphones!

On the other hand, many stations buy good microphones but use them in studios that are not flat. You'll find acoustic ceiling tile cemented to the walls which does nothing for the bottom end while absorbing the highs leaving the studio with a response looking like that of a loudspeaker or phonograph of 20 years ago. Or what about the station who does not know (or care) what tape azimuth is or maybe how to properly load a phono cartridge to obtain flat response from a test record? I squirm every time I listen to one station with an intense yearning to adjust azimuth screws on cartridge tape machines. The announcers sound like they're talking through a bail of cotton!

Limiters, compressors and other related equipment are necessary but must be used properly... not as cure-alls.

I'm for starting a nation-wide ecology movement to clean up the sound on our AM's and FM's. Let's get rid of the noisy announce studios, the hiss, hum, distortion even though station managers say only those radical audiophiles can hear it. Let's end the discrimination against bass fiddles who are being jumped on by overly active compression amplifiers and let's stop the repression of violins, muted trumpets, cymbals and percussive instruments who are being suppressed by other distorters! Let's make practical dynamic range a to-be-desired specification and then add Dolby. Wouldn't it be nice?

Thomas H. Jones
President &
General Manager
KNXR
Rochester, Minn.

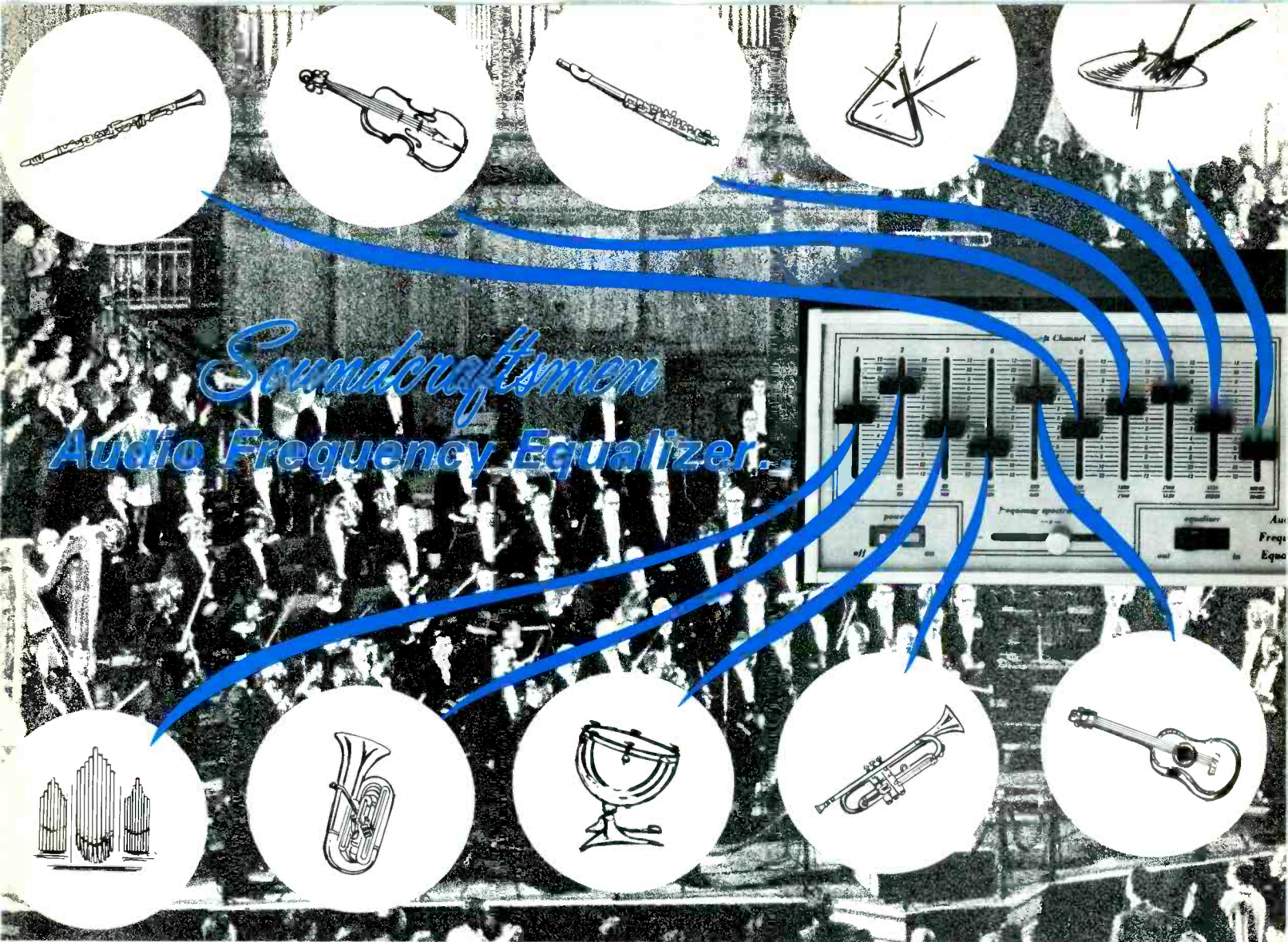

Soundcraftsmen Audio Frequency Equalizer.

Guaranteed to enhance any fine stereo system!

(Following quotes from 20-12 owners' Warranty cards on file at Soundcraftsmen)

"One of the best investments I ever made!!" . . . "Even made a believer out of my wife" . . . "I thought my system was the best sounding system going, but this equipment makes it sound un-real" . . . "Incredible! Every system should have one" . . . "Excellent — superb improvement of system" . . . "One Hell of an improvement to what I thought was a good sounding system" . . . "It would be a very great boon to anyone's stereo system — I love it" . . . "Has made a big improvement in the sound of my system" . . . "Great improvement to my system!!!" . . . This is a very fine piece of equipment. It tremendously improves the sound of my system" . . . "Can't believe how good it makes my set-up sound" . . . "WOW!!! What a change in my system!"

SPECIFICATIONS and SPECIAL FEATURES

TOROIDAL and ferrite-core inductors, ten octave-bands per channel.
FREQUENCY response: $\pm \frac{1}{2}$ db from 20-20, 480 Hz at zero setting.
HARMONIC DISTORTION: Less than .1% THD @ 2 v., Typ: .05% @ 1 v.
IM DISTORTION: Less than .1% @ 2 v., Typ: .05% @ 1 v.
SIGNAL-TO-NOISE RATIO: Better than 90 db @ 2v. input.
INPUT IMPEDANCE: Operable from any source 100K ohms or less — (any Hi-Fi Pre-amp, Receiver or Tape Recorder.)
OUTPUT IMPEDANCE: Operable into 3K ohms or greater — (any Hi-Fi Amp, Receiver or Tape Recorder.)
CIRCUIT BOARDS: Military grade G-10 glass epoxy.

RESISTORS: Low-noise selected carbon-film.
RANGE: 12 db boost and 12 db cut, each octave.
MASTER OUTPUT LEVEL: "Frequency-spectrum-level" controls for left and right channels, continuously variable 18 db range, for unity gain compensation from minus 12 db to plus 6 db.
MAXIMUM OUTPUT SIGNAL: variable Master "frequency spectrum level" Controls allow adjustment of optimum output voltage for each channel, to exactly match amplifier capability, up to 7 v.
SIZE: designed to coordinate with receivers, comes installed in handsome walnut-grained wood receiver-size case, $5\frac{1}{4}$ " x 18" x 11", or rack mount.
WARRANTY: 2-year parts and labor.

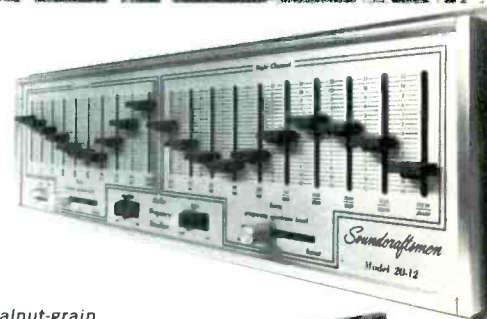

\$299.50
 includes walnut-grain cabinet, or rack-mount.

FREE!

The "Why's and How's of Equalization", an easy-to-understand explanation of the relationship of acoustics to your environment. This 8-page booklet also contains complete specifications, an editorial review of the 20-12 by J. Gordon Holt's Stereophile magazine, many unique ideas on "How the Equalizer can measurably enhance your listening pleasure," and "How typical room problems are eliminated by Equalization."

Soundcraftsmen

1310 EAST WAKEHAM
 SANTA ANA, CALIFORNIA 92705

Check No. 21 on Reader Service Card



Herewith, five helpful ideas for adding music without disturbing your decor.

PROBLEM: How do you add a stereo (or 4-channel) system to your living room without upsetting the appearance of the room or adding unwanted furniture?

ANSWER: Use Electro-Voice Custom Loudspeakers that mount almost anywhere. For instance, you can build them into a present bookcase, mount them in a wall (perhaps behind a semi-transparent drape), mount them in a closet door, even put speakers in the ceiling, or install them in existing furniture.

There are sizes and models of E-V Custom Loudspeakers to fit your available space, your budget, and your taste in sound. Write today for complete catalog information and a list of Electro-Voice dealers who'll help you put hi-fi in its place... in your home.



ELECTRO-VOICE, INC. Dept. 534A
602 Cecil Street, Buchanan, Michigan 49107
In Europe: Electro-Voice, S. A., Römerstrasse 49, 2560 Nidau, Switzerland
In Canada: EV of Canada, Ltd.

Electro-Voice
a Gulton
COMPANY

Check No. 5 on Reader Service Card

What's New in Audio

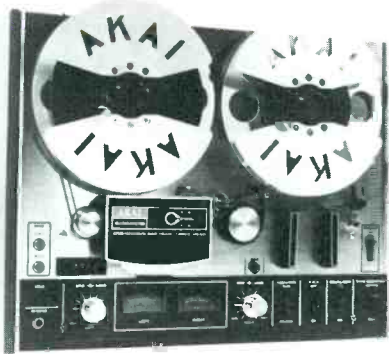

Akai 4000D Tape Deck

This is a 3-head machine offering sound-on-sound, sound *with* sound, automatic shut-off, tape monitor switch and expanded scale VU meters. A single motor is used and there is provision for low-noise tapes which extend the upper frequency response to 22 kHz \pm 3 dB at 7½ ips. Signal to noise ratio is quoted as better than 48 dB, and wow and flutter less than 0.2% at 3¾ and 0.15% at 7½ ips. Price \$264.95.

Check No. 107 on Reader Service Card

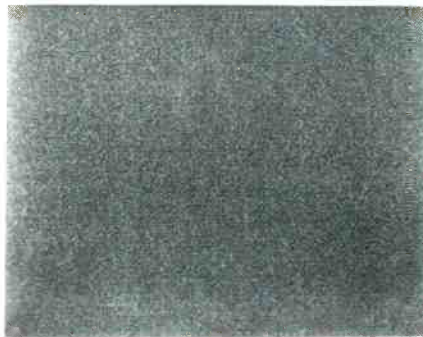

Mellotone "Change-a-Grille" Packages

As the name indicates, the Package consists of acoustic fabric pre-mounted on a perforated baffle board. This is easy to cut with household shears and simply fixed with self-stick tape—which is included. A large range of decorative weaves is available. Price: \$4.95 (18 by 24 inches).

Check No. 108 on Reader Service Card

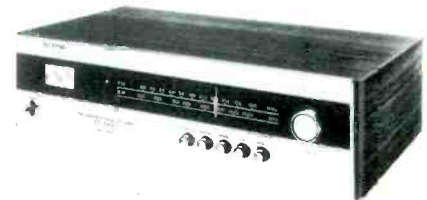

Sony ST-5055 AM/FM Tuner

This tuner features a FET front-end, IC if stage, balanced diode limiters and an IC multiplex section. A capture ratio of 1 dB is claimed and a 4 μ V signal gives 50 dB signal to noise. The dial scale is a 'black-out' type with linear calibrations and the pointer is illuminated. Price: \$159.50, with walnut finish cabinet.

Check No. 109 on Reader Service Card

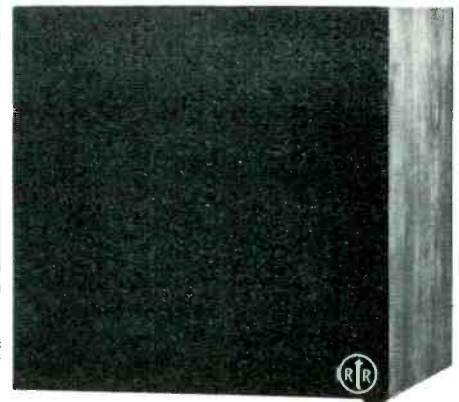

Electrostatic Speaker

RTR Industries have long been making electrostatic units for several manufacturers but have recently decided to market their own systems. Model ESR-6 is a six-element unit incorporating a crossover and power supply and can be used with any good quality dynamic bass unit having a smooth response up to 1500 Hz. Dispersion is 30 degrees in the vertical direction, 70 horizontal and dis-radiation is di-polar. A protection circuit is incorporated. Size 14½ by 14½ by 12 inches wide. Price: \$149.00.

Check No. 110 on Reader Service Card

SONY® 6650:

Two great channels for now. Two more whenever you're ready.



If you're thinking of buying a stereo receiver, why not spend a few extra dollars today and get the receiver that will take care of your tomorrow. The SONY 6650 is a superb stereo receiver with four channels for the time when you're ready to buy two more speakers to move into quadraphonic.

Every facility you'll ever need is built in. AM and FM stereo. Everything for all of today's 4-channel entertainment. Four-channel decoding circuits for SQ, and all the

other matrix systems. And, simplified controls including 4 VU meters to balance your system.

Just plug in a turntable, connect four speakers and you're ready to enjoy 4-channel sound, from discs or tape (with quadrasonic player deck). Or derived 4-channel sound from stereo broadcasts and recordings.

Here's just one example of some of the highly sophisticated electronics involved to make all of these good things possible: a

Double-Stacked Differential circuit that can go from 32 watts (RMS at 8 ohms) in 4-channel to a hefty 50 watts (25+25W RMS) in stereo. At the flip of a switch!

The SQR-6650. It costs a few dollars more than a stereo-only receiver. It delivers great stereo today. And it's ready for quadraphonic anytime you are. Hear it at your Sony high fidelity dealer. Sony Corporation of America, 47-47 Van Dam St., Long Island City, New York 11101.

Sony SQR-6650. The now and future sound.

Check No. 6 on Reader Service Card

Editor's Review

The first mention of quadraphonic headphones appeared as long ago as June 1970 (in Audio where else?) and it was in the form of an article by Jon Fixler describing a patent. Well, as we expected, it provoked a very mixed response. We had numerous comments about "people with four ears"—that kind of thing, but we also had inquiries from recording engineers and prospective manufacturers. The engineers were concerned about the difficulty of monitoring 4-channel material—headphones are essential for studio use of course. A few weeks ago, we began collecting quadraphonic headphones for a survey or progress report, and we ended up with 12 pairs—and more on the way! These have been carefully checked with all kinds of program material—matrix and discrete tape—as well as pulse, square waves and so on. I believe many people will be surprised at our findings. Mr. McProud is now testing them for isolation, frequency response etc., and the full report will appear in our June issue.

Audio Recording Workshop

Brigham Young University are having a recording technology workshop from June 25 to August 16. There are two courses, one for those already in the recording field who want to know and understand more and the other designed for students who have some technical knowledge. Details can be obtained from Division of Continuing Education, Brigham Young University, 242 Herald Clark Building, Provo, Utah 84601.

Boston Audio Society

This society has more than 80 members and it publishes a monthly newsletter which pulls no punches. An extract from a recent issue is included with our survey of open reel tapes on page 21. Details of this go-ahead society can be had from Alvin Foster, Kenmore Square 7, Boston, Mass. 02215.

The articles on loudspeaker dispersion in our March issue produced some interesting reactions. Some readers said they were too biased in favor of omni-directional systems, some thought they were prejudiced *against* omni-directional, while others maintained that a better case should have been made for a compromise wide-angle dispersion. All liked the idea of publishing various

opinions and I am sure the majority of readers want to read all sides. So we will continue to print controversial articles and let the stones fall where they may.

*And differing judgements serve but to declare
That truth lies somewhere, if we knew but where.*

Books

I am often asked what books can be recommended to beginners. So here are a few that have our endorsement, so to speak. *Understanding High Fidelity* by Martin Clifford, Drake Publishers Inc., \$5.95. Martin needs no introduction to our readers and his book is written for the absolute novice. *Selecting and Improving Your Hi-Fi System*, by Harvey Swearer. Tab Books, \$7.95. This one is also written in non-technical language and contains a glossary. The next one is intended for the man (or woman) with some technical knowledge and is written from the British point of view. It is none the worse for that and needs little translation. (Said he, tongue-in-cheek.) Distributors are Transatlantic Arts Inc., North Village Green, Levittown, New York 11754 and the price is \$8.75. *Hi-Fi in the Home* also hails from Britain and it was written by John Crabbe. Published in 1971 it is still one of the most comprehensive books on the subject. Distributors are Transatlantic Arts and the price is \$9.16. (TA must have used a slide-rule!)

And now two books for those with more technical knowledge. The first is *Trouble-Shooting Solid-State Amplifiers* by Ben Gaddis which deals with transistor theory and practice. The second is *How to Repair Musical Instrument Amplifiers* by Byron Wels. The author writes in a most entertaining way and his book deals with a wide variety of things ranging from amplifiers to electronic organs and guitars to tone generators. He even tells you how to re-cover speaker cabinets! Both books are published by TAB, the first costing \$4.95 and the second \$5.95—and well worth it.

Humor in Advertising

From a loudspeaker ad in the British "Hi-Fi News" ". . . It subjectively results in the bass staying within the box rather than generating pressure waves around the listening room."

Stanton quality is a very special quality... in headphones too.

Stanton headsets—all of them—are designed just like a fine loud-speaker system for your head. Yet there are many different models because we know there are many needs and tastes to satisfy.

Although there is a great variety of features and price ranges, two things are constant in all Stanton headsets—their exciting “presence” and their equally exciting sense of styling that makes them the handsomest headsets a head ever wore.

At the top of the Stanton Dynaphase dynamic headset line, our marvelous Dynaphase Seventy-Five (\$74.95) reigns supreme. It employs a true two-way system (separate woofer and tweeter) and an L-C crossover network

in each earpiece, plus a remote control station for volume and tone adjustment, as well as stereo and mono mode selection.

This same exceptional system is offered in the Stanton Dynaphase Model Sixty (\$59.95) without remote control station. You can always add this unit as an accessory (Model 5741, \$19.95) at a later date.

Three other Dynaphase mod-

els feature a special high performance, Stanton wide-range single-speaker system at a popular price—Model Forty and Model Forty 600 ohm and Model Fifty with balance level controls on each earpiece (\$49.95).

And for the devotee of quadraphonic sound, Stanton offers the brand, new Dynaphase Sixty-Five Four C—perfect for reception of both discrete and matrix derived compatible systems (\$64.95).

See your Stanton franchised dealer or write Stanton Magnetics, Inc., Terminal Drive, Plainview, L.I., N.Y. 11803.



Manufacturers of the world famous Stanton calibration and professional broadcast cartridges.

Check No. 7 on Reader Service Card

Be sure
to attend . . .

THE AUDIO ENGINEERING SOCIETY'S

45th Technical
Meeting and
Exhibition of
Professional
Equipment
at the
Los Angeles
Hilton
May 15-18, 1973

For details, write or phone:

AUDIO ENGINEERING SOCIETY

60 E. 42nd St., N.Y., N.Y.

10016 • Phone: 661-8528 . . . or

AES PROGRAM INFORMATION

124 E. 40th St., N.Y., N.Y.

10016 • Phone: 661-2355

WEST COAST: (213) 363-5111

Behind The Scenes



Bert Whyte

The Japanese don't do things by halves . . . they work very hard . . . and they play very hard. And their hospitality is indeed, legendary. After four hectic but enjoyable days in Japan, the 18 audio journalists who were the guests of Matsushita Electric Industrial Co. (Panasonic) and Victor Company of Japan (JVC), can attest to the validity of these statements. I was privileged to be a member of this group, who was invited to Japan for a week-long symposium on the CD-4 discrete quadraphonic disc. Last month I detailed some of the editorial group experiences in various JVC facilities in Tokyo and in Matsushita installations in Osaka. Now I will describe the second half of this fascinating trip.

After the welcoming luncheon at the Matsushita head offices, we were to inspect the company's radio and stereo factories. Now you talk about organization . . . as our bus arrived in the courtyards of these facilities, the road to the main entrances were lined on both sides with company employees . . . the men wearing blue blazers, the girls in white smocks, all madly waving blue and white Panasonic flags and shouting a lusty welcome! The radio factory manufactures a great variety of models and is said to have the largest annual production of radios in the world. The stereo factory makes receivers and integrated amplifiers, as well as consoles and compact systems. Both factories are models of efficiency and cleanliness. There is much automation, but mostly contributory to the long lines of white-clad girls sitting at their benches working on various sub-assemblies. One of Panasonic's big advantages in these mass-output type of operations is that they manufacture many of the parts, including transistors

and IC's (although not in the same factories) so they rarely have supply problems.

With the conclusion of these factory inspections, the technical phase of our visit to Matsushita in Osaka was over and our hosts were arranging fun and games and a bit of touring. That evening our group and about 20 or so Matsushita executives went to the Yamatoya restaurant, a traditional Japanese establishment. In a huge, exquisitely decorated private dining room, we were given a special Japanese dinner with our own personal geisha girls serving. I am sure our sophisticated readers know there are no sexual connotations whatever with geisha girls. They are meant to be decorative (which many are), and spend long years of highly disciplined training to achieve an ultimate refinement in social graces. One incredible example . . . I was served some beautiful red Emperor grapes and my geisha asked me (in her more than passable English) if I wanted some. When I said yes, she picked out a grape, *peeled it*, then picked up a small silver fork, *removed the seeds*, and put the grape in my mouth!! Are you listening American wives? After the dinner, the geishas presented their highly-stylized ritualistic dancing, with however, a surprising finale in which all the geishas stood on their heads!

The next day, Nov. 23, was Thanksgiving day in America, and by sheer happenstance was a somewhat similar holiday in Japan. Thus when we were driven from Osaka to Kyoto, the ancient capital of Japan, with its many lovely temples and shrines, we had a chance to observe the customs of Japanese families on a typical outing. Needless to say, our audio group burned up a lot of film in this photographer's paradise. The Gold Pavillion and the

FOR THOSE THAT CAN UNDERSTAND IT, THE SECRET OF EPI'S LINEAR SOUND:

Most people would have neither the understanding nor the inclination to read an ad like this.

But that doesn't make it a waste of our money. Because the few people that *would* read it are, by definition, the best prospects for our EPI loudspeakers.

The subject is linearity.

On a frequency response graph, an EPI speaker records a remarkably linear curve, measured from both on-axis and off-axis (60°) positions.

Why is that?

It has a lot to do with the kind of tweeter that goes into an EPI speaker.

EPI'S 1-INCH "AIR SPRING" TWEETER.

If you've never heard of an "air spring" tweeter, there's a very good reason for that: We made the name up.

We had to. EPI's tweeter is unlike any other made.

Our air spring tweeter has a concave diaphragm which is driven around its full circumference by a 1-inch voice coil. This is coupled with a 14,000-gauss magnetic field contained in a 9-ounce, permanently charged magnet and suspended in a conically-structured, air-sealed acoustic chamber, designed to create an equi-dispersed recoil effect.

The 1-inch diameter permits

radiation of a nearly perfect hemispherical sound pattern throughout the tweeter's entire frequency range, from 1800 to 18,000hz ± 3 db. And as

Stereo Review Magazine points out, wide dispersion at all levels is the major factor separating an excellent speaker from a merely good one. (*Stereo Review* placed our EPI 400 in the "superb" category.)

So, now that you know the secret of EPI's Linear Sound, all you need to know is where it comes from:

Out of eight great speakers, from \$55 to \$1000, made only by Epicure Products Inc., Newburyport, Mass. 01950.

**THE LINEAR SOUND
OF EPI.** 



Check No. 8 on Reader Service Card

Kinkakuji Temple are really spectacularly beautiful. I am one of those die-hards who still take stereo slides (Ed Canby is another) and all those temples were just made to order for this medium.

After lunch, we left Kyoto for Odawara-Hakone, which is the area for Mt. Fuji. We traveled on one of the famous Japanese "bullet" trains, and it was quite an experience sitting in a comfortable aircraft-type seat and whizzing along at 125 mph. In Hakone, well up in the mountain country, we stayed in the sprawling, multi-level

Fujiya Hotel. Just one year shy of being one hundred years old, it was built as a hunting lodge for the imperial visit of the Russian Crown Prince in 1871. (He never came and they had a war instead.) What a place! My bathroom was bigger than the average rooms in American hotels. Lovely grounds, with pools full of huge fat pink and white Japanese goldfish. No Thanksgiving turkey in the dining room that night, but there was fresh Malossol caviar, and brook trout, followed by Kobe beefsteak (this is from cattle

which are raised just outside Kobe and are given rations of beer and are massaged by hand daily) washed down with a good Pommard. Not too bad a substitute for the traditional bird!

The next morning by a combination of a boat trip across Lake Hakone and a drive higher into the mountains, we reached the overlook for Mt. Fuji. Fortunately for us the weather had turned very cold and there were high winds, so that the cloud cover that usually obscures Mt. Fuji had blown away, affording us a really clear view of the magnificent snow-covered cone. As you can imagine, there was much posing and photographing by our press group against the instantly recognizable backdrop of Mt. Fuji. Later on we were driven the 60-odd miles to Tokyo, and that evening we had dinner in a restaurant perched on the 39th floor of the World Trade Center Building.

I hope you will forgive this little travelog I have presented in the last few paragraphs, but I thought it might give you something of the flavor of this diverse land. It is also in appreciation of the fact that although our hosts thoroughly immersed us in, and impressed us with their technology, they did not overlook social and aesthetic considerations.

On Saturday, the audio editorial group, by this time a bit weary, assembled for their last "official" day in Tokyo. We were taken to the Akihabara area of the city where there is a concentration of over 400 stores selling hi-fi and other electronic equipment.

AN INVESTMENT IN SOUND...

When you buy a Frazier speaker, you've made a sound investment. And with any good investment, you expect a good return.

Your return with a Frazier speaker is in unequalled sound. Whether it be from the handsome Mark VI with its 12 inch woofer, 8 inch mid-range speaker and compression horn tweeter... or the Super Midget... efficiency

such that only 1/2 watt of power or less is required for your listening pleasure... with every Frazier speaker you'll be assured of a product that has earned a reputation for excellence during its 30 years in the business.

With a Frazier speaker, you'll make an investment in sound that has a fantastic return.

FRAZIER
INCORPORATED

1930 Valley View Lane
Dallas, Texas 75234
Phone 214-241-3441

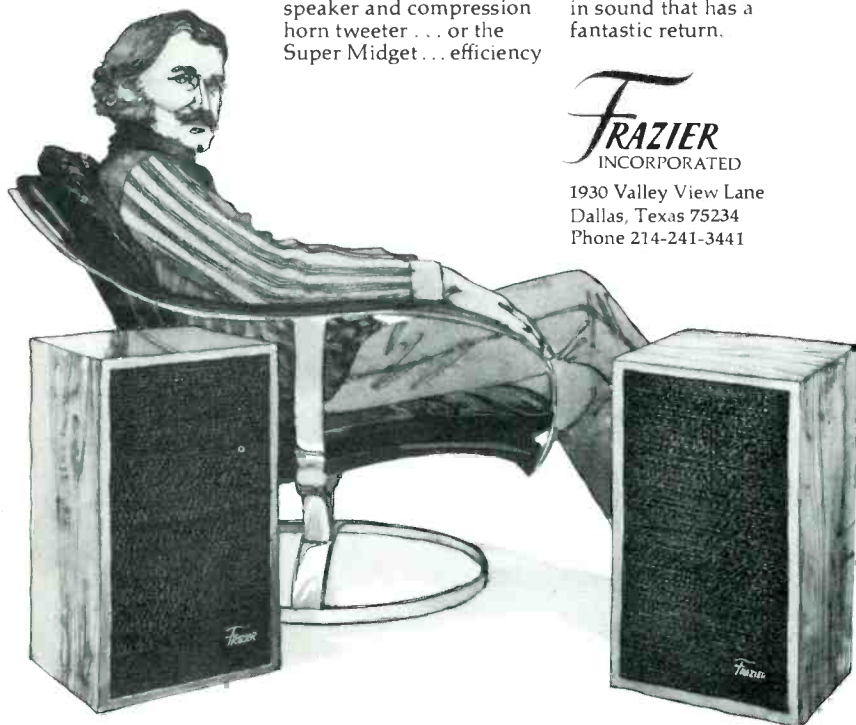

Check No. 20 on Reader Service Card



The area had roughly the character of the old Courtlandt St. hi-fi market in New York, but on a much larger scale. One of the most unusual sights for this New Yorker, was that many of the stores had "browser bins" on the sidewalk in front of them, full of blank and

(Continued on page 60)

All quadraphonic systems are not created equal... Sansui has created the QS vario matrix.

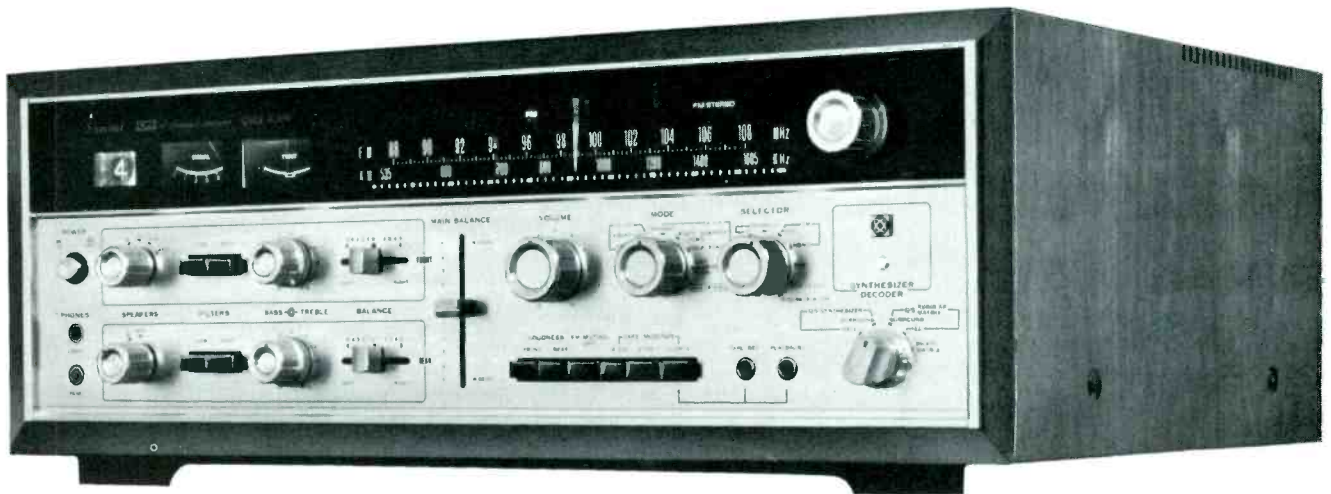

QRX-6500

Here at last is the development that once and for all will lay to rest the dispute over discrete vs. encoded recordings. The Sansui vario matrix—a technological extension of the QS Regular Matrix—provides unbelievable front-to-back separation, to a degree never before possible with matrix recordings—separation so great that engineers have hailed it as the “discrete matrix.”

Two new units in the Sansui four-channel lineup—the QRX-6500 and the QRX-4500 contain this outstanding new decoder. These full-featured four-channel receivers have high power output (280 watts and 240 watts IHF), superb FM sensitivity, and are loaded with special features to make quadraphonic listening a totally trouble-free and fulfilling experience.

The new decoder includes a position for Phase Matrix recordings, and both “Hall” and “Surround” positions for the QS Regular Matrix and for the synthesizer section, for accurate decoding of any current matrix as well as creating enhanced 4-channel sound from two-channel recordings.

Other special features include a sound-field rotation switch, linear balance controls for front/rear and for left/right, and the capability to drive up to 10 speakers—all front-panel switch-selected.

Treat your ears to a demonstration today at your nearest Sansui dealer. Your listening will never be the same again.



QRX-4500



SANSUI ELECTRONICS CORP.

Woodside, New York 11377 • Gardena, California 90247
ELECTRONIC DISTRIBUTORS, Canada,

SANSUI ELECTRIC CO., LTD., Tokyo, Japan • Sansui Audio Europe S. A., Antwerp, Belgium

Check No. 17 on Reader Service Card

tape

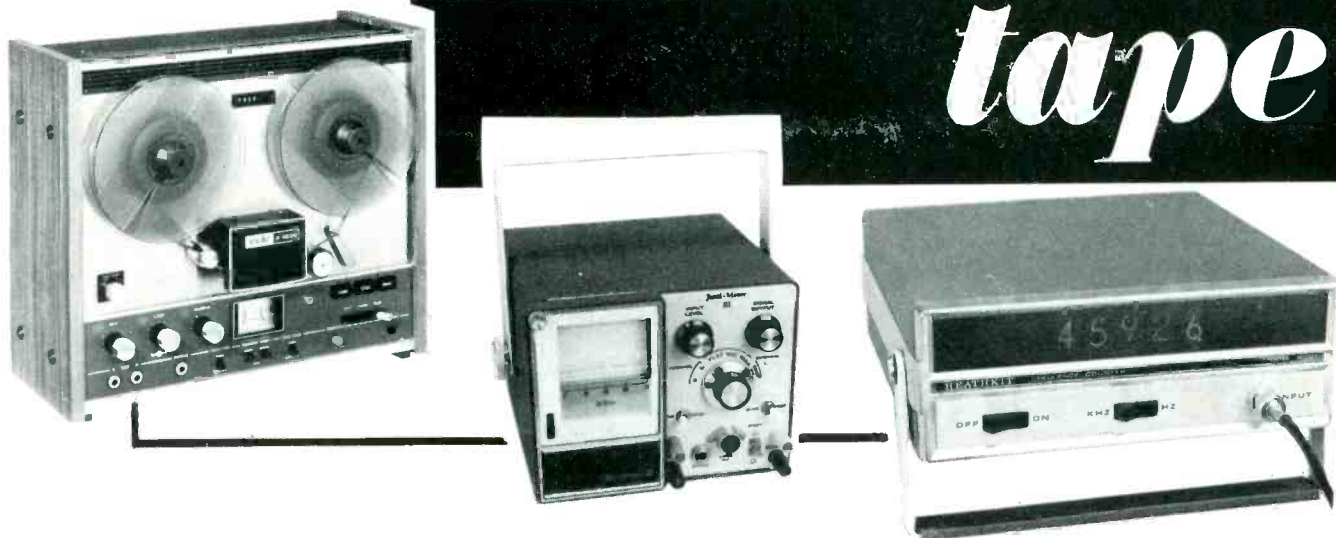

I suppose few products in the Hi Fi world (with the exception of loudspeakers) are advertised with such exuberance as magnetic tape. Each manufacturer proclaims that his tape is the absolute best with the lowest noise, highest output and widest frequency response. New coating materials and improved formulations are launched almost every month with fanfares of publicity. And so we have Low Noise, Ultra-Dynamic, Super Dynamic, High Efficiency, Low-Noise-High Output and dozens of other permutations—no wonder many people are confused and a little skeptical!

Tape recording parameters are very much of a compromise with bias, equalization and output adjusted for frequency response, noise and distortion—all conflicting requirements. For example, a high value of bias might well reduce distortion at mid-frequencies but at the cost of a lower output above 10 kHz or so. Thus a tape with a rising frequency response, a characteristic of the new formulations, will help matters considerably. Figure 1 shows what happens when a Low Noise tape is played on a recorder matched to a normal tape. It will be seen that the response rises from about 3 kHz. If the amplifier treble control is turned down to get a more or less flat response, the inherent noise will be reduced too. Present day recorders are fitted with a switch—usually labeled Normal and High to cope with these LN tapes by changing the bias and equalization and the net result is a reduction of noise by some 4 dB—plus an extended high frequency response. Machines are matched for one particular tape at the factory and the first objective of our survey was to determine how the tape characteristics varied. These tests were made with a TEAC 1230, a medium priced deck, selected for its high overall performance and because of the accessibility of the bias adjustments. First, it was carefully matched for Scotch 207 tape so the response was within 0.5 dB up to 20 kHz and then the other tapes were checked, without changing the bias. Frequency runs were made from 1 kHz to 20 kHz with a recording level of -20 VU. Levels were adjusted to 0 dB at 1 kHz and the results tabulated for three frequencies, 10 kHz, 15 kHz and 20 kHz as shown in the chart. Variations at 15 kHz ranged from -4.5 dB for the Dak to +3.1 dB for the Maxell UD. In theory, tapes with the highest increase would have the best signal-to-noise potential but this is also dependent on sensitivity and other factors.

For the next series of tests, the recorder was adjusted to suit each individual tape, using only the bias control and frequency responses taken at the standard input level of -20 VU. Equalization was unchanged and only the bias was

adjusted—not too difficult to do with most recorders. Results are shown in the graphs. The response below 1 kHz is not shown as the low frequency deviations were insignificant. Then the measurements were repeated at a higher signal level—0 VU, a drastic test which shows the effect of tape saturation or maximum capacity. This has long been a limiting factor on obtaining good transient reproduction and it is also why it is still standard practice to measure recorders at the 20 VU level. Obviously this cannot give a true indication of performance and in the future our tests of recorders will be made at the higher signal level. It will be noticed that all the tapes show some falling off above 15 kHz but even the worst has more 'headroom' than the best tapes of a few years ago.

Distortion was measured at 0 VU and +3 VU at 1 kHz and signal-to-noise computed. The standard 3% distortion level was used and the ASA weighting employed. It was felt that this method gives a truer indication as the curves are based on human hearing characteristics and it also reduces the effects of low frequency preamplifier noise. (See figure 2). The figures *do* include some residual electronic noise—note also that a half-track machine would give a further 3 dB improvement. Finally, output at 0 VU input (1 kHz) was measured using 0 dB with the Scotch 207 as a reference.

Dropouts

Dropouts, not the scholastic kind, can be caused by minute imperfections in the tape which push it away from the

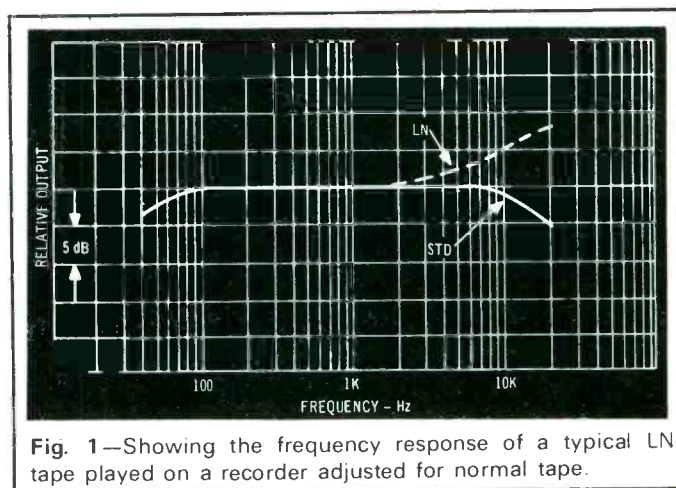
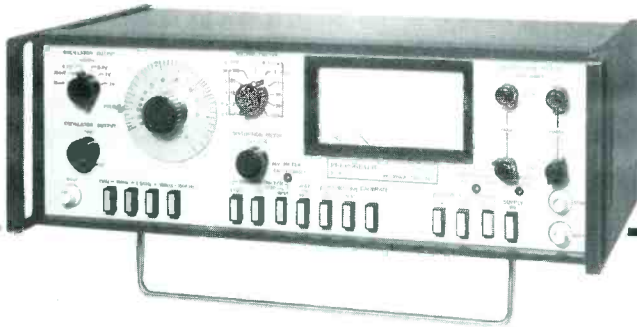

Fig. 1—Showing the frequency response of a typical LN tape played on a recorder adjusted for normal tape.

Survey



head. The effects are more audible at high frequencies and tape speed plays a part too. A dropout might pass unnoticed at 7½ ips but sound horrendous at 1⅞ ips. And so they are more noticeable on cassette machines where mechanical difficulties compound the problem.

The usual method of assessing dropouts is to record a high-frequency signal on the tape for 3 to 15 minutes, then playing back and watching the variations on an output meter. This is tedious and seems a little crude and so work is proceeding on an automatic counter detector (we are just lazy, that's all). In the meantime, the 15 tapes were checked using the first method and all were found satisfactory.

As far as open reel is concerned, we had long thought the dropout problem (when it was not due to pressure pads) was due to bad handling and some tests made by the Boston Audio Society seem to confirm this opinion. These tests were made by Alvin Foster who writes in the BAS publication. "Dropout is particularly severe in the first and last feet of most open reel tapes due mainly to the mistreatment that these sections endure in the normal loading and unloading of the tape. This is the reason why some manufacturers include a few feet of leader tape and why tape recording perfectionists never record a signal on the first or last few feet of tape. . . . I was surprised to find such noticeable deterioration between new and slightly used tapes and was convinced that careful handling of tape is a prerequisite to good recording. Even the type of reel one used affected dropout.

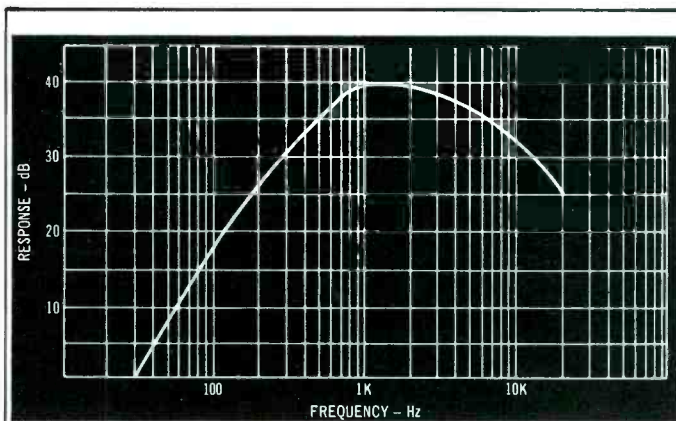

Fig. 2—ASA weighting characteristics.

Take up reels which cover the tape with only one or two small holes for threading protect it because the larger plastic area covering the tape inhibits pinching or creasing of tape as the reel is handled. The pressures exerted when handling the reel of tape are distributed more evenly over the tape edges."

We would add that the back coatings used by Scotch and Capitol are definitely a step in the right direction as they not only tend to improve traction but strengthen the tape as well.

What *do* the tests show? In brief, they confirm that the new generation of tapes, Low-Noise, Super-Dynamic or whatever, do give a worthwhile improvement; moreover, signal-to-noise is so good that you can record at a lower level and avoid the risk of peak overloading. But the divergencies mean that the recorder must be adjusted to suit. That is, if you want the best results—and who doesn't.

Next month, we compare cassette tapes.

TAPE	10 kHz	15 kHz	20 kHz
Agfa P36	0	0	-1
Ampex LNP	+0.5	+0.3	0
BASF LP 35	+1.8	+2.0	+2.0
Capitol 2	+2.0	+3.0	+3.0
Dak LNE	-2.0	-4.5	-7.0
Irish 274	+1.5	+1.8	+1.8
Maxell LNE35-7	+1.7	+1.7	+1.0
Maxell UD50-7	+2.5	+3.1	+3.6
Memorex	+1.0	0	-0.5
Scotch 207	0	0	+0.5
Scotch 228	+1.0	+0.3	+0.5
Sony SLH 180	+2.5	+2.5	+2.0
TDK 7	0	-1.0	-1.6
TDK SD	+2.0	+2.2	+2.3
Tracs Plus	0	-1.0	-2.0

Table 1—Frequency responses compared with Scotch 207

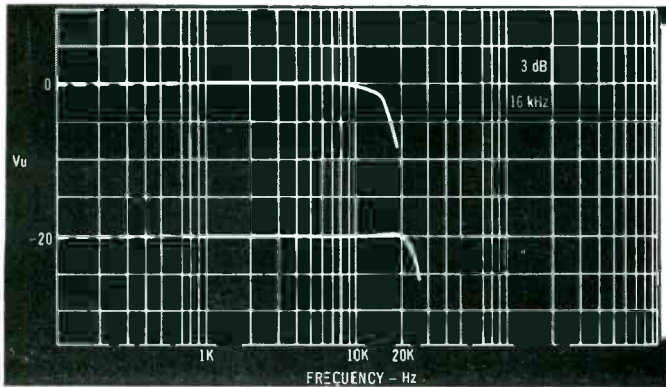

Agfa PE 36

1 mil polyester, plastic case, leader tape. Output +1 dB, signal/noise 67 dB. Distortion 0 VU 1.1%, +3 VU 2.5%.

Ampex LNP

1 mil polyester, plastic case, no leader tape. Output 0 dB, signal/noise 67 dB. Distortion 0 VU 0.95%, +3 VU 2.8%. Frequency response nearly identical to Scotch 207.

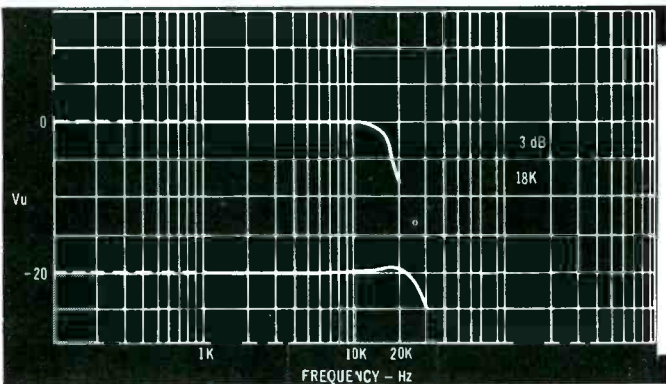
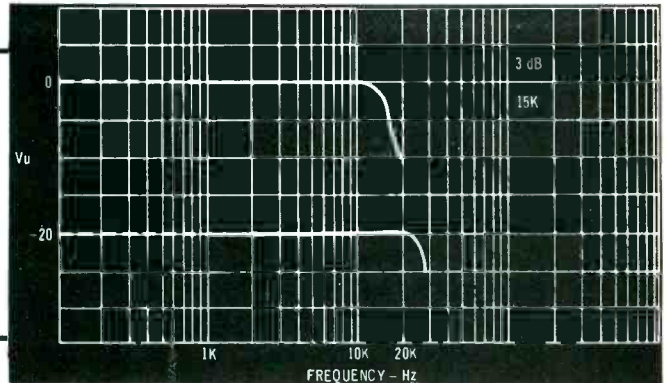

BASF LP 35

1 mil polyester, plastic case, leader tape. Output +0.5 dB, signal/noise 69.5 dB. Distortion 0 VU 0.6%, +3 VU 1.1%. Low distortion with good headroom.

Capitol 2

1.5 mil polyester, plastic case, no leader tape. Output 0 dB, signal/noise 68 dB. Distortion 0 VU 0.75%, +3 VU 2.0%. "Cushion-aire" back coating.

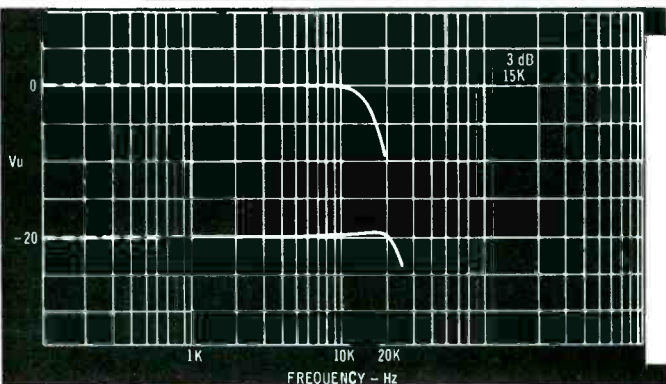
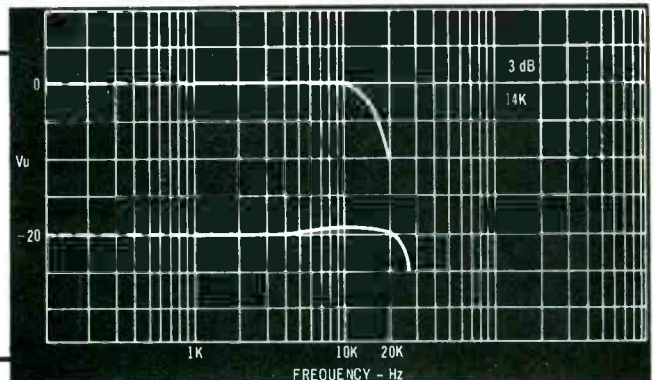

Dak Low Noise

1 mil polyester, cardboard box, no leader tape. Output +0.5 dB, signal/noise 62 dB. Distortion 0 VU 1.2%, 0 VU 3.2%. An inexpensive tape with excellent frequency response, good headroom but with slightly inferior signal/noise.



It took a lot of guts to build 4 great receivers

Take a look at AKAI's exciting new 900 Series stereo receivers. They're beautiful, right? Complete with rosewood cabinets to enhance their styling.

But it takes more than beauty to make a truly great stereo receiver. It takes guts!

Because it's what's inside your receiver that determines performance. And for innovative engineering where it counts, AKAI leads the way.

You can choose from four new

receivers. All great performers. At a price that's right for you.

The 910 delivers a power level sufficient for any need. With a wide frequency response and low distortion.

And if you want to add Dolby,® you'll find it in the 910D.

Our new 930 offers separate signal and tuning indicators. Plus Sound Monitoring. And 122W IHF total music power.

For peak performance there's the 940. Delivers 180W total music power... sensitivity of 1.7 μ V... frequency response of 5 to 80,000 Hz... and IM distortion of 0.05% at rated output. What's more, Sound Dubbing Controls allow you to monitor from two separate decks.

Which all adds up to four great reasons to see your AKAI dealer. He'll show you what guts are all about.

"Dolby" is a trademark of Dolby Laboratories, Inc.

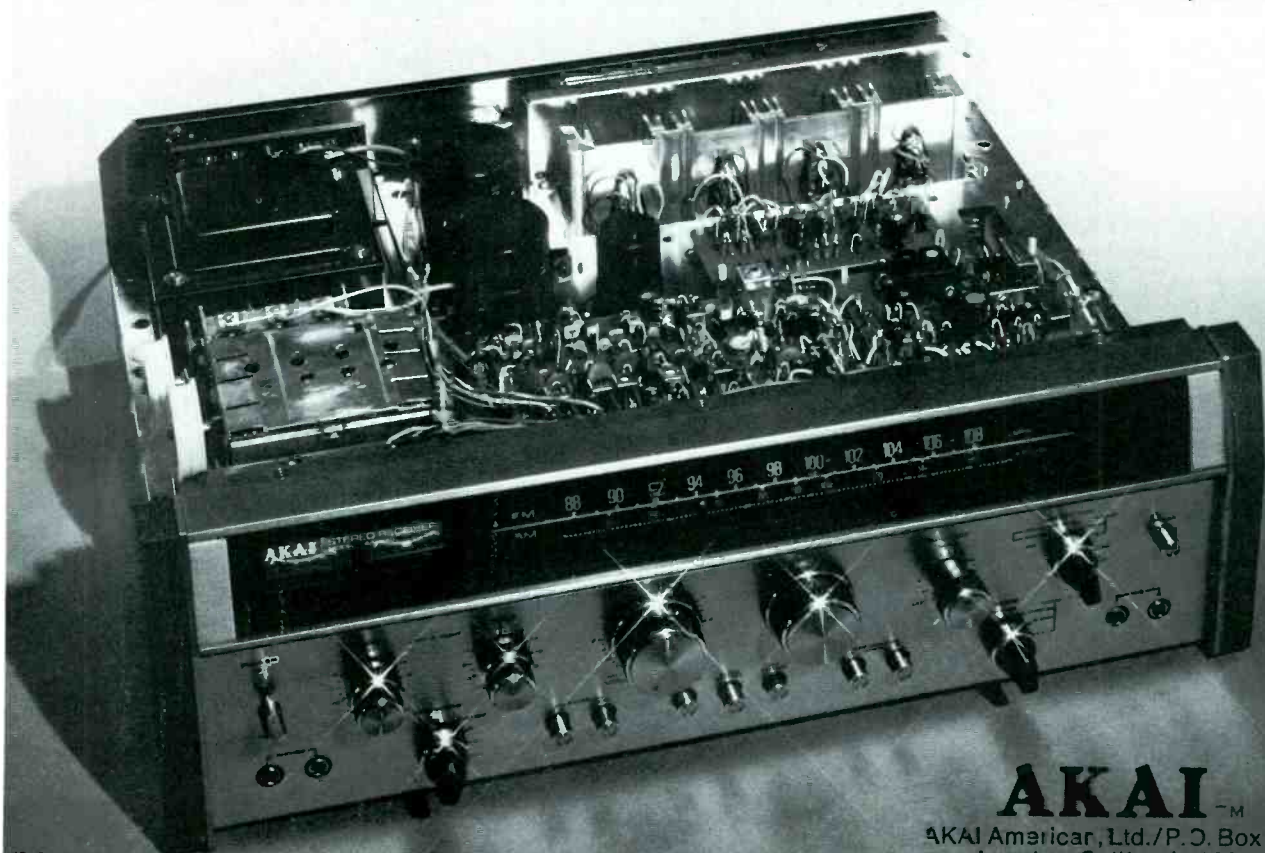

AKAI™

AKAI America, Ltd./P.O. Box 55055,
Los Angeles, California 90055

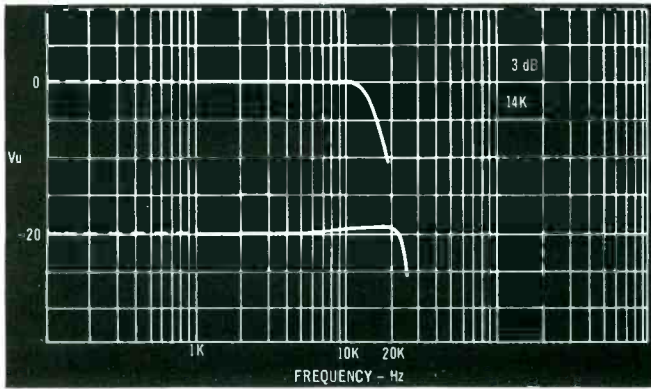

Irish 274

1 mil polyester, cardboard box, leader tape. Output -2 dB, signal/noise 68 dB. Distortion 0 VU 0.6%, +3 VU 2.1%.

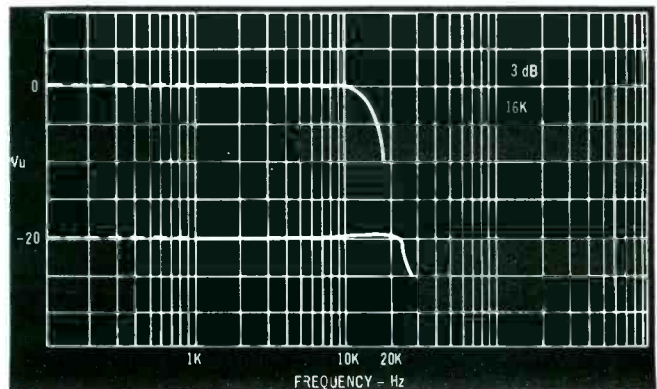

Memorex LN 40

1 mil polyester, plastic case, leader tape. Output -0.5 dB, signal/noise 67 dB. Distortion 0 VU 0.7%, +3 VU 2.8%. Rear coating. Bias requirements similar to Scotch 207.

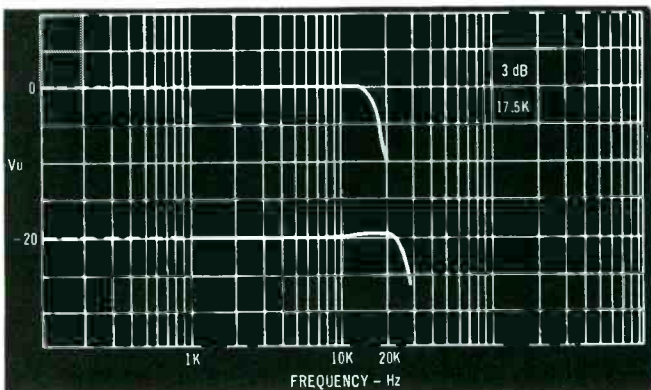

Maxell LNE 35-7

1 mil polyester, leader tape. Output 0 dB, signal/noise 70.5 dB. Distortion 0 VU 0.65%, +3 VU 1.6%. Excellent signal/noise and good headroom.

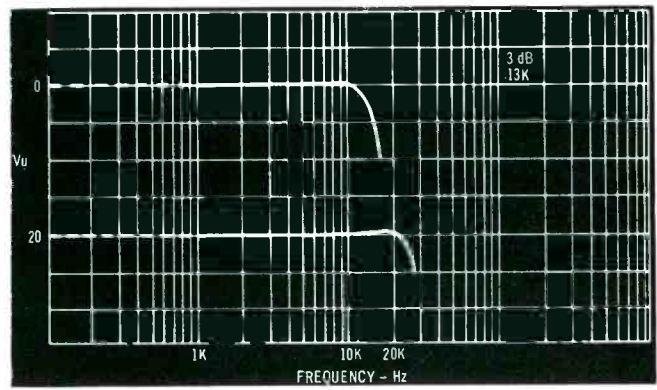

Scotch 207

1 mil polyester. Scotch 206 is similar but is 1.5 mil polyester. Output 0 dB signal/noise 68.5 dB. Distortion 0 VU 0.6%, +3 VU 1.6%. Rear coating.

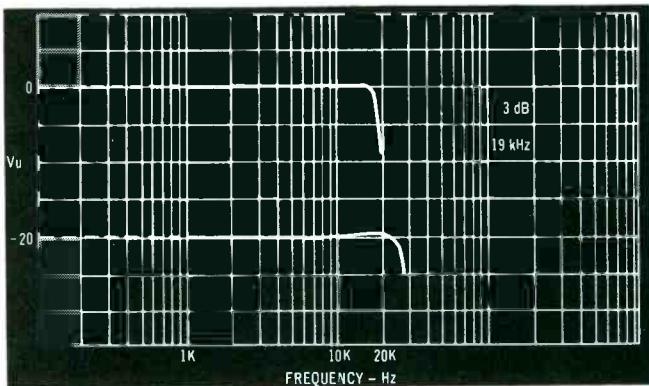

Maxell UD 50-7

1.5 mil polyester, cardboard box, leader tape. Output -0.5 dB, signal/noise 70.5 dB. Distortion 0 VU 0.7%, +3 VU 1.5%. Similar to LNE with greater headroom—one of the best.

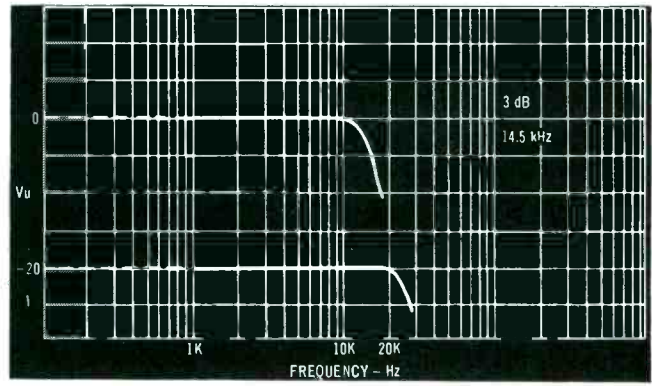

Scotch 228

1.5 mil polyester. Scotch 229 is similar but is 1 mil polyester. Cardboard box, leader tape. Output -1 dB, signal/noise 68 dB. Distortion 0 VU 0.9%, +3 VU 2.8%. One of the Highlander series—probably a best buy for those who like Scotch tapes but prefer to save money and do without the fancy plastic box!

Dynaco A-25
\$89.00

Experts Agree: the Dynaco A-25 loudspeaker is unquestionably the best!

"... (The Dynaco A-25's) are quite probably the best buy in high fidelity today."

The Stereophile Magazine

"... The Dynaco had a remarkably neutral quality... The A-25 had less of this coloration than most speakers we have heard, regardless of price... Nothing we have tested had a better overall transient response... Not the least of the A-25's attraction is its low price..."

Julian Hirsch in Stereo Review

"... it was its outstanding transient response which really impressed us. Tone bursts throughout the meaningful frequency range showed up its excellence. In truth, the A-25 produced the finest tone-burst response of any speaker in this manner, regardless of price."

Audio

dynaco inc. Division Tyco

3060 JEFFERSON ST., PHILADELPHIA, PA. 19121
Also available in Canada from Dynaco of Canada, Ltd.

Gentlemen:

Please send new 1973 full color catalog.

Name _____

Address _____

City _____ State _____ Zip _____

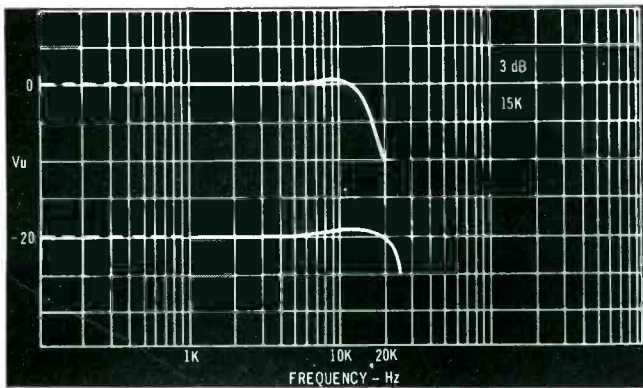

Sony SLH 180

1 mil polyester. Cardboard box, leader tape. Output -1 dB, signal/noise 69 dB. Distortion 0 VU 0.7%, +3 VU 1.9%.

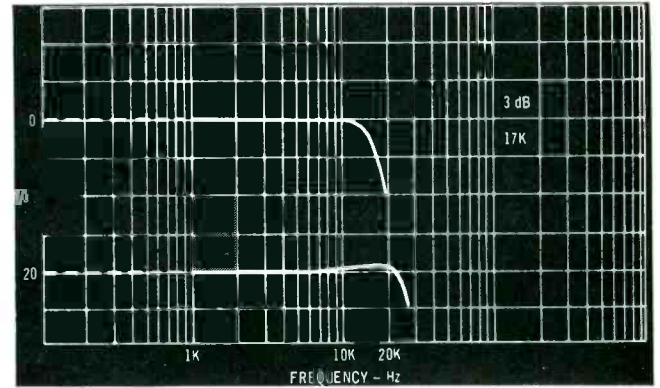

TDK SD

1 mil polyester. Plastic case, leader tape. Output +2 dB, signal/noise 70 dB. Distortion 0 VU 0.6%, +3 VU 1.6%. Similar to TDK 7, but greater headroom.

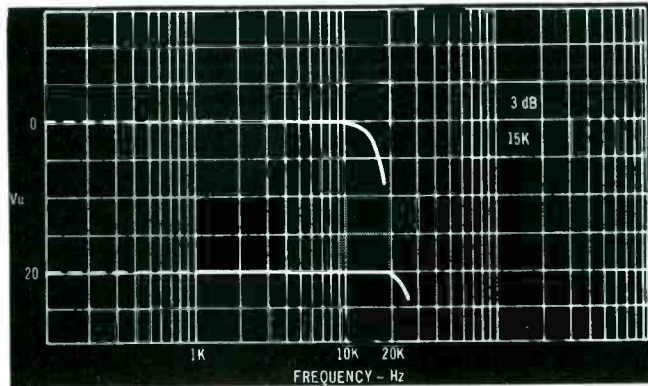

TDK 7

1 mil polyester. Plastic case, leader tape. Output +2 dB, signal/noise 70 dB. Distortion 0 VU 0.7%, +3 VU 1.6%. One of the highest outputs in the group tested.

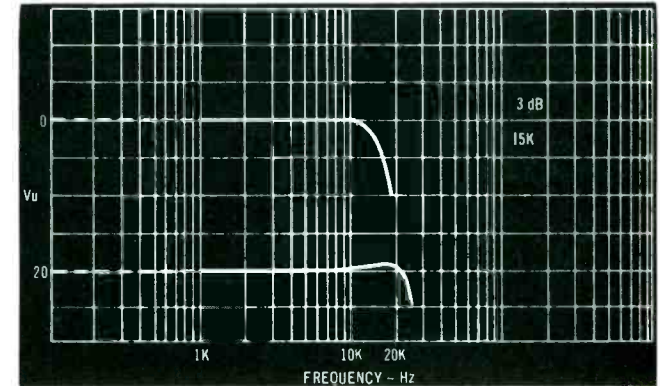

Tracs Plus

1.5 mil polyester. Plastic case, leader tape. Output 0 dB, signal/noise 68.5 dB. Distortion 0 VU 0.7%, +3 VU 1.8%. A new tape from Audio Magnetics.

Simple Volume Compressor

With medium-quality music reproducing systems, the details of very quiet recorded passages can only be heard by turning the gain control to a high value. However, louder passages will inevitably follow, also at the high gain. The listener's family or neighbors are often not so vitally interested in the music as to

enjoy the ensuing blasts. (The listener himself may not enjoy the ensuing counterblasts from the other people!)

To promote harmony of the interpersonal kind, a compressor is useful for limiting the louder passages to a maximum volume, while allowing the desired high gain for the softer passages.

A volume compressor can be obtained as a built-in part of at least one commercial amplifier [1], or it can be constructed at home according to the various plans described in previous articles [2,3,4]. These are sophisticated and complex circuits.

A very simple compressor is illustrated in Fig. 1. It does not perform as well as the more complicated circuits (for instance, it is not as fast), but most listeners will find it to be adequate. At the correct setting of the variable resistor, this circuit limits volume peaks without being an intrusive presence.

The main circuit element is a pilot lamp which acts as a nonlinear resistor. The effect is multiplied by making a differential comparison to a fixed resis-

tance, using a Wheatstone bridge design. The types of lamps should be chosen according to whether the speaker is efficient or inefficient. The values in Fig. 1 are for cases where less than 1 watt is dissipated in the speaker. This is as much as most people actually use with efficient systems. Less efficient speakers can be handled by a pair of type 222 bulbs instead of the combination shown. For people who can listen to several watts of actually-dissipated output, type 13 bulbs for three-cell flashlights can be used, instead.

One of the circuits shown is required for each stereo channel.

Daniel Shanefield

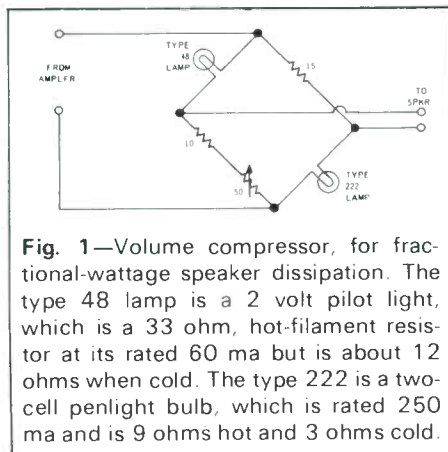

Fig. 1—Volume compressor, for fractional-wattage speaker dissipation. The type 48 lamp is a 2 volt pilot light, which is a 33 ohm, hot-filament resistor at its rated 60 ma but is about 12 ohms when cold. The type 222 is a two-cell penlight bulb, which is rated 250 ma and is 9 ohms hot and 3 ohms cold.

Present Address: Western Electric Co., Princeton, N.J. 08540

References

1. Bogen Model BR 360 Receiver, as listed in *Audio*, Sept. 1971, p. 34.
2. R. R. Russell, "Build a Hi-Fi Volume Compressor/Expander," *Popular Electronics*, Oct. 1964, p. 41.
3. J. C. Wright, "Audio-Compression Preampifier," *Electronics World*, Nov. 1964, p. 32.
4. S. S. Andrews, "Low-Cost High-Performance Volume Compressor," *Audio*, Dec. 1964, p. 19.
- (5) C. Caringella, "Distortionless Audio Compressor," *Popular Electronics*, December 1971, p. 25.

All in the family.

In the space of a few short years, the critically acclaimed Revox A77 has established itself as the tape recorder of choice for the knowledgeable enthusiast.

Now, from the same dedicated design team that created the Revox A77 come two new meticulously engineered components, an FM tuner and a stereo amplifier, that extend performance to the limits of current technology.

Take the Revox A76 FM stereo monitor tuner. With its incredibly sensitive front end, unique dual action IF strip, specially developed discriminator circuit and two regulated power supplies, the A76 represents an entirely new approach to FM signal processing.

In fact, the Revox A76 sets new performance standards in a half dozen different categories.

But simply quoting a list of specifications, however fine, doesn't begin to describe the capabilities of this remarkable instrument.

For what distinguishes the Revox A76 from all the rest is its uncanny ability to capture the weakest signals with a clarity and a freedom from noise that is truly startling.

As for the Revox A78 stereo amplifier, it does everything a superb amplifier should do. And it does it just a little better.

Together or separately these remarkable components are a fitting addition to the Revox family and provide further proof of what we've said all along...

Revox delivers what all the rest only promise.



A76 FM
Stereo Tuner

A77 Tape
Recorder

A78 Stereo
Amplifier

Revox Corporation

155 Michael Drive, Syosset, N.Y. 11791, Calif: 3637 Cahuenga Blvd. West, Hollywood 90068. Canada: Revox Sales and Service, Montreal

Check No. 13 on Reader Service Card

THE LANGUAGE OF HIGH FIDELITY

Martin Clifford

(Continued from MARCH)

Part X Record Players

The Phono Cartridge

The stylus fits into the cartridge, which, in turn, is mounted in a shell at the tip of the tonearm. As the stylus tracks in the rotating grooves, it is deflected laterally and vertically, depending on the modulations inscribed in the groove walls. In theory this sounds easy enough, but if the stylus is to track well, it must follow the complicated meanderings of the groove instantly and it must do so without bottoming (that is, without hitting the bottom of the grooves), without losing contact with the walls, yet not pressing unduly hard against them, and without jumping out of the grooves. Further, its contact or pressure must be the same against both walls—inner and outer—despite the fact that the very motion of the stylus makes such an equilibrium very difficult. To be able to do all this, the mass of the stylus and moving parts must be kept as little as possible, since the greater the moving mass, the greater its inertia—that is, the greater its resistance to quick changes in motion. And so the conditions for good tracking are quite difficult. But these aren't the only requirements. There must be a sufficient downward force, known as tracking force, on the stylus, to keep it in the grooves. Too much will cause stylus and records to wear out more quickly than necessary.

The stylus assembly must have freedom of movement—technically called trackability of compliance. The greater the compliance, the smaller the tracking force required. And since the stylus is going to wiggle around thousands of times a second as the record rotates beneath it, it becomes obvious that with high compliance we are permitting the stylus to do its job, to follow even the most delicate tracings in the groove walls.

In spec sheets you may find compliance listed for both dynamic and static conditions. Compliance is specified in terms of centimeters per dyne, usually written as cm/dyne. The cm figure

means the amount of deflection, in centimeters, that a force of 1 dyne upon the stylus will produce. The larger the figure the better. It also depends on the tracking force and should be at least 8×10^{-6} cm/dyne. 8×10^{-6} is just a scientific and easier way of writing 0.00008, and so a stylus with such a compliance will move 0.00008 centimeter when a force of 1 dyne is applied. The dyne is a unit of force, just as an inch is a unit of linear measurement, or an ounce is a unit of weight. A quality cartridge would have a compliance of 15 or 20×10^{-6} cm/dyne or possibly more, while the cheapies go down to around 3 to 5×10^{-6} cm/dyne. Dynamic compliance is usually measured at some spot frequency, possibly at 100 Hz.

Tonearm

No cartridge is an island unto itself, for it must form an integral part of the tonearm on which it is mounted. A cartridge can only deliver its full performance if it is joined with a tonearm of equally high quality. The tonearm's main function is to hold the cartridge in its path while it travels across the record, and to apply the necessary tracking force while compensating for other,

unwanted forces. Neither the stylus, the cartridge or tonearm must acquire delusions of grandeur, but since they are working under conditions in which vibration is the order of the day, it isn't too surprising to find that these elements would like to resonate. And they do and when they do they form sound sources of their own, contributing their mite to the overall sound. An unwanted mite for they form no part of the original sound source inscribed on the walls of the disc. The best thing to do with unwanted resonances is to kill them. If that isn't possible, attenuate them. And if that isn't possible, to try to make the resonant frequencies move down into a subaudible frequency.

Most high-quality tonearms are made of some lightweight metal alloy, supplying maximum structural strength with a minimum of weight and ease of machining. Tonearms in the past have taken on some fancy configurations, but most can be grouped into three types: the straight or I-shaped, J-shaped and S-shaped (Fig. 6). In each instance, though, the shell-cartridge assembly forms an angle with the tonearm axis. The arm axis is an imaginary line drawn between the tip of the stylus and the tonearm pivot. This angle is known as the offset angle and its purpose is to minimize the tonearm's tracking error. Tracking angle is the angle that the cartridge axis deviates from the record tangential at any given point on the record. The smaller the tracking error, the better. It should not exceed 2° to 3° .

Integrated Arms

On some economy type equipment the shell cannot be removed from the tonearm and so such units are known as integrated arms. Most modern tonearms, however, have standardized plug-in connections for the cartridge-shell assembly, so that all cartridges following these standards can be interchanged.

Problems of the Offset Angle

While the tonearm's correct offset

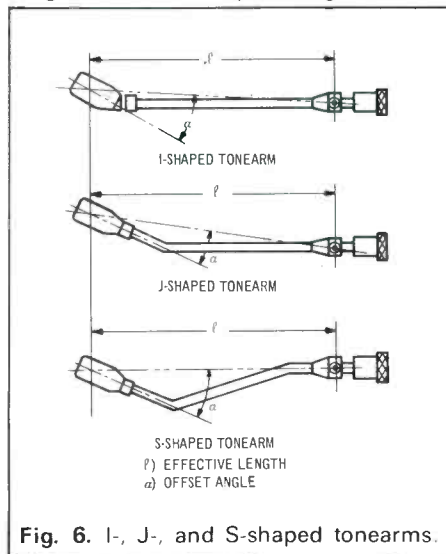

Fig. 6. I-, J-, and S-shaped tonearms.

The ADC-XLM "...in a class by itself."



That's the way Stereo Review described our XLM. High Fidelity headlined their review, "Superb new pickup from ADC" and went on to say, "...must be counted among the state of the art contenders." And Audio echoed them with, "The ADC-XLM appears to be state of the art."

With the critics so lavish in their praise of the XLM, there's hardly any necessity to add anything. Far better to let the experts continue to speak for us.

Frequency response The CBS STR-100 test record showed less than ± 1.5 dB variation up to 20,000 Hz. *Stereo Review*
...response is within ± 2 dB over the entire range. *Audio*
Frequency response is exceptionally flat. *High Fidelity*

Tracking This is the only cartridge we have seen that is really capable of tracking almost all stereo discs at 0.4 grams. *Stereo Review*
The XLM went through the usual torture test at 0.4 grams (some top models require more than a gram). *High Fidelity*
The XLM is capable of reproducing anything found on a phonograph record. *Audio*

Distortion Distortion readings ... are almost without exception better than those for any other model we've tested. *High Fidelity*

The XLM has remarkably low distortion in comparison with others. *Audio*
At 0.6 grams the distortion was low (under 1.5 per cent). *Stereo Review*

Hum and noise The XLM could be instrumental in lowering the input noise from the first stage of a modern transistor amplifier. *Audio*
The cartridge had very good shielding against induced hum. *Stereo Review*

Price This would be a very hard cartridge to surpass at any price. *Stereo Review*
We found it impossible to attribute superior sound to costlier competing models. *High Fidelity*
Priced as it is, it is a real bargain in cartridges. *Audio*

**The Pritchard High Definition
ADC-XLM \$50.**

Check No. 4 on Reader Service Card

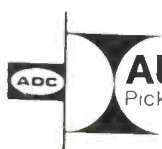

AUDIO DYNAMICS CORPORATION

Pickett District Road, New Milford, Connecticut 06776

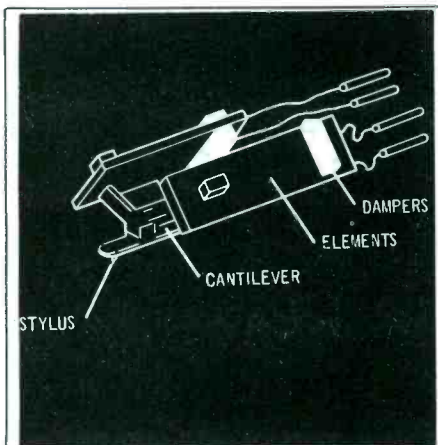

Fig. 7. View of a ceramic cartridge.

angle helps minimize tracking error, it introduces a problem of its own. It results in what is known as 'skating force' a force which pushes the pickup toward the center of the record. Thus, instead of tracking both groove walls with equal force, it is much greater on the inner groove wall than the outer. This can produce two effects, both undesirable. One of these is uneven wear, with the possibility of decreased record life. The other is distortion due to insufficient tracking force on the outer wall.

To place all the blame for skating force on offset angle is a simplification, for a tricky combination of forces act on the stylus and tonearm as they track the record. In extreme cases, the effect is to cause the stylus to jump out of the groove. To assure perfect tracking of both groove walls—that is, both stereo channels—some compensating force is used. In one method a little weight affixed to a string applies a corresponding counterforce on the tonearm. Another technique is the magnetic type anti-skating device which employs the repulsion power of magnetism. As the skating force varies with stylus tracking

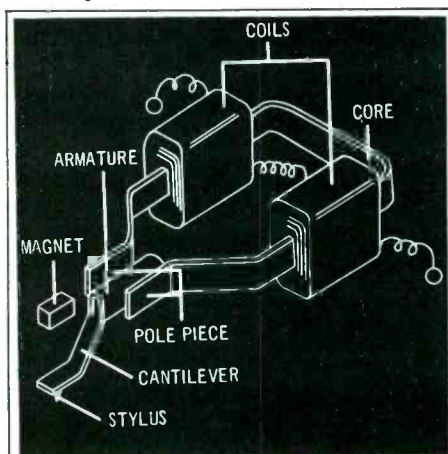

Fig. 10. The induced magnet (IM) cartridge.

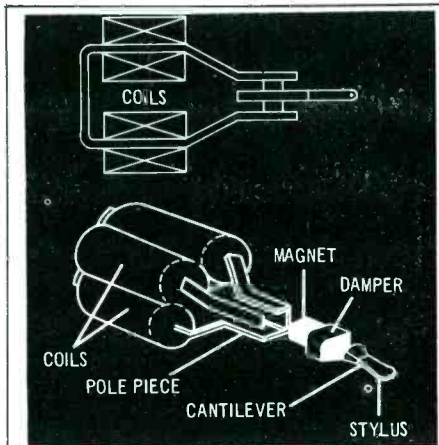

Fig. 8. The moving magnet (MM) cartridge.

force, the anti-skating device should be readjusted each time the tracking force is changed.

Cartridge Types

There are various systems for converting the vibrations of the stylus into an equivalent electrical signal. Ceramic cartridges (Fig. 7) take advantage of the fact that certain crystalline materials develop a voltage when they are subjected to stress, such as a twisting action. Movements of the cantilever (which is affixed to the stylus) apply varying forces, twists and pressures, on a special crystalline material which generates an electrical voltage in accordance with the stylus movement. The rigid armatures required to exert this twisting force naturally increase the moving mass, and the ceramic elements are sometimes affected by heat and moisture. Ceramic cartridges are more commonly used in low-priced record players.

Various types of magnetic cartridges are available. The moving magnet (MM) cartridges (Fig. 8) have a tiny permanent magnet attached to the cantilever which moves freely between an assembly of coils, inducing a voltage in these coils.

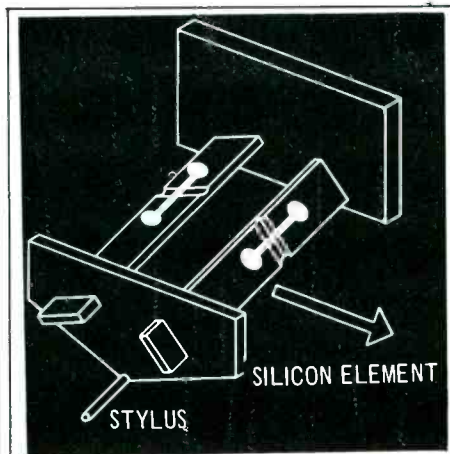

Fig. 11. The semiconductor cartridge.

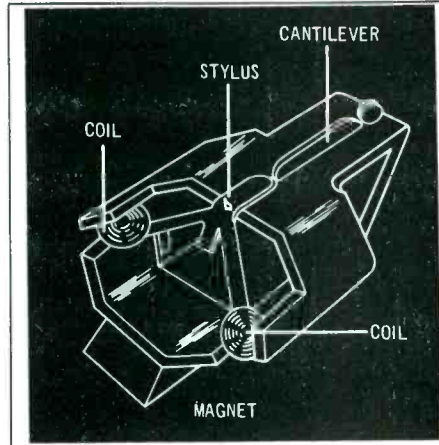

Fig. 9. The moving coil (MC) cartridge.

Moving magnet cartridges have the benefits of a small moving mass and high efficiency—that is, relatively high output voltage.

The reverse principle is applied in moving coil (MC) cartridges (Fig. 9). Here the magnet is fixed, and the coils—one for each channel—move in the magnetic field, receiving an induced voltage in the process. The moving mass of moving coil cartridges is even smaller than that of the moving magnet type, but they have quite a small output voltage. Both types, moving magnet and moving coil cartridges, do supply good frequency response and stereo channel separation.

Still another magnetic cartridge is the induced magnet (IM) with fixed magnet and coil assemblies (Fig. 10). Two tiny iron plates move in the magnetic field, causing variations in the magnetic flux. Because of the changes in magnetic flux lines, a voltage can be induced in the coil assembly.

The output voltage of the cartridge is usually measured at a specific frequency, such as 1,000 Hz and at a certain stylus-to-groove velocity. The voltage output will depend on the kind of cartridge used, but should always be greater than the sensitivity (expressed in millivolts) of the amplifier's phono input.

The frequency response of the cartridge represents the entire range of audio the cartridge will deliver. A wide range is desirable, with no peaks or dips within the range. A quality cartridge should extend from 20 Hz to 16 kHz, ± 3 dB, or better.

While magnetic cartridges are the generally accepted types, others have been proposed. Thus, there are two not being widely used, although they hold excellent promise. One is the semiconductor (Fig. 11) cartridge in which mechanical forces created by stylus vibration change the electrical resistance of a silicon semiconductor in corres-

The best time to upgrade your component system is before you buy it.

If you're a typical reader of this magazine, you most likely have a sizeable investment in a component system. So our advice about upgrading might come a little late.

What you might have overlooked, however, is the fact that your records are the costliest and most fragile component of all. As well as the only one you will continue to invest in.

And since your turntable is the only component that handles these valuable records, advice about upgrading your turntable is better late than never.

Any compromise here will be costly. And permanent. Because there is just no way to improve a damaged record.

If the stylus can't respond accurately and sensitively to the rapidly changing contours of the groove walls, especially the hazardous peaks and valleys of the high frequencies, there's trouble. Any curve the stylus can't negotiate, it may lop off. And with those little bits of vinyl go the high notes and part of your investment.

If the record doesn't rotate at precisely the correct speed, musical pitch will be distorted. No amplifier tone controls can correct this distortion.

If the motor isn't quiet and free of vibration, an annoying rumble will accompany the music. You can get rid of rumble by using the bass control, but only at the expense of the bass you want to hear.

Experienced component owners know all this. Which is why so many of them, especially record reviewers and other music experts, won't play their records on anything but a Dual. From the first play on.

Now, if you'd like to know what several independent test labs say about Dual, we'll send you complete reprints of their reports. Plus a reprint of an article from a leading music magazine telling you what to look for in record playing equipment. Whether you're upgrading or not.

Better yet, just visit your franchised United Audio dealer and ask for a demonstration.

You'll find Dual automatic turntables priced from \$109.50 to \$225.00. That may be more than you spent on your present turntable, or more than you were intending to spend on your next one.

But think of it this way. It will be a long, long time before you'll need to upgrade your Dual.



United Audio Products, Inc., 120 So. Columbus Ave., Mt. Vernon, N.Y. 10553

Exclusive U.S. Distribution Agency for Dual.

Check No. 15 on Reader Service Card

pondence to stylus vibration. Another is the photoelectric in which light from a tiny bulb in the cartridge falls on a phototransistor which converts it into an electric voltage.

Impedance

In its broadest sense, impedance means opposition to the flow of an electric current. Low impedance and high impedance do not imply quality, for the words low and high have no relationship to value in this sense. Impedance is like friction. On an icy

road you want lots of it between your tires and the surface, while some of it is necessary at all times. Impedance is one of the descriptive factors of electronic components. A speaker has impedance. A tuner or receiver has several: one at the input, the other at the output. As a rule, when individual components are connected, it is desirable to match impedances—the output impedance of one component should match the input impedance of the component to which it is connected. This rule should be prefaced by 'generally' since, as in the

case of many rules, there are desirable exceptions.

In the case of cartridges, load impedance is the input impedance of the amplifier. The amplifier is the load, or the device to which the tonearm will deliver its electrical signal. For MM and IM pickups, the standard impedance is about 47,000 ohms to 50,000 ohms, with the ohm being used as the basic unit of impedance. Most amplifier phono inputs are designed for this. MC cartridges have low impedances: 2 to 10 ohms, and so the amplifier to which this cartridge will be connected must have special MC phono inputs. Otherwise, a step-up transformer or booster amplifier will be required between the MC cartridge and its following amplifier.

Automation

Convenience is the keynote in the modern record player and automatic record changer. One step in the direction of automation is the 'auto return' tonearm in which the arm is raised and lowered by a button type oil elevation device. At the end of the record, it lifts off and returns to its rest position automatically. The logical extension of this is the fully automatic turntable (Fig. 12). A single function controls the entire operation. In position start, the tonearm moves over the initial record grooves, the platter begins to revolve, the tonearm floats down, the record is played, and at the end of the play the tonearm lifts off and returns to its rest position. There are usually two other controls: a speed selector and a record size selector which adjusts the tonearm drop point for various record diameters.

A record player is a sound source, just as a tuner, or cassette deck, or microphone, are regarded as sound sources. The sole function of the record player is to extract the information modulated into the walls of the record grooves and to deliver that information in the form of an electrical signal to a pre-amp. It is hi fi only to the extent to which it does this. If the record player, in part or in toto, behaves like a signal source in any way, then to that extent it is not high fidelity. (Continued on page 36)

FAIRFAX

SUPERSOUND SPEAKERS

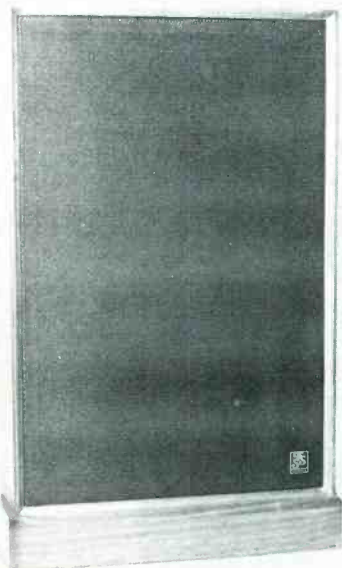

Wall of Sound II

Designed
to meet the
demands of
today's sound!

FAIRFAX SUPERSOUND MEANS:

- ★ High Power handling capacity
- ★ High efficiency
- ★ Wide frequency response
- ★ 8 models from \$69.95 – \$399.95
- ★ Five year unconditional guarantee

FAIRFAX INDUSTRIES

900 PASSAIC AVENUE
EAST NEWARK, NEW JERSEY 07029

Check No. 16 on Reader Service Card

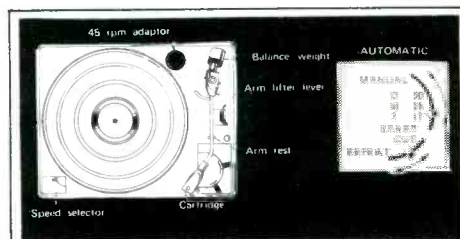

Fig. 12. Turntable with automatic features.

Listen



to the irresistible sound of Martin Speakers

The sound of Martin Speakers can be as quiet and irresistible as the gentle meeting of sand and surf. Or vibrant and deepthroated as the roar of thunder in the summer sky.

Martin Speakers, for people who are attuned to the irresistible sounds of the audible universe.



MARTIN SPEAKER SYSTEMS • A DIVISION OF EASTMAN SOUND MANUFACTURING CO., INC.

Harmony Road and Route 295
Mickleton, New Jersey
08056

Martin Speakers from \$44.50 to \$350.00

"A new standard of performance built
by people who listen."

Check No. 10 on Reader Service Card

ANYTHING

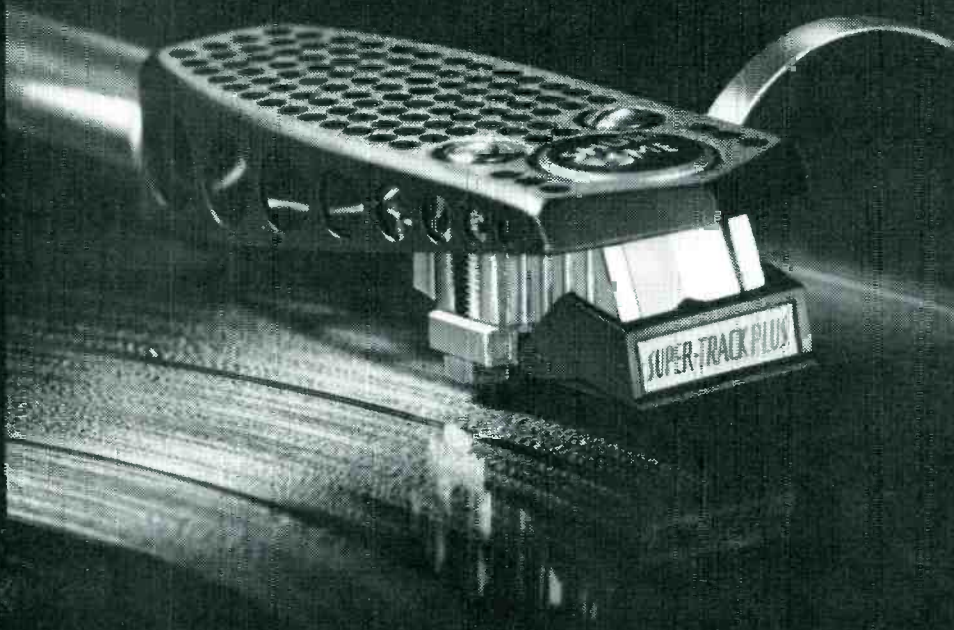

II COULD DO III CAN DO BETTER!

Several years ago, we decided that our next challenge would be to go beyond the best there was. Our computers told us we had taken the existing cartridge structure and stylus assembly of the V-15 Type II Improved as far as we could, and that hereafter, any improvement in one performance parameter would be at the expense of performance in some other parameter.

Therefore, over the past several years, a wholly new *laminated cartridge* structure has been developed, as was an entirely new stylus assembly with a 25% reduction in effective stylus mass! These developments have resulted in optimum trackability at light tracking forces ($\frac{3}{4}$ – $1\frac{1}{4}$ grams), a truly flat, unaccented frequency response, and more extended dynamic range than was possible even with the Type II Improved, without sacrificing output level!

Further, because these factors are held in perfect equilibrium, wherein each design parameter enhances every other parameter, the total audio effect is greater than the sum of its individual engineering achievements. Engineers call this effect a Synergistic Reaction; ergo, we call the Type III the Synergistic Cartridge.

If you like its sound today, you will like it even more as time goes on. In fact, to go back to any other cartridge after living with the Type III for a short while is simply unthinkable, so notable is its neutral, uncolored sound. You must hear it. \$72.50.

INTRODUCING THE NEW



V-15 TYPE III Super-Track "Plus" Phono Cartridge

Shure Brothers Inc. • 222 Hartrey Ave. • Evanston, Ill. 60204

Check No. 18 on Reader Service Card

(Continued from page 32)

Audio For Beginners

Radio waves are far from genteel, for they cannot be so and survive. But the strongest signal isn't always the most preferable, and so we now have tuners capable of reaching out and succoring those emaciated signals that, a technical decade ago, would have perished. That ability of a tuner to respond to the weakened remnant of a signal is called sensitivity, a good word, a pleasant word, but a most

unfortunate one since it implies a certain sensibility and kindness on our part. Nothing of the sort, of course. We want tuners having high sensitivities to be able to pick up weak signals for the sole practical reason that those signals may be the ones we want. The desideratum of a signal isn't its strength or ability to survive, but simply a relationship to our own personal wants.

The FM band covers a range of 88 - 107.9 megahertz, a total of almost 20 megahertz. You can realize how wide this band is by comparing it to

the AM broadcast band which extends from 535 to 1635 kilohertz, a total of 1100 kilohertz or 1.1 megahertz. And so the FM band is approximately 20 times as wide as the AM band. Into this FM band playroom are crammed all the broadcast FM stations with each occupying individually much more band space than comparable AM stations.

AM vs FM

Per se, audio waves have a very short travel span. If you want to know how far audio waves can travel unassisted, and are willing to experiment in the name of science, try shouting out of your bedroom window in the quiet early morning hours. If you can avoid capture and confinement, you will have learned that the distance covered by your voice is a few hundred yards, if that. To overcome this limitation, at the broadcast station the audio signal is electronically loaded on another, much higher frequency wave, called a carrier for very obvious reasons. (The carrier is the assigned frequency in the FM band). The loading process is called modulation, whether for AM or FM (Fig.13). The reverse process in the tuner, that of discarding the carrier and recovering the original audio signal, is demodulation. Amplitude modulation, or AM, changes the strength or amplitude of the carrier wave; frequency modulation changes its frequency.



The Amp that handles orchestral onslaughts!

700 WATTS R.M.S.! Do you really need an amplifier with all that power? The fact is, you need much more power than you might think to accurately reproduce the more difficult music passages that occur in many live performances. "Anyone using a low-efficiency speaker system with a 60 to 100 watt (total power) amplifier cannot approach a realistic listening level . . . the tendency is to operate at a lower (undistorted) level and to delude ourselves into accepting it as 'realistic', which it is not!" So says Julian Hirsch.

With a Phase Linear 700 you take a quantum jump closer to true high fidelity.

The Phase Linear 700 watt R.M.S. Direct Coupled Stereo Power Amplifier is a product of recent major advances in high voltage silicon

power transistor technology — and Phase Linear's exclusive, patented energy limiter protection circuit. It is the most powerful, most advanced solid state amplifier available today. It is, says Mr. Hirsch, "... in a class by itself." Ask your dealer for an audition soon.

Power — Greater than 350 watts/channel R.M.S., both channels driven into eight ohms, zero to 20 kHz.

Harmonic or I.M. Distortion — Less than .25%; typically, less than .01%.

Protection — Patented electronic energy limiters, together with supply fuses, prevent excursions into unsafe operating regions, regardless of load condition.

Warranty — Three years, parts and labor, for normal use.

Price — \$779.

The Powerful Difference

Phase Linear 700

P.O. Box 549, Edmonds, Wash. 98020

Check No. 9 on Reader Service Card

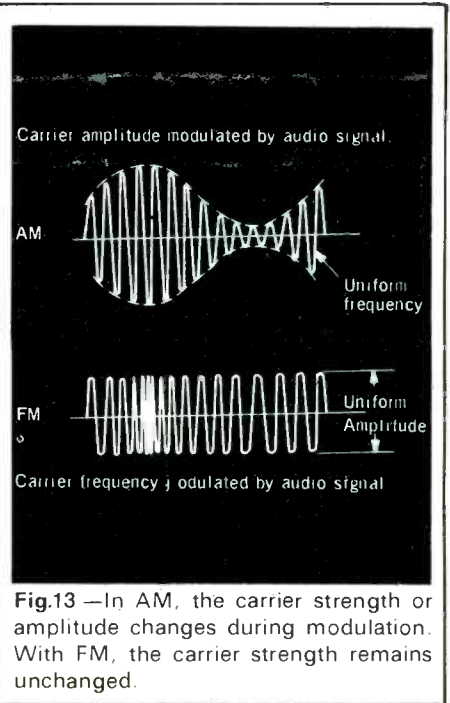
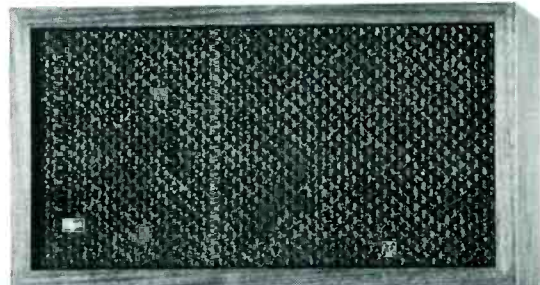

Fig.13 — In AM, the carrier strength or amplitude changes during modulation. With FM, the carrier strength remains unchanged.

(To be continued)

when you've made the best big speakers what next?



B-201

make the best little speakers.

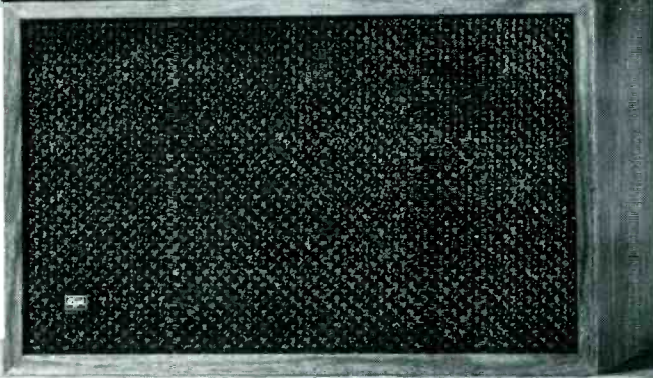

B-301

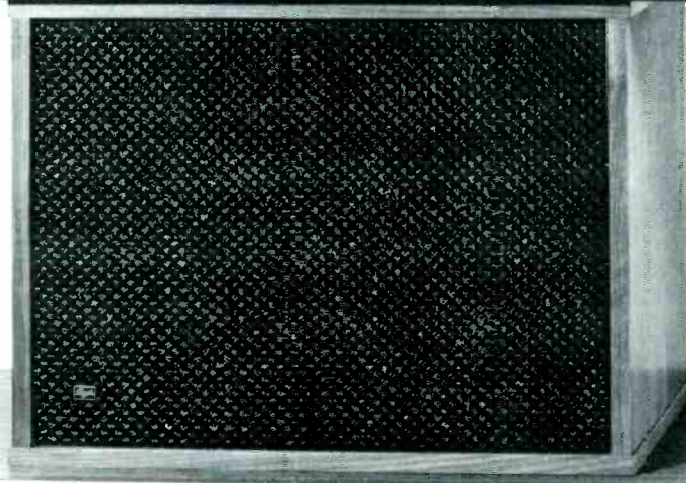

B-401

For a generation Bozaks have been the choice of the most critical music listeners, of musicians, and of the world's great orchestras to reinforce their sound in outdoor concerts.

Now in the tradition of the renowned Symphony No. 1 and incomparable Concert Grand, Bozak proudly offers an outstanding selection of "book-shelf" and compact speaker systems designed especially for those with an ear for superb sound, but with limited space.

SONORA (top) smallest of the Bozaks—as unobtrusive as a bookend. Two-way system with 8 inch driver and treble speaker. Outperforms many 'big' speakers.

TEMPO (center)—genuine 3-way loud-speaker system. Special high compliance 12" bass driver and unique Bozak variable density diaphragm produces true pitch bass without coloration.

RHAPSODY (bottom shelf) compact 3-way system incorporates 12" extended travel, high compliance woofer to produce remarkably full bass for its size. Also available, a Rhapsody floor-standing model with identical speaker components.

Each, "best in their class," deliver in limited space a purity and range of sound unavailable in speakers many times their size and cost. All are equal in craftsmanship and tonal-quality, matched in power. Removable front panels permit the owner to change the grille cloth to match a room's decorative scheme.

Yes, they too are all Bozak. The nicest thing anybody can say about a speaker system.

See and hear them at your Bozak Dealer, or write for full details.

BOZAK, Box 1166, Darien, Conn. 06820
Overseas Export: Elpa Marketing Industries, Inc., New Hyde Park, N.Y. 11040



Where quality speaks for itself.

Helping THE HANDICAPPED....

Billy G. Brant

FM subcarrier frequencies (SCA) have become valuable assets to modern broadcasters, either as an additional commercial enterprise or as a service offered free to the public. The most common commercial application of the SCA is the uninterrupted easy listening music service offered to supermarkets, drug stores and other such businesses in which the public congregates. The public service uses of the SCA are generally more unique in design and programming format than the commercial utilizations.

One such unique development of a subcarrier for public service use is the project called Audio-Reader, now in operation at the University of Kansas. Audio-Reader is a service for the blind and physically handicapped and consists entirely of spoken word broadcasts.

On October 11, 1971, KANU-FM in Lawrence, Kansas, began its Audio-Reader operation. Every day since that date those who are physically or visually handicapped have the opportunity to listen as someone reads them excerpts from newspapers, magazines and books. The typical broadcast day begins at 8 a.m. with the Audio-Reader sign on. From 8-10 a.m., local newspapers are read live. 10-6 p.m. is made up of prerecorded tapes of books with hourly changes of material and interludes of varied programming such as live readings from current periodicals or selections from old-time radio dramas. Then from 6 p.m. until sign off at 8 p.m., the format is selected readings from local and regional newspapers.

The basic purpose of Audio-Reader is to keep those who cannot use the printed page up to date with the world around them. Being informed is not a privilege, but rather, a right. Audio-Reader is attempting to keep its audience informed.

Interestingly enough, Audio-Reader is not only providing a service to the

blind, it is also encouraging community involvement. Those who read are volunteers from the city and university communities. These people donate their time and energies to Audio-Reader and without their efforts Audio-Reader could not continue its operation. Community support for this project is growing rapidly. By helping others the community actually helps itself.

Since Audio-Reader is a sub-carrier service, special receivers are required to monitor it. These receivers are loaned to the user free of charge by the University of Kansas. Approximately 600 receivers are in use at the present time. Audio-Reader's main coverage area is within a 100 mile radius of Lawrence, although there are a few people receiving Audio-Reader as far away as a hundred and fifty miles from Lawrence.

The response from the listeners has been very favorable. Most of the letters are in this vein: "I find Audio-Reader very useful and educational. It keeps me abreast of the times." The selectiveness of the audience is a key factor in the favorable response. The service is designed for a selective audience and they in turn shape its programming.

Audio-Reader's conception began in January, 1971, when an anonymous person suggested the idea to Dick Wright, station manager of KANU, and promised to provide financial backing for such a project. It was estimated that at the end of Audio-Reader's first year of operation that promise involved more than \$100,000.

Although Audio-Reader has yet to complete two full years of operation, plans are already being made for future expansion and developments. It is hoped that Audio-Reader will serve as an example and a motivating factor in the development of other such services. The possibilities for public service are indeed limitless.

Billy Brant is the Executive Producer at KANU-FM in Lawrence, Kansas and is an authority on binaural sound—ED.

Where it's at

There's more to the TASCAM board than we have room to tell. But we've got strictly qualified dealers throughout the country who can fill you in on the technical details and answer all your questions. Just as important, they service what they sell. Because what you're doing is important to them. So talk to our experts, we think these are the best there are.

ARIZONA

Phoenix: Bruce's World of Sound (602) 277-7493
Scottsdale: Universal Audio (602) 947-2596

CALIFORNIA

Anaheim: Videodetics (714) 532-3364
Hollywood: Custom Fidelity (213) 654-4522
Los Angeles: Hannon Engineering (213) 936-5176
Westlake Audio (213) 655-0303
San Diego: Pacific Recorders & Engineering (714) 453-3255

San Leandro: Tabor Mfg. & Eng. (415) 635-3832
San Francisco: Sound Genesis (415) 391-8776
Sunnyvale: Recording Specialties (408) 739-7201

CONNECTICUT

Stamford: Audiotechniques (203) 359-2312

GEORGIA

Atlanta: General Audio Electronics (404) 691-9122

FLORIDA

Tampa: Audio Visual Services (813) 884-1461
Studio 70 (813) 238-6021

HAWAII

Honolulu: The Audio Center (808) 531-3153

ILLINOIS

Chicago: B. W. Associates (312) 935-4900
Continental Music House (312) 267-3890
Sound Market Recording (312) 664-4335
South Pekin: Milam Audio (309) 348-3112

LOUISIANA

New Orleans: National Broadcast Equipment (504) 522-3089

MICHIGAN

Dearborn: Pac-3 Recording (313) 581-0520

MINNESOTA

Minneapolis: Audio King (612) 920-4272
Sound 80 (612) 721-6341

MISSOURI

St. Louis: Best Sound (413) 862-0003

NEVADA

Las Vegas: Global Productions (702) 457-3060

NEW JERSEY

Oakhurst: Sound Arts (201) 493-8666
Patterson: Professional Audio Video (201) 523-3333

NEW MEXICO

Albuquerque: Head Ltd. (505) 843-6262

NEW YORK

Bearsville: Bearsville Records (914) 679-8900
New York: Martin Audio (212) 265-6470
Rochester: Brighton Sound (716) 454-3030
Tonawanda: Seneca Sound (716) 832-2100

PENNSYLVANIA

Frazer: LPB Inc. (215) 644-1123
Pittsburgh: RPC Electronics (716) 832-2100
Willow Grove: Music & Sound Ltd. (215) 659-9251

TENNESSEE

Nashville: Studio Supply (615) 256-6685

TEXAS

Garland: Accurate Sound (214) 278-0553

5440 MCCONNELL AVENUE
LOS ANGELES, CALIF. 90066



If you're seriously into music or sound reinforcement you want more than hi-fi products can give you. But full professional studio gear costs an arm and a leg, and you pay for a lot of things you may not really need.

You pay for what you need

up to four additional input modules and other optional accessories including talkback, remote transport control, quad pan-ner, and headphone monitor.

That's why there's a TASCAM Model 10. It's an 8-in, 4-out mixing console, and it's just \$1890.

With the Model 10 you get what you have to have. Without sacrificing a single necessary function.

Each input module gives you mic and line attenuation, three bands of peak and dip equalization (two with frequency selection), pre- and post-echo send and receive circuitry, pan function, and a unique straight-line fader.

Each of the four submasters has a meter control switch (line/echo), independent monitor level control, echo receive level control, and a straight-line fader. You also get a master gain module and 4" VU meters with LED peak indicators. Plus pre-wired facilities for

That's what you need and that's what you pay for. Some things, however, you may or may not need, and we leave that choice up to you. For instance, the basic Model 10 is high impedance in and out, but studio line impedances are available optionally. You'll probably want low impedance mic inputs, but you may not need all low impedance line inputs. So we don't make you pay for them. You can order any combination of high and low input/output impedances according to your application.

Details and specs on the Model 10 are available for the asking. At the same time we'll tell you about our new Series 70 Recorder/reproducers.

We've got what you need.



TASCAM CORPORATION

5440 McConnell Avenue
Los Angeles, California 90066

Check No. 19 on Reader Service Card

Equipment Profiles

Marantz 1120	40
SAE Mk XII	42
Sherwood S-7200	46



The Marantz 1120 Amplifier

MANUFACTURER'S SPECIFICATIONS: Power output, 20 Hz to 20 kHz: 70 watts per ch. into 4 ohms, 60 watts into 8 ohms, rms. THD: Less than 0.2% at rated power IM: Less than 0.2% at rated power. Frequency response: 20 to 20 kHz, ± 1 dB. Damping factor: Greater than 30. Inputs: Mic, phono, tape 1, tape 2, tuner, aux. Dimensions: 15 $\frac{3}{8}$ by 5 $\frac{3}{4}$ by 13 $\frac{1}{4}$ inches deep. Weight: 27 lbs. Price: \$395.

The Marantz 1120 is a versatile integrated amplifier in the medium-high power class having some rather interesting features. It is styled in the workmanlike Marantz tradition with the typical instrumentation kind of panel and metal knobs to match. Actually, there are only two rotary controls—the rest are slides or push-buttons. Microphone and tape dubbing inputs are on the left, then comes the input selector switch and slide controls for bass and treble. There are four of these, one pair for each channel. Next is the volume control and then, at the right are loudspeaker-select push-buttons and a headphone socket. At the bottom are push-button switches for two tape monitors, stereo-mono, low filter, high filter, muting, loudness and power on/off. In the center is a horizontal slide control for balance. At the rear are the usual input sockets, including two DIN type and preamp-amplifier connections which permit independent operation if so desired. Or of course, an equalizer like the Metrotec or Soundcraftsman can be inserted at this point.

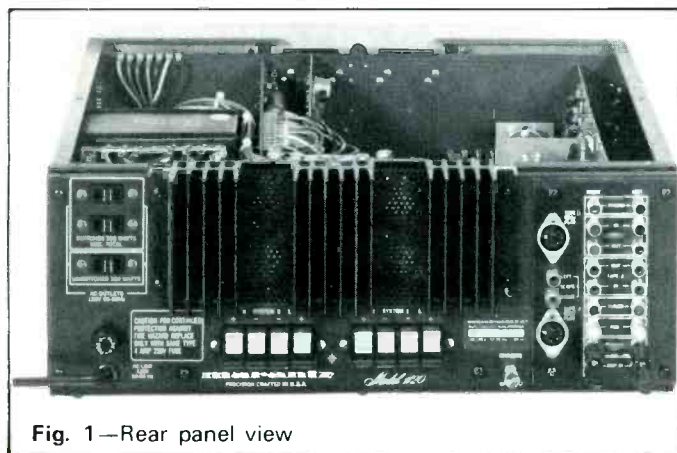

Fig. 1—Rear panel view

Yet another possibility is the recording of a program source via the tone control and filter facilities and this method is described in the owner's manual. We were pleased to note that heavy spring-loaded push connectors were used for the loudspeaker outlets. Not only are these much easier to use but there is less chance of shorts with this type than with the tiny screw terminals sometimes used. Also on the rear panel are three convenience ac sockets—one unswitched and two switched, and one unusual feature: output sockets for a 'scope.

Figure 1 shows the rear panel and figure 2 shows the view inside. Note the large power transformer and the neat layout which will be appreciated by the service engineer.

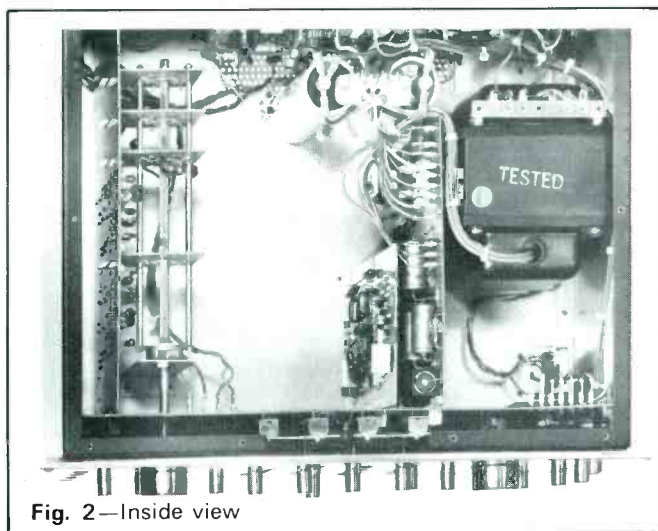

Fig. 2—Inside view

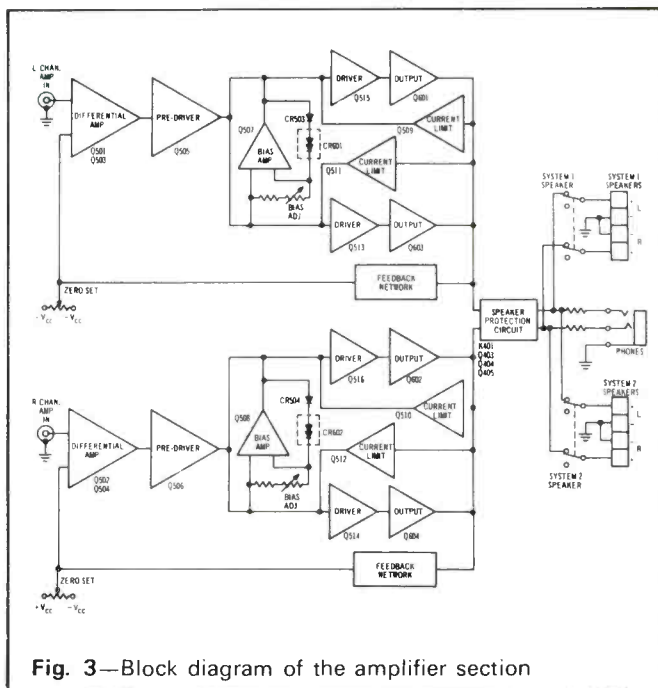

Fig. 3—Block diagram of the amplifier section

Circuit Details

A block diagram of the power amplifier section is shown in figure 3. The output transistors function in a quasi-complementary mode at a voltage of 44 plus 44. They are driven by a full complementary driver stage and a current limiting circuit monitors the output current. If this rises to a high level, the drive to the output transistors is automatically cut off. Two more protection circuits are used: thermal switches installed on the output transistor heat sinks and a three-transistor amplifier with a relay which disconnects the loudspeakers if sub-sonic surges occur. It also provides a 5-second delay after switch on—avoiding that annoying “thump.”

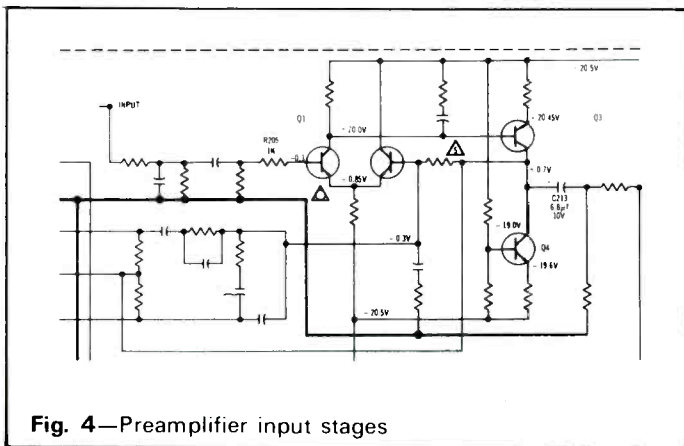

Fig. 4—Preamplifier input stages

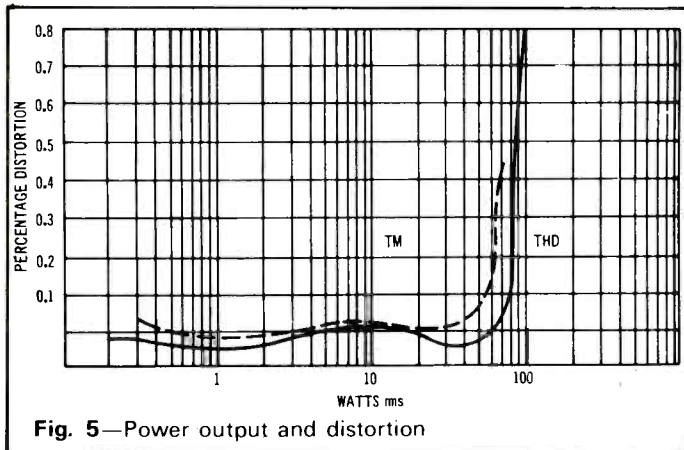

Fig. 5—Power output and distortion

The preamplifier is fairly straightforward in design although differential input circuits are not *that* common. They *do* cost more but if used properly can give superior signal/noise and handle much greater voltage swings than most conventional single transistor arrangements. Figure 4 shows the basic circuit. The three transistors Q1, Q2, and Q3 are all part of an op. amp. with Q4 providing a constant current source. Equalisation is provided by a network connected between Q2 and Q3.

Measurements

The 1120 is rated at 70 watts per channel into 4 ohms but this appears to be a conservative figure as we measured 82 watts per channel at the specified 0.2% THD. At 1%, power was just under 100 watts per channel, both driven, of course. Power output with 8 ohm loads was 80 watts per channel at 1% THD. Power bandwidth was difficult to measure precisely owing to the action of the protection circuit but it was below 15 Hz to over 50 kHz. Figure 5 shows the THD and IM and figure 6 shows the distortion versus frequency. Overall frequency response and filter characteristics are

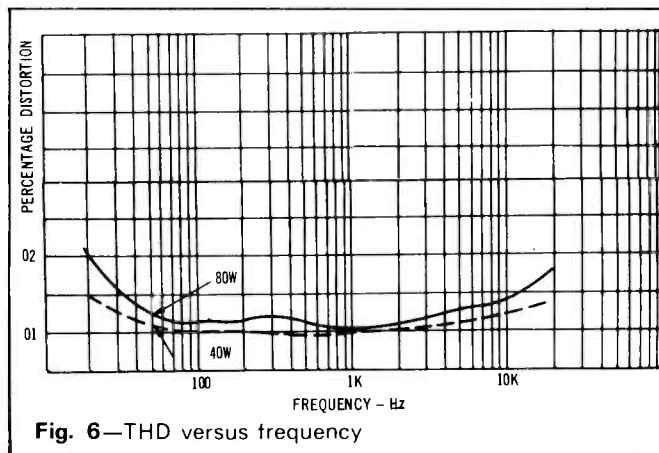

Fig. 6—THD versus frequency

given in figure 7. Square wave responses at 70, 1000 Hz and 10 kHz are shown in figure 8, and tone control characteristics in figure 9.

Input sensitivity was 1.3 mV for phono and 100 mV for high level inputs. The phono input could accept a signal of 130 mV before overload. Signal to noise came out at 69 dB and 85 dB respectively. Residual hum and noise was 86 dB. Simulated electrostatic speaker loads were used to test for stability and we can report that any electrostatic or dynamic-electrostatic system can be used without causing trouble.

Listening Tests

The 1120 was tested with a pair of Imperial 7's which seemed appropriate enough and the combination has been working for about two months. The lab. standard speakers were also used for a period and there was ample power to spare. The turntable was a Thorens 125 Mk. II so the low frequency filter was not required to reduce rumble (unless it was on the record, by no means unknown!) The sharp attenuation below 70 Hz would remove much of the annoying rumble from lower quality record-changers without removing too much of musical value. Many so-called rumble filters start to attenuate at 200 Hz—or even higher! The high frequency filter rolls off from 7 kHz and we *did* find this facility useful to reduce some *wiriness* or *chromium plating* which spoiled string tone on some otherwise good

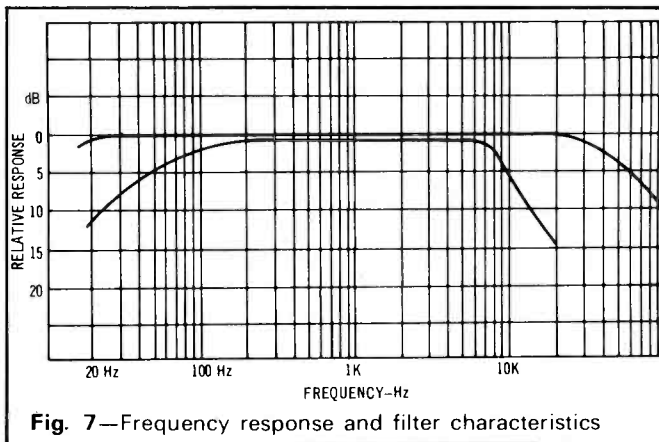

Fig. 7—Frequency response and filter characteristics

recordings. One or two recent Telefunken discs were bad offenders in this respect. Tape enthusiasts will find that front panel dubbing facility useful—almost essential, in fact.

Like all top-quality amplifiers, the 1120 seemed to have

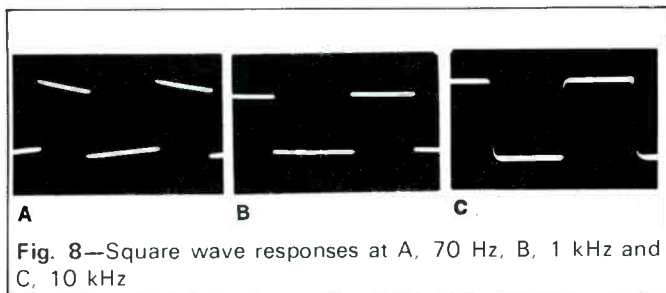

Fig. 8—Square wave responses at A, 70 Hz, B, 1 kHz and C, 10 kHz

no sound of its own. Overload characteristics were excellent—a point often overlooked—and all controls were easy to use. A horizontal balance control is a very logical way of doing things—at least for two-channel stereo. Summing up then, the Marantz 1120 is a well-made amplifier that more than meets its specifications and, just as important—it should give years of trouble-free service.

TA., GWT.

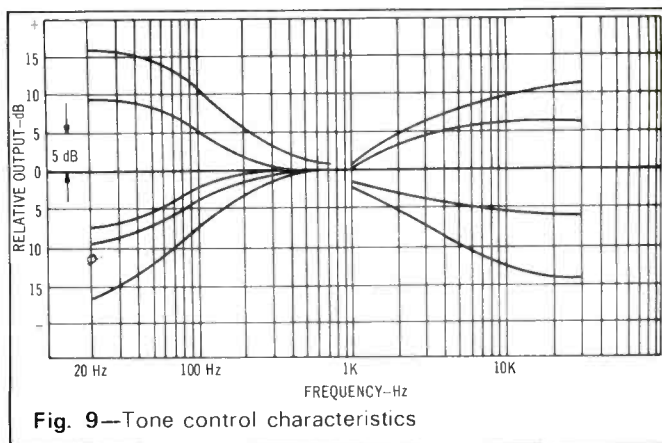

Fig. 9—Tone control characteristics

Check No. 100 on Reader Service Card



The SAE Mk XII Speaker System

MANUFACTURERS SPECIFICATIONS: **Bass unit:** 12 inch, 8-spoke cast aluminum frame, 12,500 gauss flux, 4.175 inch voice coil. Integral heat sink in 12 lb. magnet. **Mid-range:** 5 inch, 1 inch voice coil. Mounted in sub-enclosure. **High Frequency:** 3 Electrostatic elements. **System impedance:** 8 ohms nominal. **Finish:** Walnut or rosewood. **Dimension:** 27 by 17 by 12¼ inches deep. **Shipping weight:** 175 lbs. **Price:** \$850 a pair in Oiled Walnut, \$950 in Rosewood.

The SAE Mk. XII is a most ambitious bookshelf system—and at \$850 a pair it must be one of the most expensive too! The bass unit is unusually massive with its cast aluminum frame and 17 lb. magnet structure. A huge 4 inch voice coil is used and the coil former is black anodized. Figure 1 shows a cut-away section, note the double spider assembly and rigid cone. The mid-range speaker is a 5 inch dynamic with 1.75 lb. magnet and high frequencies are handled by a 3-panel electrostatic array which radiates to the rear as well as forward. In other words, a dipole. Crossover frequency is given as 1440 Hz. Low frequency crossover points are switchable giving a choice of 120, 240 or 480 Hz and level controls are provided for both midrange and high frequency

units. A very elaborate protection circuit disconnects the loudspeakers if triggered by supersonic oscillations, d.c. voltage or severe overload signals. Three transistors are employed in this circuit and an indicator light warns the listener that something is amiss and that the speaker has been switched off. The crossover and protection assembly is shown in Figure 2. It is mounted at the rear as it contains the input terminals and level controls.

The enclosure is sealed and system resonance is a low 38 Hz. The cabinet is available in rosewood or walnut and the grille cloth is detachable.

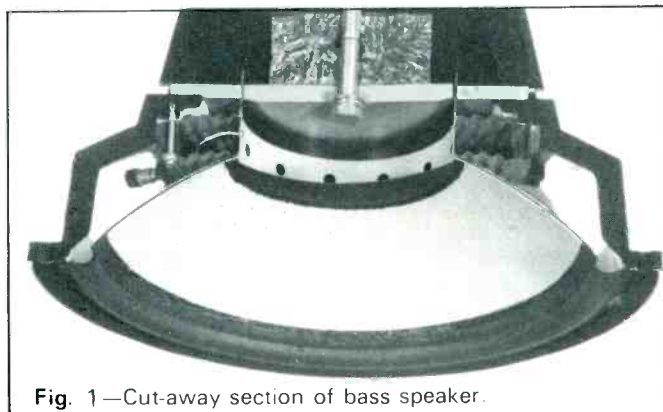

Fig. 1—Cut-away section of bass speaker.

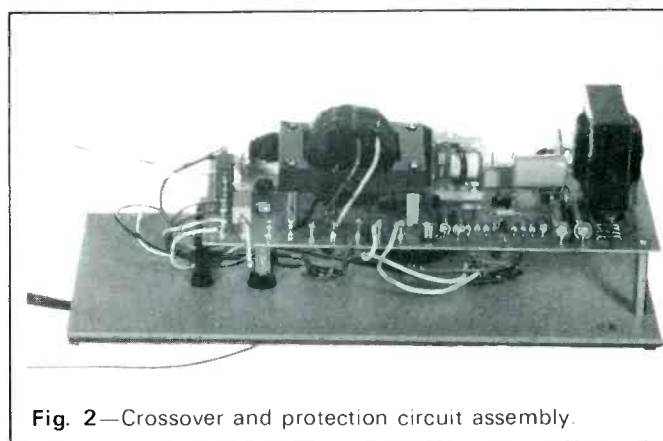

Fig. 2—Crossover and protection circuit assembly.

Measurements

Figure 3 shows the frequency response taken with one-third octave pink noise. A was measured on-axis, B at 30 degrees and C at 60 degrees off-axis. Figure 4 shows the



THE PROBLEM SOLVER

Say farewell to the grand old DC300, and welcome to THE PROBLEM SOLVER, the amp that is going to make your job easier and your customers happier. The original model DC300 was a great amp — the first super-power low distortion amp in the world, when Crown introduced it five years ago. Meanwhile, top sound systems designers have used it successfully in hundreds of demanding situations, and made some excellent recommendations for improvements. The response of the Crown design team was *not* an updated DC300, but a totally *new* and different amplifier, the DC300A. It is the *only* high power low distortion amp specifically *designed* for commercial sound applications. (CAUTION: *There are some large consumer-type amps attempting to sell in the commercial sound field without providing adequate continuous power for all load impedances.*)

Power You Can Count On

One of the DC300A's most outstanding features is that it has *double* the number of output transistors. This means effectively twice the muscle of the old DC300 — at the same price. Each channel has eight 150-watt devices for *1200 watts* of power dissipation *per channel*. The DC300A is rated at 150 watts per channel continuous into 8 ohms with both channels driven, 300 w/ch into 4 ohms or 500 w/ch into 2.5 ohms.

Two Amplifiers in One

As a dual-channel amplifier with separate level controls and circuitry for each channel, the DC300A is almost *two* amplifiers in one. This gives you additional flexibility in controlling your speaker load, as when driving separate front and back speaker systems in a large auditorium, or when bi-amping a system. For 600 watts continuous output at 8 ohms, the DC300A converts to a mono amp with two plug-in parts. This makes it possible to drive a 70-volt line directly without a matching transformer.

Superior Output Protection

The DC300A output protection circuitry is a radically new design which completely eliminates DC fuses and mode switches and further reduces service problems to the negligible level. It is superior in every way to the old VI-limiting circuit pioneered by Crown and now used by most other high power amplifiers, since it introduces *no* flyback pulses, spikes or thumps into the output signal, whether operating as a single-or dual-channel amp.

Gone too is the need to baby the amp by carefully juggling load configurations. The Problem Solver can drive *any* speaker load — resistive or even totally reactive — with *no* protection spikes! Parallel speakers with no deterioration of sound quality, since changing the load impedance only affects the maximum power available, not the ability of the amp to keep on producing clean sound.

Lowest Distortion and Noise

Also new is the DC300A's IC front end, which sets new world's records for low distortion and noise. At the 8-ohm rated output, IM and harmonic distortion is less than 0.05% full spectrum; hum and noise is 110db below. Servicing — if ever necessary — is a snap, since removing the front panel accesses the entire circuitry.

Although it is a completely redesigned model, the DC300A has inherited some characteristics from its predecessor:

PRICE - \$685, the same as the 1968 introductory price, incredibly. As two amps in one, it will probably give you or your customers a welcome cost-break when you design your next multiple-amp system.

WARRANTY - three years, covering all costs of parts, labor and round-trip shipping.

COOLING - excellent heat dissipation provided by massive cooling fins and the entire chassis itself.

DEPENDABILITY - stringent pre- and post-inspection and testing proves every electronic component, every circuit module and every finished unit, to bring you one step closer to install-and-forget field dependability.

PEOPLE - the same innovative design team and careful craftsmen who made the DC300 such a sound success. And the same knowledgeable customer-service men ready to discuss your special application and send you detailed technical data. Phone 219 + 294-5571 or write Crown International, Box 1000, Elkhart, Indiana 46514.



CROWN

MADE ONLY IN AMERICA

Check No. 14 on Reader Service Card

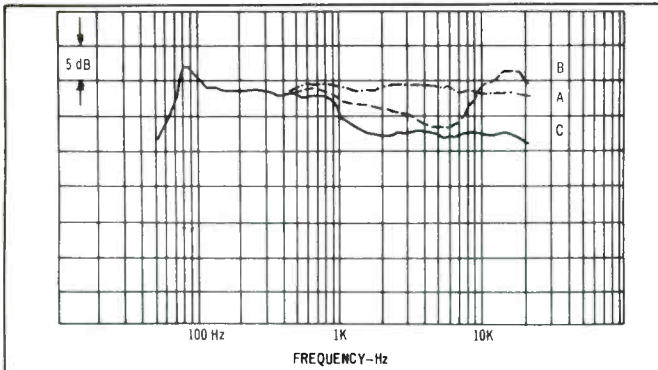

Fig. 3—Frequency response taken with one-third octave pink noise. A was measured on-axis, B at 30 degrees and C at 60 degrees off-axis.

range of the mid and high frequency controls. All these measurements were made with the low frequency crossover set at 480 Hz. The two lower frequencies, 120 and 240 Hz merely introduced a dip in the response as the midrange range is not extended downward. We doubt whether this particular option is really worthwhile although it *could* be argued that a crossover might reduce the effects of standing waves if the speakers were stood in the corner of a room. Tone-burst responses at 100, 500 and 5,000 Hz are given in Figure 5. The low frequency response shows a sharp recovery and freedom from hangover and the high frequency pulse shows the effect of multiple reflections. Impedance characteristics are shown in Figure 6 and it will be seen that the lowest point is a fraction under 4 ohms with the mid-range control at maximum. Low frequency distortion and SPL figures are given in Figure 7. The system would take a continuous sine wave input of 42 watts at 40 Hz without distress, 59 watts at 70 Hz and 168 watts at 100 Hz. White noise tests showed a slight coloration mainly due to the reflections or diffraction from the cavity in which the ESL units are mounted. It was not considered serious and we ought to emphasize that we are being more than usually critical having regard to the price and complexity of the system.

Listening Tests

Sensitivity is somewhat lower than average and SAE recommend a minimum power of 60 watts per channel. For most of the tests we used a Sony 1130 and a new Phase Linear 400 was pressed into service later. The 1130 gave ample power for a fairly large room and the Phase Linear just loafed along with plenty of power to spare. A 1,000 Hz sine wave activated the protection circuit at about 150 watts and the red light duly came on. Removal of the signal brought the speaker back into circuit after 5 seconds. These indicator lights can be seen through the grille cloth—red showing that the protection circuit is operating and amber confirming that the power supply is switched on.

With the controls at maximum the sound had a slightly forward quality and we found the best position for both was just above the "Normal" level. Best place for the systems was about 3 feet from the floor and placed a foot or so from the wall. Other positions were tried (not without some unaccustomed effort as the systems turn the scales at 160 lbs. a piece!) In some locations they may be stood on the floor; this was fine in the lab but in the larger listening room, the bass tended to be over-prominent—especially if the systems were placed near the corners.

Having arrived at the optimum positions for systems and controls we put the Mk XII through some severe tests—including direct speech recordings and some top-quality

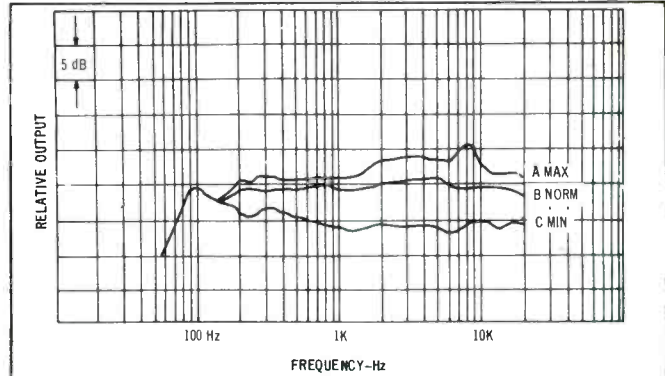

Fig. 4—Range of mid-range and high frequency level controls.

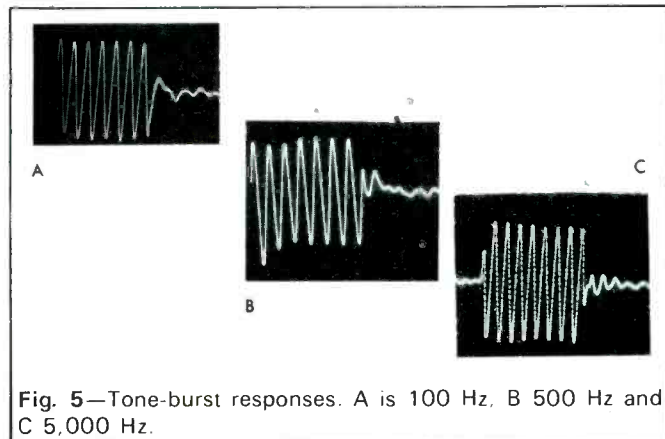

Fig. 5—Tone-burst responses. A is 100 Hz, B 500 Hz and C 5,000 Hz.

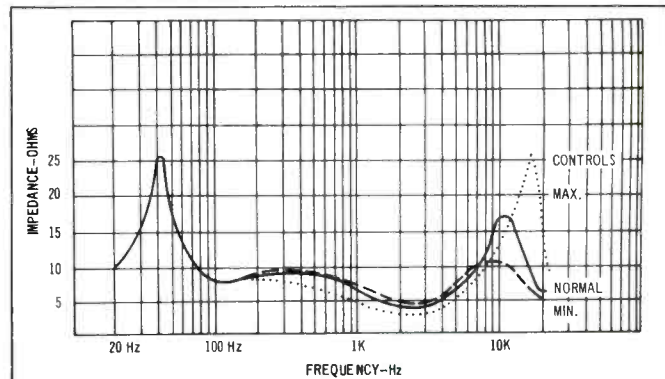

Fig. 6—Impedance characteristics.

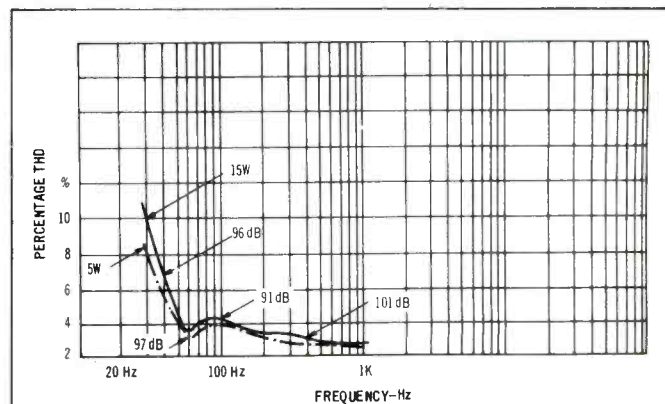

Fig. 7—Low frequency distortion and SPL figures.

Why spend \$273⁰⁰

when you can enjoy
the breathtaking sound of the
Onkyo Model 20 3/way speaker system
that's built like this...

TWEETER

- Super-Hard, Duraluminum Extra Thin Diaphragm — 1" Dia.
- Magnet — ½lb. Ferrite
- Frame — Cast Aluminum

MID-RANGE

- Super-Hard, Duraluminum Diaphragm — 2" diameter
- Magnet — 1½lb. Ferrite
- Cavity Damping — 2"d. Fiberglass

WOOFER

- 12" E.I.A. Diameter
- Molded Non-Press Cone, Ported Dome
- Neoprene Surround
- Cast Aluminum Frame
- 2lb. Ferrite Magnet
- Aluminum Foil Voice Coil Bobbin
- 1½" Dia. Long-Throw Voice Coil
- Heavy, Bolted Construction

CABINET

- ¾" Flake-Core Walnut
- Forty ¾" Joint Braces plus 1½" Hzt'l. & Vert'l. Internal Struts for Air Tight Design & to Prevent Cabinet Resonance
- Double Thickness Fiberglass Damping Mats
- Removable Front Grille
- Solid Walnut Front Molding

NETWORK

- Exclusive, RC Filtered, Integrated Circuit
- P.C. Board Construction
- Large Air Core Chokes
- Mylar Non-Polarized Capacitors
- 12dB per Octave Slope
- Choke Attenuator, 5 Position, 2dB per Step, Tweeter and Mid-Range

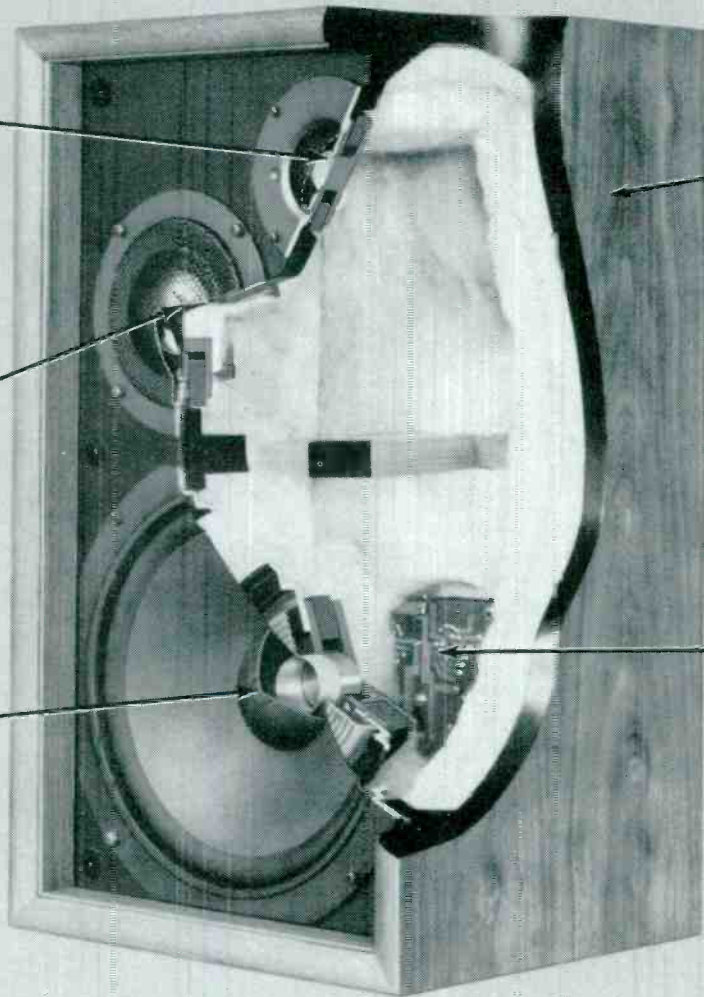

Close-up View of
3/way Integrated
Crossover Network

and it's just \$199⁹⁵

ONKYO
Artistry in Sound

Mitsubishi International Corp./Onkyo Sales Section
25-19 43rd Avenue, Long Island City, N.Y. 11101 / (212) 729-2323

Check No. 22 on Reader Service Card

15 ips tapes. Overall sound was spacious with the typical electrostatic transparency coupled with the solid bass of the massive 12 inch woofer. Speech was natural without that chesty coloration and there was no trace of low frequency

hangover. Perhaps SAE will now design another system with the ESL crossing over at 400 Hz or thereabouts. Unfortunately it will have to be larger than the Mk XII and more expensive too!

Check No. 99 on Reader Service Card

T.A., G.W.T.

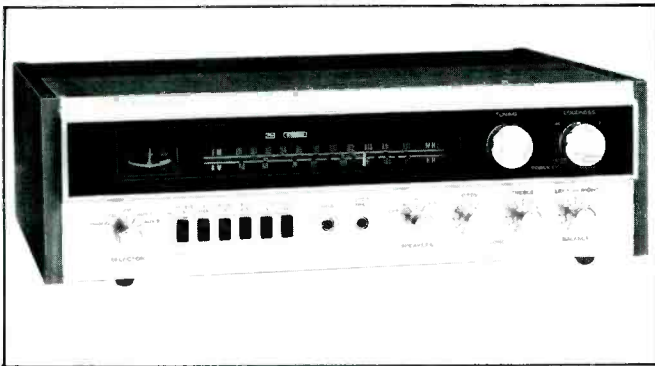

SHERWOOD

Model S-7200 AM/FM Stereo Solid State Receiver

MANUFACTURER'S SPECIFICATIONS:

FM Tuner Section:

IHF Sensitivity: 1.8 uV. **S/N Ratio:** 66 dB. **Capture Ratio:** 1.9 dB. **AM Suppression:** 60 dB. **THD (Mono):** 0.25%. **Image Rejection:** 80 dB. **IF Rejection:** 85 dB. **Spurious Response Rejection:** 90 dB. **Selectivity:** 60 dB. **Stereo FM Separation:** 40 dB @ 1 kHz.

AM Tuner Section:

IHF Sensitivity: 10 uV. **Image Rejection:** 70 dB @ 1 MHz. **IF Rejection:** 72 dB @ 1 MHz. **Selectivity:** 8.0 kHz @ -6 dB.

Amplifier Section:

Power Output: 40 watts/channel, 8 ohm loads, continuous power; 50 watts/channel continuous, 4 ohm loads. **THD:** 0.7% at rated output, 8 ohm loads. **Power Bandwidth:** 12 Hz to 35 kHz (reference: 1% THD) **Frequency Response:** Aux: 20 to 20 kHz $\pm 1/2$ dB; **Phono:** RIAA ± 1.5 dB. **Damping Factor:** 40 @ 8 ohms. **Bass and Treble Control Range:** ± 12 dB @ 100 Hz and 10 kHz. **Input Sensitivity:** Phono: 2.2 mV; **Aux:** 230 mV. **Input overload capability:** Phono: 60 mV. **Hum and Noise (IHF):** Phono: 60 dB; **Aux:** 80 dB; **Volume Control at Minimum:** 85 dB.

General Specifications:

Power Requirements: 115-125V 50/60 Hz, 20 to 200 watts. **Overall Dimensions:** 17 1/2 in. w. x 5 3/4 in. h. x 14 in. d. **Shipping Weight:** 32 lbs. **Retail Price:** \$299.95 (including walnut cabinet).

The truism that it is possible to get more value per dollar in a stereo receiver today than it was five years ago certainly applies in the case of the Sherwood S-7200 unit we just finished testing. In the popular "just under \$300" price category, few receivers offer the power capability and tuner performance of this smart-looking entry from one of the older, well established companies in the high fidelity component industry.

The front panel of the S-7200 is made of an attractive gold-anodized extrusion and a black plastic "blackout" dial that runs the full length of the upper half of the panel. Large tuning and loudness control knobs are located in this upper portion, and the calibrated (in dB below maximum) loudness control also serves as the power on/off switch. Along the lower portion of the panel are the program selector switch, speaker selector switch, bass, treble and balance controls—all in the form of circular metal-turned knobs. Secondary functions such as a pair of tape monitor facilities, muting switch, mono-stereo mode switch, high filter and loudness circuit

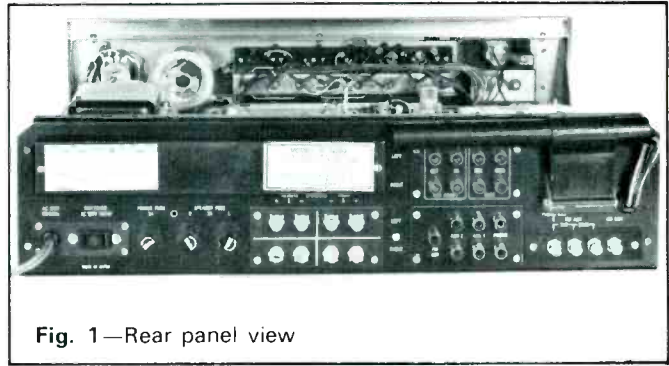

Fig. 1—Rear panel view

are all actuated by push-pull buttons. A front panel tape-dubbing jack (wired in parallel with the tape monitor jacks on the rear panel) and a stereo phone jack are centrally located on the panel. The second tape-monitor button, incidentally, is labelled "4-channel in-out" which simply means that it can be used to interrupt the circuit for connection of a 4-channel "matrix" decoder, while the first tape-monitor facility is used for the purpose originally intended—namely tape monitoring. The well illuminated blue dial scale area also includes program source lights, a stereo FM indicator light and a zero-center tuning meter for FM, which reads up-scale from center when used for AM signal-strength indications.

The rear panel, shown in Fig. 1, includes a pair of terminal strips for main and remote pairs of speakers, speaker protection and line fuses, the necessary input and output jacks, antenna terminals for both 75 ohm and 300 ohm connection of FM antennas as well as provision for connection of an external AM antenna, a pivotable AM ferrite bar antenna, an AC convenience outlet and a special "4-channel decoder" jack intended for the future, in the event that a system of four-channel FM discrete broadcasting is authorized by the FCC. Nearly all new receivers and tuners are including this jack again—much as this feature was included in the years before stereo broadcasting became a reality. The terminals provided for speaker connection are of the screw type (as opposed to the fancier "push to insert wire" type on more expensive sets) but they are sufficiently spaced to prevent speaker cable shorts.

As can be seen in Fig. 2, modular printed circuit board

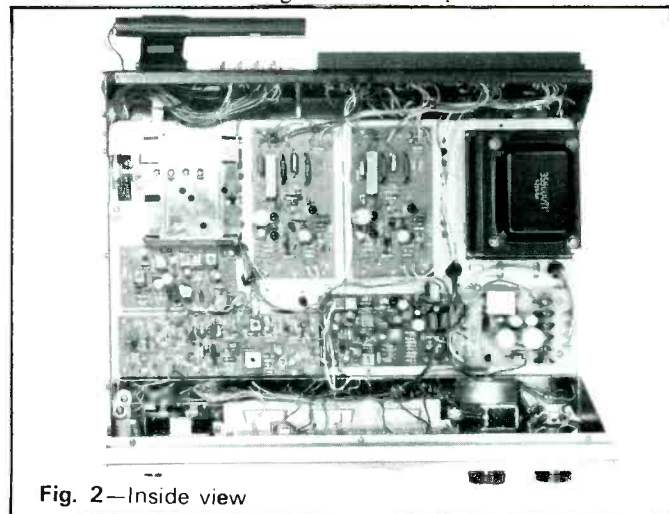

Fig. 2—Inside view

You buy us best When you buy us last



It's unusual when an audio system begins with headphones. You usually begin with receivers, turntables, and speakers. Along the way you learn a lot about performance and value. Just in time to select your headphones.

We like it that way, because the more you know about audio, and value, the more likely you'll take the time to select a headphone specialist.

You might begin now by writing for a free brochure about our new headphone line.

SCINTREX

HEADPHONE SPECIALISTS

Scintrex Inc., Amherst Industrial Park, Tonawanda, N. Y. 14150

Check No. 23 on Reader Service Card

construction is used throughout the S-7200 chassis. The sealed front-end includes an FET RF stage, plus two conventional low-noise transistors used for local oscillator and mixer stages. The IF section includes 3 transistor stages, an IC amplifier-limiter stage and a conventional ratio detector stage. Interstage bandwidth is determined by three ceramic filters which require no alignment and double-diode limiters further improve limiting characteristics of the IF system. Preamplifier audio sections utilize discrete transistors, as do the stereo multiplex decoder circuit, tone control circuits (which are of the preferred Baxandall "feedback" type) and power amplifier modules. The power output stages are operated in a push-pull series-parallel arrangement and these NPN devices are powered by positive and negative supplies, so that speaker connection point is at zero potential, eliminating the need for coupling capacitors between outputs and speakers. Noteworthy, too, are the pair of "bridged-T" R-C filters employed at the output of the multiplex decoder section to reduce content of any sub-carrier 38 kHz, 19 kHz or 76 kHz components in the recovered "left" and "right" output signals. A voltage regulated supply which includes a zener diode and a series current regulating transistor maintains stable operating voltages for the low-level amplifying stages and tuner sections.

Laboratory Measurements

As shown in Fig. 3, our particular sample fell a bit short of making the 1.8 uV IHF sensitivity claimed for this model, measuring 2.3 uV. Ultimate S/N, however, reached published specs of 66 dB exactly and, more important, with a signal of as little as 5 uV, quieting had already reached an impressive 52 dB. If the interstation muting feature is used, all signals received will be heard with a quieting of better than 52 dB, since the muting threshold is set at about 7 uV for this model. THD in mono exceeded published claims, reaching a low figure of just 0.2% at mid-audio frequencies. In the stereo mode, THD at 1 kHz measured 0.6%—a very acceptable figure but one which cannot be compared to published claims because Sherwood fails to note this specification.

Figure 4 combines our measurements of stereo FM separation with complete measurement of THD versus frequency for both mono and stereo reception. The 40 dB mid-band separation figure is exceeded by 3 dB and 30 dB of separation is maintained up to 10 kHz and to well below the 50 Hz lower audio limit of FM stereo broadcasting. As for THD, it remains under 1.0% to about 12 kHz in mono and is under

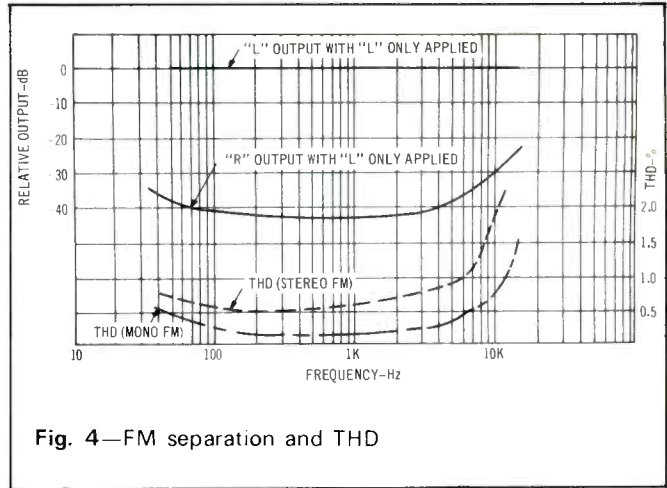

Fig. 4—FM separation and THD

1% up to about 6 kHz in stereo, rising at higher frequencies because of the presence of "beats" between the recovered signal and the internally generated 19 kHz signal. As has been pointed out in the last several reviews, these "distortion" figures are not nearly as audible as their "numbers" would indicate since, under random musical conditions, the beats occur in random fashion and are not "continuous" in nature. We show these figures primarily so that readers can compare this effect from one unit to another. It should also be noted that the zero-center meter indication on our sample unit occurred at the lowest distortion point, as it should, which means that the meter can be used as an accurate guide to perfect tuning. We have encountered other sets in which this is not true, and such discrepancies usually indicate inaccurate alignment of the ratio detector stage or, when more tunable circuits are involved, some of the IF stages as well. Measured capture-ratio was 2.0 dB, just a bit short of the 1.9 dB claimed.

Our power amplifier tests were confined to 8-ohm loads, but at that, the Sherwood S-7200 exceeded its claims and pumped nearly 43 watts into each load, with both channels driven. 1% THD was reached when output meters read 45 watts per channel—again with both channels driven. These measurements are graphically shown in Fig. 5, together with the IM measurements which, though not mentioned in Sherwood's published specs, were quite respectable, reaching

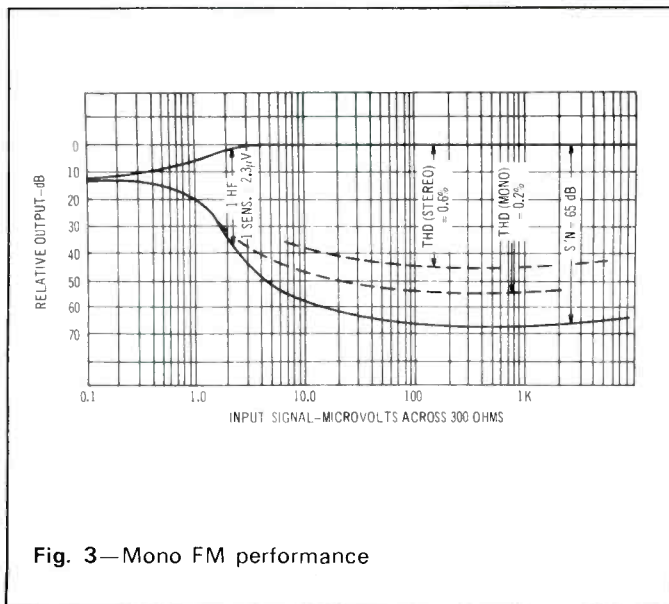

Fig. 3—Mono FM performance

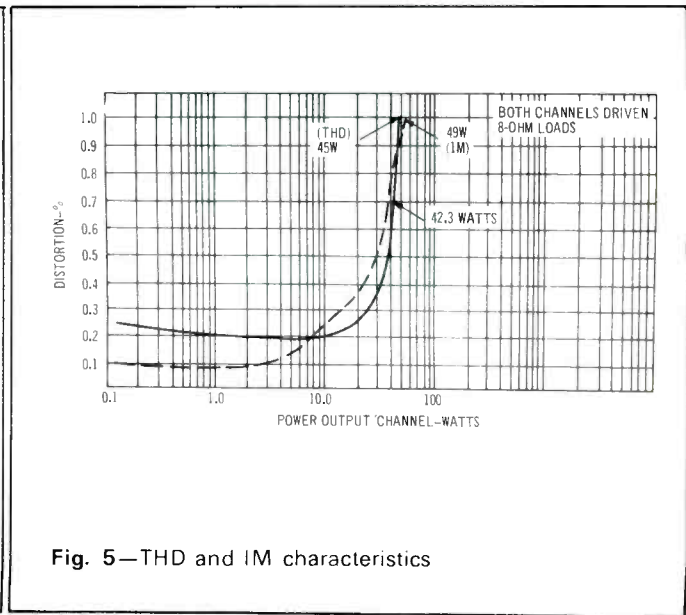

Fig. 5—THD and IM characteristics

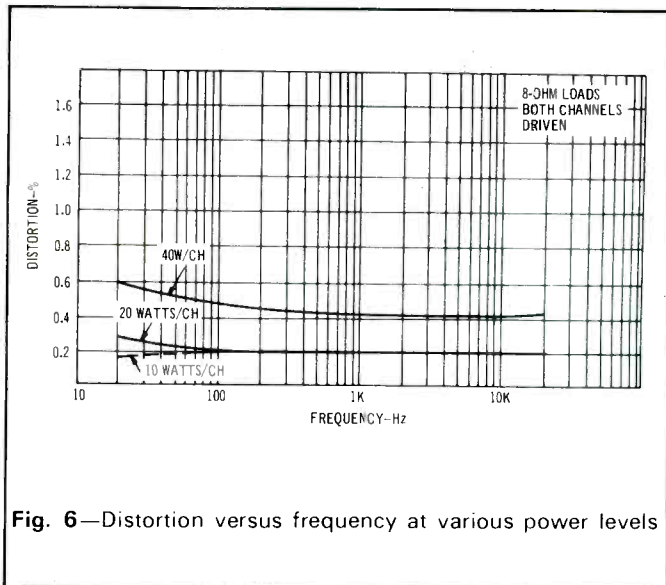

Fig. 6—Distortion versus frequency at various power levels

1% at 49 watts per channel output into 8-ohm loads.

Based upon a 40-watt rated output per channel, power bandwidth extended from 10 Hz to 40 kHz, quite a bit better than claimed. At the audio limits of 20 Hz and 20 kHz, 1% THD was reached at 36 watts per channel and 40.5 watts respectively, while at all power levels below 40 watts, THD remained well under 0.5% for all audible frequencies, as can be seen in Figs. 6 and 7.

Phono hum measured exactly 60 dB as claimed, while residual hum in AUX checked out at -76 dB, a bit poorer than claimed, but virtually inaudible at practical listening levels. The loudness-volume control of the S-7200 deserves special mention. The tracking of the two sections of this control was excellent—with no more than 1 dB variation all the way down to 60 dB from the full clockwise position—which means that high quality potentiometers are used in this all important control.

Bass, treble and filter characteristics are graphically plotted in Fig. 8 and are seen to conform to published claims. The high frequency filter rolls off at a rate of 6 dB per octave, but its 6 kHz turnover point makes it useful for record scratch reduction as opposed to treble control attenuation for the same problem.

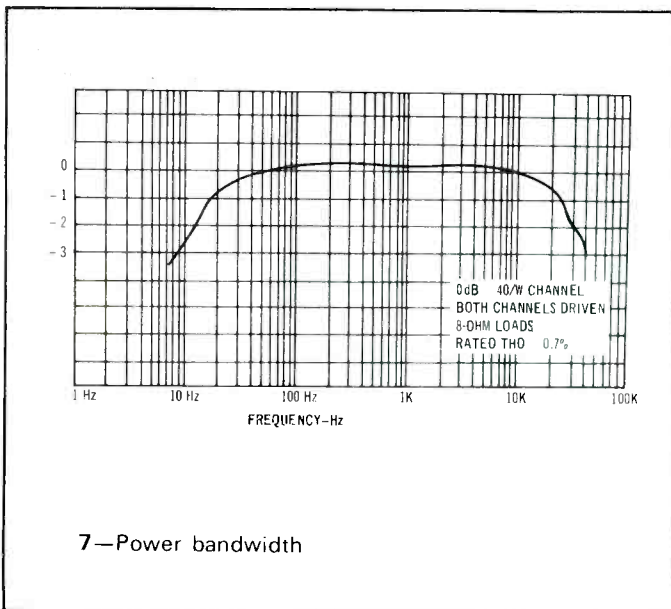

7—Power bandwidth

Listening Tests

The Sherwood S-7200 is, first and foremost, a fine FM performer. We liked the muting action, which is noiseless and seems adjusted to just the correct point to reject noisy signals and accept all usable transmissions. We logged some 47 acceptable signals with the muting "on" rejecting some five others that would have been too noisy to listen to comfortably with the muting circuit defeated. Tuning is very smooth and pin-pointing center of channel is quite easy with the meter. The selectivity characteristics of this receiver are typical of the Sherwood units we've tested in the past, a characteristic we particularly like. So far as FM performance is concerned, the unit behaves in every way like its more expensive counterparts made by this manufacturer.

It was in the area of audio amplification, however, that we got our biggest surprise. The S-7200 is one powerful set! The numbers had indicated as much in our lab measurements but, somehow, when you're dealing with an "under \$300" model you come to expect certain power limitations which just did not show up on this unit. Using low-efficiency speaker systems in our main listening area, we just could not overdrive the amplifier portion at any desired listening level—and we mean all the way up to over 100 dB sound-pressure levels. We did note a tendency for our cartridge (nominal output 4.0 mV) to slightly drive the input stages into distortion when particularly loud passages on some records were played and we would recommend using a somewhat lower-output cartridge with this model, since the 60 mV overload limitation is a bit on the low side. Alternatively, external resistive padding could be done, providing the cartridge continues to see its proper load impedance. In most instances, however this will not prove to be a problem, since the recordings we used to check out this point are very heavily cut and cartridge output probably exceeded the 60 mV limit during very loud passages.

Sherwood's association with its Japanese source of manufacture is obviously a fortuitous one for consumers interested in a top-performance receiver in this price class. The engineering and design continues in the Sherwood tradition—the price tag should open a whole new market for the company.

Leonard Feldman

Check No. 106 on Reader Service Card

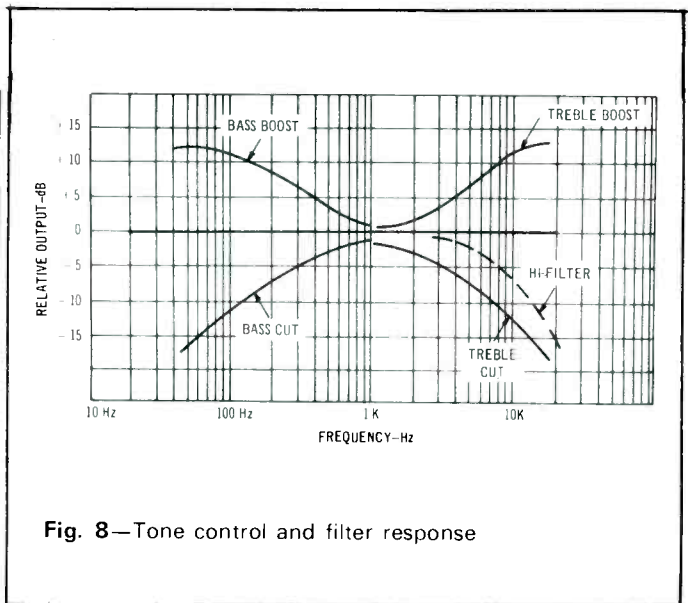

Fig. 8—Tone control and filter response

correction

The tone-burst responses of both the Infinity 1001 and Design Acoustics D-12 loudspeakers were printed upside down

Advertising Index

ADVERTISER	PAGE	ADVERTISER	PAGE	ADVERTISER	PAGE
AKAI America, Ltd.	23	Fairfax Industries, Inc.	32	Sansui Electronics Corp.	19
Series 900 Receivers		Loudspeakers		Quadraphonic Components	
Check No. 11 on Reader Service Card		Check No. 16 on Reader Service Card		Check No. 17 on Reader Service Card	
Audio Dynamics Corp.	29	Frazier, Inc.	16	Saxitone Tape Sales	68
ADC-XLM Cartridge		Loudspeakers		Magnetic Recording Tape	
Check No. 4 on Reader Service Card		Check No. 20 on Reader Service Card		Write Direct to Advertiser	
Audio Warehouse	69	Innermedia Electronics Corp.	65	Schober Organ Corp.	64
Mail Order Discounts		High Fidelity Components		Electronic Organ Kit	
Check No. 37 on Reader Service Card		Check No. 34 on Reader Service Card		Check No. 32 on Reader Service Card	
BSR (USA) Ltd.	63	KLH Research & Development	7	Schwann Record & Tape Guide	58
Turntable		Model Fifty-Four Receiver		Guide to Current Records & Tapes	
Check No. 30 on Reader Service Card		Check No. 3 on Reader Service Card		Write Direct to Advertiser	
Bose Corporation	Cover 3	Linear Design Laboratories	2	Scintrex Inc.	47
901 and 501 Loudspeakers		LDL 749 Loudspeaker System		Headphones	
Check No. 38 on Reader Service Card		Write Direct to Advertiser		Check No. 23 on Reader Service Card	
R.T. Bozak Mfg. Co.	37	Marantz Co., Inc.	Cover 4	Shure Brothers Inc.	34, 35
Loudspeakers		Speaker Systems		Mark III Cartridge	
Write Direct to Advertiser		Check No. 43 on Reader Service Card		Check No. 18 on Reader Service Card	
British Industries Co.	3	Maximus Sound Corp.	60	Sony Corp. of America	11
Zero 100 Turntable		Loudspeakers		6650 Receiver	
Check No. 1 on Reader Service Card		Check No. 25 on Reader Service Card		Check No. 6 on Reader Service Card	
David Clark Co., Inc.	61	McIntosh Laboratories	65	Soundcraftsmen	9
4-Channel Headphones		MX 113 & Catalog		Equalizer	
Check No. 26 on Reader Service Card		Check No. 33 on Reader Service Card		Check No. 21 on Reader Service Card	
Crown International	43	Midwest Hi Fi	67	Southwest Technical Products Corp.	64
DC300A Amplifier		Mail Order Discounts		207 Amplifier	
Check No. 14 on Reader Service Card		Check No. 36 on Reader Service Card		Check No. 31 on Reader Service Card	
Dynaco Inc.	25	Onkyo Sales	45	Stanton Magnetics	13
A-25 Loudspeaker		3/Way Speaker System		Headsets	
Write Direct to Advertiser		Check No. 22 on Reader Service Card		Check No. 7 on Reader Service Card	
Eastman Sound	33	Phase Linear Corp.	36	Tascam Corporation	38, 39
Martin Speakers		700 Amplifier		Mixing Console and Dealers	
Check No. 10 on Reader Service Card		Check No. 9 on Reader Service Card		Check No. 19 on Reader Service Card	
Electro-Voice, Inc.	10	U.S. Pioneer Electronics Corp.	Cover 2, 1	Trusonic	62
Loudspeakers		Amplifiers and Receivers		JR-200M Speaker	
Check No. 5 on Reader Service Card		Write Direct to Advertiser		Check No. 24 on Reader Service Card	
Empire Scientific Corp.	63	Revox Corp.	27, 61	United Audio Products, Inc.	31
Cartridges		High Fidelity Components		Dual Turntables	
Check No. 29 on Reader Service Card		Check No. 13 on Reader Service Card		Check No. 15 on Reader Service Card	
Epicure Products	15	Record Cleaning Method		Wholesale Audio	66
Speaker Systems		Check No. 27 on Reader Service Card		Mail Order Discounts	
Check No. 8 on Reader Service Card		Rogersound Laboratories	6	Check No. 35 on Reader Service Card	
		Loudspeakers			
		Check No. 28 on Reader Service Card			

THE WORKBENCH

An Inexpensive Microphone

By Roland H. Reiss

MOUNT THIS MINIATURE INTEGRATED CIRCUIT CONDENSER TRANSDUCER INTO A TIME WORN MICROPHONE HOUSING AND ADD A NEW DIMENSION TO YOUR LIVE TAPE RECORDINGS.

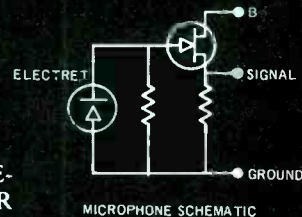

A prime example of man's inhumanity to man is to provide him with a wonderful extended range tape recorder and include an inexpensive microphone to use for recordings. Most inexpensive microphones crop off a small band of frequencies on the low end of the audio range and an even greater band of high frequencies. The resulting recordings made with these microphones leave much to be desired by the serious minded audiophile. Music recordings that lack the high frequency transients and low overtones, sound lifeless and flat. No recorder can overcome this handicap imposed on it by an inferior microphone.

In search for a better microphone, it doesn't take long to discover that prices are directly proportional to the increased frequency response. The higher the fi, the higher the price. The condenser microphone is capable of recording sounds well above the range of most recorders but its cost has been high enough to keep it out of the amateur's hands.

A recent development in microphones has been the electret condenser microphone. This microphone has most of the fine qualities that the standard condenser microphone has, but has eliminated the need for the high voltage used to polarize the diaphragm of the standard condenser microphone. This does away with the bulky high voltage power supply. The electret's diaphragm is pre-polarized by subjecting a thin metalized plastic film to a high voltage flux field and raising the temperature of the plastic close to the melting point. Cooling the plastic film slowly while it remains in the flux

field results in a permanently polarized plastic film that is used for the diaphragm of the microphone. By placing this charged diaphragm close to the gate lead of a field effect transistor, a solid state electret microphone is created.

The operating principles of this electret condenser microphone are fairly simple. The metalized plastic diaphragm, vibrating with the sound pressure close to the FET gate, acts as a charged capacitor and converts the sound vibrations into voltage variations. The varying voltage signal is taken from the low impedance point of the FET source follower circuit. The extremely high impedance of the electret element is thus reduced to a lower impedance capable of working directly into most high quality recorder preamps.

Browsing through the classified section of AUDIO recently I came across an ad for an electret microphone module which costs only \$13.50. So I sent for one and I must say I have been very pleased with the performance. The unit is combined with an FET preamplifier and is housed in a tiny package measuring slightly more than a quarter of an inch square and less than three sixteenths of an inch thick. It is basically a complete microphone in itself, needing only a small penlite cell to power it and an output cable to transfer the signal output to the recorder. The current drain of the package is so small (30 microamps typical), that no provision need be made for an on-off switch. Ten thousand hours of battery life is common.

This tiny microphone module may be used as is by building it directly into the

front panel of a tape recorder to provide a permanent high quality sound pick-up for live recordings. Small as it is, it can easily be mounted inside a discarded microphone housing, converting it into a hand held mike. When mounting the module inside a microphone housing, it is suggested that a pop filter made from 1/2" to 1" of open grained foam plastic be placed between the front grill and the front of the module. This type of foam is common, and is often used as packing material for shipping fragile instruments. A simple method of mounting the module after it is wired, is to sandwich it between two pieces of foam plastic cut to proper size to fit inside the microphone housing. The two pieces of foam act as a pop filter and shock mounting. With a little ingenuity, any time worn microphone can become a professional quality condenser microphone.

With the development of these small electret condenser microphone modules, professional sounding recordings are easy to get and at a cost within the range of any recording enthusiast. This miniature integrated circuit transducer, model 5333, is available from Electronics Enterprises, 3305 Pestana Way, Livermore, California 94550.

I agree with Mr. Reiss that microphones supplied with recorders are often of poor quality. On the other hand good quality microphones can be bought quite cheaply. For instance, there is the Sony ECM 18 electret type around \$20 and the TEAC dynamic MC-106L at \$18. However, I must say the specifications of the 5333 look good and its small size gives a lot of scope to the experimenter. We hope to review one of these modules in the near future—ED.



Leader Model LBO-301 Oscilloscope

MANUFACTURER'S SPECIFICATIONS:

Vertical Sensitivity: 10 mV p-p to 5 V p-p per division, in 9 steps; uncalibrated continuous control between steps up to 10 V p-p per division. **Bandwidth:** d.c. to 7 MHz. **Input Impedance:** 1 Meg/40 pF direct; 10 Meg/15 pF (or less) with probe. **Horizontal Amplifier:** Sweep Speed, 1 μ sec to 0.2 sec/division in 17 steps; uncalibrated continuous control between steps to 0.5 sec/division; 5X magnifier at all TIME/DIV settings. **Sweep Synchronization:** triggered and automatic. **Control:** triggered and automatic, internal and external, + and -slope. **Sensitivity:** 1 V p-p normal; 200 mV p-p at X5 magnification. **Sweep Bandwidth:** 2 Hz to 200 kHz. **Dimensions:** 4 $\frac{3}{4}$ " H x 8" W x 12" D. **Weight:** 8.8 lbs. **Price:** \$389.95.

Miniaturization of practically everything in the electronics field has resulted in a whole new breed of instrumentation which does not require a truck to handle it nor does it necessarily imply any diminution in performance. One instrument which traditionally has been the largest element on a test bench is the oscilloscope—and this is likely due to the fact that the user wants as large a screen as possible, and a large screen demands a longer tube. Thus the usual dimensions of the common 5-inch 'scope were about 10 in. wide by 13 in. high by, say, 17 in. deep, and if one wanted sweep triggering it was almost impossible to get it in anything less than the 5-in. variety. That is, unless one could afford one of the professional models which could run up in price close to that of the average automobile.

The Leader LBO-301, however, provides practically every facility found in the more expensive scopes—and the larger ones, too—in a compact unit. All solid-state, of course (except for the CR tube itself), with nine steps of attenuation as well as a continuously variable control, and with triggering or automatic sweep over 17 steps, together with switch settings for both vertical and horizontal TV sweep speeds as well as for external horizontal sweeping. Input to the vertical amplifier may be either a.c. coupled or direct for d.c. measurements. Separate triggering input is also available. For users who have need to service color TV sets, there is a built-in vectorscope facility available on rear panel input jacks, together with switches to set either normal or vector operation. In addition, there is a 10-V p-p

sawtooth output jack for those applications requiring it. There is also a jack providing for intensity modulation of the beam.

Mechanically, the unit is equipped with a carrying handle, and with four rubber feet for use in the usual horizontal position. On the rear are four rubber feet on standoffs which serve to store the a.c. cord when carrying, as well as to permit vertical operation.

The front panel accommodates the CR tube in the upper left corner, with its graticule marked in 8 vertical and 10 horizontal divisions of 6 mm each, with 5 minor divisions on the centerlines, and with 12 markings 30 deg. apart for vectorscope application. The remainder of the front panel is divided into three sections—the one under the CR tube accommodates the intensity and focus controls, as well as the power switch and pilot light. The upper right section has a jack which provides a 0.5-V p-p square wave of approximately 1000 Hz (the test sample was 961 Hz) for calibration purposes. Below the jack is the vertical positioning control.

Next to the right is the dual-concentric sensitivity control with 9 positions for calibrated inputs. The smaller red knob provides a variable sensitivity between steps of the switch, being out of circuit when turned fully to the right to the "CAL'D" position. At the far right are the input jacks—the "hot" input being a UHF receptacle which accommodates a standard UHF plug or the 10X probe cable. The latter, a furnished accessory, has several interchangeable tips—a sharp point, a hook, and a spring-loaded retractable hook. The cable is 6 feet in length and offers a 10 to 1 reduction in signal level, and presents a load of 10 megohms shunted by 15 pF. Also furnished are six clip-terminated leads and a UHF plug fitted with a 5-way binding post, and a grounding lead which snaps around the base of the probe. Under the UHF input jack is the ground jack, so spaced as to accept the usual $\frac{3}{4}$ -in.-spaced dual banana plugs. Below the ground jack is the input switch, with three positions—AC, DC, and GND—the latter grounding the input jack.

The lower right section is for the horizontal control. At the left are the horizontal positioning control, the knob, when pulled out, actuates the 5X magnifier—increasing the sweep magnitude by five times. Below it is the trigger level control, with a switch at the maximum counterclockwise

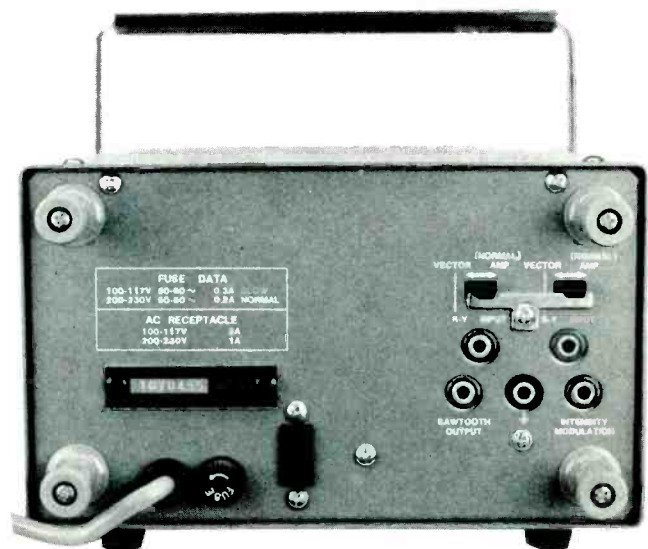

Fig. 1—View of rear panel showing vectorscope switches and input jacks for the vector display, as well as the sawtooth output and intensity modulation jacks.

position actuating the automatic sweep. The next large knob sets the sweep rate, with 17 positions from 0.2 sec/div to 1μ sec/div; two more positions for automatic TV vertical (approximately 60 Hz) and automatic TV horizontal (approximately 15,750 Hz). The remaining position is for external horizontal input to the sweep amplifier. The small red knob of the dual concentric control provides for continuously variable sweep speed. At the far right are two slide switches—the upper one controls trigger slope, + or -, while the lower one selects internal or external triggering. Two more jacks (all jacks accept banana plugs) are for external horizontal input or external trigger input and the necessary ground inputs.

The extreme compactness of this instrument makes it a joy to use, and after several months of workbench application, it has been found to provide every needed function. For years, this observer used a conventional tube-type 5-inch scope—also a triggered type—but space and modernization dictated the use of a smaller unit, and the Leader LBO-301 serves admirably. Bandwidth was noted as reaching 7.5 MHz easily; intensity and focus controls provided an exceptionally usable display, and for all audio applications the 'scope serves well. This observer has never had occasion to use the vectorscope facility, but if it performs as perfectly as the remainder of the instrument, it would be completely satisfactory.

No review of this type of device should be complete without complimenting the manufacturer for a complete and informative instruction book. Since the circuit employs 45 transistors (of which three are FET's) and 30 diodes (of which five are Zeners), complete circuit data is desirable. This book describes the unit completely and could serve as a short course in the applications of the 'scope in voltage measurement, frequency measurement, and the checking of diodes and transistors. The circuit is assembled on five circuit boards, with the 1500-volt CR tube anode supply being derived from a transistor oscillator and the associated transformer and rectifier/filter circuitry. Full instructions for servicing are furnished in the instruction book, together with a very complete parts list. In short, a very serviceable book.

In the interest of extreme compactness, two items have been omitted which we would have liked to find in the instrument—one is a source of illumination for the graticule, and the other is a d.c. input for the horizontal input. Space probably ruled against the former, and because a d.c. bal-

ance voltage is fed to the base of the input transistor in the horizontal input, the application of a direct voltage to this point would disturb the balance. However, neither of these "omissions" is of great importance, and the instrument as it stands is exceptionally convenient to use, provides everything necessary for the audio experimenter and the TV technician, and is well within the price range of the average user. This observer certainly welcomes it for its performance and its compactness. It fits easily on a typical instrument shelf above the workbench, not requiring a separate support adjacent to the bench area. On the whole a most desirable unit.

The Leader LS-5 Electronic Switch is a useful accessory for use with the 301 'scope—or with any other, for that matter. This device offers dual-trace capability to the 'scope, functions over a range from d.c. to 200 kHz, and offers a wide range of switching frequencies. Calibrated at 1.5, 5, 30, and 50 kHz, its switching frequencies actually measured 1799, 4910, 31,423, and 79,188 Hz on a frequency counter. When the maximum switching frequency of an electronic switch does not exceed 5 kHz—which was the approximate limit of the writer's previous electronic switch—the input frequencies are limited. However, with the extension of switching rates to 50 kHz at least, the displayed frequency presents a pair of practically continuous lines, which makes it much easier to comprehend.

The LS-5 is small, measuring only $3\frac{1}{8} \times 5\frac{1}{2} \times 4\frac{3}{8}$ " deep, and it weighs only 2.7 lbs. A bracket attached to the case is intended to permit attachment to the bezel-mounting screw on the average 'scope, so it becomes almost a permanent part of the 'scope, since a receptacle is provided on the rear into which the 'scope can be plugged, thus saving an extra power cable.

The switch is fitted with three slide switches—one for power, and the other two for a.c. or d.c. connection to the inputs, both of which are provided with a pair of diode-connected transistors for protection. The inputs are fed to the gates of two FET's, with the vertical positioning being controlled by varying the source bias on the FET's. The outputs of the two circuits are combined in an emitter follower and fed to the 'scope through the OUTPUT jack. The four-frequency multivibrator employs two transistors, with the speed being controlled by selecting capacitor pairs. Gain controls are provided for both channels, as positioning controls, and the front panel accommodates six binding posts with banana receptacles—two inputs with a common ground on the left side and trigger and output binding posts on the right side with their common ground. A pilot light (neon) and the switching-rate selector complete the layout.

The circuit employs the aforementioned two FET's for inputs and a third FET for the trigger output. Two bipolar transistors are diode connected to serve as input protectors. Two more serve as amplifiers which have their outputs combined to feed another as the output emitter follower; two more comprise the multivibrator, and the remaining two are regulators for the +9 and -9 volt supplies required for the circuit. The power transformer can be wired for either 100- or 115-volt a.c. mains, or for 200 or 230 volts, as required.

The unit does exactly what it is supposed to do, and is most handy in use. As with the LBO-301 'scope, the instruction book is complete in both description and operating instructions, as well as a detailed parts list, printed-circuit board layout, and schematic—everything needed to perform your own maintenance.

C.G. McProud

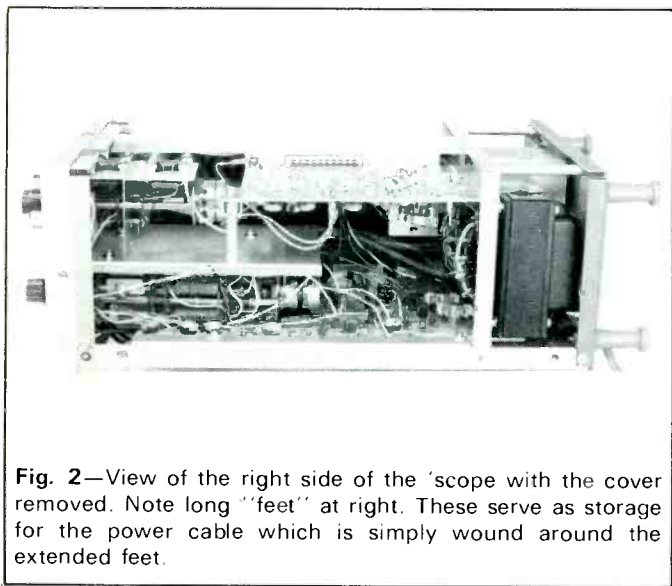

Fig. 2—View of the right side of the 'scope with the cover removed. Note long "feet" at right. These serve as storage for the power cable which is simply wound around the extended feet.

Check No. 101 on Reader Service Card

STOP

BEFORE YOU BUY THAT RECORD . . .

WAIT A MINUTE!

IS IT REALLY A BARGAIN?
IS IT THE PERFORMANCE YOU REALLY WANT?

Check the other performances and recordings in the latest Schwann Record & Tape Guide.

If it saves you disappointment over one poor purchase, it's well worth the time to look in Schwann first.

Schwann-1 Monthly. Special new listing section has latest releases: records, 8-track cartridge and cassette tapes. Nearly 45,000 total listings on 773 labels in classical, recent popular, rock, jazz, musical shows, country, opera, ballet, electronic, quadrasonic, etc.

Schwann-2 Semi-annual catalog for specialized categories: pop more than two years old, classic jazz, older and re-released mono and reprocessed stereo classical recordings, classical on lesser-known labels, international pop & folk on domestic labels, spoken, educational, religious, etc.



SPECIAL PRICE SAMPLE OFFER

If your favorite store doesn't carry Schwann, order samples by mail. Prices include postage and handling.

- Schwann Sampler one Schwann-1 (monthly) and one Schwann-2 (semi-annual)\$2.00
- Latest Schwann-1 (monthly)\$1.25
- Latest Schwann-2 (semi-annual)\$1.00
- Newly revised Basic Record Library booklet.

Lists 1,000 suggestions in classical music by musical periods for your enjoyment. Send 15¢ for cost of handling, also 8¢ stamped self-addressed long envelope.

I enclose \$.....for the items checked above.

Name _____

Address _____

City _____ State _____ Zip _____

Dealer's Name & Address _____

Schwann Record & Tape Guide

137 Newbury Street, Boston, Mass. 02116

AU



Cordless soldering iron

This unique Wahl "Iso-Tip" soldering iron is powered by rechargeable nicad battery built into the handle. It comes to full 700 degrees heat within 5 seconds and can solder up to 100 joints on a single charge. A guide light is incorporated and the price is \$22.95.

Check No. 102 on Reader Service Card

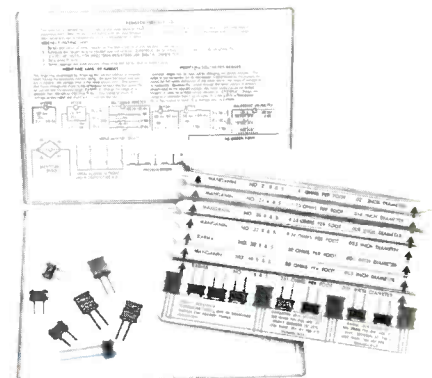

Instant ohms?

Chronomite Laboratories of California have just released details of their resistor kits which contain 7 kinds of resistance wire ranging from 0.5 ohms a foot to 300 ohms. Also included are 11 epoxy bobbins, instructions and schematics. It is stated that resistances can be made at about 2 cents each. Price \$12.95.

Check No. 103 on Reader Service Card



Head demagnetizer

Model QM-202 is a professional head demagnetizer from Nortronics. It features a flexible probe which can reach usually inaccessible recorder parts such as capstans, guides. A micro-switch is built in. Price: 3 or less, \$10.55 each.

Check No. 104 on Reader Service Card

Home Constructors

An interesting publication catering to the home constructor is the *Audio Amateur* which is excellent value at \$5 for four issues. Details can be had from E. Dell, 307 Dickinsin Ave., Swathmore, Pa. 19081.

Check No. 105 on Reader Service Card

Canby's Capsules

Titta Ruffo; Elizabeth Rethberg. RCA VIC 1680, 83, mono, \$2.98 ea.

Traubel; Baccaloni; Kirsten; Stevens; Farrell; Melchior. Columbia Y 31735, 6, 7, 8, 9, 40, mono (Farrell is stereo), \$2.98 ea.

Ten Famous Tenors. London OS 26207, stereo, \$5.98.

The Art of Ina Souez. Glyndebourne Festival; London Philharmonic; Busch, Erede, Barbirolli. Orion ORS 7293, mono, \$5.98.

Szell/Debussy/Ravel. *La Mer; Daphnis & Chloe, Suite #2; Pavane.* Columbia Y 31928, stereo, \$2.98.

Ravel: Daphnis et Chloe, Suites #1 and #2; Ma Mere L'Oye. Concertgebouw Orch., Haitink. Philips 6500 311, stereo, \$6.98.

Monster Concert. Ten Pianos, 16 pianists. Members Eastman Sch. faculty and grads., Adler. Columbia MQ 31726, quadraphonic, \$6.98.

Switched-On Bach. Walter Carlos, Moog Synthesizer. Columbia MQ 31018, quadraphonic, \$6.98.

An Introduction to the World of Quadraphonic Sound. Columbia QX 31403.

Sheer Sonic Sorcery! The Fantastic Philadelphians Great Showpieces of a Great Orch. Philadelphia Orch., Ormandy. RCA ARD 1-002, quadradisc, \$5.98.

The Glorious Gabrieli! 8 Symphoniae Sacrae (1597). 6 trumpets, 6 trombones. N.Y. Brass Ensemble, Samuel Baron. Orion ORS 7270, stereo, \$5.98.

As we continue to react from oversupply of classics, the companies mine the vivid opera world of the audible past—now reduced to low-price format. Those interested should check details at record stores, also note many more. Each of these is an entire LP devoted to one singer; the “takes” range from early acoustic through electric 78s and on into tape, with Farrell into stereo. Excellent modern restorations.

This regular-priced item cuts the cake a special way—all tenors, all stereo. Del Monaco, Di Stefano, Bergonzi, Bjoerling, Pavarotti, Domingo, McCracken, Prevedi, King, Corelli. Three standard French arias and one Wagner (King), the rest standard Italian.

An unfamiliar name here, but a top European singer (born in Colorado!) beginning in the mid-thirties. She was one of the early Glyndebourne stars under the famed Fritz Busch and her first side here is all Mozart, from Glyndebourne. Side 2 gets into Puccini, Bizet, Bellini, Verdi, with the Philharmonic. Fine old electrical 78 sound, evidently direct from EMI archives—no hiss. This EMI “farming out” idea is a good British innovation for reissues.

A whopping price difference between these overlapping discs, but it has some reason. The hi-priced Philips, lower in level than Columbia's (more music), even so is quieter, and marvelously clean in sound, a superb record. Columbia's older job is not quite as clean though perfectly OK. Szell's *La Mer* (Debussy) is polished and chilly; his Ravel steely tense, ending in controlled frenzy. The Dutch playing is warmer, meticulously accurate, intense but not frenzied. I like it better.

A perfectly nutty SQ recording and lots of fun—the assembled pianists have a ball, showing off their stuff like crazy. Sounds like a gargantuan music box with millions of trills and doodlings from 160 fingers. Old familiars: *William Tell, Stars & Stripes, Blue Danube, Maple Leaf Rag*, etc. etc.

Don't miss this one if your four-way set-up is set up, even if Walter Carlos objected to it. Doesn't matter—the record is delightful (especially the Brandenburg Concerto) any way you play it, and this version adds, as they say, new dimensions.

Ah, demos! Just what you'd expect, complete with super sales plug. Complements the first SQ demo, with different narrator (Michael Tolan), different material. No narration on side 2; just pop music. Bit of everything, humpback whales to Bernstein Mass, on side 1. Along with the goeey superlatives, which get tediouser and tediouser. How about *underplaying*, Columbia?

Quite OK, if not exactly sheer sorcery. Same work that Columbia calls *fabulous*, but here more distantly recorded, a mellower sound. Pending decoder, I played it via SQ—sounds fine. Level only slightly substandard, the stereo good. *Sorcerer's Apprentice, Danse Macabre, España, Night on a B. Mt.*

These big pro N.Y. brass men make an enormous hi-power sound, gorgeous, glorious, brilliant—and totally out of style. Some day, our pros will move out of their musical burrows to find what's going on elsewhere. The Gabrieli sound was *not* loud—it was brave but gentle, from sackbuts and (wooden) cornettos, and these instruments are now heard all over, even in N.Y. The music is intense, with strong rhythms and sharp lines; these players do it with loose, lax phrasing, little shape, in the New York manner. Alas, a typical American session. But it *is* brilliant.

by any name...

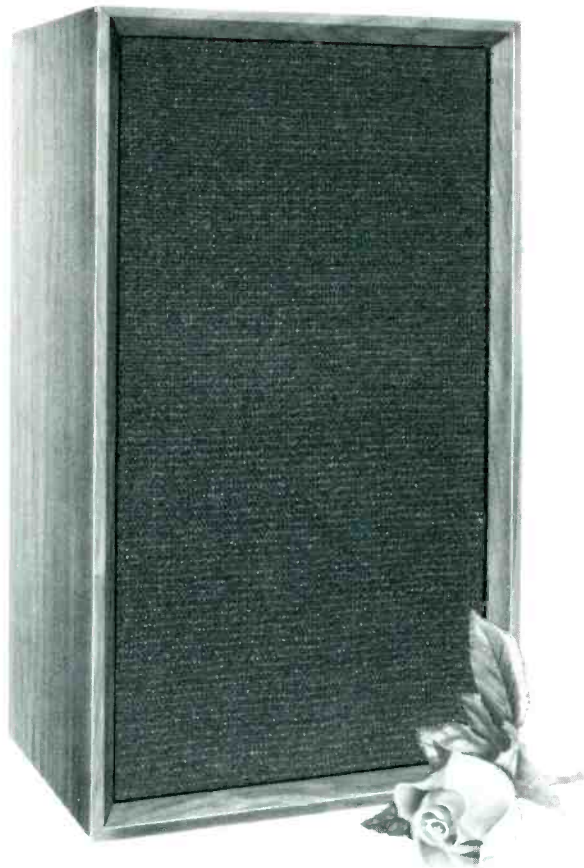

you'll **LOVE** it!

A Maximus made speaker by any name sounds as sweet. Your favorite dealer may well be one of the many who have Maximus made speakers under their own name. If so, the sweetest buy in sound may soon be yours.

Look for the Maximus  Hallmark of manufacture. It is your assurance that the highest principles of sound technology were used to create speaker systems *especially* for that dealer.

You needn't mention our name...

MAXIMUS SOUND CORPORATION

1000 Zeckendorf Boulevard, Garden City, N.Y. 11530 (516) 877-2500
MAXIMUS WEST, 1530 El Segundo Boulevard, Gardena, Calif. 90249 (213) 770-1284

Check No. 25 on Reader Service Card

(Continued from page 16)

recorded cassettes, cartridges and open reel tapes, and an assortment of electronic knick-knacks. Evidently pilferage is a very minor problem here . . . in New York, sad to say, the junkies would strip such bins in a very short time. Some of the stores in this area are very large . . . one six story establishment had three full floors devoted to hi-fi equipment. From what I could observe, the layouts of these hi-fi stores differ from typical stores in our country, in that few appear to have sound rooms as a separate entity. They are jam-packed with equipment, much of which can be demonstrated right on the spot. The result, when half a dozen customers are having simultaneous auditions, is sheer cacophony. All the brands of amplifiers, pre-amps, receivers, speakers, tape decks, etc. that you are familiar with in the U.S. are on display, but also many items that you never see here. For example, the Japanese never seem to be very keen on record changers (although BSR is now opening a plant there) preferring instead, manual turntable and arm combinations. There are some very intricate and ingenious turntable designs that for some reason are not exported to the U.S. The same can be said for a number of models of tape decks, and for more exotic items like acoustic-delay line pre-amplifiers. Another point of interest (and a page out of our own hi-fi history) is that "raw" speakers are still very much in vogue. There are bins of woofers of all sizes and display cases full of tweeters and mid-range units and electronic crossovers. Enthusiasts still make up their own speaker systems and bi- and tri-amplification setups are popular. Cheek-by-jowl with expensive receivers are compact systems and consoles. As noted previously, most consoles above the \$300 range are quadraphonic. There are many of these on display, but as far as I could see, few could be demonstrated with their rear speakers in action. Quadraphonic equipment of all kinds was much in evidence, and it would appear that the Japanese have embraced four-channel sound more quickly and to a much greater extent than we have. This, in spite of the fact that the matrix/discrete disc dispute is as much a factor in Japan as it is in the U.S. The record bins in the shops are full of Regular Matrix (QS), SQ and CD-4 discs, and there seems to be a tacit acceptance of the co-existence of these competing systems. However, in the light of some recent developments (about which I'll tell you a little later on) this situation could change quite rapidly.



Later in the afternoon, our group met with some prominent Japanese audio writers and critics, for an interchange of ideas. Although hampered considerably with language difficulties . . . both English-to-Japanese and Japanese-to-English suffered in interpretation . . . we had an interesting and in some ways surprising session. As you might expect, quadraphonic sound dominated the discussions. Without meaning to denigrate these gentlemen, it must be said that some of us felt that in spite of their closeness to the quadraphonic scene, they did not seem as "au courant" on the subject as we thought they would be. In particular, their knowledge of four-channel recording technology, both pop and classical, was fairly limited. However, even though it was obvious that these gentlemen had differing ideas about quadraphonic sound between themselves, in the overall sense they were totally committed to the idea of four-channel stereo. It is too bad we did not have more time together, and especially a chance to listen to some quadraphonic recordings, which I feel would have established a better rapport between our groups.

As the grand finale of our Japanese trip, Mr. H. Momose, Chairman of the Board and Mr. Y. Kitano, President of JVC, hosted an elaborate buffet party for us at the Imperial Hotel. Wonderful food, beautiful flowers everywhere, the buffet table dominated by a 5 ft. high pagoda carved out of ice, and super service by some lovely geishas . . . all added to the camaraderie and good ambiance of the affair. Thus ended our trip to Japan. I think we all learned some valuable things, not only about quadraphonic sound in general . . . and CD-4 in particular . . . but an appreciation of the Japanese character and their remarkable industry. We enjoyed all the social amenities offered so graciously, and the trip will long be a pleasant memory.

Æ

The Kleen Machine.

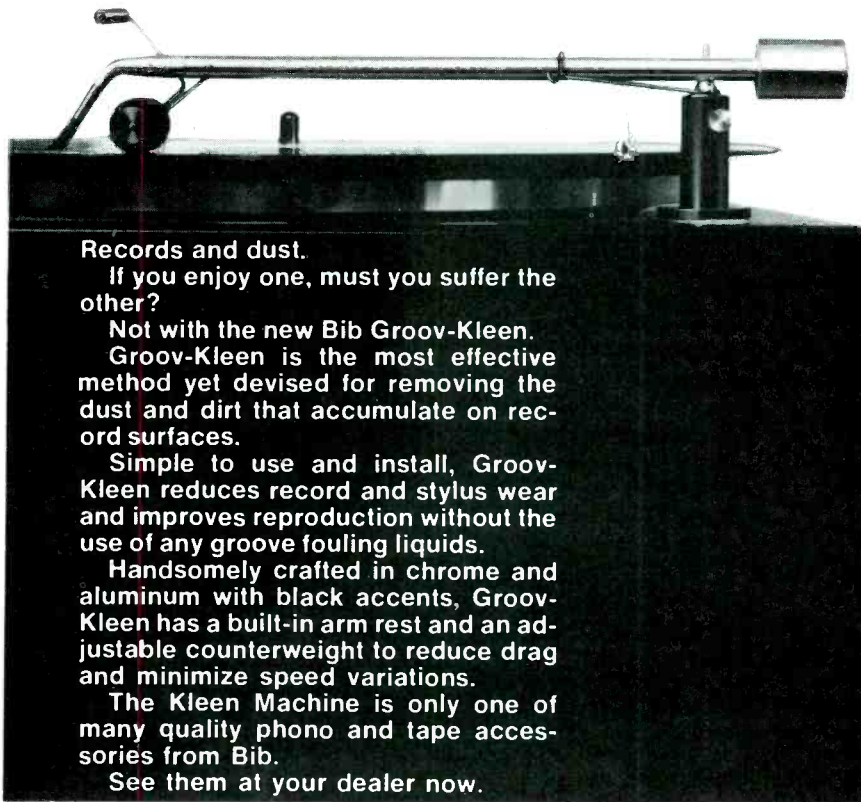

Records and dust.

If you enjoy one, must you suffer the other?

Not with the new Bib Groov-Kleen.

Groov-Kleen is the most effective method yet devised for removing the dust and dirt that accumulate on record surfaces.

Simple to use and install, Groov-Kleen reduces record and stylus wear and improves reproduction without the use of any groove fouling liquids.

Handsomely crafted in chrome and aluminum with black accents, Groov-Kleen has a built-in arm rest and an adjustable counterweight to reduce drag and minimize speed variations.

The Kleen Machine is only one of many quality phono and tape accessories from Bib.

See them at your dealer now.

Revox Corporation, 155 Michael Drive, Syosset, N.Y. 11791

Check No. 27 on Reader Service Card

CLARK/4 CH-A
FOUR CHANNEL
HEADSET



clark's
BIG
4

DC-2A DECODER

The all-new Clark 4 Channel Headset and DC-2A "Derived Ambience" Decoder, a 4 Channel System designed to be used with existing 2 channel equipment. The combination headset and decoder provides a complete system for 4 Channel Headset listening.

Send for complete information. **David Clark COMPANY**
INCORPORATED

360 Franklin St., Worcester, Mass., 01604

Check No. 26 on Reader Service Card

Weingarten;
Off
The
Record

-LAST TANGO IN PARIS (United Artists, UA-LA045-F) is the unexciting original motion picture score for the film that has stirred up more controversy than the devaluation of the dollar. Unfortunately, the music, composed by Gato Barbieri, is hardly worth discussing; it is bland for the most part, despite everyone possible rushing around in a tizzy trying to cash in on the publicity by pushing through another version of the title tune. The soundtrack includes three versions of it, not incidentally—a tango,

a ballad and a jazz waltz. But three times nothing still equals nothing.

-FRANK SINATRA 1943 to 1951 (Columbia, KG 31358) provides nostalgia-seekers with some of the smoothest vocals ever, not as superlative as Sinatra's work for Capitol perhaps, but great nonetheless. Highlights of the two-vinyl package include *Nancy (With the Laughing Face)*, *The Girl That I Marry*, *The House I Live In (That's America to Me)*, *Saturday Night (Is the Loneliest Night of the Week)*, *Mean to Me*, *Day by Day* and *Ol' Man River*. Ah, for the days when life was less frenzied!!

-LESS THAN THE SONG (A&M, SP 4376) finds Hoyt Axton performing magnificently to an armchair audience all too small. One of the most underrated singer-composers, Axton does a number on 10 of his own pieces plus a couple of others. His deep voice, with just the right touch of coarseness, is totally appropriate for his simple, direct and poignant lyrics. Backed by a vocal quintet that includes Linda Ronstadt, he stands out on *Peacemaker*, a beautiful anti-war, pro-sanity song, and *Sweet Misery*, a plaintive yet bouncy blues.

-d/b/a CROW (Amaret, AST-5013) showcases a brand of folk-rock-blues that is prevalent still—mediocre. Backed by two dozen musicians in Los Angeles, ex-Crow David Wagner offers 10 tunes that go nowhere in a hurry. His voice is ordinary—if anything, a bit weak—and manages only to show something on *Before My Time*, a modern bluesy outing. The disc is distributed by MGM, who shouldn't have bothered.

-FEELIN' (MGM, SE-4881) spotlights Steve Lawrence & Eydie Gorme doing what they do best, singing in a slick, professional manner without hype. There are 10 cuts arranged and conducted by Don Costa that have appeal-plus for the middle-of-the-road listener. Best are *I Am Woman*, *It Never Rains in Southern California* and *Smoke Gets in Your Eyes*.

-THE ISLEYS LIVE (T-Neck, TNS 3010-2) offers exciting soul-rock, so vital that the audiophile is almost defied to remain static. Even the slower tunes are filled to the brim with vibrant sex-soul. The two-disc package, distributed by Buddah, includes nine tracks by the Brothers; among them are four by the Isleys themselves, *Work to Do*, *It's Your Thing*, *Pop That Thing* and *Lay Away*. But don't overlook the others, rousing versions of pieces by Carole King, Stephen Stills, Bob Dylan, Neil Young and Jimi Hendrix.



what is a JR-200M to an audiophile?

Sound is to the audiophile what salt is to pepper, diamond's to a girl, or an oasis to a desert. Each has a most important relationship. That's why an audiophile, a real sound expert prefers TRUSONIC JR-200M's magnificent studio quality reproduction. Clean, undistorted sound from this 12" 3-way speaker system again demonstrates the incomparable electronic technology of TRUSONIC. THE PRICE? You

can pay twice as much, but you won't find a better studio quality system. Write TRUSONIC for complete information on JR-200M.

Just a few of JR-200M's impressive engineering features are 12" woofer for distortion-free low frequency bass performance 5" mid-range speaker for clean voice and horn reproduction, and a horn-loaded dome radiator tweeter for high frequency. A carefully engineered crossover network, plus individual level controls to adjust midrange and tweeter sound independently, are included. Size is: 24" x 15¼" x 12" deep. Finish: Hand-rubbed oil finish, Walnut veneer.

NET \$149.95



1100 E. Franklin Street, Huntington, Indiana 46750
West Coast Facility: 4950 Santa Anita Ave.
Temple City, California 91780

Check No. 24 on Reader Service Card

-IMMORTAL (Roulette, RE-125) is a return to the early Sixties when singers were expected to have trained voices as well as style, and, moreover, clarity. The late Dinah Washington shows, on this double-disc part of the "Echoes of an Era" series, that she knew one hell of a lot about jazz, blues and pop and could utilize that knowledge. Reissued highlights include *Make Someone Happy*, *Red Sails in the Sunset*, *That's My Desire*, *Something's Gotta Give* and *I'll Never Stop Loving You*. Other winning packages in the series include **KANSAS CITY SUITE/EASIN' IT** (RE-124) with Count Basie and his orchestra, and **'61/SL. SL. M.F.** (RE-122) with Maynard Ferguson's mystical trumpet and band.

-UNCLE JESUS, AUNTY CHRIST (United Artists, UA-LA009-F) is a tragicomic opus by Biff Rose, whose banter and light lyrics don't hide too well his displeasure at the world around him. His gallows-type humor is unleashed via a squeaky voice without range, almost perfect for his acid commentaries in music. Recorded, mostly, live at the Ice House in Pasadena, California, this disc is not for the faint-hearted or prudish. Rose, who penned all but two of the 11 cuts, is most fascinating on *Garbage*, an anti-pollution treatise; *San Anselmo*, a cutesy narrative without music, and *All Man's Got Is His Story to Tell*, which includes the introspective line: "It's good to make peace with your madness."

-THE HISTORY OF THE GUESS WHO (Pride, PRD-0012) deals up a dozen old cuts by the moderately successful Canadian rock group. Most interesting facet of the previously-issued material is that it proves that rock really *has* progressed and really does have a history. Also in the series, distributed by MGM, are **THE HISTORY OF SMALL FACES** (PRD-0014), **THE HISTORY OF SOLOMON BURKE** (PRD-0011) and **THE HISTORY OF THE GRATEFUL DEAD** (PRD-0016).

-LIFE IN A TIN CAN (RSO, SO 870) offers eight songs written and performed by the Gibb boys, a/k/a The Bee Gees. Barry, Robin and Maurice still provide one of the best soft-rock sounds around, and the pleasure never wanes because their products are consistently good. On this outing, distributed by Atlantic, Barry solos twice on *South Dakota Morning* and *While I Play*, is joined for a duet by Robin on *My Life Has Been a Song*, and all three dish out the rest.

When you make a better cartridge the world beats a path to your door.

From the U.S.

"Separation was tops... square wave response outstanding. We tracked it as low as 1/4 gram." **Audio Magazine**

"Among the very best. Frequency response was flat within ± 1 dB from 20-20,000Hz. Compliance measured 35 x 10⁻⁶ cm/dyne." **High Fidelity**

"The I.M. distortion at high velocities ranks among the lowest we have measured. A true non-fatiguing cartridge." **Stereo Review**

From Great Britain

"A real hi fi masterpiece. A remarkable cartridge unlikely to wear out discs any more rapidly than a feather held lightly against the spinning groove." **Hi-Fi Sound**

"A design that encourages the hi-fi purist to hold his hands with joy." **Records and Recording Magazine**

From Canada

"One of the world's greatest cartridges." Dealer's Choice. **Scotty's Stereo**

From Japan

Grand Prize for cartridges in first all Japan stereo Component competition.

Radio Gijutsu Magazine

Write for your free "Empire Guide to Sound Design."

EMPIRE Scientific Corp. Mfd. U.S.A. Garden City, New York 11530



Check No. 29 on Reader Service Card

What do you think of a guy who bought a \$150 turntable to go with a \$75 amplifier and a pair of \$40 speakers?

Smart. Audio "accountants" have formulas for appropriating funds to the various components in a stereo system.

Usually they recommend about 20% of the total to take care of the turntable and cartridge, which is OK if your total is \$500 or more.

But what do you do if you really love music, and have a 10-LP-per-month habit that leaves you with peanuts to spend for hardware.

If you followed the accountants' advice you might end up with a \$5 or \$10 cartridge in a \$30 changer. It would be arithmetically compatible, and might even sound OK. But later on, when you can afford that monster system

you've had your eyes on, you might find that your records sound worse than they did on your old cheapie system — because the inexpensive changer, with heavy stylus pressure and unbalanced skating force, was grinding up the grooves. And your cheap amp and speakers wouldn't let you hear the damage.

And now that you've spent a pile on high power, low distortion electronics, and wide-range speakers, you have to spend another pile replacing your records.

So, if you think you will want the best amplifier and speakers later, be smart and get the best turntable now... the BSR 810. Send for detailed specifications. BSR (USA) Ltd., Blauvelt, N.Y. 10913.



Check No. 30 on Reader Service Card

IM-Maximum-.01%



That's right .01% up to full rated output of 60 Watts. Thanks to our unique new all push-pull circuits we are able to offer an amplifier with performance that you are going to find hard to believe. Bandwidth is 5 to 150,000 Hz at the -1.0 db points. Our circuit features a complementary differential amplifier input, a triple in the output and volt-amp limiting.

The amplifier is supplied complete with the meter and perforated cover as shown. Front panel is standard 1/4 rack size for maximum convenience when multiple units are used. Single channel construction makes expansion of a stereo system to quad simple. Circle the number on the reader reply card, or write for a schematic and additional details.

207/A Amplifier Kit - 14 lbs. - \$ 75.00
207-AA Assembled - 14 lbs. - \$105.00

SWTC SOUTHWEST TECHNICAL PRODUCTS CORPORATION

219 W. Rhapsody, San Antonio, Tex. 78216

Check No. 31 on Reader Service Card

Now the most enjoyable, do-it-yourself project of your life— a Schober Electronic Organ!

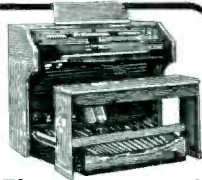

You'll never reap greater reward, more fun and proud accomplishment, more benefit for the whole family, than by assembling your own Schober Electronic Organ.

You need no knowledge of electronics, woodwork or music. Schober's complete kits and crystal-clear instructions show you— whoever you are, whatever your skill (or lack of it)— how to turn the hundreds of quality parts into one of the world's most beautiful, most musical organs, worth up to twice the cost of the kit.

Five superb models, with kit prices from \$500 to around \$2,000, each an authentic musical instrument actually superior to most you see in stores.

Join the thousands of Schober Organ builder-owners who live in every state of the Union. Often starting without technical or music skills, they have the time of their lives— first assembling, then learning to play the modern King of Instruments through our superlative instructions and playing courses.

Get the full story FREE by mailing the coupon TODAY for the big Schober color catalog, with all the fascinating details!

The Schober Organ Corp., Dept. AE-47
43 West 61st Street, New York, N. Y. 10023

Please send me Schober Organ Catalog.
 Enclosed please find \$1.00 for 12-inch L.P. record of Schober Organ music.

NAME _____

ADDRESS _____

CITY _____ STATE _____ ZIP _____

Check No. 32 on Reader Service Card

Jazz & Blues

Martha Sanders Gilmore

MONGO SANTAMARIA: *Afro Roots*. Prestige PR 24018.

Musicians: Mongo Santamaria— congas, bongos, percussion; Willie Bobo—timbales; Francisco Aguabella—congas, percussion; Modesto Duran—congas, percussion; Carlos Vidal—congas, percussion; Armando Peraza—congas, bongos, percussion; Jose Gamboa—vocals, tres, percussion; Juan Cheda—vocals, percussion; Jerry Rivera, vocals, percussion; Al McKibbin—bass; Emil Richards—vibes; Paul Horn—flute; Cal Tjader—vibes; Vince Guaraldi—piano; Jose "Chombo" Silva—tenor sax; Pablo Mozo—cowbell, sticks, triangle, percussion; Israel Del Pino—vocals; Mercedes Hernandez—vocals.

Songs: *Afro Blue; Che-que-re-que-che-que; Rezo; Ayenye; Onyaye; Bata; Meta Rhumba; Chano Pozo; Los Conguitos; Monte Adentro; Imaribayo; Mazacote; Ye Ye; Congobel; Macunsere; Tumbales y Bongo; Yambu; Bricamo; Longoito; Canga Pa Gozar; Mi Guacango; Columbia*

Prestige has been busying itself with reissuing some fine material out of Fantasy's catalogue, thus this specially-priced, two-record collection of Mongo Santamaria, previously released as Fantasy 8032, *Mongo* and Fantasy 8012 *Yambu*. It is certainly enough to last one a while and a gracious bushel for your money.

The twenty-two succinct and concise cuts of this happy ethnic music date from 1958-59 and are the first recordings Santamaria made as a leader on conga in the Afro-Cuban field which came into its own during the mid-fifties in the big bands of Noro Morales, Enric Madriguera, and Xavier Cougat. And you may recall Prez Prado and his popular *Cherry Pink and Apple Blossom White*. The exhilarating rhythmic tradition was further perpetuated by the smaller ensembles of Nat King Cole, George Shearing, and Cal Tjader. In the notes, Ralph Gleason gives an interesting history of the Afro-Cuban form and how its exotic rhythms and melodies breezed across the Gulf of Mexico from the Caribbean to New Orleans in the company of black exiles.

Three of the most prominent figures in the movement are featured here: Santamaria, Willie Bobo, and Armando Peraza together with vibist Cal Tjader, flutist Paul Horn, and a colony of percussionists who implement noisemakers so expertly to create music.

This is exemplary Santamaria, authentic and much less commercial than his work of more recent years in music in which rhythm is master and melodic lines lie few and far between as though overlooked or merely unnecessary. *Afro Blue* however, is most melodic, a Santamaria tune that has been reproduced in about seventeen different versions—clearly a hit for him featuring Emil Richards on vibes and Paul Horn on flute, pleasing intervals apart. And the chants, they are many, such as *Che-que-re-que-che-que* which sounds like a chirping cricket and *Meta Rhumba* which remains neat and tidy in spite of the rhythmic complexity of everything happening at once.

Pianist Vince Guaraldi of *Cast Your Fate To the Wind* fame, lays a chordal foundation in *Mazacote*, one of the longest, most infectious tracks that builds but never actually fulfills its promise. It does, nevertheless, permit Mongo and friends to display some of their many exotic wares, acting as a showcase for percussive talent with a bit of tenor sax thrown in by Jose "Chombo" Silva. Pablo Mozo's triangle acuity contributes a further dimension in *Congobel*, in fact I've never heard a triangle played like this before. (Please forgive me if it is the cowbell for which he is famous.)

The late fifties were not known for their excellence in fidelity. Many engineering advances have been made since those years.

This package should be an inspiration to any potential percussionist. But taken in large doses and heard all at one stretch, beware of redundancy and reaching the saturation point. Be that as it may, for sheer rhythmic expertise produced by "skin on skin", Mongo Santamaria is your man.

Performance: B+

Sound: C+

GEORGE & ETHEL McCOY: *Early In the Morning*. Adelphi AD1004S

A dozen low-key blues by the brother/sister team of George and Ethel McCoy representative of that blues center that lies along the banks of the Mississippi River of East St. Louis, Illinois. While there is similitude about their approach to traditional and modern blues—they are strictly easy going—they shine forth instrumentally, Ethel on her National and George on his Gibson J-200, combining strumming with arpeggios and judicious picking. The guitar assistance

of Sam Firk is enjoyed in the pulsating *Juanita Stomp* and *Rainy Day Blues* while Catherine McCoy's rub-board affords some rhythmic texture and Jimmie Brown contributes an additional bounce on bass can. Ethel McCoy's expressive tones in *Childhood Dream Blues* truly capture the blues.

PIANO RED; *Dr. Feelgood All Alone With His Piano*

Arhoolie 1064, Stereo

Musician: Piano Red (Willie Perryman) piano and vocals

Piano Red displays his gift as a raconteur with a touch of humor who emerges stronger vocally than instrumentally in these straight-forward personal blues recorded in Macon, Georgia. *Dr. Feelgood*, as he came to be called in 1962, favors the treble which trembles with octaves and bar-room piano rolls over a pared-down rocking horse bass in an uncomplicated style which unfortunately allows the mind to wander. Best instrumentally are some of his 1936 Vocalion recordings (never actually released until now) such as *Red's Boogie*, *Rockin' With Red*, and *Wrong Yo-Yo*, but his more recent snail-paced *Red's How Long Blues* and *My Baby Left Me* better capture his warm-hearted intonation and sophisticated sense of timing and at once endear him.

Piano Red can be heard live at *Underground Atlanta* and lately has been known to do some traveling.

THE CHARLES FORD BAND

Arhoolie 4005; Stereo

Musicians: Robben Ford—guitar, vocals, piano; Mark Ford—harmonica; Patrick Ford—drums; Stanley Poplin—bass; Michael Osborn—rhythm guitar

The Charles Ford Band, hopefully only temporarily disbanded, has laid out a handful and a half of blues for us in a funky, never harsh groove, piloted by the strongly rhythmic pulse of guitarist Robben Ford, backed by drummer Patrick Ford. Ford's jazz-oriented guitar lends an additional fire and intricacy to traditional blues patterns. He also wears vocal and pianistic hats on occasion. The group is blessed with brother Mark who blows a whale of a harmonica as though it were for the last time.

Despite the band's rhythmic drive, it is at its best on slow numbers such as *Blue and Lonesome* and *Black Night*, two examples of the blues' constantly recurring themes of loneliness. It's not in the least surprising that bluesmen Muddy Waters and Jimmy Witherspoon have sat in recently with this young white blues band.

AUDIO • MAY 1973

FREE McIntosh CATALOG and FM DIRECTORY

Get all the newest and latest information on the new McIntosh Solid State equipment in the McIntosh catalog. In addition you will receive an FM station directory that covers all of North America.



MX 113

FM/FM STEREO - AM TUNER AND PREAMPLIFIER

SEND TODAY!

McIntosh Laboratory, Inc.
East Side Station P.O. Box 96
Binghamton, N.Y. 13904
Dept. 1

NAME _____

ADDRESS _____

CITY _____ STATE _____ ZIP _____

If you are in a hurry for your catalog please send the coupon to McIntosh. For non rush service send the *Reader Service Card* to the magazine.

Check No. 33 on Reader Service Card

as perfect as a circle

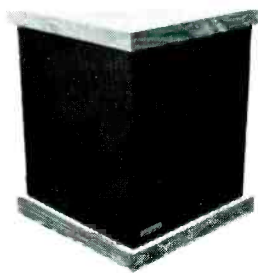

TRI-PLANE I



Check No. 34 on Reader Service Card

Classified

Rates: 25¢ per word per insertion for noncommercial advertisements; 50¢ per word for commercial advertisements. Frequency discounts as follows: 3 times, less 10%; 6 times, less 15%; 12 times, less 20%. Closing date is the FIRST of the second month preceding the date of issue. *Payment must accompany all orders under \$10.00.* Use the handy self-addressed, postage paid card at the back of this issue. When replying to AUDIO box number ads, send letters c/o AUDIO, 134 No. 13th St., Phila., Pa. 19107. For more information about classified advertising, circle Reader Service Card #135.

FOR SALE

FREE 64 PAGE CATALOG offers hundreds of recordings of rare renaissance, baroque and classical music. Some records priced as low as \$1.00 each! All late recordings. In stereo only. Musical Heritage Society, Box 932-AU, New York, N.Y. 10023.

ACOUSTIC SUSPENSION SPEAKER KITS Build your own... Save. 10¢. AudioCessories, 320 W. Edmonston, Rockville, Maryland 20352.

WORLD'S LARGEST, DEEPEST, MOST POWERFUL SUB WOOFER SYSTEM can be had only at Music and Sound Ltd., 11½ Old York Road, Willow Grove, Pa. 19090. 215-659-9251. From \$1,000.

ii **OUR RABCO SL-8E SOUNDS BETTER THAN YOUR SL-8E!!** For \$100 we'll convert "yours" to "ours". Professional Products Div., Music and Sound Ltd., 11½ Old York Road, Willow Grove, Pa. 19090. 215-659-9251. Dealer inquiries invited.

BUY DIRECT FROM ENGLAND'S HI-FI MAIL ORDER SPECIALISTS! Save on SME, Leak, Goldring, Decca, Tandberg, Revox, Gold Speakers, Garrard, Wharfedale, KEF, Celestion, Transcriptors, Cambridge etc. Insured shipping quotes free or send \$2.00 bills for catalog (\$4.00 air post) credited on first purchase over \$100. Goodwin Ltd., 7 Broadway, Woodgreen, London N22. Visitors welcome to showrooms.

ENGLAND'S LEADING MAIL ORDER AND DISCOUNT SPECIALIST OFFER.—SME RADFORD TANNY B & W TEAC KEF DUAL-SANSUI AT VERY COMPETITIVE PRICE. PLEASE SEND FOR QUOTES REPLY BY AIRMAIL SHIPPED IMMEDIATELY. FREIGHT COLLECT. SOUTHERN AUDIO SERVICES LTD. 43, HIGH STREET, KINGSTON-ON-THAMES, SURREY.

TEST FREE COMPARISONS

Comparisons by Pittsburgh's Audio experts of over 100 speakers, receivers, changers, and cartridges included in the most informative catalog of its kind. Complete with lowest wholesale prices.

Wholesale Audio Inc
3916 SAW MILL RUN BLVD., D-2
PITTS., PA. 25527 (412) 884-8797

Check No. 35 on Reader Service Card

FOR SALE

SCOTCH MAGNETIC TAPE, discount Box 167A, Orwigsburg, Pa.

JAPAN HONG KONG DIRECTORY World products information. \$1.00 today. World Trade Inquiries, Hillyard, Washington 99207.

ii **HAND-PICKED DECCA LONDON EXPORT SERIES & MK V!!** At long last the ultimate cartridges, guaranteed from Music and Sound Ltd., 11½ Old York Road, Willow Grove, Pa. 19090. 215-659-9251.

DIAMOND NEEDLES and Stereo Cartridges at Discount prices for Shure, Pickering, Stanton, Empire, Grado and ADC. Send for free catalog. All merchandise brand new and factory sealed. LYLE CARTRIDGES, Dept. A, P.O. Box 69, Kensington Station Brooklyn, New York 11218.

ELECTROENCEPHALOPHONE: brainwave monitor. Professional biofeedback instruments. J&J, Rt. 8, Box 8102, Bainbridge Island, Wash. 98110.

B&W 70CA, PHASE LINEAR, THE WORLD'S FINEST SPEAKER AMPLIFIER COMBINATION. JVC 5011 super preamp. Transcriptor, EPI Tower, Quad, Electrostatic specialists. Finest, best equipped laboratory in the country. Formerly supplying to professionals only. Now you can benefit from the unique services of THE AUDIO-LAB, 146 French St., New Brunswick, N.J. 08901 201-249-9191.

PROTECT YOUR VALUABLES For a fraction of the cost of a burglar alarm system. Our reflectorized label tells the world that your premises are protected by an ELECTRONIC BURGLAR ALARM SYSTEM (exact wording not given in ad). 2/\$5.00 to LABLE, POB 44017, Dallas, Texas 75234 Satis. Guar.

CLOSEOUT SALE!! 8 TRACK STEREO TAPES. Over nine-hundred titles to choose from. ALL ORIGINAL ARTIST. Only \$3.98 ppd. Limited offer only—Hurry! Send 25¢ today and have a look at our available stock. Moonlit Enterprises TP-2, 120 Eighth St., West Des Moines, IA. 50265.

CONNECTICUT AREA Audio research speaker and amps. Dyna-mod kit and transcriptor turn tables. The Stereo Lab, 158 State St., New London, Conn. (203) 447-9802.

HI FI FURNITURE? See Toujay Designs at SEE 70, Hi Fi Expo, 443-A, Park Ave., S., NYC, 10016, Tues. to Fri. 11-5 Sat. 11-4. Full line brochure 25¢.

LOWEST DISCOUNT PRICES ANYWHERE on audio equipment. All major brands discounted. Write for quotes; K&L Sound Services, 264 N. Beacon St., Watertown, Mass. 02172.

FOR SALE

BUY IRISH TAPE at discount prices, get Free leaders trailers. Write for catalog and order form. Also ask for pre-recorded specials. Direct Main Cassette Corp, Box 71, Plainview, N.Y. 11803.

KARLSON—Fantastic new line of patented advanced technology speaker systems for stereo, p.a., and music now available. Write Karlson Research & Mfg. Corp., Box 117, W. Hempstead, N.Y. 11552.

AUDIO RESEARCH CORP'S Magneplanar* Woofer Screen* SP 3 Preamp* EC-3&4 Cross-overs* Dual-51 & 75 Amps* Dual-400 (5/73)* Tone Arm (5/73)* Normally shipped from stock, pre-paid insured Music & Sound Ltd., 11½ Old York Road, Willow Grove, Pa. 19090. 215-659-9251.

THE INVENTORS, ENGINEERS, COLLEGE INSTRUCTORS AND PROFESSIONAL MUSICIANS at Music & Sound Ltd. offer their clients a new standard of technical competence, certain proprietary testing procedures, a mind boggling research laboratory, and a host of the most advanced professional services, including hand picked component matching/customization/assembly/alignment, room acoustical design and treatment, calibrated environmental equalization, and the most flexible demonstration facilities anywhere for the distinguished array of products from: Sequerra, Infinity, Crown, Decca, I.M.F., Quad, Rogers, Spondor, B.B.C. Monitors, Stax, E.S.S., B&O, J.B.L. Professional, Schoeps, S.S.I., Boyer, Custom Rabco, Gately, Otari, Braun, Tascam, shipped pre-paid insured. Music & Sound Ltd., 11½ Old York Rd., Willow Grove, Pa. 19090. 215-659-9251.

STEREO cartridges, headphones, components, blank and pre-recorded tapes. Wholesale prices in any quantity. Request quotes: SOUNDSCAPE, Box 175, N. Branford, Conn. 06471.

AUDIO RESEARCH, Magneplanar, Crown, McIntosh, Thorens, Decca, Stax, Revox on display. Free List used equipment. Stereo Shop, 107 3rd Ave. SE, Cedar Rapids, Iowa 52401. 319-365-1324.

SEND FOR LATEST STUDIO CLEARANCE sale list featuring microphones, tape recorders, equalizers, limiters, turntables, lathes, cutter heads, loudspeakers, mixing consoles, organs, and pianos. Only professional studio equipment listed. Wiegand Audio Laboratories, RD #3, Middlesburg, Pa. 17824. 717-837-1444.

MEMORIES SEMICONDUCTORS FREE FLYER, UTI, P.O. Box 252, Waldwick, N.J. 07463.

MARANTZ 10B TUNER Excellent Condition. \$600 or best offer. 713-569-0561—Apt. 86, 200 Beal St., Nacogdoches, Texas.

BASF, MEMOREX, SCOTCH reels, cassettes, 8 tracks, Lowest prices. Satisfaction guaranteed. S&S Audio, Box 523 Skokio, Ill. 60676.

KLIPSCH, TANNY, JBL, MARANTZ, THORENS, RABCO No discounting. Superior Sound, 2780 Erie Boulevard East, Syracuse, New York, 13224.

NAB HUB ADAPTERS—Fit Revox, Crown, TEAC, Roberts, \$3/pair postpaid. No C.O.D. Quantity prices available. John Kountz, 1065 Van Dyke Dr., Laguna Beach, Calif. 92651.

RARE STAMPS! 101 Old United States 1861-1935 \$1.50. Approvals. J. Cuddihy, 80 Lexington Ave., Jersey City, New Jersey 07304.

SCOTCH RECORDING TAPE, lowest prices. TAPE CENTER, Box 4305B, Washington, D.C. 20012.

FOR SALE

CANADIANS: FREE 120 PAGE BARGAIN electronics catalog. Etco (Au), Box 741, Montreal.

AUDIO RESEARCH, SAE, CROWN, PHASE LINEAR, INFINITY, KLIPSCH, TANNOY, BRAUN, QUAD, DECCA, REVOX, STAX, TRANSCRIPTORS, RADFORD, and many more. Factory authorized service on all brands sold. No appointment necessary. Hoffman's "House of Stereo", 5931 Smith Rd., Cleveland, Ohio. 216-243-2772.

FREE LITERATURE AND QUOTES on Hitachi stereo equipment. Write: Dixco Electronics, Inc. P.O. Box 146, Springfield, New Jersey 07081.

TV & RADIO TUBES 36¢ EA. Free 48 page Color Catalog. Cornell 4215 A University, San Diego, California 92105.

8-TRACK TAPES at unbelievable savings. Latest list 15¢. Bob Musial, Box 11907-A, Chicago, Ill. 60611.

CUSTOM Engineered Electronic Equipment. Equalizers, Power Amplifiers, Test Equipment. 50¢ for Catalog (Refunded first order). C. D. Electronics, Box 12584, El Paso, Texas 79912.

WHOLESALE! Professional Amplifiers, PA Systems, Guitars. Free Catalog. Carvin, Escondido, Calif. 92029.

STEREO COMPONENTS Lowest discounts. \$1.00 for catalog. Defa Electronics, 2209 Broadway, N.Y., N.Y. 10024. Tel.: 212-874-0900.

CASH FOR YOUR UNWANTED STEREO LPs & reel to reel tapes. Record House, Hillburn, N.Y. 10931.

PROTECT YOUR LPs poly sleeves for jackets 5¢ round bottom inner sleeves 5¢ Poly lined paper sleeves 11¢ White jackets 25¢ Postage \$1.00. House of Records, Hillburn, N.Y. 10931.

AUDIO RESEARCH, B&O, BOZAK, BRAUN, CROWN, DECCA, KLIPSON, HARTLEY, PHASE LINEAR QUAD, RADFORD, REVOX, SAE, SENHRISER MICS. Others. Custom designed and constructed music reproduction systems for homes, musicians, and auditoriums. Each component analyzed and optimized. Demonstration by appointment. Phone or mail consultations. C.M. Santmire, Audio Consultant, 1340 S. 20th St., Lincoln, Nebraska, 68502. 402-477-8469.

YOU'VE NEVER SEEN LOWER PRICES, until you've seen ours. Send Quotes to **ULTIMATE DISCOUNTS, NEW HAMPTON, NEW HAMPSHIRE** 03256.

HI-FI ENTHUSIASTS WANTED!! Earn more than just spare money in your spare time. We need campus representatives to sell name brand stereo components at discount prices in your area. High commission, no investment required. Serious inquiries only, please. Contact: Mick Santillo, K&L SOUND Services Co., 264 N. Beacon St., Watertown, Mass. 02172.

SAVE MONEY BY THE BUSHEL WHERE THE CORN GROWS . . . Fantastic Savings on Name Brand Stereo Equipment—**WRITE FOR QUOTE** **MIDWEST AUTO WHOLESALERS, P.O. Box 1132, WATERLOO, IOWA 50704.**

10½" REEL SPECIALISTS: Used boxed 10½" metal recording reel. Excellent condition. Pre-paid. 1-9 \$2.00 each. 10-24 1.75 25 or more 1.60. Nab Centers. Used Fiberglass 10½" small hole half above price. Box 15¢ extra. Any make recording tape available, new or used. **SOUND INVESTMENT CO., POB 88338, DUNWOODY, GEORGIA 30338.**

FOR SALE

TOP 500 STEREO 8 TRACK TAPES Free catalog. Introductory offer. 5 different only \$5.00. Sound, Box 14, West Union, Iowa, 52175.

ALPHAPHONE headset—brainwave trainer. Free literature. Aquarius Electronics, Box 627-S. Mendocino, Ca. 95460.

ATTENTION MIDWEST AUDIOPHILES: Quad, Braun, Ortofon, Radford, Quintessence, Rabco, ERA, JansZen, DBX, Citation, Sheffield Records, Open-Reel Dolby Tapes, and more now on display in our studio. Send for free newsletter. **AUDIOPHILE SYSTEMS, 851 West 44th Street, Indianapolis, Indiana 46208. 317-283-5404.**

CROWN TAPE RECORDERS, Amps, IMF Monitor Speakers, AKG professional mikes, UREI limiting, little dipper, Fairchild, Crown Warranty, Service Station, more. Barclay, 503 Haverford Ave., Narbeth, Pa. 19072. 215-667-3048 or 120 Villa Crest Drive, State College, Pa. 16801. 814-238-1598.

WE HAVE THE FINEST! Dayton Wright, Audio Research, ESS, SAE, Quad, Radford, Stax, Decca, B&W, ERA, Revox, Panasonic Professional, B&O, Celestion, Braun, Phase Linear, Crown, Grace, Satin, and Acousta-voicing. Advanced Audio Systems, 2985 College Ave., Berkeley, Calif. 94705. 415-548-5212.

AUDIO RESEARCH Radford, Phase Linear, Crown, Quad, Stax, Infinity, JBL, Braun, ESS. Information available. Hartley Electronics, 1502 Butternut, Richland, Wa. 99352. 509-947-5026 after 5 pm weekdays, all day, weekends.

PROFESSIONAL SMALL ALUMINUM BLOCK Parallel precision Dove-Tail grooves expertly splices 250 or Cassettes. Splicing Tabs included. Guaranteed \$4.95 postpaid. Details, NRP, Box 289, McLean, Va. 22101.

NEW PHASE LINEAR 700 and Crown DC-300 (with cabinet). Warranty cards. Used less than 5 hours each. Phase Linear \$600, Crown \$450. 919-449-4132 or 449-6912.

THE OHM "A" LOUDSPEAKER IS NOW AVAILABLE A radical approach to reproducing sound. Extremely low T.H.D., I.M., & phase distortion. High transparency, dispersion, and dynamic range. \$1465/pair shipping included. Literature available. **ONI ENTERPRISES, P.O. Box 14074, Hartford, CT. 06114.**

FALL IN LOVE AGAIN—Marantz tubes: 7-C, 10-B, with cases: 8-B two 9's; all for \$15.00. David Camp, 228 Fieldstream, Idaho Falls, Idaho 83401.

KLH NINES, REVOX 1222 HS, STELLAVOX SP-7 and accessories all as new. Disc recorded, ready for service, Gampian-D head, vacuum microscope, stereo convertible, stereo amplifiers included. Real bargain. Hyde, 301 Springdale Ave., Wintersville, Ohio 43952. 614-264-4987.

SPEAKERS CUSTOM BUILT Folded or straight axis horns for the perfectionist. These horns will provide the finest sound in the world. Duluth Electronics Co., 24 East 1st, Duluth, Minnesota 55801. 218-624-4153.

ESS TRANSTATICS (New) SPKRS \$950; Marantz 120 FM/AM Tuner/Scope \$275; Dayton-Wrights (New); Quads (New); ERA turntables (studio) new; others! 405-364-6297 or Box AA 3-1.

ATTENTION: CASSETTE OWNERS! Protect valuable tapes with Cassette Carousel! Holds 25 tapes without boxes! Guaranteed—only \$9.95 plus 50¢ postage. Order today. Gifts 'n Gadgets, (1F4), Box 312, Carrollton, Texas 75006.

check with the
East-Coast Stereo
Discounters...
...then **BUY** from

MIDWEST
HI-FI
WHOLESALERS

Box 567
Ellsworth Industrial Park
Downers Grove, Ill. 60515
312/852-5885

Write for our new
WHOLESALE price list
& catalog. You'll
be glad you did!

OVER 50 NAME BRANDS
FACTORY - SEALED CARTONS
WHOLESALE PRICES
● **SAVE ON TIME**
● **& FREIGHT CHARGES**

Check No. 36 on Reader Service Card

FOR SALE

SUMIKO INC. factory authorized distributor for the following Japanese components: A&E pre-amps, head amps, 2 to 5 way electronic cross-overs, Satin "moving coil" cartridges, Grace cartridges with Shibata styli, Guya oil damped tone arms. Dealer inquiries invited. P.O. Box 5046, Berkeley, Ca. 94705.

SPEAKER SPECIALIST TOBY Corporation of America; 4620 Camp Bowie, Fort Worth, Texas 76107.

SCOTCH STUDIO TAPE on 7" reels, degaussed and boxed. #150-1800-12 for \$12; #111-1200-12 for \$10; #294-2400-12 for \$11. **POSTPAID.** Free price list. **WIDE RESPONSE.** 2926 BENTLEY AVE., LOS ANGELES, CALIF. 90064.

DAYTON WRIGHT, QUINTESSENCE, SEQUERA \$1600 TUNER, BGW SYSTEMS, B&W Ltd., IMF, Quad, E.P.I., Infinity, Crown, B&O, ERA, E.S.S., Stax, Celestion, Phase Linear, Decca, Satin, Transcriptors, Hegeman, Radford, A.K.G., Panasonic Professional, Revox, Taxcam, DBX, Rabco, Connoisseur, PE, Sendor JBL Professional. TRANSCENDENTAL AUDIO, 1214 WALDEN AVE., BUFFALO, N.Y. 14211. 716-897-3984.

SONY 854-4S (Sync) Quad Tape Deck, \$1350. Mint Condition. Sony 850-2 Stereo Tape Deck, \$650. ½ Track 7½—15 ips. Mint Condition. Ampex PR-10½ Track Stereo Tape Deck in Portable Carry Case, \$425. Excellent Condition. Ampex 601 ½ Track Mono in Portable Carry Case, \$200. Good-Very Good Condition. **Appalachia Sound Recording Studios.** Route 8, Box 525, Chillicothe, Ohio 45601.

SCOTCH BRAND CASSETTES	1-9	10	48
SC-45 Low Noise, 45 Min.	1.35	1.21	1.15
SC-45 High Energy, 45 Min.	1.65	1.48	1.40
SC-60 1-Hr. Low Noise	1.50	1.35	1.21
SC-60 1-Hr. High Energy	1.80	1.62	1.54
SC-90 1-1/2 Hr. Low Noise	2.25	2.02	1.92
SC-90 1-1/2 Hr. High Energy	2.70	2.43	2.31
SC-120 2 Hr. Low Noise	3.30	2.70	2.56

Shipping—Handling + 10% (+5% over \$80.00)

*Above May Be Assorted For Best Quantity Price

TAPE RECORDERS

5% ABOVE DEALER COST!

SCOTCH MAGNETIC TAPE (USED)

150, 1800 ft., 7 inch reel, 1 mil polyester, recorded once, bulk erased (no box), 99¢ plus 10% shipping & handling (min order \$10.00); slightly used 10-1/2 inch fiberglass reels, 3/4 hole, 50¢ each, plus shipping by weight and zone.



SAXITONE TAPE SALES

1776 Columbia Rd., N.W., Washington, D.C. 20009

FOR SALE

MARANTZ 10B, \$400. Good Condition. Michael Cheluk, 7719 Evergreen Dr. Goleta, Calif. 93017. (805) 968-5491.

DECCA'S SENSATIONAL #SC4E CARTRIDGE limited special \$89.95. Futterman tubed stereo handcrafted 100 watts channel amplifier, new \$410.00. Hartley DUO stereo speaker-cabinet with Wharfedales just \$150.00 German 5x7 automobile speakers, connoisseur quality \$10.00 each. Alpha rearview mirror electronic automobile antennas with extra mirror passenger side, just \$75.00 set. Many inventory, demo, and used specials. We take trades. Audiocraft, South Rockwood, Michigan 48179. Telephone: (313) 379-9945.

ELECTRONIC MUSIC STUDIO—\$3000. Includes ARP 2600-c Synthesizer four Tandberg 65/2 decks, Advent graphic equalizer, Sony active filter network, Schoeber Tunemsmith and Dynabead, Eico audio generator, Fisher and Panasonic reverbs. A tape or work done on this equipment is available—\$2.00. John Dunn, Suite 108, 1915 NE 45 St., Ft. Lauderdale, Fla. 33308. Phone (305) 771-0245.

McINTOSH M1200, 200 watt \$120, MC60 \$60. Both mono rack mount tube amplifiers. Arthur Fisher, 723 N. Oakhurst Dr., Beverly Hills, Calif. 90210.

APPROX 1200 EDISON RECORDS. New. Never sold retail. From music store closed in '30's. Also Console Edison phonograph, Edison "Morning Glory" cylinder phonograph, with 25 cylinder records. Make Offer. Post Office Box 5145, Eugene, Oregon, 97405.

MINT USED COMPONENTS—KLHs, B & W 70s, Super Quad, JBLs, Quad Speakers, ARCD-75, 50 F.B. Citation 11, 12; Marantz 9s, Paul Heath Audio, 644 Clinton Ave. S, Rochester, N.Y. 14620, 716-461-2340.

ADVENT, B & O, EPI, FISHER, ORTOFON, PHASE LINEAR, REVOX, SANSUI, TANDBERG, THORENS, HI-FI SHOP EVANSVILLE, IND. 47714.

(2) BOWERS & WILKINS model 70 standard loudspeakers, teak, like new \$900. M.T. Kobal, 3003 Van Ness St. N.W. Washington D.C. 20008.

ACOUSTA VOICETTE \$550; 2 Shure M67 w/accs. \$200; Telegquipment S54 \$325; KLH 18 \$75; Decca II, IV, Quad tuner, esi parts, miscellaneous, enquire. M.T. Kobal, 3003 Van Ness St. N.W., Washington, D.C., 20008.

KLIPSCHORNS, Style B, Walnut. New! Cost \$1,990 Sell \$1,350. 1-704-847-4705.

BACK ISSUES—Audio, March 1966—present (40 lbs.), High Fidelity, January 1957—April 1971 (125 lbs.) missing few issues. Best offer takes, you pay shipping. Clyde E. McNeilly, 2125 Beech Ave., Richland, Wash. 99352.

WHY NOT JAM unwanted noise with relaxing pink noise? Kit \$4.95, assembled \$6.95. Flyer, Mindlight, POB 2846A, Van Nuys, Ca. 91404.

MARANTZ SACRIFICE. 19 receiver \$795, 20 tuner \$595, 33 preamp \$350, all less than 1 week old! Guaranteed immaculate and in warranty. Moy, Lake St., Greenville, Miss. 38701.

ADVENT DOLBY MODEL 100 with carrying case \$155.00. Stanley Nelson, 180 Island Ave., East Moline, Ill. 61244.

AR, KLH, ADVENT, DYNACO, ADC, RECTILINEAR OWNERS—low cost electronic equalization for your particular speakers overcomes limitations of bookshelf enclosures, provides full-range performance. Complete specifications, test reports, from Norman Laboratories, 520 Highland Parkway, Norman, Oklahoma 73069.

FOR SALE

HEATHKIT AR-1214 RECEIVER. Completely wired, still under warranty, < \$275.00. B. Oberman 10 Sandalwood Drive, Clark, New Jersey, 07066.

PRINTED BOARD DESIGN AND FABRICATION. Write to P.C.D.S., 10 Melville Ave., Fairfield, Ct. 06430.

SALE MARK-9 PRE-AMP MARK-4B POWER AMP WITH CABINETS. BOZAK SPEAKER B-410. CLASSIC PAIR, THORENS TURNTABLE TD-125 WITH BASE TINTED DUST COVER, SHURE TONE ARM. STANTON 681-EE CARTRIDGE ALL SYSTEM USED ONLY ONE MONTH \$2,000—WRITE Mr. Don Rim, Pratt Institute, Brooklyn, N.Y. 11205.

E.S.S. TRANSTATIC is superb, \$7.50; S.A.E. Mark IIB \$350; Citation II preamp \$200. Douglas S. Robinson Waterloo, Nebraska. (402) 779-2589.

GARAGE DOOR OPENERS Extremely heavy duty reliable operator & radio system. Made especially for home installation. Special instructions for difficult jobs & balky doors. Write: C.P. Rodo, Dept. 102, 34 Keating Place, Staten Island, New York 10314.

MEMOREX TAPE LOWEST PRICES. WRITE FOR FREE INFORMATION. SOUND DYNAMICS, BOX M-3, FREMONT, CALIFORNIA 94537.

"OPERA NEWS" Magazines, volume 12 to 36 in binders, except volume 13. No. 1 is missing. Sent postpaid \$100.00, early issues, scarce. Also "Story of Life" magazines in binders complete, excellent. Postpaid \$40.00. Irving Sperleng, 17 Lenox Avenue, Mt. Vernon, N.Y. 10552.

SPEAKERS, Acoustic Suspension, 8 inch heavy woofer, 2 inch tweeter, walnut, excellent quality. \$37. 219-264-3233. M. Stoll, 1812 Grant, Elkhart, In. 46514.

"STYLUS SENTRY"

Counting the hours until your next stylus inspection is due? Relax and let the Stylus Sentry count for you. Counts to 1000 hours again and again, forever! Simple installation. Use for 1000 hours and if you're not convinced that it's worth \$13.50 we'll refund your money. THIRTY-SECOND REST, 3673 W. 113th St., Inglewood, Calif. 90303.

MAGNECORD 1022 Two Track Stereo Deck. New heads, factory installed \$350. Specs as new, 7 1/2-15 ips. G. Toot, 12044 Millersburg Rd., Massillon, Ohio, 44646.

PRESTO 28N—(28N lathes in one console w/control panel). Perfect condition, includes 2 Presto 1-D heads. Best offer. Trutone Records, 6411 Bergenwood Ave., North Bergen, N.J. 07047 201-868-9332.

TEAC—A-4010GSL BRAND NEW. \$600. FIRM. CANADIAN BUYERS ONLY. PAUL WONG, BOX 955 6560 N.W. Marine Drive, Vancouver 8, B.C.

JBL PARAGON TEAK w/energizer, beautiful. Best offer. Marascio, 749 Rt. 35, Middletown, N.J. 07748. (201) 671-1161.

TAPE RECORDINGS

RENT 4-TRACK open reel tapes—all major labels, 3,000 different. Free brochure. Stereo-Parti, 55 St. James Drive, Santa Rosa, Cal. 95401.

TAPE Ampex, BASF, Sony TDK, Memorex. From 52¢. Catalog 10¢. AudioCessories., 320 W. Edmonston, Rockville, Maryland 20852.

RENT ANY CASSETTE or Open Reel Pre-recorded tape. All Labels. Catalog 75¢. Tape & Time, 1116 4th Ave., No., Sauk Rapids, Minn. 56379.

FOR SALE

SENSIBLE SYSTEMS & PRICES: Hegman, IMF, LTD, Celestion, ARP Synth AR-LST, JVC, Citation, Marantz, BGW Thorens, B&O, Connoisseur, Equa, Akai, Dokorder, Tandberg, Revox-Beyer Soundcraftsmen, BGW, Hartley, JansZen, 54 other makes. Trades, 89 Day Speaker Approvals. By appointment only (404) 252-8569. Write for famous "Blue Sheet." ATLANTA AUDIO PROJECT Ltd. Suite 106-108, 141 West Wieuca Rd. Atlanta Ga. 30342.

ATTENTION ALL SERIOUS CASSETTE ENTHUSIASTS—At last—No nonsense cassette labels. Send for free samples. Joe Bly Enterprises, 339 W. 88th St., N.Y., 10024.

NEUMANN MICS & ACCESSORIES Gately Pro kits and mixers. Most models in stock. Immediate prepaid shipment. Mastercharge. Write or call Dick McGrew Recording Service, 7027 Twin Hills, Dallas, Texas 75231. 214—691-5107.

J.B.L. S7R SOVEREIGN Enclosures, 1 year old, \$1000 T. McMullen, 72 Sherwood Ave., Webster, N.Y. 14580.

PRESTO 6N RECORDING LATHE with 1D cutter, excellent condition. E.R. Meissner, 4630 N.W. Woodside Ter., Portland, Ore. 97210.

CIZEK LOUDSPEAKERS Lowest price in the country. Quotes on your favorite system. Sound Center, Box 1242, Bloomington, Indiana 47401. 812—332-4252.

+ STEREO PLUS The store owned by engineers. All items lab. tested, data supplied, response curves, graphs. Best makes kept prices. Unique loudspeaker try before you buy plan. Free advice by experts Stereo Plus, Parkway Center South High St., West Chester, Penna. 19380.

1 PR. KLH 9's MANUFACTURED NOV., '72. ADRENALIN-PRODUCING FIDELITY. NO ARCING OR RELIABILITY PROBLEMS. LIST FOR \$1,400; PAID \$1,200; ASKING \$900. OR TRADE FOR MARANTZ TUBE EQUIP. + \$. MAKE OFFER. Randy Cail, 1984 Wellbourne Dr. N.E. #2, Atlanta, GA. 30324.

RABCO SL-8E TONEARM; immaculate, perfect condition—just checked at factory; all accessories: \$125; James Ebbert, Chatham Hill K-22, 25 Hickory Place, Chatham, N.J. 07928; (201) 377-6959

TAPE RECORDINGS

COBALT ENERGIZED CASSETTES Ultra high frequency tape special price C40—\$1.00; C60—\$1.25; C90—\$1.58. Special Low Noise tape 1800' 1 mil 7"—\$1.50 all ppd DAK Dept. A81, P.O. Box 69920, Los Angeles, Calif. 90069.

VALUABLE RECORDED TAPES lose highs and become progressively noisier each time they are played on equipment that is not thoroughly demagnetized. You can measure damaging magnetic residuals with the Pocket Magnetometer and really demagnetize recorder components with powerful Han-D-Mag. Now available, complete Audiophile Han-D-Kits including: Magnetometer, Probe, Han-D-Mag, experimental sensors and "Notes". Kit 20/B5 \$29.75, Kit 25/S5 \$51.00, postpaid U.S.A. Literature available. R. B. Annis Company, 1103 North Delaware, Indianapolis, Indiana 46202.

"B" TRACK TAPES only \$3.00 each postpaid. Send for our free catalog. Lists over 400 G.M.O., 58 Hillside, Verona, N.J. 07044 Dept. 8TRAm-73.

KENNEDY/TIPPIT/OSWALD MURDERS! Actual episodes & police recordings! Reels/cassettes: \$10 Majestic, 9651 Foxbury, Pico-Rivera, California.

8-TRACK TAPES \$4.00. Sample and list \$2.50. Metco, Box 246-A, Marion, Ct. 06444.

RADIO PROGRAMS

RADIO MEMORIES. Custom recorded reels and cassettes. Professional quality equipment assures best sound, but at prices YOU can afford. Large catalog and supplement \$1.00 (refundable). 1033 Gypsum, Salina, Kansas 67401.

1930—1962 RADIO PROGRAMS ON TAPE Huge catalog! Sample recordings! \$1.00, refundable!! AM treasures, Box 192 M, Babylon, N.Y. 11702.

REMEMBER RADIO? On cassettes or reels. Amos & Andy, Inner Sanctum, Jack Armstrong, Fred Allen, I Love a Mystery, Your Hit Parade, Grand Ole Opry, All your Favorites live again. High quality, low prices. Catalog only 50¢. Remember Radio, Inc., Box 2513-B, Norman, Okla. 73069.

OLD RADIO SHOWS BIG SELECTION catalog and demo tape \$1.00 Audio Antiques, Box 6651, Cleveland, Ohio 44101.

NOSTALGIA RADIO PROGRAMS traded. Private collection. Drawer 3226, Newport, Delaware 19804.

THOUSANDS OF OLD RADIO COMEDIES. Dramas, Band Remotes, Mysteries, etc. \$6.00 for 6 Hour Reels. Catalogue: \$1.00 (Refundable). Cassettes also available. RADIOVOX, 1756 Washtenaw, Ypsilanti, Michigan 48197.

SERVICES

CUSTOM RECORDING SERVICE Tape and disc. Stereo and mono. Live and copies. Editing. Masters and pressings. High quality at reasonable rates. Joseph Giovanelli, Audio Tech Laboratories, 2819 Newkirk Ave., Brooklyn, N.Y. IN 9-7134.

LEARN Electronic Organ Servicing at home. All makes including transistors. Experimental kit—trouble-shooting. Accredited NHSC. Free Booklet. Niles Bryant School, 3631 Stockton, Dept. 1D, Sacramento, Calif. 95820.

ACOUSTECH AMPLIFIER REPAIR Original performance or improved specifications. BKM Associates, Box 22, Wilmington, Mass. 01887.

MULTI-CHANNEL TAPES Processed from YOUR Mono Records/Tapes. Demo Tape \$1.50. Free Information. R. R. Faulkner, Box 26, Redondo Beach, Calif. 90277.

SERVICES

DON'T PAY the high mail order prices. Thieves Warehouse is coming up to your area. Franchises available. Thieves Warehouse, P.O. Box 8057, Pensacola, Florida 32505.

HIGH FIDELITY SPEAKERS REPAIRED
AMPHRITE SPEAKERS SERVICE
655 Sixth Avenue, New York 10, N.Y.

RECORDS MADE FROM YOUR TAPES Also, editing and mastering. Send for free brochure. Nashville Record Productions, Inc., Dept. AM 204 19th Ave., So., Nashville, Tennessee 37203.

TAPE RECORDER HEADS brought back to spec. Wear removed. Brilliant finish. \$10.00 each. One day service. E. Maher, 5 Evans Place, Orinda, Calif. 94563.

THE ABSOLUTE SOUND, a quarterly for the audio iconoclast, is about to publish its second issue. Reviewed: the Audio Research Magneplanar, the Audio Research pre-amp, the Hegeman One speaker, the Crown DC 300a and more. Cost: \$8 annually. That will also get you the charter issue and reviews of the Dayton-Wright electrostatic, the ADC XLM, the Citation 11a, the Phase Linear 700, and the Double Advents. The Absolute Sound, Box 115aa, Sea Cliff, New York, 11579.

"BATTLE OF THE GIANTS"

Crown DC-300 vs. Phase Linear "700"
Order today your copy of this in-depth comparative lab and listening test. Only \$1. Sent FREE with subscription. \$7.50 per year (6 issues) in USA. \$8 in Canada. \$10 elsewhere. Other test reports available. Please inquire. Send your remittance today to: The Hi-Fi Newsletter, Box 593, Hialeah, FL 33011. The HFN is an independent publication funded solely by audiophiles all over the world.

MIRACLE ELECTRONIC TV ANTENNA PLUGS In Socket. Outstanding Reception. No Ghosts or Jumping Pictures—\$2.95 Ppd. House of Ruscarr 3908 West Franklin, Richmond, Virginia 23221.

QUADRAPHONIC DUPLICATION. Unsurpassed quality High-speed CASSETTES, REELS from your Quadtapes NATIONAL TAPE DUPLICATORS, 111 Valley, Wilmington, DE 19804.

NOW . . . LOWEST PRICES FOR STEREO MASTERS expertly cut on a Scully lathe with the Estrex 3D stereo cutting system. Stereo: 12"—\$33 per side 7"—\$12 per side Mono: 12"—\$22 per side 7"—\$7 per side. Trutone Records, 6411 Bergenwood Ave. North Bergen, N.J. 07047 201-868-9332.

ADDRESSING FROM YOUR LIST. Gummed Labels. \$1.75/100—\$15.00/1000. Send to Wilhelm's, 2415 S. Manchester, Anaheim, Calif. 92802.

"HOW TO BUY 4 CHANNEL" THE MOST COMPLETE USER'S GUIDE TO QUADRAPHONICS. HOW TO GET THE MOST FOR YOUR MONEY. SEND \$1.00 TO THE STEREO SHOP, BOX 10550 CLEVELAND, OHIO 44110.

INSTRUCTION & EDUCATION

BIBLE Degrees—Correspondence—Fundamental Bible. Seminary, P.O. Box 942, Elk City, Oklahoma 73644.

CANDLE MAKING INSTRUCTION KIT—Learn to make professional quality candles. Kit includes everything needed to make candles, plus instruction book. Send \$4.95 plus 50¢ postage to Craft Candle Creations, 7282 Westminster Ave., Dept. 1-A, Westminster, Calif. 92683.

LOGIC trainers catalogs 50¢. UTI, POB 252, Waldwick, N.J. 07463.

HUGE SAVINGS ON FAMOUS BRAND STEREO COMPONENTS

DISCOUNTS

ON NATIONALLY ADVERTISED
TURNTABLES • CARTRIDGES

COMPACTS • RECEIVERS
AMPLIFIERS • TAPE RECORDERS

Wholesale Prices! Audio Warehouse Sales, One of the Capitol's largest stereo wholesalers will fill and deliver all your mail orders promptly in factory sealed cartons, at prices that will amaze you.

Write for quote on Famous Brand, Stereo Components. We guarantee satisfaction.

AUDIO WAREHOUSE SALES
3310 NEW YORK AVE. N.E.
WASHINGTON, D.C. 20002
(202) 832-1616

Check No. 37 on Reader Service Card

INSTRUCTION & EDUCATION

TAPE RECORDING COURSE: Taught by studio engineers. Free information. NNA, Box 721E, Rye, New York 10580.

STAMPS

VATICAN XMAS SET (1967) 50¢. Approvals. Barricks. Box 7154, Detroit, Michigan 48202.

CLOSEOUT SALE: Large assortment \$1. High Value Packet \$2. Schollmeyer, 436 New York Avenue, Brooklyn, New York 11225.

RECORDS

CATALOGS Broadcasts, soundtracks. Personalities of Thirties, Forties, Box 225, New York, N.Y. 10028.

SHOW ALBUMS—Rare, Out of Print LP's. Free large list. Broadway/Hollywood Recordings Georgetown, Conn. 06829.

SOUNDTRACK RECORD ALBUMS from films, original, rare, free list. Whalon. 2321—N. Hill, Redondo Beach, Calif. 90278.

SOUNDTRACK ALBUMS Write, Call William Koutek, 1125 Ives Lane, Minneapolis, Minn. 55441. 544-0867.

RARE Deleted Motion Picture Soundtrack and Show Albums. Steiner, North, Goldsmith, Waxman, Young, Bernstein, Styne, etc. "ONLY THE BEST." Send 25¢ for new quality catalog to ReCollections, P.O. Box 197, Roselle Park, New Jersey 07204.

RECORDS

OLDIES—45 RPM Original hits. Catalog 50¢ C&S Record Sales, Box 197, Wampsville, N.Y. 13363.

COLLECTORS' SOUNDTRACKS LIST 25¢ Jemm's, P.O. Box 157, Glenview, Ill. 60025.

COLLECTIVE EAR RETAILING AT WHOLESALE Any \$5.98 album at \$3.10—Any \$6.98 tape at \$4.05—Catalogue 25¢. Collective Ear, Box 9355-(E), St. Louis, Mo. 63117.

FABULOUS PERSONAL SOUNDTRACK COLLECTION! Rush \$1.00. Receive Computerized Lists/\$2.00 Credit slip. Leonard Heifetz, Box 7951, Fresno, California 93727.

CLASSICAL monaural LP's. Buy-Sell. Box 10997, Midwest City, Okla. 73110.

FILM-STAGE SOUNDTRACKS Large free list. A. Lutsky, Box 7342, Miami, Fla. 33155.

AMERICA'S LARGEST SOUNDTRACK SPECIALISTS! FREE CATALOGUE, RTSA, 1111 S. Benito, Suite F, Alhambra, California 91803.

SOUNDTRACKS, Casts, Personality. List 16¢. Don, 2914 Westerland, Houston 77042.

RARE RECORDS—Send wants. Box 410, Bronx, N.Y. 10469.

RECORDS—VINTAGE SELECTION—oldies but goodies. Free list. Songs & Records, Box 863A, Burbank, Calif. 91503.

SOUNDTRACKS—O.C.—Personalities & Jazz. Want lists to: Theo's Records, P.O. Box 4994, Panaroma City, Ca. 91412.

EQUIPMENT WANTED

CASH FOR YOUR unwanted LP's and pre-recorded tapes. Record House, Hillburn, New York 10931.

WANTED: JBL HARTSFIELD C&F at my expense. Dr. Fumihiko Umezawa, M.D., Jujin Hospital, 1-12-5 Shinbashi Minato-ku, Tokyo, Japan.

WOULD LIKE TO BUY any audio equipment such as: amps, turntables, speakers, audio-cables. Send to Tom Harvey, 124 E. 5th Ave., Lancaster, Ohio 43030. Will pay cash for any equipment accepted.

WANTED: THE FOLLOWING ALBUMS by Percy Faith and his orchestra on Columbia records: Bon Voyage CS8214; American Serenade CS 8757; Music from South Pacific CS 8005; Music from Porgy and Bess CS 8105; Columbia Album of Victor Herbert C2S801. Please send quote stating price and condition to: Bill Halvorsen 646 Azalea Drive, Rockville, MD 20850.

WANTED McIntosh CII PREAMPLIFIER AND MC 240 AMPLIFIER OR MC75 AMPLIFIER. PLEASE STATE CONDITION AND PRICE. MELVIN ROBINSON, 214 W. 15th STREET, CINN. OHIO, 45210.

BUSINESS OPPORTUNITIES

ADDRESSERS, MAILERS wanted. Application 25¢. Keneco 1101 Worth, Durham, North Carolina 27701.

SUCCESS AND POPULARITY—Six ways to Develop your Creative Powers. A Formula To Guarantee Success and Prestige in Any Endeavor. Send \$2.00 J.N. TRINIDAD—2731 W. Cortez—Chgo. Ill., 60622.

EARN MONEY AT HOME. How-to-do-it Manuals WILHELM'S, 2415 S. Manchester, Anaheim, California 92802.

BUSINESS OPPORTUNITIES

MAKE MONEY. Clip newspaper items, details self-addressed stamped envelope and 25¢ to Dept. 1, Victor, 25 Tara Lane, Montville, N.J. 07045.

MAILORDER MONEYMAKING KIT Home Business Valuable lists, concrete information, detailed steps. Capital unnecessary. Free Details. Pictures. Meadows, Box 327-AU5, Boston, 02199.

MAILORDER—Carry no stock. Companies will pack, ship under your label. One-man operation capable of \$10,000—\$20,000 year. Details Free! Distributors, Box 9—M, East Rockaway, New York 11518.

QUALITY EQUIPMENT OWNERS to make on-location recordings for profit. No investment. Box 264, Union, Ohio 45322.

GOVERNMENT SURPLUS

JEEPS Typically From \$53.90 . . . Trucks From \$78.40 . . . Boats, Typewriters, Knives, Airplanes, Clothing, Multimeters, Oscilloscopes, Transceivers, Photographic, Electronics Equipment. Wide Variety Condition 100,000 Bid Bargains Direct from Government. Nationwide. Complete Sales Directory and Surplus Categories Catalog \$1.00 (Deductible on Orders From Separate Included Catalog). Surplus Service, Box 820-AUD, Holland, Michigan 49423.

SIGNAL CORPS Surplus Communications Equipment, catalog 25¢. Colonel Wayne D. Russell, 9410 Walthampton, Louisville, Kentucky 40222.

HELP WANTED

RECORD MANUFACTURER is seeking field representatives and recordists. No gimmicks or fees. Send resume to: EWING, Box 343, West Milton, Ohio 45383.

SERIOUS RECORDISTS NEEDED Excellent remuneration. We train and equip. Modest investment required. Write Box 278, Englewood, Ohio 45322.

EPICURE PRODUCTS, INC. is seeking quality applicants to meet expansion needs. Applicants must be willing to travel extensively four or five days per week; be knowledgeable of, or willing to learn, all aspects of the hi fi industry—products, policies, and future developments. Position requires a professional approach to sales, and a person interested in rapid advancement into a growing management team. Base salary and monthly incentive. Epicure Products, Inc. Newburyport, Mass. 01950 Call: Robert Fuller, Personnel (617) 462-8191.

WANTED: INSTRUCTOR—BROADCAST ENGINEER Technician—Two-Year College—Southeast Ohio—Challenging & Rewarding Position—Salary Open—Contact Dean of Education, Hocking Technical College, Route 1, Nelsonville, Ohio 45764 (614) 753-3514—The College is an Equal Opportunity Employer—

SERVICE MGR. WANTED. for Audio Repair Shop. Must be working professional, capable of managing and expanding business. Equity can be developed. Chicago Area. David Lewis, 24 St. Charles Place, Highland Park, Ill. 60035.

TUBES

TUBES receiving, factory boxed, low prices, free price list. Transletronic Inc., 1306 40th Street, Brooklyn, N.Y. 11218. Telephone: 212—633-2800.

BOOKS

U.S. ARMY "HAND TO HAND COMBAT" manual \$3.50. Catalog 25¢. Hillcrest (IJ-22), McDonald, Ohio 44437.

PHOTOGRAPHY

SYNCHRONIZED SOUND IS SIMPLE for your slide shows—adds sparkle and punch. For home, education, industry. Free "How To" literature. A/VCO Division, Ace R/C Inc., Higginsville, Missouri 64037.

AUDIOVISUAL EQUIPMENT HEADQUARTERS. Slides come alive with synchronized tape sound track. Free literature, "Slides with Sound". S&S Supply, Box 12375B, North Kansas City, Mo. 64116.

COLOR SLIDES

ART-EDUCATIONAL-TRAVEL, 50,000 individually sold . . . Samples-Catalog \$1.00 refundable. Visuals D21 440 N.W. 130 Street, Miami, Florida 33168.

PLANS & KITS

COMPONENT CABINETS

Direct from the factory at low factory prices. Finished-Unfinished-Kits . . . free brochure.

AUDIO ORIGINALS

546 S. Meridan St.
Indianapolis, Ind. 46225

SITUATION WANTED

DISC JOCKEY WITH MASTERS DEGREE in electronics/mass communications desires position in field of broadcasting. Experienced in all aspects of broadcasting. FCC licensed. Write to Box #AA3-4.

MUSIC

RARE ROMANTIC PIANO SCORES—Moscheles, Henselt, Herz, Litoff, Scharwenka, Scriabin, etc. Free catalog. MUSIC TREASURE PUBLICATIONS, Box 127, Highbridge Station, Bronx, New York 10452.

AUTO ACCESSORIES

SPEAKERS—Acoustically designed and built for ¼—¾ cost of factory speaker systems. SAVARD, 600 East Roosevelt, Box 360, Baton Rouge, LA. 70802.

AUTHORS

PUBLISH YOUR BOOK! Join our successful authors: All subjects invited. Send for free appraisal and detailed booklet. Carlton Press (Dept. VRQ) 84 Fifth Avenue, New York 10011.

INVENTIONS WANTED

INVENTORS!

It is easy to protect and profit from your creative ideas. For brief step by step information send \$3.00 to CREATIVE ENTERPRISES 1511 Patricia Lane, Billings, Mont. 59102.

MUSICAL INSTRUMENTS

REBUILD A PLAYER PIANO! Details from Vestal Press, Vestal 71, N.Y. 13850.

REAL ESTATE FOR SALE

IDEAL 5-ACRE RANCH Lake Conchas, New Mexico. \$3,475. No Down. No Interest. \$29/mo. Vacation Paradise. Money Maker. Free Brochure. Ranchos: Box 2003SM, Alameda, California 94501.



“If music be the food of love, play on.”

TWELFTH NIGHT, Act I, Scene i, Line 1

In past articles we have discussed the research and the technology behind the Bose Direct/Reflecting® speakers. It would indeed be misleading for us to imply that the unprecedented series of rave reviews¹ and the worldwide acceptance of these speakers is the result of only the research and technology that gave birth to their new design². While these factors are absolutely necessary, they are far from sufficient to provide the performance for which these speakers are famous.

The more accurate the performance of any instrument or loudspeaker, the more apparent are small imperfections. Variation in the responses of individual speaker drivers, that might be masked by performance limitations inherent in the basic design of conventional speakers, can become annoyingly apparent with the accuracy of music reproduction associated with Direct/Reflecting speakers. The realization of this fact has led us to develop *quality control* measures that we think have no close second anywhere in our industry.

Here are some of the items we check:

1. Acoustical properties of the cone material
2. Annulus material and doping
3. Thickness and bond of the critical glue joints where the cone joins the voice coil bobbin. Errors in either direction can cause audible coloration
4. Density of voice coil winding
5. Flux density in the magnetic circuit
6. Sixteen mechanical parameters are checked ranging from the length of the flexible voice coil leads to the centering tolerance of the voice coil
7. Power tests to check for possible thermal problems
8. Accelerated humidity tests
9. Power sweeps after complete assembly in cabinet to check for any extraneous noises
10. Extensive computer checking of all parameters in the 901 active equalizer

Some of the items in this list cannot be directly tested after the speaker is assembled. For example, we can't see the glue joints or the voice coil. These tests and many others are made by our newly developed Syncom™ speaker testing computer. In addition, this computer selects matched drivers for each 901; and it matches the woofers and tweeters in each 501. One of the significant achievements of this computer is that its measurements are directly related to audible effects rather than to typical specifications whose correlation to audible performance has not been established. When the Syncom computer rejects a speaker, it means that a critical listener could hear the difference between that particular speaker and our standard of quality – more on this in a later issue.

When you couple this unique *quality control* system with all the technology behind the Direct/Reflecting speaker systems, you can appreciate our confidence in asking you to A-B the 901 with any speaker regardless of size or price. And while you're at it, audition the 501 against direct radiating speakers costing several times as much.

*Photograph of Shakespeare First Folio
courtesy of Harvard College Library*



¹For copies of the reviews, circle our number(s) on your reader service card.

²Copies of the Audio Engineering Society paper, ON THE DESIGN, MEASUREMENT AND EVALUATION OF LOUDSPEAKERS, by Dr. A. G. Bose, are available from the Bose Corporation for fifty cents.

You can hear the difference now.

BOSE®
Framingham, Massachusetts 01701

Check No. 38 on Reader Service Card



A Marantz speaker system breaks up that old gang of yours.

Separation of sound is a true test of a speaker system. And to put Marantz—or any speaker—to the test you should listen to something you are already familiar with so you'll be able to hear for yourself that it's the speaker and not the recording that makes the difference. Oh, what a difference Marantz makes! What you thought were two oboes are now clearly an oboe and a flute and that barbershop quartet...well, they're really a quintet.

Let's face it: ALL speakers claim to be the very A-1 HOT SHOT MOSTEST BEST.

But the proof is in the listening. And that's where Marantz speakers come in. Each model is engineered to handle a plethora of continuous RMS power and each

employs a long excursion woofer and a tweeter with fantastic off-axis response. And Marantz offers you a wide selection of sizes. Each model for the money is truly the very A-1 HOT SHOT MOSTEST BEST.

However, keep this in mind. Marantz speaker systems are built by the makers of the most respected stereo and 4-channel equipment in the world. The same quality that goes into Marantz receivers and amplifiers goes into the entire line of Marantz speaker systems.

To find out how much better they sound, listen. That's all we ask. Listen.



Check No. 43 on Reader Service Card

marantz
We sound better.

©1972 Marantz Co., A subsidiary of Superscope, Inc., P.O. Box 99 H, Sun Valley, Calif. 91352. In Europe: Marantz Int'l. S.A., Brussels, Belgium. In Canada: Electrohome, Ltd., Kitchener, Ontario. Prices and models subject to change without notice. Consult the Yellow Pages for your nearest Marantz dealer. Send for free catalog.