

PART 2"
MICROPHONES

AUDIO

JANUARY
1973 60c

The Authoritative Magazine About High Fidelity ® ▲

23602

Canby
Looks at Flat Speakers

New Tuner Specs for '73

Audio looks at

NEW TUNERS & RECEIVERS



5 0
052HUNTER-DON-0 1 0573
DON L HUNTER
2608 CENTRAL BLVD
EUGENE OR 97403

re of everything.

Four new and completely different AM-FM stereo receivers with increased performance, greater power, unsurpassed precision and total versatility.

SX-525 AM-FM STEREO RECEIVER — 72 WATTS IHF



SX-626 AM-FM STEREO RECEIVER — 110 WATTS IHF



Pioneer has mo

SX-727 AM-FM STEREO RECEIVER — 195 WATTS IHF



SX-828 AM-FM STEREO RECEIVER — 270 WATTS IHF



**Think of everything you've ever wanted in a
stereo receiver.**



Long before the current wave of consumerism, Pioneer had established its reputation for superior quality craftsmanship. This reputation has been continuously augmented by our commitment to building high fidelity components with a measurable extra margin of value. Our four new receivers — SX-828, SX-727, SX-626, SX-525 — are designed to meet a wide range of requirements and budgets. Yet each unit incorporates a significant array of features and refinements built into the top new model — the SX-828. Regardless which new Pioneer receiver you finally select, you are assured it represents the finest at its price.

Conceptual diagram

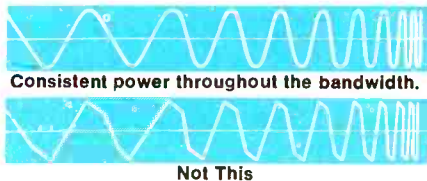

More meaningful power.

When it comes to power, each model provides the most watts for your money. This is meaningful power. Power that is consistent throughout the 20-20,000 Hz bandwidth (not just when measured at 1,000 Hz.) Especially noticeable at the low end of the spectrum with improved bass response, the overall effect is greater frequency response and low, low distortion.

Model	IHF Music Power 4 ohms	RMS @ 8 ohms Both channels driven @ 1KHz
SX-828	270 watts	60+60 watts
SX-727	195 watts	40+40 watts
SX-626	110 watts	27+27 watts
SX-525	72 watts	17+17 watts

Direct-coupled amplifier circuitry and twin power supplies improve responses.

Of course, having power to spare is important; but directing it for maximum performance is even more vital. In the SX-828 and SX-727, you will find direct-coupled circuitry in the power amplifier combined with two separate power supplies to maintain consistent high power output with positive stability. This means transient, damping and frequency responses are enhanced, while distortion is minimized. In fact, it's less than 0.5% across the 20-20,000 Hz. bandwidth.

Ultra wide linear FM dial scale takes the squint out of tuning.



You can't expect great music without great specifications.

Pioneer's reputation for high performance capability is thoroughly reinforced in these four receivers. Listening to them substantiates it; the specifications tell the reasons why. Since Field Effect Transistors increase sensitivity, they're incorporated into the FM tuner section of each unit. For example, the SX-828 uses 4 FET's. You get greater selectivity and capture ratio with Integrated Circuits and Ceramic Filters in the IF stage. Here's a mini spec list.

	SX-828	SX-727	SX-626	SX-525
FM Sensitivity (IHF) (the lower the better)	1.7uV	1.8uV	2.0uV	2.2uV
Selectivity (the higher the better)	+75dB	+70dB	+70dB	+45dB
Capture Ratio (the lower the better)	1.5dB	2.0dB	2.5dB	3.0dB
Power Bandwidth	All exceed by a wide margin the usable sound frequency spectrum			

Inputs and outputs for every purpose including 4-channel sound.

Depending on your listening interests and desire to experiment in sound, each receiver provides terminals for a wide range of program sources.

Inputs:	SX-828	SX-727	SX-626	SX-525
Tape monitor	2	2	2	2
Phono	2	2	2	Phono/Mic.
Auxiliary	1	1	1	1
Microphone	2	1	1	Phono/Mic. (as above)

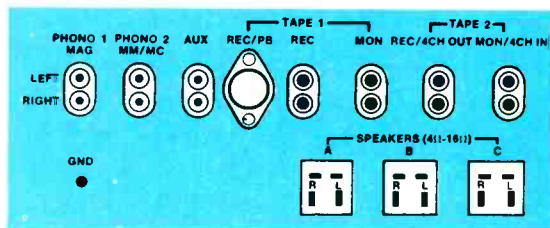

Outputs:	SX-828	SX-727	SX-626	SX-525
Speakers	3	3	3	2
Headsets	2	1	1	1
Tape Rec.	2	2	2	2

Someday, if you want 4-channel sound, all models have 2 inputs and 2 outputs to accommodate a unit such as Pioneer's QL-600A Decoder Amplifier. With it, and two additional speakers, perfect 4-channel sound is simply achieved.



Exclusive protector circuit for speakers.

Another example of Pioneer's advanced engineering is the automatic electronic trigger relay system designed into the SX-828 and SX-727. Since the signal is transmitted directly to the speakers because of the direct-coupled amplifier, this fail-safe circuit protects your speakers against damage and DC leakage, which can cause distortion. It also guards against short circuits in the power transistors. It's absolutely foolproof.

Versatile features increase your listening enjoyment.

Our engineers have outdone themselves with a host of easy-to-use features. All four units include: loudness contour, FM muting, mode lights, click stop bass/treble tone controls with oversize knurled knobs, and an ultra wide linear FM dial scale that takes the squint out of tuning. Except for the SX-525, they all employ high and low filters. Enlarged signal strength meters make tuning easier than ever. Center tuning meters

are included as well in the SX-828 and SX-727. Further sophistication is offered on the top two models with a 20dB audio muting switch — the perfect answer to controlling background music. As the senior member of the family, the SX-828 is endowed with speaker indicator lights (A,B,C,A+B,A+C) and a tuning dial dimmer for creating a more intimate lighting atmosphere.

Some day other stereo receivers will strive for this total combination of power, performance, features, precision and versatility. Why wait? Pioneer has more of everything now.

See and hear these magnificent receivers at your local Pioneer dealer. SX-828—\$429.95; SX-727—\$349.95; SX-626—\$279.95; SX-525—\$239.95. Prices include walnut cabinets.

U.S. Pioneer Electronics Corp.,
178 Commerce Road, Carlstadt,
New Jersey 07072

PIONEER
when you want something better

**WE'VE MADE
THE BEST
EVEN BETTER**

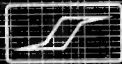

SHARPE AUDIO DIVISION
SCINTREX, INC.
14150 TONAWANDA, N.Y. 14150
(716) 231-0800



... 3
**NEW MODELS
BETTER!**



NEW MODEL 10/10
The frequency curves are actual tracings from a new Sharpe production Model 10/10. Improved design of the famous top-rated Model 10A. Smooth, brilliant, full response. Striking new decor.

NEW MARK III
For new bright sounds to satisfy the highest standards of discriminating professionals and audiophiles alike. Smart new appearance with advanced acoustical designs.

NEW MODEL 7/7
See this new budget-priced version of one of Sharpe's most popular models. Price and quality make it a "best-buy." Lightweight stereo listening. Rich new ebony decor. Your Sharpe dealer will gladly demonstrate the complete Sharpe Stereo line.

**SHARPE
AUDIO
DIVISION**
SCINTREX, INC.
Tonawanda, N.Y.
14150

Export Agents
**ELPA MARKETING
INDUSTRIES, INC.**
New Hyde Park,
N.Y. 11040

AUDIO

JANUARY 1973

Successor to **RADIO** Est. 1917

Vol. 57, No. 1

FEATURE ARTICLES

- | | |
|---|-----------------------------|
| 16 New Tuner Specifications for 1973? | <i>Len Feldman</i> |
| 22 Canby Looks at Flat Speakers | <i>Edward Tatnall Canby</i> |
| 24 A Look at the New Receivers and Tuners | |
| 34 Microphone Primer: Part II | <i>Jim Long</i> |

EQUIPMENT PROFILES

- | | |
|-------------------------|-----------------|
| 46 ESS Speaker System | <i>Mk. VII</i> |
| 50 TEAC Amplifier | <i>AS-100</i> |
| 54 EPI Speaker System | <i>601</i> |
| 56 Onkyo Speaker System | <i>Model 20</i> |

RECORD AND TAPE REVIEWS

- | | |
|----------------------|-------------------------------|
| 60 Classical Reviews | <i>Edward Tatnall Canby</i> |
| 66 Tape Reviews | <i>Bert Whyte</i> |
| 70 Off The Record | <i>Sherwood L. Weingarten</i> |
| 74 Jazz & Blues | <i>Martha Sanders Gilmore</i> |

AUDIO IN GENERAL

- | | |
|--|---------------------------|
| 4 Coming In February | 14 Editor's Review |
| 4 Tape Guide <i>Herman Burstein</i> | 6 What's New In Audio |
| 8 Audioclinic <i>Joseph Giovanelli</i> | 72 Advertising Index |
| 10 Behind The Scenes <i>Bert Whyte</i> | 76 Classified Advertising |



EDITOR *George W. Tillet* PUBLISHER *Jay L. Butler*
ASSOCIATE EDITOR *Edward Tatnall Canby* MARKETING DIRECTOR *Sanford L. Cahn*
ASSISTANT EDITOR *Eugene Pitts* COVER DESIGN *John Kwasizur*
DESIGN *David Adams* SUBSCRIPTION MANAGER *Jean Davis*
ADVERTISING PRODUCTION *Sharon Mancini*

CONTRIBUTING EDITORS: *Herman Burstein, Martin Clifford, Leonard Feldman, Richard Freed, Joseph Giovanelli, C. G. McProud, Harry E. Maynard, Alexander Rosner, Sherwood L. Weingarten, Bert Whyte*

AUDIO (title registered U.S. Pat. Off.) is published monthly by North American Publishing Co., Irvin J. Borowsky, President; Frank Nemeyer, Jay L. Butler and Roger Damio, Vice Presidents; R. Kenneth Baxter, Vice President/Production; Nate Rosenblatt, Promotion Director; Mary Claffey, Circulation Director.

RATES—U.S. Possessions, Canada, and Mexico, \$6.00 for one year; \$10.00 for two years; all other countries, \$9.00 per year. Printed in U.S.A. at Columbus, Ohio. All rights reserved. Entire contents copyrighted 1973 by North American Publishing Co. Second class postage paid at Philadelphia, Pa. and additional mailing office. Back issues, \$2.00 each.

REGIONAL SALES OFFICES: Jay L. Butler, Publisher, and Sanford L. Cahn, Marketing Director, 41 East 42nd St., New York, N.Y., 10017, telephone (212) 687-8924.

Jay Martin, 15010 Ventura Blvd., Sherman Oaks, Calif. 91403, telephone (213) 981-7852.

REPRESENTATIVES, United Kingdom: The American Magazine Group, 9 Warwick St., London, W 1, England

Continental Europe: John Ashcraft, 12 Bear St., Leicester Square, London W.C. 2, telephone 930-0525. For Benelux and Germany, W.J.M. Saunders, Mgr., Herengracht 365, Amsterdam, Holland, telephone 24.09.08.

Japan: Japan Printing News Co., Ltd., No. 13, 2 Chome Ginza Higashi, Chuo-ku, Tokyo, telephone 541-5795.

AUDIO Editorial and Publishing Offices, 134 N. 13th St., Philadelphia, Penna. 19107
Postmaster: Send Form 3579 to the above address

Check No. 2 on Reader Service Card

**We are the Garrard Engineers
who made the Zero 100.**

**We are the Garrard Engineers
who are going to sell it to you.**

We're engineers, not salesmen.

Yet, here we are, looking out at you from the pages of this magazine, selling you the machine we made. Not because we have anything against salesmen. But because we are so involved, over-involved perhaps, with the Zero 100.

It's understandable. After seven years of computations, of planning, of drawing and redrawing, of failure after failure, we made the automatic turntable people said could never be made.

A turntable that actually made a difference in the sound we heard. One with zero tracking error. That worked; not just in theory, but in hard practical fact.

We started traditionally by defining the problem.

Distortion.

A record is cut at right angles, from the outside groove to the final one. To reproduce this sound perfectly, a turntable should have a cartridge head that tracks the record exactly as it was cut, at the same 90 degree tangency. But no automatic turntable could achieve this.

Our solution? We created a turntable like no other turntable. A turntable with two arms.

The first arm of the Zero 100, the more normal looking arm, is the one with the cartridge head. The auxiliary arm, our innovation, is attached to the first arm by a unique system of ball bearing pivots. Because of the precision pivots built into this auxiliary arm, the cartridge head keeps turning so that the stylus is always at a 90 degree angle to the grooves of the record.

The result? No distortion.

We are not men who are comfortable with words like "vision" or "dream." And yet we have had one, and seen it come true.

We have read reviews of our work in Stereo Review. High Fidelity. Audio. Rolling Stone. The Gramophone. And they fill us with pride.

We stand proudly beside the Zero 100. And offer it to you.

The Garrard Engineers

Check No. 3 on Reader Service Card



Mfg. by Plessey Ltd. Distributed by British Industries Company

Tape Guide

Herman Burstein

coming in
February

Whats what in amplifiers—
Len Feldman

Amplifier Design Trends

The Language of High Fidelity, Part 8 of Martin Clifford's Guide for Beginners

Equipment Reviews include

Phase Linear 400 amplifier AR 7 speaker system



ABOUT THE COVER:

Shown is the Harman-Kardon Citation 14 Dolby Tuner, the Fisher 504, Marantz 4430, Sony SAR-6650, Kenwood KR-614A and Sansui QR-4500 receivers. All these are good examples of present-day design and styling. The vintage Browning tuner circa 1949 or thereabouts makes an interesting contrast.

Sluggish Take-Up II

The September issue of AUDIO contains a letter from Mr. Ellison concerning sluggish take-up on a Revox tape recorder. I wonder if the problem is not with the take-up motor itself but with the tape guides.

On the Revox the tape guides are cylinders with chrome end plates. It seems to be very easy for minute particles of tape to catch between the cylinder and the end plate thus slightly reduce the width of the channel for the tape. This makes the tape drag on the guide causing very poor take-up.

This cure is to take apart and clean the offending guide, a straightforward operation, and then to use only tape which does not shed pieces of oxide.

G. W. Waters
Providence, R.I.

Distortion On Old Recordings

Q. During the early 1950's I had a Webcor tape recorder and frequently taped broadcasts of the Metropolitan Opera. Toscanini, and others, which I cherished. The recordings were excellent, at least at that time. I sold the Webcor in 1956 but kept the tapes. I did not purchase another recorder until 1968, at which time I bought two (Sony 666-D and 560-D), along with a complete component system. I could hardly wait until I could play my tapes again. But what a shock to discover that every one was distorted. And I noticed that as I attempted to play them the needles of the VU meters stayed at maximum level. Can you explain why this happened, when I am certain that when I made the recordings I did not overload the recording?—Richard T. Koory, Arlington, Va.

A. Have you tried playing your old tapes on machines other than your Sony ones? If they still sound distorted, this would absolve the Sony's and place the fault in the tapes. Possibly, distortion in your old sound system may have masked the tape distortion. Another possibility is that winding stresses may have physically distorted the tapes while they were standing unused for a dozen years. If this is so, the situation might be helped by winding and rewinding the tape several times before using it, thereby relieving tape stress. Still another possibility is that your new

tape recorders and your new audio system are much more revealing of tape distortion than was your old Webcor; this could be in part because of the better high frequency response of your new components.

If your tapes sound satisfactory when played on another tape machine, then the fault is in your tape machine. In other words, the high level on your tapes may be overloading your machine.

Headphones

Q. Is there a set of stereo headphones which have a water-filled pad which conducts the sound to your ears. I have heard of such earphones, and that they produce exceptional sound. Please tell me whether such earphones exist and who makes them.—Benjamin Noval, APO San Francisco, Calif.

A. Stereo headphones with liquid-filled cushions are made by Sharpe Instruments, Division of Scintrex, Inc., Amherst Industrial Park, Tonawanda (Buffalo), N.Y. 14150.

Tape Storage

Q. A question regarding storage of recorded magnetic tapes: It is suggested that they be stored in metal cans. Surely this means cans of magnetic metal, steel, or sheet iron. I suppose a cabinet lined with sheet iron would do as well and avoid handling all those cans. A letter some time ago in AUDIO (November 1969) suggests that our homes are vast collections of bulk tape erasers. Your thoughts would be appreciated.—F. A. Fetvedt, Fergus Falls, Minn.

A. I think that the danger of erasing tape from home a.c. sources (motors, TV sets, power lines, etc.) tends to be exaggerated. I believe that a metal can, or a cabinet lined with metal (iron or steel) of similar thickness to the can, will provide adequate protection. To check on the degree of danger, I have done the following. I have taken a tape containing substantial high frequency material (these frequencies are the most susceptible to erasure) and brought it within less than a foot of a very powerful bulk eraser, and then played it. I could detect no change in the audio content of the tape.

What's a 4-channel system without a 4-channel deck?

Not very complete. Because so much of the 4-channel music available is on discrete 4-channel tape. That's also one of the reasons Panasonic picked discrete as the standard for our 4-channel equipment. Including our 4-channel cartridge decks.

We have two. The RS-847US plays 4-channel and 2-channel cartridges, automatically. No switches to turn. No knobs to set. You've also got controls for continuous play. Or automatic eject. A digital program indicator. Plus one program selector button to control all eight tracks. And inside that lovely walnut cabinet,

there's an AC hysteresis synchronous motor. So voltage variations won't cause wow and flutter.

But maybe you're tired of listening to pre-recorded music. You want to make some of your own. Then you need a deck that records as well as plays back. Like our RS-858US. It could be your own sound studio for 4-channel and 2-channel tapes. The 4 output level controls let you blend the sound any way you want. And the 4 separate VU meters let you see what you're doing. There's even a headphone selector switch so you can monitor the sound on the front or the back speakers.

Of course, you also get a lot of extras on the RS-858US. Like a locking fast forward button. And an Automatic Timing counter. To help you find out where you are on the tape. You see how much time has elapsed. In minutes.

Our 4-channel components play discrete, matrix, stereo and monaural. They even enhance the sound of stereo with our "Quadruplex" circuitry. See our other components with our decks at a franchised Panasonic Hi-Fi dealer. Because what's a 4-channel deck without a 4-channel system.

FOR YOUR NEAREST FRANCHISED PANASONIC HI-FI DEALER, CALL TOLL FREE 800 243 6000. IN CONN., 1-600 882-6500

Panasonic® HiFi 4-Channel Tape Decks



RS-858US

RS-847US

Check No. 5 on Reader Service Card

**Either way
you get the
world's first
universal
four-channel
decoder.**



EVR-4X4
Four-Channel
AM/FM Receiver
\$249.95

EVX-44
Universal
Four-Channel
Decoder \$99.95

Now Electro-Voice offers our new universal decoder circuit built into both a stereo receiver and a 4-channel decoder.

The EVR-4X4 Receiver has every needed feature for 2- and 4-channel sound. Yet it costs no more than many 2-channel units that offer half the pleasure. And it will properly decode any matrix 4-channel input without switching. Ideal for playing SQ*, Stereo-41, or any other matrixed records, tape, or FM sources.

The EVX-44 Universal Decoder creates a 4-channel control center for existing stereo equipment. Just add a second stereo amp and two more speakers. Unique separation enhancement circuit automatically adjusts front-back separation as required by program material.

Both the receiver and the decoder are also designed to accommodate 'discrete' inputs like 8-track tape if you wish. Hear the finest in four-channel sound at your Electro-Voice showroom. Where the excitement is!

E-V 4-channel products are produced under U. S. Patent No. 3,632,886
*T.M. CBS, Inc.
†T.M. Electro-Voice, Inc.

Electro-Voice
a **Gulton**
COMPANY

ELECTRO-VOICE, INC., Dept. 134A
602 Cecil Street, Buchanan, Michigan 49107
In Europe: Electro-Voice, S. A., Römmerstrasse 49, 2551 Nidau, Switzerland
In Canada: EV of Canada, Ltd., Ganoanoue, Ontario

Check No. 6 on Reader Service Card



**IN
WHAT'S NEW AUDIO**



New power amplifier

Tomlinson Research Instruments have introduced a 100 watt power amplifier which features an oversized power supply for continuous operation, massive heatsinks, special protection circuits and modular construction. Power rating is 100 watts per channel into 8 ohms and 160 watts per channel at 4 ohms. Designated Model 1002, the price is \$450.

Check No. 100 on Reader Service Card



Pioneer turntable

Model PL-61 is claimed to be a professional type turntable and it has some unusual features. Motor is a high torque, brushless servo type using the Hall effect. It has a belt drive and speed control is accomplished electronically. Other features include a magnetic anti-skating device, a turntable strobe, oil-damped cueing device, direct reading stylus pressure counterweight, lateral balance control and adjustable feet. Wow and flutter is given as less than 0.05% (WRMS) and a s/n of 55 dB or better. Price \$299.95 complete with base and dust cover.

Check No. 101 on Reader Service Card

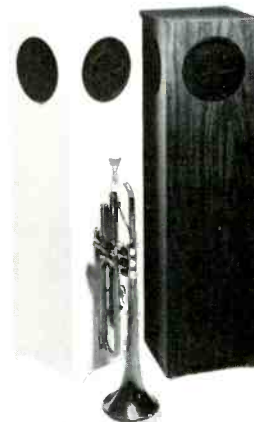

Miniature Columns

EPI announce a new column type speaker called a Microtower which measures only 32 inches high. It is said to deliver accurate bass down to 50 Hz and have exceptionally good dispersion. Two 4½ inch units are employed and only 5 watts of power are needed. Because of the small floor space required, EPI suggest that these Microtowers would be ideal for four-channel use in small or medium size rooms. Obtainable in walnut, black or white. the price is \$99.95 a pair.

Check No. 102 on Reader Service Card



Wollensak cassette recorder

The new recorder from Wollensak is distinctively styled with "eye appeal." It features Dolby noise suppression, memory rewind and has provision for chromium dioxide tapes. Frequency range is quoted at 30 to 14 kHz +3 dB with standard tape and up to 15 kHz with CrO2. Price is \$259.95.

Check No. 103 on Reader Service Card



TEAC AN-80 Dolby noise reduction unit

TEAC 3300: the strong, silent type

If you've been shopping the field for a semi-pro deck with studio-size reels, you've probably had to cut your way through a lot of noise about silence. And you've probably wondered why you haven't heard TEAC blowing its horn on the subject. The answer is simple — we didn't feel we had to. Long before the dawning of Dolby,* TEAC perfected the kind of electronics that lets you use the most advanced low-noise / high-output tapes on decks like the 3300 with startling results. We effectively reduced tape noise and hiss below audible levels. And let Dolby take it from there. But we wanted to keep the 3300 a truly versatile semi-pro deck for the audiophile. So instead of building Dolby in, we outboarded it, as you can see — in the AN-80 Dolby Noise-Reduction Unit. Now you could get better signal-to-noise than was dreamed of in your ratio for \$149.50. Not only on your 3300 but on any other existing

deck. At the same time, we addressed ourselves to making the 3300 transport (already world-renowned for its superlative quality and unmatched reliability) a near-perfect mechanism. By manufacturing all critical components in-house — and to specs and tolerances we wouldn't dare impose on anyone else. By quality control tantamount to paranoia — for example, we adjust, check, and readjust our heads as many as 17 times during manufacture. Over and above this, we provide audiophile conveniences overlooked on other decks. Like a bias-level switch. And the famous Edi-Q control for one-hand editing and cueing. Two full-size VU meters. All this for only \$499.50. Now would you really expect a machine as strong as all this to be anything but silent? And if all you need is a 7"-reel deck with many of the 3300's fine features, checkout our 1230 at \$359.50.

TEAC® TEAC Corporation of America,
7733 Telegraph Road, Montebello, California 90640

TEAC Corporation, 1-8-1 Nishi Shinjuku, Shinjuku-ku, Tokyo, Japan
TEAC EUROPE N.V., Kabelweg 45-47, Amsterdam - W.2, Holland
In Canada: White Electronic Development Corp., Ltd., Toronto

*Dolby is a trademark of Dolby Laboratories, Inc.

audioclinic

Joseph
Giovanelli

Hum in TV Audio

Q. My problem is in attempting to hook the audio output of my new Motorola Quasar TV set into the rest of my audio system. The TV dealer tried to cooperate with me by installing a phone jack on the back of the TV set. He took the audio signal from the volume control, the idea being to feed in a signal into my Dynaco PAT4 preamplifier, which would be constant and not affected by the volume control. When I attempted to use this arrangement, I got an unpleasant buzzing along with the TV audio. It sounded as though the set was not properly grounded. I discussed this problem with the dealer and he said that the ground was "incompatible." This does not explain much to me.

By experimenting I find that I can run the output of the TV into my Revox A77 tape recorder with no problem as long as the recorder is not con-

nected in any way to the rest of the audio system. I can record from the TV set as long as the recorder is not connected to the system.

I hope you will be able to give me some suggestions as to what to do so that I can plug the TV into the Dynaco preamplifier.—Leonard F. Blanchard, Clayton, N.Y.

A. I do not know exactly what TV set you are discussing. (There are a number of models which carry the Quasar designation.) Once I had this information I would then need a schematic which might shed some light on your problem. Therefore, what follows is based on past experience with TV sets in general.

Any television receiver has a number of circuits, which, when improperly adjusted, will enable video to enter the audio circuit; this will be heard as a buzz.

It could be that you have a set with

a "hot" chassis, one having no power transformer. If this is the case, you stand a chance of damaging some components as well as introducing audible hum when attempting to connect this TV set to your sound system. You will require an isolation transformer capable of handling at least as much power as is required by your TV set, plus a reasonable safety margin. If all of these assumptions are correct, the addition of this transformer may solve your problem immediately.

If the hum still persists, try connecting the chassis of the TV set directly to the chassis of your preamplifier. Connect the shield of the interconnecting cable only at the *preamplifier input*. The other end of the cable should not be connected. Use No. 16 wire to interconnect the two chassis. (This wire will serve to carry the signal and not the shield.)

If the hum is still present or if the audio of the TV set no longer operates as it should, the audio input circuit is not standard. I would then need to see a schematic of the set before proceeding further.



Dear Mr. Giovanelli:

Thank you for your letter regarding the problem I had in attempting to connect the audio output of my new TV receiver through my high fidelity music system. I have the problem solved.

I first tried a good-size isolation transformer as you suggested. I plugged it into the a.c. wall outlet and then plugged the TV set into the transformer. This entirely solved the problem.

A transformer of enough capacity to handle the TV set's requirements plus a safety factor was rather costly. I tried another approach. I got a small matching transformer and used it in the audio line only. This also solved the problem.

Now I am using the inexpensive matching transformer rather than the heavy isolation transformer. I plugged the output from the matching transformer into the high level input of a Shure 4-position mike mixer, which also enables me to add reverb. I am now getting very good sound from the TV

(Continued on page 75)

If you have a problem or question on audio, write to Mr. Joseph Giovanelli, at AUDIO, 134 North Thirteenth Street, Philadelphia, Pa. 19107. All letters are answered. Please enclose a stamped self-addressed envelope.

A couple of winners.

This new tuner/amplifier combination represents one of the best values Sherwood has introduced. To give you matchless sound.

S-2400 AM/FM Stereo Tuner:

Four gang variable tuning capacitor
1.8 uv FM sensitivity
"Stereo Only" switch
Walnut case included

S-9400 Stereo/Dynaquad Amplifier:

100 watts RMS, 8 ohms 1KHz @ T.H.D.
Built-in Dynaquad four channel matrixing circuit

Inputs for 2 phones, mics, tuner,
2 auxiliary sources
Provision for Four Channel decoder (can
double as a second tape monitor).
Walnut case included

The S-2400 tuner at \$229.95
The S-9400 amplifier at \$259.95

A very compatible couple.

Sherwood Electronic Laboratories
4300 N. California Avenue
Chicago, Illinois 60618



Sherwood Excitement

Check No. 8 on Reader Service Card



Listen free
for 10 days! Then
SAVE
50%

off our already-
low price if you
decide to keep this
superb 3-record set
plus free bonus LP...

AN EVENING WITH THE BOSTON SYMPHONY ORCHESTRA

No obligation to buy anything!

\$7.47

ALL YOURS FOR ONLY

plus small postage/handling charge

WILLIAM STEINBERG CONDUCTS
THE PLANETS

HOLST'S ASTROLOGICAL SPECTACULAR "SEEMS TO HERALD
A NEW ERA IN RECORDED SOUND" (STEREO REVIEW)

MICHAEL TILSON THOMAS CONDUCTS

WINTER DREAMS

TCHAIKOVSKY'S FIRST SYMPHONY, ROMANTIC MOOD-PAINTING
AT ITS MOST BEAUTIFUL AND CAPTIVATING

RAFAEL KUBELIK CONDUCTS

THE MOLDAU

SMETANA'S PORTRAIT
OF AN ENCHANTING RIVER. PLUS ITS RADIANT COMPANION,
FROM BOHEMIA'S WOODS AND FIELDS

CLAUDIO ABBADO CONDUCTS

DAPHNIS & CHLOE

RAVEL'S SHIMMERING SECOND SUITE FROM THE BALLET,
PLUS HIS TENDER PAVANE FOR A DEAD PRINCESS

Extra! Free Bonus Record!

STEINBERG CONDUCTS STRAUSS'

**ALSO SPRACH
ZARATHUSTRA**

Famous dramatic theme music
from "2001: A Space Odyssey" in
a triumphant performance



Here's a fabulous opportunity! Listen *free* for 10 days to a complete concert of magnificent music...played by the incomparable Boston Symphony Orchestra under four celebrated conductors...recorded by Deutsche Grammophon with astonishing stereo realism...pressed in Europe on superior, silent-surfaced discs. And if you act today. *An Evening with the Boston Symphony Orchestra*—three records boxed *plus* free bonus record *plus* big brochure filled with pictures and articles about the music and artists—can be yours at *50% off* our regular price to introduce you to the International Festival of Great Orchestras. Return the set after 10 days, or keep it if you wish for only \$7.47 plus small postage/handling charge. (You save *more than \$20 off* suggested list price of comparable records in retail stores!)

Then continue to save! For you also receive a 10-day free audition privilege, with *no obligation to buy*, on other exciting three-record concert programs (plus free bonus LP), one sent every two months, by the world's great orchestras, like the London Symphony and Berlin Philharmonic. Return any set, or keep it at our low regular price of only \$14.95 plus small postage/handling charge—a \$12.97 saving off comparable retail value! You may cancel at any time. Open your heart and ears to the ultimate in home listening pleasure! Mail the card right now!

SEND NO MONEY! MAIL THIS COUPON IF POSTPAID CARD IS MISSING

Limited Opportunity! New Members Only!
INTERNATIONAL FESTIVAL OF GREAT ORCHESTRAS
333 North Michigan Avenue, Chicago, Illinois 60601

AM-3

Please send, for my free audition, the three-record boxed concert program with brochure. *An Evening with the Boston Symphony Orchestra*, plus bonus record. I may return all four records after 10 days and owe nothing, or keep them and pay only \$7.47 (half your regular price) plus a small postage/handling charge (sales tax extra where required). I will also receive, at two-month intervals, further concert programs—three records plus bonus LP—by famous orchestras for my free 10-day audition. I may return any set, or keep it at your regular low price (only \$14.95 complete plus small postage/handling charge). I am not obligated to buy any records whatsoever, and I may cancel this arrangement at any time.

NAME _____ (please print)

ADDRESS _____

CITY _____ STATE _____ ZIP _____

IT'S LIKE 'NOTHING' ELSE FOR

LENCO
PROFESSIONAL L75 TURNTABLE \$99⁹⁵

When the Swiss make a watch, they make a watch. And when they make a turntable, they make stereo history!

The Swiss-built Lenco Professional L75 Turntable brings you closer to "NOTHING" than any other comparable turntable. ("NOTHING", of course, is the elimination of everything that interferes with the perfect reproduction of stereo sound.) Moreover, the L75 is loaded with features an audiophile could learn to love:

- 1 Low mass cartridge head,
- 2 Precisely balanced tonearm,
- 3 Infinitely variable speed control,
- 4 Viscous-damped cueing.

Write for the full, exciting specs to: Lenco Division, Benjamin Electronic Sound Corp., Farmingdale, N.Y. 11735 A division of Instrument Systems Corp. Available in Canada.



LENCO

BENJAMIN

puts more engineering in...
so you get more music out.

Check No. 10 on Reader Service Card

Behind The Scenes

Bert Whyte

NEXT YEAR MARKS my 20th anniversary as a critic, and as you might expect, I have accumulated zillions of recordings. As the stereo disc era became firmly established, out of sheer lack of storage space, I gave away or sold thousands of mono discs. Tape recordings have been piling up since 1949, and today we have open reel tapes, cassettes, and cartridges both stereo and quadraphonic. Plus quadraphonic discs of all the matrix formats and CD-4 discrete as well. In short, I have an almost infinite choice of music, and since, very frankly, all these tapes and discs were "freebies", there is a tendency to treat them in a rather "offhand" or "cavalier" fashion. Now don't misunderstand me. There is no lack of respect for the music, the artists, or the technological accomplishments represented by the discs or tapes in my collection. There just isn't that sense of "possessiveness" experienced by those who have plunked down their hard-earned dough for a disc or tape recording. Let's face it . . . even with the discounts available today, discs average out to about 4 dollars each and the various tape formats more than that, so that even a very modest collection of say, a hundred or so recordings, can represent a sizable investment. Needless to say, for a person truly interested in music, whether his tastes run to pop or classical or both, he wants to sample a much broader spectrum of music than that which he can afford to incorporate in a collection. Not too surprisingly, this person turns to FM stereo radio and acquires either a receiver or a tuner to pick up broadcasts in this medium.

In any case, although changing tastes have had a profound effect on FM programming (mainly, sad to say, in the diminution of classical music broadcasting) there are more FM stations going on the air every year, and for a great many people, more and more reasons for acquiring a receiver or tuner. Now I have owned many FM tuners over the years. In the early days of mono FM, the principal reason for incorporating a tuner in one's hi-fi system, was that with *live* symphony

orchestra broadcasts, you were getting the *highest quality sound available*. In the case of the absolutely superb special broadcasts provided by Major Edwin Armstrong (which I related to you earlier this year) the fidelity of the sound was far beyond any disc you could buy, and indeed was better than *master* tape recordings of that time, since the signal-to-noise ratio of the recorders was *poorer* than the FM signal! In spite of this we still did a lot of "off-the-air" recording. One fondly remembers using the REL "Precedent" tuner, the "Rolls-Royce" unit of those days, teamed up with a 15 ips Magnecorder.

Nowadays I live about 60 miles from the FM transmitters atop the Empire State Building in New York. Over the past few years I have used a fairly comprehensive sampling of the better quality FM tuners. At that distance from the transmitter, and using a high quality log periodic antenna I got what I would describe as fair to good reception. But frankly, it just wasn't good enough for me to warrant much listening to this medium. I am particularly bugged by ignition noise, and in spite of fancy shielded cable and very "sanitary" wiring and lead-in practices, all of the tuners I used had this problem in varying degrees. Then too, the signal-to-noise ratio and the "quieting" on quite a few stations was less than satisfactory. One must note that because the G.E./Zenith system of FM stereo multiplexing was chosen over the technically superior Crosby system (in large part because of the aforementioned SCA) the FM stereo signal-to-noise ratio is somewhere between 16 to 23 dB *poorer* than FM mono SNR. As I pointed out earlier, I have an almost limitless choice of music on very high quality discs and tapes from my collection, as an alternative to FM. This, plus some of the technical shortcomings I encountered, have made me feel what may best be described as "indifferent" to FM stereo these past couple of years. In fact, I have not even had an FM tuner in my home for over a year.

You will recall that some months ago I reported on the use of the Dolby B Type noise reduction system in FM broadcasting. Essentially, a B Type encoder is installed at the transmitter before the FM signal is pre-emphasized, and the complementary B Type decoder (such as those made by

AUDIO • JANUARY 1973

WE SPEAK SOFTLY

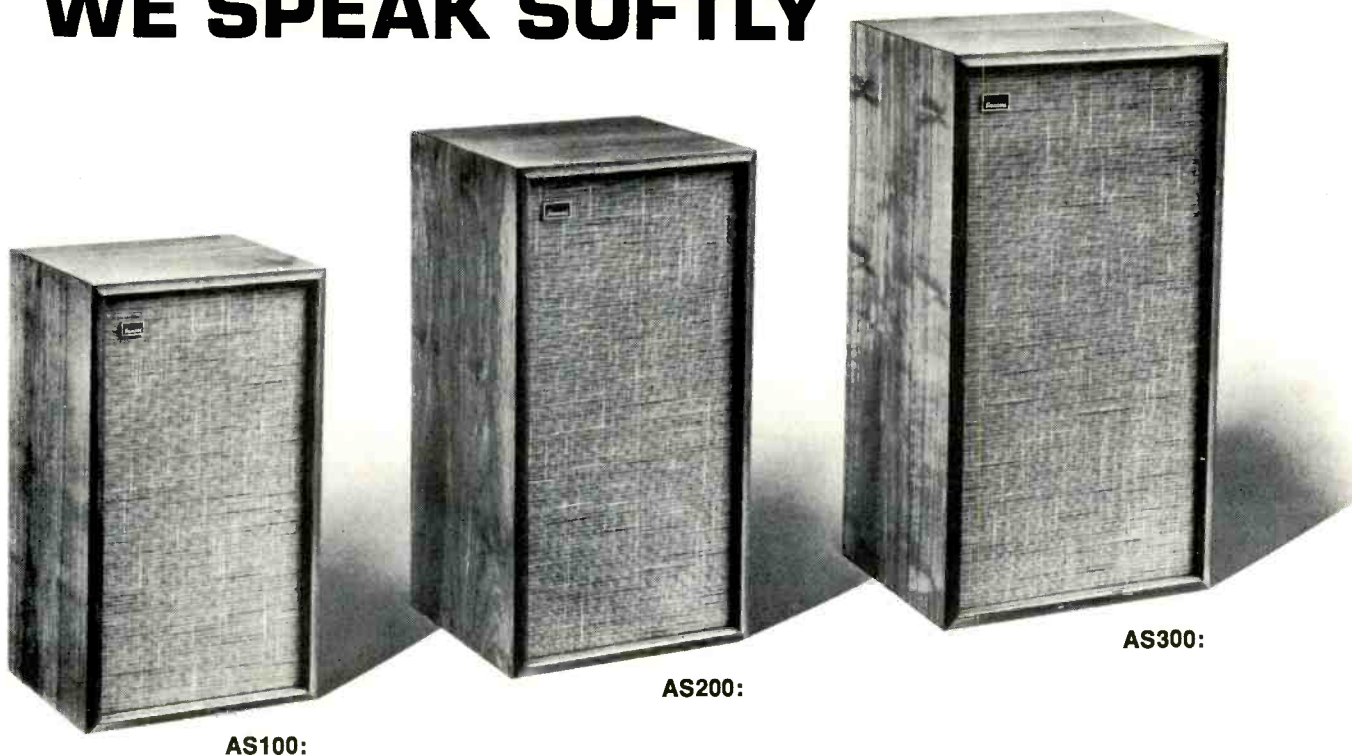

AND CARRY A BIG SOUND

From the most delicate whisper to the thunder of a full orchestral climax, Sansui's new AS acoustic-suspension speakers reproduce the full dynamic range, distortion-free and with impartial precision.

Loud or soft—high volume setting or low—their special quality remains steadfast—and that quality will be a revelation to American ears. For the AS line was designed only after careful research into our listening preferences.

But traditional acoustic-suspension design was only the starting point. Next came new woofer cones blended of selected pulp and wool, then custom-impregnated for well-damped sound. Leakproof, mitred-joint cabinets. New wide-dispersion cone tweeters with excellent transient response. The results are lowered resonances, extended low-end response and smoother high-end performance. They add up to a new standard for reproduced sound, more natural yet more dramatic than anything you're accustomed to.

Listen to them yourself. You'll hear what we mean.

AS100: 2-way system with 10" woofer and 3" tweeter.
Response: 45 to 20,000 Hz. Peak power: 40 watts. \$89.95.

AS200: 3-way system with 10" woofer, 6.5" midrange and 3" tweeter.
Response: 40 to 20,000 Hz. Peak power: 50 watts. \$119.95.

AS300: 3-way system with 12" woofer, 6.5" midrange and 3" tweeter.
Response 35 to 20,000 Hz. Peak power: 60 watts. \$149.95.

© COPYRIGHT 1972 BY SANSUI



SANSUI ELECTRONICS CORP.

Woodside, New York 11377 • Gardena, California 90247
ELECTRONIC DISTRIBUTORS (Canada), Vancouver 9, B.C.
SANSUI ELECTRIC CO., LTD., Tokyo, Japan • Sansui Audio Europe S. A., Antwerp, Belgium

Check No. 11 on Reader Service Card

Advent, Teac, Concord and others) used in reception. The result of this is an overall 8-9 dB subjective reduction in noise level, which increases the station's effective coverage area with acceptable SNR, which coverage could not ordinarily be obtained without an approximate 8-fold increase in transmitter power. Various stations around the country such as WDCS/Portland, Me.; WAKR/Akron, Ohio; and WVUD/Dayton, Ohio have inaugurated Dolby B Type broadcasts, and the prestigious WFMT/Chicago is presenting several hours of Dolbyized broadcasts every day. Some months ago WQXR, the New York Times renowned classical music station, announced it would be broadcasting Dolby B encoded programs on a permanent round-the-clock basis. At about the same time as the WQXR/Dolby programming went into effect, the enterprising people at Harman/Kardon introduced their Citation 14 stereo FM tuner with built-in Dolby B Type noise reduction . . . the first tuner specifically designed for this advance in FM broadcasting techniques.

I have "lived" with a Citation 14 for some months now, and must say I am impressed with the performance of this singularly well-engineered tuner. Now I am not about to compete with the inquisitors who will minutely dissect and discuss the inner workings of the Citation 14 in a typical Audio Profile. Let the technocrats wax enthusiastic about the "phase-locked loop circuits", the 5 section gang FM front end", "I.f. filter with sealed 9 pole phase linear LC network", "I.f. strip with 2 extremely high gain IC's", etc. etc. I leave to others the nit-picking about sensitivity figures. All I know is that I have picked up listenable stereo programs from Philadelphia, from parts of Eastern Pennsylvania, all sorts of burgs in Connecticut, and from little one-lunged college radio transmitters. Freaky? Perhaps, and I would be the first to confess that the program content of these stations was quite inconsequential. The important thing is that the stations that I *am* interested in . . . WNYC, WQXR and several other "good music" stations, "pop in" instantly, 60 miles from the source, rock-steady and with a cleanness of sound I have not previously encountered in FM listening.

Physically, the Citation 14 is a departure from the "traditionally" styled tuners. For one thing there is no long tuning scale. Instead there is a large window with the station frequencies in brightly luminous numbers, which

are actually on a drum, which is controlled by a very smooth-acting knurled flywheel below the window. To the left of the dial scale is a center channel tuning meter, and to the left of it, the Citation 14's unique "quieting" meter. This meter "reads" signal-to-noise ratio . . . the quality of the received signal, rather than merely an indication of signal strength. In use, you strive for maximum deflection of the meter to the highest number, which represents the best listening position, even if the tuning meter is not at the center of the pass band. The front panel has an array of controls for function (mono, auto, stereo only) stereo noise filter, sliding gain controls, mute switch, power switch, etc. There are several controls unique on this tuner. One is the Dolby switch, which activates the B Type decoding circuits, and a little "double D" Dolby trademark lights up on the panel to indicate you are in this mode. The other control is a level set tone switch which activates a generator which produces a 400 Hz sine wave test tone at a level equivalent to 50% of full modulation of an FM signal. This is for use in making "off-the-air "recordings", in which the test tone is fed into recorder input level controls and the controls adjusted to read "O" VU. This will generally insure optimum SNR, but depending on the overload and input characteristics of the recorder it may be necessary to experiment a bit to find the right setting of the controls in case the reference level is too high. It is also useful in maintaining correct "left/right" balance. I think this level set tone is a long overdue convenience and in conjunction with the handy front panel tape output jack, it makes recording from this tuner a cinch. The rear panel has the usual input/output facilities, plus an output for a quadraphonic decoder, a scope output, and a stereo threshold control and a mute threshold control, which according to their setting will permit the reception of all stereo signals irrespective of strength, or which may be set for varying degrees of signal quality.

The Dolby facilities of the Citation 14 worked very well with the Dolby B Type encoded signals from WQXR. As expected, the sound of the undecoded broadcast was a bit on the bright side, but a modest treble roll-off was all that was needed to cope with this characteristic, and it seemed to cut noise a little. With the WQXR signals decoded, there was a very audible improvement in SNR, and for the most part at least as quiet as FM stereo stations very much closer to me

than 60 miles. Of course, one must not forget that the Dolby B decoder cannot overcome the basic noise of poor records or tapes. A hissy tape is still a hissy tape, but at least the noise problem isn't compounded with the noise I would be picking up from a non-Dolby broadcast which would be in effect like increasing my distance from the transmitter by a factor of three.

Getting back to the Citation 14 tuner, I am happy to report that I have yet to encounter any of my pet peeve, ignition noise. This is the first unit I have ever used in which this annoyance is apparently fully suppressed. Probably the most impressive aspects of this tuner are the really effective quieting on most of the stations I pick up from New York, and the extremely low distortion as evidenced by the cleanness of the sound. However, it must be noted that these qualities also impose certain penalties . . . to wit; the Citation 14 is mercilessly revealing of the poor program material and technical inadequacies of many FM stations. I am utterly appalled by the rumble I hear from poor turntables, and the wow and flutter as well. And from tape machines too! And the terrible cacophony of ticks, clicks, scratches and hiss from the recordings. I suppose part of it is my fault. Probably a great many people use their FM for background listening, and thus at the usual low levels don't hear all these terrible noises and distortions. Plus the fact that few of the tuners are of the quality of the Citation unit and some masking occurs. I am not one for background music, except perhaps if it murmurs politely and unobtrusively at a cocktail bash. When I listen, I listen at a good room-filling level, and thus I hear the noises of all that junky equipment and bad recordings. Fortunately, most of the stations I like to listen to, have pretty fair equipment and distracting sounds are minimal.

In summation, the Citation 14 Dolby FM tuner is a magnificent piece of equipment, which already has partially restored my faith in the FM medium. While I will still draw heavily on my record and tape collection for the highest quality sound, I now know I can be confident of hearing those Boston Symphony and Philadelphia Orchestra tapes over WQXR with optimum quality via the Citation 14.

One final note . . . wouldn't it be nice if the musicians union would lessen their broadcast fees, so that once again we could hear the New York Philharmonic . . . LIVE!

The ADC-XLM "...in a class by itself."

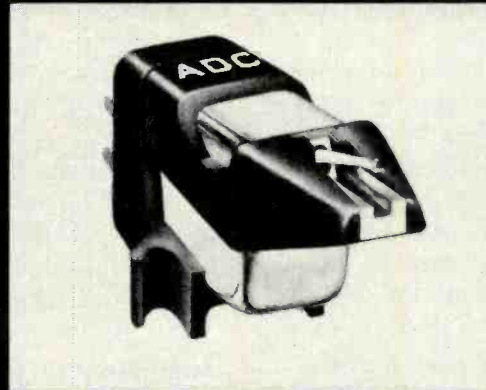

That's the way Stereo Review described our XLM. High Fidelity headlined their review, "Superb new pickup from ADC" and went on to say, "...must be counted among the state of the art contenders." And Audio echoed them with, "The ADC-XLM appears to be state of the art."

With the critics so lavish in their praise of the XLM, there's hardly any necessity to add anything. Far better to let the experts continue to speak for us.

Frequency response The CBS STR-100 test record showed less than ± 1.5 dB variation up to 20,000 Hz. *Stereo Review*
...response is within ± 2 dB over the entire range. *Audio*
Frequency response is exceptionally flat. *High Fidelity*

Tracking This is the only cartridge we have seen that is really capable of tracking almost all stereo discs at 0.4 grams. *Stereo Review*
The XLM went through the usual torture test at 0.4 grams (some top models require more than a gram). *High Fidelity*
The XLM is capable of reproducing anything found on a phonograph record. *Audio*

Distortion Distortion readings... are almost without exception better than those for any other model we've tested. *High Fidelity*

The XLM has remarkably low distortion in comparison with others. *Audio*
At 0.6 grams the distortion was low (under 1.5 per cent). *Stereo Review*

Hum and noise The XLM could be instrumental in lowering the input noise from the first stage of a modern transistor amplifier. *Audio*
The cartridge had very good shielding against induced hum. *Stereo Review*

Price This would be a very hard cartridge to surpass at any price. *Stereo Review*
We found it impossible to attribute superior sound to costlier competing models. *High Fidelity*
Priced as it is, it is a real bargain in cartridges. *Audio*

**The Pritchard High Definition
ADC-XLM \$50.**

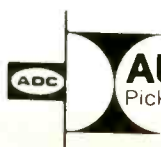
 **AUDIO DYNAMICS CORPORATION**
Pickett District Road, New Milford, Connecticut 06776
Check No. 13 on Reader Service Card

Editor's Review

Some very interesting tuners and receivers are described in this issue—they have certainly come a long way since the days when I, as a schoolboy in London built my own. One of the first efforts was a single tube short-wave job with the tuning coil wound on an (empty) wineglass—greatly esteemed in those days as being ultra low-loss! Now, as I look around the lab at digital tuners, matrix and discrete quadraphonic systems, super-power amplifiers and so on, I must admit that there are a lot of exciting things happening these days. Even so, I doubt whether anything can match the thrill I experienced in that top attic in London, listening to KDKA in the small hours, hardly daring to breathe lest the thing went off-tune

Speakers and SPL's

Sharp-eyed readers will have noticed some changes in the loudspeaker tests. The distortion curves are now presented with some SPL (Sound Power Level) measurements which allow more meaningful comparisons to be made. Two loudspeakers might both handle 40 watts at 40 Hz before distortion becomes evident, but one could be delivering twice the acoustic power of the other. Incidentally, power input levels are measured at the specific frequencies and not related to a nominal 4 or 8 ohms which might only apply at some mid-band frequency.

Many readers have expressed their appreciation of the comparative tests on the 14 small speaker systems. Some have suggested that similar tests be carried out with larger systems. This is not so easy because people interested in buying systems in the \$200 to \$500 range really want to know more about them than can be compressed into a capsule report. However, we will certainly evaluate systems in the \$70 to \$100 range later this year and will print more speaker reviews too. At the moment, there is still a large backlog which includes such exotic systems as the SAE Dynamic-Electrostatic, the 12-sided Design Acoustics and the new Fisher Sound Panels.

Correction

The new Philips Videodisc does not play at 25 rpm as stated in the November issue—the speed is the same as the Teldec: 1800 rpm. Playing time is said to be 45 minutes and because a laser beam is used instead of a mechanical contact there is no record wear.

Demonstration Disc

Some time ago, in May 1970 to be exact, I recommended a special high quality direct-disc recording made by Sheffield Records. This was called "Lincoln Mayorga and Friends, Part I." Now Part II has made its appearance, and if anything, it is superior to number 1. At \$7.50, it is not cheap, but it *does* show what your system can do. The address is Sheffield Records, P.O. Box 5332, Santa Barbara, Calif. 93108. Incidentally, they tell us that a few copies of the Part I disc are still available.

Anniversary

December, 1972 marked the 25th anniversary of an invention which has made a tremendous impact on almost every field of human endeavor. I am referring, of course, to the transistor which was invented by a group at Bell Labs. What has happened to those pioneers? Well, many are still at Bell, but four of them are teaching—William Shockley at Stanford, Walter Brattain at Whitman College in Washington, John Bardeen at the U. of Illinois and John Pierce at the Cal. Institute of Technology. John was responsible for the name "transistor" which he evolved from "transfer resistor".

Success Story

In 1971, EPI had 10 employees and the sales for that year were \$200,000. The 1972 sales were just under \$3 million and the number of employees had increased to nearly 90! This is an almost unbelievable achievement in such a short space of time. As the "Boston Globe" stated, "This is an example of the growth potential of the high fidelity components industry".

San Francisco Show

The Hyatt House in Burlingame, near the airport, will be the site of the next IHF Hi-Fi Show. Dates are April 11 to the 16th.

Dirty Sound

According to Bob Hackett of Ampeg, there might be a swing back to tube amplifiers for guitar use. Not because of lower distortion, frequency response or reliability but because "you can get harmonious distortion or *dirty sound* with tubes not possible with solid state". The largest Ampeg system puts out 300 watts and it was stated that the Rolling Stones use 5 of these plus a 10 kw system.

G. W. T.



Pickering **100%** Music Power Cartridges "tell the truth, the whole truth and nothing but the truth."

There is only one truth in recorded music—the sound that is in the record grooves.

In the reproduction process, a lot of things can distort the truth.

To begin with, the cartridge.

An inefficient cartridge can rob music of its instrumental definition, of its overtones and harmonics in the upper frequency range. In these important audio frequencies, some cartridges suffer as much as a 50% loss in music power. Which means that what you are hearing is a half-truth.

All Pickering XV-15 cartridges deliver 100% Music Power. They reproduce evenly across the entire musical spectrum. They don't add. They don't subtract. They don't distort.

All Pickering cartridges are designed for use with all two and four-channel matrix derived compatible systems.

What's more, every Pickering XV-15 is designed to provide this optimum performance with specific record players. So, when you buy a Pickering XV-15 cartridge, we ask you to check its DCF (Dynamic Coupling Factor) rating with our DCF chart first, to make certain you get the model that's best for you. That way you just spend what you have to to get at the truth. In price ranges to suit your equipment.

For more information write: Pickering & Co., Inc., Dept. D, 101 Sunnyside Blvd., Plainview, New York 11803.

 **PICKERING**

"for those who can hear the difference"

Check No. 15 on Reader Service Card

NEW SPECS FOR THE NEW TUNERS

Leonard Feldman

NEARLY FIFTEEN YEARS ago, the fledgling Institute of High Fidelity undertook what seemed like an impossible task—the formulation of measurement standards for FM and AM tuners. Until that time, most manufacturers published performance specifications based upon standards that had been issued by the Institute of Radio Engineers (now the IEEE) in 1947, just after the birth of commercial FM broadcasting on a national scale. High fidelity component manufacturers realized that the tuner of 1958 could no longer be judged by measurements devised in 1947. To the everlasting credit of a few brave engineers affiliated with what was then a very tiny segment of the home entertainment electronic industry, the “new” standards were issued in late 1958. Before long, everyone who hoped to sell high quality FM receiving equipment adopted the newer standards and a relative measure of specification standardization prevailed.

If you can remember 1958 clearly, you’ll recall that in that year, FM stereo was just a dream in the mind of Murray Crosby. Transistors had been invented a decade or so earlier, but were to be found only in a few, expensive imported AM “pocket” radios which presupposed your having pretty large pockets. In short, the “new” tuner specs of 1958 are pretty well outdated and it’s time for their retirement—or rejuvenation, if you just can’t bear to see “old specs die”. As of this writing, the IHF has again turned to the matter of measurement standards and, hopefully, it won’t be long before updated standards will be proposed and, accepted by the industry at large. As one who has had to deal with the “old” specs both in my daily work and in the course of reviewing the performance of various FM products for readers of AUDIO, I’d like to propose a few ideas for consideration by the newly formed committee and, perhaps, come up with a set of more meaningful specifications in the light of today’s state-of-the-art FM product.

Down With IHF Sensitivity!

If you read FM tuner spec sheets as I do, you may have wondered whether or not there is really a meaningful, audible difference between a tuner that boasts, say 1.9 μV IHF sensitivity and one that shamefacedly admits to only 2.0 μV . The fact is the *neither* product sounds particularly good when fed with its “least usable sensitivity” signal (a once-popular synonym for “IHF sensitivity”). That is because with such a minimal signal applied to the antenna terminals, the total noise and distortion content of the resultant audio output will be some 3%. If this percentage consists primarily of distortion (THD), you’d hardly want to listen to the

program. If the content is primarily noise—why, even a cheap cassette machine (the garden variety “dictating machine” type) can provide a better signal-to-noise ratio than *that*. Your low-level phono-preamplifier nearly always boasts at least 60 dB of S/N and high-level inputs of amplifiers are capable of 75 or even more dB of dynamic range above noise level. Why worry, then, about whether it takes 1.8 or 1.9 μV of signal input to produce a “listenable” signal that you wouldn’t want to listen to?

Usable Sensitivity

Suppose that instead of “least usable sensitivity” we propose that manufacturers specify the least signal which will provide a 50 dB signal-to-noise ratio. Such an S/N is quite listenable, with just a bare trace of background noise. A comparison between this proposed spec and the IHF sensitivity for a given receiver is shown in Fig. 1. The new specification could be stated as: *Usable Sensitivity (50 dB S/N); 4.5 μV* . Since THD and noise (both unwanted signal content) were correctly linked together by the creators of the original IHF specs, an accompanying specification should be: *THD at Usable Sensitivity*. The number will always be less than 3% and, in our example of Fig. 1, turns out to be a very listenable 1.2%. We’re all for continuing the practice of quoting “ultimate” S/N, but feel that instead of arbitrarily measuring it at 1000 μV signal input, some statement should be made establishing just what the signal input has to be before this “ultimate” or best S/N is reached. *That* kind of statement would really separate the “men from the boys”. Thus, a typical specification might read: *Ultimate Signal-to-Noise: 70 dB at 75 μV input* and you’d know that the set has a better, faster quieting characteristic than one which states: *Ultimate S/N: 70 dB at 150 μV* . This idea is conveyed in Fig. 1 as well and the same approach could be used to define lowest harmonic distortion (THD), which, in our example would be stated as: 0.3% with 40 μV input.

THD vs. Frequency

Although the old IHF specs rightly recognized the fact that the de-emphasis curve built into the tuner output circuitry tends to make THD readings above 1 kHz or so look “better” than they would otherwise be, we find an increasing tendency on the part of many quality manufacturers to quote THD for frequencies above and below the nominal 1000 Hz and believe that this is a trend in the right direction. Thus, in our new specs, we’d propose that THD be quoted for 100 Hz, 1 kHz and 10 kHz as a minimum, with a full plot (as shown in Fig. 2) optional—but desirable. You’re probably not

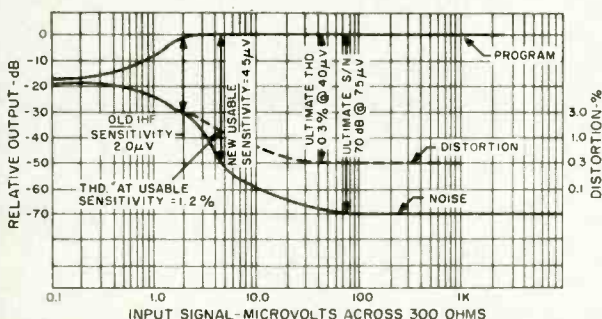

Fig. 1—New, more meaningful FM mono performance specifications include usable sensitivity, THD at usable sensitivity, ultimate THD and ultimate S/N.

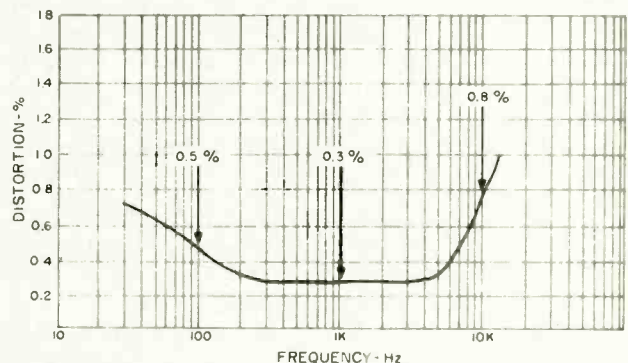

Fig. 2—FM Mono THD versus frequency. Standards would require statement of THD at 3 key frequencies.

Crown

PROFESSIONAL STUDIO EQUIPMENT

Specs	15ips	7½ips
w. & fl.	0.06%	0.09%
f. resp. +2dB	40Hz to 30kHz	20Hz to 20kHz
S/N	-60dB	-60dB

3 speeds - 15, 7½ & 3¾ips; hysteresis synchronous drive motor

computer logic controls for safe, rapid tape handling and editing; full remote control optional

torque reel motors
"capable of providing the most faithful reproduction of sound through the magnetic recording medium... to date" - Audio magazine, 4/68
optional Trac-Sync
individual channel equalizers
third head monitor with A/B switch; meter monitoring of source, tape, output and source+tape; sound-with-sound, sound-on-sound and echo
2 mixing inputs per channel
individual channel bias adjust

"construction rugged enough to withstand parachute drops" - Audio magazine, 4/68

\$1790 for basic rack-mount half-track stereo deck, about \$2300 with typical accessories; Formica floor console \$295, rugged portable case - \$69

modular construction with easy access to all 10 moving parts and plug-in circuit boards; deck rotates 360° in console, locks at any angle

RECORDERS & REPRODUCERS

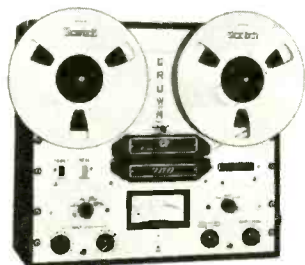

SX711 Claimed by its pro audio owners to be the finest professional tape recorder value on the market today - price versus performance
 ■ Frequency response at 7½ips ±2dB 20Hz-20kHz, at 3¾ips ±2dB 20Hz-10kHz
 ■ Wow & flutter at 7½ips 0.09%, at 3¾ips 0.18%
 ■ S/N at 7½ips -60dB, at 3¾ips -55dB
 ■ Facilities: bias metering and adjustment, third head monitor with A/B switch, sound-with-sound, two mic or line inputs, meter monitoring same as CX822, 600Ω output
 ■ Remote start/stop optional, automatic stop in play mode
 ■ \$895 for full-track mono deck as shown, \$995 for half-track stereo deck



SP722 Ideal reproducer for automation systems
 ■ Meets or exceeds all NAB standards
 ■ Remote start/stop optional, automatic stop in play mode
 ■ \$595 for half-track stereo reproducer

STUDIO MONITOR AMPLIFIERS



D60

Delivers 30 watts RMS per channel at 8Ω
 ■ Takes only 1¾" rack space, weighs 8½ lbs.
 ■ IM distortion less than 0.05% from 1/10w to 30w at 8Ω
 ■ S/N 106dB below 30w output
 ■ \$229 rack mount



D150

Delivers 75 watts RMS per channel at 8Ω
 ■ IM distortion less than 0.05% from 0.01w to 75w at 8Ω
 ■ S/N 110dB below 75w output
 ■ Takes 5¼" rack space, weighs 20 lbs.
 ■ \$429 rack mount



DC 300

Delivers 150 watts RMS per channel at 8Ω
 ■ IM distortion less than 0.05% from 0.01 w-150w at 8Ω
 ■ S/N 110dB below 150w output at 8Ω
 ■ Lab Standard performance and reliability
 ■ "As close to absolute perfection as any amplifier we have ever seen" - Audio magazine, 10/69
 ■ \$685 rack mount

CX822

Check No. 17 on Reader Service Card

too surprised to find that in our example, THD tends to be *higher* at the extremes of the audio spectrum—deemphasis notwithstanding. It wouldn't be a bad idea if manufacturers were asked to specify nominal THD at some high signal level—such as a volt or more, since it is well known that *some* input circuits can be overloaded with disastrous effects as far as distortion is concerned.

All of the other specs relating to mono performance are quite acceptable, as far as we're concerned, and they are tabulated at the end of this discussion for you to examine. Before going on to stereo-related specs (of which there are *none* in the existing pre-stereo standards), one brief word about AM suppression. The true severity of the problem of "multipath signal reflections" in terms of their effect on FM and stereo FM listening has only recently been studied in detail by the FM technical fraternity. Admittedly, AM suppression has been a recognized "spec" all along, but again, it is only measured with reference to a signal level of 1000 μ V—and that's not always available for every FM listener. A better approach would be to quote AM suppression referenced to the new "Usable Signal" level as well as to the usual 1000 μ V reference. Still better would be a continuous plot of this characteristic, as shown in Fig. 3. Multipath interference often creates AM signal components and the ability of a tuner to reject such components is directly related to how multipath reflections are likely to affect your FM (and especially your FM stereo reception. The new spec would read: *AM Suppression: 50 dB at Usable Input; 65 dB at 1000 μ V input.*

Specs For FM Stereo

Most high fidelity component manufacturers, having no guidance from some central authority, have created a set of stereo FM specs to define performance of this portion of their circuitry. Usually included are: "Stereo Separation at 1 kHz" and, more often than not these days, "THD, Stereo at 1 kHz". While we don't think that extremely high orders of separation are that important for a satisfactory stereo localization effect, a more complete specification should, minimally, include separation capability at 100 Hz and 10 kHz. In equipment reviews published in AUDIO, we always show a plot of separation versus frequency, as illustrated in Fig. 4.

Stereo Usable Sensitivity

It is by this time well known that signal-to-noise ratios for stereo FM listening are inferior to those typical in monophonic performance. The reasons have to do with the nature of the composite signal and its wider bandwidth, but anyone who has switched a noisy stereo FM program back to mono knows that mono produces inherently quieter background noise. Some manufacturers "let the noise fall where it may" when the mode switch is set to "Stereo FM". Others only

If *all* of my suggestions were followed and incorporated in a new set of IHF Tuner Standards, a future "spec sheet" for the tuner of 1974 might well look like this:

Monophonic Performance

Usable Sensitivity (50 dB S/N):*	4.5 μ V
THD at Usable Sensitivity:*	1.2%
Ultimate S/N:*	70 dB at 75 μ V input
Ultimate THD:	
1 kHz:	0.3% at 40 μ V input*
100 Hz*	0.5% at 40 μ V input*
10 kHz*	0.8% at 40 μ V input*
AM Suppression:	
At Usable Input:*	50 dB
At 1 k μ V input*	65 dB
Selectivity:	60 dB
Capture Ratio:	1.9 dB
Image Rejection:	85 dB
IF Rejection:	85 dB
Spurious Response Rejection:	90 dB
Frequency Response:	30 Hz to 15 kHz \pm 0.5 dB
Frequency Stability:	\pm 1 kHz
Input impedance, antenna:	300 ohm bal.; 75 ohm unbal.

Stereo Performance

Usable Stereo Sensitivity (50 dB S/N):*	10 μ V
THD at Usable Stereo Sensitivity:*	1.7%
Ultimate Stereo THD:	
1 kHz*	0.9%
100 Hz*	1.3%
5 kHz*	2.4%
Stereo Threshold*	Variable; 7 μ V to 20 μ V
Stereo Separation:	
1 kHz*	40 dB
100 Hz*	33 dB
10 kHz*	28 dB

SCA Rejection:*

Sub-Carrier Product Rejection:*

* Items which are not now in the IHF Standards for Tuner Measurement.

permit the set to "switch to stereo" when a reasonably strong input signal is provided at the antenna terminals. In either case, a specification calling out "Usable Stereo μ FM Sensitivity" is needed, and its parameters could be exactly those applied to the Usable Sensitivity described earlier—the signal required to produce 50 dB of S/N in the presence of a stereo FM broadcast. A THD specification referenced to this Usable Stereo Sensitivity should accompany this primary spec as well. Thus, the two specifications might read: *Usable Stereo Sensitivity (50 dB S/N): 10 μ V. THD at Usable Stereo Sensitivity: 1.7%*. For the manufacturer who really wants to go all out, a graph completely analogous to Fig. 1, such as that shown in Fig. 5, could be presented. This graph would also

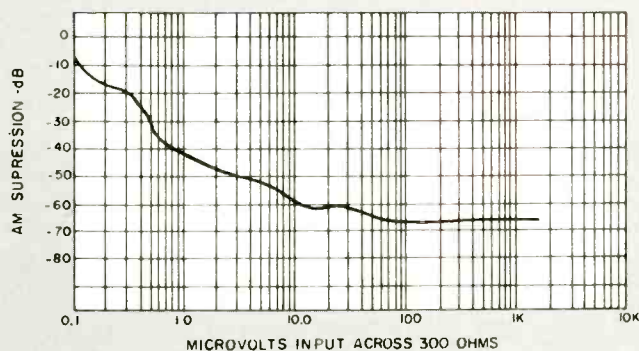

Fig. 3—Relative importance of AM suppression in FM equipment should be stressed in new standards.

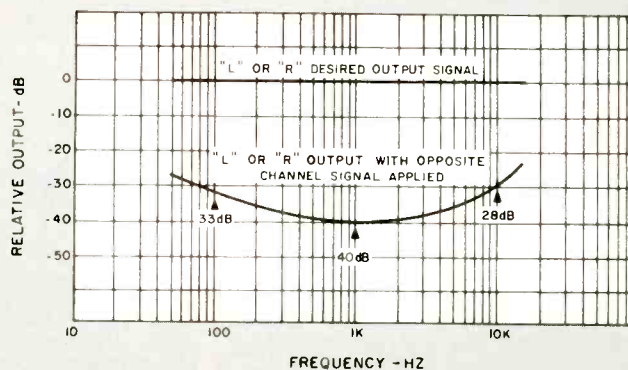

Fig. 4—Separation for FM stereo should be stated in new specifications for at least three frequencies.

KLH has always made a lot of very good loudspeakers. Now we make a lot of very good receivers, too. And like our loudspeakers, our receivers deliver an inordinate amount of performance at a very modest price. For instance our new Model Fifty-Five is an AM/FM stereo receiver with power, dependability and every feature you could possibly want—all for \$199.95.* Team it with our nifty Model Thirty-Two loudspeakers and our new automatic turntable made especially for us by Garrard (includes base, dust cover, Pickering cartridge and diamond needle) and you've got a super sys-

tem for just about \$300! Or step up to a pair of Sixes with the Model Fifty-Two. Or match a pair of Seventeens with the Model Fifty-One. Or simply mix and match them anyway they sound best to you. It's fun. It's easy. And it really doesn't cost a whole lot of money. So why settle for someone else's "bargain" system, when you can get the best for less? Complete KLH component music systems. At your KLH dealer now.

For more information on KLH components, write to KLH Research and Development Corporation, 30 Cross Street, Cambridge, Mass. 02139.



**Now
you can
mix and match
a complete
KLH component
music system
for as little as \$300.**



KLH RESEARCH AND DEVELOPMENT CORP.
30 Cross St., Cambridge, Mass. 02139

*Suggested retail price.

Check No. 19 on Reader Service Card

www.americanradiohistory.com

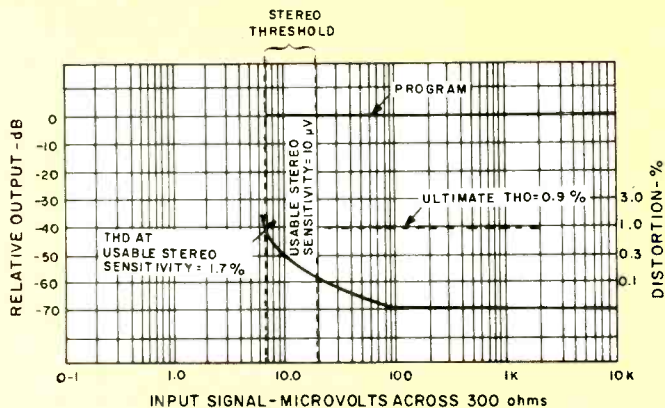

Fig. 5—FM stereo performance characteristics should be plotted or stated separately in new standards.

define "Stereo Threshold" level for such tuners or receivers that switch from mono to stereo at a pre-determined signal level. Since there are some sets which provide a variable adjustment for this switching, the range of adjustment could be easily shown in the same graph. Often, residual 19 kHz, 38 kHz and harmonically related products appear in the outputs of a stereo tuner or receiver. Their level should be quoted separately (and is already, by a goodly number of manufacturers), but if it is less than 50 dB down from program level at 100% modulation, the manufacturer should be permitted to insert a low-pass (15 kHz cut-off) filter when making his Usable Stereo Sensitivity and THD measurements, since these components, while objectionable, are not truly "noise" or "distortion" in the traditional sense and do not contribute directly to our audible displeasure.

Ordinary THD at various frequencies, with the set operating in the stereo mode, poses certain problems which are not present when THD is measured in the mono mode. Because of the presence of super-audible frequencies in the multiplex decoder section of an FM tuner or receiver (19 kHz, 38 kHz, etc.), any non-linearities in the circuits will result in the generation of "beat" frequencies between the desired audio program tone and one or more of these sub-carrier high frequencies. For example, a desired 12 kHz tone beating with the locally generated 19 kHz pilot carrier signal may result in a 7 kHz difference signal. A variety of other mathematical combinations are possible and do, in fact, occur in varying degrees when static THD measurements are attempted. The ordinary distortion analyzer cannot discriminate between these extraneous signals and true harmonic distortion and, as a result, some very high "THD readings" may be obtained when specific frequencies are used to modulate the FM test generator in stereo THD measurements. Audibly, these "beats" never seem to sound quite as bad as they appear in static tests—probably because their duration is so short under true musical program conditions. Nevertheless, we do feel that a graphic plot, or at least a statement of THD versus frequency for 100 Hz, 1 kHz and 5 kHz should be included in the new stereo test specifications. 5 kHz is chosen in this instance simply because the measurable "beats" discussed tend to occur when higher frequencies are applied and should not affect true THD readings if they are limited to the frequencies just selected. A full graphic plot is shown in Fig. 6.

A statement regarding the presence of residual sub-carrier products at the output is sometimes given by manufacturers and, in our opinion, this specification should become mandatory, since the presence of significant amounts of 19 kHz, 38 kHz or harmonics can seriously affect tape recordings made "off the air". Bias oscillators used in tape

recording products also operate at super-audible frequencies and may "beat" with, say, any residual 76 kHz present in the output of the tuner or receiver. While the individual high frequencies may not be audible in the recording, the "beats" themselves may well fall within the audible range and can destroy a well-planned and otherwise flawlessly executed recording.

Tuning Accuracy and Drift

Drift of an FM set after warm-up was included in the old IHF tuner standards and, for many years, most manufacturers included this specification in their brochures. More recently, however, solid state designs (and the attendant reduction in component heating) has reduced overall drift in most of the better tuners to very low values. As a result, most manufacturers have eliminated this specification entirely. In all fairness to those FM products which have lately appeared and which employ phase-lock-loop circuitry referenced to a highly accurate crystal controlled oscillator, we feel that a statement regarding drift should be required once more—if only to point up and justify the extra design cost inherent in the more sophisticated phase-lock-loop approach to tuning accuracy. In the case of these new tuners the drift figure might well be measured in Hz, rather than kHz, but that would provide an opportunity for the prospective purchaser to see just how stable the new products really are.

It is, of course, impossible to predict the course of future FM developments today any more than the writers of the 1958 Standards could have foreseen the need for the changes and additions recommended in this article. Undoubtedly, a means for multi-channel broadcasting (quadraphonic or, perhaps, even more channels) will eventually be sanctioned by the FCC. Considerations of this problem are only just beginning, and it is likely to be some time before we are presented with a new composite signal that may require still newer specifications and measuring techniques. Nevertheless, to wait until those deliberations are concluded would, in my opinion, be a serious error, since technological advancement is a never ending thing and the standards we approve this year, or next, are likely to need revision at some time in the future regardless of how intelligently we write them now.

The modifications for the FM Standards just discussed are by no means all-inclusive. As the new committees are formed, other suggestions are likely to emerge and, for that matter, any readers who have ideas relative to new FM Measurement Standards are invited to send them along to the Institute of High Fidelity, at 516 5th Avenue, New York, N.Y. 10036, attention: Chairman, Standards Committee.

Len Feldman is now Chairman of the above committee—a most appropriate choice-Ed.

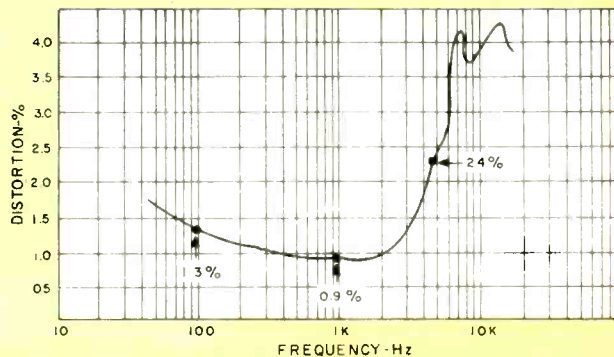
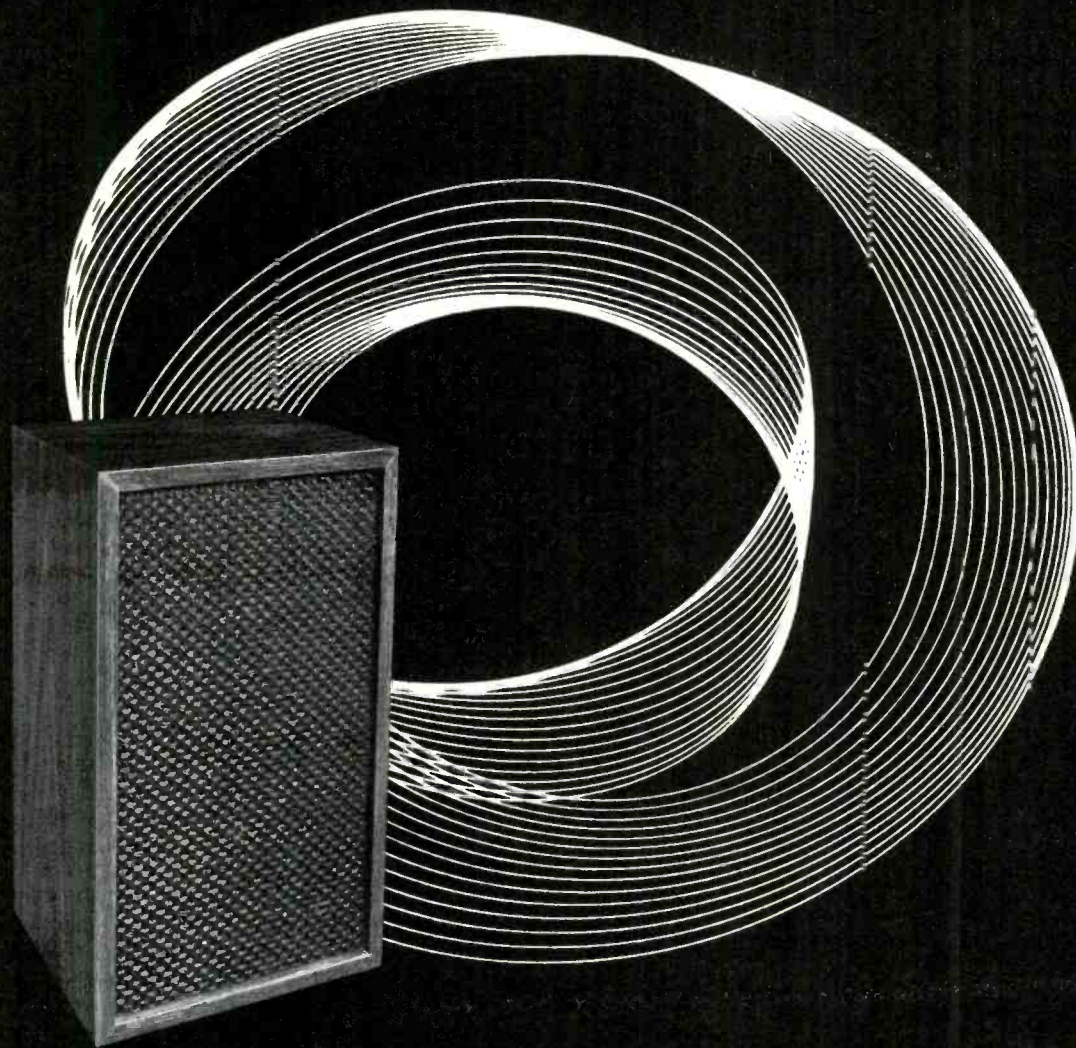

Fig. 6—THD in stereo versus frequency will show up undesirable "Beat" signals.



it really comes alive...

and it's under \$100...

True to the Bozak Tradition of "best in its class", our new **Sonora** (Model B-201) delivers dramatically clean sound at far higher levels than other speakers under \$100 — and many costlier ones.

The secret of **Sonora** is our unique 8-inch Bass/Midrange driver. Its aluminum diaphragm radiates a solid, true-pitch Bass and a transparent, breakup-free Midrange, while serving as a heat-sink for the voice coil. As a result, it can easily handle the output of any amplifier up to 60 Watts RMS rating, with freedom from overloading.

Sonora is a two-way system, with an LC Crossover linking the 8-inch driver with a single-section of B-200Y, the tried-and-true Treble Speaker used in all Bozak systems.

The enclosure is a sturdy, resonance-free box of ¾-inch compacted-wood material, covered with walnut-grain vinyl.

Be it rock or traditional, in stereo or quad, Music Really Comes Alive with **Sonora!**

Hear them at your Bozak Dealer's.

11¾" x 20¼" x 10" deep;
walnut-grain vinyl.
8 Ohms; 60 Watts RMS.



Bozak, Darien, Connecticut 06820 / Overseas Export by Elpa Marketing Industries, Inc. / New Hyde Park, New York 11040, USA

audio ETC

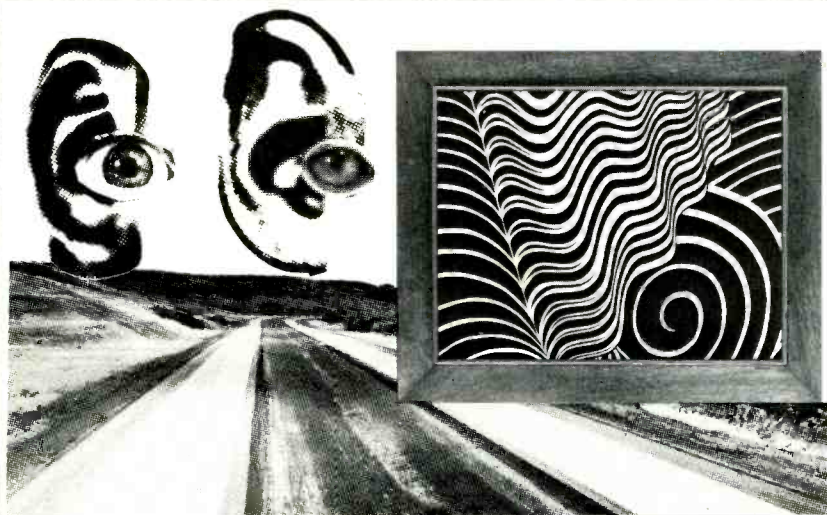

Canby
looks at
and listens
to
flat
loudspeakers

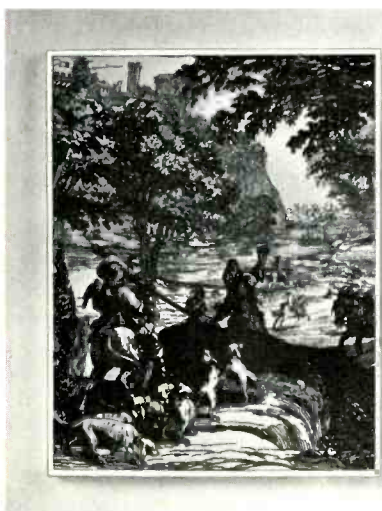

polymer, a hard plastic, via a resilient and carefully calculated connecting linkage—Fisher calls it hammer action, related to the “hammer” linkage of small bones in the human ear and, perhaps, to the sound post in violins. The patent, it is rumored, comes from South America. (Argentine—Ed.)

If one can judge at a press unveiling, the Sound Panel is “flat” in the sonic sense as well, within highly respectable tolerances, down to a good 40 Hz. These are full-range speakers that can fill any need where quality is concerned. But looks are what really dominate. The variously decorated Sound Panels—eight picture-like front exteriors in cloth and more to come—make one of the cleverest eye jobs in the business. These speakers, at last, do not look like speakers. They look like *décor*. That is the intention.

Several inches, first of all, go into a handsome deep-dish curved surround or frame of wood, totally functionless in respect to sound but astonishingly effective as pure decoration. And appropriately, the functioning center panel is covered with one of the print-like or tapestry-like designs, to choice. Hung on the wall, this ensemble looks for all the world like an expensive and good looking work of art, richly framed. But Fisher also provides feet. The Panels may be stood up, free of the wall, like decorative screens. Either way, with their variety of stylings, they key into a living room as no speaker system has done before.

A definite plus, very much up to date, is the non directional sound propagation of the Fisher Sound Panel. Placed on the floor, it radiates sound



in front and the rear like a figure 8. The effect, in stereo or quadraphonic, is to eliminate the close-to beaming directionality of some forward-aimed conventional speakers. On the Wall, the radiation is in a hemispheric pattern. Another ultra-modern plus feature is efficiency. The patented new Fisher drive fills a normal living room with sound from six to eight watts of amplifier power. Extra remote speakers can be driven without strain by modestly powered amplifier equipment.

Can you paste your own choice of painting on the Sound Panel? Not advisable, since the panel is the sound propagator. Without a doubt, Fisher will eventually be persuaded to offer a Sound Panel with a blank “canvas”—for creative home artistry. At the user’s risk.

Suggested List: \$138

For as long as can be remembered, the idea of a flat loudspeaker—a speaker that could stand free on the floor without depth like a panel, or even better, hang unobtrusively on the wall—has been a kind of ultimate hi fi goal. Television too. Flat TV for the living room wall. We may get the TV wall picture some day. The hi fi flat speaker is here, right now.

Fisher’s ingenious new Sound Panels are not quite two dimensional, but almost. Less than three inches deep, and handsomely wide, all of two and a half feet by two, they sound good as well as plenty loud. This is a real speaker, not a compromise, using a new principle, no paper cones or domes, no acoustic suspension, no ports and baffles. Inside, the two voice coils (one is a tweeter) together move a flat front panel of dense acoustic



We make the microphones, too.

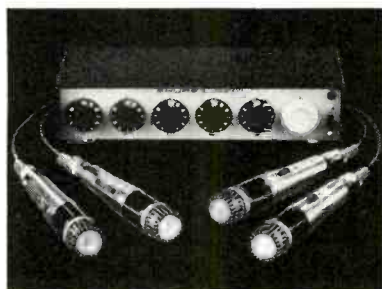

Since our job is to make your job easier, we've developed an entire line of ingenious, low-cost circuitry devices that take the headaches out of tough installations. For instance, Shure makes nearly a dozen different-type modular add-on *Mixers*, including a professional mixer. They're the talk of the industry. We offer an *Audio Control Center* to shape response to match room acoustics. Our *Level-Loc* effectively controls audio levels. In-line transformers, and plug-in problem solvers (such as phase reversers, attenuators, etc.) are instant cures for knotty problems. Interested? Write

Shure Brothers Inc.,
222 Hartrey Ave., Evanston, Ill. 60204.



Check No. 57 on Reader Service Card

THE NEW RECEIVERS

Pioneer QX-4000



Most of the new quadraphonic receivers have quite elaborate decoder sections with provision for more than one system. A good example is the Pioneer QX-4000 which has switch positions for SQ and "regular matrix". The latter gives a kind of surround sound which some people prefer when playing old 2-channel discs. Figure 1 shows the basic arrangement of the decoder in the regular matrix mode. Signals applied from the left channel are formed into L and -L (representing a phase difference of 180 degrees) by the 3 transistors Q1, Q3 and Q5. These outputs are taken to a phase-shifter network with Q7 and Q11 and then to two emitter-followers, Q15, and Q17. Output is then left-front and left-rear. The right channel input is taken through a similar network emerging at the other two emitter followers Q20 and Q18 (right-front and right-rear). The resistor R1 gives some blending between front channels and R2 blends the rear channels.

Figure 2 shows what happens in the SQ mode: the phase shifter outputs are separated by 90 degrees as before, but a two-transistor network is inserted in the left-rear and right-rear circuit and the outputs are taken to another pair of emitter-followers, Q16 and Q19. Front and rear channels are bridged by R3 and R4 thus improving separation by cancelling some out-of phase information. Model QX-4000 uses a total of 71 transistors plus 30 diodes and 2 IC's. Power output is quoted as 4 x 20 watts (continuous) into 4 ohms and 4 x 15 watts at 8 ohms. FM sensitivity is listed at 2.2 μ V and AM at 15 μ V. Price \$349.95.

Harman-Kardon have a range of quadraphonic receivers which are called "Multichannel"—all using the new strapping technique of paralleling the four channels for two channel operation. Actually, the idea is not really new as Bell Labs published a paper on the subject many years ago. However, H.K. were one of the first to use it for this particular application. The four models in the Multichannel range are designated the 50+, 75+, 100+, and 150+. Because of the bridging circuit, the amount of power per channel in the stereo mode is more than double the power available per channel in the four-channel mode. Figure 3 shows the basic arrangement and it will be seen that one amplifier output stage is virtually in series with the other in the two-channel function. Remote speaker switching is not shown for the sake of clarity. The two transistors at the input act as phase-changers in the stereo mode.

Harman-Kardon 150+

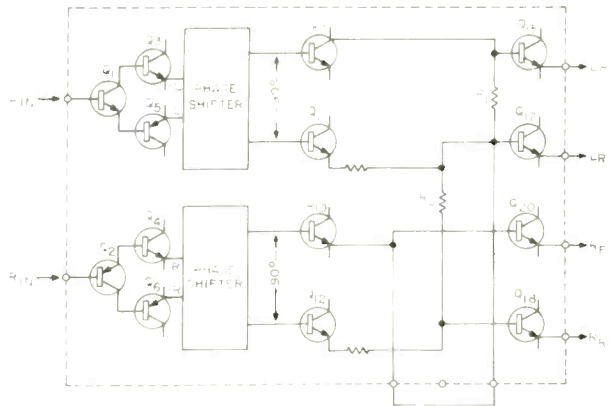
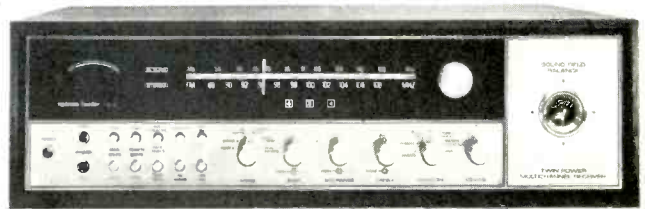

Fig. 1—QX.4000 matrix in "regular mode".

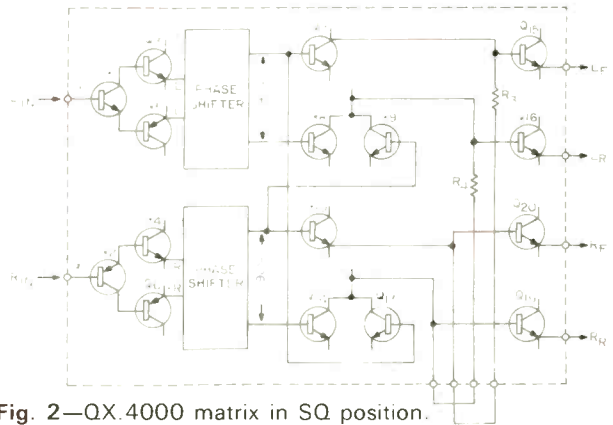

Fig. 2—QX.4000 matrix in SQ position.

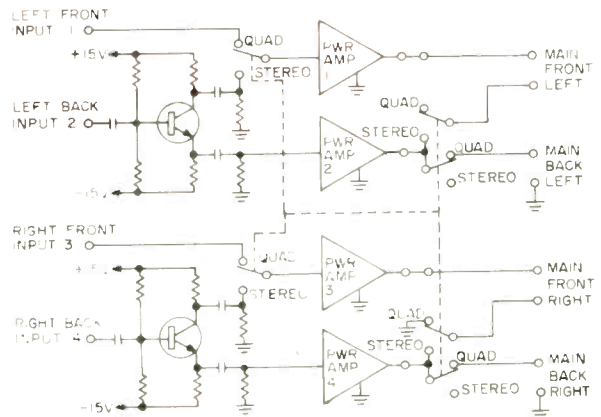
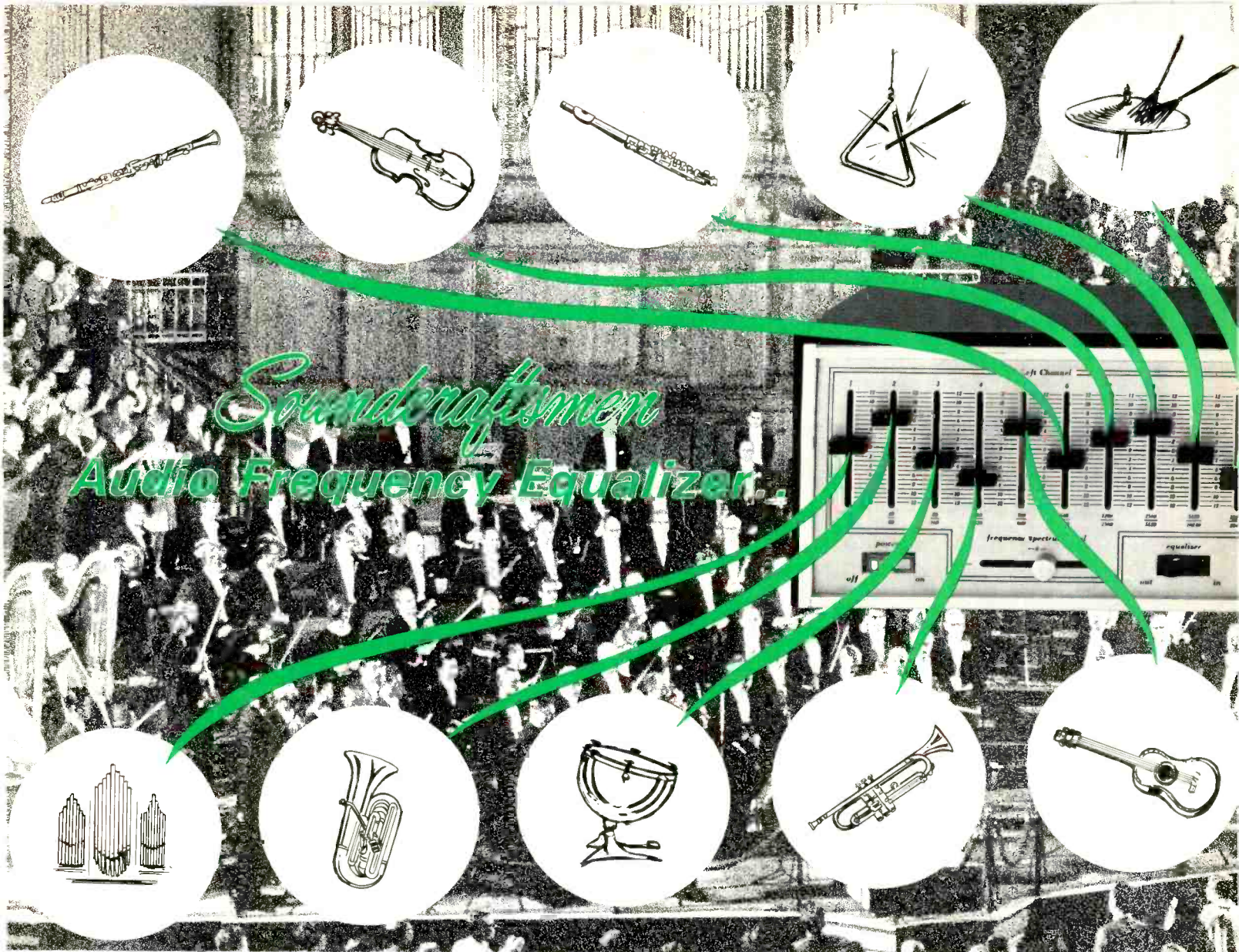

Fig. 3—Bridging circuit used by Harman-Kardon.



Soundcraftsmen Audio Frequency Equalizer..

Guaranteed to enhance any fine stereo system!

(Following quotes from 20-12 owners' Warranty cards on file at Soundcraftsmen)

"One of the best investments I ever made!!" . . . "Even made a believer out of my wife" . . . "I thought my system was the best sounding system going, but this equipment makes it sound un-real" . . . "Incredible! Every system should have one" . . . "Excellent - superb improvement of system" . . . "One Hell of an improvement to what I thought was a good sounding system" . . . "It would be a very great boon to anyone's stereo system - I love it" . . . "Has made a big improvement in the sound of my system" . . . "Great improvement to my system!!!" . . . This is a very fine piece of equipment. It tremendously improves the sound of my system" . . . "Can't believe how good it makes my set-up sound" . . . "WOW!!! What a change in my system!!"

SPECIFICATIONS and SPECIAL FEATURES

TOROIDAL and ferrite-core inductors, ten octave-bands per channel.
FREQUENCY response: $\pm 1/2$ db from 20-20, 480 Hz at zero setting.
HARMONIC DISTORTION: Less than .1% THD @ 2 v., Typ: .05% @ 1 v.
IM DISTORTION: Less than .1% @ 2 v., Typ: .05% @ 1 v.
SIGNAL-TO-NOISE RATIO: Better than 90 db @ 2v. input.
INPUT IMPEDANCE: Operable from any source 100K ohms or less - (any Hi-Fi Pre-amp, Receiver or Tape Recorder.)
OUTPUT IMPEDANCE: Operable into 3K ohms or greater - (any Hi-Fi Amp, Receiver or Tape Recorder.)
CIRCUIT BOARDS: Military grade G-10 glass epoxy.

RESISTORS: Low-noise selected carbon-film.
RANGE: 12 db boost and 12 db cut, each octave.
MASTER OUTPUT LEVEL: "Frequency-spectrum-level" controls for left and right channels, continuously variable 18 db range, for unity gain compensation from minus 12 db to plus 6 db.
MAXIMUM OUTPUT SIGNAL: variable Master "frequency spectrum level" Controls allow adjustment of optimum output voltage for each channel, to exactly match amplifier capability, up to 7 v.
SIZE: designed to coordinate with receivers, comes installed in handsome walnut-grained wood receiver-size case, 5 1/4" x 18" x 11", or rack mount.
WARRANTY: 2-year parts and labor.

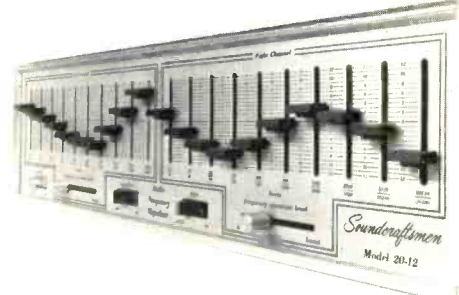
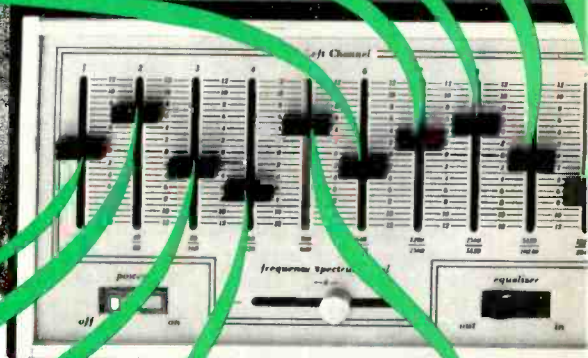

\$299.50
 includes walnut-grain cabinet, or rack-mount.

FREE!

The "Why's and How's of Equalization", an easy-to-understand explanation of the relationship of acoustics to your environment. This 8-page booklet also contains complete specifications, an editorial review of the 20-12 by J. Gordon Holt's *Stereophile* magazine, many unique ideas on "How the Equalizer can measurably enhance your listening pleasure," and "How typical room problems are eliminated by Equalization."

Check No. 25 on Reader Service Card

Soundcraftsmen

1310 EAST WAKEHAM
 SANTA ANA, CALIFORNIA 92705

All these receivers incorporate SQ matrix decoders, discrete four-channel tape facilities and provision for quadraphonic headphones. The three larger models have some additional features such as provision for a Dolby unit, two tape monitors, twin power supplies and a "joystick" balance control. Prices range from \$249.95 for the 50+ to \$599.95 for the 150+.

"The Fisher Studio" range of quadraphonic receivers use a very similar 2-4 channel bridging circuit to the Harman-Kardon series. The largest receiver in the range is the 504 which is rated at 4 x 50 watts continuous power into 4 ohms or 4 x 40 watts at 8 ohms. Two Light Emitting Diodes (LEDS) are used to indicate 2 or 4 channel operation. A "Joystick" balance control is employed together with an Audio Display Circuit. The output of all four amplifiers is connected to logarithmic amplifiers which in turn drive four light bulbs (see fig. 4.) These are mounted behind a small square on the front panel thus giving visual indication of balance. Other unusual features include a gain-controlled MOSFET Rf amplifier and a "Lumped Selectivity" i.f. stage. What is "lumped selectivity"? Briefly, it is a method of design where the selective circuits are placed at the i.f. input stage in one block so to speak. The normal approach is to divide the selective circuits among several stages but Fisher claims that their "one block" system gives a wider bandwidth and better capture ratio. A Multi-pole ladder filter is used as the main selective element. The FM detector is a quadrature type and it is combined with the limiter stages, meter amplifier and amplifying stages in a single IC. The MPX section employs a Phase Locked Loop circuit—also using an IC. More than usual attention has been given to the broadcast band and the 504 incorporates a dynamic noise limiter. All the receivers—304, 404, and 504 use the same basic circuit but only the 504 has the AM noise limiter and some other refinements. All have built-in SQ decoders. Power output of the 304 is 4 x 20 watts at 4 ohms and the 404 is rated at 4 x 36 watts. All have FM sensitivities of 1.8 μ V and a capture ratio of 1.2 dB. Prices are \$299.95, \$399.95 and \$399.95.

Tandberg, who have long had an enviable reputation for tape recorders recently introduced an AM/FM receiver. This is Model TR 1020 and it is rated at 2 x 40 watts into 8 ohms and 2 x 50 watts into 4 ohms. FM sensitivity is given as 2 μ V with a capture ratio of 1.8 dB. As you might expect, special attention has been paid to the needs of the tape recording enthusiast. There are input and output sockets for two tape recorders and on the front panel concealed by the hinged lower part, is another tape recorder outlet designated "Tape 3". This particular output is taken through the tone and filter controls—a useful feature for the enthusiast. A MOSFET front end is used for both AM and FM bands and there are separate power supplies for each channel. As is customary with many European receivers, the filter circuits are very efficient. The rumble, or low frequency filter attenuates at 12 dB per octave below 70 Hz and the high frequency filter operates at 8 kHz with a choice of two slopes: 3 dB per octave or 12 dB. Figure 5 shows the arrangement: C1 and C2 form part of the two-step low frequency filter and R2, R3, C4 and C5 are part of the high frequency network. R4 provides negative feedback necessary to sharpen up the attenuation and reduce distortion. We hope to publish a full scale review of the TR 1020 in the near future. The price is \$429.90.



Fisher 504

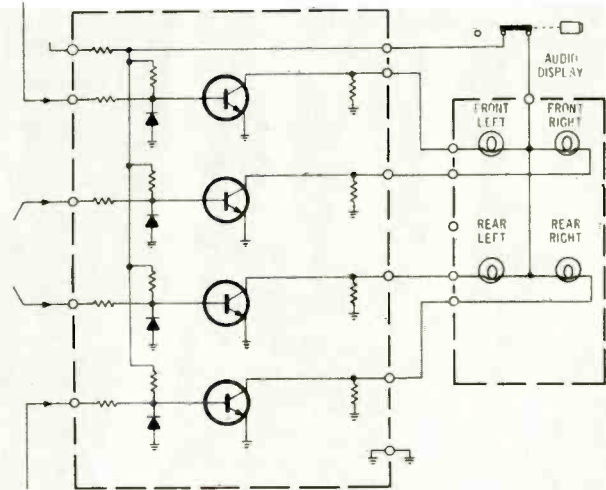
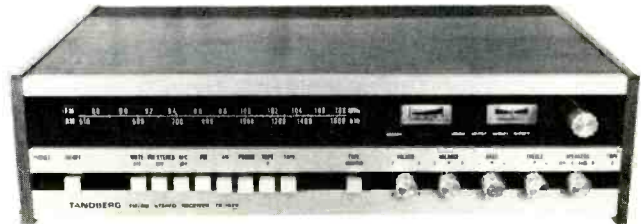

Fig. 4—Fisher 504 Audio Display amplifier



Tandberg TR-1020

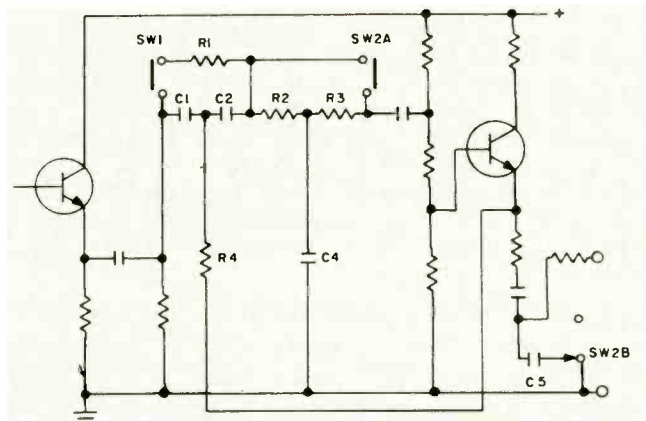
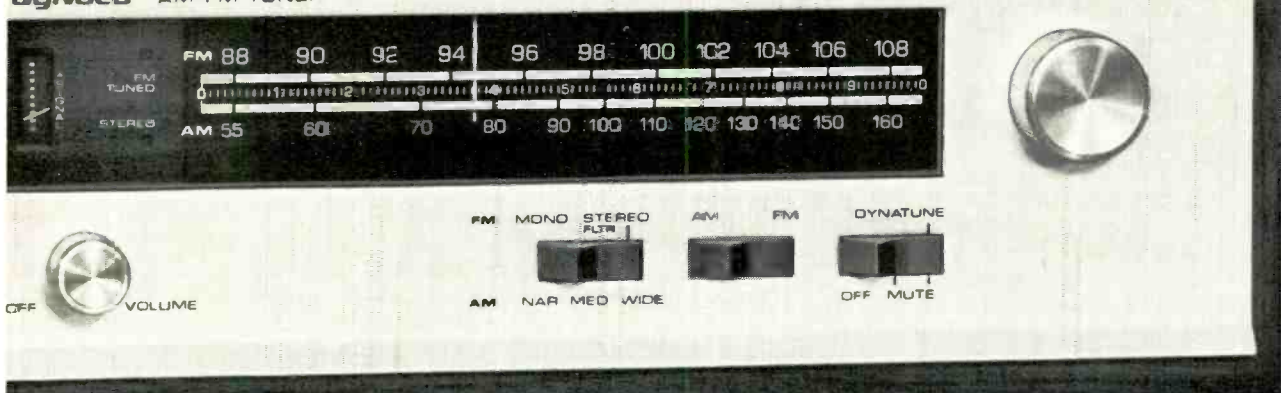

Fig. 5—High and low pass filter circuit used by the Tandberg TR 1020.

dynaco AM-FM TUNER



New! dynaco AF-6 am-fm tuner

The closest approach to high fidelity AM!

Wide-band, low distortion AM with the impeccable specifications you'd expect from Dynaco. An exclusive audio bandwidth circuit extends the audio range when the signal quality warrants it for the best AM you've ever heard; yet it retains sharp 55 dB selectivity with a 12 section LC design IF filter. Switch to normal reception for weaker signals, or to a narrow bandwidth for high interference conditions. Coupled with all the superlative performance and features of the FM-5 (test reports on request), the AF-6 kit takes just two evenings to build. Now you can enjoy the unmatched convenience of Dynatune™ automatic FM tuning with sound which is "entirely a function of the FM program quality" according to Stereo Review, plus AM that may fool you into thinking it is FM.

\$199.95 kit; \$299.95 assembled
Walnut cabinet shown \$17.95

dynaco inc.

Division Tyco

3060 JEFFERSON ST., PHILADELPHIA, PA. 19121

In Canada DYNACO OF CANADA LTD., Montreal, 760, Quebec, Canada



Superscope R-250

Sony-Superscope have a whole new range of inexpensively priced receivers, tuners and amplifiers. Model R-250 AM/FM receiver is typical. It has a rated power output of 10 watts per channel, (continuous, rms) and the FM sensitivity is quoted as $2.5 \mu\text{V}$. Capture ratio is 2 dB and 58 dB of quieting is claimed for an input signal of $100 \mu\text{V}$. In spite of the low price, the R-250 has a number of refinements like a tape monitor switch, low-pass filter, FM muting switch, ceramic i.f. filter and so on. An ideal receiver for the beginner. Price \$199.95.

The SAE Mk. Six FM tuner has some very interesting features. It uses a digital readout display with four Nixie tubes, a 3 inch rectangular scope for displaying multi-path distortion, center-of-channel tuning, Lissajous displays, a 15-pole Butterworth i.f. filter circuit with toroid coils and an 8-stage IC limiter. The front end employs a four-gang tuned circuit with two FETS. In order to display the signal with any degree of accuracy it is necessary for the display signal to be a logarithmic function of the input. This is not easy to achieve because of the normal limiting and so a separate channel has been incorporated for this purpose. One of the most intriguing features of the SAE Six is the touch-sensitive tuning knob which automatically switches on a correct display when the user is tuning and then reverts back to an audio signal. This is accomplished by a relay circuit shown in figure 7. The two diodes at the input prevent too high signals being applied to the FET. The capacitor C1 is 10 microfarads and it gives a small delay making relay action more positive. Mk Six specifications include a sensitivity of $1.5 \mu\text{V}$, harmonic distortion of less than 0.1%, alternate channel selectivity of 140 dB and a rear-channel jack for 4-channel MPX. Price is \$950.00.

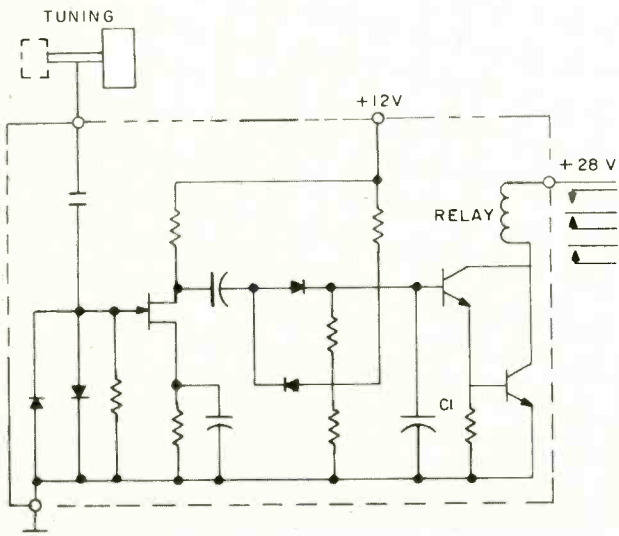
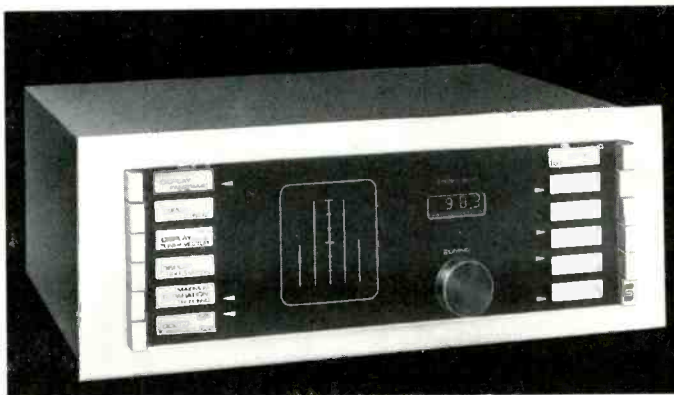

Fig. 7—Proximity operated relay used in the SAE Mk.



Sequerra Model 1

The Sequerra FM tuner is probably the most ambitious tuner to appear on the scene. Some of the criteria were discussed in our January, 1972 issue in an article entitled, "The Perfect FM Tuner?". Figure 1 shows the basic block diagram. The Rf front end is a differential processor using a push-pull balanced FET mixer which is said to handle very large signals without causing cross-modulation. This mixer has two outputs, one going to the FM i.f. filter and the other to the panoramic i.f. filter. Varactors are used for tuning in conjunction with a manual potentiometer and a positive-negative ramp for automatic frequency scan. The i.f. filter is an 18 pole papoulis type which gives optimum phase linearity with minimum bandwidth. It has a dynamic signal handling capacity of better than 120 dB. The FM limiter is a six stage broad band RC coupled configuration having a bandwidth of over 50 mhz. It is arranged in gain blocks of +20 dB which allow the vertical components to be displayed in a logarithmic function. Detector is a switching type.

The MPX decoder is similar to the one used by the old 10b—but with some stability and separation improvements. The panoramic spectrum analyzer is a system which displays all of the signals for 1 mhz above and 1 mhz below the station tuned in. This kind of "window" allows the user to rotate the antenna for best reception in terms of multipath or signal to noise. The counter displays the frequency of the station tuned (note that the Sequerra tuner is *not* a digital tuner as such). Oscilloscope displays include panoramic, tuning and audio vectors and the screen size is $4\frac{1}{2}$ inches flat. Finally, the power supply is fully stabilized. Specifications include $2 \mu\text{V}$ sensitivity, 0.1% THD at 100% modulation and 50 dB separation at 1 khz. Price: \$1600.00.

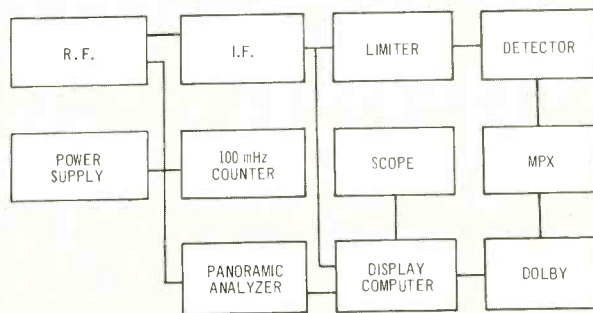

Fig. 8—Block diagram of the Sequerra Model 1 tuner.



If you're seriously into music or sound reinforcement you want more than hi-fi products can give you. But full professional studio gear costs an arm and a leg, and you pay for a lot of things you may not really need.

That's why there's a TASCAM Model 10. It's a floor-standing 8-in, 4-out mixing console, and it's just \$1890.

With the Model 10 you get what you have to have. Without sacrificing a single necessary function.

You get mic and line attenuation, three bands of peak and dip equalization (two with frequency selection), pre- and post-echo send and receive circuitry, pan function, unique straight-line faders, independent monitor level controls, and 4" VU meters with LED peak indicators. Plus pre-wired facilities for up to four additional input modules and other optional accessories

You pay for what you need

including talkback, remote transport control, quad panner, and headphone monitor.

That's what you need and that's what you pay for.

Some things you may or may not need, and we leave that choice up to you. For instance, the basic Model 10 is high impedance in and out, but studio line impedances are available optionally. You'll probably want low impedance mic inputs, but you may not need all low impedance line inputs. So we don't make you pay for them. You can order any combination of high and low input/output impedances according to your application.

Details and specs on the Model 10 are available for the asking. At the same time we'll tell you about our Series 70 Recorder/reproducers, featuring a 1/2" machine for just \$1770.

TASCAM. We've got what you need.

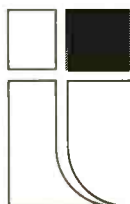

TASCAM CORPORATION

5440 McConnell Avenue, Los Angeles, California 90066

Check No. 28 on Reader Service Card

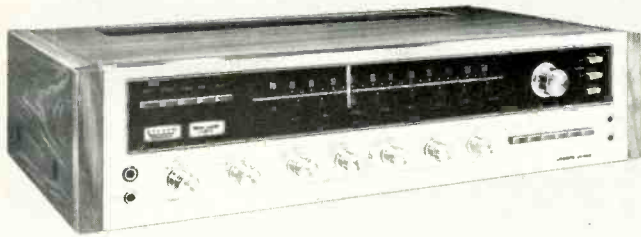

Lafayette 4000



Marantz 4430



Realistic QTA-790

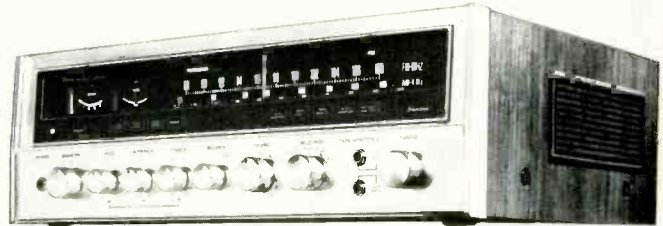

Sansui Model 7

The new Realistic AM/FM quadraphonic receiver from Allied uses no less than 103 transistors—plus two more in the remote control unit! Model number is QTA-790 and power output rating is 4 x 36 watts continuous at 8 ohms. FM sensitivity is given as 2.2 μV with a capture ratio of 1.5 dB. Bass, midrange and treble tone controls are provided and other features include tape recorder dubbing jacks, AFC switch, high and low-pass filters and push-buttons for 5 pre-set FM stations. Matrix is SQ and a second position called "Stereo All" parallels left-front with left-rear channels and right-front with right-rear. The remote control system uses an ultra-sonic transducer as shown in figure 6. Pre-selected stations can be tuned sequentially and two other buttons control the volume level. The control receiver uses 21 transistors and a small motor which drives a volume control. Price of the QTA-790 is \$549.95 and a unit is now being tested.

The Sansui Model Seven is a medium power receiver with several unusual refinements. Three tone controls are provided—bass, midrange and trable. It has provision for connecting a Dolby unit, two phono pickups, sockets for a 4-channel adaptor, no less than 3 pairs of speakers (A, B or C, A+B, A+C and Off) and for the tape enthusiast—two tape monitor circuits. Two tuning meters are provided—one for center-channel, one for signal strength. Rated power output is 41 plus 41 watts continuous at 8 ohms and 55 plus 55 watts at 4 ohms. FM sensitivity is given at 1.8 μV with a capture ratio of 1.5 dB. Price \$459.95.

The Lafayette LR-4000 incorporates a full logic SQ decoder in addition to a surround sound matrix called a "Composer" circuit. Like the Pioneer "regular matrix" system, this is intended for use with ordinary two-channel program sources. Other features of the LR-4000 include a PLL (Phase Locked Loop) FM detector, 2 tape monitor switches, front and rear channel headphone outlets, Bass, Midrange and Treble tone controls and a Remote speaker selector for 4 channels. FM sensitivity is quoted as 1.65 μV and power output at 47.5 watts per channel (continuous). A detailed review of this model will appear shortly. Price: \$499.95.

The Marantz 4430 has several interesting features including an optional remote control, Model RC-4, and provision for plug-in SQ module. The built-in decoder is a general purpose type called Varimatrix (not to be confused with the new Sansui semi-logic Vario-Matrix) The cable-connected remote control operates four-channel balance, volume and loudness. Other features of the 4430 are Gyro-Touch tuning, switching for headphones and eight loudspeakers, separate tone controls for front and rear channels, two illuminated tuning meters, tape monitoring for two 3-head stereo or four-channel tape decks and a "dimension" control for optimum four-channel effect. Power rating is 4 x 30 watts continuous power. FM sensitivity is said to be 1.7 μV with a capture ratio of 1.6 dB. Price is \$599.95.

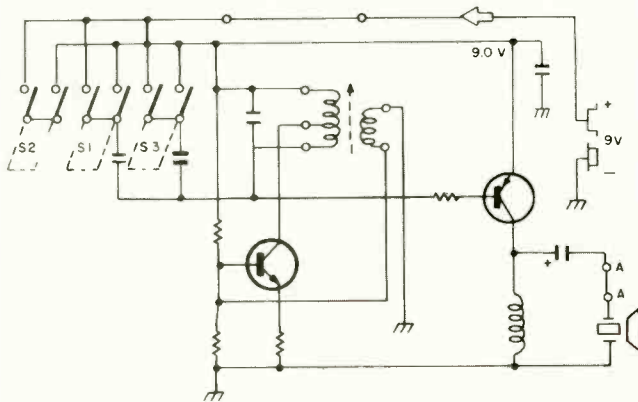

Fig. 6—Remote control transmitter used in the Realistic QTA-790.

RECEIVERS OR SEPARATES.. the new **KENWOODS** offer more!

Whether you prefer a separate amplifier and tuner or enjoy the convenience of a stereo receiver these new **KENWOOD** components give you professional features and top performance to enhance the quality of your stereo system



KR-6200 . . . 240-WATT (IHF), FM/AM STEREO RECEIVER (Left): With direct coupling, advanced new PNP can-type transistors, and **KENWOOD's** exclusive new double-switching demodulator, the KR-6200 provides excellent broadcast reception, exceptional stereo performance, and outstanding dependability for the heart of your stereo system. **SPECIFICATIONS:** FM Sensitivity $1.7\mu\text{V}$ ■ S/N Ratio 66 dB ■ Capture Ratio 1.5 dB ■ Selectivity 65 dB ■ RMS Continuous Power Output 45 watts per channel, both channels driven into 8 ohms, from 20-20k Hz ■ THD & IM 0.5% ■ Frequency Response 20-40k Hz ■ Power Bandwidth 13-30k Hz.

KT-6005 . . . FM/AM STEREO TUNER (Top Right): **KENWOOD's** advanced double-switching demodulator (DSD circuit) and new block filter design assure excellent stereo separation and crisp, clean sound in FM-stereo reception. Other features include MPX filter, FM muting, linear frequency dial scale, signal strength and zero-center tuning meters. **SPECIFICATIONS:** FM Sensitivity $1.5\mu\text{V}$ ■ S/N Ratio 70 dB ■ Capture Ratio 1.3 dB ■ Selectivity 80 dB.

KA-6004 . . . 220-WATT (IHF) STEREO AMPLIFIER (Lower Right): Direct coupling in the power amplifier stage assures flat frequency response, low distortion and high damping factor. **KENWOOD's** exclusive dual protection circuit prevents damage to transistors and speakers. Terminals for 2-system tape monitor, 2 phono, 2 aux, tuner, mike, and 2 sets of stereo speakers provide a flexible control center for a sophisticated sound system. **SPECIFICATIONS:** RMS Continuous Power Output 40 watts per channel, both channels driven at 8 ohms, from 20-20k Hz ■ THD 0.5% ■ IM 0.3% ■ Frequency Response 20-40k Hz ■ Power Bandwidth 10-50k Hz.

For complete information visit your nearest Authorized **KENWOOD** Dealer, or write . . .

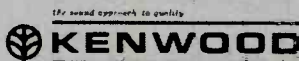

15777 So. Broadway Gardena, Calif. 90248 ■ 72-02 Fifty-first Ave., Woodside, N. Y. 11377
In Canada: Magnasonic Canada, Ltd., Toronto, Ontario; Montreal, Quebec; Vancouver, B. C.

Check No. 31 on Reader Service Card

Shown on the right is the Heath AJ-1510 FM tuner. This is a true digital tuner as the tuning frequencies are determined by a crystal controlled oscillator with the appropriate dividers. In other words the digital readout does not merely indicate the frequency tuned by a manual control. In fact the AJ-1510 has no tuning knob! It was reviewed in some detail in the May 1972 issue and the reviewer, Len Feldman said, "The ultimate tuner? Well, if it isn't, it will do until someone comes up with something better". Specifications include: IHF sensitivity better than $1.8 \mu\text{V}$, THD less than 0.3%, Channel frequency accuracy better than .005%, AM suppression 50 dB plus. Actual test figures were somewhat better— $1.6 \mu\text{V}$ sensitivity and 0.18% distortion. There are three methods of station selection, auto-sweep, push-button or punched card for three preprogrammed selections. The price of the AJ-1510 is \$539.95 as a kit. Heath has just introduced a medium priced receiver—Model AR-1302 which costs \$239.95. Power rating is 20 watts per channel into 8 ohms and features include two ceramic i.f. filters, plug-in modular design to speed up kit-building and fully assembled and aligned FM tuning section. There are two tuning meters, preset input controls and a built-in test circuit. Slide type controls are used for bass, treble, balance and volume and the panel has "Black Magic" lighting.



Heathkit AJ-1510

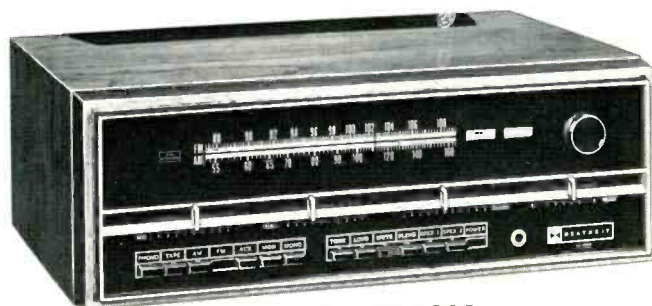

Heathkit AR-1302



Kenwood KR-6070

Finally, for the man (or woman) who really wants something different: an AM/FM tuner with almost everything on board except the kitchen sink—to use a British expression! The receiver is the Kenwood KR-6070 "Jumbo" model which is called, "an electrical marvel that permits the widest scope of musical fun and creativity." It numbers among the attractions an electronic rhythm composer, reverb unit, front panel jacks for one or two electric guitars, multiple mixing for "live" and source sound, multi-presence control and an array of level, frequency, balance and tone controls. The rhythm composer can give you bass drum, conga, claves, snare drum, cymbal in any of twelve rhythms. The reverb unit has an echo delay time of 40 milliseconds and a duration of two seconds. It can be switched to separate output terminals to give a quasi-4-channel sound with an external amplifier. The 6070 has input sockets for two phono pickups, two tape decks and output for four sets of speakers. I almost forgot—power output is 50 watts per channel. The price is \$549.95.

The Sony ST-5555 is called "a spectrum scanner tuner" and it uses a total of 100 illuminated push buttons—one for each channel. Tuning is controlled by a quartz reference frequency oscillator and PLL (Phase-Locked-Loop) circuit which gives better than 99.995% tuning accuracy irrespective of temperature. The tuner can be set to automatically sweep the entire FM band, stopping at all receivable stations, or the scanning circuit can be programmed. During the scanning cycle a memory system can be set to illuminate the appropriate buttons showing all stations receivable with good signal to noise. The memory device is a computer type array using the new Sony MAOS (Metal Alumina Oxide Semi-Conductor) and the memories are not erased when the tuner is switched off. When it is switched on again, the MAOS memory automatically brings in whatever station had been tuned in before. No tuning meter is used—obviously—but an interesting five-step digital indicator is employed. Oscilloscope monitoring outputs are on the rear panel—useful for multipath indication. Outputs for quadrasonic decoders are also provided—also a headphone output with level control. The price is not yet fixed, but it will probably be around \$1000.00.

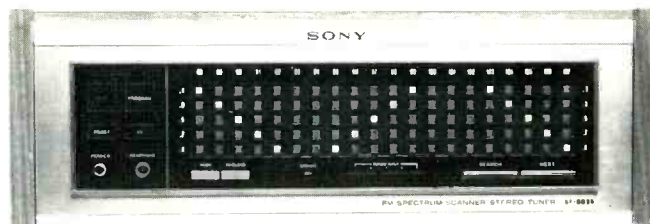

Sony ST-5555

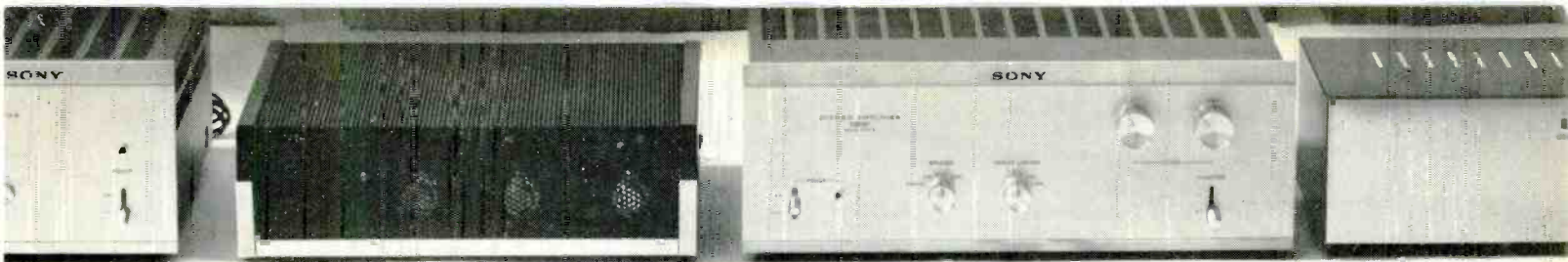

We left the power to the people

The new Sony STC-7000 combines a super $1.7\mu\text{V}$ tuner and a preamp with the widest possible flexibility. There's no power amplifier section — leaving the choice of power output completely up to you. You can make it a receiver with the thundering power of today's mightiest amplifiers, or make it a moderate-power receiver whose other specifications are anything but moderate.

All the convenience and compactness of ordinary receivers are still yours, with your power amplifier neatly tucked out of sight. But the performance is anything but ordinary. Consider the impressive tuner specifications: $1.7\mu\text{V}$ IHF sensitivity, 100 dB selectivity, and a signal-to-noise ratio of 70 dB. And to make

the most of that performance, the tuner facilities include switchable high-blend and muting, signal-input and center-channel tuning meters, a long, linear-spaced dial, rear-panel oscilloscope output jacks to help you aim your antenna for minimum multipath. There's also a coaxial connector for a 75-ohm shielded antenna lead.

The preamplifier is equal to the finest separate components. High voltage integrated circuits and other advanced features give it sensitivity, overload resistance, wide dynamic range, and clean, quiet performance to match the high standards of the tuner: only 0.1% harmonic or IM distortion, with 10Hz to 100 kHz response, and a 90 dB signal-

to-noise ratio. And its facilities are as complete as those on any separate preamplifier, including such unusual extras as rear-panel audio scope output jacks, dual tape monitors with direct tape-to-tape dubbing, front and rear panel Aux inputs, a microphone mixing input with shutoff, and sharp-cutting 12 dB/octave high and low filters.

Think of it as the finest, *most* powerful receiver you can buy — or the finest, *least* powerful. The choice is yours. The cost of this high quality component, \$549.50* Sony Corporation of America, 47-47 Van Dam Street, Long Island City, New York 11101.*Suggested retail price.

SONY® Preamp/Tuner

Check No. 33 on Reader Service Card

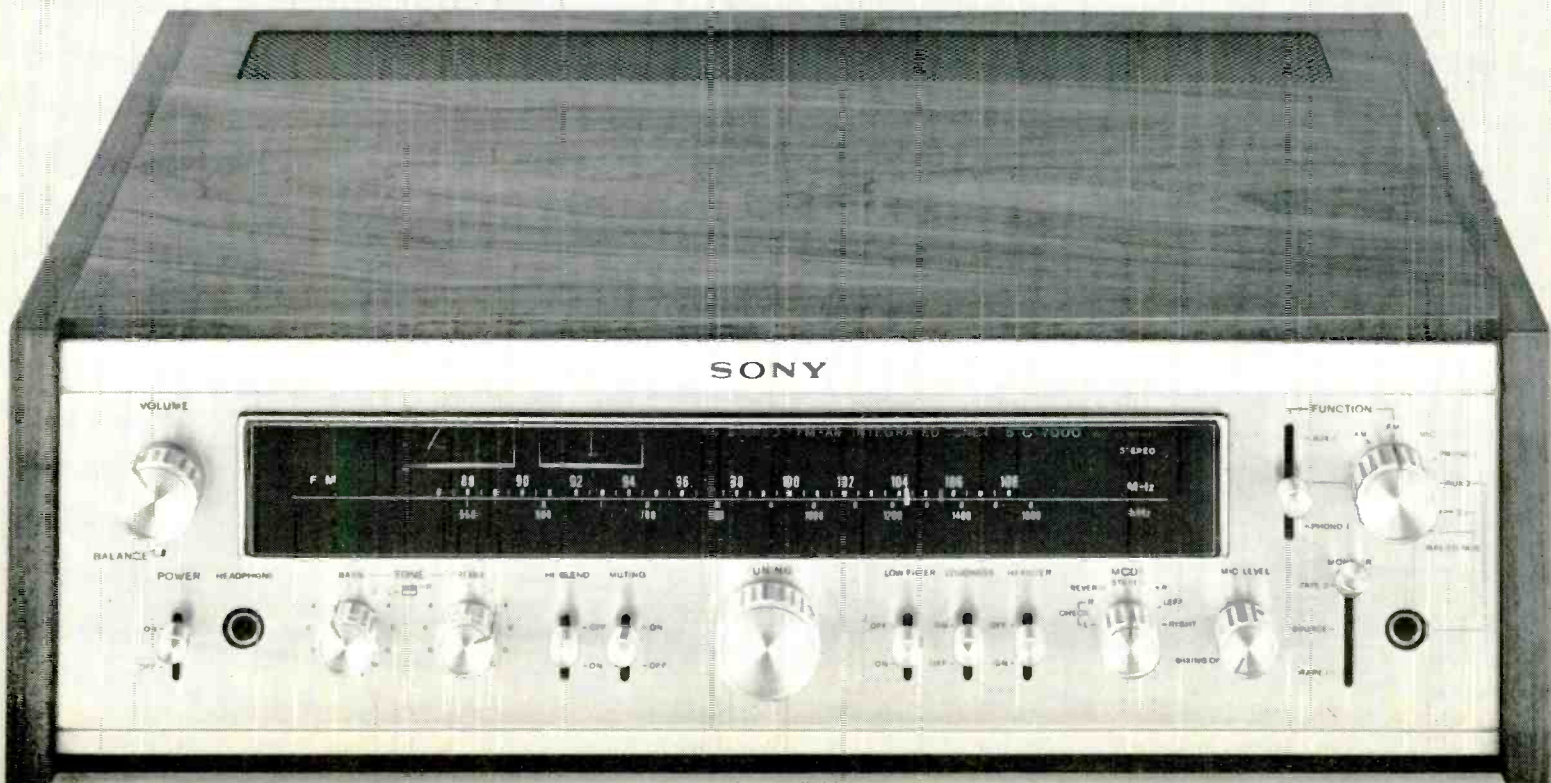

A MICROPHONE PRIMER:

Omnidirectional

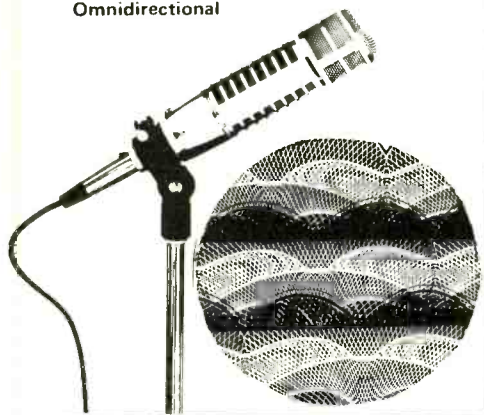

BASIC CONSTRUCTION, PERFORMANCE, AND APPLICATIONS

Cardioid



PART II: CHOOSING AND APPLYING

JIM LONG*

Choosing Between Omnidirectional And Cardioid: A Summary

THE DISCUSSION of cardioid designs in Part I made clear the advantages and compromises involved, to the point that a choice will be obvious in many instances. The following is a summary, with amplifying commentary.

Partly because of the compromises involved in cardioid microphone design as well as the advantages inherent in omnidirectionals, it is prudent to reject the panacea that states "cardioids are the all-around best." This frequently-seen statement is apparently based on the assumption that feedback, background noise, and room reverberation are lurking in the wings, ready to sabotage any effort involving microphones! Although the panacea should be rejected, a knowledge of microphone performance characteristics permits several reasonably clear statements.

If You Have a Choice, Try an Omni First.

Many recording and sound reinforcement activities could well benefit from an omnidirectional microphone. Try one where you would never dare. You'll be surprised!

If you can afford only ONE type of microphone in sound reinforcement, buy a cardioid. This is because feedback is frequently the overriding concern in sound reinforcement. Keep in mind, however, that where microphones are hand-held at close working distances the feedback-reducing nature of a cardioid is often not needed—and neither are its higher susceptibility to breath popping and mechanically-induced noise! Also, a cardioid with rough frequency response may feedback more easily than a smooth omnidirectional.

If you can afford only ONE type of microphone for recording, buy an omnidirectional. The advice runs contrary to many recording recommendations, but comes from experience in recording the usual run of things encountered by the serious amateur recordist: choirs, bands, vocal and instrumental ensembles, pipe organs, etc. The rationale follows!

First, at a given price level, omnidirectionals nearly always have the smoothest and most extended frequency response.

*Electro-Voice, Buchanan, Mich. 49107

This situation may contribute to the observations of "open" and "airy" that some enthusiasts attribute to a microphone's omnidirectionality *alone*.

Second, the need, in recording, for a cardioid's reduction of room reverberation and unwanted background noise is often overrated by amateurs and professionals alike. Background noise is typically not unduly annoying and can often be controlled if it is (pull the switch on the air-handling system). As for reverberation, it is frequently a fight to get *enough* of the room "sound" that is so much a part of an effective listening experience, live *or* recorded. To sum up, two properly placed omnidirectional microphones can provide impressive musical results with a minimum of risk and frustration!

Naturally, if a selection of microphones is possible, cardioids would be among them, first to control reverberation and noise when it *is* uncontrollably excessive, and, second, to utilize the off-axis rejection to solve problems of balance in "classical" two-mic stereo recordings and problems of instrumental isolation in multiple-microphone recording. This is business for the more advanced recordist; important tips are discussed later.

Cardioids are also appropriate where recording is non-musical. The acoustics of a living room are not an essential part of a good recording of a child's voice, for instance. It would be more useful to suppress the sounds of gurgling radiators, tape recorders, or vociferous guests, by aiming the "dead" side of a cardioid at the offending noise sources!

What Frequency Response Is for You (And How to Get It)?

"Flat and very wide," would be the first answer. But wait a minute! "Peaky" and rough, of course not, but it turns out that smooth nominal deviations from ruler-flat response can be useful.

These deviations would certainly *not*, it seems, be unalterably built into the electronics and loudspeakers used in home and studio environments. Speakers and amplifiers should be flat, or should be able to be made flat, for reference. But microphones are small and easily changed, one for another, promoting a healthy atmosphere of "getting the sound you want." In the professional studio, different

**"When EPI first asked me
to endorse their speakers,
I asked EPI to go take a walk."**

-Buddy Rich

"I'm not the kind of a guy that goes around endorsing every product somebody asks me to endorse. But when I heard an EPI speaker, I knew it was different. My drums sounded like my drums, instead of like a recording of drums. A sax sounded like a sax. The bass was a real bass. Trumpets were crisp and sharp. Cymbals were bright and clear. EPI loudspeakers are the best I've ever heard for true-to-life music. I own them and listen to them. I recommend them to my friends. If I were you, I'd buy them."

Buddy Rich

The true-to-life sound Buddy's talking about comes out of eight linear speakers, from \$55 to \$1000, made only by Epicure Products, Inc., Newburyport, Mass. 01950.

The True-to-Life Sound of EPI.



Check No. 35 on Reader Service Card

www.AmericanRadioHistory.com

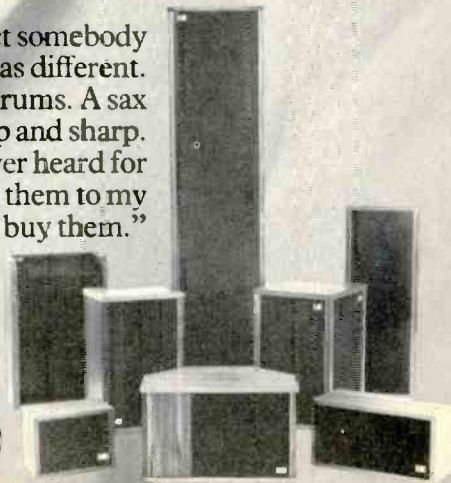

microphone responses are easily modified by sophisticated equalization facilities, but these facilities are not as yet widely available to audiophiles. So it pays to know the several basic response options available from many microphone manufacturers.

Bass Response in Omnidirectionals

It is generally easier to get flat, extended bass response in an omnidirectional design. Many omnidirectional dynamics are essentially flat to 40 or 50 Hz, with fairly rapid rolloff below. Many omnidirectional condensers—even one or two of the modestly-priced electrets—are essentially flat to 20 or 30 Hz. Actually, it is virtually impossible *not* to have super extended bass in an omnidirectional condenser, as long as the internal impedance converter has sufficiently high input impedance.

Even 40 or 50 Hz response surpasses the flat-response portion of many, many loudspeakers, and can be downright impressive on pipe organ material. However, if pipe organ and bass drums are your specialty, *and you've seen to it that the rest of your system can reproduce them*, microphones flat to 20 or 30 Hz can be lots of fun! They also pickup subways very well.

Bass response in Cardioids

It is much more difficult to attain flat, extended bass response in both dynamic and condenser cardioid designs, though conventional condensers usually exhibit less rolloff than their dynamic counterparts. The rolloff in both designs is not sharp, but gradual, typically flat at 200 Hz, 1-to-5 dB down at 100 Hz, and 5-to-15 dB down at 50 Hz. Single-D dynamic designs usually follow the lower limit, in part to compensate for proximity effect's close-up bass boost and to minimize sensitivity to mechanical shock.

Cardioids absolutely flat in the 50-Hz-and-below range to exist, but are rather rare, and often have other performance defects.

The Case for Tailored Response

There are three reasons why the rolled-off, "tailored" low-frequency response typical of many cardioids can be very useful under adverse conditions. The usefulness is universal enough to have made available a number of similarly-tailored *omnidirectional* microphones.

1. *Much of the "bass" we hear does not range below 100 Hz.* Even if the fundamental is substantially below 100 Hz, the ear often reacts more strongly to the harmonics and doesn't feel cheated if the fundamental is reduced a bit in amplitude. A piano is a good example.

The second and third reasons need an introduction: Our ears and brain can discriminate between wanted and unwanted sound in a way far superior to anything that can be built into a microphone polar pattern or a two-speaker stereo setup. We hear, to a great extent, what we want to hear. The only way we usually hear a refrigerator compressor is when it shuts *off!* Microphones, however, even in stereo and with cardioid patterns, pick up the noise and send it through the loudspeakers as clearly heard as the music.

2. *Much of the unwanted noise encountered under adverse conditions is very low frequency.* It may therefore be subjectively more pleasing to lose a little bass fundamental in order to eliminate the noise.

3. *Reverberant sound is bass oriented.* Sometimes microphones must be located relatively far from the performers, in their reverberant field. This would tend to occur with cardioids placed to take advantage of their working-distance expansion. In this case, a high percentage of the sound reaching the microphone is reverberant. To the extent that

reverberant sound favors the low frequencies, as it often does, the pickup will be over-bassed with a flat microphone. A subjectively flatter sound would result if the bass were rolled-off. This phenomenon also justifies a moderate, broad rise in high-frequency response. This alternative is available in some microphones.

Microphone Response Table

To take the above discussion out of the range of an academic curiosity, Table 1 lists a number of Electro-Voice microphones that give the various response alternatives mentioned above. Happy experimenting!

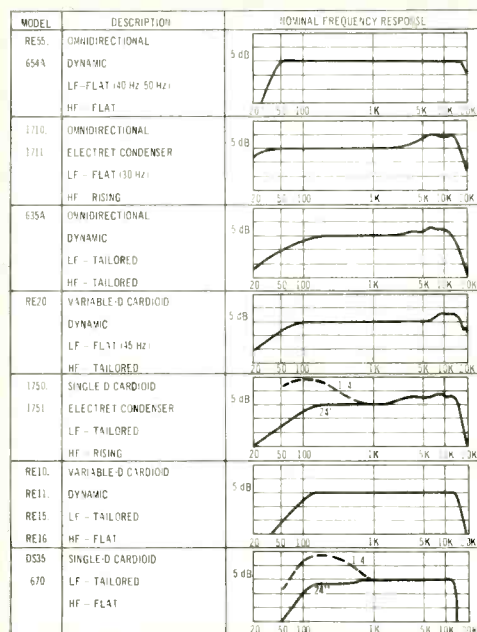

Guidelines For Placement in Recording

"Classical" Two-Mic Stereo

The easiest way to get a stunning recording with a minimum of risk and frustration is to record with two microphones located relatively high, separated by a number of feet, in front of the performing ensemble. If there ever was a panacea for the serious amateur in the recording field, "two microphones in front of the group" is it. Two tips and some sketches will be helpful.

The "best seat in the house" is not the best place for microphones! In general, the recorded pickup from "the best seat in the house"—with either omnidirectional or cardioid microphones—will sound distant, lacking the impact, presence, and sizzle of a live performance. Though going from monaural to stereo substantially reduces this problem, the by-now familiar inability of recording techniques to duplicate the discriminatory powers of our ears and brain is once again the culprit.

The solution is simple: move the microphones closer to recapture the clarity. Right up on stage with the ensemble will do. Figure 18 illustrates a "reasonable" microphone setup. The idea is to: 1, get good *perspective*, a decent compromise between a bright, clear sound and a nice feel of the room acoustics, and 2, preserve the *balance* heard in the hall—with no row or section of the ensemble overpowering another due to poor microphone placement.

In general, the perspective will be bright and clear, with little hall sound, for relatively close miking distances. It will

A love letter.



As you probably know, Revox has always received the highest praise from the experts. And by now, we almost take it for granted.

But even we were bowled over by the unabashed declaration of love we received from audio editor Michael Marcus writing in *Rolling Stone*. In fact, we were so pleased that we'd like to share our pleasure with you. Herewith, Mr. Marcus' comments in their entirety.

The Top "Semi-Pro" Tape Deck

If you get turned on by big bridges, German cars, Swiss watches, Leica cameras, and computers; if you had three Erector sets at the *same* time as a kid; if you shadowed the TV repairman and the plumber when they worked in your house; if you just know they're going to bury you with a screwdriver tucked into your shroud, a Revox tape deck would make you very, very happy.

And if you are a music maker or music listener besides, a Revox would make you *** ecstatic!

The Revox A77 Dolbyized deck sells for \$969, and can make recordings with sound equal to million-dollar studios. It is compact enough to strap on the back of a motorcycle, and rugged enough to survive a crash. It either contains or may be combined with every imaginable feature and accessory, and is as fool-proof and easy to operate as any recorder I know of.

My tests, and reports in the hi-fi mags, back up Revox's claim that this is truly the top performing "semi-pro" tape deck available. Technical performance characteristics have seldom, if ever, been bettered by any other home machine: wide, flat frequency response; extremely low distortion; perfect speed; imperceptible wow and flutter; and noise level, even without the Dolby circuits, that matches the best studio equipment.

With the Dolby noise reduction circuits operating, the A77 is so quiet it's scary. This machine really provides sound reproduction! No person for

whom I demonstrated the recorder could distinguish between live and recorded sound in A-B tests. For decades hi-fi ads have been bullshitting about "concert hall realism." The Revox really achieves it.

From across the room you could mistake it for an old \$199 Radio Shack clunker: It has none of the carefully cultivated "professional" look found on current popular Japanese tape machines. But it has everything: ten-inch professional size reel capacity for hours of taping without flipping over the reels; Dolby circuits so you can use low tape speeds without sacrificing quality, saving tape expense and further reel-flipping; three-motor transport with electronic speed control; push-button solenoid operation with provision for remote control; spring clips built into the reel spindles to hold the tape on in any position without bothering with rubber clamps; different tape tension for each speed and reel size; safety record buttons with red signal lights for each channel; and automatic shutoff.

And individual input selection for each channel; internal track transfer; front and rear panel jacks for either high or low impedance mikes; stereo, single-channel, or merged mono output modes; output volume and balance controls; and a Dolby calibration tone generator that lets you get the noise reduction circuitry working in two seconds.

And there's a lever that pushes the tape against the heads with the motors off for editing; a high frequency filter to prevent interference from FM sta-

tion multiplex signals, and a head-
phone jack.

Inside the machine is where the technofreaks will really get off. Rigid girders, heavy metal plates, big Pabst motors, carefully routed wiring, beautiful plug-in circuit boards, fancy connectors, the works. Everything NASA quality; built for quiet, smooth operation and long life. It's obviously a machine that should last as long as you do, and Revox guarantees it to; and from looking it over, it doesn't seem like they're going to spend much money making good on their pledge. A few parts that come in contact with moving tape (heads, pressure roller, and capstan) are only guaranteed for one year; but the heads are the big-radius professional type that should be good for many years of normal use, and roller and capstan sleeve are cheap and easy to replace.

If you can't afford the full \$969, the A77 is available without the Dolby circuits for about \$200 less, and if you only plan to dub from records or radio, or record loud rock music, you may as well save the bread. Other formats and options are also available, including built-in playback amps and speakers, rack mounting, variable speed, half-track operation, 15 ips speed, selsync, and on and on and on.

I have a few bitches about the machine: the braking is slow; the meters are a bit small; and the photocell tape shutoff can be annoyingly activated by white leader tape spliced between tape sections; but I manage. I have really gotten to love the Revox A77 Dolby B. I know of nothing better.

© 1972 by Straight Arrow Publishers. All rights reserved. Reproduced by permission.

Once again, Revox delivers what all the rest only promise.

Revox Corporation, 155 Michael Drive, Syosset, New York 11791.
California: 3637 Cahuenga Blvd. West, Hollywood 90068. Canada: Revox Sales and Service, Montreal

Check No. 37 on Reader Service Card

www.americanradiohistory.com

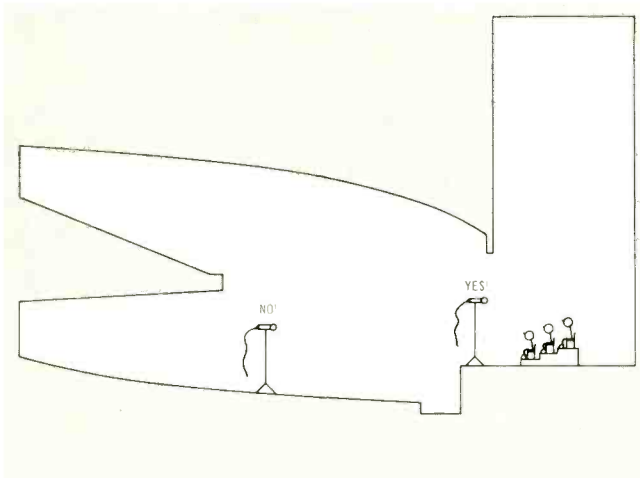

be dull and muffled, with lots of hall sound, for relatively large micing distances. The perspective inherent in a particular microphone and hall situation can only be determined accurately by making trial takes at several microphone working distances and monitoring the results on *loudspeakers* (headphones are better than nothing but create a "larger-than-life" sound, compared to the same tape reproduced on spaced loudspeakers). Fortunately, in practice, a fairly broad range of perspectives produces a very acceptable recording (though what is "ideal" is an elusive and very personal judgment). Therefore, the recordist who is not blessed with the luxury of experimentation time will probably be in good shape if his microphones are 10 to 20 feet from the middle of the source, for the typical chorus, band, orchestra, or organ. Very small ensembles could use closer miking—say 5 to 10 feet—but the room sound would be reduced.

The recordist must, however, be concerned about balance, which he can do without rehearsal. In considering balance, it helps to remember the *inverse square law*. The direct sound from a section of the performing group will experience a 6 dB loss in level every time the distance from that section is doubled. If microphones are relatively close to the group as a whole, the rear row can easily be twice the distance from the microphones as the front row. This spells balance problems. Such a large relative difference does not occur if microphones are placed at a greater distance from the group as a whole. Figure 18A illustrates the inverse square law.

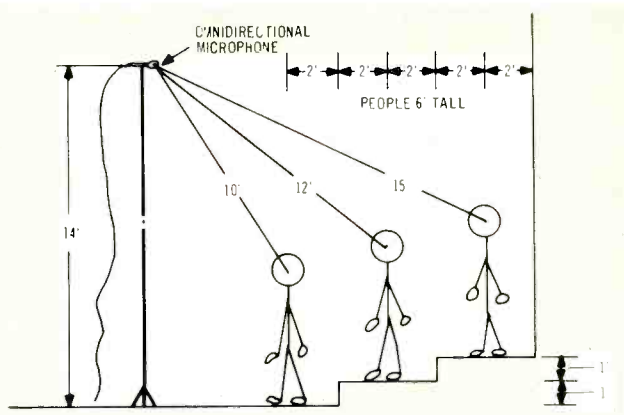
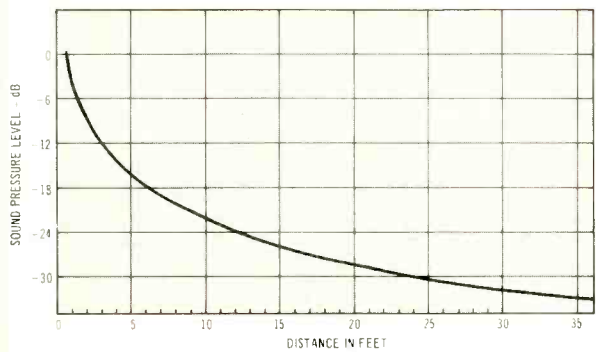

In general, the recordist will find that, given an adequate setup with respect to direct-to-reverberant perspective, his distances for proper balance will put the microphones fairly high, as in Fig. 19. Figure 19 places the microphones at approximately 12 feet from the middle of the group and the extreme distances (10 feet and 15 feet) are consistent with good balance. Figure 19A preserves the same 12-from-the-middle distance, so perspective is unchanged. Balance, however, definitely favors the front row (8 feet from the microphones) and the rear row will be weak and indistinct (16 feet). Figure 19B, with the short microphone stands move to 24 feet from the middle of the group, restores balance but the pickup includes too much of the room sound—muddy and lacking in presence. Moral: the usual five-foot microphone stands are often not particularly useful to the serious amateur recordist!

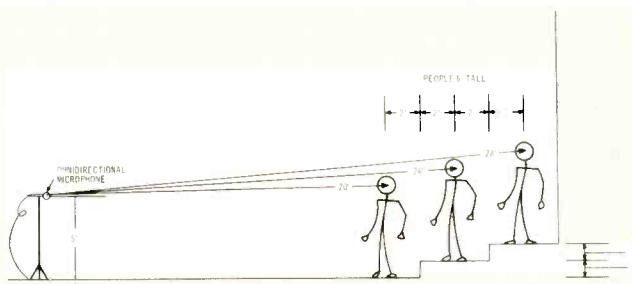
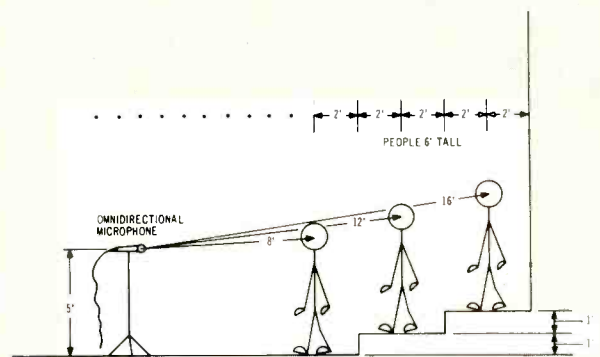

**If you want to be completely surrounded by music
you need a 4-channel receiver
that completely adjusts to your surroundings.**



Since JVC wants to give you nearly perfect sound, we also have to give you a nearly perfect listening area.

The JVC 5445 4-channel receiver does just that.

A special sound effects amplifier (SEA) takes discrete and matrix 4-channel sources, plus stereo and monaural sources, and breaks them up into five frequency ranges, instead of just the usual bass and treble.

So you can bring up any frequency that's absorbed or tone down any one that's reflected too much. You can bring up any instrument. Or push any down. That's sound control you'd expect only

in a professional studio.

And the separate SEA control for the rear speakers lets you adjust for any future 4-channel sound system.

This receiver also makes your present stereo records, tape and FM stereo broadcasts sound better than ever by picking up previously hidden sounds through the rear speakers.

Naturally, this receiver is completely compatible with your present equipment. And the equipment you'll probably buy in the future. It even has optional remote control and 4-channel headphones.

JVC also makes a top-quality inte-

grated 4-channel amplifier, the 280 watt Model 990. And if you have a really good stereo amplifier, you can convert your system to 4-channel instantly with JVC's add-on amplifier, the 5101.

The JVC receiver, amplifier and add-on amplifier. They can take a beautifully arranged room and help you orchestrate it.



JVC

JVC America, Inc.
38-75 Queens Midtown Expressway
Maspeth, New York 11378

Check No. 39 on Reader Service Card

www.americanradiohistory.com

If the 24 foot distance shown in Fig. 19B *must* be used, cardioid microphones will help restore proper perspective.

Figure 20 is a view from the top, to illustrate distance *between* the two microphones in a stereo pair. A reasonable guide is to center each microphone on one-half of the group. Again, this distance is fairly non-critical, but extremes will upset balance and significantly alter the stereo effect. Microphones too far apart from left to right will produce a hole-in-the-middle, a disjointed, schizophrenic effect, lacking in solidarity. Microphones too close together tend toward monophonic reproduction, destroying stereo's sense of direction and hall acoustics.

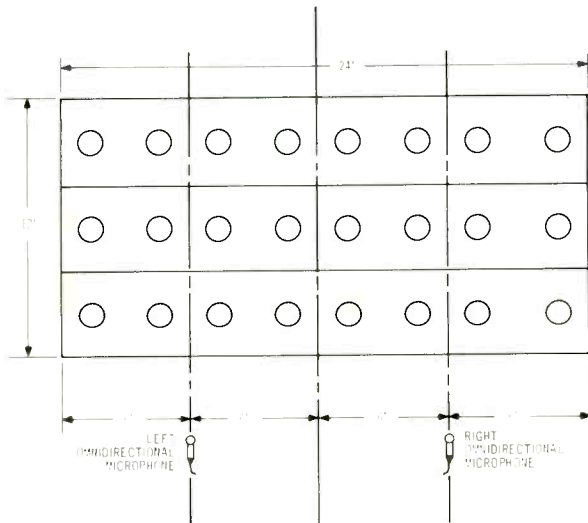

Fig. 20—Typical left-to-right separation.

What About Soloists? There seems to be an innate urge—perhaps because of the wide availability of microphone mixers—to augment the classical two-mic setup by “spot-lighting” the soloists with an accent microphone. After all, we don’t want to lose anything! In years past, the grave compromises of monophonic reproduction forced the spot-lighting of soloists: the subjective realism of monophonic reproduction was improved. Stereo is certainly not a complete answer, as mentioned earlier, to sorting out wanted and unwanted information (witness the great amount of accent miking done in professional recording sessions). It is, however, a sufficient improvement to make the added responsibility and complexity of accent mics usually not worth the amateur’s effort. The key word is “responsibility;” the amateur is mixing in real time, without the benefit of multi-channel recording, and if he accents too much (which seems to be a universal tendency) it’s just too bad. Let things fall where they may, with just a stereo pair of microphones: you will be pleasantly surprised.

It is perhaps worth noting that four-mic/four-channel recording reduces the need for accent microphones even further. The ability of four-channel stereo to sort out a single event amidst complex aural confusion—if the recording is properly handled—can be downright uncanny!

Tips on Taking Advantage of Cardioids

The recording advantages of cardioids, with their reduced pickup to the sides and rear, have been mentioned earlier: (1) control of reverberation and background noise and (2) solving problems of instrumental balance and isolation when

miking under what might be termed adverse conditions. To put the second item another way, a cardioid will let you “patch things up” when a straightforward two-mic stereo setup, as just described, cannot provide optimum balance. In performing such a patchup, however, it should be remembered that a cardioid accepts sound equally well over a surprisingly wide angle. Reference to Fig. 8 shows that output is constant over nearly an 80-degree angle. If a too-loud instrument or group is to be reduced in level to any extent at all, a cardioid microphone would have to be oriented at least 45° off axis, 90° off axis would provide just a 6 dB reduction.

Cardioid Polar-Pattern Uniformity

Some cardioid microphones (especially inexpensive ones) are cardioid only over a certain range of frequencies. In practice, it is no simple task to maintain the ideal cardioid pattern throughout the frequency range. Off-axis pickup, then, will be colored to the extent that the polar pattern is not uniform with frequency. As long as the microphone is pointed at the group of interest, the audible effect is not too severe, but if a major portion of the ensemble is being picked up off axis, any coloration is unfortunate.

Avoiding Acoustic Phase Interference When Multiple Miking

It is certainly no secret that “classical” two-mic stereo recording plays a very small part in commercial recording today, especially in the predominant recording of contemporary rock and jazz. Instead, multiple microphones are used, virtually one for each instrument or small section. Each microphone is fed to a separate track on a multi-channel recorder—up to 24 channels, at last count. The microphones are placed very close to the instruments—from “right in the bell of a trumpet” to a foot or two away. The pickup is bright and very dry, with no natural room sound. Tracks are often recorded at separate times, redone if necessary, and then mixed down to form a two-channel working master which eventually appears as the stereo disc. Equalization and artificial reverberation are added at many stages in the process.

The ready availability of microphone mixers often tempts the amateur recordist to make his own multiple-microphone recordings. It’s lots of fun, but certainly not the “easy” way. Without multi-channel recorders, the session must be mixed live, in real time, with no opportunity for remix or re-recording of offending tracks. Again, responsibility rears its head: the balance and perspective are entirely in the hands of the recordist. The musicians’ natural balance has nothing to do with it!

Acoustic Phase Interference

Even more serious than the responsibilities of balance, however, is the problem of acoustic phase interference. This phenomenon causes huge, varying voids in frequency response that create, at best, a vague feeling that “something’s terribly wrong.” Figure 21 shows the basic elements: a vocalist being picked up by two microphones whose outputs are being combined in a microphone mixer. The second microphone (to the right) is of course intended to pick up another vocalist (or instrument), but in fact does a pretty good job of picking up the first vocalist!

The interference arises because the sound of the first vocalist reaches the two microphones at slightly different times, since path 2 is longer than path 1. Depending on the frequency and distances involved, the two signals, when com-

A superb condenser microphone for just \$39.75. What's the trick? Brilliant engineering.



Condenser microphones have long been known for their sound...and their cost, and their complexity. Now Electro-Voice introduces a series of genuine condenser microphones that provide sound embarrassingly close to the most expensive studio models, without the high cost and complexity.

A big problem with conventional condenser microphones has been the need for a high voltage power supply to polarize the diaphragm. E-V has eliminated it completely with its new *electret* condensers. We've found a way to permanently trap this voltage right on the surface of the diaphragm, thus doing away with the need for bulky, expensive power supplies.

How do the new Electro-Voice electrets sound? Response is clean, flat, and transparent, with very high output for full recording volume. It's just what you would expect from condenser microphones costing much more, and by far the best sound-per-dollar you've ever heard.

A simple FET circuit inside each E-V electret microphone matches both professional and home tape recorder inputs with equal quality. This low-noise, high-output circuit operates from a single "AA" penlite battery for as long as 1200 hours of use.

Choose either omnidirectional or Single-D cardioid types. The chart shows the prices, and some of the reasons for the difference in cost. Whichever model you choose will give you excellent transient response, high sensitivity, and uniform polar response. Our "second-generation" electret design offers vastly improved protection against extremes of humidity and temperature. And the ruggedness of E-V electret condensers is rivaled only by E-V dynamic models. All-in-all, new E-V condensers are a significant improvement over less sophisticated condenser microphones (electret or otherwise).

If your goal is to record natural sound, or natural music — try an E-V electret. Or in the PA field where condensers have never been sufficiently reliable — try an E-V electret. But don't tell your listeners how much you paid for your new microphones. They'll never believe you!

ELECTRO-VOICE, INC., Dept. 132A
602 Cecil Street, Buchanan, Michigan 49107
In Europe: Electro-Voice, S.A., Römerstrasse 49,
2560 Nidau, Switzerland.
In Canada: EV of Canada, Ltd., Gananoque, Ontario

•Gulton
COMPANY

Check No. 41 on Reader Service Card



MODEL 1710
Omnidirectional
80-13,000 Hz response
Unbalanced 150 ohm output
-50 dB output level*
\$39.75

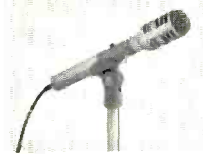

MODEL 1750
Single-D Cardioid
80-13,000 Hz response
Unbalanced 150 ohm output
-43 dB output level*
\$45.00



MODEL 1711
Omnidirectional
80-15,000 Hz response
Balanced 150 ohm output
Professional cable connector
-50 dB output level*
\$59.70



MODEL 1751
Single-D Cardioid
60-15,000 Hz response
Balanced 150 ohm output
Professional cable connector
-43 dB output level*
\$75.00

*Output level rel. to 1 mw/10 dynes/cm². The smaller the number, the better. Prices shown are suggested retail.

Electro-Voice®

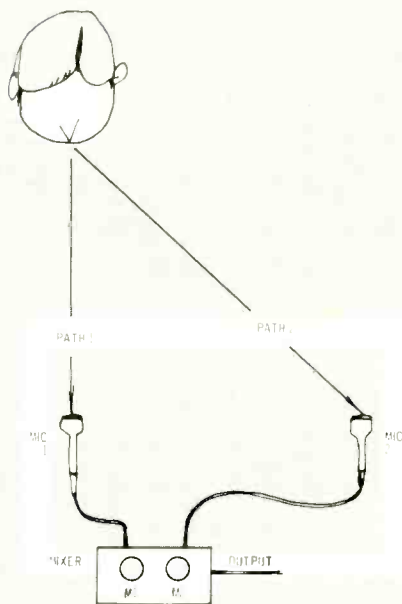

Fig. 21—Basic mechanism of acoustic phase interference.

combined in the mixer, either add (in phase) or cancel (out-of-phase), or something in between. The effect is audibly shocking and is shown on a frequency response basis, for several distances between microphones, in Fig. 22. The first curve shows the response of the left microphone alone. The remaining curves show the combined response as distance between microphones is increased. Complete interference is eliminated only at a rather large distance, but 3 feet is relatively void free and suggests the following rule-of-thumb.

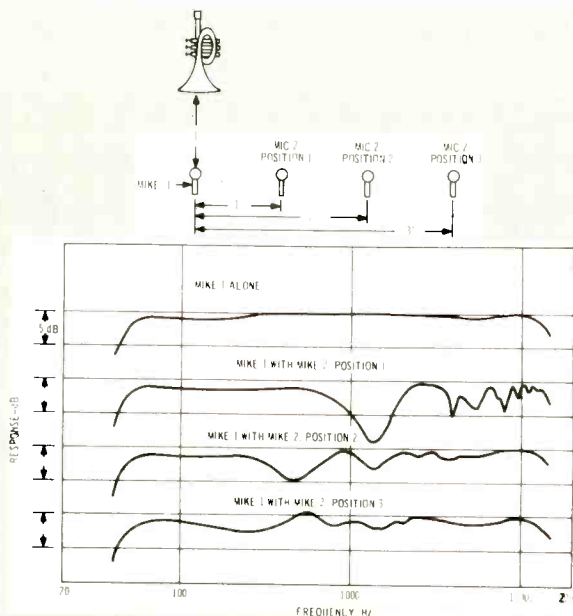

Fig. 22—Acoustic phase interference as a function of distance between microphones.

The Three-to-One Ratio

To avoid acoustic phase interference, the distance between microphones should be at least three times the distance be-

tween the sound source and the nearest microphone. Several good and bad multiple-mic setups are shown in Fig. 23.

Strictly speaking, the three-to-one rule assumes sound sources of equal level. If meters are available on the mixer or recorder, however, even unequal levels can be handled. A little slide-rule work will show that the three-to-one ratio implies an isolation of 9 dB. If the gain on the right mic is such that its pickup of the left instrument is 9 dB below the pickup of the left microphone, interference will be acceptably low. It is interesting to note that many professional recording people do not observe this rule, and that if they did, the need for so-called "flats" or "baffles," with their imperfect solution to isolation or separation problems, would not exist!

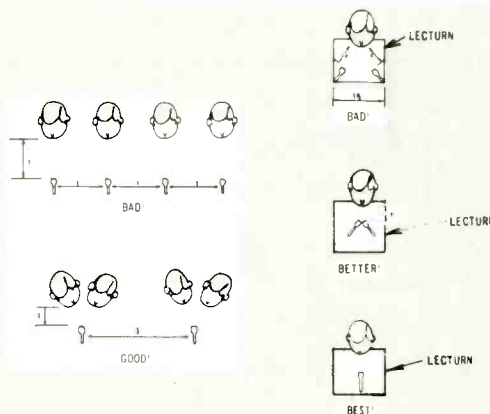

Fig. 23—"Good" and "bad" multiple micing setups.

Beating the Three-to-One Ratio with Cardioids

A cardioid's rejection of sound from the sides and rear, if properly applied, can reduce the three-to-one ratio. Figure 24 shows two cardioids angled away from each other, to increase isolation and decrease interference.

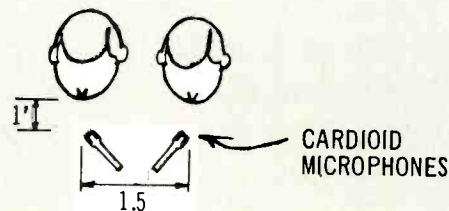

Fig. 24—Decreasing the 3-to-1 ratio with cardioid microphones.

Microphone Termination

Connecting the Microphone To the Preamp Input

High-impedance cable and inputs: High impedance cables are single-conductor shielded, as shown in Fig. 25. The output of the microphone is carried by the inner conductor and shield, which also acts as ground to prevent hum. High impedance preamplifier inputs have two connections, with the shield going to the preamplifier's ground. Because one of the microphone's output terminals is connected to ground in such an input, the inputs are called *unbalanced*.

Low-impedance cable and inputs: Low impedance microphone cables have two inner conductors and a shield, as shown in Fig. 26. In such low impedance cables, the micro-

Listen



to the irresistible sound of Martin Speakers

The sound of Martin Speakers can be as quiet and irresistible as the gentle meeting of sand and surf. Or vibrant and deepthroated as the roar of thunder in the summer sky.

Martin Speakers, for people who are attuned to the irresistible sounds of the audible universe.



MARTIN SPEAKER SYSTEMS • A DIVISION OF EASTMAN SOUND MANUFACTURING CO., INC.

Harmony Road and Route 295
Mickleton, New Jersey
08056

Martin Speakers from \$44.50 to \$350.00
"A new standard of performance built
by people who listen."

Check No. 42 on Reader Service Card

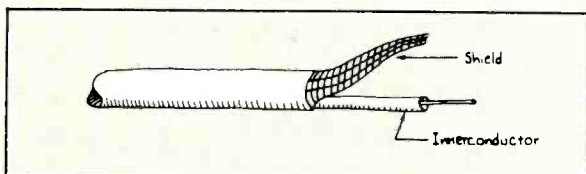
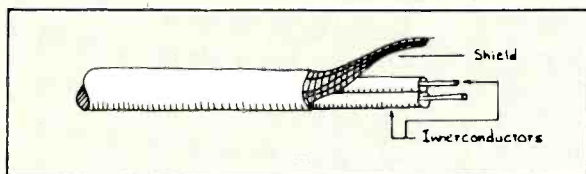

Fig. 25—Single-conductor shielded cable.

Fig. 26—Two-conductor shielded cable.

phone output is carried on the two inner conductors, while the shield acts only as a hum and noise protector. This configuration is termed *balanced line* since neither microphone output terminal is connected to ground. The balanced line arrangement provides hum and noise protection superior to the unbalanced lines used with high-impedance microphones.

Low impedance microphone preamplifier inputs generally have three connections, with the shield going to ground. Occasionally, preamplifier inputs for low-impedance microphones will have two connections like typical high-impedance inputs. Such low-impedance inputs are unbalanced, similar to their high-impedance counterparts. In order to use an unbalanced input with a standard low impedance microphone cable, one inner conductor must be connected to ground. This should be done at the preamplifier input only, by connecting either one of the inner conductors to the shield at the preamplifier input.

The Truth about "Impedance Matching"

Microphones are connected to preamplifier inputs whose impedance "looking in" varies widely. There is often great concern to "match" the microphone impedance to that of the input. A microphone should certainly be *suited* to its input, in terms of voltage delivered and the input's compatibility with that voltage, but this certainly does not necessarily mean equating ("matching") the microphone and input impedances! If matching were necessary, life would be indeed difficult, since examples of the following are everywhere to be found:

1. A fine line of tape recorders whose inputs are recommended for use with "low-impedance" microphones but whose input impedance is 600 ohms.

2. A popular microphone mixer whose balanced "low-impedance" microphone inputs are actually about 800 ohms.

3. A high-quality home recorder whose unbalanced microphone input works with many low-impedance microphones, yet the measured impedance of the input is 10,000 ohms.

4. A fine microphone rated at 150 ohms whose measured impedance is nearly 400 ohms.

What gives? It turns out, since they are essentially resistive sources, that ribbon, dynamic, and condenser microphones may be loaded with any impedance value from slightly below their rated impedance on up to an open circuit. Distortion and frequency response are not affected. Only output voltage level is affected: maximum output is

achieved into an open circuit with output reducing as the load impedance is reduced. The loss is 6 dB when the load impedance equals the microphone's measured impedance.

"Line matching" transformers may now seem mis-named: they are perhaps more clearly viewed as voltage step-up devices, increasing the low output level of low-impedance microphones to a higher level more appropriate to the sensitivities of typical high-impedance microphone inputs.

Capacitive-source piezoelectric microphones (ceramic or crystal) are affected quite differently by cables and preamplifier input impedances. Such microphones are referred to as high impedance, but this is purely capacitive and of quite a different nature than the resistive high impedance of, say, a dynamic microphone. The impedance magnitude is a function of frequency. For capacitive-source mics, added capacitance of longer and longer cables has no effect on frequency response, since both the source and cable impedance change proportionately, with a constant voltage-division effect maintained. Level, however, drops drastically.

Output Level or Sensitivity

Microphone output level or sensitivity is a way of expressing the microphone's "output" when 1, loaded in a specific manner (R_L) and 2, driven with sound of a specific "loudness." Output level is usually given at a single frequency. Two commonly used frequencies are 1000 Hz and 250 Hz. The 1000-Hz measurement is used for speech-frequency, communication-type microphones, and the 250-Hz measurement is used for the wide-range microphones more likely to be employed by the serious amateur and professional.

Sensitivity often is expressed as "-60 dB." This figure is absolutely meaningless. It could refer to several valid, though different, rating methods now currently used by the American audio industry. If the actual voltage delivered to the amplifier input is desired, some or all, depending upon which rating method is employed, of the following additional information is required to give the "-60 dB" meaning: 1, the sound pressure level driving the microphone, 2, the internal impedance of the microphone (R_G), and 3, the load on the microphone (R_L). The two most used sensitivity specifications are discussed below.

Open-Circuit Voltage Rating

This rating is most frequently applied to high-impedance microphones, but may be applied to microphones having any source-impedance value. The open-circuit method states explicitly the load (R_L) as open circuit. In practice, measurements may be made as long as R_L is about 20 times that of R_G . The error would be limited to about 0.1 dB. A microphone rated according to the open-circuit method would read, stated completely:

$$\text{Sensitivity} = -60 \text{ dB re/1 volt/microbar.}$$

The "re" (referred to) is the key to our question of what voltage drives the amplifier, and is part of the sensitivity statement because the rating is expressed in dB. Decibels, like per cent, are a *relative* measurement. If we want an *absolute* answer from the dB sensitivity rating, we must answer the question "relative to what?" As an example, we could say that board "A" is three times the length of board "B." That's relative. If we want to know exactly how long board "B" is, however, we must know the length of "A." If "A" is three feet, then "B" is, absolutely, 9 feet. Returning to the open-circuit microphone voltage rating, the only difference is that the reference is "1 volt," rather than "3 feet." (To be continued)

A short discourse on Frequency Equalization.

By MICHAEL MARCUS

Technical Editor, and former Audio Columnist of Rolling Stone Magazine

Hi-fi equipment is really pretty good today. There are amplifiers with all but non-existent distortion; tape hiss has been banished by the Dolby system; home record playing gear is as good as the finest studio equipment of a few years ago, and the best speakers offer frequency response as linear as electronic equipment.

But one component is as bad now as it was at the turn of the century, still distorting heavily and often negating the quality of the finest audio hardware.

That component is the listening room.

It really is an audio component, plugging in between your speakers and your ears, and is just as important as your amplifier or phono cartridge.

The problem is that most listening rooms are only listening rooms by accident. They were designed, rather, for talking, or eating, or sleeping; and the conditions that make a room good for something else might make it horrid for listening to music.

Floor and wall coverings, ceiling tile, furniture, doors, windows, and hallways, even the number of people or a pet sheep dog can dramatically and detrimentally affect the sound you hear. Now, finally, there is something you can do about it.

The hard way is to completely rebuild the room, eliminating every feature that detracts from sonic purity. The easy way is to use an adjustable frequency equalizer—an electronic box that lets you counteract many if not most of the bad acoustic features in a room, and eliminate many other hi-fi hassles as well.

Basically, an equalizer is a super tone-control system that takes up where the customary bass and treble controls leave off. Instead of boosting or cutting back the two large chunks of the audible frequency spectrum that we refer to as lows and highs, room equalizers work in a larger number of narrower frequency bands that cover all of the audible range.

A room laden with lots of overstuffed furniture, thick carpeting, heavy drapes, and acoustical tiles on the ceiling can absolutely ruin your listening experience. These soft furnishings swallow up your stereo system's sound, and leave you with none of that live-feeling sock or "presence" you expect from your records and tapes.

Another room, with lots of undraped windows, large expanses of mirror, glass-covered artworks, modern furniture, and highly polished floors also presents big problems, becoming a virtual reverberation chamber for the high notes, sending them rebounding like a billiard ball from every surface and sounding so strong as to overwhelm the bass notes.

Simple tone controls can help you fix things up a bit, but in order to avoid specific architectural and decorating gremlins without affecting the other frequencies that do not need to be controlled, you need the pinpoint accuracy

found in multi-band equalizers. Any time you move a piece of furniture, you risk upsetting the tonal balance of the room, but the proper equalization can keep your music humming smoothly.

But patching up the sound within the room is just the beginning. You can also correct for frequency-response distortion and compensate for other trouble that develops mechanically and electronically, and even completely recreate a recording.

If you have a disc or tape with a vocal track buried behind lots of lush instrumentation, by boosting the 1,000 Hz equalization control you can make the singer dominate the musicians; and conversely, if you wish to concentrate on the instrumental sounds, the same control moved in the opposite direction will suppress the voice.

Beyond the actual music there are a good many other changes and improvements you can make. Starting at the bottom, in the 20-80 Hz range, you can cut back response to eliminate the hum from the AC electrical power line as well as turntable or tape-deck motor rumble, and acoustic feedback caused by a phonograph cartridge picking up vibrations from your speakers.

You might want to boost both this range and some of the higher ones while listening at low levels in order to have a precision loudness control, one that is designed for your particular hearing instead of the average Fletcher-Munson curve used in the loudness compensation circuitry found in most components.

Commercial recordings made in recent years all employ a standard equalization scheme that correlates to playback electronics, but it wasn't always so. In the early days the record business used many different standards, but by using a multi-band equalizer you can make those 78's sound just like those old engineers wanted them to sound.

Similarly, equalizers can be helpful with some prerecorded tape cartridges that use special frequency balancing to sound better in automobiles but need adjustment for playing on quality indoor music systems, and in restoring radio broadcasts from stations that utilize major frequency rolloffs in the extreme ranges.

Many of the new recording tapes have intentionally nonlinear frequency response and are intended for use with specially equalized recorders. If your own tape unit is not correctly adjusted, an accessory equalizer can restore normal tone balance.

By cutting back around 10,000-Hz you can reduce a lot of the hiss inherent in tape playback, and the same frequency adjustment will eliminate a lot of the annoying scratches and other surface noise on records, and if you patch an equalizer through a PA system you can use the 10,000-Hz adjustment for controlling feedback whine.

If you have prerecorded tapes that

have been processed with Dolby noise reduction, but do not have access to a Dolby playback decoder unit, an equalizer may be used to compensate for the boosted highs without chopping away as much music as would a normal treble control.

Equalizers are particularly useful in dealing with speakers, not only in correcting their performance in relationship to a particular room, but in adjusting their own overall characteristics. It may be the case that your speaker system has an unadjustable crossover network that is not providing the tonal balance you prefer. As long as the drivers can handle the extra power, you can boost the frequencies you want and almost redesign the speaker system. Some two-way systems are weak in the midrange, a problem that can often be alleviated by boosting frequencies in the 800-2,500 Hz range. Other transducers—phonograph cartridges and microphones—may similarly be "rebuilt" to your own specifications.

The possibilities for sonic manipulation are almost without end. With an equalizer and a little patience you can make any good speaker or cartridge sound like almost any other good speaker or cartridge.

Music or recorded sound effects may be altered beyond recognition. You can make a sweet and gentle singer like Melanie groan like Broderick Crawford at his belligerent best; Al Hirt can be rendered into a little kid puffing on a penny whistle; a set of Lionel trains can assume the thundering resonance of a giant diesel in a mountainous hollow; and the most attention-grabbing radio announcer can be demoted to a barnyard cackler. Once you have used an equalizer for a couple of days, you'll wonder how you ever managed without it. There are few audio products indeed that can be so legitimately useful and so darned much fun too.

The BSR-Metrotec FEW-1 equalizer operates in five frequency ranges, flexible enough for most any application, and simple enough for even the non-audiophile to benefit from.

It connects to your amplifier or receiver through the tape monitor jacks, or between pre- and power amplifier in a more complex component system.



It is available in kit form for \$79.95, or factory wired for \$99.95. For a free full-color catalog sheet, write BSR (USA) Ltd., Blauvelt, N.Y. 10913.

BSR
METROTEC

Check No. 45 on Reader Service Card

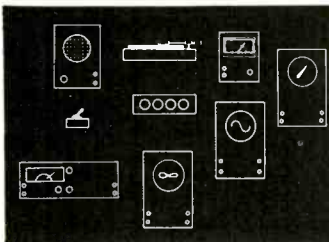

EQUIPMENT PROFILES

ESS Mk VII 46
 TEAC AS-100 48

EPI 601 54
 Onkyo 20 56

ESS Mk VII Speaker System MANUFACTURER'S SPECIFICATIONS

System Type: Resistance loaded port. **Speaker Components:** 9-in. by 12-in. bass; 5-in. cone mid-range, and 2¼-in. dome tweeter. **Frequency Response:** 40-20,000 Hz \pm 3½ dB. **Crossover Points:** 550 and 2,700 Hz. **Dimensions:** 16 in. by 14 in. by 27 in. **Weight:** 65 lbs. **Price:** \$299.00.

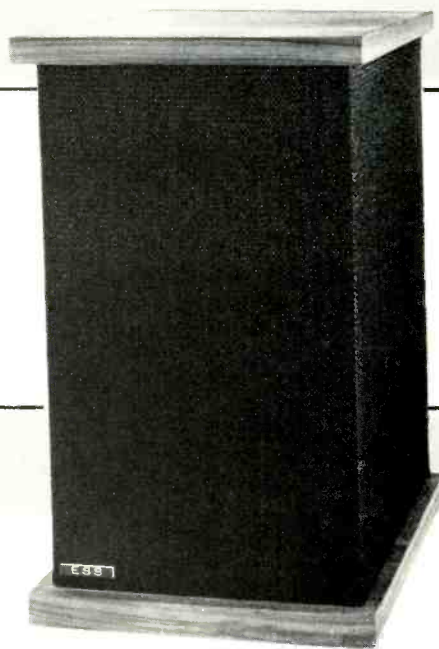

ESS stands for Electrostatic Sound Systems, but the name is a little misleading as not all of their systems use electrostatic units—in fact, most of them are dynamic! The ESS Mk VII, which we tested, is a small floor-standing system using a wrap-around grille cloth which gives it a distinctive appearance. The bass unit is an elliptical type made by KEF in England, and it employs a flat polystyrene diaphragm measuring about 13 in. by 9 in. Mid-range speaker is a 5-in. cone type and the HF speaker has a 2 in. cone with a small center dome. Crossover points are 550 and about 3,000 Hz. The system is not a conventional reflex but has a resistance loaded port which puts it nearer the totally enclosed system category in some respects. System resonance is 50 Hz. At the rear is a three-position level control for the treble unit. The rather solid-looking top and bottom cabinet sections are made of walnut but rosewood is also available. The grille cloth is brown which will harmonize with most furnishing schemes.

Listening Tests

The first impression of the VII's was a solid, full bass response—even when the units were placed on a table, three feet from the floor. The best positions were actually *on* the floor near the corners of the room—about two feet away—or placed flat against the wall. Angling slightly inward gave the best stereo image—especially if the systems were placed more than 12 ft. apart. Overall sound had a forward quality compared with our lab standard systems but coloration was commendably low. Later measurements confirmed the excel-

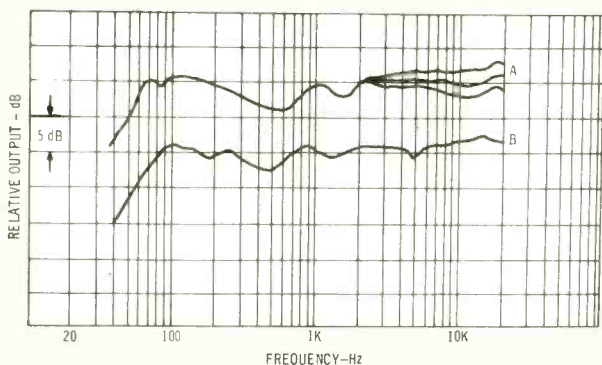

Fig. 1—Frequency response with one-third octave pink noise. A was taken on-axis at the three positions of the treble switch and B at 45 degrees off-axis.

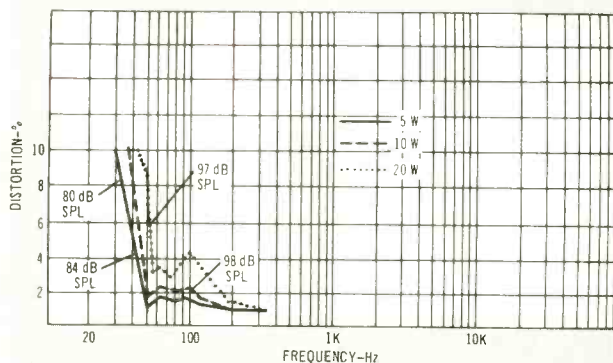

Fig. 2—Low frequency distortion and SPL.



Our town



The sun never sets in our town, nor do our microphones and sound systems get any rest. "Our town" is the mecca for sound specialists, and here, Shure Microphones and Vocal Master Sound Systems handle it all: you'll hear them in hotel show rooms and lounges used by famous professional entertainers whose livelihoods depend on sound excellence; you'll hear them in hotel convention halls, in club after club, in casino after casino; and you'll hear them 'round-the-clock as keno scores are announced. Why? Because the predictability and reliability of Shure microphones and sound systems simply make everyone's job a lot easier. The Shure sound is the Las Vegas sound — and we're proud of it.

Shure Brothers Inc.,
222 Hartrey Ave., Evanston, Ill. 60204.



Check No. 47 on Reader Service Card

lent dispersion and high power handling capabilities. (A Phase Linear 400 was used for some of the tests—this unit can really put out some watts!) Preamp was a Sony 2000F and the phono cartridge, a Decca Mk-5—a nice combination.

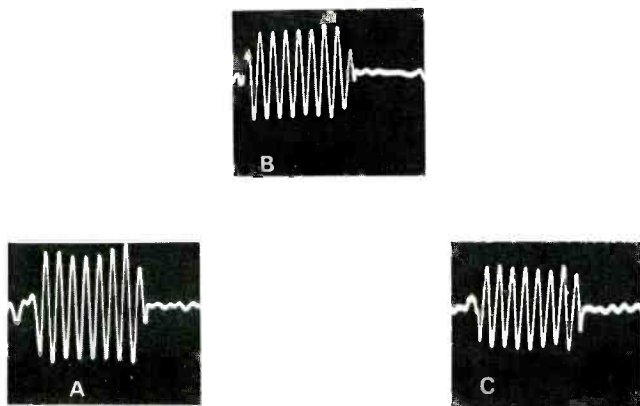

Fig. 3—Tone burst characteristics at A, 100 Hz; B, 1,000 Hz, and C, 5,000 Hz.

Measurements

Figure 1 shows the frequency response taken with one-third octave pink noise. Curve A is the response on-axis at the three positions of the treble control, and B is the response 45 degrees off-axis. As can be seen the response is exceptionally smooth from 2,000 Hz up with good dispersion. Figure 2 shows the low frequency distortion and some representative SPL measurements for 5, 10, and 20 watt inputs. Frequency

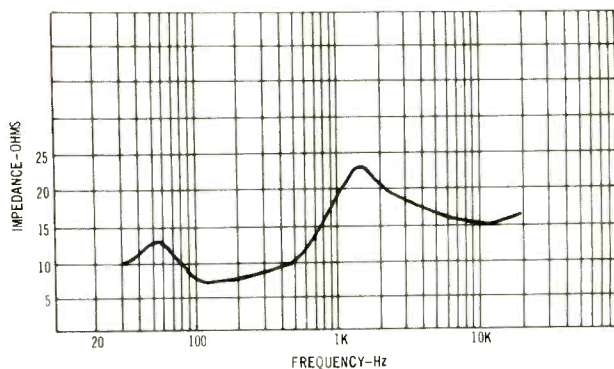

Fig. 4—Impedance versus frequency.

doubling commenced at 50 watts input at 40 Hz and with 84 watts input at 70 Hz. The system could handle a continuous sine wave power of 105 watts at 100 Hz without audible signs of distress. Response to tone bursts was excellent as can be seen from Fig. 3. Lowest point in the impedance characteristics is 5.8 ohms with a high of 23. The rise at resonance is quite low (12.3 ohms), indicating a low-Q system. White noise tests showed no serious coloration—just a trace of low frequency noise. All-in-all, the ESS VII can be recommended to those who require a floor-standing system of reasonable size—and not too expensive. Sensitivity was just a little below average and we would agree with the maker's suggested figure of a minimum amplifier power of 25 watts per channel for an average room.

T.A. & G.W.T.

Check No. 105 on Reader Service Card



TEAC Model AS-100 Integrated Amplifier.

MANUFACTURER'S SPECIFICATIONS

POWER AMPLIFIER SECTION

Rated Power: 30 watts/channel, 8-ohm loads, both channels driven; 40 watts/channel, 8-ohm loads, single channel driven. **THD:** 0.2% at rated output; below 0.1% at 0.1 watt. **IM Distortion:** Less than 0.2% at rated output. **Power Bandwidth:** 10 to 40,000 Hz. **Frequency Response:** 5 to 200,000 Hz, +0, -2 dB. **S/N Ratio:** Better than 90 dB. **Residual System Noise:** Less than 0.3 mV. **Input Sensitivity:** 1 V.

PREAMPLIFIER SECTION

Input Sensitivity: Phono 1, 2, 2 mV; Tuner, 150 mV; Aux 1, 2, Tape, 150 mV. **Output Level:** Preamp-out, 1 Volt at rated inputs; Record Out, 150 mV at rated inputs. **Frequency Response:** 10 to 50,000 Hz +1 dB. **S/N Ratio:** Phono 1, 2, 70 dB; AUX 1, 2, 80 dB. **Tone Control Range:** Bass, +10 dB @ 100 Hz; Treble, +10 dB @ 10 kHz. **Filter Characteristics:** Low Cut, 100 Hz, 6 dB/octave; High Cut, 8 kHz, 6 dB/octave.

GENERAL SPECIFICATIONS

Power Consumption: 15 watts @ no signal; 160 watts @ rated power. **Dimensions:** 16-1/8 in. W. x 5-9/16 in. H. x 12-15/16 in. D. **Weight:** 22 lbs. **Price:** \$299.50.

Although I have had an opportunity to work the TEAC recording equipment in the past (both their TCA-43 4-channel open-reel job and their excellent new Model 350 cassette deck), this was the first time we checked an integrated amplifier designed and produced by a company more noted for its excellent tape products. Like its bigger brother, the Model AS-201 (Reviewed in AUDIO, March 1972), the Model AS-100 has much to commend it in its particular power and price

class. The front panel, shown in the photo, is black and light gold in color, surrounded by heavy extruded black framing. Major controls include a five-position source selector switch (a pair of PHONOS, TUNER, and two AUX positions. Individual left-channel and right-channel BASS and TREBLE controls are each of the switch-step type (rather than continuously variable rotary controls) and each provides accurately calibrated 2 dB steps of boost or attenuation at the reference frequencies of

How to move gracefully from two channels to four

Just flip the mode switch on Sony's new TA-1150 and it switches from mono to stereo to true four-channel sound. It's the first stereo integrated amplifier designed for the four-channel era. Because it has built-in circuitry and switching specifically designed for an SQ four-channel decoder (our SQD-1000 is perfect match) or decoders for any other quadraphonic disc system. You can even put your SQ decoder and your rear-channel amplifier out of sight, and control the volume of all four channels with the TA-1150's

master volume control.

And the four-channel connections are additional to the two sets of stereo tape output and monitor connections (with direct dubbing provisions).

The amplifier section puts out 100 watts IHF music power at 8 ohms, very clean watts, too, thanks to our direct-coupled circuitry. The TA-1150's bass and treble controls let you select the degree of tonal correction you want, as well as the frequency at which that correction takes effect. And you can discon-

nect the TA-1150's preamplifier from its power amplifier section, to insert electronic crossovers or equalizers. Two quite delightful channels, now, two more for later. And all for only \$229.50* The ST-5150, a superb FM stereo tuner matches the TA-1150's performance, appearance, price; \$229.50* Sony Corp. of America, 47-47 Van Dam St., Long Island City, N.Y. 11101. *Suggested retail price.

SONY TA-1150

Check No. 49 on Reader Service Card





Fig. 1—Rear panel.

100 Hz (for the BASS controls) and 10 kHz (for the TREBLE pair). Master VOLUME and BALANCE controls are concentrically mounted at the upper right of the panel. Secondary switches and facilities along the bottom edge of the panel include a TAPE-MONITOR switch, TAPE IN and OUT jacks (in parallel with tape jacks on the rear panel), HIGH-CUT, LOW-CUT filter switches, LOUDNESS switch, MAIN and REMOTE speaker on-off switches, a stereo headphone jack and a push-push POWER on/off switch.

The rear panel, shown in Fig. 1, features three convenience a.c. outlets (two switched, one unswitched), speaker terminals for connection of main and/or remote pairs of stereo speaker systems, a power line fuse, left and right channel speaker fuses, TAPE RECORD and PLAY jacks, input pairs for TUNER,

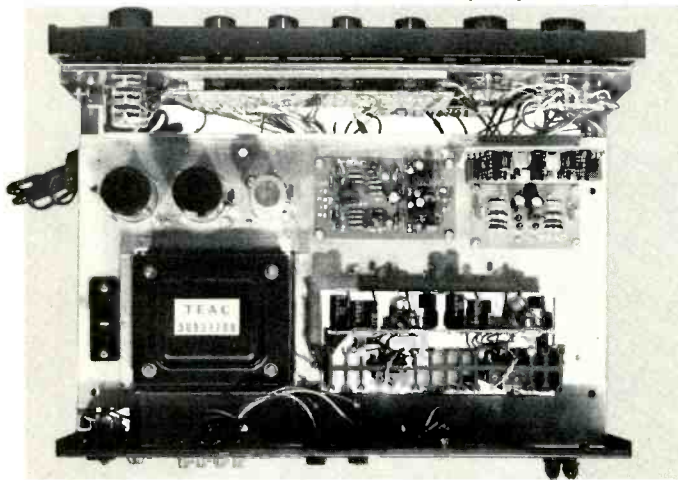

Fig. 2A—View from above.

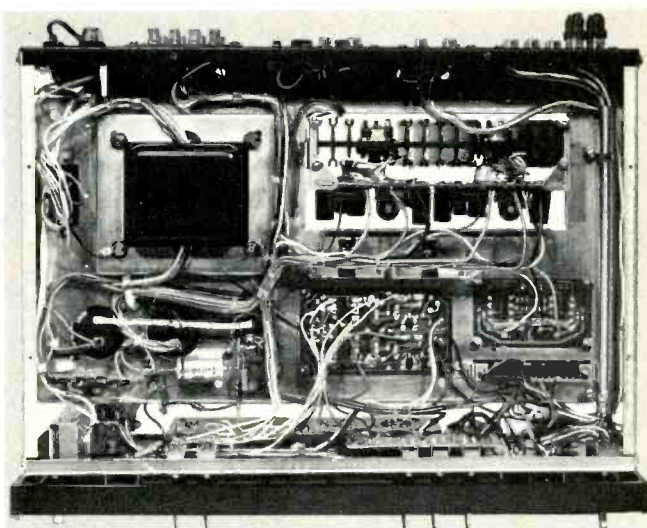

Fig. 2B—View from beneath.

AUX1, AUX2 and PHONO1 and 2. A slide switch enables the user to separate the preamplifier and power amplifier circuits and there are PRE OUT and MAIN IN jacks next to it so that the equipment can really be used as two separate audio components (as part of an electronic cross-over system, using extra amplifiers, or to insert any of the many devices which belong between the preamp-control chassis and the main power amplifier). A DIN record-play connector (for similarly equipped tape recorders) and a ground terminal complete the rear panel layout.

Views of the topside and bottom-side of this thoughtfully laid out chassis are shown in Fig. 2. The well proportioned dual heat sink arrangement, housing the power output devices, can be seen in Fig. 2A as can the relatively large size of the power transformer (considering the fact that the unit is, by today's standards, a medium powered amplifier). Modular p.c. board construction is used throughout, with the pre-amplifier module placed well away from any hum-inducing power supply components. While we were not supplied with a full schematic diagram of this amplifier, a block diagram, supplied in the owner's manual is reproduced in Fig. 3. Note

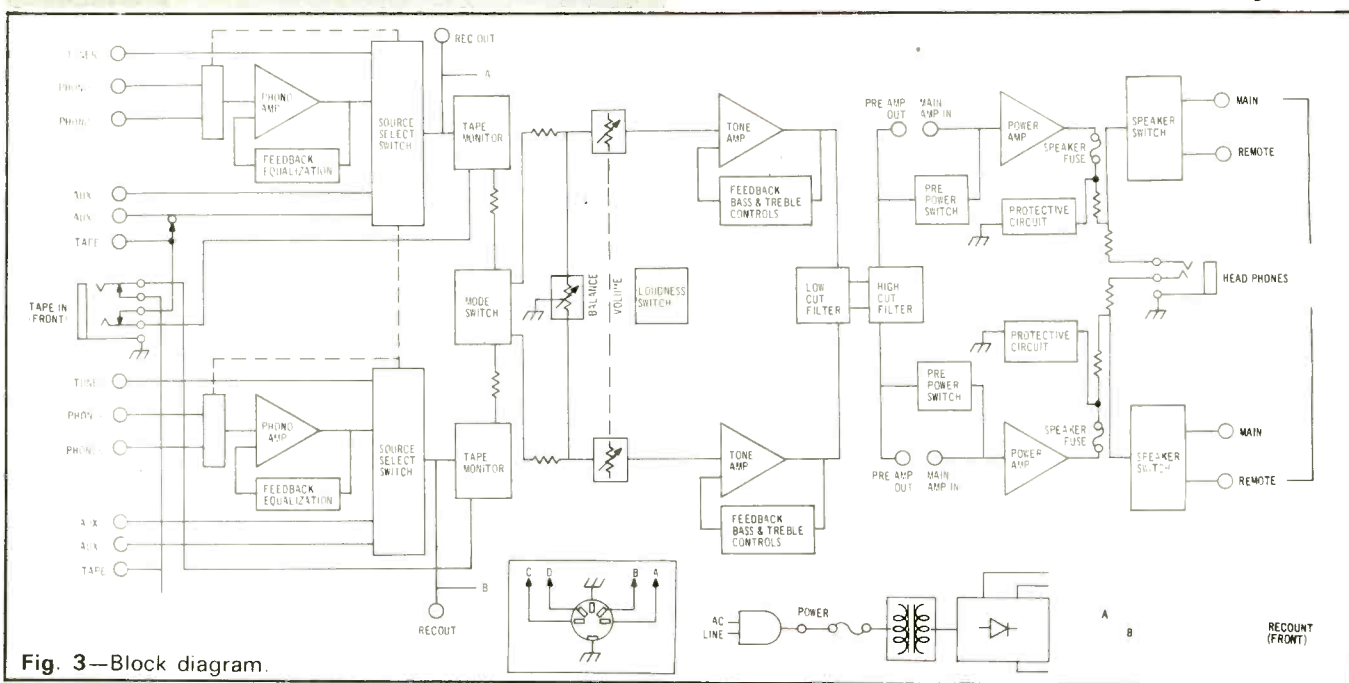

Fig. 3—Block diagram.

Some of the reasons why other turntables don't perform quite like a Dual.

Because of the wide acceptance and acclaim Dual has earned over the years, especially among audio experts, many Dual features inevitably appear on competitive turntables.

To copy a Dual feature is one thing; to achieve Dual performance and reliability is quite another matter. The true measure of a turntable's quality is not its features alone, but how well the entire unit is designed and manufactured.

Following are just some of the ways in which Duals differ from other automatic turntables.

Gyroscopic gimbal suspension.

The gyroscope is the best known scientific means for supporting a precision instrument that must remain perfectly balanced in all planes of motion. That is why the tonearms of the 1218 and 1229 are suspended in true, twin-ring gimbals.

Every Dual gimbal is hand-assembled and individually checked with gauges especially developed by Dual for this purpose. This assures that the horizontal bearing friction of the 1229 for example, will be no greater than 0.015 gram, and vertical friction no greater than 0.007.

True single-play automatic tonearm.

A turntable of the 1229's caliber is used primarily in its single play mode, so the tonearm is designed to parallel a single record on the platter. For multiple-play, the entire tonearm base is moved up to parallel the tonearm to the center of the stack.

The 1218 tonearm provides the single-play adjustment within the cartridge housing, and the cartridge pivots around the stylus tip to maintain the correct overhang.

Stylus pressure around pivot.

Today's finest cartridges, designed to track at around one gram, have little margin for error. In the 1229, therefore, the tracking pressure scale is calibrated within 0.10 gram from 0 to 1.5 grams.

To maintain perfect balance on every Dual tonearm, stylus pressure is applied internally and around the pivot. This is accomplished by a very long spring coiled around the pivot. Only a small portion of the spring's length is needed to apply the required pressure, thus contributing greatly to the accuracy of the calibrations.

Avoiding sounds that weren't recorded.

The rotor of every Dual motor is dynamically balanced in all planes of motion. Each motor pulley and drive wheel is also individually examined with special instruments to assure perfect concentricity.

Any residual vibration within the motor is isolated from the chassis by a three-point damped suspension. Finally, every assembled Dual chassis is "tuned" to a resonance frequency below 10 Hz.

The best guarantee.

All these precision features and refinements don't mean that a Dual turntable must be handled with undue care. So we're not being rash when we include a full year guarantee covering both parts and labor for every Dual. That's up to four times the guarantee you'll find on other automatic units.

Now, if you'd like to know what several independent test labs say about Dual, we'll send you complete reprints of their reports.

Better yet, just visit your franchised United Audio dealer. You'll see for yourself that only a Dual performs precisely like a Dual.

Dual[®]



Dual 1215S, \$109.50

Dual 1218, \$155.00

Dual 1229, \$199.50

United Audio Products, Inc., 120 So. Columbus Ave., Mt. Vernon, N.Y. 10553

Exclusive U.S. Distribution Agency for Dual.
Check No. 51 on Reader Service Card

that the tone control circuits are of the preferred feedback type and that, in addition to the externally accessible speaker fuses, output protective electronic circuits are incorporated in each power amplifier channel.

Electrical Measurements

It has become increasingly important, in recent years, to "qualify" power ratings when discussing an integrated amplifier. A mere statement of "30 watts per channel" (even assuming that one has gotten past the "peak," "dynamic," and "IHF music power" ambiguities) still does not tell the whole story. There are 30 watt amplifiers that fail to drive even moderately efficient speakers and there are other 30 watt per channel amplifiers that seem to put out more clean power than their manufacturers claim. The TEAC AS-100 fits in the latter

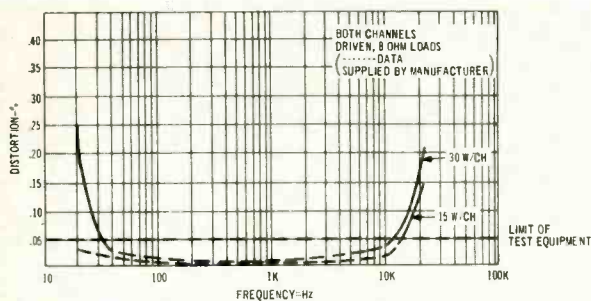

Fig. 4—Distortion vs. frequency at two power levels.

category, and the reasons become apparent as you examine the curves which resulted from our measurements. Of increasing importance is a set of measurements which we began showing less than a year ago—that of distortion versus frequency at various power levels. These curves are *not* a requirement in the IHF standards but, hopefully, if and when the standards are revised they could possibly become the most important measurements of all. As you can see in Fig. 4, distortion at 30 watts per channel (with both channels driven into 8 ohm loads) is all but unmeasurable at all frequencies above 30 Hz and below 15 kHz (our generator has "built in distortion" of about 0.5%) and at the very extremes of 20 Hz and 20 kHz, the THD measures 0.25% and 0.2% respectively. At the half-power point of 15 watts per channel, the only meaningful measurement we could get was at 20 kHz, where THD measured 0.15%—still

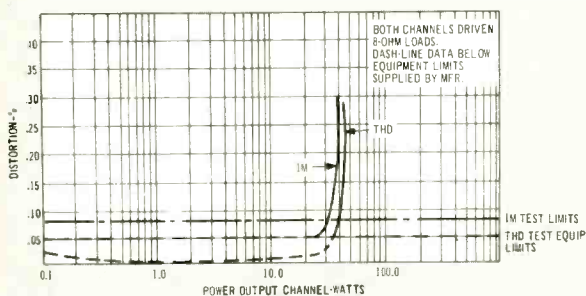

Fig. 5—Mid-band THD and IM characteristics.

well below the 0.2% rated THD which TEAC conservatively quotes for mid-band. At all levels below 15 watts per channel, we could not get a significant distortion reading at any frequency in the audio range, owing to the limitations of our own audio generator. The manufacturer includes published curves for frequencies of 40 Hz, 1 kHz and 10 kHz at levels of power up to and beyond rated output and from these we were able to read figures no greater than 0.04% at any power level from as little as 0.1 watt up to and including 30 watts per channel. The low power level readings are just as significant as the power levels near rated output, since many amplifiers exhibit a rising distortion characteristic in the milliwatt

regions of power output.

As for mid-band power output capability, shown in the curves of Fig. 5, 45 watts of power per channel (again, with both channels driven) was obtained before the rated THD of 0.2% was reached. Rated IM distortion (0.2%) was reached at a power output of just over 40 watts per channel. Again, lower power outputs resulted in IM readings below the capability

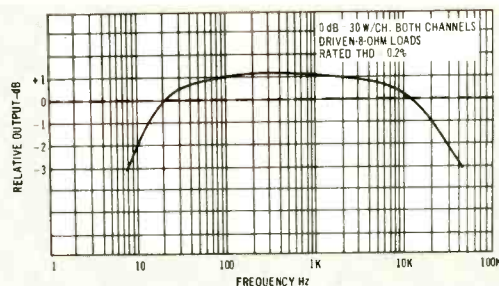

Fig. 6—Power bandwidth.

of our test equipment, whose limit is known to be around 0.08%, but the manufacturer's published curve shows IM levels of around 0.05% at all lower power levels down to 0.1 watts.

Power bandwidth extends from 8 Hz to 42 kHz, a bit better than claimed by the manufacturer, as shown in Fig. 6. Tone control characteristics, as well as filter characteristics are plotted in Fig. 7 and, since the tone controls are of the switching type, we plotted the full response at each discrete setting, rather than just the "end points" of each control. Note that at 100 Hz and 10 kHz, the curves are exactly two dB apart as claimed.

Listening Tests

We used the Teac AS-100 amplifier for about two weeks, both as a primary system (with low-efficiency air-suspension type speaker systems in a 15 ft. x 20 ft. listening room) and to drive the rear speakers in our new four-channel array. As a

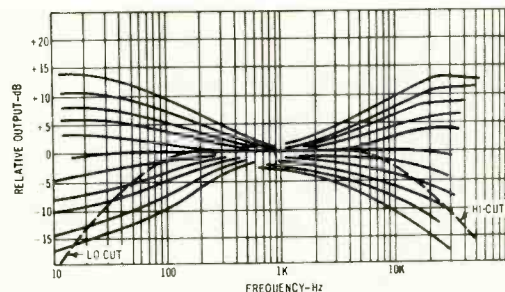

Fig. 7—Tone control and filter characteristics.

primary system, the amplifier seemed to deliver more clean power than its nominal power rating would suggest. Excellent bass reproduction and good transients and attack time were a significant contribution of the amplifier (our speakers have been in use for a long time with many amplifiers, so we do have some basis of comparison here). We particularly were interested in the use of the AS-100 as a rear amplifier in four-channel arrays, since, at its price, this amplifier is very likely to find its way into the homes of "all-in-one receiver" owners who are ready for the step-up to four channel. Our particular receiver has a power rating of 45 watts per channel (nominal) rms, yet we found the AS-100 completely compatible as a "rear" amplifier at all dynamic levels using a wide variety of four-channel discrete and matrixed source material. In all, a very fine medium power job whose performance rivals that of many higher-powered, more expensive integrated amplifier components.

Leonard Feldman

Check No. 104 on Reader Service Card

*"With this cassette pair from Radio Shack,
you can record your favorite
music at home, then
play it back in your car.
That's the kind of
convenience I appreciate!"*

Arthur Fiedler

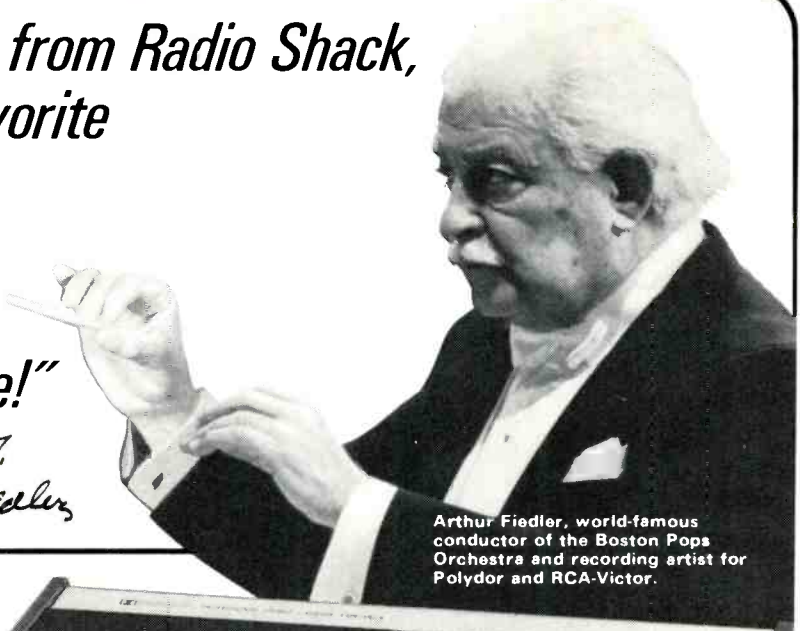

Arthur Fiedler, world-famous conductor of the Boston Pops Orchestra and recording artist for Polydor and RCA-Victor.

PLAY OR RECORD AT HOME WITH THIS ONE...

Our Realistic® SCT-6 features advanced Dolby* Circuitry that makes hiss a thing of the past! Your recordings pop out of a starkly silent background with fidelity that rivals expensive reel-to-reel equipment. "Pro performance" specs too—30-15,000 Hz (± 2 dB) with chromium dioxide cassettes. 0.14% wow & flutter. 56 dB S/N ratio with Dolby "on". Has separate VU meter and record level control for each channel, master volume for both, pushbutton controls including pause for easy editing as-you-go, mixing, end of tape shutoff, more. Oiled walnut wood case and brushed aluminum panel make it a stylish addition to any stereo setup. **19995**

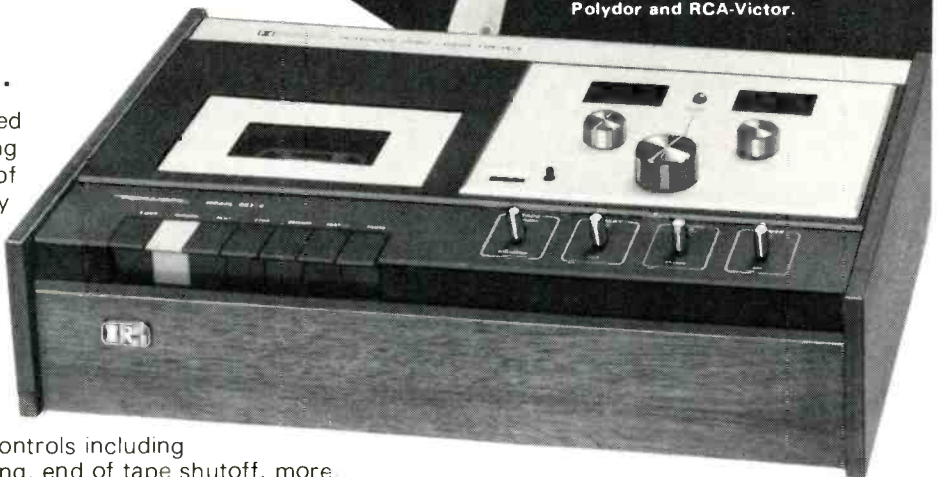

*Dolby is a trademark of Dolby Laboratories, Inc.

... AND DRIVE WITH THIS ONE!

Mobilize your stereo cassettes . . . in your car, truck or boat . . . with this two-in-one unit that offers slide-in cassette convenience PLUS outstanding FM stereo! It's a safe and sure mobile performer with easy-to-use thumbwheel controls, cassette indicator light, lighted FM dial, auto-eject, fast-forward and rewind with lock. FM radio has stereo-mono switch for optimum reception at all times. Powerful full-fidelity 10-watt stereo amplifier. Only 8 x 7 x 2¼" — fits just about anywhere. 12 VDC. Another exclusive at 1600 Radio Shack stores in all 50 states. **10995**



FREE '73 CATALOG! AT YOUR 127
NEARBY STORE OR SEND IN THIS COUPON
180 pages! Stereo Hi-Fi, CB, Ham, Kits, Radios, Recorders, Tools, More!

Name _____ Apt. # _____
 Street _____
 City _____ State _____ Zip

Check No. 53 on Reader Service Card

Radio Shack®
 and ALLIED RADIO STORES
 A TANDY CORPORATION COMPANY
 P. O. Box 1052, Fort Worth, Texas 76107

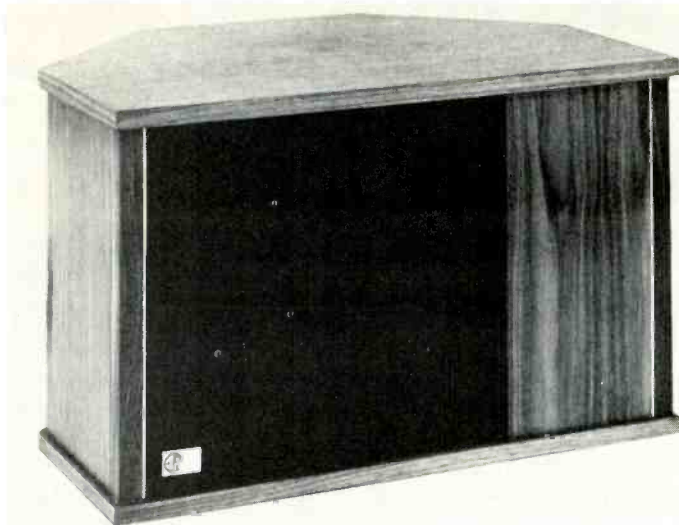

EPI 601 Speaker System

MANUFACTURER'S SPECIFICATIONS

Speaker Components: Three 1-in. cone tweeters; two 8-in. bass, and one 6-in. bass. **Magnet Weight:** Total of 3 lbs. per speaker. **System Type:** Acoustic suspension for both woofers and tweeters. **Power:** Minimum of 35 watts at 4 ohms; maximum of 150 watts at 4 ohms (rms). **Frequency Response:** 36 to 17,000 Hz ± 5 dB. **Size:** 24 by 16 by 15 inches. **Weight:** 60 lbs. **Price:** \$249.00.

The EPI 601 is a little unusual in that it uses both forward and rear facing speakers to give the effect of a large sound source.

A total of six speakers are used—two 8-in., one 6-in. and three 1-in. wide angle cone tweeters. The 6-in. unit and a tweeter are mounted on the front and the other two pairs "fire" from the rear-angle sides. A three-position switch controls the input to the front module and a variable control adjusts input to the three tweeters. Crossover is around 1800 Hz and, following EPI practise, roll-off is purely mechanical (i.e. by appropriate cone design) and no inductors are used.

Measurements

Figure 1 shows the response taken with one-third octave pink noise, measured with the system placed 12 inches from a wall. Response with the front module level switch at "high" is shown at A and with the switch at "normal" at B. Off-axis response at 45 degrees was not substantially different so is not shown. Figure 2 shows the tone-burst responses at 100 Hz, 1 kHz and 5 kHz, and the impedance characteristics are shown in Fig. 3. It will be noticed that the rise at resonance is quite small—partly due to the parallel operation. The actual system resonance was commendably low at 40 Hz. White noise tests showed very little coloration indeed and in this respect the 601 must be ranked with the best. Figure 4 gives the distortion measurements at inputs of 10 and 20 watts. Output was well maintained down to 30 Hz

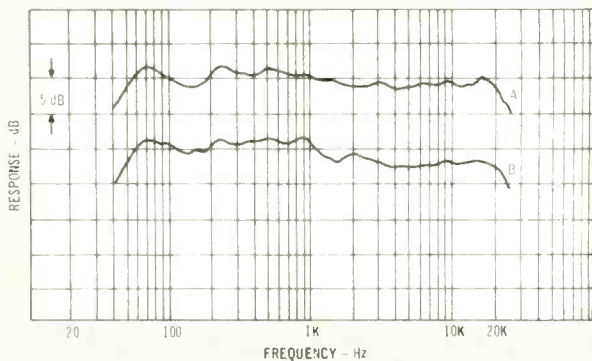

Fig. 1—Frequency response taken with one-third octave pink noise. Curve A was taken with the front module control at "high" and curve B with the control at "normal."

and no less than 120 watts was required before frequency doubling became evident at 40 Hz. This is mainly due to the long traverse voice coils fitted on the bass units—a linear excursion of a half inch is claimed. Sensitivity is slightly below average and an amplifier giving at least 40 honest watts per channel is recommended for best results.

Listening Tests

The actual listening tests took place before the lab measurements were made: this of course avoids any pre-judgments based on the figures. The systems were tried

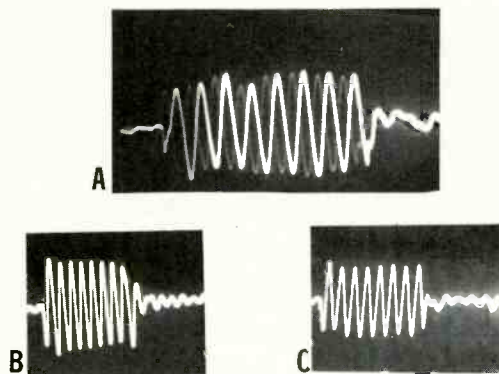

Fig. 2—Tone burst responses at A, 100 Hz; B, 1 kHz and C, 5 kHz.

out in various positions but finally ended up on stands about 20 inches from the floor and some 12 inches from the walls near the corners. The amplifier used was a Sony 1130 which puts out about 80 watts per channel. The room size was about 25 by 16 feet, fairly heavily damped. The first impression was a lack of coloration and a smoothness in overall sound—confirmed later by the response curves and white noise tests. Once the optimum positions were found, it was possible to get a good stereo image. As stated previously, this kind of system which depends on wall reflections is probably more critical in positioning than most. EPI states in their leaflet that the 601 should be kept at least 12 in. from shelves and 15 in. on either side should be kept free of large solid objects. It can be placed directly against a wall, although in our listening room the preferred position was a few inches away. Best position for the treble control, which regulates all three tweeters, was at maximum. We found the best position for the front module control switch was at "high"—in other words, with the highest ratio of direct sound.

To quote from the EPI leaflet, "Most of the sound is reflected off the rear and side walls of the room. Only a

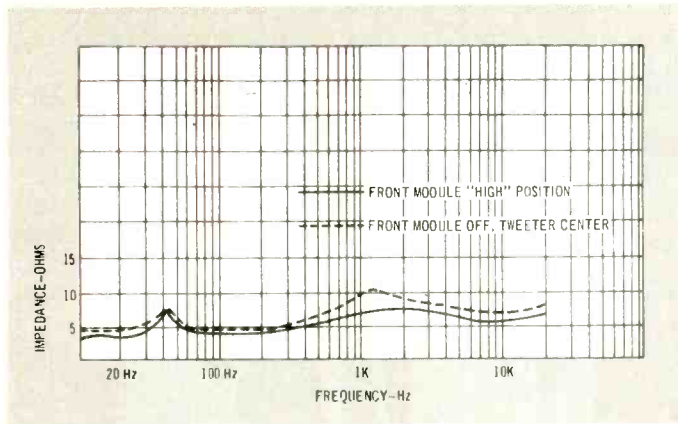

Fig. 3— Impedance characteristics.

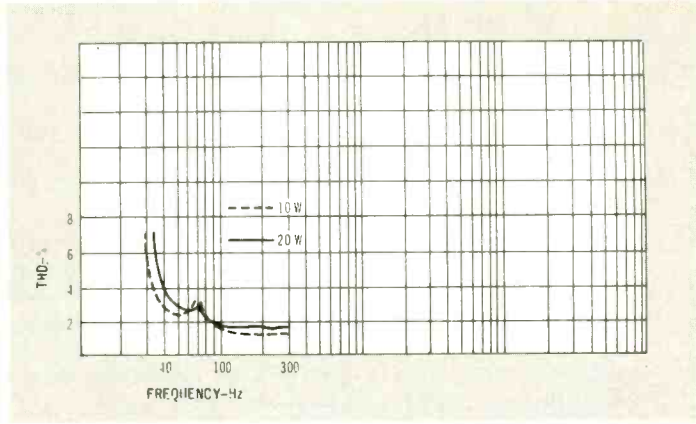

Fig. 4—Low frequency distortion at 10W and 20W.

small percentage of the sound comes directly to the listeners. This direct sound provides the information necessary for proper stereo realism; the indirect sound adds the fullness and body to the music, and together they achieve close to concert hall realism." It is only fair to say that some experts disagree with this philosophy but the subject will be discussed at some length in a later issue. It is sufficient to state here that very directional speaker systems give a sharp well-defined stereo image over a small listening area, while so-called omni-directional systems tend to produce a diffuse image over a much wider listening area. The 601 is not described as an omni-directional system and really combines some features of both concepts.

Overall sound quality was excellent with smooth highs and a tight, well-controlled bass. EPI sound has been criticised in some quarters*as "lacking in warmth." We disagree; the warmth should be provided by the program source, not the loudspeaker. Summing up, the EPI 601 can be recommended to the attention of those who want a reasonable size system with high power handling capacity, low coloration and better than average performance. It will particularly interest those who like a *spacious* kind of sound.*

T.A. & G.W.T.

Check No. 106 on Reader Service Card

*We understand that the 601 has now been superceded by the 602. The only difference is that the three-position switch has been replaced by a variable control.—Ed.

WHY DO PROFESSIONALS IN
MUSIC AND RECORDING PREFER

FAIRFAX?
SPEAKER SYSTEMS

Professionals in the Music & Recording Industry are coming over to FAIRFAX. Hear why for yourself in a listening comparison. FAIRFAX SUPERSOUND means no distortion, no coloration, just the natural sound and presence of the source, with true pitch, zero overlap and total musical balance. FAIRFAX SUPERSOUND SPEAKERS are designed to meet the demand of today's sound. You get all this with SUPERSOUND

- True pitch and zero frequency overlap
- Differential circuitry gate design
- Sturdy 1" and 3/4" high density acoustical board construction
- Advanced sound chamber design engineering
- Compatible to 4 channel, 2 channel and monophonic systems
- Grill cover of attractive, soil and sag resistant acoustical material
- Handsome, hand rubbed natural oiled walnut veneered cabinets
- Specially selected high quality dampening material
- Dependable electronic circuitry
- Excellent power handling capacity
- High efficiency (more sound for your \$)
- 5 year UNCONDITIONAL guarantee

FAIRFAX SUPERSOUND . . . a new definition of the listening experience.
INDUSTRIES INC. 900 Passaic Ave., East Newark, N.J. 07029

Check No. 55 on Reader Service Card

Onkyo Model 20 speaker system

MANUFACTURER'S SPECIFICATIONS

System Type: Three-way, acoustic suspension. **Components:** 12-in. woofer; 2-in. dome midrange, and 1-in. dome tweeter. **Maximum Power Capacity:** 50 watts. **Minimum Amplifier Power:** 10 watts rms/channel. **Woofer Free-Air Resonance:** 28 Hz. **Nominal Impedance:** 8 ohms. **Level Controls:** High and Mid-Range in 5 steps, each +2 dB. **Crossover Frequencies:** 700 and 7,000 Hz. **Dimensions:** 23¼ by 13½ by 11⅝ in. **Weight:** 40 lbs. **Price:** \$199.95.



Onkyo is only beginning to get a reputation here but they are one of the largest organizations of their kind in Japan. They were established in 1946 and some idea of their size can be gleaned from the 1971 sales figures of \$60 million and that the monthly production of stereo systems is 2,000 and loudspeakers—two million! Loudspeakers were, in fact, their first products more than 20 years ago, and Onkyo now has a most extensive range. Model 20, the system tested, uses a 12-in. bass speaker, a 2-in. mid-range dome, and a 1-in. high frequency dome. The first impression was rather favorable—the packing carton comes complete with handles for easy lifting—a feature that other manufacturers could copy with advantage! Then the first item we saw on opening the box was a pair of long connecting wires packed away in a plastic bag—not many manufacturers do this these days! The cabinet itself appears to be very well made; it is beau-

tifully finished and solidly constructed throughout. The bass unit has a rubber surround and both domes are made of aluminum alloy—duraluminum, in fact. As can be seen from the photograph, they are protected by metal grilles. Separate level controls for mid-range and treble are provided. These are step types, giving variations of 2 dB. Figure 2 shows the arrangement. Crossover frequencies are 700 and 7,000 Hz.



Fig. 1—Model 20 with grille cloth removed.

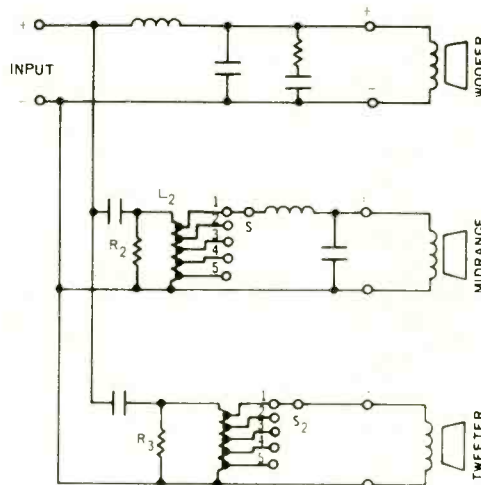

Fig. 2—Crossover and attenuator arrangement.

Listening Tests

Initial tests using a Sony 2000F preamplifier with a Phase Linear 400 amplifier showed the overall sound to be relatively uncolored but a little on the bright side. Reducing the mid-range control by two steps, or 4 dB made for a better balance—at least to our ears. Although the suspension of the bass unit was relatively stiff, low frequency performance was very good, with a tight, well-controlled bass with no trace of boom. As might be expected from a 1-in. dome, high frequency dispersion was excellent.

ADRS*

The curve that bent the Cassette Market out of shape.

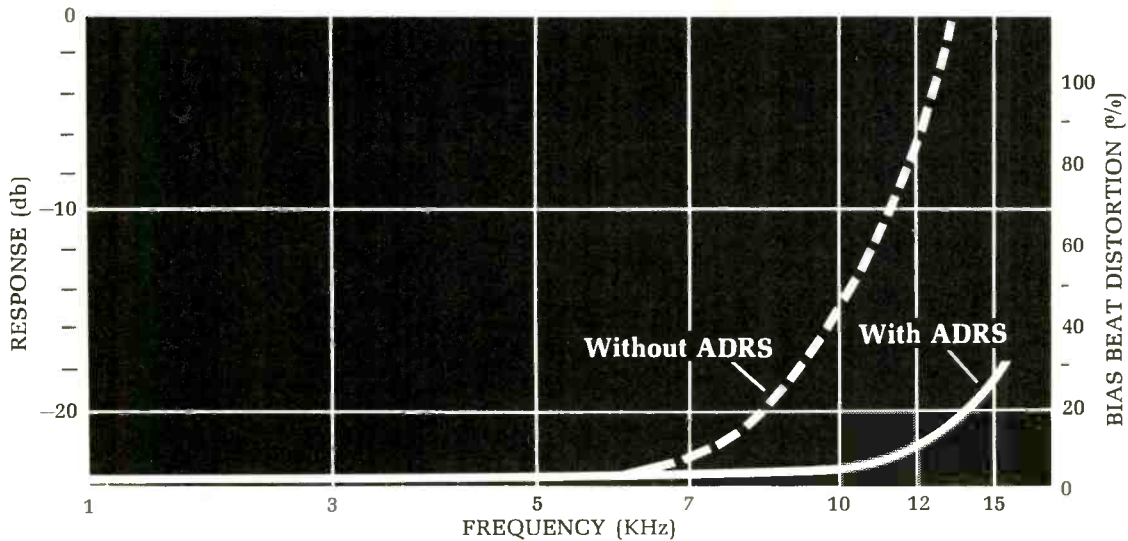

You are looking at a distortion measurement curve. It compares high-frequency distortion found in other cassette decks to the exclusive new AKAI cassette line equipped with ADRS. The results are extraordinary. ADRS eliminates almost all distortion above 8,000 Hz. And only AKAI combines ADRS and GX** Heads with Dolby to give you the most perfect cassette recording in the world today.

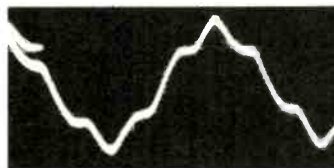

Without ADR System

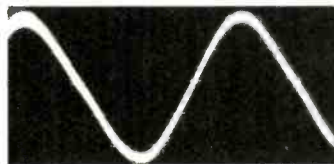

ADR System

Illustrated at left are the actual output curves of a 13KHz signal from a Dolby equipped cassette deck without ADRS, and a comparable curve from a new AKAI GXC-46D cassette deck with ADRS, GX Head and Dolby. The clear, undistorted signal is a pleasure to behold. And an even greater pleasure to hear.

*Automatic Distortion Reduction System
**Glass and Crystal Ferrite Head



GXC-65D

Invert-O-Matic - Automatic Continuous Reverse - Mechanism guaranteed two full years . . . parts and labor



GXC-46D

Why settle for second best in cassette decks?

Only AKAI offers you ADRS, GX Heads and Dolby at a price no more than you would pay for decks equipped with Dolby alone. See . . . and most of all hear . . . our revolutionary new GXC-46D and GXC-65D. Your ears will make up your mind for you.

AKAI™

AKAI America, Ltd. / P. O. Box 55055, Los Angeles, California 90055
For your nearest AKAI dealer call 800-243-6000 Toll Free. In Connecticut, 1-800-882-6500.

Check No. 23 on Reader Service Card

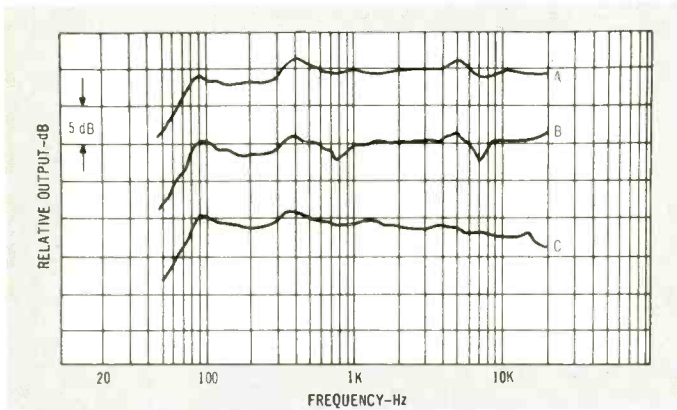

Fig. 3—Response curves taken with one-third octave pink noise.

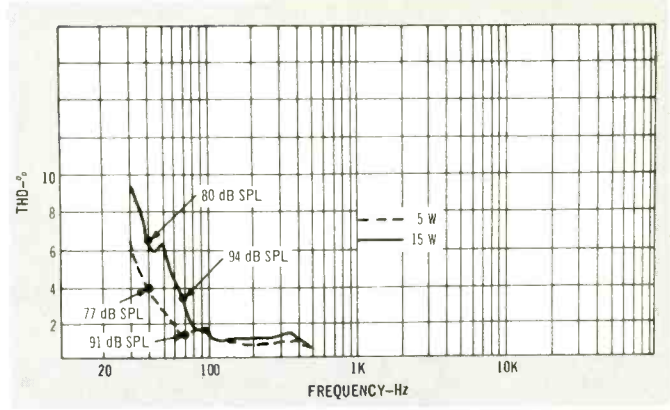

Fig. 4—Low frequency distortion and SPL.

Measurements

The frequency response curves taken with one-third octave pink noise is shown in Fig. 3. Curve A shows the response with both level controls at maximum; B shows the response at 45 degrees off-axis. Dispersion is very good indeed. The small dips at 700 and 7,000 Hz are caused by phase-cancellations. Curve C is the response on-axis with the treble control at minimum and E gives the response measured at the preferred position of the mid-range control—minus 2. Distortion measurements are shown in Fig. 4, and the impedance curve in Fig. 5. Lowest point is 5.2 ohms with an average of around 8. The tone burst characteristics at 100, 1,000, and 5,000 are shown in Fig. 6. White noise tests confirmed a slight

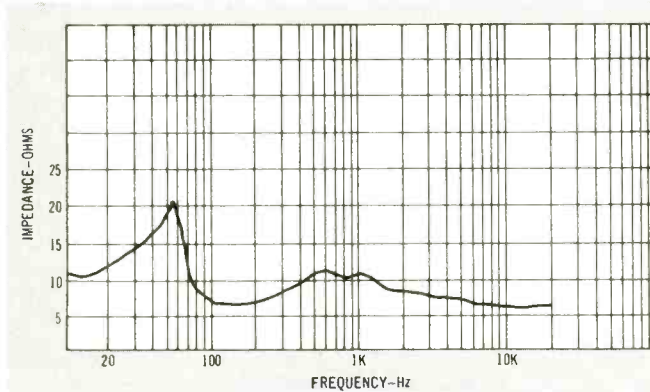

Fig. 5—Impedance versus frequency.

hard coloration with the mid-range control at maximum. This gives a rather forward character to the sound and the general impression was that minus 1 or 2 gave a more natural sound. Frequency doubling did not commence until 44 watts was applied at 70 Hz and the system would handle 9 watts continuous power at 35 Hz before doubling. System resonance was 57 Hz, and sensitivity was slightly above average—a power of 20 watts per channel should be adequate for most amplifier requirements. Summing up: An exceptionally well-made system with good all-around performance.

T.A. & G.W.T.

Footnote—We have just read a statement by Onkyo President Takeshi Godai which we print without comment. "We build the Onkyo speaker to be a musical instrument. It isn't just for reproducing sound. It should have a sound itself that will appeal to music tastes."

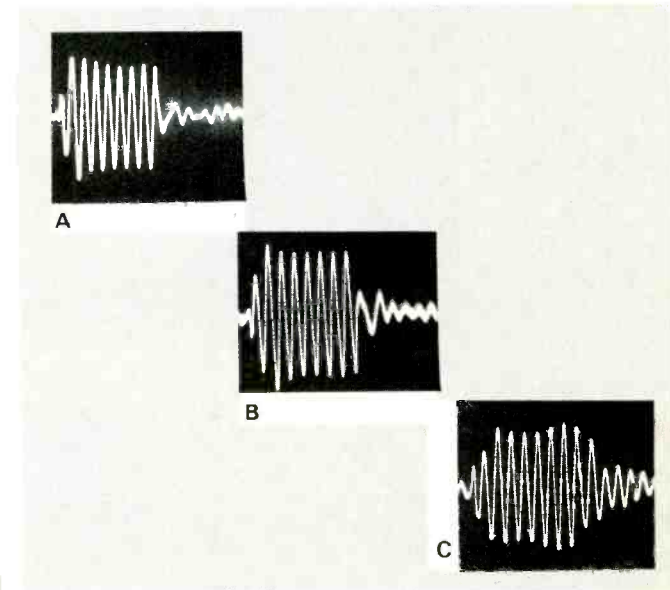

Fig. 6—Tone burst performance at A, 100 Hz; B, 500 Hz, and C, 5,000 Hz.





if you are
serious about
music
use the tape
of the pro.
TDK

Ask any artist or musician, any recording engineer or audiophile, chances are he uses TDK for his professional work. Unmatched in purity and fidelity over the full range of human hearing, crystal clear in its dynamic response and with complete reliability, TDK truly is the tape of the expert. Cassettes, 8-track cartridges or reel-to-reel, in the widest choice of formulations and lengths, including cassettes running as long as 3 hours.

Purity In Sound



TDK ELECTRONICS CORP
23-73 48TH STREET, LONG ISLAND CITY, N.Y. 11103 • 212-721-6881



TDK



Check No. 59 on Reader Service Card

www.americanradiohistory.com



QUAD
Electrostatic
Loudspeaker
 —you simply have to
 listen to it.

QUAD for the closest approach to the original sound.

QUAD is a registered trade mark.

To have further details of your nearest dealer write to

Acoustical Manufacturing Co. Ltd.,
 Huntingdon, PE17 7DB, England

Check No. 60 on Reader Service Card

Classical
Record
Reviews
Edward Tatnall Canby

Paucina musicae virtusq; ceteris excellens gra-
 edum gaffori laudabilis. Quatuor: ubi modula
 tulima: Summaq; diligētia nouissime ipseffa.



**Vaughan Williams: Pastoral Sym-
 phony (No. 3); Tuba Concerto in F
 Minor.** London Symphony, Previn.
RCA LSC 3281 stereo \$5.98.

Vaughan Williams, now at the ripe old posthumous age of 100 (he died in 1958), has rapidly been replacing those British stalwarts, in chronological order, Sir Edward Elgar and Frederic Delius as the foremost British composer of recent but nostalgic times. V-W (please do not think of the German VW) was a fine human being, an impressive and persuasive personality, a great early researcher in *echt* British folk music, an excellent choral composer, and last and largest, a writer of smoothly mellifluous large-scale symphonies, bridging the Romantic-Impressionist gap with never a trace (to my memory!) of the 1920s blat-and-squawk irreverence. Throughout that gravelly, lowbrow period he ploughed onward straight ahead, and forward into the mid-fifties, with the most admirable consistency and Britishness. What more?

You'll have to pardon me then, as a somewhat lover of blat-and-squawk (even unto Stravinsky) if I say that while V-W pleases me as a fabulous musical technician and stylist, in a more profound listening sense he leaves me absenter-minded and absenter-minded, as these vast, genial-serious, light-and-dark musical symphonic landscapes and seascapes move majestically past my ears in all their due length. You just have to like that kind of music. And be tuned to British ineffable conservatism! My review piles of discs, alas, are filled up with

dozens of the big works, notably in this RCA series and in that from Angel with Boult and other eminences, all of which I duly note as being available in profusion for those—many listeners—who thrive on V-W. It's a banner year.

I do find, oddly, that the more Romantic, somewhat more extrovert, earlier big works get through to me more easily than those of later and more complex vintage. It was not easy to write big, serious, elegant symphonies in the twenties and thirties, not to say the fifties, and V-W was neither a Prokofieff nor a Shostakovich, but a much more complicated personality. Again, it's up to the individual listening temperament. No. 3, with the fabulous Heather Harper providing a beautifully elastic soprano instrumental line in the last movement, is a work in the earlier vein, often still impressionistic (did V-W ever wholly abandon that mystical outlook?) though dating from, of all brassy times, 1921. It is well suited to Andre Previn's outspoken sort of orchestral projection.

As for the filler, the Tuba Concerto (1954), it is—on discs—something a bit less than preposterous. I can see it as a glorious piece for the tuba player with its skillful virtuoso writing for that elephant of the instruments. I can even imagine it as highly edifying in the visible circumstances of the concert hall, such lively noises coming out of the big, golden boiler-sized tube! But on records—no. The damn thing just blats, at speeds not quite believable. A supremely professional work piece.

but it ain't really for the passive listener. No way.

Performance: B+ Sound: B+

The Virtuoso Trumpet. Italian Baroque Concertos. Don Smithers; I Musici. Philips 6500 304 stereo \$6.98.
Weber: Symphony No. 1; Cherubini: Symphony in D. New Philharmonia Orch., Boettcher. Philips 6500 154 stereo \$6.98.

With the American "classical" record biz in the prolonged throes of the re-issue/repackage syndrome—a really new recording almost by now a statistical rarity—Philips of Europe brings a refreshing sense of the excitement of days past, when the untapped repertory of music was still nearly infinite and each month brought us music scarcely before imagined. Of course the Philips imports are not necessarily brand new in actual date. But for us, at least, they represent virginal grooves, with never a hint of reissue. Here are some varied samples, out of plenty—and the extra dollar is surely worth it.

The concept holds in every respect, even to the engineers' recorded balance. The trumpet playing is superb but also very much in the Baroque tradition—none of that corny cornet style that some of the general-purpose trumpeters apply to "old" music! The ornaments are brilliantly right, the tone is clear and pure, the phrasing both forceful and modest, making no more of the trumpet part than it warrants in relation to the rest of the musical interest. And the orchestra, too, plays real music, not a perfunctory accompaniment: clearly the famed "I Musici", which once was pretty stumpy and not very authentic, has learned much in its current incarnation. (The group was singled out by Toscanini many years ago and subsequently produced quantities of recordings.) Why, there's even a harpsichord.

The music comprises eight different works of considerably impressive variety, all from the school of Bologna, in Northern Italy, where the Baroque concerto was subjected to very intensive cultivation. Side 1 is a survey of Torelli, who is demonstrably as good a composer as the much more familiar Corelli, down in Rome. Side 2 portrays some of Torelli's little known contemporaries at Bologna and an interestingly high-level lot they were—Bononcini, Gabrielli (with two Is) Grossi, Perti. The trumpet appears in all the works, but not to the point of surfeit. They knew when to stop, in those days.

The second disc is, of course, from

When you make the number one tape recorder, you make the number one recording tape.

Sony!

Cassette. Reel-to-reel. 8-track.

SONY **SUPERSCOPE**
You never heard it so good.®

Check No. 63 on Reader Service Card

FREE

McIntosh CATALOG and FM DIRECTORY

Get all the newest and latest information on the new McIntosh Solid State equipment in the McIntosh catalog. In addition you will receive an FM station directory that covers all of North America.



MX 113

FM/FM STEREO - AM TUNER AND PREAMPLIFIER

SEND TODAY!

McIntosh Laboratory, Inc.
East Side Station P.O. Box 96
Binghamton, N.Y. 13904

NAME _____

ADDRESS _____

CITY _____ STATE _____ ZIP _____

If you are in a hurry for your catalog please send the coupon to McIntosh.
For non rush service send the *Reader Service Card* to the magazine.

Check No. 61 on Reader Service Card

another world, that new period of our discovery, the very early Romantic era of the beginning of the last century. Weber is well enough known for his big German operas, for the brilliant showpiece semi-concerti he wrote for piano, clarinet, and for the opera overtures, now standard symphony repertory stuff. His first symphony, with another in the same key, was no more than an aberrant youthful experiment; the symphony was not his game. Written at 21, it already sounds much like Weber, with a decided bit of Rossini mixed in. But in particular, it is far too dramatic, too interested in details and momentary effects, to

suit the definition of a symphony in terms of shape and form. You can hear an opera, and imagine scenery, in almost any page.

As for Cherubini, he was more mature, his symphony somewhat later, but he, too, tried only once, and in the face of the great Beethoven—this was 1815—his music is a Romantic version of a Haydn symphony, lush and wonderfully melodic but on the reserved, aristocratic side. Cherubini, by the way, spent his musical life in Paris and thus was a successor to Gluck, who moved from Vienna to Paris in the last days of the Bourbons. If you know Gluck's music, you will hear the relationship.

The New Philharmonia and the German-Austrian conductor Wilfried Boettcher do a splendid job with the Cherubini and a manful one with the more boisterous and tricky Weber—both of the works, no doubt, previously unknown to the players, and probably learned in a few rehearsals.

Performances: B+ Sound: B+



Dvořák: Legends, Op. 59. London Philharmonic, Raymond Leppard. Philips 6500 188 stereo \$6.98.

Sometimes Philips is less than savvy—"FIRST RECORDING", this disc proclaims. Not quite, though maybe the first complete recording of all ten short pieces for full orchestra. My (sometimes) excellent card system lists two others, one from Columbia, the other on Urania, both mono and 'way back. I got out the Urania pronto, six of the pieces on one LP side with the postwar Radio Berlin Symphony and the estimable Fritz Lehmann. (The other disc was from the Little Orchestra in New York.) Excellent! But dated. A most unfortunate off-center wow, a common occurrence in the early LP days; but otherwise, a lively, very expressive performance. Curiously, the level is cut much higher than on the new stereo Philips, but is not noticeably distorted. Compensates for the inevitable pops and ticks of early LP vinyl. One can still enjoy these old LPs on occasion, even via a four-channel SQ-logic system.

The Philips recording is milder, with less drive than the old Lehmann disc, and I sense that perhaps the hard working London Philharmonic is less than well rehearsed for this particular job with unfamiliar Romantic music. Dvořák uses copiously a violin trick he perhaps borrowed from Brahms, the constant doubling of the fiddles in octaves on the melodic line, the upper part very high indeed and tending to squeal if not done with absolute accuracy, in precise tune with the instruments at the lower octave. A million Brahms symphony performances have momentarily foundered on such octave string passages! Even with utter familiarity on the players' part. Not surprising that Dvořák's music would offer problems, and more a reflection on that composer than on the performers themselves, in this case.

Performance: B- Sound: B



Bach: Cantata No. 32, Liebster Jesu, mein Verlangen; No. 57, Selig ist der Mann. Eilly Ameling, sopr.



Look for the Maximus Hallmark (M) but...

**don't
mention
our
name!**

Maximus loudspeaker systems are tailored to their hi-fi dealer's standards and to yours. These systems may be recognized in most cases by the manufacturer's Hallmark on the back of the equipment and the MAXIMUS Hallmark banner displayed in the store. When you see it... you don't have to mention our name—but you should listen to the speakers that bear his. You are about to save money on the particular system that suits you best and with complete assurance of its quality.

Why? Simply because MAXIMUS expertise is acknowledged by audio industry experts and music lovers alike. They, like your dealer, are certain of MAXIMUS dedication to the highest principles and latest technology of sound reproduction. You can rely on the trouble-free performance of MAXIMUS Hallmark products...

(Your dealer signs his name to that!)

And—all MAXIMUS speaker systems are fully guaranteed by this "recognized" manufacturer.



MAXIMUS headsets are designed, developed and engineered to meet the same high standards of all MAXIMUS speakers and speaker systems.

MAXIMUS SOUND

CORPORATION 5 South Street, Garden City, N.Y. 11530 (516) 248-6404
MAXIMUS WEST, 1900 West 135th Street, Gardena, Calif. 90249 (213) 770-1284

Presenting the perfected iron-oxide tape: Capitol 2.

Other companies aren't getting the kind of performance out of iron-oxide that we are. No wonder they've switched to different materials.

We at Capitol, on the other hand, have found a way to perfect iron-oxide tape.

And when we say perfected, we mean perfect. A tape that outperforms chromium dioxide and cobalt-energized tapes in many ways, yet retains all the inherent advantages of iron-oxide formulations.

What has Capitol done differently?

Capitol makes more efficient use of iron-oxide particles than anyone else. We get more energy from each iron-oxide particle by keeping the particles from touching one another (which would cause them to lose some of their energy). The process we use is secret, but the results aren't secret.

Capitol 2 is the world's highest-output iron-oxide tape.

The new high-output, low-noise tape, both cassette and reel, works harder than other iron-oxide tapes. You can record them at a higher record-level without distortion.

Capitol 2 has the world's best dynamic range, bar none.

Efficient use of oxide particles and smooth tape surfaces all but eliminate the three most annoying forms of noise bias, modulation, and DC. So Capitol 2 has the world's highest dynamic range. You can record both louder and softer signals than ever before.

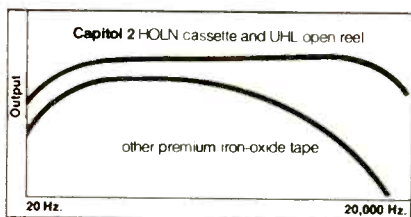

Frequency Response at 3 3/4 IPS (open reel) or 1 7/8 IPS (cassette)

Capitol 2 is the world's first low-print, high-output, low-noise tape.

Print-through is a problem in high-output tape (both cassettes and reels) that Capitol 2 is really the first to solve. The uniform particle size, combined with a secret processing technique, reduces print-through to inaudibility.

Capitol 2 high-output, low-noise is a tape of a different color.

The side of the new tape that faces the heads is a shiny brown, and not as dark as most tapes. The shiny mirror-smooth tape finish improves high-frequency response by improving head-to-tape contact.

The light color is the result of taking the carbon out of the oxide side of the tape. Carbon doesn't help the recording properties of tape in any way. But other manufacturers are forced to use it in order to achieve good static properties. Capitol 2 solves that problem differently.

The backcoating.

Just as the side of the tape that touches the heads should be smooth, the texture of the back of the tape should have a controlled roughness that improves handling characteristics.

So Capitol puts the carbon into its new Cushion-Aire™ backcoating. The new black backcoating not only prevents electrostatic charges from building up, but improves the handling

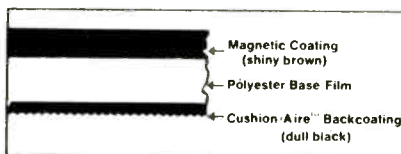

characteristics of our reels, helps make our cassettes jamproof, and extends the tape life considerably.

Presenting the world's best open-reel tape: Capitol 2 Ultra-High-Output, Low-Noise (UHL).

Capitol 2 UHL is the perfected reel tape. At 15,000 Hz (at 3 3/4 ips) the new tape is, on the average, 4.5 dB more sensitive than the top tape made by the best known brand.

Presenting the perfected iron-oxide cassette: Capitol 2 High-Output, Low-Noise (HOLN).

Capitol 2 cassettes aren't just the best iron-oxide cassettes you can buy (at least 6 dB more sensitive than conventional premium tapes at high frequencies, where it really counts). For many reasons, they're the best cassettes you can buy.

Capitol 2 HOLN cassettes are compatible.

Say you bought a good cassette recorder two years ago. You can't use chromium-dioxide cassettes. But you can use Capitol 2. With the kind of results chromium-dioxide users have been bragging about ever since it came out. The new iron-oxide cassettes will improve the sound of any cassette recorder in the house, from the old one you gave to your kid, to the new Dolby-ized one you bought yesterday.

Capitol 2 HOLN cassettes are jamproof.

The Cushion-Aire™ backcoating not only improves cassette winding, it

makes cassettes jamproof.

The texture of the backcoating assures that the tape will always wind smoothly with no steps, protruding layers, and other pack irregularities that cause, among other things, jamming.

So Capitol 2 HOLN cassettes just don't jam.

The perfect cassette package: the Stak-Pak.™

If you've ever tried to locate a cassette in a hurry, or pick one from the bottom of a pile, or put one away in an orderly fashion, you'll appreciate the Stak-Pak.

It's modeled after something you find around the house: the chest of drawers.

The Stak-Pak is, very simply, a double drawer. It holds two cassettes. But the unique part of it is that Stak-Paks slide together and interlock to form a chest of drawers. The more you have, the higher your chest of drawers. Each cassette is neatly filed away in its own drawer.



The world's most acclaimed cartridge.

The Capitol 2 Audiopak® is the world's most popular cartridge, long a favorite not just with consumers, but with broadcast studios and duplicators. The cartridge tape is a special formulation of iron oxide, different from the new Capitol 2 cassettes and reels. It is specially lubricated (that's why it's often called 'lube tape').

Capitol 2 Audiopak cartridges are the standard against which all other cartridges are measured.

The price, perfected.

Your dealer will sell you four Capitol 2 cassettes, 60's or 90's, your choice, packaged in two Stak-Paks, for the price of three cassettes alone.

How to find Capitol 2.

Capitol 2 is new. Not all stores stock it yet. If you can't find it, ask your dealer to order it for you.

Capitol 2

Capitol 2 is the family name that includes Ultra-High-Output, Low-Noise reel tapes, High-Output, Low-Noise cassettes, Audiopak® professional 8-track cartridges, and High-Performance, All-Purpose reel tapes.



Hermann Prey, bass; German Bach Soloists. Winschermann. **Philips 6500 080** stereo \$6.98.

You have other choices in modern recordings of these two Bach cantatas for soprano and bass, with assorted instrumental obbligato parts to go with them. The big appeal of this record is in the two top-rank soloists, the superbly accurate and musical Elly Ameling and the well known bass-baritone, Hermann Prey. They are wonderful to a fault throughout, subject only to the musical styling of the players, the German Bach soloists (Deutsche Bachsolisten) under Helmut Winschermann.

That, unfortunately, is a mild qualification. This German performance is on the fast, economical side, in comparison particularly with the Viennese-style Bach performances. Nothing intrinsically wrong; Bach can surely go faster or slower, to taste, within leeway. But what irks my ear is a familiar conductorial trait in Bach and other Baroque music, a tendency towards rigidly metronomic playing, a pounding, inflexible beat and, above all, a lack of "breathing" sense. The singers are not really inconvenienced here; they have the breath. But one senses, with increasing irritation, that this conductor is bound to drag them

along on the fixed pattern of his inflexible beat—and it just isn't either human or natural. To be sure, I have heard far worse examples. But even a small amount of this rigidity *viz à viz* the human wind instrument (and the others too, such as the oboe) and its freedom to breathe is enough to engender uneasiness. Perhaps you would not know just why, in your own listening. But lack of breath is a thing that affects us instinctively, a sort of claustrophobia in mild form, like a lack of ventilation. Not good!

The recitatives, which are basically without rhythmic beat, are just fine. There, the pair of singers are at their respective best, and most expressive. The impeccably correct rendition of the rest in scholarly terms, the excellent recorded balance, the intelligent playing of the instrumental soloists, do much to make this a good disc. Both cantatas feature the familiar Bach dual roles, the soprano as the seeking soul, the bass as the disembodied Jesus, offering haven and protection, peace, security, in the Heavenly abode.

Performances: B- Sound: B+

Phase Linear 700: The critics lay it on...

"The world's best amplifier!"

W. R. Hickman,
High Fidelity Editor
Seattle Post-Intelligencer

"... in a class by itself"

Julian Hirsch, Stereo Review

"... a product for the all-out audiophile interested only in superlatives! ... in terms of sheer power it is the most impressive we have tested."

High Fidelity

"Based on its sound quality only — regardless of price or power output — the 700 is in our opinion an excellent buy, and probably also a must with the majority of acoustic suspension loudspeakers and the new "hybrid" electrostatic reproducers so popular these days. At about \$1.00 per watt ... the Phase Linear 700 amplifier is probably the best bargain on the market today."

Editor, Hi Fi Newsletter

"An incredible instrument, really too good for home high fidelity use."

Collyn Rivers, Editor
Electronics Today

"... distortion ... was as low as we can go with the present equipment! There's no need to present a frequency response curve ... since it is perfectly flat ... to beyond the limits of our generator! Hum and noise figures were below anything we have encountered before. Breakup, as when an opera singer hits her high C, need never happen again, for now there is the Phase Linear amplifier and when that enormous reserve of power is needed, the 700 is capable of handling practically anything you care to feed it."

C. G. McProud, Audio

"WE WONDER IF 700 WATTS IS ENOUGH!"

Julian Hirsch, Stereo Review



Phase Linear
CORPORATION

405 Howell Way, Edmonds, Wa. 98020

"Salve Festa Dies." Gregorian Chant. Benedictine Monks of the Abbey Saint-Maurice & Saint-Maur (Luxembourg). **Philips 6580 061** stereo \$6.98.

We Praise Thy Name. Majorie Hayward Madey, soprano. Dan Talbot, organ. **Link stereo** \$5.95. (O. Winston Link.)

A good many recordings are special-purpose releases, avowedly or by implication. Yet they are sent out to general reviewers. Meaning they are supposed to have general appeal? One never knows. Here are two such discs, of particular interest to Catholics, those who were brought up on the church music, widely prevalent before Vatican II, that is now gradually being modified or replaced.

Vatican II, of course, made basic reform, these changes left numerous in the use of the local language in place of the old Church Latin. The intention was to improve. But like any reform, these changes left numerous people unhappy in the face of the unfamiliar, and in the loss of the familiar. It was as though suddenly our annual blasts of "Jingle Bells," "Silent Night" and "White Christmas" were proscribed from Xmas radio and TV. In terms of comfortable, familiar music, then, both these discs may be a sort of Catholic nostalgia release. But for people who weren't reared on the music they are likely to be pretty much

meaningless and may offend musical taste.

Philips' beautifully produced and performed Gregorian chant disc is not for many non-Catholic turntables, not even for many Catholics. The ancient traditional chant is accompanied on the organ—forcing the splendid modal shapes of the melody into pat Nineteenth century harmonies. Very up to date as of around 1880, with that vaguely French color, à la César Franck, that is still standard in large numbers of churches, cathedrals, monasteries around the Catholic world. (I listened in on a provincial French wedding in Normandy last summer where it was in full flower, if slightly out of tune.)

On the other hand, many of the more sophisticated Catholic churches and monasteries practice the restored Gregorian chant, unaccompanied, as per the reforms of the famed Abbey of Solesmes in France. (Cf. London Records.) For those who love Gregorian as music the addition of distorting "modern" harmony is absolutely unacceptable. But for others who have been brought up with those harmonies, this recording will surely be a pleasure. It could not be more persuasively performed. That sums it up.

Miss Madey's recording is direct and to the point. It is designed, says the jacket, "to give Catholics an opportunity to enjoy again, with a certain sense of nostalgia, some of the hymns and songs that were so often sung before Vatican Council II." Suffice it to say that for those who are attracted, the job is very well done—though just how the "Battle Hymn of the Republic" complete at a snail's pace with an obbligato trumpet, got into this category of music I do not know. The old fashioned pieces are soothingly sanctimonious and reverent, the organ accompaniment is discreet in churchly fashion. Miss Madey's voice is projected with a fine, rich wobble.

Best organ feat of the decade: Dan Talbot, the organist, is said to be just nineteen—his beaming picture looks it. He has been—it says—Miss Madey's accompanist for the *last eleven years*. Since age eight?? Well, maybe so. (Or maybe the picture and caption are eleven years old).

Please note that O. Winston Link, whose label appears here, was the promoter a few years ago of some of the finest steam railroad recordings ever made, with his own fabulous photographs as accompaniment.

Performances: *Depends*
Sound: B+, B+

... Aware of
The Finest ... ?

Dealer & Representative
Inquiries Invited

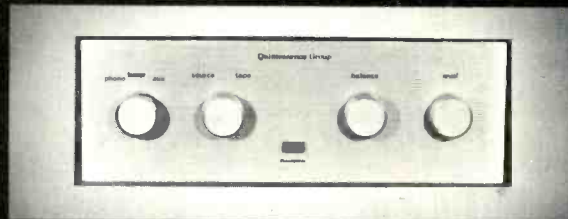

Pre Amp 1 - Part of the audio electronics line

Quintessence Group

Audioworks Division

1E26 North "C" Street
Sacramento, CA 95814
Phone: (916) 446-0557

Check No. 65 on Reader Service Card



CAPSULE
Model F-10-2T

MARK IV
Model F-10H

**Ask the Guy
Who Owns a Pair**

... he likes **FRAZIER
SPEAKERS**

**...he'd like to get
another pair!**

Most of our Hi-Fi customers buy two speakers - NOW with 4 channel - many want another pair EXACTLY like the first pair. Frazier speakers provide sound that guarantees satisfied listening! The clear sounds from one pair of Frazier speakers only cause you to want another pair. Ask your dealer - he likes to demonstrate Quality!

Write for color folder of Frazier speakers — and the name of your nearest dealer.

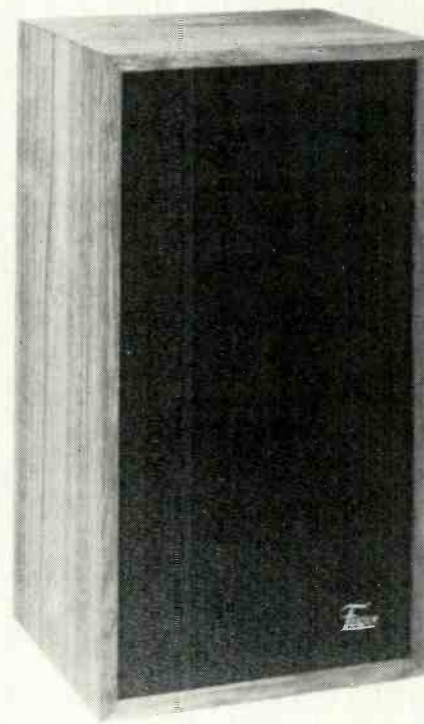

FRAZIER
INCORPORATED

1930 Valley View Lane • Dallas, Texas 75234
Ph: 214/241-3441

Check No. 4 on Reader Service Card

IMAGINE:

THAT A MANUFACTURER PERFECTED AN ABSORPTION-TYPE ENCLOSURE THAT ALLOWED A SPEAKER TO SOUND SO CLEAN AS TO OUTPERFORM MANY \$600 "STATE OF THE ART" SPEAKERS FOR ONLY:

\$299 BUT.....



RSL Max

IMAGINE:

YOU COULD BUY IT WHOLESALE FROM THE MANUFACTURER FOR:

\$160

**ROGERSOUND
LABORATORIES
A REALITY!**

*There are 14 models in the RSL speaker line—
All at wholesale.*



5706 LANKERSHIM BLVD.
NORTH HOLLYWOOD, CALIF. 91601
(213) 877-1420, 763-0855

Check No. 7 on Reader Service Card

RECORDED Tape REVIEWS



Lawrence of Arabia. Original soundtrack recording conducted by Maurice Jarre with the London Philharmonic Orchestra. **Ampex/Bell-M 1205**, open reel, 7½ ips, \$6.95.

This blockbuster picture has been making the rounds again, hence the renewed interest in the film score. As movie music goes this has become something of a classic, with the theme music being arranged and re-arranged in countless recorded "collections." Certainly parts of it are less than inspirational... if not outright cornball. However, it is exciting in many parts, well suited to the action. The scoring is properly full of exotic touches, especially in the percussion. If the whole thing seems rather flamboyant, it certainly reflects the subject matter of the film. Most original sound tracks are poorly recorded, or perhaps I should say, at least when we hear them on tape or discs. Not so here, where we have fairly wide-range sound, quite clean, with little of the "fuzziness" that seems to afflict soundtrack recordings. All in all, there is little to quarrel with, sonically speaking.

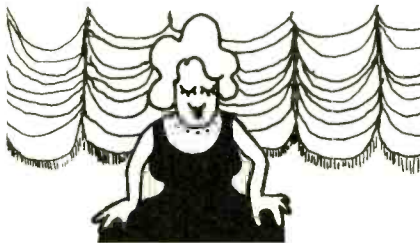

Schubert: Symphony No. 4, Symphony No. 5. Istvan Kertesz conducting the Vienna Philharmonic Orchestra. **Ampex/London-L80242**, open reel, 7½ ips, \$7.95.

Schubert is of course just the cup of tea for the Vienna Philharmonic, and it is obvious they play his music with relish. Kertesz, who has done such a fine job of recording the Dvorak symphonies, may be embarked on a traversal of all the Schubert symphonies. On the eloquent evidence of these fine performances, such a product would be most welcome. Kertesz is fairly straightforward, but he is never dull. There is plenty of sinew when it's needed, but never at the expense of lyricism. Mr. Kertesz seems to be on good terms with the orchestra, for they certainly give him some richly sonorous playing. The string basses are especially noteworthy. This is another sonic winner from London, one of the most opulent recordings from Vienna in some time. Orchestral balances are nigh perfect, without any sections swamping each other. Miking is close enough for good detail, but a good sense of spaciousness and depth is maintained. Stereo localization is precise but not, in the overall view, too broad. The exceptionally clean recording is aided by a fairly low level of tape hiss. A classic view of Schubert, and a good one. **AE**

Bartok: Music for Strings, Percussion, and Celesta. Kodaly: Suite from Háry János. Bernard Haitink cond. the Amsterdam Concertgebouw Orch. **Ampex/Philips PHI-L5015**, open reel, 7 1/2 ips, \$7.95.

Haitink is rapidly becoming one of our premier conductors, noted especially for his fine work in the Mahler/Bruckner idiom. I frankly felt he would not be too comfortable with this Bartok/Kodaly combination, but the performances are basically good. He is a bit too fussy over detail in spots, and he has ideas of tempo at variance with the work of other conductors of these scores. One can accept these minor shortcomings in return for the absolutely glorious sound and playing of his great Concertgebouw orchestra. The first strings are positively glowing in the Bartok. The superb acoustics of the Concertgebouw hall permit a lovely spacious sound, yet the most intimate details of percussion, the delicate tracery and texture in much of the Bartok and in sections of the Háry János Suite are never swamped or out of balance. For all this, the sound has power. Note in the opening of the battle scene in the Háry János Suite, the weight and authority of the bass drum and the massive sonority of the bass trombones and tuba. Their presence is almost palpable. Here we have the bonus of less tape hiss than usual, although not as little as Dolby recording. A little print-through was evident, but all in all, a clean production and worth your attention.

Richard Strauss: Also Sprach Zarathustra, William Steinberg cond. the Boston Symphony Orch., **Ampex/DGG L3160**, 7 1/2 ips, \$7.95.

I wonder how many people buy this work after viewing "2001" and never play the record past the famous opening theme? Pity if they don't, for there certainly is a wealth of stirring, eloquently dramatic, and often passionate music throughout the score. William Steinberg gives us a fairly straightforward account of the work, letting the music speak for itself instead of forcing for effects, as is the wont of many conductors with this music. Some may find it a mite bland, in comparison to the Mehta/London recording, but it has the advantages of superb playing from the Bostonians and a clean, nicely proportioned sound, with excellent handling of hall reverb plus definition. Although somewhat under-stated sonically, it does not suffer from the extraneous low

ROBINS SOUND ENHANCERS: HIGHER FI FOR LOWER DOUGH

You make it happen. We make it possible. With the "Sound Enhancers"—a group of amazingly sophisticated (but low-priced) mini-components that lets you get the most from your system, whatever its complexity.

Read about six of our Sound Enhancers below. Be sure and check the price! Once you have, we think you'll want to visit your Robins dealer for a closer look. Or, send in the coupon for more information.

Quad on sale: \$6.95 You supply a second pair of speakers, and our Quad Synthesizer provides the excitement of derived 4-channel sound. Nothing else to buy. Unless you prefer our Deluxe model with dual volume controls, \$9.95.



8dB More Enjoyment Our Stereo Enhancer (Dynamic Expander) compensates for compression in all recordings, restores full, lifelike dynamic range, reduces noise. Self-powered. Under \$30.

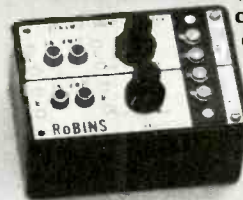

Speaker Insurance Robins Speaker Protector guards the dollars you've invested by electronically preventing speaker blow-outs. Self-powered limiter protects a pair of speakers; maintains tonal quality. Less than \$25.



Happier Headphones Our Headphone Enhancer gives you rich lows and pure highs without ear-shattering volume, through advanced equalization. Self-powered, costs less than \$20.



Wipe out Record Noise A quick wipe of our velvety plush Record Ionizer gently lifts off dirt, deposits a minute amount of anti-static fluid, aligning ions in the same direction to reduce dust build-up. Increases record life, improves fidelity. Under \$5.



Ultimate Quiet Yours, thanks to our Professional Groovemaster, built like a precision tone arm. Its feather-light touch removes dust and dirt like a magnet. Under \$12.

Gentlemen: I want to know more about higher fi for lower dough Please tell me more about the items checked:

- Quad Synthesizer Speaker Protector Record Ionizer Headphone Enhancer
 Dynamic Enhancer Professional Groovemaster

NAME _____

ADDRESS _____

(city) _____

(state) _____

(zip) _____

ROBINS®

ROBINS INDUSTRIES CORP.

75 AUSTIN BOULEVARD, COMMACK, N.Y. 11725 (516) 543-5200

Enjoy this UNWINDING CENTER for Two Weeks Free

\$21.73 PER MONTH
FOR 11 MONTHS



SUPERIOR COMFORT CENTER

Look for these quality features

- Genuine Naugahyde Cover
- Foam filled comfort
- Chrome steel, rugged frame
- Gentle tilting action
- Big size (24" wide x 42" high)
- Sturdy matching ottoman
- It swings . . . It Tilts

HERE'S WHAT YOU GET—

The Commander Chair, Matching Ottoman and the big White Bear or Tiger Rug

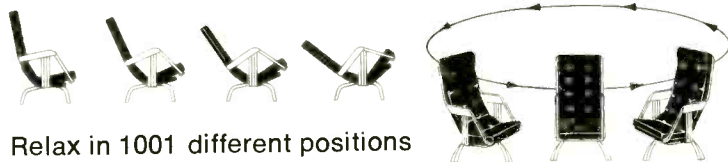

Relax in 1001 different positions

ENJOY A MAN'S KIND OF COMFORT . . . A MAN'S KIND OF CONTROL! You're in command of total comfort with this special chair that lets you control the relaxing action. Scientifically contoured and shaped to new space-age seating concepts for extending seating comfort.

ALL AROUND SWIVEL ACTION! For TV watching . . . for reading . . . for talking with guests . . . for pure relaxing fun.

GENTLE TILTING ACTION! Unique center balance control allows chair to swing into an infinite number of positions by shifting your weight.

RELAX AND UNWIND! In the hammock-like comfort of thick resilient foam. You are totally surrounded in the luxury of genuine Naugahyde upholstery. Rugged and distinctively man-styled!

YOU DESERVE YOUR OWN SPECIAL CHAIR! Where you can rest, relax and relieve tensions from the hectic pace of a busy day. Roomy size: 24" wide, 42" high.

ANIMAL RUGS—Perfect replicas, made from modacrylic fur . . . a tough, durable, stain resistant miracle material. Adds a special flair to your comfort center. A 5' x 7' white Bear Rug.

"TRY IT" ORDER FORM

Please send me the Commander Chair, matching Ottoman and white Bear Rug for a ten day free trial. If I do not return it within the trial period I agree to pay as follows:

EXTENDED PAYMENT

I wish to pay \$21.73 a month for 11 months for each Unwinding Center (which includes the Commander Chair, Ottoman and White Bear Rug) ordered, for a total cash price at the end of the 11 month period of \$239.03. No Finance Charges or Down Payment is required. Annual percentage rate 00%. I further understand that this agreement is governed by the laws of the state of New Jersey. The purchaser is entitled to assert, as to the holder, all rights and defenses against the seller.

CREDIT CARD

Bill my credit card # _____ for \$239.03
 American Express Diners Club
 Master Charge (Bank # _____)
 Expiration Date _____

CASH

I prefer to pay cash. Enclosed is my check in the amount of \$239.03 for the complete Unwinding Center. If I am not fully pleased, I may return the Center in good condition and receive an immediate and full refund. Local sales tax, where applicable will be added. Sorry no merchandise shipped to P.O. Box numbers.

Please fill out all information

My Name _____ Title _____
 Institution _____
 Street _____
 City _____ State _____ Zip _____
 Home Address _____
 City _____ State _____ Zip _____
 Telephone _____
 Spouse's Name _____
 Bank or Department Store Reference _____
 Signature _____

(Order must be signed)

Please ship Home Office

SELECT YOUR CHOICE OF COLOR FOR CHAIR

#3B8 Burnt Orange #3T8 Tan
 #3A8 Avocado #3X2 Oxblood # 3R8 Black

Select Rug: Bear Tiger

EXECUTIVE DISCOUNT SHOPPING SERVICE
 1309 Cherry Street/Phila., Pa. 19107 AU-1

frequency sounds and assorted other rumblings that mar the London recording. One cannot give his ultimate opinion of this recording until some happy day the four-channel Dolby tapes of this performance, now reposing in the DGG vaults in Hamburg, are released.



Peter Nero: The First Time Ever (I saw your face), Columbia CT31335, Dolby cassette, \$5.95.

As I have said before . . . the only thing consistent about cassettes is their inconsistency. Frankly, I just went through a whole run of cassette clinkers . . . one production batch after the other with the whole catalog of cassette shortcomings painfully audible. And then just when you're ready to say the hell with it . . . you encounter this new Peter Nero production which displays every virtue that makes you think anew that cassettes have all the potential of a really high quality sound medium. Here were such items as the by-now-ubiquitous theme from "The Godfather", *Never Can Say Goodbye*, *Brian's Song* and others, all dressed up in classy arrangements and with the Peter Nero piano ringing out clear as crystal, true and steady, with never an off-pitch quiver . . . even on held pedal notes and chords. The clean wide range sound, free of modulation noise and with few audible drop-outs, coupled with the silky silences of the Dolbyized tape processing, make for a very superior listening experience. Nero, of course, displays the easy relaxed style of playing, which has earned him a well-deserved reputation. In all, a winner . . . technically and musically.



De Falla: Nights In the Garden of Spain; Chopin: Piano Concerto #2, Alice de Larrocha, piano; Orch. de la Suisse Romande, cond. by Sergiu Commissiona, Ampex/London M10252, Dolby cassette, \$6.95.

Delarocha of course absolutely owns the De Falla piece . . . an incredible display of piano virtuosity combining dazzling technique and melting lyricism. Sensational! A lovely piece of music too. The Chopin is good but here she has stiff competition from any number of artists. Add to the superb music making, a fine recording, with a "just right" balance between piano and orchestra in both pieces, and broad spacious acoustics. The Dolby processing is vital to this kind of music with the many soft passages for piano. It is marvelous to encounter a rest in the scores, and then have the next note just appear out of the silence, clear as a bell. If you are a cassette man, this is a *must!*

When you make the number one tape recorder, you make the number one recording tape.

Sony!

Cassette. Reel-to-reel. 8-track.

SONY SUPERSCOPE

You never heard it so good.®

Check No. 63 on Reader Service Card

ROTEL

THE ALTERNATIVE

RA-1210

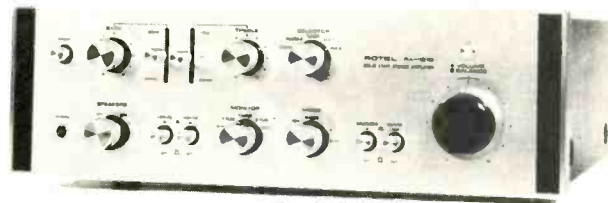

THE STEREO AMPLIFIER: RMS power, 60W/channel with both channels driven into an 8 ohm load. Two separate power supplies each with its own power transformer. Power Bandwidth of from 5-50KHz and a THD of below 0.3% from 20-20KHz. Add to this 2dB step controls, 3 stage differential pre-amplifier, adjustable input sensitivity/impedance on phono 2, plus tape monitoring and dubbing for two sets of tape recorders. A host of other features make the RA-1210 the stereo amplifier to hear and buy. ROTEL is the alternative, for the critical audiophile.



THE EVERYTHING LINE FROM ROTEL
 ROTEL of America, Inc., 2642 Central Ave., Yonkers, N.Y. 10710

Check No. 12 on Reader Service Card

NOW SCHWANN IS 14



To give you all you want to know about all kinds of records and tapes, Schwann now publishes 14 issues per year. The monthly **Schwann-1** carries all new listings and available classical and popular. The semi-annual **Schwann-2** catalog lists more specialized categories, also older and re-released music.

You need both **Schwann-1** and **Schwann-2** because each is part of the complete Schwann. Look for the dealer who displays this sign.

Schwann-1 Monthly. Special new listing section has latest releases: records, 8-track cartridge and cassette tapes. Nearly 45,000 total listings in classical, recent popular, rock, jazz, musical shows, opera, ballet, electronic, quadrasonic, etc.

Schwann-2 Semi-annual supplement. Expands coverage of Schwann-1 in specialized categories: pop more than two years old, classic jazz older and re-released mono and reprocessed stereo classical recordings, classical on lesser-known labels, international pop & folk on domestic labels, spoken, educational, religious, etc.

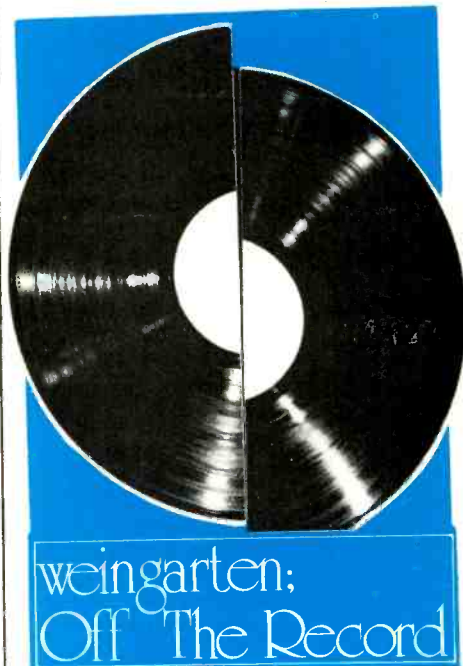
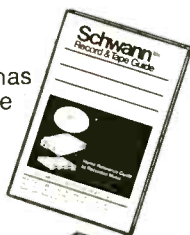

Sherwood L. Weingarten

L. A. Reggae (United Artists, UAS-5650) takes singer-guitarist Johnny Rivers back to the funky rock he started with. One of the finest LPs in months, this is highlighted by five of his own creations (best of which is "Come Home America") and some new versions of old hits, Steve Cropper's "Knock on Wood," Van Morrison's "Brown Eyed Girl" and Paul Simon's "Mother and Child Reunion." A solid, earthy beat and rich sound fill "Crazy Mama," standout of the dozen cuts. Rivers has sold 20 million records; listen to this and find out why.

THE GIANTS OF JAZZ (Atlantic, SD 2-905) is an extraordinary double-disc package recorded live at the Victoria Theatre in London. Spotighting six jazz oldtimers who paid their dues many times over to reach the apex of professionalism, the LP features magnificent versions of "Night in Tunisia," "Blue Monk" and "Round Midnight." Plus six others. Much has been heard of the super-sessions by rock artists, but this is better than any of them. Witness particularly, the solos of drummer Art Blakey, trumpet master Dizzy Gillespie, pianist Thelonious Monk, and tenor alto sax artist Sonny Stilt. And the work of Kai Winding on trombone and Al McKibbin on bass leaves little to be desired. Sure to be a classic!

CAN'T YOU HEAR THE SONG? (Chelsea, CHE-10003) offers 11 tracks by Wayne Newton, who's more polished (though still slightly nasal and twangy) on this RCA-distributed outing than

SPECIAL PRICE SAMPLE OFFER

If your favorite store doesn't carry Schwann, order samples by mail. Prices include postage and handling.

- Schwann Sampler one Schwann-1 (monthly) and one Schwann-2 (semi-annual)\$2.00
- Latest Schwann-1 (monthly)\$1.25
- Latest Schwann-2 (semi-annual)\$1.00
- Newly revised Basic Record Library booklet.

Lists 1,000 suggestions in classical music by musical periods for your enjoyment. Send 15¢ for cost of handling, also 8¢ stamped self-addressed long envelope.

I enclose \$.....for the items checked above.

Name _____

Address _____

City _____ State _____ Zip _____

Dealer's Name & Address _____

Schwann Record & Tape Guide

137 Newbury Street, Boston, Mass. 02116

AU

past efforts. His voice is getting deeper, it appears, but his appeal still is to little old ladies in rockers who need a freckled-faced kid to mother. All things considered, he does a pleasing job with other singers' tunes, such as Neil Diamond's "Song Sung Blue" and Gilbert O'Sullivan's "Alone Again, Naturally."

BATDORF & RODNEY (Asylum, SD5056) provide what might be termed moderate rock, music that's neither too loud nor soft, neither too heavy nor light. Highlights of the nine cuts, all penned by John Batdorf (who also does the lead vocals), are "All I Need," a poignant thing dedicated to Dalton Trumbo, and "Let Me Live the Life," which sounds almost as if it were written by Paul Simon. There's also interesting use of strings on "Between the Ages," a slow number that's a change of pace for the Atlantic-distributed album.

COUNTRY CAPERS (Ranwood, R-8099) showcases Buddy Merrill, featured guitarist of the Lawrence Welk videopus. Unfortunately, he never quite escapes the Hawaiian sound of his steel guitar, even when rendering such items as "Spanish Harlem." There's nothing special, despite a heavy leaning on chart successes. Instrumental pleasantries, geared for those who don't take their music too seriously, include "Proud Mary," "Jambalia," "Okie from Muskogee" and "If I Were a Carpenter."

ELVIS AT MADISON SQUARE GARDEN (RCA, LSP-4776) captures the excitement of the concert stage as Presley mixes slow and fast stuff for an audience that grew up with him. Each side has one running track, marred occasionally by muffled sound (and what seems like hundreds of thank-yous to an appreciative audience). Highlights are "That's All Right," "Heartbreak Hotel," "The Impossible Dream," "Hound Dog" and "For the Good Times." For those who wait until budget discs arrive on the scene, another Presley outing is available, **BURNING LOVE AND HITS FROM HIS MOVIES, VOLUME 2** (RCA Camden, CAS-2595). There are ten tracks, including the title entry, a hit single getting heavy air play.

BLACK HEAT (Atlantic, SD 7237) is both group and album title. The sextet, with horn section and percussion added, spotlights funky soul-rock. There are particularly good dance
(Continued on page 73)

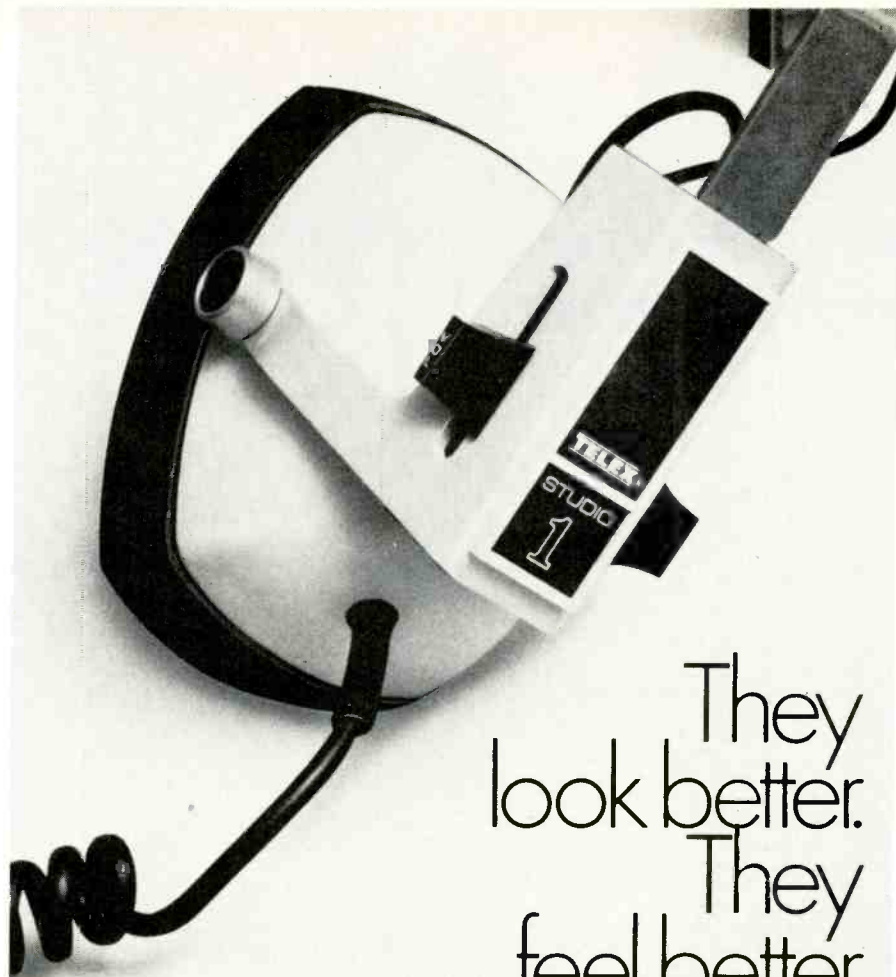

They
look better.
They
feel better.
They
sound better.
Studio stereophones by
Telex.

Don a pair of Studio stereophones, the best looking stereophones made. They feel better because surgical silicone ear cushions comfortably conform to your head, even if you wear glasses. The real test is listening. A unique audiometric-type driver faithfully delivers all the sounds from a disc, tape or receiver. Choose either the Studio 1 with volume and tone controls, or the Studio 2.

The proof? Try them yourself at a better hi-fi dealer.

products of sound research

TELEX®

COMMUNICATION DIVISION

9600 Aldrich Avenue South / Minneapolis, Minnesota 55420

Studio stereophones are made by the world's largest manufacturer of aviation and educational headsets, stereophones, and other listening devices. Write for catalog.

CANADA: DOUBLE DIAMOND ELECTRONICS, LTD., Scarborough 4, Ontario
EUROPE: ROYAL SOUND COMPANY, INC., 409 North Main Street, Freeport, N. Y. 11520 U.S.A.
INTERNATIONAL: TELEX EXPORT DEPT., 9600 Aldrich Ave. So., Minneapolis, Minn. 55420 U.S.A.

Check No. 14 on Reader Service Card

advertising
advertising
advertising

index

advertising
advertising
advertising

ADVERTISER	PAGE	ADVERTISER	PAGE	ADVERTISER	PAGE
Acoustical Manufacturing Co.	60	Kenwood Inc.	31	Saxitone Tape Sales	78
Quad Speaker system		Receivers & tuners		Magnetic tape	
Check No. 60 on Reader Service Card		Check No. 31 on Reader Service Card		Write direct to advertiser	
Akai America Ltd	57	Lafayette Radio Electronics Corp	75	Schwann Record & Tape Guide	70
Tape Recorders		Catalog		Guide to current records and tapes.	
Check No. 23 on Reader Service Card		Check No. 22 on Reader Service Card		Write Direct to Advertiser	
Audio Dynamics Corp	13	Marantz Co.	Cover IV	Sharpe Audio Division of Scintrex	2
ADC-XLM Cartridge		Adapter		Headphones	
Check No. 13 on Reader Service Card		Check No. 43 on Reader Service Card		Check No. 2 on Reader Service Card	
Audio Warehouse	74	Maximus Sound	62	Sherwood Electronics Corp	8
Mail order discounts		Headphones, loudspeakers		Receivers	
Check No. 18 on Reader Service Card		Check No. 64 on Reader Service Card		Check No. 8 on Reader Service Card	
Benjamin Corp.	10	McIntosh Laboratory Inc.	61	Shure Bros.	47,23
Lenco L75 turntable		MX-113 tuner/Preamplifier		Microphones	
Check No. 10 on Reader Service Card		Check No. 61 on Reader Service Card		Check No. 47 & 57 on Reader Service Card	
Bose Corp.	Cover III	Metrotec Electronics	45	Sony Corp. of America	33
Loudspeaker systems		Decoder/amplifiers		STC-7000 preamp/tuner	
Check No. 1 on Reader Service Card		Check No. 45 on Reader Service Card		Check No. 33 on Reader Service Card	
Bozak	21	Midwest Hi-Fi	77	Sony Corp. of America	49
Loudspeaker systems		Wholesale price list		TA-1150 Preamplifier	
Write direct to advertiser		Check No. 24 on Reader Service Card		Check No. 49 on Reader Service Card	
British Industries Corp	3	Panasonic	5	Soundcraftsmen	25
Zero 100 turntable		4 Channel tape deck		Equalizers, loudspeakers	
Check No. 3 on Reader Service Card		Check No. 5 on Reader Service Card		Check No. 25 on Reader Service Card	
Capitol Audio	63	Phase Linear Corp	64	South West Technical Products	74
Magnetic tape		Model 700 amplifier		Power amplifiers	
Check No. 58 on Reader Service Card		Check No. 62 on Reader Service Card		Check No. 20 on Reader Service Card	
Crown International	17	Pickering	15	Southern Sound	79
Professional Studio Equipment		XV-15 Cartridge		Mail order discount	
Check No. 17 on Reader Service Card		Check No. 15 on Reader Service Card		Check No. 20 on Reader Service Card	
Dynaco Inc.	27	Pioneer Electronics Corp.	Cover II,I	Sony/Superscope	61,69
AF-6 AM-FM tuner		High fidelity components		Recording tape	
Write Direct to Advertiser		Write direct to Advertiser		Check No. 63 on Reader Service Card	
Eastman Sound	43	Polygram International	9	TDK Inc.	59
Martin loudspeakers		Boston Symphony Orchestra Records		Magnetic Tape	
Check No. 42 on Reader Service Card		Write direct to advertiser		Check No. 59 on Reader Service Card	
Electro-Voice Inc.	6	Quintessence	65	Tascam Corporation	29
4 x 4 Receiver		High Fidelity Components		Mixing Console	
Check No. 6 on Reader Service Card		Check No. 65 on Reader Service Card		Check No. 28 on Reader Service Card	
Electro-Voice Inc.	41	RadioShack	53	TEAC	7
Condenser microphones		Extension Speakers		Model 3300	
Check No. 41 on Reader Service Card		Check No. 53 on Reader Service Card		Check No. 29 on Reader Service Card	
Epicure Products Inc.	35	Revox Corp.	37	Telex	71
Loudspeaker systems		A77 tape deck		Studio 1 headphones	
Check No. 35 on Reader Service Card		Check No. 37 on Reader Service Card		Check No. 14 on Reader Service Card	
Fairfax Industries Inc.	55	Robins	67	United Audio Products	51
Loudspeaker systems		Sound Enhancers		Dual 1229	
Check No. 55 on Reader Service Card		Write direct to advertiser		Check No. 51 on Reader Service Card	
Frazier Inc.	65	Rogersound	66	United Stereo	79
Capsule & Mark IV speakers		Loudspeaker systems		Mail order	
Check No. 4 on Reader Service Card		Check No. 7 on Reader Service Card		Check No. 9 on Reader Service Card	
Garrard	3	Rotel of America	69	Utah	73
Zero 100 turntable		Model RA-1210		Trusonic JR 200	
Check No. 3 on Reader Service Card		Check No. 12 on Reader Service Card		Check No. 16 on Reader Service Card	
JVC America Inc.	39	Sansui Electronics	11	Wholesale Audio	76
4 Channel receiver		Speaker Systems		Mail order discount	
Check No. 39 on Reader Service Card		Check No. 11 on Reader Service Card		Check No. 27 on Reader Service Card	
KLH Research & Development, Inc.	19				
Component systems					
Check No. 19 on Reader Service Card					

table four—John Lewis, leader
nist; Milt Jackson, vibraharpist;
leath, bass player, and Connie
ummer—and each is a master-
pealing to the listener's mind
of his feet. It's an up trip,
arly for a leisurely Sunday after-
nen there's a quiet drizzle out-
our of the cuts are by group
s (two by Lewis, Jackson);
rs are "What Now My Love"
sty Roses."

HURTWOOD EDGE (A&M,
SP4352) provides a crystal, exciting
sound, and variety. Weisberg, a flutist,
offers basic jazz that gets better each
time he plays and each time you listen.
His flights of fancy start with "Tibetan
Silver," a rip-snorter, as they used to
say, and moves through the Latin
coolness of the title tune (with alter-
nate cookin' spots) to the almost pas-
toral "Another Time" and the foot-
stomper "Our Thing."

They're all hers, with the exception of
Pete Seeger's "Rainbow Race," which
only helps to point up that her own
melodies are more disjointed than not.
The disc, distributed by Famous Music
Corp., is perhaps best summed up by
her lyrics: "I am not a poet, living is
the poem/I am not a singer, I am in
the song . . ."

KREAG CAFFEY (Decca, DL7-5363)
is folk-rock of the old Dylan school.
Lyrics are power-drive, melodies are
tossed in the back seat, and the vocal
treatment is something that reminds you
of a jalopy traveling an unpaved country
road. Caffey, who treats ten of his own
works with abandon, plays acoustic
guitar and harmonica with equal
ability. His voice, a scratchy thing that
sounds like a fingernail on a black-
board, is so horrible he'll probably be
the next superstar, replacing Rod
Stewart.

CLASS CLOWN (Little David, LD
L004) is as funny as his last Atlantic-
distributed outing, "AM & FM,"
though more structured. He's hilarious
when reliving the past, a la Bill Cosby,
especially when he imitates the sounds
kids use to attract attention. Devastat-
ing are his bits about the Catholic
Church (though some will probably
be offended) and religion, and there's
a gig on obscenity that will shake
the pure-hearts from the room.

THE LEGENDARY PROFILE (At-
lantic, SD1623) proves that the Modern
Jazz Quartet is still cerebral, still ex-
quisite. There are six numbers by the



Sound is to the audiophile what salt
is to pepper, diamond's to a girl, or an
oasis to a desert. Each has a most
important relationship. That's why an
audiophile, a real sound expert prefers
TRUSONIC JR-200M's magnificent stu-
dio quality reproduction. Clean, un-
distorted sound from this 12" 3-way
speaker system again demonstrates
the incomparable electronic technol-
ogy of TRUSONIC. THE PRICE? You

can pay twice as much, but you won't find a better studio quality
system. Write TRUSONIC for complete information on JR-200M.

Just a few of JR-200M's impressive engineering features are
12" woofer for distortion-free low frequency bass performance
5" mid-range speaker for clean voice and horn reproduction,
and a horn-loaded dome radiator tweeter for high frequency.
A carefully engineered crossover network, plus individual level
controls to adjust midrange and tweeter sound independently,
are included. Size is: 24" x 15 1/4" x 12" deep. Finish: Hand-
rubbed oil finish, Walnut veneer.

NET \$149.95



TRUSONIC

1100 E. Franklin Street, Huntington, Indiana 46750
West Coast Facility: 4950 Santa Anita Ave.
Temple City, California 91780

HUGE SAVINGS ON FAMOUS BRAND STEREO COMPONENTS

DISCOUNTS

ON NATIONALLY ADVERTISED
TURNTABLES • CARTRIDGES
COMPACTS • RECEIVERS
AMPLIFIERS • TAPE RECORDERS

Wholesale Prices! Audio Warehouse Sales, one of the capitol's largest stereo wholesalers will fill and deliver all your mail orders promptly in factory sealed cartons, at prices that will amaze you.

Write for quote on Famous Brand, Stereo Components. Ask about our Special Policy. We guarantee satisfaction.

AUDIO WAREHOUSE SALES
2024 W. VIRGINIA AVE. N.E.
WASHINGTON, D.C. 20002
(202) 832-1616

Check No. 18 on Reader Service Card

NOTHING FANCY



JUST LOTS OF GOOD CLEAN POWER

Our 75 Watt RMS basic amplifiers are not the most beautiful available, but if it is performance you want and at a very reasonable cost, perhaps you can find a place to hide them. Harmonic distortion is typically less than .05% up to rated output and IM less than 0.1% at any level up to full output.

The circuit features differential inputs, current drive to complementary outputs with complete volt-amp protection. Circle the number on the reader reply card and we will send you a schematic, a copy of the Hirsch Lab. report, and our complete catalog of audio products.

UT-MA Single channel
75 watts \$90.00
UT-M Kit. \$60.00

plus postage & insurance 14 lbs.

SWT SOUTHWEST TECHNICAL PRODUCTS CORPORATION
219 W. Rhapsody, San Antonio, Tex. 78216

Check No. 20 on Reader Service Card

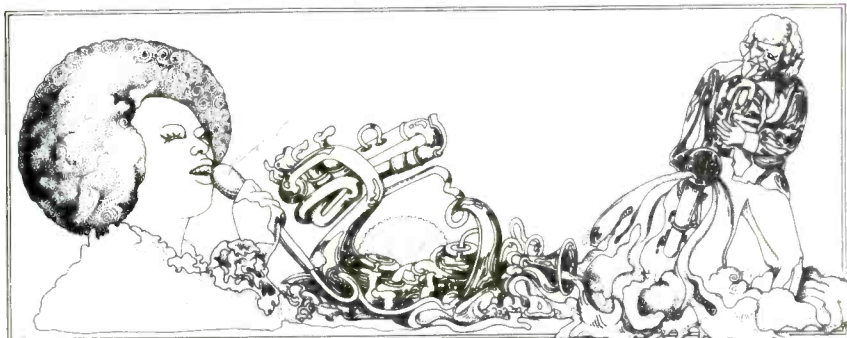

Jazz



Blues

Martha Sanders Gilmore

Barbara Lewis: *The Best of Barbara Lewis.* Atlantic SD 8286, stereo, \$5.98.

Here is a so-so selection of soul by Barbara Lewis in material reminiscent of Bacharach-David, which is admittedly the "now sound of today." The album does move right along, and Barbara fits easily into the genre with an easy singing style and a voice that is cool, liquid, and lilting. The arrangements, although contrived as if to dwarf Miss Lewis' vocal talents, are not half bad, especially in Carole King's "Don't Forget About Me," "I Remember the Feeling," "Stop That Girl," and "Stand By Me." Initially, it all sounded the same, but as I listened I was halfway won over by Miss Lewis together with her vast musical menage. Some pleasingly close harmony was struck in "Hello Stranger," a composition by Miss Lewis which features a male chorus, but Miss Lewis' composition "Puppy Love" is as deplorably cute and squeaky as Teresa Brewer startled by a mouse. The old standard "It's Magic" is done much too close to the mike. The personnel go nameless, and no information is given about Barbara Lewis who I assume Atlantic either expects us to already know or slighted by trying to save pennies on liner notes.

Jean Leccia: *The Jean Leccia Interpolation.*

Musicians: Pat Henderson, lead singer; Jean Leccia, piano; conductor, composer, and arranger; Ed Whiting, lead singer and lyricist, and unidentified orchestra.

Songs: *Good Morning To You; Lady Rain; I Can't Live Without You;*

Love Is; Drop!; Lovelight; Carnival; Lovely Bird; I Worship You; Only A Dream, and Mother Of Us All.

MGM S-4810, stereo, \$5.98.

Webster's definition of *interpolate* is "to polish, dress up, enlarge by putting in new words, subject matter." Such is the essence of jazz. The group here presented does just this in all original material that they composed, arranged, produced, and conducted—a fabulous feat. One Jean Leccia is the amazing young man at the helm who even contributes some funky piano solos along the way.

It is a thoroughly exciting album, ambitious to the end. The music knows no boundaries, fits into no specific groove, and is a fusion of Broadway (*Lady Rain*), soul (*I Can't Live Without You*), rock, (exemplified by some Beatle and B. S. and T touches as in *Drop!*), Bacharach (*I Worship You*), and the wonderfully apocalyptic Jacques Brel (*Mother of Us All*). It is in their cogency of material and musical message-giving that they recall this French master of song. This is music of today!

MGM again does not see to detail personnel of a together orchestra which is bursting with effects and is vitally alive. Leccia conducts his very own sparkling arrangements of symphonic proportions, brilliant, complex, and definitely not Sing Along music. There are tempo changes and the textures are abundant in *Good Morning To You*, a ship-shape opener sung by Pat Henderson and which features a banjo and kazoo in counterpoint in a kind of honky-tonk interlude—an optimistic meeting of the day!

Miss Henderson's voice has a flexible

and ample range and nuances of Dionne Warwick minus her coyness and with more of a tendency to settle upon notes like a bumblebee atop a flower. Miss Henderson also projects very well—some experience on Broadway perhaps? Nothing is told about the performers.

Rain and thunder follow right along, taking us directly into *Lady Rain* in which Ed Whiting speaks his mind vocally. It is a strident, dramatic, rock-based tune that has some nice horn riffs but sadly Whiting doesn't come through the ticket of lush orchestrations. Engineer Jack Hunt should have pulled out the soloists more; it is difficult to discover the singers beneath the orchestra. And the exhaustive arrangements sometimes appear cluttered as if by interpolative overkill.

Despite this tendency, Leccia's adventurous material proceeds like an operetta, his vast musical montage superimposed upon an undulating rhythm as in *I Can't Live Without You* and the scintillating *Lovelight*. And it is nice to sniff out a soprano saxophone in *Carnival*, but again, must the instrumentalists go nameless?

Mother of Us All is heavy, hymnal, and most ambitious, Whiting's *piece de resistance* which modulates and builds beautifully.

The Jean Leccia Interpolation is a group full of spirit and song and should travel far with proper management. They do so much more than is required. Catch their wave!

Sound: B+

Performance: A

Audio Clinic

(Continued from page 5)

set, and the added reverb further improves it . . . at least I like the reverb. The mixer, in turn, plugs into one of the inputs of my Dynaco PAT4 pre-amplifier. I will not carry the matter any further, as it is now commencing to sound like "the ankle bone is connected to the foot bone," etc.

EDITOR'S NOTE: The use of an isolation transformer is indeed an excellent solution to the problem. The television set must, however, never be grounded to a radiator, electrical outlet box, earth ground, etc. Grounding of this sort must be done only when an isolation transformer is used. (I am, of course, assuming that the television receiver in question does not employ a power transformer.)

The impedance at the volume

control of tube-type television receivers is of an extremely high value. It would be difficult, if not impossible, to find a matching transformer which could bridge this audio line without seriously loading it down. Therefore, I suggest that matching transformers be used only in the case of television receivers employing transistorized audio circuitry. The primary impedance of such a matching transformer should be approximately 10 to 20 K ohms; the secondary's impedance may be 10

K ohms. However, this will depend on the application. If the input impedance of the stage driven by the set is 600 ohms, the matching transformer should have a secondary impedance of this value. If the input impedance of the device is high, 100 K or so, the impedance of the transformer can be quite high. 50 K is not unreasonable here. Because the output from solid state audio circuits (TV) is low, the transformer will provide added voltage.



FREE



The World's Largest Consumer Electronics Catalog

The world's Foremost consumer electronics catalog is yours for the asking! Over 25,000 items . . . jam-packed with illustrations and descriptions of the very latest in Hi-Fi, CB, Tape recorders, Radios, Television, Electronic Parts, Technical Publications.

Your Complete Electronics Buying Guide

Electronics For Home, Business, Industry
PLUS The Latest in 4-Channel Stereo!

LAFAYETTE 1973 CATALOG 730

Our 52nd Year

Stores From Coast-to-Coast

**MAIL
THE
COUPON
TODAY**

Lafayette Radio Electronics
P.O. Box 10, Dept. 27013
Syosset, L.I., N.Y. 11791

Send For Your Free Lafayette Catalog Today!

Send me the FREE LAFAYETTE Catalog

27013

Name

Address

City

State

Zip

Classified

Rates: 25¢ per word per insertion for noncommercial advertisements; 50¢ per word for commercial advertisements. Frequency discounts as follows: 2 times, less 15%; 6 times, less 20%; 12 times, less 30%. Closing date is the FIRST of the second month preceding the date of issue. *Payment must accompany all orders under \$10.00.* Use the handy self-addressed, postage paid card at the back of this issue. When replying to AUDIO box number ads, send letters c/o AUDIO, 134 No. 13th St., Phila., Pa. 19107. For more information about classified advertising, circle Reader Service Card # 135.



FOR SALE

FREE 64 PAGE CATALOG offers hundreds of recordings of rare renaissance, baroque and classical music. Some records priced as low as \$1.00 each! All late recordings. In stereo only. Musical Heritage Society, Box 932-AU, New York, N.Y. 10023.

LOUDSPEAKER KITS, complete or cabinet only, original and published designs. Amplifier kits. Factory direct at great savings. Catalog 25¢. R.C.S. Co., P.O. Box 30312, Santa Barbara, Cal. 93105.

ACOUSTIC SUSPENSION SPEAKER KITS. Build your own. Save 10¢. AudioCessories, 320 W. Edmonston Rockville, Maryland 20352.

TEST FREE COMPARISONS

Comparisons by Pittsburgh's Audio experts of over 100 speakers, receivers, changers, and cartridges included in the most informative catalog of its kind. Complete with lowest wholesale prices.

Wholesale Audio Inc
3916 SAW MILL RUN BLVD., D-2
PITTS., PA. 25527 (412) 884-8797

Check No. 27 on Reader Service Card

FREE 4-TRACK Stereo Tapes, 8-Track Cartridge, Cassette Write Music, Box 27815, Los Angeles, Calif. 90027.

WORLD'S LARGEST, DEEPEST, MOST POWERFUL SUB WOOFER SYSTEM can be had only at Music and Sound Ltd., 11½ Old York Road, Willow Grove, Pa. 19090. 215-659-9251. From \$1,000.

iiOUR RABCO SL-8E SOUNDS BETTER THAN YOUR SL-8E!! For \$100 we'll convert "yours" to "ours". Professional Products Div., Music and Sound Ltd., 11½ Old York Road, Willow Grove, Pa. 19090. 215-659-9251. Dealer inquiries invited.

BUY DIRECT FROM ENGLAND'S HI-FI MAIL ORDER SPECIALISTS! Save on SME, Leak, Goldring, Decca, Tandberg, Revox, Gold Speakers, Garrard, Wharfedale, KEF, Celestion, Transcriptors, Cambridge etc. Insured shipping quotes free or send \$2.00 bills for catalog (\$4.00 air post) credited on first purchase over \$100. Goodwin Ltd. 7 Broadway, Woodgreen, London N22. Visitors welcome to showrooms.

FOR SALE

ENGLAND'S LEADING MAIL ORDER AND DISCOUNT SPECIALIST OFFER.—SME RADFORD QUAD TANNOY B & W TEAC KEF DUAL-SANSUI AT VERY COMPETITIVE PRICE. PLEASE SEND FOR QUOTES REPLY BY AIRMAIL. SHIPPED IMMEDIATELY. FREIGHT COLLECT. SOUTHERN AUDIO SERVICES LTD. 43, HIGH STREET, KINGSTON-ON-THAMES, SURREY.

BASF, MEMOREX, SCOTCH reels, cassettes, 8 tracks. Lowest prices. Satisfaction guaranteed. S&S Audio, Box 523 Skokie Ill. 60076

PROTECT YOUR LPS. Poly sleeves for jackets 5¢ Inner sleeves 4¢ Poly lined paper sleeves 10¢ White Jackets 25¢ Postage \$1.00 House of Records, Hillburn, N.Y. 10931.

KLIPSCH, TANNOY, JBL, MARANTZ, THORNS, RABCO. No discounting. Superior Sound, 2780 Erie Boulevard East, Syracuse, New York 13224.

NAB HUD ADAPTERS—Fit Revox, Crown, TEAC, Roberts. \$3/pair postpaid. No C.O.D. Quantity prices available. John Kountz, 1065 Van Dyke Dr., Laguna Beach, Calif. 92651.

AMPEX PRO TAPE by the carton. Send for prices. BKM Associates, Box 22 Wilmington, Mass. 01887.

INFINITY AND CROWN SYSTEMS—Aurelinear speakers. AKG microphones. UREI limiting. Fairchild equipment. RABCO, Decca Mark V. All laboratory tested. Barclay 503 Haverford Ave. Narbeth, Pa. (215) 667-3048.

ON DEMONSTRATION—Trans-static electrostatic transmissionline monitors, Super Quad speaker system. Audio Research Corp. D-75 amplifier. Phase Linear 700 and 400 amplifiers. Sound System International arm-turntable combination. Paul Heath, 81 Big Tree St., Livonia, N.Y., 14487 (716) 346-5630.

RARE STAMPS! 101 Old United States 1861-1935 \$1.50 Approvals J. Cuddihy, 80 Lexington Ave., Jersey City, New Jersey 07304.

SCOTCH RECORDING TAPE, lowest prices, TAPE CENTER, Box 4305B, Washington, D.C. 20012.

AUDIO RESEARCH, INFINITY, SAE, BRAUN, TRANSCRIPTORS, DECCA, ESS, STAX, QUAD, EPI, and others. THE STEREO SET, 1737 Wisconsin Ave., Washington, D.C. 20007. (202) 338-1493

AUDIO RESEARCH DEMONSTRATION THE STEREO SET
1737 Wisconsin Ave., N.W.
Washington, D.C.

FOR SALE

VISITING WASHINGTON D.C.? THE STEREO SET specializes in the world's finest audio equipment. Relax in one of our 3 sound rooms. 1737 Wisconsin Ave., (202) 338-1493

SCOTCH MAGNETIC TAPE, discount Box 167A, Orwigsburg, Pa.

NEW LOW PRICES ON COMPONENTS: SYSTEMS! SAME DAY QUOTES! FAST LOW-COST GUARANTEED DELIVERY! YOU'LL HEAR MORE FROM REDWOOD STEREO! R.S.C., PO Box 2794, SAN RAFAEL, CA. 94901. (415) 472-2255

FREE Electronics plans and kit catalog. McCord Electronics, Box 41, Sylvania, Ohio 43560.

SAVE AT LEAST 35% on high-quality 8-track stereo tapes with 30 of the top country western songs, or 25 of the top pop songs as listed in Billboard each month. Send for information today: Mildred's Gifts P.O. Box 7253 Portsmouth, Va. 23707

JAPAN HONG KONG DIRECTORY. World products information. \$1.00 today. Sekan Shogyo Annai, Hillyard, Washington 99207.

ii DECCA MK. VII. This is not a misprint. At long last the ultimate cartridge, and guaranteed from Music and Sound Ltd., 11½ Old York Road, Willow Grove, Pa. 19090 215-659-9251

DIAMOND NEEDLES and Stereo Cartridges at Discount prices for Shure, Pickering, Stanton, Empire, Grado and ADC. Send for free catalog. All merchandise brand new and factory sealed. LYLE CARTRIDGES, Dept. A P.O. Box 69, Kensington Station Brooklyn, New York 11218.

BUY IRISH TAPE at discount prices, get Free leaders trailers. Write for catalog and order form. Also ask for pre-recorded specials. Direct Mail Cassette Corp., Box 71, Plainview, N.Y. 11803

THE ONLY ULTRA HIGH POWER HANDLING (400 Wt). ULTRA LOW DISTORTION, HIGHLY RELIABLE, TRULY LINEAR, FULL RANGE ELECTROSTATIC SPEAKER IS THE DAYTON WRIGHT XG-8. FEW PEOPLE ARE READY FOR THEM. TRANSCENDENTAL AUDIO, 1214 WALDEN AVE, BUFFALO, N.Y. 14211, 716-897-3984

CONNECTICUT AREA. Audio research speaker and amps. Dyna-mod kit and transcripator turn tables. The Stereo Lab, 158 State St. New London, Conn. (203) 447-9802.

HI FI FURNITURE? See Toujay Designs at SEE 70, Hi Fi Expo, 443-A, Park Ave., S. NYC, 10016. Tues to Fri 11-5 Sat 11-4. Full line brochure 25¢

FOR SALE

ELECTROENCEPHALOPHONE: brainwave monitor. Professional biofeedback instruments. J&J. 8102-A, Bainbridge, Wash. 98100.

TUBE Headquarters of World! Send 10¢ for Catalog (tubes, semiconductors, equipment Barry 512 Broadway, N.Y.C. 10012.

8 TRACK HOLDER—Compact, attractive walnut finish wood and masonite construction. Holds 48 cartridges. Lazy susan swivel base. 9½" X 9½" X 12½" high. Also available for cassettes. Regular price \$14.95. Now reduced to \$9.95 Postpaid. House of the Swanson, Box 808A, E. Norwich, N.Y. 11732.

FLORIDA AUDIOPHILES! Phase Linear, E.S.S. Transtatic I, Rabco, Klipsch, Bozak, Revox, Marantz, Sony, B&O, Barzilay, Interiors Plus Sound, 3038 N. Federal Hwy. Ft. Lauderdale, Fla., 33306. (305) 566-3511.

B&W 70CA, PHASE LINEAR, THE WORLD'S FINEST SPEAKER AMPLIFIER COMBINATION. JVC 5011 super preamp. Transcripator, EPI Tower, Quad, Electrostatic specialists. Finest, best equipped laboratory in the country. Formerly supplying to professionals only. Now you can benefit from the unique services of THE AUDIO-LAB, 146 French St., New Brunswick, N.J. 08901 (201) 249-9191.

ALPHAPHONE headset—brainwave trainer. Free literature. Aquarius Electronics, Box 627-S, Mendocino, Ca. 95460.

QUAD, Radford, Bang & Olufsen Audio components to superb quality for the connoisseur. Audio Imports, 5557 Versaille Dr., Indianapolis, Ind. 46227.

A.E.A. WILL BUILD to your specifications or ours, any cabinet used for audio. Send plans for quote. **ADVANCED ELECTRO ACOUSTICS** 1610 South Park Avenue Buffalo N.Y. 14220 716-826-5832

E.R.A. PERFECTIONIST TURNTABLES* Phase linear* Quad* Hartley* C.M. Janszen* B&O* Tannoy* Acoustical* Hadcock* Grace* Hopkins* Decca* Hegeman. **ADVANCED ELECTRO ACOUSTICS** 1610 South Park Avenue, Buffalo, N.Y. 14220 (716) 826-5832.

WE GIVE CONSULTATION on stereo equipment. Braun, Benjamin, Transcripator, E.S.S., Quad, S.A.E., and many others. Also, classical and English released labels, jazz and rock albums. Mail orders accepted: Flip Side Systems, Inc. 300 W. Market St. Louisville, Ky. 40204 phone (502) 584-3334
P.S. Write to us about our all new record club!

AUDIO RESEARCH, Radford, Phase Linear, Crown, Quad, Stax, Infinity, JBL, Braun, ESS. Information available. Hartley Electronics, 1502 Butternut, Richland, Wa. 99352 (509) 947-5026 after 5 pm weekdays, all days, weekends.

EXCLUSIVELY IN USA "Satin" Moving Coil Cartridges. Impedance matches magnetic input. M14LE (Elliptical) \$99.95. M14LX (Shibbata) \$129.95. Send Check to Michael-Scott Enterprises, Room 24 6056 West Broadway, Minneapolis, Minnesota 55422

NEWATCHICAGO'S AUDIOPHILE: CELESTION, DAYTON-WRIGHT, HARTLEY, and SPENDOR. Visit the store with the largest selection of the world's best loudspeakers. **AUDIOPHILE,** 8 East Erie, Chicago, IL (312) 787-0750.

AMPEX AG500-2 RECORDER. Portable case, 7½-15 IPS, ½ track. Moderate use. \$800 Baker, 1165 Phelps Circle, MTN, Home, Idaho. 83647. (208) 587-5790.

FOR SALE

BOSE 901'S-mint condition, will sacrifice. 219-862-4429 or write Jim at 101 Olive, Wakarusa, Ind., 46573.

PRINTED CIRCUITS in 24 HOURS from magazine page, magic marker layout, etc. Etch & trim \$3. Up, Holes .01 ea. Send for brochures. BECO, Box 686 Salem, Va. 24153

INFINITY SERVO STATICONE. Walnut. \$1,000. (414) 961-0184.

FREE LITERATURE AND QUOTES on Hitachi stereo equipment. Write: Disco Electronics, Inc., P.O. Box 146, Springfield, New Jersey 07081.

REK-O-KUT TURNTABLES and Replacement Parts. Send self-addressed stamped envelope. REK-O-Kut 716 Jersey Ave., Gloucester City, N.J. 08030

WOLLENSAK RECORDERS. Scotch Recording Tapes. Catalog 25¢ Tower, Lafayette Hill, Pa. 10444

RECORDING tape Dozen 2400' reels \$14.00. Dozen 1200' reels 7.00 900' sample 25¢. guaranteed. Mitchell Box 444A, Flushing, N.Y. 11367

FISHER FM 200 B TUNER \$90.00, Acrosound S-1001 Stereo Preamp \$35.00, Presto K-8 Disc Recorder \$85.00. Box #AJAN-3-7.

TELECTRO PROFESSIONAL Tape Recorder Mod. AN/TNH-2B (Government version of Mod.-938) Similar to Ampex 350 series \$475.00 Additional recording amplifier \$125.00. Box #AJAN-3-5.

ROBERTS 450A STEREO TAPE DECK, \$125. BSR TD-10 stereo tape player deck \$50.00. HITACHI TRQ-717 4 track stereo recorder with Level-Matic volume control, built in speakers, amplifiers etc., \$125. Electro-Band solid state Cassette tape recorder. Automatic level control AC/DC with remote control Mic. \$30.00. All machines are in very good condition. P.W. JACKSON, Rt. 9, Box 292—Athens, Ala. 35611

TV & RADIO TUBES 36¢ EA. Free 48 page Color Catalog. Cornell 4215 A University, San Diego, California 92105.

TRANS-STATIC I BY ESS, brand new with full warranty \$5-year, must sell, will take best offer. Steve Metheny, 603 Lyncrest, Lincoln Nebraska, 68510. (402) 589-6236.

8-TRACK TAPES at unbelievable savings. Latest list 25¢. Bob Musial, Box 11907-A, Chicago, Ill. 60611.

AUDIO RESEARCH SP-3 and Pre Amp, used only 3 hours, natural finish, full 5 year warranty. Cost \$595.00, will ship for \$495.00. Charles W. Phillips, P.O. Box 487, Gibsonville, N.C., 27249.

LEARN WHILE ASLEEP, Hypnotize with your recorder phono! Astonishing details strange catalog 10¢. Sleep-Learning Associates, Box 24-AZ, Olympia, Washington.

SEND FOR LATEST STUDIO CLEARANCE sale list featuring microphones tape recorders, equalizers, limiters, turntables, lathes, cutter heads, loudspeakers, mixing consoles, organs, and pianos. Only professional studio equipment listed. Wiegand Audio Laboratories, RD #3, Middlesburg, Pa. 17824 (717) 837-1444.

SAVE IN THE SOUTH! Lowest prices on all leading name brand stereo components. ACT-South Dept. A-2, Box 16777, Memphis, TN 38116.

FOR SALE

VALUABLE RECORDED TAPES lose highs and become progressively noisier each time they are played on equipment that is not thoroughly demagnetized. You can measure damaging magnetic residuals with the Pocket Magnetometer and really demagnetize recorder components with the powerful Han-D-Mag. Now available, complete Audiophile Han-D-Kits including: Magnetometer, Probe, Han-D-Mag, experimental sensors and "Notes". Kit 20/B5 \$29.75, Kit 25/S5 \$51.00, postpaid U.S.A. Literature available. R. B. Annis Company 1103 North Delaware, Indianapolis, Indiana 46202

IMF STUDIO & MONITOR speakers special price on demo pair; Futterman custom hand-crafted amplifiers; special prices on Decca and Goldring cartridges. We trade. Audiocraft, South Rockwood, Michigan 48179. Telephone: (313) 379-9945.

BASS REINFORCEMENT STUDIO SPEAKER. Blueprint and schematic for enclosure and crossover you can build complete for under \$40.00 with drivers. Complete plans for \$1.00 to Audio Research Union, 214 E-26 Ave., Wildwood, N.J. 08260.

IMF STUDIO SPEAKERS, \$500/pair. Tandberg 6000X, \$425. Citation II preamp, \$210. Citation I preamp, \$80. Acrosound output transformers \$10 each. University 312 speakers in walnut cabinets, \$90/pair. Like new equipment, reasonable offers considered.

SONY 854-4 SEL-SYNC New condition. Sacrifice \$1300. Randy Burton Marissa, Ill. 62257

check with the
East-Coast Stereo
Discounters...
...then BUY from

MIDWEST
HI-FI
WHOLESALE

Box 567
Ellsworth Industrial Park
Downers Grove, Ill. 60515
312/852-5885

Write for our new
WHOLESALE price list
& catalog. You'll
be glad you did!

OVER 50 NAME BRANDS
FACTORY - SEALED CARTONS
WHOLESALE PRICES

• SAVE ON TIME
& FREIGHT CHARGES

Check No. 24 on Reader Service Card

FOR SALE

AMPEX MAGNETIC TAPE		RECORDING TAPE RIOT!		Scotch MAGNETIC TAPE	
FACTORY FRESH CHOICE OF SCOTCH #150/203 1800 FT 1 MIL POLYESTER 7 REELS OR AMPEX #611 1200 FT 7 ACETATE QUANTITY					
		1-11	12+	48+	
#150-18	Scotch Polyester 1800 ft.	1.95	1.83	1.75	
#203-18	Scotch Low Noise 1800 ft.	2.65	2.55	2.45	
#611-12	AmpeX Acetate 1200 ft.	1.68	1.50	1.39	
SCOTCH BRAND CASSETTES					
SC-30	1/2 Hr. Extended Range	1.10	1.06	1.01	
SC-30-HE	1/2 Hr. High Energy	1.43	1.39	1.32	
SC-60	1 Hr. Extended Range	1.30	1.26	1.18	
SC-60-HE	1 Hr. High Energy	1.62	1.58	1.49	
SC-90	1 1/2 Hr. Extended Range	1.94	1.90	1.76	
SC-90-HE	1 1/2 Hr. High Energy	2.51	2.47	2.23	
SC-120	2 Hrs. Extended Range	2.52	2.48	2.29	

LARGE VOLUME BUYERS—WRITE FOR QUOTE
ABOVE MAY BE ASSORTED FOR BEST QUANTITY PRICE
SCOTCH MAGNETIC TAPE (USED)
#150 1 MIL POLYESTER 3600 FT ON 10 1/2
IN. FIBERGLASS REELS USED ONCE \$1.99
1800 FT 7 IN REELS 99¢—GUARANTEED
TO PERFORM AS GOOD AS NEW OR MONEY
REFUNDED (BULK NO BOX) USED 10 1/2 IN.
FIBERGLASS REELS (SMALL HOLE) 50¢ NEW
HINGED BOXES 10 1/2 IN 39¢ IN 9¢
ADD 10% TO ABOVE TAPE PRICES FOR
SHIPPING HANDLING—5% OVER \$80.00
EXTRA BOXES, REELS, ETC.—PLEASE IN-
CLUDE FUNDS FOR WEIGHT AND DISTANCE!

SAXITONE TAPE SALES
1776 Columbia Rd. N.W. Washington, D.C. 20009



EVERYTHING ON OPEN REEL! Thousands of prerecorded classical/popular tapes. Latest releases. Discounts. Complete new 96-page catalogue \$1. Barclay-Crocker, Room 333C, 11 Stone Street, NYC 10004

VAN EPS 3-SPEED CUTTING LATHE WITH PRESTO 1-D HEAD \$250.00 INCLUDING SHIPPING. M.D. BERGAN JR., 7022 N. 10th Pl., PHOENIX, AZ. 85020

INFINITY SERVO-STATIK I \$1200 or best offer. 1033 Varsity Court, Mt. View, Ca. 94040. 415/968-8368.

FOR SALE: RECORDING EQUIPMENT. Custom built mixing console, Fairchild reverb units, Ampex 440-2 Recorder, other items; approximately \$10,000.00 value, will sell at great reduction. Write Box 252 Flora, Ill. or Ph 618-662-3521.

MUST SELL MARANTZ 10-B. \$400. SLT-12 Turntable, \$100. Two matched AKG C-12A Studio Condenser Systems orig. \$1000., \$350. All in excellent condition. Derbick, 64 Sands, Staten Is., N.Y. 10304

FOR SALE: H.P. 330-B—\$275.00. H.P. 650-A—\$250.00. H.P. 205-AG—\$175.00. H.P. 206-A—\$200.00. H.P. 150-A with 4. Plug-ins.—\$300.00. Several Tek. Scopes, other instruments. Write: DESIGN CONSULTANTS. Box 67, Richardson, Texas, 75080.

MIRACORD-MODEL 50-H AUTOMATIC TURN-TABLE. Mint condition. Also Ortofon cartridge. John Donmoyer, 2635-Parkway Blvd. Allentown, Penna. 18104.

THE COMPLETE AUDIO RESEARCH SYSTEM ON DEMONSTRATION: including Magneplanar Speakers tri-amped with Audio Research D-51, D-75 and Phase Linear 700 amplifiers; Audio Research SP-3 Pre-amplifier with Audio Research EC-3 Electronic Crossover. Critical Evaluation Invited! Also, Infinity, Quad, Spondor, Thorens, Revox, Rabco and Radford. D S Audio, 410 E. Evergreen Road, Lebanon, Penna. 17042 (717) 273-6314

CONDENSER MICROPHONES in easy to build kits. Free details. Write Electronic Enterprises, 3305 Pestana Way, Livermore, Calif. 94550.

FOR SALE

ESS TRANSTATIC (NEW) SPEAKERS \$975.00 pair; Marantz 120 FM-AM tuner \$280.00; McIntosh 2105 Power amplifier \$500.00; McIntosh MX112 tuner Pre-Amp \$350.00; Bose 901 (Pedestals) \$350.00. (405) 364-6297. Box # AJAN-3-4.

ALTEC LANSING ACOUSTA-VOICETTE. \$625.00. Mac 2105, \$500.00. Mac C-28, \$400.00. 1 Pr KLH 9's, \$600.00. 1 Pr Advent SPKrs, \$175.00. Braun Auto Turntable-changer, \$200.00. (617)-326-8921. F. J. Giovino.

TRANSCRIPTORS SATURN TURNTABLES list 280.00 now 150.00. **STYLUS SCALE 15.00** 8.00. **SWEET ARM 15.00**, 8.00. **STYLUS BRUSH 12.00**, 6.00. **FACTORY SEALED. LESS SHIPPING ALSO LOWTHER SPEAKERS AT GREAT SAVINGS. WHILE THEY LAST. R GOEWEY 33.45 92 Street Apt 5G Jackson Heights, N.Y. 11372**

IMF STUDIOS Mint—\$350 1-203-227-6705

ELEKTRA AMPLIDYNE RESEARCH SE—III. \$75.00. Irving, 36 Coolidge St., Methuen, Mass. 01844.

RCA RECORDING TAPE CLOSEOUT! 1800' Polyester 1 Mil, 7" reel. First quality, white boxed. \$14.95 per 10, \$50.00 Case/40. Send check for prepaid shipment in U.S. Joseph Electronics, 1733 N. Harlem Ave. Chicago, Ill. 60635.

HI-FI ENTHUSIASTS WANTED!! Earn more than just spare money in your spare time. We need campus representatives to sell name brand stereo components at discount prices in your area. High commission, no investment required. Serious inquiries only, please. Contact: Mike Santillo K&L SOUND Services Co. 264 N. Beacon St. Watertown, Mass. 02172

LOWEST DISCOUNT PRICES ANYWHERE on audio equipment. All major brands discounted. Write for quotes: K&L Sound Services, 264 N. Beacon St. Watertown, Mass. 02172.

KARLSON—Fantastic new line of patented advanced technology speaker systems for stereo, p.a., and music now available. Write Karlson Research & Mfg. Corp., W. Hempstead, NY 11552

LIKE-NEW STEREO SYSTEM. Consists of AR receiver, Garrard SL-95 turntable, Empire 999-SEX cartridge, and Rectilinear X speakers, all in beautiful enclosures. Cost over \$1000., will sell for \$375.00. Lincoln, 127 W. 87th St. N.Y.C.

HEATH AR-1500, FACTORY TESTED—Perfect—637-3088.

TANDBERG 6041X. Like New, only \$395.00. Toshiba KT43D Cassette Deck, \$30.00. Box AJAN3-1.

CLOSEOUT SALE!! 8-TRACK STEREO TAPES. Over nine-hundred titles to choose from. ALL ORIGINAL ARTIST. Only \$3.99 ppd. Limited offer only—Hurry!! Send 25¢ today and have a look at our available stock. Moonlit Enterprises TP-2, 120 Eighth St., West Des Moines, IA 50265

McINTOSH "STATE OF THE ART" SYSTEM C-28 Pre-amp MR-77 Tuner 2105 Power Amp Pair of Bose 901 Walnut speakers with microstatic tweeters Dual 1219 with base and shure V-IS II improved cartridge all like new \$1650 takes all shipped PPD Also Phase Linear 400 brand new unregistered \$375. S.N. P.O. Box 1275 N.Y. N.Y. 10022

FOR SALE

THE INVENTORS, ENGINEERS, COLLEGE INSTRUCTORS AND PROFESSIONAL MUSICIANS at Music & Sound Ltd. offer their clients a new standard of technical competence, certain proprietary testing procedures, a mind boggling research laboratory, and a host of the most advanced professional services, including **hand picked** component matching/customization/assembly/alignment, room acoustical design and treatment, calibrated environmental equalization, and the most flexible demonstration facilities anywhere for the distinguished array of products from—Infinity, Crown, Decca, I.M.F., Quad, Rogers, Spondor, B.B.C. Monitors, Stax, E.S.S. Transtatic, J.B.L. Professional, Schoeps, S.S.I., Beyer, Custom Rabco, Gately, Otari, Braun, dozens more **shipped pre-paid insured.** Music & Sound Ltd. 11 1/2 Old York Rd. Willow Grove, Pa. 19090.

SOUND SYNTHESIZER kits imitate nature's background music. Surf \$11.95, Wind \$11.95, Wind Chimes \$16.95, Electronic Songbird \$6.95. Also electronic music accessories, waa-waa, sustain, many more. Catalog free. PAIA Electronics, Box D14359, Oklahoma City, OK 73114.

SOUND SYNTHESIZER kits imitate nature's background music. Surf \$11.95, Wind \$11.95, Wind Chimes \$16.95, Electronic Songbird \$6.95. Also electronic music accessories, waa-waa, sustain, many more. Catalog free. PAIA Electronics, Box D14359, Oklahoma City, OK 73114.

PROTECT YOUR VALUABLES For a fraction of the cost of a burglar alarm system. Our reflectorized label tells the world that your premises are protected by an **ELECTRONIC BURGLAR ALARM SYSTEM** (exact wording not given in ad). 2/\$5.00 to LABEL POB 44017, Dallas, Texas 75234 Satis. Guar.

AUDIO RESEARCH, B&O, BOZAK, BRAUN, CROWN, DECCA, KLIPSON, HARTLEY, PHASE LINEAR, QUAD, RADFORD, REVOX, SAE, SENHEISER MICs, Others. Custom designed and constructed music reproduction systems for homes, musicians, and auditoriums. Each component analyzed and optimized. Demonstration by appointment. Phone or mail consultations. C.M. Santmire, Audio Consultant, 1340 S. 20th St. Lincoln, Nebraska, 68502. (402) 477-8469.

BOSE 901 SPEAKERS and stands \$390.00. Marantz 7T Pre-amp \$195.00. Sony TA-2000 Pre-amp \$195.00. SAE Mark III Power amp. \$500.00. All used equipment in excellent condition. C.M. Santmire, 1340 South 20th St. Lincoln, Nebraska 68502, (402) 477-8469.

SPEAKERS—Acoustically designed and built for 1/4—3/8 cost of factory speaker systems. SAVARD, 600 East Roosevelt, Box 360, Baton Rouge, LA. 70802.

AMPEX FINELINE 44 TAPE DECK. Perfect condition. \$250. John Schott 1053 St. Gregory Cinti Ohio 45202 (513) 421-3733

FOR SALE SHURE MIXERS all in excellent condition, must sell! (2) M67 Promixers \$100.00 ea. (1) M63 Audiomaster \$60.00. (1) M68RM Reverbmixer \$70.00. Ron Shagula, 1627 North 20th, Abilene, Texas 79601

G.R. 1800 B VTVM \$75.00, Ballantine 300 VTVM \$35.00, Ballantine 305 VTVM \$60.00, Ballantine 310A VTVM \$60.00, Analab 1100 Scope w/200 plug-in \$150.00, HP 212A Pulse Generator \$70.00, Panoramic AP-1 Audio Spectrum analyzer \$200.00. Box #AJAN-3-6.

FOR SALE

ARP SYNTHESIZERS, 2600-P, 2500, Odyssey, Mooo-Mini, Hammond B-3, A-100, Wurliizer, Univox, RMI pianos, Leslie, Echoplex, Sony 854-4s, Charles M. Solak, 6 Van Ness Road, Binghamton, New York 13905 607-797-3909

STEREO cartridges, headphones, components, blank and pre-recorded tapes. Wholesale prices in any quantity. Request quotes: SOUNDSCAPE.

BASF/MEMOREX, SCOTCH reels, cassettes, 8-tracks. Lowest prices. Satisfaction guaranteed. S & S Audio, Box 523, Skokie, Ill. 60076.

CUSTOM LOADED C-60 CASSETTES WITH BASF-Low Noise tape \$1.25 each-12 for \$13.00 postpaid. Low Noise Calendared C-70, C-90 and C-100 also available. MJS Sound, 1010 Clyde Ave. #2 Santa Clara, Calif. 95050

+ **STEREO PLUS**. The store owned by engineers. All items lab tested, data supplied, response curves, graphs. Best makes, keen prices. Unique loudspeaker try before your buy plan. Free advice by experts. Stereo Plus, Parkway Center South High St., West Chester, Penna. 19380.

AUDIO RESEARCH, Magneplanar, Crown, McIntosh, Thorens, Decca, Stax, Revox on display. Free List used equipment. Stereo Shop, 107 3rd Ave SE, Cedar Rapids, Iowa 52401 (319) 365-1324

DAYTON WRIGHT QUINTESSANCE, SEQUERRA \$1600.00 TUNER, Braun, B&W Ltd., IMF., Quad, E.P.I., Infinity, Crown, B&O, ERA, E.S.S., Stax, Celestion, Phase Linear, Decca, Satin, Transcriptors, Hegeman, Radford, A.K.G., Panasonic Professional, Revox, Tascam, DBX, Rabco, Connoisseur, PE, Spondor JBL Professional. **TRANSCENDENTAL AUDIO, 1214 WALDEN AVE. BUFFALO, N.Y. 14211. (716) 897-3984.**

"YOU'VE NEVER SEEN LOWER PRICES, until you've seen ours" Send Quotes to **ULTIMATE DISCOUNTS NEW HAMPTON, NEW HAMPSHIRE 03256**

TAPE RECORDINGS

RENT 4-TRACK open reel tapes—all major labels, 3,000 different. Free brochure. Stereo-Parti, 55 St. James Drive, Santa Rosa, Cal. 95401

MEMOREX recording tape, audio & video*lowest prices, write for free information **BERGETZ SYSTEMS CO.**, Box 1181, Melrose Park, ILL. 60161.

TAPE—Ampex, BASF, Sony, TDK, Memorex. From 52¢. Catalog 10¢. AudioCessories, 320 W. Edmonston, Rockville, Maryland 20852.

USED Mylar Tapes 1800' 50 reels \$35.00 postpaid. Send check with order. Fremmerman, 4041 Central, Kansas City, Missouri 64111.

CASSETTES—60-minute stereo/monaural rentals (90 days): \$21 Majestic, 9651 Foxbury, Pico Rivera, California.

RENT ANY CASSETTE or Open Reel Pre-recorded tape. All Labels. Catalog 75¢. Tape & Time, 1116 4th Ave., No., Sauk Rapids, Minn. 56379.

SPECIALIZE IN CHINESE TRADITIONAL MUSICS and all kinds of musics on cassette tapes. For catalogs please remit one dollar for postage. Y. K. Lam, G. P. O. Box 14126, Hong Kong

1/2 INCH VIDEO TAPE. \$6.00 PER HOUR on 7" reel. Low headwear 0.9 mil polyester. Free literature. **OREGON MAGNETICS** Box 13374, Portland, Oregon 97213.

RADIO PROGRAMS

RADIO RERUNS, Complete broadcasts. 8¢ stamp for free catalog. Box 724-A, Redmond, Wash. 98052.

OLD RADIO PROGRAMS at low prices yet a large selection. Catalog 50¢. The Best of Radio. P.O. Box 1692, F.D.R. Sta., New York, N.Y. 10022.

OLD RADIO PROGRAMS. CATALOG \$1.00 (refundable). The Radio Vault. Box 9032, Wyoming, Michigan. 49509.

FREE CATALOG. Radio Mysteries. Detective House, 218 Orangeview Lane, Lakeland, Fla. 33803.

MOST AMAZING SHOW ever produced for Radio, Ken Nordine, narrator, network cast. Introductory notes by show's creator-producer. Complete series. 19 Cassettes. Volume One, \$3.98, subsequent releases, 3 for \$10.00 Postpaid. Guaranteed "Incredible, But True!" Sawyer, Michigan 49125.

RADIO MEMORIES. All of your favorites in reel or cassette. Mystery, science fiction, comedy, adventure. Catalog. 50¢ in stamps or coin. (refundable) 1033 Gypsum, Salina, Kansas 67401

OLD RADIO SHOWS big selection. Catalog and sample tape 50¢ Antique Radio 2268 E. 95 Cleveland, Ohio 44106

RADIO MEMORIES. All of your favorites on reel or cassette. Mystery, science fiction, comedy, adventure. Catalog. 50¢ in stamps or coin. (refundable) 1033 Gypsum, Salina, Kansas 67401.

SERVICES

DON'T PAY the high mail order prices. Thieves Warehouse is coming up to your area. Franchises available. Thieves Warehouse, P.O. Box 8057, Pensacola, Florida 32505.

RENT STEREO TAPES \$1.50 week. Catalog 25¢ Tape Library, Box 8126, Washington, D.C. 20024.

CUSTOM RECORDING SERVICE. Tape and disc Stereo and mono. Live and copies. Editing Masters and pressings. High quality at reasonable rates Joseph Giovanelli, Audio-Tech Laboratories, 2819 Newkirk Ave., Brooklyn, N.Y. IN 9-7134.

LEARN Electronic Organ Servicing at home. All makes including transistors. Experimental kit—trouble-shooting. Accredited NHSC. Free Booklet. Niles Bryant School, 3631 Stockton, Dept. 1D, Sacramento, Calif. 95820.

TRADE STEREO TAPES, \$1.25 each postpaid. Minimum three. Tapetrade. Box 2181, La Jolla, Calif. 92073.

HIGH FIDELITY SPEAKERS REPAIRED
AMPRITE SPEAKERS SERVICE
655 Sixth Avenue, New York 10, N.Y.

RECORDS MADE FROM YOUR TAPES. Also, editing and mastering. Send for free brochure. Nashville Record Productions, Inc., Dept. AM, 204 19th Ave., So., Nashville, Tennessee 37203.

CUSTOM STYLUS and cartridge re-tipping, repairing (Weathers, Ortofon, Edison, Shure, etc.) Box 322A, Tuckahoe, N.Y. 10707. 914-SP 0-1297.

SPEAKERS rebuilt, Hi-Fi foreign instrument amplifier. Speakers 2409 1/2, W. Colorado, Colorado Springs 80904

**We Don't Have Gimmicks
Just Low Prices**

Southern Sound Wholesalers

Every Major Brand

Mail Order Discount Prices
Same Day Service

- Memorex
- Garrard
- Dynaco
- KLH
- Scotch
- Sherwood
- Koss
- ADC
- Acoustic Research
- Harmon Kardon

To Mention a Few!
"Ask For A Quote"

P. O. Box 44
Magnolia, N. J. 08049

Check No. 30 on Reader Service Card

SITUATION WANTED

SERIOUS YOUNG MAN with recent degree in Physics, desires a position in the Audio field. Reply to box A Jan-3-2.

STAMPS

VATICAN Xmas Set (1967) 50c. Approvals Barricks. Box 7154, Detroit, Michigan 48202.

100 DIFFERENT United States 25c. United States and Foreign Approvals included. Sheldron, Box 547P North Miami, Florida 33161.

MISCELLANEOUS

COIN-OPERATED RECORD MAKING RECORDING BOOTH. Brevda, 2732 Florida Ave., Tampa, Fla. 33602.

MUSICAL INSTRUMENTS

FREE CATALOG 30% DISCOUNT Best Names In Musical Instruments. Dial For Music Inc., 90 North Main Street, Spring Valley, New York 10977.

NEW!

STEREO TAPE ACCESSORIES

Everyone Who Owns a Home or Auto Tape Deck Will Need All of These Accessories

HUGE PROFITS FOR YOU—UP TO 600%

NOW, FOR THE FIRST TIME, United Stereo Accessories offers you the tape customer a complete line of accessories for resale. PLUS profit margins so big that you can be a distributor, a jobber, or a retailer. You can sell to local jobbers, or to retail stores or to the consumer—wherever there are people who buy tapes.

Sooner or later if you are dealing in tapes you'll be doing business with us, so why wait?

SAMPLES OF EVERYTHING A box of samples for only \$5.00 PLUS free details, prices, valuable marketing information all sent postpaid! ACT NOW. Send cash or money order and get the ball rolling on this HOT PROPOSITION.

UNITED STEREO ACCESSORIES
P.O. Box 524, COSTA MESA, CA. 92627

Check No. 9 on Reader Service Card

INSTRUCTION & EDUCATION

FREE D.D.—B.D.—M.D.—With Lifetime Ordination. Box 333 PM. Rillton, Pennsylvania 15678.

LEARN RECORDING FROM STUDIO ENGINEERS. Free Literature. Write: NNA, Box 721-E, Rye, New York 10580.

"AUCTIONEERING" Learn at home. Invest a six cent post card for lifetime career. Send name and address to—Auctioneering, Box—3514, San Bernardino Calif. 92413.

BIBLE Degrees—Correspondence—Fundamental Bible. Seminary, P.O. Box 942, Elk City, Oklahoma 73644.

RECORDS

OLDIES—45 RPM. Original hits. Catalog 50¢. C&S Record Sales, Box 197, Wampsville, N.Y. 13163.

CATALOGS. Broadcasts, soundtracks. Personalities of Thirties, Forties. Box 225, New York, N.Y. 10028.

DELETED L.P.'s? Get on my sales list. Vincent Scaparro, 904 Allerton Avenue, Bronx, N.Y. 10469.

COLLECTORS JOURNAL—VALUABLE DATA RECORD MART 12 issues \$3.00—Record Research, 65 Grand Ave., Brooklyn, New York, 11205.

SHOW ALBUMS—Rare. Out of Print LP's. Free large list. Broadway/Hollywood Recordings, Georgetown, Conn. 06829.

SOUNDTRACK RECORD ALBUMS from films, original, rare, free list, Whalon. 2321—N Hill, Redondo Beach, Calif. 90278.

ORIGINAL HIT RECORDINGS. Popular entertainers 1920's, 1930's, 1940's New LP's. Low Prices. Fast Reply. DIBS-AD Box 388 San Pedro, Calif. 90733

SOUNDTRACKS, magnificent selection. Lynn Hunt, 8890 Country Club, Spring Valley, Calif. 92077.

SOUNDTRACKS, very extensive list, Joseph Manning, Main St., Woodbury, Conn.

RARE FACTORY-SEALED SOUNDTRACKS. Free List. The Record Keeper, Box 7342, Miami, Fla. 33155

CLASSICAL LP'S, Buy-Sell. Midwest Classical Record exchange. Box 10997, Midwest City, Okla. 73110

SOUNDTRACKS. Swap-sell, write "Miller", Box 2993, Pompano, Florida 33060.

EQUIPMENT WANTED

CASH FOR YOUR unwanted LP's and pre-recorded tapes. Record House, Hillburn, New York 10931.

WANTED—Mint condition AMPEX 351-2 or 350 converted to 2 Track stereo w/or w/out modifications. Reply to Box #AA2-1.

WANTED MARANTZ MODEL 1 PRE-AMPS and Marantz model 9 amps. State Sr. no., condition and price. Reed G. Hinton, 3001 N. 51st St., Kansas City, Kansas 66104.

WANTED—SONY TTS-3000A turntable. Chuck Dinunzio, 902 W. 18th, Erie, PA 16502.

MARANTZ 9A's or 9B and model 7C preamp must be as new. Also want H.R. Citation tubed components. Randy Cail 538 Little St #5 Marietta, GA. 30060.

BUSINESS OPPORTUNITIES

MAILORDER MONEymAKING KIT. Home Business. Valuable lists, concrete information, detailed steps. Capital unnecessary. Free Details, Pictures. Meadows, Box 327-AUA, Boston 02199.

MAILORDER—Carry no stock. Companies will pack, ship under your label. One-man operation capable of \$10,000—\$20,000 year. Details Free! Distributors, Box 9—M, East Rockaway, New York 11518.

1000% PROFIT Bronzing or Chinakoting Anything. Free Literature. NBC Box C—4—AM. Coral Springs Fla. 33065.

UP YOUR OWN ORGANIZATION! A complete guide on how to start and finance your own business. Free brochure. Entrepreneur Press. Dept. Drawer 2759 Santa Clara, California Dept. B 39 95051.

\$2,000 MONTHLY SPARE TIME FREE DETAILS G & B SALES P.O. BOX 782 DEPT. 102 NIAGARA FALLS ONTARIO CANADA

RADIO STATION FOR SALE: FM, Class "A", Chicago Suburb! Presently not profitable. \$10,000 down necessary. \$105,000 Full Price. 3,000 Watts ERP. (415) 751-1974 or Box AD2-2.

MAILORDER MILLIONAIRE helps beginners make \$500 weekly. Free report reveals secret plan! Executive 1Q1 333 North Michigan, Chicago 60601

GOVERNMENT SURPLUS

JEEPS Typically From \$53.90 . . . Trucks From \$78.40 . . . Boats, Typewriters, Knives, Airplanes, Clothing, Multimeters, Oscilloscopes, Transceivers, Photographic, Electronics Equipment. Wide Variety. Condition 100,000 Bid Bargains Direct from Government Nationwide Complete Sales Directory and Surplus Categories Catalog \$1.00 (Deductible On Orders From Separate Included Catalog). Surplus Service, Box 820-AUD, Holland, Michigan 49423.

HELP WANTED

ELECTRONICS/AVONICS Employment opportunities. Report on jobs now open. FREE details. Aviation Employment Information Service Dept. A, Box 240, Northport, N.Y. 11768.

SERIOUS RECORDISTS to make and distribute records for major companies. We train and equip. Modest investment required. Send resume to Mr. Bloch, 418 N. Main St., Englewood, Ohio 45322.

COLOR SLIDES

ART-EDUCATIONAL-TRAVEL, 50,000 individually sold Samples-Catalog \$1.00 refundable. Visuals D21 440 N.W. 130 Street, Miami, Florida 33168.

TUBES

TUBES receiving, factory boxed, low prices, free price list. Transletronic Inc., 1306 40th Street, Brooklyn, N.Y. 11218. Telephone: 212-633-2800.

PRINTING

1,000 DISTINCTIVE, Gold Stripe Address Labels \$1.00. Specialty Shop, Box 1242A Warren, Michigan 48090.

PUBLISH your book! Join our successful authors: All subjects invited. Send for free appraisal and detailed booklet. Carlton Press (Dept. VRM) 84 Fifth Avenue, New York 10011.

SERVICE TO THE TRADE

MULTI-CHANNEL TAPES Processed from YOUR Mono Records/Tapes. Demo Tape \$1.50. Free Information. R.R. Faulkner Box 26 Redondo Beach, Calif. 90277.

TAPE WORM a professional and unique indexing system. Catalogue your tapes and records along with all pertinent information. Send for FREE sample and literature. Tape Worm P.O. Box 74 Dayton, Ohio 45406.

RAW SPEAKER SPECIALIST. Plans, Components like AR, KLH, Rectilinear. TOBY CORPORATION OF AMERICA; 4620 Camp Bowie, Fort Worth, Texas 76107.

ACOUSTECH AMPLIFIER REPAIR. Original performance or improved specifications. BKM Associates, Box 22, Wilmington, Mass. 01887.

INVENTIONS WANTED

FREE "DIRECTORY OF 500 CORPORATIONS Seeking New Products." For information regarding development, sale, licensing of your patented/unpatented invention. Write: Raymond Lee Organization 230-AM Park Avenue, New York City 10017.

PHOTOGRAPHY

16MM-8MM Movies Sound, Silent. Free catalog. Imperial, 15 Park Row, N.Y.C. 10038

HELP!

Anytime you have a question about your Audio subscription, please include a mailing label to insure prompt service on your inquiry.

CHANGE OF ADDRESS

If you're about to move, please let us know approximately four weeks before the move comes about. Or, if there is anything wrong with your current mailing label, please let us know on this form also. Simply affix your present label here, and carefully print the updated information below.

PLEASE HELP US TO SERVE YOU BETTER

AUDIO MAGAZINE

134 N. 13th Street • Phila., Pa. 19107

Name _____
(Please Print)

Company _____

Address _____

City _____ State _____ Zip _____

AFFIX LABEL HERE

Twelve years — Five major advances



BOSE 901*



BOSE 501*



**CONVENTIONAL
SPEAKER**

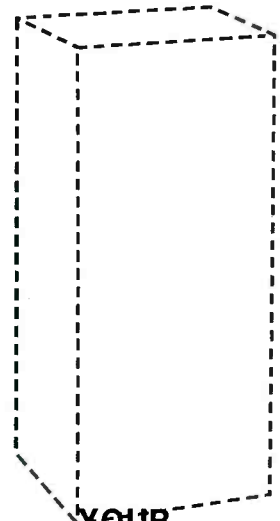

**YOUR
SPEAKER
?**

1	YES	NO	NO	
2	YES	NO	NO	
3	YES	YES	NO	
4	YES	YES	NO	
5	YES	YES	NO	

The twelve years of university research† that led to the design of the BOSE 901 and BOSE 501 DIRECT/REFLECTING® speaker systems revealed five design factors which optimize speaker performance:—

- 1** The use of a multiplicity of acoustically coupled full-range speakers — to provide a clarity and definition of musical instrument sounds that can not, to our knowledge, be obtained with the conventional technology of woofers, tweeters and crossovers.
- 2** The use of active equalization in combination with the multiplicity of full-range speakers — to provide an accuracy of musical timbre that can not, to our knowledge, be achieved with speakers alone.
- 3** The use of an optimum combination of direct and reflected sound — to provide the spatial fullness characteristic of live music.

- 4** The use of flat power response instead of the conventional flat frequency response — to produce the full balance of high frequencies without the shrillness usually associated with Hi-Fi.
- 5** Acoustical coupling to the room — designed quantitatively to take advantage of adjacent wall and floor surfaces to balance the spectrum of radiated sounds.

To appreciate the benefits of these five design factors, simply place the BOSE 901 directly on top of the largest and most expensive speakers your dealer carries and listen to the comparison.

You can hear the difference now.

BOSE®

FRAMINGHAM, MASS. 01701

* Patents issued and applied for

† Copies of the Audio Engineering Society paper, 'ON THE DESIGN, MEASUREMENT AND EVALUATION OF LOUDSPEAKERS', by Dr. A. G. Bose, are available from Bose Corp. for fifty cents.

"It has not been publicized and it is little known to the general public that BOSE Corporation for many years, has been involved in the research and design of the most advanced electronic systems under contracts from NASA, the Department of Transportation and other government agencies. It has long been rumored that BOSE Corporation's top flight team of scientists and engineers has been devoting significant research to consumer electronics. We have it on reliable information that they soon will introduce their first electronic product to the consumer market—a highly sophisticated power amplifier."

Check No. 1 on Reader Service Card

Now Marantz adds full 4-channel to any stereo system.

Got the urge to go 4-channel, but don't want to give up your great stereo system? Well, Marantz ends your dilemma with the new Model 2440 adaptor/amplifier.

Rated at 40 Watts continuous RMS power with less than 0.3% distortion, the Model 2440 converts virtually any stereo receiver to full 4-channel capability.

But that's not all. Marantz components synthesize 4-channel sound from any stereo source (including your stereo records and tapes), decodes any matrix-

encoded 4-channel disc or FM broadcast, and accept optional SQ* matrix decoders and CD-4** demodulators. This Marantz-exclusive decoder feature provides built-in snap-in, snap-out adaptability to any future 4-channel matrix development. So you'll never have to worry about your system becoming obsolete.

The Marantz Model 2440 is another member of the Marantz family of 2 or 4-channel receivers, amplifiers and adaptors starting at just \$149.95. See your Marantz dealer now.

marantz®
We sound better.



OPTIONAL MARANTZ MODEL SQA-1 DECODER (shown) is just one of a variety of optional matrix decoders which snap instantly into *exclusive SQ* decoder pocket* found on all Marantz 4-channel equipment.

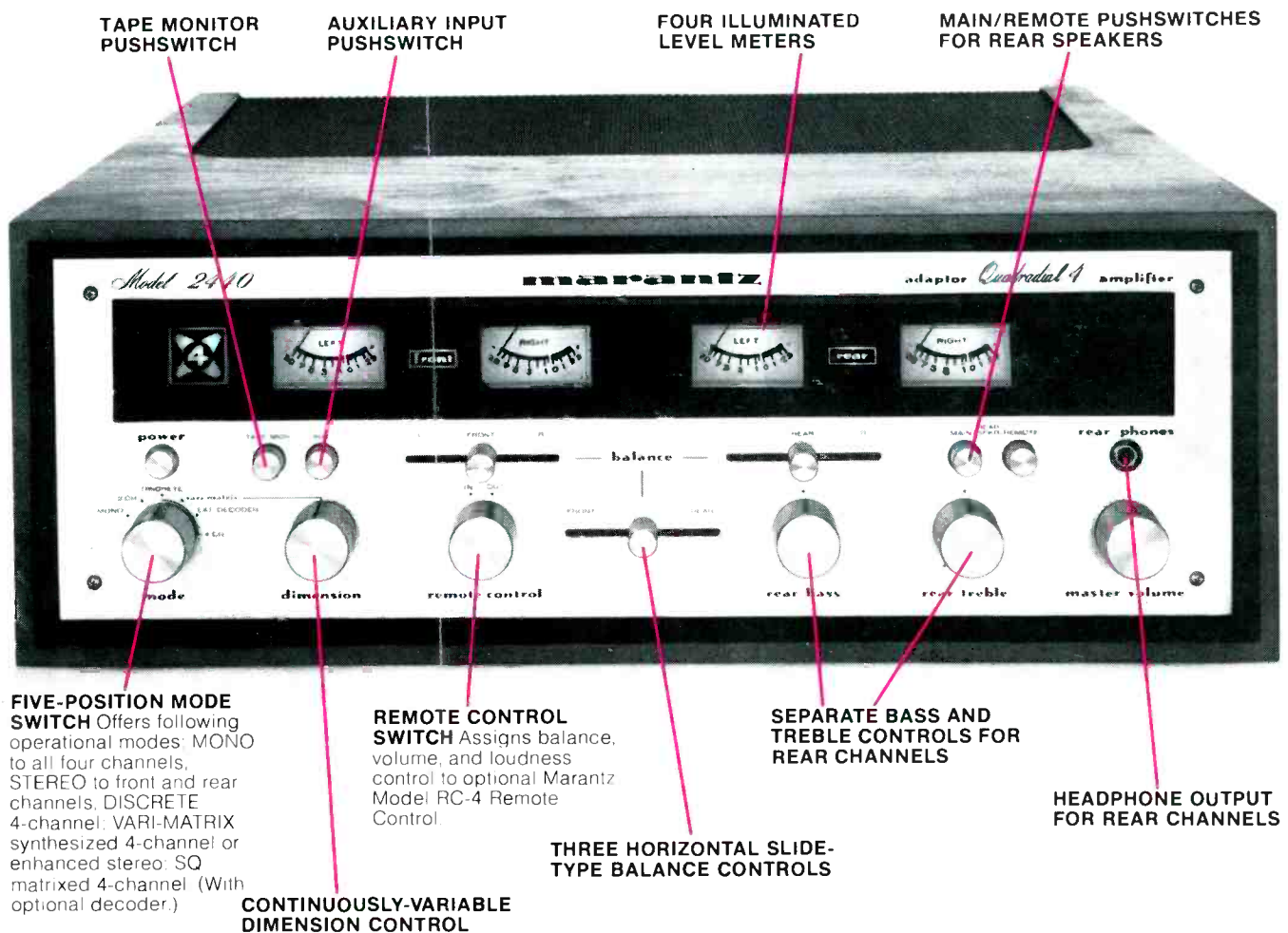

TAPE MONITOR PUSHSWITCH

AUXILIARY INPUT PUSHSWITCH

FOUR ILLUMINATED LEVEL METERS

MAIN/REMOTE PUSHSWITCHES FOR REAR SPEAKERS

FIVE-POSITION MODE SWITCH Offers following operational modes: MONO to all four channels, STEREO to front and rear channels, DISCRETE 4-channel, VARI-MATRIX synthesized 4-channel or enhanced stereo, SQ matrixed 4-channel. (With optional decoder.)

CONTINUOUSLY-VARIABLE DIMENSION CONTROL

REMOTE CONTROL SWITCH Assigns balance, volume, and loudness control to optional Marantz Model RC-4 Remote Control.

THREE HORIZONTAL SLIDE-TYPE BALANCE CONTROLS

SEPARATE BASS AND TREBLE CONTROLS FOR REAR CHANNELS

HEADPHONE OUTPUT FOR REAR CHANNELS

*SQ is a trademark of CRS Labs, Inc.
**CD-4 is a trademark of Victor Co. of Japan.