

The Authoritative Magazine About High Fidelity

# AUDIO

FEBRUARY  
1971

60¢

*phono cartridge directory  
recording in quadraphonics*

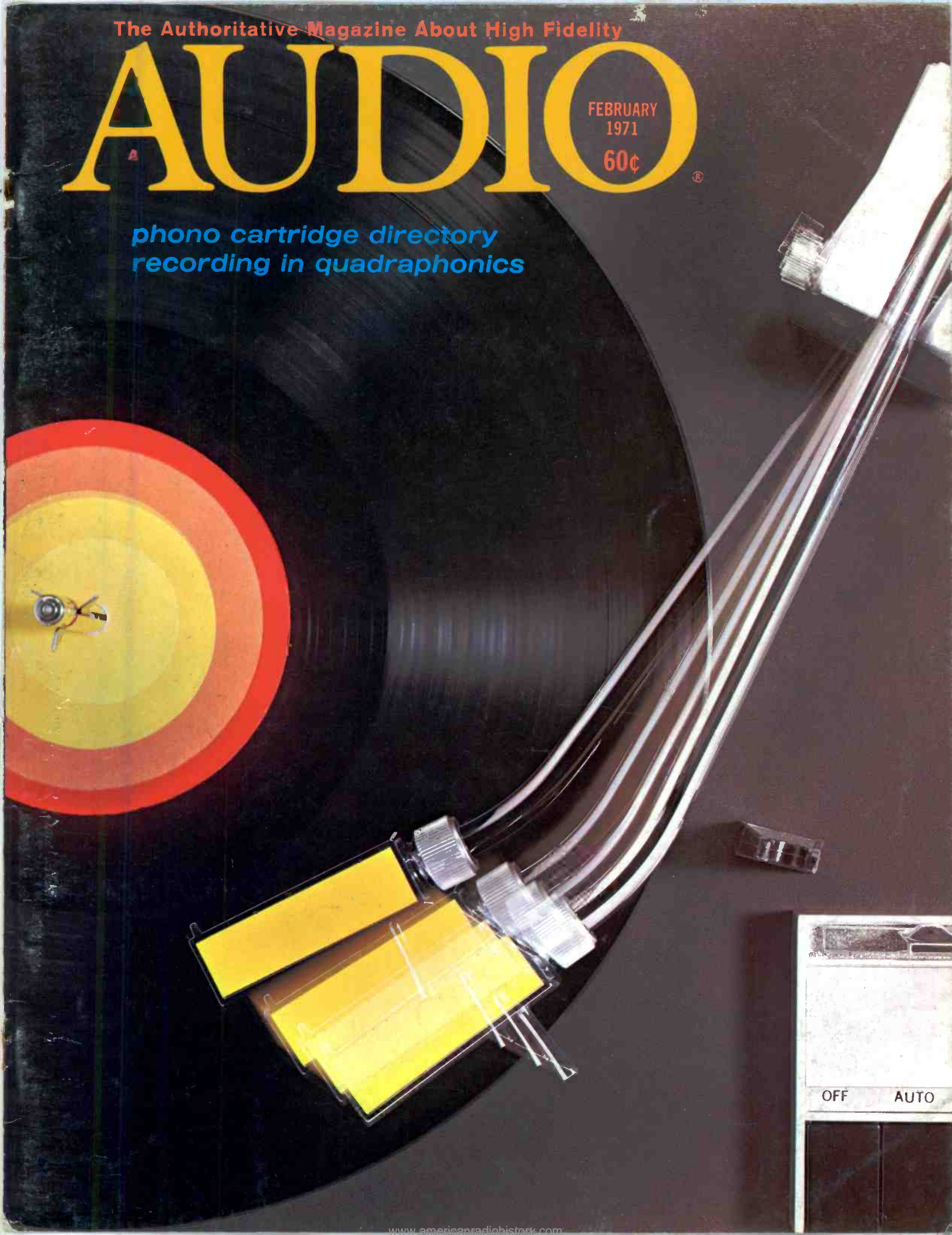

OFF AUTO

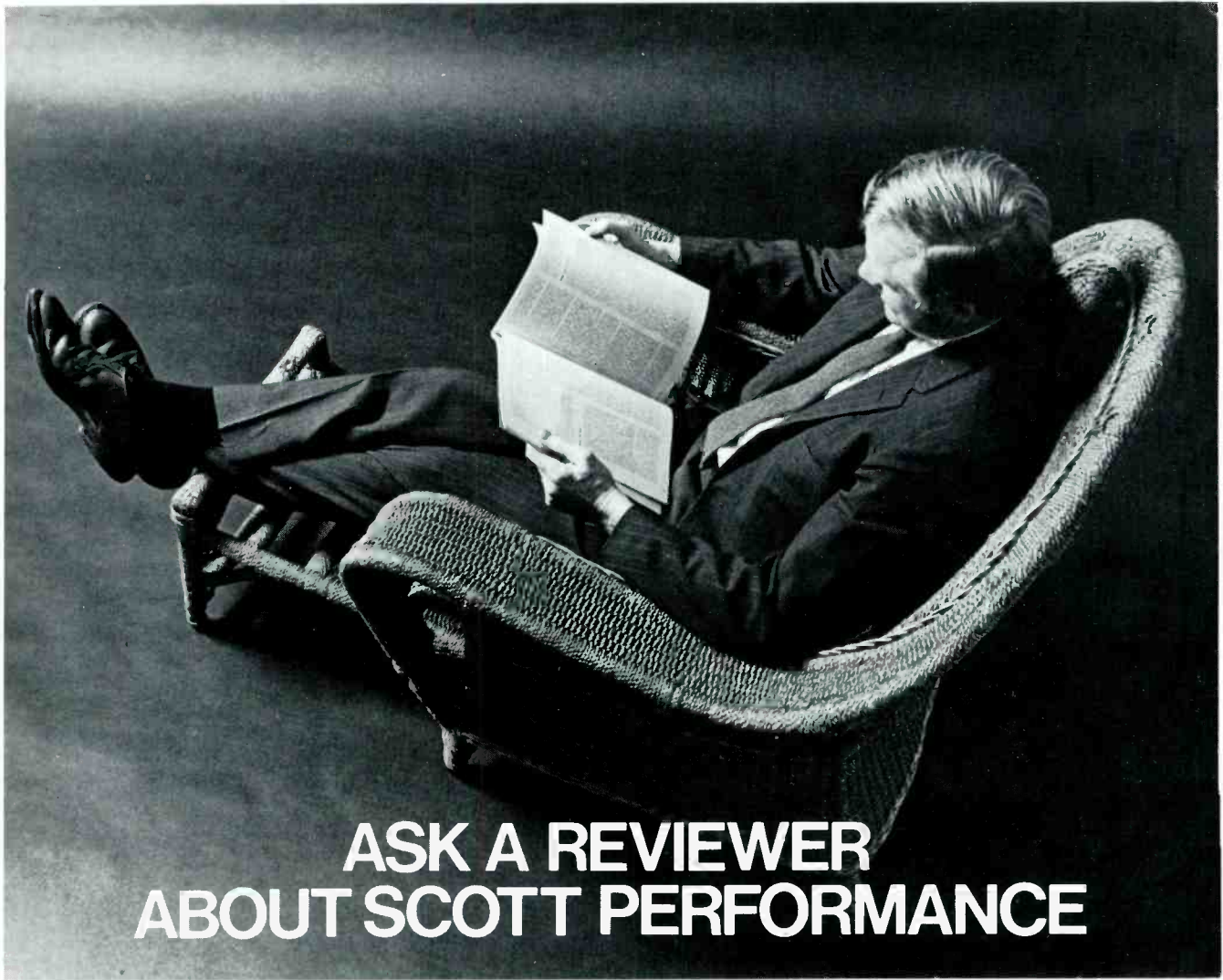

## ASK A REVIEWER ABOUT SCOTT PERFORMANCE

Hirsch-Houck Laboratories put the Scott 382-C 110-Watt AM/FM stereo receiver through its paces for a review in a recent issue of *ELECTRONICS WORLD*. In Hirsch-Houck's own words, here's how the Scott measured up:

"... the Perfectune FM tuning indicator ... is far easier to use and more accurate than a zero-center tuning meter."

"AM ... has a clean, undistorted sound ... easy to listen to."

"The unit proved to be very sensitive, to no one's surprise."

"The FM tuner has an IHF usable sensitivity of 1.8 microvolts, with full limiting at 3 microvolts — one of the steepest limiting curves we have measured to date."

Make your own review ... listen to the modestly priced Scott 382-C at your dealer's. For complete information on Scott stereo components, write:

# **W** SCOTT®

H. H. Scott, Inc., Dept. 010-02, Maynard, Mass. 01754  
Export: Scott International, Maynard, Mass. 01754

# This is the tape deck your components have been saving themselves for.

Right off the top, our RS-736US gives your components an incredible head start. Because its three heads are made of Hot Pressed Ferrite. And Ferrite (pioneered by Panasonic) improves frequency response a fantastic 25%. All by itself!

It also lets us create the world's narrowest, most precise tape-head gap. Which is exactly what makes the high fidelity so high. And it stays high. Because Ferrite heads live more than ten times longer than non-Ferrite ones.

As you might expect, our RS-736US has a top speed of 15 i.p.s. Which is nothing less than broadcast quality. (For flexibility, it also has two other speeds: 3¾ and 7½.)

And the controls are designed to keep everything well under control. You'll find a separate switch for tape and speed equalization. Two large VU meters to let you supervise separate sources (live and electronic). Slide controls. And a monitor switch (for each channel) to let you compare what's inside with what's outside.

To let you know where you're at, there's a cue lever. And for momentary stops, a pause control. A Noise-Free Device takes care of unnatural tape hiss. There's even an automatic adjustment for the tape tension. One sweet lever to control fast forward, rewind, stop, play and pause. And tinted dust cover.

Just like the decks you find in recording studios, the RS-736US lets you record sound on sound. Or sound *with* sound. Or mix music in, up and out. And add echo. And there's more.

200 kHz AC-bias. A signal-to-noise ratio that's better than 53 db. And a frequency response curve of 20 Hz to 30,000 Hz at 15 i.p.s. We even include a chart that gives you the personal frequency response of your particular unit.

Go see the RS-736US at your Panasonic component hi-fi dealer. And hear why this tape deck is the one you (and your components) have been waiting for. Breathlessly.



**PANASONIC**<sup>®</sup>  
just slightly ahead of our time.

Check No. 1 on Reader Service Card

200 Park Avenue, N. Y. 10017. For your nearest Panasonic Hi-Fi dealer, call 800 631-4293. In N. J., 800 962-2803. We pay for the call. Ask about Model RS-736US.

# SHARPE announces another first



**MODEL 770  
STEREOPHONES**

the ultimate in listening  
pleasure . . . now  
*guaranteed* for life

Superior craftsmanship and highest standards of quality control. These ingredients, built into every **SHARPE** model 770 Stereophone are now backed by a lifetime guarantee . . . for a lifetime of listening pleasure.

**SCINTREX** will repair or replace any **SHARPE** model 770 Stereophone which develops a malfunction due to defective workmanship or materials, or from normal wear and usage . . . during the life of the original owner.

#### **SHARPE MODEL 770 STEREOPHONES**

. . . designed for those who appreciate the finest in sound.

- outperform the most advanced speaker systems in undistorted reproduction of the entire sound spectrum.
- drivers are calibrated and matched for identical audio characteristics . . . assure uniform reproduction in both channels.
- actual frequency response tracing accompanies each unit.
- individually fused channels with independent volume control.
- attractive styling in contemporary walnut grain and 24K gold . . . an outstanding addition to the most sophisticated sound system.

Hear for yourself the dramatic difference **SHARPE** brings to listening enjoyment. Visit your authorized

**SHARPE** dealer for a demonstration and all the facts on this unique lifetime guarantee. Use the reader service card for the name of your nearest dealer and a free full-color brochure.

*Say SHARPE for the sound of satisfaction*

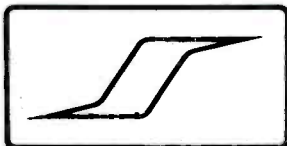

#### **SHARPE AUDIO DIVISION SCINTREX INC.**

390 Creekside Drive, Amherst Industrial Park  
Tonawanda, N. Y. 14150  
Export Agents

**ELPA MARKETING INDUSTRIES INC.**

New Hyde Park, N. Y. 11040

ALSO AVAILABLE IN CANADA

Check No. 2 on Reader Service Card

# AUDIO

Successor to **RADIO**, Est. 1917

FEBRUARY 1971

Vol. 55, No. 2

**George W. Tillett**  
Editor

**Edward Tatnall Canby**  
Associate Editor

**Eugene Pitts**  
Assistant Editor

**Marlyn Rentschler**  
Designer

**Jay Butler**  
Publisher

**Sanford L. Cahn**  
Marketing Director

**Ruth E. Napp**  
Advertising Production

**Jean Davis**  
Subscription Manager

*Contributing Editors*

**Herman Burstein**  
**Leonard Feldman**  
**Richard Freed**  
**Joseph Giovanelli**  
**C. G. McProud**  
**Alexander Rosner**  
**Bertram Stanleigh**  
**S. L. Weingarten**  
**Bert Whyte**

## FEATURE ARTICLES

- 20 Audio Transmission Line Equalization
- 26 Recording in Quadraphonics
- 28 How Many Channels? Part II
- 30 Boris, Igor, and The Dutchman
- 36 Phono Cartridge Survey

**Buck O. Kraft**  
**Ronald M. Klein**  
**Duane H. Cooper**  
**Richard Freed**

## EQUIPMENT REVIEWS

- 44 V-M Automatic Turntable
- 46 TEAC Tape Deck
- 50 Sherwood AM/FM Stereo Receiver

**Model 1555 Synchro-Matic**  
**Model A-7030U**  
**Model S-7100**

## RECORD/TAPE REVIEWS

- 54 Classical
- 58 Canby's Capsules
- 62 Weingarten Looks At . . .

**Edward Tatnall Canby**  
**Edward Tatnall Canby**  
**Sherwood L. Weingarten**

## AUDIO IN GENERAL

- 4 Audioclinic **Joseph Giovanelli**
- 6 What's New
- 8 Tape Guide **Herman Burstein**
- 12 Behind the Scenes
- 16 Editor's Review
- 18 London Letter **Donald Aldous**
- 64 Classified
- 66 Advertising Index

**AUDIO** (title registered U.S. Pat. Off.) is published by North American Publishing Co., I. J. Borowsky, President; Frank Nemeier and Roger Damio, Vice Presidents; R. Kenneth Baxter, Production Director; Nate Rosenblatt, Promotion Director; Mary Claffey, Circulation Director. Subscription rates—U.S. Possessions, Canada, and Mexico, \$5.00 for one year; \$9.00 for two years; all other countries, \$8.00 per year. Printed in U.S.A. at Philadelphia, Pa. All rights reserved. Entire contents copyrighted 1971 by North American Publishing Co. Second class postage paid at Columbus, Ohio.

**REGIONAL SALES OFFICES:** Jay L. Butler and Sanford L. Cahn, 41 East 42nd St., New York, N.Y. 10017; Telephone (212) 687-8924.  
Jay Martin, 15010 Ventura Blvd., Sherman Oaks, Calif. 91403; (213) 981-7852.

**REPRESENTATIVES:** **United Kingdom:** Overseas Newspapers (Agencies) Limited, Cromwell House, Fulwood Place, London, W.C.1./Telephone: 01-242 0661/Cables: WESNEWS London PS4. **Continental Europe:** John Ashcraft, 12 Bear St., Leicester Square, London W.C. 2. England. Tel. 930.0525. For Benelux & Germany: W. J. M. Sanders, Mgr. Herengracht 365, Amsterdam, Holland. Tel. 24.09.08. **Japan:** Japan Printing News Co., Ltd. No. 13, 2 Chome Ginza-Higasi, Chuo-ku Tokyo, Japan. Phone 541-5795



**AUDIO** Editorial and Publishing Offices, 134 N. 13th St., Philadelphia, Pa. 19107  
Postmaster: Send Form 3579 to the above address

Front view

Rear view with decorative panels removed.

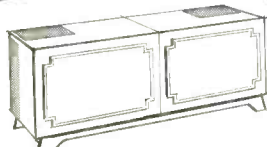
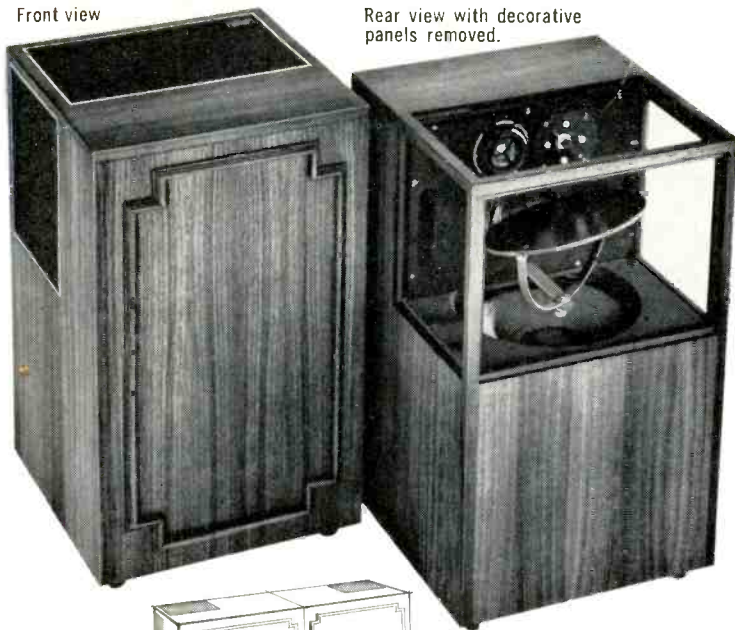

Two W80As on a single optional pedestal.

# The W80A Variflex is different!

Unlike any other speaker system available today, two W80As can be placed anywhere in a room, any distance apart or from a wall . . . even together on an optional pedestal as a single-cabinet console . . . and still preserve stereo perception and original tonal balance no matter where in the room you are listening. Here's why:

1.

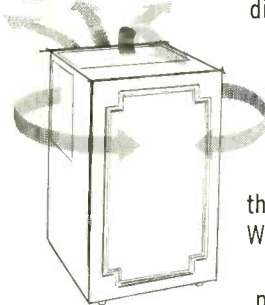

The exclusive variplanular disc inside the cabinet provides a discreet amount of direct frontal energy which is projected from the top of the cabinet; omni-directional energy from the sides and rear of the cabinet; and reflected sound, mostly from the rear and top of the enclosure. The W80A is therefore not just an "omni" or just a "reflecting" a forward-projecting speaker . . . it is all three.

2.

Furthermore, the W80A is a "VARIFLEX", because the variplanular disc is also adjustable. The disc is easily set just once while the system is being installed, without tools or special instruments. There are numerous possibilities, to meet virtually every decor or physical requirement.



For example, setting the discs out-board widens the stereo sound, if you need to keep the two W80As close together.



Setting the discs toe-in prevents the hole-in-center problem, if the room requires placing the two W80As far apart.

3.

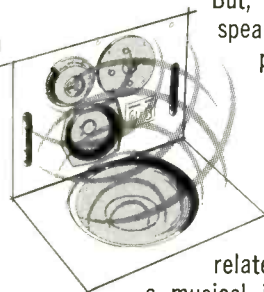

But, unlike most other multi-speaker systems, the bass reproducer does not splatter its sound downward onto the floor, and the mid and treble speakers do not project in other directions. In the W80A, the fundamental tones and related harmonics, which give a musical instrument its identifying timbre and natural, realistic qualities, are reconstituted within a "mixing chamber" which contains the variplanular disc, so that the sounds of musical instruments enter the room as a whole, retaining tonal balance and further abetting stereo perception.

4.

So startlingly effective is the combination of the mixing chamber and its adjustable variplanular disc, that you can freely walk about the room, even sit directly in front of one speaker, and you'll always hear both stereo channels. The music, always stereo, will literally follow you!

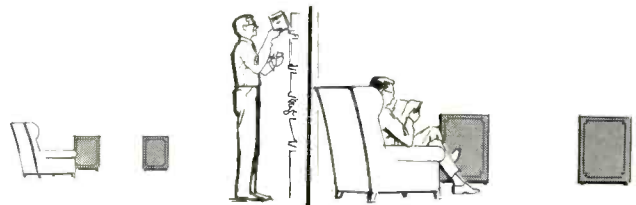

The W80A VARIFLEX is a decorator's dream, and happily, practical in cost. At \$317.60 list each, it is more than a match for old fashioned speakers that are a lot bigger (the W80A is only 28" x 17 1/4" x 17" deep) and much more expensive.

For a complete catalog, write to Wharfedale Division, British Industries Co., Dept. HA-21 Westbury, N.Y. 11590.

## Wharfedale

VARIFLEX SPEAKER SYSTEM

Check No. 3 on Reader Service Card

## Coming in March

**Special loudspeaker number—  
Directory of Loudspeaker  
systems.**

**Loudspeaker Design**—Victor  
Brociner looks at some of the  
problems.

**Equipment Profiles include:**  
Tandberg Model 600 tape  
recorder



Marantz Model 19 deluxe  
receiver

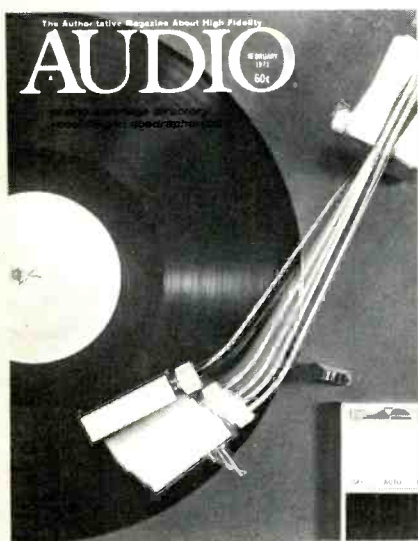

**About the cover:** This shows a modern record-changer as it would probably look in a discotheque! First changer came on the market in the late 1930's and was extremely complicated weighing upwards of 70 pounds! Present-day machines are not only streamlined in design but have a performance close to that of semi-professional turntables.

# Audioclinic

JOSEPH GIOVANELLI

## Microphonic Cartridge

*Q. When my tonearm is in its rest position, any time I tap the turntable anywhere on its surface, my speakers reproduce this tapping. What causes this problem?* John Hanley, Woodside, New York.

A. The fact that you hear sound when you tap your phonograph is perfectly normal. Sound vibrations are transmitted from the arm to the cartridge. Something in the cartridge, perhaps the stylus assembly, is microphonic. In other words, something in the cartridge changes its physical shape or position in such a way as to cause a slight voltage to appear at the output of the cartridge, and you hear this output as a "ping." Some cartridges exhibit this tendency more than others. Any cartridge, however, will produce this strange sound if the volume control is turned up far enough.

## Wow and Flutter

*Q. What is "wow and flutter"? I understand that these are important factors in selecting equipment. I gather that "wow" is a change in motor speed in both tape decks and turntables but flutter?* Sgt. Paul Bonney, APO San Francisco, California.

A. "Wow and flutter" refer to speed variations which occur in both turntables and tape recorders. Tape and discs are intended to be driven at a constant speed. It is very difficult to make a piece of equipment drive these media at a constant speed. To the extent that the speed varies, there will be a corresponding variation in musical pitch. If the speed variation is slow, we call it a "wow." If it is fast, we refer to it as a "flutter." Wow and flutter are measured as a percentage of the speed of the equipment. A piece of equipment is considered to have reasonably low wow and flutter if the speed variations are below 0.2 per cent. Some feel that 0.3 per cent is an acceptable amount of wow and flutter. Other experts will say that 0.1 per cent wow and flutter must be attained for high quality sound. When these speed variations are extreme, we have an audible wavering of musical pitch. This is especially noticeable when listening to such instruments as the piano and the clarinet because they produce long, sustained tones. When musical tones are produced in rapid succession, the ear does not hear a particular tone long enough to perceive speed variations.

except in cases of severe wow and flutter.

Wow and flutter are not necessarily present at the same time or in the same piece of equipment. Turntables will have more wow than flutter, while the reverse is true of tape machines.

## Editor's Note

Most of you are supplying stamped, self-addressed envelopes with your requests for information. I very much appreciate this. I handle a tremendous number of letters, and do so without a secretary. You can readily see that the time required to make out return envelopes would be better spent in actually answering letters. Thus, it would speed up my answers to your questions.

Related to this same subject, I realize that readers who reside in countries other than the United States, do not have access to American stamps, and that it is impossible for them to supply a stamped return envelope. However, it would be of great help if the envelope could be supplied, complete with the address to which the letter is to be sent.

I gather that GI's often have a difficult time in obtaining envelopes, especially those in forward positions. I certainly can understand the problem. Don't worry about the envelopes under these circumstances.

I would also appreciate it if you all could put your return address in the body of your letters. This would help in cases where the outside and return envelopes are lost. If any of you have written and have never received an answer, it is because there was no way to forward your letter to you.

I answer every letter received, even when the questions are not suitable for inclusion in this column. However, as some of you know, when a question requires a great deal of study, it sometimes might take a while before it is answered. I regret this very much, and I thank those of you who are now awaiting such answers for your considerable patience. J.G.

If you have a problem or question on audio, write to Mr. Joseph Giovanelli at AUDIO, 134 North Thirteenth Street, Philadelphia, Pa. 19107. All letters are answered. Please enclose a stamped, self-addressed envelope.

**"... (The Dynaco A-25)  
has established a  
new standard of performance  
in uncolored, natural sound."**

THE HI-FI NEWSLETTER (P.O. Box 539, Hialeah, Fla. 33011)

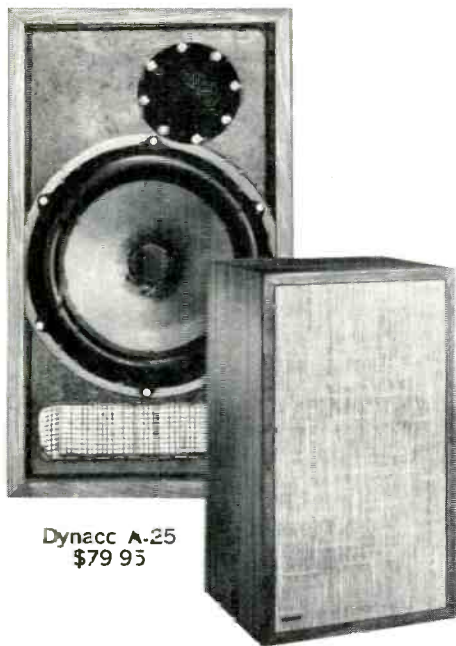

Dynaco A-25  
\$79.95

**"... you'll have a  
hard time buying  
more musical  
naturalness  
at any price."**

THE STEREOPHILE (Box 49, Elwyn, Pa. 19063)

The critiques from these hobbyist magazines have unusual merit as these publications accept **no** advertising. Their comparative evaluations are funded solely by the subscriptions of ardent audiophiles.

The A-25's sound quality is a direct consequence of its smooth frequency response, outstanding transient characteristics, and very low distortion. Its aperiodic design (virtually constant impedance over its range) provides an ideal load so any amplifier can deliver more undistorted power (and thus higher sound

levels) for a given speaker efficiency.

Uniformity of impedance also makes the A-25 the best choice for adding two new speakers to an existing stereo setup using the Dynaco system\* for four-dimensional reproduction. In this way, true "concert hall sound" can be enjoyed with a standard stereo amplifier. Many existing stereo discs, tapes and FM broadcasts already contain this ambience information which, now revealed in the additional loudspeakers, gives far greater realism to your listening.

\*Send for literature or pick some up at your dealer where you can see and hear Dynaco equipment.

**DYNACO INC.**

**3060 JEFFERSON ST., PHILA., PA. 19121**

# THE FIRST CROWN PREAMPLIFIER



IC 150

What would happen to a preamplifier design, if the design engineer could free himself from stereotyped ideas and start fresh with only a list of customers' requests? Well, at CROWN that has just happened, and the result is the IC150, an exciting "new concept" control center with simplified circuitry, controls that are easy to understand and use, several exclusive features, unsurpassed quality, and — to top it all off — a lower price tag.

Crown Engineers discovered that pre-amp switches don't *need* to pop . . . that there is something *better* than the stereo mode switch . . . that the phono preamp *can* be dramatically improved . . . and, that by using IC's, a versatile high-quality, advanced-performance preamplifier *can* be priced to beat inflation.

Of course, the true uniqueness of such an innovative design cannot be appreciated by *reading* about it. The only answer is to experience the IC150 yourself. Let us tell you where Crown's "new concept" is being introduced in your area. Write today for a list of locations.

World's quietest phono preamp  
Infinitely variable stereo panorama control  
Silent switching and automatic muting  
at turn-on and turn-off  
Integrated circuit modules  
Industry's lowest distortion levels  
Full range tone and loudness controls  
Guaranteed phase response  
3-year parts and labor warranty  
Will drive *any* amplifier  
\$239, walnut enclosure \$33



D 150

Ask your dealer also about Crown's new companion D150 power amplifier, which delivers 200 watts IHF output at 8 ohms or 350 watts at 4 ohms. No amp in this power range — however expensive — has better frequency response or lower hum, noise or distortion. It offers performance equal to the famous DC300, but at medium power and price. It's worth listening into!

Exported as  
AMCRON



**Crown**

BOX 1000, ELKHART, INDIANA, 46514, U.S.A.

Check No. 6 on Reader Service Card

# What's New in Audio

## Panasonic Digicorder

This compact-sized unit offers a cassette player/recorder, AM/FM radio and a digital clock. The cassette recorder section has an automatic stop device and an automatic level control in-



put circuit. Other features include a tape monitor system, alarm and 24-hour timer on the radio, AFC on FM, and illuminated clock face.

Check No. 123 on Reader Service Card

## Jensen loudspeakers

A completely redesigned line of Concert Series loudspeakers has been announced by Jensen. The line is keyed to the needs of the distributor and service technician and includes 167 speaker models, one or more of which fits almost any application. Sizes range from 3 in. to 15 in. in the round type and from 2-by-6-in. to 6-by-9-in. in the oval models.

Check No. 122 on Reader Service Card

## Electro-Voice paging projectors



The PA12 and PA12F paging projectors are designed for low cost and high performance where reproduction quality and high intelligibility are demanded in an outdoor speaker. Both feature computer-calculated horn flare, a new design for diaphragm and voice coil assembly, plus an Alnico V magnet. The PA-12 is shown. Prices: PA12, \$27; PA12F, \$33.

Check No. 121 on Reader Service Card

## Sansui Model 8 receiver



This AM/FM stereo receiver combines features of Sansui's AU999 control center/amplifier and the TU999 tuner. The direct-coupled amplifier section produces 180 watts (IHF) power into 4 ohms. Response is said to be 5 to 50,000 Hz  $\pm$  1 dB with less than 0.3% total harmonic and less than 0.4% intermodulation distortion. The FM tuner has 1.7  $\mu$ V (IHF) sensitivity, 1.5 dB capture ratio, and a signal-to-noise ratio of better than 65 dB. Featured are step-switched, dB-calibrated tone controls for bass, mid-range and treble. Price: \$499.95.

Check No. 120 on Reader Service Card

## Harman-Kardon Festival compacts



This line of music systems is available in eight models, each with amplifier, AM/FM tuner, automatic turntable, speakers, and magnetic cartridge. The tuner section features automatic tuning with center-channel locking, and tone controls are provided for bass, mid-range, and treble. The styling is a refreshing departure from conventional presentations. Prices: from \$329.95.

Check No. 119 on Reader Service Card

## Standard SR-A1000S receiver



This solid-state AM/FM stereo receiver offers 20 watts rms per channel with a IHF power bandwidth of 15 to 50k Hz. The FM tuner section is said to have a sensitivity of 2.5  $\mu$ V and a frequency response of 20 to 20,000 Hz  $\pm$  1 dB. Loudness, low filter, muting, mode and AFC are controlled by rocker-type switches. Price \$209.95.

Check No. 118 on Reader Service Card



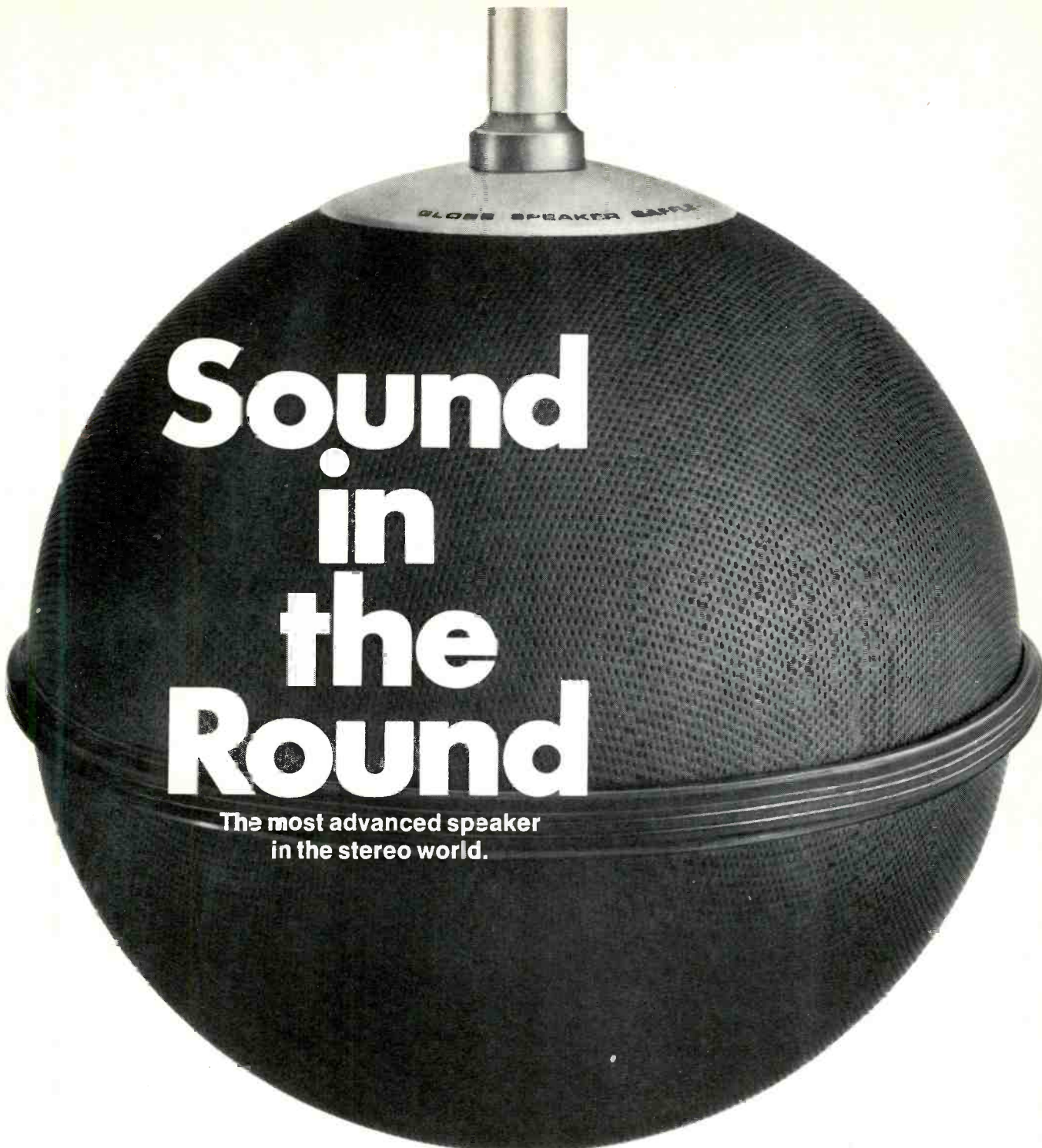

# Sound in the Round

The most advanced speaker  
in the stereo world.



Sleek, black and omni-directional, the 5303 virtually eliminates tight polar patterns on the upper highs. Gives you deep, full timbred bass on the ultra lows. Banishes that bothersome "hole in the middle." Ends nailing your chair down to that one "best" spot common with conventional speakers. Gives you the freedom to roam around your own room, enveloped in rich stereo sound.

The 5303 utilizes four woofers and four horn tweeters. Flawlessly reproduces the 20 to 20,000 Hz

range. Handles up to 80 watts input with ease. Can be mounted on stand (included), or hung from ceiling to give you more living space.

If your tastes are more traditional, then check out JVC's Model 5340. It handles up to 80 watts. Integrates a cellular horn in its powerful 4-way speaker system. There are many other fine speakers in the JVC line. See and hear them at your nearest JVC dealer. He will be proud to demonstrate them, just as you will be proud to own them.



## JVC Catching On Fast

JVC America, Inc., 50-35, 55th Road, Maspeth, New York, N.Y. 11378

Check No. 7 on Reader Service Card

# Tape Guide

HERMAN BURSTEIN

## Condenser Microphones

*Q. I plan to buy a Roberts 400X tape machine, operating at 15 ips. I would appreciate any comments on the quality of this machine, and on its advantages and disadvantages. If condenser microphones are the best, can you please tell me the ones that would operate the best with the above machine.—John Mastronardi, Cortland, N.Y.*

A. The policy of AUDIO prohibits me from commenting on specific items of audio equipment. Therefore I cannot comment on the tape recorder you mention nor suggest specific condenser microphones.

However, I can offer the following general comments. Condenser microphones are considered by many to be the best type available. But also they cost the most. Most audio stores are willing to demonstrate their high-price microphones, enabling you to choose by ear.

If you plan to do live recording, it is a good idea to have a tape recorder that operates at 15 ips, because it will provide a wider dynamic range than one operating at 7½ ips. The reason is that more treble boost is supplied at 7½ ips than at 15 ips; with more treble boost there is more danger of running into tape saturation. When recording material with strong transients, for example guitar music, you are apt to run into the problem of insufficient "headroom."

## VU Meter Calibration

*Q. I have just purchased a tape deck. How do I know if its VU meters are calibrated right? If they are not, what can I do to correct them?—Leroy Mowatt, Bronx, N.Y.*

A. To check calibration of your VU meters, you probably need the assistance of an authorized service agency. The meter should read 0 VU when the machine is fed a 400 Hz signal that produces 1% harmonic distortion on the tape.

## Life of Acetate Tape

*Q. I have heard of acetate tape lasting through 15 years of storage, and I have read of a person who discards acetate tape after three years of use. How long does acetate tape last, and what factors*

*affect its life?—Leroy Mowatt, Bronx, N.Y.*

A. Life span of an acetate tape depends upon the quality of the tape and conditions of storage. A good tape stored under conditions of moderate temperature and humidity can probably last 15 years or more. I have some acetate tapes purposely stored under extremes of heat and humidity (temperatures from about freezing to over 100 degrees and humidity from very damp to very dry), and they still play well after more than 10 years.

## Speed of Head Wear

*Q. I have an Akai M-8 which a friend is letting me use. He purchased the unit in Japan and used it for approximately 20 to 25 hours. No one else has used the recorder. The heads are worn badly enough to make 3¾ ips unacceptable; 7½ ips is all right but could be better. The unit has been used about 50 hours total. What caused the heads to wear so quickly?—George Harris, Chicago, Ill.*

A. If the machine uses pressure pads, the cause might be excessive pad pressure. If the machine relies on tape tension, the cause could be excessive tension. Also, the heads themselves could be at fault. Good heads are made with deep gaps so that they can withstand considerable wear before serious deterioration in performance occurs, and they are made of materials resistant to wear. Cheap heads are not. Still another possibility is the absence of tape lifters to space the tape away from the heads during rapid wind and rewind.

## Sound-on-Sound

*Q. In reading about the Sony 255 tape deck, I noticed that you must purchase a mixer so that the deck can make sound-on-sound recordings. This is a two-head deck, and I thought that in order to have sound-on-sound there must be three heads. Could you explain how the mixer can add sound-on-sound?—Leroy Mowatt, Bronx, N.Y.*

A. To make true sound-on-sound recordings does require three heads in the case of a mono machine. However, in the case of a stereo machine, one channel of the record-playback head can serve for playback, while the other simultaneously serves for recording. It would seem that the role of the mixer

is to combine Signal 1 obtained in playback with the new Signal 2, and feed the combined signal into the tape machine for recording.

## Recording-Only Problem

*Q. Is it possible for a 4-track record-playback head to be defective only during recording and perfectly all right in playback? My problem is exactly that. Playback of 4-track stereo prerecorded tapes as well as my mono tapes (4-track) previously recorded on my machine is all right. But for stereo recording, while the right channel is okay, the output from the left channel is very, very weak. I have tried checking the selector switch and the tubes; thoroughly cleaning both the erase and the record-playback heads, as well as demagnetizing them—and testing with used and virgin tapes of reliable brands.—Rodolfo C. Penserga, Ormoc City, Philippines.*

A. While few things are absolutely impossible, I am strongly disinclined to think that a tape head which operates satisfactorily in playback will not also do so in recording. Your difficulty seems to lie in a defective part in the left recording channel, such as a resistor or capacitor. Possibly this defect prevents bias current from reaching the left channel, or it cuts down the audio drive signal, or both. Low or missing bias current would result in very weak, and very distorted, sound. If the sound is only weak but not distorted, then the problem lies somewhere in the audio portion of the recording circuit. Signal tracing would be necessary to establish in what part of the circuit lies the fault.

## Taping Discs

*Q. I have had problems in taping records, and I do not know what the cause might be. I recently purchased an Angel stereo recording of Don Giovanni and have tried several times to make a tape of this. However, the level of my tape on playback is about half the level of the recording when played through my record player and amplifier. Also, the sound quality of the tape is not nearly equivalent to the records. The output of my phono pickup is stated to be 7.5 mV, and I have put the phono sensitivity switch of my audio amplifier in the maximum*

(Continued on page 10)

TCA-40



TCA-40

**= TCA-40**  
4-track, 4- and 2-channel playback



RA-41

**= TCA-41**  
4-track, 4- and 2-channel playback  
2-channel record



TCA-40

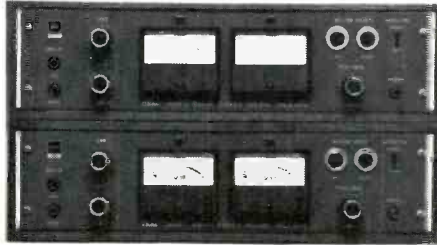

2 RA-41's

**= TCA-42**  
4-track, 4- and 2-channel playback  
4- and 2-channel record

(Mounting cradle and dust cover optional)

# HIGHER MATH

Three decks, three capabilities: the Simul-trak<sup>®</sup> TCA Series from TEAC.

Buy one, add onto it, and you're up to the next model. Keep going till you reach the top. Or start at the top, and get everything going for you at once.

All three units feature 4- and 2-channel playback — the only brand with auto reverse. And Models 40 and 41 can be modified to the full 4-channel capability of Model 42 as shown. Meanwhile, any one of these decks is compatible with your present 2-channel equipment without modification.

Other 4-channel tape decks may look like ours. But they either have only one motor — or they cost a king's ransom. (They don't sound as good, either.)

And any way you add them up, the TCA Series can never be obsolete. You don't even need a slide rule to show you why. Just a good pair of ears.

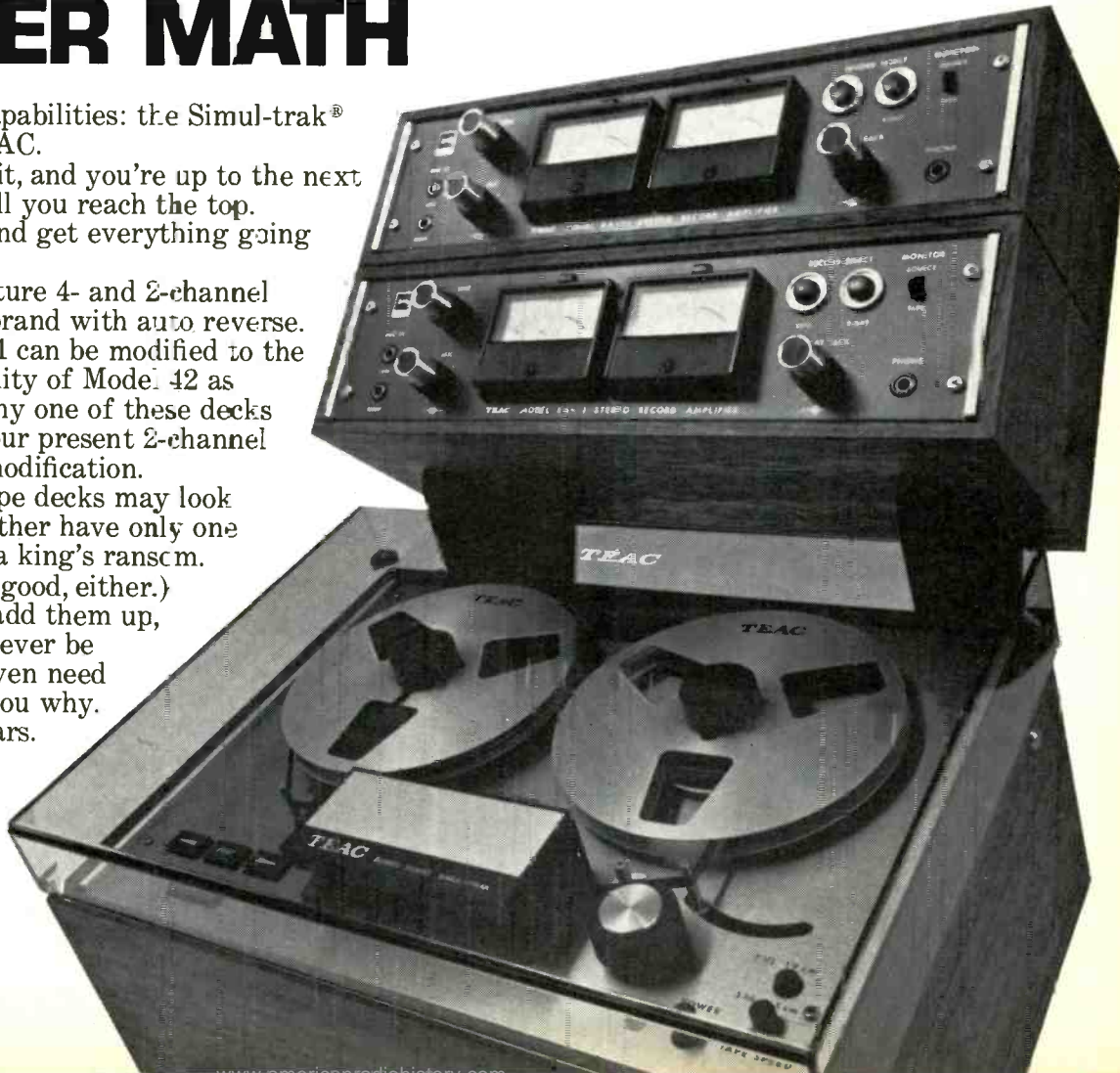

**TEAC**

TEAC Corporation of America  
2000 Colorado Avenue  
Santa Monica, California 90404



Check No. 9 on Reader Service Card

# THE PHASE LINEAR AMPLIFIER



## 700 WATTS R.M.S.

### WHY 700 WATTS?

Among the most stubborn misconceptions common among hi-fi enthusiasts is that forty or fifty watts is sufficient power to drive most speaker systems to their maximum performance. Amplifier manufacturers, however, have understood the advantages of higher power, particularly in driving multiple systems with their high power handling capabilities, or modern, high quality but inefficient air suspension system. Consequently, progress in amplifier design has gradually increased power ratings, but the considerable technical problems involved in producing a reliable and reasonably priced amplifier of ample power have led many audiophiles to believe that what was available must be sufficient.

The benefit of an available 700 watts is not in producing music several times louder than one is accustomed to hearing, rather it is in the elimination of severe distortion caused by amplifier clipping (overload). A one hundred watt amplifier is not capable of producing the sound pressure levels often demanded on any but the most efficient speaker systems, with the result that many audiophiles have confused amplifier clipping with "speaker breakup".

The power output capabilities of previous power amplifiers have been based, not on acoustic requirements, but on electro-economic considerations. It turns out that with today's low efficiency speaker systems, a power input of several thousand watts would be required (dissipation allowing) to produce the sound pressure peaks that occur in live musical performances. Clearly, the larger the amplifier, other things being equal, the more faithful the sound. We find that even the Phase Linear is overloaded from time to time when driving low efficiency speakers with, for example, Stravinsky's *Rite of Spring* at realistic volume levels. These demands led to the development of the Phase Linear... the most powerful, most advanced amplifier that today's silicon power transistor technology could reasonably produce.

#### SPECIFICATIONS:

**POWER:** Greater than 350 watts/channel R.M.S., both channels driven into eight ohms.

**DISTORTION:** Distortion is typically less than .01%.

**DAMPING:** Greater than 1,000 at 20 hz.

**FINISH:** Light brushed gold and black anodize

**PHASE LINEAR CO.**  
19555 23 Ave. N.W.  
Seattle, Wn. 98177  
Phone: (206) 542-6533

ONLY PHASE LINEAR CAN DELIVER THE  
AMPLIFIER THAT CAN DELIVER THE POWER

## Tape Guide

(Continued from page 8 )

position. I have made the tape recording at the highest level according to my VU meters. Am I doing something wrong? Or is it normal to expect the taping of a record through a system such as mine to be inferior to the recording itself? My equipment consists of an Ampex model 2160 tape recorder, a Scott 260B amplifier, a Garrard record player, and Pickering V-1513 cartridge.—Charles B. Baker, Brussels, Belgium.

A. It is quite possible and not unusual for the recording level on tape playback to be less than on phono playback. The factors involved are the output of the particular tape machine used, the output of the phono cartridge employed, and the gain of the phono preamp in the amplifier employed. You need not be overconcerned about the differences in level, provided you get as much level as you desire on tape playback.

The deterioration in sound quality when taping records may be due to the following. First, you are using a pickup with relatively high output. If your amplifier's sensitivity switch is in the position for maximum gain, you may be overloading the phono preamp, with consequent distortion. Second, you state that you have made the tape recordings at the highest level according to the VU meters. Recording at excessive level would have two deleterious results: It would result in distortion, and it would saturate the tape at high frequencies, causing treble loss.

### Cross-Field Heads

*Q. What is the function of the cross-field head?—E. Richmond Bauer, APO 96308*

A. Its purpose is to reduce the erasing effect of bias current on high frequencies when recording, thus leading to better treble response. Bias current is necessary in recording in order to reduce distortion and increase the amount of signal recorded on the tape (i.e. to improve the signal to noise ratio).

### Equalization at Different Speeds

*Q. I would like to ask you a question in reference to extra preamp gain. I happen to own a Fisher X 101-C amplifier. This is a tube amplifier. I also own a Viking 88 stereo tape recorder, and a Viking 807 stereo playback transport without preamps. I do a lot of recording with the Viking 88, off the air and*

*from records. The reason I bought a separate playback deck was to save my other recorder a lot of wear and tear on the heads. The way I see it, wearing out one head is a lot better than wearing out three, and less costly. My Fisher amplifier has a provision for TAPE HEAD and for TAPE PLAY. After I finish making a recording on the Viking 88 and play it back through the stereo system using the TAPE PLAY switch on my amplifier, the results sound great. But if I take that same recording and play it back using the Viking 807, and with the equalization switch of my amplifier in the tape position, I automatically get a bass boost and treble cut. What I'd like to know is what can I do to overcome this problem? The technical specifications of my Fisher state that the TAPE HEAD input requirement is 2 mV at 1 kHz, and the Viking 807 output is 2 mV at 1 kHz. Since these two units are matched up sensitivity-wise, why am I getting bass boost and treble cut? Is there anything I can do to correct this problem?—Artis W. Evans, Jr., Brooklyn, N.Y.*

A. So far as I can see, the input and output sensitivities of your amplifier and Viking 807 have nothing to do with your problem of frequency balance. Inasmuch as your playback deck has no preamp, you are feeding the tape playback head signal directly into your Fisher TAPE HEAD input. Therefore the only equalization supplied is by the Fisher. And this equalization should properly consist of a very substantial amount of bass boost—36 dB in all at 7½ ips. Inasmuch as the bass boost begins at 3,180 Hz (3 dB up at this point), it sounds like a combination of bass boost and treble cut. However, you complain that the net result is *too much* bass boost and treble cut.

One reason for this excess could be that you are operating at 3¾ ips, but using equalization intended for 7½ ips. The required playback equalization for 3¾ ips involves less bass boost and treble cut than at 7½ ips. Another possibility is that either the record head of your Viking 88 or the playback head of your Viking 807 (or both) is out of azimuth alignment, resulting in treble loss. Checking and correcting azimuth alignment requires an azimuth test tape, a VTVM, and the necessary know-how: this is usually best left to a competent technician.

If you have a problem or question on tape recording, write to Mr. Herman Burstein at AUDIO, 134 North Thirteenth Street, Philadelphia, Pa. 19107. All letters are answered. Please enclose a stamped, self-addressed envelope.



# The same precision that guides the automatic pilot of a 747 tunes the Pioneer SX-2500.

Just press the tuning bar and the servomechanism takes over. It stops the dial pointer precisely at the zero point of detector. The result is dead center tuning which you can actually see when the tuning needle lights up. And you can tune from twenty three feet away with the convenient remote control unit which also adjusts the volume.

Rated at 340 watts IHF (72/72 RMS at 8 ohms), Pioneer endowed the SX-2500 with extraordinary versatility. It has five inputs and seven outputs, accommodating two pairs of speaker systems. The FM section alone features five C's and two crystal filters for superb selectivity. Employing three dual gate FET's, sensitivity is a matchless 1.6µV, to pick up even the weakest stations. Or you can flip

the Local Station Switch and decrease the sensitivity to pick up the strongest local stations only. When you're looking for stereo programs, the Stereo Selector Switch automatically tunes in those stations broadcasting in stereo only.

Whatever refinement you're looking for in an AM-FM stereo

receiver, Pioneer has designed into the SX-2500. There are stepped tone controls . . . loudness contour control . . . adjustable muting . . . center channel output for three dimensional systems. Pre and main amplifier may be used independently with multi-amp stereo systems.

**The SX-2500 offers more meaningful features**

And in the same way that the 747 offers more conveniences, the Pioneer SX-2500 offers more meaningful features than any comparably priced stereo receiver.

See and hear the SX-2500 at your local Pioneer dealer. Complete with remote control unit, \$549.95.

Pioneer Electronics U.S.A. Corp.  
178 Commerce Road, Carlstadt,  
New Jersey 07072.

Remote Control Unit



**PIONEER**®



# BEHIND THE SCENES

BERT WHYTE

THE AUDIO industry has always seemed to be particularly plagued by the "chicken and the egg" syndrome. Many examples come to mind, and were it not for the pioneering efforts of some far-sighted individuals who were willing to "go out on a limb," and introduce new (and usually controversial) audio products, we probably would still be playing 78 rpm records with cactus needles. A classic example of the syndrome is the pre-recorded cassette.

Even the most ardent advocate of the cassette system will admit that the major failing of music cassettes has been the intolerably high level of tape hiss. The cassette has other problems, but this factor alone has kept the cassette out of consideration as a medium for high quality recorded music. Tape hiss in professional master recordings had been successfully overcome by use of the Dolby A301 Noise Reduction System. While applicable to the cassette hiss problem, at nearly \$1500 the A301 was hardly a consumer product! Dr. Dolby came to the rescue by introducing the "B Type" noise reduction system, a simplified single-band version of the professional system. To make the Dolby "B Type" system a practical reality in terms of pre-recorded cassettes, one would need a reasonably priced noise reduction unit in the home, which would be used to "expand" in a mirror image, pre-recorded cassettes issued in "compressed" form by the various record companies. In this manner the consumer would get the benefit of the 10 dB reduction of tape hiss afforded by the "B Type" system. At this point we reached the "chicken and egg" problem. To wit: which comes first . . . the noise reduction unit or the specially recorded cassettes? Fortunately the problem was eventually resolved, because the "B Type" system was designed for recording as well as playback, thus allowing a more "saleable" unit. With this as a plus factor, the Advent Corp. made the decision to manufacture a "B Type" record/playback noise reduction unit, which could be used with existing types of consumer tape recorders. As you know, this resulted in the marketing of the Advent Model 100, and a simplified less expensive unit, the Model 101. Having done this, Advent felt there was a market for a cassette recorder with built-in Dolby "B Type" noise reduction system. Thus we have had for some



Advent Model 200



Harman-Kardon CAD5



Fisher RC 80

time the hardware for making Dolby "B Type" recordings and for playback of Dolbyized cassettes. The rub of course was that no such cassettes existed. From the record companies' viewpoint, it was felt that they could not undertake the manufacture of Dolbyized cassettes on a low volume, "specialized product" basis. The alternative was to Dolbyize practically all of their cassette output, which on this mass basis would add little cost in the manufacturing process. The question here was whether such "compressed" cassettes would play satisfactorily on standard equipment without the Dolby noise-reduction circuitry.

After we all agonized about this for some time, Ampex Stereo Tapes, by far the largest manufacturer of pre-recorded cassettes, conducted experiments which proved to their satisfaction that not only could Dolbyized cassettes playback on typical consumer equip-

ment, but that the slight added "brightness" often enhanced the sound. Those who felt the sound was overbright could always turn down their treble controls. On the strength of their experiments, Ampex announced they would be issuing Dolbyized cassettes. Either on their own volition, or spurred by the Ampex announcement, several record companies indicated interest in releasing Dolbyized cassettes. Finally, Vox and London/Decca announced their definite plans to issue Dolbyized cassettes, and other record companies are soon expected to follow suit.

After months of eager anticipation, I now have before me Dolbyized cassettes from Ampex, Vox, and London/Decca. There are only seven cassettes to be sure . . . but I know of at least 15-20 more in the works in the immediate future, and I feel confident that the dam will burst soon and we

(Continued on page 14)



## Fisher has the world's first 4-channel stereo receiver.

### What do you have?

Let's compare what you have and what the Fisher 701 has.

It has 250 watts (62½ per channel). Integrated Darlington output stages.

It has 1.7 microvolts FM sensitivity (IHF). All active elements in front end are IC's.

IF plus multiplex section contains 5 IC's comprising 14 amplifying stages.

It has 2 permanently tuned multipole filters, one with 5 high-Q toroidal resonators. (Alternate channel selectivity is 65 dB!)

Besides flywheel-assisted tuning, it has pushbutton electronic tuning with no moving parts (AutoScan®). And *remote-control* AutoScan is included in the \$699.95 price.

The AM section has 2 permanently tuned multipole filters, one with 5 high-Q toroidal resonators.

It has sliding volume controls that operate as smoothly as studio faders.

And it has a Wide Surround® switch that feeds ordinary stereo signals at a reduced volume (after a slight delay) into the rear speakers, to create a 4-channel effect from 2-channel material.

But, most important of all, the Fisher 701 has 4 independent channels.

Now, how does that stack up against what *you* have?

## The Fisher

We invented high fidelity.



OVERSEAS AND CANADIAN RESIDENTS PLEASE WRITE TO  
FISHER RADIO INTERNATIONAL, LONG ISLAND CITY, N.Y. 11101.  
PRICES SLIGHTLY HIGHER IN THE FAR WEST.

**Only 25¢! \$2 value!**

Send for your copy of The Fisher Handbook, 1971 edition, a fact-filled 80-page guide to high fidelity. This full-color reference book also includes complete information on all Fisher stereo components. Enclose 25¢ for handling and postage.

Fisher Radio, P. O. Box 1367  
Long Island City, N.Y. 11101

Name \_\_\_\_\_

Address \_\_\_\_\_

City \_\_\_\_\_

State \_\_\_\_\_

Zip \_\_\_\_\_

0302711

# here's what Hirsch-Houck laboratories discovered about the model SP-12 cartridge

“ Flat, smooth and gently rising response to between 25,000 and 30,000 Hz, with excellent stereo separation maintained over the full range . . .

The cartridge met or bettered every published specification for which we could test.

Stereo Review  
December, 1970

”

“ B & O emphasizes its use of a diamond mounted directly on the cantilever without an intermediate cup or bushing, which would add undesirable mass to the moving system. Its success is obvious from the outstandingly wide range and flat response of this cartridge . . .

When playing records with the cartridge it is difficult to assign any special character to the sound. This is a logical result of its smooth, wide-range response, which gives it a very neutral quality. This highly desirable property means that the cartridge will reproduce records faithfully, without imposing any of its own characteristics on the sound.

Electronics World  
January, 1971

”

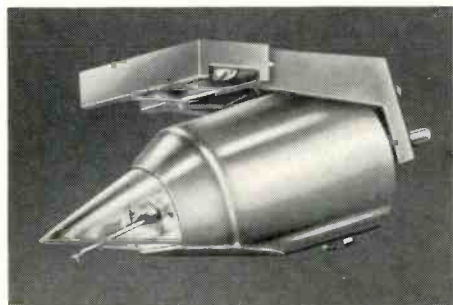

**WHAT MORE CAN WE ADD?  
ASK YOUR DEALER FOR A DEMONSTRATION!**

## Bang & Olufsen of America, Inc.

525 EAST MONTROSE • WOOD DALE, ILLINOIS 60191

Check No. 14 on Reader Service Card

## Behind The Scenes

(Continued from page 12)

will see Dolbyized cassettes from many record companies. To playback these Dolbyized cassettes, I used a Wollensak/3M cassette deck in conjunction with the Advent Model 100 Dolby noise reduction unit.

In order to have some sort of reference when evaluating these cassettes relative to their noise content, I set up a General Radio sound level meter 12 feet from my loudspeakers. I then adjusted my playback levels so that the loudest *peaks* in the music on the cassettes registered 100dB on the meter. At that level, I listened to the pianissimo sections, and especially noted the hiss background whenever there were rests in the music and no sound at all was being produced. Admittedly, this assessment is partially subjective, but I think it works well enough to provide useful information. You may have raised an eyebrow at the figure of 100 dB. Remember this is on peak passages and is by no means average playback level. I wanted to playback the cassettes at what I would call a psychoacoustic equivalent of concert hall level when sitting no further back than about the 20th row of seats. The loudness perception you would get from this level would depend on the size of your listening room. Obviously, if one sets the playback level in a room at an excessively low point, the hiss level you perceive will be lower. The problem with pre-recorded cassettes up to now is that even at comparatively low playback levels, tape hiss was obtrusive.

The first Dolbyized cassettes from Ampex were the operas "Tosca" and "Norma," drawn from the London/Decca catalog. I played "Tosca" first and then "Norma," and in listening to the quiet sections discovered I still could hear some residual hiss. Upon investigating, I found that Ampex had made a merchandising boo-boo. Instead of putting their best foot forward in this new enterprise and drawing from the wealth of Dolby A301 masters in the London catalog, they choose "Tosca" and "Norma," which were made before the Dolby System was in use. This brings up an important point.

You must first understand that when I say I heard some hiss from these operas, it was far below the level that I would have heard if these had been standard non-Dolby cassettes. The improvement was very audible and definitely worthwhile. Now quite obviously, the vast majority of classical recordings in the various catalogs were made prior to the introduction of the



Dolby System. The signal-to-noise ratio of the recorders on which these productions were made, even going back as far as 1958, was on the average about 60-62 dB. This is pretty quiet and would satisfy a lot of people. *If the actual master* and not a "sub" or "working" master several generations removed from the master is processed for Dolby "B Type," the subsequent cassettes in the majority of cases should be quiet enough to warrant their release. Nonetheless, there is no question that the optimum noise reduction in cassettes is going to be those that are processed from Dolby A301 masters.

The Ampex/London "Tosca" in this Dolby cassette release is astonishing for its big, full-bodied sound, generally quite clean. The sound is definitely wide range and of course the dynamic range is quite wide due to the Dolby processing. You won't believe the solidity and weight of the cannon that are so prominent in this opera. Ampex scores high on the mechanical side... the cassette winds smoothly, and it is in only two or three spots that a flute or an oboe has a slightly "burbly" sound due probably to irregularities in the lining of the cassette. While it would have been more desirable if Ampex had released a production made from a Dolby master, the present cassette is very much worthwhile. "Norma" is not nearly as good as "Tosca" in several ways. Tape hiss is a shade more prominent, there are more "burbly" sounds in exposed woodwind sections of the score. The orchestral sound is impressively full. The most glaring fault is a shrillness and stridency to the voices that really grates on one's nerves. It would appear that equalization is off in some respect. It doesn't jibe that the orchestral sound is fairly well balanced, while at the same time the voices appear to be loaded with high frequency distortion.

The London/Decca Dolbized cassettes were sent to me from London and represent somewhat of a departure for this company, in that their cassettes will be distributed through London Records offices in this country. As you are probably aware, all London tape products have been made and distributed in this country by Ampex Stereo Tapes for quite a few years. London/Decca claims there is no conflict of interest in their new distribution venture, that their contract with Ampex will remain in force. Whatever the case, I have listened to Albéniz-Suite Espanola, Vienna Imperial, and Serenade For Strings and Souvenir De Florence by Tchaikovsky, all Dolbized

(Continued on page 60)

# QUAD®

For 20 years and throughout the world the trade mark QUAD has identified the high quality audio equipment made by this Company.

Because others are now seeking to use the name in other ways we have to make it clear that by itself or combined with other words or numerals, QUAD identifies only audio equipment, components and related goods of our manufacture or sponsorship.

All other use of QUAD in connection with such goods is either a misuse, abuse or infringement which must and will be prosecuted.

ACOUSTICAL MANUFACTURING CO. LTD.,  
Huntingdon, England.

Check No. 12 on Reader Service Card

**FREE**

## McIntosh CATALOG and FM DIRECTORY

Get all the newest and latest information on the new McIntosh Solid State equipment in the McIntosh catalog. In addition you will receive an FM station directory that covers all of North America.

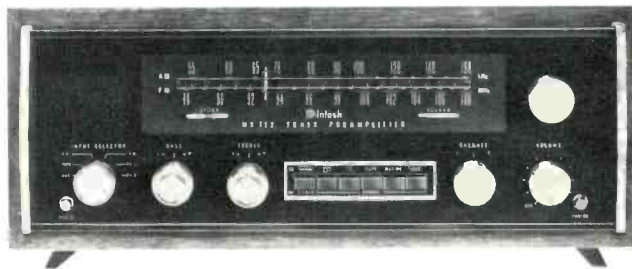

**MX112**  
**FM STEREO/AM TUNER PREAMPLIFIER**  
**— ALL SOLID STATE**

**SEND  
TODAY!**

McIntosh Laboratory Inc.  
2 Chambers St., Dept. AE11  
Binghamton, N.Y. 13903

NAME \_\_\_\_\_

ADDRESS \_\_\_\_\_

CITY \_\_\_\_\_ STATE \_\_\_\_\_ ZIP \_\_\_\_\_

# Editor's Review

---

**T**HE PHONO cartridge directory on page 38 lists some 46 units of which 13 have been selected for capsule reviews which appear on pages 40 through 43. The modern light-weight cartridge is a far cry from the early models used on the old 78 rpm records. One I designed in the mid-thirties weighed no less than 4 ounces and had an adapter for attachment to a tone-arm of an acoustic phonograph: (how many readers remember those xxxx springs?)

Like loudspeakers, phono cartridges have improved enormously over the past few years and like loudspeakers, the best ones tend to sound more and more alike. Just six years ago, John Crabbe, Editor of the British "Hi-Fi News" said "... there are really no pick-ups at present available which will properly track high frequencies on the most heavily modulated stereo discs at playing weights significantly less than about 1½ grams; in fact most require 2 grams or more on the occasional difficult passages. In some cases it is claimed that cartridges will track at ¾ gm or less in high quality arms; it can be stated categorically that this is untrue." Well, things have improved since then and now there are several cartridges available which can track below 1½ gms in a suitable arm. It should be mentioned, however, that too low a tracking weight can cause as much damage to the fine grooves as a heavier weight than necessary, so great care must be taken when setting-up.

## JVC Wins

From the Land of the Cherry Blossom comes news that the Japanese Record Manufacturers Association have decided to adopt the JVC system (described briefly in our November issue) as standard. If only U.S. record companies would get together and evolve a standard too. At the moment, CBS have two viable systems but other companies are experimenting with the Feldman-Fixler, Hafler, and Scheiber methods. Perhaps they are wise in being a little cautious. . . . Meanwhile, my pile of quadrasonic discs gets bigger and bigger—but no decoders. Not even a prototype—infuriating!

## Greek Hybrids

Several erudite readers have suggested that *Tetraphonic* or *Quadrasonic* are more appropriate names for four-channel than quadrasonic, which, they say

with some pain, is a Latin-Greek hybrid. And so it is—just like the word *television* which has been accepted by the pundits for many years! Tetraphonic is a little clumsy and as for quadrasonic, it is not really the logical equivalent of monophonic and stereophonic. Moreover, it conveys the impression of four *sounds* instead of four *sound sources*—an important difference. So, for the time being, we will stick with quadrasonic.

## PLL PLL PLL

Another acronym to plague us! PLL stands for Phase-Locked-Loop and it refers to a new system of FM detection involving a voltage controlled oscillator which is kept in phase with the signal by a phase comparator. The control voltage, or difference signal, is the audio output. A simplified explanation—but it will suffice for the moment.

What are the advantages of PLL? In theory, distortion should be low because it is relatively easy to design an extremely linear oscillator. Secondly, capture ratio could be significantly better because of the locking-in effect. So far, tuners using this system have not come up to expectations but you will hear more about PLL. . . .

## Audio Shows

The Institute of High Fidelity announce a new show to be held later this year in Palo Alto, California. The place selected is the Cabana Hyatt House Motel and the dates are March 29 to April 5. Meanwhile, Teresa Rogers has been very pleased with the response to the forthcoming Washington Show. Three floors were originally reserved but now a fourth floor has been added. The dates are February 12 to the 15th and it will be held in the Hotel Washington at 15th and Pennsylvania Avenue—with in a stone's throw of the White House.

## Humor In Advertising

"For Quadrasonic, you really need two heads (or at least four ears) . . . Two sounds coming from a proper stereo set-up is frightening enough to comprehend, but four different directions is sure to send you to the nearest analyst"—Skyline Electronics (makers of headphones).  
G.W.T.

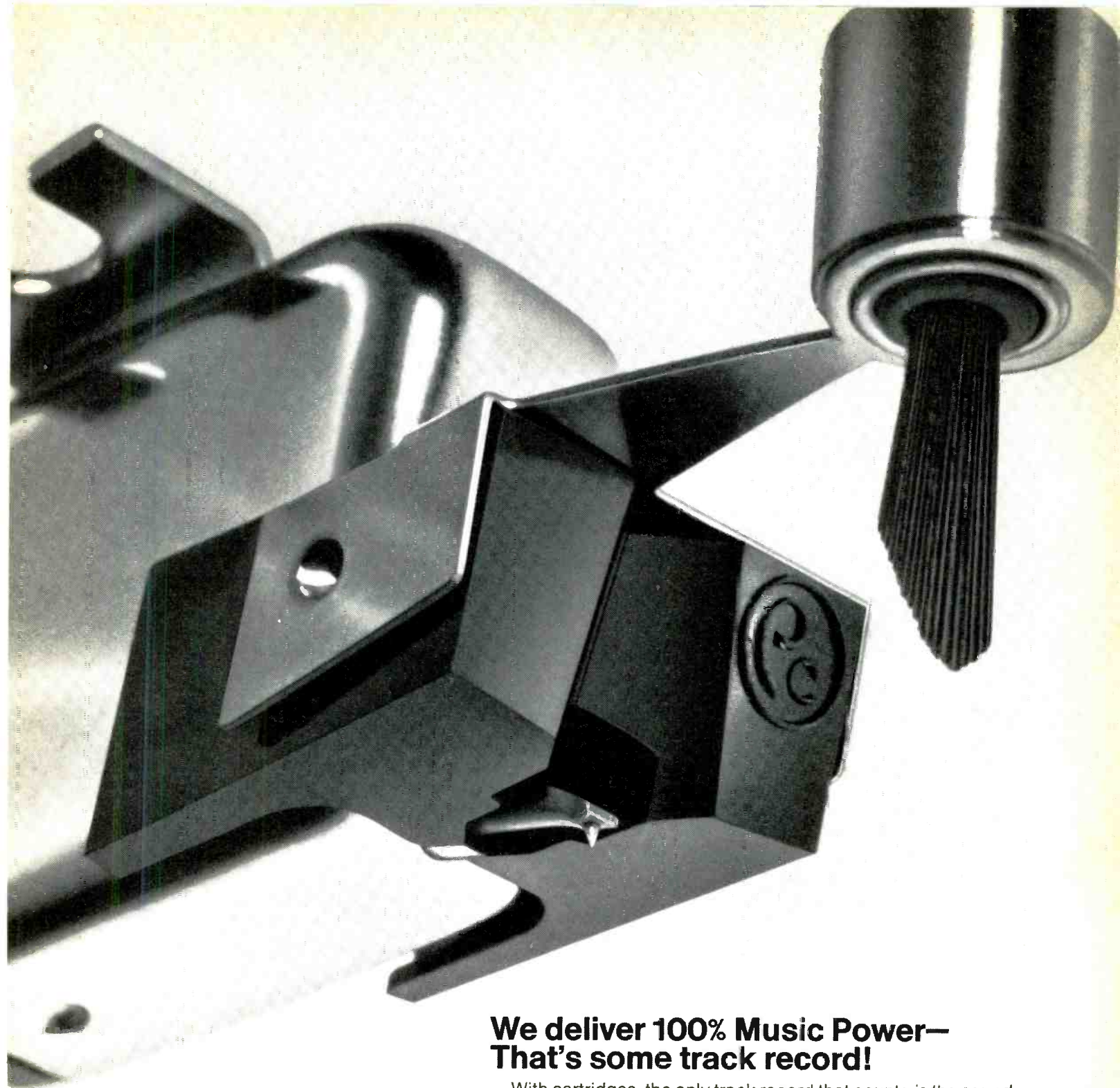

## We deliver 100% Music Power— That's some track record!

With cartridges, the only track record that counts *is the sound*.

To provide great sound, a cartridge should be able to deliver 100% music power, especially at the high frequencies. Just like Pickering XV-15 cartridges do. You will hear the difference! Not an *oboe*, *clarinet* and *flute* but an *oboe*, *clarinet* and *flute*. And gone is that disturbing masking effect over the music. The Pickering XV-15 cartridge produces the 100% music power needed to clearly delineate all of the instruments of the orchestra.

And only Pickering gives every XV-15 model a Dynamic Coupling Factor (DCF) rating to help you select the right one for your record player (just like a horsepower rating serves as a guide to the proper engine for a vehicle).

Improve your high fidelity music system with a Pickering XV-15 cartridge—priced from \$29.95 to \$65.00. For free catalog and DCF rating chart, write Pickering & Co., 101 Sunnyside Blvd., Plainview, N.Y. 11803.

**PICKERING**

"The 100% Music Power Cartridge for those who can hear the difference."



# London Letter



Donald Aldous

INDICATIVE of what has been called an "audio explosion" in England, as well as on the Continent, has been the number of audio fairs, festivals, exhibitions, demonstrations, and company presentations offered during 1970 to the growing hi fi public. Mind you, the technical standards achieved at some of these shows have been amusingly described by one of my colleagues as varying between "the real hi fi, some commercial hi fi, some lo fi, and quite a lot of no fi!" but *sound* entertainment in the home—in one form or another—is certainly on the upgrade. A straw in the wind, however, occurred at the 19th International Tape Recording Contest (CIMES) staged in Geneva last November. The committee and judges were shown some winning *video* entries in a Dutch contest, and the results were so impressive that video is now a new class in the 1971 CIMES. The time limit will be 5 minutes, and entries are not restricted to clubs so that individuals can submit video tapes. A pointer to the future, as use of VTR equipment becomes more widespread in schools and in the home, enthusiasts using the medium must know what type of videotape configuration is acceptable. Incidentally, without wishing to wave the British flag too much, our own Peter Bastin's tape "Not a Word" won the Grand Prix and the special prize for the tape most suitable for broadcasting. Yet another British entry, the documentary "Sunderland Hospital Broadcasts" by Ken McKenzie won the first prize in the reportage class. This tape was earlier judged to be the "Tape of the Year" in the British Amateur Tape Recording Contest, of which I am one of the judges. Thanks to these and other British tapes, the UK scored the highest average marks and so got the cup for "the best

Donald Aldous is a well-known British authority on hi fi. He is Equipment Reviews Editor of the newly combined British magazine *Hi-Fi News/Record Review*.

national selection." Switzerland came next, followed by Norway, Holland, Denmark, France, Germany, Czechoslovakia, Italy, and Belgium. Why were there no American entrants? I must discover if there are any restrictions on USA tape, as surely some fine examples could be submitted.

\* \* \*

Many of you will have an untarnished 1971 diary on hand, and so this would seem to be a good moment to jot down some dates for the English hi fi scene, just in case you can get over to England yourself and sample the 1971 vintage. If you cannot, I'll report the highlights in one of these letters. "Sonex '71," the audio show sponsored by the Federation of British Audio's special company formed for such promotions, will run from Wednesday, March 31 to Sunday, April 4, with the first two days as trade only. The 17th International Audio Fair and Music Festival will again be mounted in the Olympia exhibition hall, London, during mid-October, and the 1970 show features are discussed below. Not strictly hi fi, but worthy of attention by the professional sound engineer is the "Sound '71" exhibition organized by the Association of Public Address Engineers (APAE) from March 16-19, in London. My friend Haydon Warren, APAE Technical Officer, tells me that all stands have been sold and the lecture theme for this year is up-to-the-minute techniques for the sound man!

I don't know whether there is a comparable public address engineering organization in the USA, but the history of the APAE really started with a group of reputable P.A. contractors getting together to form a trade association, led by the late Alex J. Walker, in 1948, when the association was born. Over the years the APAE has expanded its activities and, in addition to its important annual exhibition, publishes a journal, along with other literature,

and helps promote the exports of British PA equipment, now amounting to several million pounds.

The quality of sound (or rather the lack of quality in many instances) in public places, from theatres to open-air entertainments) is a pet hobbyhorse of mine, and I make my critical views known whenever the reproduced sounds fall below an acceptable level. There are no technical reasons today why most-satisfying sound fidelity cannot be offered in any auditorium, but the usual reason for very inferior results is unwillingness to pay for the best. An example of how good such systems can be, to which I can testify personally, is the Shure Vocal Master sound projection system, which offers selective control of volume and vocal effects over six microphone channels, plus anti-feedback switching, and developing 100 watts rms continuous power. It was used most effectively for all of the 20 lecture/recitals presented in the Hi Fi Theatre by John Borwick at the 1970 Audio Fair at Olympia, and a most pleasing reproduction in the huge Royal Opera House auditorium to reinforce the voices of Pierre Boulez and CBS record producer Paul Myers when introducing the first public playback of the CBS record set of Debussy's *Pelléas et Mélisande*. This line-source sound system demonstrated what can be done to keep the "golden ears" happy in such a place!

In the last year, a most-complex sound system, traveling with a group of American university students presenting a show called "Up the People," greatly impressed me when I heard it in two locations in England. On one occasion some 20 microphones were operative on stage without feedback in a highly reverberant enclosure, controlled by a 24-way mixer, I think, in the body of the hall.

\* \* \*

(Continued on page 52 )

# Much has been said about the Heathkit® AR-29.

## All good:

### High Fidelity, September 1970 —

"For its rated output of 35 watts (sine-wave power) per channel, the set produced less than 0.1 per cent distortion across the normal 20-20,000 Hz audio band."

"Frequency response, virtually a ruler-straight line from 10 Hz to 100,000 Hz, was the best we have ever measured in a receiver."

"On every count, the completed AR-29 either met or exceeded its published performance specifications — and did so with only the normal adjustments spelled out for the kit builder. No professional alignment was needed."

### Elementary Electronics, September-October 1970 —

"... it's quite likely that many, if not most, users will consider the AR-29 the best buy in receivers. Even a nitpicker would have trouble finding fault with the AR-29."

### Stereo, Winter 1971 —

"An exceptionally good value for the kit builder; set meets or exceeds specifications without need for professional alignment or adjustments; one of the best performing receivers available in any form."

### Audio, August 1970 — C. G. McProud on the AR-29:

"The Heathkit AR-29 is a worthy companion to the famous AR-15 — somewhat easier to build, somewhat lower in power, somewhat less expensive — but nevertheless a superb receiver in its own right."

"... measured distortion of 0.15 per cent as typical over most of the audio range, even though the specifications rate the receiver at a distortion of 0.25 per cent."

"We noted a power output of 36 watts per channel at a distortion of 0.15 per cent, with both channels driven, and at the rated distortion of 0.25 per cent, we measured an output of 42 watts per channel. Power bandwidth also exceeded specifications, extending from 7 Hz to 43 kHz at the half-power point. Frequency response at the 1-watt level was from 7 Hz to 62 kHz,  $\pm 1$  dB, and from 4 Hz to 110 kHz  $\pm 3$  dB, also exceeding specifications. Full limiting occurred at an input signal of 1.4  $\mu$ V, while IHF sensitivity measured 1.8  $\mu$ V."

"After such an impressive set of measurements, we could only hope that listening tests would bear out what we had measured, as indeed they did. We first found that we could pull in 26 stations with only our finger on one of the FM antenna terminals, which was impressive in itself. After we connected the antenna, we brought in 43 stations, with 32 of them in stereo." "... to date we have never pulled in over 41 stations heretofore with any receiver, and not all of them were listenable."

"Even the AM reception was excellent ..."

"... the construction and final testing is a short course in electronics, well done as is usual with Heath instructions, and effective enough that it is not necessary to give a final alignment with instruments to get the receiver operating in accordance with its specifications."

"Its performance should satisfy the most critical audiophiles thoroughly."

### Popular Electronics, April 1970 —

"How does a company that is reputed by the experts and hi-fi purists to be the maker of the world's finest top-of-the-line stereo receiver (AR-15) outdo itself? Simple (or so it seems)! It proceeds to make the world's finest medium-power, medium-price stereo

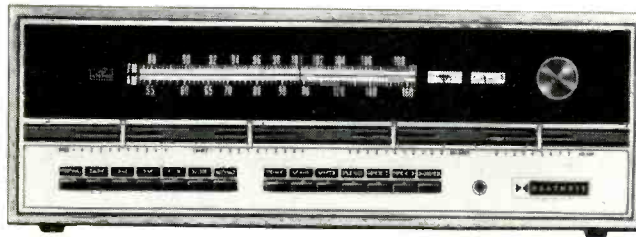

receiver. This is exactly what the Heath Company... has done with its Model AR-29 receiver. For features and styling, the AR-29 is, in our opinion, a triumph of modern technology."

"The assembly/operating manual that comes with the kits bears the usual Heath mark of excellence."

"You don't have to live with the AR-29 to know you have a good receiver. Turn it on and tune along the dial and listen to how stations drop in and stay solidly in place in both FM and AM."

"You will know right away that the Heathkit AR-29 is the best medium power receiver you have ever heard or are likely to hear."

### Stereo Review, April 1970 — Julian Hirsch on the AR-29:

"Its FM tuner had an IHF sensitivity of 1.75 microvolts, placing it among the finest in respect to sensitivity." "Stereo FM frequency response was extremely flat,  $\pm 0.25$  dB from 30 Hz to 15,000 Hz."

"We found the audio amplifiers to be considerably more powerful than their rated 35 watts (RMS) per channel. With both channels driven at 1000 Hz into 8-ohm loads, we measured about 50 watts (RMS) per channel just below the clipping level."

"Harmonic distortion was under 0.1 per cent from 0.15 to 50 watts, and under 0.03 per cent over most of that range. IM distortion was about 0.1 per cent at any level up to 50 watts. At its rated output of 35 watts per channel, or at any lower power, the distortion of the AR-29 did not exceed 0.15 per cent between 20 and 20,000 Hz. The distortion was typically 0.05 per cent over most of the audio range, at any power level."

"Hum and noise were extremely low: -90 dB at the high-level auxiliary input and -71 dB on phono, both referenced to a 10-watt output."

"... the AR-29 construction made a positive impression". "... assembly has been markedly simplified."

Says Mr. Hirsch about overall performance: "The test data speaks for itself." "... no other receiver in its price class can compare with it."

Kit AR-29, 33 lbs. .... \$299.95\*  
Assembled AE-19, pecan cabinet, 10 lbs. .... \$ 19.95\*

See these and 300 other Heathkit products at one of the following Heath Electronic Centers:

<b>CALIFORNIA</b> Anaheim, 92805 330 E. Ball Road El Cerrito, 94530 6000 Potrero Avenue La Mesa, 92041 8363 Center Drive Los Angeles, 90007 2309 S. Flower St. Redwood City, 94063 2001 Middlefield Rd. Woodland Hills, 91364 22504 Ventura Blvd.	<b>DOWNERS GROVE, 60515</b> 224 Ogden Ave. <b>MARYLAND</b> Rockville, 20852 5542 Nicholson Lane <b>MASSACHUSETTS</b> Wellesley, 02181 165 Worcester St. <b>MICHIGAN</b> Detroit, 48219 18645 W. Eight Mile Rd. <b>MINNESOTA</b> Hopkins, 55343 101 Shady Oak Rd.	<b>NEW YORK, 10036</b> 35 W. 45th Street <b>OHIO</b> Cleveland, 44129 5444 Pearl Rd. Woodlawn, 45215 10133 Springfield Pike <b>PENNSYLVANIA</b> Philadelphia, 19149 6318 Roosevelt Blvd. Pittsburgh, 15235 3482 Wm. Penn Hwy.
<b>COLORADO</b> Denver, 80212 5940 W. 38th Ave. <b>GEORGIA</b> Atlanta, 30305 5285 Roswell Road	<b>MISSOURI</b> St. Louis, 63123 9296 Gravois Ave. <b>NEW JERSEY</b> Fair Lawn, 07410 35-07 Broadway (Rte. 4)	<b>TEXAS</b> Dallas, 75201 2715 Ross Avenue Houston, 77027 3705 Westheimer <b>WASHINGTON</b> Seattle, 98121 2221 Third Ave.
<b>ILLINOIS</b> Chicago, 60645 3462-66 W. Devon Ave.	<b>NEW YORK</b> Jericho, L.I., 11753 15 Jericho Turnpike	<b>WISCONSIN</b> Milwaukee, 53216 5215 W. Fond du Lac

Retail Heathkit Electronic Center prices slightly higher to cover shipping, local stock, consultation and demonstration facilities. Local service also available whether you purchase locally or by factory mail order.



### FREE

### NEW 1971 CATALOG

Featuring these and dozens of other exciting new kits for home, hobby, test and service, education and recreation... over 300 easy-to-build, fun-to-use electronic kits in all. Get your FREE copy now... use coupon or write: Heath Company, Benton Harbor, Michigan 49022.

HEATH COMPANY, Dept. 41-2  
Benton Harbor, Michigan 49022

Enclosed is \$ \_\_\_\_\_, plus shipping.

Please send model (s) \_\_\_\_\_

Please send FREE Heathkit Catalog.

Please send Credit Application.

Name \_\_\_\_\_

Address \_\_\_\_\_

City \_\_\_\_\_

State \_\_\_\_\_

Zip \_\_\_\_\_

\*Mail order prices; F.O.B. factory. Prices & specifications subject to change without notice. HF-245



a Schlumberger company

# Audio Transmission Line Equalization

Buck O. Kraft\*

**I**N OUR PRESENT day society of modern conveniences, push-button equipment and instant everything, we take most things for granted. We are conditioned to expect the Sunday paper to be on the front porch, the milk on our front doorstep in time for breakfast, the garbage to be removed twice a week, a flip of a switch and *light*, a flip of a switch and *music*.

Behind most of the conveniences we take for granted is a multitude of little-known technical problems, sometimes monumental in scope. In this article a few of the problems and solutions related to the transmission of high quality stereo music on wire transmission lines will be considered.

The question of what is an adequate frequency range to faithfully reproduce sound with a high degree of realism has been investigated by many researchers. The conclusions of Harvey Fletcher of the Bell Telephone Laboratories state that the range of frequencies which can be perceived by the listener depends upon his innate hearing ability, the average level of the sound, and upon the characteristics of the background noise. Statistically, the median frequency range for the population is from 20 to 15,000 Hz at an intensity of 120 dB. As the intensity of the sound is diminished, the response of the ear falls off at the high and low ends of the audio spectrum. Within the range of normal listening levels, a frequency response of 50 to 15,000 Hz  $\pm$  1 dB is considered satisfactory for high quality sound reproduction. An increase in bandwidth or a tighter tolerance could be achieved but the economic penalty would not be justified in that only an extremely small percentage of the population could detect the change. It must also be understood the frequency response of the transmission line extends above and below the specified frequency range before the half-power points are reached.

\*Southern Bell Telephone Co., Charlotte, N.C.

## Line Noise

Although the frequency limit of the transmission line is based on the inherent physical capabilities of the ear to perceive various frequencies, the line noise limit is determined by the construction of the line itself. Multiple pair cable is generally used as the transmission media. This means many telephone and teletype circuits are in the same cable and each causes a small but perceptible amount of noise to be induced into the audio transmission line. Some of the larger cables contain as many as 2100 telephone circuits. As might be expected, this large number of interfering circuits could cause a severe noise induction problem. With the initial installation of high quality cable and the application of proper maintenance procedures, the noise requirement of -57 dB can not only be met, but exceeded by a number of dB in many instances. In telephone technology, the standard transmission line impedance is 600 ohms and the standard power reference level is 1 milliwatt. This combination of 1 milliwatt and 600 ohms is called 0 dB. Any power less than 1 milliwatt is represented by so many -dB; any power greater than 1 milliwatt is represented by so many +dB. A noise requirement of -57 dB, in essence, means the total measured noise power is 57 dB below the reference power of 1 milliwatt. Mathematically, this equates to a peak of 2,000 pica-watts.

Harmonic distortion occurs when a device such as an amplifier or transformer has non-linear characteristics. If a transistor amplifier is operated on any non-linear portion of its characteristic, a change in input results in a change in the output which is not directly proportional. The resulting distortion is harmonic or non-linear distortion. Harmonic components are generated by the device and appear in the output, in addition to those frequency

components present in the input. Measurement of harmonic distortion is one basic method of testing the quality of a program circuit. Circuits that have low harmonic distortion will generally deliver program material of good quality. At the present time, a harmonic distortion figure of 0.4 percent is reasonable and within economic limits when consideration is given to all of the equipment involved.

## Line Loss Characteristics

Now that we are aware of the circuit requirements, let's look at a situation and one possible solution. The problem is to install an audio transmission line between an FM studio and a transmitter some ten miles away. Figure 1 indicates what we might do. What we would have in this situation is, essentially, a pair of wires ten miles long. How would it work? Could all the circuit requirements be met? The solid line in Fig. 2 tells the story. Due to line loss, our expected receive power would be very low; therefore, the signal-to-noise ratio would be unsatisfactory. The frequency response would be  $\pm$ 26 dB with the high frequency range all but lost in the line noise. Obviously this method will not prove satisfactory so other techniques must be used.

The present day technique of audio transmission line conditioning, as shown in Fig. 3, requires an amplifier and equalizer at each telephone office. This method breaks the line into relatively short segments which can meet the necessary requirements.

Let's take a closer look at one of these line sections, including line loss characteristics, equalizer characteristics and amplifier characteristics. In the example, let the cable facility be 22 gauge and the distance from the studio to the first central office be four miles. The dashed line in Fig. 2 indicates the approximate bare loss (with no equipment attached) of the cable pair. It is clear from the figure that the difference in loss between the high and low ends of the frequency band is about 18 dB. The general contour and the magnitude of the frequency-versus-loss characteristic of the cable pair is the result of the d.c. resistance and the parallel distributed capacity of the metallic conductors which make up the pair. The d.c. loss of the pair is constant at all frequencies under consideration. The attenuation, which is a result of the distributed capacity, increases with an increase of frequency. This results in an increase in loss with increase in frequency. The method used to negate this rising-frequency-versus-loss characteristic is to insert a device in the cable pair called an equalizer.

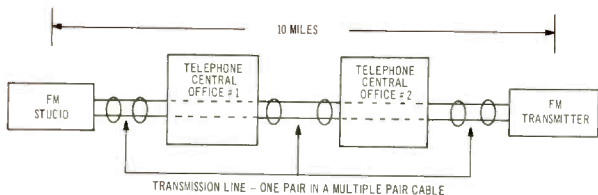

Fig. 1—Showing a straight-through audio transmission line connection.

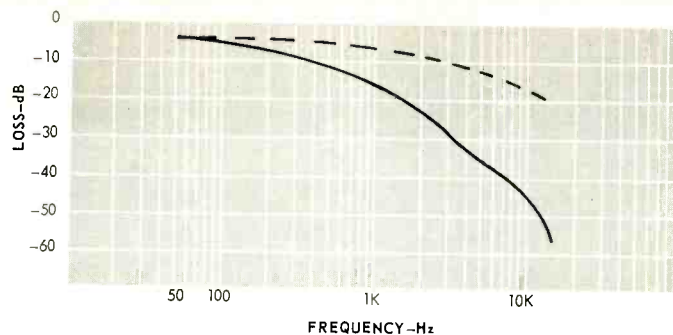

Fig. 2—Dashed line shows loss in 4-mile section of 22-gauge cable. Solid line shows loss in 10-mile section of 22-gauge cable.

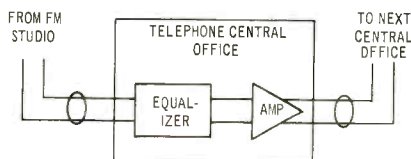

Fig. 3—Audio transmission line with equalizer and amplifier replacing the straight-through connection in the telephone central office.

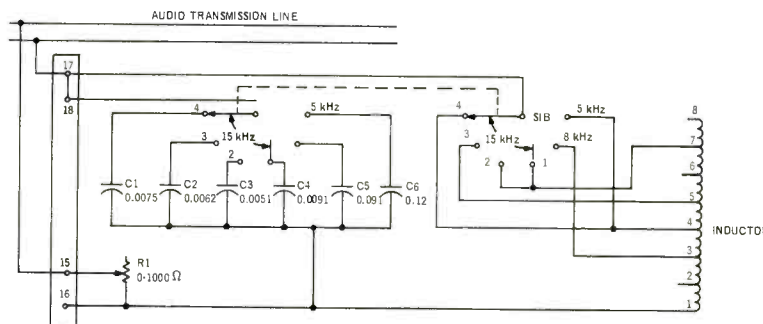

Fig. 4—Showing a schematic of a line equalizer.

The equalizer shown in Fig. 4 uses a parallel resonant circuit. Below the resonant frequency, the reactance is inductive and, hence, according to the formula for inductive reactance ( $X_L = 2\pi FL$ ) the equalized loss increases as the frequency decreases. Since the equalizer acts as a variable resistance bridged across the cable pair, it introduces more loss at the low frequencies than it does at the high frequencies. Also, the lower series resistance introduced by R1, the greater the amount of equalized loss provided. As the frequency increases, the inductive reactance increases. The resistance of R1 now has less equalizing effect as the inductor and capacitor approach resonance. Therefore, the equalizer introduces less loss at the higher frequencies. The resultant frequency of the equalizer is designed to be sufficiently above the highest equalized frequency so as to provide the proper slope as indicated by Fig. 5.

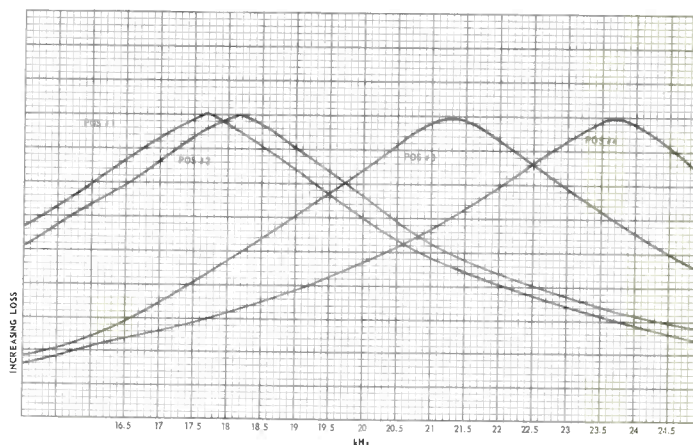

Fig. 5—Equalizer slopes for 4 kHz switch positions.

The amount of equalization that has to be provided in the first section of the circuit, according to Fig. 2, is 18dB. At the studio, all frequencies from 50 Hz to 15,000 Hz, in 100 Hz steps, are transmitted at 0 dB over the circuit to the first central office. Here the equalizer is adjusted by first selecting the proper 15 kHz position. This is done by experimenting to find out what contour most closely fits the loss of the cable pair. Now R1 is adjusted until the loss of the equalizer is equal but opposite to the loss of the circuit. Figure 6 indicates the result when this adjustment is properly completed. The result of this equalizing process is not

only a flattening of the frequency response but also a drop in overall level. This drop in level is the price which must be paid to achieve a flat frequency response.

### Amplification

The next process is to introduce sufficient gain at this point to compensate for circuit and equalizer loss and leave the first central office at a level of 0 dBm. (dBm indicates 1 milliwatt developed into 600 ohms.) Located in telephone offices are amplifiers associated with line equalizers. Figure 7 is a schematic of a solid state program amplifier; Fig. 8 is a picture of the current version. Table A lists some of the amplifier specifications.

A brief discussion of a few of the characteristics might be in order. The

maximum gain of the amplifier is  $42.5 \pm 1$  dB, which indicates this is not a particularly high gain device. The reason for this is the level of the input signal is normally not lower than -20 or -25 dB. If the input signal was very low—the order of -35 or -40 dB—the signal-to-noise ratio would be so low as to make the signal unusable. Additional gain in this case would serve no useful purpose. The maximum output power is -22 dBm or 158 milliwatts. This figure may seem unusual until certain considerations are reviewed. The normal average power of the audio signal leaving the studio and all other points which contain gain devices is 0 dBm or 1 milliwatt. Higher output levels would cause interference to be introduced into the other circuits in the cable. Lower output power would cause the signal-to-noise ratio to be

Characteristic	KS-16831, Amplifier
1,000 Hz	42.5 ± 1 dB
Frequency Response	35 to 15,000: ± 0.5 dB of 1,000 Hz value
Output Power	+ 22 dBm with 0.5% total harmonic distortion (rms)
Noise	-60 dBm with dc-supply noise not exceeding 64 dr n and 15 kHz flat weighting
Gain Controls	Nineteen 2 ± 0.25 dB steps—total 38 dB and OFF position, Vernier control range 2 dB
Impedance	150 or 600ohms in 25, 100, 150, 600ohms out

**Table A**—Electrical characteristics of a solid state program amplifier, which compensates for circuit and line loss.

poor at the receiving end of the circuit, as a result of low received power. A 0 dB transmission level is a compromise which allows the best results to be obtained, from both a signal-to-noise ratio and an interference standpoint.

Dependability is a prime requirement in telephone company equipment. Program amplifiers are no exception. As a rule, the equipment is turned on when it is installed and tested and never turned off except for maintenance. Thousands of these amplifiers have been performing successfully throughout the country for five or more years, which is a credit to the design and manufacture of this equipment.

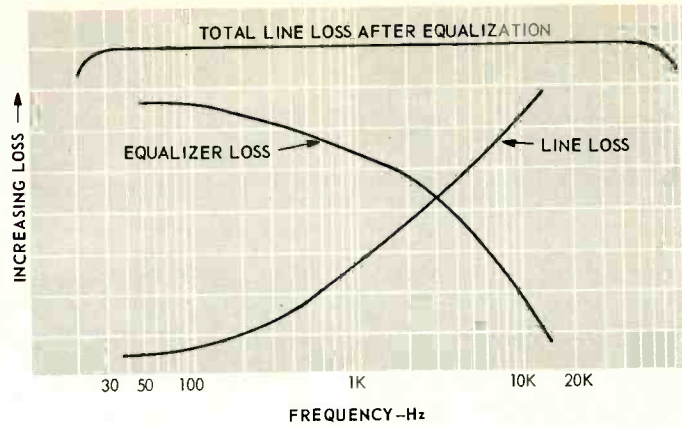
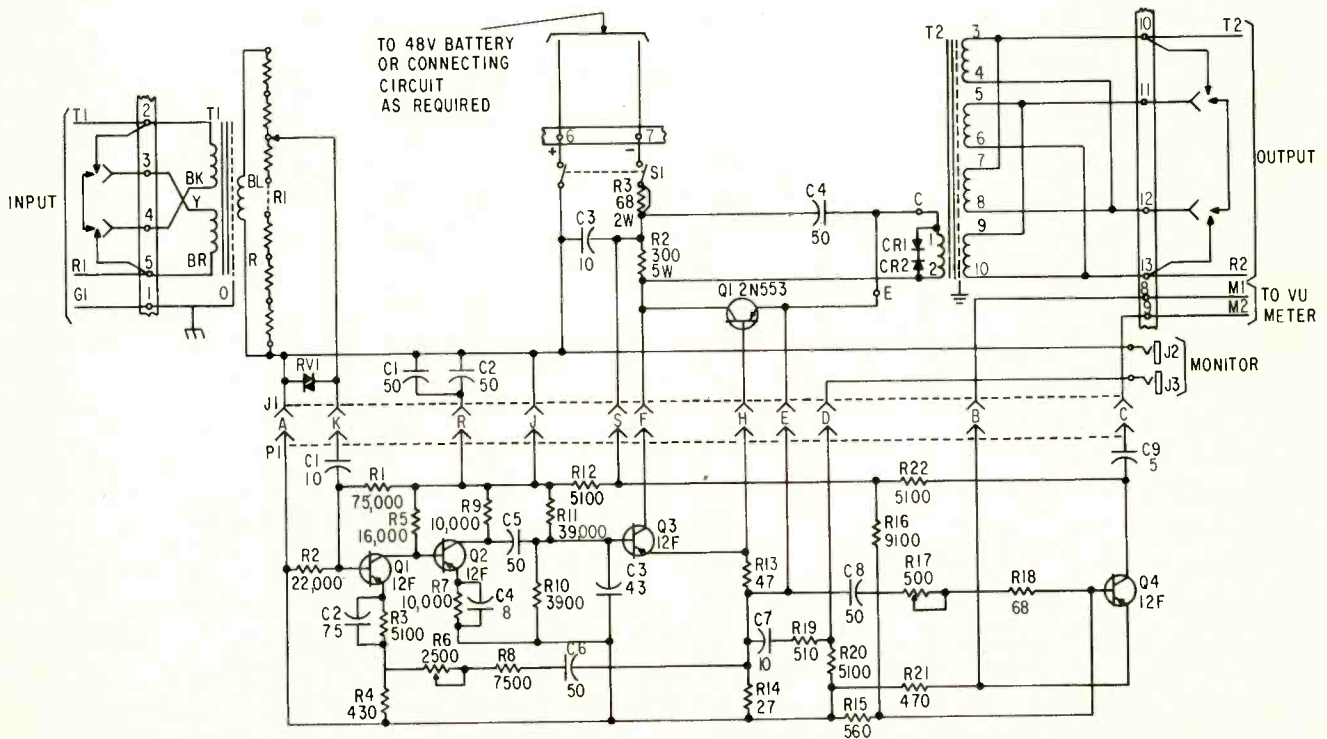

**Fig 6**—Equalizer effect on total line loss.

The operating voltage for the amplifier is 48 volts d.c., which is obtained from central office batteries. In the event of a commercial power failure, the equipment still operates because the central office batteries are charged independently of commercial power. Jacks are associated with the equipment so that, in case of a failure, a spare amplifier can be patched (inserted) into the circuit in a few seconds. Monitor jacks are provided to check the quality of the circuit if an abnormal condition does exist.

It now becomes quite apparent what has been accomplished in the first section of the circuit. Transmitted from the first central office is a bandwidth of 50 to 15,000 Hz ± 1 dB at a level of 0 dBm. The noise level will be below -67 dB and the distortion will be below 0.4 percent. In effect, the studio has been moved four miles closer to the transmitter as far as the audio output of the first central office is concerned.

The type of circuit that has been described is known as a local program circuit. These are relatively short in



**Fig. 7**—Showing a schematic of a program amplifier.



Miles Davis uses AR-3a speaker systems for home listening. Their accuracy and lack of coloration account for their choice by many professional musicians.



One of America's most distinguished musicians, Miles Davis is enthusiastically heard by listeners in every part of the world, live during his tours, and recorded on Columbia Records. His most recent recording is "Miles Davis At Fillmore".

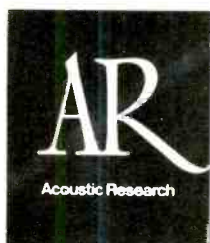

Free product catalog available on request from Acoustic Research, 24 Thorn-dike Street, Cambridge, Massachusetts 02141.

Check No. 23 on Reader Service Card

length, possibly up to about 30 to 40 miles. In this situation, there could be a maximum of eight amplifiers in series strung along the circuit. The limiting factor as far as the number of amplifiers in series is the distortion contributed by each. With this many amplifiers in series, a reasonable distortion factor is 1.5 percent. Where very long program circuits are involved, such as coast-to-coast networks, this technique is not used. Microwave radio or wire carrier systems would be used in these cases. Briefly, in these systems, the audio band is translated to higher frequencies and transmitted as sidebands in the radio frequency spectrum.

The next section of the circuit shown in Fig. 1 is from the first central office to the second central office. The same techniques are used to equalize the second and the remaining sections of the circuit. It is important to know, however, that the audio oscillator remains at the studio and transmits the test frequencies through each equalized section to the next section. With this arrangement, any residual discrepancies in one section can be remedied in the next section or sections. It is important, however, that each section, as far as practical, should be equalized to not only meet but exceed the circuit requirements.

The last section of the circuit, which is from central office number three to the transmitter, is treated differently than the previous sections. An equalizer will be located at the transmitter but an amplifier probably will not be, unless this section is long and, consequently, the received audio level low. The signal-to-noise ratio at the transmitter determines the need for amplification at that location. As an example, if the equalized level is -18 dB, what could the maximum signal-to-noise ratio be? The normal sending level at the studio for program material is +8 VU (volume units) with a peak factor of +10 VU. (Peak factor indicates the maximum amplitude the signal will momentarily reach). This means the maximum level is +18 VU. Now if the equalized loss in the last section is 18 dB, the peak level would arrive at a level of 0 VU. If the inherent circuit noise was -60 dB, the signal-to-noise ratio would be 60 dB. Of course, for signal levels less than the peak value, the signal-to-noise ratio would be less.

### Stereo Considerations

When the program material is in stereo form, two of the facilities previously described are required. This type of transmission necessitates added specifications comparing the two transmission media. As indicated, the frequency response in each channel

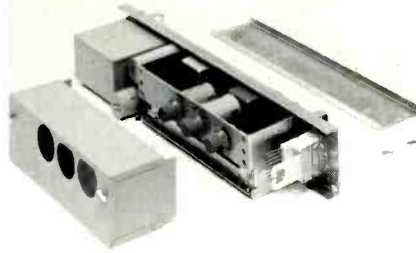

Fig. 8—Showing an audio amplifier and jacks.

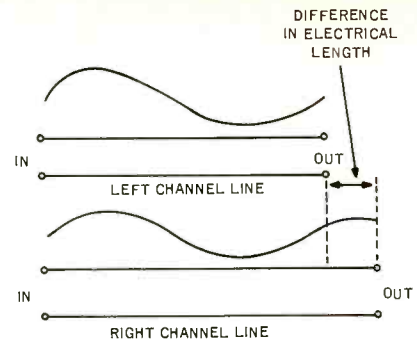

Fig. 9—Showing differential phase shift, with the left-channel line shorter than the right-channel line.

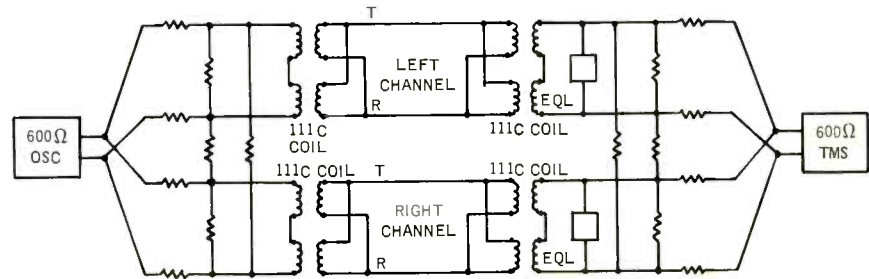

Fig. 10—Arrangement for measurement of differential phase shift in stereo channels. (TMS is transmission measuring set.)

shall be  $\pm 1$  dB from 50 to 15,000 Hz. The added specification requires the transmission frequency characteristics of the two channels be within 0.5 dB of each other anywhere in the specified audio range. If this requirement is met, the monophonic listener will receive a satisfactory signal. A difference in electrical length between two transmission facilities results in differential phase shift. If one path is slightly longer than the other electrically, the two signals will add vectorially at the receiving end. Figure 9 represents an extreme case of differential phase shift. The signal which traverses the longer path requires a greater time to reach the end of the circuit. The worst possible condition would result if the two paths differed in electrical length by 180 degrees, which is a half-wave length for a particular frequency. As would be expected, this frequency would be greatly attenuated. Differential phase shift between two circuits increases as the frequency is increased because a slight difference in length can represent an appreciable part of a cycle. As a rule, differential phase shift between two circuits used for stereo transmission is quite small and if the requirement can be met at 15,000 Hz, it will be met in the rest of the audio band.

In order to have negligible differential phase-shift, the two circuits must be completely identical in all respects. Both circuits should be in the same

cable in all parts of the transmission facility. Identical amplifiers must be used and installed at the same locations. Equalizers must be of the same type and installed at identical locations.

The test arrangement used to check for differential phase shift is indicated in Fig. 10. At the transmitting end, the oscillator is adjusted for an output of 10 dB at 1 kHz. The received level should be equal to the normal received level plus the loss of the resistance network which is 15.4 dB. If this requirement is not met, a frequency check is made. When the differential phase shift is negligible, the response characteristic of the combined circuits should be  $\pm 1$  dB from 50 to 15,000 Hz. If one of the circuits is reversed, the two signals will be 180 degrees out of phase and the received level will usually be 20 to 30 dB lower than expected.

Minor discrepancies, where the response at the high end is out of limit, are due to slight accumulated differences in the make-up of the two circuits. This is generally quite easy to remedy.

This is just a brief look into the current technology of audio transmission lines. Many more engineering considerations are involved which we haven't covered. The basic concepts that were examined do give an accurate picture and should give the reader a good insight in this one small facet of audio techniques. **AE**

# Extravagance in the pursuit of excellence is no vice.

At first blush, \$225 for a record playing instrument would appear to be rather expensive. That is about \$50 more than today's acknowledged standard in record playing instruments, our own Miracord 50H. But, if you're one of those people who derive great satisfaction from an instrument that is precise in every detail and offers meaningful features not available anywhere, then the new Miracord 770H is designed for you.

The 770H takes for granted all features that exist in the finest of turntables available today. It shares all of the im-



portant exclusive 50H features—Papst hysteresis synchronous motor; external stylus overhang adjustment with built-in gauge; massive, dynamically balanced turntable and cueing in both manual and automatic modes. To these features, the 770H has added several that are new, that never existed before, and that

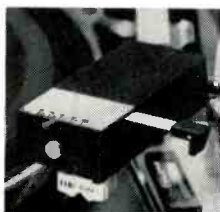

will contribute to flawless play and greater enjoyment from your records. Such features include TRU/TRACK, an adjustable head that can be set so that the cartridge assumes the precise 15 degree vertical angle for any number of records when used automatically, or for a single record when used manually. There's a variable speed control with digital stroboscopic speed indicator. Not only can you adjust the speed of the 770H over a 6% range, but you can restore it to the precise originally selected speed (33 or 45 rpm) with the help of a built-in illuminated stroboscopic speed indicator. Digital readouts of the exact speed are always visible on the rim of the turntable.

Another breakthrough is the built-in ionic elapsed time stylus wear indicator which keeps tabs, by the hour, of precisely how long your stylus has been in use. It even reminds you to check your stylus.



So, you see, the rewards of the 770H for the music lover more than compensate for the enthusiasm of our engineers. See it at selected audio specialists or write for full color brochure, Benjamin Electronic Sound Corporation, Farmingdale, New York 11735/a division of Instrument Systems Corp.

## Miracord 770H



Check No. 25 on Reader Service Card



# Quadraphonic News

## Recording In Quadraphonics

Ronald M. Klein\*

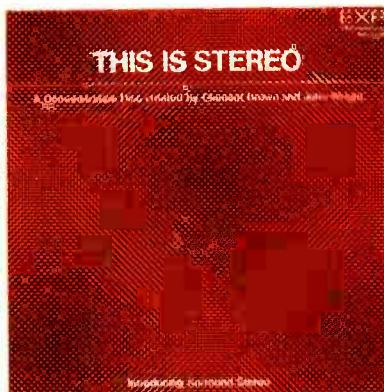

At the top of the page is a British record which is mainly devoted to the normal stereo setting-up procedures. However, one band has been recorded for a three-speaker arrangement. The Hafler demonstration disc is shown in the middle, and underneath is the KL record mentioned in the article. Information concerning it can be obtained direct from KL Recording.

QUADRAPHONIC stereo ideally lends itself to recording large groups and intricate performances. The auditory impact of such a recording is almost beyond description and certainly represents a giant step forward in the area of recording techniques.

However, small groups will also benefit by making use of this new medium. One of our specialties is traditional music, including polka, old time, and Dixieland music, which all require a similar recording technique. When recording groups of this type, the emphasis is on the most natural sound possible. This can be achieved to a great extent by recording in a hall with good natural acoustics and retaining these acoustics through a quadraphonic recording. To take full advantage of this new sound, we are now recording all LP master tapes in quadraphonic under these conditions. In our technique, the main stereo information is recorded on the normal front channels. Pickup of ambient acoustics from each back corner of the hall becomes the rear channels. There is a natural blend between all channels, and the result is very realistic. We have also tried the "surround" type of quadraphonic technique, with direct instrument pickup on each channel. The results are pleasant, but decidedly artificial for this type of music. This technique is very effective with certain types of modern music however, particularly when electronic instruments are included in the orchestration.

Effective location recording in quadraphonic stereo would be very cumbersome when using up to ten microphones and conventional equipment. To solve this problem, we have designed and built all the auxiliary equipment we use in our laboratory.

Everything is transistorized and as small as practical. This also allowed us to customize the entire system for maximum efficiency and lowest possible distortion. Electro-Voice RE-55 microphones are used. They were chosen for their very low distortion and extremely smooth response. Taping is done on a Sony TC-366-4 machine.

\*KL Recording Service  
P.O. Box 55  
Hubertus, Wis. 53033

chosen for its small size and exceptional quality. The entire recording system can be set up on a two-by-four-foot table and will handle up to 12 microphones or lines, complete with stereo panning facilities. Master tapes produced with this system have a usable frequency response of 20 to 20,000 Hz at a maximum measured intermodulation distortion of 0.8 percent. This is indeed a tribute to the excellence of present day electronic components and assemblies.

At the time of this writing, a system for quadraphonic disc recording is still under discussion. When this is finally resolved, we will be issuing quadraphonic disc recordings from master tapes now being recorded as previously described.

One of the four-channel disc systems now under discussion has a very interesting secondary use. Using part of this system as described by David Hafler



Sony 366-4

(AUDIO, July 1970, page 24), a "triphonic" recording can be made. As suggested by Mr. Hafler, we have recently released a record containing an encoded third channel. (*Sig Loomis and the Tag-A-Longs*, KLP-4) In this recording, a single microphone was placed in the back of the hall to pick up ambient acoustics. This signal was fed to both channels in equal amounts, with one channel inverted to produce the L-R component. On playback, this signal will appear across the high sides of each channel as an additive component, assuming the low or common sides are tied together. This signal can then be reproduced by connecting

(Continued on page 28 )

When the Citation Twelve power amplifier was introduced, it was immediately hailed by HIGH FIDELITY magazine as "... a virtually distortionless device." STEREO REVIEW said, "... the amplifier circuit... is disarmingly simple, yet it offers essentially state-of-the-art performance." STEREO & HI-FI TIMES summed it up by saying, "Harman-Kardon has produced an amplifier that is so close to theoretical perfection that it may be said that the Citation Twelve simply drops out of the reproduction chain. It simply produces no discernible sound of its own."

Now Harman-Kardon presents the Citation Eleven, a superlative preamplifier worthy of the Citation name.

The Citation Eleven specifications are unmatched by any preamplifier ever made. But specifications alone do not begin to convey the scope of this remarkable instrument.

For one thing, instead of conventional tone controls, the Citation Eleven employs a series of precision filters that permit you to boost or attenuate the signal at five critical points within the audio spectrum. By judicious use of the audio equalizer you can correct deficiencies in program material, speakers and room acoustics—literally shaping your system's frequency response. What you actually hear is acoustically balanced to the requirements of your listening room.

But more. The Citation Eleven

offers a full complement of professional controls, and enough inputs and outputs to satisfy the requirements of the most demanding audiophile. For example: two tape monitor switches; a front panel speaker selector switch for two sets of speakers; two low impedance headphone receptacles; a special defeat switch that removes the audio equalizer from the circuit for instant comparison of equalized and flat response.

The extraordinary performance and unparalleled flexibility of the Citation Eleven are unrivaled by any preamplifier on the market today.

To fully appreciate the Citation Eleven, you should hear it in combination with the Citation Twelve. But the Citation Eleven, in combination with any top flight amplifier, will provide unexcelled performance. Your Harman-Kardon dealer will be happy to provide a demonstration.

For complete specifications and technical information, write to Harman-Kardon, Inc., 55 Ames Court, Plainview, New York 11803.



**harman kardon**

A subsidiary of Jervis Corporation

# Now... The Citation Eleven awaits the experts.



Check No. 27 on Reader Service Card

www.americanradiohistory.com

## Recording in Quadraphonics

(Continued from page 26)

a speaker across these points. This speaker should be placed in the rear of the listening area, so as to simulate the actual hall acoustics in proper perspective. A diagram showing this is on the record jacket for the benefit of those who wish to try it. As Mr. Hafler pointed out, this speaker will reproduce any out of phase components on a stereo record, and we have found it does make an improvement in the playback of other recordings. The effect

of the encoded third channel is most striking with earphones, as sound is actually heard from slightly behind the listener's head. Even the normal stereo sound on speakers is somewhat enhanced by this additional acoustic information.

Another method of retaining acoustics will be used in a forthcoming Dixieland LP release (*Riverboat Rascals at the Rangeline*, KLP-5) The master tape is in quadraphonic, but the first issue of the record will be in normal stereo. When the master is cut, a portion of the right rear signal will be mixed in with the right front, and a portion of the left rear with the left front. This will give an effect similar to the encoded

third channel, but will be more apparent on speaker playback.

However, the best arrangement will still be a true quadraphonic recording, and we are hopefully awaiting a system that will be fully compatible with present stereo disc reproducing equipment. We are also hoping to see a truly usable quadraphonic tape system made available to the public at a reasonable price. As one step in this direction, quadraphonic reel-to-reel tapes will be available from us on a limited basis in the early part of 1971. We hope other recording companies will also make some quadraphonic material available, so as to acquaint the consumer with this exciting new method of recording.  $\text{\AE}$

## How Many Channels? Part II

Duane H. Cooper\*

THE TRIPHONIC system, which I described recently (*AUDIO*, p. 36, Nov., 1970), was one which had been stripped to its psycho-acoustic fundamentals. For the sake of clarity, mention of possible refinements and extensions had been omitted. However, this system does share with other stereo systems using widely-spaced speakers a problem that may be designated as sound-image polarization—the old hole-in-the-middle problem. Here, this problem is that of an instability, against varying listening positions, of images along the front-to-side axes.

A smoother frontal spread is obtained if the front speaker by replaced by a spaced pair of speakers, each carrying the sum signal. For example, an existing stereo pair, mono connected, may be used with minimal modification of an operating installation. Many experimenters will prefer this quadraphonic array using what may be called "split" front speakers. The reproduction should still be regarded as triphonic, however, since the two front speakers still carry the same information.

With existing recordings, the smoothing benefits of split front speakers are easy to demonstrate. Whether splitting the side speakers will produce similar benefits is a question not so easily settled, since commercial recordings designed to exploit triphonic reproduction for side and back localizations are not, of course, available. Any such

\*Univ. of Illinois, Urbana, Ill. 61801.

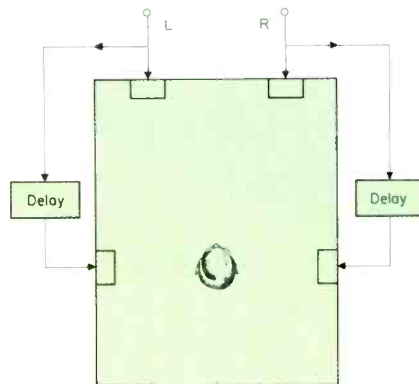

Fig. 1—The triphonic system explained by Cooper in his earlier article.

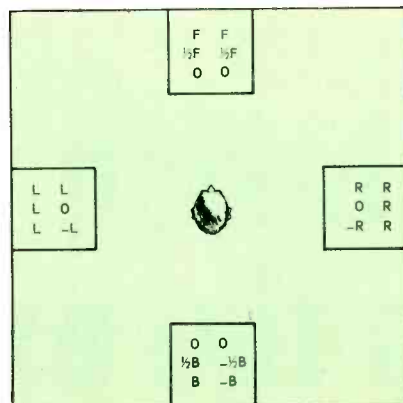

Fig. 2—One possible quadraphonic speaker arrangement.

splitting should be designed, however, to make the most effective use of the greater psychoacoustic weight attaching to the side locations.

For example, the left side speaker could be moved forward somewhat to take the 0 degree position (Fig. 1), and a speaker in the extreme left-back position could be added to carry an L-R signal. The corresponding provisions would be made on the right, but with the extreme right-back speaker to carry an R-L signal. Thus the off-center bias in back localization which I earlier noted as being a hazard for a single difference-connected back speaker would be avoided. It is this use of such difference-connected speakers that would merit further study in schemes that are basically triphonic.

A matrix-like array may be used to indicate the speaker locations and signal combinations described above, as follows:

F	F
L	R
B	-B

in which F stands for L+R, and B stands for L-R. Then, with R = O, L = R, L = -R, and L = O, the arrays obtained are shown in Fig. 2. In-between combinations are clearly possible.

Microphone arrangements and their matrix combinations to obtain specific localizations other than these are not obvious in every instance. Further experimental data, whereby the psycho-acoustic weight of the side-speaker locations may be determined, are needed. It will be recalled that it is this weight that would make it possible to obtain a subjective impression of excellent channel separation in the face of rather little electrical separation. Thus, automatic circuitry to detect level balances and to steer these to effect an enhancement of subjective separation would not be needed.  $\text{\AE}$

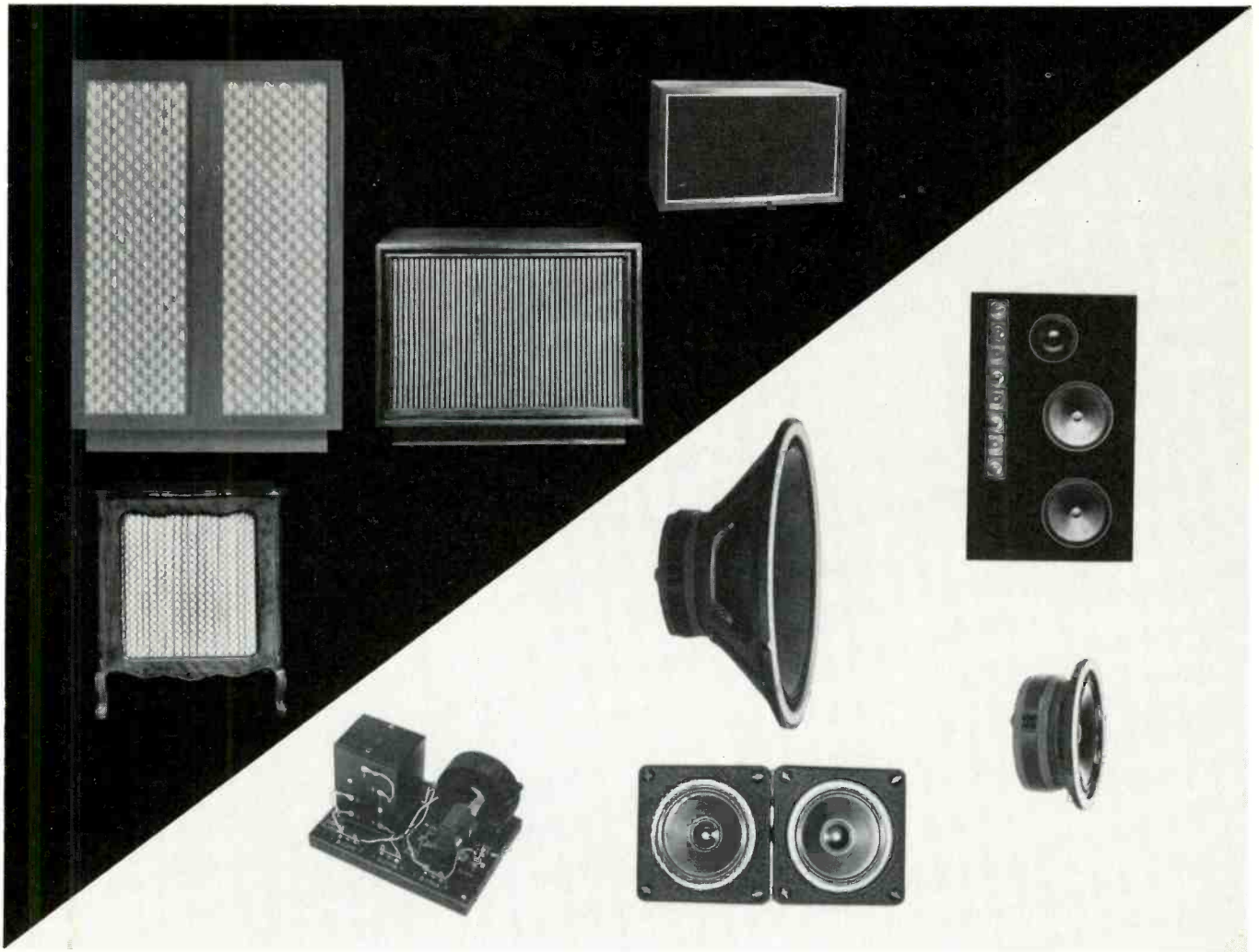

# Bozak...value unsurpassed

for integrity of sound

for quality and elegance of cabinetwork

and above all,  
for ability to meet your needs  
of today and your greater need tomorrow.

Our Catalog tells the story of Bozak's two decades of leadership in loudspeakers, and explains the dynamic concept of Systematic Growth. Ask for your copy.



P.O. Box 1166 • Darien, Connecticut 06820 Overseas Export: Elpa Marketing Industries, Inc. New Hyde Park, New York 11040 U.S.A.  
Check No. 29 on Reader Service Card



Richard Freed

# Boris, Igor, and The Dutchman

LONDON HAS reissued three more of its mid-fifties opera sets on its half-price Richmond label and, while most such reissues from this source have been welcomed as genuine bargains and some even as treasures beyond price, one must seek far for justifications for these particular revivals. One is a dismayingly unsatisfactory account of Wagner's *Flying Dutchman*, taped live at Bayreuth in 1955 (SRS-63519, \$8.94). The other two are products of English Decca's pilgrimage to Yugoslavia, a year or so earlier, to record Russian opera: Borodin's *Prince Igor* (SRS-64506, \$11.92) and Mussorgsky's *Boris Godunov* (RS-63030, \$8.94). This *Dutchman* was not issued in stereo before, and neither was this *Boris*; the latter, in fact, is still offered in mono only.

While investment in any of these three sets would seem to me the most false kind of economy, a case of sorts might be made for *Prince Igor*, since

there is not—and, for that matter, never has been—any other really complete recording of the opera. Oscar Danon (who conducted the work in Chicago a few seasons ago) is a superb musician who made the most of the opportunity he was given: an opportunity to record a fascinating but relatively neglected masterpiece in its entirety for a major company, but with conspicuously inadequate personnel. From his shaping of the Overture (a delicious confection of Glazunov, based on his recollection of Borodin's extemporization at the piano), it is at once obvious that the music is important to him, that he understands and enjoys it thoroughly, and that his enthusiasm and authority are communicated easily. It is equally obvious, unfortunately, that the orchestra of the Belgrade National Opera is not a very distinguished ensemble, with good enough strings (rather good ones, in fact) but winds that just won't do.

In the vocal complement, the mezzo Melanie Bugarinovich is a very attractive Konchakovna, and Biserka Cvejic (who has become a star at the Met since making these recordings, but whose name is still transliterated by London as "Tzveych") makes an excellent impression in her two very minor roles (a Polovetsi maiden and a nurse). From there on, though, it's all downhill. Zharko Cvejic (or Tzveych), in the classic dual role of Khan Konchak and Prince Galitsky, does nothing either to honor or to efface the memory of Chaliapin or any of his other distinguished predecessors: there is neither subtlety nor style nor much of anything especially musical about his singing, and his notions of characterization are crude. Dushan Popovich, in the title role, is actually far from unappealing, but one feels a little less "dignity" and a little more vocal security would not be amiss. Valerie Heybalova, as Yaroslavna, seems to personify the character of



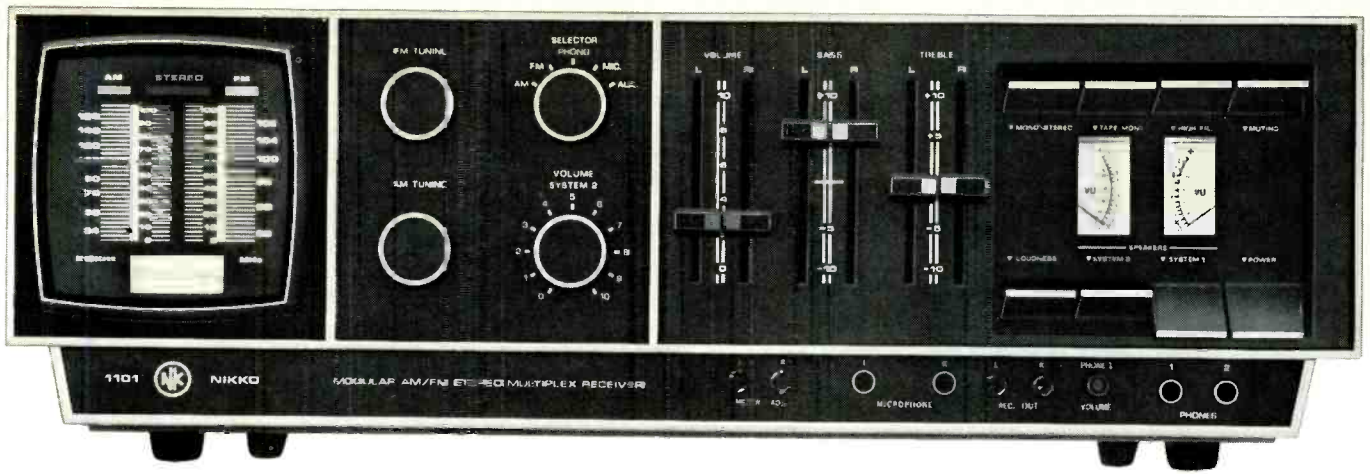

# Handsome is as handsome does

1 ceramic and 2 crystal filters provide greater sensitivity and higher selectivity

FET booster strengthens received signal at the antenna

Unique FET demodulator in AM section increases sensitivity and reduces spurious response and cross modulation

4 FET's in FM front end minimize spurious response and cross modulation

Black-out glass panels light up as functions are selected

Separate AM and FM tuning eliminates needless dial spinning

Separate stepped volume control for remote speaker system

Reliable silicon power transistors deliver 200 watts of clean, pure music power

Spring-loaded connectors eliminate the need for tools when changing speaker or antenna connections

Muting circuit eliminates between-station background noise and hiss

Computer-type plug-in circuit boards

Dual headphone outputs and microphone inputs

Professional separate slide controls for volume, bass, and treble of each channel

Nikko 1101 AM/FM Stereo Receiver  
200 watts \$399.95 list

If that handsome brute is a bit much, check these beauties:



Nikko 701B AM/FM Stereo Receiver  
90 watts \$239.95 list

Nikko 501S AM/FM Stereo Receiver  
64 watts \$189.95 list

Nikko 301 AM/FM Stereo Receiver  
40 watts \$159.95 list



Nikko Electric Corporation of America, 5001 Lankershim Blvd., North Hollywood, Calif. 91601. Manufacturers of a full range of receivers, pre-amp/amplifiers and tuners that deliver the cleanest, purest sound in their price range. Hear them at your Nikko dealer's today.

Check No. 31 on Reader Service Card

# Put an AKG on the job.



D-200E  
\$69.00  
Net

AKG-50

## It will sound better!

For complete information  
on AKG performance at  
prices ranging from  
\$40. to \$75. net write to:



**MICROPHONES • HEADPHONES**

DISTRIBUTED BY  
NORTH AMERICAN PHILIPS CORPORATION  
100 EAST 42nd STREET, NEW YORK, NEW YORK 10017

AKG CANADA • DIVISION OF DOUBLE DIAMOND ELECTRONICS • SCARBOROUGH, ONTARIO

Check No. 32 on Reader Service Card

## Boris, Igor and The Dutchman

(Continued from page 30 )

this undertaking: there can be no questioning her sincerity or her feeling for the music, but she simply lacks the technical equipment to enable the listener to stop fretting about which note she may ultimately land on and enjoy the performance.

So, why go on? The only reason for "going on," or considering this set, would be its uniqueness, but who really wants a complete *Igor* of such poor quality? Disregarding the cloudy old Bolshoi recording on Period, the only competing version, on Angel, omits Act III and has numerous other cuts, including a huge chunk of the Overture itself—but it does have Boris Christoff as Galitsky and the Khan, some other very fine singers, and the superb conductor Jerzy Semkow, who has a far better aggregation of instrumentalists in the Sofia Opera orchestra than Oscar Danon had in Belgrade. The sound, too, of course, is more than a dozen years newer. There will probably be a complete *Igor* from Moscow sooner or later on Melodiya/Angel (although the omission of Act III is traditional there). My advice for the present, to those who want a really complete recording but do not wish to be without this glorious music altogether while waiting for it would be to rest content with the single disc of excerpts from the Christoff/Semkow version on Angel S-36568, which offers eminently satisfying versions of most of the highlights (omitting, sadly, Yaroslavna's aria).

Kreshimir Baranovich, on the evidence of his recordings, was much less of a conductor than Danon, and there is simply not much point getting into a discussion of his surpassingly pedestrian treatment of *Boris*, which, as noted, is in mono only, and has nothing special in its favor, except perhaps an unusually vigorous chorus and some real excitement in the Kromy Forest scene. The Rimsky-Korsakov version is used, of course, but with substantial cuts, including the scene with Marina and Rangoni in its entirety. Miro Changa-lovich sings the title role and, while he does nothing *wrong*, he does little to bring it to life. The Columbia recording of a Bolshoi Theatre production under Melik-Pashayev, with George London in the title role, costs twice as much but is worth it, and the Angel conducted by the late André Cluytens, with Christoff as Boris, though more expensive still, makes price too trivial a matter to consider. However, if

Christoff's earlier (mono) recording, conducted by the incomparable Issay Dobrowen, were to reappear on Seraphim, we could then simply forget about all the others. Whether officially so designated or not, *that* was one of the "great recordings of the century," and, though recorded two or three years before the Belgrade *Boris*, it was superior sonically as well as musically.

Even though the reissued *Dutchman* bears the Bayreuth imprimatur, it is really about in the same class as the Belgrade *Boris*, which is to say "undistinguished" would be an understatement. The cast looks good on paper: the late Hermann Uhde as the Dutchman, Astrid Varnay as Senta, Ludwig Weber as Daland. But, while Uhde and Varnay both gave us many great performances, on records and in the theatre, they were both off their form when this one was taped, and so was Ludwig Weber. Joseph Keilberth conducted with a heavy hand and a stunning abstinence from imaginativeness, and the orchestra and chorus go a long way toward cementing the impression of a thoroughly second-rate effort. This was an early stereo recording, and at best it is no improvement over the mono offered earlier, in which the stage business sounds clumsy instead of vivifying, and balances and perspectives are not at all comfortable. According to the label, side one opens with the fanfare that calls Bayreuth audiences into the theatre, but it is not on the disc, which actually begins, conventionally enough, with the familiar Overture. In the old mono edition we did have the fanfare, the warning bell and the orchestra tuning up—the whole works in terms of atmosphere—but it was still, after all, the same unsatisfactory performance. The Klemperer version, on Angel at full price, is the one to go for if you want a *Dutchman*—and if you think you don't, the Klemperer could change your mind.

Since these three sets happened to be among the very few disappointments in London's exceptional catalogue, one can only wonder why it was felt necessary or desirable to reissue them. Perhaps, now that Böhm's marvelous *Frau ohne Schatten* has been restored in this series (in stereo now, at one-third of its original price in mono) and such other gems as the Clemens Krauss *Salome*, Ansermet's *L'Enfant et les Sortilèges* and Flagstad's *Alceste* have also been revived, it has become a matter of scraping the bottom of the barrel. But the indispensable Krauss *Zigeunerbaron* is still in Limbo, and it is high time it were made available again. **AE**

# it's KENWOOD: *pure...and simple*

Pure, clean tone...simple, elegant styling. And the most meticulously engineered stereo receivers, tape decks, compacts, tuners, amplifiers and speakers you've ever laid ears on. It's all waiting for you at your nearest KENWOOD Dealer — the best stereo components **pure...and simple!**



*the sound approach to quality*

 **KENWOOD**

15711 S. Broadway, Gardena, Calif. 90247  
72-02 Fifty-first Ave., Woodside, N.Y. 11377

Check No. 33 on Reader Service Card

**Oh?**

**This is what you'll say when you hear the price of the Sony 6200**

# ah!

## This is what you'll say when you hear the Sony 6200

The unusually high price of the new Sony 6200 receiver is a come-on. For once you know it, you can hardly resist the temptation to hear it perform and justify its lofty price. And once you hear it perform, you'll have to own this superb component.

The real joy of the 6200 lies in its performance. Balanced positive and negative power supplies permit direct coupling all the way through to the speakers for unusual clarity. There is power to spare by whatever measure: 360 IHF watts into 4 ohms, 70+70 watts *continuous* power into 8 ohms with both channels driven; a minimum of 60+60 at all frequencies from 20 to 20,000 Hz.

FM performance is equally distinguished. The FET front end raises the sensitivity to its theoretical limit (1.2  $\mu$ V for 20 dB quieting; 1.8  $\mu$ V IHF), while retaining the ability to handle strong local stations without overload and spurious response. Solid state i.f. filters ensure that the same superb performance you hear today, you'll enjoy many years later; the receiver never needs re-alignment.

Throughout, the accent is on pleasure: the silky feel of the flywheel tuning action. The precision and stability of the 6200's tuning: locate the frequency you want on the long, linear dial *with the power off*, and the station comes in clearly an instant after the power is turned on.

And the 6200 is always easily adaptable to your

desires: You can elect to hear only stereo broadcasts. Or you can switch out the interstation muting to find the weak and distant stations normally hidden in the interstation "hash" that muting eliminates (less than 3 $\mu$ V). Even moderately noisy stereo signals can be heard in stereo, thanks to a high-blend switch that reduces noise without affecting separation.

We could document all this performance with a host of specifications and graphs. But even these can merely indicate performance, not reveal it. The true revelation is your own listening experience, and the "ah" of your reaction to it. For many, that "ah!" will prevail over the "oh?" engendered by its price—converting that "oh?" perhaps to a Hmm... With which, of course, your Sony dealer will be glad to harmonize. For if he, too, did not take pleasure in good sound, he would not be a Sony dealer. Sony Corporation of America, 47-47 Van Dam St., Long Island City, New York 11101.



## New SONY® 6200 Stereo Receiver

Check No. 35 on Reader Service Card

# Phono Cartridge Survey

## *A buyers' guide to the best cartridges now available.*

**A**NY ROUNDUP of products is a fairly massive procedure, and there are certain to be omissions of individual reader's favorite products in the category, when one considers that in the directory 46 separate cartridges are listed, and these do not begin to include all the products of the several manufacturers. We estimate, for example, that there must be at least 65 different cartridges on the market from those manufacturers who are in the high fidelity industry. The only ones listed, too, are magnetic cartridges, since they have become the accepted standard for high quality sound reproduction.

Any testing of cartridges involves the use of phonograph records, and to be fanatically accurate, one should use a new record for each test—prohibitively expensive, considering that a frequency record, a square-wave record, and a wide-range test record must be used to provide a complete dossier on each cartridge. For frequency runs, the usual test record is the CBS STR-100. For wide-range measurements, the STR-120 is required, since the STR-100 covers the range only from 40 to 20,000 Hz. The STR-120 extends the range to 50,000 Hz at the high end, and down to 10 Hz at the low. Square-wave and intermodulation distortion tests necessitate the use of the STR-111 disc, which also has tracking information, although we used the STR-100 for tracking.

Additionally required are a scope, a graphic recorder, an a.f. voltmeter, an IM distortion analyzer, and a camera. The chart shows the "fixed" or static information about the cartridges tested, and will indicate that an ohmmeter and an inductance bridge are also needed, in addition to the equipment listed before.

Our first test was that of frequency

response, using the STR-100 record. Response was first recorded for the left channel from 40 to 20,000 Hz, followed immediately by crosstalk response of the left channel to a right-channel modulation on the disc. Next we duplicated the measurement using the right channel of the cartridge. We then put on the STR-120 record and measured response on the sweep from 500 to 50,000 Hz, also on both channels, and followed this by running curves on response from 500 down to 10 Hz. We then measured the output from the cartridge at a signal of 3.54 cm/sec, 1000 Hz, and divided the figure obtained by 3.54 to obtain the relative output in mV for a stylus velocity of 1 cm/sec, which provides a comparative figure.

We then connected the IM analyzer to the output of the measuring preamp—which, by the way, is equalized to provide a boost of 6 dB/octave below 500 Hz, and to be flat above that turnover frequency. The recording characteristic of the STR-100 record consists of a straight line at a slope of 6 dB/octave from 500 Hz down, and flat above. A complementary equalization to this is not obtainable by a simple RC network such as is used in ordinary preamps, and if the usual RIAA equalization is used, the resulting curve will have a 1.5 dB "bump" at 500 Hz, and will roll off slightly below 50 Hz. This latter we accept, but a resonant circuit is necessary to flatten the "bump" at 500 Hz. All measurements are made through this preamp except for the square-wave photos, which require a wide-band linear preamp.

The IM measurements are done at two recorded levels—at +9 dB for the lateral bands of different levels—starting

at +6 and increasing in 3-dB steps. The lateral bands of different levels—at +6 and increasing in 3-dB steps. The vertical portion has only three bands, +6, +9, and +12. These IM bands are presented in duplicate with different pairs of frequencies—one is with 400 to 4000 Hz, while the other is with 200 to 4000 Hz. We have selected only the +9 lateral modulation at 200 and 4000 Hz, and for the vertical measurement, we chose the +6 modulation at the same pair of frequencies. Thus the measurements should not be considered "absolute," but only relative.

One series of bands on the STR-100 consists of a 100-Hz signal recorded at stylus velocities of 6, 12, 18, 24, and 30 cm/sec. To determine the tracking force listed on the chart, we measured the lowest force that would track the 30-cm/sec groove without breaking up. All these measurements were then followed by changing the preamp and projecting the square wave on the scope and photographing it. The square wave photos are unretouched and are simply prints from the negatives made of the patterns displayed on the scope. One should always remember that the curves and photos are those of a single cartridge (two at the most), and while they are likely to be characteristic of the entire run of the specified models, they cannot necessarily be guaranteed as such. This is a caution which should be remembered with respect to reports on *any* equipment. The only realistic curves and data should be the average of a large number of individual units, which is, of course, impossible in a limited compilation such as this.

(Continued on page 38 )

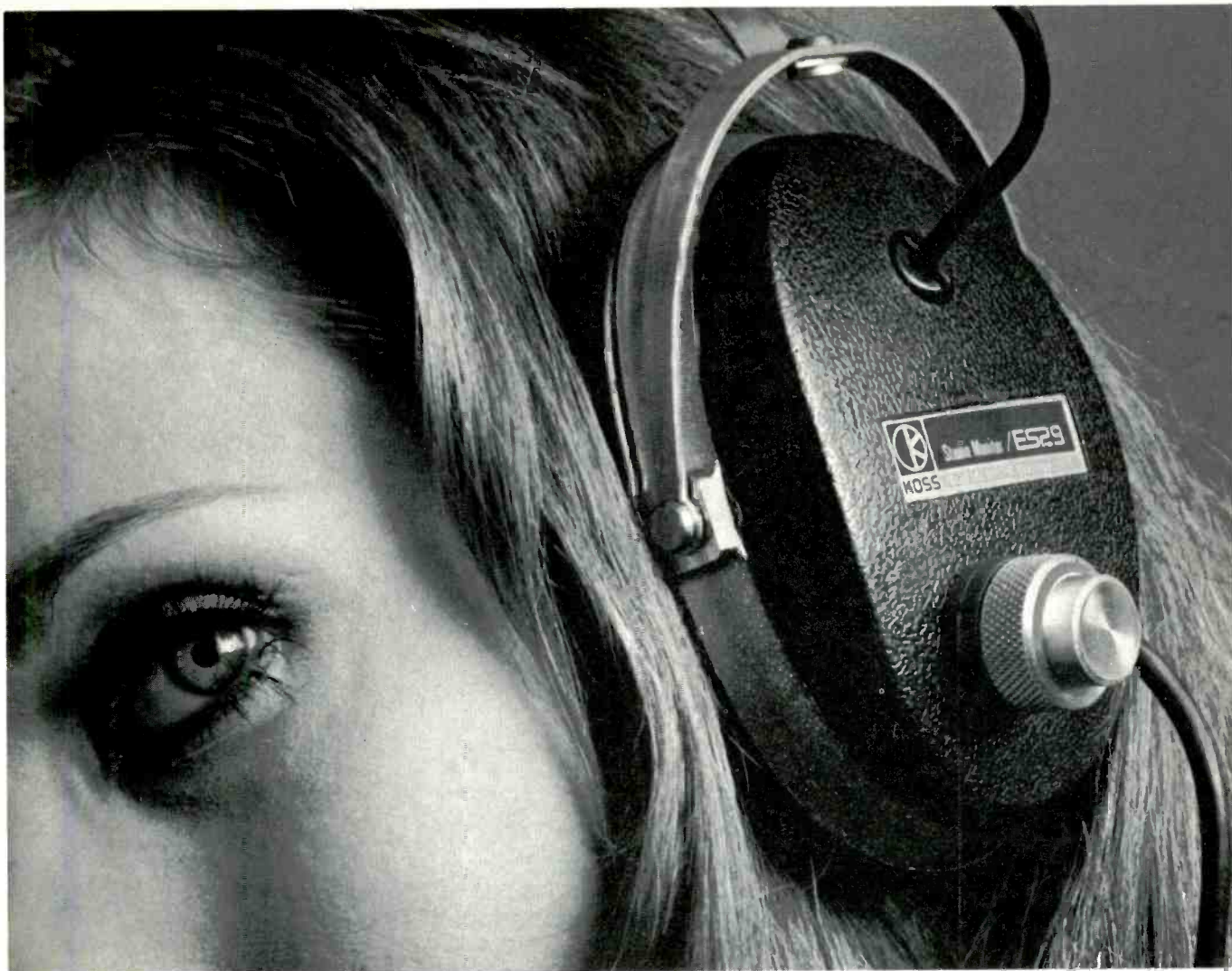

## If you haven't heard the only Stereophone in the world that lets you hear all ten audible octaves

### you haven't heard anything yet

The remarkable Koss ESP-9 Electrostatic Stereophone brings you distortion-free wide-range frequency response never before possible in headphones . . . flat  $\pm 2$  db monitoring over the entire audible spectrum of ten octaves. What's more, you get push-pull, balanced acoustical circuitry that cancels out all second harmonic distortion. The ESP-9 surpasses the range of even the finest loud speaker systems. Large, oversized coupling transformers in the external energizer unit provide high-power capability in the very low bass range . . . produce good wave form at 30 Hz with up to 10 volts



input. A simple selector switch on the energizer unit lets you quickly choose self-bias, or ac line energizing for precision level measurements. A soft, wide headband and patented, fluid-filled ear cushions provide for fatigue-free monitoring of the longest recording session. There's more to hear about the Sound of Koss. But until you try a set of Koss Stereophones for yourself . . . *you haven't heard anything yet.* Send for our new, free 16 page full-color catalog. Address your request c/o: Virginia Lamm, Dept. 41.

**KOSS Stereophones**

Koss Electronics, Inc., 4129 N. Port Washington Rd., Milwaukee, Wis. 53212 • Koss Electronics S.r.l., Via Valtorta, 21 20127, Milan, Italy

Check No. 37 on Reader Service Card

# STEREO CARTRIDGES

Directory of Manufacturers

ADC (see Audio Dynamics Corp.)

**Audio Dynamics Corp.**  
Pickett District Road  
New Milford, Conn. 06776  
Check No. 135 on Reader Service Card

**B & O of America**  
525 E. Montrose  
Wood Dale, Ill. 60191  
Check No. 134 on Reader Service Card

**Benjamin Electronic Sound Corp.**  
40 Smith St.  
Farmingdale, N.Y. 11735  
Check No. 133 on Reader Service Card

Decca (see Paoli High Fidelity Consultants)

EMI (see Benjamin Electronic)

**Elpa Marketing Industries**  
New Hyde Park, N.Y. 11040  
Check No. 132 on Reader Service Card

**Empire Scientific Corp.**  
1055 Stewart Ave.  
Garden City, N.Y. 11530  
Check No. 131 on Reader Service Card

Goldring (see IMF Products)

**Grado Laboratories, Inc.**  
4616 Seventh Ave.  
Brooklyn, N.Y. 11220  
Check No. 130 on Reader Service Card

**IMF Products**  
7616 City Line Ave.  
Philadelphia, Pa. 19151  
Check No. 129 on Reader Service Card

Norelco (see North American Philips Corp.)

**North American Philips Corp.**  
100 E. 42nd St.  
New York, N.Y. 10017  
Check No. 128 on Reader Service Card

Ortofon (see Elpa Marketing)

**Paoli High Fidelity Consultants**  
P.O. Box 876  
Paoli, Pa. 19301  
Check No. 127 on Reader Service Card

**Pickering & Co., Inc.**  
Sunnyside Blvd.  
Plainview, N.Y. 11803  
Check No. 126 on Reader Service Card

**Shure Brothers, Inc.**  
222 Hartley Ave.  
Evanston, Ill. 60202  
Check No. 125 on Reader Service Card

**Stanton Magnetics**  
Terminal Drive  
Plainview, N.Y. 11803  
Check No. 124 on Reader Service Card

MANUFACTURER (Circled number indicates adv. page)	MODEL	Frequency Response, Hz	S/N Ratio, dB	Separation, 100 Hz @ 10 dB	Separation, 10 kHz @ 10 dB	Output, mV/cm/sec	Tracking-force Range, dyn.	Load Resistance, ohms	Stylus Type (see letter code)	Stylus Radius (Rd), mils	Replacement	Weight, gms.	Price	SPECIAL FEATURES	Stylus type C - Conical E - Elliptical
ADC	25	10-24K ±2	30	30	0.73	1/2-1 1/4	47K	E	0.3 x 0.7 0.3 x 0.7 x 0.6	User		100.00		Only 3-stylus ctg. which allows custom matching to each record.	
	26	10-24K ±2	30	30	0.73	1/2-1 1/4	47K	E	0.3 x 0.7	User		75.00		As above, but with single stylus assembly.	
	27	10-22K ±2	30	30	0.73	1/2-1 1/2	47K	E	0.3 x 0.7	User		65.00			
	10E-MK II	10-20K ±2	30	30	0.73	1/2-1 1/2	47K	E	0.3 x 0.7	User		59.50			
	550XE	10-20K ±2	20	20	0.92	1/2-2	47K	E	0.3 x 0.7	User		44.95		Top of new line of induced magnetic ctg. All stylus in "X" series are interchangeable.	
	990XE	10-20K ±2	20	20	0.92	1-2	47K	E	0.3 x 0.7	User		29.95			
	220	10-18K ±3	20	20	0.92	2-5	47K	C	0.7	User		9.95		220XE, with elliptical stylus, \$22.00.	
B&O	SP-12	15-25K ±3	25	20	1.0	1/2-1.5	47K	E	0.2 x 0.7	User		8.5	69.95	Response 50-10K ±1.5dB "Naked" diamond stylus.	
DECCA	4RC	30-16K ±3	25	23	7.5	3-3 1/2	47K	E	0.5 x 0.5				65.00		
ELAC	444-E	10-24K	26	17	1.0	.075	47K	E	0.2 x 0.9	User		6.5	69.50		
	444-12	10-24K	26	17	1.0	.075	47K	C	0.5	User		6.5	59.50		
	344-17	20-22K	24		1.0	1	47K	C	0.7	User		6.5	39.50		
	244-17	20-22K	22		1.5	1.5	47K	C	0.7	User		6.5	24.95		
EMPIRE	1000ZE X	4-40K	35	25	1.5	1/2-1 1/2	47K	E	0.2 x 0.7	User		7	99.95		
	999VE X	6-36K	35	25	1.7	1/2-1 1/2	47K	E	0.2 x 0.7	User		7	79.95		
	999TE X	6-32K	35	25	1.7	1/2-1 1/2	47K	E	0.2 x 0.7	User		7	64.95		
	999SE X	8-32K	35	25	2.0	1/2-1 1/2	47K	E	0.3 x 0.7	User		7	49.95		
	999PE X	8-32K	35	25	2.0	1/2-2	47K	E	0.3 x 0.7	User		7	44.95		
GOLDRING	800-Super E	15-21K	30	20	0.8	1/2-1 1/2	47K	E	0.3 x 0.8	User		7	69.50	For "state-of-the-art" tone arms; response curve furnished	
	800E-Mk II	20-20K	30	20	1.0	1-2	47K	E	0.3 x 0.8	User		7	39.95	For very good record players; tracing at 1 gm or slightly over.	
GRADO	F-1	7-40K	35	30	0.8	0.7-2	Any	*	*	User		5.5	75.00	*Patented twin-tip-2 separate 0.3-mil conical tips ground on one diamond "Fluxbridge" generator.	
	F-3	7-40K	35	30	0.8	0.7-2	Any	C	0.6	User		5.5	49.50	"Fluxbridge" generator.	
NORELCO	412	20-20K	30	20	1.0	1/2-1 1/2	47K	E	0.3 x 0.7	User		7	67.50	Individually calib. chart of freq. resp. supplied with each cartridge.	
ORTOFON	S-15M/T	20-20K	30	25	0.6	1-2	47K	E	0.3 x 0.7	Factory		31	85.00		
	S-15/T	20-20K	30	25	0.6	1-2	47K	E	0.3 x 0.7	Factory		18 1/2	80.00		
	SL-15/T	20-20K	30	25	0.6	1/2-1 1/2	47K	E	0.3 x 0.7	Factory		7	75.00		
	SL-15	20-20K	30	25	.02	1/2-1 1/2	2	E	0.3 x 0.7	Factory		7	60.00	Pre-amp MP-235, \$60.	
PICKERING	XV-15/750E	10-25K	30	22	4.4	1/2-1	47K	E	0.2 x 0.9	User		5	65.00		
	XV-15/40E	10-25K	30	22	5.5	1/2-1 1/2	47K	E	0.3 x 0.9	User		5	54.95	All XV-15 models include "V-Guard" replaceable stylus and "Dustomatic" brush hinged to stylus assembly, exclusive snap-in cartridge mount.	
	XV-15/350	10-25K	30	22	6.0	1-3	47K	C	0.7	User		5	39.95		
	XV-15/200E	10-25K	30	22	8.0	2-4	47K	E	0.4 x 0.9	User		5	49.95		
	V-15/Phase IV-AME	10-25K	30	22	5.5	1 1/2	47K	E	0.3 x 0.9	User		5	49.95	V-15/Phase IV series has high profile; Low mass stylus assembly includes "Dustomatic" brush.	
	V-15/AM-3	10-25K	25	20	6.5	1-3	47K	C	0.7	User		5	34.95	V-15 3 series has "Dustomatic" brush; 15-degrees tkg. angle; snap-in cartridge mount.	
	V-15/AME-3	10-25K	25	20	5.5	1/2-1 1/2	47K	E	0.3 x 0.9	User		5	49.95		
	SHURE	V-15 Type II Improved	20-25K	25+		0.7	1/2-1 1/2	47K	E	0.2 x 0.7	User		6.8	67.50	Analog-computer-designed for finest-quality TT's.
V-15 Type II-7 Improved		20-25K	25+		0.7	1/2-1 1/2	47K	C	0.7	User		6.8	62.50	As above, except with conical stylus.	
M91E		20-20K	25+		1.0	1/2-1 1/2	47K	E	0.2 x 0.7	User		5	49.95	New series of high-trackability cartridges for good turntables.	
M93E		20-20K	25+		1.2	1 1/2-3	47K	E	0.4 x 0.7	User		5	39.95	As above.	
M75E		20-20K	25+		1.2	1/2-1 1/2	47K	E	0.4 x 0.7	User		6	34.95	Lowest cost high-trackability cartridge for upgrading older turntables.	
M-75-6		20-20K	25+		1.2	1 1/2-3	47K	C	0.7	User		6	24.50	As above, conical stylus.	
STANTON	681A	10K-20K	35		1.1	1 1/2-3	47K	C	0.7	User		5.5	66.00	All models with "Longhair" brushes. Primary calib. std. for rdg. sys. checkout.	
	681EE	10-10K ±1/2 dB	35		0.82	1/2-1 1/2	47K	E	0.2 x 0.9	User		5.5	72.00	For critical listening; high compliance, low mass, and low kg. force assure min. wear.	
	681SE	20-10K ±1/2 dB	35		1.1 +2	2-4	47K	E	0.4 x 0.9	User		5.5	66.00	More rugged ctg. ellip. stylus des. for med. force, exc. freq. resp. and linearity.	
	500A	20-10K ±1dB	35		1.0	2-5	47K	C	0.7	User		5	30.00	For heavy-duty on-the-air use	
	500AA	20-10K ±1dB	35		1.0	1-2 1/2	47K	C	0.5	User		5	35.00	For auditioning-room use	
	500E	20-10K ±1dB	35		1.0	2-5	47K	E	0.4 x 0.9	User		5	35.00	Larger stylus radius, tougher armature susp. for long life in broadcast applications.	



# THE SANSUI QS-1 QUADPHONIC SYNTHESIZER®



**SANSUI QS-1**

## 4-CHANNEL SOUND FROM ANY 2-CHANNEL SOURCE

**Senses and recovers the ambient information hidden in your stereo discs, tapes and broadcasts**

After having discovered that the ambient components of the original total sound field are already contained in hidden form, in conventional stereo records, tapes and broadcasts, Sansui engineers developed a method for sensing and recovering them. These subtle shifts and modulations, if re-introduced, breathtakingly recreate the total of the original sound as it existed in the recording or broadcast studio.

The heart of the Sansui Quadphonic Synthesizer\* is a combination of a unique reproducing matrix and a phase modulator. The matrix analyzes the 2-channel information to obtain separate direct and indirect components, then redistributes these signals into a sound field consisting of four distinct sources.

This type of phase modulation of the indirect components, applied to the additional speakers, adds another important element. It sets up a complex phase interference fringe in the listening room that duplicates the multiple indirect-wave effects of the original field. The result is parallel to what would be obtained by using an infinite number of microphones in the studio (M1 through Mn in the accompanying illustration) and reproducing them through a corresponding number of channels and speakers.

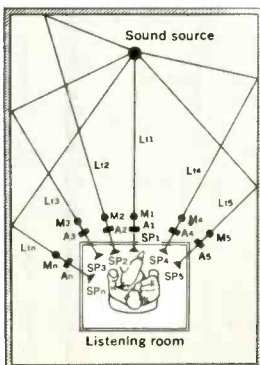
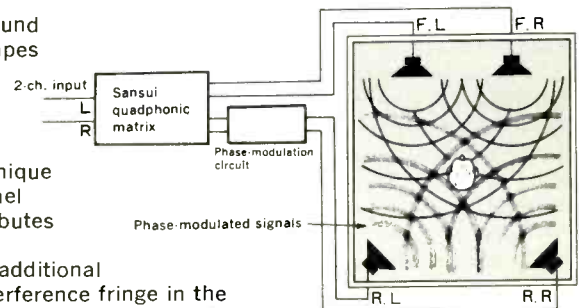

The startling, multidimensional effect goes beyond the four discrete sources used in conventional 4-channel stereo, actually enhancing the sense of spatial distribution and dramatically expanding the dynamic range. Also, the effect is evident anywhere in the listening room, not just in a limited area at the center. And that is exactly the effect obtained with live music! This phenomenon is one of the true tests of the Quadphonic system.

The Sansui Quadphonic Synthesizer QS-1 has been the talk of the recent high-fidelity shows at which it has been demonstrated throughout the country. You have to hear it yourself to believe it. And you can do that now at your Sansui dealer. Discover that you can hear four channels plus, today, with your present records and present stereo broadcasts. \$199.95.

\*Patents Pending



**SANSUI ELECTRONICS CORP.**

Woodside, New York • Gardena, California

SANSUI ELECTRIC CO., LTD., Tokyo, Japan • Frankfurt a. M., West Germany

Electronic Distributors (Canada), British Columbia Check No. 39 on Reader Service Card

## Phono Cartridge Survey—Continued

### ADC-25

This cartridge was profiled in the July, 1969 issue and is included in addition to the ADC-220 because we have long used it as a reference standard. Our unit has a frequency response which is within 1dB up to 20,000 Hz! It uses the induced-magnet principle whereby the stylus does not move a heavy magnet; instead the magnet is fixed and the stylus moves between the pole pieces. Three styli are provided—two bi-radial or elliptical and one conical type. Styli can be interchanged in a matter of seconds and, in theory, the critical user can get optimum results from his records. Available as ADC-26 with single elliptical stylus at a reduced price.

IM dist.: 1.6 lat., 2.2 vert. Tracking: 0.75 g.

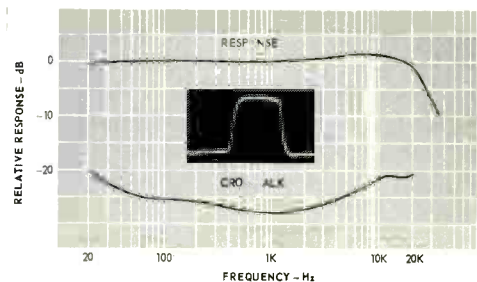
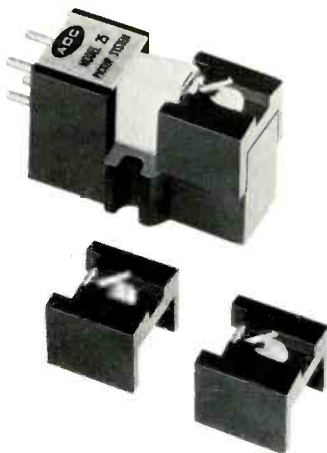

### ADC-220XE

This is a relatively inexpensive model, using the same induced-magnet principle as the ADC-25 described above. Response continues to about 35,000 Hz preceded by a small peak around 15,000 Hz. Separation is in the vicinity of 25dB at 1000 Hz, falling to 20 dB at 10,000 Hz. It is an up-dated version of the older ADC-220, having the new snap-on stylus assembly.

IM dist.: 2.5 lat., 5.4 vert. Tracking: 0.75 g.

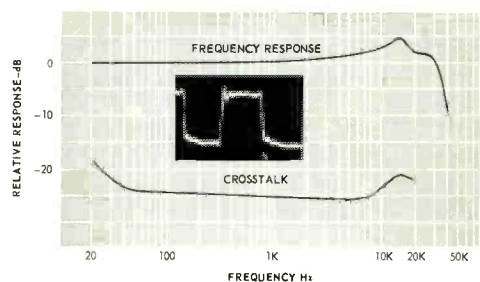

### Audio Technica

This unit may or may not be on the market under this name, but the product is used by a number of manufacturers in completed modular systems. Performance is reasonably comparable with other models—flat to about 5 kHz, then rising 4 dB at 9000 and remaining there to 20,000, then rolling off to -5 dB at 30 kHz. Separation is 22 dB through most of the range, rising to 26 at 3500 Hz, then gradually decreasing to 10 dB at 15 kHz.

IM dist.: 2.1 lat., 2.8 vert. Tracking: 0.75 g.

This model, AT-35X, is used in the Electro-Voice *Landmark 100* compact system, which was reviewed in the November, 1970 issue.

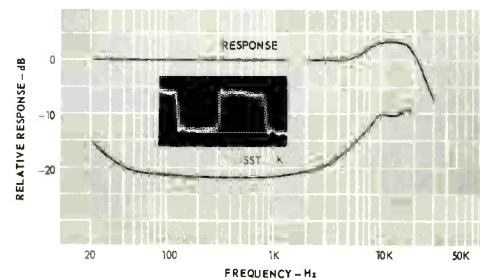

### Decca 4RC

This cartridge was reviewed in June, 1970 and it has several interesting features. No cantilever is used between stylus and magnet which, it is claimed, results in more accurate tracing of the record grooves. Tracking weight is higher than most other top-grade cartridges but, according to the manufacturers, record wear is less due to the lower effective tip mass and use of a hand-polished diamond. The reviewer stated "it measures better and sounds better than any other pickup I have tested to date." Note that this product is manufactured by Decca Gramophone Ltd. of England, which is in no way connected with Decca Records, a division of MCA, Inc. of New York.

IM dist.: 2.1 lat., 2.5 vert. Tracking: 3 g.

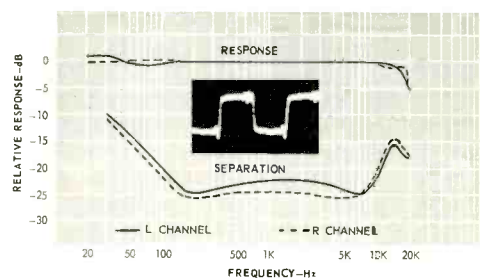

## B&O SP-12

This unit was profiled in the October, 1970 issue with a complete description of its mechanism. The stylus arm terminates in a "micro-cross" which relays the flux to the four pole pieces. Response is smooth up to about 15 kHz, then rises some 4 dB at 21 kHz, after which it drops off to -10 dB at 30 kHz. Separation is around 20 dB dropping to 12 dB at 20 kHz.

**IM dist.:** 3.2 lat., 4.0 vert. **Tracking:** 0.5 g.

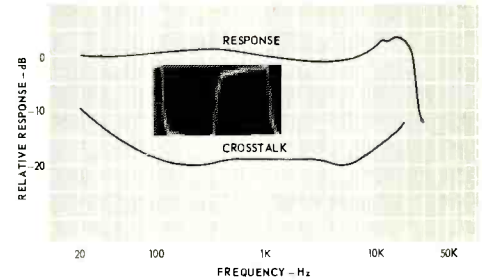
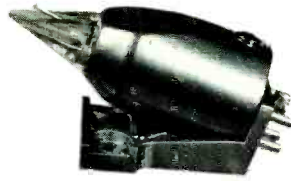

## Elac STS-444E

The Elac cartridge employs the moving-magnet principle, invented by Dr. Ahrens of that company. The magnet—a tiny bit—is in the end of the stylus arm opposite the stylus, and its movements generate the flux changes through the four coils. The method is simple, effective, and relatively easy to manufacture. The differences in performance of the various models using this construction testify to the ingenuity of the individual designers in adapting the method to their products. This cartridge is very flat up to 20,000 Hz, then drops off to 10 dB down at 26,000. Separation is better than 25 dB throughout most of the range, dropping to 15 at 10 kHz, and 10 at 20 kHz.

**IM dist.:** 3.0 lat., 4.0 vert. **Tracking:** 0.75 g.

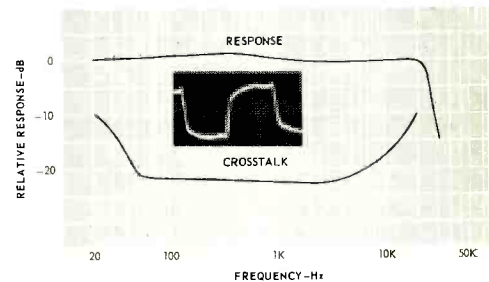
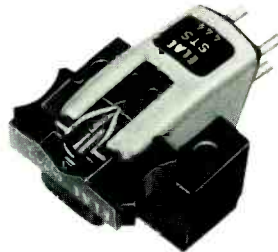

## Empire 1000ZE/X

The 1000 ZE was profiled in the November, 1970 issue, but the "X" model is still an improvement. Response is smooth, being 1 dB down at 10 kHz, 3 dB at 20 kHz, and about 8 at 30 kHz. Separation is better than 25 dB to above 10 kHz, and then drops to 15 at 20,000. Flatness of response is attributed by the manufacturer to the use of laminated pole pieces. The built-in stylus protector swings down to keep the stylus from contact with undesirable objects until you want to play a record. Then you swing the protector up and away.

**IM dist.:** 2.2 lat., 3.0 vert. **Tracking:** 0.5 g.

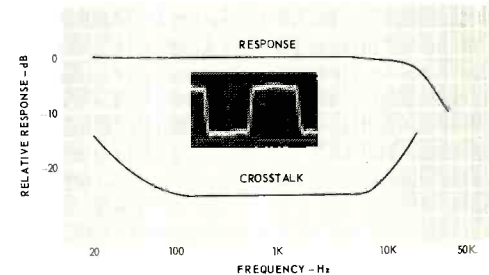

## Goldring 800 Super E

This British-made product is praised by many users, and it is a pleasant sounding unit, fairly flat to 20 kHz, with a little trough at 5000 to 7000 Hz—about 3 dB. This is not an uncommon condition with cartridges, and probably results from damping to eliminate the main resonant peak, which in this unit is about 21 kHz. Separation is about 22 dB throughout the spectrum up to about 15 kHz, and then it decreases to about 15 dB at 20 kHz.

**IM dist.:** 2.1 Lat., 4.3 vert. **Tracking:** 0.75 g.

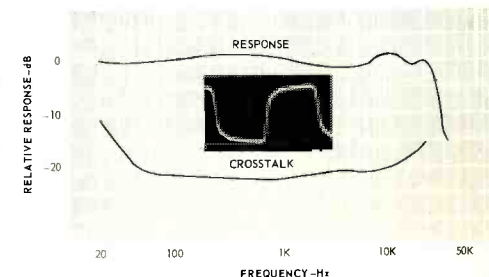
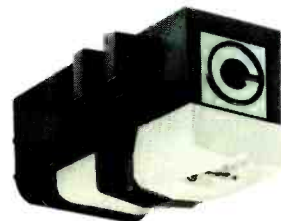

# Phono Cartridge Survey—Continued

## Grado F-2

Another new principle—this time using a “flux-bridging” generator. The generator itself is a toroidal structure with four gaps. The moving element is placed adjacent to the gaps but affects only the fringe field and acts much like a moving-coil pickup. Note the low inductance of the coils which are so placed as to neutralize hum pickup, thus eliminating the need for a shield. Response is flat and slightly rising to +1 dB at 20 kHz, then drops to only 10 dB down at 50 kHz. Obviously this cartridge should be a logical choice for playing the four-channel discs. Separation is better than 25 dB over most of the spectrum, and is still at least 15 dB at 45 kHz.

**IM dist.: 2.5 lat., 6.0 vert. Tracking: 1.0 g.**

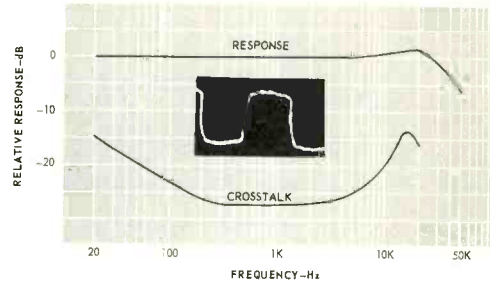

## Ortofon SL-15

The only moving-coil cartridge in this survey, the Ortofon has long been on the market in two forms—with a transformer built into the cartridge itself, and with a separate transformer to be connected between the cartridge and the usual 47,000-ohm-input preamp. Note that in the chart, the inductance of the coil itself is shown as 350 microhenries, rather than in the usual millihenry range. Since the cartridge output impedance is only 2 ohms and its output is .04 mV/cm/sec, some additional step-up in voltage is required for the average preamplifier. We had both the separate transformer, and a new pre-preamp which is now available for use with the Ortofon, and we made measurements with both. Response was similar, essentially flat to 10 kHz on the high end, then rising to a peak of about 15 dB at 23 kHz, then dropping back to flat again at 50 kHz. This would result in considerable “brightness,” but with some speakers it might be considered desirable. And for four-channel records, it would be ideal. The response peak, which is quite broad, actually, can be corrected readily by most tone controls, and especially so with some of the selective equalizers. Separation with either amplifier or transformer was about 22 dB throughout the entire range, in consideration of the increased response in the 20-30 kHz range.

The new pre-preamp consists of a single grounded-base transistor in each channel along with a very well filtered power supply and input and output jacks. It represents a desirable addition to the Ortofon, since it eliminates the possibility of hum pickup by the exposed—although well shielded—transformer.

**IM dist.: 2.2 lat., 3.8 vert. Tracking: 1.0 g. with transformer: 2.6 lat., 4.0 vert.**

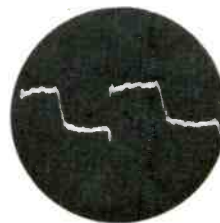
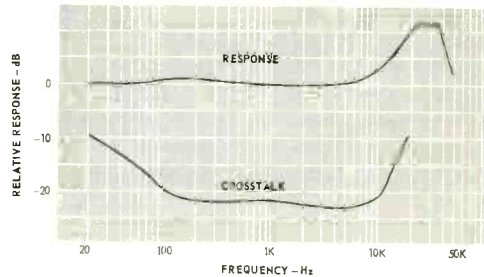

With amplifier.

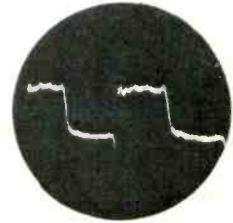

With transformer.

## Pickering XV15-750E

The top-of-the-line descendant of the first magnetic cartridge to attain popularity in the high fidelity field, the XV15-750E has a very flat response to 10 kHz, then rises about 3 dB at 19 kHz and drops off to -10 dB at 30 kHz. Separation is better than 25 dB, then decreases smoothly to about 6 dB at 20 kHz. The Pickering's employ the "Dustomatic" brush which rides in the groove ahead of the stylus and clears it from dust and lint—no more "rugs" on your styli. The new plastic fixtures for mounting simplify the entire operation of putting a cartridge into the head, since the fixture snaps into the head or attaches by a single screw and the cartridge is simply snapped into the plastic fixture.

**IM dist.:** 2.6 lat., 2.8 vert. **Tracking:** 0.5 g.

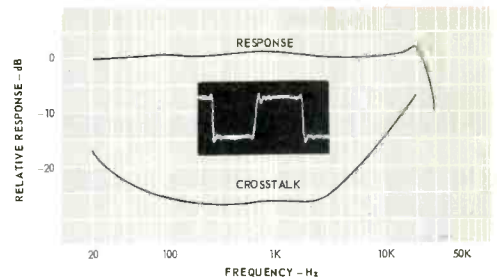
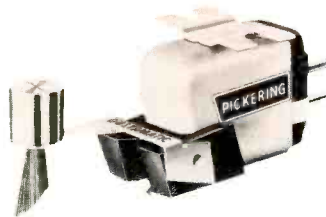

## Shure V15-II, Improved

This cartridge is the top of a long line of fine cartridges—individually tested before leaving the factory, and recognized as one of the choices of many audiophiles. When used with the recommended capacitance in the connecting cables—450 pF—this cartridge is flat within 1 dB to 20 kHz, then falls off rapidly, being down 10 dB at 24 kHz. Separation is around 27 dB throughout, up to 15 kHz, then decreasing to 15 dB at 20 kHz. The V15-II, Improved was profiled in the March, 1970 issue.

**IM dist.:** 2.6 lat., 2.8 vert. **Tracking:** 0.5 g.

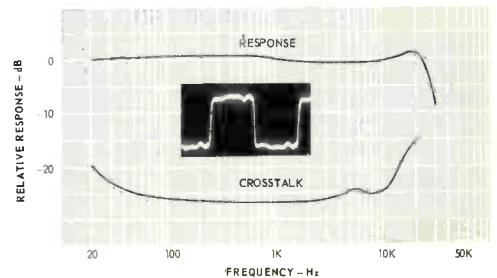
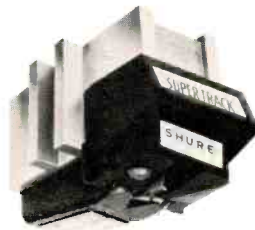

## Stanton 681EE

This cartridge is known as the "calibration standard," and is used for this purpose in many recording studios and record factories. It is guaranteed flat within +1.5 dB to 15 kHz, and a calibration is provided with each one as it leaves the factory. The one we measured was right on the button with the specifications on the calibration slip which accompanied it (which serves as a justification of our own equipment.) The separation is better than 25 dB from 60 to 2000 Hz, then decreases gradually and smoothly to 8 dB at 10 kHz, and remaining in that vicinity up to 20 kHz. The unit is beautifully packaged (as a matter of fact, packaging of cartridges is becoming as important as the packaging of cosmetics has been for years), with a gleaming metal case, plus a smaller metal case in which you can store your spare styli and also a small screwdriver. And with the exception of the Ortofons and Decca every cartridge in this survey has a user-interchangeable stylus, so you can go from conical 0.5-mil to various tip radii on elliptical or in some instances, to a 3.0 or 2.7-mil stylus for playing your old 78's. If you can remember that far back. The unit is shown with its dust brush.

**IM dist.:** 2.3 lat., 2.3 vert. **Tracking:** 0.5 g.

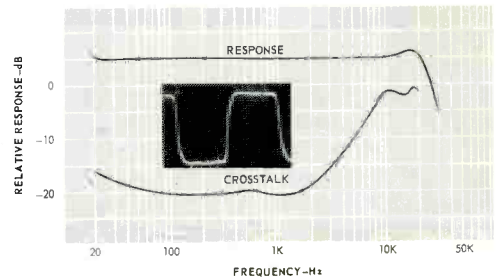

# Equipment Profiles

- V-M Synchro-Matic Turntable 44
- TEAC A-7030U Stereo Tape Deck 46
- Sherwood S-7100 AM/FM Stereo Receiver 50

## V-M "Synchro-Matic" Automatic Turntable, Model 1555

### MANUFACTURER'S SPECIFICATIONS:

**Speeds:** Two, 33 $\frac{1}{3}$  and 45 rpm. **Motors:** two, synchronous; one for turntable, one for cycle change. **Dimensions:** 18 $\frac{3}{4}$ " wide, 14 $\frac{3}{4}$ " deep, 6 $\frac{1}{2}$ " high over dust cover. **Weight:** 20 lbs. **Price:** \$220, with Shure M-71 cartridge, dust cover, and base.

For some strange reason, there have been no truly high fidelity record changers made in the U.S.A. for almost the history of the high fidelity industry. There have been many excellent single-play turntables made here, and very few anywhere else in the world, but the high quality *changer* has remained the province of the Germans and the British, with one recent importation from Italy which looks good, but which we have not tested to date.

The new V-M "Synchro-Matic" does qualify as a high fidelity changer, and it offers a number of features not exhibited heretofore in automatic turntables.

Audiophiles have often been worried about the use of a single motor for both record turning and the operation of the changing mechanism, in spite of the excellent performance that several European manufacturers have gotten out of single-motor automatics. The audio buff who sticks with his single-play turntable will argue that the better tape recorders have three motors, so why can't a turntable have a motor for each function—which would require but two, while the professional tape recorders need three for the functions of rewinding, take-up, and the constant-speed capstan drive.

The V-M is the first automatic we have seen that employs two motors. Both are small "clock-type" synchronous designs, with the turntable motor revolving at 300 rpm and the changer motor turning at a geared-down 4 rpm, but still completing its change cycle at 13 seconds at either turntable speed.

The operating procedure of the V-M turntable is as follows: After actuating the cycle—by depressing either the automatic or manual play keys or by the arm on completion of a record—the turntable motor stops, the arm rises and swings

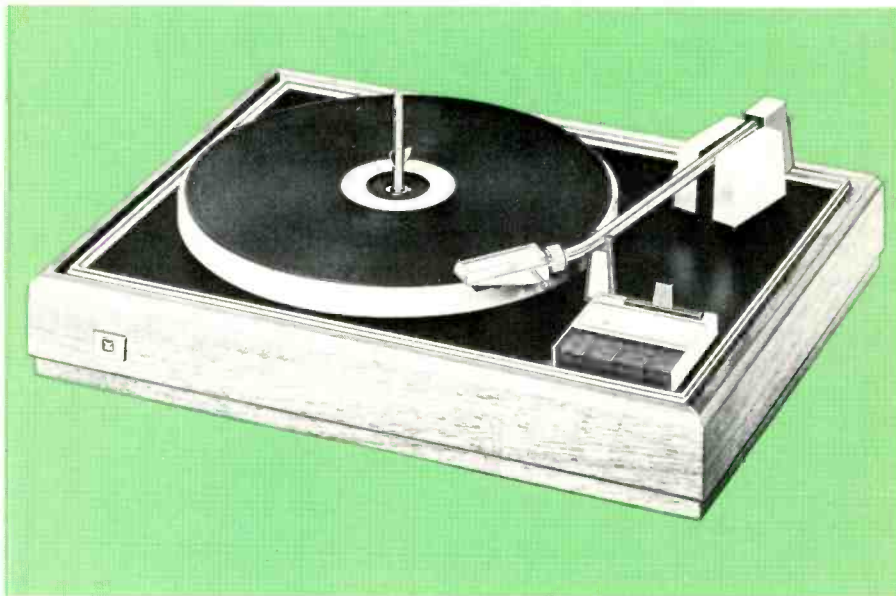

to the right, the next record is lowered half way to the platter, its diameter is sensed by the arm, which then backs off about  $\frac{1}{8}$  in., the record is lowered to the platter, the arm moves in to the first-groove position, the turntable starts rotating, and the arm lowers gently to the record. That is quite a complicated procedure, but it is controlled by a single cam driven directly by the change-cycle motor, geared down to 4 rpm. During the cycle, a switch wafer driven by the shaft of the change-cycle motor shorts the pickup leads for silence during the change. While the record is playing, the arm has no mechanical connection with any of the cams and levers of the changing mechanism. It has an extension of arcuate form which obscures the light from a small lamp, preventing it from shining on a photo-sensitive cell. At the end of the play, the end of the extension moves past the light beam, which illuminates the cell and inaugurates the change cycle. The operating cam is a die-cast disc with grooves and convolutions on it which actuate the various levers that perform the multitudinous movements to cause the change. The center spindle, with its three arms, is actuated by a flat beryllium-copper spring strip which is moved horizontally, parallel to the chassis, then is guided around a curved path to end up as a vertical motion in the spindle.

The turntable proper—an aluminum stamping with its rubber pad neatly finished—rests on the "drive turntable," another stamping which is driven by a flat rubber belt from the drive motor turning at 300 rpm. Change of speed is accomplished by a lever which coaxes the belt from the smaller diameter of the motor shaft for the 33 $\frac{1}{3}$  speed to the larger diameter for the 45, and back again as directed by the control just back of the operating keys. Raised numbers are uncovered as the control is moved from one position to the other to indicate the turntable speed.

The arm is an aluminum tube with a 28-deg. bend near the head, which plugs into a socket in the end of the arm. The head—a plastic molding, chrome "plated" by the usual evaporation process—is held in place by a collet-like ring, and accommodates the cartridge in an adjustable position to compensate for variations in overhang. Balancing the arm is simplified by a knob which actuates a roller that bears on the underside of the arm extension and moves the weight forward and backward as the knob is turned. Auxiliary metal strips are provided to increase the mass of the counter-weight for cartridges heavier than normal.

After the arm and cartridge are balanced, the stylus force is set by another knob on the left side of the arm mounting, with the force being

indicated through a small hole in the front of the housing. A height adjustment screw is accessible from the top of the mount, while another adjustment for stylus landing is accessible once the platter is removed—a simple operation, since it is held onto the drive turntable by a “C” washer.

The mechanism is supported from the chassis plate by rubber mounts to reduce the effect of external bumps or vibration on the unit. Cup washers can be inverted over the rubber mounts to lock the mechanism to the chassis plate for transporting.

At the rear of the unit are three openings—one for the power cord, one for an accessory a.c. outlet, and one for the signal output phono receptacles, along with a ground screw. Four good-sized rubber feet serve to hold the mechanism into the walnut-finished case, which provides excellent protection to the mechanism with its fiber-board bottom plate. An attractive smoky plastic dust cover fits onto grooves in the base.

## Operation

Four operating keys are provided—stop, automatic, manual, and cue. As many as six records may be stacked on the spindle, and automatic play is started by depressing the auto key. For manual playing, a single record is placed on the spindle and the manual key is depressed, starting a change cycle, lowering the record to the platter, and bringing the arm over the starting groove, where it can be lowered by depressing the cue key. The arm may be lifted at any place by again depressing the cue key, and lowered again into the same groove by another action of the key.

## Performance

Before actually using the unit to play records, we made all the usual tests and measurements, using the Shure M71MB cartridge with which the unit is equipped. In the important range—6 to 250 Hz—we found wow-and-flutter to be a low .06%, which increased to only 0.1% in the range from 0.5 to 6 Hz. The signal-to-noise ratio measured 34 dB, unweighted, which would approximate 54 dB if we convert this to the “audible rumble loudness level,” which more accurately describes the effect on the ear with the average home system. The 13-second change cycle was constant for either speed of the turntable, as would be expected since it is the result of using a separate motor for the changing operation. Most changer mechanisms are driven by the turntable platter itself, and at different speeds

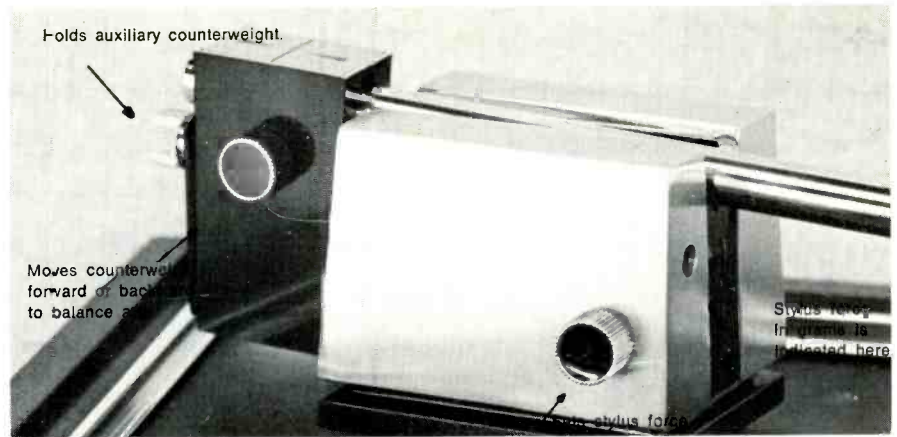

Fig. 1—Close-up of arm mounting and counterbalance.

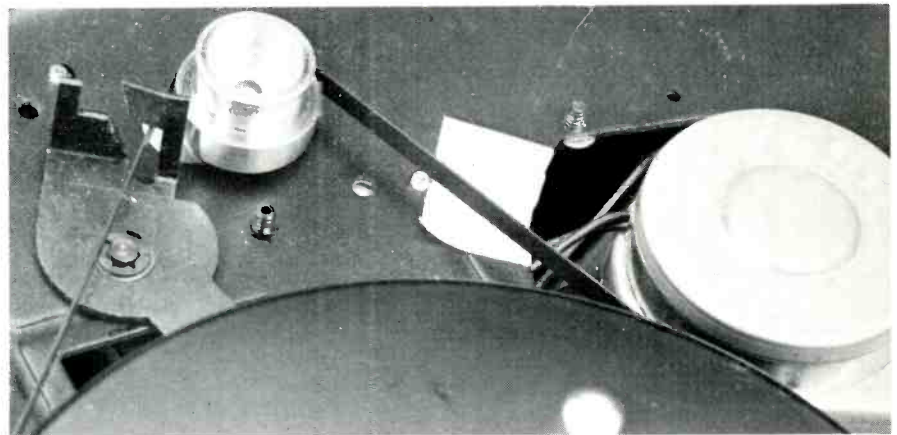

Fig. 2—Close-up of turntable drive motor pulley and belt-shifting mechanism. Belt is in the 45 rpm position.

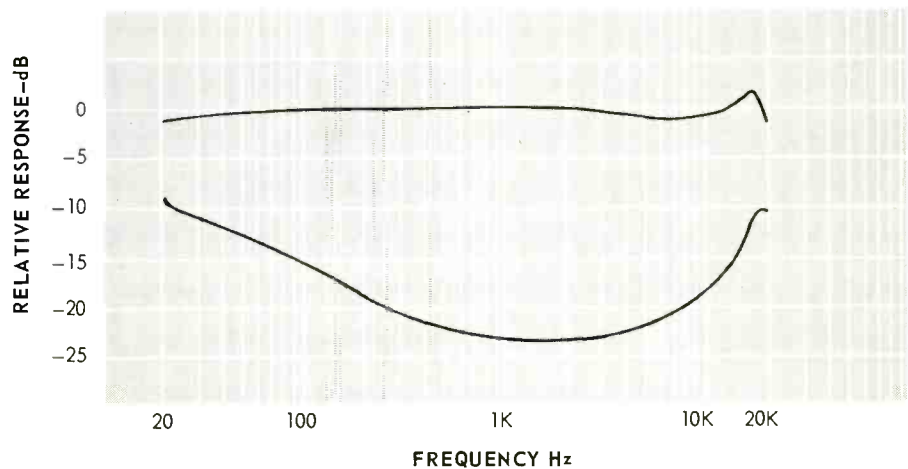

Fig. 3—Frequency response curves of the V-M Synchro-Matic 1555 equipped with a Shure M71MB cartridge.

the time of cycling varies.

In playing use, the unit performed as its measurements indicated, with consistent operation over a number of hours of listening. The V-M “Synchro-Matic” is built economically, with the use of plastics where they would suffice, as is usual with modern designs. But we could find no fault with their use in the performance of the unit. We did find one “problem” in its operation—with a single record on the platter, de-

pressing the manual key would cause a change cycle, and then the turntable drive motor would stop. A little study taught us that the turntable motor could be persuaded to continue if we stopped the arm during the cycle at the time it was “feeling” the diameter of the record. That was the simple answer to the puzzling behavior of the unit, and once we learned that, the problem ceased to exist.

C. G. McP.

Check No. 45 on Reader Service Card

## TEAC A-7030U Stereo Tape

### Deck

#### MANUFACTURER'S SPECIFICATIONS:

**Speeds:** Two, 15 and 7½ ips. **Heads:** Four; two-track erase, record, and playback, and four-track playback. **Reel Size:** 10½" max. **Motors:** Three; dual-speed hysteresis synchronous for capstan drive, two eddy-current for reel turntables. **Wow and Flutter:** 15 ips, .05%; 7½ ips, .08%. **Signal-to-Noise Ratio:** 58 dB (2-track); 55 dB (4-track). **Crosstalk:** 40 dB at 1000 Hz. **Frequency Response:** 15 ips, 40 to 20,000 Hz ± 2 dB; 7½ ips, 50 to 15,000 Hz ± 2 dB. **Inputs:** Microphone, 10,000 ohms, 0.5 mV min.; line, 300,000 ohms, 0.1 V min. **Output:** Approximately 1 V for a load impedance of 100,000 ohms or more. **Fast Winding Time:** Approximately 200 sec. for 2400 ft. of tape. **Dimensions:** 20¾" high, 17¾" wide, 8-1/16" deep, (10" over knobs). **Weight:** 62 lbs. **Price:** \$749.50.

This is the first tape deck with the 15-7½-ips speed combination we have been privileged to examine in a long time, and it is a delightful machine to operate. The control is by relays and solenoids, which makes it possible to add a remote-control accessory when desired, and for special applications such as language laboratories, another accessory—a remote pause control—is available.

The A-7030U accommodates 10½ reels, as well as any smaller sizes one wishes to use. It is basically a two-track machine, but has the additional four-track head for playing tapes recorded with this configuration—which naturally includes most pre-recorded tapes.

The unit has the usual arrangement with the reels at the top, the operating controls in the lower portion of the transport section, the amplifier is in a separate chassis mounted in the same cabinet as the transport.

The operating controls along the lower portion of the transport are: the power switch, with a pilot light above it, followed by the tape-speed switch, the reel-size switch, the two track/four track switch, all of which are push-push buttons, and the CUE button, a momentary switch. To the right are three short bars controlling tape motion—REWIND, FAST FORWARD, and PLAY, with a long STOP bar underneath them. At the right edge of the panel are the RECORD button, with the RECORD pilot light above it. The head assembly is above the push-push switches, and the counter, driven by a belt from the supply reel, is to its left. Above the counter is a stabilizer roller with a compliance arm alongside, the latter

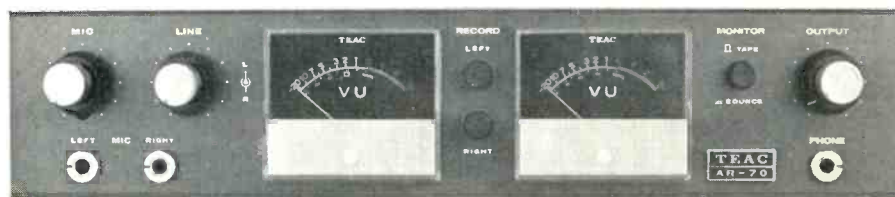

Fig. 1—Front view of amplifier section.

with a sensing post over which the tape is threaded. The stabilizer roller is fitted with a 1¼-lb. flywheel to iron out any variations in tape feed from the supply reel. The sensing post is designed to work with a piece of aluminum foil on the back of the tape, and as the foil passes the post, the machine will either do nothing, stop, or rewind the tape and then stop, depending on the setting of a switch on the rear panel of the deck. To the right of the head assembly is the capstan—of massive dimensions, since it measures 0.475 in. in diameter. Above it is the pinch roller, and to its right is the automatic shut-off lever.

Holding the reels in place are two large reel clamps which accommodate NAB 10½-in. reels, and which lock in place with a slight turn of the knob.

For 7-in. and smaller reels, rubber slip-on reel holders are provided. In addition to the stabilizing roller, there is also a scrape-flutter roller between the record and play heads, as well as tape-lifters which are retracted in the fast-wind positions when the CUE button is depressed.

The amplifier section, shown in Fig. 1, has two phone jacks for left and right microphone inputs under the record-level controls—the left pair controlling microphone levels and the right pair for the line inputs, which may be mixed together for recording. The controls are dual-concentric types, with the anodized aluminum front knobs controlling the left channel, while the larger black plastic knobs are for the right channel. Next are the two 4½-



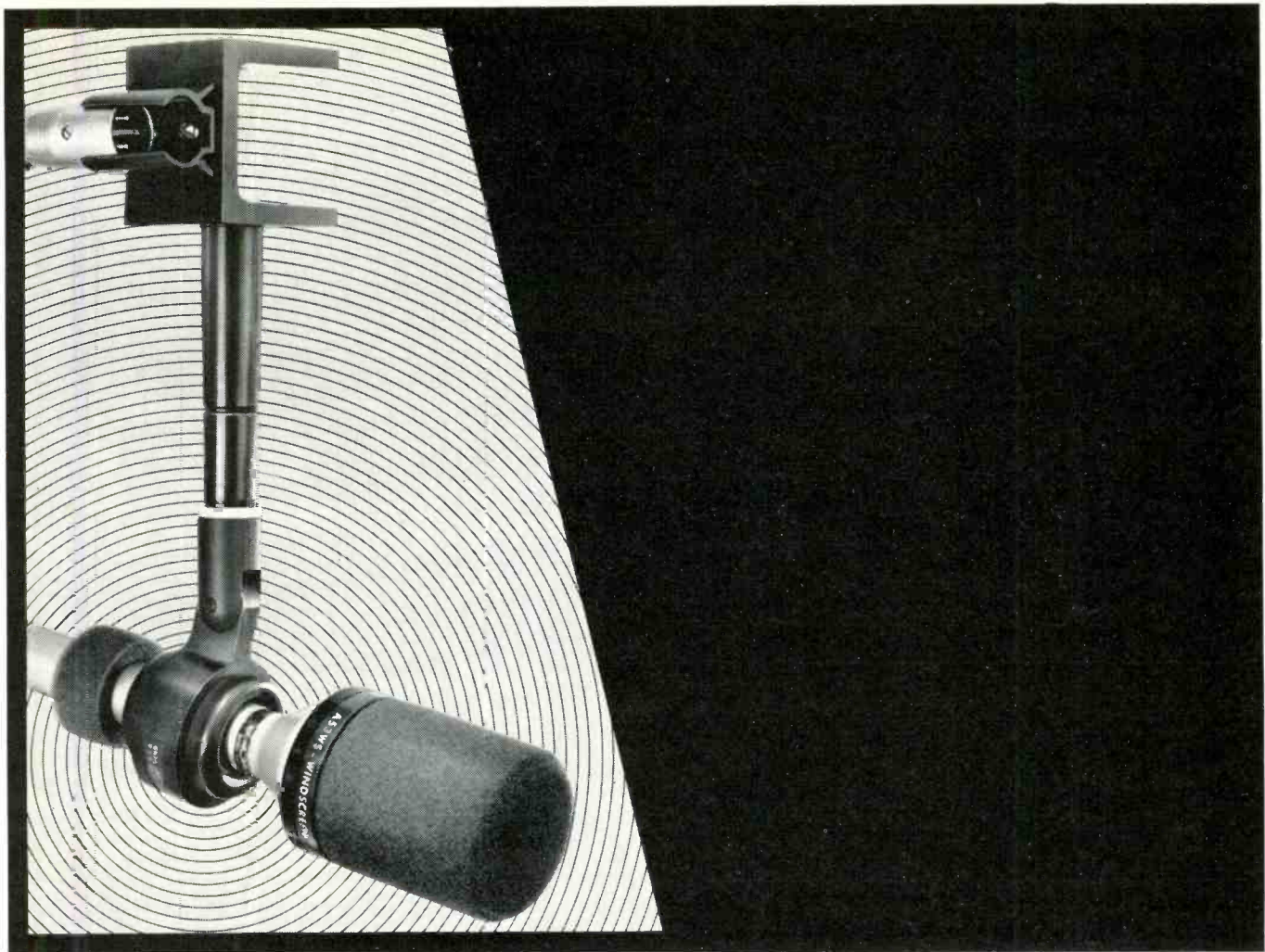

## Boom Boon.



We've taken our most versatile, best-performing unidirectional studio microphone, the *Shure SM53*, and made it even more versatile by developing a complete boom accessory system that equips the SM53 for every conceivable boom and "fish-pole" application! Shure design engineers started with a major breakthrough in design: a small, lightweight, extremely effective isolation mount. They developed a super-flexible isolation cable, a pair of highly-efficient front-and-rear windscreens, and a 20" boom extension pipe. Finally, they developed a complete boom assembly that combines unusually small size with superb control and noise isolation. Result: an accessory lineup that makes every Shure SM53 studio microphone a complete microphone system! Write: Shure Brothers Inc., 222 Hartrey Avenue, Evanston, Illinois 60204.



**SHURE**

Check No. 47 on Reader Service Card

in .VU meters, illuminated whenever power is on. Between them are two more push-push switches which control which channel is recording. To the right of the meters is another push-push button which selects source or tape monitoring, followed by the output level control, also a dual-concentric type. Below this is a stereo phone jack.

The amplifier and the transport assembly are connected electrically by two cables, each with octal plugs, and by two separate play-head cables plugged into phone jacks on both amplifier and transport. The remote control accessory requires a 11-pin plug, while the pause control uses a 6-pin DIN plug, with only three wires. Actuation of the pause control in the accessory releases the brake and capstan solenoids, stopping the tape motion. In addition to the interconnecting cables, there is a ground strap between the two sections.

### Amplifier Circuitry

The amplifiers are relatively straightforward in design, with conventional solid-state circuitry. Each play amplifier consists of a three-transistor pre-amplifier section, ending in an emitter follower, with feedback from its emitter to the emitter of the first transistor, switched by a relay as the speed-change button is actuated. The preamp is followed by a twin-T filter, followed by the TAPE-SOURCE switch and the output-level control. This feeds a two-transistor amplifier which provides the necessary gain to supply the output signal and also drives the meter amplifier—a single transistor—which is also switched from tape to source. Adjustable resistors serve to balance the indications between the two signals. In addition to feeding the meter amplifier, the amplifier also feeds another transistor which is a transformer coupled to the phone jack to permit use of conventional low-impedance headphones. A bias trap across the output terminals eliminates any residual bias from the amplifier.

The record amplifier consists of a microphone preamp stage followed by the mic volume control, which is paralleled by the line input volume control. Both are adjusted to similar outputs by variable resistors. The mixing controls then feed a two-transistor feedback pair with some high-frequency equalization, and the output drives the recording output stage, a single transistor with resonant circuits across part of its emitter resistor to provide the required high-frequency peaking. The output from the collector feeds the record head through another bias trap, with bias being adjusted by a variable resistor. In the

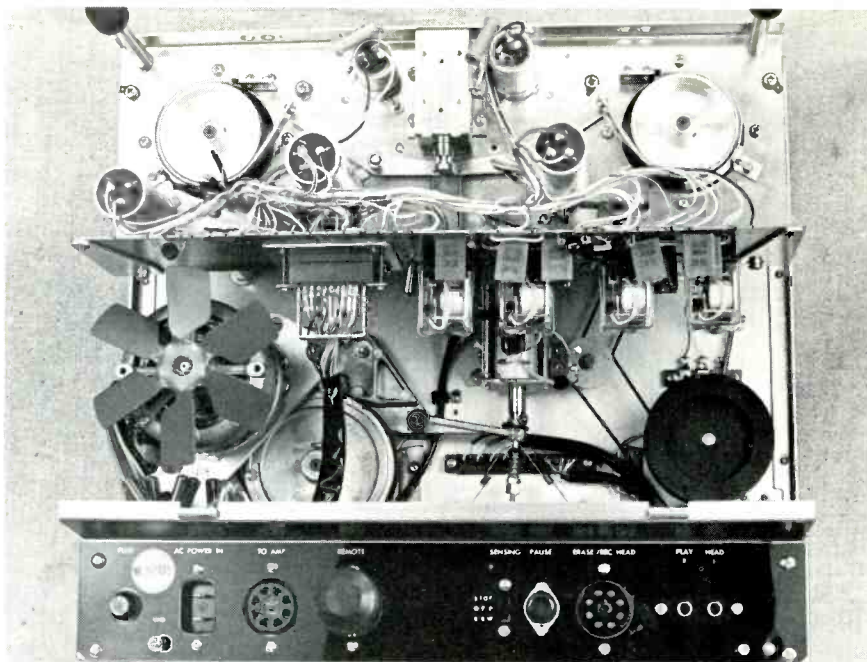

Fig. 2—Showing transport section from rear. Note massive flywheels on both capstan (left) and stabilizing roller (right).

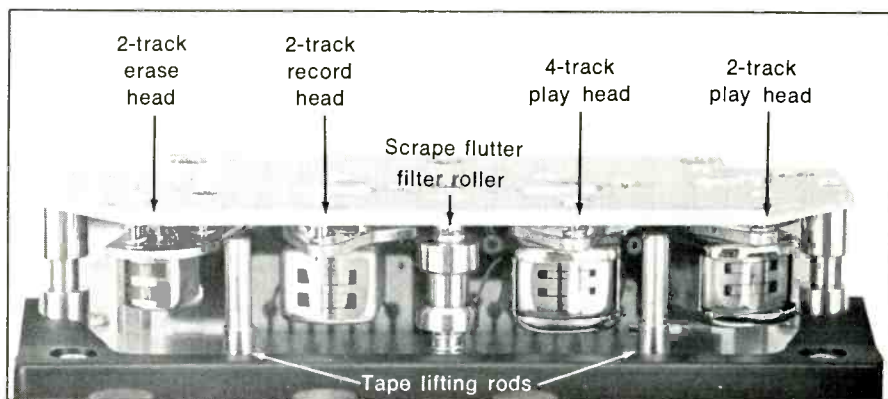

Fig. 3—Close-up view of the head assembly. Note the additional head at right for playback of four-track tapes.

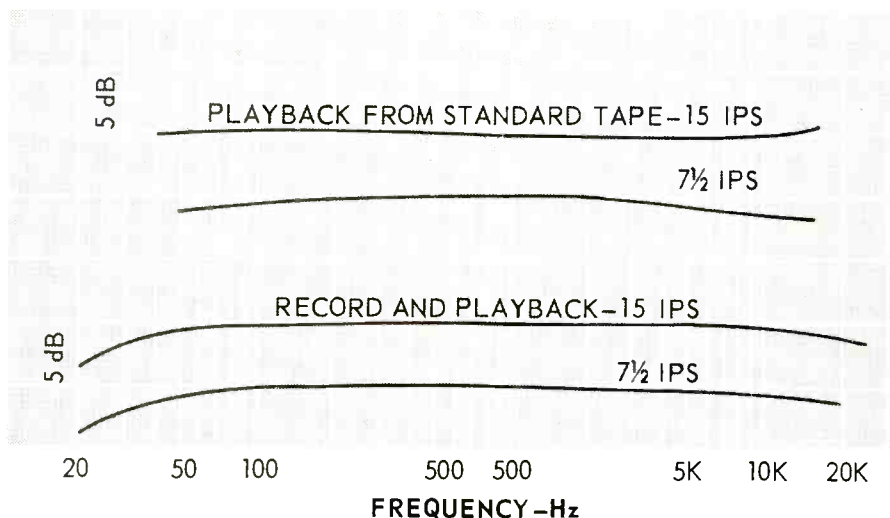

Fig. 4—Response curves for playback of standard frequency tapes and for recording and playback at both speeds.

play mode, the record heads are shorted to ground.

The bias/erase oscillator, operating at 108 kHz, consists of a balanced push-pull circuit, with the output deriving from a secondary winding on the oscillator coil. When recording on only one channel, a simulated load impedance absorbs the signal which would normally be supplied to the head not in use.

The power supply utilizes a transformer with two secondaries—one for the meter lamps and one for collector supply for the amplifiers. This is rectified by two diodes, and is well filtered. A relay in the amplifier chassis performs the equalization changes necessary for the two speeds, and with six more relays in the transport, there is a complement of seven altogether, along with 24 transistors and 10 diodes.

Accompanying the A-7030 is an attractive flexible plastic cover which can be used to protect the machine from dust and exposure. Also included are the ubiquitous flannel polishing cloth, two spare fuses, a small bottle of oil, and two Allen wrenches for use in ordinary maintenance operations. Also included, of course, are the two NAB reel holders, two rubber reel stops for 7-in. and smaller reels, and one aluminum NAB empty reel. The power cord, separable, and two phono-tipped patch cords are provided for the necessary connections.

### Operation

As would be expected from a professional caliber unit, such as this one, the machine performed flawlessly. One of the usual tricks that reviewers are wont to perform is trying to break the tape. I can be done if you try real hard, but it requires two fingers or two hands to operate the controls fast enough *and* if you do not follow the instructions given. It is suggested that when fast winding and a stop is desired that you should first depress the fast-winding lever for the other direction, then the stop button. If you do this, you can't break the tape. If, however, you go from fast wind to stop and then immediately to play, you are likely to break the tape, but it requires some very fast finger work. The first time we succeeded in breaking the tape we thought we had outwitted the machine, but it happened at an old splice. We did succeed later in breaking the tape itself, but only by disregarding the directions.

There is understandable joy in using a machine at 15 ips, even though it uses tape up fast. But what can we use for a source? We did have some 15-ips tapes that have been on hand for some

time, and used this as an opportunity to dub them to another machine at 7½ so we can play them at will. But the advantages of those tapes were only that we had them—they were mono, and almost twenty years old.

The performance of the A-7030U is so good at 7½ that the only advantage of the 15-ips speed would be for the individual who does a lot of original recordings—there is no need for 15 ips if you are recording from the air or for dubbing from phonograph records. Thus the main advantage of this machine is that of its finely finished construction, its very low wow and flutter, its excellent separation, and its signal-to-noise ratio.

### Performance

The frequency response of the A-7030U is shown in Fig. 4 from standard tapes, and from signals fed in at a constant level. The slight rolloff at the low end was not in evidence when we adjusted the input signal to the VU meters on the recorder, only from a flat input signal.

Flutter and wow measured a very low of .03% at 15 ips, and .06% at 7½, both of which are excellent. Signal-to-noise ratio at 15 ips was measured at 58 dB below the 3% distortion point, which occurred at +9 dB above the indicated 0 dB of the VU meters. At 7½ ips, S/N was 56 dB. Harmonic distortion was 3% at +9 dB, 1.6% at +6 dB, and 0.5% at 0 dB and at 10 dB below indicated 0. These figures were for all frequencies from 100 to 10,000 Hz, increasing to 1.2% at 50 Hz (which might be the fault of the generator). Rewind time for 1800 feet of tape was clocked at 90 seconds, which is pretty fast. Channel separation was measured at an even 50 dB, also excellent. Four-track performance was essentially identical, with only 2 dB lower S/N.

Using a hysteresis motor for capstan drive through a belt to a heavy flywheel, there was no change in speed as frequency was varied. Nor was there any change as voltage was lowered to 50. However, the machine would not start at any voltage lower than 96, but once playing it would continue down to 50 volts. The brakes, employing 270-deg. felt-lined copper bands, were extremely effective.

In conclusion, the A-7030U is a solid machine, built on a 3/16" steel panel as the main chassis, and it should last forever. And it is also a "solid" performer which should require a minimum of maintenance. It is a recorder of which anyone could be justly proud. *C.G. McP.*

Check No. 48 on Reader Service Card

# GREAT STEREO STARTS HERE!

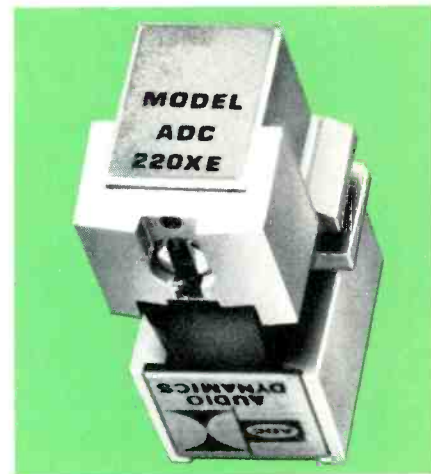

If you're becoming serious about listening to stereo equipment, here's a cartridge to get you started on the right track—the ADC 220XE. Like its more expensive brothers, it is carefully crafted by hand with our exclusive induced magnet design. It tracks accurately and yields faithful sound reproduction with virtually any changer or tonearm. As you can see, the 220XE is really a great first cartridge. And even its low price of \$22 will be music to your ears.

Of course, when you're ready to move up to more sophisticated stereo equipment, you can choose from ADC's complete line of superior cartridges. Isn't it nice to know we won't desert you on the way up?

#### ADC 220XE SPECIFICATIONS

**Output:** 6 mV at 5.5 cms./sec. recorded velocity.

**Tracking Force:** 1 to 2½ grams.

**Frequency Response:** 10 Hz to 18 kHz ± 3 dB.

**Channel Separation:** 20 dB from 50 Hz to 10 kHz.

**Compliance:** 20 x 10<sup>-6</sup> cms./dyne.

**Vertical Tracking Angle:** 15°.

**Rec. Load Impedance:** 47,000 ohms nominal.

**Price:** \$22 Suggested Resale.

Write for detailed specifications on other "X" series cartridges.



## AUDIO FOR AUDIOPHILES

Check No. 51 on Reader Service Card

# from Alpha to Omni

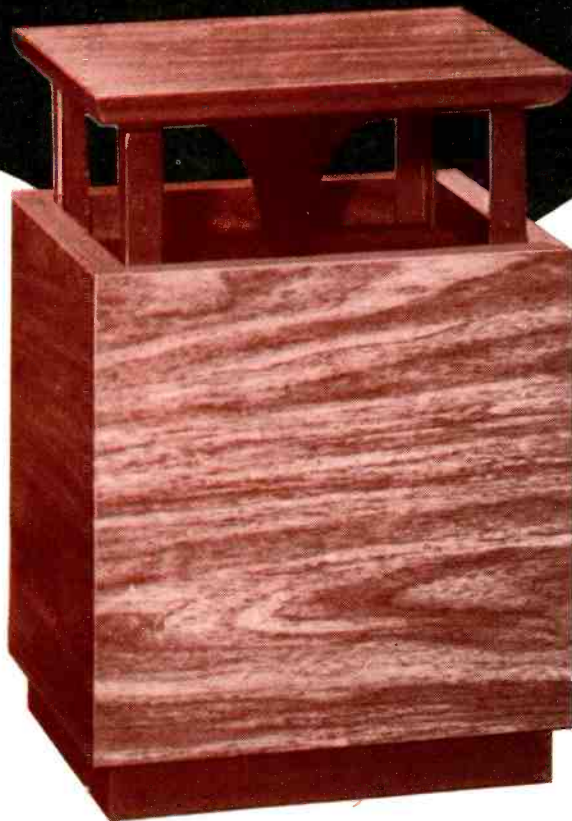

**OM-1 OMNI SPEAKER SYSTEM.** We've been in it from the beginning... at point ALPHA in time. Our engineers took audible sounds—electronically produced, and made them clear, high fidelity tones. We participated in the design and engineering of speakers to create the world's finest stereophonic sound reproduction. Now, we have reached OMNI... OM-1 OMNI SPEAKER SYSTEM produces sound uniformly for any part of the room. It is "omni-directional," (radiates 360 degrees). This new concept radiates both direct and reflected sound deftly, creating a real depth sensation. You can place this OMNI speaker anywhere from the middle of the room to a corner bookshelf. The UTAH Omni Speaker is a wonderful new way to enjoy music.



## SPECIFICATIONS

Woofer; 8" diameter, cloth roll suspension, 1<sup>3</sup>/<sub>4</sub> pound magnet structure, 1" voice coil. Tweeter; 3" diameter, co-axially mounted, Alnico V magnet. Crossover frequency; 4,500 Hz. Cabinet; 9<sup>3</sup>/<sub>4</sub> x 9<sup>3</sup>/<sub>4</sub> x 14<sup>1</sup>/<sub>2</sub>" high, durable laminated walnut finish. Power; 30 watts peak, (15 watts program). Response, 35/18,500 Hz. Impedance, 8 ohms. Shipping weight, 15 pounds.

# utah

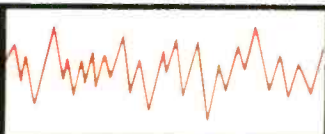

HUNTINGTON, INDIANA 46750

Check No. 50 on Reader Service Card

## Sherwood Model S-7100 AM/FM Stereo Receiver

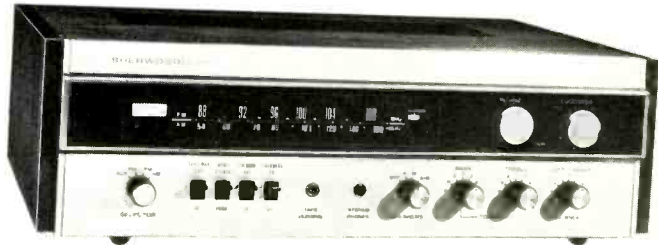

### MANUFACTURER'S SPECIFICATIONS:

**FM TUNER SECTION:** **IHF Sensitivity:** 1.9  $\mu$ V. **S/N:** -65dB. **THD:** 0.5%. **Selectivity:** 40 dB. **Capture Ratio:** 2.8 dB. **Spurious Response Rejection:** 87 dB. **Image Rejection:** 78 dB. **I.f. Rejection:** 90 dB. **Stereo Separation:** 40 dB @ 1 kHz.

**AM TUNER SECTION:** **Sensitivity:** 5  $\mu$ V @ 60% Mod. for 6 dB S/N. **Selectivity:** 7.5 kHz @ -6 dB. **Frequency Response:** -6dB @ 4 kHz. **Image Rejection:** -50 dB @ 1 MHz. **I.f. Rejection:** -45 dB @ 1 MHz.

**AMPLIFIER SECTION:** **IHF Power:** 70 watts total, 8 ohm load. **RMS Power:** 25 watts/channel. **THD:** 1.0% at rated output, 0.2% at 10 watts. **IM Distortion:** 1.0% at 8 ohms, rated output; 0.35% at 10 watts. **Power Bandwidth:** 25-20kHz. **Frequency Response:** (Aux): 30-20 kHz  $\pm$ 2 dB. **Damping Factor:** 30 @ 8 ohms. **Tone Control Range:** Bass:  $\pm$ 13 dB @ 100 Hz; Treble:  $\pm$ 13 dB @ 10 kHz. **Input Sensitivity:** (For rated output): **Phono:** 1.5 mV; **Aux:** 3.8 V. **Hum and Noise (IHF):** **Phono:** -65 dB; **Aux:** -75 dB.

**GENERAL:** **Size:** 17<sup>1</sup>/<sub>2</sub> in. W. x 5<sup>1</sup>/<sub>2</sub> in. H. x 13<sup>1</sup>/<sub>2</sub> in. D. **Price:** \$199.95 (Walnut case included).

We never cease to be amazed at just how much value can be packed into a receiver chassis these days in the "just under \$200.00" price bracket. The latest receiver in this category to be measured and evaluated was the new Sherwood S-7100 which is obviously manufactured for that firm by an overseas factory. If we had to summarize our findings in two sentences we would say: The tuner section is outstanding for this price. The amplifier does not quite come up to its specs (at least the model we tested didn't), but is, nevertheless a good performer—within this price category.

The front panel layout (in anodized gold and black finish) is shown in the opening photo. The upper section includes a peak-reading tuning meter (active in both AM and FM tuning functions), a well-illuminated, if somewhat foreshortened dial scale, flanked by the usual stereo indicator light, tuning knob coupled to a smooth flywheel, and the loudness (or volume) control which, in its counterclockwise position also turns off power to the unit. The lower section of the panel includes a four-position function-selector switch, a speaker selector for main, remote, both or no speakers (when using phones), and bass, treble and balance controls. Four two-position "key" switches provide tape monitoring functions, stereo/mono mode, FM interstation muting, and loudness compensation on/off. Finally, at center panel, there are stereo phone and tape-dubbing jacks. The latter jack duplicates the "tape monitor input" jacks located at the rear of the chassis, enabling the user to record to or play-back from a second tape recorder. This feature also permits dubbing from one recorder to another.

The rear panel layout is quite conventional in features, including a switched convenience a.c. receptacle, line and speaker fuses, well-spaced screw terminals for main and remote speaker hook-up, input jacks for PHONO and AUX, record-out and tape-monitor jacks, and a terminal strip for connection of FM and AM antennas as well as a ground terminal screw for connection to the phono changer or turntable if required. A built-in

"Loopstick" antenna is also provided, and it is capable of being swung away from the chassis for best AM reception.

Removing the walnut enclosure discloses the circuit board layout of the chassis (See Fig. 1), since there is no inner metal housing supplied. A fully-sealed front end drives separate AM and FM i.f. circuit boards. The multiplex decoder circuitry is located on another circuit board. Twin driver-amplifier circuit boards feed the power-output transistors located on the heat sinks at the rear of the chassis. Preamplifier and tone-control-stage circuit boards are located below chassis surface, just visible in Fig. 1 adjacent to the front panel. Although output-transformerless, the audio amplifiers of the S-7100 do utilize driver transformers in a conventional push-pull circuit design. The only output-circuit protection afforded is in the form of a fast-acting 2.5-ampere speaker-line fuse in each channel.

### Performance Measurements

If sensitivity were the only criterion of FM tuner perform-

with sets costing two y measured an IHF 1.9  $\mu$ V claimed. This ant FM performance ate S/N ratio reached never quite made the o) was 0.65 percent on was excellent, reaching vity and capture ratio therein lies the some- ection, in terms of its eting units. A 40-dB minimal, particularly of the tuner. That is, ions crowd each other characteristic leads to -and indeed, in one or h effects were in evi-

aration are plotted in closely with published (claimed). At extreme decreased to about 20

at 23 watts output per an be seen in Fig. 4. recent figure at an out- s driven. If one meas- nnel driven, published perhaps this is the way l, although IHF stand- n to full output when width measured from :characteristic is plotted levels (around 1 watt) 2.5 dB at 20 kHz with

tone controls set for mechanical center. By boosting the setting slightly, flat response was attained within 1 dB from 18 Hz to 23 kHz. This response, as well as tone control range and loudness compensation curves for -30 dB setting of the volume control, are shown in Fig. 6.

### Listening Tests

The Sherwood S-7100 receiver was used with a pair of medium-efficiency book-shelf loudspeaker systems for most of our listening tests. It drove them nicely at all levels of volume which we would normally want in a modest-size listening area. In oversize listening areas, however, or with very low-efficiency

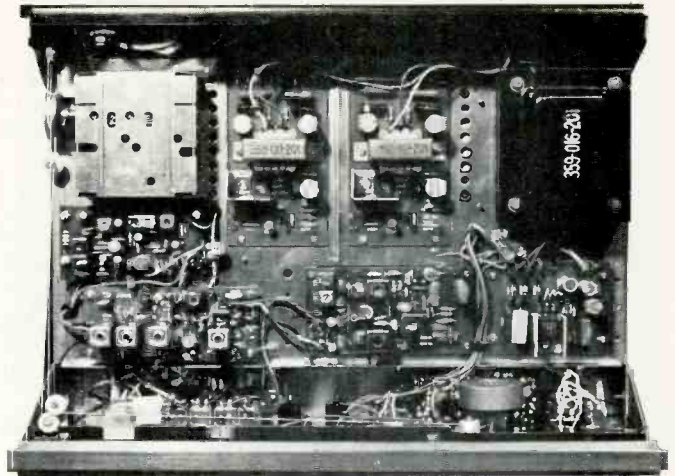

Fig. 1—Showing top view of Sherwood S-7100 receiver.

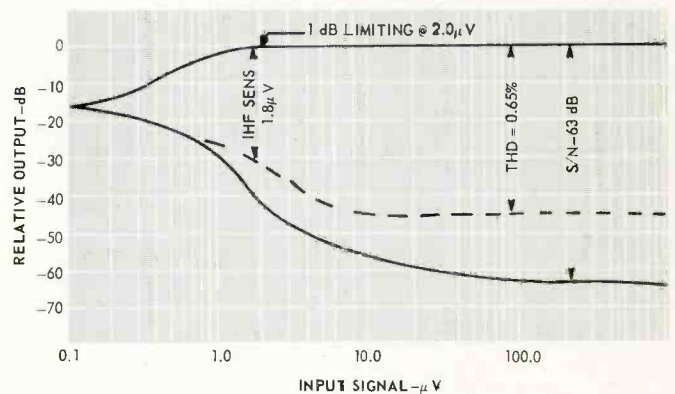

Fig. 2—Sensitivity, THD, and S/N of the tuner section.

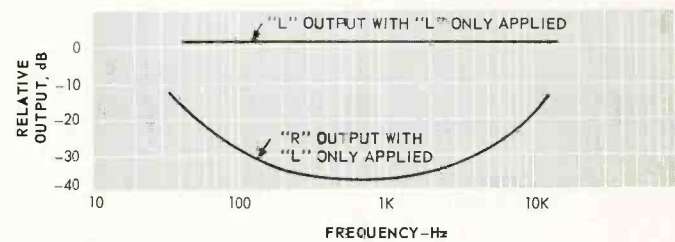

Fig. 3—FM Stereo separation.

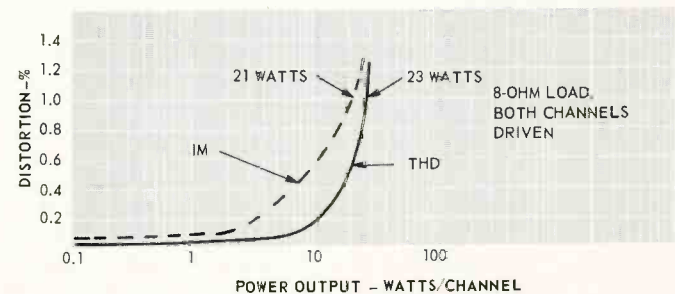

Fig. 4—THD and IM characteristics of the amplifier section.

speaker systems, the amplifier showed signs of going into overload and distortion was apparent at high listening levels. If two sets of speakers are to be used with this receiver (main and remote locations), it is recommended that only one pair be used at a time in view of these power limitations, unless fairly high-efficiency systems are chosen.

As for FM reception, a count of all stations received with a directional outdoor multi-element antenna came to 43, but again, this must be tempered by the fact that some six of these stations were heard with evidence of alternate channel interference to a greater or lesser degree. That still leaves 37 stations which were acceptable, devoid of any noticeable background noise and low enough in distortion to be satisfactory. For all but the ardent FM "DX-er" that's a lot of FM in a low-priced receiver!

It is difficult to rate an under-\$200.00 receiver, such as the Sherwood S-7100, in absolute terms. Obviously, the manufacturer has built in just about every feature and performance spec that modern technology could come up with at this retail price. Is it the equal of \$400.00 receivers? Of course not! Should it be rated as a "high-fidelity" unit in the context in which readers of this magazine recognize that term? Absolutely! Certainly, for the less-affluent devotees of good sound in the home, the Sherwood S-7100 would make a great "starter" system—far superior to any of the mass-advertised so-called "cheapie" compacts which appear in newspaper advertising around the country—and even more superior to *any* package or console equipment which purports to be "high fidelity" and offers inflated specifications that are all but meaningless. L.F.

Check No. 52 on Reader Service Card

## London Letter

(Continued from page 18)

This is not the place for a discussion of the politics of the British hi fi industry, but to reflect the current British scene we must say that with hi fi expanding into a bigger market (perhaps a mass market) the traditional and truly hi fi manufacturers have their problems. The big radio manufacturers are casting eyes at this area, and Mr. John Portlock, Managing Director of the UK end of Bang & Olufsen, has offered his view that rationalization must come, "as the small British hi fi firms are too fragmented to compete with the major firms moving into audio. . . ." He appears to see the future of hi fi in the UK as fewer and larger manufacturers, on Continental lines with probably Great Britain joining the Common Market!

Yes, a dilemma certainly, but the outlook is not so dismal for the genuine hi fi firms as Mr. Portlock opines. The best will always have their followers, and the big boys have a long way to go to bridge that mid fi/hi fi gap.

\* \* \*

The space remaining will allow me only to mention some of the products that attracted attention at the IAMF show, concentrating on British designs, as most of you will be familiar with the American and Japanese items. John

Bowers (of Bowers & Wilkins) provided an impeccable demonstration from a pre-recorded tape, using his latest DM70 combined electrostatic and dynamic loudspeaker, the DM3 model, and the bookshelf design DMI performing admirably with its improved crossover network. Celestion introduced their new Ditton 120 speaker, measuring about 17 x 8 x 9 in., incorporating two drive units, the familiar HF 1300 for high-frequencies, and a long-throw LF/MF unit of high-flux, aided by an ABR (acoustic bass radiator) for the extreme bass. Goodmans' latest "Minister" two-unit reflexed enclosure, fitted with an 8-in. long-throw bass unit with plastic coated cone and a new type dome radiator mid-range/treble unit, was heard to advantage for the first time here.

One of the most satisfying sonic demonstrations was staged by Rogers Developments, using the latest Monitor models fed from a Ravensbourne amplifier. Full marks here. In the modest-price category, the old electronics firm of Whiteley demonstrated three loudspeaker systems, LC.93, LC.94, and LC.95, and Tannoy's family of loudspeakers put up a very good overall show that attracted big audiences. Another manufacturer who has succeeded in obtaining a family resemblance in their range of speakers is Mordaunt-Short. Sonic similarity is a good sign that the designer knows

what he is aiming for, and the new Mordaunt-Short MS077 has a similar character to its brothers. The MS077 is a three-unit model and the essential differences in the models relate to the power handling and bass output only.

Turntables from JP, handled here by Howland-West Ltd., especially the belt-driven models TP.601 and T.500, performed well, and Transcriptors Ltd., demonstrated a new turntable, first seen at the Dusseldorf show last August. This has a synchronous motor driving a 6-lb. non-ferrous platter via a belt, resulting in rumble-free performance. The whole baseboard floats at a resonance below 5 Hz and a fluid dashpot can be used to damp this movement. The main bearing is PTFE. This company also offered an exceptional pickup arm (the fluid model) which employs a ball-race to stabilize a uni-pivot. Sinclair Radionics demonstrated an early prototype turntable, with electronic control and the record bearers and pickup arm made from glass tube!

Audix Ltd. demonstrated their new Graphic Stereo pre-amp and Stereo Power amplifier, equipment of professional caliber. The pre-amp has a low-noise level, magnetic-input circuit, five adjustable equalizers (covering range 80 Hz to 8 kHz), comprehensive mixing facilities, and output PPMs. The power amplifiers are 160W and 70W types, which include "acoustic environmental correction" (or shelf

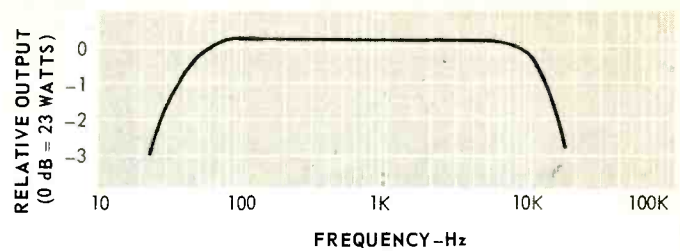

Fig. 5—Power bandwidth (at 8 ohms, both channels driven).

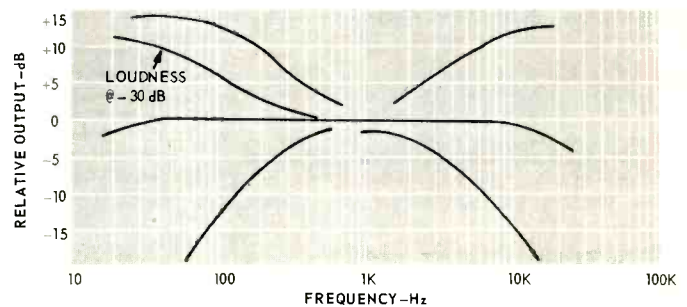

Fig. 6—Tone-control range, frequency response, and loudness-contour action.

controls) working over the ranges below and above approximately 800 Hz.

A novelty item was an FM-crystal locked radio-guitar, derived from work on radio-microphones. This device frees the electric guitarist from wire connections! Reslo is the company responsible for this innovation.

Two eminent personalities from America came over specifically to take part in the junketings at and around Olympia—Dr. Robert Moog demonstrated his synthesizer in conjunction with J. B. Lansing loudspeakers in a joint room and later presented a lecture on the instrument and its electronic music to capacity audiences. As an extra-mural event, Dr. Amar Bose, Professor of Electrical Engineering at M.I.T., talked in an easy, lucid style about his Bose 901 loudspeaker system. Dr. Bose's philosophy of loudspeaker design, based on extensive research, is probably well known to AUDIO readers, but the sound was certainly impressive from these comparatively small cabinets housing nine 4-in. units. An equalizer unit is used, of course, and powerful amplifiers are essential to drive the speakers, hence their high price.

With a colleague, I was fortunate enough to be given a special demonstration of the new Nivico JVC four-discrete-channel disc system, a system employing a pilot-tone, plus FM and phase-modulation techniques. The bandwidth extends to 45 kHz, and the record is fully compatible. The improved pickup available will play ordinary two-channel stereo discs. The directional information was well presented with good separation, and the system has many features of technical interest. I seem to recall that English Decca engineers had patents on such a system, when the 45-45 stereo system was introduced.

As a collector of test and demonstration records I was intrigued to discover three specimens demonstrated at the Fair: John Borwick's excellent "Enjoyment of Stereo" (HMV .SEDM6), "This is Stereo" by John Wright and Clement Brown (EXP.70) marketed by Howland-West Ltd., and a stereo test/demo disc from Audix, Stansted, Essex. Next time you read these notes, we shall have gone over to decimal currency!

\* \* \*

Thank you to my American friends and readers, who have sent me some encouraging messages about the first of these Letters from London, which appeared in the September 1970 issue. It will appear more frequently than quarterly, if the reactions continue favorably and the Editor agrees. (*I'll think about it!* Ed.)

# Anyone should be able to name 45,000 records and tapes

No feat of memory. Just reach for SCHWANN—the complete catalog of information on thousands of currently available phonograph records and tapes. Covers classical, popular, jazz, rock and every other category. Tells who recorded them, manufacturers record numbers, and gives other facts you need to get the most pleasure from the records you buy.

**MONTHLY SCHWANN RECORD & TAPE GUIDE**—contains 35,000 listings of Stereo L.P. records, 8-track cartridge and cassette tapes. Classical, popular, rock, jazz, folk, shows, electronic music. Approx. 600 new listings each month. 75¢

**SCHWANN SUPPLEMENT**—contains older popular music, imported, mono, spoken, and religious records. Issued twice a year. 60¢.

**SCHWANN COUNTRY & WESTERN TAPE & RECORD CATALOG**—New 1970-71 edition lists available Country & Western music on more than 60 labels. Includes titles of selections on the recordings. Cassette tape and 8-track cartridge numbers as well as record numbers given. 75¢

**SCHWANN ARTIST ISSUE**—Currently available classical records listed by performing artist: orchestras, quartets, instrumental soloists, etc. Needed by music lovers and record collectors. 1970 edition. \$1.75

Schwann, though helpful to record dealers and their sales persons, is for anyone who is serious about records. Get a copy and browse through it at your leisure. Keep a Schwann at home for reference and to help you decide on additions to your record library.

*Schwann Catalogs are available  
from your Record Shop*

If your dealer does not have SCHWANN CATALOGS, we will help you to get acquainted with this valuable "bible" of the record world. Send the coupon for the SCHWANN SAMPLER, and/or individual Schwann publications.

- Last Monthly **SCHWANN RECORD & TAPE GUIDE**  
Postpaid \$1.00
- Latest semi-annual **SCHWANN SUPPLEMENT**  
Postpaid 75¢
- SCHWANN ARTIST ISSUE**—1970 Edition  
Postpaid \$2.25
- SCHWANN COUNTRY & WESTERN TAPE & RECORD CATALOG**—1970-71 Edition  
Postpaid \$1.00

~~~~~ **SPECIAL OFFER** ~~~~~

- SCHWANN SAMPLER . . . ONLY \$1.25 POSTPAID**  
Latest monthly **SCHWANN CATALOG** plus most recent  
Semi-annual **SUPPLEMENT**  
Regular value . . . . \$1.75 Postpaid

Amount enclosed \$ \_\_\_\_\_ for items checked above.  
Name \_\_\_\_\_  
Address \_\_\_\_\_  
City \_\_\_\_\_ State \_\_\_\_\_ Zip \_\_\_\_\_  
Dealers Name \_\_\_\_\_

## **SCHWANN RECORD & TAPE GUIDE**

137 Newbury Street, Boston, Mass. 02116

AU



## Classical Record Reviews

**Edward Tatnall Canby**

**Louisville Orchestra 100th Golden Edition 1954-1970.** (Strauss: Six Songs, Op. 68; Rhodes: The Lament of Michal.) Rita Shane, Phyllis Bryn-Julson, soprani; Louisville Orch., Mester. **LS-704 stereo** (Mail order: Louisville Orchestra, 321 West Broadway, Louisville, Ky. 40202).

The Louisville people got so excited about this, their one-hundredth release on LP, that they forgot to put the content of the record on the cover, on either back or front! It's OK—they stuck on a gummed label and inserted a booklet.

Good cause for excitement. The disc combines an unusual and beautifully done set of orchestrated songs by Richard Strauss, from the top of his late-period vocal writing (1918) with a well-matched serial-style work for soprano and orchestra by Phillips Rhodes, also beautifully performed by another soprano. I found both sides quite absorbing, and—for once—not bad as a pair of back-to-back offerings. (Too often, modern works

of utterly diverse types are arbitrarily coupled up on LP.)

One hundred records! Would that our columns could have done justice to all of them, over the years. Alas, they are merely a ripple in the big LP flood that still continues, and there are other contemporary series as prolific, notably that from Composers Recordings and such newcomers as the Acoustic Research offerings. But Louisville was the pioneer, and as a self-help project, centered on its own home activities, this has been a remarkable enterprise. The prime mover, Robert Whitney, no longer conducts but the new man, Jorge Mester, carries on, mixing modern classics in with new works.

---

Performances: A—                      Sound: B

---

**Ecco la primavera—Florentine music of the 14th century.** Early Music Consort, David Munrow. **Argo ZRG 642 stereo** (\$5.95)

Want a super-hi-fi record of totally new kind of music? (Well, not exactly—there are numerous records of such music if you keep up with them.) New, in any case, for most listeners. The Italian title, "Behold the Springtime" gives the cue to the mood. Classical but *not* heavy! It's music out of that lively Florentine period when all the arts were blossoming, unbelievably and healthily. Music, too, though we've been discovering it only recently. This record combines a fine group of instruments of the time—rebec, mediaeval fiddle, lute, sackbut, crumhorns, shawms, recorders, harp, assorted percussion instruments—with the new kind of voice for such music, light, accurate, non-operatic, blending perfectly with the instruments. Easy listening.

The sound on this record is unusually fine—don't know what they've done. Crisp, clear, the transient sounds beautifully tight, the colors splendidly natural and alive, all against a supernaturally quiet background, virtually soundless. Shows what recording can do, state-of-the-art.

---

Performances: A—                      Sound: A

---

**J. C. Bach Symphonies.** English Chamber Orchestra, Colin Davis; Hurwitz Ch. Orch., Emanuel Hurwitz. **L'Oiseau-Lyre SOL 317 stereo** (\$5.95)

These four short symphonies by the youngest of the Bach sons, the one who sounds like Mozart and was called the "London Bach," will startle listeners

who know their Mozart symphonies. Perhaps it is intentional; in any case there are so many Mozart-like ideas in these, either suggestions or almost literal repetitions, that one might accuse J. C. of plagiarism if he had not come first! In addition, the sound of these orchestras, notably the English Chamber Orchestra with Davis (Hurwitz takes care of the first of the four works), is broad and big enough to equate with the familiar sound of Mozart symphonies as we usually hear them.

The coincidence of themes and style is in part merely due to common usage of the time, the musical formulas that were put to work by every composer. There are dozens of "Jupiter Symphony" beginnings, by composers both big and small, because this was an effective way to start off and a very "in" sound for any musician who knew what was right for the moment.

But the peculiar relationship between Bach and Mozart, Bach having been the prime influence on the young Mozart throughout Mozart's first brilliant years of composing, surely accounts for some of the "Mozart-like" ideas in these works. More properly, they are Bach-like themes when they appear, later on, in Mozart's music.

The difference between the two are significant too. What, indeed, makes Mozart a genius and Bach merely a fine composer? The evidence is right before your ears here, in splendid detail.

---

Performances: B                              Sound: B

---

**John Stanley: Concertos from Op. 2.** Hurwitz Chamber Orch., Hurwitz. **L'Oiseau-Lyre SOL 315 stereo** (\$5.95).

Don't quite place the name? Stanley was one of the "minor" British composers who followed along in the wake of the great Handel in London, overshadowed (so we always were told) into total obscurity by the Great Man Himself.

Well, not quite. Stanley, though blind, did very well for himself in England, was much in demand in all musical respects and after Handel's death took over some of the work of producing the Handel oratorios. He wrote quantities of his own music, very successfully.

Yes, it sounds *very* much like Handel. You'd be fooled in an instant. But on closer examination, over a longer span, you find that this younger composer is actually more modern (he was 28 years younger than Handel); there are definite signs here and there of the new *galant* style of graceful ornament, pointing to—

(Continued on page 56)



# IF YOU DO ANYTHING WITH 1/4" TAPE, YOU CAN DO IT BETTER WITH REVOX.

- Automated broadcast operations
- Scientific analysis
- On location mastering
- Tone or time changing
- Audio tape quality control
- Electronic music synthesis
- Noise analysis
- Film synchronization
- Radio telescope
- Language laboratory
- Machine tool control
- Phonetic analysis
- Radio telemetry
- Industrial research
- Information retrieval
- Electrocardiography
- Making calibration tapes
- Tape mastering with SELFSYNC
- Data storage from digital computers

And that's a simple statement of fact.

From the moment it was introduced, the Revox A77 was hailed as a recording instrument of unique quality and outstanding performance. The magazines were unanimous in their praise. Stereo Review summed it all up by saying, "We have never seen a recorder that could match the performance of the Revox A77 in all respects, and very few that even come close."

So much for critical opinion.

Of equal significance, is the fact that the Revox A77 rapidly found its way into many professional recording studios.

But what really fascinates us, is that the A77 has been singled out to

perform some unusual and highly prestigious jobs in government and industry. The kinds of jobs that require a high order of accuracy and extreme reliability.

Take NATO (the North Atlantic Treaty Organization) for example. When they wanted a machine to standardize on, a machine that would lend itself to use in a wide variety of circumstances and most importantly, a machine that was simple to use, the logical choice was the Revox A77.

Or take the governmental agency that wanted an unfailingly reliable tape machine to register and record satellite bleeps. The choice? Revox.

Or the medical centers that use

specially adapted A77's for electrocardiographic recording.

We could go on and on (see accompanying list), but by now you probably get the point.

No other 1/4" tape machine combines the multi-functioned practicability, unfailing reliability, and outstanding performance of a Revox.

If you have a special recording problem that involves the use of 1/4" tape, write to us. We'll be happy to help you with it.

And if all you want is the best and most versatile recorder for home use, we'll be glad to tell you more about that too.



**REVOX  
DELIVERS  
WHAT ALL  
THE REST  
ONLY PROMISE.**

Revox Corporation  
212 Mineola Avenue, Roslyn Heights, N.Y. 11577  
1721 N. Highland Ave., Hollywood, Calif. 90028  
In Canada: Tri-Tel Associates, Ltd., Toronto, Canada

Check No. 55 on Reader Service Card

# When was the last time you saw a round piano?



Or a round violin or guitar?

You haven't. Because these instruments have acoustical sounding boards with irregular shapes. They produce sound with a bending motion. Natural sound.

And that's why our Yamaha Natural Sound Speaker isn't round. It's irregular in shape like the sounding board of a grand piano.

So when sound comes out, it comes out with a bending motion. The way it was originally produced.

With Yamaha, you don't have to get bent out of shape to get the most natural sound.

It comes to you naturally. Write for complete technical information. The Yamaha Natural Sound Speaker.

## YAMAHA

YAMAHA INTERNATIONAL CORPORATION, AUDIO PRODUCTS DIVISION, 7733 TELEGRAPH ROAD, MONTEBELLO, CALIF. 90640

Check No. 54 on Reader Service Card

## What started out as a romance in Los Angeles...

A salesman in Los Angeles recommended a Concord receiver to a couple from Phoenix, the couple from Phoenix told their lawyer in Colorado Springs, the lawyer from Colorado Springs told an oil man from Tulsa, the oil man from Tulsa told his lodge brother from Peoria, the lodge brother from Peoria told a druggist from Cleveland, the druggist from Cleveland told a truck driver from Philadelphia, the truck driver from Philadelphia told his stock broker from New York, and the stock broker from New York loved the Concord stereo receiver.

## ...has ended up as a love affair in New York!

And this is the reason for the love affair. The Concord Mark 20, AM-FM stereo receiver is 300 watts\* of beauty. It can deliver enough distortion-free power to fill an auditorium. Or it can whisper sweetly. Solid state circuitry utilizing field-effect transistors and integrated circuits provides maximum pulling power, superb performance on records, tapes and broadcasts. A tuning meter for FM, signal strength meter for AM, provide pinpoint tuning. And it has all of



\*total power at 4 ohms single channel driven  $\pm 1$  dB.

the audiophile controls—tape monitoring, speaker selector switch, stereo headphone jack, loudness contour controls, calibrated slide pots for tone, balance and volume, interstation muting and automatic stereo switching. All of this wonderful performance is wrapped up in a handsome solid-walnut cabinet with a back-lit, smoke-black plexiglas front panel. The price is under \$300. Other Mark Series receivers starting at under \$200 for Mark 10, under \$240 for Mark 12.

### Concord Mark Series Receivers

Concord Electronics Corp. 1935 Armacost Avenue, Los Angeles, Calif. 90025. A Subsidiary of Ehrenreich Photo-Optical Industries, Inc. 

Check No. 56 on Reader Service Card

## Classical Record Reviews

(Continued from page 54)

wards Mozart and the like. Handel influenced, but did not quite obscure these younger British composers, as we had thought.

Not as strong music as Handel either but it flows very easily and with much polish. Excellent addition to your Handel collection.

Performance: B+

Sound: B

**Aleksei Nasedkin Schubert Sonata in D, Two Impromptus.** Melodiya Angel SR-40145 (\$5.98).

**Schubert: Sonatas in A Minor, A Major.** Lili Kraus, piano. Vanguard Cardinal VCS 10074 stereo (\$3.98).

As we all remember, Schubert, with his famous little glasses, was a timid, gentle soul. But inside, there was a real demon in the man and it came out in musical terms. His last works, especially for piano, are tremendous big things, straining even the modern grand in their passionate force. Here are two really top Schubert pianists, each one doing one of those late monsters, each of them beautifully recorded: Lili Kraus, a veteran in Schubert, Mozart, and such (her Mozart piano playing was famous on records 'way back in the middle '30's, as I can remember) straight out of the central tradition, and the young Russian Aleksei Nasedkin, from an alien land but with an astonishing understanding of the Schubert sense and message.

Lili Kraus is almost unexceptionable, even at a comfortable age and as a woman! Her power is still big, she gets that grand sound, she is the equal of Schubert's pianistic demands. Nevertheless, I still sense, somehow, too much preoccupation with close-up detail, a lack of the long-range drive in spite of her plenty powerful fingers. She is, in a well-bred musical way, a bit too polite *à la Viennoise*. It is the way Schubert is played in those parts, right in the Viennese tradition. But Schubert today needs a stronger, rawer approach.

Nasedkin has it. His huge piano, in a golden liveness (Kraus' is characteristically miked in a dry acoustic), is technically something out of Rachmaninoff and Tchaikovsky, quite strikingly Russian. No matter! He won the famed Tchaikovsky prize, but more importantly, he copped the International Schubert Competition in Vienna. He deserved it. He understands Schubert.

projects Schubert, as very few pianists have ever done on records. Beneath the Russian-style exterior there is extraordinary drive, an amazing control of rhythmic power (the very life of Schubert) and, even more important, a real sense for those marvelous Schubert changes of key, strange chords, unexpected shifts of harmony. Some of our finest Western pianists flounder only too audibly in this respect. And so, with all this and a superb sense of the grand shape and drama, this young man plays Schubert as I have never heard it before. He doesn't miss a trick—and some of them have been missing ever since Schubert's day, as far as I can figure.

Vanguard's drier recording is at a lower level on the disc and thus at first seems less impressive than the glorious big Melodiya-Angel sound with all its liveness. Actually, the two recordings are of equal merit, both offering big, eloquent piano sound without distortion or unevenness and minus a trace of unpleasant percussion.

*Performances: A, A-    Sound: B+, B+*

**Schubert: Sonata in D. Eugene Istomin, piano. (Columbia MS 7443 stereo (\$5.98))**

How different! The same late-Schubert piano sonata that the young Russian Aleksei Nasedkin plays on Melodiya-Angel and the two performances could not be in greater contrast.

Istomin's Schubert is clear, precise, economical and very much of the piano. Whereas Nasedkin seems to play beyond the piano, into a universal realm of musical expression—the piano is only the vehicle: we forget it (when we aren't concentrating upon the technique displayed) in favor of what it is saying. Istomin's piano does not let you forget. Nasedkin is all Russian, a big, passionate, heavy player, in the achieved sound; Istomin, in spite of the background suggested by his non-Yankee name, is all American (as Lili Kraus in her Schubert is sheer central Europe). American in the crisp, no-nonsense efficiency, in the smooth technique applied so precisely, in the warm but not passionate involvement, in the professional attitude that, somehow, treats the Schubert as a problem in piano performance.

Odd—in Columbia's Beethoven Trios this same Istomin is the leading force, the most dynamic of the three players, the most lively and rhythmic. In the Schubert he is cooler and more didactic,

though the music would seem to demand just the opposite.

*Performance: B                      Sound: B+*

**Rachmaninoff plays Chopin (1920-1930). RCA Victrola VIC 1534 mono (\$2.98).**

**The Art of Alfred Cortot (1930-1948). Chopin, Schumann, Liszt, Albéniz, Debussy, Ravel. Seraphim 60143 mono (\$2.98).**

Here they come, more of the old recordings of the grand old pianists who dominated the recorded art between the big wars. The supply is enormous—Rachmaninoff left 250 separate items, a few of which (two on this disc) have never been published.

Rachmaninoff—massive, potent, dark and brooding, the man of steel whose explosive fingers seemed too strong for mere piano keys. Rachmaninoff the austere; for in a Romantic way he was austere, tailoring his performances to an exact perfection. Was he really, as they said, the first “modern” pianist? He does sound so now. That is, he still sounds normal, if such a powerhouse could be called normal. His style, clearly Russian-built and massive, is not yet old fashioned as we listen. Side 1 of this disc, including the four-movement Sonata in B Flat Minor, is mostly electric with a massive bassy piano sound. (Two items from 1927 are evidently electric even that early.) Side 2 is acoustic, seven out of nine items dating from 1920 through 1923. Surprisingly similar sound, if scratchier and minus bass. They were splendid acoustic recordings.

Alfred Cortot, whose recordings are a decade younger, is old-fashioned—marvelously so. Alongside Rachmaninoff his pianism is outwardly pale, with a French pastel sound; but the impression is misleading—the fire is there, if dampened by low-level recording (one way to avoid percussion and buzz). What counts is the marvelous subtlety of piano color, the layers of forward and background, each of incredible precision, as though played by several people on different instruments. And the old-fashioned impulsiveness, the rubato, the surgings and hesitations! Really beautiful and no pianist could hope to do it today. Yes—there are mistakes, flubs. Everybody (except Rachmaninoff) flubbed a bit in those pre-editing days but Cortot was well known for it. Never bothered *him*, and so it scarcely bothers us: he goes sailing right on.

*Performances: A, A                      Sounds: C+, C*



## WE GUARANTEE YOU'LL GET STONED!!!

At last Electro-Harmonix has developed a device that can literally get you stoned electronically. This revolutionary accessory, the **STEREO PULSE MODULATOR** can be conveniently attached to any stereo system be it components, console or a compact set.

Two pulses of existing music are continuously re-generated per channel, each with a separately adjustable speed and volume control. It is the mix of these 4 pulses with their intermittent beat frequencies that will give you a new high or reinforce one you already have.

The master volume control aids in balancing these stereo pulse pairs with your existing music.



(also available at your retail music or hi-fi store)

Every object and sub-object has a *resonant frequency*. The high achieved by the **STEREO PULSE MODULATOR** is a result of tuning in to your own resonant frequency.

All mail order sales (factory wired) are on a two week money back guarantee. We absolutely guarantee you'll get stoned using the **STEREO PULSE MODULATOR**. Buy it and try it. If you don't think it's the greatest return it for a full refund.

Enclose a check and Electro Harmonix will pay shipping. Or, if more convenient order C.O.D. for cost plus shipping.

**electro-harmonix** **WSQ**  
15 West 26th St., New York, N.Y. 10010

Please ship **STEREO PULSE MODULATOR**

- Enclosed is check for **\$49.95** (factory wired)  
 Enclosed is check for **\$29.95** (complete kit)  
 Please ship C.O.D.     wired     kit

NAME .....

ADDRESS .....

CITY ..... STATE ..... ZIP .....

Check No. 57 on Reader Service Card

# Canby's Capsules...

## TITLE HANDEL

## CONTENT & SOUND

**Handel: The Complete Concerti Grossi, Op. 3 (with oboes); Concerto in C from Alexander's Feast.** Collegium Aureum. RCA Victorla VICS 6036 stereo (\$2.98).

The Baroque music craze began with Handel—Ernest Ansermet recorded the complete concerti Op. 6 back around 1929 and Sir Hamilton Harty's "Water Music" Suite was almost as early. Typically, these Op. 3 concerti, with oboes as well as strings, sum up everything most people like about Baroque. Nice playing, authentic old instruments as a matter of course.

**Handel: Messiah.** Complete/Original Instrumentation. Price. Minton, Young, Diaz; Amor Artis Chorale, Engl. Ch. Orch., Somary. Vanguard Cardinal VCS 10090/2 stereo (\$11.94).

One step nearer to the ultimate "authentic" Messiah, but still not quite the whole bit: the solo voices are unreconstructed modern, so is the chorus. A fine soprano, a superb contralto, an old-fashioned bell-bottomed tenor and a booming bass. But the instruments are near-Baroque, tempi properly brisk, the whole free of the cloying ancient tradition of church and festival. Lots of added improvisation, correct but a bit clumsy; the soprano does superb fast runs but her trills sound like a nanny goat. Recommended as the best try yet.

**Handel: Messiah.** Morison, Thomas, Lewis, Milligan; Huddersfield Choral Society, Royal Liverpool Philh. Orch., Sargent. Seraphim SIC 6056 (3 discs) stereo (\$8.94).

The Huddersfield-Sargent Messiahs, over the years, summed up the old festival tradition, straight down from Mendelssohn in the 1840s and a billion miles from Baroque "authenticity." Huge choral masses, vast orchestra, the music re-scored to Romantic proportions, ponderous tempi, and a stately impressiveness. Not at all unmusical—just totally non-Baroque! There were two Huddersfield recordings; this is the second, just into the stereo era. Grand spread of sound but a bit scratchy.

**Chorlieder der Romantik** (Romantic Choral Songs). Bergedorfer Kammerchor, Wormsbäcker. Telefunken SLT 43115-B stereo (\$5.95).

Schumann, Mendelssohn, Schubert, Dvorak, Brahms, Tchaikovsky in wonderfully heartfelt Romantic songs for chorus, with and without accompaniment, sung with superb style and musicianship. One odd thing—why do Telefunken violins and chorus voices sound so grainy in loud passages? Like a stylus beginning to wear. Again and Again I notice it.

**Bizet: Carmen** (original 1875 *opera-comique* version). Bumbry, Vickers, Freni, Paskalis; Chorus, Orch. Paris Opera, de Burgos. Angel SCL 3767 (3 discs) stereo (\$17.96).

The *opera-comique* genre, like the German *Singspiel*, included spoken parts; Bizet, like Mozart (and Beethoven) converted it for serious purposes. But Carmen was quickly turned back into a standard-type non-speaking opera, the one we know. Several scenes were cut, too. Here's the original work, first time since 1875—very odd for Carmen lovers, no great change for those who are newish to it. A curiously chaste performance, accurate but non-expanding—Burgos drives ahead fast. Principals' French is lousy—the spoken parts are done by French actors; I find the discontinuity unpleasant. Two added scenes, plus the dialogue. Interesting.

**Buskers.** RCA LSP 4426 stereo (\$4.98)  
**Music of the Waits.** Argo ZTG 646 stereo (\$5.95).  
**Indian Street Music.** The Bauls of Bengal. Nonesuch H 72035 stereo (\$2.98).

Street music! Buskers are current-day music makers in London, recorded outdoors—all sorts, slapstick to rock. The Waits, 16th C., hired by towns, were on call ("waited") for municipal events: lots of crumhorns, recorders, etc., dances by well knowns. The Bauls sing wailing semi-ragas with cryptic meanings, to strings, tabla, cymbals. All these in excellent hi fi stereo.

**Glenn Gould. Beethoven Variations** (32 Vars. in C Minor; Vars. in F on an Original Theme; "Eroica" Variations.) Columbia M 30080 stereo (\$5.98).

Excellent Beethoven. Is it more straightforward, less individual and eccentric, because Gould is older now? Or (more likely) because the Beethoven playing tradition is stronger, the music more recent, than that of Bach and Mozart, where past Gould interpretations have taken on new and highly personal shapes? Gould plays no concerts now; he surely allows tape editing, for the best out of various takes. Makes not the slightest difference! That is the way records must be made and are *best* made. I do not see why we should care a fig if Gould were unable to play in "live" concerts at all, for it is quite irrelevant. Here is he, and he is good to listen to. The two huge variation sets, the 32 in C Minor and the Eroica Variations (precursors of the Eroica Symphony's last movement) are, to be sure, somewhat gentle and less heroic than is customary. I find the change refreshing. There is no lack of architecture, sweep, eloquence; the music simply is played for itself, not for the big show.

# Fairfax introduces the Unheard Speaker!

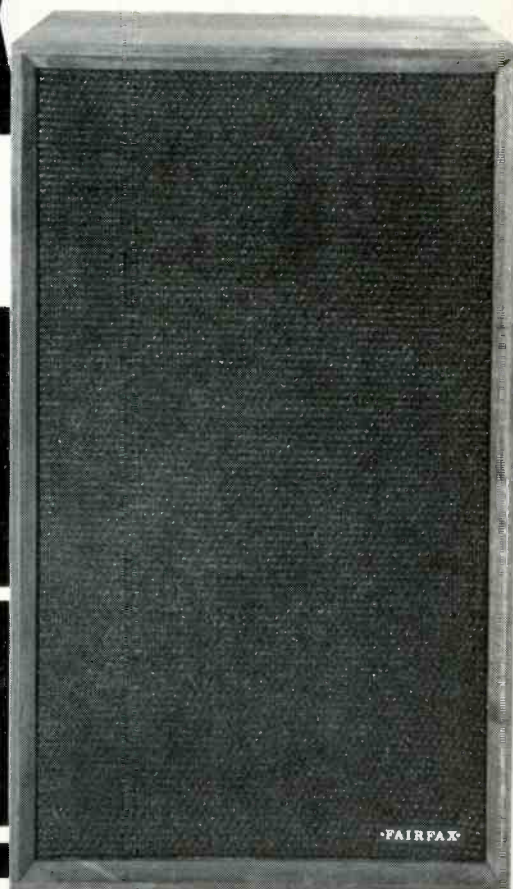

Now hear the speaker with the unheard of performance. The first speaker system to break with traditional stagnation in loudspeaker design and create the last word in audio reproduction. The FAIRFAX FTA is an electronic instrument so perfectly engineered and precisely tuned that it reproduces the original recorded music or human voice in unheard of dimensions and living presence realism.

The FAIRFAX FTA simply cannot be heard. All you can hear is the reproduction of the audio signals fed into it—no discoloration . . . no distortion . . . pure, pure rich, full-bodied sound.

Originally the FAIRFAX FTA system was built to custom specifications of audio engineers and professionals in the music industry because they demanded a speaker system which would not introduce any audible sound of its own, no undesirable harmonics and imperceptible distortion. A standard of performance that could not be achieved on most well-known speaker systems.

## INCREDIBLE ZERO OVERLAP AND TRUE PITCH

The FAIRFAX FTA is the first speaker system to achieve the unheard of state-of-the-art standard of zero overlap—an achievement coveted throughout the audio industry—which

now permits the unconscious differentiation between each of the individual musical instruments in a complete orchestra.

You don't have to be an orchestra conductor, recording engineer or audio technician to appreciate the astonishing results in the degree of realism that is so remarkably enhanced by the FAIRFAX FTA. All you have to do is love music and know how it should sound.

The realistic well-rounded, linear-in depth sound that you experience with the FAIRFAX FTA will enhance your stereo recordings and FM reception either mono, stereo or quadradial to a degree you've never believed possible.

The next time you're auditioning speakers insist on comparing the FAIRFAX FTA to other speakers of its class or even selling for as much as \$100.00 more. You'll be amazed at the superiority of the FAIRFAX FTA in all areas including the price! Unheard of at only **\$139.50** (suggested audio-ophile net).

## SPECIFICATIONS of the FAIRFAX FTA:

4 speakers, 3-way system; 1 low bass, 1 mid bass 8" woofers; 1 mid-high 3½" tweeter; 1 ultra-high tweeter; freq. response 28-20,000Hz; 60 watt input; 25" H x 14" W x 12" D.



Other FAIRFAX Speaker Systems are available from \$79.50 to \$399.50 at quality-minded audio dealers. Ask your dealer for a demonstration or write to us for the name of your nearest FAIRFAX dealer.

**FAIRFAX INDUSTRIES**  
INC.

900 PASSAIC AVENUE, EAST NEWARK, N. J. 07029 (201) 485-5400

## GRAPHIC STEREO TONE CONTROL

HIRSCH-ROUCK LABORATORIES HAD THIS TO SAY, "...The Frequency Equalizer performed fine in listening tests. It was able to tailor sound very well. The harmonic distortion at 1,000 Hz is virtually non-existent...IM at 2 volts was measured at 0.016%... Frequency response  $\pm 0.3$ dB from 5 to 500,000 Hz... The output clipping level occurred at 9.0 volts..."

"HERE'S WHAT WE HAVE TO SAY, "The Graphic Stereo Tone Control is Metrotec's newly developed Frequency Equalizer. Its flexible 5-segment tone control provides  $\pm 12$  dB at 60, 250, 1,000, 3,500, and 10,000 Hz. This allows precision compensation for room acoustics,

program material, speakers, and individual preferences.

In other words, it tailors sound to suit your personal listening requirements."

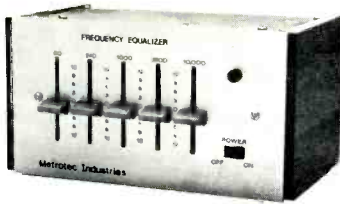

The Graphic Stereo Tone Control can be used with all preamp-basic combinations or receivers with a tape monitor switch. The system sells for \$99.95 with a 2-year guarantee or \$79.95 for an easy-to-assemble kit. See your dealer or send a check or money order (include \$1.25 for postage and handling, and N. Y. State residents should add appropriate sales tax to the purchase price) to: Metrotec Industries, 1405 Northern Blvd., Roslyn, N. Y. 11576. Dealer inquiries invited.

Check No. 58 on Reader Service Card

## Behind The Scenes

(Continued from page 15)

stereo cassettes, and to put it mildly, I am absolutely amazed at the superb quality. This is what the game is all about. This represents a new ball game... one can no longer dismiss the cassette as a "toy." The best of the lot is the "Suite Espanola," and this comes so close to the quality of a good disc, it is frightening. It doesn't have quite the wide frequency response, low distortion, and transient response of the disc, but it is very, very good. On the plus side for the cassette, there is the dead quiet background... no audible tape hiss even though this too was played back with peak levels of 100 dB. Then too, there are no "ticks" or "pops" or "scratches," which can be so distracting and annoying when listening to a disc. The overall sound is beautifully clean and has great sonority. Strings are very smooth, showing exceptionally low levels of high frequency distortion. Percussion was sharply defined and extended all the way to the lowest frequency. Brass was big and bright. In all, there was no feeling of compression so common with standard pre-recorded cassettes. One friend for whom I played this cassette just wouldn't believe he was listening to a cassette and went over and pressed the pause control on the Wollensak to convince himself! Mechanically the cassettes were good too, with just one "burble" sound on a solo flute, the only fall from grace. Much the same praise can be lavished on the Tchaikovsky pieces and the Vienna Imperial, with just a shade less stability and a bit of high frequency distortion showing up occasionally. In terms of dynamic range and tape hiss they were on a par with the Suite Espanola, which is accolade enough. It goes without saying that all three Dolbyized cassettes were processed from Dolby A301 masters... and it sure makes a great difference!

There is no doubt that the use of chromium dioxide tape would allow more headroom and even lower values of high frequency distortion, but strictly from the viewpoint of signal-to-noise ratio these London/Decca Dolbyized cassettes leave scant room for improvement.

The full report on the Vox Dolbyized cassettes will have to wait until next month, since I have discovered a slight mechanical problem with them and need new copies. As a preliminary observation they are of roughly the same quality as the London/Decca cassettes, although there seems to be a tiny wisp of tape hiss still audible. **AE**

**WANT  
SOMETHING  
FRESH...  
EXCITING?**

*new*  
**SUPEREX...**  
*it's beautiful*

Beautiful all the way! In design — a triumph of newest state-of-the-art concepts. In response — a spectacular bass; sweet, clear highs; exciting mid-range. And the experts say that overall performance is better than some expensive speaker systems. It's all made possible by our exclusive woofer/tweeter design that puts a 2-way speaker system at each ear. The name is PROB-V... and the all-new extras include "con-form" ear cushions, tuned port ear shells, retractable cord and soft, tropical green finish.

**\$59.95 — at dealers everywhere**



**SUPEREX ELECTRONICS CORP.**  
151 Ludlow Street, Yonkers, N.Y. 10705



Check No. 60 on Reader Service Card

Send for **FREE BOOKLET**: "Why's and How's of Equalization"



*Soundcraftsmen* presents...

the new component that is a "must" with every fine stereo system...

## the new **Audio Frequency Equalizer**

guaranteed to improve any stereo system and

guaranteed to improve any listening area environment!

Now, in a few minutes, you can accurately "tune" the frequency response of your stereo system and room environment to a flat  $\pm 2$  db! All you need are your own ears and the 20-12 (with its step-by-step instruction record) to transform any stereo system and room environment into an acoustically-perfect concert hall! Or, to provide any special acoustical effects you desire! The 20-12 enables you to instantly compensate for frequency response variations, in system and room.

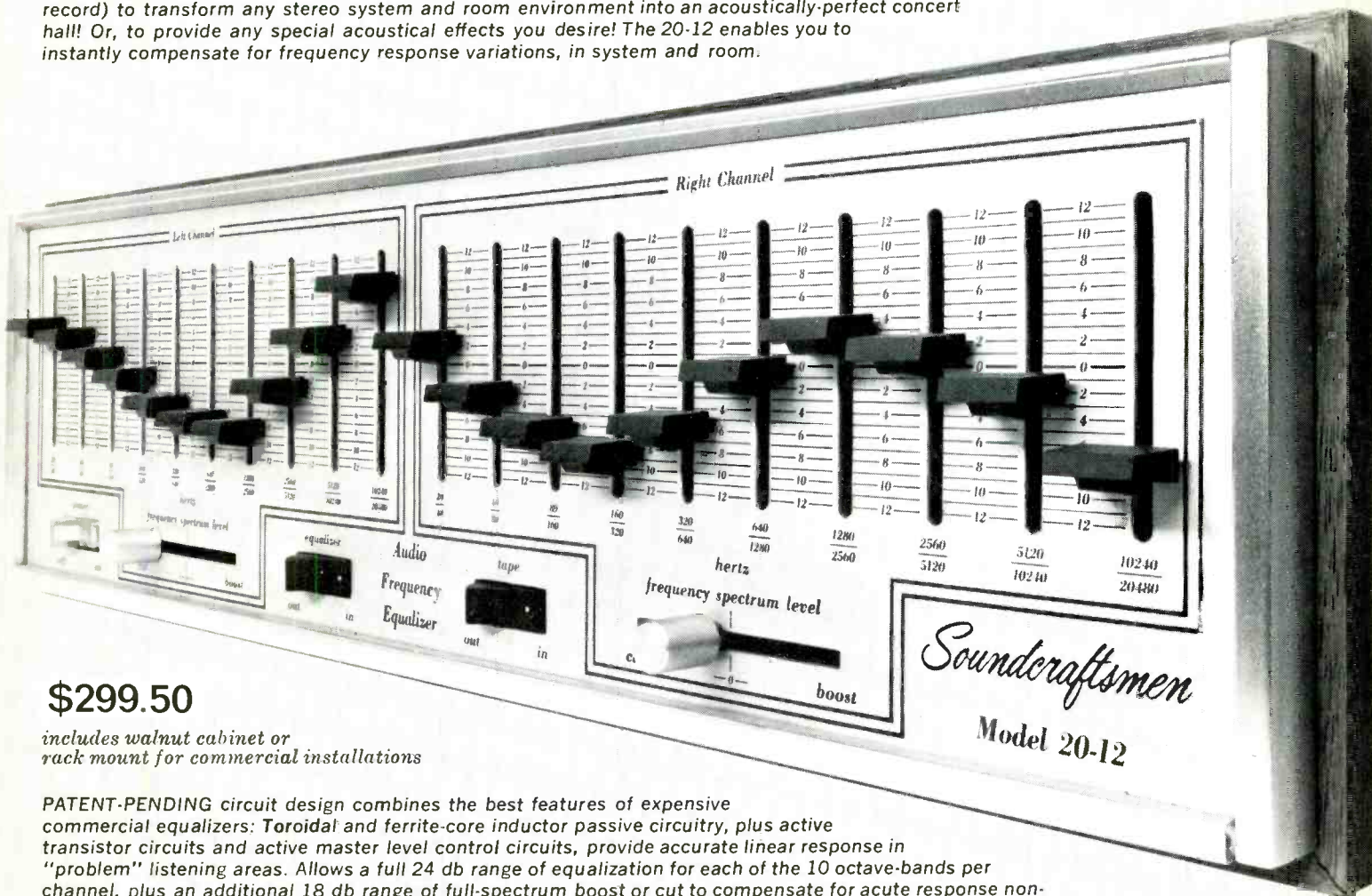

**\$299.50**

includes walnut cabinet or  
rack mount for commercial installations

PATENT-PENDING circuit design combines the best features of expensive commercial equalizers: Toroidal and ferrite-core inductor passive circuitry, plus active transistor circuits and active master level control circuits, provide accurate linear response in "problem" listening areas. Allows a full 24 db range of equalization for each of the 10 octave-bands per channel, plus an additional 18 db range of full-spectrum boost or cut to compensate for acute response non-linearities due to deficiencies in the entire recording-reproducing process.

### **SPECIFICATIONS and SPECIAL FEATURES**

**TOROIDAL** and ferrite-core inductors, ten octave-bands per channel.

**FREQUENCY** response:  $\pm \frac{1}{2}$  db from 20-20,480 Hz at zero setting.

**HARMONIC DISTORTION**: less than .1% THD.

**IM DISTORTION**: less than 0.1% at rated input(s).

**SIGNAL-TO-NOISE RATIO**: greater than 65 db at rated input(s).

**INPUT IMPEDANCE**: 100K ohms or greater.

**OUTPUT IMPEDANCE**: less than 10K ohms.

**RANGE**: 12 db boost and 12 db cut, each octave.

**MASTER OUTPUT LEVEL**: "Frequency-spectrum-level" controls for left and right channels, continuously variable 18 db range, for unity gain compensation from minus 12 db to plus 6 db.

**MAXIMUM OUTPUT SIGNAL**: variable Master "frequency spectrum level" Controls allow adjustment of optimum output voltage for each channel, to exactly match amplifier capability, up to 6 v RMS.

**SIZE**: designed to coordinate with receivers, comes installed in handsome walnut-grained wood receiver-size case, (5 $\frac{1}{2}$ " x 17 $\frac{3}{4}$ " x 11").

**WARRANTY**: 2-year parts and labor.

Soundcraftsmen: 1320 E. Wakeham Ave., Santa Ana, Ca. 92705, Ph: (714) 835-1087  
CIRCLE NO. 49 ON READER SERVICE CARD

*please  
write  
for a  
free*

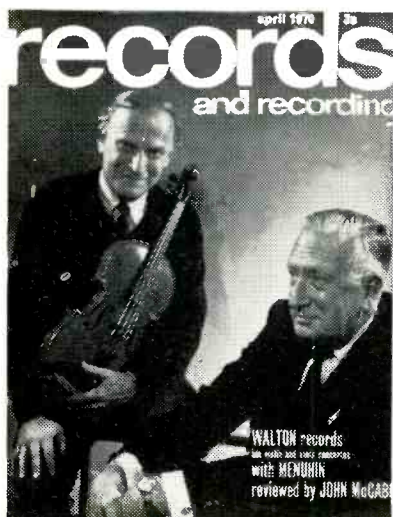

*intro-  
ductory  
copy*

WRITE YOUR NAME & ADDRESS HERE.  
CUT & POST THIS COUPON or write a  
separate letter to RECORDS AND RECORDING,  
75 Victoria St., London, SW 1, England.

name

address

city

state

## Weingarten Looks At



## John Mayall

**J**OHAN MAYALL, who is virtually a one-man history of British blues, has crossed the Atlantic to form as close an Anglo-American alliance as existed before the Revolution.

For the first time, he has recorded an LP with only U.S. musicians, as good a combo as he has had—with the possible exception of groups featuring sidekick John Allman's steel and gut-reaction virtuosity.

The emphasis of the album, *USA UNION* (Polydor 24-4022), is, naturally, blues. But there are heavy overtones of jazz—and some straight pop seeps in now and then. It also is a message LP, evidenced quickly by the lead piece, "Nature's Disappearing," an unsubtle appeal to save our environment. Witness part of the lyrics:

"Man's a filthy creature  
"Raping the land and water and  
the air.  
"Tomorrow may be too late—  
"Now's the time that you must be  
aware.  
"Nature's disappearing  
"Polluted death is coming . . . Do  
you care?"

"Garbage going nowhere  
"Soon the dumps will spread to your  
front door.  
"Lakes and rivers stagnant  
"Nothing lives or grows like years  
before.  
"Nature's disappearing.  
"The world you take for granted—  
soon no more. . . ."

Coupled with the tune are, on the inside of the dustjacket, tips on fighting pollution, including pleas against littering and for buying only deposit bottles.

The music itself, on all 10 tracks, is fascinating. The combo, first of all, is drummerless. Thus there is a combination of sounds from Don Harris'

violin, itself a rarity (but one may wonder why after hearing "Deep Blue Sea" and "Crying"); Larry Taylor's bass guitar (hear, in particular, "My Pretty Girl" and "Off the Road"), and Harvey Mandel's lead guitar. Mayall, himself, of course, is outstanding on harmonica and guitar—and he tosses in a bit of shuffle piano. The leader's singing, gruff at best, would leave something to be desired in any other format, but blues numbers are the perfect setting for the coarseness.

All the tunes (ranging from the shortest to "Crying," the longest at 6:25) were penned by Mayall, and all prove that you don't have to be black to have soul or to care about life on this planet, or about loneliness or love.

A soft rock-pop sound, à la Harpers Bizarre, emanates pleasantly from a disc that carries the name of the group as title. *REDEYE* (Pentagram, PE 10.003). The 10 cuts, written wholly or in part by Dave Hodgkins, who is the quartet's acoustic rhythm guitarist, range from entries in the softness sweepstakes to bouncy novelty-flavored winners.

Best of the recording, distributed by Viva-Bravo, are "Games," straight pop-rock with a driving beat; "Empty White Houses," with a gospel aura; "Mississippi Stateline," a bluesy soft rock success, and "Collection of Yesterday and Now," the longest piece (4:26).

Bob Bereman, who is outstanding on drums and percussion, is the only Redeye member who doesn't sing. Vocals are, however, augmented by Douglas "Red" Mark, the electric guitarist, and Bill Kirkham, bassist.

A great waste of talent—specifically that of Hugo Montenegro and Al Hirt—is found on an RCA Victor recording, *VIVA MAX!* (LSP-4275), with music



from the film of that name that dealt, supposedly in a comedic vein, with an attempt by latter-day Mexican patriots to recapture the Alamo.

The movie missed the mark, and the album suffers the same fate. Only a couple of the 10 tracks, all arranged and conducted by Montenegro, are more than film background music and have any meaning by themselves. The lead piece, "Viva Max March," is one of the few—it is bright and breezy, and by far the best item on the LP. "Sentries Charge" is interesting in its approach, mainly through the use of heavy jazz riffs (combinations of Hirt's magical trumpet and flashing drums), and "Paula's Theme," 3 a.m. music with superlative horn work.

On the negative side, though, are "Sneaky Lady," a conglomerate without definition; "Operation Morning After," to which only "ditto" fits; "Don't Turn Back," which features good stereo separation but is otherwise unimaginative—despite the presence of the Ron Hicklin Chorus; "Viva Max Hat Dance," a slight update of the traditional theme; "March to the Alamo," a cacophony of traffic sounds, loud music, and a disoriented choral effect, and "After Mass on Sunday" and "The Alamo Letter," both of which intersperse dialogue and musical fragments.

As a whole: Ecchh!!

Roger Williams, a master at taking pop tunes and adding classical flourishes, continues his best-selling ways with THEMES FROM GREAT MOVIES (Kapp, KS 3629). Backed by an orchestra conducted by Don Costa (except for "Windmills of Your Mind" and "Airport Love Theme," on which Ralph Carmichael holds the baton), Williams' piano shows an excellent variety of moods and tempos, and does its bit to bridge the generation gap.

On the first side, for instance, "On a Clear Day You Can See Forever" is a longish tune that ends with jazzy passages. This contrasts with "Hello Dolly!" traditionally a big, brassy, up-tempo scorcher, and the stringed softness of "Midnight Cowboy." Other differences can be seen on "Windmills . . ." with a heavy classical interlude, and "Song from 'M\*A\*S\*H' (Suicide is Painless)," that showcases a soft rock beat and chorus.

The flip side contains the pensive Rod McKuen chartbuster "Jean," the whistling and march tempo of "Patton Theme" (which also is jazzy at its midsection), and "Come Saturday Morning," with a pizzicato flavor that leads to a smooth, Muzak-type arrangement.



## The all new PE-2040 PERfection in PERFORMANCE

Your inevitable choice among automatic turntables. Sooner or later other automatic turntables will incorporate the exclusive features now available on the new PE-2040: Dial-a-Matic vertical tracking angle adjustment for all records . . . Independent, ultra-gentle, fingertip cueing control . . . Fail safe stylus protector . . . Automatic record scanner . . . Single lever control for all modes of operation . . . Continuous record repeat. These are just some of the exclusive features. Stop by at your PE dealer for the complete story and a demonstration of PERfection in PERFORMANCE. PE-2040—\$155.00; other PE models from \$70.00. For further information on PE and name of your nearest dealer write: Dept. A-2 Elpa Marketing Industries, Inc., New Hyde Park, N.Y. 11040



PERfection in PERFORMANCE



# FREE!

Golden Jubilee Edition . . .

LAFAYETTE 1971 Catalog 710

468 Pages

Your 1st Guide To  
Everything In Electronics

Stereo Hi-Fi . . . Receivers . . . Tuners . . .  
Speakers . . . Turntables & Accessories  
■ Automatic Reversing Stereo Tape Recorders & Decks ■ Color TV's ■ FM Radios  
■ Tubes & Parts ■ Intercoms & PA Systems  
■ Closed Circuit TV Equipment  
■ Cameras ■ Auto Tape Players ■ Musical Instruments

LAFAYETTE Radio ELECTRONICS  
Dept. 27021 P.O. Box 10  
Syosset, L.I., N.Y. 11791

Serving The Public  
Since 1921

Send For  
**FREE!**  
1971 Catalog Today!

Send me the FREE 1971 Catalog 710 27021

Name

Address

City  State  Zip

**Classified** Rates: 25¢ per word per insertion for noncommercial advertisements; 50¢ per word for commercial advertisements. Frequency discounts as follows: 2 times, less 15%; 6 times, less 20%; 12 times, less 30%. Closing date is the FIRST of the second month preceding the date of issue. *Payment must accompany all orders under \$10.00.*

## SERVICES

### HIGH FIDELITY SPEAKERS REPAIRED AMPRITE SPEAKER SERVICE

655 Sixth Ave., New York, N.Y. 10010  
CH 3-4812

**RENT STEREO TAPES** \$1.25 week. Catalog 25¢. Tape Library, Box 8126, Washington, D.C. 20024.

**CUSTOM STYLUS** and cartridge re-tipping, repairing. (Weathers, Ortofon, Edison, Shure, etc.) Box 322A. Tuckahoe, N.Y. 10707, 914-SP 9-1297.

**CUSTOM RECORDING SERVICE.** Tape and disc. Stereo and mono. Live and copies, Editing. Masters and pressings. High quality at reasonable rates. Joseph Giovanelli, Audio-Tech Laboratories, 2819 Newkirk Ave., Brooklyn, N.Y. IN 9-7134.

**LEARN** Electronic Organ Servicing at home. All makes including transistors. Experimental kit—trouble-shooting. Accredited NHSC. Free Booklet. Niles Bryant School, 3631 Stockton, Dept. 1D, Sacramento, Calif. 95820.

**MAKE FRIENDS WORLDWIDE** through international correspondence. Illustrated brochure free. Hermes, Berlin 11, Germany.

**PROTECT YOUR LP's.** Poly sleeves for Jackets 5¢. Inner sleeves 4¢. Poly lined paper 10¢. White Jackets 25¢. Minimum order \$5.00. House of Records, Hillburn, N.Y. 10931.

**ELECTRONIC TUBES,** Semiconductors, Equipment and Parts. Lab-matched tubes, Finest quality. Serving TV/Hi-Fi Servicemen, Engineers, and Industry for 30 Years. Advise your needs. Send 25¢ for Catalog. A Barry Electronics, 512 Broadway, New York, N.Y. 10012. (212) 925-7000.

**ACOUSTECH AMPLIFIER REPAIR.** Original performance or improved specifications. BKM Associates, Box 22, Wilmington, Mass. 01887.

**MIDWEST'S** only AR/Dyna factory-authorized repair station. Large stock of parts and factory-trained personnel. Haynes Microelectronics, 9 W. 14th St., P.O. Box 457, Lawrence, Kansas 66044.

**NEED SOMETHING "SPECIAL"?** Four channel power amplifiers, electronic crossover network, special mixers or filters? State of the art technology now in any system or component. Act as your own project engineer: Our staff and lab are available. Development Engineering Services Co., P.O. Box 693, Pacoima, Calif. 91331.

**PSYCHEDELIC LIGHTING MANUAL!** Make strobes, kaleidoscopes, color organs, etc. Send \$2.95. Lightrays, 1315-B Weaver, Philadelphia, Pa. 19150.

## SERVICES

**RECORDS MADE FROM YOUR TAPES.** Also, editing and mastering. Send for free brochure. Nashville Record Productions, Inc. Dept. AM, 204 19th Ave., So., Nashville, Tennessee 37203.

## FOR SALE

**GUARANTEED USED EQUIPMENT:** Marantz 7 preamp \$195. • Crown DC300 Amplifier \$485. • Marantz Electronic Crossover \$40. • McIntosh C-22 preamp \$195. • Thorens TD124 w SME \$150. • Teac 6010 \$400. • JBL SE400 Amp \$195. • Marantz 18 Receiver \$395. • AR1W's \$65 ea. Dual 1219 w cartridge \$135. • Marantz 15 amplifier \$195. • Tandberg 64X \$250. • Marantz Mdl 1 audio console \$50. • Leak Point 1 Stereo preamp/amp \$115. • Marantz 8 Amplifier \$100. • Audio Consultants, 517 Davis Street, Evanston, Illinois 60201. (312) 864-9565.

**SCOTCH MAGNETIC TAPE,** discount, Box 167A, Orwigsburg, Pa.

**NEW CM CC-2** Preamplifier, wood case. \$165. New SAE Mark IV Amplifier. \$245. (203) 661-1888. Reply to Box #AF1-1.

**OLD TIME RADIO:** 15 minute demonstration tape, catalog, 25¢. Double-R-Radio, 505 Seeley Road, New York 13224.

**MARANTZ 8B AMP.** \$110, after 5 P.M. Dave Scoville, 2312 Cassopolis St., Box 15, Elkhart, Indiana, 46514. (219) 264-7397.

**KLIPSCH, S.A.E., REVOX,** other quality components. Individually designed and installed music reproduction systems. C. M. Santmire, Audio Consultant (402) 477-8469, by appointment. **LINCOLN, NEBRASKA.**

**FISHER XP-18** speakers \$400 pr. originally \$660, excellent condition. **MARANTZ 10B** tuner \$425, 33 preamp \$300, 16 poweramp \$350, less than 6 months old. **McINTOSH MC-30s,** 3 at \$100 each. **KLH 27** receiver \$225. C. E. Fields, 1340 S. 20th St., Lincoln, Nebraska (402) 489-8237.

**THREE AMPEX PR-10-2** Stereo Recorders (unmounted), two in good condition, \$350.00 each. One needs work, but enough spare parts are available from a fourth recorder. Make offer for both of these, write: Howard White, Director of Audio-Visual Services, Oberlin College, Oberlin, Ohio 44074. Or call (216) 774-1221, Ext. 3100.

**SCHOBER Rv-3** Reverbatape, new, \$125. Brand new Crown 4 channel recorders, ss844 two mix inputs per channel. \$1900. each. Used Ampex 602-02 full track, top condition. \$250. Call area (614) 252-2626.

**NATIONALLY** advertised Audio Equipment, Cost Plus 10%. Stereo World, 3250 Duke Street, Alexandria, Virginia 22314.

## FOR SALE

**INFINITY SERVO-STATIK I** as tested in High Fidelity magazine. Rosewood finish. Private party needs cash. J. D. Griggs, 3515 Manhattan Ave., Manhattan Beach, Calif. 90266. Phone: (213) 545-2577.

**GATES 52CS STUDIOETTE,** Excellent. \$500. E. Stolz, (916) 489-8659.

**TEAC A-6010** Deck, excellent, best offer over \$350. Ed Daily, 2801 Neil Drive, Roanoke, Virginia 24019.

**STUDIO CLEARANCE SALE:** Crown 714C-L.P./Z Quarter track stereo recorder with adjustable heads for half track stereo playback, 2 V.U. meters, 4 mixed microphone or line inputs, 3¼, 7½, & 15 ips speeds, 14" reel capacity, portable carrying case. Excellent condition \$455.00. Line output transformers available at \$25.00/pair. Ampex MX-10 four input mic./line stereo mixers. Three at \$250.00 each. Fisher KX-10 reverbs at \$30.00 ea. Pultec model EQP-1 Program equalizers. Two for \$550.00, 285.00 ea. Altec 1566A line amplifier/preamp. \$40.00. Presto 92-B recording amplifier with 4½" illuminated V.U. meter and Presto 1-D cutterhead \$210.00. Presto 6-N lathe, 45/33 speed, suction tube, lamp, floor cabinet, and two leadscrews \$270.00. Extra leadscrews, hot stylus, and microscope available. Pickering model 410 mono. preamp. on rack panel \$180.00. 5¼" rack panel with three Simpson 4½" rectangular V.U. meters and three controls \$53.00. E.V. 666 dynamic microphone and cable \$89.00. A.K.G.-Norelco D-200E two-way dynamic with new cable \$44.00. **WIEGAND AUDIO LABS,** 3402 Windsor Rd., Wall, N.J. 07719. Phone: (201) 681-6443.

**STEREO TAPE TRANSPORT.** Made for leading manufacturer, two-speed, pause control, 7" reel, 50-15000 Hz, 0.25% wow and flutter, with record/play and erase heads. Without case. Send money order or check for \$19.50 to Stereo Center, 218 Columbia Street, Utica, New York 13502. Add \$2.50 for prepaid shipping & insurance.

**PROFESSIONAL STEREO TONEARM**—similar to Shure M232 or Rek-O-Kut S520. Plug-in shell, finger lift, adjustable counterweight, no springs, heavy connecting cables with pin plugs, beautifully balanced. One-year warranty. Made by famous turntable-arm manufacturer in Switzerland. Send check or M.O. for \$9.50 plus \$1.50 for shipping and insurance. Stereo Center, 218 Columbia Street, Utica, N.Y. 13502.

**OLD RADIO PROGRAMS.** Large selection. Lowest prices. Catalog 25¢. Roger Massel, 1533 50th S.W., Wyoming, Michigan 49509.

**BRAUN,** fabulous German stereo components, full catalog 50¢. ADS, P.O. Box 293, Huntsville, Ala., 35801.

**OLD RADIO** programs catalogue 25¢. Steve Monaco, 1306 Park Ave., Des Moines, Iowa 50315.

**INFINITY SYSTEMS**—The finest reproduction possible today. CROWN—so pure—DC-300 IC-150 tape. Phila. area (609) 854-3448, Mid Penna. area (717) 273-6314.

**CONSUMERS CASSETTES** and Accessories, Blank Cassettes as low as C-30—50¢, C-60—54¢, C-90—99¢, C-120—\$1.22. All Cassettes licensed quality control by North American Philips. Lifetime guarantee. **WRITE FOR FREE CATALOG!** CONSUMERS ELECTRONICS CO., 103 Park Avenue, Dept. AM, New York, N.Y. 10017.

**OLD RADIO PROGRAMS** on tape for sale or trade. Send 35¢ for current 1970 catalog. Bob Joseph, 1250 La Baron Circle, Webster, N.Y. 14580.

## FOR SALE

**HARPSICORD**—Completely new design six feet long with either one, two, or three sets of strings. Kits from \$1.75; also completed instruments. Clavichord kit from \$100. Write for free brochure. Zuckermann Harpsichords, Inc., Department R, 115 Christopher Street, New York, N.Y. 10014.

**KLIPSCH, TANNOY, BOZAK, MARANTZ, THORENS, RABCO**—No Discounting—Superior Sound, 1801 Brewerton Rd. (Rt. 11) Syracuse, N.Y. 13211.

**NAB HUB ADAPTERS**—Fit Revox, Crown, TEAC, Roberts. \$3/pair postpaid. No C.O.D. Qty prices available. John Kountz, 1065 Van Dyke Dr., Laguna Beach, Ca. 92651.

### IMPROVE YOUR AR or KLH.

Microstatic, the first Total-Coverage high-frequency speaker system, is designed to improve the performance of AR and KLH speakers. Write for detailed brochure. Micro-Acoustics Corp., Box 302, White Plains, N.Y. 10602.

**REK-O-KUT** Turntables, Tonearms, and Replacement Parts are now available. Contact our Main Plant at Rek-O-Kut, 1568 North Sierra Vista, Fresno, Calif. 93703. Phone: (209) 251-4213 or our Parent Company CCA Electronics Corp., 716 Jersey Avenue, Gloucester City, N.J. 08030, Phone: (609) 456-1716.

**OLD** Radio Programs on tape, 6 hours for \$8.00 Catalog 50¢. Remember Radio Inc., 1926 Cherokee, Norman, Okla. 73069.

**SCULLY** Professional Tape Recorders, from 1 to 24 tracks, complete recording studio package designed to order featuring W.A.L. console systems and other leading professional audio products. Phone (201) 681-6443, Weigand Audio Laboratories, 3402 Windsor Road, Wall, N.J. 07719.

**DISC RECORDING EQUIPMENT:** Complete mono and stereo cutting systems featuring rebuilt Scully, Neumann, Van Eps, and Fairchild lathes and new W.A.L. amplifiers. Priced from \$2500.00 Wiegand Audio Laboratories 3402 Windsor Road, Wall, N.J. 07719.

**RADIO YESTERYEAR!** Biggest and best in the industry we created. Over 7000 of those great old-time radio shows. ANY program you remember, drama, bands, serials, comedy, etc. Highest fidelity possible with Ampex duplicators. Free catalog. Radio Yesteryear, Box H. Dept. A, Croton-On-Hudson, New York 10520. Member Better Business Bureau.

**VINTAGE RADIO** on LP records at last. Highest Fidelity, most reasonable prices. Free catalog. The Radiola Co., Box H, Dept. A, Croton-On-Hudson, New York 10520.

**CATALOGS** Broadcasts, soundtracks, Personalities of Thirties, Forties, Box 225, New York, N.Y. 10028.

**REVOX, QUAD, Thorens, Stanton, Ortofon, P. E., Sony, Dual, Marantz, Bozak, S.A.E., Rabco, KLH, Dynaco, Barzilay Cabinets, Interiors Plus Sound, 1322 E. Commercial Boulevard, Ft. Lauderdale, Florida, 33308. (305) 771-4715.**

**BUY-SELL-TRADE:** AR, Altec, Advent, Marantz, Sony, Dynaco. **SHURE** V15-11 improved, \$47 and old cartridge, shipped prepaid. **STEREO Shop**, 1201 Ellis, Cedar Rapids, Iowa 52405.

**UHER 400-S** tape recorder with extras. \$195.-Berlant series 30 play preamp \$35. - KLH model 18 tuner \$80. - Gerald Rucks, P.O. Box 866, Oswego, Ill., 60543 (312) 554-8277.

## FOR SALE

**CUSTOM SPEAKER CABINETS** to your specs., and duplication of any discontinued enclosure. Price list available. Custom sound systems installed in Wash. D.C. area. Custom Audio Components, 3921 Lantern Drive, Wheaton, Md. 20902. (301) 942-8540.

**BUY DIRECT FROM ENGLAND'S HI-FI MAIL ORDER SPECIALISTS!** Save money on SME, Leak, Quad, Goldring, Decca, Bowers & Wilkins, Thorens, Ferrograph, Tandberg, Revox, Gold Speakers, Transmission Line, Garrard BSR, Dual, Lowther, Wharfedale, KEF, Celestion, Transcriptors, Radford etc. Insured shipping: quotes free, or send \$1.00 in include specified leaflets. Godwin Ltd., 7 Broadway, Wood Green, London N. 22. 6 DU. Visitors welcome to showrooms.

**COLOR CONVERTER** for black and white television. New patented color television system. An electronic do-it-yourself kit for hobbyists and experimenters. Plans, instructions and brochure only \$2.50. Bele Electronics Corp., 111 Northeast Second Avenue, Miami, Florida 33132.

**MICROPHONES — CONDENSER, RIBBON,** dynamic, precision-built in West Germany, top value, performance and appearance. Write for distributor costs, catalog and FREE booklet, "HOW TO CHOOSE AND USE MICROPHONES." Stanford International, San Carlos, Ca. 94070.

**SPECIALIZING** taped radio mysteries. Reels or cassettes. Catalog \$1.00, refundable first order. Detective House, 218 Orangeview Lane, Lakeland, Fla. 33803.

**FM BACKGROUND MUSIC** without commercials available on many FM stations! **MUSICON** Adapter plugs into your FM Tuner, delivers continuous music through your amplifier and speakers. Line-cord operated. No adjustments or tuning, ever. New design breakthrough guarantees optimum performance (15-day refund for any reason). Lowest price ever—\$39 postpaid to K-LAB, Box 572A, S. Norwalk, Conn. 06856.

**PATENT RIGHT** for sale—Tonearm, Servo-controlled strait-line tracking. U.S. inquiries. J. Jeles, Box 182, Chemainus, B.C. Canada.

**INFINITY AND S. A. E.** equipment—unquestionably the finest available. Send for brochures, other components. Paul Heath, 81 Big Tree St., Livonia, N.Y.

**AMPEX 440-8-C** Recorder. Mint condition—\$8950. Ampex 440-2-C with additional ¼ track play head \$2200. Ampex 300-2-C \$1750 all guaranteed. Joe Tarsia. 212 N. 12th St., Phila., Pa. 19107 (215) 561-3660.

**FREE CATALOG** offers high fidelity speaker systems at manufacturer's prices. CTAL, Box 543, Newark, Calif. 94560.

**HI FI FURNITURE?** See Toujay designs at S.E.E. 70's High Fidelity exhibit, 443 Park Ave. S., N.Y.C. 10016, Tues. to Fri. 10-6, Sat. 10-4. Full line brochure 25¢.

**COMPLETE LINE** of magnetic car & truck signs, 36 std. sizes. 40% profit. Mobil Magnetics, Bx 283PI, Decatur, Ind.

**INFINITY SYSTEMS,** Quad, Stax, Crown International, Citation, Decca, K. E. F., Thorens, Transmission-Line speakers, anything else exotic. Plus custom electronic cross-overs and amps—Electrostatic Sound Systems Co., 1823 20th St., Sacramento Calif. 95814.

**STEREO HEADPHONES—\$20—DISCOUNTS AVAILABLE.** WRITE H & M DEPT. A BOX 474, PT. HUENEME, CALIF. 93041.

## FOR SALE

**BASF—4 TRACK PRE-RECORDED STEREO TAPES,** Lowest Prices, Postpaid U.S.A. Free brochures. Write **STEREOTONE TAPES, Box 657, Sterling, Illinois 61081.**

**TAPES** - Pre-recorded and blank. Reels, Cartridges, Cassettes. **Lowest Prices anywhere.** Alan Enterprises, 5023 Lee St., Skokie, Illinois 60076.

**DYNAMIC RANGE EXPANSION** can restore inert undulating sensitivities into spectacular stereophonic realism . . . The **HARMONIC WAVE FORM PROCESSOR** is \$119. Postpaid, connects easily, and is completely guaranteed. Information free. **AUDIO ENGINEERING LABORATORIES, INC.,** King Ferry, N.Y. 13081.

## EQUIPMENT WANTED

**TEAC CORPORATION** of America Erath models LW-1 and LW-6 speaker systems. Heathkit AJ-15 Deluxe stereo tuner John Barrett, P.O. Box 207, Immokalee, Fla. 33934.

**KARG LABS XT-1** TV Audio receiver. John Slagle, 325 West 19th, New York, N.Y. 10011.

**CASH FOR YOUR** unwanted LP's and pre-recorded tapes. Record House, Hillburn, New York 10931.

## HELP WANTED

**Serious recordists** to make records for five companies. We train, equip and provide protected franchised territories. Modest investment required. Send resume to Mr. Bloch, 418 N. Main St., Englewood, Ohio 45322.

## RECORDS

**"HARD TO GET"** records—all speeds. Record Exchange, 842 Seventh Avenue, New York, N.Y. 10019.

**OLDIES-45 RPM.** Original hits. Catalog 50¢. C & S Record Sales, Box 197, Wampsville, N.Y. 13163.

**"HARD-TO-FIND"**, deleted LPs and 45s, all types and categories, vast resources. RECORDS, Dept A, Box 16115, San Francisco, CA USA 94116.

## BUSINESS OPPORTUNITIES

**MAKE BIG MONEY** raising chinchillas, rabbits, guinea pigs for us. Catalog 25¢. Keehey Brothers Farms, Inc., New Freedom, Pa. 17349 or Summerfield, Fla., 32691.

## SITUATION WANTED

**VIBRAHARPIST** seeks alliance with recording studio equipped with electronic music synthesizer to produce, record, and explore the world of rhythm and tones. Reply to Box A00-1.

**Young Experienced Salesman** seeking sales position in Audio field. Will travel. Full knowledge of merchandise. Charles Gulley, 2712 Bartlett B-2, Pascagoula, Miss. 39567.

**HONEST MAN** looking for an honest job. Must be 100% on the up and up. No phonies please. Very retentive memory. Albert Francis Safran, Jr., 819 Pierson Run Road, Pittsburgh, Pa. 15239.

**IN OR AROUND BATON ROUGE,** Louisiana. Would like to work part time in the Audio field, while attending junior college for electronics. SP/4 John D. Davis E434-68-6984, Co. A, 523rd Sig. BN., Chu Lai Run, APO S.F. 96374.

S  
P  
E  
A  
K  
E  
R  
  
S  
Y  
S  
T  
E  
M  
S



STEREO  
HI-FI  
Direct  
service  
from the  
factory  
to you.

Systems that feature handsome walnut finished enclosures, surrounding perfectly coordinated high compliance speakers, that surround you with the full dynamic spectrum of sound.

A very special feature is their price.

MODEL CMS 83, \$40,  
comparable to \$69 value.

MODEL CMS 124, \$90,  
comparable to \$160 value.

Money back guarantee if not satisfied.

CLARK MUSIC INDUSTRIES, INC. Send for  
P. O. BOX 888 Dept. 3 your Free  
61 WALNUT AVENUE Catalog  
CLARK, NEW JERSEY 07066 today.

Check No. 101 on Reader Service Card

**HEAR HERE**

FOR THE UTMOST IN

**DISCOUNTS**

ON NATIONALLY  
ADVERTISED

**HI-FI STEREO  
COMPONENTS**

WRITE FOR OUR QUOTE

All Merchandise Shipped  
Promptly Fully Insured From  
Our Warehouse.

**DOWNTOWN  
AUDIO, INC.**

17 WARREN ST.  
NEW YORK, N.Y. 10007  
267-3670-1-2  
DEPT. A

Check No. 102 on Reader Service Card

# Advertising Index

|                                      |           |
|--------------------------------------|-----------|
| Acoustical Manufacturing Co.         | 15        |
| Acoustic Research, Inc.              | 23        |
| AKG Div., Norelco                    | 32        |
| Audio Dynamics Corp.                 | 49        |
| B & O of America                     | 14        |
| Benjamin Electronic Sound Corp.      | 25        |
| Boston Audio Co.                     | 66        |
| Bozak Mfg. Co.                       | 29        |
| British Industries Corp.             | 3         |
| Clark Music Industries, Inc.         | 66        |
| Concord Electronics Corp.            | 56        |
| Crown of America                     | 6         |
| Downtown Audio                       | 66        |
| Dynaco, Inc.                         | 5         |
| electro-harmonix                     | 57        |
| Elpa Marketing Industries            | 63        |
| Empire Scientific Corp.              | Cover IV  |
| Fairfax Industries, Inc.             | 59        |
| Finney Co.                           | 66        |
| Fisher Radio Corp.                   | 13        |
| Harman-Kardon, Inc.                  | 27        |
| Heath Co.                            | 19        |
| JVC America, Inc.                    | 7         |
| Kenwood Electronics, Inc.            | 33        |
| Koss Electronics, Inc.               | 37        |
| Lafayette Radio Corp.                | 63        |
| Marantz Co.                          | Cover III |
| Matsushita Electric Corp. of America | 1         |
| McIntosh Laboratory, Inc.            | 15        |
| Metrotec Industries                  | 60        |
| Nikko                                | 31        |
| Norelco                              | 32        |
| Panasonic                            | 1         |
| Phase Linear Co.                     | 10        |
| Pickering & Co., Inc.                | 17        |
| Pioneer Electronics (USA) Corp.      | 11        |
| Records & Recording                  | 62        |
| ReVox Corp.                          | 55        |
| Sansui Electric Co., Inc.            | 39        |
| Schwann, Inc.                        | 53        |
| Scott, H.H., Inc.                    | Cover II  |
| Sharpe Audio Div., Sintrex, Inc.     | 2         |
| Shure Brothers, Inc.                 | 47        |
| Sony Corp. of America                | 34, 35    |
| Soundcraftsmen                       | 61        |
| Superex Electronics Corp.            | 60        |
| TEAC Corp. of America                | 9         |
| Utah Electronics                     | 50        |
| Wharfedale                           | 3         |
| Yamaha International Corp.           | 56        |

*you're shopping  
discounts  
because you want  
the most system  
for your money.*



**KOSS** **DYNACO** **SHURE** **AR INC.**

Before you buy, be sure to  
check our price list. You'll be  
glad you did.

Write us for our price list, DEPT. A,  
or check our number on the reader  
service card.

**Boston** / **AUDIO  
COMPANY**

1 Discount Drive, Randolph, Mass. 02368  
( East Randolph Industrial Park, )

Check No. 103 on Reader Service Card

**GET  
MORE and BETTER  
FM Stereo Multiplex  
BROADCASTS**

WITH

**FINCO**

Award Winning FM Components

FM ANTENNA  
Model FM-4G

\$28.50 list

FM BAND  
PASS FILTER  
Model 3007  
\$7.30 list

FM INDOOR  
AMPLIFIER  
Model 65-7  
\$24.95



Write Dept. AM- 2- for Catalog 20-213

**THE FINNEY COMPANY**

34 W. Interstate St., Bedford, Ohio 44146

Check No. 104 on Reader Service Card

# READER INQUIRY CARD

FEBRUARY 1971 ISSUE

THIS CARD EXPIRES APRIL 30, 1971

Name \_\_\_\_\_

Firm \_\_\_\_\_

Address \_\_\_\_\_  Office  Residence

City \_\_\_\_\_ State \_\_\_\_\_ Zip \_\_\_\_\_

Are you a subscriber to AUDIO Magazine?  Yes  No

### OPTIONAL INFORMATION:

I am a:

- 1  High Fidelity Enthusiast
- 2  Home Recordist
- 3  Professional Recordist
- 4  Broadcast Engineer/Manager
- 5  Audio Service Technician
- 6  Audio Manufacturer or Dealer
- 7  Other \_\_\_\_\_

I would like to see more:  Technical articles  Articles for beginners

- Construction projects  Articles on music
- Music reviews:  Classical  Jazz  Rock
- Other \_\_\_\_\_

I buy an average of \_\_\_\_\_ records a year. Age \_\_\_\_\_

I have purchased the following equipment after seeing it advertised in AUDIO Magazine. \_\_\_\_\_

I am planning to purchase the following equipment in the next year. \_\_\_\_\_

Use this FREE Post Paid Card for more facts on the products described and advertised in this issue.

### CHECK BOX A or B beside each coupon number

- A to help me make an immediate decision to purchase.
- B to explore a new method or to keep my files on the subject up to date.

| #  | A | B | #  | A | B | #  | A | B | #  | A | B | #  | A | B | #  | A | B |     |  |  |     |  |  |     |  |  |
|----|---|---|----|---|---|----|---|---|----|---|---|----|---|---|----|---|---|-----|--|--|-----|--|--|-----|--|--|
| 1  |   |   | 16 |   |   | 31 |   |   | 46 |   |   | 61 |   |   | 76 |   |   | 91  |  |  | 106 |  |  | 121 |  |  |
| 2  |   |   | 17 |   |   | 32 |   |   | 47 |   |   | 62 |   |   | 77 |   |   | 92  |  |  | 107 |  |  | 122 |  |  |
| 3  |   |   | 18 |   |   | 33 |   |   | 48 |   |   | 63 |   |   | 78 |   |   | 93  |  |  | 108 |  |  | 123 |  |  |
| 4  |   |   | 19 |   |   | 34 |   |   | 49 |   |   | 64 |   |   | 79 |   |   | 94  |  |  | 109 |  |  | 124 |  |  |
| 5  |   |   | 20 |   |   | 35 |   |   | 50 |   |   | 65 |   |   | 80 |   |   | 95  |  |  | 110 |  |  | 125 |  |  |
| 6  |   |   | 21 |   |   | 36 |   |   | 51 |   |   | 66 |   |   | 81 |   |   | 96  |  |  | 111 |  |  | 126 |  |  |
| 7  |   |   | 22 |   |   | 37 |   |   | 52 |   |   | 67 |   |   | 82 |   |   | 97  |  |  | 112 |  |  | 127 |  |  |
| 8  |   |   | 23 |   |   | 38 |   |   | 53 |   |   | 68 |   |   | 83 |   |   | 98  |  |  | 113 |  |  | 128 |  |  |
| 9  |   |   | 24 |   |   | 39 |   |   | 54 |   |   | 69 |   |   | 84 |   |   | 99  |  |  | 114 |  |  | 129 |  |  |
| 10 |   |   | 25 |   |   | 40 |   |   | 55 |   |   | 70 |   |   | 85 |   |   | 100 |  |  | 115 |  |  | 130 |  |  |
| 11 |   |   | 26 |   |   | 41 |   |   | 56 |   |   | 71 |   |   | 86 |   |   | 101 |  |  | 116 |  |  | 131 |  |  |
| 12 |   |   | 27 |   |   | 42 |   |   | 57 |   |   | 72 |   |   | 87 |   |   | 102 |  |  | 117 |  |  | 132 |  |  |
| 13 |   |   | 28 |   |   | 43 |   |   | 58 |   |   | 73 |   |   | 88 |   |   | 103 |  |  | 118 |  |  | 133 |  |  |
| 14 |   |   | 29 |   |   | 44 |   |   | 59 |   |   | 74 |   |   | 89 |   |   | 104 |  |  | 119 |  |  | 134 |  |  |
| 15 |   |   | 30 |   |   | 45 |   |   | 60 |   |   | 75 |   |   | 90 |   |   | 105 |  |  | 120 |  |  | 135 |  |  |

My Comments On This Issue \_\_\_\_\_

## BUSINESS REPLY MAIL

No Postage Necessary if Mailed in the United States

POSTAGE WILL BE PAID BY:

# AUDIO

134 North Thirteenth St.  
Philadelphia, Pa. 19107

FIRST CLASS  
Permit No. 22,489  
Philadelphia, Pa.

CLASSIFIED ORDER CARD Fill in other side to order a classified ad

# SUBSCRIPTION ORDER CARD

Don't wait until your subscription runs out. Renew now and insure uninterrupted service. The remaining issues on your current subscription will be added.

GENTLEMEN: PLEASE ENTER MY SUBSCRIPTION TO AUDIO

Name \_\_\_\_\_

Address \_\_\_\_\_  Office  Residence

City \_\_\_\_\_ State \_\_\_\_\_ Zip \_\_\_\_\_

- New Subscription
- Renewal

**1 YEAR—\$5**  
  
**(Foreign - \$8)**

**2 YEARS—\$9**  
  
**(Foreign - \$13)**

**3 YEARS—\$12**  
  
**(Foreign - \$17)**

**BILL ME**   
**PAYMENT**  
**ENCLOSED**

FOR OFFICE USE

BUSINESS REPLY MAIL  
No Postage Necessary if Mailed in the United States

FIRST CLASS  
Permit No. 22,489  
Philadelphia, Pa.

POSTAGE WILL BE PAID BY:

# AUDIO

P.O. BOX 8671  
PHILADELPHIA, PA. 19101

## READER INQUIRY CARD

Fill in other side to get more information on advertised products

## CLASSIFIED ORDER CARD

Want to buy, trade or sell components? Looking for a rare piece of equipment? Want to offer or buy a service? Want a job in the audio field? If your answer is "yes" to any of these questions, your ad belongs in Audio Classified. Rates are comfortably low—readership is astoundingly high. Use this handy order form to include your message in the next issue.

### PLEASE CHECK ONE:

- |                                                 |                                                                     |
|-------------------------------------------------|---------------------------------------------------------------------|
| <input type="checkbox"/> For Sale               | <input type="checkbox"/> Insert in next issue                       |
| <input type="checkbox"/> Wanted to Buy or Trade | <input type="checkbox"/> Insert in next 2 issues                    |
| <input type="checkbox"/> Situation Wanted       | <input type="checkbox"/> Insert in next 6 issues                    |
| <input type="checkbox"/> Help Wanted            | <input type="checkbox"/> Insert in next 12 issues                   |
| <input type="checkbox"/> Services               | <input type="checkbox"/> Assign box number<br>(additional cost \$1) |

RATES: Commercial, 50¢ per word; situation wanted or non-commercial, 25¢ per word. We reserve the right to determine classification as commercial or non-commercial. **Payment must accompany all orders under \$10.00.**

### COPY FOR YOUR AD

---

---

---

---

---

---

---

---

Name

Address

City

State

Zip

Office  
 Residence

BUSINESS REPLY MAIL  
No Postage Necessary if Mailed in the United States

FIRST CLASS  
Permit No. 22,489  
Philadelphia, Pa.

POSTAGE WILL BE PAID BY:

# AUDIO

134 North Thirteenth St.  
Philadelphia, Pa. 19107

SUBSCRIPTION ORDER CARD Fill in other side to order a new subscription

# You have to be really crazy about music to spend \$1000 for a receiver.

But not crazy. Because if you are a purist and willing to pay for perfection, the Marantz Model 19 will more than justify your investment.

The Marantz Model 19 is a magnificent new

Stereophonic FM receiver. It is strictly for music lovers whose demand for sound fidelity is beyond the pale of the average listener.

The Model 19 combines the superior performance and features of individual Marantz components with the ease of installation and simplicity of a single receiver. It also is engineered for the sound of the future — ready for 4-channel multiplex.

Visit your Marantz dealer.

He'll let you personally handle the controls of the Model 19 as if you owned it. You can also compare it to other makes. Then let your ears make up your mind.

By the way, if your budget has you in a bind, look over our line of the other fine Marantz receivers starting as low as \$219. **marantz**.

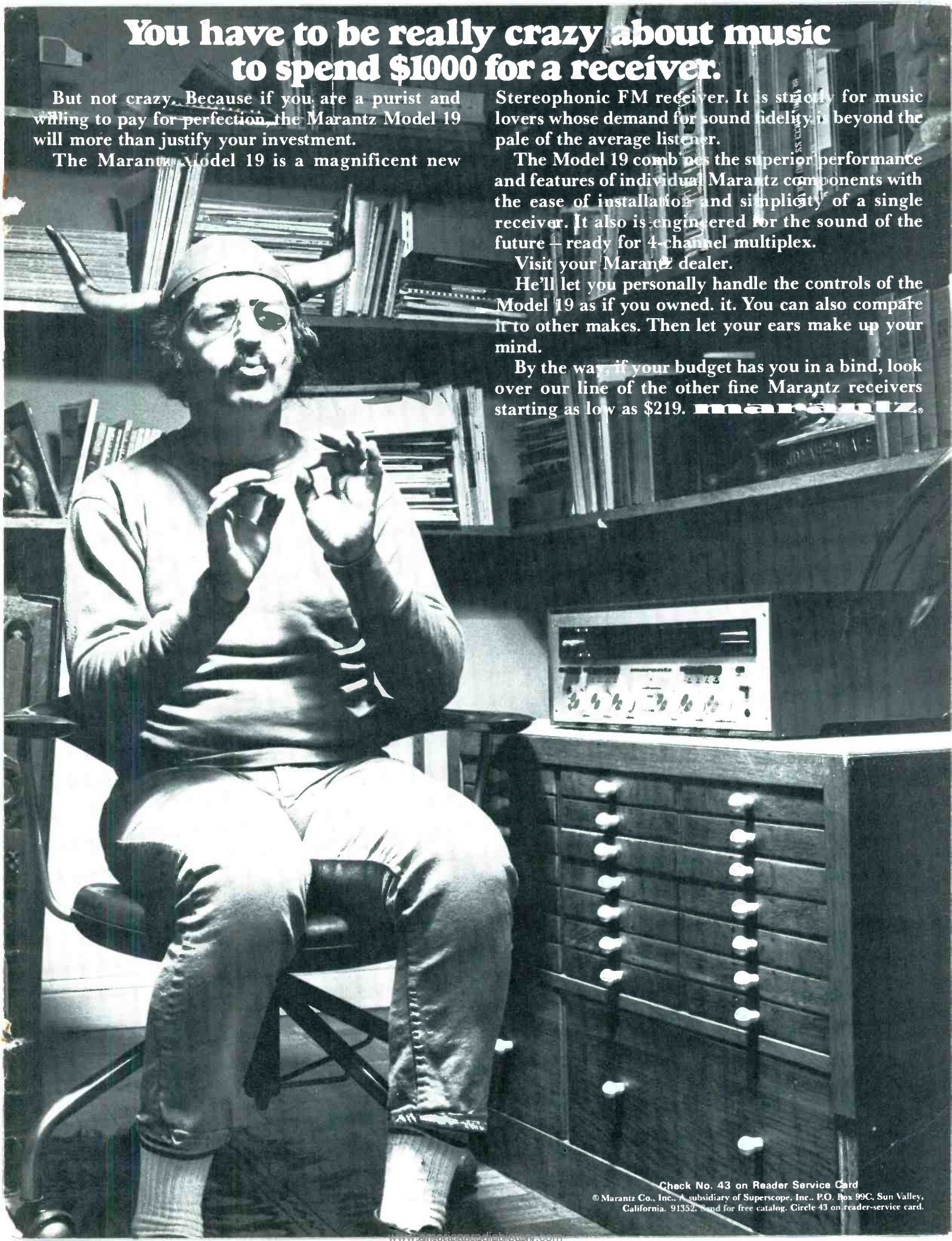

Check No. 43 on Reader Service Card

© Marantz Co., Inc., a subsidiary of Superscope, Inc., P.O. Box 99C, Sun Valley, California, 91352. Send for free catalog. Circle 43 on reader-service card.

# matched pair

Empire's model 598 Troubador turntable system  
and 1000 ZE/X long playing stereo cartridge.

Here are two of the world's greatest stereo components. Empire's model 598 turntable system exceeds every broadcast specification for professional playback equipment while the 1000 ZE/X cartridge allows you to track any record at forces so low you never get stylus or record wear. Superb alone—they are spectacular

together. Ask your hi fi dealer for a totally unforgettable demonstration.

Write for a free *Guide to Sound Design for 1971*: Empire Scientific Corp., 1055 Stewart Ave., Garden City, N.Y. 11530

**EMPIRE**



CIRCLE NO. 96 ON READER SERVICE CARD

[www.empirescientific.com](http://www.empirescientific.com)