

AUDIO

CDC

®

MAY / 1966

60¢

...the original magazine about high fidelity!



Space-age Scott FET design improves AM as dramatically as it does FM



New Scott 382 Receiver lets you hear more stations, more clearly! 65-watts/Space-age FET circuits in both AM and FM/Only \$339⁹⁵

Scott engineers are constantly on the search for new developments to continually improve a near-perfect product.

After experiencing the miraculous improvements FET's brought to FM, Scott engineers applied amazing new FET circuitry to Wide-Range AM. The result — the new 382 AM/FM stereo receiver — incorporating, for the first time anywhere, a Field Effect Transistor AM circuit along with Scott's astonishing FET FM front end. Introduction of this new model marks the first real improvement in AM circuitry design in more than a decade.

AM Comes of Age

Recent improvements in AM broadcasting equipment, plus the Federal Communication Commission's decision to split AM and FM programming, have given audiophiles renewed interest in superior AM reception. Introduction of the new 382 now brings Scott FET sound to the exciting news, sports, current events and music broadcasts available only on the AM band.

Scott AM Has Advanced FET Circuits

Advanced Scott 382 circuitry incorporates Automatic Variable Bandwidth, a unique feature which automatically adjusts tuner bandwidth to the quality of the incoming signal. The bandwidth automatically narrows for best reception of weak, distant stations, blocking out noise and interference. When tuned to stronger stations, the bandwidth automatically broadens, providing full frequency wide-range reception. In addition, the new Scott Automatic Gain Control circuit, which increases tuner sensitivity when incoming signal decreases, also increases resistance to cross modulation as the signal gets stronger.

Field Effect Transistor FM Lets You Hear More Stations, More Clearly

The 382 utilizes revolutionary new Field Effect Transistor circuitry for maximum FM sensitivity with virtually no cross modulation, no drift, no more problems caused by changing tube characteristics. Scott is the first, and only, manufacturer to use this important advance in solid-state design.

Scott's all silicon IF strip provides three stages of true IF amplification for strong as well as weak signals plus three additional stages of IF limiting action, giving optimum selectivity and stereo separation.

Direct-Coupled Silicon Output Amplifier Section

Output and driver transformers, major causes of diminished power and distortion, are eliminated from Scott's radically new direct-coupled solid-state amplifier design . . . allowing more power over a wider frequency range, with virtually no distortion.

The 382 includes these popular features found in the most expensive Scott components: Tape Monitor switching, Speaker switching with provision for remote speaker selection, switched front panel stereo headphone output, front panel stereo balance switch, separate-channel clutched bass, treble, and volume controls, fully automatic stereo switching with indicator, and precision tuning meter.

382 Specifications: Usable sensitivity, 2.5 μ v; Harmonic distortion, 0.8%; Drift, 0.02%; Frequency response, 18-25,000 cps \pm 1 db; Music Power rating per channel (4 ohms), 32½ watts; Cross Modulation Rejection, 85 db; Stereo separation, 35 db; Capture ratio, 6.0 db; Selectivity, 40 db. Price \$339.95.

Scott . . . where innovation is a tradition



For complete information and specifications, circle Reader Service Number 100.

H. H. Scott, Inc., 111 Powdermill Road, Maynard, Mass. Dept. 35-05 Export: Scott International, Maynard, Mass.
Prices and specifications subject to change without notice. Prices slightly higher west of Rockies.

Circle 100 on Reader Service Card

AUDIO

May, 1966 Vol. 50, No. 5

Successor to **RADIO**, Est. 1917

LARRY ZIDE
Associate Editor

HAROLD D. WEILER
Roving Editor

JANET M. DURGIN
Production Manager

Contributing Editors

EDWARD TATNALL CANBY
JOSEPH GIOVANELLI
HAROLD LAWRENCE
CHESTER SANTON
HERMAN BURSTEIN
BERTRAM STANLEIGH

AUDIO Articles

Evaluation and Application of Artificial Reverberation to Conventional Sound Installations	19
The Servo Groove Tracker	21
Audio Measurement Course—In Five Parts, Part 5	23
Solid-State Flutter Meter—In Four Parts, Part 3	39

Light Listening	10
Record Revue	42
Jazz and All That	45

Heath Color TV Set	46
Dual Automatic Turntable	48
Sony 2010 Videocorder and Video Camera Kit	50
Scott Receiver and Scott Speakers	52

Audioclinic	2
Letters	6
Audio ETC	12
About Music	14
Editor's Review	16
Audio Magazine Fifteen-Year Advertising Club	41
Sound and Sight	54
Tape Guide	56
New Products	58
This Month's Cover	61
Advertising Index	68

AUDIO Reviews

Chester Santon
Edward Tatnall Canby
Bertram Stanleigh

AUDIO Profiles

Model GR-25
1019
2010 and VCK-2000
342 and S-8

AUDIO in General

Joseph Giovanelli
Edward Tatnall Canby
Harold Lawrence
Harold D. Weiler
Herman Burstein

Number 33 in a series of discussions
by Electro-Voice engineers

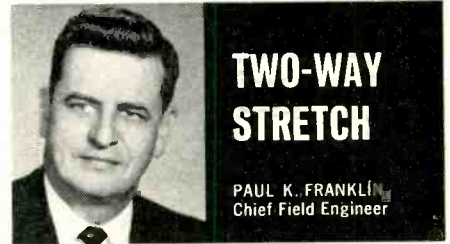

TWO-WAY STRETCH

PAUL K. FRANKLI
Chief Field Engineer

In a growing number of applications, need for greater performer-to-microphone distance is needed. Both TV and stage sound reinforcement demand this longer pick-up to render the microphone less obtrusive—if not invisible—to the audience.

Greater performer-to-microphone distance introduces a well-known problem: the performer's signal level at the microphone drops in relation to ambient noise, thus degrading the signal/noise ratio.

Obviously, a directional microphone will help to offset the lower performer signal level, by reducing the level of off-axis sounds. In this manner, an improvement of up to 20 db in signal/noise ratio can be achieved.

Typical cardioid microphones, of course, provide this improvement primarily to the rear of the microphone—noise reduction at the sides is only about 6 db. Yet, microphone placement at great distances from the performer increases the likelihood that ambient noise will occur at the sides as well as at the rear. In addition, reflections from walls and ceilings can make the potential 20 db improvement impossible to achieve—even when the noise originates from the rear.

Microphones using the distributed front-opening principle, such as the Electro-Voice Models 642 and 643 provide greater cancellation at the sides, particularly at higher frequencies, and thus can offer a further improvement in signal/noise ratio.

It was found in the development of these microphones that mere reduction of signals arriving at the sides and back was insufficient at great distances to achieve a satisfactory signal/noise ratio. The problem was simple: as the microphone distance doubled, a 6 db loss was incurred. This led to problems with noise generated in the input equipment that limited the effective range of the microphones.

For this reason, microphone sensitivity was increased far above the normal value for dynamic cardioid microphones. A typical cardioid microphone may have an output of -58 db*, normally considered quite adequate for most applications. The E-V 612 and 643 offer an output level of -48 db* to compensate for the lower signal levels encountered with long distance sound pickup. This higher level is accomplished without amplifiers, but rather with a sophisticated and highly efficient magnetic circuit.

This high level would create problems if the microphones were used in close-talking applications, since they would tend to over-drive most broadcast input equipment. However, when used as intended, the high level available from the microphones makes possible distant pickups not otherwise achievable with preceding designs. The combination of greater directionality and higher level permits audio engineers to stretch the useful range of sound systems.

*0 db = 1mw/10 dynes/cm²

For technical data on any E-V product, write:
ELECTRO-VOICE, INC., Dept. 563A
602 Cecil St., Buchanan, Michigan 49107



Circle 105 on Reader Service Card



AUDIO (title registered U. S. Pat. Off.) is published monthly by Radio Magazines, Inc., C. G. McProud, President; Henry A. Schober, Secretary. Executive and Editorial Offices, 204 Front St., Mineola, N. Y. Subscription rates—U. S. Possessions, Canada, and Mexico, \$5.00 for one year, \$9.00 for two years; all other countries \$6.00 per year. Single copies 60¢. Printed in U.S.A. at Blanchard Press Inc., Garden City, N.Y. All rights reserved. Entire contents copyrighted 1966 by Radio Magazines, Inc. Second Class postage paid at Mineola, N.Y. and additional mailing offices.

RADIO MAGAZINES, INC., P.O. Box 629, MINEOLA, N.Y., 11501
Postmaster: Send Form 3579 to AUDIO, P.O. Box 629, Mineola, N.Y., 11501

COMING

Articles:

Professor R. A. Greiner returns to the fold with "Power Amplifier Overload Characteristics and their Importance," a well documented coverage of a question which should interest every serious audio buff.

Norman H. Crowhurst takes us into the realm of theory with "The Finite Approach to the Infinite."

Marshall K. Steele describes a new "Switch-Type Tone Control."

Profiles:

Two new **Thorens** Turntables.

The **Syncon** Condenser Microphone.

Euphonics "Mini-conic" Phono Cartridge.

In the June Issue

On the newsstands, at your favorite audio dealer's, or in your own mailbox.

AUDIO CLINIC

Joseph Giovanelli



Send questions to:
Joseph Giovanelli
2819 Newkirk Ave.
Brooklyn, N. Y.
Include stamped, self-addressed envelope.

FM Reception in Automobile Radios

Q. I have a 1965 Chevrolet with an AM-FM Delco (original equipment) radio with rear-mounted antenna.

I wish to improve the station-getting ability of this radio.

Would an FM "range-extender" help?

Please recommend as to what I could do to bring about the improvements I desire.

Michael R. Rott, Buffalo, New York

A. First of all, really good FM reception from auto radios is influenced to a considerable degree by the fact that the antenna used is the same antenna designed for AM reception in the car. This antenna is vertically oriented, or polarized. Most FM stations are horizontally polarized. This causes a considerable attenuation of the FM signals. However, FM stations are gradually installing antennas capable of simultaneous vertical and horizontal polarization, and these new transmitting antennas will solve this problem.

As the automobile moves along, it enters areas of vastly different signal strength, sometimes by moving only a few feet. Multipath reflections come and go. In order to minimize these effects, the receiver must have excellent limiting. If the receiver is of poor design, nothing can help you.

If the receiver is of reasonably good design, it may not be aligned properly. A receiver of good design cannot work at its best possible level of performance without being properly adjusted. I have seen all too many receivers of good *and* bad design which are misaligned either from long use or from poor inspection standards as they left the manufacturer.

Have someone go over the unit very carefully or do this yourself.

Once you have determined that the receiver is working in the best possible manner, then you must determine whether ignition noise is the limiting factor in the reception of FM signals. You may have to use suppressors around your ignition system and shield some of the wiring. It may be that you will have to silence the generator by means of a co-axial capacitor at its output. The tailpipe may have to be grounded to the car's body.

At any rate, once you know that you have gotten ignition interference down to an absolute minimum (and this is not

easily done), you can then make some further checks. Does your FM reception now meet your standards? If not, then you should next consider the use of a booster as suggested in your question.

A booster is not likely to enable you to hear too many more signals than you can hear without it. However, what the booster will do is add strength to the signals you do receive and this added signal strength will result in better limiter action. This is very, very important when receiving FM stations in an automobile because even when your ignition system is not producing significant radio interference, other cars on the road will cause you considerable difficulty at times.

FM and TV Antennas

Q. I am thinking of buying an antenna whose manufacturer claims that it is suitable for FM and for VHF and UHF television. FM reception is said to be good up to a distance of 75 miles. From the standpoint of space such a combined antenna would seem to be ideal. However, I'm interested in a distant FM station located some 175 miles from me. What do you advise? Michael R. Rott, Buffalo, New York.

A. The antenna of which you speak probably will do an excellent job, especially in those instances where space limitations are an important consideration. However, because you are interested in the reception of distant FM stations, I suggest that you use a separate FM antenna, rather than a combined unit.

If you are to obtain reliable FM reception over a distance of 175 miles you must have a good antenna, having lots of elements. Preferably, this antenna should be cut to the frequency of the desired station and optimized for that frequency, which indicates a yagi. You should stack two such arrays or, better still, four of them, in order to improve both directivity and gain.

You may find it necessary to design a special, low-noise front end or a booster to be placed ahead of your present receiving equipment. In the latter instance, be sure that the signal-to-noise ratio of the booster is better than that of the tuner or you will lose more than you will gain. Such boosters or front-ends can be designed around tubes such as the Western Electric 417A or 416B. These tubes are available on occasions through surplus radio parts jobbers. The 416B is to be preferred over the 417A because of its higher gain and lower noise output. However, the 416B must be forced-air cooled just before, during, and just after operation. This latter consideration is likely to be a serious drawback to many experimenters.

This is the Lab 80. Add up the galaxy of innovations which Garrard has developed and engineered into it...including built-in cueing... variable anti-skating compensation...ultra-sensitive magnetic tripping... and you will begin to visualize why this superbly performing automatic has revolutionized the turntable industry.

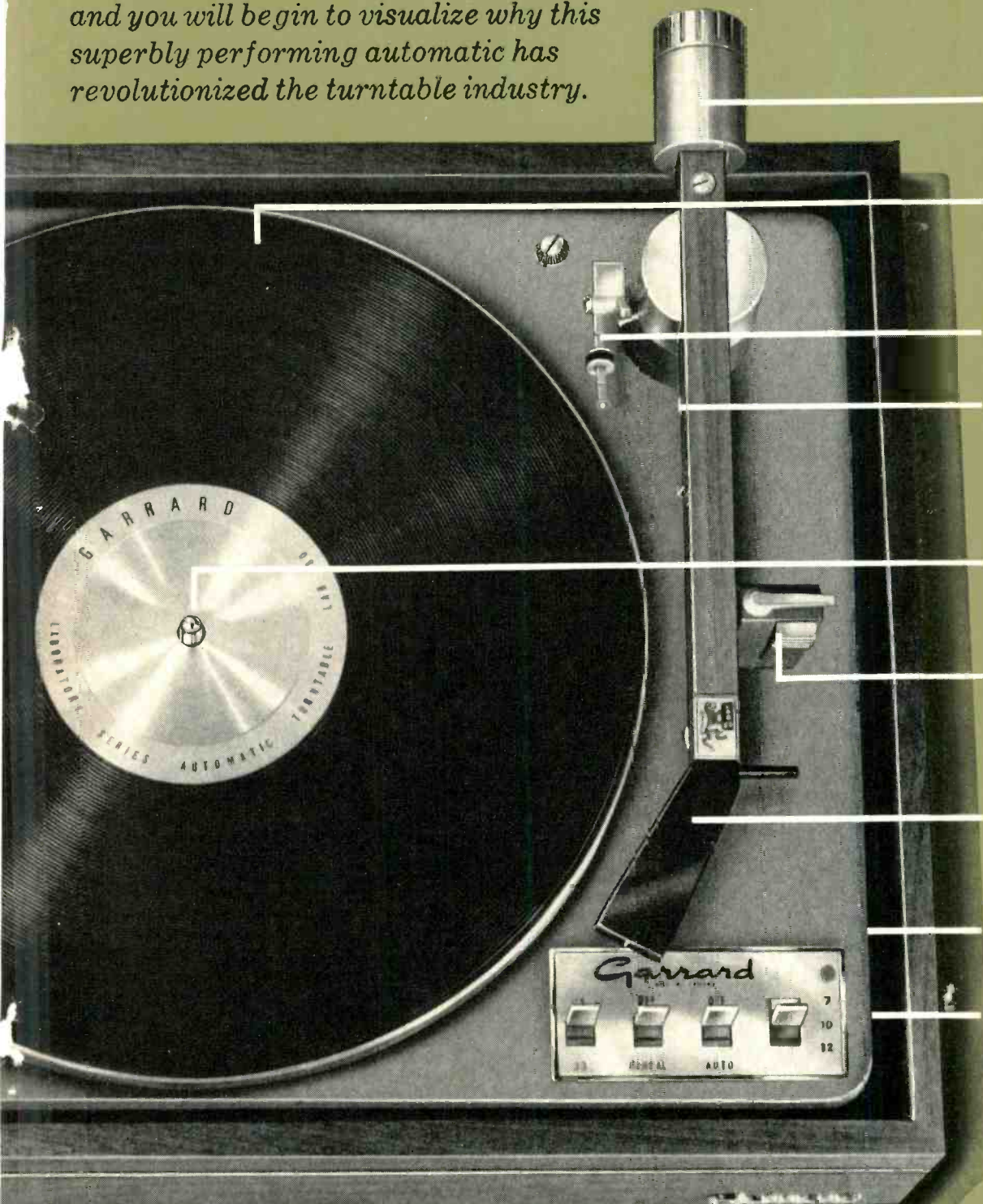

Dynamically balanced, counterweight-adjusted tone arm, built of Afrormosia wood for light weight, low resonance.

Full 12" anti-magnetic turntable—heavy and dynamically balanced for perfect speed. Anti-static mat.

Anti-skating control—with patented foolproof sliding weight design—does not use springs. The natural side pressure on the stylus which frequently causes distortion and rapid record wear is eliminated.

Calibrated stylus pressure gauge with precision 1/4 gram click adjustments for accurate audible/visible settings.

Two spindles—one for manual play, the other for automatic operation. Convenient short spindle interchanges with revolutionary center drop spindle, which handles 8 records fully automatically when desired. Exclusive... spindles remove for safety and convenience when taking records off the turntable.

Built-in cueing control eliminates all danger of accidental damage to records or stylus through manual handling. A great operating feature and a tremendous convenience which permits selecting any band of the record with complete safety.

Low mass cut-away shell—with extended finger lift—compatible with the most advanced cartridge designs.

Exclusive super-sensitive magnetic trip, with Dupont Delrin® to offset friction... performs perfectly with highest compliance pickups at correct minimal tracking force.

Silent Laboratory Series® 4-pole shaded motor with vibration-proof total isolation suspension.

Important reading: 32-page Comparator Guide detailing all Garrard models. Write for complimentary copy to Garrard, Dept. GE-16 Westbury, New York 11591.

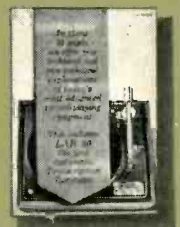

Only Garrard could have created the Lab 80. Only Garrard could have produced it to sell for \$99.50. This results from more than 50 years of leadership, supported by the great advantages of substantial international volume, vast manufacturing facilities, and truly exceptional engineering resources.

CIRCLE NO. 103 ON READER SERVICE CARD

Garrard®
WORLD'S FINEST

Only complete line of FM ANTENNAS finest in every price range!

**AWARD WINNING
FINCO FM-4G
ANTENNA
\$24.90 list**

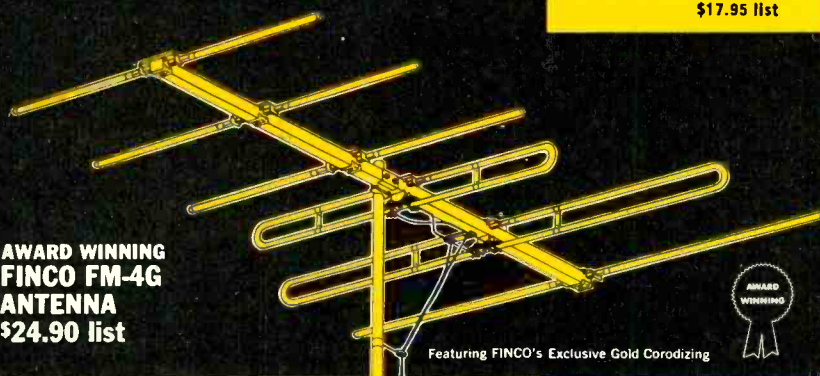

Featuring FINCO's Exclusive Gold Corodizing



**Award Winning
FINCO FM-5
\$36.35 list**

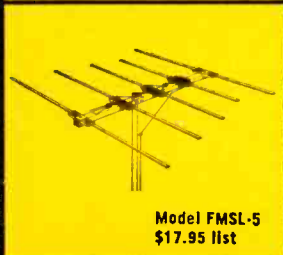

**Model FMSL-5
\$17.95 list**

FINCO

Discover the difference that a FINCO Antenna makes in FM sound. FINCO's maximum gain means a substantially greater signal over the full 88 to 108 MC band. Regardless of your location, you bring in more stations—with exacting station separation—free from multipath reflections. Choose a superb FINCO FM Antenna, and get perfect FM sound.

Include a FINCO FM Band Pass Filter and stop FM interference by blocking out unwanted signals from TV stations, citizens band, amateur transmitters, electric motors, fluorescent lamps, automobile ignitions, etc. You'll never hear a signal that's cleaner, clearer, purer.

FINCO is the name to look for, when you want the very best in FM reception.

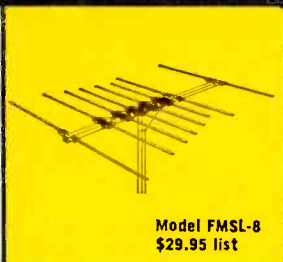

**Model FMSL-8
\$29.95 list**

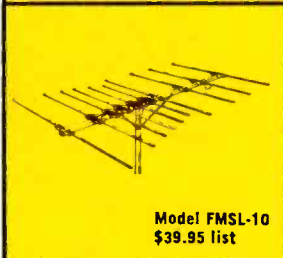

**Model FMSL-10
\$39.95 list**

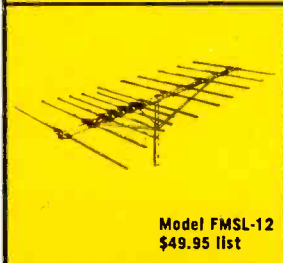

**Model FMSL-12
\$49.95 list**



**Model 3007
Band Pass Filter \$6.95 list
Eliminate FM Interference
with FINCO's Band Pass Filter**

If you do not use a tube of this type, then I suggest that you design a cascode nuvistor front-end—but the performance will not be quite as good as can be obtained by using the Western Electric 416B. It is probably a toss-up as to whether the 417A or the nuvistor is to be preferred.

Keep the transmission line between the antenna and the tuner as short as possible to keep signal loss at a minimum.

If you are located away from heavy traffic, use open-wire twin lead rather than shielded twin lead or coaxial line.

Now that I have mentioned twin lead, I want to say that in a previous column I recommended coaxial line over shielded twin lead. Since writing the manuscript for that column I have seen some excellent shielded twin lead, and I believe that now it is at least as good and probably better than coaxial line. Further, shielded twin lead has the virtue of simplicity of installation; you don't need the two matching transformers.

Loudspeaker Protection with Solid-State Amplifiers

Q. With the advent of solid-state amplifiers, a potential problem arises which is not inherent in tube-type amplifiers. I refer to the possibility of d.c. reaching speaker voice coils. When buying a solid-state amplifier, what protective devices should one look for in order to be safe from this possible hazard? John Golemo, Syracuse, New York

A. Transistorized power amplifiers all have some kind of safety device which is designed to limit the current flowing in the output stage. Such protection is important, not only to prevent damage to the speaker but also to prevent damage to transistors and other circuit elements. As designs improve, I notice more and more safety schemes being used. Some schemes involve the use of fast-acting fuses which disconnect collector voltages to the output stage or remove a.c. power from the amplifier. Some other amplifiers use thermal overload devices which act to prevent overloads. These devices automatically reset themselves after a time.

The chances are that the instruction manual supplied with a given amplifier will explain the safety devices incorporated into it. If the instructions are not clear as to safety precautions, I suggest you consult the manufacturer of the specific piece of equipment in which you are interested, and obtain the desired information from him. If you are dissatisfied with the safety provisions included in his amplifier, you probably should consider another piece of equipment.

I think that you should understand, however, that I have not seen a loudspeaker which was damaged by too much d.c. flowing through it—brought about through a circuit fault in a solid-state amplifier. Further, no one else has brought such a circumstance to my attention. I can only conclude that damage to loudspeakers because of this possibility is unlikely.

If some kind of speaker fusing is employed, you will have even more assurance that your speakers are safe from accidental overload, either from excessive d.c. or from excessive power fed into them.

Æ

1. With 1 Finger Of Your Right Hand, Pick Out Key A, Key F, Etc.

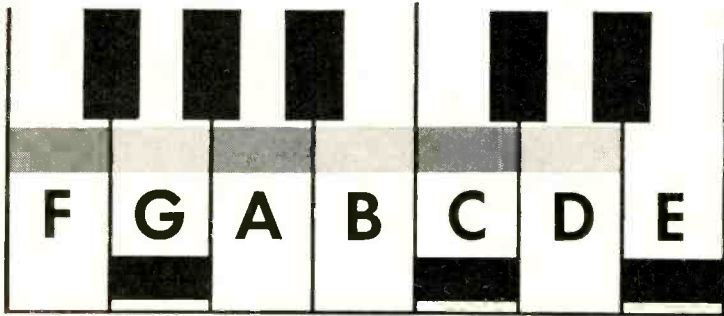
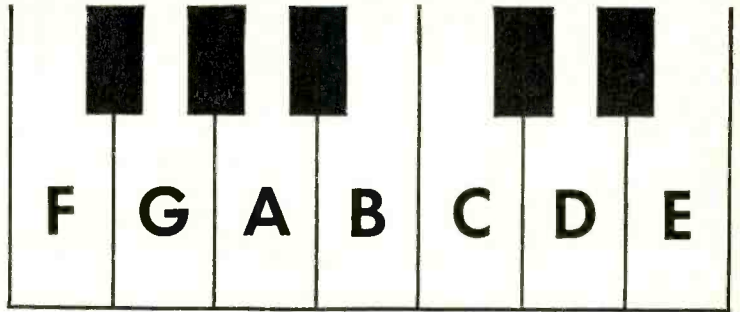

2. Now Put 2 Fingers And A Thumb Of Your Left Hand On The Red Keys... The Green Keys... Or The Black Keys.

3. That's All It Takes To Play Complete Songs On The New Heathkit®/Thomas COLOR-GLO Organ

Play Complete Songs In Minutes . . . Instead Of Months! Color-Glo key lights on this new Heathkit/Thomas Transistor Organ show you the correct notes and chords. You play melody, harmony and bass notes *instantly* . . . even if you've never played an organ before!

Switch On The Color-Glo, And You're Ready To Play! Each key on the upper keyboard lights up with a letter. You simply match the key's letters with the letters on the music to play melody. For harmony, there are 3 red keys, 3 black keys and 3 green keys on the lower keyboard. Just press and hold the notes that match the background color in the Thomas Color-Glo music book (included). To add the bass, press the pedal that's marked with the same color as the harmony notes. That's all there is to it. Touch the switch again, and the Color-Glo keys disappear, leaving a beautiful spinet organ.

All Genuine Thomas Factory-Fabricated Parts! Other features include ten organ voices; repeat percussion; two 37-note keyboards; 13-note heel & toe bass pedals; variable expression pedal; 2 levels of vibrato; balance control; 12" speaker; 50-watt EIA peak music power amplifier; and hand-crafted walnut cabinet. The transistorized tone generators, the heart of the organ, are warranted for 5 years.

Build It In About 50 Hours! Takes no special skills or knowledge . . . you even tune the organ with a pretuned tone generator. Easy credit terms available, too. Get the full story . . . use the coupon to send for demonstration record and the FREE Heathkit catalog.

Kit GD-325 Organ, 153 lbs. \$349.95
 GDA-232-1, matching walnut bench, 18 lbs. \$ 24.95



Kit GD-325
\$349⁹⁵
 (less bench)

Hear It Perform Yourself!



Send 50c for 7", 33 1/3 rpm demonstration record (see coupon). For full details on this, plus over 250 other Heathkits, mail coupon or write Heath Company, Benton Harbor, Michigan 49022 for FREE Heathkit Catalog.

Heath Company, Dept. 41-5
 Benton Harbor, Michigan 49022

Enclosed is \$ _____, plus shipping.

Please send model(s) _____

Enclosed is 50c. Please send Organ Demonstration Record No. GD-232-5.

Please Send FREE 1966 Heathkit Catalog.

Name _____

Address _____

City _____ State _____ Zip _____

Prices and specifications subject to change without notice. CL-238



Is complementary symmetry the only way to sell audio transistors today?

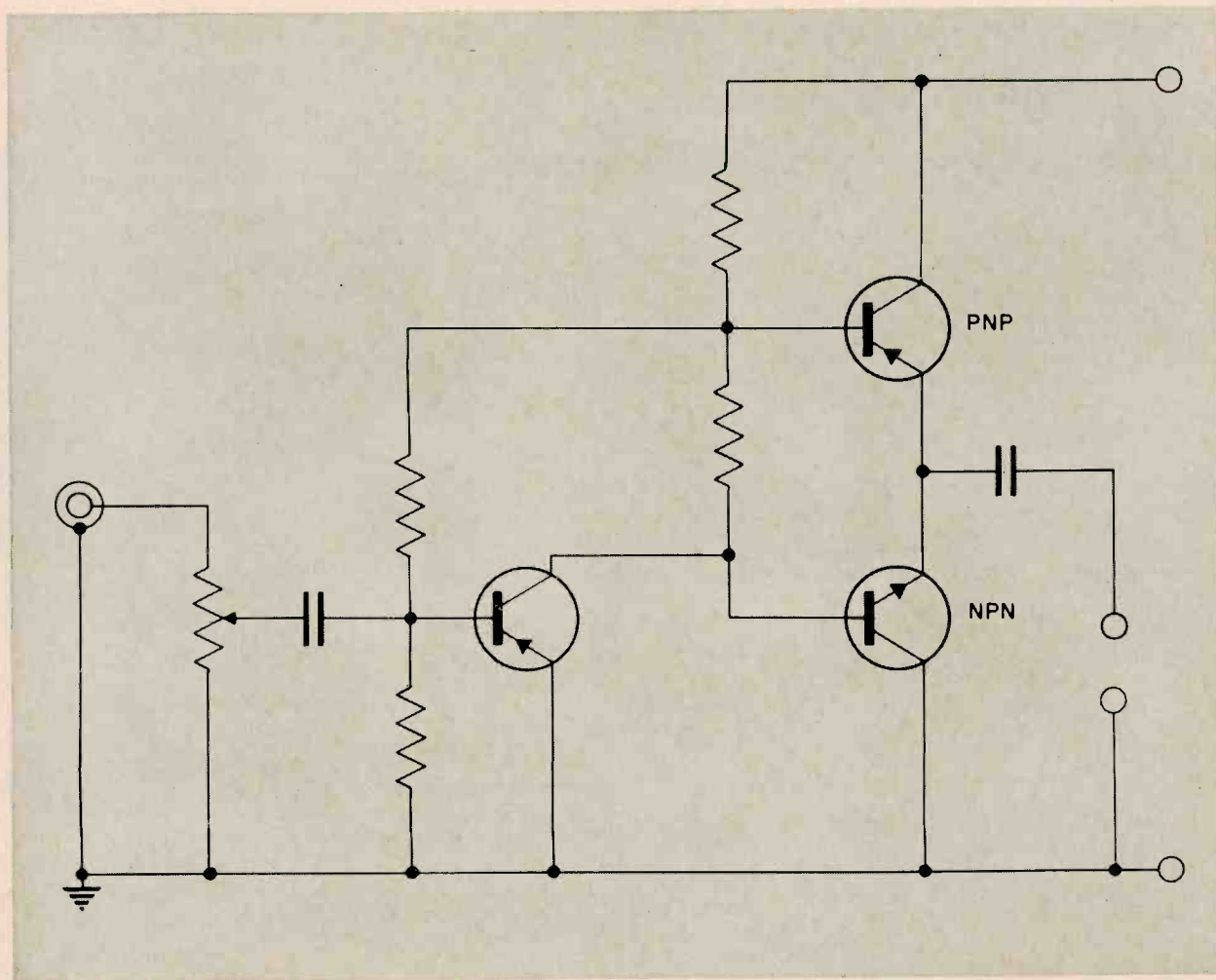

You bet it is!

Complementary Symmetry is the ultimate in economical, reliable circuitry for audio applications up to 12 watts.

FOR PHONOS (1 to 5 WATTS)

Complementary Symmetry achieves enormous manufacturing savings with no sacrifice in reliability, by using transistors as they should be used—as low voltage, low impedance, low temperature devices for Class B push-pull, instead of high voltage, high impedance (Class A) with transformers and associated components and high temperatures.

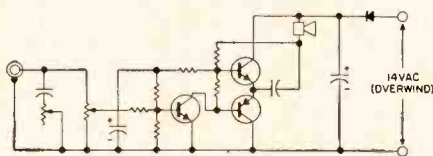

THE AMPEREX WAY

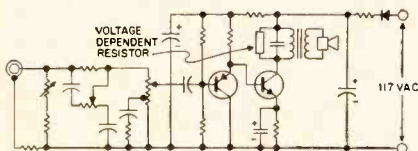

THE OLD WAY

Low voltage eliminates need for bottom plates, interlocks, etc. **Low temperatures** mean longer, more reliable component life. **Simple mounting clip** eliminates need for expensive heat sinks, mica insulating washers and mounting hardware. **No output transformers or VDR's**... low

output impedance of emitter follower output circuit obsoletes impedance-matching output transformer and related voltage dependent resistors.

Complementary Symmetry is not a new audio engineering approach! It has long been an audio designer's dream—a textbook approach! What is new, is that Amperex now provides the tools to make the textbook dream come true. We have the matched, paired transistors, dual heat-sinks, simplified circuits and application reports. Our applications department is at your service... and where required, complete breadboarded prototypes will be provided.

2N2707 matched pair 2N2430 (NPN) and 2N2706 (PNP) for power up to one watt for low cost phonos, amplifiers and radio; TO-1 cases in dual heat-sink clip.

2N4136 matched pair 2N2430 (NPN) and 2N2431 (PNP) for power up to 2.5 watts; TO-1 cases in dual heat-sink clip.

2N4107 matched pair 2N4105 (NPN) and 2N4106 (PNP) for power up to 7 watts; TO-1 cases in extruded aluminum heat-sink.

2N4079 matched pair 2N4077 (NPN) and 2N4078 (PNP) for power up to 12 watts; TO-3 cases.

**FOR AUTO RADIO OUTPUTS
(5 watts at 13.6 volts)
THE NEW 2N4079 PAIR
IS IDEALLY SUITED**

For data and for details of the Amperex "whole ball of wax" sales and applications program (transistors, circuits, prototypes, lab reports, etc.), write Amperex Electronic Corporation, Semiconductor and Receiving Tube Division, Dept. 371, Slatersville, Rhode Island 02876.

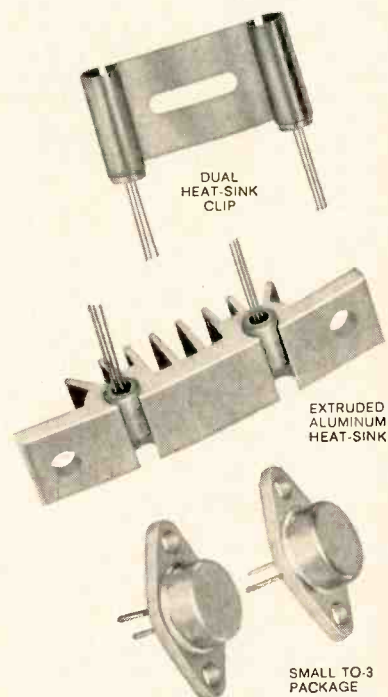

Amperex®

NEW! ROBERTS 400X 60 WATT STEREO SOLID STATE TAPE RECORDER with EXCLUSIVE 22,000 CPS CROSS FIELD



featuring
REVERSE PLAY automatically
SELECT PLAY automatically
REPEAT PLAY automatically

- | | | |
|--|---|--------------------------------------|
| <input type="checkbox"/> 4 Heads, 3 Motors | <input type="checkbox"/> 2 Speakers | <input type="checkbox"/> 2 VU Meters |
| <input type="checkbox"/> Timed or Signal Reverse | <input type="checkbox"/> Echo Chamber Effect | |
| <input type="checkbox"/> Sound-on-Sound | <input type="checkbox"/> Remote Controllable | |
| <input type="checkbox"/> Sound-with-Sound | <input type="checkbox"/> 10 1/2" Reel Adaptable | |
| <input type="checkbox"/> Sound-over-Sound | <input type="checkbox"/> 3 Speeds (15 ips optional) | |
| <input type="checkbox"/> Push Button Controls | <input type="checkbox"/> 4 Digit Index Counter | |

\$799.95

ROBERTS 400X—THE ULTIMATE IN A TAPE RECORDER.



ROBERTS

5922 Bowcroft St., Los Angeles, Calif. 90016

A DIVISION OF RHEEM MANUFACTURING, AN INTERNATIONAL COMPANY WITH OVER 75 PLANTS AROUND THE WORLD

27R

Circle 110 on Reader Service Card

LETTERS

Terminology

SIR:

There has been increasing use of the term "rms power" in amplifier ratings. I urge you to put your weight against this nonsense, not only in your editorial material, but in advertising as well. To maintain communication in a technical field, it is one of the first requirements to be exacting about terminology. "RMS" means root-mean-square, which is the d.c. heating equivalent of an a.c. voltage or current. (*Isn't a.c. current redundant?* Ed.) "RMS" has no meaning as applied to power. Taken literally, it means the root-mean-square value of all the instantaneous power values, which is surely not intended. Therefore, it is false on face value.

What puzzles me is why there is any need for this usage at all. What is meant is *average* power, so why not say just that? Sine-wave power is an acceptable term also, or continuous power, but average power is the logical term to use in contrast to peak power, transient power, etc.

In addition, I must put in my two cents' worth for sticking to "average power" ratings on amplifiers. Ratings for music power only encourages degraded power-supply regulation. Also, I have seen much real sine-wave power in program material, especially when bass boost is used. Listening tests in which I have had a part pointed to the superiority of the amplifiers with higher average power rating.

DONALD E. PHILLIPS
 1384 Elmhurst Drive, NE,
 Cedar Rapids, Iowa 52402

(*We have to agree to a large extent, but of course we cannot change the terminology in an advertisement. Obviously, though, if there is a wide disparity between "music power" and sine-wave power ratings, the amplifier is likely to have been designed to a price rather than to performance. However, very high peak powers, such as those resulting from a short-duration transient, do not necessarily require a high average-power rating.* Ed.)

Ignition Noise

SIR:

I have a 1966 Chevrolet with a 275-h.p. engine and a Mark 10 capacitor-discharge ignition system. The FM radio in the car makes a buzzing sound whenever the engine is in operation. However, when the outside antenna to the radio is disconnected, the buzzing goes away.

Can you offer any ideas as to how this can be eliminated?

GERALD GRIEPENTROG,
 2420 Orchard Place,
 New Brighton, Minn.

(*Our only idea would be the possibility of shielding the plugs and the high-voltage leads to them, and perhaps the entire capacitor-discharge ignition unit. We have seen some transistorized systems which radiated r.f. noise, but have no direct experience with C-D systems. Shouldn't the car dealer—or whoever sold you the ignition system—take care of it?* Ed.)

The Sound of Marantz is the Sound of Music at its Very Best.

SLT-12 Turntable, with Straight Line Tracking—a revolutionary development from Marantz. Finally, the art of tracking a record precisely duplicates the art of cutting a record. The Marantz SLT-12 Straight Line Tracking System exactly conforms to the angle, posture and the tracking used in the cutting of an original master stereo record. This perfect compatibility eliminates inherent deficiencies of conventional swing arm record player systems and gives incredibly perfect reproduction. It is the only system available which faithfully reproduces sound as it was originally recorded.

10B FM Stereo Tuner—rated by Hi Fi/Stereo Review magazine, “I have never seen a tuner to compare with it...so outstanding that it is literally in a class by itself.”

7T Solid State Stereo Console—a solid state component unequalled in performance, versatility and flexibility.

8B Dual 35 Stereophonic Power Amplifier—American Record Guide magazine says, “The Marantz 8B is a logical choice for ears that demand the best sound for now and for the future.”

marantz

MARANTZ, INC. SUBSIDIARY OF **SUPERSCOPE** * INC.
25-14 BROADWAY, LONG ISLAND CITY, NEW YORK

Model 7T Stereo Pre-Amplifier

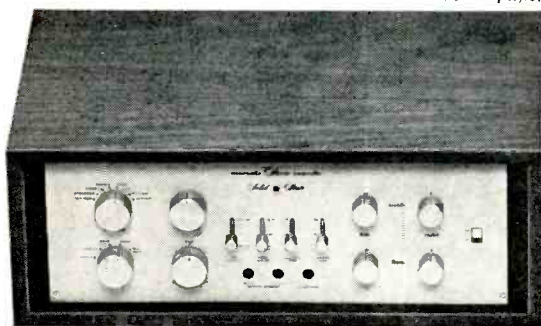

Model 8B Stereo Amplifier



Model SLT-12 Turntable



Model 10B Stereo Tuner

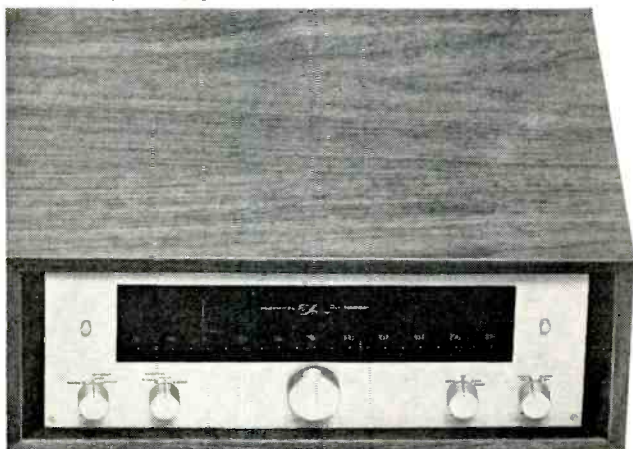

A wonderful adventure in sound awaits you with your discovery that the sound of Marantz is the sound of music at its very best. You, too, can own an incomparable Marantz system. Ask your dealer about the easy finance plan.

Circle 111 on Reader Service Card



LIGHT LISTENING

Chester Santon

Man of La Mancha (Original Broadway Cast)

Kapp Tape KTA 41109

A little to its own surprise, Broadway has a real musical on its hands in "Man of La Mancha," based loosely on episodes that could have happened to Don Quixote and Sancho Panza in the Cervantes classic. I consider it a real musical in the sense that it offers singing and acting in the flamboyant style we last saw on Broadway in a show such as "Kismet." If that's your cup of tea in musicals, you'll rate this show highly. It is perhaps no accident that Richard Kiley, of "Kismet" fame, was cast in the title role of "Man of La Mancha." The nearly all-male singing roster also boasts Robert Rounseville and a star of earlier Broadway productions, Ray Middleton. Perhaps you remember him opposite Ethel Merman in "Annie Get Your Gun." This trio of male singers is blessed with full voices easily capable of filling a theatre. They're heard to excellent advantage in this fine Kapp reel. Even without the fresh elements in the staging that made this show so welcome when it opened last November at the ANTA Theatre, the singing on the recording is more than enough to set "Man of La Mancha" on a very high plane. And, miracle of miracles, some acting actually takes place in the course of the show. Joan Diener as the tavern wench and Irving Jacobson as Sancho create surprisingly vivid characters by use of voice alone. In the closing moments of the play, Kiley's portrayal of the dying Don will flabbergast followers of musicals who have considered him a much better singer than actor. Mitch Leigh's musical score, although a bit repetitive in use of certain rhythms, is very effective for a first try on Broadway by a chap whose reputation has been made in the creation of radio and television commercial jingles. The title song, "Dulcinea," and "Impossible Dream" are worthy of Broadway's top writers. In its best moments, "Man of La Mancha" will sustain fresh hope in the hearts of those who have been despairing of Broadway's musical future.

Myron Cohen at the Americana

RCA Victor LSP 3534

Considering his stature as a storyteller, it's surprising how infrequently Myron Cohen's distinctive brand of comedy has appeared on records. Long before the diminutive raconteur of New York life became a fixture on the Ed Sullivan and Johnny Carson TV shows, he was a leading exponent of the Jewish story delivered with dialects of devastating accuracy and disarmingly mild manner. A headliner for decades in theatres

and nightclubs, Cohen has always required, for maximum impact, an audience fairly well versed in the inner workings of the mind of the Jewish tradesman in the city of New York. In appearance, Myron Cohen himself could easily be mistaken for one of the city's cab drivers whose cap barely reaches above the top of his steering wheel as he weaves through traffic in a stream of repartee. Where other comedians of his generation (Benny, Cantor, Baker, Holtz, or Jessel) were able to reach national fame in radio because of the more universal nature of their material, Cohen was considered a "local" boy, a comedian's comedian. In recent years, a combination of factors has conspired to bring Myron Cohen to the forefront where he belongs. Television's insatiable demand for new comedy material, a more sophisticated audience, and last but not least, an almost missionary zeal on the part of TV impresarios such as Sullivan and Carson in boosting a performer capable of mixing a tremendous amount of insight into his dialect stories. This recording finds him running through a cross section of his far-ranging tales before an audience at the Royal Box of New York's Americana Hotel. Some of the yarns have a full and elaborate buildup, others are over almost before you know it.

Morton Gould: Two Worlds of Kurt Weill

RCA Victor LSC 2863

Here's an instrumental release of Kurt Weill's music somewhat more ambitious than most. Morton Gould has been a champion of Weill's compositions for many decades (how many times did he feature "Speak Low" on his radio shows alone?) but now he's going back to Weill's European pieces as well. Half the record is given over to the more familiar music Weill wrote for the Broadway stage in great shows such as *One Touch of Venus*, *Lady in the Dark*, *Lost in the Stars*, and *Knickerbocker Holiday*. That half of the disc is titled "New York." On the side called "Berlin" Morton Gould offers the seldom-heard tunes Weill created in Germany before coming to the States in the early '30's. Linking the two careers of Kurt Weill on the record, as in real life, is the tune "Mack the Knife," which appears in a different arrangement on each side of the record. Gould has drawn upon all his arranging resources to recreate some of the European atmosphere of the early works in contrast to more sophisticated Broadway melodies. For further fill-in on the Weill career in America, RCA has included a seven-inch flexible disc offering recollections of the composer by Ogden Nash, Ira Gershwin and Langston Hughes—all of whom furnished lyrics at some time or other for Weill shows. An undertaking of this

scope should earn RCA Victor the gratitude of all boosters of Kurt Weill's music.

Henry Mancini: The Academy Award Songs

RCA Victor LSP 6013

Over the years, few discoveries have been so pleasing to the record companies as the fact that a three or four-minute song from a hit movie could sell the contents of a whole 12-inch LP record. In the heyday of movie music on records it hardly mattered what else was on the disc in question so long as a "Moon River" or "Never on Sunday" occupied a prominent place on the release, ideally on Band One of the first side. In common with other consumers of mass entertainment, record fans are becoming more selective in their acquisition of movie music. This latest release by Henry Mancini seems to indicate RCA's conviction that nothing less than a blockbuster will sell in today's market for songs from the movies. Well aware of the association of the Mancini name with Academy Award winners in the public mind, RCA Victor has now devoted a two-record album to his arrangements of the 31 songs that have won "Oscars" since the awards were started back in 1934. Chronological order is not followed in this recording as Mancini leads his chorus and orchestra in just about every important song Hollywood has turned out. Some listeners may fail to work up much enthusiasm for the selections originally aimed at the kiddies in the audience ("Zip-A-Dee Doo Dah," "Chim-Chim Cher-ee," or "White Christmas") but the rest of the lineup is surefire and the well-known Mancini treatment is as lush as ever.

Mary Martin in "Hello, Dolly"

RCA Victor LSO 2007

This is the original cast recording of the London version of David Merrick's production of "Hello, Dolly." The fact that it has appeared on the domestic record market gives further indication of the shortage of worthwhile musicals on Broadway this season. The last time an important New York musical appeared in record stores in both the domestic and London-cast versions was "My Fair Lady." In that case Columbia has a logical excuse for the duplication because only the London production offered key members of the cast in stereo sound. The reasoning behind the release of this album will seem more obscure to the general public. And yet it's always interesting to see what another star can do with a role made famous by its original creator. Most show fans will be curious about this record for precisely that reason. Even as they plunk down their money at the counter, some purchasers will feel in their bones that no one, not even Mary Martin, can follow the footsteps of Carol Channing as the heroine of "Dolly." As soon as they play the album, their unvoiced fears will be confirmed. Without Miss Channing, Dolly simply isn't Dolly. Definitely on the plus side in this new release, the members of the supporting cast are just about on a par with the original New York crowd. The sound here is a bit crisper than the original version but that probably won't suffice as reason to select the second version in the case of the few remaining show fans who don't possess either disc. **A**



Enjoy it.

The Lively Sound of 66! New from UNIVERSITY — A lively trio of new, enjoyable compact 3-way speaker systems. Modern Scandinavian styling in rich, natural oiled walnut with contemporary boucle grille. Three sizes that go anywhere.

The SENIOR 66 Description — New high compliance 12" woofer, high efficiency mid-range, patented Super Tweeter. ■ 30 watts IPM* ■ 22 Hz to beyond audibility. ■ 23¾" x 15⅞" x 11½" D. ■ Brilliance/Presence control.

The COMPANION 66 Description — New high compliance 10" woofer, high efficiency mid-range, new 3½" wide-angle tweeter. ■ 30 watts IPM* — 24 Hz to beyond audibility. ■ 24" x 13½" x 11½" D. ■ Brilliance Control.

The MINI-FLEX 66 Description — Exclusive mass-loaded long throw woofer, direct radiator mid-range, new 3½" wide-angle tweeter ■ 20 watts IPM* — 40 Hz to beyond audibility. ■ 15" x 9½" x 6" D. ■ Sealed air suspension system — ebony trim on oiled walnut. ■ *IPM — Music Power

Listen to the lively 66's at your franchised University dealer today — ask him about his special component stereo systems that feature *University's total lively sound of music*. Send for University's newest catalog and guide to PSE — a master blueprint for better speaker systems. **ALL FREE**. Write to Desk E63.

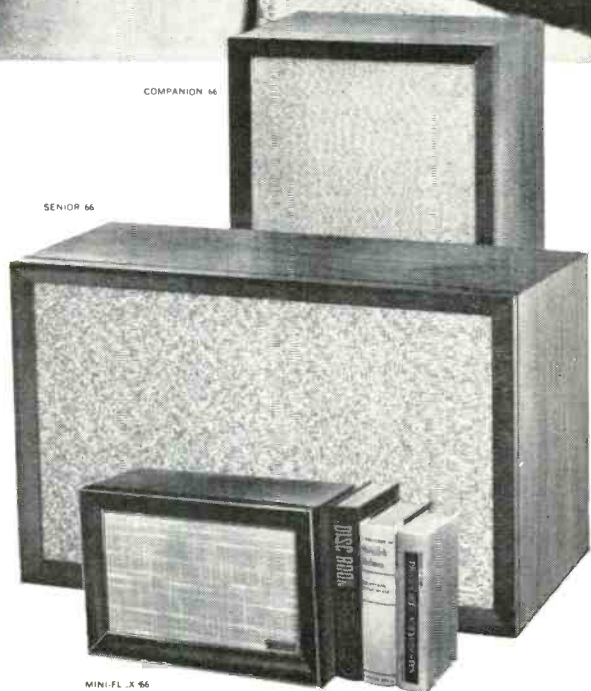

Listen—University Sounds Better

UNIVERSITY SOUND
A DIVISION OF LTV LING ALTEC, INC.

9500 W. Reno Oklahoma City, Oklahoma

Circle 112 on Reader Service Card

AUDIO ETC.

Edward Tatnall Canby



Spring Thoughts

The Red and The Blue

Every so often I am moved to explain the complicated expansion that has blown the record industry up to its present size out of the far simpler record industry—at least in this country—which existed when I first went into record reviewing, many very short years ago.

I don't try very often. It's too hard. When I started reviewing, you understand, there were no LPs and no 45s. Just the old mercifully short-play, mercifully heavyweight 78s, in singles and especially, in albums. Huge albums sometimes. Mercifully short, because a reviewer could get to play everything he received without musical indigestion. Mercilessly heavy, because the same reviewer often had to be a superman merely to heave the darned things around in any reasonable quantity.

The thing I remember best about the first LP demonstrations was that pair of piles: the same quantity of music on 78 and on LP. The 78 albums tottered in a huge stack some four feet high, just the sort I used to spend my time lifting. The equivalent in LPs sat modestly on the floor, rising up maybe three or four inches.

(Now, of course, I think nothing of lifting ten or twelve feet of LPs, in one-foot installments, as I shift the new records around the house, trying to find a better way to keep from tripping over them.)

In those old days the Post Office didn't seem to mind handling great monster boxfuls of 78 albums, each 8-minutes'-worth of 12-inch shellac surrounded by more stiffening and padding and reinforcement than you can possibly imagine, wood-backed, layered in corrugated cardboard inches thick, bedded down into huge cartons sometimes a foot thick as well as 14 by 14 inches. Two or three times a month, every respectable record reviewer received a small truckload of those things. They would arrive in the strong arms of special supermen hired by the P.O.; then you would swing out your specially built crane, mounted high up on the side of the house, and slowly haul the cargo up and in, say, a third-story window, to land safely on a reinforced section of flooring next to the phonograph.

Then with the aid of a razor blade, hacksaw, axe, hammer, screwdriver, scissors, and wire cutters, you would spend an hour or so getting the cargo open, prying out the assorted stuffing and at last, gingerly, extracting the fat albums themselves, uncompacting the compressed cardboard interleaving and then, after so

much effort, finally drawing out a sleek, brand new shellac disc.—Or half of one.

Again and again, for all the packing, one or two discs, quite inevitably would be cracked or broken or shattered into dozens of sharp shards. So you just didn't review those items. (What—send for another album, and go through all that torture again? Are you crazy?)

Worst of all, though, was when the P.O. or the Express came with the whopping packages and you were out. Nobody home. They left those nasty little notices. (We get 'em still—but not for such weights.) So I would totter the twenty blocks down to the P.O. (no parking for five miles around in NYC) and present my slip at the window. Invariably, the man would tell me to come back later; the stuff was out on the truck. When I'd get home, there would be another slip under my door.

I finally moved into an apartment house *solely* for this reason. (The super takes delivery.) I was rapidly going nuts, and getting muscle-bound, too. I'm still in the apartment.

Well, as I say, things have changed. Before the war there were only two important classical record companies for me. Victor and Columbia. That was all. (Lots of imports were sold in the stores but, mostly, these got reviewed only in the specialized record magazines of that day. Didn't send out review copies. The rest of us just reviewed Victor, then Columbia, then Victor again. RCA Victor—pardon me.) So all my records were either red or blue. Red label for Victor, blue for Columbia. Nice color combo. And I could play a whole monthful of red or blue music in one interesting evening of listening. What a pleasure!

After the war, and the era of reconditioned shellac (you turned in your old records to be melted down for new ones), we suddenly began to get new companies, even on 78. Upstarts, unbelievable, trying to challenge the familiar red and blue. (Yeah, yeah, there had been Decca, Brunswick *et al.*; but in my day of 78s they weren't doing much new classical stuff.) There was that new upstart, Vox, for instance. And Musicraft. And Asch-Disc-Union and Technicolor. They were tiny outfits but their 78 albums were plenty heavy. By 1948 I was staggering under the new total weight. And the total playing time.

With LP in full swing, 1952 saw me staggering all over again and I have been ever since. Not from LP weights, which remain liftable, but because of the sheer mileage. In the 50's there were so many

LP record companies a'borning we thought it would never stop. It didn't. Every year now we seem to get more records, week, month, season in and out. And now the cycle is repeating—the old discs are coming back at us all over again in re-releases (and re-re-re-releases), lower in price and better in quality of sound. It's like a re-run of a reviewer's professional life.

The latest trend? I can give it to you succinctly. It follows a general move in the U.S. towards clumping, agglomeration, merger, snowballing or what have you. Like rabbits. Put two together and you get dozens.

It goes like this. Only a few years back, there was a new record company called Everest. Just *one* company (though it was an offshoot of a larger non-record concern). One label. Then, too, there was a label called ABC-Paramount, or something of the sort. (A bit out of my area, you know . . .) A few weeks ago or a couple of months, I got two cheery cards in the mail, each one noting a change of address for these same outfits. Or rather, for what they have now turned into. Talk about rabbits! I quote without further comment. Here's Number one.

"WE HAVE MOVED INTO OUR OFFICES IN THE NEW ABC BUILDING, 1330 Avenue of the American, New York, N. Y. 10019. (Signed) ABC-Paramount Records, Impulse Records, ABC Records, Westminster Records, Music Guild Records, Whitehall Records, Ampco Music, Inc., Porgie Music, Inc., Westpar Music Corp., Par Productions, Inc., Command, Grand Award Records, Apt Records, Dunhill Records, Tangerine Records, Jerden Records, Pamco Music, Inc., Apt Music, Inc., Ampar Music, Inc."

And here is the second change of address for the erstwhile Everest:

"THE EVEREST GROUP HAS MOVED ITS OFFICES TO: 10920 Willshire Boulevard Suite 410, Los Angeles, California 90024 . . . (signed) Apollo Distributing Co., Archive of Folk Music, Arvee Music, Arvon Music, Baroque Records, Concert-Disc Records, Concertapes Distributors, Counterpoint Records, Esoteric Record Distributing Co., Everest Records, Fidelity Distributors, Hi Fi Records, La Comedie Française, Period, Renaissance, Scala Stradivari, Summit Records."

Well, the Columbia Group moved into its new offices at 51 West 52nd St., N.Y.C. last year, but they didn't bother saying so, everybody knew it already. As for the RCA Group, it's still sort of spread out all over the country, New York, Indianapolis, West Coast, Camden. I haven't heard yet from the hundreds of other labels that are likely to clump up any day now—say the Vanguard Group (279 labels) or the Elektra Group (1161 labels); but I know all about EMI-Capitol-Angel-Odeon and Philips-Mercury (each with 5000 international labels). And so I can guess what's on the way soon, if things go on like this.

They'll all boil down and agglutinate and agglomerate right back to two giants again—what else? Like old Victor and Columbia.

Maybe we'd better plan to call them the Red Group and the Blue Group, after the old days. That'd do it nicely. 1,576,289 labels in Red, 1,654,321 in Blue. Some clumps! (Continued on page 60)

LIKE THE HORSE N' BUGGY AND THE CRYSTAL RADIO

Magnetic Cartridges are now obsolete

Here's why! ONLY THE
EUPHONICS MINICONIC
SILICON SEMICONDUCTOR
CARTRIDGE . . .

**Retains intimate groove contact
at all audible frequencies**

It does this by achieving the high stylus-groove resonance of 47 KHz along with uniform response well past 50 KHz. No magnetic cartridge remotely approaches this requirement of noise-free and distortion-free reproduction because of the mass of the iron and copper used to form it.

FACTS . . . Semiconductor vs. Magnetic

Miniconic gives best tracking through lowest effective tip mass: approximately .3 milligram as established by resonant test method; less than .6 milligram by calculation. The most exotic magnetic does not approach this.

Miniconic Banishes Groove Destroying Mass to Give Stylus Groove Resonance of 47 KHz. The best magnetic known is about one-half this and most of the fine ones are between 12 and 15 KHz. Easily determined by testing with CBS STR-120 Test Record.

Mass of Miniconic Cartridge is Less than 2 grams; the good magnetics average 6 times this mass, thus demanding low vertical compliance to prevent stylus retraction into cartridge body on usual record warps.

Miniconic is a Modulator-Valve, so a small power source does the work, not the delicate record groove. Magnetic cartridges contain a massive generator which must be moved at accelerations of over 1000 G's by the groove to give a tiny output.

Best Bass in the world because Miniconic Semiconductor responds uniformly to DC! No magnetic cartridge can do this because magnetic output diminishes as the frequency goes down.

Miniconic Inherently Distortion Free. Uses resistive principle—no distortion in resistors. Magnetics are inherently reactive and thus distortion prone.

Miniconic maintains Noise-free Groove Contact at High Levels: Impossible for even the best magnetics at levels encountered on present LP recordings. Low magnetic stylus groove resonance will not allow tracking of vertical recorded frequencies above 10 KHz without chatter.

Miniconic Basically Hum-Free because it has 10,000 times the output of the best magnetics.

Miniconic is Flat to RIAA. Magnetics must use 38.1 db of costly, hum inducing equalization to play RIAA.

Through funds supplied by
THE OFFICE OF NAVAL RESEARCH
under Contract Number 1866(24)*

IT HAS BEEN INCONTROVERTIBLY SHOWN THAT STYLUS GROOVE RESONANCE MUST BE HIGHER THAN 40 KHz OR LOSS OF GROOVE CONTACT WILL TAKE PLACE.

Restoration of groove contact is in the form of shock, producing impulse excitation of the stylus system and corresponding broad band chatter and distortion.

*Acoustics Research Laboratory, Harvard University, Dr. F. V. Hunt in "The Rational Design of Phonograph Pickups"; subsequently published in the Journal of the Audio Engineering Society.

Only Miniconic Prevents Chatter

The Miniconic tracks second harmonic pinch effects of all fundamentals from 0 to 23.5 KHz. It can do this because the active silicon semiconductor element is smaller and lighter than the diamond tip itself. It is impossible for a magnetic cartridge to attain this low mass.



Model TK-15-LS Miniconic Laboratory Standard Phono System. Consists of U-15-LS plug-in cartridge with biradial diamond stylus. TA-15 low-mass tone arm and PS-15 power source. Works into magnetic or auxiliary inputs. With instructions. Shpg. wt., 3 1/2 lbs. USER NET. \$87.50

Model TK-15-P Miniconic Professional Phono System. As above, but with U-15-P plug-in cartridge with .5 mil diamond stylus. Shpg. wt., 3 1/2 lbs. USER NET. \$71.50

Model CK-15-LS Miniconic Laboratory Standard Phono Conversion Kit. Consists of U-15-LS cartridge (with biradial diamond stylus) for standard heads and PS-15 power source. Works into magnetic or auxiliary inputs. With instructions. Shpg. wt., 2 lbs. USER NET \$55.00

Model CK-15-P Miniconic Professional Phono Conversion Kit. As above, but with U-15-P cartridge with .5 mil diamond stylus. Shpg. wt., 2 lbs. USER NET. \$39.00

NOTE: For broadcast and recording studio use, 16" low-mass tone arm and/or power source with 600-ohm output also available. Write for details.

The Experts Say:

Hirsch-Houck Labs, in ELECTRONICS WORLD. "...most basically hum-free cartridge on the market . . . rivals anything we have heard."

Jerry Wesson, hi-fi columnist for U.S. CAMERA. "I've really heard that passage in the Sibelius 3rd Symphony for the first time, with the Miniconic . . ."

Reprinted with permission of the authors and publishers cited.

For complete information on the world's first and only semiconductor cartridge—Euphonics Miniconic, see your dealer or write . . . DEPT. A-5.

Euphonics
MARKETING

173 West Madison Street, Chicago, Illinois 60602
FACTORY: Guaynabo, Puerto Rico, U.S.A.

SOUNDMEN GET SOUND ANSWERS FROM FAIRCHILD!



NEW! FAIRCHILD COMPATILIZER

An automatic approach to the production of compatible stereo records. Unit rejects low frequency information automatically above a predetermined level. COMPATILIZER also permits increase in high level recording time on discs and provides maximum separation on stereo records above 100 cycles.

NEW! FAIRCHILD BASS-X

A dynamic low frequency roll-off filter—that can roll off high level low frequency information, starting at 500 cycles, with a maximum obtainable attenuation of 12 db at 30 cycles. Device is automatic, is in use only when needed—therefore it does not alter overall apparent low end response to the ear. THE FAIRCHILD BASS-X allows higher levels to be maintained in disc recording, and particularly assists AM stations in increasing their effective signal by automatically controlling the often troublesome low end response.

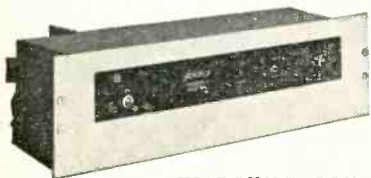

FAIRCHILD CONAX

The world-accepted way to control high frequency spillovers in FM due to pre-emphasis. Lets your station maintain real high levels even with brass and crashing cymbals and still avoid FCC citations.

THE REVERBERTRON

The new compact reverberation system which gives your station that real big voice. With the Reverbertron you can have that Carnegie Hall effect as close as the gain control on the Reverbertron. And there's the added plus of an increase in apparent loudness of your station sound due to reverberation, as originally described by Dr. Maxfield.



Write to FAIRCHILD — the pacemaker in professional audio products — for complete details.

FAIRCHILD

RECORDING EQUIPMENT CORPORATION
10-40 45th Ave., Long Island City 1, N. Y.

Circle 114 on Reader Service Card



ABOUT MUSIC

Harold Lawrence

Recording in the Concertgebouw (Part 2)

Harold Lawrence

A certain well-celebrated European conductor is the despair of his recording crews because he usually gives them only five minutes to get ready. The microphones had better be in position and the balance perfect when he lifts his baton for the downbeat. We had no such problems. In fact, Willem van Otterloo, the efficient conductor of the Hague Philharmonic, apologized because the first work to be recorded, the *Overture and Three Dances* from Smetana's *Bartered Bride*, was not in the orchestra's repertoire and would require extensive rehearsal. Two minutes into the *Polka*, and we realized we would need every minute of rehearsal time.

Nearly everything was wrong. Starting from the bottom of the frequency spectrum, the bass drum rattled, the timpani sounded dull and thuddy, the brass lacked focus, violas and bassoons were weak, cymbals and piccolo piercing, and the overall sound too reverberant. Otherwise, as the French popular song goes, "Tout Va Très Bien, Madame la Marquise" (Everything's Just Fine, Marquise).

Where to start? On the closed-circuit television screen, I noticed that the double basses were tilted away from both the microphones and the podium, robbing the orchestral sound of its harmonic underpinning. Without interrupting the rehearsal, engineer Hans Lauterslager approached each player and whispered instructions into his ear. Moments later, with all f-holes beamed at the right and center microphones, the basses at last began to "speak."

As van Otterloo led his players into the first tutti climax of the *Polka*, the pointer of the left VU meter lurched into the red and began banging against the pin. We didn't have to see the meter to sense trouble: each time the bass drum player pounded the loud beats, a gigantic calabash with built-in distortion shook the listening room. The chief engineer went upstairs to take a close look at the drum. He observed that the vibrations were being transmitted through the supporting frame to the floor, so that the rattle dominated the sound of the instrument. Engineer J. L. Ooms's eyes twinkled: "Let's get this fellow some galoshes," he announced. Four gray rubber tips were located and fitted onto the feet of the drum stand. Isolated from the floor, the sound now tightened up, the rattle vanished, and the meter behaved.

The kettledrum is the *bête noire* of re-

ording engineers. When it is not too loud, it lacks bite, resonance, and a real bottom. But, like the bass drum, it makes the VU meter jittery in loud passages. Most engineers take the easy way out and admonish the timpanist to play as lightly as possible—to the profound irritation of every red-blooded drummer. (Who would ask Sandy Koufax to stop pitching his fast ball?)

Even then, some engineers still are unsatisfied, and try other ways to tame the timpani. One is to adhere patches of felt to the drum heads. This often sounds as if the timpanist was flogging a damp sheet.

The musical solution to the problem of the intemperate timpanist is not to restrain him, but to move his drums to different positions until the balance and level are correct, to place a canvas under his instruments, or to experiment with different sticks. A change to harder sticks and a new location was all that was necessary in the Concertgebouw to achieve a realistic timpani sound, one with bite and substance.

Now we turned to the winds, so often the stepchildren of the orchestra—with the eternal exception of the piccolo, at whose first piercing notes we pulled the riser out from under its player. Flutes sounded clear and bright. But the oboes and the darker clarinets and bassoons tended to be swallowed up by the *tutti*. Was our microphone setup to blame? To check this, we listened to the orchestra in the hall. Same problem. It was too risky to raise these instruments further; one of the players confessed he became dizzy when blowing at more than 18 inches above floor level.

Lauterslager had an idea. Pointing to the sardine-packed violas directly in front of the wind riser, he suggested that the dullness of the wind pickup might be due to the absorption of the tightly congested viola section. Spread the strings slightly and we could benefit from the hardwood floor's reflective properties. A short break was called to rearrange the seating. Ten minutes later the winds emerged with a clarity we were to hear for the first time that afternoon.

Throughout the first half of the session, we were all vaguely unhappy with the hall's reverberation period, which lent a cool impersonal quality to the overall sound; but we were too preoccupied with more obvious problems to grapple with this one. Finally, we postponed our section-by-section treatment and reviewed the situation. Nearly all the upholstered seats

(Continued on page 61)

THE SUPERB NEW SOLID-STATE
HARMAN-KARDON
SR-900B

100 WATTS
 BANDWIDTH 5 TO 60,000 CPS
 AT FULL RATED POWER

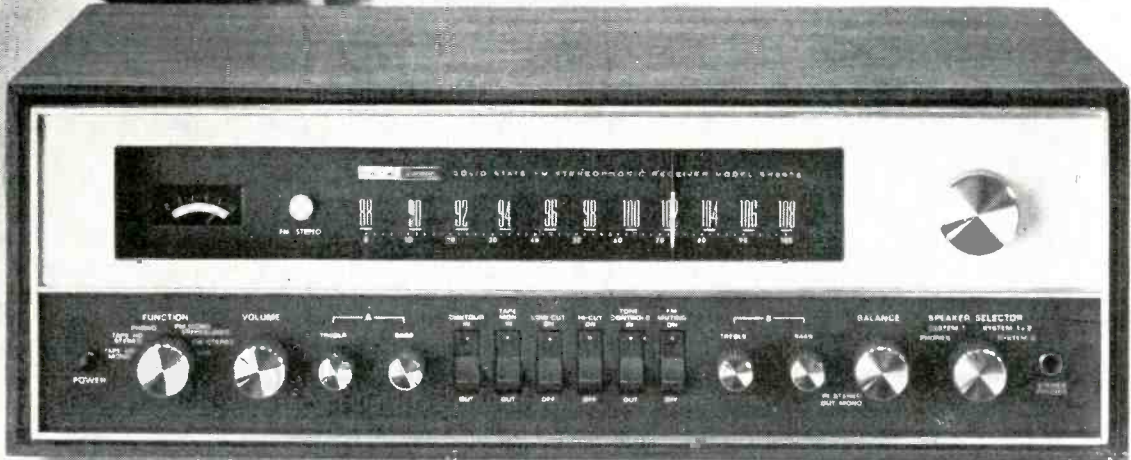

SR-900B • Gives you stereo in one or two rooms—separately or simultaneously • 0.2% distortion • 1.85 μ v front end • D'Arsonval tuning meter • Automatic stereo indicator • \$449* suggested retail

**Faithfully reproduces frequencies you can't hear,
 for better definition of the sound you can hear**

Compare the flat response of the SR-900B at full 100-watt power with the response of other receivers at one watt! You'll hear the difference. Make the test with a "tough" record that has peak-after-peak of murderous percussion and brass. The opening of the last movement of Tchaikowsky's 4th Symphony is a good one. Receivers that clip off response at low and high ends gush out sound that smears together. The SR-900B virtually eliminates phase distortion and holds the important overtones that are the difference between instruments. You'll hear the difference between oboe and clarinet, cello and viola on the same pitch—even the bite of the bow on string. All are part of the complete musical experience, the *extra realism* of Harman-Kardon sound.

The SR-900B with diffused-junction germanium output transistors not only produces very low distortion and ex-

tended bandwidth, it also is far more reliable and cooler in operation. It installs in *any* position, in *any* enclosure—without fans or worry about heat breakdowns. Hold your hands over the SR-900B and any other receiver while they're operating. Harman-Kardon's SR-900B is the cool one—and the one that sounds best. Make the test today at your Harman-Kardon dealer. You'll find that the SR-900B meets all your most critical requirements—and then some. Harman-Kardon, Inc., 401 Walnut St., Philadelphia, Pa. 19105

*Slightly higher in the West. Enclosure optional.

harman kardon

A subsidiary of The Jerrold Corporation

LEADER IN SOLID-STATE STEREO COMPONENTS

EDITOR'S REVIEW

LOS ANGELES WAS THE HIGH POINT of the month of March, as everyone in the industry expected it to be. Fine weather (with only a *little* smog), the best hi-fi show facilities we have ever used in the U.S., and a general optimism over the prospects for the year made the entire show one of enthusiasm. Even though the attendance was a little disappointing for the first few days, that of Saturday and Sunday practically made up for it.

The Institute premiered an innovation this year which, in our opinion, points to a trend that could lead to a greater interest because of the ideas offered to the people who attended the show. In a large grassy area in the gardens of the Ambassador Hotel there was a "tent city"—the tents being of the colorful types usually seen in colored movies set in Arabia. One almost expected to encounter some real live shieks in their burnooses and mounted on camels. In fact, there *was* a camel—used for publicity pictures of opera star Anna Moffa in conjunction with the opening ceremonies.

The tents housed eight room settings designed by several members of the American Institute of Decorators to show some novel and attractive ways to integrate hi-fi components with the less important elements of rooms, such as furniture. Not the least of the unique values of the entire display was the introduction of a line of "components" bearing the name IHF. One of the problems of displays of this type has always been the necessity of selecting name-brand components for the settings, and with some sixty or seventy members of the Institute—each of whom rightfully felt that its products should have been included, so almost invariably some felt slighted. Stu Murphy headed a group which planned the display area, and this group was responsible for the design of the "Brand X" component line. The line consisted of a tuner, receiver, preamp, power amplifier, phono turntable, and tape recorder, along with a number of speaker enclosures. Needless to say, the components were only front panels and cabinets without anything inside. The design job was excellent—each of the units looked *somewhat like* all well-

known brands, yet without directly being identifiable as any specific one. Somebody suggested that since the units all bore the name "IHF," it was likely that an Irving H. Feldman might adopt the line as his own. Could happen, of course. The entire project of the Arabian Village comes under the promotional activities of the Institute, and is one which deserves much commendation for the idea as well as for the execution. A superb job, we say.

One subject of discussion invariably comes up after each high fidelity show—the high cost of reaching each visitor. It has, for example, been variously estimated that it costs the total group of exhibitors in the vicinity of twenty to thirty dollars for each visitor who attends the show. The cost is made up in exhibition fees, room rental, decoration, shipment of equipment to the exhibit site, and expenses of those who man the individual display rooms. One of the questions often asked is, "Isn't there a better way to reach these potential customers?"

We think there is—an idea gained from a consideration of the Arabian Village display along with the three exhibits staged by local dealers at the Chapman Park Hotel across the street from the Ambassador. We think that both the public and the manufacturers would be best served by having the Institute continue with the decorator-planned room displays as the center of attraction for the entire show, but the "live" displays, with sound, would be the responsibility of the local dealers. One of the disadvantages of the present format has always been that if a potential customer becomes "sold" on a product as a result of the demonstrations he has heard, he must then go away from the show, find a dealer, and start over from scratch, practically. With this proposed plan, the dealer could actually complete the transaction while the prospect was "hot."

We do not mean to be bearish on the entire show idea—we can't be, since we originated it—but we must finally suggest that the underlying concept might well be changed, and this plan seems to be more productive of immediate sales, as well as being much less costly for the manufacturer-members of the Institute.

Nine out of ten musicians prefer the natural sound of Pickering.

PHOTO BY FRANZ EDSON



Microgroove discs are recorded by magnetic processes. Naturally they sound better when reproduced with a Pickering Micro-Magnetic™; there's a natural compatibility. From the tiniest peep of a piccolo to the mightiest roar of an organ, Pickering produces sound as natural as the original performance. That's why musicians prefer Pickering. And so does everyone else who can hear the difference.

Pickering makes it easy to get natural sound in any stereo installation. There are four Pickering Micro-Magnetic pickups, each designed for a specific application. The V-15AC-2 is for conventional record changers, where high output and heavier tracking forces are required. The V-15AT-2 is for lighter tracking in the newer automatic turntables. The even more compliant V-15AM-1 is ideal for professional-type manual turntables. And the V-15AME-1 with elliptical stylus is the choice of the technical sophisticate who demands the last word in tracking ability.

No other pickup design is quite like the Pickering Micro-Magnetic. The cartridge weighs next to nothing (5 grams) in order to take full advantage of low-mass tone arm systems. Pickering's exclusive Floating Stylus and patented replaceable V-Guard stylus assembly protect both the record and the diamond.

But the ultimate test of a cartridge is the human ear. Find out for yourself. Listen carefully to a Pickering. You'll hear the difference.

For those who can hear the difference.

Pickering
Pickering & Co.
Plainview, L.I., N.Y.

Circle 116 on Reader Service Card

Compare these Sherwood S-7800 features and specs! ALL-SILICON reliability. Noise-threshold-gated automatic FM Stereo/mono switching, FM stereo light, zero-center tuning meter, FM interchannel hush adjustment, Front-panel mono/stereo switch and stereo headphone jack, Rocker-action switches for tape monitor, noise filter, speakers (A) and (B) disconnect. Music power 100 watts (8 ohms) @ 0.3% harm distortion. IM distortion 0.1% @ 10 watts or less. Power bandwidth 12-35,000 cps. Phono sens. 1.8 mv. Hum and noise (phono) -70 db. FM sens. (IHF) 1.6 μ v for 30 db quieting. FM signal-to-noise: 70 db. Capture ratio: 2.4 db. Drift \pm .01%. AM sens. 2.0 μ v. AM bandwidth 7.5 kc. 43 Silicon transistors plus 16 Silicon diodes and rectifiers. Size: 16½ x 4½ x 14 in. dp.

Did you miss our last ad*?



*If you missed our previous ad comparing Sherwood's new S-8800 ALL-SILICON FM receiver with many other receivers, write for your free copy.



S-7800 100-W. FM-AM Receiver
Chassis: \$399.50
Wal. Cab. 28.00

Now we've added AM...and the industry's longest warranty —3 years—to our ALL-SILICON 100-watt FM receiver.

How can Sherwood offer this long warranty? Only because we said "No!" to both ordinary Germanium Transistors and old-fashioned tube Nuvistors, insisting on ALL-SILICON reliability. No other receiver has its pacesetter 1.6 μ v FM sensitivity, its remarkable 0.1% distortion rating, for the most true-to-life sound.

Sherwood

Sherwood Electronic Laboratories, Inc., 4300 North California Avenue, Chicago, Illinois 60618 Write Dept. A5

Circle 117 on Reader Service Card

Evaluation and Application of Artificial Reverberation to Conventional Sound Installations

PART 2

GEORGE S. LEHSTEN*

Part 1 of this series (February, 1966) included such factors as the general types of equipment available, the basic approach for their use, and a reference to their application. This Part 2 deals with the selection of the type of reverberation generator, its calibration, and its subsequent use. In addition a detailed description of the method used to obtain the calibration data will be given.

EQUIPMENT TYPES. Of the four basic types of equipment available for the generation of reverberation signals, the *electro-mechanical systems* are considered to be the least costly. These systems consist of an audio amplifier with a response curve tailored to the desired frequencies to be delayed and/or processed. The delay interval itself is developed by a series of springs or rods, as the case may be, with transducers located at the ends. The chief disadvantage of this type of system lies in the inaccuracy of the transducer-spring combination to reproduce the input signal faithfully. This type of device, however, is acceptable where true fidelity to the original is not a requirement, such as would be the case with auto radios or home organs. This type of device also represents the smallest physical size of any of the systems designed for this purpose.

The *electro-acoustical systems* are quite similar to the electro-mechanical systems except that an acoustical path or enclosure is used to effect the delay characteristics. If good design is accomplished in this system, the results are quite acceptable when limited to narrow-bandwidth applications. The major limitations are size and as an end result, cost. Several recording studios make use of such systems in their application of reverberation signals to master recorders. They are, as a rule,

individually manufactured to specifications set forth by the studio itself.

The *electronic recording systems* employ modified endless-loop tape transports with a series of spaced reproduced heads to effect the delay by means of the effective tape speed of the transport. The delay can be varied within narrow limits by the changing of these tape speeds provided they are not changed during any one operation. The lower-priced versions of this tape system delay the desired "notes" by the process of recording the signal on magnetic tape and then removing the signal via an erase head after the tape transport has placed the signal across a succession of reproduce heads. The number of reproduce heads and their spacing represent the over all delay possible, remembering of course, that only the original note recorded was delayed. On more expensive models the effect is improved considerably by taking a portion of the delayed signal in sequence from all the reproduce heads and re-recording it along with the new signals to be delayed. This is closer to what actually happens in a music situation in a concert hall as the original "note" could be reflected several times from the walls of the hall. This system, however, requires rather sophisticated electronics, since to be truly effective this recording step must be done for each individual reproduce head.

In order to obtain the desired and effective reverberation signals satisfactorily, a large number of reproduce heads are needed. Some systems are known to make use of as many as 11 reproduce heads. It is quite obvious that

such a tape transport and the associated electronics package would be quite expensive. The results, however, are very impressive. Aside from the cost the only other detrimental factor is the FM noise commonly known as tape hiss, produced by the tape machine itself. Since some of the delay signals may be re-recorded as many as ten times, this level can and does become a limiting factor. To reduce the number of heads—and as a result the number of re-record cycles—will reduce the level of this noise but will also deteriorate the over-all delay effect. Therefore a compromise is in order to achieve the best results.

The *all electronic system* makes use of delay logic amplifiers to achieve the necessary delay characteristics. Since these amplifiers can be designed with unity gain it becomes an easy matter to sample a portion of the delay-amplifier output based on the acoustical level of the original delay signal and reinstate this signal along with the new signal to be delayed. The applied level of the delay signal to be again delayed must be equal to the attenuation that a similar signal would encounter in the concert hall. An added advantage is that the noise level of such a system (as compared with that of the tape assembly) is considerably improved. In a sample system designed in our plant, at Perfectone Sound Laboratories, eleven such delay amplifiers are used for each of the two original A and B channels of audio information. Thus 22 such amplifiers are used and yet the over-all system noise level is better than 80 dB down from a 55-watt-per-channel

*480 Teaneck Rd., Teaneck, N.J. President Perfectone Sound Laboratories; Chief Engineer, Alpine Geophysical Associates, Inc.

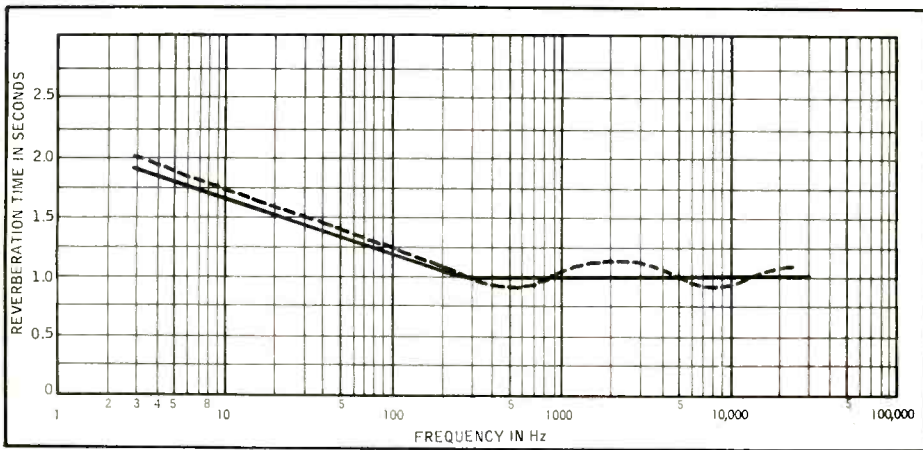

Fig. 1. Curve of reverberation time vs. frequency as measured in 1940 in the Danish Broadcasting Studios, Copenhagen, by Richmond and Heyda.

level. The all electronic system compares somewhat as to both cost performance, (with the exception of the noise figure), to the best of the tape systems. An additional added advantage is that no maintenance is needed such as would be required with the tape systems. The total size of a system of this type could be made approximately equal to a conventional FM tuner if solid-state electronics were used exclusively. The tube version described is mounted in a 19-inch rack installation utilizing 28 inches of panel height. Although this system is in itself an independent two-channel assembly, the delay characteristics for both sides are somewhat equal. The point of designing the assembly in two channels is to determine if the apparent listener placement position could be moved to one side or the other and still retain the correct feeling of the hall acoustics. The effect was substantiated although it required two spaced rear-mounted speaker systems, one for each delay network.

Calibration

Once the choice is made on the type of equipment to be used, a means to apply this equipment to existing systems is needed. The application is as important as the choice in that each type has its limitations and use. Satisfactorily calibration and use of such a system makes it necessary to understand how these signals differ from the normal A and B signals of any conventional sound installation.

As the music is being played the sound approaches the listener directly. Since all the sounds must travel an approximately equal distance, the listener is not aware of any delay effects.² However, a certain percentage of the original sounds proceed past the listener and are reflected from the rear walls of the concert hall. The listener then hears these sounds delayed by the time it took

the sound to make the trip from a point where the listener is located to the rear of the hall and back to the listener. This can be considered to be D_1 . The reflected sound that the listener hears continues on and is again reflected, this time by the front walls of the hall and back to the listener. This can be considered to be D_2 . This procedure is continued until the amplitude of reflected sound is below the level that can be heard because of ambient noise. If each successive half travel time is designated D_1 , D_2 , and soon, it is now possible to appreciate the rather long over all delay time required until the reflected sound can no longer be heard. Actual tests have proved that 18 or more reflected cycles are not uncommon. Sufficient energy is normally available to make at least 10 such cycles audible. As a result over all delay times of more than 3 seconds are quite real and indeed quite noticeable.

The fact that the delayed signal is so clearly heard and that the listener can perceive the direction of the signal is significant. A type of stereophonic action could occur if the reflected signals were picked up via a separate microphone and recorded on a separate track with a separate playback speaker system located in much the same location as was the original microphone. This is not really required since the directional effects can be achieved simply by radiating the odd numbered delay signals (D_1 , D_3 , D_5 , and so on) via rear mounted speaker systems and the even numbered delay signals (D_2 , D_4 , D_6 , and so on) via the normal or reinforcing forward speakers.

It is the task of whatever reverberation generator system is selected to initiate, in synthetic form, the equal of all of these signals both as to frequency and delay and to, in addition, reduce their level by the original decay rate. Such a system is complex to say the

least, however, the end result is perhaps as startling as the difference between mono and stereophonic sound.

Calibration Data

During the study of various concert halls and studios several facts became apparent, the most important fact being that a given hall that seemed excellent for one type of music was completely unacceptable for another. A classic example of this is that of the famed Royal Albert Hall of England. This hall has gained the reputation as the place to hear two orchestras for the price of one. The delay characteristics of this hall were so long that the effect is that of an echo rather than reverberation as it is commonly known. When music such as the 1812 Overture is performed, the hall takes on a new significance and the result is quite pleasant. The latter part of this music makes use of a good deal of impulsive-type noise and as a result of the long delay times these impulse-type signals seem to be greatly improved.

Although this is an exaggerated example, the qualifications of almost any hall complement greatly one type of music and in some cases can be considered detrimental to another. This fact alone would serve to reject the electro-mechanical and electro-acoustical systems since their delay characteristics are not readily adjustable. The tape systems and the logic systems can be adjusted at the flip of a switch with any number of delay set-ups available. The tape systems however are still limited primarily by the spacing and number of reproduce heads. Sufficient versatility can be achieved, however, by electrically switching in or out any number, or any combination of these heads. The all-electronic systems do not suffer from any of these affects and as a result are the most flexible.

It must be quite obvious at this point that the calibration of a device of this sort must be based on the acoustic pattern of one specific, well designed hall rather than a compromise of hypothetical data. Only in this manner can a truly representative parallel exist between the reproduced music and the original. Any attempt to compensate for some hall deficiencies merely takes on the same effect as accentuating bass notes because of hearing loss of individual preference, or editing out errors or audience noise of live recordings. They did happen at that level in the original and therefore should be reproduced to be "as close as possible to the original."

Figure 1 represents what can be con-
(Continued on page 61)

The Servo Groove Tracker

ARTHUR G. JOHNSON

While not actually a constructional article, the author outlines an approach to the problem of reducing tracking error to a minimum by employing a servo mechanism to move a pickup arm radially across a record.

In an attempt to discover an improvement over the conventional tangent-single pivot tone arm in widespread use today many devices such as the radial arm (Fig. 1) and the linkage arm (Fig. 2) have been tried in the past. None of these devices ever became as popular as the conventional tangent arc of Fig. 3. The main feature of the radial and linkage arms was that they had negligible tracking error. However, because of the friction of all the extra pivots and rollers they required, tracking force had to be increased to a point where excessive record and stylus wear resulted.

With the high degree of perfection that the tangent arm has been brought to, one may wonder why other types of tone arms should be considered. A study of the tangent arm reveals that a compromise between tracking error and drift force must be made in the design. Most audio enthusiasts recognize that tracking error is the angle of deviation that the pickup axis makes as it traverses the record with respect to the axis of the cutter by which the grooves were cut. Drift force—which is much less familiar—can be observed from the following experiment if a high-quality tangent arm is available.

Be sure that the turntable is level with the horizontal and the arm properly balanced. Place a record on the turntable and start it. Lower the arm to the record but

63 Rhoades Ave., E. Walpole, Mass. 02032



Over-all view of the servo groove tracker mounted in the corner of a turntable cabinet. An experimental preamp is seen just behind the arm, while the servo amplifier is located underneath the motor assembly.

place the stylus not in the groove but on the land between any of the widely spaced lead grooves near the center of the record. The tone arm will drift toward the center of the record until it falls into a groove.

This drift is the result of drift force, sometimes called "skating." Drift force is caused by the geometry of the tangent arm along with the stylus-groove friction. Excessive amounts of

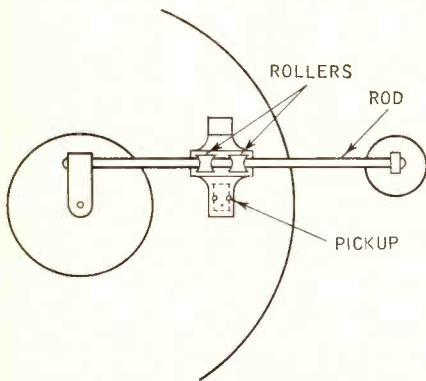

Fig. 1. Representation of the radial arm, several types of which have been on the market in recent years.

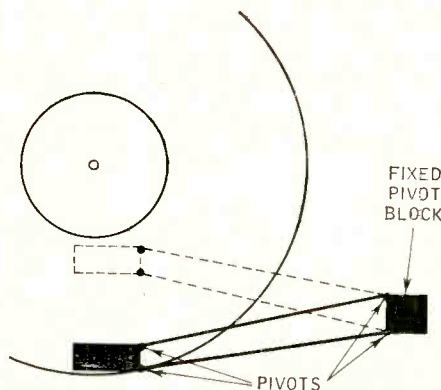

Fig. 2. A parallelogram linkage type of phono arm, also formerly on the market.

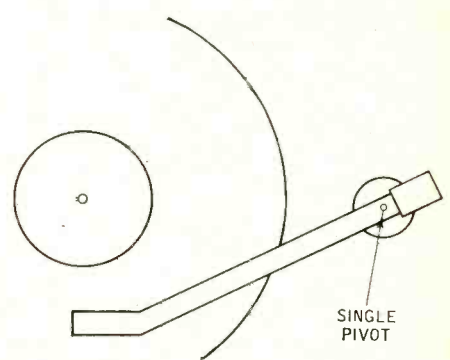

Fig. 3. The conventional tangential arm.

this force results in unequal wear on the contact areas of the stylus. It also results in unequal wear on the groove walls, the inner wall (the left channel on stereo discs) showing wear before the outer wall although the right channel will show more distortion in playing, due to lack of reliable contact with the groove wall. A fact not often realized is that this drift force is not constant, but varies with the amount of modulation in the groove. This is very likely a factor in playback distortion, record-stylus wear, and excitation of tone-arm resonance.

It has been stated² that a small amount of drift force is desirable to help the arm to the center of the record instead of relying on the groove alone to

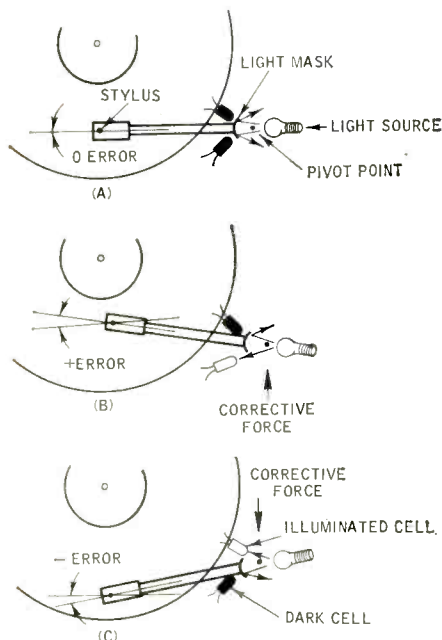

Fig. 4. Three positions of the groove-tracking arm, showing how the light mask shades both cells when there is no tracking error, (A), or allows light to shine on one or the other of the cells, (B) and (C), when there is any tracking error, thus causing a corrective force to be applied to move the arm pivot to mask both cells again.

move it across. However, since records are usually more or less warped and often come with their spindle holes off-center, the help that the drift force would give is swamped out by the non-precision nature of the disc.

The Servo Groove Tracker

To eliminate drift force and improve record tracking the servo groove tracker was developed. The arm of the tracker is a short straight arm with pivots to allow movement up and down and side to side as with conventional arms. However, the arm, including its pivots, is mounted on a carriage that is free to

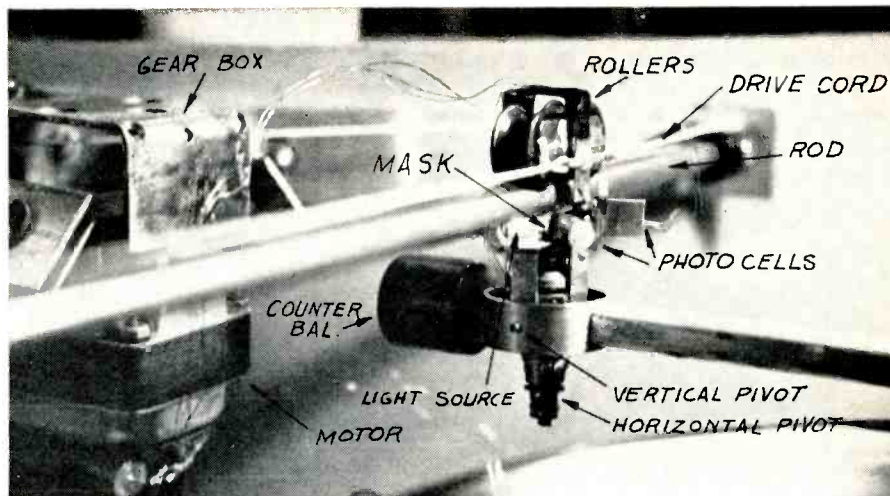

Fig. 5. Close-up of arm carriage showing physical arrangement of photo cells, light, and movable mask.

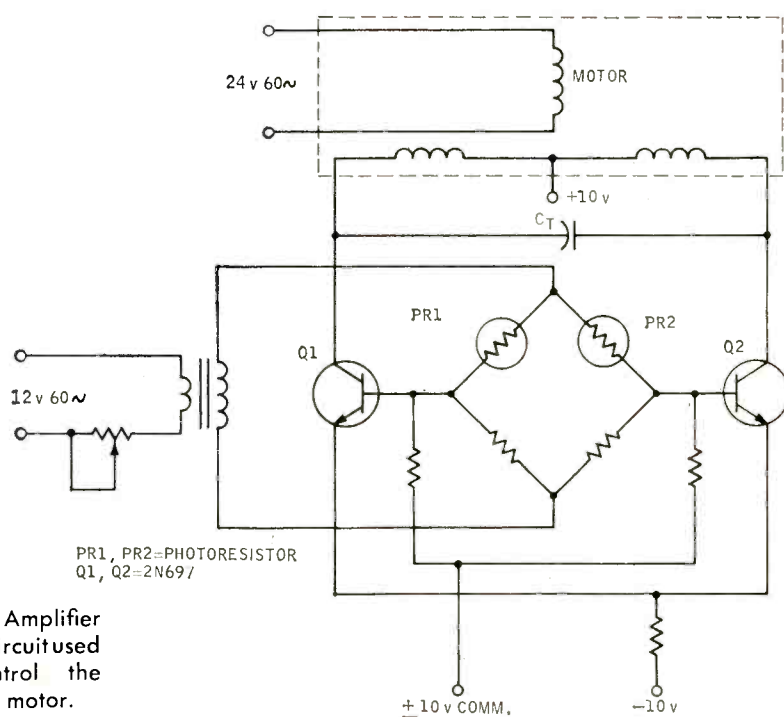

Fig. 6. Amplifier bridge circuit used to control the servo motor.

roll on a rod. The carriage is coupled to a cord which in turn is coupled (through gears) to the shaft of a motor. Now if the arm is placed on a record an error angle results as the groove spiral moves the arm. By the use of a sensing device mounted on the carriage this error angle can be detected. The sensor output can be fed to an amplifier that drives the motor, which in turn moves the arm in

such a way as to make the error angle zero. (See Fig. 4) The arm itself is not required to exert force on the sensing device therefore the arm is as free to move with as low amount of pivot friction as a conventional arm of the same quality.

Such a system is called a position servo. The input to the servo is created (Continued on page 62)

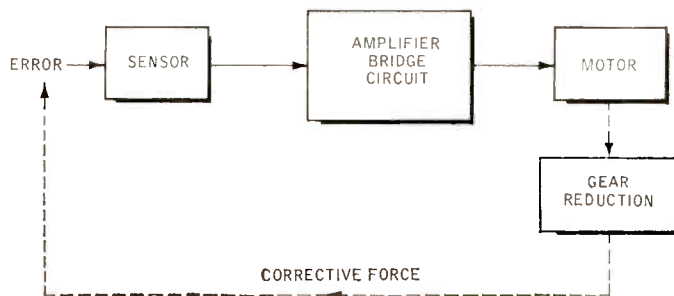

Fig. 7. Servo loop diagram

Audio Measurements Course

NORMAN H. CROWHURST

in Five parts—Part 5

In this concluding installment of the first series, the author describes some improved methods of IM testing, covers several transient-testing methods, and proposes some standardization of the latter for future application to amplifier evaluation. The second series will start in the July issue.

THE ONLY WAY TO DETECT all forms of modulation of the higher test frequency by the lower—the SMPE-type of signal—is to remove both original frequencies. This requires a double bridge of the type suggested (and used quite extensively) for harmonic measurement, to null input against output.

With the simple harmonic-nulling test, the balance was obtained by adjusting attenuation to match amplitude, with a small phase adjustment on the "ratio arm" of the bridge to null phase-shift effects. When two test frequencies are used, one high and one low, both must be correctly nulled in both amplitude and phase, which means there must be at least four adjustments, some of which will be interacting to a degree.

We start with the same basic ratio arms, using unity ratio. The low frequency can be phase adjusted (without materially interfering with the high-frequency phase correcting) more effectively by using capacitors in series with the ratio arms, rather than in parallel. As these will be relatively large capacitors, it is simpler to provide the necessary adjustment by means of two equal capacitors, shunted by a potentiometer that can vary the relative resistance shunting them (Fig. 5-1).

For the small phase shifts that should be encountered, this will not materially invalidate the ratio. Values can be chosen to ensure that it doesn't, so that larger phase shifts just do not allow a balance to be achieved—a fact that may be discovered, either because the control reaches one end before balance occurs, or by observation on the 'scope, as described later.

The high-frequency phase balance can use the same method as before, except that amplitude can be included with phase by inserting resistors in series with the differential capacitor elements, so that combined adjustment will correct both amplitude and phase; for the high frequency, these two controls will be highly interacting—both resistance and capacitance affect both amplitude and phase—but this does not matter too much, because they have far less influence on low-frequency balance, and when making balance for either high or low frequency, one is not essentially aware whether lack of balance is momentarily due to an amplitude or phase error, or a combination of both.

Balancing Aid

To aid in effecting balance at the two operating frequencies, a good plan is to have alternative sync connections

for the 'scope, with time bases chosen to match (Fig. 5-2). When balancing the controls for low frequency, switch the 'scope to low-frequency time base and sync, so that the low frequency can be observed in spite of the higher frequency that may also be present (and almost certainly will, until both are balanced).

When the low-frequency controls have been adjusted so the trace is essentially a level and flat envelope in this position (Fig. 5-3), switch to the high-frequency time base and sync, and adjust the high-frequency controls for the same purpose. Note that amplitude and phase balance for low frequency are the attenuator and phase adjustment respectively.

Having adjusted the high-frequency controls so that its envelope is level and flat, revert to the low-frequency adjustment again, to see whether the high-frequency adjustment has thrown the low-frequency setting off balance a little. Go back and forth, until both are at the flattest. As you do this, the trace will get narrower in the vertical direction and vertical amplification can be brought up for better observation and ultimately to calibrate the reading obtained as residue.

When the final trace is obtained, it will detect both low-frequency harmonic distortion and intermodulation distortion (Fig. 5-4). These can be evaluated separately from the 'scope traces, or filters can be employed to separate them. For routine measurement of this type, it may be preferable to use filters and meters for successive balancing of the four controls as well as for making the ultimate readings (Fig. 5-5).

Calibration of the result must be related to the respective amplitudes. Harmonic distortion relates to the low-frequency amplitude, while intermodula-

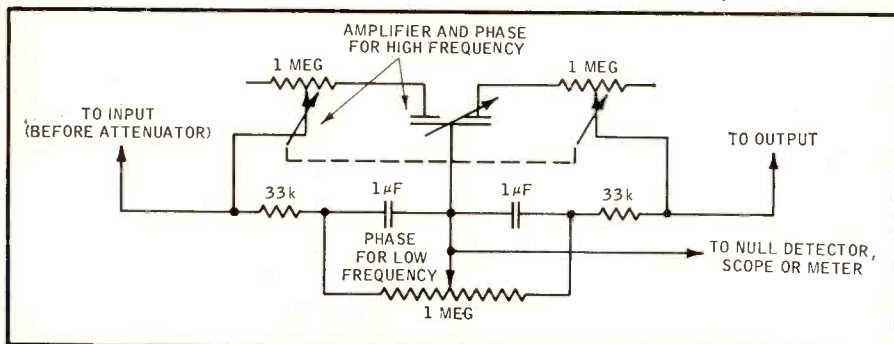

Fig. 5-1. Modification to ratio arms of input/output bridge, to enable it to be used for the SMPE type intermodulation test.

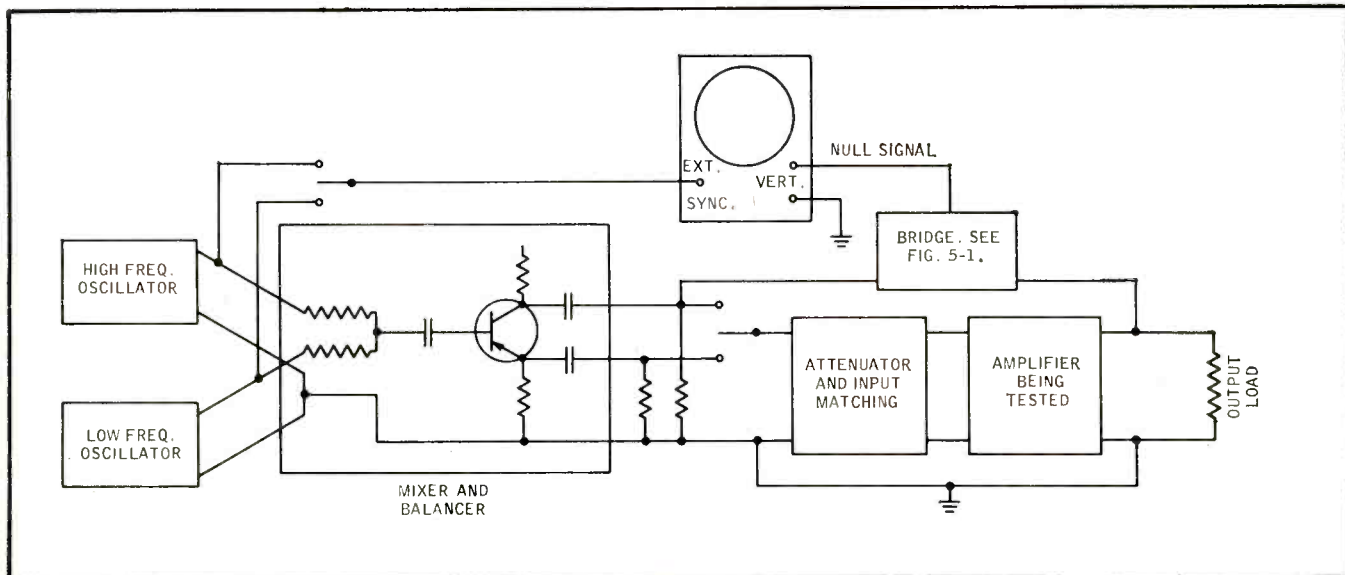

Fig. 5-2. Sync connections for 'scope, to enable it to be used for more effective nulling on the SMPE input/output null test.

tion distortion relates to the amplitude of the high-frequency wave, taken as unity, or 100 per cent. If the low frequency causes a 2 per cent fluctuation in amplitude of the high-frequency wave, from 98 to 102 per cent, this is 2 per cent intermodulation distortion.

Frequency or phase shift is related, by this test, to the phase-shift aspect of the modulation. A fluctuating phase shift of ± 11 deg. (approximately) will result in the same residue as 2 per cent amplitude fluctuation and so will register as 2 per cent intermodulation distortion.

With a unity-ratio-arm bridge, the amplitude of high-frequency residue would be 1/100 of the high frequency present at the input before attenuation, or at the output, for there to be 2 per cent IM distortion. Low-frequency harmonic distortion is similarly found by relating the low-frequency harmonic part of the residue to the low-frequency amplitude at input or output.

As you adjust the higher test frequency used, the amount of distortion may change quite rapidly on some amplifiers, so careful exploration of the frequency range is necessary to find the true distortion characteristic of the

amplifier. This increased distortion at certain frequencies is caused by interaction between dynamic parameters of active elements and reactive elements of the amplifier.

For example, where an output transformer is used, the plate or collector resistance of the stage feeding it will change the high-frequency response of the amplifier with different points on the low-frequency waveform, although the transfer characteristic, and maybe even the measured frequency response, may be quite linear. Under these circumstances, change in the a.c. resistance of the output stage over different parts of the low-frequency waveform can cause different high-frequency phase shifts and/or amplitude changes, not directly due to transfer nonlinearity as such.

Problems with Feedback Amplifiers

In feedback amplifiers, such effects may be exaggerated and with feedback they may also occur in amplifiers that do not use such non-linear devices as output transformers, due to changing impedances in other stages and their associated transfer reactances. There is no way of telling, without making

either the measurements or quite advanced calculations on performance parameters, when this kind of defect may show up.

A more sophisticated measurement system of this type could use automated control adjustment, based on the information obtained from the filters, to balance the bridge simultaneously to both test frequencies, so the meters read off low-frequency harmonic distortion and intermodulation distortion in the high frequency directly.

For making a measurement with two upper-frequency tones, a somewhat simpler bridge will serve. The low-frequency phase compensation is unnecessary, but it is necessary to be able to produce correct null at two closely spaced higher frequencies. In general a third control, consisting of adding a variable resistance in series with each half of the differential capacitor (Fig. 5-6) will enable correct phase and amplitude to be achieved at the two frequencies. In both Fig. 5-1 and Fig. 5-6, the two variable resistances are changed, so one increases when the other decreases.

Correct amplitude and phase at either frequency can be achieved by a variety

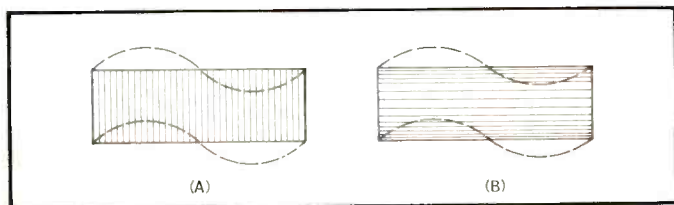
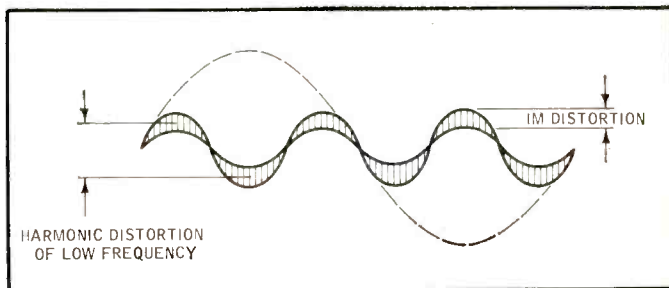
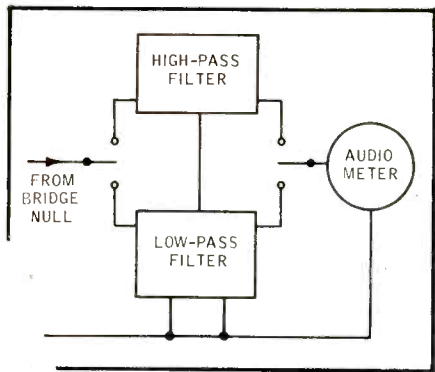

Fig. 5-3, (left). 'Scope traces at stages during nulling: (a) low-frequency component momentarily nulled; (b) high-frequency component momentarily nulled. In each case, the change in envelope shape with departure from null is indicated with dashed lines. Fig. 5-4, (right). The final form of residue with this test, and its significance. Dashed line indicates period of fundamental low-frequency tone, which is nulled out in final trace.





5. Use of alternative filters can enable balancing of this test to be achieved with meters only.

Settings of the resistance and capacitance combination, with slight changes on the attenuator setting to compensate for changes in relative amplitude. Adjustment of the three controls enables a two-frequency correct balance alignment to be achieved. What happens at other frequencies is unimportant.

In making this test, the two frequencies cannot be separated so readily as with one low and one high, to facilitate pulling each in turn. The better way in this instance is to arrange the input circuit that combines the two frequencies in such a way that either frequency can be removed without disturbing the balance of the other. This requires that the combining network be fed from source resistances that are carefully controlled—padded out to a predetermined value—so either can be exchanged, by switching, for a dummy resistance with no signal source (Fig. 5-7).

A three-position switch will facilitate rapid reading, arranging that the center position applies both frequencies in the required (1:1) mixture, while the side positions eliminate one or other, replacing it with the dummy resistance, so as not to disturb the balance of the remaining frequency.

Interpretation of the results can most easily be made by taking a sampling of the combined signal through a

buffer stage and rectifying it to produce a definite frequency with which to synchronize the 'scope (Fig. 5-8). This will then lock the 'scope trace to a complete cycle (or more than one, if preferred) of the beat tone, so that the precise nature of the distortion components may be recognized.

Symmetrical components that did not show up with the conventional CCIF test (using a 100-Hz filter) at all, will cause periodic broadening of the trace, as the higher frequencies spill through both above and below. Asymmetrical components appear as deviations of the line (with some broadening) in one direction at a time (up or down) (Fig. 5-9).

Having thus covered all "steady state" aspects of amplifier testing, we are left with only the transient measurements to make. To date, no standards have been established in this area. We have already seen how complicated "steady-state" consideration can get, when you accept more than a single test frequency (at a time). When one considers transient behavior, the possibilities for different test "signals" multiply very rapidly, as do the possibilities for variation in behavior. So the best we can do here is to discuss what has been done, and its relative validity, or perhaps its area of validity.

Transients

The earliest type recognized as a possible test signal, and used quite extensively for time, is not really a transient at all, in the true sense of the word: it is a square wave. But square-wave testing certainly uncovered some deficiencies in amplifiers that had been rated very highly by tests previously available. While, in some instances, it was found that amplifiers giving a good-looking square-wave response did sound cleaner than those that did not, more extensive work showed that the correlation was not as close as had been hoped.

Some amplifiers that pass excellent-looking square waves did not sound as

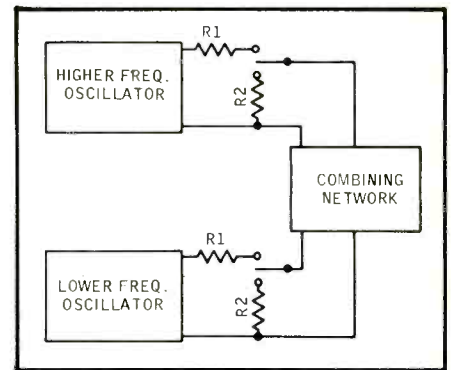

Fig. 5-7. Basic input switching to aid in balancing one frequency at a time with the CCIF type test. On each input, R2 should equal the effective source resistance, including R1. Actual switching would be carried on a multi-position switch, to facilitate functional operation.

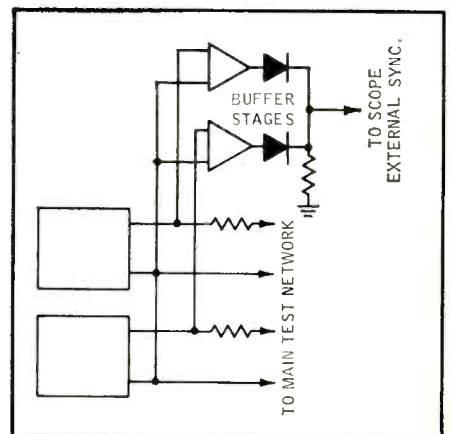

Fig. 5-8. Additional connections to provide for 'scope sync. locked to different, or beat frequency.

clean as some that pass inferior-looking square waves. The test was not infallible. The reason is not difficult to fathom. A square wave is essentially an *electrical* signal form. It never gets into the room as an *acoustic* square wave.

A square wave is essentially an infinite series, of fundamental and odd-order harmonics. The truth or otherwise of square-wave performance merely attests to the amplifier's ability to handle that many harmonics, usually with a slow die away at the top end, rather than a sudden fall off, and without appreciable phase shift. This, in itself, is good, but is by no means the only criterion of "cleanness."

Acoustically, multiple reflections and even the time delay in transmission of a square wave through space soon completely destroy its squareness. And the way an amplifier handles a steady square wave is no criterion of what it will do to a wave that starts up suddenly, which is the musical significance of transient, and which was the origi-

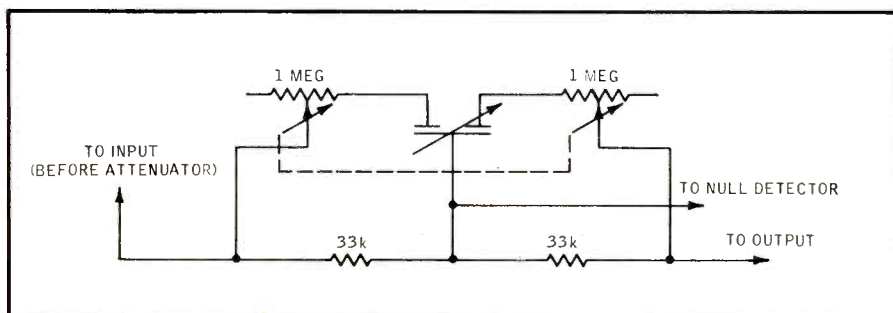

Fig. 5-6. Ratio arms for input/output bridge, when used with two high-frequency test signals, such as CCIF test.

nal motivation for selecting the square-wave form.

The next step was tone-burst testing—modulating an ordinary sine wave by switching it on and off with a square-wave envelope. This is far more meaningful, but it requires far more sophisticated equipment to perform. The object is to see how an amplifier behaves when a burst of tone is suddenly applied to it, and before it settles down to steady amplification of that tone. One way to do this is simply modulating a sine-wave tone with a square wave.

The disadvantage of this method is that another form of distortion can occur when the tone is switched off, and this form of test signal will not find it. Some amplifiers quit amplifying momentarily when a large signal is abruptly removed. With no signal present to test with, there is no way of knowing whether the amplifier is working or not. So the accepted form of tone-burst signal came to be a square-wave modulation that leaves a specific minimum signal level between the bursts, usually 30 dB below the “top” level (Fig. 5-10).

With this, it is possible to see if any distortion occurs after a large amplitude tone terminates, as well as after it starts. A problem of correlating results of these tests arises from the fact that

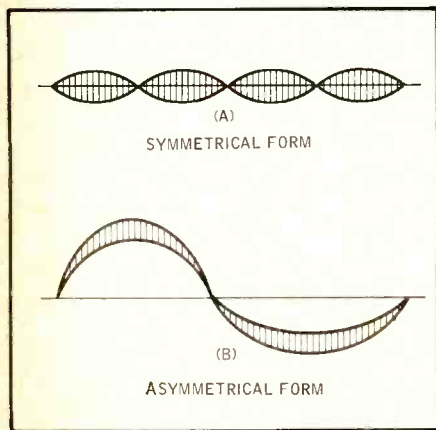

Fig. 5-9. Kinds of residual trace obtained with the CCIF test, using input/output null method.

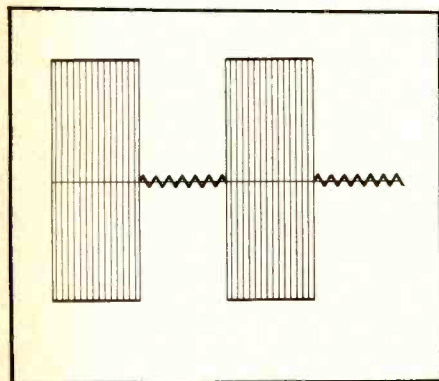

Fig. 5-10. The basic tone burst test waveform.

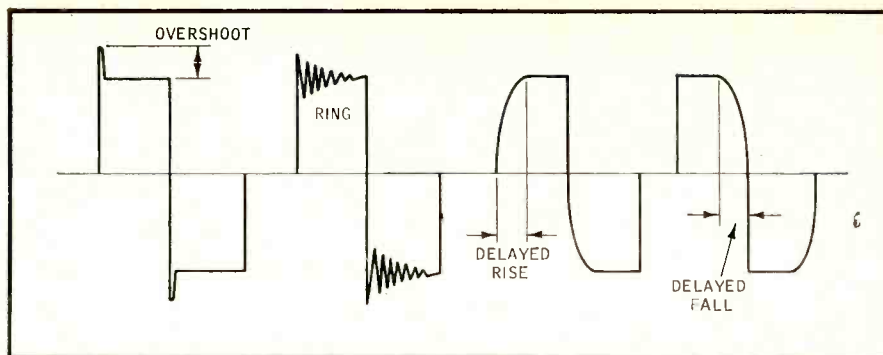

Fig. 5-11. Some distortions common in square-wave testing. These have correspondences with tone-burst envelope forms.

simple square-wave modulation of tone is apt to produce a non-repetitive waveform, even apart from any distortion effects: the amplitude may be switched at any point on the sine waveform, with consequent variation of input waveform at the transient point. Then it is difficult to know what, of the output waveform observed, is due to amplifier distortion and what is due to random change of the input-waveform timing.

To overcome this, the square-wave switching should be controlled by an accurate timer, set to count every so many cycles or waves of the modulated tone, and to switch its level at a very precise point on its waveform, usually when it passes through the zero point in a positive-going direction. This is getting to be quite sophisticated test equipment.

Even with this, which eliminates variation in test waveform effectively, there are problems in interpreting the results. A large variety of distortions can occur. How does one evaluate them?

With the simple square-wave testing, there was overshoot, ring, slow rise time, slow fall time, and so forth, each of which could be evaluated only by looking at the waveform (Fig. 5-11). The tone-burst test, even when properly sophisticated to prevent variations of input waveform, has a like number of possible deviations from “truth” to be interpreted by visual examination of the waveform.

This is the main reason this test has not become more popular. This kind of test is too qualitative. True figures can be given to different parts of the shape. Thus an envelope may have 30-per cent overshoot, 10-per cent rise time, 20-per cent fall time and some undershoot (Fig. 5-2). How do you rate this against another wave shape with a different set of figures for these variables?

Each of the properties previously measured could be reduced to relatively simple numerical results. Using this kind of test, transient distortion requires

quite a complicated set of figures to tell even part of the story. Some manufacturers and independent testing facilities have published “typical” tone-burst responses (photographs of the scope trace) which admittedly give a visual picture of what happens.

But even this can only be a partial picture, because it is only the response at the one particular test frequency (of the sine-wave tone), rate of burst (square-wave frequency), and amplitude levels used. Change any one of three quantities, and you’re likely to get a quiet different picture. So determining what is typical about a certain amplifier may end up as a matter of wishful thinking, depending on who may be doing the thinking!

Apart from the question of interpretation and the possibility of personal elements entering the choice of a “typical” display, there just are so many variables that no simple “figure of merit” type rating can readily be given or devised. While this is a course on measurements, primarily as they are made, we would like to offer suggestions at this point: the null method has proved helpful in getting more mean-
(Continued on page 59)

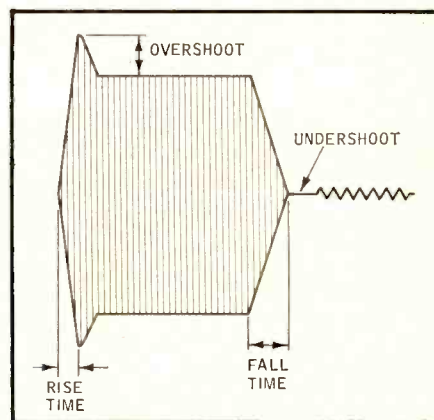

Fig. 5-12. One variation that a tone burst output waveform could take. Possible variations are virtually unlimited.

Solid-State Flutter Meter

ARTHUR E. GLADFELTER

In this installment the author finishes his discussion of the operating characteristics of the flutter meter. Also included, and certainly as relevant as the instrument itself, is a discourse on the standards of flutter measurement.

IN FOUR PARTS—PART 3

The flutter meter does have three peculiarities, all of which are minor and can be readily explained. The first is the turn-on settling time. After the power is switched on, the meter will indicate full scale (and possibly vary from zero to full scale) for about the first 30 seconds. This, of course, is the various capacitors charging. The lengthy settling time is easily understood when one considers the low-frequency response of the various stages.

The second item deals with the meter zero position. With the meter on and no input signal, the meter will indicate zero per-cent flutter; however, when a 3-kHz signal (which theoretically has zero per-cent flutter) is applied to the

input, the residual flutter is about 0.013 per cent. This was traced to the interaction between the power transformer and the discriminator coils. I consider the problem minor, unless accurate readings must be made down in the 0.02 to 0.04 per cent region. If so, the residual reading can be reduced considerably by placing a sheet of mumetal near the discriminator coils. Alternately, the residual reading can be reduced to zero by mounting the power transformer externally or by using an external d.c. power supply.

The third item that some readers will invariably detect is the result of a sudden change in temperature on CR_1 . Because of the positive temperature coefficient of CR_1 , a sudden change in temperature, such as might be caused by a blast of air, will cause a small change in the zener voltage of CR_1 . The sudden change is, however, amplified and can be readily observed on the meter. The temperature dependence of CR_1 is a minor problem, and is practically non-existent when enclosed in the meter case.

The dynamic performance of the flutter simulator and flutter meter can be shown most easily with the waveforms of Fig. 15. For the photographs, the sine-wave generator used in conjunction with the flutter simulator, was ad-

justed for 0.25 per cent rms flutter and a flutter rate of 90 Hz. (A) in Fig. 15 shows the multivibrator 3-kHz output waveform, measured at the junction of the 1800- and 200-ohm resistors. Note at (A), Fig. 15, a small amount of flutter (or jitter) can be detected on the last cycle of the waveform. (B in Fig. 15 shows the multivibrator waveform after passing through the 4.5-kHz low-pass filter. This is the waveform of the flutter simulator output, or the signal that is applied to the flutter meter input (J_1). (C) shows the waveform at the emitter of Q_3 . Note that in comparing (B) and (C), the band-pass amplifier has improved the waveform. The limiter output, measured at the emitter of Q_6 , is shown at (D) in Fig. 15. All these figures show a nominal frequency of 3 kHz. It is virtually impossible, however,



Fig. 15 (A). Multivibrator output measured at the junction of 1.8k- and 200-ohm resistors. Vertical sensitivity: 0.5 volts/cm; horizontal sweep: 100 μ sec/cm. Per cent flutter: 0.25% rms; flutter rate 90 Hz (Sweep: from left to right).

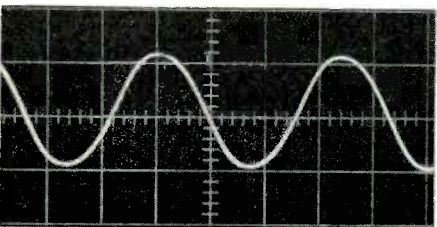

Fig. 15 (B). Calibrator output. 1.0 volt/cm; 100 μ sec/cm. Per cent flutter: 0.25% Flutter rate: 90 Hz.

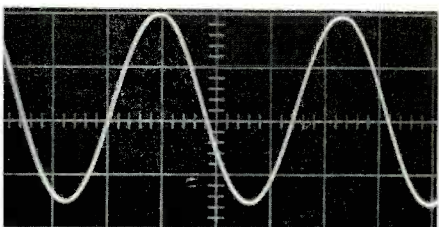

Fig. 15 (C). Emitter of Q_3 (in flutter meter). 5 volts/cm; 100 μ sec/cm. Per cent flutter: 0.25%. Flutter rate: 90 Hz.

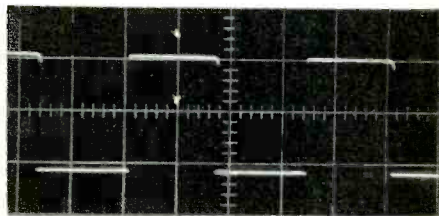

Fig. 15 (D). Limiter output at the emitter of Q_6 . 10 volts/cm; 100 μ sec/cm. Per cent flutter: 0.25%. Flutter rate: 90 Hz.

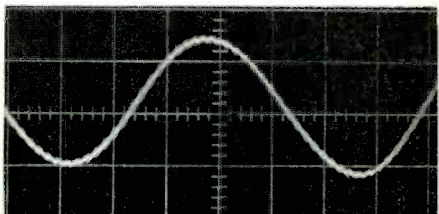

Fig. 15 (E). Oscilloscope output (J_2). 1.0 volts/cm; 2.0 milliseconds/cm. Per cent flutter: 0.25%. Flutter rate: 90 Hz.

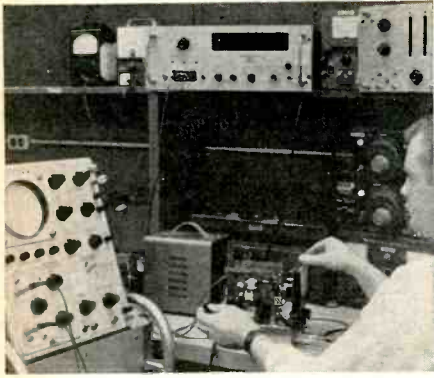

Fig. 16. R14 is being adjusted until a symmetrical waveform is observed. The voltmeter is connected to the collector of Q-5 and indicates about 16.99 volts d.c.

by looking at the waveforms, to measure the flutter with any degree of accuracy. (E) shows the waveform after passing through the discriminator and low-pass filter. This was measured at the scope output jack (J_2). The basic flutter frequency of 90 Hz has been recovered, along with the very low amplitude 3-kHz components, that are riding on top of the 90-Hz flutter rate.

Measurement of Flutter

This portion of the article describes briefly an accepted standard that does exist for the measurement of flutter. The standard, "Flutter in Sound Recording," is by the American Standards Association (ASA) Z57.1-1954.⁷ The "Standard" indicates that a constant wavelength "test tape" or a test tape having relatively negligible flutter content is to be used. The test tape is played on the machine under test and the readings are observed on a flutter meter. Percentage of flutter is to be that for one operation alone, that is, playback only.

Standard flutter test tapes are available from Ampex. These are recorded on a highly refined tape transport and the flutter content is guaranteed to be less than 0.03 per cent, with a typical value of 0.015 per cent. The actual flutter content is, however, marked on the container of each tape. Test tapes are available for tape speeds of 3 $\frac{3}{4}$, 7 $\frac{1}{2}$ and 15 inches/sec. Tape length is 600 feet and the price is \$21.95.

Even though the ASA Standard has existed for many years, it was impossible until recently to comply with it due to the lack of a suitable test tape. This has led to the common use of an Alternate (Non-Standard) method which does not require the use of a special tape. This method allows one to record and reproduce the tape on the same machine. Thus, the flutter obtained in this manner is for two operations, and must be converted to represent flutter for one operation. The Alternate Standard states: "It must be understood that when this procedure is used, flutter components due to a given

excitation in recording and reproduction add vectorially". It further states that "... while testing machines with its own recorded signal, ... if the measuring equipment indicates rms flutter, and if conditions are such that

Upon completion of the instrument— and on the occasion of any subsequent servicing, it is desirable to have at hand a table showing the element voltages for each of the transistors. Table II provides all of this information in easy reference form.

POSITION	VOLTAGE (v.d.c.)
Q1 E	10.5
Q1 B	11.0
Q1 C	18.2
Q2 E	8.6
Q2 B	9.3
Q2 C	17.4
Q3 E	16.9
Q3 B	17.4
Q3 C	27.1
Q4 E	4.4
Q4 B	5.1
Q4 C	4.8
Q5 E	4.4
Q5 B	2.1
Q5 C	27.1
Q6 E	26.5
Q6 B	27.1
Q6 C	27.1
Q7 E	13.2
Q7 B	13.2
Q7 C	29.9
Q8 E	13.2
Q8 B	13.2
Q8 C	0
Q9 E	12.5
Q9 B	13.2
Q9 C	22.0
Q10 E	19.5
Q10 B	22.0
Q10 C	29.9
Q11 E	1.5
Q11 B	2.1
Q11 C	14.5
Q12 E	14.0
Q12 B	14.5
Q12 C	29.9
Q13 E	14.4
Q13 B	15.0
Q13 C	31.0
Q14 E	13.7
Q14 B	14.4
Q14 C	31.0
Q15 E	0.8
Q15 B	1.4
Q15 C	24.0
Q16 E	1.3
Q16 B	1.9
Q16 C	15.0
Q17 E	10.4
Q17 B	10.0
Q17 C	25.5
Q18 E	33.4
Q18 B	32.9
Q18 C	41.5

E=EMITTER
B=BASE
C=COLLECTOR

Note: Readings taken with no signal input and with an input line voltage of 116 volts a.c. Voltages associated with the Schmitt trigger, Q-4, Q-5, and Q-6 may vary depending on the state of the transistors.

equal flutter is to be expected in recording and reproduction, the most probable flutter for either operation alone is 0.707 of the measured flutter."

A report published previously⁸ compares measured data from the Standard and Non-Standard method. The tests performed indicate that with the Standard method, the flutter-meter needle is much easier to read. Also, with the Non-Standard method, cancelation and addition of flutter components can lead to results which misrepresent the true flutter in the machine. The actual difference in methods is dependent upon the particular machine being tested, and is related to the frequency and relative phase of the flutter vectors.

In addition to the previously described flutter Standards, reference is oftentimes made to "Weighted" and "Unweighted" flutter. The flutter meter, as described in this article, will indicate "Unweighted" flutter when the Filter switch is in the 0.5- to 250-Hz position. To measure "Weighted" flutter it is necessary to insert an additional band-pass filter after the existing 250-Hz low-pass filter. The filter provides minimum attenuation at about 4 Hz, and has half-power frequencies of about 1.2 and 12 Hz. For more detailed information on the filter requirements, the reader should consult reference⁹. Because of a more restricted bandwidth, the "Weighted" flutter can never exceed the "Unweighted" flutter. For example, at 7 $\frac{1}{2}$ inches/sec. the NAB Standard¹⁰ allows the maximum "Unweighted" flutter to be 0.20 per cent rms and the "Weighted" flutter to be 0.07 per cent rms.

In the previous discussion of flutter measurement, it has been assumed that the tape recorder is totally free of tape-dropout. The reader should understand, however, that a flutter measurement on a tape machine with excessive dropout can give an erroneously high flutter reading, even though the actual flutter may be very low. This is because tape dropout produces a very large voltage at the discriminator output.

To be concluded

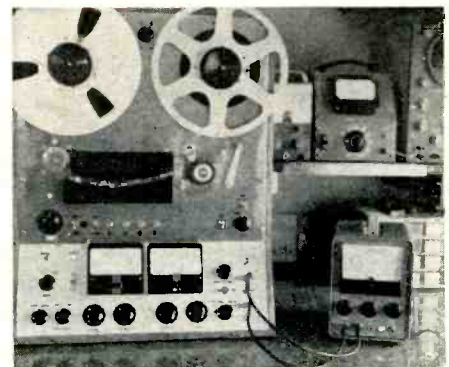

Fig. 17. The flutter and wow meter connected to a tape recorder for flutter measurements.

Introducing . . .

Audio Magazine Fifteen-Year Advertising Club

On March 30, AUDIO Magazine inaugurated its Fifteen-Year Advertising Club with the first annual award luncheon for the Charter Members of this distinguished group. The event was held at the Ambassador Hotel, site of the Los Angeles High Fidelity Music Show which was then in progress. In attendance were manufacturers who had advertised in AUDIO for 15 consecutive years or more and who had actively participated in the growth and development of the high fidelity industry. Awards—in the form of plaques mounted with the membership certificate—were presented to Acoustic Research, Allied Radio Corp., Altec Lansing, R. T. Bozak, British Industries Corp., Electro-Voice, Inc., Fairchild Recording Equipment Co., Fisher Radio Corp., Harvey Radio Company, Inc., Heath Company, Jensen Manufacturing Co., McIntosh Laboratory, Inc., Newcomb Audio Products Co., Pickering & Co., Inc., Radio Corporation of America, Shure Brothers, Inc., and UTC Sound—a total of 17.

Most of the companies were represented at the luncheon. Walter Stanton, (Pickering & Co., Inc.)

President of the Institute of High Fidelity, and R. T. Bozak were unable to attend because of a Board of Directors meeting, but Mrs. Lillian Bozak accepted the award for Rudy—thus giving us an excuse to choose her picture as representative of all the presentations.

Everyone seemed to enjoy the proceedings, and we noted later that the membership plaques were being displayed in the exhibitors' rooms. The biggest surprise of the affair came at the end of the luncheon when Editor-Publisher McProud was presented with a completely unexpected award from Shure Brothers, Inc. The presentation—a gold microphone and its new plastic carrying case—was made by Mr. H. T. Harwood, Director of Public Relations for Shure. Mr. McProud was singled out for his excellent service to the industry through both his personal efforts and those of his magazine. With characteristic Shure modesty and generosity, the presentation was made in the name of all the assembled companies. Eleven more memberships will be similarly awarded at the New York High Fidelity Show this coming Fall. Æ



The group assembled for luncheon at the presentation of the 15-Year Advertising Club Membership Plaques.



Mrs. Lillian Bozak accepts the plaque from Editor-Publisher McProud for her husband, R. T. Bozak.



Shure Brothers' H. T. Harwood presents a gold microphone to Editor-Publisher McProud.

RECORD REVUE

Edward Tatnall Canby *

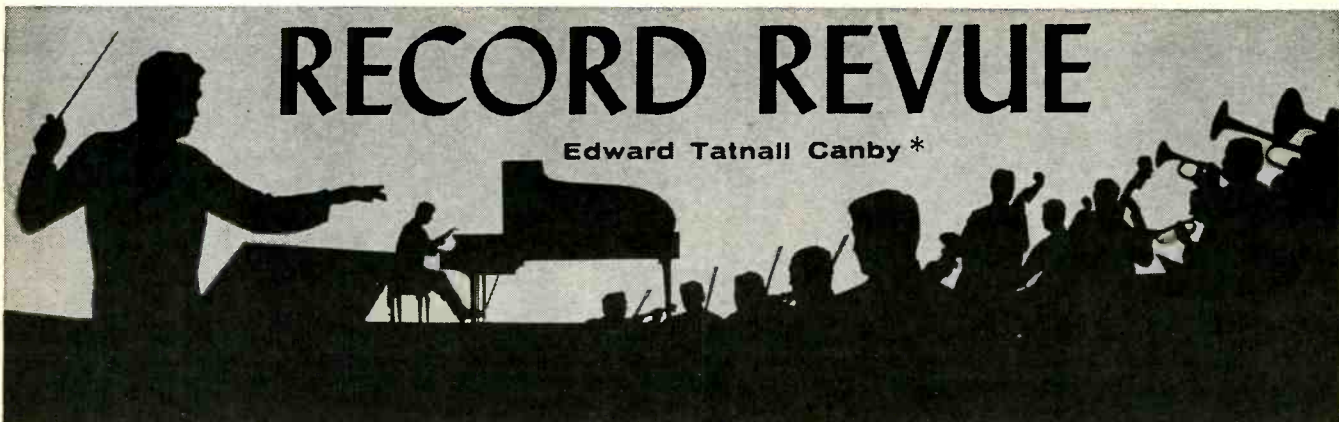

BIGGS' BIG SOUND

Bach on the Pedal Harpsichord. E. Power Biggs.

Columbia MS 6804 stereo

An unusually interesting record from "America's favorite organist" (as Columbia modestly puts it) and an intriguingly new sound for all who enjoy Bach, organ music or harpsichord music—not to mention big hi-fi bass is on hand. Mr. Biggs here plays the huge "standards" of the Bach organ literature—the *Pasacaglia* and *Fugue in C Minor*, the well-known *Toccatina* and *Fugue in D Minor*, the "Great" *G Minor Fantasia* and *Fugue*, and more—and they roll out with impressive grandeur from this monster instrument, showing all sorts of new aspects of themselves. A fine sound, and Mr. Biggs has obviously worked out each piece very carefully in terms of the harpsichord; this is one of his better performances.

The instrument he uses is modern, by John Challis. It is a very large regular harpsichord mounted on top of a second one, lying on the floor, hooked up to a standard organ foot pedal board. The player, of course, operates both at once, via hands and feet. It is an eight-way machine, two manuals and five stops, plus lute (harp), on the upper part, three more stops down below, and both halves including the big 16-foot strings, sounding an octave below written pitch, found only on the biggest regular harpsichords. There is even a "Venetian swell"; these are adjustable sound louvers like those of the swell box on a pipe organ, to regulate the volume of the pedal harpsichord.

The record is wonderful sound-evidence of the well known close relationship between the Baroque harpsichord and organ literature. This music sounds like no harpsichord music you've ever heard, nor yet like an organ, but has qualities of both. The Biggs record isn't the first (Bruce Prince-Joseph on an early Cook 10-inch LP) but it is the only one of its sort now available. Let's hope for more!

"Classical", it is good to begin to hear some of those long-lost earlier Prokofiev works which have long been taboo because they seemed "too modern". Here are two of them, rediscovered, and they make good and novel listening.

They were "modern" all right! These have the characteristic raw, brash, dissonant sound of the 1920s, the Symphony made out of an unperformed opera (begun in 1919) and the ballet music concerning the workings of a steel mill—a popular subject in the mid-twenties. And yet, anyone who knows the familiar later Prokofiev will recognize him here too, modern or no. To hear Prokofiev in this buoyantly youthful early phase is musically plenty interesting.

The Utah musicians under Abravanel do a splendid job—they couldn't do very much better.

Stravinsky: *Renard* (1917); *Mavra* (1921); *Scherzo à la Russe* (1944). Soloists, L'Orch. de la Suisse Romande, Ansermet.

London OS 25929 stereo

Two delightful early Stravinsky musical skits with voices are here; plus a similar instrumental piece, the brief *Scherzo* composed for Paul Whiteman in 1944. These are authoritative performances, under the redoubtable Ansermet, but the music suffers from two unhappinesses taking its value down a few pegs.

First, the vocal works, the wonderfully irascible *Renard*, about the Cock, and the Fox who tries to eat him, and the humorous Russian-style farce *Mavra*, about a hussar-lover disguised as a maid who is caught shaving, are done here in English, and for that purpose a not-so-good cast was assembled. Too much sloppy, wobbly, out-of-tune singing in *Mavra*, American-style, and in *Renard* the English is forced and mostly unintelligible; the original would have been easier on the ears (French).

Second, London's big, Romantic stereo liveness is not at all suited to this dry, snazzy, humorous music, out of the early post-War I era. For once, we really need a wholly dry acoustic. Instead, we get a big Romantic blur.

I still enjoyed the music—I always do, given half a chance. It's such a pleasure today to hear that curiously tinny, slapstick 1920 sound, now so totally, irrevocably old fashioned! Stravinsky did it up to perfection.

Stravinsky: *Petrouchka*. Hindemith: *Duet Sonata*. Brahms: *Neue Liebeslieder*, Op. 65. Yaltah Menuhin, Joel Rye, dual pianists.

Everest 3130 stereo

This isn't for two pianos—here we have two people at one piano. There's

lots of music for this kind of cosy performance.

The 1944 Stravinsky arrangement of his *Petrouchka* (1911) is superbly played, bringing out all the color of the stage scene as though a whole orchestra were on hand. Very nice. And Hindemith's gracious, graceful *Sonata* finds these players entirely at home and is accordingly easy on the ears and a pleasure to hear. The second set of Brahms *Liebeslieder* is played, as a novelty, without the four voice parts that go with the piano music. Good idea. There's so much stuff in these waltzes that the voices usually obscure the piano's lovely detailwork, and vice versa. This gives us a chance to hear what goes on at the keyboard. Beautifully done, too, with just the right half-humorous, very Romantic spirit.

Yaltah Menuhin is, if I'm right, of the Yehudi Menuhin family. Howcome the different spelling? Might it be an Everest boo-boo? Anyhow, it's Menuhin here, in large letters on the cover. (But, ha ha! it's Menuhin on the disc itself! Caught you, Everest!) (Also, while I'm picking bones, it's *Walzer*, not *Waltzer*. You have both spellings . . .)

Britten: *Variations on a Theme of Frank Bridge*. Tippett: *Fantasia Concertante on a Theme of Corelli*.

Corelli: *Concerto Grosso in F, Op. 6, No. 2*. Bath Festival Orch, Menuhin.

Angel 36303 stereo

The English hopefully export a steady stream of contemporary British music to us over here, thinking maybe we'll like it. Most of it, they should know, just doesn't go down in the States. Only Benjamin Britten has picked up a steady American clientele. So it works out with this record.

The Tippett *Fantasia*, based—of course—on a slice of the Corelli concerto also on the record, is a dismally turgid and lengthy work of late-Delius post-Romanticizing, based on music that is much more satisfactory in its own clear Corelli original. It doesn't even "sound" as string music—a fatal weakness, I'd say. Just not at all to the American taste, this stuff. Ugh.

Good old Britten, the sure-fire, is another story. His sprightly, lively, dramatic variations on a Romantic-style theme by his teacher, are dazzlingly communicative, wonderfully orchestrated, a cross between his own well-known Purcell *Variations* (Young Person's Guide to the Orchestra) and the "Enigma" *Variations* of Elgar, a piece that Americans do like for its warmth and conciseness.

Too bad—the Britten and the Corelli

NEWISH

Prokofiev: *Symphony No. 3; Suite from Le Pas d'Acier*. Utah Symphony, Abravanel.

Vanguard VSD 71122 stereo

After so many years of "Peter and the Wolf", the *Fifth Symphony* and the

go nicely together. Angel should have found something more congenial than the Tippett to round out the disc.

Mahler: Symphony No. 4. Judith Roskin; Cleveland Orch., Szell.

Columbia MS 6833 stereo

Columbia has a musically better "Fourth"—for my ear, at least—in the old Bruno Walter version; for who could beat Walter in total dedication to the genius of Mahler and the utterly high-intensity realization of his genius in terms of orchestral expression? I expect I'd even like Leonard Bernstein's, also on Columbia (what duplication!) better than this one, from the musical viewpoint.

But then one can't be sure on short acquaintance. This Mahler interpretation is *different* and maybe it takes an aural adjustment to bring it into musical focus. Could be. Nevertheless, I kept finding places where my inner voice would shout (figuratively) to George Szell,—more, *more*, that's not enough! . . . ah, *too late*; you missed it cold!

It is, indeed, a careful but cool sort of Mahler, orchestrally perfect, yet lacking in, shall I say, the controlled ecstasy that must somehow be in every good Mahler performance.

The Columbia recording is extraordinary in its detailed, accurate portrayal of the Mahler orchestra. That in itself is almost enough to make the listening first rate. Judith Raskin is earnest, musical but a bit wobbly in tone, in the last movement.

OLDISH

Bach: The Well-Tempered Clavier. Rosalyn Tureck, piano.

Decca DL 71020,21,22 (3) stereo

If you're going to play Bach on the piano, you might as well play it like piano music—but you must never forget for a moment that it isn't. (It belongs primarily on the harpsichord, or on the clavichord, or even the Baroque organ.) And no matter how you play your Bach, it must be *musical*.

That's Rosalyn Tureck. She has made piano Bach a major life study and has worked out her own way of piano-izing the music, as right for our time as Harold Samuel's piano Bach was right a generation ago.

There is no one way to play Bach, on the piano or on anything else; Tureck has her special mannerisms and limitations of style. But home and professional pianists, even though they do it very differently, will find much to learn from La Tureck's well-balanced and sober renditions. All 48 preludes and figures are here, played consecutively on three records, each available separately.

Early Baroque Music of Italy (Monteverdi, Frescobaldi, Turini, dalla Casa). New York Pro Musica, Greenberg.

Decca DL 79425 stereo

Like many an American industrial product, the New York Pro Musica's semi-mass-produced old music has steadily improved in quality from a very bug-ridden and unmusical early output. This latest and posthumous offering (Noah Greenberg died suddenly early this year) is among the best out of dozens of Pro Musica records released since the early 50s. (Many of the older and inferior discs are being reissued on low-priced records.)

The improvement is dual. First, the

personnel keeps changing, and for the better. The present group is really musical, and especially the new vocalists. Second, Greenberg himself, long a steely, powerhouse sort of director, was beginning to glow with something more than a briskly mechanical energy. He was actually becoming a trace poetic—or did his improved performers just carry him along with them? Who knows!

Anyhow, these are *musical* performances throughout, well sung and well played as well as "authentic", with the right old instruments in the right places and a liveliness of tempo that contrasts with the lugubrious weightiness of most European performances of this type of music. All to the good. And here's hoping for more.

The tasteful and elaborate album, with good notes and complete texts, makes the record well worth the "first-line" price. You can't get that sort of treatment on the low-cost labels.

German Liturgical Music. Soloists, RIAS Chamber Choir, Consortium Musicum.

Mace M 9022 mono

Here's another new low-priced label (a division of Scepter Records) and another excellent import series, this one from German Electrola. This record is a typically German browse among major and minor short masterpieces, mostly 16th and 17th century—Scheidt, Walter, Isaac, Schein and others including J. S. Bach, the music alternating between instrumental and vocal numbers with pleasing variety and freshness. The choir is lively and musical, the instrumental ensembles vary, with recorders, brass, strings, and organ. And there is further variety via a tenor solo. All of the items are well sung and played, with understanding and musical respect.

It makes a marvelous semi-background record, this one, of the sort you'll play straight through again and again; for some of the short pieces are poignantly memorable and grow lovelier with each repeat.

WORDS AND NOISES

John Cage: Variations IV.

Everest 3132 stereo

Outrageous! John Cage always is. The only trouble with this disc is that it is a pale shadow of the "live" original, which apparently lasted for hours. (I wouldn't put that past Mr. Cage—decidedly not.) The guy definitely has something and is important. But if you're going to be outraged by him you might as well do it "live" and get a real swinging mad on.

However—this sample may be able to turn you purple with rage, even so. Might be worth trying.

A Cage "Variation" is an eveningful of centrifuged sound, produced before an audience. It is set up as one of those carefully planned affairs called a happening, where all sorts of things occur by sheer accident-on-purpose. This one took two roomful of hi-fi equipment, two separate channels (for ping-pong) stereo, with radio tuners, tape, phono and assorted mikes including one out on the street and another at a local bar. Sounds both live and pre-recorded were fed out to the audience by the armful, the bucketful, the tapeful—such a racket you've never heard. Everything from women screaming to Tchickowsky's "Nutcracker", fragments of the Swingle Singers doing Bach's "Art

of the Fugue", the roar of traffic, babies squawking, unintelligible conversations, maniacal laughs, motors pounding, bits of assorted live broadcasts, various horrendous crashes and bangs, and so on. Never less than a dozen or so sounds at once in each channel, and undoubtedly the "live" loudspeakers blasted the audience at an unrelentingly ear-splitting volume. That's Cage.

The pay-off (for us audio souls) is that the whole sound is distorted, throughout. Not only is it "loudspeakerish" (the record was made, I gather, simply by sticking mikes out in front of the bel-lowing speakers) but the sound itself is almost always overloaded, the circuits in hideous electronic agony. Cage *likes* electronic distortion, or any other kind. (It is, in fact, a fine pain producer, for stirring up hot passions!) And so I am sure all this was quite deliberate. Added spice to the outrage. I'm telling you, Cage is a man to be reckoned with.

The four excerpted "movements" here are Arrivals (7 pm to 8 pm), Small Talk (8 pm to 9 pm), After 3 Martinis (9 pm to 10 pm) and Departures (10 pm to 11 pm). Some party!! But I don't really think it is well designed for records. The shock value isn't nearly enough, and boredom is quick in coming.

A live Cage performance is something you will *never* forget I've been to several. I wouldn't have missed the experience for anything—even if I did walk out, once, simply to save my precious ears for more prosaic necessities. If you *must* listen here, then turn up the volume to TOP—and *don't stop the record*, no matter what! An approximation of the original.

The Stevenson Wit. Narrated by David Brinkley.

RCA Victor VDM 107 mono

Stevenson himself does the talking here, in dozens of excerpts from his speeches over the years, the whole sewed together by the pleasantly off-hand, underplayed comment of the well-known David Brinkley.

It isn't easy to make the jokes out of after-dinner speeches sound really funny in this sort of situation — Stevenson would probably turn pale to hear himself multiplied so monstrously in joke after joke over the years! Yet, with the commentary to help, it isn't too bad, and you do get a good impression of the man Stevenson as he spent so very much of his time—making after-dinner or political speeches.

Main technical problem here is an odd one—the violent differences not only in acoustics, between the widely different "takes," but in recorded quality and, even more, in Stevenson's own voice, which varies from low-pitched to high, tired to fresh, youthful to aging, all without apparent sequence. Can't be helped; that's the way spoken excerpts are bound to be in this tape-editing age.

Twilight of Steam, Vol. 2

Mobile Fidelity MF 15 stereo

Aha! More steam! I always fall for these, no matter how many (and even if I don't know a 2-8-2 from a 25-64-78).

"Volume 2" refers to an earlier volume that was rather laboriously tied in with the book of the same title. (The tie-in was snafued by lack of visible page numbers in the book, by which you could locate the sight of what you were hearing the sound of.) Book itself was quite OK. So was the record. This time there's

no tie-in at all and just as well. Just a bit of salesworthy public relations.

And, of course, two sides more full of steam. Plenty more choo-choos, lotsa whistles (*always* too many; these whistle artists can't resist the lure of a tape recorder beside the track!) and a great deal of assorted clanking and banging. Mostly excursion trains and obscurely dilapidated work trains; there isn't much of anything else left now.

Very so-so liner notes on this. Full of romantic allusions but minus such important details as to whether we are on board an engine or by trackside. If the train starts off manfully and never seems to get anywhere, just puffing and blowing in one spot, you can figure you and the mike are aboard. Frankly, the off-board ones are better listening, especially with a big natural echo—as in some excellent cuts on this record.

FACETS OF FOLK MUSIC

English Folk Songs. Arranged by Ralph Vaughan Williams. The Purcell Singers, Imogen Holst.

Everest 3137 stereo

Here's the purest turn-of-the-century folk music, as collected (mostly around 1904) and arranged for elegant "classical" performance by one of the folk pioneers in England, Ralph Vaughan Williams.

These settings, and others by Gustav Holst and the folk-dance pioneer. Cecil Sharp, have fascinated musical ears for a solid half-century—but don't expect any gee-tars, nasal twangs or current-day "folk" atmosphere here. This is First Generation folk music, from the earliest of the folk collectors, who operated long before the day of the gramophone and tape recorder. They went out and took down songs by ear, wrote them out on paper, then went home and made them into classical-style music—harmonized and counterpointed as the original tunes never had been, of course. It is a lovely body of classical music, and the tunes themselves are superb.

The Purcell Singers include descendants and associates of the pioneers and are thus right in the tradition. No concessions whatsoever to "modern" folk-song style! Nor should there be. The singing (and playing) is strictly classical and very elegant as well as musical. The arrangements vary all over the lot, from unaccompanied chorus to solos with flowing piano accompaniments, as well as an instrumental suite of six tunes set for viola and piano. Also two Vaughan Williams "originals"—sung directly as noted down in his collection books, by single voices without accompaniment. These are very close to "authentic" since the English folk singers sang mainly without instruments. The rest of the music is strictly "art music"—but the very best. And the tunes are superb.

Songs for Singing Children John Langstaff, with chorus of children.

Odeon CSD 1470 stereo (import)
(via Capitol)

John Langstaff, out of Brooklyn, N.Y. (upper crust div.), has a rich, well-modulated baritone voice and has long identified himself, and here and in England, with British folk song of the Sharp, Holst, Vaughan Williams school of collecting and performance. He is utterly removed from our urban American "authentic" folk, and sings his stuff in

cultured art-song style—but he is good; and he has worked with kids for years.

So here in England he sings assorted English and American songs (plus some Dutch, in translation), all in a very pretty English, from The Frog in the Well to The Old Grey Goose and My Boy Billy, out of familiar Anglo-American tradition. And the kids sing along with him in enthusiastic British accents.

If you like a British touch, this is for you and *your* singing kids.

Madeleine Grey, Chants d'Auvergne (arr. Canteloube). Ravel: *Trois chants Hébraïques; Chansons Madécasses*. With Maurice Ravel, piano and conductor.

Angel COLH 152 mono

Old-timers will recognize these once-famous recordings, especially the *Chants d'Auvergne*, with a shock of pleasure. For many years these were highly prized collectors' items in their original releases on 78s (recorded in 1932)—so much so that critical clamor finally led to a 78 re-release many years later, a rare thing in those days. Now we have the contents of six 78 originals on one LP. The Ravel discs, less well known in the past, are particularly valuable today because the composer himself plays piano accompaniment and conducts a small instrumental ensemble.

Madeleine Grey, French, was one of those superbly musical and dramatic singers who become composers' favorites thanks to sheer musical talent. (Maggie Teyte, English born, was another of the sort in the same period.) It is easy to hear why on these recordings. Not a huge voice, but luminously musical, utterly dramatic, *communicative* to any ear! No wonder the records were beyond price.

The Canteloube songs are wild French-dialect (langue d'oc) peasant music set with the most elaborately beautiful large-orchestra accompaniment ever conceived for folk music—lushly impressionistic, wonderfully lyric. They were the models for a million inferior imitations of later years—and they'll strike to the heart if you have half a musical ear. So will Madeleine G. herself.

The Ravel works are of less "universal" appeal but, today, easy to enjoy even so. The Hebrew songs, with piano, are spicy affairs sung in Hebrew and Yiddish, full of orientalisms. The *Chansons Madécasses* are Ravel settings of poetry, by Evariste Parry (1753-1814), a native of Reunion Island. There isn't much flavor of Madagascar—it's sheer Ravel; but the poems are stunning examples of a very early native expression, (including the one about "*Méfiez-vous des blancs*"—don't trust the whites!); and Ravel's settings are powerfully "native" in a sort of Gauguin style, European-primitive.

All in all, truly one of the great recordings of the past.

The Pennywhistlers. (Folk Songs of Eastern Europe.)

Nonesuch H 72007 stereo

A delightfully mixed-up record, this one. It is sung by an enthusiastic all-girl ensemble that sounds as if it were straight from the Russian steppes or the Volga River or something, all fresh and charmingly Slavic—until you realize you are hearing some very American English: Portland Town, Will You Kiss Me When I'm Gone. It still sounds de-

lightfully Slavic. So does their Yiddish and their Serbo-Croatian.

The girls are straight out of New York, that's why. Second generation, most likely. Well, New York or no, they sing Bulgarian, Hungarian, Russian, Czech as well as Yugo and Yiddish, in a very musical fashion, charmingly "old world". A most happy record, if not overwhelmingly profound or anything like that.

'Bout Changes and Things. Eric Andersen
Vanguard VSD 79206 stereo

Eric Andersen is sort of a Bob Dylan only with straight touseled hair instead of tangled and curly. He writes big messages into his texts, but sings them to rather naive and (for my ancient ear) amateurishly simple harmonies. They make me wince; but the spirit is nice and the words and tunes that go with them have an earnest and sincere quality that counts for plenty.

It's amazing where "popular" music is going these days. (If this music isn't popular, it certainly isn't classical!) Take a text like this, one of Eric Andersen's: "*In blindful wonderment's enchantments, you can lift my wings softly to flight; your eyes are like swift fingers, reaching out into the pockets of my night. O whirling, twirling puppy warm before the flashing cloaks of darkness gone, come see the no colors fade blazing into petal sprays of violets of dawn.*" That kind of stuff goes over big, now. It used to be called poetry.

This is Eric Andersen's second Vanguard record. AE

WATCH OUT FOR THE OTHER GUY

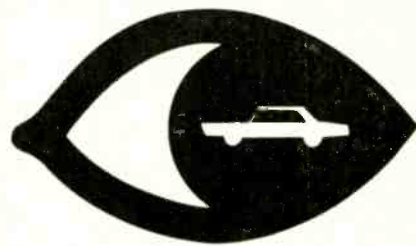

Drive Defensively!

Just being in the right isn't enough. Nearly half the drivers in fatal collisions are in the right. Drive defensively—as if your life depended on it. (It does.)

Published to save lives in cooperation with
The Advertising Council and the National Safety Council.

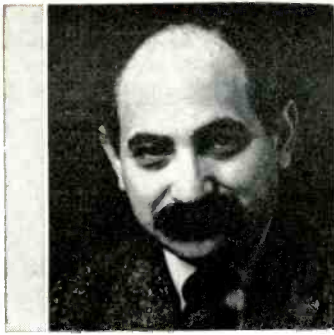

JAZZ and all that

Bertram Stanleigh

Oscar Peterson Trio: Eloquence

Limelight Stereo LS 86023

When it comes to ways to mess up an otherwise good recording, Limelight seems to have developed advance techniques that are in a class by themselves. On the present offering—recorded live at Copenhagen's Tivoli Gardens—they have taken great pains to open each side with loud and prolonged applause. Side A, band 1 has fifteen seconds of applause, a short and amusing Peterson original, *Children's Tune*, lasting 27 seconds, and 20 more seconds of applause. Side B, band 1 opens with 18 seconds of applause. Band 2 opens with 13 seconds of clapping, and the final band closes with 17 more seconds of applause. Only one of the platter's 8 numbers begins without a helping of audience noise. As a result, an otherwise agreeable recording, in one of Limelight's lavish and tasteful albums, becomes as welcome as an intermittent toothache.

Art Blakey: Soul Finger

Limelight Stereo LS 86078

The ever changing personnel of the Jazz Messengers is, of course, one of the bits of spice in each Blakey feast. The present group is a fine one and makes many worthy contributions, but, as always, the real meat is in the fantastic percussion and dominating personality of Blakey himself. John Hicks, piano, Freddie Hubbard, trumpet, Lee Morgan, trumpet, Gary Bartz, alto, Lucky Thompson, tenor and soprano sax, and Victor Sproles, bass, make up a well balanced and attractively youthful group of collaborators. *Freedom Monday*, a Blakey original that opens side 2, offers one of the master's finest solos on wax. It is neatly framed by a stylish instrumental opening and closing.

Shirley Horn: Travelin' Light

ABC-Paramount Mono ABC 538

Miss Horn displays an attractive voice, a direct, intimate style, and first class musicianship as she performs a dozen numbers with the assistance of the other members of her trio: Marshall Hawkins, bass, and Bernard Sweetney, drums. Most of the selections have the benefit of an augmented instrumental group that includes some outstanding contributions by Joe Newman, trumpet, Frank Wess and Jerome Richardson, sax and flute, and Kenny Burrell, guitar. While Miss Horn is credited on the jacket as a pianist, it is her vocal contributions that occupy the most prominent portion of the set and give this record its real distinction. Shirley Horn has a remarkable ability to deliver the lyrics of a song in a meaningful manner with each word crisply enunciated. That she manages to do this without detracting from the purely musical line of each number is an impressive

achievement. The wide variety of this disc's offerings includes *Travelin' Light*, *Sunday in New York*, *I Could Have Told You*, *Big City*, *I Want to Be With You*, *Some of My Best Friends are the Blues*, *Have You Tried to Forget?*, *Don't Be on the Outside*, *You're Blase*, *Yes, I Know When I've Had It*, *Confession*, and *And I Love Him*.

The New Wave in Jazz

Impulse Mono A-90

In March of last year, Impulse hauled its microphones down to the Village Gate in Greenwich Village to record a benefit concert given by the Black Arts Repertory Theatre School. The recording is not only an interesting survey of most of the important new trends in jazz, it's also a collection of spine tinglingly great performances in each of these styles. John Coltrane, Archie Shepp, The Ayler Brothers, Grachan Moncur, and Charles Tolliver each lead their groups in one long number. No other collection of such diverse styles—that I know of—has such a unified quality. There seems to be an easy, natural transition from one track to the next. The sound is superb, and Impulse has manifested exemplary good taste in its elimination of all but the slightest minimum of audience sound at the end of each number. Nothing gets in the way of the music. The only tiresome detail is the liner copy by LeRoi Jones who continues to belabor that single note of his. Surely Mr. Jones is too old fashioned by now to be allowed to muddy up something fresh and bright with his angry old four-letter clichés.

Les McCann & The Gerald Wilson Orchestra

Pacific Jazz Mono 91

These are very solid, rock steady performances in which a controlled, but also slightly subdued, solo piano by McCann is paired with the brilliant Wilson band. The results are fine; McCann has all of his full tone, rhythmic ease, and ability to speak out with simplicity. The band functions like the precision group it is, providing color and excitement but never allowing its weight to obscure the solo instrument. In his solo passages, McCann has the backing of Victor Gaskin, bass, and Paul Humphrey, drums, and it is during these solo moments that the disc rises to its highest level. For some reason, Les is not as relaxed when he's working with the full orchestra as when he's supported by the members of his own trio. But the results are still highly satisfying, and the sound is bright and alive.

Lambert, Hendricks, & Ross: Sing a Song of Basie

Impulse Mono A-83

This is a re-release of the great 1958 platter on ABC-Paramount. The main purpose of the new cutting would ap-

pear to offer a version in what Impulse calls "Technically Augmented Stereo." This is a recording that would unquestionably have benefitted from stereo techniques, and it would be interesting to hear what kind of a job engineer Rudy van Gelder did in repositioning the three voices on the stereo version. But, alas, Impulse sent me a mono copy! I can merely report, therefore, that the mono sound is an improvement on the original pressings, and that the recording remains as one of the most brilliant technical triumphs in recording and one of the most exciting jazz performances ever waxed. The excellent notes by Stanley Dance tell the story of the original recording, and texts of nine of the ten numbers are included. Sad to say, the words left off are for *One O'Clock Jump*.

Saga Sjöberg & Kai Söderman:

Best Loved Songs of Sweden

Monitor Mono MF 440

Monitor is particularly adept at seizing opportunities to snag the finest in foreign folk music talent when it touches these shores, and it employed its skill to splendid effect when Miss Saga Sjöberg arrived in New York recently for across-country tour. By recording her with the popular Swedish singer, Kai Söderman, who has been in the United States since 1948, they have produced a neatly balanced, delightfully varied, and thoroughly entertaining collection of melodies. Both singers accompany themselves on guitars and additional accompaniment is provided by Erik Olaf Eriksson, accordion and violin, Karl Wennerburg, violin, Oscar Fival, cello and Karl Otto Westin, clarinet. These instrumentalists are also heard in four amusingly rustic folk dances. The quality of the recording is impeccable with the voices agreeably forward so that each syllable may be heard clearly. As is so often the case with Monitor's folk song recordings, a description of each song is provided in English on the back of the album, and a complete text of the songs in Swedish is contained on a four-page leaflet that comes with the disc. In addition to its other virtues, the record contains twenty-five selections. All but the final one are Swedish in origin, and I'd have been happier if that last number was left out. It's a medley, sung in Swedish by Söderman, of *Campground Races*, *Polly Wally Doodle*, *Billy Boy*, and *Carry Me Back to Old Virginny*.

Harry Secombe

Phillips PHS 600-175

The long arm of coincidence is still an active part of the show business scene. It stretches across the Atlantic in this case as Philips brings us an English comedian's singing voice that is almost a dead ringer for that of our own Jan Peerce. Harry Secombe may lack the typical training expected of a concert star these days but the voice itself has an uncanny resemblance to the timbre Peerce's voice had at the start of his long career. In this collection of solid songs from stage and screen, Secombe offers no clue to the fact that he started out as a comedian on British radio. His association with Peter Sellers on the famous "Goon Show" led easily to appearances in films, television and a record-breaking engagement at London's Palladium. Prominent in Secombe's first release in this country is the tune "If I Ruled the World" which he introduced on the London stage this past year in the show "Pickwick." It would seem that "Oliver" is not the only Dickens work to find itself in musical guise these days. With the polish that usually comes in a few more recording sessions (studio playback can be quite instructive to an alert artist), Harry Secombe should be able to write his own ticket in a field other than comedy.

EQUIPMENT

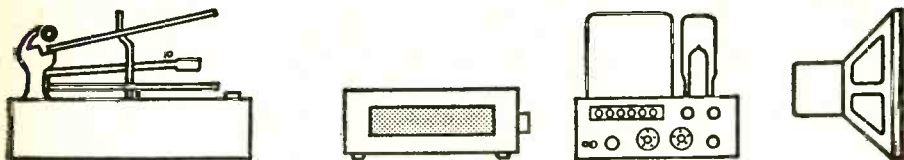

PROFILE

HEATHKIT COLOR TV SET MODEL GR-25

Audio has long been notorious for ignoring television, with the exception of two profiles in all its years—one on the Conrac "Fleetwood," and another on a Bell TV-sound tuner. Living for years with the Fleetwood tends to spoil one's acceptance of run-of-the-mill TV sets because of its superb picture quality, but it is still only a black-and-white set. Today, when color is becoming so much a part of our television lives, we finally bowed to the inevitable and obtained the Heathkit—and what a revelation it is.

In kit form, of course, the GR-25 takes some 25 hours to build. None of the assembly is difficult nor does it require any special electronic knowledge, so anyone

capable of following directions should be able to put it together and make it work. It can only be said that the construction is complex, though not complicated. There is a lot of assembly work, of course, since there are 27 tubes, including the 25-in. rectangular "Hi-lite" RCA tube which employs the new "rare-earth" red phosphor.

It is generally understood that the picture has a mask just behind the screen, and that the screen itself is composed of thousands of dots of the three colors of phosphor. Early picture tubes were comparatively coarse, so the picture seemed to lack definition—much as a newspaper halftone compares with those in a magazine. The holes in the mask in this tube are centered .029 in. apart, which means that there are over 200,000 over the 295-sq. in. screen. Since there are three phos-

phor dots for each hole, this means that there must be some 810,000 dots on the screen. The net result is that the picture is fine enough for anyone's taste. One characteristic of color TV still fascinates this observer—at a distance of, say, five feet, a white object appears to be a perfectly pure white. Viewed close up with a magnifying glass, the "white" is seen to consist of triads of red, green, and blue dots, which combine at a normal viewing distance into pure white. (The opposite obtains with ink pigments as seen in a four-color printed page. The three pigments would combine to form black.)

Circuitry

The over-all circuitry is too complex for a detailed stage-by-stage description. But the set consists of the usual TV elements—a tuner section, i.f. and video section, the color section, the sound-sync section, the high-voltage power supply, and the picture tube and yoke. In addition, a color set requires convergence controls and pin-cushioning controls. The tuner section consists of two separate tuners—VHF and UHF—with the former serving as two additional i.f. amplifier stages in the UHF position, while the UHF tuner has only a mixer diode and a transistor as the oscillator. In addition, all operating controls are mounted on the tuner panel, which is at the upper right of the complete set as shown in Fig. 1. The two tuners are factory built and aligned, as is the i.f. and video detector section. The kit builder assembles the sound-sync section and the color section on printed-circuit boards, as well as most of the chassis-mounted parts. The high-voltage section is also factory assembled. The picture tube with its integral bonded safety-glass faceplate assembles to the plastic masking frame, and the yoke is simply clamped to the neck of the tube, along with its d.c. converging magnets and the dynamic converging coils and the purity rings.

"Convergence" may be a new word to those not steeped in color-TV terminology, but it is extremely important to a good color picture.

Considering that a color tube has three "guns," one for each color—all being deflected by the same yoke coils—must track each other very accurately, even though they have paths of differing lengths from the gun to the screen, it appears to be a remarkable task. Furthermore, each beam must impinge only on the phosphor dot for which it is intended, which is the reason for the "purity rings," adjustable magnets which aim the beams properly. Thus in order for the beams to track linearly over the entire screen, certain modifications are made to both the vertical and horizontal sawtooth waves, and a small amount of vertical sawtooth is mixed with the horizontal sawtooth and fed through the dynamic convergence coils to ensure the tracking. Similar juggling of the waveforms in the "pin-cushioning" coils keeps the picture in a perfect rectangular form to the corners of the screen. In fact, the final adjustment of convergence is likely to take two or three hours, at least, but when correctly done the

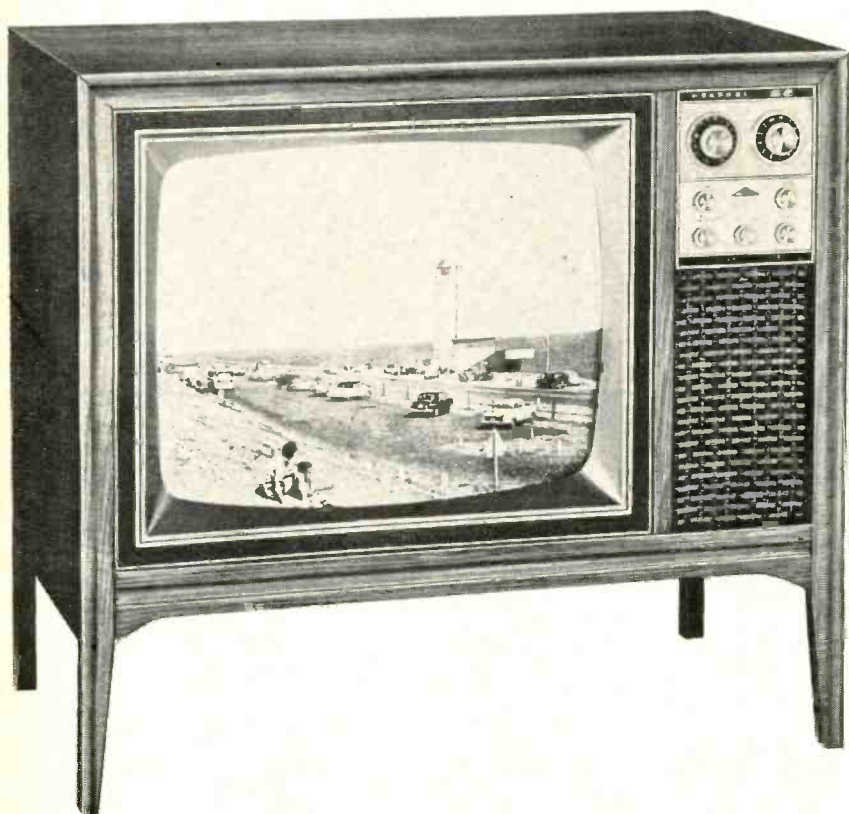

Fig. 1. Heathkit color TV set with a 25-in. rectangular "Hi-Lite" picture tube. The cabinet measures 32 in. wide, 31 in. high, and 19 in. deep.

Perfection results from CHOICE...NOT CHANCE

Since no single phono cartridge can be all things to all people, we earnestly recommend that you employ these individual criteria in selecting your personal cartridge from the broad Shure Stereo Dynetic group:

YOUR EAR: First and foremost, listen. There are subtle differences in tonality that beggar description and are quite unrelated to "bare" specifications—yet add immeasurably to your personal listening pleasure.

YOUR EQUIPMENT: Consider first your tone arm's range of

tracking forces. Too, keep in mind that the cartridge ordinarily represents the smallest monetary investment in the system, yet the ultimate sound delivered depends *first* on the signal reproduced by the cartridge . . . "skimping" here downgrades your *entire* system.

YOUR EXCHEQUER: Shure cartridges cover the entire economic spectrum. And they are ALL Shure in quality, all Shure in performance. Even the least costly has received copious critical acclaim.

RUGGED AND RESPONSIVE

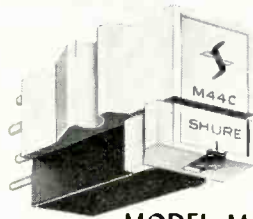

MODEL M44-C

An exceptionally rugged cartridge that tracks at forces up to 5 grams. Ideal for older model, heavier-tracking turntables, or where children or guests have access to your system. Retractable stylus prevents record damage. 15° tracking for minimal IM and Harmonic distortion. Truly musical sound. Only \$17.95

ECONOMICAL TREND-SETTER

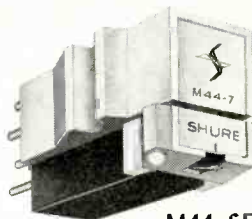

M44 SERIES

Premium quality at a modest price. 15° tracking angle conforms to standard adopted by major record companies. Remarkably low IM and Harmonic distortion . . . excellent channel separation, providing superlative stereo effect. Scratch-proof retractile stylus. M44-5 with .0005" stylus for 3/4 to 1 1/2 gram tracking. Only \$21.95. M44-7 for 1 1/2 to 3 grams, .0007" stylus. Only \$19.95

ALL THE MOST WANTED FEATURES

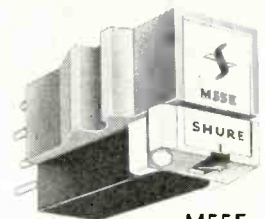

M55E

15° TRACKING, ELLIPTICAL STYLUS

Professional performance at a modest price. Compares favorably to the incomparable Shure V-15, except that it is produced under standard Shure quality control and manufacturing techniques. Remarkable freedom from IM, Harmonic and tracing distortion. Will definitely and audibly improve the sound of monaural as well as stereo records. A special value at \$35.50. Upgrade M44 cartridge (if you can track at 1 1/2 grams or less) with N55E stylus, \$20.00

THE "FLOATING" CARTRIDGE

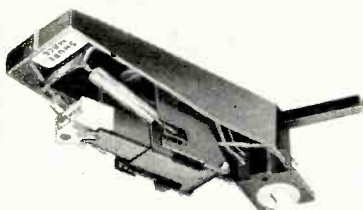

M80E GARD-A-MATIC® WITH ELLIPTICAL STYLUS

Bounce-proof, scratch-proof performance for Garrard Lab 80 and Model A70 Series and Dual 1009 automatic turntables. Especially useful where floor vibration is a problem. Spring-mounted in tone arm shell. Stylus and cartridge retracts when force exceeds 1 1/2 grams . . . prevents scratching record and damaging stylus. Model M80E For Garrard turntables. \$38.00 Model M80E-D For Dual 1009 turntables. \$38.00

THE ULTIMATE!

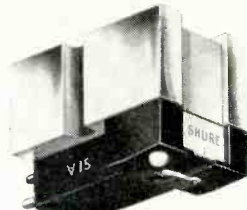

V-15 WITH

BI-RADIAL ELLIPTICAL STYLUS

For the purist who wants the very best, regardless of price. Reduces tracing (pinch effect), IM and Harmonic distortion to unprecedented lows. 15° tracking. Scratch-proof, too. Produced under famed Shure Master Quality Control Program . . . literally hand-made and individually tested. In a class by itself for mono as well as stereo discs. For manual or automatic turntables tracking at 3/4 to 1 1/2 grams. \$62.50

"THE BEST PICK-UP ARM IN THE WORLD"



SHURE SME

Provides features and quality unattainable in ANY other tone arm. Made by British craftsmen to singularly close tolerances and standards. Utterly accurate adjustments for every critical factor relating to perfect tracking . . . it realizes the full potential of the cartridge and record. Model 3012 for 16" records \$110.50; Model 3009 for 12" records \$100.50

SHURE

Stereo Dynetic®

High Fidelity Phono Cartridges . . . World Standard Wherever Sound Quality is Paramount
Shure Brothers, Inc., 222 Hartrey Ave., Evanston, Illinois

Circle 111 on Reader Service Card

colors are pure and consistent all over the screen.

Several features of the GR-25 appear to make it a far better value than most commercial color sets, particularly for the user who has sufficient interest to prefer to maintain his set himself rather than call in a service man every time some re-touching is necessary.

In the first place, the set is entirely enclosed in a steel cabinet to eliminate the effect of external magnetic fields—especially that of the earth itself. In the second place, automatic degaussing coils are built in (though these are common now) so the entire chassis and picture tube are “degaussed” every time the set is turned on. (The audio buff may want to read “erased” for “degaussed.” In the third place, an external degaussing coil (bulk eraser?) is furnished so as to demagnetize the cabinet and the tube screen whenever it becomes necessary. (If you doubt that an external magnetic field can affect a picture, just try holding a magnet near the screen of any TV set and see what happens to the picture.) Undoubtedly, everyone has heard that once a set is adjusted for perfect convergence in one location, and then pushed back to the wall to its normal position, it is likely to be out of adjustment again, because of the earth's magnetic field. The steel cabinet largely eliminates this problem.

A second feature of special interest to the self-sufficient “handyman” type, which applies to the average audio buff, is the provision of a built-in dot generator, along with the ability to cut off any one of the color guns separately without having to resort to a “jury-rig” arrangement at the CR tube socket, even if that would work. A jumper wire with a clip on the end is provided which can be clipped on the wire lead of an upstanding resistor—one for each color—to eliminate any one of the three colors selectively. In making convergence adjustments, the blue gun is cut off and adjustments are made to obtain pure yellow dots, indicating convergence of red and green. When this is done to the user's satisfaction, the blue gun is turned on and the adjustments

made to obtain pure white dots all over the screen. Similarly, with the blue and green guns cut off, one adjusts for purity of the red screen, which ensures that the red beam is properly positioned to strike only the red-phosphor dots. This is performed by moving the two purity rings, either together or separately.

The presence of the dot generator eliminates the need for an external test instrument. It provides a series of dots, in 9 to 15 horizontal rows, each dot being about $\frac{1}{4}$ in. wide and an inch high, and with 18 to 24 columns of the dots. These dots make it possible to perform all the convergence adjustments without external equipment, since the dot generator is actuated by the movement of a single slide switch.

Another desirable feature of the GR-25 is the hinged chassis, as shown in Fig. 2, which gives access to all of the electrical wiring in the cabinet proper. Figure 3 shows the convergence panel, which contains nine potentiometers and three adjustable coils on the circuit board, all of which serve in adjusting convergence. In addition, the panel mounts the height, vertical linearity, AGC, color killer, and sync controls, as well as one control which varies the number of rows of dots when the dot generator is turned on. This entire panel is accessible from the front—one simply tilts the speaker panel forward, and the convergence assembly is in convenient position. Most color sets seem to have their convergence controls at the rear, making it necessary to make all adjustments with a mirror.

Over-all “gray-scale” adjustment can be made from the rear of the chassis. It has been said that any color set will produce a color picture—it takes an especially good one to produce a good black-and-white picture, one that is not shaded over-all with either a greenish or a bluish cast. The GR-25 produces a pure gray scale throughout, resulting in a black-and-white picture of excellent quality.

Color Quality

One of the problems of color picture tubes of a year or so ago was that the brilliance of the red phosphors then available was so low—even at best—that the green and blue had to be reduced to balance with the red so as to make a pure white, and consequently the over-all brightness was low. The new “rare-earth” phosphor in the Hi-Lite tube provides a brightness more in keeping with the natural brightness of the blue and green, so the over-all brightness is now perfectly adequate, even enough to permit good color viewing in a well lighted room.

Without professing to be an authority on color TV, this observer has begun to notice what other sets look like and it can be said that the color of the Heathkit GR-25 is the best that we have seen in any color set to date. Like most people with a new gadget, we were inclined to use too high a setting of the color control at first, resulting in somewhat gaudy coloring much like early Technicolor pictures. However, after living with the set for a few weeks, we gradually adopted a softer pastel coloring, which is pleasanter and

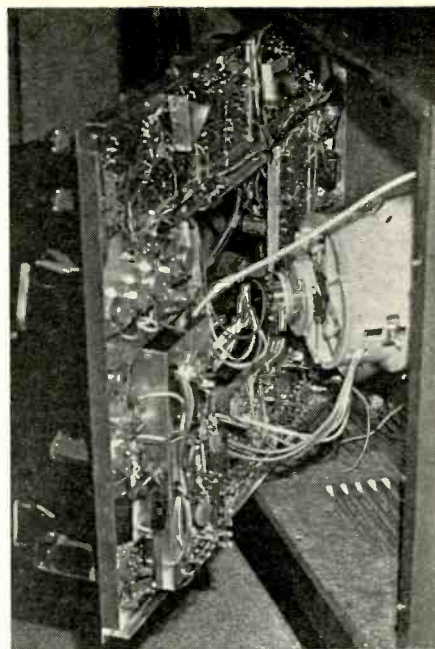

Fig. 2. Hinged swing-out chassis gives access to all wiring for easy servicing.

more natural, giving the effect seen in the movie “Tom Jones,” as compared to some other spectaculars such as “Inna la Douce.”

Details

The GR-25 is priced at \$469.95, with an additional \$59.95 for the GRA-25-1 Walnut cabinet shown in Fig. 1. This represents a real bargain to the user, since sets similar in appearance seem to run around \$700, without the built-in service features like the dot generator. Add to this the saving in service costs which the average set would require, since the builder would undoubtedly service his own set throughout its life, and the GR-25 is a real bargain. Besides that, it is capable of a great picture. Not that it matters, since one does not count on distance reception for TV, but we have played a station in Philadelphia—104 miles—with good color and little snow, and another in Wilmington, Delaware, both from our Mineola location and a built-in apartment antenna. This is more than adequate sensitivity.

Circle 200

DUAL 1019 AUTOMATIC TURNTABLE

Once upon a time you could tell the changers from the manuals. And furthermore, there was no question about the performance superiority of the manuals.

That has been changed in recent times. This Dual 1019 is the latest product to come along that convinces us that there is no longer a separation of the species.

Quite the contrary, this 1019 removes any vestige of doubt that may have lingered. There is no differentiation to be made in terms of performance capabilities.

The 1019 model is actually an embellishment of the earlier 1009—a unit that established performance standards for an automatic. All of the features, including an excellent and versatile change mechanism, have been retained. Control remains in the hands (as it were) of a single fric-



Fig. 3. Service and convergence controls are front accessible when the speaker panel is tilted forward



Plain Talk from Kodak about tape:

Giving your tape library a longer prime of life

How long can you keep a recorded tape? As of today, nobody knows for sure. Recording companies have tapes dating back to the late 1940s that are still in fine shape. Actually, the aging problem for tape is somewhat akin to the ones faced by movie-makers. Their problems are tougher, though . . . movie-makers have to worry about latent chemical reactions, greater mechanical strains, etc. And yet, we can see movies made more than a half century ago if the films have been given proper care and expert duping. Like photographic films, many audio tapes are made on ace-

goes for tapes. One obvious safeguard is to keep tapes away from strong magnetic sources like large electric motors or transformers which could demagnetize a recording.

Keep it clean. Tapes hate dirt just as much as regular records do. Thanks to sturdy, one-piece construction, Kodak's new "library décor" box helps keep dirt out . . . won't fall apart over the years as conventional tape boxes sometimes do. And this new box looks better. Play it clean too, of course. Clean your recorder heads, capstans, rollers and guides regularly with a cotton swab moistened with one of

keep your tapes in the "tails out" format rather than rewinding them. The uneven winding induced in the tape by fast rewinding can cause physical warping of the tape over a period of time. Here too, you're better off with KODAK Tapes because KODAK 5" and 7" Thread-Easy Reels are of dynamically balanced, one-piece construction. This gives you freedom from wobbles and pulsations on both "record" and "rewind" . . . keeps the tape under smoother tension . . . just what the doctor ordered for long tape life. The need for smooth winding can not be overemphasized.

Last but not least, it's a good idea to dupe your really old tape recordings onto fresh KODAK Tape in order to standardize on KODAK Tape quality. That's an interesting subject all by itself, and we'll try to devote a "Plain Talk" to it soon! KODAK Tapes on DUROL and polyester bases are available at electronic, camera and department stores. To get the most out of your tape system, send for free 24-page "Plain Talk" booklet which covers the major aspects of tape performance. Write Department 940, Eastman Kodak Company, Rochester, N. Y. 14650.

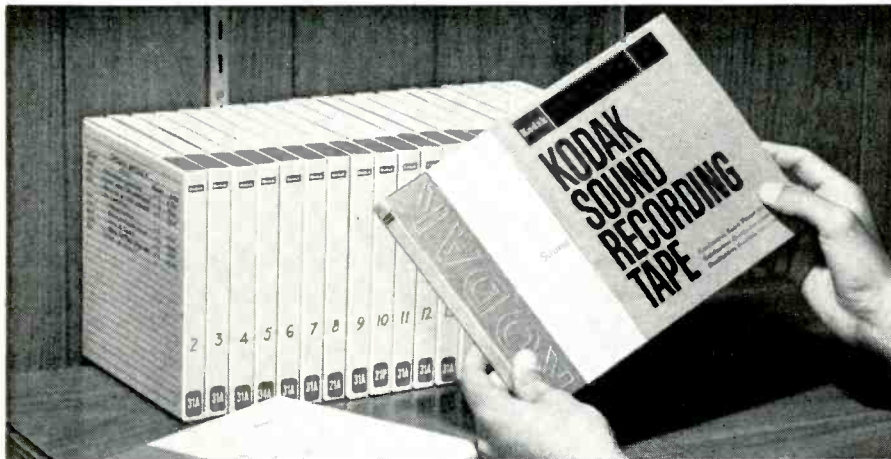

tate base. Ours is Kodak's famous DUROL Base, the stronger, tougher triacetate (we also make KODAK Tapes with a tempered polyester base for extra toughness or for long-play applications). Lab tests show that DUROL Base holds up as well as photographic film. So . . . tape wise, there's no reason your great grandchildren won't be able to enjoy your present efforts.

T.L.C. makes the big difference. Tender loving care is a must when saving anything worthwhile. The same

the commercial cleaners sold for that purpose. Use a degausser periodically to remove any magnetization of recording heads.

Keep it cool. Tapes should be kept away from extremes of temperature and humidity. High temperatures may affect the plastic support and increase the possibility of print-through . . . the transfer of magnetic signals from one layer of tape to the next.

Keep it "backwards." For truly valuable recordings, a good trick is to



EASTMAN KODAK COMPANY, Rochester, N.Y.

Circle 120 on Reader Service Card



Fig. 4. The Dual 1019 Automatic Turntable.

tion-free lever. With it, automatic or manual operation is accomplished. The Duals will operate automatically (pick up and set down) even with a manual (short) spindle in place.

The short spindle has been changed from earlier models. It is now a snug friction fit into the center hole, becoming one with the platter. Thus one area of flutter (and rumble) generation has been improved.

An effective arm cue mechanism is now incorporated into 1019. This gently lowers the arm in an absolutely vertical direction. There is no side thrust—you can use this cue lever to interrupt a selection and then return to the same groove.

The arm itself is the center of many of the changes incorporated in this new unit. It has been made lighter; the cartridge shell locks into place securely; that shell allows the cartridge to be mounted for minimum tracking error (a gauge is provided). The main innovation, however, is at the base of the arm. Here a rotating wheel selects the amount of anti-skating compensation, commensurate with the stylus size and force being employed.

Dual provided us with a novel device they call a Skate-O-Meter. This attaches to the front of the arm in place of a cartridge and rides the grooves of a record with its own stylus. A meter pointer indicates the exact degree (in mg) of side thrust acting on the arm—in either direction. Thus, it acts readily to prove the effectiveness of anti-skating devices. It proved the system installed in the 1019 to be completely adequate to the needs of skating compensation.

Measurements

Rumble—41 dB below a recorded velocity of 3.54 cm/sec stereo.

Flutter and wow—0.08 per cent.

Sensitivity to line voltage—100-130 volts; insignificant. (The 1019 features a vernier speed adjustment of ± 3 per cent around each speed. Thus, any actual speed change vs. voltage can be exactly compensated. However, in practice, the drive motor of this unit is relatively insensitive to normal voltage variations.)

Maximum tracking error—1.25 deg. at the outside of a disc, reducing to near zero at a 3-inch diameter.

Arm resonance—well damped at 16 Hz.

Stylus force change vs. record stack thickness—0.1 gram.

Stylus force necessary to activate arm trip—0.25 grams.

These are the prime measurements. They

would be excellent if applied to a true manual system. For an automatic selling at \$129.50 less base, they are the proof that *no gulf at all* exists between manual and automatic. We suggest no cartridge restrictions for use with this table. Nor could we hesitate to suggest its use with any system, no matter how superior other components.

Circle 201

SONY 2010 VIDEOCODER AND CVC-2000 VIDEO CAMERA

To anyone accustomed to the operation of a conventional audio tape recorder, the acquisition of a Sony Videocorder will offer a brand new field of interest without introducing any complications in handling, so that even the novice can begin to enjoy the immense possibilities of the new medium at once. The actual mechanics of operation should require no special training or skill not possessed by anyone capable of tuning in a TV program.

The Sony Videocorder assembly comes in two forms—the 2010 pictured is in a carrying case with its monitor, and can be

considered a portable (it has handles), and the 2020 is in a walnut cabinet suitable for placement anywhere in the home, and comes with a clock-timer for recording desired programs automatically with no attendance. The recorder section alone is Model 2000; the monitor/TV receiver is a 9-in. CVM-51 UW which is hinged in the case and raises to an upright position for use. For transporting, the monitor is lowered into the case. The over-all dimensions of the entire unit are 18 by 28½ by 12 in.

The recorder unit alone measures 16 by 14 by 8½ in. and employs a helical-scan tape drive utilizing ½-in. tape. The feed reel is elevated approximately ½ in. above the take-up reel, and as the tape passes from one to the other it is guided around the scanning drum at an angle for one-half of the circumference of the drum. The scanning heads rotate in a horizontal plane, contacting the tape through a slot in the stationary drum, with the result that the scanning lines run diagonally across the tape. As the heads rotate at a speed of 1800 rpm, which is 30 rps, and the length of each scan is approximately 6½ in., the actual scanning speed is in the vicinity of 200 in./sec. Instead of recording the video signal directly, a frequency-modulated signal is employed in which the carrier of 1.7 MHz is modulated by the video signal with a deviation of ± 1 MHz. This method makes it possible to record a wide video-frequency range without deterioration of high-frequency response, which would, of course, adversely affect the picture quality.

Only one of the two rotating heads is used for recording. Since the *frame* frequency of a TV picture is 30/sec (the *field* frequency is 60/sec, but it takes two fields to make up one *frame*) the rotating record head actually records one field during its contact with the moving

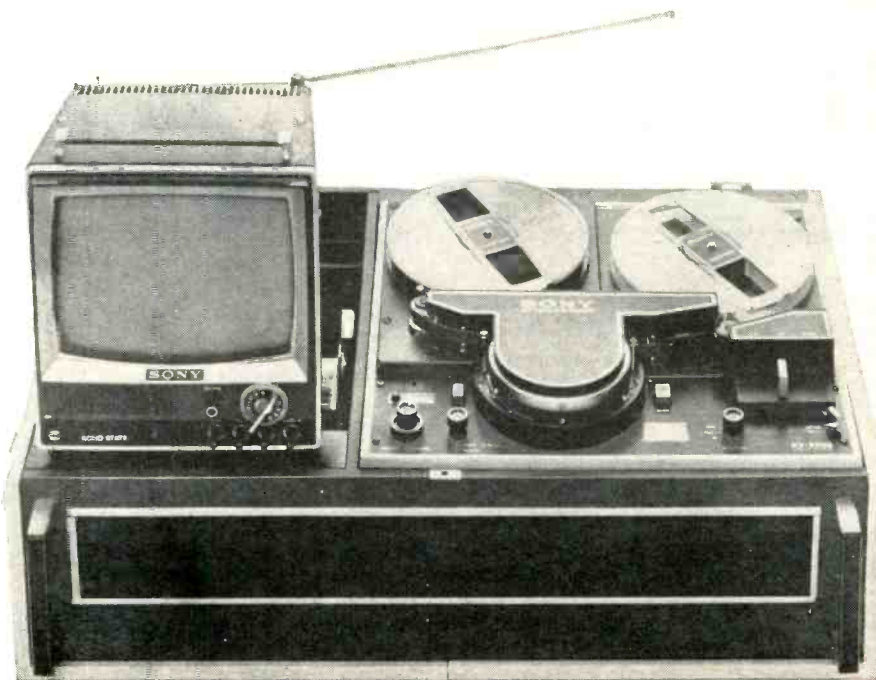
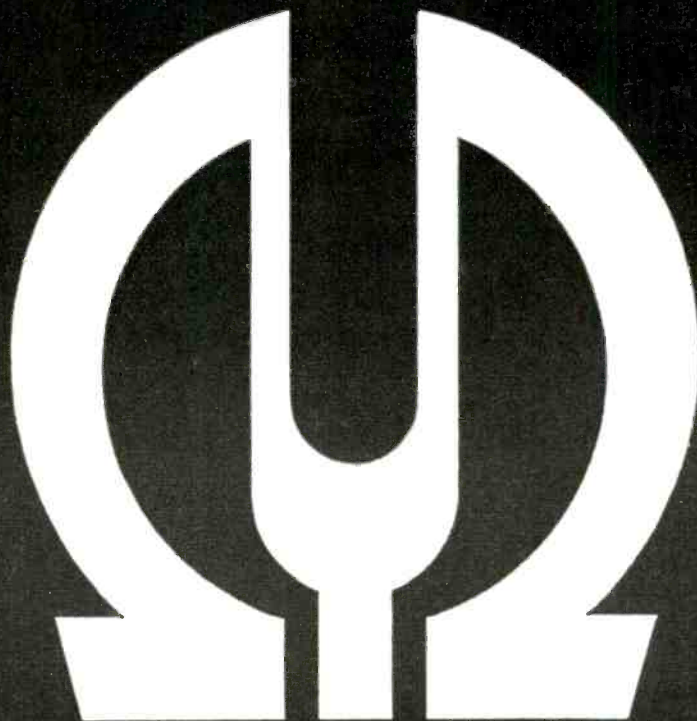

Fig. 5. Sony Model 2010 Videocorder, with its built-in 9-in. monitor/TV receiver.

A MARK TO REMEMBER



Reg. U.S.-T.M.

The faithful re-creation of sounds and music by man-made means, as close to the original sounds as possible, using the power of electricity has always been our guiding principle. The PIONEER trademark was conceived from this basic principle, by combining a tuning fork, that generates the standard waveform of sound, and the standard electrical symbol for the ohm.

As a major producer in one of the largest markets in the world the name PIONEER is synonymous with quality.

We will soon introduce some of our new Receivers at the better Hi Fi dealers. Ask them to demonstrate Pioneer equipment. REMEMBER THE MARK of the tuning fork and the ohm.

PIONEER ELECTRONICS U.S.A. CORPORATION

350 FIFTH AVENUE, NEW YORK, N. Y. 10001

Phone: (212) 524-1757

tape, but during the second field, the head is passing around the open back of the scanning drum where there is no tape. Thus only the alternate fields are recorded.

On playback, however, both heads are in operation, and because of their differing placement, each recorded line is scanned twice—once by each of the heads. This is equivalent to a TV picture of half the normal number of lines, or what would be seen by a camera taking a still picture of a TV screen at a shutter speed of 1/60 sec. (To get a picture of *all* the lines in a TV picture, the shutter speed must be no greater than 1/30 sec.) This does reduce the *effective* number of lines in the picture by half, since on playback one sees one field twice, then the next field twice, and so on. However, it does eliminate the need for commutating the heads—one cause of the occasional discontinuity seen in taped TV programs. The head connections are made by simple slip rings.

To maintain synchronism, two separate pulse sensors are mounted with the scanning assembly. One consists of a magnets on the rotating head arm which pass through the poles of two fixed coils, thus generating a 30-Hz pulse used for speed control as well as a 60-Hz pulse which is fed to the camera for vertical sync. The other pulse frequency—15,750 Hz—is generated by a toothed wheel passing another coil, and this signal is fed to the camera for horizontal synchronization.

The 30-Hz pulses are doubled and compared with the transmitted sync signals from the TV set, then integrated and used to control the brake on the rotating head shaft to maintain synchronism. (Thus the "unbraked" speed is seen to be slightly higher than 30 rps.) Part of the pulse signal is recorded on the edge of the track during recording by the combination audio and control head, and is used to maintain synchronism during playback.

The CVC-2000 Video Camera, available as an accessory, employs a Sony Vidicon tube, 26 transistors, and 25 diodes, and has a video output of 1.4 V with a resolution of 400 lines (which is better than the average TV set). It operates from a 117-V a.c. line with a power consumption of only 10 watts. The normal lens is a 25-mm, f/1.9 unit in a standard "C" mount, thus permitting the use of any 16-mm camera lens. The automatic sensitivity system compensates for light variations by changing the gain of the video amplifier so the camera operates over a light range of about 6000 to 1. The unique circuit of the camera involves the amplification of the video signal in two ranges, with differing amounts of gain in each range. The d.c. component of the signal is amplified considerably less than the high-frequency portion, and since most of the noise is contained in the low-frequency portion, it does not appear in the over-all output since low end and noise have not been amplified as greatly. Thus detail is maintained without appreciable noise. This results in a S/N of some 40 db, which is good for a vidicon-equipped camera.

The sound signal is recorded on the other edge of the tape from the control signal by the audio/control head and sep-

arate amplifier circuitry. The tape speed is 7½ ips, which is more than adequate for the audio range of 80 to 10,000 Hz. The amplifier accommodates an unbalanced microphone input at a 600-ohm impedance, and a balanced, transformer-isolated auxiliary input at an impedance of 10,000 ohms. The recorder unit employs 49 transistors and 24 diodes, while the 9-in. monitor/TV receiver employs 27 transistors, 14 diodes, a selenium rectifier, two thermistors, and a tube-type high-voltage rectifier. Camera output and video input match at 75 ohms.

The monitor/TV receiver is modified from a conventional 9-in. Sony TV set, with a sensitivity of 5 μ V on both VHF and UHF. The video output available to the recorder is 1.0 V. composite with negative sync, and the input from the recorder on playback is of the same value.

Performance

The brief description of the components can only serve to arouse more curiosity, but a thorough outline of the circuitry would require a volume larger than this entire issue. After living with this unit some three months, we have found it reliable in performance and a real source of entertainment. Sony only claims a resolution of 180 lines, but this compares with many a 14 to 19-in. TV set on the market today. With the addition of an r.f. adapter, the recorder can feed any TV receiver (direct connection does not seem to be possible because of the negative sync), and it is likely that various methods of connection will be added as the demand grows.

At its 7½-ips speed, a 2400-ft. reel of tape (which can be had on a 7-in. reel) will run for a bit over an hour. If you are recording an old movie on the Late Show to build a library, you can stop the machine during commercials to get more running time on one reel, of course, starting the machine again when the commercial is over. When the tape transport is stopped, the heads scan the same scene over and over, giving a stop-motion picture when desired. Separate audio and video level controls are provided, along with a meter which indicates either of these levels—selectable by a switch, as well as the line voltage. The monitor can also be used as an ordinary TV set, with the motor of the recorder switched off. An automatic switch stops the machine when tape runs out.

One application of the camera which appeals to those who also indulge in photography is its use as a continuous monitor to aid in lighting a portrait, for example. It would seem as though it would be a great help, since the picture is, of course, in monochrome, making it easier for the photographer to see how the lighting will appear in the finished picture.

In all, the Videocorder offers a myriad of applications which should appeal to all true experimenters, and experience with it and its accessory camera could undoubtedly uncover hundreds of uses in the home, in addition to the commercial and industrial applications—to say nothing of the educational field, which could become its most important user. Consider, for example, the value of the Videocorder for storing educa-

tional programs, or telecast school work, for later study or review.

Or maybe even for improving your golf game?

Circle 203

SCOTT 342 RECEIVER

This is the low-end receiver of the Scott line but it is no low-end product. It is designed to sell under \$300, yet it is capable of performance characteristics far beyond what you would expect. It is also the first receiver to come our way (and the first on the market) to use a field-effect transistor in the FM front end. The results are impressive.

This is the first tuner of transistor design that we have seen that combines the virtues of high input sensitivity with an indifference to overload from strong local signals. Scott claims an IHF sensitivity of 2.5 μ V; we measured 2.2 μ V. At the same time, a bombardment with 100,000 μ V caused no problems. Frequency response of the tuner was also within specification, \pm 1 dB from 30 to 15,000 Hz. Stereo separation is an excellent 27 dB for either channel at mid-frequency points; it is still in excess of 20 dB above 10 kHz.

Tuning is by signal-strength meter and is light in feel. Any usable signal will present no tuning problems. Stereo switching is triggered by the 19 kHz sub-carrier; this also lights an indicator.

All of the front-panel expectations are on this receiver. Layout is logical and uncluttered. Some of the extras that have been included are a three-position switch for speakers—OFF, MAIN, REMOTE. In conjunction with the off position there is a low-impedance stereo earphone jack.

The Scott 342 is of modest power output.

(Continued on page 65)

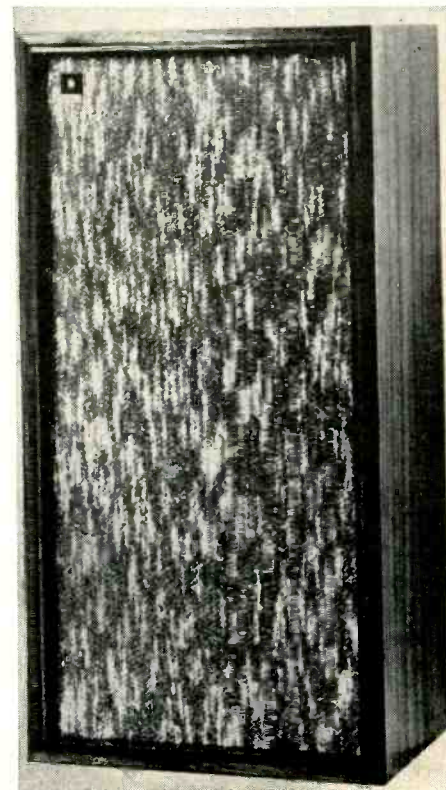

Fig. 6. Scott S-8 Speaker System

Leadership PERFORMANCE

ELECTRONIC ADVANCES

- ☞ Performance as yet unequalled
- ☞ Two years proven Solid State circuitry
- ☞ Extremely low noise Control Center
- ☞ Plug-in etched circuit modules

TRANSPORT ACHIEVEMENTS

- ☞ Patented Electro-Magnetic Brakes never need adjusting
- ☞ Complete head accessibility
- ☞ Precision Construction
- ☞ Low Wow and Accurate Timing

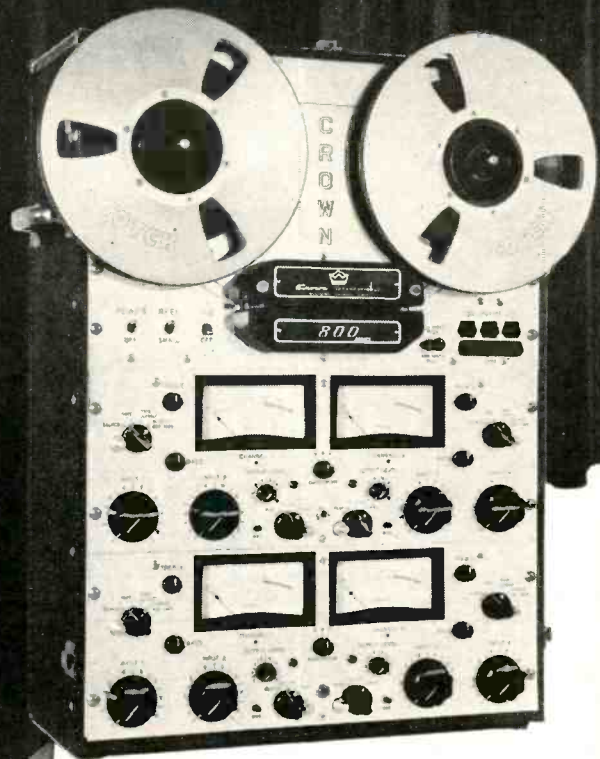

SS844 Four Channel
from \$3060.

ips	db	cps	s/n	w & f
7-1/2	±2	50-25,000	54db	0.09%
3-3/4	±3	50-15,000	50db	0.18%
1-7/8	±3	100-9,000	42db	0.30%

SS822 Two Channel
from \$1770.

ips	db	cps	s/n	w & f
15	±2	50-20,000	57db	0.06
7-1/2	±2	30-20,000	55db	0.09
3-3/4	±2	30-10,000	51db	0.18



*Write
to*

Crown INTERNATIONAL
BOX 1000, DEPT. A-3, ELKHART, INDIANA 46517

Sound & Sight

HAROLD D. WEILER
IN TWO PARTS—PART 1

WE continue our description of the operation of the vidicon camera which began in the March issue.

If the video camera were directed at a card containing a line composed of alternate black and white areas, as illustrated in Fig. 1A, the resultant video signal voltages generated would appear as illustrated in Fig. 1B. This electronic duplicate of the optical image elements is obtained in the following manner.

As the electron scanning beam passes over the first black area of the line, the amplitude of the video signal voltage generated is high as shown. When the beam strikes the image of the white area the amplitude drops to zero. This scanning process continues across the remainder of the line generating the total video show.

If the video camera were to be directed toward a grey scale such as illustrated in Fig. 2A, the resultant video signal would appear as illustrated in Fig. 2B. The amplitude of the video signal voltage would vary in direct proportion to the amount of light reflected onto the vidicon faceplate by each shade of grey in the scale. As the electron beam moved from left to right it would first scan the black area (10) and produce a high amplitude signal as shown. When the beam reaches the dark-grey area (9) the amplitude of the signal would drop slightly due to the increased amount of light it reflects. The lighter grey area (8) reflecting still more light would again cause the signal amplitude to drop and so on across the scale until the white area (1) was reached, at which point the video signal amplitude would be zero.

When the human eye "sees" any object or scene, its complete image is instantly impressed on the retina; each individual picture element is delivered to the brain simultaneously, by the large number of nerve fibers which make up the optic nerve. During the projection of motion pictures the complete image on the screen is also impressed on the eye in essentially the same manner.

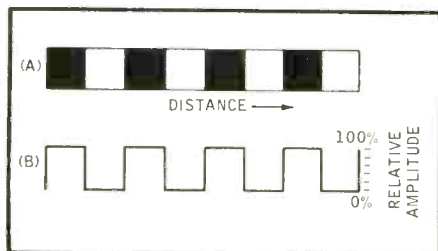
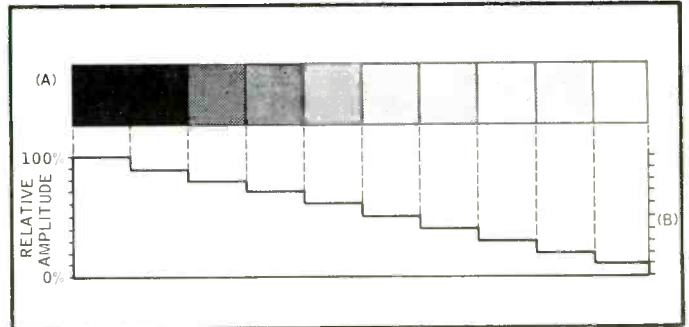

Figure 1 The relative amplitude of the signal generated by the camera while it scans alternate black and white areas.

Figure 2 The relative amplitude of the signal generated by the camera while it scans a grey scale.



In motion pictures the complete picture information is contained on the film. All of the individual picture elements which make up each complete picture are contained on that one frame and presented simultaneously. However, it is essential that the images be presented at exactly the same speed as recorded.

In professional motion pictures this speed is 24 frames-per-second. The film movement in the projector and the camera must be synchronized. When one differs from the other the presentation is unnatural; should the film be projected at any speed greater than the speed at which it was recorded, moving objects, will appear to move more rapidly than normal. Conversely, if the film is projected at a speed which is lower than that at which it was recorded, moving objects, will appear to move more slowly than normal. Thus it becomes obvious that in motion pictures the speed of the projector must always be in exact synchronization with that of the camera or the picture will not appear normal.

A similar situation is encountered in video, the action of the receiver and the camera must be synchronized. This situation is further complicated by the fact that the video picture has been divided into a great number of individual picture elements which are transmitted in an orderly sequence.

Thus in addition to displaying a complete moving picture on the screen, the receiver, like a computer, must reassemble the individual picture elements received. It must do this in the same orderly sequence in which they were transmitted and then recreate the same image "seen" by the camera. In short, to recreate an image the receiver must be synchronized with the camera.

The video signal voltage generated by the vidicon tube in the camera does not by itself contain sufficient information to recreate an image. In addition to the varying voltages, indicating degrees of light and shade in the original subject, it be-

comes necessary to provide supplementary information which will synchronize each action of the video receiver with that of the video camera.

In addition to recreating the exact voltage variations (the picture information), it is also necessary to recreate these variations in their exact time sequence. So that, as the electron beam in the camera scans each line, the electron beam in the receiver kinescope must function in exact synchronization, scanning the exact same line at precisely the same moment. As the electron beam in the vidicon is retracing its path the electron beam in the kinescope must do likewise, during the same time interval.

The first supplemental information required is that it is necessary to eliminate the retrace lines in the monitor kinescope since their inclusion would obviously detract from the picture quality. This first bit of supplementary information is provided in the form of additional electronic pulses generated at the camera, so timed that they occur after each scanning line is completed and cease just before the following line begins. This information when received with the picture signals is employed to cut off the beam of the kinescope during all retrace intervals, thus eliminating superfluous retrace lines on the receiver kinescope. This horizontal blanking pulse when added to the picture information provides a waveform such as is illustrated in Fig. 3.

To be continued

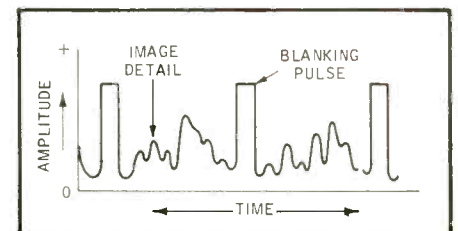
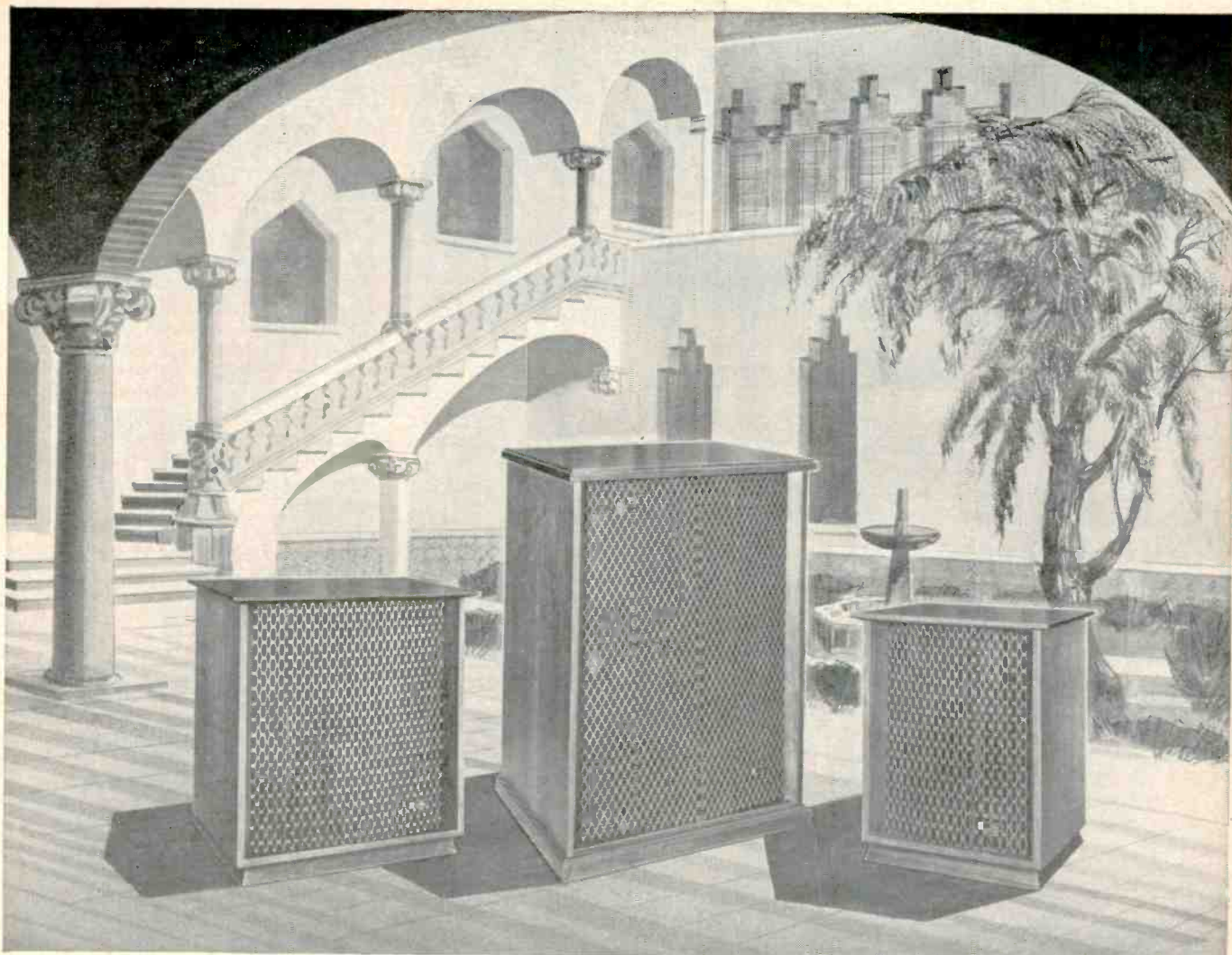

Figure 3 The waveform of the combined video signal and blanking pulse.



846A

A7-500W-1

847A

THE LOOK: Inspired by 16th-Century Spain

THE SOUND: Inspired by Altec's Famous "Voice of the Theatre"® Speakers

Three speakers. Alike in beauty and dignity, differing in size. Their carved fretwork façades tell of a courtyard, ambuscadoes and Spanish blades. A fiery tale augmented in lustrous grain of hand-rubbed walnut.

Behind the fretwork, the same **PLAYBACK** speaker components that have made Altec the standard of the nation's broadcast and recording studios for 35 years.

How large a speaker system will fit the décor of *your* home? Whichever of these new Altec Full-Size speaker systems you choose, you'll enjoy a big measure of beauty with a full measure of sound.

A7-500W-1 Magnificent ... ONLY ITS NAME COULD DESCRIBE IT! In all the world, the new **Magnificent** is the most beautiful speaker ever built. In sound, in looks. Same components, same cubic volume as the famous A7-500 "Voice of the Theatre"®, the **PLAYBACK** speaker system whose massive perfection thunders and whispers in recording studios throughout the nation. A sound matched *only* by the new **Magnificent**. Size: 44 H" x 32 W" x 25 D". \$498.

846A VALENCIA PLAYBACK SPEAKER SYSTEM • Same components as famous A-7 "Voice of the Theatre"® system. Size: 29¾" H x 27½" W x 19" D. \$333.

847A SEVILLE FULL-SIZE SPEAKER SYSTEM • Combines exceptional performance and space-saving cabinet. Size: 26" H x 19" W x 14" D. \$231.

See the glory of Spain, hear the glory of the world's finest speaker systems! Your Altec dealer is waiting to let you make your own test: A-B Full-Size Altec speakers against any others. You'll hear right away that bookshelves are for holding books, Full-Size speaker systems for making music! These Altec systems will accommodate any room requirement, from the grand hall of a mansion to the limited space of an apartment.

Guaranteed to reproduce any program material recorded on tape and records, or broadcast on FM.



©1966 AL

ALTEC LANSINGA Division of **LTV** Ling Altec, Inc.

ANAHEIM, CALIFORNIA



The Tape Guide

HERMAN BURSTEIN

Send questions to:

Herman Burstein

280 Twin Lane E.

Wantagh, N. Y.

Include stamped, self-addressed envelope.

VU Meter Adjustment

Q. The alignment instructions for my tape recorder state that record current is adjusted at 1000 Hz until 0 VU on the meter is 12 dB below saturation level. They state the reference level of recording current is .05 mA., and that the reference level is 12 dB below tape saturation. Therefore, I adjusted record head current to .05 mA at 1000 Hz and adjusted the potentiometer in the VU circuit so that the VU meter indicates reads -12 dB. Is this correct?

A. No. The instructions mean that the meter should indicate 0 VU (not -12 VU) when the record current is .05 mA, namely, 12 dB below the current which causes tape saturation at 1000 Hz. Your calibration of the VU meter results in a reading about 12 dB too low, leading you to record at too high a level, with consequent distortion.

If your tape recorder is capable of recording and playing simultaneously, a preferable procedure is as follows. Simultaneously, record and play back a 400-Hz signal, and measure total harmonic distortion in playback. Adjust the recorded signal level and the meter calibration so that the meter indicates 0 VU when distortion reaches 1 per cent. It is general practice in high-quality home recorders to consider 3 per cent distortion as the maximum permissible amount. Using 1 per cent instead allows about 6 to 8 dB safety margin for the mechanical lag of the meter behind the true level of transients.

Prerecorded?

Q. Why the use of the term "prerecorded tape"? You don't ask for prerecorded discs or presensitized photo film. (The term presensitized is still used in connection with offset plates.) There are so many items that could be adequately described without the use of "pre."

A. I don't share your viewpoint. The term prerecorded tape is used not only because of the absence of a better term but also for what seems to me a good

enough logical reason: Every owner of a tape recorder has tape that he has recorded, and naturally he calls this recorded tape as distinguished from raw (virgin or erased) tape. If the tape he buys already has a recording on it, then it is in fact prerecorded. This term seems preferable to "commercially recorded," which is a more ponderous way of distinguishing between tapes recorded by the owner of a tape recorder and tapes recorded by a professional organization for sale. As for phono discs, mighty few of us go around recording our own discs, so there is scant need of a distinction between our own recordings and those of professional organizations. If you really want to quarrel with "English as she is spoke," there are probably several thousand better arguments you could pick. Just to get you started, I give you the word invaluable; it should mean having no value, but instead means having incalculable value.

And here *AUDIO's* editorial policy disagrees with Mr. Burstein. Normally, the "pre" is eliminated from "prerecorded" in the editorial pages (we can not change the advertisements) even as it was in a preceding question. Only to bring up the subject is it used here, Mr. B's opinion to the contrary. We have a few other "taboos" also. In *AUDIO*, nothing is ever a "must," no plan is ever better "businesswise" or reproduction better "soundwise" and we abominate the sentence which describes something as being "typical of this type of equipment." Furthermore, meters indicate, they do not read, although they do indicate readings. We feel all of these taboos are against poor or loose writing, and that there is no reason why a technical magazine should not try to be as precise as possible. Not that we always succeed, but at least we try to adhere to this goal.

(Also, we might add "inflammable" and "flammable" to Mr. B's examples of language oddities.) Ed.

10½-in. Reel Adapters

Q. I am contemplating making an auxiliary outboard adaptation on one of my tape decks to enable it to use 10½-in. reels. Can you tell me what the correct take-up rpm should be for 7.5 and 3.75 ips? I would also like to know where to obtain a catalog that advertises motors of the type used in tape machines.

A. The hub circumference should tend to move at greater than tape speed. Assume

the hub diameter is 3-in. Then the hub circumference is about 3.14×3 , or 9.42 in. If tape speed is 7.5 ips, it is 450-in. per minute. Dividing 450 by 9.42 we find that the hub must tend to rotate at least 48 rpm as it begins gathering tape. As tape winds onto the reel, the effective hub circumference gets larger so that rpm are less than 48. For 3.75 ips the rpm should be at least 24 with a 3-in. hub diameter. For smaller or larger hubs, the rpm would be inversely greater or smaller; thus at 7.5 ips a 2-in. hub would require at least 72 rpm. The various rpm's I have cited are minimums; taking into account the motor torque and clutch arrangement, which allows for slippage, the motor should tend to rotate at a speed which drives the take-up reel at greater speeds than indicated. To find the type of motor you are looking for, I suggest that you try the tape machine service agencies in your area. You might also write to such mail order organizations as Allied Radio, Harvey Radio, and Lafayette Radio. Essentially you are concerned with a manufacturer's rather than consumer's item, and that is why I suggest a service agency.

Stereo Track Standard Designations

Q. In half-track and quarter-track recordings, which tracks are left channel and which tracks right channel? In quarter-track mono recording in what order should the tracks be recorded?

A. When the tape is moving from left to right, and when it is viewed from the base side (the side away from the heads), the upper track of a half-track stereo tape is the left channel. In the case of quarter-track operation, with the tape viewed in the same manner as just described, the track numbering sequence from top to bottom is 1, 2, 3, 4. Track 1 is the left channel and Track 3 is the right channel. After the tape has run through in one direction and then reversed, Track 4 becomes the left channel and Track 2 the right channel. When recording 4 mono tracks, the standard sequence is Tracks 1, 4, 3, 2. (You could, if you wanted, record in the sequence 1, 2, 3, 4, but this would involve extra and confusing transfers between operation with the upper gap and operation with the lower gap of the tape heads. The standard sequence provides for recording two mono tracks with the upper gap, and then two mono tracks with the lower gap. Some machines force variances in these customs, however.)

Inverters

Q. I would like to play tapes in my auto during long drives. I would like to use my own open reel tapes on my own portable tape player, instead of using the cartridge units now on the market. Are 12-volt d.c. to 115-volt a.c. inverters available which would power the transport adequately and with accurate speed?

A. To my knowledge such inverters are available, but depending upon your power requirements and desired speed accuracy (i.e. frequency accuracy) they may not be exactly cheap. I suggest that you contact electronic supply houses for further information on this subject.

(Continued on page 63)

This Sony has ESP*



Model 660 Solid State

The world's first fully automatic tape reversing system

*Electronic Sensory Perception—an amazing Sony development. The ESP electronic brain constantly scans and automatically senses the voice or music modulations on your recorded tapes. Within 10 seconds after the sound has ended, the Electronic Sensory Perceptor *automatically reverses the tape direction!* Then, magically, the music resumes—every note flawlessly reproduced. You never touch the tape, you never touch the recorder—Sony ESP reverses the tape automatically. You never again bother about recording electronic reversing signals. Sony ESP tape reverse is activated solely by silence. Sony ESP automatic tape reverse works on

your old tapes and on your new tapes. The Sony 660 also records in both directions for making your own 4-track tapes.

And the Sony 660 adds a whole lot more. XL-4 Quadradial Speaker System surrounds you with a virtual curtain of stereophonic sound. 50 watts of pure music power per channel. Two professional V U meters. 3 motors. 2 speeds. Sound on sound. Separate bass and treble controls. FM stereo inputs. Push-button solenoid activation of all mechanical modes. For literature and address of dealer nearest you, write Superscope, Inc., Department 11, Sun Valley, California.

SONY **SUPERSCOPE** *The Tapeway to Stereo* ®

Circle 124 on Reader Service Card

NEW PRODUCTS

● **Professional Turntable.** The EMT 930st is designed for broadcast use. This version is the latest in a line of systems from this firm. Many of these units are in use at broadcast stations and recording studios throughout the world. The EMT 930st is complete, furnishing line-level outputs from a built in equalizer/amplifier. Precision construction permits wow and flutter figures of 0.03 per cent

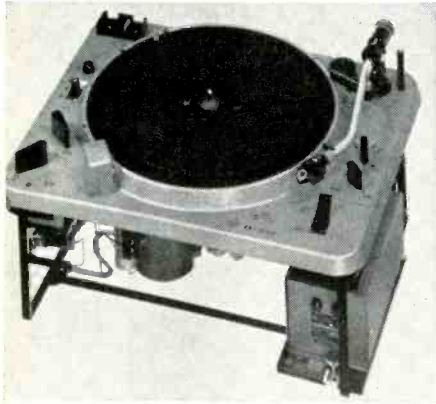

rms and rumble figures are better than NAB standard. The turntable is equipped with remote start-stop control. It comes up to speed in 0.4 seconds. Output is cut off for wowless starts. Three speeds are provided, 33 1/3, 45, and 78 rpm. Drive is from a synchronous motor, an EMT-Ortophon stereo cartridge/arm is provided complete with cue lowering device. There is a groove illumination light. Interchangeable mono and standard groove cartridges are available. Price is \$1295.00 less console. Circle 211

● **All Solid-State Receiver.** Allied Radio's new Knight KN-376 is a deluxe all-transistor receiver of compact dimension and size but with a big voice. Combined on the single chassis is a 70-watt stereo amplifier, dual preamplifiers and individual AM and FM tuning sections with multiplex circuitry for stereo reception. Full control operation is offered from all sources including auxiliary, tape, and phono inputs. There is a front-panel jack for stereo earphones, an illuminated tuning meter, automatic FM-stereo switching with a indicating stereo lite, and switchable AFC. Also built-in AM and FM antennas and automatic thermal self-resetting circuit



breakers. Important specifications include: 35 watts per channel IHF, 20 watts continuous; 20-20,000 Hz power response; THD is 1 per cent at full power, and less than 0.25 per cent at 1 watt; IM is less than 1 per cent at normal listening levels. Phono sensitivity is 4 mV and hum and noise is -60 dB. The tuner has 3 μ V usable sensitivity (IHF); IF bandwidth of 300 kc; capture ratio of 3dB; AM suppression of 48 dB and stereo separation of 30 dB. List price is \$269.95. A metal case is \$9.95 and a walnut enclosure is \$22.75. Circle 212

● **Solid-State Voltmeter.** Claimed as the industry's first to use a field effect transistor, this voltmeter is designed to measure a.c., d.c., and ohms throughout the audio, rf, uhf, and vhf spectrums. The use of a FET is responsible for a claim of freedom from initial drift. All-transistor design makes practical the use of battery-operated power for completely portable operation. Independence of the ground system from the power line allows for easy differential measurements. Specifications are: Voltmeter



operations—d.c.—0-1000 volts in 7 ranges; a.c.—0-300 volts rms in 6 ranges. Ohmmeter operations—0-infinity, 7 mid-scale ranges (to 10 megohms). Voltage accuracy— \pm 2 per cent; Resistance— \pm 3 per cent of mid scale; Input impedance on d.c.—greater than 100 megohms, a.c.—as high as 15 megohms in parallel with 2 pF. Frequency response is 20 Hz to 700 MHz. Power is 13.5 volts and is supplied by standard mercury cells. List price is \$215.00. Circle 213

● **Electronic Tuning Fork.** A new product for orchestras and bands has been announced by a California company. It is a portable tuning instrument, battery powered, and engineered with solid-state devices to provide a precise reference tone. It is 99.995 per cent accurate at room temperatures and almost immune to temperature changes from 40 deg. to 100 deg. F. The product is the Symphonic-Tuner and is made by Electronic Research Products. It derives its "A" from a high-frequency tuning fork controlled oscillator. The frequency is

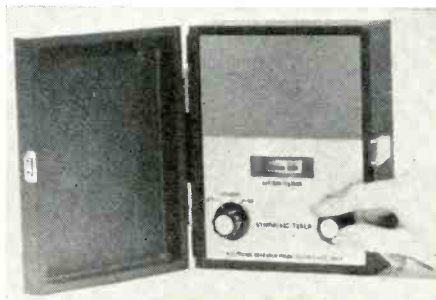

divided within the unit to produce a tone of 440.00 Hz. Any special frequency, such as 442.00 Hz can be engineered into the unit on special order. The Symphonic-Tuner thus provides an extremely accurate tuning "A". Currently the Minneapolis Symphony is reported to be using this device. List price is \$195.00. Circle 214

● **Earphones.** This new set of phones from Clevite "Brush" has been designed to match the requirements of recorded speech instruction. They are considered

as a practical and economical choice for classroom use, particularly where both recorded and live instruction are conducted simultaneously. According to the Company, these low-impedance earphones have been field-tested by millions of members of the armed forces and have demonstrated an ability to withstand a high degree of rough handling. Comfortable and removable ear



cushions eliminate outside noise. Thus each student becomes, in effect, a class of one. These phones, model number ED-150, have a stainless steel headband covered with a vinyl plastic sheath. Heavy-duty ear pieces adjust to any head size. The phones are magnetic in operation and are furnished with a standard molded phone-type jack at the end of a five-foot cord. Circle 215

● **Spanish-Styled Speaker System.** The new Altec Lansing 847A "Seville" is styled in a contemporary upright walnut cabinet with a Spanish wood fret-work grille. It requires less than two square feet of floor space; thus it is ideal for the smaller listening room. Inside the enclosure is a 414 type 12-inch bass driver, a mid-range exponential

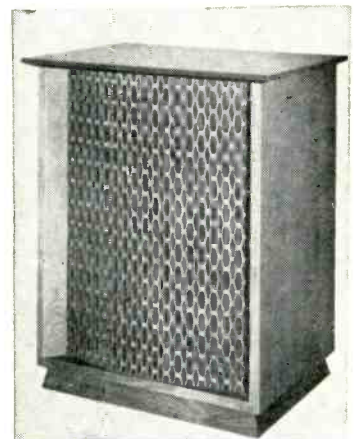

horn and a compression high-frequency driver. There is also a special two-section 3000-Hz crossover. The Seville can be driven from an 8- or 16-ohm source and is rated at 20 watts. Over-all response is claimed at 40-22,000 Hz. Dimensions are 26 in. high, 19 in. wide, and 14 in. deep. The net price is \$231.00. Circle 216

AUDIO MEASUREMENT COURSE

(from page 38)

ingful "answers" in both harmonic distortion and intermodulation measurements and has gained some acceptance in the former: could it not also be extended to transient measurements?

We believe it can. Nulling would be extremely difficult if the conventional tone-burst pattern is used, because not only must the modulated tone be nulled, the modulating signal is essentially a square wave, which produces a virtually infinite spectrum to be nulled.

A sinusoid modulated by a sinusoid is very much easier to null, because it contains only three frequencies—a carrier and two sidebands. This kind of envelope differs from the two-frequency intermodulation test, using two high frequencies, mainly in the choice of modulating frequency. For the intermodulation test, the difference frequency is low audio, usually 60 or 100 Hz. For this test the modulating frequency should be sub-audio producing sidebands spaced from the carrier by a sub-audio difference frequency.

The rate of fluctuation of the audio tone should be below the pass-range the amplifier is intended to handle, say 1 or 2 Hz. With this change, the nulling method becomes quite similar to that for the CCIF test, using input/output null. The metering of the nulled result will need a longer time constant, to average over the period of the modulation. But this presents no basic difficulty.

If desired, the modulating envelope can be other than the simple sine wave. A successive growth, hold, and decay that could be analyzed into a fundamental with third through seventh or ninth harmonics, with a basic fluctuation rate of once or twice per second, would only spread the range of test frequency components over ten or twenty Hz from the center (input) frequency. This would still null quite readily with the configuration used for the CCIF test.

It is also advisable to try various ultra-low fluctuation rates, because the kind of defect this will find may include

effects due to supply-circuit time constants. Distortion may be emphasized at a particular rhythmic rate of transient fluctuation.

So much for measuring straight amplifiers. With our next installment, we'll start considering the measurement of more specialized pieces of equipment, such as preamplifiers with equalization, following which we will go on to phonograph pickups and turntables, tape recorders and tuners, microphones and loudspeakers, and so forth.

Meanwhile, to sharpen your own thinking, try to think what differences will be necessary in measuring equipment with equalization, as compared with amplifiers whose response is essentially "flat." Can all the measurements we have described for amplifiers be applied, or modified in some way, to be useful for preamplifiers including equalization? This we'll take up in the second series, starting in the July issue.

Æ

We may not sell you what you THINK you need:

Some problems don't have pat, obvious answers. For instance . . . The NEUMANN U-67 Condenser Microphone is one of the most versatile ever invented, yet it may not be the best choice for your particular purpose. We are probably as valuable a source for application information as we are a supplier of some of the finest sound equipment in the world. It's our way of doing business. We know good advice makes friends *and* customers. NEUMANN, EMT and our many other manufacturers provide the optimum professional quality . . . we'll help you apply it with effect.



GOTHAM
AUDIO CORPORATION

2 WEST 46TH STREET, NEW YORK, N.Y. 10036. 212-CO 5-4111
In Canada: J-Mar Electronics Ltd.



© 1966

SETTING THE PACE WITH ENGINEERING KNOW HOW AND UNEXCELLED IMPORTED PROFESSIONAL AUDIO SYSTEMS

Circle 125 on Reader Service Card

BOYNTON HAS IT!



THE NEW SYNCRON AU-7a CONDENSER MICROPHONE

FOR PREMIUM SOUND PICKUP
AT A FRACTION OF USUAL COST!

At last! An American made quality condenser microphone in a self-contained 9 3/4" unit that is reshaping the recording industry.

Now . . . P. A. engineers, broadcasters, studios and audiophiles can utilize the full potentials of "condenser" sound without the bulk and expense of conventional condenser mikes.

Connect the cable and it's ready to go. Over 2500 hours transistor battery life with low cost mercury cells.

Frequency range: ± 3 db 40-20,000. Directional characteristics: cardioid, with front to back ratio of better than 20 db.

Output level: ± 50 db. Distortion: less than 0.5%. Rugged diaphragm provides broad, smooth frequency response with total absence of annoying peaks. Maximum sensitivity, outstanding clarity of sound. **PRICE \$16950**

ONLY SYNCRON MAKES IT. ONLY BOYNTON SELLS IT.



BOYNTON STUDIO DEPT. A10
295 Main St., Tuckahoe, N.Y. 10707 Tel. (914) SP 9-5278
SOLE DISTRIBUTOR FOR
SYNCRON AU-7a CONDENSER MICROPHONE
Dealerships available
Circle 126 on Reader Service Card

AUDIO ETC.

(from page 12)

2. The Holy Ghost

Sometimes the strangest subjects get tangled up with my hi fi. Recently, I got about the best explanation I'd ever had for a concept in religion that has always been abstruse for those not in the know, though simply a matter of faith and belief for those who do understand. I'm telling this without the slightest intent towards ribaldry, nor with any idea of disrespect towards an exalted and very ancient conception, no less than the Holy Ghost, the third part of the Trinity.

You see, many religious people accept these three Persons of the Divinity without needing to think—They are just comfortably and permanently *there*, and always have been. The Father, the Son and the Holy Ghost. All three of Them. Other people, whose faith is perhaps of a simpler sort, do not so often contemplate the Trinity, or perhaps do not find the concept at all within their own area of faith.

And so it is left to a relative few to stop, and to think, and to question with real perplexity—what *is* the Trinity? How come there are Three? If Jesus, in Christianity, is the Son, and the Lord is His Father, and ours, then who is the Holy Ghost? It is a perfectly honest question and one that any ministerial or priestly expert will be glad to answer in his own informed terms.

Now it happens that the second record sung by the Canby Singers, under my direction, just out on the Nonesuch label, is entitled "The Dove Descending". Those words are from a poem by the late T. S. Eliot, a part of his famous "Four Quartets", called "The Dove Descending Breaks the Air". Igor Stravinsky set the short text to twelve-tone music in 1962. And in 1965 the Canby Singers recorded the music. Hence our title.

The dove is symbolic, both in the Eliot poem and in numerous places in the Bible. It refers to the Holy Ghost. You will see representations of the Dove in countless works of art through the centuries.

And so, for a better understanding of what we were singing, I asked one of our sopranos, a very active Episcopalian, to explain the whole thing to me as well as she could. She was more than willing—and it just happens that I had lent her a stereo system a year or so ago, on which she had been able to play our *first* record ("O Great Mystery"—plug), as well as other records.

"The Holy Ghost", she said, "the Dove, is between the Father and the Son, of them both, yet beyond; it is the Spirit of the Son and the Spirit of the Father, all in one. It is the glue that binds them together." I only looked more perplexed.

Then suddenly her face lit up. She gave me a big smile and said, "I know *exactly*

how to explain it to you! You know what? You know that *thing* you hear between your stereo speakers, that's sort of in the air and behind, and around and out beyond, that comes *out* of the speakers but isn't *in* them, that gives the music a sort of *presence* entirely separate from those two speakers, and yet belongs to them and *is* of them? Well, *that's like the Holy Ghost.*"

By golly, I think she must be right! With all humility, I say that she has a fine analogy there. And so I recommend it to whatever preacher may read these words, for next Sunday's sermon. Ought to be a real good one.

Now, I think I understand the Dove and the Trinity, in all three Persons, just a bit better. For as everybody ought to know, I've always believed in stereo (very soberly, too) and my faith in its powers has never failed me. So now, quite soberly, I see no reason why the Trinity should not be compared to stereo and the Holy Ghost to the successful stereo image. I really mean it.

3. Solid State Tuners

I hereby report very, *very* briefly on three novel solid-state radio receivers I have recently been concerned with.

The first was an M3D stereo cartridge from Shure. Very efficient little receiver. Mr. K. Busch of Rutherford, N.J. reports that whenever its stylus is pushed gently against his hand, music and speech come out of the speakers. This was a bit more than he had bargained for—a real "bargain", though, at Shure's current price for this distinguished elderly model. Maybe this is the stereo tuner of the future, micro-electronicized? More likely just something micro-loose in the microcircuit.

The second receiver came built into a KLH Model Sixteen amplifier-preamp-control-center which I used last summer for an earphone amplifier, as previously reported. Late in the season, I discovered that a sexy lady who was singing in one of my ears—but not in the other—did not belong to the recording I was playing. She was quite persistent; she wouldn't stop. In fact she sang for me all the rest of the month. No matter what I did with the KLH controls, she was there, so long as the juice was on. I got to sort of like her after awhile. That's why I haven't told KLH before this. As usual, I suspect it was no more than a tiny semi-conductor—that is, another loose connection, acting as a detector. But the idea did intrigue me.

The most dismally inappropriate solid-state tuner I've ever heard of was the tuner a lady discovered in her mouth. She heard music. It was just one more semi-conductor, probably that old filling she had cracked on a piece of steak bone. I guess *that* tuner got fixed by a dentist.

THIS MONTH'S COVER

This system does not exist—yet it is not a fake nor a mock-up. It *did* exist, having been put together in 1962 by Lt. Daniel P. March, USN, while stationed in Pensacola, Florida. Transferred to Viet Nam in 1964, Lt. March dismantled the system and sold it piecemeal—intending to start all over again when he can settle down to normal living.

Lt. March tells us, "I have always been interested in good music and authentic sound reproduction, so I set my sights on the components which I felt to be the best—Bozak, McIntosh, Empire, Audio Dynamics, and Crown International."

From top to bottom, the components are: McIntosh MR-66 tuner, Crown Model 624 four-track recorder, McIntosh C20 preamp, Crown Model 300 four-track, reverse-play tape deck, Empire Model 398 with an ADC cartridge, two McIntosh MC240 amplifiers, all flanked by two Bozak B4000 Symphony No. 1 speaker systems. The two Simpson VU meters at the ends of the MC20 indicate the sound

level fed to the speakers.

The cabinet stands about 7 ft. tall, and is made of oiled walnut to match the speaker enclosures. The amplifiers are mounted in its base, and ventilated by a small Whisper fan mounted between them. The entire cabinet—nicknamed "The Coffin"—is mounted on rollers, which made it possible to move all 500 lbs. of it out for servicing, which is easy since each component is mounted on its own shelf accessible through the full-length ventilated door at the back.

Although some of the components are "old" by today's standards, the system is still—in our opinion—of a notable design. We are sure that Lt. March will come up with a "bigger and better" rig when he has the opportunity.

All the equipment was purchased from F.T.C. Brewer Co. of Pensacola, while the owner-designed cabinet was built by Hugh White of the same city. Photograph taken by Mr. R. E. Fields, Jr., of Pensacola.

ARTIFICIAL REVERBERATION

(from page 20)

sidered the optimum reverberation time for the full bandwidth. Note that all frequencies should have the same inherent decay time (addition of the total values of D_1, D_2, D_3, D_4 , and so on) of approximately one second. The individual delay of any one travel time seems to become annoying after travel times of 30 to 40 milliseconds. After individual delay times of approximately 67 milliseconds are passed we can consider these echos and, as a result, highly undesirable. Again however, bear in mind that these values can depart substantial amounts depending on the type of music—requiring smaller values for speech, and permitting larger values for organ, for example.

If all this tends to be somewhat confusing and rather complicated to attempt to produce synthetically, remember that in addition to the generation of these signals sufficient over all compensation must be applied to the complete system to reject or reduce as much as possible the actual detrimental acousti-

cal properties of the room containing the sound equipment. In smaller rooms this aspect of the problem becomes almost as critical as the generation of the desired reverberation signals. Æ

¹At the time the decision was made to release the data described thus far it was thought that equipment to synthesize such delay and decay signals electronically were well known to the industry. Since that time, however, it has been found that devices of this nature are individual in design and not generally available. For this reason it becomes necessary to withhold certain design specifications until suitable circuit and system protection can be obtained.

²This statement is not technically correct since the sounds do change slightly as a result of the distance traveled. In addition to the somewhat better blending of the orchestra, the listener is subject to many additional paths for the music to travel between the orchestra and himself such as reflections between the walls and overhead and at times the floor. This effect is demonstrated quite clearly when recordings that were made in an open-air concert stage are compared to a studio recording of the same selection by the same orchestra.

ABOUT MUSIC

(from page 14)

had been removed from the hall. To recapture the missing warmth, intimacy, and presence, we restored several rows of chairs to various parts of the hall. The sound improved at once, as we anticipated; moreover, the slight damping brought about an improvement in stereo separation.

After two hours of scampering up and

down the stairs leading from the auditorium to the monitor room, raising or lowering microphone booms, sliding risers in and out of position, erecting baffles, and moving chairs, the sound at last was in proper focus. To the casual observer the final orchestral setup would not have appeared radically different from the original. But in the control room the sound-

Up- grade your sound !

Whatever your receiver or amplifier is capable of doing, EMI loudspeakers have a unique way of making it sound better.

Perhaps it's the ease with which EMI loudspeakers project sound. So smooth and natural, it seems to float on the air in all its concert hall glory. Filling the room.

Or perhaps, it's the deep bass, the incomparable realistic midrange and the full, silky highs.

Or it could be the subtle detailing of their transient perfect response that catches you unawares.

So, for better sound from your receiver or amplifier, come on up to EMI loudspeakers.

There's an EMI loudspeaker to meet any requirement and budget. From \$49.95* to \$395.00*

**Slightly higher in South and West*

EMI / SCOPE

Scope Electronics Corporation
470 Park Avenue South
New York, New York 10016
Also available in Canada.

Circle 127 on Reader Service Card



this



leprechaun
will charm you

Try recording just one reel of Irish tape. You'll be enchanted by the clarity and crispness of response. Friends will call you a "pro"—but you'll know that the Leprechaun was working for you. Ask for Irish at better stores. Happily, at popular prices.



WITH
ferro-sheen®
PROCESS



Write for catalog describing complete Irish line sizes and technical specifications.



IRISH MAGNETIC RECORDING TAPE

458 Broadway, New York, N.Y. 10013

Circle 128 on Reader Service Card

picture had gradually shifted from confusion to clarity, from blur to sharp focus, and from distortion to balance. All of which makes recording such an exciting musical experience. **Æ**

TRACKER

(from page 22)

from the position of the pickup as it is moved by the groove and the output is used to keep the stylus bar tangent (at the stylus) to the groove radius.

The sensing device shown in Fig. 5 uses two photo-resistor cells, a mask, and a miniature lamp as a light source for the cells. The mask is mounted directly on the arm pivot while the photo-resistor cells and lamp are fixed to the cartridge. As an error angle is generated the mask is moved, blocking the light from one of the cells and illuminating the other cell more. Since the resistance of a cell varies with the amount of light falling on it, the cells can be used to unbalance a bridge circuit that in turn can vary the excitation to the amplifier. (See Fig. 6.) A block diagram of the system is shown in Fig. 7.

The motor is 60-Hz capacitor type with two windings, one of which is center-tapped. This type of motor was selected because of its ability to be driven in two directions by a rather low-power amplifier.

Performance

The tracking error of the servo arm can be made much smaller than a tangent arm. The one pictured in the photograph tracks well within $\pm \frac{1}{4}$ deg. In general the tracker error of the servo arm depends on how sensitive the sensing device is and the amount of gear reduction the motor—the more reduction the slower and more precise is the tracking.

The arm of the tracker was made no longer than it had to be for ease in changing records. Since it is about 3 inches shorter than conventional arms its mass is that much less, which results in improved tracking.

As high fidelity pickups continue to be perfected (especially with respect to compliance) it becomes obvious that they are also becoming more and more delicate, putting more stringent requirements on the tone arm. It may become necessary to use arms like the groove tracker to take full advantage of future pickups. **Æ**

¹Maximilian Weil, "Facts Behind Stereo Hi Fi," 1961, BW Printers, N. Y.

²F. Langford Smith, Radiotron Designers Handbook," Fourth edition, p. 726. Wireless Press.

³Julian D. Hirsch, "Hi-fi pickup arms," Radio Electronics, Feb. 1958



*If you were buying a speaker system,
which one would you choose?*

Don't let beauty sway your mind. Think performance only. The one on the left is the new Empire Grenadier 8000P, world's most perfect speaker system. It's the only speaker system that features a revolutionary wide angle die-cast divergent acoustic lens, assuring fuller frequency and separation, plus broader sound propagation (over 50% more sound dispersion of its highs and mids than conventional speakers). Its exclusive dynamic reflex stop system allows you to adjust the bass and treble response to suit your individual room acoustics. Lets you sit anywhere, hear everything. Can a piece of furniture that elegantly styled really deliver such performance? Only a live demonstration will bear it out. Visit your Empire dealer today. For complete color literature write:

EMPIRE SCIENTIFIC CORP.,
845 STEWART AVE., GARDEN CITY, N.Y.

Circle 129 on Reader Service Card

TAPE GUIDE

(from page 56)

Microphone Transformer Connections

Q. Can you suggest why my microphone, when wired for low-impedance output, will not work properly when connected to the high-impedance input of my tape recorder via a line-matching transformer? I followed the directions in connecting the microphone, and also in connecting the line transformer. The end result, as far as I can tell, is a balanced line except for grounding of the center tap. In my case, the secondary of the mike output transformer is hooked to the secondary of the line transformer and neither is grounded.

A. If, as you say, "the secondary of the mike output transformer is hooked to the "secondary of the line transformer," there is your trouble; the secondary of the mike output transformer should be connected to the primary of the line transformer. However, if your error is only in describing your hookup, I suggest that you recheck all connections very carefully, including those involved in wiring your microphone for low-impedance output.

2-Track/4-Track Compatible

Q. Are quarter-track stereo heads compatible with half-track stereo tapes?

A. Essentially yes. The present RIAA standard for half-track stereo calls for an island at least 30 mils (thousands of an inch) wide in the center of the tape, and permits each track to be recorded to the respective outer edge of the tape. Nominal tape width is 246 mils, so each half-track can be at most 108 mils wide ($2 \times 108 = 216$; $216 + 30 = 246$). Under the RIAA standard for quarter-track recording, each track may be at most 43 mils wide, and in this case each island between tracks would be 24 mils wide. Also, assuming a nominal tape width of 246 mils, the uppermost track must start 1 mil below the tape edge, and the lowermost track must start 1 mil above the tape edge. The lower gap of a quarter-track stereo head spans track 3, and the upper edge of track 3 (and of the lower gap) is 111 mils above the lower edge of the tape on the basis of the above specifications. However, as previously indicated, the lower track of a half-track recording would extend only 108 mils above the tape edge. Thus the lower gap of a quarter-track stereo head would not fall wholly within the lower track of a half-track tape. Still, the loss of 3 mils out of a possible 43 is not serious. As for the upper gap of a quarter-track stereo head, it would fall wholly within the upper track of a half-track recording.

It must be recognized that the RIAA standard does not require a half-track recording to be 108 mils wide. It only requires an island of at least 30 mils. To the extent that the island is made wider, the recorded track becomes narrower, and even more of the lower gap of a quarter-track



If you're not impressed with these 10 exclusive features in the new Uher[®] 9000 tape deck,

listen to this.



For a demo visit your hi-fi dealer or write for literature, Martel Electronics, Los Angeles: 2356 South Cotner, New York City: 1199 Broadway; Chicago: 5445 North Lincoln Avenue. End wasted tape. Send for the new Martel "Tape Tabulator" for the timing of classical repertoires (\$2.75 value). Dept. B, California office. Enclose 25 cents for postage and handling. Sound begins and ends with a Uher Tape Recorder.

Circle 130 on Reader Service Card

The 5th AUDIO Anthology

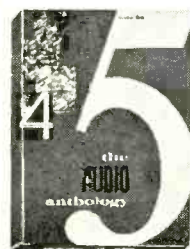

No. 125 \$3.50

Edited by C. G. McProud, publisher of AUDIO. An anthology of the most significant articles covering: stereo recording and reproduction; stereo multiplex; measurements; stereo technology, construction and theory—which appeared in AUDIO during 1958 and 1959. The 5th is truly a collectors' item and a valuable reference for the professional engineer, teacher, student, hobbyist and hi-fi fan. 144 pages.

The 6th AUDIO Anthology

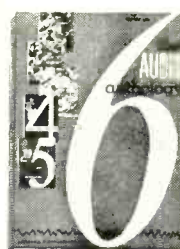

No. 130 \$3.95

Edited by C. G. McProud, publisher of AUDIO. Includes articles on the two most significant milestones in the field of high fidelity: FM STEREO and TRANSISTORS IN AUDIO EQUIPMENT. A meaningful reference for everyone in the fields of audio engineering, recording, broadcasting, manufacturing and servicing of components and equipment. A necessary book for the high fidelity enthusiast. 144 pages.



The 7th AUDIO Anthology

Edited by C. G. McProud. A compendium of articles relative to the art of high fidelity reprinted from AUDIO Magazine. A valuable reference tool for the audio hobbyist, the latest edition of this great series. 144 pages.

No. 135 \$3.50

SPECIAL

Order all three

SAVE \$3.00

Circle 567

YOUR COST \$7.95

AUDIO Bookshelf—AUDIO MAGAZINES, INC.
P. O. Box 629, Mineola, New York 11501

*All U.S.A. and Canadian orders shipped postpaid.

Please send me the books I have circled below. I am enclosing the full remittance of \$..... (No C.O.D. or billing.)

125 130 135 567

NAME _____
ADDRESS _____
CITY _____ STATE _____ ZIP _____

WORLD'S FINEST
5-CORE SOLIDER

ERSIN MULTICORE
NEW EASY DISPENSER PAK ONLY **69¢**

BUY IT AT RADIO-TV PARTS STORES
MULTICORE SALES CORP., WESTBURY, N.Y. 11590
Circle 132 on Reader Service Card

Live Better Electronically With

LAFAYETTE RADIO ELECTRONICS

FREE!

512 Pages
1966 Catalog
660

Featuring Everything in Electronics for
• HOME • INDUSTRY • LABORATORY
from the
"World's Hi-Fi & Electronics Center"

Mail the Coupon Today for Your
FREE 1966 Lafayette Catalog 660

LAFAYETTE Radio ELECTRONICS
Dept. AC-6, P.O. Box 10
Syosset, L.I., N.Y. 11791

Send me the Free 1966 Lafayette Catalog 660 AE-6

Name _____
Address _____
City _____
State _____ Zip _____
(Please Give Your Zip Code No.)

Circle 133 on Reader Service Card

stereo head would fall outside (above) the lower track of a half-track tape. It should be further recognized that at one time half-track stereo recordings employed tracks only about 90 to 100 mils wide. In such a case, an appreciable part of the lower gap of a quarter-track stereo head would extend above the lower track of a half-track recording, and there would be significant signal loss. You may recall that at one time some stereo tape machines made provision for moving the quarter-track playback head up and down, respectively for playing quarter-track stereo tapes and half-track stereo tapes. Other machines made no such provision, perhaps because the manufacturer felt that the problem of azimuth disturbance (when moving the head) outweighed the problem of signal loss.

Reference Book

Q. I have read your books on tape recorders. Can you recommend further reading in the nature of a design handbook or text that will give me more technical information on the design of tape recorder circuits?

*A. An excellent advanced book on tape recorders is the one by W. Earl Stewart, *Magnetic Recording Techniques*, published by McGraw-Hill.*



Prevent heartbreak and hunger across the world — each dollar sends a Food Crusade package through CARE, New York 10016.

SELL: Marantz 8B stereo amplifier, \$170; Marantz mono preamp with cabinet, \$65; Electro-Voice 636 microphone, \$29. New condition. R. J. Vanderbilt, 38 W. River Road, Rumson, N. J. 07760.

Ampex console cabinet for 351, brand new, \$125. Marantz audio consolette (mono), \$65. Tom Rose, 3410 Rockbluff, Dallas, Texas 75227.

WANTED: Questar telescope manufactured by Quesar, New Hope, Pa. Send price, age, and condition to Box 343, Wausau, Wis. 54401.

CANADA
High Fidelity Equipment
Complete Lines • Complete Service
Hi-Fi Records — Components and Accessories

ELECTRO-VOICE SOUND SYSTEMS
126 DUNDAS ST. WEST, TORONTO, CANADA

Circle 141 on Readers Service Card

CLASSIFIED

Rates: 10¢ per word per insertion for noncommercial advertisements; 25¢ per word for commercial advertisements. Rates are net, and no discounts will be allowed. Copy must be accompanied by remittance in first of the month preceding the date of issue.

HIGH FIDELITY SPEAKERS REPAIRED
AMPRITE SPEAKER SERVICE
168 W. 23rd St., New York, N. Y. 10011
CH 3-4812

HARPSICHORD: Same as owned by Philadelphia Orchestra and RCA Victor. In kit form for home workshop assembly, \$150. Clavichord kit, \$100. Free brochure. Write: Zuckermann Harpsichords, Dept. R, 115 Christopher St., New York, N. Y. 10014.

HI-FI SPEAKERS EXPERTLY REPAIRED
USED SPEAKERS BOUGHT
AUDIO SPEAKER TECHNIC'S
22 Astor Place, New York, N. Y. 10003
AL 4-2140

PRESSINGS FROM YOUR TAPES, WHOLESALE PRICES, SPECIALIZING IN SMALL QUANTITIES, DUBLE DUBLYU RECORDINGS COMPANY, 221 Carton Avenue, Neptune, N. J. 07753.

ANY RECORD PUT ON TAPE: Single, I.P. stereo. Quantity prices, 1 or 100. Write John G. Ellis, Box 15852, Del Valle, Los Angeles, California 90015.

FREE! Send for money saving stereo catalog A5M and lowest quotations on your individual component, tape recorder, or system requirements. Electronic Values, Inc., 200 West 20th St., New York, N. Y. 10011.

STEREO REVERBERATORS for experimental application, \$7. Mono, \$5. Cal's, Box 234, Dearborn, Michigan.

5-YEAR INDEX TO STEREO EQUIPMENT TEST REPORTS appearing in 15 American and British periodicals. 1700 reports (1961-65) listed by type of equipment, \$2.00. J. B. Woy, P. O. Box 4216, Philadelphia, Pa. 19144.

FOREMAN: Supervise 15 to 35 people; electronic and mechanical assembly; military audio devices. Call (201) 248-1330, Newark, New Jersey.

NEW, an innovation in record care, removes dust right out of the bottom of the record grooves. No static attraction, no added weight to tone arm. Easy installation to either turntable or automatic changers. Complete instructions, \$1.00 ppd, satisfaction guaranteed. Val Tek Labs, 609 O'Connor Ave., La Salle, Ill. 61301.

SERVICE TECHNICIAN for major professional equipment importer. May expand into sales engineering, background from recording or broadcasting essential. Salary open. Write: Gotham Audio Corp., 2 W. 46th St., New York, N.Y. 10036.

HEATHKIT AUDIO ENGINEERS
Heath Company, the world's largest manufacturer of electronic equipment in kit form, has requirements for Audio Engineers. Interested individuals should have BSEE, and a background of solid-state design is desirable. Experience: 0-3 years. Write to:
W. F. Donahue
Director of Personnel
Heath Company
Benton Harbor, Michigan 49022
An Equal Opportunity Employer

WANTED: McIntosh NC240, MC275; Marantz 8B; quality receiver, turntable, changer, recorder, speakers, tweeters. Specifics, sealed envelope: Joe Wheeler, 2664 Benny, Rancho Cordova, California 95670.

MAGNECORD: M-81 professional full-track recorder 7½ and 15-in custom Formica cabinet. Original price, \$1,265.00. Sale price, \$395.00. D. F. Taylor, Box 125, Mill Creek Road, Hockessin, Delaware 19707.

SELL: JBL 130A, \$51. Wharfedale W15/RS, \$40; Altec 416A (2), \$36 each; Citation A, \$135; Fisher FM 200B, \$125; Citation II, \$60; Fisher 400CX, \$80. Bell RT360, \$240. Rek-O-Kut B121, \$60. Pratt, 2908 Waveland NW, Cedar Rapids, Iowa 52405.

Bulk Erasing

Q. Can you explain how to bulk-erase tape without leaving residual magnetism in the form of very-low-frequency thumps or disturbances? For years I have followed all the instructions carefully. I rotate the reel on the degausser, turn it over, and move it away very slowly before releasing the "on" button. Nevertheless, some magnetism is invariably left on the tape. This is seldom a problem in normal operation because of the extremely low frequency of the disturbances. But it is noticeable when rewinding fast across the head.

A. I haven't encountered the problem of low-frequency disturbances with bulk erased tape, perhaps because I haven't looked for them, perhaps because I erase very carefully, perhaps because my tape machine lifts the tape away from the heads during rapid wind. I would first suggest that you find some way of lifting the tape away from the heads during rapid wind. This can often be done by simply removing the tape from the tape slot and winding directly from reel to reel. Another method is to insert a piece of smooth celluloid between the heads and the tape during rapid wind (this also protects the heads from undue wear). Finally, I can describe the bulk eraser and erasing procedure that I use, with the thought that you may find a clue here to solving your problem: The bulk eraser is one I made from a hefty power transformer weighing about six pounds. I removed the E and I plates from the core, threw away the I plates, and replaced the E plates *all in the same direction*, leaving a powerful electromagnet which can be used about one or two minutes before heating substantially. Before bringing the tape reel in the vicinity of the eraser, I turn the latter on. I gradually bring the reel of tape to the eraser, then remove it gradually while describing a rotary motion so as to cut all parts of the magnetic field. I turn the reel over, again bring it to the eraser, remove it very gradually while describing a rotary motion, and slowly bring the reel to a resting place about 10 feet away. Then I shut off the bulk eraser.

Dep't of Easy Answers

Q. I have a **** tape deck and a *** amplifier. Everything seems to work except the following: (1) If I hook the monitor outputs of the deck to the monitor jacks of the amplifier, I get no sound, although at first I did for a very short time. (2) If I hook the monitor outputs of the tape deck to the auxiliary inputs of the amplifier, the deck plays back all right. (3) If I hook the amplifier outputs of the tape deck to the monitor jacks of the amplifier, it monitors all right but not as loud as the hookup described in (2) above. I had the tape deck checked by the authorized service agency for my tape machine, and they could not find anything wrong. Would you kindly explain why the amplifier jacks work for one circuit but not for another, Can you suggest any remedy?

Q. (Two days later). Please ignore my letter of several days ago regarding trouble with my **** tape deck. It suddenly began to function. I do not know why. May-

be a screw was shorting something. Thank you.

A. I wish they were all that easy.

Editor's Note

The Tape Guide column in the February issue erroneously stated Mr. Burstein's belief that the RIAA standards of tape equalization are the first officially promulgated for 7.5 and 3.75 ips. Mr. Burstein has informed us that John G. McKnight of the Ampex Corporation has written to state that the NAB Standard Magnetic Tape Recording and Reproducing (Reel to Reel) April 1965 did cover these speeds. Mr. Borstein extends his apologies to all concerned.

EQUIPMENT PROFILE

(from page 52)

As with most transistor amplifiers, actual power is dependent upon the load. So that at 4 ohms, the 342 delivers 25 watts per channel. At 8 ohms this is reduced to an 18-watt figure; at 16 ohms it is 10 watts. Power bandwidths for the various loads are constant extending +0, -2 dB from 50 to 20,000 Hz. Over-all 1-watt response was measured at ± 1.5 dB from 15-30,000 Hz.

Amplifier IM distortion, the downfall



S-10
SYNCRON
SOLID STATE

**CONDENSER
MICROPHONE**

Self Contained Convenience

FET circuitry eliminates external power supply • Permanently polarized
Powered by 1000-hour battery • Frequency Response: 40 — 20,000 Hz
Pressure gradient • Mylar diaphragm • Cardioid Pattern • 20 db discrimination
• No overload protection needed • Low noise (less than 23 db)
High output (-53 dbm) • Connector is on-off switch • Beautiful satin
nickel finish • Only 9 ounces with battery • Full accessory line • Wind
screen • Elastic suspension • Desk stand • Fully guaranteed • \$240 com-
plete (with battery, case, swivel mount, 20-feet of cable) • Made in U.S.A.

SYNCRON CORPORATION
WALLINGFORD, CONN., U. S. A.

Circle 135 on Reader Service Card

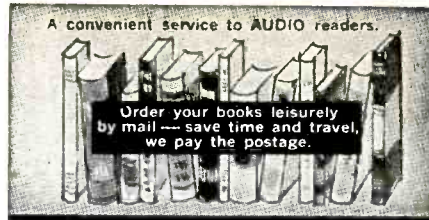

Maintaining Hi-Fi Equipment
Joseph Marshall
 A valuable reference for anyone whose living or hobby is servicing hi-fi equipment. Outlines the professional approach for servicing all types of hi-fi components. Covers trouble-shooting of electronic, mechanical and acoustic problems. 224 pages.
No. 58 Paperback \$2.90*

Designing and Building Hi-Fi Furniture
Jeff Markel
 Written by a professional hi-fi furniture designer who has taught furniture design at leading colleges, this book is an authentic reference of value to the hi-fi fan and professional custom builder. Covers everything from types of woods to furniture finishing for the mechanically adept; design principles, styles and arrangements for the decor minded. 224 pages.
No. 79 Paperback \$2.90*

HI-FI TROUBLES
 By Herman Burstein
HOW YOU CAN AVOID THEM HOW YOU CAN CURE THEM
 Just published! At last, a book which deals directly with the problems you face in maintaining your audio system in peak condition. Tells you how to locate troubles, what to do about them and how to do it—and, just as important: what NOT to do. Helps you to achieve the best in listening pleasure from your equipment.
No. 120 \$3.95

McProud High Fidelity Omnibook
 Prepared and edited by C. G. McProud, publisher of AUDIO and noted authority and pioneer in the field of high fidelity. Contains a wealth of ideas, how to's, what to's, and when to's, written so plainly that both engineer and layman can appreciate its valuable content. Covers planning, problems with decoration, cabinets and building hi-fi furniture. A perfect guide.
No. 115 \$2.50*

The 5th AUDIO Anthology
 Edited by C. G. McProud, publisher of AUDIO. An anthology of the most significant articles covering: stereo recording and reproduction; stereo multiplex; measurements; stereo technology, construction and theory — which appeared in AUDIO during 1958 and 1959. The 5th is truly a collectors' item and a valuable reference for the professional engineer, teacher, student, hobbyist and hi-fi fan. 144 pages.
No. 125 \$3.50

"The AUDIO Cyclopaedia"
 Howard M. Tremaine
 • 1280 pages
 • 3400 topics
 • 1600 illustrations
 Here is one single volume with the most comprehensive coverage of every phase of audio. Concise, accurate explanations of all audio and hi-fi subjects. More than 7 years in preparation—the most authoritative encyclopedic work with a unique quick reference system for instant answers to any question. A vital complete reference book for every audio engineer, technician, and serious audiophile.
No. 123 \$19.95*

Tape Recorders and Tape Recording*
Harold D. Weiler
 A complete book on home recording by the author of *High Fidelity Simplified*. Easy to read and learn the techniques required for professional results with home recorders. Covers room acoustics, microphone techniques, sound effects, editing and splicing, etc. Invaluable to recording enthusiasts.
No. 112 Paper Cover \$2.95*

"the best of AUDIO"
 edited by C. G. McProud
 A new compendium of AUDIO knowledge. Here is a collection of the best of AUDIO — The AUDIO Clinic by Joseph Giovanelli, noted audio engineer and the original high fidelity answer-man — EQUIPMENT PROFILES edited by C. G. McProud, Editor of AUDIO. Here is a wealth of hi-fi and audio information. Answers to the most important issues in high fidelity and a valuable reference.
No. 124 Volume I \$2.00*

The 6th AUDIO Anthology
 Edited by C. G. McProud, publisher of AUDIO. Includes articles on the two most significant milestones in the field of high fidelity: FM STEREO and TRANSISTORS IN AUDIO EQUIPMENT. A meaningful reference for everyone in the fields of audio engineering, recording, broadcasting, manufacturing and servicing of components and equipment. A necessary book for the high fidelity enthusiast. 144 pages.
No. 130 \$3.95

● MONTHLY SPECIAL! SAVE \$5.00
 Save almost 50% with this collection of AUDIO books.
 "best of AUDIO" (\$2.00) 5th AUDIO ANTHOLOGY (\$3.50)
 McProud High Fidelity Omnibook (\$2.50) and
 Tape Recorders & Tape Recording (\$2.95)
TOTAL VALUE ALL FOUR BOOKS . . . \$10.95
Your cost only . . . \$5.95 Postpaid
CIRCLE OS400
 This offer expires May 31, 1966, and is good only on direct order to the Publisher

High Fidelity Simplified
 Harold D. Weiler
 3rd Edition
 The complete hi-fi story — answers all questions about tuners, changers, amplifiers, tape recorders, speakers, record players, etc. Lots of ideas for custom installations. Tells how to achieve concert hall reception in your home. 216 pages.
No. 142 \$3.30

AUDIO Bookshelf—RADIO MAGAZINES, INC.
 P. O. Box 629, Mineola, New York 11501
 *All U.S.A. and Canadian orders shipped postpaid.
 Please send me the books I have circled below. I am enclosing the full remittance of \$..... (No C.O.D. or billing.)

58	79	112	115	120	123
124	125	130	142	251	OS400

NAME _____
 ADDRESS _____
 CITY _____ STATE _____ ZIP _____

Getting The Most Out Of Your Tape Recorder
 Herman Burstein
 Written in "plain talk" for the man who has, or wishes to buy, a tape recorder. It answers the myriad questions raised by tape recording enthusiasts. Its chapters cover every phase of operation and maintenance—from adding a tape recorder to the hi-fi system, to a thorough dissertation on microphones. Lots of practical information on how to buy. 176 pages.
No. 251 \$4.25

of many a transistor unit, measured extremely well. Judge from the following table (both channels were quite close):

Equiv. Power	1M Distortion
1 w. (8Ω)	0.20 per cent
5 w.	0.12 per cent
10 w.	0.27 per cent
15 w.	0.65 per cent
18 w.	0.98 per cent

The Phono-input circuit is unusual in that a front-panel switch selects PHONO LOW or PHONO HIGH. These are the same magnetic phono inputs as on the rear panel. The two different positions serve to change the input sensitivity (and hence the overload point). At maximum sensitivity 5.9 mV will provide rated output and the overload point will be 56 mV. The other position results in 9 mv being needed for full output but 115 mV must be reached before overloading sets in. Thus, Scott offers moderately good sensitivity for owners of low-output cartridge; while high-output cartridge owners can use the 342 without encountering overloading of the input circuit.

RIAA equalization accuracy is ± 2 dB from 30-15,000 Hz. There is permanent loudness compensation added to the volume control so that at 12 o'clock settings there is an additional 3 dB of bass boost at 100 Hz. At 9 o'clock, 100 Hz boost is +9dB.

Our listening tests confirmed what our instruments found. This is a good-sounding product, providing a level of performance that far exceeds the relatively modest price asked. Plainly, we like this unit. Circle 204

SCOTT S-8 SPEAKERS.

Also included at the time we received the 342 were a pair of S-8 speakers. These are two-way systems of modest dimension, approximately 12" x 24" x 9" and finished in a glossy walnut.

They are made to be used either as separate component speakers or with the several Scott modular systems. Toward these ends, they contain dual inputs on their rear panel. The usual screw terminals are there. In addition, however, a parallel RCA-type phono female is provided. Impedance is 8 ohms and there is a continuously variable tweeter-level control.

We were duly impressed by the quality of these units. Their range is not tremendous—there is little output below 50 Hz and although rolloff commences at 10 kHz, the speakers are still usable to 15 kHz. However, the frequency sweeps we made revealed a constant output smoothness that we have not come to expect from modestly-priced speakers. In point of fact, not too many high-priced units can do better than this little S-8.

Power requirements are modest. An amplifier such as that found on the Scott 342 is more than adequate.

This speaker "listens" well. It produces a sound at once gentle and full. One of the effects we have noticed in the past is that a speaker that has no serious bumps or dips in its response appears to have wider range than is actually the case. Such is true here.

This S-8 is suitable as a modest investment for either primary or remote listening applications. Circle 205



World-Wide Products of Distinction

The Remarkable REVOX

The tape recorder acclaimed throughout the world. Is there another tape recorder anywhere that matches it? Decide for yourself:



The remarkable ReVox boasts features found only in the most expensive, professional tape recorders. Each of the two reels, for example, has its own Pabst motor. Direct coupling eliminates wow and flutter; no belts to break or slip. Tension adjustment control allows use of any reel up to 10½ inches (the only recorder in its price class that takes a 10½-inch reel.) All operating modes switched electrically.

OUTSTANDING FEATURES

- Records up to 4800 feet of LP tape • Complete 4-track stereo recorder • 10½" reels • For horizontal or vertical mounting • Cathode follower outputs • Oversize solenoid brakes assure quick, positive breaking even with extremely fast rewinding speeds • Automatic stop at end of tape • Two VU meters

The only one of its kind with these features at \$500.



JUST OFF PRESS! New book tells you how to get the most out of your tape recorder. YOUR TAPE RECORDER by Tall and Clifford only \$1

Available from your hi-fi dealer or order book directly.

ELPA MARKETING INDUSTRIES, INC. • Dept. 124A5 • New Hyde Park, N.Y.

Available in Canada

Circle 136 on Reader Service Card

Get in the groove, any groove



gently! With the Cueing Device affixed to your Miracord 40A or 40H turntable, you can locate your cartridge stylus to start play in any selected groove on the record.

It works simply and precisely, and independently of the arm and turntable mechanism. A flip of a lever raises a small platform, and elevates the arm a bare fraction of an inch, so that it can be moved across the record without touching the surface. Thus the stylus can be positioned exactly over any band or groove. Resetting the lever lets the platform (and arm) sink slowly, gently lowering the stylus into the selected groove. All Miracord 40 Series turntables are pre-drilled to accept this accessory. Price is \$12.50 at most hi-fi dealers.

Benjamin Electronic Sound Corp., 40 Smith Street, Farmingdale, N. Y. 11736

Miracord 40 Series Cueing Device

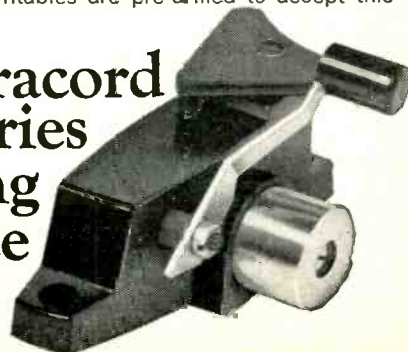

Circle 137 on Reader Service Card

FREE
STEREO
INFORMATION

FM station directory . . . covers FM stations in U. S. and Canada. Factual equipment test reports. Test reports on tuners, preamps, poweramp/preamps. Find out what the experts think. A complete 36 page catalog tells about tuners, power amplifiers, preamplifiers, preamp/power amp combinations, and tuner preamp.

ALL FREE —
JUST WRITE
TO:

McIntosh Lab. Inc. 6 Chambers St.
Binghamton, N. Y. 13903

NAME _____
STREET _____
CITY _____
STATE _____ ZIP _____

Circle 138 on Reader Service Card

LEVELING AMPLIFIERS

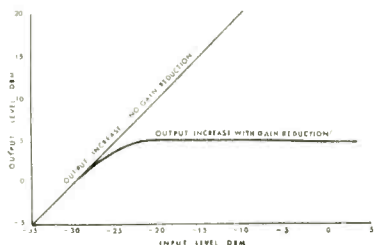

Typical gain-reduction plot

- NO LAG
- FLAT RESPONSE
- REPLACES EXISTING LINE AMPLIFIERS
- LOW NOISE LEVEL

OVER 500 IN USE BY MAJOR NETWORKS
INDEPENDENT STATIONS & RECORDING
STUDIOS

Our 8th Year Of Service To Industry

TELETRONIX ENGINEERING CO.

manufacturers of
FM Broadcast Transmitters and RF Amplifiers
Audio Relays, Solid State Remote Station Controls
Volume Levelers, FM Broadcast Antennae
308 Monterey Road, South Pasadena, Calif.

Circle 139 on Reader Service Card

Advertising Index

Acoustic Research, Inc.	25-36
Altec Lansing Corporation	55
Amperex Electronic Corporation	6, 7
Audio Bookshelf	66
Benjamin Electronic Sound Corp.	67
Boynton Studio	6
British Industries Corporation	3
Classified	64
Crown International	53
Eastman Kodak Company	49
Electro-Voice, Inc.	Cov. IV, 1
Electro-Voice Sound Systems	62
Elpa Marketing Industries, Inc.	67
EMI/Scope	61
Empire Scientific Corporation	62
Euphonics Marketing	13
Fairchild Recording Equipment Corporation	14
Finney Company	4
Garrard Sales Corporation	3
Gotham Audio Corporation	59
Harman-Kardon, Inc.	15
Heath Company	5
Hi Fidelity Center	68
Irish Tape	62
Lafayette Radio Electronics	64
Marantz, Inc.	9
Martel Electronics	63
McIntosh Laboratory, Inc.	68
Multicore Sales Corporation	64
Pickering & Company, Inc.	17
Pioneer Electronic Corporation	51
Roberts Electronics	8
Scott, H. H., Inc.	Cov. II
Sherwood Electronic Laboratories, Inc.	18
Shure Brothers, Inc.	47
Stanton	Cov. III
Superscope, Inc.	57
Syncron Corporation	65
Teletronix Engineering Company	68
University Sound	11
Willy, John & Sons, Inc.	68



*A comprehensive book
on all types of
audio systems . . .*

AUDIO SYSTEMS

By JULIAN L. BERNSTEIN,
RCA Institutes

Covers all of the major circuits employed in the audio portion of sound studios, broadcast and TV stations, and hi-fidelity systems. Discusses fully the concepts of decibel notation and resistive attenuator networks, mixing circuits, bridging circuits, amplifiers (both tubes and transistor amplifiers are treated side by side), recording devices, equalizers for studio and hi-fi use, and concludes with descriptive material on microphones and loudspeakers. Contains material not previously available; for example, the sections on equalizers and mixers. Mathematical analysis of important circuits, and thorough-going verbal descriptions of all circuits are given. 1966. 409 pages. \$4.50 paper \$7.95 cloth.

Available from your bookseller, or

JOHN WILEY & SONS, INC.
605 THIRD AVENUE
NEW YORK, N. Y. 10016

Circle 140 on Reader Service Card

SAVE MORE

On HI-FI

COMPONENTS & TAPE RECORDERS

- Easy-Pay-Plan—Up to 24 mos. to pay.
- 15 day money-back guarantee.
- Our guarantee — unconditional — 2 yrs. parts & labor, except stylus and tape heads 90 days.
- Most items shipped promptly from our \$250,000.00 inventory.
- Trade-Ins—Highest allow—Send your list.
- Shipments double packed & fully insured.
- Special consideration — Export & APO inquiries.
- 21st yr. dependable service—World Wide. Write for our price first. You'll be glad you did.

"We own the sharpest pencils in the U.S.A."

HI-FIDELITY

CENTER
"The House of Low Low Prices"

239 U East 149 St.,
New York, N. Y. 10451

Circle 141 on Reader Service Card



PHOTOGRAPHED AT CAPITOL RECORDS BY FRANZ EDSON

Good records start with Stanton.

A professional needs to know for sure. When he listens to a test pressing, he needs a cartridge that will reproduce exactly what has been cut into the grooves. No more, no less. Otherwise he would never be able to control the final product. The record you buy in the store.

That's why the professionals keep using Stanton. It tells them the whole truth, and nothing but.

In the photograph above, studio engineers are shown listening to

a test pressing. This is a critical stage in record making. The stereo playback system they are listening through is fronted by a Stanton 581 EL Calibration Standard. (The turntable also happens to be a Stanton. Other fine turntables will work, too.) They're getting the whole message. You'll get it, too, in an upcoming release.

Each Stanton Micro FLUX-VALVE® Calibration Standard is custom made. That means that

each will perform exactly as the original laboratory prototype. We laboriously adjust them until they do. It also means that you will get the same accuracy that the professionals get. Guaranteed.

Stanton Calibration Standards are hard to make. And the price reflects it. \$49.50. But that really isn't much to pay for uncompromising accuracy.

STANTON Stanton Magnetics, Inc. Plainview, L. I., N. Y.



Circle 102 on Reader Service Card



ELECTRO-VOICE, INC., Dept. 564A, Buchanan, Mich. 49107

Of Beetles, Beatles, and Beethoven!

The new E-V SEVEN speaker system—like the VW beetle—is not for everyone. You have to be someone special to appreciate its value.

That's because the E-V SEVEN doesn't go along with the crowd. There are no claims that it's the world's finest loud-speaker regardless of size—none of that malarkey. (You know better, and so do we.)

So let us show you how much rare value we've packed into this practicalized cabinet. Value you'd not suspect

in a speaker this size.

First off: it really fits a bookshelf. Just 9" deep, 10" high, 19" wide. Easier to park anywhere you want to play it.

Then the sound: it starts with an honest 50 cps from the 8" acoustic-suspension woofer. On up—smoothly—to 15,000 cps from the 3½" cone tweeter.

And no mere switch or volume control adjusts the highs. An expensive RC network actually "tilts" the E-V SEVEN's response—up or down—from flat to, whatever your room may need. Con-

tinuously smooth. Absolutely unique.

You can put up to 50 watts peak power into the E-V SEVEN: no strain, just music. Beethoven. The Beatles. Anything! All this for just \$65.00 list, in an oiled walnut cabinet finished on four sides.

The E-V SEVEN is carefully engineered, carefully constructed, and far ahead of the other compacts in value—just like the VW.



There is one big difference. We think you'll like our styling better!

Circle 104 on Reader Service Card