

AUDIO

MARCH, 1954

ENGINEERING MUSIC SOUND REPRODUCTION

50c

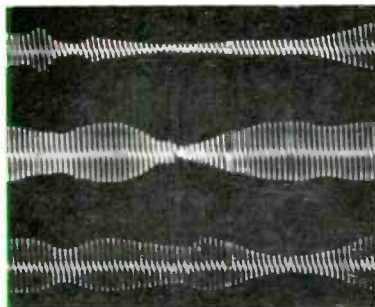

Careless splicing of magnetic tape can result in pops and noise as shown by the oscillogram. For corrective measures see page 19.



Composer-conductor Igor Stravinsky's "The Rake's Progress" is possibly the first major composition in history to be heard and judged by the public solely in a recorded version. See The Record Revolution and Music, page 29.

PLANNING YOUR HOME MUSIC INSTALLATION
PROBLEMS INVOLVED IN MAGNETIC TAPE RECORDING
THE RECORD REVOLUTION AND MUSIC
DESIGN OF A CONTINUOUSLY VARIABLE LOW-PASS FILTER

NEW HOT-SLITTING PROCESS

GIVES **audiotape** EXTRA STRENGTH

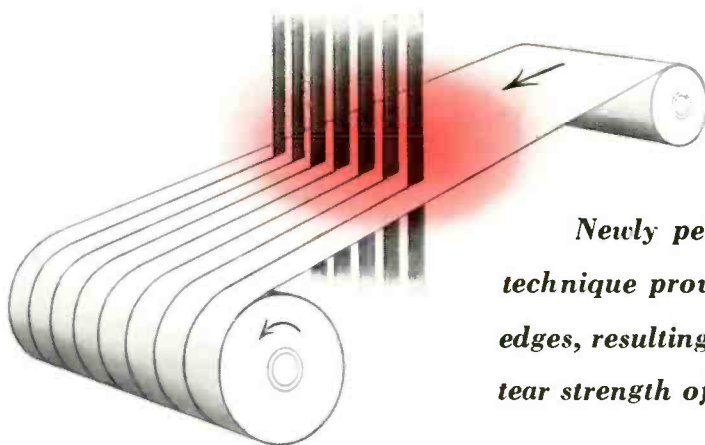

Newly perfected thermal-slitting technique provides smoother, cleaner edges, resulting in increased break and tear strength of plastic base Audiotape

IN THE manufacture of Audiotape, particular care has always been given to the slitting operation, in which the processed tape is cut into reel-size widths. Precision straight-line slitting has been one of the reasons why Audiotape tracks and winds perfectly flat and has no fuzzy edges to impair frequency response.

Now, however, even this superior slitting operation has been still further improved by precisely controlled heat application. The result, though not visible to the naked eye, is a significant increase in tape *strength*.

For thermal slitting avoids the formation of the microscopic cracks and irregularities which result, in varying degrees, from any cold slitting process. Each such defect is a source of weakness and a potential tape break.

The thermal treatment in no way alters Audiotape's *balanced performance*. Hence Audiotape not only offers you the most faithful reproduction of the original sound, but also assures the highest mechanical strength obtainable with cellulose acetate base material—all at *no extra cost*.



Audiotape is now available on this
NEW 7" PLASTIC REEL

• 2½ inch hub • more area for labeling • less chance of tape spillage • greater protection to tape • rugged, non-warping construction • distinctive, modern design

... and in colors, too!

Audiotape 7" reels can now be obtained, for special applications, in red, blue, green, yellow or clear plastic. And Audiotape is also being offered on either blue or green colored plastic base, in addition to standard red. These distinctively colored tapes offer interesting possibilities for specialized recording and filing applications. Write for further details.

AUDIO DEVICES, INC.

444 Madison Avenue,
New York 22, N. Y.

Export Dept., 13 East 40th St., New York 16, N. Y., Cables "ARLAB"

audiorecords • audiotape • audiofilm • audiopoints

AUDIO

ENGINEERING MUSIC SOUND REPRODUCTION

C. G. McProud, Editor and Publisher
 Henry A. Schober, Business Manager
 Harrie K. Richardson, Associate Editor
 Edgar M. Villchur, Contributing Editor
 Florence Rowland, Production Manager
 Edgar E. Newman, Circulation Director
 S. L. Cahn, Advertising Director
 H. N. Reizes, Advertising Manager



Representatives

H. Thorpe Covington, Special Representative
 7530 North Sheridan Road, Chicago 26, Ill.
Sanford R. Cowan, Mid-West Representative,
 67 W. 44th St., New York 36, N. Y.

West Coast

James C. Galloway J. W. Harbison
 816 W. 5th St., Los Angeles 17, Calif.

CONTENTS

Audio Patents—Richard H. Dorf	2
London Letter—Richard Arbib	6
Letters	8
Audiology—W. R. Ayres	10
Editor's Report	14
Problems Involved in Magnetic Tape Recording—Norman E. Gibbs	19
Planning Your Home Music Installation—In Two Parts, Part 1— Irving Greene and James R. Radcliffe	22
Design of A Continuously Variable Low-Pass Filter Utilizing Feedback Techniques—Basil T. Barber	26
The Record Revolution and Music—Rudo S. Globus	29
Handbook of Sound Reproduction—Chapter 17—Edgar M. Villchur	30
Equipment Report—Pilot FM-607 Tuner, AA-903 Amplifier	32
Record Revue—Edward Tatnall Canby	34
Tops in Hi-Fi Pops—Robert Sylvester	40
Audio ETC—Edward Tatnall Canby	42
New Products	48
New Literature	51
Book Reviews	58
Errata	59
Industry Notes and People	63
Advertising Index	64

AUDIO ENGINEERING (title registered U. S. Pat. Off.) is published monthly at 10 McGovern Avenue, Lancaster, Pa. by Radio Magazines, Inc., Henry A. Schober, President; C. G. McProud, Secretary. Executive and Editorial Offices: 204 Front St., Mineola, N. Y. Subscription rates—United States, U. S. Possessions and Canada, \$3.00 for 1 year, \$5.00 for 2 years; elsewhere \$4.00 per year. Single copies 35c. Printed in U. S. A. All rights reserved. Entire contents copyright 1954 by Radio Magazines, Inc. Entered as Second Class Matter February 9, 1950, at the Post Office, Lancaster, Pa. under the Act of March 3, 1879.

RADIO MAGAZINES, INC., P. O. Box 629, MINEOLA, N. Y.

**NOW! A Hi Fi Speaker System
 that is HEARD... NOT SEEN**

LORENZ
SOUND CORNER
 OFF THE FLOOR and OUT OF THE WAY

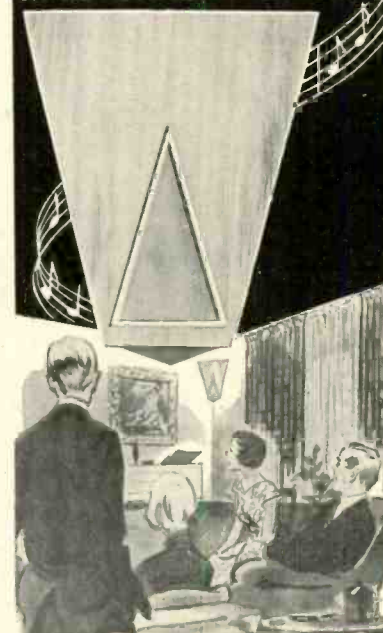

**Solves the Problem of
 SOUND—SPACE—COST**

The Lorenz SOUND CORNER—the amazing corner-wall two way speaker system is an ingenious horn design of triangular cross section which uses the walls of a room corner as two of the three rigid boundaries, the speaker baffle being the third. The SOUND CORNER uses no floor space... is as easy to install as hanging a picture on the wall, and is perfectly low-priced to harmonize with any budget.

QUALITY COMPONENTS PLUS SOUND DESIGN



Built around the LP 215 "Woofer" loudspeaker, famous for its clear tonal quality, and the brilliant high frequency LP 65 "Tweeter", the SOUND CORNER reproduces the full range from 31 to 16,000 cycles with breath-taking Concert Hall "Presence." From the smooth fundamental bass of the Organ Pedals to the sparkling "highs" of the Piccolo, the SOUND CORNER adds the Miracle of Life to the Magic of Music—a superlative complement to the finest high fidelity equipment and custom installations.

The SOUND CORNER blends deftly with any decor... can be painted easily to harmonize with any color scheme. If desired, a lamp mounting can be added with little effort to provide indirect lighting. With an overall height of only 31", the SOUND CORNER tapers down from a top width of 27 1/2" to a mere 11 3/4" at its base.

SCL SOUND CORNER—complete ready for connection to your amplifier. Available in Blonde wood only. **\$59.50**

Write for Detailed Specifications

KINGDOM PRODUCTS, Ltd.
 23 Park Place, New York 7, N. Y. • WORTH 4-8585

TO THE

E. E.

OR

PHYSICS

GRADUATE

WITH EXPERIENCE IN

RADAR

OR

ELECTRONICS

HUGHES RESEARCH AND DEVELOPMENT LABORATORIES ARE ENGAGED IN A CONTINUING PROGRAM FOR DESIGN AND MANUFACTURE OF ADVANCED RADAR AND FIRE CONTROL SYSTEMS IN MILITARY ALL-WEATHER FIGHTERS AND INTERCEPTORS.

YOU WILL serve as technical advisor in the field to companies and government agencies using Hughes equipment.

TO BROADEN your field of experience in radar and electronics you will receive additional training at full pay in the Laboratories to become thoroughly familiar with Hughes radar and fire control equipment.

AFTER TRAINING you will be the Hughes representative at a company where our equipment is installed; or you will direct operation of Hughes equipment at a military base.

THE GREATEST advancements in electronics are being made in this sphere because of military emphasis. Men now under 35 years of age will find this activity can fit them for future application of highly advanced electronic equipment.

HUGHES

RESEARCH AND DEVELOPMENT LABORATORIES

SCIENTIFIC AND ENGINEERING STAFF

Culver City, Los Angeles County, Calif.

Assurance is required that relocation of the applicant will not cause disruption of an urgent military project.

AUDIO PATENTS

RICHARD H. DORF*

THIS WRITER has no intention of getting into a controversy over the merits, if any, of eliminating amplifier output transformers. There seems, in any case, to be some interest in the subject, even to the production of at least one commercial version of such an amplifier. So, like the printer whose traditional oath of office requires him to follow the copy even if it goes out the window, we are determined to be a faithful reporter and pass on some information which turned up in two recent patents which will be of interest to OTL enthusiasts.

Both patents are the brainchild of Wallace H. Coulter and were sent in to this department by J. R. Coulter of Chicago's Coulter Electronics. The first patent was British and the second American, both covering the same invention. It may be of some interest to someone to know that the British patent (No. 688,273) was filed a year later than the American one (No. 2,659,775) and was issued some eight months earlier. Apparently the British Patent Office is somewhat less overworked than our own in Washington.

The patents are concerned with the type of output circuit which employs two power tubes in series. Figure 1 shows a general schematic of this sort of circuit, of the type which existed in the "prior art," and upon which Mr. Coulter's scheme is an improvement.

The workings of the circuit of Fig. 1 are not hard to comprehend. With no signal input to the stage and with identical tubes and cathode resistors for V_1 and V_2 , as well as identical power sources for B_1 and B_2 (batteries are shown only for convenience), we have a balanced bridge circuit and no current flows through the load. Currents from the power supplies flow equally through the two tubes, and through the load in opposite directions, so that net current through the load is zero.

When a signal is applied to the transformer primary it is applied to the two grids in phase opposition—one grid goes negative during one alternation with respect to its cathode while the other goes

positive with respect to its cathode. Current is thus decreased in one tube and increased in the other, as the result of which cancellation in the load no longer exists and a net signal appears across it. During the next alternation the unbalance is in the other direction so that the unbalance signals across the load vary in phase to produce a true a.c. output signal. Bypass capacitors C simply provide a low-impedance path around the power supplies.

As far as the load is concerned, the two tubes are in parallel for a.c. since the right end of the load in Fig. 1 is connected both to the cathode of V_1 and the plate of V_2 . It therefore sees an impedance equal to only 25 per cent of the impedance of a single tube. This is low enough to allow direct connection to a voice coil which is in the range of 100 ohms or so and results can even be obtained with a 16-ohm voice coil. At the same time, since the output signal is made up of the resultant of two out-phased tube outputs, the same even-harmonic cancellation is obtained as in a standard push-pull stage.

The disadvantage of the particular arrangement, however, is the necessity for an input transformer, something generally frowned on in present-day audio practice because it increases expense and weight and affects phase and frequency response so as to limit the possible negative feedback. The desirable solution is to use a vacuum-tube phase-splitting arrangement for the input.

But here we run into another problem. The grid signals in Fig. 1 come from transformer windings, neither end of which need be grounded, so that each signal can be applied between grid and cathode. With a tube input, however, the outphased input signals exist between the splitter output points and ground. And if we apply signal to the upper tube of Fig. 1 between its grid and ground, V_1 will act as a cathode load for V_2 , causing degeneration in V_2 , so that its output signal will not be equal to that of V_1 .

The use of a phase-splitting system and compensation for the resulting degeneration is the essence of the Coulter invention.

* Audio Consultant, 255 W. 84th St., New York 24, N. Y.

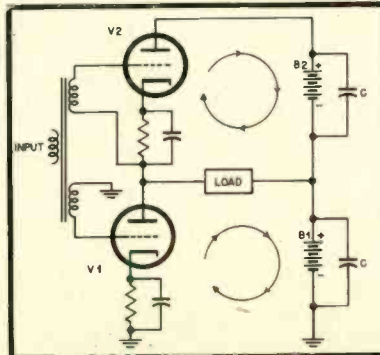

Fig. 1

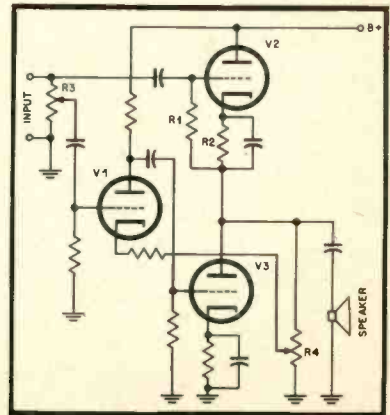

Fig. 2

If you want professional sound quality



Sound engineers know that the selection of a fine amplifier, pickup and speaker system is only part of the story; that unless the turntable is of equal quality, music reproduction must suffer. That is why they insist upon such high standards for turntable performance.

do as the professionals do...



Rek-O-Kut precision turntables are made to conform to the highest standards in the professional field, and they certainly represent the finest you can use in the home. A Rek-O-Kut turntable will make all the difference in the world. The finer your present system, the more apparent the improvement will be. Whether you select the deluxe T-12H or the standard LP-743, the entire performance of your sound system will become a new and thrilling experience.

use a



REK-O-KUT

precision turntable

Rek-O-Kut Precision Turntables are priced from \$59.50. Write for specifications and descriptive literature to Dept. KC-1.

The REK-O-KUT COMPANY

Manufacturers of Professional Disc Recorders and Specialized Sound Systems

38-01 Queens Boulevard, Long Island City 1, New York
Export Division, 458 Broadway, New York 13, U.S.A. Cables — Morhanex
In Canada: Atlas Radio Corp., Ltd., 560 King Street, W., Toronto 2B

SHURE

To simplify microphone placement in even the most difficult acoustic applications for Recording . . . Broadcasting . . . P.A.—install the

UNIDYNES 55s, 556s

the only small size, moving-coil Dynamic Microphones with Ultra  Cardioid pickup pattern. Both models reduce the pickup of random noise energy by 67%! Indoors—will improve recordings, broadcasts and P. A. performance in reverberant locations. Outdoors—will lower background noise to a minimum and will effectively reduce wind noises. Because of these outstanding features the "UNIDYNES" are used the world over—more than any other microphones regardless of size, class or cost!



Model 55s
"Sound-Systems" Unidyne
List Price \$76.50



Model 556s
Broadcast Unidyne
List Price \$110.00
(with built-in Shock-Mount and Broadcast Connector)

SHURE BROTHERS, Inc. ☆ 225 West Huron Street
Chicago 10, Illinois
Cable Address: SHUREMICRO

One preferred embodiment of it appears in Fig. 2.

Let us first clear up the identity of the load connection with that in Fig. 1. V_2 and V_3 in Fig. 2 are the same as V_1 and V_2 in Fig. 1. The grounded end of the speaker voice coil is connected for a.c. both to the cathode of V_2 and the plate of V_3 , since both these points are bypassed to ground through large cathode capacitor and large power-supply filter capacitor, respectively. The audio current through the voice coil is thus opposite in phase from the two tubes (assuming they are excited in phase opposition) and net signal through the load is the result of unbalances caused by increase of conduction in one tube and decrease in the other, as before.

The input signal, single-ended, is fed directly to the grid of the upper tube V_2 . While R_1 provides a d.c. path from this grid to the bottom of the tube's cathode resistor so that the bias is only that resulting from cathode resistor R_2 , the input signal is applied between grid and ground. That being so, V_2 causes cathode degeneration, reduces the plate-current variations of V_2 .

Phase-inverter tube V_1 is provided to transmit the same input signal to the grid of V_3 180 deg. output of phase with that on the grid of V_2 . The output of the phase inverter is between V_3 grid and ground, but there is no degeneration problem with V_3 since its cathode is bypassed directly to ground. R_3 , across the signal source, is merely a means of regulating the input to V_2 ; so that the signals applied to the grids of V_2 and V_3 will be equal in level.

The method Coulter takes to equalize the space-current variations in the two output tubes is to balance the degeneration existing in V_2 by introducing a compensating degeneration in the signal of V_3 . To do this he first places a resistor R_4 across the output. R_4 is of considerably higher value than the voice-coil impedance so as not to interfere with speaker operation. The voltage taken from R_4 by the slider causes negative feedback in V_3 in the following way.

Assume on one alternation that the main input signal is positive. It is applied to the grid of V_2 , making the V_2 plate negative. The V_2 plate is connected to the bottom (ground) of R_4 , making ground negative with respect to the upper end of R_4 when considering only V_2 . Thus, V_2 makes the upper end of R_4 positive with respect to ground.

The same main input signal is phase-inverted by V_1 , placing a negative signal on the grid of V_3 . The plate of V_3 is thus positive with respect to its cathode, making the upper end of R_4 positive with respect to ground due to V_3 . Thus, for this alternation the voltage tapped from R_4 is definitely positive with respect to ground.

This positive voltage is applied to the cathode of phase inverter V_1 . This decreases the V_1 current flow, making the plate more positive, and likewise making the grid of V_3 more positive. Since this is 180 deg. out of phase with the original signal appearing at the grid of V_2 , it constitutes negative feedback for V_2 , but does not affect V_3 . The slider on R_4 is adjusted so that its negative feedback to V_2 just offsets the cathode degeneration imposed on V_2 by V_3 , after which operation is symmetrical and the full advantages of the series-connected circuit are realized without an input transformer.

Mr. Coulter (J. R. of the letter which accompanied the patent copies) says that fidelity of this circuit is better than that of transformer-coupled push-pull output stages. A single 6AS7 duo-triode will provide 8 to 10 watts into a 150-ohm voice coil

(Continued on page 53)

ARNOLD MAGNETIC MATERIALS

TYPES "C" AND "E" CUT CORES

Arnold "C" and "E" Cores are made from precision rolled Silectron strip (highly oriented silicon steel) in 1, 2, 4 or 12-mil thicknesses and a wide variety of window sizes and core areas, for high and low-frequency applications. Sizes range up to 10 lbs. in 12-mil strip, and from fractions of an ounce to hundreds of pounds in the thinner gauges. Cores wound from ultra-thin strip (down to 1/4 mil or less) can also be supplied.

Insulated strip of the proper width is wound

on a mandrel, then heat treated, bonded and cut into halves. Careful control results in accurately dimensioned and matched core halves whose effective air gap at the butt joint is very small.

In 3-phase applications, the use of "E" Cores provides weight and size reduction, as well as higher efficiency and possible cost savings. Rigid standard tests are employed for both "C" and "E" types of cores, and special tests where required.

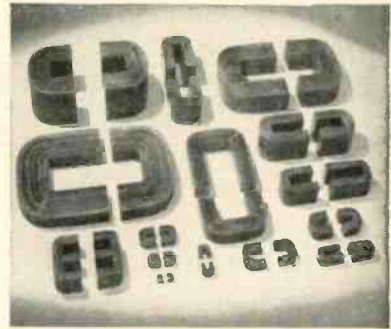

TAPE WOUND CORES

Depending upon the specific properties required, Arnold Tape Wound Cores are available made of Deltamax, 4-79 Mo-Permalloy, Supermalloy, Mumetal, 4750 Electrical Metal, or Silectron . . . in standard tape thicknesses of 1, 2, 4 or 12-mils, and in ultra-thin gauges of 1/2 and 1/4-mil where required.

Practically any size core can be supplied, from a fraction of a gram to hundreds of pounds. Toroidal cores are made in 22 stand-

ard sizes with protective nylon cases. Special sizes of toroidal cores, and all square or rectangular Tape Wound Cores, are manufactured to meet individual requirements.

Used for magnetic amplifiers, pulse transformers, current transformers, wide-band transformers, non-linear retard coils, peaking strips, reactors, etc., this gapless type of core construction results in maximum effective working permeability with minimum flux leakage.

MOLY-PERMALLOY POWDER CORES

For use in loading coils, filters, broadband carrier systems and networks, for frequencies up to 200 kc, these Toroids provide high Q in a small volume, and are characterized by low eddy current and hysteresis losses.

Arnold Powder Cores are supplied in four standard permeabilities: 125, 60, 26 and 14 Mu. They provide constant permeability over a wide range of flux density. The 125 Mu cores are recommended for use up to 15 kc; the 60 Mu at 10 to 50 kc; the 26 Mu at 30 to

75 kc; and the 14 Mu at 50 to 200 kc. Many of these cores may be furnished stabilized to provide constant permeability ($\pm 0.1\%$) over a specific temperature range.

These Moly Permalloy Powder Toroids are available in a wide range of sizes, to obtain nominal inductances as high as 281 mh/1000 turns. They are given various types of enamel and varnish finishes, some of which permit winding with heavy Formex insulated wire without supplementary insulation over the core.



ALNICO MAGNETS

Arnold manufactures permanent magnets from all grades of Alnico, although Alnico V is usually the preferred type due to the high value of energy product of that alloy. Alnico Magnets are quite hard and somewhat brittle and may be machined only by grinding. Most sizes and shapes are manufactured as sand

castings and are made to the customer's drawings and specifications. Some types and shapes of Alnico Magnets are carried as stock items.

Some small sizes of magnets may be furnished in sintered Alnico, but special shapes made in this way require rather expensive dies.

Stock sizes of all the products above are listed in Catalog GC-106. Write for your copy . . . but if you're attending the IRE show this year, see us at Booth 148.

W&D 4899



THE ARNOLD ENGINEERING COMPANY

SUBSIDIARY OF ALLEGHENY LUDLUM STEEL CORPORATION

General Office & Plant: Marenco, Illinois

New York: Empire State Bldg.

Boston: John Hancock Bldg.

Los Angeles: 3450 Wilshire Blvd.

CINEMA'S
tape and film

Degausser



TYPE 9205 DEGAUSSER

Noise and program erasure accomplished in moments by Cinema's bulk-tank type Degausser 9205. Economically priced. Buy yours today.



CINEMA ENGINEERING CO.
DIVISION AEROVOX CORPORATION
1100 CHESTNUT STREET • BURBANK, CALIF.

FACTORY REPRESENTATIVES
THROUGHOUT THE NATION

EXPORT AGENTS: Fraxer & Hansen, Ltd.
301 Clay St. • San Francisco, Calif. • U.S.A.

London Letter



RICHARD ARBIB*

AMERICAN "HI-FI" ENTHUSIASTS are apparently interested in British high fidelity equipment and have asked me for details of the models now on sale in England. I will deal briefly with them under three headings of record players, record changers, pick-ups, etc.; amplifiers; and loudspeakers.

Ever since 1927, when the first automatic gramophone (as we call them in England, and phonographs as you call them in America) was introduced by the British His Master's Voice Company there has been an ever increasing interest in the automatic method of changing records. Incidentally, most U.S.A. enthusiasts may not realise that the first mechanism for changing records automatically was designed for an acoustic gramophone and not for handling an electrical pick-up. This machine, introduced by His Master's Voice in 1927, performed many more operations than the average record changer of to-day. It played twenty records, which were stacked one on top of the other at one side of the machine. Each individual record was lifted up, put on the turntable, played, and then rejected into a felt-lined box. It could also play one

record individually, and the whole machine, even in the days of acoustic reproduction, could be operating from a pedestal up to 20 feet from the instrument itself. The only snag with this ingenious machine was that it was rather temperamental, and if it misbehaved it threw records right across the room instead of into the box.

Naturally, an instrument of this kind was not inexpensive to produce, and with the advent of the radio/phonograph combination the need was felt for a simple automatic record changing mechanism. One was developed again by H.M.V., and another one by Columbia, and then Garrard entered the field, and it was really due to their efforts that the majority of British radio manufacturers were able to produce inexpensive radio/gramophone combinations. The position at the moment is that H.M.V. have been rather eclipsed. In fact, at time of writing they do not offer a record changer of their own manufacture, and the one incorporated in their models is made for them by the giant Plessey Organisation, which is the largest British manufacturer of components. The record changer made by Plessey is just one of the thousand different lines they produce for
(Continued on page 60)

* Multicore Solders Ltd., Hemel Hempstead, Herts., England.



Mr. Alfred Lindley (right), assistant E.M.I. Record Press Room Foreman, is in direct charge of the presses turning out the new "Angel" series. Here he is with Charlie Knight, who pressed many of the early Angel discs back in 1909. Charlie is still with the company, after 44 years of service, and is now busily engaged in pressing the new Angel records.

New integrated **3-WAY** reproducers for finest Hi-Fi performance

NEW E-V TRIAXIAL

15" and 12"
REPRODUCERS



For the first time, an integrated 3-way system that combines the famous E-V Super Sonax, Radax Propagator, and large bass cone with heavy magnet in one compact concentric assembly, at lowest cost ever!

All the magic of high fidelity reproduction is now easily yours! E-V concentric Triaxial design gets the most specialized driving media for each portion of the audio spectrum. Phenomenal bass response, full-bodied mid-range and silky-smooth upper octaves to the highest audible frequencies provide an unusual musical balance without masking effects or imposed distortions. No larger than ordinary quality speakers, the E-V Triaxial can be installed in direct radiator type cabinets or in E-V recommended folded horn enclosures.

E-V ENGINEERED FEATURES

- Exclusive E-V Concentric Mounting Insures Full Range, Complete Room Coverage
- Augmented, Balanced Bass Response with Smoothest, Extended "Silky" Highs
- Carefully Tailored Mid-Range Characteristic Provides Realism and "Presence"
- Adjustable Brilliance Control for Remote Mounting Allows Matching to Room Acoustics
- Response ± 5 db, 30-15,000 cps in Recommended Enclosures
- Full $\frac{1}{2}$ Section M-Derived Crossover Network Minimizes Distortion Products
- Edgewise Wound Voice Coil Design Affords 18% More Efficiency
- Heavy Magnet Structures; Die-Cast Frame Assembly

Model 15TRX. Diam. 15 $\frac{1}{4}$ ". Depth 9 $\frac{3}{8}$ ". Magnet 5 $\frac{3}{4}$ lbs. Net wt. 44 lbs. Imp. 16 ohms. List Price, \$225.00. **Audiophile Net, \$135.00**

Model 12TRX. Diam. 12 $\frac{1}{2}$ ". Depth 8". Magnet 3 $\frac{1}{2}$ lbs. Net wt. 38 lbs. Imp. 16 ohms. List Price, \$190.00. **Audiophile Net, \$114.00**

Includes X-36-1 crossover network and AT-37 brilliance control.



Recommended E-V Folded Horn Enclosures
E-V REGENCY E-V ARISTOCRAT
for Model 15TRX for Model 12TRX



WRITE FOR BULLETIN NO. 204

Electro-Voice

BUCHANAN, MICHIGAN

Export: 13 E. 40th St., N.Y. 16, U.S.A. Cables: Arlab

for Hi-Fi

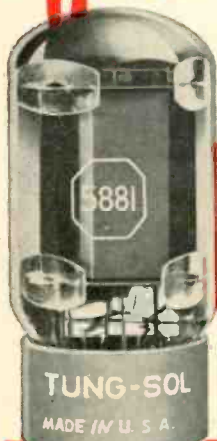

Want a really Super performance tube for your "Williamson" or "Ultra-Linear" amplifier?

Check these ratings of the Tung-Sol 5881

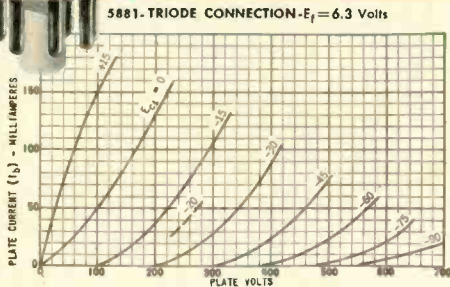

CLASS AB₁ PUSH-PULL AMPLIFIER—TRIODE CONNECTION
Grid #2 connected to Plate Values are for two tubes

Heater Voltage	6.3	Volts
Heater Current	0.9	Amp.
Plate Voltage	400	Volts
Grid Voltage	-45	Volts
Peak AF Grid to Grid Voltage	90	Volts
Zero-Signal Plate Current	65	Ma.
Maximum Signal Plate Current	130	Ma.
Load Resistance	4000	Ohms
Total Harmonic Distortion	4.4	Percent
Power Output	13.3	Watts

RATINGS (Interpreted According to RMA Standard M8-210)

Heater Voltage	6.3	Volts
Maximum Heater-Cathode Voltage	200	Volts
Maximum Plate Voltage	400	Volts
Maximum Grid #2 Voltage	400	Volts
Maximum Plate Voltage (Triode Connection)	400	Volts
Maximum Plate Dissipation	23	Watts
Maximum Grid #2 Dissipation	3	Watts
Maximum Plate Dissipation (Triode Connection)	26	Watts
Maximum Grid Resistance (Fixed Bias)	0.1	Megohm
Maximum Grid Resistance (Self Bias)	0.5	Megohm

In creating the 5881, Tung-Sol engineers have made fullest use of design and production techniques which have proved themselves over the past 15 years. Pure barium getter to effectively absorb gas for the life of the tube—gold-plated wire to minimize grid emission—are among the major design improvements in the 5881. This tube is directly interchangeable with the 6L6.

Tung-Sol produces the 5881 under laboratory conditions to insure peak efficiency and maximum uniformity. Order it from your regular supplier.

TUNG-SOL ELECTRIC INC., Newark 4, N. J.

Sales Offices: Atlanta, Chicago, Culver City (Los Angeles), Dallas, Denver, Detroit, Newark, Seattle

TUNG-SOL makes All-Glass Sealed Beam Lamps, Miniature Lamps, Signal-Flashers, Picture Tubes, Radio, TV and Special Purpose Electron Tubes and Semiconductor Products.



LETTERS

American Diaphragm

SIR: We have read with great interest the article, "Hi-Fi Sets of Yesteryear," by Charles L. Fallier, Jr., which appeared in your February issue. It was very gratifying to see the many references to Jensen high-fidelity loudspeakers which were manufactured in the middle and late '30's. The author's point concerning the excellent high-fidelity equipment available many years ago is well taken. Many new and glamorous names and products have appeared, created their following, and passed over the horizon. Many old ideas are reinvented and gain new followers. For the record we would like to clarify one misstatement noticed in the article. The special 18-inch loudspeaker used with the McMurdo Silver Masterpiece V incorporated a composite diaphragm engineered in the Jensen laboratories; it was certainly not a British-designed cone. As a matter of fact, this loudspeaker was listed in our general catalog. Two versions were available: the Model HF-18 having a dural apex and the Model V-18 having a hard paper apex. We are glad to observe that the high fidelity market has gained great impetus in this current upward swing and firmly believe that high fidelity is here to stay. Despite the excellent speakers and other equipment manufactured in the past, we recognize the merits of the current more extensive line and clearly see the need for further development.

KARL KRAMER
Manager of Tech. Services
Jensen Mfg. Co.
6601 S. Laramie Ave.,
Chicago 38, Ill.

Cathode-Follower Input Impedance

SIR: The article, "The New Golden-Ear Amplifier," by Joseph Marshall is of great interest to all who are interested in high-fidelity reproduction. The amplifier is well engineered; however, Mr. Marshall should exercise more care in his thinking about driving cathode followers with R-C networks. He states, "... the effective input resistance of the cathode follower is 10 times the grid resistor, or in this case 5 megohms. ..."

With the circuit configuration shown (grid resistor returned to ground) the effective input resistance is the same as the actual value of the grid resistor. It would be some multiple of the grid resistor value only if the resistor were returned to some point on the cathode resistor and the grid were allowed to ride up and down with the cathode.

Mr. Marshall's use of cathode followers does cause the shunt capacitance from grid to cathode to be lowered by a sort of reversed Miller effect. This is desirable in that it lessens the diminution of highs. There is nothing, though, that would cause an increase in the effective R-C time constant of the coupling network. At 3.38 cps the response is down 3 db due to the coupling network, and the voltage on the grid of each cathode follower leads the voltage on the plate of the preceding tube by 45 deg. Mr. Marshall claims his coupling network has response down to about 2 cps before phase shift sets in. Actually, at 2 cps he has a leading phase angle of 59.4 deg. and response is down 5.88 db, or down to 26 per cent of the power at midfrequencies.

WILLIAM C. HOLM
919C Birch Road,
E. Lansing, Mich.

Stereophonic Tests

SIR: We are greatly interested in stereophonic sound since we broadcast two hours of stereophonic music and drama each week, using our AM-FM facilities. We have made a number of tests similar to those described by Dr. Goldmark in the October issue. We have found that unless great care is taken, the tests can be loaded to prove almost anything.

We have found that corner speakers give almost no stereophonic effect except for listeners at the focal point. Much better results usually come from placing both speakers against a wall as recommended by R. J. Tinkham. The dihedral placement suggested by Marvin Camras in 1947 is also valuable. Microphones must be placed properly too. We use three microphones, with the center one feeding equally to the two outside channels. A-B listening tests are invalid because of too many variables. We use 30-second segments of music for each technique variation.

JAMES CUNNINGHAM
National Broadcasting Co.
Merchandise Mart,
Chicago 54, Ill.

engineers are critical people

(We know, because
we're engineers, too)

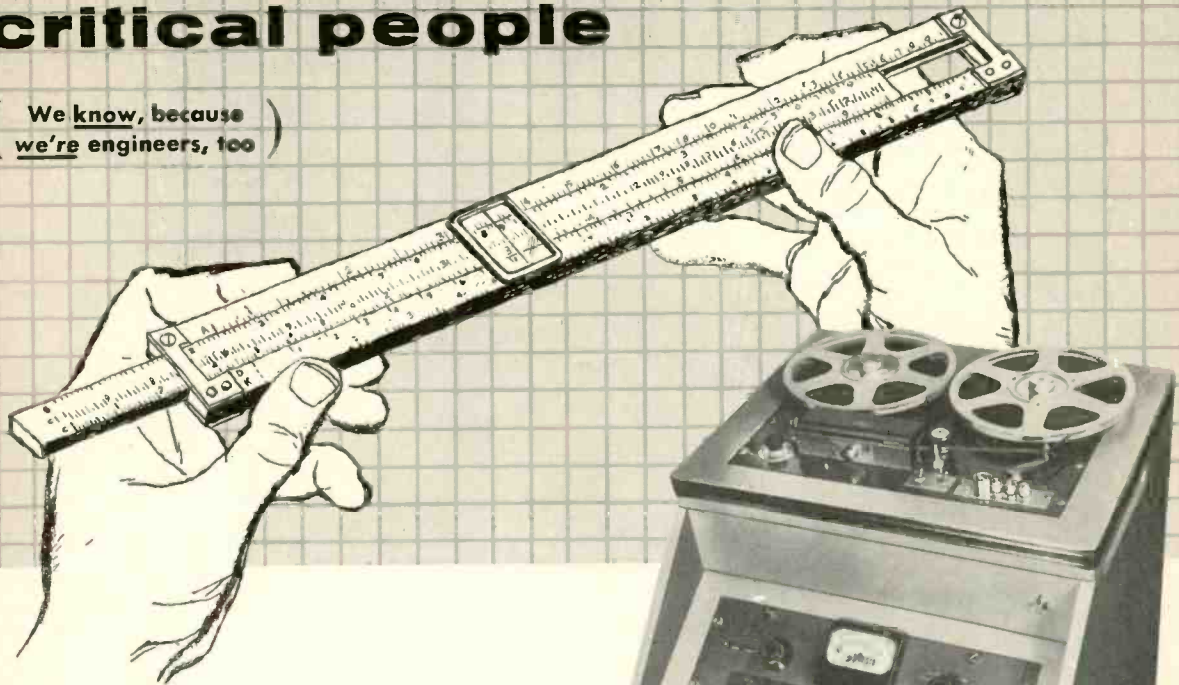

Radio and TV stations, recording studios, commercial and industrial film studios, testing laboratories, program production organizations and a host of others have long needed a thoroughly professional, well designed, easily maintained tape recorder.

More than a year ago, Presto's top engineers were assigned to the development of such a recorder. Months later a test model was completed which not only met these specifications, but embodied a completely new principle of recorder design . . . unitized construction; the entire capstan drive is a separate, easily removed unit.

The instrument was designated "Model RC-11," and then a series of rigorous tests were begun. The RC-11 was run continuously for hours at a time under the most adverse conditions. These tests resulted in further improvements.

Finally, when we were satisfied that this was the finest tape recorder of its type that could be built, we tooled up and put it into production.

By reputation engineers are the most critical people on earth. (We know, because *we're* engineers, too.) And, some of the most qualified recording engineers who have seen and operated the RC-11 share one opinion . . . that here is the finest, easiest to operate, best performing tape recorder available today.

 **PRESTO** RECORDING CORPORATION
PARAMUS, NEW JERSEY

Export Division: | 25 Warren Street, New York 7, N. Y.
Canadian Division: | Walter P. Downs, Dominion Square Bldg., Montreal



PRESTO RC-11 TAPE RECORDER

IN CONSOLE WITH 900-A3
AMPLIFIER

- Self-contained Capstan Drive Unit—3 motor drive.
- Three magnetic heads in metal enclosure.
- Push button function switches.
- Reel capacity to 10½" diameter.
- Response: 50 to 15,000 cycles ± 2 db.
- Flutter: less than 1½% at 15"/sec.
- Signal to noise: 55 db. at 2% distortion.

WORLD'S LARGEST MANUFACTURER OF PRECISION RECORDING EQUIPMENT AND DISCS

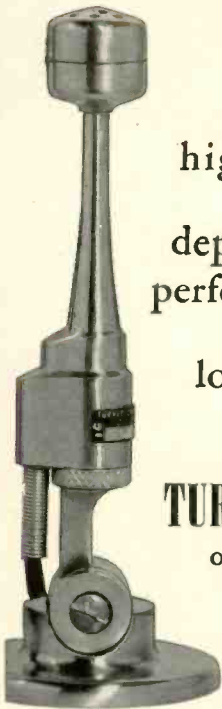

high style
dependable
performance

low price

TURNER 80
on C-4 stand

In design, there is no comparable microphone that equals Turner 80 styling and compactness. Styling that pleases the eye and fits in with modern surroundings. Compactness that makes this microphone convenient and easy to use. You can cradle it in the palm of your hand. Actual size (not including C-4 stand) only 4½" in length.

For PA, home recorder, dictating machine, office and factory call systems and amateur uses, the Turner 80 performance is always dependable.

Sensitivity: Approx. 58 db
below 1 volt/dyne/sq. cm.
Response: 80 to 7000 cps.
Weight: 5 oz. less cable.
Cable: 7 foot attached single
conductor shielded.

C-4 stand gracefully matches the Turner 80. Both are satin-chrome plated. Stand won't tip or slide with weight of cord.

Turner 80 list price.....\$15.95

C-4 stand list price.....\$ 5.75



EXPORT: Ad Auriema, Inc.,
89 Broad St., New York 4

CANADA: Canadian Marconi Co.,
Toronto, Ont., and Branches



AUDIOLOGY

W. R. AYRES*

Transient Response of Audio Amplifiers

WHEN EITHER SPEECH OR MUSIC is to be reproduced, the amplified and transduced signals are of highly transient nature, and quite different from continuous signals with which simple testing can be performed. An entirely satisfactory procedure, closely enough correlated with listening data to warrant numerical specification, is not yet forthcoming. Qualitative terms like "clean," "rough," "crisp," "muddy," etc., will perhaps be in conversational use for a long time to come. However, there are several useful sets of information, relating to transient response, from which important amplifier requirements may be deduced. These relate to the nature of hearing itself, some considerations of instantaneous peak-handling capability, and momentary overload effects due to large signals suddenly applied.

Amplifier Amplitude and Phase Response

To reproduce a complex waveform faithfully, all important frequency components must be similarly amplified, and delayed by the same time interval. It is by no means necessary that phase shift be zero at all frequencies, but simply that phase shift be directly proportional to frequency. As plotted on linear graph paper, phase shift vs. frequency over the useful frequency range preferably lies along a straight line which passes through the origin, or through some multiple of 180 deg. When R-C and/or transformer coupling is used, output customarily lags in phase at high frequencies and leads at low frequencies.

Obviously at low frequencies the phase response curve must ultimately depart from linearity, unless direct coupling is used throughout. In commercially successful audio power amplifiers, direct coupling usually amounts to eliminating coupling capacitors between (say) two of possibly four stages, with the output transformer untouched; thus only minor improvement can be expected for rather expensive efforts.

In a broad class of transmission circuits known as minimum-phase-shift networks, of which commonly used amplifiers are representative, amplitude and phase characteristics are related in such a way that establishment of one sets the other. Low phase shift occurs automatically in the frequency range of flat response, and so has no independently useful significance. Clearly then, if the frequency response of a linear amplifier is uniform (say within a db or so) throughout the audio frequency range, then the phase distortion is low as a natural consequence, and the transient response is far beyond audible reproach.

Amplifier Nonlinearity

A much greater offender is nonlinearity, at which all amplifiers fail to some extent.

* RCA Victor Div., Camden, N. J.

Particularly through use of negative feedback and good components, the linearity of a modern high-fidelity amplifier in terms of intermodulation distortion can be held to a small fraction of one per cent up to within a few db of normal rated output. That same negative feedback reduces the amplifier output impedance, with generally desirable effect upon electrical speaker resonances; however, there appears to be no trick of amplifier design which can materially affect the many large and steep response variations caused by the cone mounting, speaker enclosure, and listening room acoustics.

Nonlinearity represented by even momentary overload during transient peaks can sound very objectionable. Obviously, with recorded material, as from disc or sound-on-film, there is little need for 10 db power capability over that represented by full modulation, since excess peaks have already been suppressed. With live program material not previously clipped, peaks may be reproduced if greatest fidelity is sought, but only with power capability considerably in excess of normal volume requirements.

The Hearing of Complex Sounds

The hearing process involves selective excitation, according to frequency, of thousands of separate nerve fibers leading from the ear cochlea to the brain. Tests have shown that this amazing equipment divides the audio-frequency range into roughly 1400 just-detectable changes in pitch, with acuity greatest at mid-frequencies.¹ For example, in the frequency range from 1000 to 2000 cps, there are well over 200 perceptible changes in pitch, while the equally tempered musical scale has only 12 tones in this range. Since in effect sound at each frequency is detected with separate apparatus each receiving separate recognition by the brain, we can, incidentally, more readily understand the occasional development of the novel accomplishment known as absolute pitch.

The cochlea portion of the ear is not only the frequency selective mechanism, but a sort of sound analyzer as well. When a particular portion is excited by the characteristic frequency thereof, the signal transmitted by the appropriate nerve fiber to the brain is not a continuous wave of selected sound, but simply a series of impulses at rate depending upon the intensity of the sound component heard. There being no apparent means by which the phase relation between (say) harmonically related tones can be transmitted to the brain (without being obliterated by the effects of their relative amplitudes), a reasonable conclusion has resulted that phase shift alone cannot be heard.

But more correctly, since phase shift rep-

¹ H. F. Olson, "Musical Engineering," McGraw-Hill 1952, p. 249.

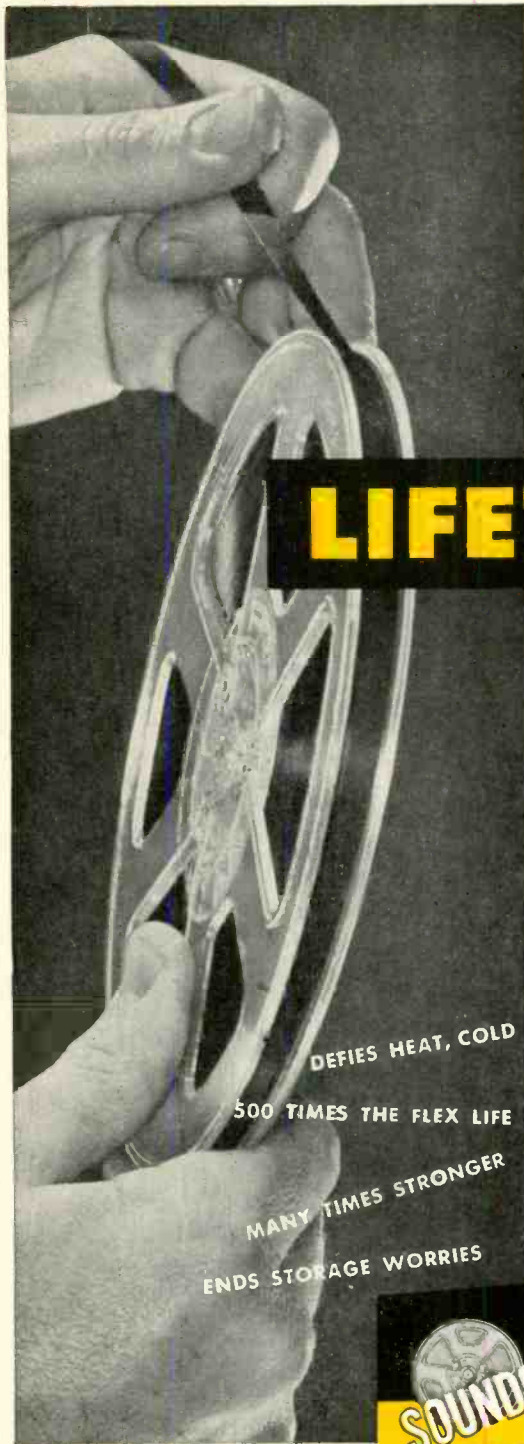

NOW Soundcraft
brings you
tape perfection!

the revolutionary new

LIFETIME[®] magnetic recording tape

Here is news of monumental importance to every recording perfectionist. It is the all new Soundcraft LIFETIME Tape. We've called this amazing high-fidelity tape "LIFETIME" because . . .

*It will last, to the best of engineering knowledge, forever!**

Your recording machine will never break it. Neither will careless handling. Because LIFETIME Tape is fully a third as strong as machine steel. It ends tape shrinkage and stretch when your home or studio air is dry or humid. It will never cup or curl. You can forget about storage problems.

All this means that for the first time you can preserve your important recordings, capture and keep those precious moments of music and the spoken word, for generations to come—in all their original fidelity!

LIFETIME Tape owes these new and permanent qualities to its new magnetic oxide coating, and to its base of DuPont "Mylar" polyester film. For both are free of plasticizers whose gradual loss from ordinary tapes limits their useful life.

LIFETIME Tape is indeed the biggest development in tape since the tape recorder itself. Your serious recordings deserve it. Order LIFETIME Tape today.

REEVES

SOUNDCRAFT

CORP.

Dept. B3

10 East 52nd Street, New York 22, N.Y.

DEFIES HEAT, COLD
500 TIMES THE FLEX LIFE
MANY TIMES STRONGER
ENDS STORAGE WORRIES

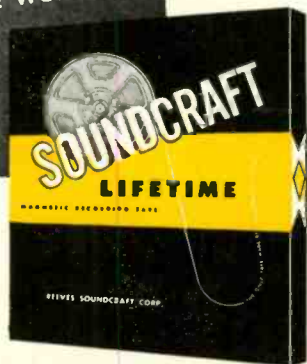

Like all Soundcraft magnetic products, LIFETIME Tape is Micro-Polished[®], assuring maximum high-frequency response. It provides uniformity of $\pm 1/4$ db. within a reel, and $\pm 1/2$ db. reel-to-reel. It is splice-free in 600-, 1200- and 2400-foot reels.

*LIFETIME GUARANTEE. Soundcraft unconditionally guarantees that Soundcraft LIFETIME Recording Tape will never break or curl, and that the magnetic oxide will never flake or crack, when the tape is used under normal conditions of recording and playback.

Precision Prints

**YOUR PRODUCTIONS
BEST REPRESENTATIVE**

CLOSE CHECK ON PROCESSING

Picture and sound results are held to the closest limits by automatic temperature regulation, spray development, electronically filtered and humidity controlled air in the drying cabinets, circulating filtered baths, Thymatrol motor drive, film waxing and others. The exacting requirements of sound track development are met in PRECISION'S special developing machinery.

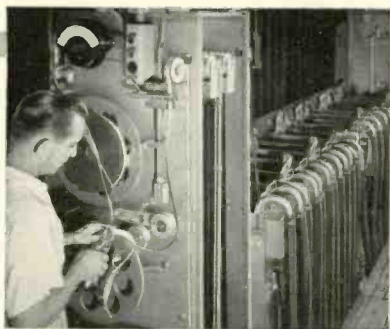

YOUR ASSURANCE OF BETTER 16mm PRINTS

16 Years Research and Specialization in every phase of 16mm processing, visual and aural. So organized and equipped that all Precision jobs are of the highest quality.

Individual Attention is given each film, each reel, each scene, each frame — through every phase of the complex business of processing — assuring you of the very best results.

Our Advanced Methods and our constant checking and adoption of up-to-the-minute techniques, plus new engineering principles and special machinery enable us to offer service unequalled anywhere!

Newest Facilities in the 16mm field are available to customers of Precision, including the most modern applications of electronics, chemistry, physics, optics, sensitometry and densitometry — including exclusive Maurer-designed equipment — your guarantee that only the *best* is yours at Precision!

Precision Film Laboratories — a division of J. A. Maurer, Inc., has 16 years of specialization in the 16mm field, consistently meets the latest demands for higher quality and speed.



resents time difference, then if the phase shift is great enough (perhaps many cycles), different frequency components may be heard at distinctly different times. Naturally then the signal would "sound different." This is quite close to what actually happens, and when considering transient waveforms, a viewpoint preferable to one of phase shift is that of permissible variation in time delay in the reproduction of various frequency components represented in the complex waveform. Logically, the time delay of various reproduced components should vary materially less than the 10 to 15 millisecond average sampling time required for the establishment of pitch consciousness. Using 1000 cps as convenient reference, and 1 millisecond as permissible delay variation, the permissible phase shift would be 36 deg. at 100 cps, and 3600 deg. (10 whole cycles) at 10,000 cps. According to measurement,² in the 5000 to 8000-cps range, the time delay could be as much as 10 milliseconds different from the 1000-cps value, and at 50 cps that time delay difference could be as much as 75 milliseconds, without noticeably affecting the quality of reproduction. The phase shift amounting to such time delay is obviously enormous compared with the characteristics of ordinary amplifiers. In fact, if one set out to produce either of the quoted conditions, considerable effort and apparatus would be required.

Power-Supply Transient Dip

When true Class A amplification is used in the power stage, the average plate current is constant from no signal to maximum undistorted power output. But with more efficient classes of operation now almost universally employed, average plate current to the output stage changes markedly when signal is applied, often being twice as much (or more) at rated power output as when no signal is applied.

An occasionally troublesome characteristic of conventional rectifier filter circuits is the transient fluctuation in output voltage with sudden changes in load current. With large additional load suddenly applied to the power supply, the voltage may momentarily fall to a materially lower value than its final steady value at the new load current. When the load is suddenly lessened (i. e., less current drawn), the voltage momentarily jumps to a higher value than its final steady value, and particularly in this case the voltage may periodically fluctuate ("ring") in damped fashion at a rate depending upon the filter inductance and capacitance.

The fractional dip in supply voltage is given approximately by the relation:³

$$\Delta e_n = \sqrt{L/C} / R_L \quad (1)$$

where L is the series inductance in henrys, C is the shunt capacitance in farads, and R_L is the partial load producing the change in output current. For example, if the load on a 300-volt supply increases 100 ma when full signal is applied, the partial R_L is 3000 ohms. With L and C of 8 henrys and 8 microfarads, respectively, the fractional transient dip is:

$$\Delta e_n = \sqrt{8 \times 10^{-6}} / 3000 = 1/3 \quad (2)$$

Momentarily the 300 volts dips to only
(Continued on page 47)

² Research Council, Academy of Motion Picture Arts and Sciences, "Motion Picture Sound Engineering," D. Van Nostrand Company 1938, p. 191.

³ Reuben Lee, "Electronic Transformers and Circuits," Wiley 1947, p. 102.

The eye-opening event of the radio-electronic new year!

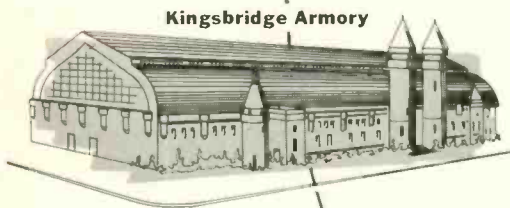
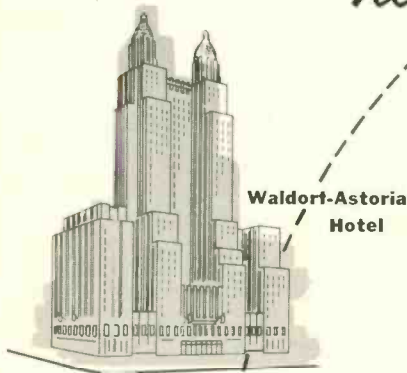
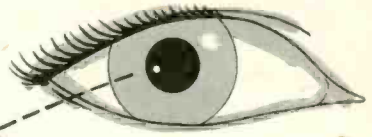

For the past 12 months the vast, fast-growing radio-electronic industry has been preparing for 4 great days — March 22-25. This is when the IRE National Convention and Radio Engineering Show — the biggest and best ever — will take place in New York City. Be sure to join the other radio-electronic men — nearly 40,000 are expected — who will come, see and appraise the show at which all that is new will be unveiled.

A practical summary of radio-electronic progress will be unfolded at 54 technical sessions during the four-day period. 243 scientific and engineering papers, grouped by related interests, will be presented during these sessions, more than half of which are organized by IRE professional groups. Actually, you will be attending 21 conventions fused into one. New York's finest meeting facilities are provided — the Waldorf Astoria Hotel plus 3 huge halls in Kingsbridge Armory. Transportation between the two locations is quick, easy — by subway and bus service.

At the show you will find over 600 firms "spotlighting the new" in their high-interest product exhibits. These will extend over a mile and a half along avenues appropriately named for radio elements: "Instruments," "Components," "Airborne," "Radar," "Transistor," "Audio," "Microwave," etc. These exhibits, an education and revelation in themselves, fill the four-acre space of the great Kingsbridge Armory . . . and can be viewed throughout any one or all of the four days.

Admission is by registration only, and serves for the four-day period. For IRE members the cost is only \$1.00. For non-members it is a low \$3.00, covering sessions and exhibits. Social events have been carefully planned. These are priced separately.

March 22-25, 1954

**is the date! New York is the city
where the radio-electronic event
of the year will take place.
Come! See! Enjoy!**



THE 1954
IRE NATIONAL CONVENTION
AND
RADIO ENGINEERING SHOW
THE INSTITUTE
OF RADIO ENGINEERS
1 EAST 79th STREET, NEW YORK CITY

EDITOR'S REPORT

AUDIO FAIR—LOS ANGELES

AT THE CONCLUSION of each assemblage of the public, the hi-fi fans, and those music lovers who are just desirous of hearing their music properly reproduced, it becomes the duty of this reporter to review the event, cite the unusual in displays, and credit those to whom credit is due. In the reverse order, let us first award an editorial orchid for the fine work displayed by the Los Angeles Section of the Audio Engineering Society in preparing the aspects of the show designed to educate the visitors. Under the direction of John T. Mullin, who was the first Western vice-president of the Society, a series of slides was prepared to go with a tape-recorded description of hi-fi which would be thoroughly understandable to a complete stranger to the word (if there are any such left). The story centered around a visitor from outer space who drops into the Fair to learn about hi-fi. Since the whimsical little character was named ψ and was, in addition somewhat bashful about attendance at a function peopled predominantly by Earth folk, and since this character became acquainted with our own art, the show was titled "Shy Si Meets Hi Fi." This twenty-minute tape, accompanied by the colored slides, told what the visitor could expect, why the hi-fi industry existed, what hi-fi equipment would do, and what it had to do to make music approach the original. Beside doing a good job, it was also entertaining, and everyone came away pleased. The feature was repeated every half hour, and there was always a line waiting for the doors to open.

Further credit is due the Los Angeles group for the establishment of an active industry advisory committee to work with the Fair officials and the officers of the Society to smooth out operating procedures. The entire show ran with the efficiency engendered by such coordination, and the Society took a large part in the preliminary work and in the publicity—which was well done and which covered the area quite thoroughly.

The weather took its cue from the event and was Fair throughout the three days. The sun shone and there was no smog, no fog, no rain, and—to the gratification of the Easterners who attended—no snow. But so it was in 1953. Apparently what we have heard about California weather is true. Attendance at an Audio Fair for three days cannot be called a vacation by any stretch of the imagination, but the weather was perfect for one.

Exhibits were complete and were, in general, conducted in better taste than heretofore at Audio Fairs—which means that demonstrations were put on in room after room at reasonable sound levels and with considerably less disturbance to adjacent rooms than has been noticed on some previous occasions. The typical Audio Fair "curve"—up 20 db at 50 and 12,000 cps—seems to have disappeared and music is now being reproduced as music rather than as a fugue for tweeter and woofer.

The Society presented a total of nineteen technical papers covering transducers, amplifiers and equipment, applications, various aspects of recording, and new developments. All the sessions were well attended, and the

full texts will be available in due time in the *Journal of the Audio Engineering Society*.

Audio Fairs have many advantages—not the least of which is the opportunity they provide for the manufacturers and consumers to exchange ideas about products. And this opportunity extends to manufacturers of magazines as well as to manufacturers of audio equipment. The ideas that come to us from our readers at these gatherings are of real importance to us, for they help us to direct our efforts toward "building" the kind of magazine which will be of greatest value to readers. We take this opportunity to thank everyone who took the time and trouble to talk to us and to make suggestions for our guidance. We like to think these readers are our friends, and we always look forward to the next opportunity of getting together.

AUDIO SOCIETIES

There are a number of active organizations in the audio field which are not of an engineering nature. One of the most active of these is the Louisville (Ky.) Audio Society which recently announced a series of special meetings designed for those who want to learn more about audio techniques and technology. And the new four-page bulletin is meticulously done in hand lettering and offset (we should guess) and contain some well prepared material. In fact, we should even like to reproduce some of it for all of our readers.

While the members of the LAS apparently have some interest in technical matters, their principal interest seems to be in the music. We particularly liked a little box on the first page of the January *Bulletin* which stated: "WE LIKE MUSIC, TOO! Anyone interested in getting together to listen to the music and not particularly the fidelity will find. . . ." Well put, we think, for the real value of high-quality audio equipment lies not in the "fidelity"—which all too often suffers from ill-advised settings of the controls—but in the pleasure which can be had from good music properly reproduced. The Louisville Audio Society might well serve as the model for others to follow in forwarding the trend toward better audio.

RED FACE DEPARTMENT

In reviewing "Musical Gadgetry, (vol. 1)" in his February column, Mr. Canby credited Weathers industries with the recording, whereas the actual fact is that the lacquer mastering was done by the Van Levis Recording Studio of Philadelphia. Paul Weathers designed and built the Weathers Cutterhead System which is used in making Van Levis' SPECTRUMAX lacquer masters. Furthermore, the Weathers pickup is used in checking the recordings at the studio.

This is mainly a case of not reading the fine print, but for Mr. Canby our face is red. And we are pleased to render unto Van Levis the things which are Van Levis'.

(Continued on next page)

Quality is an elusive thing. Engineers measure it... copywriters glorify it... salesmen describe it. But the final test is actual performance. If a product is the best in its field, those who know quality will accept no other.

That is the story of Pickering's new 260 Turnover Cartridge.

Introduced only months ago, it is already a leader among magnetic cartridges. It has won that position because it is the nearest thing to perfection yet produced. Here are the combined advantages it offers:



A simple flip of the handy lever and you're ready to play any favorite that fits your mood—whether it's standard or microgroove.

The nearest Thing to Perfection

1. HIGHER OUTPUT—Better overall signal-to-noise ratio.
2. LOWER OVERALL DISTORTION—Less intermodulation distortion with wider frequency response.
3. MINIMUM TRACKING FORCE—Lowest practical tracking force for both microgroove and standard recordings.
4. HIGHER COMPLIANCE—Compliance of moving elements is the highest practical, consistent with best-quality transcription arms and changers.
5. LOWER MOVING MASS—Lowest of any comparable magnetic cartridge.
6. TWO DIAMOND STYLI—For longer record and stylus life and greatest economy.

These design features have real meaning to those who understand that quality reproduction depends on components which meet professional standards. If you want the best that high fidelity can offer, ask your dealer to demonstrate the new 260 Turnover Cartridge. You, too, will hear the difference!

PICKERING and company incorporated • Oceanside, L. I., New York



PICKERING PROFESSIONAL AUDIO COMPONENTS

“For those who can hear the difference”

... Demonstrated and sold by Leading Radio Parts Distributors everywhere. For the one nearest you and for detailed literature, write Dept. A-4

AMPHENOL

Qwik

microphone connectors
modern design
and efficiency

There is nothing like the new QWIK Microphone Connectors! Combining beautiful appearance with watchwork efficiency, QWIKs are the result of cooperative effort between the skilled engineers of AMPHENOL and one of America's leading industrial designers. They complement every microphone in any setting.

QWIK Microphone Connectors use only the finest materials; incorporate the latest AMPHENOL-pioneered improvements in connector design. All shell bodies are made of high grade zinc alloy and finished with a rich satin nickle coating that has a high resistance to corrosion. The dielectric is I-501 blue, an AMPHENOL developed compound that is also used in military AN connectors under government specifications. Contacts are high conductivity bronze, gold-plated over silver for easy soldering and indefinite shelf life. Gold-plated contacts are also features of AMPHENOL AN connectors. The blue release buttons are molded of tough tenite.

QWIKs are available in 3 or 4 contacts with either male or female plugs or receptacles. Their applications are practically unlimited—everyone in the audio field will be interested when seeing, enthusiastic when using the new AMPHENOL QWIK Microphone Connectors.

AMPHENOL

chicago 50, illinois

AMERICAN PHENOLIC CORPORATION

EDITOR'S REPORT (Cont'd)

WASHINGTON (D.C.) FAIR

The next event on the audio calendar seems to be the High Fidelity Fair in Washington, D. C. This exhibit will be held at Hotel Harrington on March 5, 6, and 7, and is produced with the cooperation of the Washington Audio Society and WGMS, Washington's Good Music Station. The event is being exceptionally well publicized, and we are curious to see how big a turnout the first show in the nation's capitol will rack up.

Among the serious aspects of the event is an address by FCC Commissioner George F. Sterling in the auditorium of the Perpetual Building and Loan Association on the evening of the 5th. This talk will initiate a series of meetings and lectures throughout the three days. A concert from the Library of Congress on the first evening will be the first public Washington demonstration of the Crosby Multiplex System of FM broadcasting—a scheme which allows two signals to be sent from one transmitter at the same time. Thus the boardcast will be a demonstration of a practical method of disseminating a stereophonic program.

As usual, we will be represented—partially to see the result of the Hi-Fi Fair's contest to choose the girl with the most beautiful ears.

TRIVIA FROM THE LA FAIR

Most amazing sight—an attractive model from the display of Penny-Owsley Music Co. standing alongside a large and loud speaker in High-Fidelity House's display room just daring them to make it too loud for her to enjoy—and she was smiling all the time. Second candidate for most amazing sight—blasé New Yorkers hieing to Billy Gray's Band Box two or three nights in a row to see and hear Joe Lessy and others in a riotous show.

We thought we'd been discovered by a fan at LA's famous Biltmore Hotel. We returned to the hotel one night to find a large basket of fruit—complete with cellophane bows—and naturally assumed that the manager and assistant manager, whose cards accompanied the basket, were audio hobbyists or at least readers. Denouement came when we compared notes with Henry Gage, Westminster Records prexy, who was similarly favored. This must be true California Hospitality.

Or do you suppose those two gentlemen really do like good music well reproduced?

LQ*

* *Listening Quality*

The prime function of your hi-fi **TONE ARM**

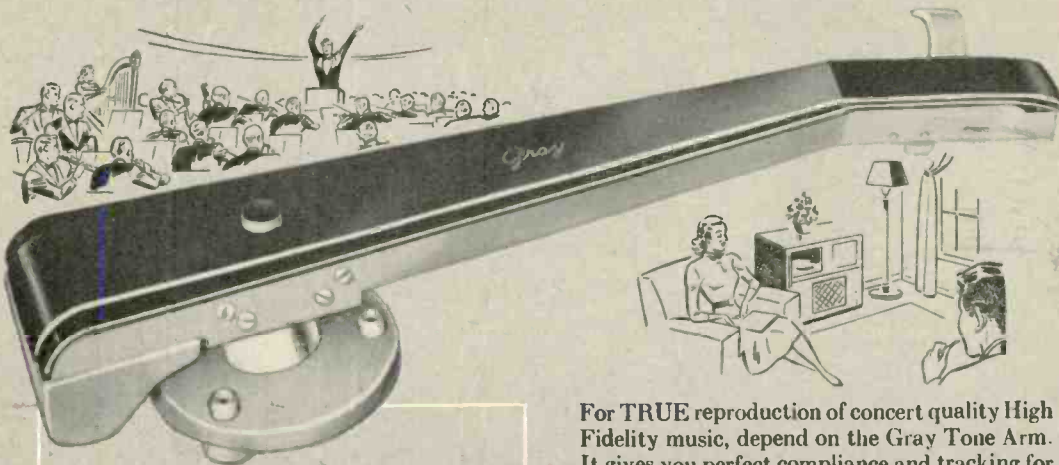

The **GRAY**
viscous-damped 108 B
TONE ARM

Gray offers a radical departure in tone arm design to assure the ultimate in performance from new and old recordings . . . 33 $\frac{1}{3}$, 45, and 78 RPM . . . up to 16" in diameter. The NEW suspension principle "damps" vertical and horizontal movement of the arm . . . stops groove jumping and skidding . . . prevents damage if arm is dropped. Instant cartridge change . . . Pickering, GE, Fairchild . . . with automatic adjustment to correct pressure.

For TRUE reproduction of concert quality High Fidelity music, depend on the Gray Tone Arm. It gives you perfect compliance and tracking for all records . . . new or old . . . at lowest stylus pressure. Virtually eliminates tone arm resonances. Today, more and more High Fidelity enthusiasts are achieving TRUE musical realism with the Gray 108 B Tone Arm. Specifically designed to meet the most exacting listening demands.

 <p>Gray 106 SP Transcription Arm Chosen by professionals for superb tone reproduction . . . for every speed record.</p>	<p>Gray 103 S Transcription Arm Leading audio engineers recognize the true tone reproduction . . . for 78 RPM records.</p>
---	---

Visit your nearest High Fidelity dealer today . . . examine the precision construction of Gray Tone Arms . . . hear them reproduce perfect Hi-Fi performance.

GRAY RESEARCH

AND DEVELOPMENT CO., Inc., Hilliard St., Manchester, Conn.
Division of the GRAY MANUFACTURING COMPANY
Originators of the Gray Telephone Pay Station and the Gray Autograph and PhonAutograph.

GRAY RESEARCH & DEVELOPMENT CO., INC.
Hilliard Street, Manchester, Connecticut.

Please send me complete descriptive literature on Gray Tone Arms.

Name _____
Address _____
City _____ State _____



BOLTING VOICES TOGETHER

Adjusting casing over splice in polyethylene cable. Edges and ends are sealed with a new Butyl rubber compound that won't harden, dry out or lose adhesion even in extreme heat or cold.

More than ever, light, flexible polyethylene sheathed cable developed by Bell Telephone Laboratories is providing speedy answers to the demand for more telephone service.

But at thousands of splices, the sheath must be thoroughly sealed against moisture. Laboratories engineers developed a protective casing which is quickly and simply bolted in place. The edges and ends of the casing are *permanently* sealed with a new compound developed by Laboratories rubber chemists.

Now, economical polyethylene cable can be installed much faster and at lower cost. Here is another example of how Bell Laboratories continually finds ways to keep telephone service high in quality, while the cost stays low.

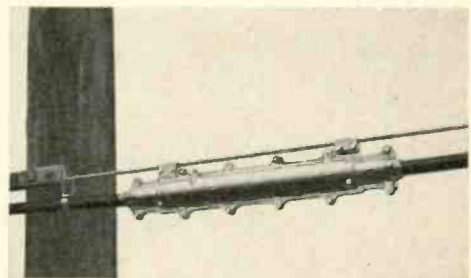

CLOSED CASING IN PLACE

BELL TELEPHONE LABORATORIES



EXPLORING AND INVENTING, DEVISING AND PERFECTING, FOR CONTINUED IMPROVEMENTS AND ECONOMIES IN TELEPHONE SERVICE

Problems Involved in Magnetic Tape Recording*

NORMAN E. GIBBS†

Results of a program of research into defects of magnetic tape and their applications to pulse reproduction when tape recorders are used as computer memory elements.

MAGNETIC RECORDING PROCESSES are rapidly being applied in many phases of scientific research, industrial measurement and control, as well as for storage of information in large-scale computers. In many of these applications it is essential that the pulsed data recorded be completely and accurately recovered.

A number of factors affect the accuracy of the storage processes. Chief among these are the design features of the tape-handling mechanism including recording heads, the characteristics and stability of the magnetic medium, and the reliability of associated circuitry.

It is the purpose of this paper to examine in particular the contribution of the medium itself, especially currently available tapes, to the over-all reliability of the magnetic recording process. Heretofore, chief attention in most applications has been focused upon design of equipment, and the currently "best available" tapes have been utilized.

In observing the cathode-ray patterns produced during playback of a continuous train of pulses from a magnetic tape, it has often been noted that the amplitude of some of the pulses became quite small or practically disappeared from the otherwise nearly constant signal envelope. These apparent losses of pulses have been termed "pulse drop-outs." A program of investigation which has been pursued at Raytheon for nearly two years is summarized in the following brief outline of the causes and effects of "drop-outs."

Continued research has established conclusively that the causes of drop-outs are (a) defects inherent in the tape itself, (b) foreign matter, such as dust, temporarily on the tape surface, and (c) mechanical flutter in tape drive and accumulation of static charge.

Inherent Tape Defects

At the start of the investigations, the

* From a paper delivered at the Symposium on Electronic Computers, sponsored by the Los Angeles Professional Group on Electronic Computers, University of California, April 30th, May 1st, 1952. Reproduced by permission from the *Symposium Proceedings*.

† Computer Equipment Section, Raytheon Mfg. Co., Waltham, Mass.

high-power microscope revealed that the surface of the magnetic tape contained zones varying in color which departed from the usual flat and smooth texture.

Before examining the causes of these abnormal areas, consideration of the construction of a typical tape lends perspective. In general, a thin film of magnetic material approximately .00025 to .0004 inch in thickness is deposited upon a cellulose acetate base which is itself only about .002 inch thick. Fabrication is complicated by several factors. The magnetic particles must be sub-micron size in order to provide favorable magnetic properties. Colloidal suspensions of these minute particles must be utilized, and contamination by traces of impurities or dust may cause flocculation of particles at local zones, resulting in lumps of adhering material. It is imperative that filters and agitators be used, that all ingredients be checked as to purity, and a high degree of cleanliness maintained in all operations.

Traces of impurities, dust, or vapor, may affect the surface tension of bonding agents, causing pin-holes where surfaces were not perfectly wetted. Great precautions must be taken during drying operations to avoid dust falling on the still tacky surface of the tape. Yet the over-all thickness of the applied layer must be maintained within close limits or response characteristics will suffer. Fabrication of good tapes is not an easy task.

It was found that defective areas in tapes were due chiefly to:

1. Particles of metal or other foreign matter embedded in the tape surface.
2. Bubbles formed during the drying of the tape which left a ring of magnetic material in the center of which the film had collapsed and dried in folds and crevices.
3. Pin-holes in the magnetic layer, easily visible by holding the tape up to a light source.
4. Droplets of magnetic material were rolled out over the tape and attached stickily to the magnetic layer like chewing gum on a floor.
5. Smaller particles of magnetic material, evidently not very tacky since a few passes of tape under the heads wipes them free.
6. Clumps, formed by a process of which the exact nature is unknown, but which entails the apparent growth of the

clump at the expense of the magnetic material in the surrounding area.

7. Areas in which the bonding agent had failed to keep magnetic layer intact and the latter had flaked off.

8. Imperfections in the acetate base such as wrinkles and roughness somewhat resembling orange-peel in appearance.

It has been gratifying to find during the course of time that the tape manufacturers have succeeded largely in eliminating many of these causes of defects. Tapes are now much cleaner and are minus the metal particles, "globs" resembling gum, and usually the pin-holes.

The sketch of *Fig. 1* shows a cross section of the chief offender remaining unconquered. The zone surrounding a clump is marked by its rough appearance. Apparently clumps are formed after the magnetic material has been applied to the tape and is still in a moist condition. Some factor causes adherence of the particles in this local zone to form a clump while sufficient migration of others in the suspension causes the recession in the surface level in the surrounding area.

With elimination of metal particles embedded during tape fabrication, dust and dirt constitute the chief sources of foreign material on tape surfaces. Magnetic mud, consisting of small particles sloughed off the tape and mixed with minute particles of core material and dust, frequently becomes rolled into small lumps which stick to the tape. Elimination of all of these is highly desirable.

Mechanical flutter of the tape as it passes under the heads results in variation of contact between tape and head surfaces which produces serious shifts in signal amplitude if not actual loss of information. These variations in signal level are due to the additional gap be-

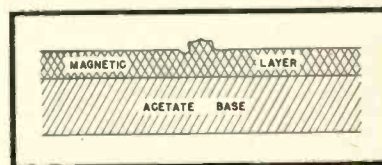

Fig. 1. Cross-section of a clump, showing the effect on the surface of the tape.

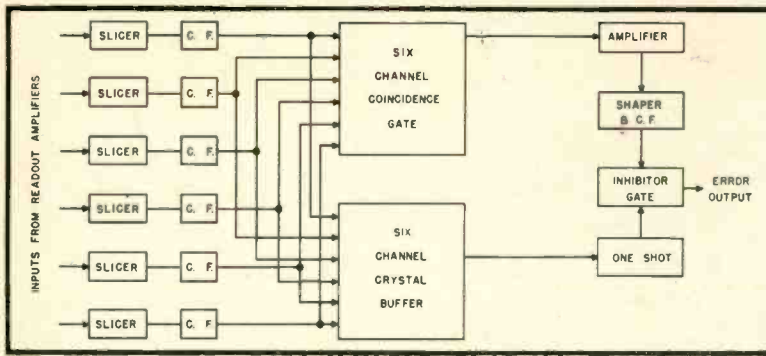

Fig. 2. Block diagram of the 6-channel coincidence circuit used in the investigations.

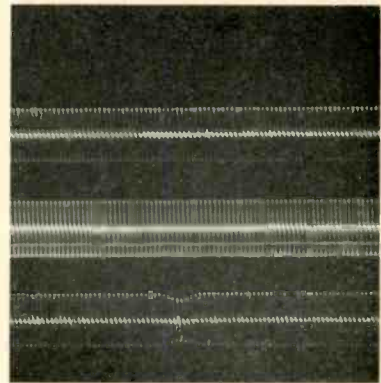

Fig. 3. Photograph of recovered pulses as they appear on an oscilloscope shows a typical minor defect appearing on tape using permanent magnetic bias.

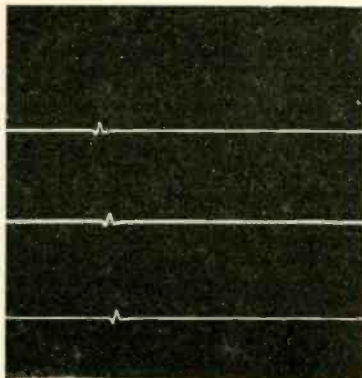

Fig. 7. Playback of tape with butted splice shows this pattern after permanent-magnet erasure.

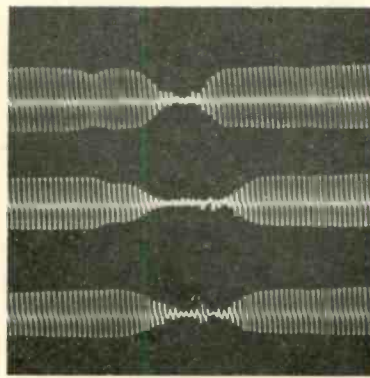

Fig. 8. Playback of writing over a lapped patch.

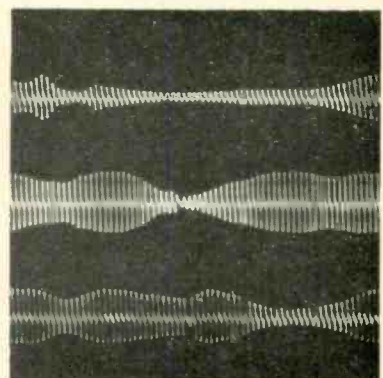

Fig. 9. This is the result of an attempt to cut and splice tape containing a continuous train of pulses.

tween the head and the magnetic surface.

All of these losses may not be due to the tape mechanism, however, since wrinkles in the tape, scalloped edges, etc., may cause similar effects. Stretching in local zones may cause curling of the tape and hence a variation in tension as these zones travel under the head. Attention must be paid at all stages of handling tapes to factors such as alignment of guides and idlers, use of proper tension in rewinding, and so on, to avoid these difficulties.

In rooms where the relative humidity is quite low the tape may acquire a static charge. Unless this is dissipated it may cause undesirable transients in playback circuits and every vary the tape tension due to adherence of adjacent layers of tape.

Having ascertained that defects existed in the magnetic medium which probably were responsible for pulse drop-outs, several problems remained. Methods of detecting tape defects had to be devised in order to determine the number of defects per roll of tape and reality of correlation between defects counted and presence of actual bad areas on the tape. As a defect passes under the playback heads actual effects taking place had to be determined. What could be done with tapes containing defects to make them usable in computer service?

Methods of Detecting and Counting Defects

Microscopic inspection of tapes would be difficult to achieve. With illumination at a grazing angle, however, microscopic studies were valuable in establishing size and contour of clumps.

Observations of cathode-ray patterns are informative but it is usually difficult to stop the tape upon sighting a drop-out. High-speed photography of multi-channel patterns appearing simultaneously on cathode-ray tubes is highly effective in establishing the effects produced by clumps.

Comparison bridge circuits proved promising when checking playback signals from two channels in which continuous trains of pulses had been written.

The most satisfactory unit, however, was designed to permit simultaneous examination of all six channels on the tape. As shown in the block diagram, Fig. 2, the playback signals from the six-channel preamplifiers are fed through slicers and cathode followers. A steady stream of pulses reaches the six-channel coincidence gate simultaneously from all channels. As long as this condition exists, these pulses are fed through the amplifier, shaper, and cathode-follower to the inhibitor gate.

Meanwhile, however, pulses have been fed simultaneously to the six-channel crystal buffer causing operation of the one-shot. The output of the latter is

led to the other side of the inhibitor gate. A positive pulse is emitted by the latter only when a pulse is missed in one or more of the channels. Controls can be set so that if the amplitude of the playback voltage for one or more pulses drops below 50 per cent of average value, a count results, hence the threshold is set at 50 per cent. The threshold may be varied. An electromagnetic counter can be tripped by the pulse from the inhibitor gate.

A more convenient arrangement is to use this pulse to stop a Raytheon Tape Mechanism involving a tape travel of about 3/16 in. so that the area of the tape immediately under the playback head may be carefully inspected.

This detector, with requisite precautions, yielded consistent counts on repeat runs of the same reel of tape.

Test Procedures and Results

Test procedures were as follows:

1. A tape was cleaned of dust by wiping it with a lens tissue pad during writing and playback operations.
2. Using the coincidence detector, the number of defects in a given length of tape was determined for all six channels.
3. This section of tape was then played back and the cathode-ray patterns of three channels were photographed simultaneously with a high-speed camera. A repeat run provided data on the remaining three channels.

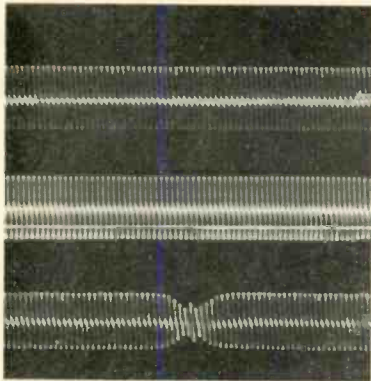

Fig. 4. A serious defect on tape with permanent-magnet bias. Note the trend to partial center recovery.

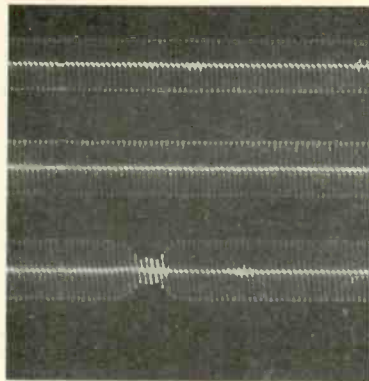

Fig. 5. A serious defect without any center recovery.

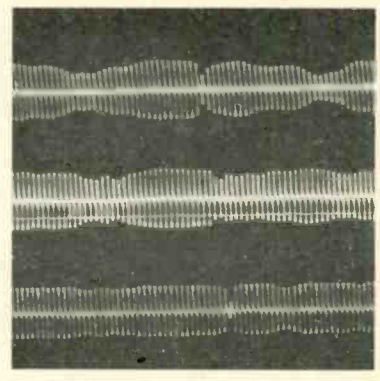

Fig. 6. This oscillogram shows the effect of writing over a butted splice on magnetically neutral tape.

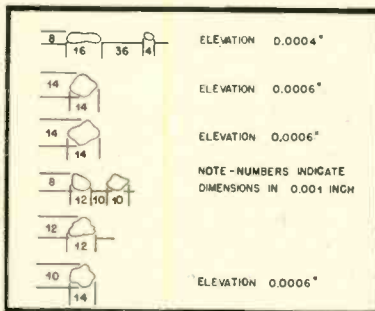

Fig. 10. These were among the defects manually removed from the tape. The drawings show the general shapes and sizes. Dimensions are given in thousandths of an inch.

4. The tape was erased, then rewritten. 5. Recounts were made on the coincidence detector, which checked with originals.

Figure 3 shows the effect produced by a typical minor defect. About a half dozen pulses are affected. Pulse density is 100 per inch in all the illustrations. Counting pulses therefore gives an idea of the area affected by the tape defect.

In Fig. 4 can be seen the typical effect produced by an average clump. Figure 5 shows a somewhat different effect caused by a clump in which no center recovery occurs.

Since a patch in the tape introduces a defect, some photographs were made of these also. Figure 6 shows the effects caused by a typical butted splice held by splicing tape and Fig. 7 shows the effect produced by the same splice when tape was erased with a permanent magnet.

A lapped patch causes greater disturbance of patterns as shown in Fig. 8. Figure 9 shows the effect produced by attempting to cut and splice a tape bearing a continuously recorded train of pulses.

It is apparent in many of the photographs that practically no variation of signal amplitude occurs except at areas of defects. This indicates that mechanical flutter effects are quite small. Some effects could be observed in the case of the patches.

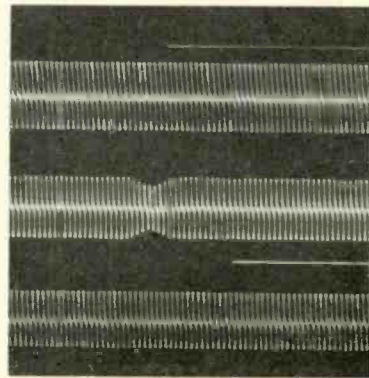

Fig. 11. After removal of defects from the tape, this pattern is indicative of about the worst remaining fault.

Using the techniques described, it was possible to examine small local areas, rather precisely located by the stopping of the tape drive, for defects. In nearly every case where the drive was stopped due to action of the coincidence detector a defect was found by microscopic examination.

Figure 10 shows the general shape and gives measurements for six typical defective areas. Elevation of the clumps was measured also. Some of the photographs correspond to these defects.

In some cases no defect was found on the tape. In the huge majority of these, however, a small dust particle or bit of lint was found adhering to the tape.

At the marked locations of the errors removal operations were attempted to determine whether unmarred magnetic material lay below most of the clumps. By very dextrous and delicate use of small scalpels under a microscope it was found possible to scrape away all of these defects leaving a relatively unmarred, normal surface of the tape. In removing one such defect an actual pit was dug through the magnetic layer. This was dexterously filled with some of the material removed. Utmost cleanliness and care were used during these processes.

The tape was now erased, rewritten and passed through the coincidence detector. The area of tape formerly giving

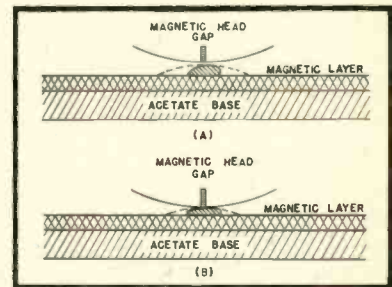

Fig. 12. The action of the tape and head when a defect appears. In A a condition like that of Fig. 5 is produced. In B some center recovery is possible, as in Fig. 4.

a count of 7 now gave a count of 1. A pattern of one of the worst effects on this section of tape now appears in Fig. 11. Effects are much less than the approximate 50 per cent shift in level formerly obtained.

Mechanics of a Drop-out

Figure 12 portrays the mechanical lifting of the head away from intimate contact with the tape surface under two conditions. In B center recovery is possible since the center flat portion of the "glob" permits laying down of at least one magnet.

R. L. Wallace Jr. of the Bell Laboratories has made experimental determinations of the spacing losses involved when a playback head loses contact with the magnetic surface. As reported in the October, 1951, issue of the *Bell System Technical Journal*, this loss corresponds in db to 55 times the ratio of the separation distance to the wavelength of the magnets involved.

The elevation of clumps was found to be about .0006 in., as shown in Fig. 10, and the wavelength of the magnets is close to .005 inch giving a ratio of .012. Fifty-five times this ratio gives a figure of 6.6 db as the separation loss. This agrees closely with the operation of the detection circuit and the photographic data.

(Continued on page 52)

Planning

Your Home Music Installation*

IRVING GREENE** and JAMES R. RADCLIFFE***

In Two Parts—Part 2

The facilities offered and the appearance of the finished installation are limited only by the imagination of the person doing the planning—just decide what you want and how it should look, then go ahead.

PREPARATION OF A THOROUGH PLAN for a high-fidelity installation is a simple, commonsense project which ensures satisfaction and eliminates any possibility of disrupting room decor. Of greater importance is the fact that it prevents the possibility of added and unwarranted expenditures for redoing a piece of furniture or unloading, at a loss, a tuner or amplifier that proved to be an incorrect choice.

Years back, when Radio was only within the reach of the technically informed experimenter, breadboard¹ circuits were arranged atop the dining room buffet or table amid a maze of wires and batteries. Consoles or cabinets were un-

* Excerpted from the book "THE HIGH FIDELITY HANDBOOK" by Irving Greene and James R. Radcliffe, to be published by Crown Publishers, Inc. in the Fall of 1954. Copyright 1953-1954 by Irving Greene and James R. Radcliffe.

** 17-49 166th Street, Whitestone 57, New York.

*** 170 Twin Lane North, Wantagh, New York.

heard of and yet to come. But, the thrill and wonder of this electronic phenomenon obviated any woman's desire for orderly and decorative cabinetry for science's last contribution to gracious living. Today, the same awesome respect for electronic gadgetry is still exhibited by the average American Housewife provided it is attractively packaged and will not mar the beauty and decor of her home. Almost without exception, the average woman of the house will veto any plan which involves one or more "naked" chassis cluttering the top of any article of furniture in the home.

The problem is always "... well, now that we have decided on a group of components for our music system ... where shall we install it?" To select equipment without giv-

¹ The term "breadboard" derived from the square or rectangular wood base on which experimenters constructed and wired their "receivers" during the late 1920's and early 1930's. It was so named because it resembled the breadboard Mother used to use, and in fact, often was one which had been liberated from the kitchen.

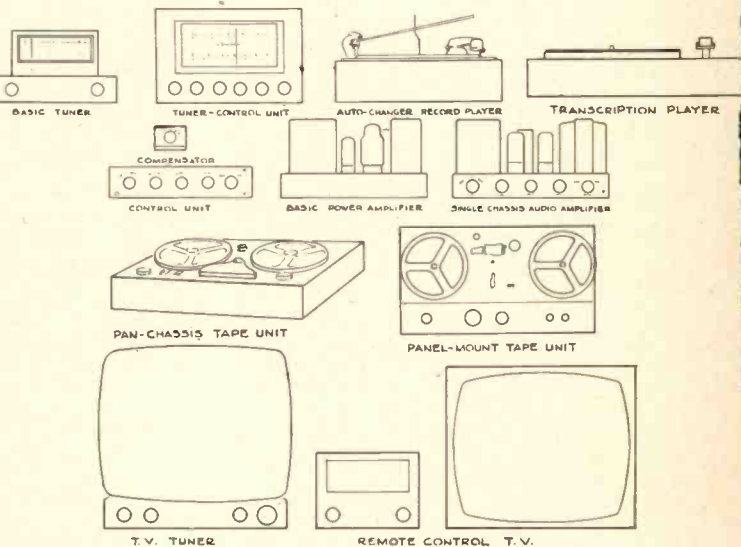
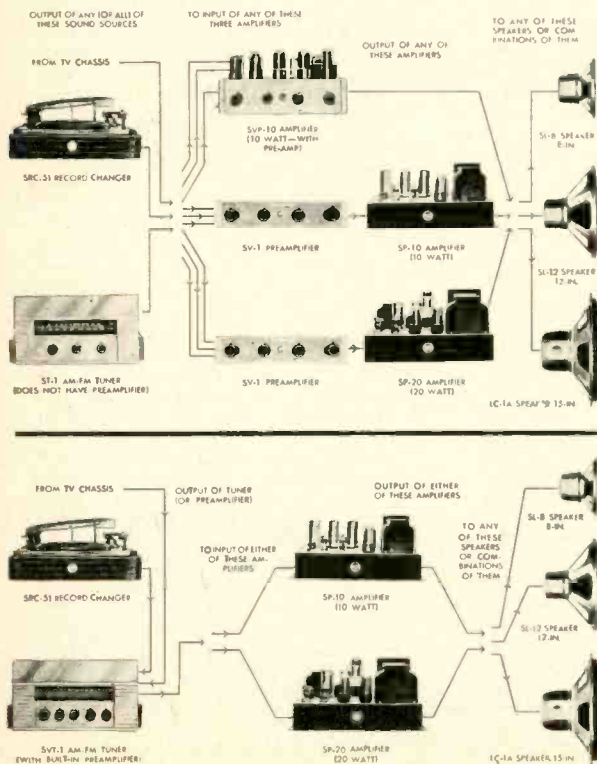

Fig. 2 (above). Basic outline of twelve types of hi-fi chassis indicating the controls that have to be considered for panel layout.

Fig. 1 (left). Block sketch of various types of hi-fi chassis and their relationship to each other in assembling a system. (Courtesy R.C.A.)

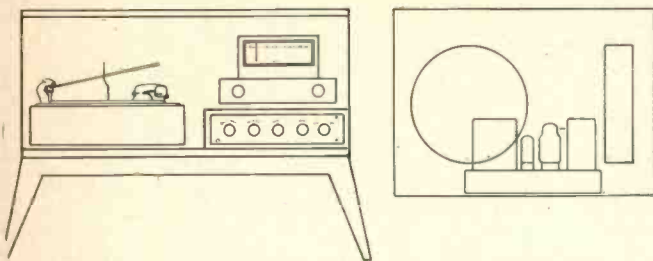

Fig. 4 (right). A compact two-unit music system. Equipment cabinet is simple in design, yet completely functional and attractive. Basic power amplifier is mounted into the speaker enclosure on the right. (Courtesy R.C.A.) Fig. 4A (above). Outline sketch of components pictured in Fig. 4.



ing thought to enclosures is like selecting furniture for a home or apartment that hasn't yet been seen. The proof of such folly is easily seen in the case of Mr. Jones² who decided to "rush out and get a system" after visiting a music lover friend who let him hear his set-up but didn't discuss any details. Not being satisfied with any of the commercial cabinets, Mr. and Mrs. Jones decided to install it into their breakfront. Soon after the equipment was delivered, he called in the cabinet-maker and proceeded to work out the layout of components. He found while planning the layout (something he should have done before he bought a single piece of equipment) that things weren't working out well at all. The one part of the breakfront that was useable for housing the system, didn't have enough space for tuner, amplifier and record player.

The quality of the components was excellent. But, from a practical point of view they were just not compatible or "matched" as hi-fi jargon will have it. The radio tuner, of popular make, was replete with controls. It had everything from record compensator and equalized phono preamplifier to bass and treble controls as well as a loudness control. The amplifier, one of the finest makes, was also replete with controls, duplicating almost to exactness the features of

² The story of Mr. Jones is true. Only the name has been changed to protect the prototype.

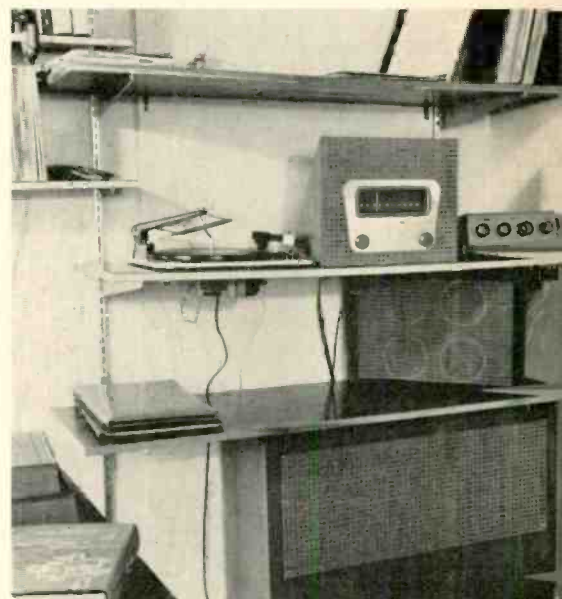

Fig. 3. A simple basic installation for a hi-fi music system.

Fig. 5 (right). An original wall cabinet design with a clever method of displaying bric-a-brac and other embellishments. Note tape recorder placed in the lower center section. (Courtesy Radio Craftsmen.) Fig. 5A (below). Outline sketch showing method to plan installation pictured in Fig. 5.

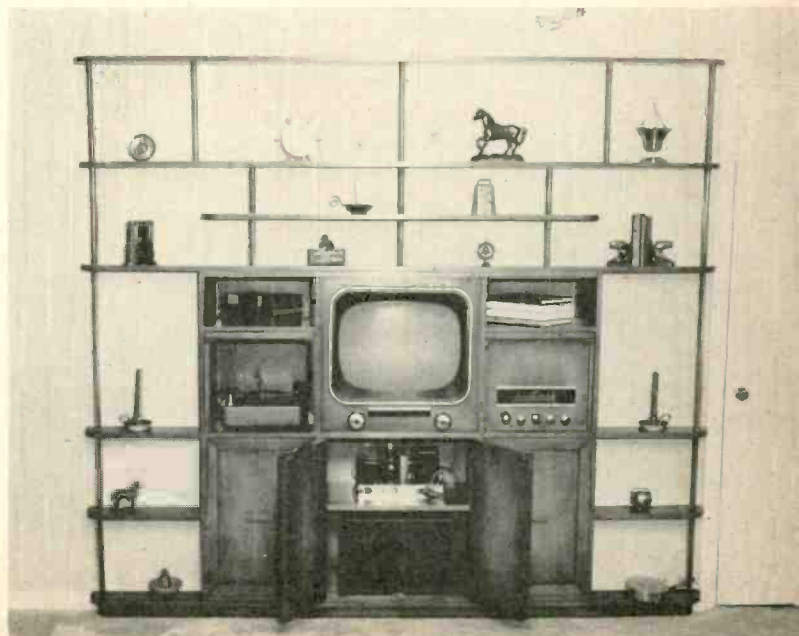
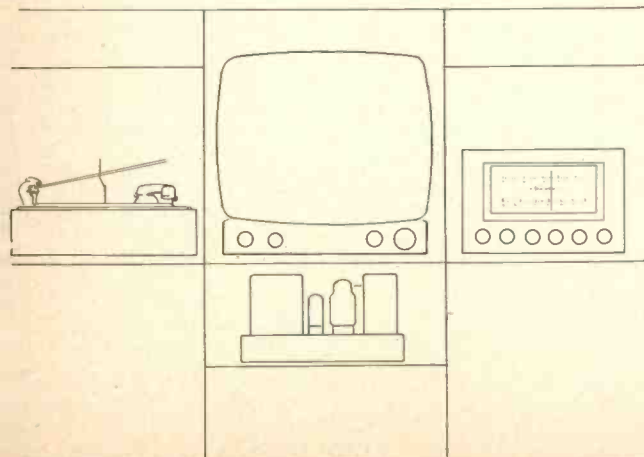



Fig. 6 (above). A complete entertainment center with every facility for gracious living. Fig. 7 (below). A closet installation containing a complete music system. (Both photos Courtesy Fisher Radio Corp.)



the radio tuner with the exception of the station selection control. Each demanded panel space so the controls could be operated conveniently.

The breakfront was of the average type with massive dimensions and little space for objects having a depth in excess of 9 in. The entire upper section had a depth of 8 in. and was used to show off the family china and glassware, protected by glass paneled doors. The lower section had a center portion that was 16 1/4 in. deep by 32 in. wide and 24 in. high, with a shelf running across the width making two compartments, each 11 1/2 in. high. Each of the lower side sections was 16 in. wide and 11 1/2 in. high, but only 9 in. deep. Requiring space for record storage, Mr. Jones had planned to place the tuner and amplifier on the upper shelf with the record player. Since the upper shelf was only 32 in. wide and the three units required as much as 45 in., this plan would not work. To place the amplifier below would require the loss of much needed record storage. Besides, the tuner and amplifier mounted one above the other on the upper shelf required a height of more than 14 1/2 in. which is four inches more than is available. Since the amplifier is 13 in. deep it could not be mounted into one of the side sections as they each are only 9 in. deep. Even if it were possible, it would be impractical as poor Mr. Jones would have to perform all sorts of acrobatic feats to operate the radio tuner and adjust the controls of the amplifier as he juggled the doors of the center section to get to the side section.

If he had stopped to do a little planning with the aid of a measuring tape, he would have considered these facts, which unfortunately became apparent to him after he had made his purchases and had given his cabinet-maker a difficult task. He would have found out that

a better choice of amplifier would have been a basic power chassis that was void of controls and could be located remotely from the tuner which had all the necessary audio controls. The average basic amplifier is of a dimension that would permit installation into a space 16 in. wide by 11 1/2 in. high and 9 in. deep. Concealed behind a perforated masonite panel it would be unobtrusive and well ventilated for normal operation. It would also be less expensive (for like quality) and eliminate the nuisance of operating two sets of audio controls, which can also create problems of balance and become a source of distortion. Here is a simple and basic situation that occurs every day. Despite any counsel offered by a salesman, the music lover insists upon treading into pitfalls of improper selections because he once read somewhere that such and such a tuner was a good buy and then read somewhere else at a later date that a certain amplifier was one of the best. He had never read anywhere that they were to be used together because any reputable writer on the subject of hi-fi would not recommend the use of a tuner with audio controls and an amplifier that would have a like set of controls. Figure 1 illustrates the combinations of various styles of tuners, amplifiers and record players which are compatible for use in a system.

The basic types of component chassis number about twelve, and these include everything from the diminutive record compensator to the huge and heavy pantype tape-recorder chassis. Outlines of these chassis are illustrated in Fig. 2. For effective and practical layout, much consideration must be given the width and height of the components. The minimum depth varies from 12 in. for the average tuner or amplifier to 16 in. for a record changer and 18 to 22 in. for

Fig. 8 (left). A music system mounted into a minimum of wall space. note tremendous record storage facilities available despite the small amount of space this installation occupies. (Courtesy Fisher Radio Corp.) Fig. 8A (below). An outline drawing of the original plan that resulted in the completed installation pictured in Fig. 8.

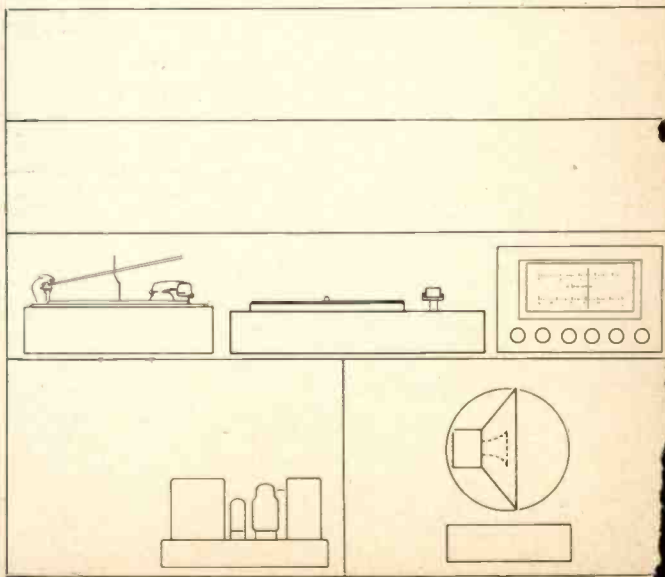



Fig. 9 (right). A narrow set of bookshelves beside a handsome fireplace was easily converted to house a complete music system. (Installation by Bennett Music House, Courtesy Radio Craftsmen.) Fig. 10 (above). Closeup of open cabinet pictured in Fig. 9 showing layout of components.



a transcription player or pan-type tape recorder.³

Panel Arrangement

Panel arrangements can usually be made to suit the aesthetic and decorative tastes of the individual. However, they should be resolved before any purchases are made. The information and brochures provided by manufacturers and the catalogs of leading audio dealers contain all of the dimensions and illustrations necessary to lay out a panel arrangement. Commercial hi-fi cabinetry have equipment compartments which permit the installation of components in many panel arrangements. One type, Fig. 4, has a width of 32 in., others range from 16 to 18 in. Some provide enough height to mount one component atop another (this is also a feature of the cabinet in Fig. 4). Cabinets may be custom built to place the components to suit individual needs as seen in Figs. 5 to 12. Average units of furniture to be altered to house hi-fi equipment offer widths ranging from 12 to as much as 48 in., the latter dimension usually being found in bookcases or center sections of sideboards. Height usually runs from 10 to 11 in. in bookcases and as much as 30 to 36 in. in sideboards, breakfronts, and credenzas. Depth is often the problem. Record players require a minimum of 16 in. (inside dimension) to permit mounting a base on slides and yet have ample space so as not to damage or wear the insulation of the cables which connect to the amplifier or tuner. The cables must be tacked down, and a sufficient length must be provided to permit the base to be pulled out for use. When the base is pushed back in place, there must be ample room for the cables to fall back without bunching up under the slides to avoid cutting or damaging the insulation.

To lay out a panel arrangement effectively one must understand the functional purpose of each type of component. While there are many more components that can be discussed in an article such as this, there are fortunately only about a dozen basic types that are used in all of the numerous brand names and models (one manufacturer catalogs six separate and distinct radio tuner models). Actually tuners and amplifiers have only two basic chassis outlines each. (See Fig. 2.) The listing below covers the function of each basic chassis type.

³ See table of minimum space requirements: Irving Greene, "Place your music decoratively," *AUDIO ENGINEERING* Feb. 1954, p. 24.



Fig. 11. Here is a simple but very effective manner of installing a complete system into a small area providing an ideal corner for a loudspeaker and a very advantageous location for the television unit. (Courtesy Radio Craftsmen.)

The Basic Tuner. This unit is usually void of any audio function (such as tone or volume control etc.). Some makes include a single tone control and selector switch for phono or auxiliary (TV or tape recorder playback) if the music lover should wish to use it with a tape recorder, or to modify or improve an existing non-high fidelity radio. The basic tuner may be for AM-FM or for FM only (one or two manufacturers make a unit for AM only for cities where FM is not broadcast). Some types have only two knobs and these include a station selector and a volume control with switch. Other models do not have a volume control since the basic tuner is used with amplifiers having complete audio control facilities which include a volume control. The basic tuner is usually more compact than the tuner-control chassis. When used with a complete amplifier (Continued on page 55)

Design of a Continuously Variable Low-Pass Filter Utilizing Negative Feedback Techniques

BASIL T. BARBER*

The development of the theory behind an R-C filter which is readily controllable, and a presentation of a finished unit employing the resulting filter.

IN A HIGH-FIDELITY SYSTEM, in order to eliminate any objectionable noise or record hiss, a low-pass filter is sometimes introduced capable of effectively reducing the noise present without eliminating a considerable portion of the program's musical content which may exist below the cutoff frequency.

Several methods exist utilizing chokes or feedback-type twin-T networks which, in addition to their advantages, also have a number of serious disadvantages. These include hum pickup, ringing, poor transient response, phase reversal at the null frequency, a limited number of cutoff frequencies, and the use of critical or precision components.

A method is presented here for designing a low-pass filter with a continuously adjustable cutoff frequency from 4 to 16 kc and an attenuation rate of 12 db per octave. Over the range from 4 to 16 kc the "peaking" remains the same and is less than 1 db. A 12-db-per octave rate is considered adequate and a number of high-quality control units (Radio Craftsmen RC-300, Stromberg-Carlson AR-425, Electronic Workshop C-5) utilizing chokes have adopted this rate with satisfactory results.

Some familiarity with the concept of the Laplace transforms and the principles of negative-feedback theory is required to follow the derivation of the design equations.

*Project Engineer, Sperry Gyroscope Corp., Great Neck, N. Y.

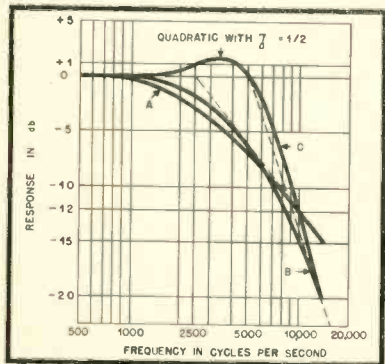

Fig. 1. Frequency response of a single RC lag, a double RC lag, and a quadratic.



A complete preamplifier and control unit which utilizes the filter circuit described.

General Considerations

Referring to Fig. 1, let us assume that a 12-db attenuation at 10 kc is required. It is obvious that the smaller the slope, the further to the left we shall have to start attenuating in order to obtain the required 12 db attenuation at 10 kc. The frequency band between the turnover point and the 10-kc point will also be attenuated to a degree proportional to the slope of the curve employed. For example, if a single R-C lag is used with a slope of 6 db per octave, the turnover will have to be two octaves below 10 kc, or at 2500 cps as curve (A) indicates. The signal will be attenuated by 3 db at 2500 cps and 6 db (ideally) at 5 kc. Most tone controls follow this curve and their effectiveness is therefore limited.

By cascading two R-C lags having the same time constant, a 12-db-per-octave attenuation is obtained. The turnover point is one octave to the left, but as seen from curve (B) of Fig. 1, the midfrequencies also suffer a proportional attenuation, although not as great as the single R-C lag.

A method must therefore be devised that would minimize all this unnecessary attenuation of the midfrequencies, but still be able to give us the necessary 12 db drop at 10 kc.

Figure 2 represents the frequency response of a quadratic equation of the form¹

$$\frac{1}{(j\omega)^2 + 2\zeta(j\omega) + 1} \quad (1)$$

¹ Brown and Campbell, "Principles of Servomechanisms," Wiley, chap. 4. Chestnut and Mayer, "Servomechanisms and Regulating System Design," Wiley, p. 311.

In a non-dimensional form, the resonance peak of the curve depends on the value of ζ , the damping factor of the quadratic equation. By making ζ equal to 1/2, a curve is obtained having practically no loss up to an octave before the frequency where the 12 db attenuation is required. The problem can therefore be restricted to making an actual circuit which will follow Eq. (1) with $\zeta = 1/2$, utilizing resistors and capacitors only.

Methods of Approach

Figure 3 represents the network to be employed.

1. Assume that we attempt to solve the problem by cascading two R-C lags having the same time constant. Then,

$$K_2 = \frac{3}{40} = \frac{\frac{R_1 R_2}{R_1 + R_2}}{R_2 + \frac{R_1 R_2}{R_1 + R_2}} \quad (11)$$

$$K_1 = \frac{9}{10} = \frac{\frac{R_1 R_2}{R_1 + R_2}}{R_1 + \frac{R_1 R_2}{R_1 + R_2}} \quad (12)$$

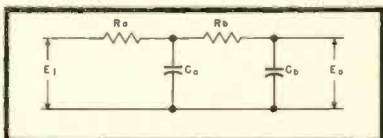
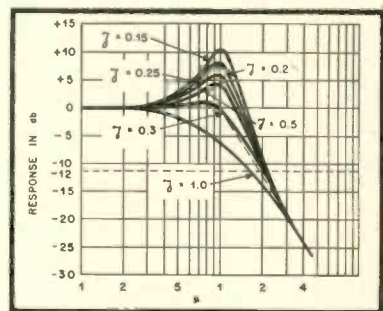

Fig. 2 (upper). Frequency response of a quadratic lag as a function of ζ . Fig. 3 (lower). Network of resistors and capacitors to be solved for transmission characteristic.

And if $R_s \gg R_t$
 $R_s \gg R_t$

then Eqs. (11) and (12) can be approximated as follows:

$$K_s \approx \frac{R_t}{R_t + R_s}$$

$$K_i \approx \frac{R_s}{R_t + R_s}$$

We have two equations and three unknowns. If we make R_t equal 1 megohm, then we have

$$R_s = 82,000$$

$$R_s = 1 \text{ megohm}$$

$$R_s = 470,000.$$

The total gain will be

$$\left[\frac{9}{10} e_t - \frac{3}{40} e_o \right] 40 = e_o,$$

from which

$$A = \frac{e_o}{e_t} = \frac{36}{4} 9 \approx 19 \text{ db.}$$

A good compromise for R_a in Fig. 3 is 100,000 ohms, and with $m=5$, R_b becomes 500,000 ohms. Setting 5 kc as the low limit of the filter, from Eq. (10) we have,

$$f_n = \frac{1}{\pi RC} = 5 \times 10^3.$$

Therefore

$$\tau = RC = \frac{10^{-3}}{5\pi} \text{ seconds.}$$

$$C_a = \frac{10^{-3}}{5\pi \times 10^3} = \frac{10^{-6}}{500\pi} \approx 680 \mu\text{mf.}$$

and

$$C_b = \frac{C_a}{m} = \frac{680}{5} \approx 120 \mu\text{mf.}$$

Complete Circuit

Figure 6 presents the complete circuit. The 680- and 120- μmf capacitors are connected to ground through switch Sw_1 which is attached on the back of the ganged pots R_a and R_b . At the extreme counterclockwise position of the pots the switch opens, giving a flat frequency response to beyond 50 kc. The switch opens at a logical point because the extreme counterclockwise position represents the point of minimum suppression. The first cathode-follower can be eliminated as long as the 82,000-ohm resistor looks into a reasonably low impedance (10,000 to 20,000 ohms). The 1-megohm feedback resistor and the 0.1 μf of the cathode-follower output have a time constant of 0.1 second, giving a break frequency

$$f = \frac{1}{2\pi RC} = \frac{10}{2\pi} \approx 1.6 \text{ cps,}$$

far enough below the audio spectrum not to cause any trouble.

Final Curves

Figure 7 shows the actual curves taken with the circuit of Fig. 6. The circuit parameters have been selected to give the best possible results. The cut-off frequency can be varied from 4 kc (maximum clockwise) to 16 kc (maxi-

imum counterclockwise) with a provision for a completely flat response. The overshoot is always less than 1 db at any cutoff frequency selected, eliminating ringing and distortion. Owing to the nature of the filter, no phase reversal exists similar to the one present in the choke or the twin-T feedback-type filter. In addition, since the -180 deg. in the phase domain will be reached only when the frequency approaches $+\infty$, and since at that point the gain will approach the $-\infty$ point, there exists no real frequency at which the circuit may become self-oscillatory.

Figures of Merit

The final criterion of any circuit is, of course, a listening test. A large per-

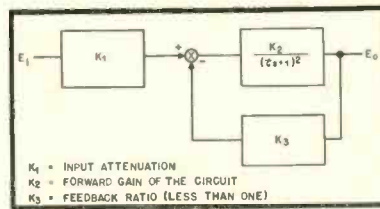

Fig. 4. Network of Fig. 3 with addition of a feedback loop.

centage of a group of critical listeners have found that the circuit described definitely eliminates most of the noise and hiss of recorded music without seriously impairing the actual "musical substance" present in the program.

We went a step further and have attempted to determine quantitatively this rather intangible characteristic of "musical substance." The word suggested that if we can measure the area "sliced" between the turnover frequency and the frequency at which the required attenuation is present, we could establish some means of comparison between several curves as to their effectiveness.

Assume again that a 12-db attenuation is required at 10 kc and that most of the noise lies beyond that point. In

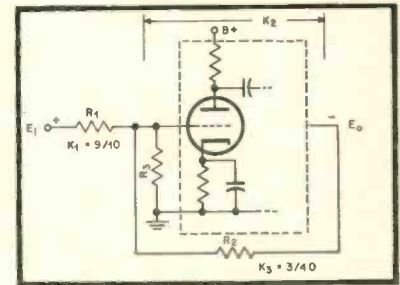

Fig. 5. Practical application of networks.

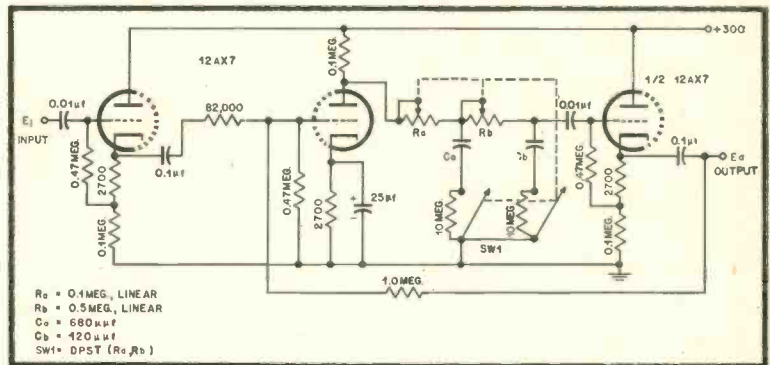

Fig. 6. Over-all schematic of filter giving 12-db-per-octave slope.

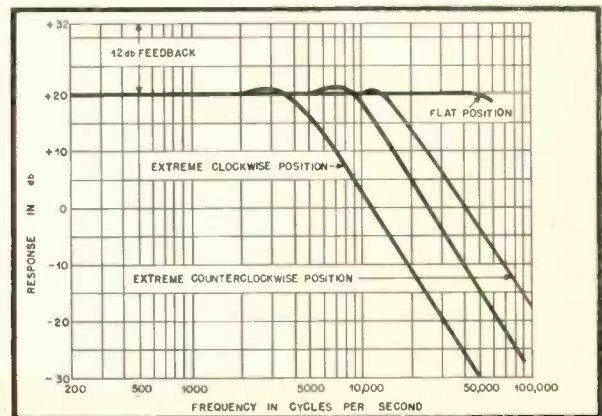

Fig. 7. Frequency response of circuit shown in Fig. 6.

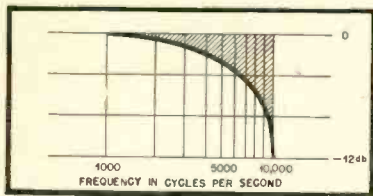

Fig. 8. Shaded area represents "intelligence" lost to secure desired attenuation at 10,000 cps.

Fig. 8 the shaded area represents the amount of musical energy that must be lost in order to attain the required attenuation at 10 kc. The smaller this area, the more the musical "substance." This area can be calculated by taking the transfer function of the filter employed and integrating it from 1 to 10 kc. The integrals of the double R-C lag and the quadratic with $\zeta = 1/2$ can be quite involved and a planimeter was therefore employed to measure their areas, since what we are actually interested in are their relative values.

Referring to Fig. 1 we obtain.

$$A_1 = 2.6 \text{ for the single R-C lag, curve (A)}$$

$$A_2 = 2.2 \text{ for the double R-C lag, curve (B)}$$

$$A_3 = 0.8 \text{ for a quadratic with } \zeta = 1/2, \text{ curve (C)}$$

and therefore

$$\frac{A_1}{A_3} = \frac{2.6}{0.8} = 3.25 : 1$$

$$\frac{A_2}{A_3} = \frac{2.2}{0.8} = 2.75 : 1$$

and

$$\frac{A_1}{A_2} = \frac{2.6}{2.2} = 1.2 : 1.$$

$$C_b = \frac{C_a}{m}, \quad \tau_b = R_b C_b = (m R_a) \frac{C_a}{m} = R_a C_a = T_a$$

therefore $T_a = T_b = \tau$

The value of m must be greater than 5 for an effective impedance separation. Letting $\tau = RC$ and using Laplace transforms, we have

$$\frac{e_o}{e_i} = \frac{1}{(TS+1)^2} = \frac{1}{T^2 S^2 + 2TS + 1} = \frac{1}{\frac{S^2}{\omega_n^2} + \frac{2\zeta}{\omega_n} S + 1} \quad (2)$$

and therefore

$$\omega_n = \frac{1}{\tau} = \frac{1}{RC} \text{ (in radians/sec)}$$

and

$$\zeta = \omega_n \tau = \frac{\tau}{\tau} = 1$$

The above can only be approximated if $m \gg 1$. If m is not much greater than 1 however, Eq. (2) becomes

$$\frac{e_o}{e_i} = \frac{1}{\tau^2 S^2 + \left(2\tau + \frac{\tau}{m}\right) S + 1}$$

giving a $\omega_n = \frac{1}{\tau}$ as before, but

$$a \zeta' = \zeta + \frac{1}{2m} = 1 + \frac{1}{2m}$$

For a 10% error in the value of ζ , the value of m must therefore be equal to or greater than 5.

From Fig. 2 it is seen that such a network will be unsuitable as analyzed previously, since it gives a loss of 6 db one octave below the cutoff frequency.

2. Suppose the network of Fig. 3 is made up of two R-C units having different time constants. Then if $R_b \gg R_a$, and

$$\tau_a = R_a C_a \\ \tau_b = R_b C_b$$

$$\frac{e_o}{e_i} = \frac{1}{(T_a S + 1)(T_b S + 1)} = \frac{1}{T_a T_b S^2 + (T_a + T_b) S + 1} \quad (3)$$

and therefore

$$\omega_n = \frac{1}{\sqrt{T_a T_b}}$$

and

$$\zeta = \frac{\omega_n}{2} (T_a + T_b) = \frac{T_a + T_b}{2\sqrt{T_a T_b}} \quad (4)$$

In our case we need ζ equal to 1/2. Therefore

$$\frac{T_a + T_b}{2\sqrt{T_a T_b}} = 1/2$$

$$\text{or } T_a + T_b = \sqrt{T_a T_b}. \quad (5)$$

No real values of T_a and T_b will satisfy Eq. (5) and therefore the desired curve cannot be attained with this approach either. In addition, since

$$\zeta = \frac{T_a + T_b}{2\sqrt{T_a T_b}}$$

even if the values of T_a and T_b were real numbers, it would have been very difficult to have the values of R_a and R_b made variable with potentiometers of standard tapers and still maintain the relationship of

$$\frac{T_a + T_b}{2\sqrt{T_a T_b}} = 1/2.$$

3. Let us now use the same network we had in the first approach but enclose it in a feedback loop as shown in Fig. 4.

$$\text{Then } A = \frac{e_o}{e_i} = \frac{K_1 K_2}{1 + \frac{K_1 K_2}{(TS+1)^2}} = \frac{K_1 K_2}{T^2 S^2 + 2TS + K_1 K_2 + 1} = \frac{K_1 K_2}{1 + K_1 K_2} \frac{2\tau}{1 + K_1 K_2} S + 1 \quad (6)$$

and therefore

$$\omega_n = \frac{\sqrt{1 + K_1 K_2}}{\tau} \quad (7)$$

and

$$\zeta = \frac{\omega_n \tau}{1 + K_1 K_2} = \frac{1}{\sqrt{1 + K_1 K_2}} \quad (8)$$

and for the $\zeta = 1/2$ required,

$$\frac{1}{2} = \frac{1}{\sqrt{1 + K_1 K_2}} \text{ or } K_1 K_2 = 3 \quad (9)$$

A significant point of Eq. (8) is that the value of ζ is independent of the value of the time constant τ of the R-C networks employed.

From Eq. (7) we have

$$f_n = \frac{\omega_n}{2\pi} = \frac{\sqrt{1 + K_1 K_2}}{2\pi\tau} = \frac{1}{\pi\tau} = \frac{1}{\pi RC} \quad (10)$$

Design of Actual Filter

Equations (9) and (10) are all that we need to design the filter. A K_1 of 40 can be obtained with a cathode-bypassed 12AX7 or 6SL7.

Therefore

$$K_2 = 40 = 32 \text{ db (original gain)}$$

and from Eq. (9)

$$K_2 = \frac{3}{K_1} = 3/40.$$

Also from Eq. (6), the total gain of the circuit is

$$A = \frac{e_o}{e_i} = \frac{K_1 K_2}{1 + K_1 K_2} = \frac{40 K_2}{4} = 10 K_2$$

and therefore $K_2 = A/10$.

Since $K_1 < 1$, A must therefore be equal to or less than 10. This additional gain of 20 db can be used as gain compensation for tone controls, loudness control, and so on. Since the original gain of the amplifier was 32 db, the remaining 12 db is left in the circuit as negative feedback at all frequencies, reducing the harmonic distortion and improving the linearity and signal-to-noise ratio of the over-all circuit by a factor of 4 to 1.

In Fig. 5 assume that both R_1 and R_2 come from a low-impedance source. R_2 is required as a grid leak and therefore it enters into the calculations of K_1 and K_2 . We therefore have, Taking the single R-C lag as a measuring unit, we see therefore that a double R-C lag is only slightly better and that a quadratic with $\zeta = 1/2$ is at least three times as good. Using the planimeter on the actual curves of Fig. 7, we find that:

$$\left. \begin{aligned} A_1 &= 1.0 \\ A_2 &= 0.35 \end{aligned} \right\} \frac{A_1}{A_2} = 3.85 : 1$$

and therefore

$$\frac{A_1}{A_3} = 3.85 \times \frac{3.25}{2.75} = 4.5 : 1.$$

The actual curves are better than a single lag by a factor of 4.5 to 1.

Variation of Parameters

The value of ζ is rather critical and must be maintained at 1/2. From Eq. (8) is seen that ζ is a function of K_2 , the gain of the tube and K_1 , the feedback ratio. If we assume that a maximum deviation of ± 10 per cent is possible in tube gains and the values of resistors,

(Continued on page 54)

The Record Revolution and Music

RUDO S. GLOBUS

The future of music has left the concert hall behind.
The record buyer will be its maker or its destroyer.

JUST A FEW SHORT WEEKS ago, I sat down to lunch with David Oppenheim, impresario and guiding hand behind the activities of Columbia Records' classical division. Over a bowl of formidable Spanish fish soup, we talked for well nigh two hours about Stravinsky, *The Rake's Progress*, recordings, music, philosophy, aesthetics—and a little bit of gossip thrown in. The ostensible purpose for the lunch was some talk-talk about the recent Columbia recording of *The Rake's Progress*—one of the most thoroughly publicized recording sessions of recent history. For this recording is in its own way a symbol and a symptom of a rather remarkable thing that has happened to this queer world of ours.

If we examine the recording, the session that produced it, and a few other things more or less closely, a pattern begins to emerge. The first performance of the Stravinsky work was widely heralded. A major composer, Stravinsky, and a major poet, Auden, created a new opera. Its premiere performance in Venice got mixed reviews—ranging from the ecstatic to the uncertain. It received a few more performances—including three in the United States.

The likelihood is that it will not be performed with any frequency, and there are no indications that it will become a mainstay in the opera houses here and abroad. An overwhelming percentage of the music lovers of this fair world will never have an opportunity to hear a live performance of the opera. Even if New York's Metropolitan Opera Company were to perform it once a year, every year (and this is unlikely), you can figure out that the total number of adults throughout the United States who will hear the work will be identical to the seating and standing capacity of the Metropolitan Opera House.

Whether you like it or not, whether you consider it first rate or second rate (or even third rate) Stravinsky makes little or no difference. *The Rake's Progress* deserves a hearing. So along comes Columbia Records and the work is recorded. This means that everybody and anybody with a record player of one sort or another will have a chance to hear the opus. But *The Rake* is an opera, meant to be seen as well as heard. The libretto, the score—both anticipate stage settings, action, drama. The record listener is compelled to inject these factors by way of imagination—and this is a difficult job at best. Oppenheim has tried his best to help out. Where the original score calls for a piano, a harpsichord is substituted in the recording to supply the sound and feel of period and of setting. Where the live performance compensates for linguistic inaudibility by way of action, the recording has gone the limit to make

every last word and syllable distinct and clear . . . while still preserving the texture of vocal and instrumental sound so dear to Stravinsky. Since it is unlikely that not too many more recordings will be made of *The Rake*, every effort has been made to produce an authentic, definitive performance. The composer conducts an orchestra thoroughly rehearsed and familiar with the work in performance. So here we are! The place of *The Rake's Progress* in musical history may very well depend on a recording. What kind of a strange freak of logic is this? Take heed, friendly readers, for we are about to make a pronouncement marking the most important revolution in aesthetic history since the invention of the printing press!

We know that live music, of necessity, was always limited to a minority of the consuming public. Even today, and in a certain sense, especially today, the opportunities for hearing live performances of the full repertoire in any field are small indeed. We may have more orchestras than before, true. But for the most part, they are mediocre, if not worse. They play the war-horses over and over again and are certainly not competent to attack the problems of new and more difficult composition. Opera, chamber music, solo performances are matters for a few of our major metropolises. Until only a few years ago, the course of the history of music was entirely in the hands of a ridiculously small group of critics, wealthy patrons, musicians, and penny-wise music lovers.

But now things are somewhat different. The major music activity of our time—and probably for centuries to come—lies in the area of recording. The great majority of "serious listeners" hear their music exclusively through this medium—and on their taste, their judgment as reflected in their buying habits depends the future history of music.

In our time—right now, for that matter—artists are establishing themselves entirely through the recording medium. A

pianist, Paul Badura-Skoda, a conductor, Munchinger, and an orchestra, the Philharmonia, all sprang to prominence through recordings. Badura-Skoda was well-nigh unknown both here and abroad, and yet a concert appearance in this country was extremely successful. There are dozens of cases of such phenomena. And now, with better equipment, better recordings, the record "personality" is surely going to become the musical "personality" of our time—an unseen name on a record label.

The significance of this revolution is staggering. Let's take another case. A remarkably large percentage of recordings since the advent of LP are of music that has never been heard in an American concert hall. An even larger percentage has had one or two performances in a span of over a hundred years. Already recordings are being produced of new works which have had either no live performance, or an esoteric one at best. During the formative stages of the LP market, a number of music entrepreneurs have appeared who have been willing to sell to specialized markets, making small amounts of profit on small pressings. The ancient music market, the modern music market, etc., have made possible record activities which the major manufacturers have ignored. Sooner or later, this type of activity is doomed. The small record company comes into being, exists for a short period of time, and then dies out. The crucial core of record manufacturing—and consequently music making—lies in the hands of the few large or comparatively large companies. It is they who will create the concert artists, the orchestras, the repertoires of the future.

But not so fast! The record business is just that—a business. If the overwhelming majority of the record-buying public shows an inclination to buy experimental modern music, the record manufacturer will record it. If the record-buying public rejects second rate orchestras, soloists, conductors, and so on, so will the record companies after a while. Everytime anybody plunks down the \$5.95 (minus 30 per cent off) for a 12-inch LP, he is directly affecting the course that music is to take in this world. The critic is less important in such a situation, for if he fails to influence purchasing patterns, his plaudits or his agonizing groans and moans will mean absolutely nothing to the powers that be.

The public—the record-buying public—can reduce music to a gross mediocrity. They have done so in the past and are fully capable of doing so again. If we pay attention to the analogy of the printing press and the book, major works of literary

(Continued on page 59)



"They're playing it MUCH too loud!"

Handbook of Sound Reproduction

EDGAR M. VILLCHUR*

Chapter 17. System Assembly

While individual components should be well made, matching and connecting them properly is what makes a good system.

THE PERFORMANCE CHARACTERISTICS of an audio reproducing system are not exclusively dependent upon the quality of the individual components. It is possible to lose some of the potential fidelity of such components by improper assembly, and system design as well as unit design must be considered as part of the reproducing problem.

The objectives involved in the design of the over-all system may be listed as:

1. Choice of the quality level of each unit so as to create a balanced system, in which strong links are not wasted by having to work with much weaker ones.
2. Correct electrical inter-connection and physical layout to take full advantage of the quality of each unit.
3. Operating convenience.
4. Adequate ventilation and easy removal of parts for servicing.

Selection of Components

We have seen that the electro-mechanical reproducing units, and particularly the loudspeaker, cannot be expected to live up to the standards of a high-quality amplifier. Primary attention must therefore be directed to the former components. No simple rule about the subdivision of the budget among the various units can be made, except to state that as good an amplifier as possible should be chosen first. When the budget is severely limited, one possible procedure is to select speaker, record player, and pickup with the minimum possible requirements, and then to purchase the best amplifier possible with the remainder of the money.

Where speaker systems with good low frequency response are used the

hum level of the electronic components, and especially of the preamplifier stages, must be especially low. A preamplifier which is acceptable in a medium-grade system can fill the room with 60 cps hum when playing through a horn-loaded woofer. Conversely, the finest speaker will show off the distortion characteristics of a poor amplifier, but even a medium-quality speaker will sound "clean" with a good amplifier.

Electrical Inter-connection of Components

Commercial audio components such as amplifiers, preamplifiers, and pickups normally have high-impedance inputs and can usually be connected one to the other without having to worry about careful impedance matching. Occasionally an amplifier will have a set of low-impedance input terminals; a high-impedance line should never be connected to such terminals, at the peril of severe bass attenuation. The bass discriminating voltage divider formed by such a mismatch is illustrated in Fig. 17—1.

The higher the total impedance across an interconnecting cable (that is, the output impedance of one unit in parallel with the input impedance of the other) the greater will be the tendency of the line to introduce high-frequency losses and to pick up hum. The cable capacitance does not have much effect on high frequencies if it is shunted across a low impedance, and, as pointed out in Chapter 15, the impedance across the line forms the lower arm of a voltage divider across which hum voltages are applied. Many modern preamplifiers and control units, which are apt to be located at positions physically distant from the amplifier, often provide low-impedance cathode-follower outputs that solve the problem of hum pick-up and treble loss, and can be connected directly to the normal input terminals of the amplifier.

Interconnecting cable between high-impedance terminals should be of low capacitance. Shielded cable with composition (not rubber) insulation, of about 25 μf per foot, is suitable, and should be kept as short as is practical. Where the cable must be fairly long a shunt resistor of 50,000 ohms or so across the input may help the situation provided that the output circuit is designed so that it can be connected to a

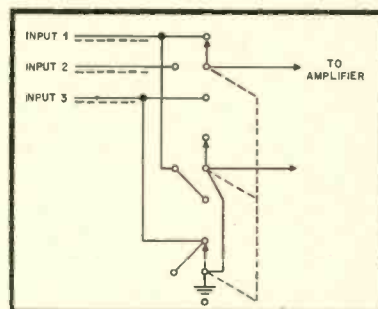

Fig. 17—2. Signal selector circuit that grounds out unused channels to prevent cross-talk.

load of such low impedance. If the plate resistor of this output circuit is of the order of 50,000 ohms, and the output capacitor is 0.25 μf or higher, the relatively low impedance input is proper. The assembler may wish to convert the output circuit to this design; in such a case the bias resistor must be changed to suit the new load. The correct value of bias resistor can be found in the R-C coupled circuit charts of receiving tube manuals.

The cable connecting the speaker to its appropriate winding of the output transformer is in a circuit of such a low impedance that ordinary rubber-covered lamp cord may be used. Flat TV transmission line is also convenient in this application, as the cable can be conveniently laid under rugs or tacked to mouldings. A transformer winding having an output impedance of 500 ohms can be employed, in conjunction with step-down transformers at the speakers, where it is important to minimize IR losses. This procedure is often followed when the signal is distributed over various parts of a building and the length of cable becomes excessive.

In order to prevent capacitive pick-up between signal inputs, which could, for example, introduce a faint background of radio program material while records are being played, the circuit of Fig. 17—2 may be employed. This arrangement grounds out all input cables other than the one being used at the moment.

A typical signal cable network is shown in Fig. 17—3. Ideally there should be a separate type of connector for each part of the network so that a

* Contributing Editor, AUDIO ENGINEERING.

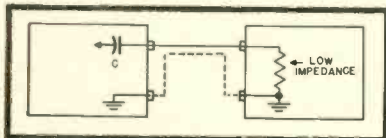

Fig. 17—1. Bass discriminating voltage divider formed by connecting a high-impedance output circuit to a low-impedance input. C has a high reactance at low frequencies compared to the input impedance.

plug can never be inserted into the wrong socket, but if such a scheme is not feasible the next best system is to color code all male and female matching connectors.

The power plugs of the various units should be connected in such a way that the entire system can be turned on and off from a master switch, as illustrated in Fig. 17-4. The relative polarity of each plug must be tested for minimum hum. The record player, of course, requires its own series switch, so that the turntable motor can be turned off while the radio is playing. The added load on the single master switch does not normally even approach the overload point.

If remote switching is desired the least expensive solution to the problem is a relay system, in which only low voltage appears across the power cables and long runs can be installed by a non-licensed electrician. Such a system is illustrated in Fig. 17-5.

A.c. power cables should never be laid close to or interlaced with signal carrying cables.

The voltage gain of an amplifier must be sufficient to provide an adequate signal voltage at the output stage grids when a specified input signal voltage is applied. However, a large surplus of gain, besides being wasteful and introducing added amplification which is necessarily imperfect, can also be responsible for a degradation of the signal-to-noise ratio.

The hum and noise produced by stages after the volume control receive full amplification no matter what the position of the volume control slider. When there is too much gain following this control the operator can turn down the gain to secure the desired signal level, but the hum produced by the stages following the potentiometer remains at a high level. This condition is illustrated in Fig. 17-5, in which the hum produced by audio stages incorporated in a tuner meets more gain than is required by the tuner signal.

Physical Layout

The plan of component layout involves two dangers from the point of view of performance—that of hum pick-up from adjacent units, especially those of an inductive nature, and that of acoustical feedback.

Acoustical feedback is commonly set up between the loudspeaker and low-level microphonic tubes, or in some cases between the speaker and the pickup. The coupling may be through the back wave of the speaker, or through mechanical vibrations of the cabinet. The best procedure is to mount the speaker in a separate cabinet, but where this is impossible the judicious use of acoustical "shielding," in the form of sound absorbent material, may solve the problem.

The location of low-level units such as preamplifiers or magnetic cartridges, relative to power supplies, is critical

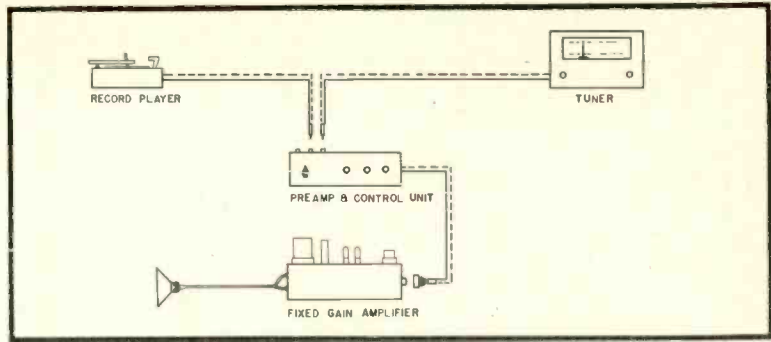

Fig. 17-3. Typical network of signal-carrying cables in reproducing system.

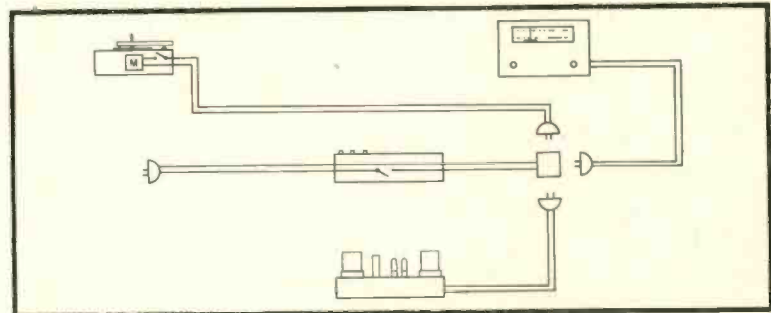

Fig. 17-4. Typical network of power lines in reproducing system.

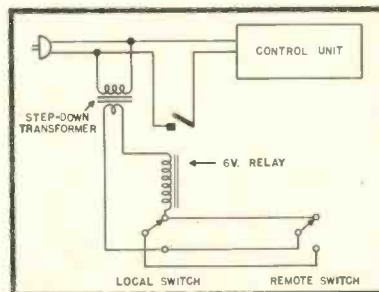

Fig. 17-5. Remote on-off switching system with relay. (After Vino.)

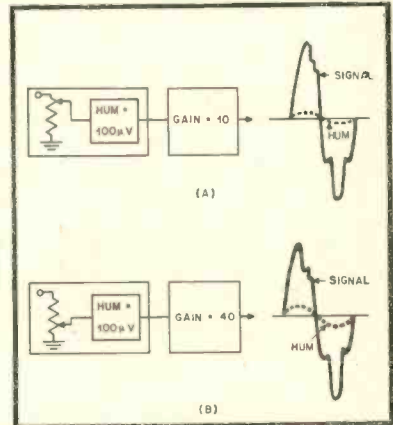

Fig. 17-6. Degradation of signal-to-noise ratio by the presence of too much gain after volume control. (After Vino.)

from the point of view of hum pick-up. When the designer is committed to an unfavorable layout with regard to the physical location of the power supply of a particular component, an added power switch for this component may supply the necessary relief. For example, a switch in series with the tuner power switch, ganged to the radio-phonograph selector, can be used to turn off the tuner during phonograph operation.

Electronic components do not have to be installed right side up, but when they are to be placed on their sides mounting data on the rectifier and output tubes, available in tube manuals, should be consulted. Certain tubes can be mounted in any position, while others, when not upright, can only be mounted with particular pins horizontal. If such specifications are not followed there is an increased danger of tube failure due to sagging elements.

The design of the standard radio console, in which the dial and controls are placed on a vertical panel a few feet from the floor, is sometimes used as a precedent even when the installation does not require it. It is a convenience to be able to tune without stooping or knee-bending, and a wall installation can have the dial at eye level with good effect.

Bottling up tubes and parts in an airtight chamber, especially when the heat-dissipating rectifier and output tubes are included, will normally decrease the trouble-free life expectancy of the system. Cross-ventilation should be provided in some form whenever possible.

(Continued on page 39)

Equipment Report

FM-607 Pilotuner and AA-903 Pilotone Amplifier

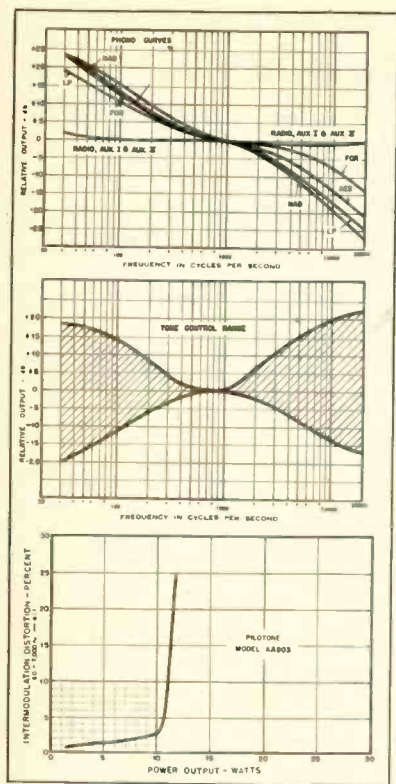

Fig. 1

MOST MUSIC LOVERS are willing to settle for a record player, an amplifier, and a speaker as the basic elements of their home music system, but from an economic standpoint the addition of a good FM tuner would increase the available music by a great amount with a relatively small increase in the cost of the entire system. True, there are a great many tuners on the market, and some of them are fairly expensive—especially when they are equipped with tone controls, selector switches, and all the elements of a preamplifier-control unit. However, for the system in which the controls are already available on the main amplifier—or on a separate preamplifier unit—the tuner does not have to represent a major purchase to offer the equivalent in hours of music that would require many feet of shelf space for storing LP records. In the FM-607 Pilotuner, shown in Fig. 2, the entire cost of the additional unit represents not more than a dozen LP's (at list prices) and the rewards in hours of music are well repaid.

Although the FM-607 does not provide for use with magnetic pickups without an external preamplifier, it does have a switch position which permits the connection of a crystal pickup to the tuner—or a magnetic pickup with an external preamplifier—and the selector switch chooses between phono and radio, the latter being accommodated with two positions, one with a.f.c. and the other without. Sensitivity is adequate for use in

most metropolitan locations with the linecord antenna, but fringe locations would require a better signal collecting system.

Technically, the tuner circuit comprises a tuned r.f. stage, a mixer-oscillator, an a.f.c. tube, two i.f. amplifier stages, and a ratio detector. A dual triode serves as a cathode follower output stage and as an additional a.f. amplifier which may be switched in or out. When this stage is in the circuit, the volume control is operative—when the amplifier is out of the circuit, the volume control does not operate. Output impedance is 500 ohms, from the cathode follower, which permits the use of a shielded output cable up to 100 feet in length.

In operation this tuner was noted to have good noise reduction qualities, to be easy to tune, and to have good audio quality in the presence of sufficient signal, equivalent to some more expensive sets.

For a low-cost installation, the FM-607 can be used with a basic power amplifier,—one having no controls—using the built-in volume control as the only variable element. The power switch controls an outlet on the rear apron, and the amplifier can be energized when the tuner is turned on. For a more elaborate installation, the tuner can be used without the amplifier stage, resorting to the controls on the main amplifier or on the preamplifier-control unit.

AA-903 Amplifier

A suitable companion to the FM-607 tuner is the Pilotone AA-903 amplifier. This model—shown in Fig. 3—provides for either magnetic or crystal pickups, the latter in one of the AUX inputs, furnishes compensation for four recording characteristics, and provides adequate power for medium sized listening rooms. Separate bass and treble tone controls give as much as 20 db of boost or cut, and the phono curves match present standards. The IM distortion is about normal for 10-watt amplifiers, as shown in the performance curves, Fig. 1.

The circuit consists of preamp stage employing a 12AX7 and giving suitable equalization LP, NAB, AES, and foreign (FOR) recordings. One desirable feature is the use of a variable resistor for a load on the phonograph pickup, so as to match any required value. The resistor is calibrated at 6800, 15,000, 27,000, 47,000, and 100,000 ohms, although any intermediate value can be obtained since the control is continuously variable. The selector switch follows the preamp stage, and at this point the desired input signal—phono (four curves), radio, or either of two auxiliary inputs—may be selected. A two-section volume control is used to reduce possibility of overload on early stages, and the tone controls are located between two sections of the second 12AX7. Two triode amplifier stages are next in line, followed by a cathodyne inverter which drives the 6V6 output tubes. Feedback extends over the output transformer and the three final stages, and 4, 8, and 16-ohm output impedances are available. The schematic is shown in Fig. 4. The power switch is combined with the volume control, and energizes a receptacle on the rear apron of the chassis.

The amplifier has sufficient sensitivity for most of the magnetic pickups now in use, and more than sufficient for radio and typi-

(Continued on page 60)



Fig. 2



Fig. 3

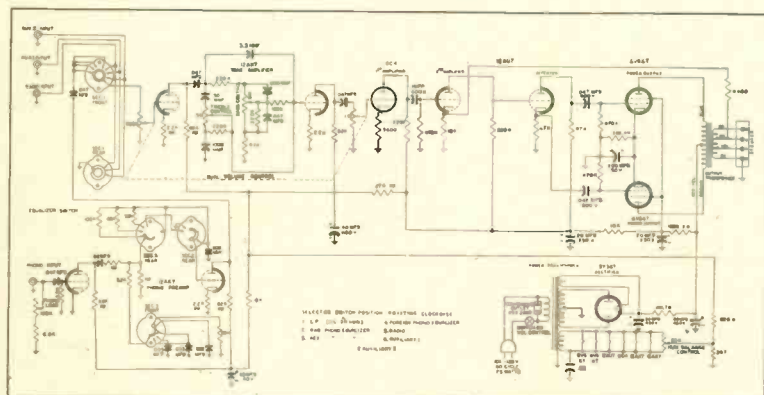
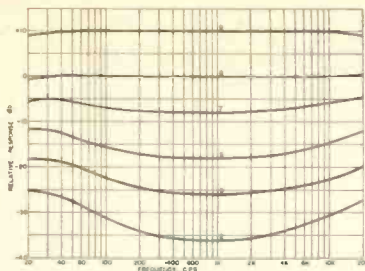
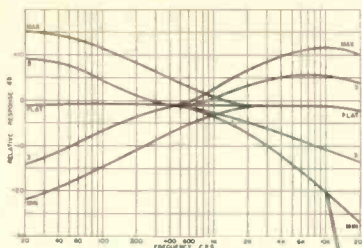

Fig. 4



Frequency response curves showing action of loudness controls.



Frequency response curves showing action of bass and treble controls.

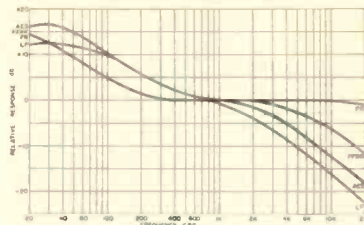

Frequency response curves showing record playback characteristics.

You're looking at performance records of the finest Hi-Fi Amplifier money can buy...

The price of the amplifier (including the de luxe pre-amplifier), whose frequency response curves are shown here, is \$189.95; and that probably represents the biggest bargain in the whole hi-fi market!

PERFORMANCE proves it. The charts will tell your practiced eye that Stromberg-Carlson's AR-425 Amplifier is built to satisfy the hypercritical. And your ear will recognize perfection, no matter how "tough" a test you ask this equipment to endure.

We make lower-priced amplifiers—good ones, too. *This* one is for the audiophile who accepts only the best—and probably thinks he has to pay much more than this really fair price.



PARTIAL SPECIFICATIONS:

POWER OUTPUT

25 watts at less than 2% total harmonic distortion.
20 watts at less than 1% total harmonic distortion.
Separate plate voltage and screen grid voltage power supplies for superior regulation.

HUM LEVEL

Hum: Basic amplifier 80 db. below 20 watts, basic amplifier and pre-amplifier below thermal noise.

REGULATION

Less than 2 db. no load to full load; damping factor 10:1; separate interlaced tertiary winding for feedback circuit.

PRE-AMPLIFIER CONTROLS

TREBLE CONTROL

Control provides 12 db. boost
20 db. droop at 10,000 cps.
Loudness control provides 6 db. boost
Maximum Treble Boost 18 db.

BASS CONTROL

Control provides 15 db. boost
20 db. droop at 30 cps.
Loudness control at 10% rotation 10 db. boost
Maximum Bass Boost 25 db.

BRILLIANCE CONTROL AND POWER SWITCH—5 position switch; off, 3000, 5000, 9000 (with 10 db. attenuation) and flat to 20,000.

LOUDNESS CONTROL—three-section control to boost bass and treble as volume is decreased in order to follow Fletcher-Munson curves.

INPUT SELECTOR SWITCH

7 POSITION: Microphone, F.F.R.R. (full frequency range recording), FR. (foreign), L.P. (long playing), A.E.S. (Audio Engineering Society), Radio and Auxiliary (television, tape recorder or crystal phono).

MAIL COUPON FOR DEALER'S NAME

STROMBERG-CARLSON®

SOUND EQUIPMENT DIVISION • 1219 Clifford Ave., Rochester 21, N. Y.

Tell me the nearest dealer where I can hear and compare your "Custom 400" Hi-Fi Amplifier, model AR-425.

Name

Address

City Zone State

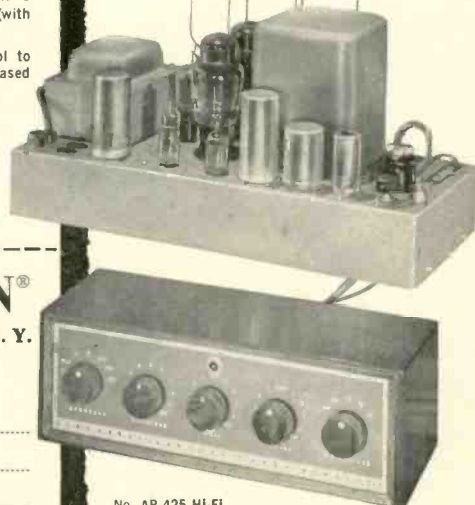

No. AR-425 HI-FI Pre-amplifier and Amplifier.



EDWARD TATNALL CANBY*

The Angels Sing

NOTE. I was the guy who hollered for factory-sealed records—and thanks to an order mixup I didn't get to see and hear any new Angel records until now—which is quite awhile before you read this, as usual. If not the first to hail the recording Angel, Factory Sealed, I'm bound to offer my congrats for the thoroughness with which this U.S. offshoot of the great EMI concern (as London is U.S. offshoot of English Decca) has set up the new system.

It's not cheap, nor is it simple. The sealed records come in one envelope, must be transferred to an ordinary slip-over with a solid back, then in turn slid into the outside jacket—all this after removing a vast outer area of cellophane or glassine. In this initial process the static generation is immense (in winter at least) and the record instantly absorbs to itself all the neighborhood dust. These are *not* static-free discs! Nevertheless the back of the trouble has been broken here, if only in the necessary new distribution setup which must of course go along with these sealed records. "It can be done."

What is left to do? The discs themselves are of high quality material but not markedly more so than other reputable non-sealed brands; there is a bit of noise and popping here and there. These are simply good normal records—sealed and new. (They're available unsealed too, at lower prices.) They are as subject as ever to static, dust, damage, after you buy them; once opened they are definitely unsealed.

I'd say that the following ultimate steps need to be added to Angel's (and others'—notably Cook's) pioneer step.

1. *We desperately need records that are initially static-free.* RCA records are supposed to be, but their claims are remarkably underplayed, considering the importance of the fact. A disc that will not build up static charges is automatically 100 per cent improved as to life expectancy and performance over one that does charge up.

2. *We need not only factory-sealed discs but a far better way of keeping them sealed, between playings.* Capitol is experimenting with the limp plastic envelope; it works but is clumsy except in boxed sets—and

it builds static up as violently as a swatch of genuine cat's fur. Bad.

Walco is issuing the plastic bags shortly, for standard records, and I'll report later in detail—but I am certain that ingenuity is needed to work out a foolproof and simple seal for *opened* records. What say, gentlemen, gadgeteers and inventors? What are your ideas?

ANGEL

Rossini-Respighi: La Boutique Fantastique. Philharmonia Orch., Calliera.

Angel 30001 (10")

Musique Militaire Francaise. (French Military Music.) Batterie et Musique de la Garde Republicaine, Brun.

Angel 35051

These I'd pick as the immediate hi-fi best prospects from the batch of Angels I have on hand—one light (quite light) classic, in frothy ballet style, the other an old-fashioned military band, French type. Both have been superbly recorded, clean, nicely alive, without stunts and tricks. The comparison with London *ffrr* will be especially interesting since this is London's closest competition at home, and the *ffrr* sound is, as we all have heard, sometimes a bit on the tricky side. Matter of taste as usual.

The Rossini is a delight in sound and in music too—for a while. It's sort of William Tellish (Heigh-O Silver) stuff. The French band musically, makes me realize anew how much Mr. J. P. Sousa did for our own band music. It may bring ready tears to every Frenchman's eyes—they have UMT, remember—but I find the stuff pretty dreary alongside the Stars and Stripes.

Set this up next to last month's Westminster Deutsche Kapelle Austrian band records. Nice comparison.

Humperdinck: Hansel and Gretel. Eliz. Schwartzkopf, Eliz. Grummer, Else Schurhoff et al, boys' and girls' choirs, Philharmonia Orch. Von Karajan.

Angel 3506B (2)

A new and charming "Hansel und Gretel," as far as I've played it, and surely a definitive one musically. Recording is superb, the cast is solidly Teutonic along with the conductor, though the children's choirs and the orchestra are British. In German, of course, with translation.

The innovation here is the close-to, low-level singing. This is an intimate opera and yet paradoxically it was scored for big orchestra and is normally presented on large stages where the singers of course must sing loudly—even when the plot calls for "singing to one's self." That is standard opera convention, and nobody minds. But on records there are new possibilities, here exploited nicely. The singers can—and do—more or less sing to themselves when the story says

so; they talk in whispers, too, all in a truly fire-side manner! Wonderful, except that in a way it makes for a stylistic absurdity; a complete transition—say into a TV opera-play—would logically call for a small orchestra and even for rewritten music to make it possible to sing really, literally, as the plot indicates. A new opera is the ultimate answer if you want to be logical, but that isn't the intention here; and so the music is still the large-scale stuff Humperdinck wrote and it does sound a trace incongruous, the vast orchestra (in a big opera-house live-ness) backing up a whisper-sung colloquy between singers at a few inches' distance!

No matter. This is a beautiful version and you'll be amazed at how well the compromise in technique works out.

Ravel: L'Heure Espagnole. Artists Orch. of the Opera Comique de Paris, Cluytens.

Angel 35018

Strange how this more modern opera of Ravel's (it's called a musical comedy) adapts itself so much more easily to the recorded technique than "Hansel"! Somehow in the 20th century most composers have unconsciously felt or even anticipated 20th-century ways of doing things even before they existed in fact. This chatty, conversational opera also uses a big orchestra but it doesn't "sound big" in the heavy German Humperdinck style; it glitters, blends, surrounds and sets off the solo voices for all the world like radio-TV music, though it was composed about 1907, long before any such music was conceivable. (In fact modern show music owes a huge debt to Ravel for orchestral color and a general "dressiness," that ever so clearly did not come from German music.)

Story concerns a humorous set of intrigues in a Spanish clock shop, people hiding inside grandfather clocks and the like. The fine sound of dozens of clocks ticking, bells ringing, mechanical bird songs trilling, appears at the very opening of the opera and will endear the recording immediately to every hi-fi listener. Exceptionally fine vocal recording.

Ravel: Piano Concerto #2 in G. Faure: Ballade. Marguerite Long, piano; Paris Cons. Orch., Tzipine; Cluytens.

Angel 35013

This is one of the two Ravel concerti written under considerable American influence, notably that of Gershwin—just how much seems to depend on the performance, oddly enough. There are pages here that to us "reek" of Gershwin—not so much in the melodies, which are Gershwin enough, but in a certain brassness and raciness of color that Ravel surely picked up hereabouts. European performers, to my ear at least, seem to miss the point here in some subtle but devastating way—the "American" part just quietly disappears, though the notes are the same.

Marguerite Long, long one of Europe's first pianists, can hardly be said to do less than a good job on Ravel—but again there is a strange lack of finesse, of that crackling electric quality, that brassy hard-boiled American joyousness, that would seem to me to be of the concerto and

in music, listening quality is everything

"... Before reading Weil's *ELECTRONIC PHONO FACTS** we thought we wanted wide frequencies, but now know that what we really want is fine reproduction, or as Mr. Weil would say, 'Listening Quality'..." (excerpt from a letter)

Some people have become so engrossed in the electronic end of music reproduction that they go by purely electronic standards. They are placing all emphasis on the means of playing rather than the desired end-results—Good Music. But—as the author of the above letter has learned . . . mere highs and lows do not add up to "Listening Quality".

The revolutionary new records contain so much music that almost any pickup is bound to give some results . . . but it takes a reproducer of the highest order, one sensitized to the nth degree . . . an Audax CHROMATIC—to bring out every subtle shading, every nuance so essential to good music.

Because a jewel point, (be it diamond or sapphire), has only a limited playing time† . . . replaceability—at home—is of great importance. Only Audax (Turnover Cartridge) provides replaceability—at home—of either stylus . . . independently of the other.

Listening Quality is EVERYTHING. Only YOU can tell what sounds best. Hear the Audax CHROMATIC and—YOU BE THE JUDGE. Yet Audax costs no more than ordinary pickups. At leading dealers.

Get your copy of **FREE GUIDE**
"ELECTRONIC PHONO FACTS" from your dealer,
or write direct to us



Available with the new Compass-Pivoted Audax arms and to fit the high quality record changers

AUDAX COMPANY

500 Fifth Avenue Dept. A New York 36, N. Y.

Creators of Fine Music reproducers for over 25 Years

"The Standard by Which Others Are Judged and Valued"

Now YOU know when
to change the stylus

Audax STYLUS-DISK †

Pats. Pend.

1. Gives **VISIBLE** indication, change in color, (before valuable records are ruined) of whether or not the stylus is in playing condition.
2. Will test **ANY** type of stylus, in any type of pickup, at any speed—in less than a minute.
3. Neither the stylus nor the cartridge need be removed. Nothing need be disturbed.
4. The few grooves that are needed for the test may be used over and over again, until finally a worn or defective stylus scrapes the delicate groove-walls.
5. Should last for years—costs **ONLY \$3.90** net at your dealers. (add 35¢ if shipped from New York City)



Available at leading dealers,
or write for information

This tape recorder
costs twice as much
—and is worth
every dollar



MagneCordette

FINEST OF ALL HOME TAPE RECORDERS

There is no comparison in price or performance between the superb MagneCordette and ordinary tape recorders. For twice the cost, you can own the MagneCordette performance that gives unmatched satisfaction and enjoyment.

The MagneCordette is the standard professional tape recorder preferred 3 to 1 by broadcast engineers—now restyled with a custom amplifier in distinctive cabinets for the home. There is no finer instrument available for home recording and playback.

**MAGNECORDING
SPECIFICATIONS**

In addition to handsome cabinetry, it costs far more to build these uncompromising performance specifications into the MagneCordette:

- Flat response from 50-15,000 cps, ± 2 db.
- Signal-to-noise over 55 db, with less than 3% harmonic distortion.
- Flutter less than 0.3% maximum.

Your dealer is listed under "Recorders" in the classified telephone directory

MagneCord INC.

Dept. A 3

225 W. Ohio Street, Chicago 10, Ill.

in it. The orchestra is peppy, but (consistently) shares the pianist's interpretation, or vice-versa. Beautiful recording, though not quite as spectacular as the Angels listed above.

The sweet and sentimental Faure Ballade, a kind of feminine counterpart of the familiar Franck Variations Symphoniques for piano, are much more "on the beam," and not likely to be done more pleasantly than here.

Ravel: Piano Concerti #1, #2. Blancard, Orch. de la Suisse Romande, Ansermet.

London LL 797

(Technically, number 1 is the Concerto for the Left Hand, number 2 the Concerto in G.) This version with the famed Ansermet has both of the Ravel American-touched concerti and is an even more positive example to my American ear of a strange misconception of the very feeling Ravel must have been after. Again, it's anything but a poor performance, but I feel in place of the required raciness, an ill-defined seriousness—like a joke told without the point really being quite understood. Admittedly I put myself on a limb with such necessarily vague and general suggestions, but I think a good study of these versions will bear me out. I feel (and I know there is disagreement) a similar lack of the proper electricity in Ansermet's Stravinsky, in spite of his special position as the first conductor of numerous Stravinsky works. A matter of style.

Bartok: Concerto for Orchestra. Philharmonia Orch., von Karajan.

Angel 35003

This work presents problems interestingly like those of the Ravel, above—though minus Gershwin. The Concerto is nominally "old fashioned," in that it is composed for large and complex orchestra and has many points of "Romanticism," so-called, that bring it to some extent into the older symphonic field for many listeners, compared to numerous other modern works. But this is misleading, and has misled the Angel recording technicians. The work actually is full of "close-up" effects, sharp, colorful modernisms—it is literally a concerto for orchestra in which the solo parts are spread out (often in pairs—two clarinets, two oboes, etc.) through the whole ensemble, an idea that is closely related both to Bach (Brandenburg Concerto number 3, for instance) and to modern practice in composers as widely varied as Hindemith, Stravinsky and the writers of modern jazz.

In other words, this music needs a close-up, sharply defined treatment, both in the performance and in the recording. Instead, Angel gives it a fine, fuzzy distant aura of Brahmsian splendor, a grand sound but not at all suited to the piece—the solos are constantly lost in the distance, the sharp, acid details of the music are softened far too much for effectiveness.

If you want to hear this work rightly played and recorded (my idea at least), try the oldish Columbia LP version (ML 4102) under Fritz Reiner. Quite dead acoustics, the solos beautifully close-to and well defined, and the interpretation too has the razor-sharp intensity of modern jazz, which is very, very much in the music. Originally a disc job I think, but it was one of the best of the early LP's and its only fault now in my copy is crackly surface. (Newer copies should be better.)

Wilde: The Importance of Being Earnest. Gielgud, Edith Evans, Pamela Brown et al.

Angel 3504B (2)

This ultimate and timeless example of witty English froth has recently made a wonderful film in color—those who have seen it won't forget the ornate and preposterous Aunt Augusta, grand dame of the naughty Victorian age, the suave Earnest, otherwise known (in the country) as Jack, and the incredible Miss Prism, a lady who is not so distantly related to Little Buttercup in "H.M.S. Pinafore." Timeless just because it is so utterly without special intent, drawing no morals or theses but simply making fun of an advanced state of high society in any sophisticated town in any age—this play is as funny now as it was in 1895. The top British actors here do the expected job of stylistic finesse—the only

trouble, perhaps, being a certain difficulty at first in telling one from another, so well trained are the voices and accents.

Extremely fine speech recording (except for inner grooves on long sides), very natural and without bombiness in the male voices even on large-bass speaker systems. (See also T. S. Eliot's "Murder in the Cathedral," at the moment out of stock, due soon.)

Tonal Ingenuity

Partch: Plectra and Percussion Dances. Played by the Gate 5 Ensemble. (LP-1)
(Gate 5 Ensemble, 3030 Bridgeway, RFD 67, Sausalito, Calif.)

The principle of revolution is an interesting one. It seems that, thanks to people's normal desire for things "as is," the status quo, it takes much more than plain reason and logic to jolt them into appreciating new things. (They're likely to be scared of them, anyhow, as we all know.) In the scientific fields we are at least open to the persuasion of facts, though what really counts in the end is the evaluations we attach to facts. But in the arts, it is the sense of things that count, the interpretation, and so new advances are likely to be scoffed at automatically just because they are different.

Thus artists with new ideas have to be radicals—as violently radical as the rest of us are comfortably conservative and satisfied. One can spot this situation in an instant—and be aroused to scorn or laughter as quickly; for these people are dedicated, intense, one-track obstinate, ultralogical (so they think), they don't know when to stop (from our point of view), they carry their theories to an impossible ultimate "no compromise;" moreover, there is almost always that typical building-up-to-a-cult, that is necessary in order to sustain the whole experiment; there are inevitably the devoted, fanatic followers who are passionately faithful and will brook no criticism. (Indeed they usually show an extreme sensitivity to criticism where the "boss", the creator himself, does not—he is serenely confident in his own destiny and that of his work and no longer even worries about critics!)

That is the background for the very strange noises here produced, in utmost seriousness and after fantastic labors, building the instruments, learning to play them, composing. On paper the Partch musical system is impressive, with a special 43-note scale, a Philosophy for creative music (Bold not mine) plus a set of extraordinary gadget-instruments—a Surrogate Kithara (6 strings each on two long resonating boxes), an Eroica (wood block), Cloud-Chamber Bows, Adapted Viola (attenuated neck for microtonal scales) and plenty more—plus an elaborate collection of symbolic "stories," satires, Greek legends, . . . enough said.

When you play the music you will immediately be reminded of our old hi-fi friend Varese and his "Ionisation"—this is a sort of feminine counterpart, minus the furious energy, the superb rhythm, the ferocity of Varese. Twangs, mumbling voices, gongs, cat's squalls, weird sirens, above all a lot of mandolin-like pluckings that sound, for all their fancy designations, like what they essentially are, strings stretched over boxes. Eerie.

Conclusion? Yes, you'll think this is cracked, as you probably did the Varese record (and many another experiment, including the John Cage Prepared Piano, Henry Cowell's tone clusters—he plays with his nose and reaches inside to pluck the strings, and is a much respected elder member of the musical community), Carillo's 16-tone 13th Sound Ensemble of Havana (old Columbia records)—and, of course, the newest of the new, Electronic tape music, now very much the latest rage.

Yes, all these Movements are cracked, more or less, and not one that I have heard so far has in itself much value as musical communication. Most are insufferably naive, often almost illiterate in any true musical sense. Yet, in the way of revolutions each undoubtedly has something underneath of good—once we can put aside the fanaticism and make use of the new kinds of raw material. There are interesting tone colors here, a good sense of rhythmic counterpoint, the interchange of rhythms from one instrument to another.

Dual 6"
SPEAKERS
for diffused
room-filling sound

HEATHKIT *Dual*
RECORD
PLAYER KIT

The NEW
MODEL RP-2
\$69⁵⁰
SHIPPING WT.
33 LBS.

DUAL SPEAKERS
HERE AND
HERE

HIGH
QUALITY
TWIN
SAPPHIRE
CERAMIC
CARTRIDGE

ATTRACTIVE
TWO-TONE
CABINET

FOUR TUBE
PUSH-PULL
AMPLIFIER

SEPARATE
TONE AND
VOLUME
CONTROLS

WEBSTER-
CHICAGO
THREE-SPEED
RECORD
CHANGER

DUAL MATCHED SPEAKERS

A new economical introduction to high quality record reproduction. A simple-to-operate, compact, table-top model with two matched speakers in an acoustically correct enclosure reproduce all of the music on the record.

DIFFUSED SOUND

Because of the diffused non-directional properties of the dual speakers, listening to fine recorded music is a thrilling new experience through naturally clear, life-like reproduction of sound at all tonal levels.

HIGH QUALITY PERFORMANCE

The performance level of the Dual is vastly superior to that of the ordinary phonograph or console. Automatic changer plays all three sizes at all three speeds with automatic shut-off after last record is played.

TWIN SAPPHIRE STYLUS

A wide tonal range ceramic cartridge features an ingenious "turn-under" twin sapphire stylus for LP or 78 records providing quick selection of the correct stylus without turning the cartridge.

SIMPLIFIED CONSTRUCTION

Simplified, easy-to-assemble four tube amplifier features compensated volume control and separate tone control. Proxylin impregnated beige and saddle tan fabric covered cabinet supplied completely assembled. You build only the amplifier.

EASY TO BUILD

No specialized tools or knowledge required as the construction manual has been simplified to the point where even the complete novice can successfully construct the Heathkit Dual. The price includes cabinet, record changer, two 6" PM speakers, tubes and all circuit components required for assembly.

OTHER *Famous* HEATHKIT AMPLIFIERS

THE HEATHKIT 6 WATT AMPLIFIER KIT

MODEL A-7B

\$15⁵⁰

Shipping Wt. 10 lbs.



The Heathkit Model A-7B Amplifier features separate bass and treble tone controls—two compensated inputs—three output impedances 4, 8 and 16 ohms—frequency response $\pm 1\frac{1}{2}$ db from 20 to 20,000 cycles—push-pull beam power output at full 6 watts.

Heathkit Model A-7C \$17⁵⁰
with preamplifier stage

WRITE FOR *Free COPY*

of audio booklet "High Fidelity Especially for You." Also new 1954 catalog. Lists all kits, specifications, schematics, etc.

HEATHKIT *High* FIDELITY AMPLIFIER KIT

MODEL A-9B

\$35⁵⁰

Shipping Wt. 18 lbs.



A 20 watt high fidelity amplifier especially designed for custom installations. Low hum and noise level 9 pin miniature duo triodes in preamplifier and tone control circuits. Four switch selected inputs, frequency response ± 1 db 20 to 20,000 cycles. Output impedances of 4, 8, 16 and 500 ohms.

HEATH COMPANY
BENTON HARBOR 25,
MICHIGAN

YOU SAVE BY ORDERING DIRECTLY FROM FACTORY

AT
ALLIED

**high fidelity
is NOT expensive**



the
Golden Knight
**24-WATT DELUXE
HI-FI AMPLIFIER**

± 0.75 db
20 to 40,000 CPS
UNCONDITIONALLY GUARANTEED
FOR ONE FULL YEAR

THE FINEST FOR LESS. This is the amplifier designed to provide optimum performance in limited-budget home music systems. Delivers very wide response with extremely low distortion; has plenty of reserve power for authentic reproduction of peaks. Important features include: specially designed output transformer with interleaved windings for virtually distortionless output; input for mike; selector switch for proper loading of G.E. or Pickering cartridges; equalizer for accurate playback of all records; separate bass and treble tone controls.

Specifications. Rated output: 24 watts. Frequency response: ± 0.75 db, 20 to 40,000 cps at rated output. Harmonic distortion: less than 1% at rated output. Intermodulation: less than 0.5% at normal listening level, less than 2% at rated

output (60 cps and 7 kc tones; 4:1 ratio). Hum and noise: 80 db below rated output. Speaker out. imp.: 8 and 16 ohms. 4 inputs: 1 magnetic phono, 1 high-imp. mike, 1 tuner, 1 aux. (for crystal phono, tape, TV, etc.). Controls: Off-on-volume; Bass (calibrated from +16 to -16 db); Treble (+16 to -16 db); Input-Equalizer Selector (Aux, Tuner, Mic, Flat, AES, and NARTB). Controls at top of chassis: G.E.-Pickering input switch; also bias, output balance, hum balance controls (screw-driver type). Tubes: 3-12AX7, 2-6L6; 5U4G rect. Entire chassis is beautifully finished in satin-gold. Size: 8 x 14 x 9" deep. Complete with tubes, connectors, instructions; with control shaft extenders and removable lucite panel. For 110-130 v., 50-60 cy. AC. Shpg. wt., 30 lbs.

93 SX 321. Net. \$79.50

**"GOLDEN KNIGHT" HIGH FIDELITY MUSIC SYSTEMS
COMPLETE PHONO SYSTEM**



A super-value, true high fidelity phono system, ready for custom installation. Includes color-coded cables, plugs, hardware and instructions for quick, easy hookup. The complete system includes: the "Golden Knight" amplifier (described above); the famous Electro-Voice SP12-B 12" Radax Speaker (with built-in "Whizzer" high-frequency radiator); the precision-built Garrard RC-80 3-speed record changer, and the General Electric RPX-050 triple-play cartridge with dual-tip sapphire stylus. These top-quality matched components form a superb high fidelity installation at a truly modest price. For 110-120 volts, 60 cycle AC. Shpg. wt., 60 lbs.

94 SX 127. Net, only. \$161.75

FM-AM-PHONO SYSTEM

Same as above, but includes the new KNIGHT Model 727 FM-AM High Fidelity Tuner for complete radio-phono entertainment. Tuner has dual built-in antennas, FM RF stage, minimum drift. Shpg. wt., 76 lbs. 94 SX 128. Net, only. \$214.50

FREE 268-Page Catalog

Write today for ALLIED'S complete guide to the world's largest selection of High Fidelity home music systems, amplifiers, tuners, speakers, changers, recorders and accessories. If it's anything in Hi-Fi, it's in stock at ALLIED. Send for our FREE Catalog today.

ALLIED RADIO
Everything in High Fidelity

ALLIED RADIO CORP., Dept. 17-C-4
100 N. Western Ave., Chicago 80, Ill.

- Send 24-Watt Amplifier Spec. Sheet
- Send FREE 1954 Catalog

Ship the following.

. \$ enclosed

Name

Address

City Zone State

So it is in most avante garde stuff. We'll just have to accept the fuss, the show, the cult, as somehow a necessity in our age, smile upon it a bit indulgently, listen for new sounds and then attach our own moderate evaluation thereto—not those of the fanatic proponents.

Incidentally, this disc has on it the lowest recorded tone I've ever heard—I thought it was turntable rumble until I discovered it was something being struck, like a very low-pitched Chinese gong. 20 cps, maybe. Interesting.

Ultimate touch: the disc is made of bright green plastic. Anything to be different. And it says **PLAY BY MANUAL CONTROL ONLY.** No mere changers for this special-special record.

Cook "N-A" Beam Test Record, Series 50.

This is a unique and ingenious test device, no doubt already a familiar disc to many audiophiles but well worth signaling for those non-engineers who haven't heard of it—even though for many an amateur the "no-good" signal that may be reproduced from it will be merely a disturbing indication of a negative sort, saying only that something is wrong—somewhere.

The device used here comes as near a factual and objective analysis of distortion as would seem possible via the ear (without meters or other visual measuring methods); yet—and this is one reason I mention it—there are still traps for the unwary musician. Let me explain the system for those who are strictly non-engineers.

Cross modulation (similar to intermodulation or IM) is simply the generation of sum-and-difference tones, more popularly understood as "beats" when any two exciting tones are sounded at once. There's lots of this naturally in music itself and other "original" noise, but it occurs, alas, also in our reproducing systems, adding new tones to those already present—distortions of the original sounds. That's an important distinction: "distortion" in the original sound is one thing, a change caused by the record-reproduce system is quite another.

Testing for distortion of this sort is done by choosing just two tones, pure ones generated electronically, for simplicity, then measuring the amount of difference-tone that is generated and added to the original by the component or system under test. One can actually see these additions on the scope. This, of course, is a kind of distortion quite separate from harmonic distortion, which can also be seen.

The cook "N-A" Beam record makes use of the device used in radio airways beam signals. There is, first, a pure-tone 1000-cps pilot signal of a fixed strength, not steady but in a code pattern, the dot-dash of the letter "A" (Fig. 1).



Fig. 1

Two other tones, sirenning downward from ultrasonic regions to the 4000-cps region, are superimposed on this. As they descend, these two remain the same frequency distance apart—1000 cps. (Not the same musical interval since that is a numerical proportion.) Since the difference between them is constant at 1000 cps the difference-tone "beat" distortion in your system, if any, will itself remain constant at 1000 cps and can be heard at the same pitch as the "A" pilot tone.

To complete the arrangement the lower of these two siren tones is intermittently shut off, in the dash-dot "N" pattern, (Fig. 2) exactly filling up the spaces between the dot-dash "A". (When only one of the siren tones is on there



Fig. 2

can be no difference-tone "beat"; only when the two operate at once will the fixed-pitch "N" distortion show up, if any.)

So—if your equipment is good enough to create less than 2 per cent of this cross-modulation “beat” distortion, the “N” signal, fixed-pitch, will be inaudible or less loud than the “A” signal. If the two are the same in strength—2 per cent distortion—the two signals blend and there is a continuous tone, as in Fig. 3; if the distortion is higher than 2 per cent the “N” signal is the louder and you hear the “N” rhythm.

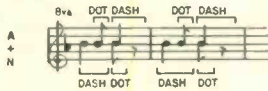

Fig. 3

Most ingenious, and it works, though of course the test is for the entire system from pickup through speaker and does not tell you where the trouble, if any, is occurring.

Now for the Canby musician's reaction. In the first place, a good musician will find it sometimes difficult to decide whether he hears the “A” rhythm or the “N” rhythm—in proportion to the state of fineness of his rhythmic sense. A good musical ear can pick out and “feel” either rhythm if both are present, even though the volume levels may be different. I have found myself disagreeing with someone else as to which was being “heard” at a given moment, since I could “hear” either one. Not important, for if the two sounds are so close to equality, the distortion is very close to 2 per cent. But, oddly enough, the wholly untrained ear is in a better position to be objective in this test than the trained one. Good!

There's another way out however for the musician that isn't specified by Cook. The ear's pitch sensitivity is greater than the accuracy of the two descending siren signals; the “N” resultant tone is actually not steady in pitch but varies above or below the fixed 1000 cps “A” sound, by a noticeable amount. I find that I can easily tell the “N” sound without even bothering with rhythm merely by its slightly wavering pitch, against the rock-steady pitch of the un-moving “A” tone.

Either way will work, and there's no doubt about the over-all value of this novel audible test. I've already tried it with three good cartridges, the rest of the system remaining fixed, and have noted considerable difference in the very high frequencies (ultrasonic) and down to around 13,000 between the three. The test does not go below 4000 cps.

The reverse side makes tricky use of the Cook Binaural double-pickup system; the two signals are separated there on two tracks for two pickups and if the two are fed into one amplifier the performance of the cartridges is by-passed and any distortion heard will be entirely from the amplifier-speaker section. No doubt there are other ingenious ways to put this versatile record to good testing use.

SOUND HANDBOOK

(from page 31)

The necessity for good ventilation of electronic components is an additional reason for having a separate or at least structurally independent speaker enclosure.

Although audio components should not be allowed to rattle around freely in the cabinet, the method of anchoring should be such that any one unit can be removed for servicing with a minimum of trouble, and without requiring special tools or special procedures.

REFERENCES

- Mark Vano, “Interconnection of audio components,” *Service*, August, 1952, p. 20.
 Mark Vano, “Physical mounting—layout of audio components,” *Service*, September, 1952, p. 46.

Here's how RCA INTERMATCHED COMPONENTS take the mystery out of High Fidelity



RCA Intermatched High-Fidelity cabinet and enclosures house any selection of components you may choose.

If you're interested in high fidelity . . . interested in the beauty of music, beautifully reproduced, but confused about how to select the system you want . . . here's how you can have everything you want in high fidelity *plus the assurance of the RCA name on every component in your system.*

Here is professional-grade equipment—bearing the best known name in professional sound—designed to bring the concert hall and the recording studio into your home. Here is RCA's broad background in acoustics and profes-

sional sound reproduction in equipment selected to meet your needs, your taste in high fidelity, and your budget.

In RCA's broad line you can find an almost limitless number of combinations—and the *one* combination you want. Because these units are all *intermatched*, you can develop your own system without a technical background—without fear of mismatch at any stage. It's the easy way to choose . . . it's the sure way to get what you want in high fidelity.

Work out any system you want—Select from these typical combinations—or plan your own

HEAR THEM AT YOUR RCA ELECTRONICS DISTRIBUTOR'S

	TUNERS				AMPLIFIERS			SPEAKERS		
	Record Changer (SRC-31)	Pre-Amplifier (SV-1)	ST-1	SVT-1	SP-10 (10-watt)	SP-10 (DeLuxe 10-watt)	SP-20 (DeLuxe 20-watt)	SL-8	SL-12	LC-1A
Quality record reproduction at low cost	X				X			X		
Quality record and radio reproduction at low cost	X		X		X			X		
Extended range record reproduction, medium price	X	X				X			X	
Extended range record and radio reproduction, medium price	X			X		X			X	
DeLuxe quality record reproduction	X	X					X			X
DeLuxe quality record and radio reproduction	X			X			X			X

“Professional-Grade”
High Fidelity
from RCA—
LEADER IN SOUND



RADIO CORPORATION of AMERICA

RCA Engineering Products
Dept. C 16, Building 15-1, Camden, N. J.

- Please send me your new, free booklet on RCA Intermatched high-fidelity equipment.
 Please send me information on the new complete RCA high-fidelity “Victrola”® phonographs.

Name _____
 Address _____
 City _____ Zone _____ State _____

krohn-hite

presents
the ultimate in
power
amplification

ultra-low distortion
POWER AMPLIFIER

delivering
99.99999996%*
distortion free power...



MODEL UF-101

0.005% Harmonic and Intermodulation Distortion at 30 Watts

80 db Feedback controlled from 0.01 cps to 20 mc with conservative gain and phase margin...

POWER OUTPUT
30 watts from 15 cps to 30 kc ± 1 db

FREQUENCY RESPONSE
 ± 0.5 db from 0.5 cps to 30 kc
 ± 3 db from 0.03 cps to 70 kc

TRANSIENT RESPONSE
Excellent at all output impedances

DYNAMIC RANGE
110 db

OUTPUT IMPEDANCE
2, 4, 8, 16 and 450 ohms

INTERNAL IMPEDANCE
Less than 1/100 of output impedance

INPUT IMPEDANCE
100k potentiometer or 6.8 megohms

VOLTAGE GAIN
14 db or 30 db to 16 ohm output

PRICE... \$350.00

*Typical harmonic distortion at 1000 cps is 0.002% in voltage, or 0.0000004% in power.



See us at I.R.E. Show
Booth 201



write for free
NEW CATALOG!

krohn-hite
INSTRUMENT COMPANY
580 MASS. AVE., CAMBRIDGE 39, MASS.

TOPS IN HI-FI POPS

ROBERT SYLVESTER

TWO RECENT RELEASES of Artie Shaw music—Artie being almost as controversial a Shaw as the late G. Bernard—pose a nice problem in listening. Offering music of sixteen years ago and music today, it's hard for the listener to determine which has undergone the greatest metamorphosis—the technique of recording music or the musical technique of Shaw.

One of these exhibits is Victor's two-platter, 12-in. LP which takes us back to Shaw's great days as a swing bandsman, the days of his orchestras in The Blue Room of the Hotel Lincoln and the Cafe Rouge of the Hotel Pennsylvania. All the great Shaw standards are here—*Begin The Beguine*, *Nightmare*, *My Reverie*, *Stardust*, *Sweet Sue*, *In The Mood*, and many others, twenty-four tunes in all.

All the great Shaw sidemen of the mid-1930's are at their jumpingest on these four sides. The hot saxophone of Georgie Auld soars out effortlessly and with driving spirit. Tony Pastor sings in his gravelly voice and Buddy Rich, greatest of the swing drummers, sets an overpowering beat and flies off on frantic solos. There is also, for the collector, a chorus by the young Billie Holiday, reminding us of a time before she was fully stylized and sang with a touch of romance instead of the veneer of despair which was to come with her own personal defeat.

It's all here, all right, all the great things of an era. But the over-all effect is disappointing and, compared to records made and played with modern techniques, these hits of yesteryear are almost amateurish in general sound accomplishment. The trouble with them is, probably, that they were originally air checks, recorded from Shaws' broadcasting sessions at the hotel rooms. Also, the dubbed-in applause sounds as if somebody did it as an afterthought and then tried to change his mind.

The other Shaw item is something different. It's his first release for Bell Records, a releasing outfit which sells records in bookstores rather than other marts. A Bell record looks about the size of a 45 but it is cut in standard 78 r.p.m. and, besides taking up less space in the record cabinet, is pliable and unbreakable.

For Bell, Shaw and his highly modern quintet do *That Old Feeling* and *Besame Mucho*. One wouldn't believe that the Shaw of *Feeling* and the Shaw of the old *Beguine* are the same musicians. With his modern group, he takes only a short riff with *Feeling* and seems content to be a part of an intensely knit and thoroughly disciplined "cool" ensemble. On *Besame Mucho* he comes closer to a solo against a jagged background beat. Here he performs a sort of exercise in dodging melody without ever straying too far away from it. All in all,

the Bell exhibit is a crazy record, man, crazy!

Les Baxter

The novelty of the moment is Les Baxter's album for Capitol (12-in., one side, LP) called, simply, *The Passions*. Baxter has established himself as one of the most highly imaginative and daring of the arrangers and with *Passions* he goes all out. The record details Despair, Ecstasy, Hate, Lust, Terror, Jealousy, and Joy according the gospel of Baxter and it features, beside tone poem music and a vocal chorus, the wailing of a girl named Bas Sheva.

In her more moody moments, Miss Sheva fairly tears herself thorax from larynx. And while doing so, you are invited to read verses from the Bible and from Shakespeare, no less. The whole idea gets a little frightening after a while.

Jackie Gleason

Jackie Gleason, a comedian who is so busy leading his own studio ensemble that one wonders how and when he finds time to think up a joke, has another Capitol (12-in., single side, LP) exhibit, this one called *Tawny* in honor of the recent Gleason television ballet. (Yes, yes, Gleason can do ANYTHING!) One side is apparently a house band doing the ballet music which sounds like perfectly good ballet music but would, naturally enough, be improved if you could watch somebody dancing to it.

On the reverse side, Gleason has assembled all his trusty fiddles and cellos and stuck the brilliant Bobby Hackett up in front of them with his golden trumpet. As Hackett & Fiddles did on two or three previous occasions, six sentimental and not-too-well-known melodies are treated to the full strings, done slowly and carefully, while Hackett ad libs in and out with his singing horn. The echo chamber is again utilized and, while the gimmick is getting familiar, there is fine music and mood to *Little Girl*, *I Cover The Waterfront*, *Some Day* and *If I Had You*.

Hillbilly Hymn

What will surely be the novelty of the month is a Coral release (8-in. 78) of two sides of *Make a Joyful Noise Unto The Lord*. And who sings this bit? Why, it is sung by four girls whose names are Jane Russell, Connie Haines, Beryl Davis, and Della Russell. That's right, I said JANE Russell, the brunette that gentlemen prefer. Jane and her sister church-women do the bit straight, taking turns at a real, regular, holy-rolling hillbilly hymn.

An accompanying press release states that this record is "remarkable... sensational... deeply spiritual... soul satis-

fyng." It is probably all these things. My fault with it is that the gals, well-meaning though they may be, all sound pretty much alike and that arranger Lyn Murray has them hustling too fast from start to finish. But it's an item that you'll want to hear if only because the gals are contributing their royalties to favorite church charities.

Piano.

As might be expected, the supply of piano collections continues undiminished. MGM offers George Shearing (16 songs, single disc, LP) in *When Lights Are Low* and has shown the good sense to collect the recording Shearing did when he first came to fame and when he would rather play something exciting than sit at the piano and tell bad jokes. In these tunes—particularly *Indian Summer, I Didn't Know What Time It Was*, and *There's a Lull in My Life*—he reminds us of the days when he had a solid beat, new chording ideas, and a nice taste in what not to do with the bop form. This one is Shearing at his best.

MGM has also issued two solid keyboard men, each taking a side (12-in., LP) for six of their best pitches. Eddie Haywood, on one side, is best with *Memories of You* and *Stormy Weather*. Teddy Wilson, who showed many of the modern favorites how it should be done, rolls forth with first class versions of *Why Shouldn't I?* and his own *Sunny Morning*.

Calypto

Eartha Kitt, this season's wunderkind, has a new Victor single (78) with a hill-billy epic called "*Lovin' Spree*" backed by "*Somebody Bad Stole de Church Bell*." This latter is—deliver us!—one of those calyptos with a lyric consisting of approximately one line and a half repeated. And repeated. And repeated.

Ballads

Lou Monte on another Victor single (78) sings *The Darktown Strutters Ball* in Italian, for reasons best known to himself, and then a pleasant ballad called *I Know How You Feel*. Both with Hugo Winterhalter's fine, smart background. Phil Harris has a Victor single (45) of two novelties called *Take Your Girl to the Movies* and *I Know an Old Lady*. Neither has Phil's usual, comic and razzmatazz style, but both are amusing enough.

Frank Sinatra, also in a sentimental mood, has eight standards on a new Capitol LP accompanied by a small combo led by Nelson Riddle. Sinatra, the eminent actor, has never paid less attention to his phrasing and also hits a couple of inexcusable flats. The highly-arranged Sauter-Finnegan Orchestra comes up with a Victor single (78) which has Joe Mooney singing *Hit The Road to Dreamland* and a satire on old movie chase music called *Where's Ace?* Both should make the juke boxes without effort.

PREDICTION:

The year's most revived and experimented song will be the Richard Rodgers-Lorenz Hart *My Funny Valentine*. Various artists are experimenting with it on four current collections and innumerable others are fiddling with it for the future.

IN STOCK NOW!

at **CHICAGO**

hermetically sealed
400 CYCLE TRANSFORMERS
that meet MIL-T-27:
CLASS B* specifications



*85° Ambient—40° Rise.

These rugged, compact transformers have been designed in close cooperation with organizations directly concerned with the development of standards for aircraft communication, guided missile and related equipment. They are engineered to meet future, as well as current requirements for 400 cycle power supplies.

POWER TRANSFORMERS (All primaries 105/115/125 V., 380-1000 cycles)

HIGH VOLTAGE A.C. Volts	SECONDARY D.C. Ma.	RECTIFIER Volts	FILAMENT Amps.	OTHER Volts	FILAMENTS Amps.	CATALOG NUMBER
270-0-270	55	5.0	2	6.3 CT	2	4PHC-55
335-0-335	70	5.0	2	6.3 CT	3	4PHC-70
375-0-375	120	5.0	3	6.3 CT	4	4PHC-120
440-0-440	165	5.0	3	6.3	7.5	4PHC-165
				6.3	3	
				6.3	3	
				6.3	0.6	
450-0-450	200	5.0	2	6.3	4	4PHC-200A
				6.3	4	
				6.3	0.6	
550-370-75-0 75-370-550	300	5.0	6	6.3 CT	5	4PHR-300
				6.3 CT	1	

FILTER REACTORS

INDUCTANCE (henries)	MAXIMUM D.C. Ma.	D.C. RESISTANCE (ohms)	INSULATION VOLTS RMS	CATALOG NUMBER
2.0	55	160	2,500	4RH-255
2.0	70	240	2,500	4RH-270
2.0	120	105	2,500	4RH-270
2.0	165	80	2,500	4RH-2165
2.0	200	77	2,500	4RH-2200
2.0	300	49	2,500	4RH-2300

FILAMENT TRANSFORMERS (All primaries 105/115/125 V., 380-1000 cycles)

SEC. VOLTS	SEC. AMPS.	INSULATION VOLTS RMS	CATALOG NUMBER
6.3 CT	3	2,500	4FH-63
6.3 CT	5.5	2,500	4FH-65
6.3 CT	10	2,500	4FH-610
6.3 CT	20	2,500	4FH-620

Write for Chicago Bulletin #32 listing more complete specifications on these units, specially designed for 400 cycle, high-temperature operation.



CHICAGO the World's Toughest Transformers

CHICAGO STANDARD TRANSFORMER CORP.
3501 ADDISON STREET • CHICAGO 18, ILLINOIS

Free

to your friends

a copy of

AUDIO

Don't give your copy away. Let us send one to each of your friends—no obligation, of course. Fill out this coupon and send to

RADIO MAGAZINES, INC.

P. O. Box 629

Mineola, N. Y.

Please send a free copy to the names given below . . .

with my compliments

omitting my name

Signed

Address

City and State

Name

Firm

Address

City and State

Name

Firm

Address

City and State

Name

Firm

Address

City and State

Name

Firm

Address

City and State

Name

Firm

Address

City and State

AUDIO *ETC.*

Edward Tatnall Canby

Sines and Ceramics

IM ABOUT TO EXAMINE a trend—not an unusual activity hereabouts. In this period of hi-fi's quickest expansion trends are trendier than ever—and more persistently overlooked than ever. How we love the present! Most of us think of the rosy future as just a Bigger Present, where business works just like now, only better. That isn't the way things go, as we ought to know. There are trends, changes, and this department at least is always prepared to throw in its 2 db worth of extrapolation as to what's coming next, and next after that.

I have in mind, for that matter, several closely related trends having to do with simplification, (a) cartridges, (b) recording and playback curves, (c) control functions. The latter two have been handily discussed by the editor in his January editorial (page 14) to which I hereby refer you. I'll stick mainly to the first and more specifically to the very embodiment of a trend to which I am at this very moment listening with some astonishment. The record I'm hearing is super-hi-fi, but not unusual in this day of super-sound. The playing equipment is of routine high quality with but one startling exception—the cartridge is the new low-priced Electro-Voice Ultra-Linear wide-range ceramic, described technically at length in the December issue. It feeds directly into a flat amplifier. No preamp. No tone control. No equalization. And yet its constant-amplitude response is within 2 db or so of the now popular New Orthophonic recording characteristic, which to all intents and purposes is constant amplitude.

And the sound is, to put it mildly, very impressive. I'll bet that nine-tenths of our readers, listening here, would never so much as suspect that I had other than one of the classic magnetics on the record. I'm not at all sure I'd want to try to pick out this cartridge in a blindfold test from a group of well known magnetics. This sound I'm hearing may be of top importance in the large hi-fi field.

Sine Curve

There's a shapely sinusoidal aspect to the curves we might construct concerning cartridges, recording characteristics, control functions—but especially cartridges—over the years. The cartridge sine curve waves gracefully back and forth in a most interesting way, as we look back, in terms of two types of cartridge response, that of the magnetics (and the old acoustical reproducer) which operate on a constant-velocity basis and that of several kinds of cartridges, notably the crystal and now the ceramic, which are constant-amplitude devices. The response of these two types is basically different and vitally affects the reproduction

of records—which also have varied in the cutting between these two.

Now every engineer-reader knows all about constant-amplitude and -velocity, but I'll wager that an awful lot of our not-so-engineers subscribers are in the perennial stew of confusion on this subject that was my state for untold years—or worse, in the state of blissful ignorance that precedes an inevitable rude awakening. This is not the moment to go into the difference, but if we are provoked, I expect that the editor and I can cook up an "Amateurs' Guide to Constant Amplitude/Velocity" for some later issue. Right now, I'll assume you can follow me, or can pick up a clue here and there as we proceed. The important thing to remember is that there are, in fact, two basic natural response or output curves for pickup cartridges (and for cutting heads similarly), before other factors even enter the picture. The difference is great—6 db per octave, a voltage-output ratio of no less than 2 to 1. That's what you run into when you change from a crystal to a magnetic, among other complications.

Anyhow . . . the sine curve of cartridge popularity fades in back in the acoustic days. The old cutting and playing equipment operated with what was basically constant velocity—not counting the whopping distortion and the vast top and bottom areas of no reproduction at all. Constant velocity continued to hold the field when electrical recording came in, for the magnetic cutter had that response and so did the earliest magnetic pickups, those two-ton terrors with the horseshoe magnets that we used to be so proud of. One compromise had to be made, though, which was of great significance. Constant velocity was fine for acoustic records because there wasn't any bass; but when electricity brought in the bass this type of cutting curve, allowing the amplitude to increase as the pitch went down, made for too-wide grooving. So, below a mid-point, there had to be the now-familiar decrease of bass, at 6 db per octave—constant-amplitude. However low the pitch went below this mid-point or crossover, for a given input level the swings of the record groove got no wider.

That made the bottom half of the record constant amplitude while the top half remained constant velocity. The point of change was the famous turnover point. The loss in bass when the electrically recorded discs were played by magnetic pickups was made up for by bass boost, as now.

But soon there came a new development and the cartridge sine curve began a graceful sweep around a corner. The crystal cartridge, a constant-amplitude device, was introduced and gradually swept through the home phonograph field, eliminating virtually all of the magnetics. The crystal played

the lower tones on the electric records correctly—but it drooped dismally on the upper part. However a complementary change in recording technique came along, the use of boosted highs (pre-emphasis) and thereby a vital new matching orientation of equipment was accomplished. The crystal's natural response gave a playback curve that was very close both to the bass roll-off, always present in records, and to the new boosted highs. Tip up the top of the curve, tip down the lower part, and you have a fine inclined plane more or less—close to the constant-amplitude characteristic.

Thus everybody was happy. Within the then acceptable frequency range the crystal played the average record "flat"—balanced as recorded, more or less. No equalization was necessary.

Most home phonographs and even the then "hi-fi" put-together systems used crystals in the thirties. In 1938 I bought a fancy Astatic model D cartridge and chrome arm (response up to 4000 cps), for the ultimate in home equipment, and was I proud! It played directly into the amplifier and my tone controls were used mainly to reduce distortion, to exaggerate the bass (for bass-shy speaker systems) and for matching room acoustics. I never heard of equalization and I didn't need to; there was little problem in the highs and the bass varied only in that European records usually had a lower turnover point and hence "more" bass (as heard) than ours.

Magnetics Again

But already at the height of the happy crystal era a new reverse section of our smooth sine curve was building up—magnetics again. They had been used right along in broadcasting; during the war we began to hear about improved new lightweight magnetics for the home, soon to come. Pickering was the first I knew of. Then, the war over, came the big boom in the new miniature magnetic pickups—and constant velocity took over again, ultra-low level, bringing new problems of preamplification and equalization to make the magnetic gadgets respond as the crystal did of its own accord.

But the magnetics took over, however, for the simplest and best of reasons—they gave and have continued to give unmatched audio quality. Why else! For that, we are willing to suffer along with preamplifiers and equalization, the dangers of hum pickup, noise, and assorted distortion, even the basically increased cost of this extra equipment needed for magnetic reproduction. After all, we want the best, every one of us. But just the same, the magnetic on its own remains vastly unmatched to present records, in both bass and treble, as many an uninformed beginner has found out the hard way. Its output must be thoroughly doctored to come out "flat." Minus the doctoring it plays the recorded preemphasis exactly as that, a ghastly screech, and it reproduces the bass droop of 6 db per octave with perfect fidelity! Nevertheless—we've come to depend on these constant-velocity midgets because they have given such superior sound, with the right doctoring.

Now it is plain for all to see that the modern recording curve is approaching more and more the true complement of the constant-amplitude phono cartridge, as the various extremes are toned down in the direction of moderation. The New Orthophonic is very likely to become an industry-wide standard now that it has been officially taken up by the various societies. It is indeed very close to the straight slope of constant amplitude. The famed turnover point is now no more than a slight hump

New! A Leonard Radio Exclusive!

"Monthly Product Series" bring you our suggestions for the finest in high-fidelity. All items have been thoroughly tried and tested in our laboratories and subjected to "A-B" listening tests.

3-Way System #1

For the Expert

- 1—C 15W
- 1—Cobraflex II
- 1—SA-HF
- 1—MA25 Driver
- 1—4402 Tweeter
- 1—4410 x over
- 1—4420 x over

Eventual 3-Way System #2

For the Budget Minded

- 1—6200
- 1—4401
- 1—4420
- (to be added)
- 1—6200
- 1—Cobraflex II w/SAHF
- 1—4410

Eventual 3-Way System #3

For the Beginner

- 1—6201
- (to be added)
- 1—C15W
- 1—4410 x over

A self-addressed, stamped envelope will bring you complete wiring diagrams and specifications. Ask for Series I Plans.

C15W—

\$73.50 net

- Power—use up to 50 watts
- Voice Coil Imped.—4 to 8 ohms, 10 to 20 ohms
- Maximum O.D.—15½"



Cobraflex 2—

\$20.58 net

- Single Assembly features. Two exponential horns with twin air columns
- Superb reproduction in 2-way or 3-way hi-fi systems



6200—\$20.58 net

- Response — 45-10,000 cps.
- Imped. — 6-12 ohms
- Power — 30 watts



4402—

\$23.52

- Response—2000-15,000 cps.
- Power—50 watts, 10-16 ohms
- Dispersion — 120° Horiz., 50° Vertical
- Impedance—4-8 ohms

6201—\$44.10

- Response—45-15,000 cps.
- Imped.—8 ohms
- Power—25 watts



4401—\$14.70

- Response—2,000-15,000 cps.
- Impedance—6-16 ohm
- Power—25 watts
- Dispersion — 90° Horizon., 45° Vertical



4410—\$20.58

4420—\$11.76

- Crossover
- Impedance

4410
600 cycles
6-16 ohms



4420
2000 cycles
6-16 ohms

Our new catalogue will be ready in March. Be sure to get in our mailing list now. Call or write your present requirements. We can ship immediately from one of the largest stocks in the U. S.

LEONARD RADIO INC.

69 Cortlandt St.

New York City

CO. 7-0315

BUY DIRECT
AND SAVE

OUTSTANDING for HIGH FIDELITY!

'PRE-FAB' COLLINS TUNERS and RECEIVERS

AUDIO PRODUCTS CO.

Two ALL NEW Complete Kits for
Every High-Fidelity Need

Collins Audio Products Co. 21 1/2 1945
Incorporated in the Collins Radio Co.

Each Collins Tuner Kit is complete with punched chassis, tubes, power transformer, power supply components, hardware, dial assembly, tuning eye, knobs, wire, etc., as well as the completed sub-assemblies: FM tuning units, AM tuning units, IF amplifiers, etc., where applicable. All sub-assemblies wired, tested and aligned at the factory make Collins Pre-Fab Kits easy to assemble even without technical knowledge. The end result is a fine, high quality, high fidelity instrument at often less than half the cost—because you helped make it and bought it direct from the factory.

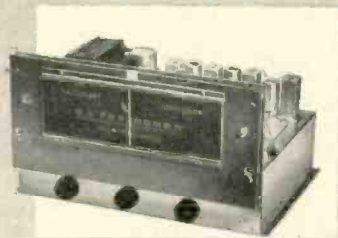

FM Tuner Kit **\$55**

The FM-11 tuner is available in kit form with the IF Amplifier mounted in the chassis, wired and tested by us. You mount the completed RF Tuning Unit and power supply, then after some simple wiring, it's all set to operate. 11 tubes: 6J6 RF amp, 6AG5 converter, 6C4 oscillator, 6BA6 1st IF, (2) 6AU6 2nd and 3rd IF, (2) 6AU6 limiters, 6AL5 discriminator, 6AL7-GT double tuning eye, 5Y3-GT rectifier. Sensitivity 6 to 10 microvolts, less than 1/2 of 1% distortion, 20 to 20,000 cycle response with 2DB variation. Chassis dimensions: 12 1/2" wide, 8" deep, 7" high. Illustrated manual supplied. Shipping weight 14 lbs.

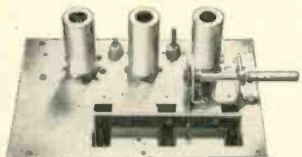

FMF-3 Tuning Unit **\$15²⁵**

The best for FM. The most sensitive and most selective type of "front end" on the market. 6 to 10 microvolts sensitivity. Image ratio 500 to 1. 6J6 tuned RF stage, 6AG5 converter, 6C4 oscillator. Permeability tuned, stable and drift-free. Chassis plate measures 6 1/2" x 4 1/2". In combination with the IF-6 amplifier, the highest order of sensitivity on FM can be attained. Tubes included as well as schematic and instructions. Draws 30 ma. Shipping weight FMF-3: 2 1/2 lbs. Dial available @ \$3.85.



IF-6 Amplifier **\$19⁷⁵**

A remarkable value! 6 tubes are used in the IF amplifier: 6BA6 1st IF, (2) 6AU6 2nd and 3rd IF's, (2) 6AU6 limiters and 6AL5 discriminator. High gain, wide-band response (200 KC) for highest fidelity. 20 to 20,000 cycles. Distortion less than 1/2 of 1%. Draws 40 ma @ 220 volts. Chassis plate dimensions: 11 1/8" x 2 1/2". Shipping weight: 3 lbs.



AM-4 Tuning Unit **\$24⁵⁰**

Tops in AM superhet performance! A 3-gang tuning condenser gives 3 tuned stages with high sensitivity and selectivity. Assembly is completely wired, tested and aligned ready for immediate use. Frequency coverage 540 KC to 1650 KC at a sensitivity of 5 microvolts. Tubes 6BA6 RF amplifier; 6BE6 converter; 6BA6 IF amplifier and 6AT6 detector. Draws 30 ma @ 220 volts. Mounts on a chassis plate measuring 4" x 7 3/8". Shipping weight 2 1/2 lbs. Dial available at \$3.85.



FM/AM Tuner Kit **\$77⁵⁰**

The original 15 tube deluxe FM/AM pre-fab kit redesigned on a smaller chassis. The tuner now measures 14" wide by 12" deep by 7 1/2" high. This attractive new front and dial assembly opens up new applications where space is at a premium. Kit includes everything necessary to put it into operation—punched chassis, tubes, wired and aligned components, power supply, hardware, etc. Kit comprises FMF-3 tuning unit, IF-6 amplifier, AM-4 AM tuning unit, magic eye assembly and complete instructions. All tubes included. Shipping weight 19 lbs.

in the line (left there, I gather, to facilitate electrical equalization circuits). We now go to extraordinary lengths to alter the natural response of our fine magnetics, creating artificially the very curve that nature gave directly to the crystal and its relatives. We've done miracles in making the required equipment practical and inexpensive and trustworthy, we've found the means to include good preamplifiers, good shielding, low distortion, and low noise levels even in our cheapest amplifiers and in many a home phonograph. But all this only because, in the end, the magnetic made possible better sound than ever before.

Wide-Range Crystal

But the sine curve of cartridge usage was getting ready to swing again even as the postwar magnetic era entered its full development. In typical sine fashion the opposing forces were gathering strength. When LP came out in 1948 it was launched with a crystal. The first Columbia-Philco cartridge was no magnetic but rather a new miniature crystal quite extraordinary in every respect except, alas, response (which was nil above 6000 cps or so). But a replacement came soon after from Astatic, the model U cartridge, which had an excellent wide-range response easily beyond 10,000 cps. with surprising smoothness and, most important, a degree of compliance that, as I figure it, must have been significantly better than some of the very fancy magnetics of the day. (That cartridge tracked LP's when other systems couldn't seem to stay in the grooves, you'll remember.)

Here was a crystal that came close to matching the magnetic sound. But the trouble was that, first, it brought with it a new shape and size—"sugar lump" I called it—which was nonstandard for existing arms; and, worse, for wide-range use it needed a filter (to remove a peak at 9000 cps or so) which cost as much as a preamplifier for a GE cartridge. Impractical for general use, though it still is holding its own in the catalogues.

This and other new small crystals now made it suddenly clear that the old-fashioned heavyweight crystal, with its huge removable needle, its limited and distorted response, was definitely not to be the last word in the field. Crystals were catching up—and they continued to hold the trump card of automatic, preamplifierless matching of the record curve. Once the change-over to the new-type replaceable "permanent" needles was complete a large number of compromise small crystals appeared, to go into commercial machines, and here and there among the hundreds, wide-range response began to appear as a definite sales point.

The crystal was in general still far from a hi-fi unit, alas. Most were terrible in any decent hi-fi surroundings though suitable for rugged commercial use. But the model U was being used for hi-fi FM broadcast. The CQ cartridge brought good wide-range quality in a new small case that included the standard half-inch mounting holes to fit any arm—and no filter needed for it. The CAC crystal, extensively written up in these columns, took over the CQ's shell and became the first really practical wide-range all-purpose crystal that could begin to compete with the magnetics in that big essential—quality sound.

As I listen retrospectively in my mind's ear I'm inclined to think that the CAC wasn't really as good in the sound as the earlier model U. But it was far more practical and achieved a far greater "circulation," notably in the Columbia LP players. And it was for the first time deliberately offered with "internal equalization" to match the (then) LP recording curve. No

WHEN YOU THINK OF TUNERS, THINK OF COLLINS' AUDIO PRODUCTS

To: Collins Audio Products Co. Inc.
P.O. Box 368, Westfield, N. J. AE-3
Tel. Westfield 2-4390

- FM Tuner Kit FM/AM Tuner Kit Slide Rule Dial Assembly
 FMF-3 Tuning Unit IF-6 Amplifier AM-4 Tuning Unit

NAME _____
ADDRESS _____
CITY _____ STATE _____
Amount for Kit \$ _____ Sec weights, add shipping cost \$ _____
Total amount enclosed \$ _____ Check Money Order

MAIL
COUPON
TODAY

filter, no preamp, no equalization, and so it brought back the outward simplicity and convenience of the older crystals with most of the advantages of the magnetics. A lot of people made good use of it.

That was a few years back. The CAC still wasn't good enough. Few hi-fi addicts so much as looked it over and engineers in general stuck to their magnetic guns. I did too. Still do. It was just a question of which magnetic. Though the CAC (and perhaps several contemporary crystals of the sort) was plainly far ahead of earlier crystals, though it was good enough to rate as wide-range and even as hi-fi—it still wasn't really up to the quality of the magnetics. Otherwise we all would have long since converted to crystals. And besides, everybody knew that crystals were sensitive to heat and moisture and broke easily. (I know one user who has had three CAC's break under normal usage in a changer.) No—the crystal was inherently not good enough. Moreover there was much talk of the typical "crystal sound"—possibly an unscientific way of describing response, but it made sense. I know the sound only too well—a kind of metallic ringing tone, a species of distortion that, the ear says, must be due to nonlinearity along the response curve. The old crystals had it so bad that there was a definite "phonograph sound" that we used to blame generally on the whole phonograph system. Records always sounded that way. Especially with male singers. Remember? So the crystal was out, for hi-tops.

Ceramic

Put aside for now a whole batch of assorted special pickups, some long since defunct, others very much alive at the moment. None has yet shown signs of big-scale importance. The ceramic cartridge is the postwar innovation that eventually has taken us beyond the crystal's ultimate stalling point. But the early ceramics had all the physical virtues you could ask for—and no tone quality worth mentioning. You could bake them, wet, freeze, boil them without harm or change in response. But they didn't sound very nice. I tried some.

The first ceramic that, at last, began to catch up with the crystal in sound quality came only a year or so ago with the Columbia 360 phonograph, the Sonotone ceramic that is now separately available and quite widely used (See *Æ*, March 1953, page 46.) I've heard more of that cartridge since then; I suspect that careful listening tests might rate it at about the same sound quality as the CAC; excellent, but still not quite up to magnetic sound. (Competition is of course most directly with the low-priced GE magnetic cartridges.) The newly practical feature of the Sonotone was the highly ingenious turnaround double stylus, two points at one end of one shank, making the complete turning over of the cartridge unnecessary. Almost instantaneous replacement of the stylus assembly goes with this and is decidedly appreciated—a physical advantage over any other cartridge of any sort.

If we started impartially from scratch right now, threw out all present equipment and designed new equipment, the Sonotone-type ceramic would at once be a formidable power in competition with the magnetics. A shade less good quality of sound, and that for many of us makes a very big difference, admittedly. But we must recognize that for countless other listeners the difference would seem slight or nonexistent, especially in systems where other elements are of less than top quality. The Sonotone-CAC type of sound still, in good equipment, is far superior to any normal commercial

Quality Guarantee

The Altec Lansing Corporation unconditionally guarantees that this loudspeaker, when mounted in a properly designed cabinet, will reproduce all of the tones from 30 cycles to 22,000 cycles.

ALTEC LANSING CORP

DUPLEX*

speakers

Altec Lansing speakers are the ONLY speakers that carry this unconditional guarantee — because Altec Lansing is the ONLY manufacturer that tests every loudspeaker in an acoustical laboratory to insure that the frequency response of each DUPLEX* is held within 2½ db of the production standard throughout its entire range from 30 to 22,000 cycles.

The quality guarantee tag on each Altec Lansing DUPLEX* speaker is your assurance of exacting quality control through each step of manufacture.



601A-12"
20 watts
\$99.00
with network



602A-15"
20 watts
\$114.00
with network



604C-15"
35 watts
\$156.00
with network

*DUPLEX: Mechanically and electrically independent high and low frequency loudspeakers mounted within the physical size of a single frame.



These DUPLEX* speakers are the finest in the world. Hear them at your Altec Lansing dealer's today. Write for illustrated brochure.



9356 Santa Monica Blvd., Beverly Hills, Calif.
161 Sixth Avenue, New 13, New York 13, N. Y.

sound of a few years back. Indeed, it's clear that the development of the new commercial "hi-fi" machines would have been quite impossible without the greatly improved ratio between sound quality and cost that came with these wide-range ceramics. Here the magnetics are at a painful cost disadvantage.

Better Mousetrap

Perhaps you can see the picture as I see it. The magnetics reign supreme now in hi-fi and ever in a good deal of medium-fi, on two bases. (1) They do produce, as of this moment, better sound quality than the ceramic competition. But the margin has been getting smaller and smaller. (2) The vast bulk of available equipment is now manufactured to make magnetics; the industrial problems presented by the pre-amplifier and equalization have been met, and virtually all presently made equipment

is designed for them. Indeed, to go a step further, the very deficiencies of the magnetic have been turned into cash—in the enormous expansion of equalizing and tone control devices that have been launched this last year or so.

But that is strictly the short-sighted view. Things will change. The public will always go for what can be shown as a better and above all a simpler mouse trap.

There are very decided signs right now that we've gone too far with all this fancy control stuff. Lots of people will take it with delight, but a still wider audience for recorded sound exists which just as definitely will have none of it. Simplification is on the books. The ceramic is simple in the most obvious and useful ways. No preamp, no equalization, no hum pickup etc etc. With the sound quality margin between ceramic and magnetic so slight, it is clearly only a matter of time before the equipment

market itself begins to veer around the great sine corner—for equipment does change, and in terms of those short years we live in, it changes fast. How long did it take the hi-fi business to equip its entire output of amplifiers with compensated preamplifiers?

Remember the early GE separate preamp—manufactured as an extra because nobody had any built-in preamps? There is no theoretical reason why the reverse process might not be just as rapid, though the slogans may be different. And remember that if anyone wants them, equalization curves can be set up for ceramics too. It's just that really, honestly, there aren't going to be very necessary—soon.

Now—the Ultra-Linear Ceramic?

There, for your inspection, is the dynamic, fast-changing background for the new cartridge to which I was listening at the head of this column, the Electro-Voice Model 84 Ultra-Linear ceramic. This cartridge takes things forward still one more step—and there isn't much further to go. It is a single model—no double stylus arrangement, but even so it is an innovation of plenty profound significance along the developing sine curve. It's good—very good. It has all the basic advantages we've seen already, plus even better-quality sound—quality that cannot be far removed, both by my ear's dictum and by the published specs, from that of the competing magnetics. Moreover its published description claims factors of compliance, lateral and vertical, low vertical pickup, wide range (flat at least to 15,000 cps) that may well approach the offerings of some magnetics in the same respects. (It has all the commonly expected features such as replaceable stylus, diamond or sapphire, slip-on rear connections, half-inch mounting holes and so on.) Above all, to my ear this cartridge does *not* have that tell-tale "crystal" sound, where in both CAC and Sonotone, as of last year, I thought I could still detect it. That denotes a new cleanness of response.

Now get me straight—I'm not really sure whether this EV Model 84 can actually and literally stand up against a battery of high-quality magnetics and hold its own. I haven't tried. At worst, there is a difference which will keep the most critical ears well away from Model 84. At best, they won't be able to tell which is which. I haven't tried. But even at worst, we have an important step and perhaps a crucial one. At worst, as I see it, this type of ceramic can easily fit into a vast number of quality home music systems of the more modest sort, quite aside from the commercial type machines which may use it. At worst its quality would still be adequate for a large number of installations now using inexpensive magnetics.

Millennium?

If this is true, then—the millennium! (Millennia used to come one in a thousand years; nowadays we're lucky if they hold off a few months.) For if a ceramic can equal a magnetic for most purposes at the same cost or less, then there are vast numbers of magnetics that are now running on sheer inertia! Their preamps are paid-up and working well—but what happens when a replacement is due?

If a low-cost ceramic can replace an equivalent magnetic cartridge in many installations, why continue to build preamplifiers and equalization? Why, when with ceramics the entire need for the vast and ingenious present accumulation of preamp and equalizing equipment is gone and a better, cheaper, simpler amplifier can be built for the same result?

It's only a matter of time, then—quite a

35 POUNDS OF STUDIO QUALITY — ON REMOTES! PORTABLE AMPLIFIER



USE this sturdy, one-package amplifier on remotes or in the studio. Get added flexibility in both operations with four built-in pre-amps, high level mixing and master gain control.

- AC or battery operation banishes power failure problems.
- Minimizes hiss, hum and microphonics.
- "Woofing" no longer necessary. Unit includes a 400-cycle tone oscillator. An original G-E development.
- Daven step-type attenuators for mixing and master gain.

PLUS low level output with volume control, high gain cue circuit, and handy write-in strips for mixer marking.

GENERAL  ELECTRIC



Chassis lifts out by simply removing 4 screws!

BA-6-B



General Electric Co., Section X4434
Electronics Park, Syracuse, N. Y.

Please send me Bulletin ECB-1

NAME.....

ADDRESS.....

CITY..... STATE.....

bit of time—before the first cheap, efficient, low-priced, preamplifierless hi-fi amplifiers (or control units) appear, designed specifically *not* to take magnetics. The sine curve will then be near the end of its latest swing.

Wishful thinking? We shall see. Personally, I intend to hang onto my magnetics for a long time to come, since I don't expect any thing better, unless in the expensive class. But hi-fi and audio are moving into big new areas now where "compromise" of a sort that brings the best possible quality in the simplest possible manner is more and more important. I'm not the one to tell you whether ceramics are for *your* personal ear. But if you're curious, get hold of an EV 84 (82 for 78 records) and put it into your own system. You'll find it interesting.

AUDIOLOGY

(from page 12)

200 volts, in damped sinusoidal fashion with an effective time duration of about one-half cycle at the resonant frequency of *L* and *C*. An amplifier rated at 10 watts with a 300-volt supply would be rated at only about 4 watts with *B+* reduced to 200 volts. Thus when a relatively large signal is suddenly applied, a 10-watt amplifier with such a filter and change in load current momentarily becomes only a 4-watt amplifier, possibly with resulting overload and "rough" sounding leading edge of the reproduced waveform.

From Eq. (1) it may be seen that the higher the *R_L* represented by changing load (i. e., the less the change in plate current), the lower the series *L* and the higher the shunt *C*, the less will be the fractional transient dip. Obviously the trouble is inclined to be worse with amplifiers having more highly biased (AB or B) classes of operation, in which small idling plate current is followed by large current demands when signal is applied.

Before high-capacitance filter capacitors were available at low cost, it was customary to minimize filter cost for given ripple reduction by employing a large filter choke. This of course is still done in equipment where electrolytic capacitors are considered unsuitable. In consideration of transient dip, *L* would preferably be little larger than the so-called critical value for pre-vailling rectifier operation,⁴ and the desired ripple-reduction factor produced with suitably large shunt *C*. Or, if rectifier operation permits the use of a capacitor-input filter, one may practically eliminate transient dip by simply omitting the choke.

A side-effect of transient dip, especially during the "ringing" period of a relatively undamped *L-C* filter section, is amplitude modulation of the signal being amplified, due to the gain varying as a function of the supply voltage. However, the negative feedback probably in use for other reasons stabilizes the gain sufficiently to make this effect too small for detection by listening.

"Langford-Smith, "Radiotron Designer's Handbook," Fourth Edition, p. 1182.

From
Station Break
to Feature...
the NEW
"BALANCED"
TV Tripod
is doing a
whale of a job
every day!

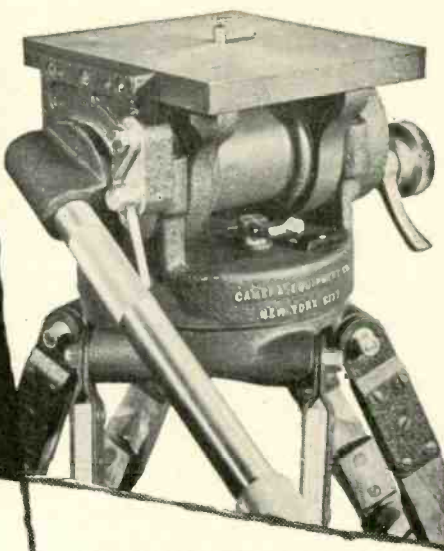

"BALANCED"
TV TRIPOD
mounted on
3-wheel
portable
collapsible
dolly
illustrated.



We THREW THE book away and engineered a brand new "BALANCED" Tripod for every photographic and video need. The result—a revelation in effortless operation, super-smooth tilt and 360° pan action.

PERFECT BALANCE prevents mishap if the lock lever is not applied. Quick release pan handle locks into desired position. Mechanism is enclosed, rustproof, needs no lubrication. Tension adjustment for Camera Man's preference. Built-in spirit level. Telescoping extension pan handle. We defy you to get anything but the smoothest, most efficient operation out of this tripod beauty.

WE CALIBRATE LENSES . . . Precision "T" STOP CALIBRATION of all type lenses, any focal length. Our method is approved by Motion Picture Industry and Standard Committee of SMPTE. Lenses coated for photography. Special TV coating.

WE DESIGN and manufacture Lens Mounts and camera equipment for 16mm — 35mm and TV cameras.

WE RENT AND SERVICE

CAMERAS * MOVIOLAS *

DOLLIES . . . Complete line

of 35mm and 16mm equipment available for rental.

MITCHELL: Standard, Hi-Speed, BNC, NC, 16mm. Bell &

HOWELL: Standard, Shiftover, Eyemos. MAURER: 16mm

Cameras. ARRIFLEX. MOVIOLA: Editing machines, Synchronizers.

FRANK C. ZUCKER
CAMERA EQUIPMENT ©
1600 BROADWAY NEW YORK CITY

IF YOU WORK WITH FILM . . .

It will pay you to get to know us.

The country's foremost professionals depend upon our portable, versatile, adaptable equipment.



Wide frequency range
30 cps to 20 kc
Low distortion
Superior transient
response

GRAMPIAN

FEEDBACK DISK RECORDING CUTTERHEAD UNIT

Engineers and musicians now realize a perfect transient response of any recording system is of paramount importance — the Grampian cutterhead with its precision-made true balanced armature and flux correcting feedback loop obtains this ideal.

The Grampian is used by international radio networks to guar-

antee Hi-Fidelity sound reproduction. You can achieve the same high quality results in your disc recording with the Grampian.

After testing and experimenting with all types of equipment many famous record manufacturers, such as CAPITOL RECORDS are converting to the Grampian Feedback Cutter for the best results.

RE REEVES EQUIPMENT CORP., 10 East 52nd Street, New York 22, N.Y.
Tel. PLaza 9-2618 • Cable Address: "REEVESQUIP", N.Y.
MANUFACTURERS, TECHNICAL CONSULTANTS AND AGENTS

NEW PRODUCTS

● **Loudspeaker Cabinet.** The "Fold-a-Flex," a new speaker enclosure for high-fidelity sound systems, recently introduced by Stephens Manufacturing Corporation, Culver City, Calif., incorporates characteristics of all three of the more popular types of speaker cabinets. Simple mechanical

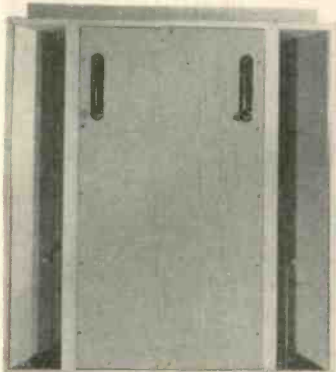

adjustments are provided for making the enclosure into an infinite baffle, bass reflex, or a folded horn. Choice of the enclosure type is determined by the listener on the basis of room acoustics and his particular listening criteria. The new three-in-one cabinet contains three ports whose openings may be varied to achieve desired enclosure characteristics. Dimensions are 36" h x 38 1/2" w x 17 1/2" d.

● **High-Pass and Low-Pass Filter Set.** Many design and production functions will be eased by the new Model 1A high-pass and low-pass filter set recently introduced by Allison Laboratories, 14155 Skyline Drive, Puente, Calif. In the past similar filters for use at audio frequencies have been heavy and cumbersome, however, the 1A is but 14 x 7 x 5 1/4 ins. and weighs only 17 lbs. The set consists of two k-type sections of low-pass filter and two k-type sections of high-pass filter in a single case. Switching is done in octave steps with continuously-variable multipliers to cover the range of each octave. The cut-off frequency of both the low- and high-pass filter is adjustable from 65 to 20,000 cps. Loss in the pass band is 1.5 db ± 1 db and the attenuation

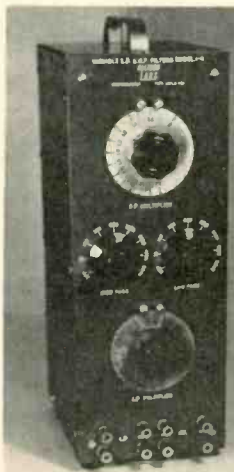

outside the pass band increases at the rate of 30 db or more per octave. Maximum attenuation exceeds 90 db. Since the unit is a passive network filter, no power supply is required. Additional information will be supplied on request to the manufacturer.

● **Long-Life Tape.** With a break strength two and one-half times as great as ordinary recording tape, the new "Lifetime" tape is expected to last indefinitely under ordinary conditions of handling and use. Due to a newly developed oxide coating and a base of DuPont "Mylar" polyester film, neither of which contains a plasticizer, "Lifetime" tape is one-third as strong as machine steel and will neither break nor stretch. The latter means that timing errors due to tape elongation cannot occur, a factor of prime importance for broadcast use. The tape is impervious to temperature and humidity effects and



is micro-polished for maximum high-frequency response. Reeves Soundcraft Corp., 10 East 52nd Street, New York 22, N. Y.

● **Message Repeater.** The Audio-Vendor, a new, automatic, message-repeating device embodying a magazine of magnetic tape greatly simplifies the use of recorded

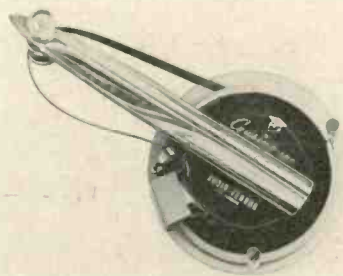

commercial announcements. Built for continuous operation, the unit pulls the recorded tape from the center of the reel and automatically rewinds on the outside. The magazine fits any standard tape recorder. Announcements ranging from 15 seconds to 15 minutes may be repeated continuously; manual rewinding of the tape is not necessary. Free brochure describing the Audio-Vendor may be obtained by writing Cousino, Inc., 2307 Madison Ave., Toledo 2, Ohio.

● **Transistorized Microphone.** Designed primarily to improve the quality of voice communication between pilots and airport control towers, this new Remler development consists of a magnetic microphone or handset with a built-in transistor pre-amplifier. In operation it derives its power supply from the same sources as the carbon microphone it replaces, and as a result may be plugged directly into existing equipment. No rewiring is necessary. The unit suppresses extraneous noises and more than triples the range of the conventional carbon microphone to include voice frequencies from the lower part of the sixth through the ninth octave. Frying and hissing sounds which are typical of carbon-type microphones are absent in the device, and stability of performance is not



affected appreciably by rough usage or changes in altitude, temperature, and humidity. The unit is scheduled for immediate production. Remler Company, Ltd., San Francisco, Calif.

● **Tiny Single Earphone.** Weighing but one-half ounce, the Telex Earset is a single-phone headset which is held in

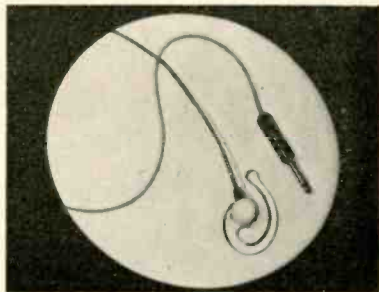

place by a flat plastic frame shaped in the form of a comma. A sensitive hearing-aid-type receiver is centered in the frame, while the "tail" of the comma slips over the ear to hold the assembly in place. The Earset can be used for radio and transcription monitoring, multiple listening, and other similar applications where a headset is required. Frequency response is from 50 to 4000 cps and comfortable listening is afforded with an input of three milliwatts. Literature and price information may be obtained from Dept. KP, Telex, Inc., Telex Park, St. Paul, Minn.

● **Hanging Corner Enclosure.** The Sound Corner is a folded-horn enclosure designed to be hung in a corner of the room about 13 inches from the ceiling. It employs the walls as two of three rigid boundaries, the

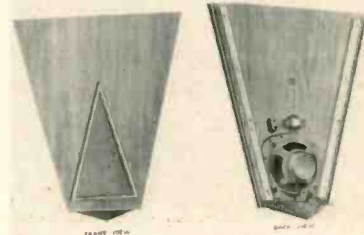

speaker baffle being the third. The edges of the baffle are lined with resilient material to simplify snug fit against the walls. The speakers are the LP 215 woofer and a direct-radiator tweeter, the LP 65. Frequency response is smooth from 31 to 16,000 cps. The new speaker system is called the Lorenz SCL Sound Corner and information is available from Kingdom Products, Ltd., 23 Park Place, New York 7, N. Y.

● **Coaxial Speaker Assembly.** Adaptability of the Bozak speaker system is greatly improved with the introduction of the new Model B-207 in which the woofer and tweeters, together with crossover filter, are all mounted on a 15-in.-square plywood panel which may be placed in conventional

hrc HARVEY the House of Audio

REK-O-KUT 12-inch, 3-Speed TURNTABLES Model L-743



A broadcast quality turntable designed for discriminating users . . . professionals and audiophiles. Driven by 4-pole motor. Turntable itself is made of cast aluminum, and exerts no pull on magnetic cartridges. It is precision machined with a heavy rim for dynamically balanced flywheel action.

A single knob permits instantaneous selection of any record speed: 33 1/3, 45, or 78 rpm. Record slippage is eliminated through use of new mat material. There is virtually no rumble, wow or flutter. Complete with 45 rpm record adapter. **\$59.50**

Model T-12H A DeLuxe version of the above for the ultimate in turntable design for 33 1/3 and 78 rpm only. Driven by constant speed hysteresis synchronous motor. **\$119.50**

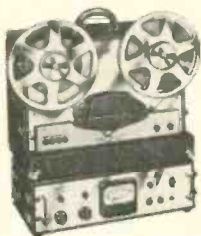

MAGNECORD PROFESSIONAL TAPE RECORDER M80 Series

Provides full range response: 30 to 15,000 cycles at 7 1/2 inches/sec., and 30 to 20,000 cycles at 15 inches/sec. Has new, slot-loading feature, and automatic tape lifter. After loading, all operations are pushbutton control. Starts and stops within 1/10 second. Accommodates 10 1/2

inch reels. Flutter and wow are less than .1% at 15 inches/sec. Employs high quality, low noise amplifiers with direct-coupled cascade input stages. Can be adapted for remote operation.

M80-ACX chassis only for rack mounting **\$1185.00**
M80-AC portable, with cases **1265.00**
M80-ACC console complete with cabinet **1345.00**

The FERRANTI RIBBON PICKUP



Designed by D. T. N. Williamson, this new pickup represents years of study and development. It is a complete unit of pickup head and arm with the head interchangeable for either standard or microgroove records.

Frequency response is uniform to 20,000 cycles with output provided to 100 kc. Only 3 grams stylus pressure. Mechanical resonance has been kept to 3 cycles, well below the recording range. Greater than normal compliance promotes uniform response and minimizes record wear. Both heads employ diamond styli with an elliptical stylus used for standard groove records. When used with appropriate transformer, output is 20 mv into 100,000 ohms.

Ferranti Pickup with arm and transformer **\$76.95**
Specify standard or microgroove.



Extra Head (standard or microgroove) **37.50**

Visit the **HARVEY AUDIOTORIUM**
If you want to See and Hear the finest . . . the widest selection of high fidelity equipment . . . be sure to visit the HARVEY AUDIOTORIUM. It will thrill you.

NOTE: Prices Net, F.O.B., N.Y.C. Subject to change without notice.

The SCOTT 99-A TRANSCRIPTION AMPLIFIER



A complete, self contained preamplifier-equalizer and 10 watt power amplifier with built-in power supply. Input switch permits selection of desired channel: phono, tuner, tape, or other program source. Phono input has provision for magnetic and crystal, or constant amplitude cartridges. Equalization controls provide 3 turn-over and 3 roll-off positions, giving a total of 9 different curves. A rumble filter cuts off below 20 cycles at 24 db per octave. Individual, continuously variable, bass and treble controls provide wide range boost and attenuation. Loudness control automatically compensates for low level aural characteristics.

Power amplifier section furnishes 10 watts with less than .8% harmonic distortion. Frequency response is flat from 20 to 30,000 cycles. Deliberate cut-off of higher frequencies avoids possible ultrasonic oscillation and distortion.

Complete with tubes **\$99.95**
Escutcheon for Panel Mounting **4.95**

The SCOTT 121-A Dynaural PREAMPLIFIER EQUALIZER



A complete self powered control unit providing equalization for all recording characteristics, independent bass and treble compensation, and noise suppression. Eight input channels and treble compensation, and noise suppression. Eight input channels and permit use with microphone, tuner, phono pickup, tape, and other program sources. Separate screwdriver controls enable balancing of input levels. Turn-over frequency control is continuously variable from 250 to 800 cycles. Roll-off control range is from 0 to -22 db of 10,000 cycles. Frequency response is flat from 19 to 35,000 cycles, with deliberate cut-off of higher frequencies to prevent ultrasonic oscillation and distortion. A rumble filter cuts off below 20 cycles at the rate of 24 db per octave. Individual, continuously variable, bass and treble controls permit boost and attenuation at both frequency extremes. Loudness control compensates for all characteristics at different levels. Disabling switch introduces conventional volume control.

Dynaural noise suppressor automatically cuts out record and rumble noise in proportion to signal-to-noise ratio. Degree of suppression is continuously adjustable. Other features include: low pass filter with sharp cut-offs at 6, 12, and 20 kc . . . cathode follower output permitting up to 70 feet of cable to main amplifier . . . additional output for recorder.

Complete with tubes in metal cabinet for panel- or rack-mounting **\$157.75**
Same as above but covered with top grain, hand tooled cowhide **162.75**

The NEW ELECTRO-VOICE REGENCY SPEAKER SYSTEMS



The **Regency** is a Klipsch-licensed corner horn enclosure, suitable for either corner or flat wall location. Superlatively styled in lowboy design, the **Regency** is available in either hand-rubbed mahogany or blonde Korina, and may be used with single 15" speakers, two-way, or three-way systems.

The **Regency II** consists of the **Regency** enclosure together with the EV 114A two-way system composed of a 15W-1 LF driver, an X-8 800 cycle crossover network, and a T-25 25 watt treble driver with 8-HD Hoodwin diffraction horn. The **Regency III** consists of the **Regency** enclosure together with the EV 114B three-way system, composed of a 15W-1 LF driver, an X-8 800 cycle crossover network, a T-25 treble driver with 8-HD Hoodwin diffraction horn, an X-36 3600 cycle crossover network, and a T-35 Super Sonax VHF driver.

REGENCY (enclosure only)	Mahogany	\$120.00
	Blonde Korina	129.00
REGENCY II with 2-Way System	Mahogany	310.20
	Blonde Korina	319.20
REGENCY III with 3-Way System	Mahogany	355.20
	Blonde Korina	364.20

HARVEY RADIO COMPANY, INC.

103 W. 43rd Street, New York 36, N. Y. JUdson 2-1500

NEW WILLIAMSON TYPE

Heathkit AMPLIFIER KIT

FEATURES

- Practically distortionless. Harmonic and intermodulation distortion both less than one half of 1% at 5 watts.
- Frequency response ± 1 db from 10 cycles to 100 kilocycles.
- Altec Lansing PEERLESS or ACROSOUND transformers available.
- First Williamson type Amplifier supplied with matching preamplifier.

When selecting an amplifier for the heart of a fine high-fidelity audio system, investigate the outstanding advantages offered by the Heathkit Williamson type Amplifier. Here is an amplifier that meets every high-fidelity audio requirement and makes listening to recorded music a thrilling new experience through naturally clear, lifelike reproduction of sound at all tonal levels. Wide acceptance of the Heathkit Williamson type Amplifier by the most critical purchasers clearly demonstrates that high-fidelity can be coupled with low cost. For factual information regarding the Heathkit Williamson type Amplifier, consult "CONSUMERS RESEARCH ANNUAL CUMULATIVE BULLETIN 1952-53."

This outstanding amplifier is offered with the optional choice of the ACROSOUND output transformer or the PEERLESS output transformer. ACROSOUND features ULTRA-LINEAR circuitry, which is the exclusive development of the Acro Products Company and provides a greater margin of reserve power efficiency and increases power output. PEERLESS features additional primary taps to permit the optional choice of either the extended power circuitry, now enjoying current popularity, or all of the advantages of the original Williamson type circuit.

The construction manual has been simplified to the point where even the complete novice can successfully construct the amplifier without difficulty. Write for a free catalogue containing complete specifications and schematics of the Heathkit Williamson type Amplifier.

HEATH COMPANY
BENTON HARBOR 25, MICH.



PRICES OF VARIOUS COMBINATIONS

W-2 Amplifier Kit (Incl. Main Amplifier with Peerless Output Transformer, Power Supply and W-A-P1 Preamplifier Kit) Shipping Weight 39 lbs. Shipped express only. **\$69.50**

W-2M Amplifier Kit (Incl. Main Amplifier with Peerless Output Transformer and Power Supply) Shipping Weight 29 lbs. Shipped express only. **\$49.75**

W-3 Amplifier Kit (Incl. Main Amplifier with Acrosound Output Transformer, Power Supply and W-A-P1 Preamplifier Kit) Shipping Weight 39 lbs. Shipped express only. **\$69.50**

W-3M Amplifier Kit (Incl. Main Amplifier with Acrosound Output Transformer and Power Supply) Shipping Weight 29 lbs. Shipped express only. **\$49.75**

W-A-P2 Preamplifier Kit only, Shipping Weight 7 lbs. Shipped express or parcel post. **\$19.75**

NOW BINAURAL

for ANY phonograph!
with the new **COOK CLIP-ON conversion**



- no special arm needed
- accepts all standard cartridges
- tracks both Binaural and standard LP's
- adaptable to standard arms AND CHANGERS

only **\$5.95**

- In stock at your dealers

For full information on converting to Binaural, write to:

COOK LABORATORIES 114 MANHATTAN ST. STAMFORD, CONN.

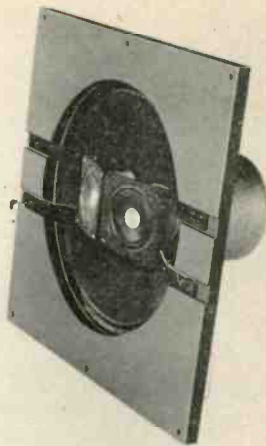

fashion behind a cut-out for standard 12- and 15-in. speakers. Thus the entire assembly may be used to replace standard speakers without the need for altering existing cabinetry. Resonance of the woofer is below 40 cps. Response of the dual tweeter extends to 20 kc with spatial distribution of 120 deg. at 10 kc. Specification sheet covering the B-207 is available on request from the R. T. Bozak Company, 114 Manhattan St., Stamford, Conn.

● **Central-Control Dual-Channel Sound System.** Flexibility is the keynote of the new Rauland Model S260 sound system designed for school and institutional use. Capable of feeding up to 160 rooms, the system offers a choice of two programs with simultaneous two-way intercommunication between any room and the



central control. Facilities are provided for selecting any two of six microphones and mixing them as desired, or with program material. Two FM-AM tuners are supplied as well as a transcription player which handles records of all sizes and speeds. Record changer and tape recorder are available optionally. Full descriptive details will be mailed free by Rauland-Borg Corporation, 3515 W. Addison St., Chicago 18, Ill.

● **Tape Splicer.** Conveniently small and formed of plastic, the Cousino tape splicer is provided with an adhesive back which greatly facilitates mounting of the unit on



a recorder or work table. After removal of protective coating, the splicer may be mounted permanently wherever desired merely by the application of gentle pressure. Splicing procedure is identical with that of conventional metal splicers. Manufactured by Cousino, Inc., 2307 Madison Ave., Toledo 2, Ohio.

NEW LITERATURE

• **Minnesota Mining and Manufacturing Co.**, 900 Fraugher St., St. Paul 6, Minn., offers an interesting paper on the problems of tape recorder head alignment and head wear in "Sound Talk" Bulletin No. 27. The three-page discussion covers azimuth alignment and tape skewing, importance of head contact, and the effects of head wear on recording and reproduction. Also included is an eight-step check list for locating high-frequency response loss caused by head problems. Available on request.

• **Jensen Manufacturing Company**, 6601 S. Laramie Ave., Chicago 38, Ill., has completed a six-page three-color folder describing the new "Duette" two-way speaker system as well as the "Duette" portable unit. Technical and practical information regarding the two models is included in the pocket-size folder which is available to dealers and distributors without cost.

• **Chicago Standard Transformer Corporation, Standard Division**, Addison and Elston, Chicago 18, Ill., in Bulletin 479 describes the construction of the new Stancor ultra-linear high-fidelity amplifier. Photographs, chassis drawings, schematics, and parts list are shown. Frequency response of the amplifier is flat to 40,000 cps at output levels up to 20 watts. Harmonic distortion is less than one per cent at 25 watts; intermodulation is three per cent at 28 watts. Owners of the original Stancor-Williamson amplifier can convert to ultra-linear operation by installing the new Stancor Model A-807² output transformer. Conversion data is included in Bulletin 479 which will be mailed free on request.

• **David Bogen Co., Inc.**, 29 Ninth Ave., New York 14, N. Y., in a handy pocket-size folder, pictures and describes its complete line of high-fidelity components. Included are recommended loudspeakers for use with Bogen tuners and amplifiers. All listings include prices. Copy will be mailed free on request. Specify Catalog HF154.

• **P. E. Mallory & Co., Inc., Resistor Division**, Frankfort, Ind., serves the needs of equipment design engineers in a handy new catalog devoted exclusively to carbon and wire-wound potentiometers and rheostats. Especially interesting is the portion of the catalog which tells engineers how to specify control requirements to facilitate quotation and sample preparation and to assure speedy production. Presented are concise, yet complete, data to assist an engineer in selecting controls for any equipment under consideration. Requests for this excellent publication should specify Form No. 79-7.

• **National Scientific Laboratories, Inc.**, 2010 Massachusetts Ave., N. W., Washington 6, D. C. recently announced a Transistor Research Bulletin which will be published bi-monthly on a subscription basis. Primary objective of the Bulletin is to keep readers informed in the field of transistors, diodes, and other solid state devices. Editor is Michael C. Ellison. If the copy submitted to this column may be regarded as a criterion, design engineers should waste no time in having their names placed on the subscription list. The publishers did not indicate whether subscriptions are complimentary or whether a charge is involved.

• **The Radio Club of America, Inc.**, 11 W. 42nd St., New York 36, N. Y., has recently published the first complete paper to cover the subject of FM multiplexing as introduced to the industry last October by the late Maj. E. H. Armstrong. Details of the system as it applies to both transmitters and receivers are described in Vol. 30, No. 3 of the Club's Proceedings under the title, "Some Recent Developments in the Multiplexed Transmission of Frequency Modulated Broadcast Signals," by Maj. Armstrong and John H. Bose. Requests for copy must be accompanied by a remittance of fifty cents.

• **James B. Lansing Sound, Inc.**, 2439 Fletcher Drive, Los Angeles 26, Calif., has issued a step-by-step construction folder covering the firm's rear-loaded folded-horn corner speaker enclosure. Published primarily for amateurs and experimenters, the four-page booklet is well-illustrated with photographs and dimensional drawings which cover cabinet construction from raw material to final assembly. Designated Catalog No. 34, the folder is available direct or through Lansing factory representatives.



Presenting
HIGH FIDELITY'S MOST REVOLUTIONARY
"Baton"

NEW!  **TONE ARMS**

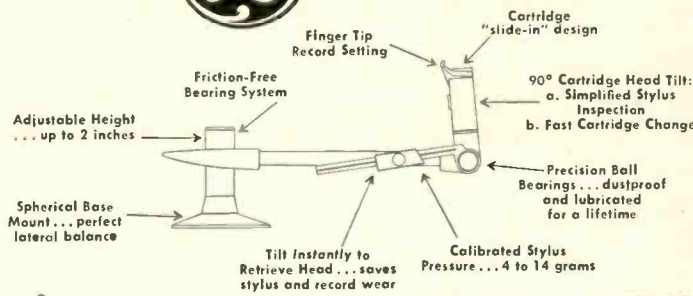

Adjustable Height ... up to 2 inches

Spherical Base Mount ... perfect lateral balance

Friction-Free Bearing System

Finger Tip Record Setting

Cartridge "slide-in" design

90° Cartridge Head Tilt:
a. Simplified Stylus Inspection
b. Fast Cartridge Change

Precision Ball Bearings ... dustproof and lubricated for a lifetime

Tilt Instantly to Retrieve Head ... saves stylus and record wear

Calibrated Stylus Pressure ... 4 to 14 grams

Just the General Electric variable reluctance cartridge and now this G-E "Baton" tone arm ... two of the most important contributions toward improving high-fidelity reproduction in many years. The advanced tone arm design sets new standards of performance ... places new emphasis on pickup balance with no perceptible torsional resonance.

Friction-free bearings minimize groove wall damage ... provide welcome assurance of *even stylus wear!* Used in your system ... tone arm bass distortion disappears ... you'll enjoy ideal response from 20 cycles up! Examine all of its features. Here is the one tone arm you should own! Available in both 12" and in 16" transcription sizes.

* * *

Order Your G-E "Baton" Tone Arm Today! Local Dealers can now supply them. Or, write us, for literature and additional information: *General Electric Company, Section R4434, Electronics Park, Syracuse, N. Y.*

GENERAL  **ELECTRIC**

**CROWNING
ACHIEVEMENT
IN LISTENING
PLEASURE**

The Coronation

BY INTERELECTRONICS



\$9250

**CLASS A-1
WILLIAMSON CIRCUITRY
SUPRA-LINEAR**

30 Watt Amplifier

It's new! There's nothing like it. It's the very finest quality amplifier combining every desirable feature: high power, versatility, minimum distortion, and the lowest cost ever.

COMPARE: Ultra compact, precision crafted throughout, with polished chromium chassis. Plug-in electrolytic condenser, terminal board for all circuit components, sealed multi-section grain oriented output transformer, KT-66 output tubes. Frequency response 10 to 100,000 cycles \pm 1 db; intermodulation distortion at 15 watts 0.15%; hum and noise level 96 db below full output; preamp power.

Hear The Coronation soon at your dealer, or write direct! Dealer inquiries invited.



**INTERELECTRONICS
CORPORATION**

2432 Grand Concourse, New York 58, N. Y.

MAGNETIC TAPE PROBLEMS

(from page 21)

The Role of Dust

The importance of dust and dirt on tapes was at first underestimated because it was believed that the wiping action of the heads would remove much of it. Once the coincidence detector had been developed so that stopping of the tape mechanism permitted easy examination of a small local zone of the tape, it was discovered that stopping was frequently caused by dust and dirt particles rather than by actual defects on the tape.

How appalling this situation was can be realized by considering early total counts for 6 channels of nearly 1000 per 900-foot reel of tape and the fact that the computer cannot miss one pulse during normal operation without creating an error.

Installation of the lens tissue wiping pads over which the tape gently glided during reading operations reduced the count by about 60 per cent. Since dust might have interfered with the original writing operation the tapes were erased and rewritten; the counts, repeatable consistently, then fell to about 200 for the same tape. Removal of the wiping pads for a few moments raised the count by 20 to 30 per cent.

While these investigations were in progress, active interest and cooperation of a number of tape manufacturers was obtained. Tapes in recent months show counts running from 3 or 4 to about a dozen per 1000-foot roll, using the 6-channel coincidence detector. The reduction in count also reflects efforts to keep dust from the tapes. Not only were wiper pads used to remove dust which had reached tape surfaces, but tapes were kept in metal cans, the tape mechanisms were provided with dust covers completely enclosing all the tape and caution was used in handling tapes. Greasy hands can coat tapes with a small amount of oil which later accumulates dust. Gloves with as little lint as possible were used until personnel handling tapes learned to let the mechanisms do most of the actual moving of tape and touched it only with very clean hands.

In an atmosphere with very low relative humidity the tapes tend to become electrically charged and hence to collect dust. Air conditioning was a great assistance in this respect, probably because filtering of the air removed considerable dust. Efforts at lubrication of tapes to minimize static charge have not proven very effective and wire brushes and other devices have given conflicting results.

However, with some degree of humidity control and the use of dust covers and wiping pads, together with care in handling tapes and storing them, the dust menace has been largely eliminated. All the precautions are vital, however, and must be maintained.

What about Remaining Defects?

The tape manufacturers have succeeded in ridding their product of the chewing-gum type of defect, embedded metal particles, the deflated and dried bubbles, and many of the other defects. Clumps are the main cause of defects sufficiently large to cause drop-outs. The orange-peel roughness in the base material apparently results from too rapid evaporation of solvent during its preparation and tape manufacturers—now that they are cognizant of the demands of computer and telemetering service—are bending even greater efforts toward improving the quality of plastic tapes.

But such programs consume time, and while they give us a feeling of optimism for the future, do not allow us to use tapes containing defects.

In the Raytheon computer, information is written on the tape in blocks, each of which is about $2\frac{3}{4}$ in. long. Normally a free zone of about $\frac{3}{8}$ in. is allowed between blocks.

Utilizing the detectors developed, it has been found possible to indicate on the tape the locations of defective areas. These indicators are picked up photoelectrically by the tape-marking apparatus which places the printed photo marks on the rear of the tape. These not only number the blocks consecutively along the tape, but also designate the beginning and end of each. On encountering an indicator designating a defective area, the tape printing equipment automatically allots spacing for the succeeding block so that the defective area is always left in a free zone between blocks. Thus, defects never are present within a designated block and all writing and playback operations may be undertaken with reasonable assurance that errors will not arise from pulse drop-outs. Precautions against dust must still be used since a grain of dust beneath the gap of a writing head may cause a number of pulses to be ineffective.

This procedure, on the whole, has been very effective. Together with Raytheon parallel-channel recording head assemblies, it has made possible relatively high pulse densities and effective use of tapes as storage media.

The Future?

As has already been pointed out, tape manufacturers are now acquainted with the demands of computer service and are actively engaged in improving the quality of their products. The strides they have made in the past two years are striking and of inestimable value.

Not only are they attacking the problems of eliminating defects but also of improving the base material. Cellulose acetate suffers because of its absorption of moisture which affects its dimensional stability and tensile strength.

With techniques already developed and assurance of better magnetic media to come, full realization of the potentialities of magnetic tape memory devices is closer to our grasp. They are here to stay and to perform their tasks in the computer field.

Acknowledgement

It is both a pleasure and a duty to acknowledge the painstaking dexterity of Dr. A. J. Devaud in the microscopic work on tapes, the suggestions of K. Rehler on circuits, and the rugged patience of J. Kent who made most of the tape measurements.

This work was undertaken as a part of Contract No. N70NR-38902 for the Office of Naval Research.

PATENTS

(from page 4)

with fidelity at least as good as the Williamson circuit.

Another embodiment shown in the patent is the opposite of that shown in Fig. 2 in that positive compensating feedback is applied to the upper tube rather than negative to the lower. Any of the standard forms of inverse feedback for the amplifier as a whole may be taken from the output of this circuit. Mr. Coulter does not state the power-supply requirements but it seems that the necessary voltage would be higher than normal.

Advice to Inventors

We would like to acknowledge grateful receipt of a letter from Mr. T. L. Bowes, Assistant Secretary and Patent Counsel of Stromberg-Carlson, a firm of which you may have heard, and pass on the helpful information it contains.

In the January issue we talked about how independent inventors can avoid some of the pitfalls of rushing to a patent attorney with hundred-dollar bills in hand, and we said among other things that an inventor can protect himself to a good degree by detailing the invention on paper and mailing it to himself or a friend by registered post. If the envelope is retained unopened, we said, the date of registry is presumptive evidence of the date of conception.

Mr. Bowes points out that many attorneys consider this of doubtful value and that it is better to have each sheet of description, drawing, and photograph signed and dated by at least two witnesses who have read and understood the principles on which the invention is based. We certainly should have thought of this, since we have actually done it ourselves upon occasion, and we appreciate the letter.

However, it seems to us that such documents are still subject to changes in the form of erasures and additions after the witnessing, which might conceivably give rise to doubts about their authenticity as proof. We have in the past used a belt-and-suspenders technique which we think is pretty foolproof and goes as follows. First we type and draw all the material on translucent drawing vellum. Then we make whiteprints of these sheets by one of the standard diazo methods used in engineering departments, after which we have the prints signed and dated and mail them by registered post for safekeeping unopened.

The idea is (1) it is difficult or impossible to alter diazo whiteprints, (2) the witnesses' signatures and dates authenticate the prints just as much as they would originals, and (3) the registered mailing causes post-office markings to be placed across the envelope flap so that you have to be pretty ingenious to open and reseal it without leaving traces.

I dare anyone to challenge successfully the authenticity of documents of this kind containing evidence of conception!

AXIOM

Regd. Trade Mark

High FIDELITY

OF SOUND

MADE IN ENGLAND



AXIOM 150 Mk II

A 12-inch twin-cone full range high fidelity reproducer, with a power handling capacity of 15 watts.

AUDIOPHILE
NETT PRICE
\$43.50

BRIEF SPECIFICATION
Frequency Coverage 30/15,000 c/s
Fundamental Resonance 35 c/s
Flux Density 14,000 gauss
Nett Weight 12lb. 13oz. (5.8 kg.)



AXIOM 22 Mk II

A 12-inch twin-cone high-power P.M. loudspeaker combining generous bass handling capacity with full range high fidelity reproduction.

BRIEF SPECIFICATION

Frequency Coverage 30/15,000 c/s
Fundamental Resonance 35 c/s
Flux Density 17,500 gauss
Nett Weight 18 lb. 4 ozs. 8.3 kg.

AUDIOPHILE
NETT PRICE
\$65.00



AXIOM 80

A medium power FREE SUSPENSION high fidelity P.M. reproducer for the professional enthusiast.

AUDIOPHILE
NETT PRICE
\$52.30

BRIEF SPECIFICATION
Frequency Coverage 20/20,000 c/s
Fundamental Resonance 20 c/s
Flux Density 17,000 gauss nominal
Nett Weight 9lb. 6oz. (4.2 kg.)

Exclusively distributed by:—

- EAST:** Goody Audio Centre Inc.,
235, West 49th St., New York 19, N.Y.
NORTH & MID-WEST: Newark Electric Company,
223, West Madison St., Chicago 6, ILL.
WEST: Hollywood Electronics,
7460, Melrose Avenue, Los Angeles 46, Cal.
SOUTH: High Fidelity SSS,
606, Peachtree St., N.E., Atlanta, Ga.
CANADIAN SALES OFFICE: A. C. Simmonds & Sons Ltd.,
100, Merton St., Toronto 12.



GOODMANS

GOODMANS INDUSTRIES LTD
AXIOM WORKS, WEMBLEY, MIDDLESEX
ENGLAND

A
CREDIT
TO YOUR
HIGH
FIDELITY
SYSTEM

Collaro

for 7, 10, and 12
INCH RECORDS

Fully Automatic

3-SPEED RECORD CHANGERS

Model 3/532
Intermixes 10 and
12 inch records.
List Price — \$65.00

Model 3/531
Non-intermix.
List Price — \$54.50

Model 3/534
Single record player.
List Price — \$33.60

WOOD BASE
Mahogany Finish.
Specify Changer or
Player.
List Price — \$9.50



Available at
Radio Parts Jobbers,
Distributors, and
Hi-Fi Dealers

Write for complete details to: Dept. FC-1
ROCKBAR CORPORATION • 215 East 37th Street, New York 16, N. Y.

VARIABLE LOW-PASS FILTER

(from page 28)

let us find what effect this 10 per cent variation will have on the value of ζ .

(1) Tube gain variation
from

$$\zeta = \frac{1}{\sqrt{1 + K_1 K_2}}$$

$$\frac{\partial \zeta}{\partial K_1} = \frac{-K_2}{2} (1 + K_1 K_2)^{-3/2} = \frac{-\zeta K_2}{2(1 + K_1 K_2)}$$

or

$$\frac{\partial \zeta}{\zeta} = \frac{-K_2 \partial K_1}{2(1 + K_1 K_2)}$$

and for

$$\left. \begin{aligned} \partial K_1 &\approx \Delta K_1 = 10\% \text{ of } K_1 = \frac{40}{10} = 4 \\ \text{and since } 1 + K_1 K_2 &= 4 \end{aligned} \right\}$$

we have

$$\frac{\partial \zeta}{\zeta} = \frac{-3 \times 4}{40 \times 2 \times 4} \approx -4\% \quad (13)$$

A 10 per cent decrease in tube gain will increase the value of ζ by 4 per cent, a negligible amount.

(2) Resistor variations.
From

again, and following the above reasoning, we have,

$$\frac{\partial \zeta}{\zeta} = \frac{-K_1 \partial K_2}{2(1 + K_1 K_2)} = 5\% K_2 \quad (14)$$

and for

$$\partial K_2 \approx \Delta K_2 = 10\% \text{ of } K_2 = \frac{3}{400}$$

we have

$$\frac{\partial \zeta}{\zeta} = \frac{-5 \times 3}{400} \approx -3.5\%$$

In making up K_2 therefore, 10 per cent resistors can be employed with no adverse effects on the value of ζ .

(3) Tracking.

From Eq. (7),

$$\omega_n = \frac{\sqrt{1 + K_1 K_2}}{\tau}$$

and

$$\frac{\partial \omega_n}{\partial \tau} = \frac{\sqrt{1 + K_1 K_2}}{-\tau^2} = -\frac{\omega_n}{\tau}$$

therefore

$$\frac{\partial \omega_n}{\omega_n} = \frac{-\partial \tau}{\tau} = -\frac{C \partial R}{RC} = -\frac{\partial R}{R} \quad (15)$$

The variation of the cutoff frequency ω_n is directly proportional to the variation of the time constant τ as can be seen from Eq. (15). A continuously variable filter is therefore feasible. R_a and R_b of Fig. 3 are ganged potentiometers commercially available. Although tracking is not very accurate, it does not effect the critical parameters as shown below. Assume that the R_b potentiometer is off tracking by $\pm \gamma$ per cent of R_b ; then, since $R_b = mR_a$ its actual value will be

$$mR_a \pm m\gamma R_a = mR_a (1 \pm \gamma)$$

and

$$\frac{e_o}{e_i} = \frac{1}{(TS + 1) [\tau(1 \pm \gamma)S + 1]} = \frac{1}{(1 \pm \gamma)T^2 S^2 + (2 \pm \gamma)TS + 1} \quad (16)$$

Eq. (16) after feedback becomes

$$\frac{1}{1 + K_1 K_2 T^2 S^2 + 1 + K_1 K_2 TS + 1} \quad (17)$$

from which

$$\omega_n' = \frac{\sqrt{1 + K_1 K_2}}{\tau \sqrt{1 \pm \gamma}} = \frac{\omega_n}{\sqrt{1 \pm \gamma}} \quad (18)$$

and

$$\begin{aligned} \zeta' &= \frac{\omega_n'(2 \pm \tau)}{2(1 + K_1 K_2)} = \\ &= \frac{(2 \pm \gamma)\tau}{(2\sqrt{1 + K_1 K_2})\tau\sqrt{1 \pm \gamma}} \\ &= \frac{2 \pm \gamma}{2\sqrt{1 \pm \gamma}} \zeta \quad (19) \end{aligned}$$

where ω_n and ζ are the values determined from Eqs. (7) and (8). For a $\gamma = \pm 10$ per cent, the variations of ω_n and ζ from the original values are negligible. A 10 per cent tracking accuracy, which is usually obtainable with standard ganged potentiometers, will therefore give very satisfactory results.

Authoritative and Enlightening...

AUDIO

Acknowledged the Leading Publication in the Field of Sound Reproduction

If you are novice, hobbyist, experimenter, or engineer... if you are a lover of music... and in pursuit of sound, undistorted... AUDIO will be your faithful, reliable companion all the way. You will find no more pleasureable and stimulating reading than there is in AUDIO; absorbingly interesting material, valuable and authentic data, workable detailed instructions... all comprehensively and yet practically presented.

"What to Do" and "How to Do" will guide your every move through this thrilling experience we call Audio.

Each new issue brings New Ideas, New Slants, and Latest Developments... month in and month out... twelve times a year.

BE SURE to get your copies REGULARLY.

MAIL this Coupon NOW

AUDIO

Box 629, Mineola, N. Y.

Enclosed is Check Money Order for \$_____ Please send a copy of each new issue of AUDIO for the next 12 months; 24 months to:

Please Print

Name _____

Address _____

City _____ Zone _____ State _____

Subscription Price: U.S.A., Canada and Pan American Union: 1 year... \$3.00 2 years... \$5.00. Other countries: 1 year... \$4.00 2 years... \$7.00.

PLANNING FOR HOME MUSIC

(from page 25)

it is usually mounted above the amplifier or, if width permits, alongside the amplifier chassis. In any case, it is mounted close to the amplifier so the controls may be easily coordinated.

The Tuner Control Chassis: Usually an AM-FM tuner, with complete audio control facilities including a phono-pre-amplifier for magnetic cartridges and a record compensator (in the newer models). Some types have push-pull audio amplifiers built into the same chassis for compact installations. The tuner-control unit was designed mainly to feed a basic power amplifier of good quality. There have been one or two FM tuners with control features, but they are no longer made, since this feature proved popular only in the AM-FM models. The tuner-control unit is somewhat wider than the basic tuner and usually deeper. Height is basically the same with one or two exceptions.

The Compensator: An accessory of compact dimension for use with some tuner-control units or amplifiers that do not have a record compensator in the circuit. Usually this unit is mounted in proximity to the audio control chassis because of the small output cable supplied (this length is critical and should not be increased). Since most modern audio control units (on both tuners and amplifiers) include a record compensator circuit, the accessory compensator will not be required in an installation except in special situations. It will be used mainly in revamping an existing system.

The Audio Amplifier: A complete circuit with complete control facilities which includes: selection of inputs, record compensation, bass and treble controls, volume control with loudness control (in some types only), plus added features, depending upon the manufacturer. These features may include cut-off filters for bass and treble frequencies which will reduce surface noise and rumble, or they may have a single switch position to provide these features. The more economical types, which are of excellent quality (both design and performance) are found on a single chassis. The more costly are made with a separate control unit and a separate basic power amplifier. Some types of two chassis units provide complete remote control as all input jacks (connections) from the tuner, record player, TV tuner, tape recorder, etc., are on the basic power amplifier and the control unit is connected with a single cable from as far as 35 to 100 feet. The other types of two chassis amplifiers are impractical

for use in this manner because of the large number of cables required between the control unit and the basic power amplifier, despite the fact that a cathode follower output may be provided in the control unit. The one factor making it impractical is that the lead from the phono cartridge on the record player should not be run in excess of 8 to 10 feet without a cathode follower. The basic power amplifier is used with the tuner-control unit as often (if not more so) as the audio control unit in present day installations. This is because of the simplicity in layout which such a combination offers. It provides the music lover with minimal requirements for space, especially if the cabinet to be used is compact, such as that shown in Fig. 4. Here, the basic amplifier was placed within the speaker enclosure (which has ample volume) with adequate ventilation provided by the open reflex port of the cabinet.

The Record Changer: This unit mounted on a base, requires a minimum of 16 in. in width. However, if a base is not used, the dimension may be as small as 15 in. (except in the cases of some types of changers). Depth must be 16 in. minimum for comfortable operation. If space is at a premium, the music lover can get one of the diminutive manual record players which only requires a depth of 13½ in. and a width only a small fraction of an inch larger. The minimum height for a record changer, is 11 in. if mounted on a base, 7½ in. if mounted on a motor board. The small manual record player requires only 6 inches above the motor board, or a total of 10 in. if a base is used.

The Transcription Player: This unit requires considerably more space than a record changer. The bare minimum using present day equipment is 18 in. wide and 16½ in. deep. Some combinations of turntables and arms require as much as 28 in. in width by 18 in. in depth while the average installation can be made into an area of 21½ by 21½ in. This problem exists because of the relationship of the turntable motor to the cartridge that is mounted into the arm. Unless a turntable and arm are mounted in the proper relationship excessive hum will result. Depth below the motor board for the average turntable is from 4½ to 5 in.; some professional types using hysteresis motors require from 6 to 7 in. Height above the motor board varies with the height of the pickup arm, from 3 to 4½ in. If greater ease in operation is desired, more clearance is desirable.

MAXIMUM TONAL REALISM
In Minimum Space
At Minimum Cost!

KINGDOM
SOUND COMBINATION
featuring **LORENZ** Speakers

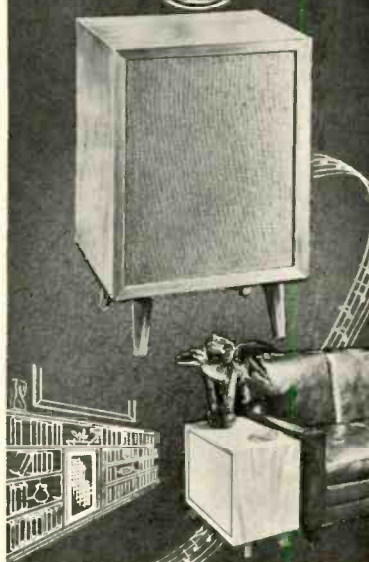

Here is a sound combination that makes music come alive in every home. The acoustically engineered KINGDOM CABINET is made of Hardwood ¾" thick. Reproduces both high and low frequencies with full tonal realism. Small in size. Versatile and Decorative . . . Blends with modern or traditional interiors. Furnished completely assembled with LORENZ LP-215 WOOFER, LORENZ LP-65 TWEETER AND KINGDOM HP-1 HIGH PASS FILTER (Shown below). All perfectly matched and balanced to bring you all the musical charm and enchantment of the original performance. . . . Natural, clear and crisp up to 16,000 cycles.

COMPLETE KINGDOM SOUND COMBINATION cabinet with speaker system. Size: 13" x 16" x 19". Available in colors to harmonize with the following finishes: Mahogany or Blonde, Net \$69.50 Unfinished \$67.00

KINGDOM CABINETS ONLY for 8" speakers or 2-way systems: Mahogany or Blonde. Net \$26.95 Unfinished \$24.45

CHAIRSIDE STAND Net \$6.95



'WOOFER' LOUSPEAKERS AND TWEETERS

Made Expressly for KINGDOM Products
The LORENZ Speakers have been tested and found excellent with the KINGDOM CABINETS, the Rebel IV CABINETS and ELECTRO VOICE BARONET. Other well-designed cabinets should work equally well.



LP-65
LORENZ
TWEETER

Carries the highs—Clean, Clear and Crisp up to 16,000 cycles. Power: 2 watts. Impedance: 5.5 ohms. Size: 2½" dia. Net \$8.50



HP-1 KINGDOM
HIGH PASS FILTER

Used with the LORENZ LP-65 TWEETER it will extend the range of any speaker to the limit of human audibility going smoothly from 4,000 CPS up to 16,000 CPS. Net \$4.95



LP-215 LORENZ
'WOOFER' LOUSPEAKER

A masterpiece of sound engineering. Performs smoothly over the full range. Response: 40 — 13,500 cycles. Power: 8 watts. Impedance: 4 ohms. Size 8½" dia. Net \$22.50

Write for Detailed Specifications

KINGDOM PRODUCTS, Ltd.
23 Park Place, New York 7, N. Y. • WOrth 4-8585
Specify Emitron KT-66

NOW...enjoy luxurious hi-fi remote control!



with the beautiful *Rauland*

LIBRETTO remote control

NOW you can have complete remote control of your present High Fidelity Music System with the

LIBRETTO! This amazing control is completely self-powered and capable of operation several hundred feet from the amplifier. Uniquely fashioned in the form of a luxuriously bound book (only 8 3/4 x 11 x 2" thick). Backbone lifts for easy access to controls. Operates in either horizontal or vertical position. Controls: 1. Crossover; 2. Roll-off; 3. Volume; 4. Bass; 5. Treble. Adapter available for simple connection to your present system. Gives you the ultimate in luxurious Hi-Fi.

See your Hi-Fi Dealer for a thrilling demonstration of **LIBRETTO** remote control operation.



Awarded the Medal of Merit, International Sight and Sound Exposition, Chicago

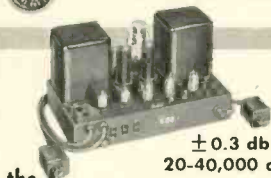

the ultra-fidelity *Rauland* **1805** custom amplifier

This truly superb unit is designed for optimum performance in the finest High Fidelity systems. Ideal for use with the LIBRETTO Remote Control (adapter not required). The specifications below speak for themselves, but the ultimate proof of quality is in the thrilling listening experience.

- Rated Power Output... 20 watts.
- Frequency Response... ± 0.3 db, 20 to 40,000 cps at rated output.
- Harmonic Distortion... less than 0.5% at rated output, less than 0.3% at 10 watts.
- Intermod. Distortion... less than 0.4% at 1 watt (home level), 0.7% at rated output—measured at 60 and 7,000 cycles, 4 to 1 ratio.
- Hum and Noise Level... 80 db below rated output.
- Output Impedance... 8 and 16 ohms.
- Input Selector... 4-position on 5-ft. extension cord: No. 1, magnetic pickup; No. 2, crystal pickup; Nos. 3 & 4, auxiliary.

See your Hi-Fi Dealer or write us today for full details

RAULAND-BORG CORPORATION
3515 W. Addison, Dept. G, Chicago 18

The Tape Recorder: Usually requires a large compartment unless it is a panel-mount chassis of compact dimension (20 in. wide by 13 in. high). Most panel-mount types are 16 in. deep by 22 in. wide, and thus require an area as large or larger than a transcription type record player. If a portable type tape recorder is to be used, an area greater by 4 in. on all sides should be calculated so the unit may be set into the cabinet when used and removed for portable use if required. Some music lovers may elect to remove the recorder and amplifier chassis from the portable case and mount them within the cabinet structure for permanent use. Most types of portable recorders will not operate in any position other than horizontal, though one or two can be panel mounted if certain modifications are made. *Figure 5* illustrates a tape recorder in its own case set into the hi-fi cabinet structure so that it can easily be removed.

The Television Unit: This unit is easy to include into a system, especially if the cabinet is to be made to order. Because of the large dimension demanded by a TV chassis and tube a minimum cube of 24 inches on all sides is required for a 17-in. or smaller tube. When a 21-in. or larger tube is used, the proportionate increase in size becomes great. Care must be exercised in calculating the proper size for a compartment to ensure adequate ventilation and room for servicing the unit in the cabinet.

Choice of Components

Whatever the reason for choosing particular components, it is wise to consider facilities in which to house the equipment at the same time. *Figure 3* shows a basic and functional method of installing a hi-fi system. The loudspeaker is mounted into a corner enclosure located in the adjoining living room. The small triangular speaker cabinet is primarily for monitoring purposes and serves to provide low level background music while the listener is working at his desk. Because the room was small in size, the addition of a cabinet would have created problems. By simply adding two shelves 16 inches deep, it was possible to mount the changer into one shelf with audio control unit and radio tuner in a simple protective case. Above the components, a shallower shelf (deep enough to store records) was mounted in the same manner. Extreme flexibility is realized from such an arrangement as the shelves are removable. The basic power amplifier is installed behind the perforated masonite panel in the small cabinet below the components.

When building a special enclosure for a music system, added features may be included with space for storage of

personal articles or display of decorative embellishments. Shown *Figure 5A* is an outline sketch of component arrangement. The unused areas provide considerable storage space. In the photograph of the finished cabinet (*Fig. 5*) a skeleton network of shallow shelves was added to provide ample space for bric-a-brac and trophies. It also fills out unused wall space. Both end compartments (record changer and radio tuner) have a panel door which pulls up and fits back into the compartment above the component. The basic power amplifier is easily accessible for service when required. Simple in design, an enclosure such as this one can be made inexpensively in economical woods or it can be elaborately built of expensive woods with many added sections which can expand to fill the complete wall as shown in *Fig. 6*. This installation uses a basic tuner and a two-chassis audio amplifier. Functional in design, the walls adjacent to the system contain storage areas and compartments. Note that there is a considerable record storage space and the loudspeaker is mounted so that it commands the attention of the entire room. The radio tuner and record player are at a comfortable level below the television unit which is mounted at a proper height for viewing. The audio control unit is installed at about eye level with other accessory units. The louvred shutter type doors can be closed if background or atmosphere music is desired, still permitting ventilation and adequate sound pressure so the benefit of the system's excellent quality can be realized.

Building into a wall, closet or other similar facility affords the greatest flexibility. The closet as a hi-fi enclosure can be used for normal storage of clothes and household necessities if only the loudspeaker is mounted into it. The average speaker-in-a-closet installation is made on a door or into a wall that faces toward the area used for listening. Usually it is mounted just above the shelf in the closet, out of the way of normal usage taking up only a little space. It is not recommended to block the rear of the speaker with pillows and hatboxes, but small articles can still be stored on a shelf that provides but little space to the rear end of a speaker. Mounting the speaker above the shelf (usually 5 to 6 ft. high) places it at an optimum height, providing the best possible coupling to the room. Components can be installed into closets so that only part of the normal use is affected or, as in the case of the installation shown in *Fig. 7*, all of the closet space can be utilized. The lower section provides three shelves of generous record storage space plus room for the basic power amplifier. The center shelf houses the tuner-control chassis and record player, with a utility shelf above for the han-

HI-FI "TICONAL" MAGNET SPEAKERS!

... with a
MIGHTY VOICE

Never before has there been a range of Hi-Fi speakers to match the new DUOTONE units manufactured by Philips. These loudspeakers, which replace the Alnico V, feature the introduction of TICONAL, the most powerful of the modern magnet steels. TICONAL gives a high flux density making possible on air gap of twice the normal depth which results in the most natural tone reproduction yet achieved. Here is a complete line of speakers that give the same tone quality whether operating at a whisper or under full power.

- Improved cone design gives extended low frequency response... absence of peaks and dips resulting in better reproduction
- Various cones for small speaker types
- Rectilinear response curves audio selection of larger types
- External centering prevents cone stresses
- Sealed air gap prevents booming
- Optimum bass reproduction
- Favorably priced competitively



Write DUOTONE today for folder on the complete line of speakers and microphones.

DUOTONE

KEYPORT, NEW JERSEY

Canadian Representatives: CHARLES W. HONIGHTON, TORONTO, CANADA
Export Division: AD. AURIBAU, INC., NEW YORK CITY, N. Y.

A patented invention of Philips Laboratories

"Spotlight the New"
at the
RADIO ENGINEERING SHOW

DEFINITION

852

March 22-25, 1954 • Kingsbridge Armory, New York City

The address to remember at the Show:
852 Audio Avenue
On display and for sale—AUDIO, the two Audio Anthologies, Newlitt's High Fidelity Techniques, and RADIOFILE, the index to radio and electronic periodicals.

RADIO MAGAZINES, INC.
P. O. Box 629 Mincola, N. Y.

AUDIO • MARCH, 1954

ding of records in use. The upper portion contains the loudspeaker system. While this installation requires the door of the closet to remain open while the system is in use, a slight modification could be made to permit use of the system with the door closed. For instance, the top panel could be removed and replaced with a grille fabric and for added ventilation the lower panel could be replaced with louvres or a matching grille fabric. This type of installation also permits the addition of a tape recorder which can be installed in one of the record storage shelves below the radio tuner.

It is often said that the most comfortable room in a home is one which has a fireplace and a fireplace is usually surrounded with book shelves. Practical planning facilitated installation shown in Fig. 8 which occupies a small amount of wall space and eliminates the need for added furniture, often difficult to blend into a room. In Fig. 8A note the manner of planning the layout of components. This music lover, a fastidious collector of LP records required the use of a manual turntable to play his slow-moving musical platters. Since his collection of standard groove records was also very large he could not deny the utility a record-changer could offer, especially for reproducing a complete opera that may appear in two full albums. Using a radio-tuner with built-in audio controls he was able to place both record players and the tuner on a single shelf with the speaker system directly below.

Rebuilding the bookshelf that normally graces the side of a fireplace is extremely popular, and the most practical and least expensive means of housing a music system. This is illustrated in Fig. 9 which shows the results of extending the lower section of a normally narrow set of bookshelves. A closeup view in Fig. 10 better illustrates the simplicity of layout, where everything is within convenient reach. Here, maximum utility was realized within a minimum of space. The fireplace need not have surrounding bookshelves to offer space for installing the family entertainment center. In Fig. 11, an area which normally would not lend itself to conversion was transformed into an effective enclosure providing a tailor made corner for a speaker system. It also permitted mounting the television chassis where it could command the attention of the entire room. The radio tuner (with all audio controls) is mounted at a very convenient working level with the record player. Aside from its almost complete effectiveness, this type of installation can well be the most economical.

Further discussions of the advantage of careful planning will follow in Part 2 of this article next month.

THE SYMBOL OF Quality IN TRANSFORMERS



dollars AND sense...

Triad quality costs no more, and those who buy Triad Transformers get what they pay for.

Superior design—finer materials—precise workmanship—distinctive appearance—continuous and unflinching service. All these contribute to the recognized value of Triad products.

Industry expects and gets—from Triad the finest transformers made.

Triad Transformers are sold by select jobbers in principal cities. Write for Catalog TR-53F.



4055 Redwood Ave., Venice, California





This is our
GROUP SUBSCRIPTION PLAN

You and your friends and co-workers can now save up to \$1.00 on each subscription to **AUDIO ENGINEERING**. The more men in a Group, the more each saves. If you send 6 or more subscriptions for the U.S.A., and Canada, they will cost each subscriber \$2.00, 1/3 less than the price of a regular 1-year subscription. **Present subscriptions may be renewed or extended as part of a Group.**

AUDIO ENGINEERING is still the only publication devoted entirely to

- Audio
- Broadcasting equipment
- Acoustics
- Home reproduction systems
- Recording
- PA systems
- Psychoacoustics

(Please print)

Name
 Address
 Position Company

Name
 Address
 Position Company

Name
 Address
 Position Company

Name
 Address
 Position Company

Name
 Address
 Position Company

Name
 Address
 Position Company

Name
 Address
 Position Company

U. S., Possessions, and Canada only.

RADIO MAGAZINES, INC.
 P. O. Box 629, Mineola, N. Y.

LOW-FREQUENCY AMPLIFICATION, by N. A. J. Voorhoeve. New York: Elsevier Press, Inc., 1953. xv+495 pages. \$9.00.

This is another work in the Philips Technical Library published by N. V. Philips Gloeilampenfabrieken in Eindhoven, Netherlands. The Library is growing fast and this volume will be of interest to a great many technically minded people in the United States. This is particularly so since for some reason U. S. publishers have still not issued what one might call a definitive or even adequate work on audio engineering, though there has been a small waterfall of books advising the consumer on "hi-fi," God rest the term.

Dr. Voorhoeve has done a good, workmanlike job here, with plenty of useful design and application information, though not on the level where English degenerates into number-language. The book starts off with a brief recapitulation of principles—*a.c.* technique, distortion, interference, units of measurement, and the like.

Next comes a rather informative chapter on the design and construction of tubes, and the meaning and usefulness of characteristics figures. The tubes used as examples are, of course, those of Philips, unfamiliar in this country, but the information is applicable to our own.

Pre-amplification and power amplification take up the next two chapters, with explanations and examples of the known circuits, plus design formulas but not any unnecessary derivations which so often serve merely to point out the erudition of the writer. The subject of feedback is treated in the same useful way, and system composition is handled in the discussion of matching, control, and limiting.

Two unusual chapters come next; they deal with the components required for practical audio systems—resistors, capacitors, transformers, rectifiers, and the like. The information here is valuable, the more so for not often being set down in print. A chapter on power supplies covers various types for various purposes.

After a discussion of some acoustic principles, the author goes into transducers—input sources and loudspeakers—and then concludes with five chapters on general aspects and applications.

While Dr. Voorhoeve's book may not be the last word (it does not concern itself with home music systems as such), it is well worth the space it will occupy on any audio man's shelf.

RADIO DATA CHARTS, by R. T. Beatty, revised by J. McG. Sowerby. London: Iliffe & Sons, Ltd., 1953. 91 pages. \$2.00

This is a series of 43 of what the British call "abacs," first published in 1930 and since become a standard work used by many thousands of electronics people, principally in Europe.

The book is principally concerned with receiver design and it provides a large variety of easy information to that end. Nomograms predominate, with some charts and simple conversion graphs. The subjects covered are too numerous to mention but include for example, frequency-wavelength, L-C-F, coil design data, selectivity, transformer winding, amplifier gain, decibels, dividing networks, wire tables, and the like.

The Magneraser*
Perfect Magnetic Tape Eraser



100% Erasure Guaranteed WITHOUT REWINDING

You no longer need a cumbersome and costly tape demagnetizer. The Magneraser* has all the features necessary for quick, efficient and absolute erasure of any recorded reel of tape. No matter what tape recorder you are using, or how severely the tape is overloaded, the Magneraser* is guaranteed to eliminate completely all recorded signal and bring the background noise level 3 to 6 db. below that of new unused tape.

You can carry the Magneraser* from room to room and use it wherever you have an AC outlet. To operate, simply place the Magneraser* on top of the reel of tape and move it once around. Within seconds, the complete reel is wiped perfectly clean.

Size 4" dia., 2 1/2" high; Weight 2 1/2 lbs.; Operating current 90 to 130 volts, 25 to 60 cycles; Power consumption 60 watts. Furnished with 8 ft. cord, molded rubber plug, and operating instructions. See your local dealer or write directly to factory. Net Price\$18.00

AMPLIFIER CORP. of AMERICA

396 Broadway, N. Y. 13, N. Y.

Pat. Reg. U.S. Pat. Off.

WANTED

for Murder...

CANCER is the cruellest enemy of all. No other disease brings so much suffering to Americans of all ages.

YET—though 23 million living Americans will die of cancer, at present rates—there is reason for hope. Thousands are being cured, who once would have been hopeless cases. Thousands more can have their suffering eased, their lives prolonged. And every day, we come closer to the final goal of cancer research: a sure and certain cure for all cancer.

THESE THINGS have all been helped by your donations to the American Cancer Society. This year, please be especially generous!

Cancer
 MAN'S CRUELEST ENEMY
 Strike back—Give
 AMERICAN CANCER SOCIETY



RECORD REVOLUTION

(from page 29)

production have languished and died because of the failure of the public to buy. For every great novel, there are thousands of Spillane's. And who buys and reads poetry any longer? But printing, after all, can neither change the feel, the impact, or the sound of an author's words. They are exactly reproduced as written. True, a good printing job results in a more attractive presentation of the author's material—but the end product is the same.

Recordings involve a difference of some consequence. A poor performance and a poor recording can do great and irreparable damage to a composition. And who's to know the difference in the case of a new work. The sole guide, in the long run, is the A & R man. He is the aesthetic conscience of a recording session. If he doesn't know his business and if he's irresponsible, the consequences are sad indeed. Sooner or later his sins catch up with him—but why wait that long! So, dear readers, you have been put on guard. If you are indiscriminate in your record buying, closed-minded, unwilling to take chances with unknown names and unknown composers, the end result is brutally clear. You will pave the way for a mediocre musical future. There isn't too much money to be made out of music any longer. Few, if any, serious composers can make a living out of their

work. Only a handful of conductors can get orchestras—and thereby money, glamor and fame. The vast—the extraordinarily vast—number of musicians aren't making a living today. If we get back to books again, the writer has an infinitely larger market for his talents than the composer or the musician. He can depend on advertising agencies, newspapers, magazines, radio, television, motion pictures, in addition to publishers. Not so the composer. If you reject the experimental, the new, you reject the composer of serious music in our time. Too much rejection breeds elimination. A healthy musical future depends on your willingness to give it a chance via records. And if you indicate your willingness by purchasing new music, the record companies will do their part.

I doubt very much whether Columbia expected or expects to make any money from *The Rake's Progress*. I doubt whether they've made any money on a superlative recording of a work which was buried until recently—a magnificent, important work—Alban Berg's *Wozzeck*. Practically your only chance of hearing them is through these two recordings. But after all—Stravinsky and Berg are both important names in the history of music. What about the little names that aren't in the books—the names that nobody knows but which are inextricably tied together with the music of the future? Not the concert hall, not the critics, but the average record buyer in every town in the United States will either put them in the books or destroy them forever!

ERRATA

On page 30 of the February issue, the diagram for the Tetrode Amplifier showed a power transformer with a voltage rating of 200-0-200 as supplying a d.c. output voltage of 330. Many of our readers believe that the transformer should have a higher voltage, with the consensus being that it should have been listed as 275-0-275. We regret to say that we must agree with them.

Also in the spirit of accuracy, we are forced to admit that the Table on page 62 of the same issue should have been headed

as shown below. The columns for HEIGHT and WIDTH were under the wrong headings—as should have been obvious—but no one but the author seemed to notice this one. Furthermore, says Mr. Greene, the lines under TAPE RECORDERS should have had some asterisks—and should have read

mounted vertically*
mounted horizontally**

These changes can be made by the reader with little trouble.

For both errors, our apologies.

TABLE 1
MINIMUM CABINET SPACE REQUIREMENTS
(in inches)

Component	Width	Depth	Height
FM tuners	15	12	11
AM-FM tuners	16	12	12
Amplifiers—one chassis	17½	12	10
Amplifiers—two chassis	17½	16	15
Record changers	16½	16	14
Manual record players	21¼	16½	14
Tape recorders			
mounted vertically*	21	16	16
mounted horizontally**	22½	16	14
TV chassis—up to 17-in.	24	24	24
TV chassis—up to 27-in.	32	24	27
10-in. record storage	***	12½	11
12-in. record storage	***	14½	13
7-in. tape storage	***	8	8
10½-in. tape storage	***	11½	11½

* Calculated for Magnecordette and smaller units

** Calculated for Concertone 1500 series and smaller units

*** Width depends upon existing or contemplated record or tape collection. Average LP album is roughly 0.7 in. wide. Single LP record will fit about 7 to the inch; 78 r.p.m. albums measure from one-half to two inches. The width of tape boxes is roughly ⅝ in. for the 7-in. reel and ⅜ in. for the 10½-in. reel.

TERMINAL First for Values!

Because Terminal Stocks
MORE of the World's Finest
High Fidelity Audio Equipment

DIRECT FACTORY DISTRIBUTORS
FOR ALL MAJOR LINES



McIntosh C-108

PROFESSIONAL AUDIO COMPENSATOR

Beautiful...flexible...easy to operate. Gives you greatest listening pleasure from any record. Rumble filter almost completely eliminates turntable rumble especially when playing older records. Five bass turnover switches and five treble attenuation positions as well as variable bass and treble controls compensate for all recording curves. Aural compensator control maintains proper bass and treble loudness when you play your system at low level volume. Has radio and auxiliary input.

Chassis only...net **\$86.50**

Complete with Cabinet...net **\$96.50**



McIntosh A-116

30 WATT AMPLIFIER

99.96/100% Perfect Amplification

McIntosh patented circuit guarantees less than 1/2% distortion at all frequencies 20-20,000 cycles, even at full power output. Because of the unique design of Output Transformer and resultant highest efficiency audio amplification, you can now have perfect reproduction of music from the softest passages to peak crescendos. Amplifier overload in your home music system is completely eliminated. Net **\$139.50**

Complete
Line of
MagneRecorders
in Stock



MagneCordette

Medium priced professional quality recorder for the best home music ensemble. Custom amplifier serves as a recording amplifier and as a playback pre-amplifier for reproduction through your high fidelity audio system. Dynamic full frequency range 50 to 10,000 cps at 7½ ips and 50 to 15,000 cps at 15 ips.

In blonde or mahogany cabinet...net **\$449.00**

10½" Reel Drive for above...only **\$39.00**

SEE, HEAR and COMPARE
the Latest Audio Equipment at
TERMINAL SOUND STUDIOS

Phone: WOrth 4-3311

Terminal

RADIO CORP.

85 Cortlandt St. • New York 7, N. Y.

HYCOR
TYPE 4201
PROGRAM EQUALIZER



Features

- **LOW HUM PICKUP** through the use of toroid coils.
- Switch contact noises are inaudible even at microphone levels.
- Low frequency equalization peaked at 40 cycles and 100 cycles in 2 db steps up to 12 db.
- High frequency equalization peaked at 3 kc, 5 kc and 10 kc in 2 db steps up to 12 db.
- Low frequency attenuation in 2 db steps at 100 cycles and has a maximum attenuation of 16 db.
- High frequency attenuation in 2 db steps at 10 kc and has a maximum attenuation of 16 db.

\$191.00

General Specifications

- DIMENSIONS:** Standard rack panel, slotted, 3 1/2" high. Maximum depth 7 1/2".
CIRCUIT: Bridged "T" constant impedance.
IMPEDANCE: 500/600 ohms, in-out.
INSERTION LOSS: 14 db constant.
CONTROLS: Low and high frequency selector switches. Low and high frequency controls in 2 db steps, in-out key.
FINISH: Engraved panel, medium gray baked enamel. (Special colors and finishes upon request.)

Send for Bulletin E

HYCOR SALES COMPANY

of California

11423 VANOWEN STREET
NORTH HOLLYWOOD, CALIF.

Representatives:

- BEBBE ASSOCIATES**
1155 Waukegan Road, Glenview, Illinois
BURLINGAME ASSOCIATES
103 Lafayette Street, New York City
HARRISON J. BLIND
1616 Cord Street, Indianapolis 24, Indiana
G. M. HOWARD & ASSOCIATES
734 Bryant Street, San Francisco 7, California

Nearly everybody reads the
audio anthology
and
the 2nd audio anthology

The original **audio anthology** is still being ordered by people who have worn out their first copy or who have just learned about the book. Contains reprints of 37 articles which appeared in **AUDIO ENGINEERING** from May 1947 through December 1949. An invaluable reference work on audio in the home.

the 2nd audio anthology continues from where the first left off and contains reprints of articles from January 1950 through July 1952. In both books the articles were brought up to date, corrected where necessary, and assembled by subject. **the 2nd** may still be had with board cover.

----- CUT OUT ----- MAIL TODAY -----

Book Division, Dept. 3V,
Radio Magazines, Inc.,
P. O. Box 629, Mineola, N. Y.

Sirs: Enclosed is check money order for \$..... Please send me
 copies of **audio anthology** (paper cover) @ \$2.00 each
 copies of **the 2nd audio anthology** (paper cover) @ \$2.00 each
 copies of **the 2nd audio anthology** (board cover) @ \$3.00 each

Name (please print)
 Address
 City Zone State

EQUIPMENT REPORT

(continued from page 32)

cal auxiliary inputs, as shown by Table I. A hum balance control across the heater winding permits adjustment for minimum hum, and a positive d.c. bias on the heaters results in a hum level measured at 62 and 74 db below 1 watt output on phono and radio respectively, with the inputs shorted.

TABLE I

Input	Volts
Phono-LP	.0048
" -NAB	.004
" -AES	.004
" -FOR	.004
Radio, Aux I, Aux II	.03

LONDON LETTER

(continued from page 6)

the Radio Industry, and, apart from one or two specialties, nothing is sold to the public under the Plessey name.

There are four British firms making changers: B.S.R., Collaro, Garrard, and Plessey. The only other record changer on sale in the British market is the Philips, made by the colossal Philips Organisation in Holland, and now probably assembled in this country.

For playing records without an automatic changer the English high-fidelity enthusiast has even less choice. Probably the bulk of the motors of the non-changing type are made by Garrard and Collaro. A high quality one is made in very limited quantities by Sugden, and there are one or two firms producing very small amounts. E.M.I., of course, also make gramophone motors which are incorporated only in their own machines sold under His Master's Voice and Marconiphone trade marks.

Nearly all firms making gramophone motors and record changers also make pickups, but in addition there are some very fine quality pickups by some specialist companies who only produce a few, but they are of really superb quality. Names that come to mind are Leak and Cosmocord. Leak produce probably the best pickup in England, but owing to the very small output they are most difficult to obtain. These pickups are of the moving coil type, and they refuse to sell them with interchangeable heads, with the result that the user who wishes to have a Leak pickup for playing 78 and LP records has to have two carrying arms mounted at the side of the turntable. Leak resolutely refuse to supply this type of pickup for use on an automatic record changer. There are rumours, however, that a new Leak pickup, which will be produced in larger quantities, will be available soon.

Another manufacturer is Goldring, but

probably the largest sales for pickups sold separately are achieved by Cosmocord. A newcomer to the market is Ferranti, of which good initial reports are heard.

Amplifiers and Loudspeakers

In considering amplifiers for the high-fidelity enthusiast, undoubtedly the two makers who have the bulk of the market are Leak and Acoustical Manufacturing's QUAD Amplifier. Leak probably has the largest sales, and is considered by many authorities to be the amplifier by which all others are judged. Popular priced amplifiers are made by Trix and Grampian. There are numerous other small makers, but the only four amplifiers distributed on a National scale are Leak, Quad, Trix, and Grampian. Manufacturers of loudspeakers are legion, and it is impossible to mention all the makes. The set makers' loudspeakers are usually supplied by Rola-Celestion, Goodmans, Plessey, R. & A. Amplifiers, and Stentorian. The high-fidelity enthusiast can choose really from a dozen makes, including Wharfedale, Stentorian, Tannoy, the better Goodmans' models, some of the Truvox ones, and then there are specialised loudspeakers such as the Acoustical Ribbon one, the Lowther-Voight, and other ones costing over 300 dollars each. I have not mentioned speakers which are made by set makers themselves. Probably the largest set manufacturer making loudspeakers is Plessey, who also supply quite a number of loudspeakers to other complete set manufacturers.

The greatest problem with which the high-fidelity enthusiast in England has to contend is probably the same as in America—where to put his loudspeaker. If one believes, as most English people do believe, the statements by Briggs (probably one of the greatest authorities on loudspeakers in the world) it is absolutely essential to have a large enclosure for a loudspeaker. One can get over the difficulty if one has very limited space by a compromise, such as using an enclosure similar to your American RJ, but if one wishes to do the job really properly then, according to Mr. Briggs, it is essential for a 15-in. loudspeaker to have an enclosure of at least 9 cubic feet. If one also follows Mr. Briggs in having two loudspeakers to deal with the treble, it means that even with his economical cabinet work the loudspeaker costs about £75 (\$210), which is just over twice the price of the Leak amplifier, which somehow seems to be ridiculous.

As labour costs in Britain are probably one-third of those ruling in the U.S.A. it is obvious that apparatus which require a high labour content can be produced more economically in this country or, alternatively, manufacturers are able to spend more on labour to produce an instrument of the equivalent price. It is probably for this reason that some British manufacturers, whose products entail a large amount of labour, are able to produce very high quality instruments of considerable reliability. Although the sales of these products in the United States must be very small compared with your mass produced lines, they nevertheless presumably fulfil a demand from those enthusiasts who want the best regardless of price. On the other hand,



Partridge Pedigree Products

THE UL2 A'C' CORE TRANSFORMER

Some salient characteristics:—

REFERRED PRIMARY LOADING. The standard models cover the requirements of all popular tubes. Each half primary is brought out separately to posts and is tapped at 43% of the turns.

POWER RATING. Peak 50 watts at 60 c.p.s. or 14 watts at 30 c.p.s. for less than 0.5% harmonic distortion without feedback.

LEAKAGE INDUCTANCE . . . 10 mH. SELF CAPACITY . . . 500 pF. full primary.

* Now for \$25 duty paid you can have this p.p. transformer, specifically designed for really high quality audio equipment. Extended frequency range and low harmonic distortion enables a large measure of N.F.B. to be taken from the secondary circuit and applied three or four stages back. Hermetically sealed in a deep drawn case.

* Type CFB Audio Transformer leads the way in 'C' Core transformers. Series leakage induct. 10 mH. Coupling between primaries—leakage induct. for one half (other shorted) 30 mH. D.C. resistance per half primary 88 ohms; Power up to 60w from 22 c/s to 30 Kc/s; distortion less than 1 per cent with no negative feed back. **\$40 duty paid.**

* Type WWFB Audio Transformer built to the famous Williamson specification and available in a varied range of impedances. Secondary windings are brought out to eight separate sections of equal impedance. Stock types comprise 0.95 ohm, 1.7 ohm, 3.6 ohm and 7.5 ohm sections. **\$26 duty paid.**

* These three models are AVAILABLE NOW! From your usual jobber; if in difficulty write direct—we'll see you are supplied without delay. Full test Technical data rushed airmail to you on request.

PARTRIDGE TRANSFORMERS LTD
TOLWORTH · SURREY · ENGLAND



NEW Carter SLIDE CHART

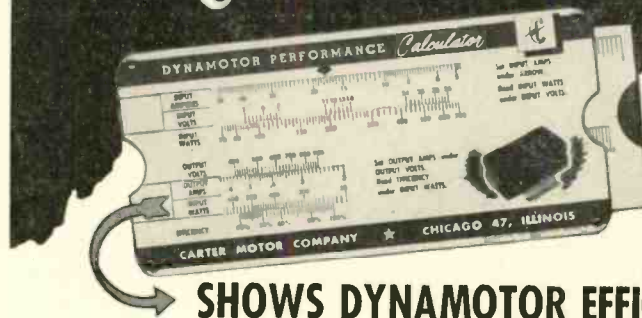

SHOWS DYNAMOTOR EFFICIENCY

25c at a Glance!

AT YOUR RADIO PARTS
DISTRIBUTOR OR
ELECTRONIC EQUIPMENT
SUPPLIER

WRITE for FREE
DYNAMOTOR
CATALOG

Now it's easy to compare Dynamotor performance efficiency under actual operating conditions. Nameplate information plus this simple slide chart enables you to read instantly the efficiency percentage right from the Calculator scale. Reverse side gives other useful information. Handy 3" x 6" pocket size, color printed on sturdy laminated stock, varnished to resist soil. For sale by radio parts distributors and electronic equipment suppliers, or 25c postpaid.

Carter Motor Co.

2648 N. MAPLEWOOD AVE. CHICAGO 47

World's largest Exclusive Manufacturers of mobile radio rotary power Supplies.

RECORDING TAPE
(PLASTIC BASE)
at NET PRICES
in Cartons of 12

WASHINGTON, D. C.: WHERE ELSE WOULD THERE
Magnetic
BE MORE RED TAPE?

- 1200 ft. plastic tape with plastic reel.
- Choice of nationally famous top quality brands such as:
Webcor (2906) 3.20; Reeves (SPN-12) 3.20;
Audio (1251) 3.25; Scotch (111-A) 3.25;
Panacoustic (711-A) 3.25; Irish, Professional grade (211 RPA) 3.30.



FREE! A 7.95 tape carrying case included with purchase of 12 new tapes.

- Recording studios, schools, radio stations and other large quantity users—write for bulk price.

USED RECORDING TAPE (PLASTIC BASE)



1.99 for 7"—1200 foot
.99 for 5"—600 foot
.59 for 4"—300 foot
.29 for 3"—150 foot
Plastic reels included with all above sizes.

New empty plastic reels in boxes for easy labeling. 3" 10¢; 4" 22¢; 5" 24¢; 7" 29¢; 7" Professional reel (2 1/4" hub) 39¢ ea. EMPTY BOXES: 3" 3¢; 4" 5¢; 5" 5¢; 7" 10¢ ea.

We carry all brands of new tape, recording blanks, tape recorders, etc. at low prices. PLEASE INCLUDE SUFFICIENT POSTAGE.

COMMISSIONED ELECTRONICS CO.

2503 Champlain St., N.W., Washington 9, D. C.

with the tremendous market you have, probably three or four or even more times greater than in this country, when it comes to a highly mass produced line, then all of Europe has to bow to the ability of the American factories.

Records

I have received some enquiries about "Angel" records. These are, of course, pressed in England at the E.M.I. plant at Hayes. They represent the records which would have been issued in America under the Columbia trade mark but for the fact that the English Columbia Company, controlled by E.M.I., has now no working arrangement with the American Columbia Company. As most of my readers will know, the E.M.I. Company in England controls H.M.V., Columbia, Parlophone, Regal-Zonophone, and M.G.M. records. The English and Continental H.M.V. recordings which are likely to be of interest to U.S.A. listeners are usually issued under the R.C.A.-Victor trade mark. Up to a few months ago the English Columbia records were issued under the American Columbia trade mark. When the arrangement with Columbia lapsed, E.M.I. were faced with the problem of establishing a trade mark in the U.S.A. under which they could issue the British Columbia records. They decided to revert to their first trade mark of all, namely that of the "Recording Angel" which was used by the original Gramophone and Typewriter Company Limited early in the century when the Company had the copyright in the word "gramophone." When they lost the use of this trade mark they commenced to use the His Master's Voice one, and whilst for a time both the H.M.V. and Angel trade marks were used, eventually the Angel one was dropped.

As the photograph illustrated here will show, a lapse of 44 years does not matter in British factories for the same man who pressed some of the original Angel records is now pressing those which are made at Hayes exclusively for the U.S.A. market.

ALTEC Lansing speaker for sale. Perfect 604B with network, slightly used, in original carton, \$100. L. D. Harmon, Box 382, Kingston, N. J.

PRESTO 6N in 1D case. \$375; 85A, \$75; 90B with 161 Eq. \$400. RCA KB2C mic. on KS5A stand, \$40; 76B2 console, \$450. W.E. 639 mic. \$75. Ampex 403C, \$650. Meissner, 4630 Woodside Tr., Portland, Ore.

FOR SALE: Scott 112B noise suppressor-preamplifier, factory reconditioned, \$35. Thomas Hudson, 275 W. 160th St., New York 39, N. Y.

FOR SALE: (Phila. area) Fisher 70-RT, 60-watt Ultra-Linear Williamson, 12-in coaxial bass reflex, used 8 hours, \$275. Box CM-3, AUDIO.

KLIPSCH H.F. HORN (3)—were used 10 mos. in stereo experiments. 1.00 and 0.875 throats. 30% under cost ea. G. Cain, 30 Waverley Terrace, Belmont, Mass. BE 5-4911R.

CRAFTSMEN C-10 tuner in excellent condition. \$75; RC-2 amplifier, \$25. Norman Teten, 2350 East 27th St., Brooklyn, N. Y.

COAXIAL speakers, tweeters, crossover networks, amplifiers, gain set, speaker enclosures, other items new and used. All below current market price. Write Box CM-4, AUDIO, P.O. Box 629, Mineola, N. Y.

CLASSIFIED

Rates: 10¢ per word per insertion for noncommercial advertisements; 25¢ per word for commercial advertisements. Rates are net, and no discounts will be allowed. Copy must be accompanied by remittance in full, and must reach the New York office by the first of the month preceding the date of issue.

AUDIOPHILES wanted for part or full time work. Technical or secretarial experience desirable. Location: north suburban Philadelphia. Send resume of education and experience to Box CM-1, AUDIO.

HEAD ALIGNMENT and record level adjustment tape, \$4.00 postpaid. E. J. Leshner, 2730 Heatherway, Ann Arbor, Mich.

PRESENCE—enjoy the realism of a Williamson-type amplifier at reasonable cost. Write the Long Island Sound Co., 19 Bennett Place, Amityville, N. Y.

SELL: Collins FM-11 FM tuner. Used three months. \$45. POB. B. A. Shaver, Box 265, 333 Cedar, New Haven, Conn.

WILLIAMSON amplifier, parallel PP KT-66, Partridge CFB, custom components, heavy duty power supply, with Altec A433A front end, \$145. Apt. 3M, 34-35 76th St., Jackson Heights 72, N. Y. Illinois 7-8649.

STEPHENS 106AX speaker in Stephens mahogany enclosure with throat port, \$110. Browning RV-10 FM tuner, \$55. Excellent condition. Baumel, 787 East 175th St., Bronx 60, N. Y. CYPres 4-3540.

FOR SALE—COLLINS 32V3, \$590; 75A3, \$430; both nearly new. Sacrifice both, \$995. Altec 604B in 606 mahogany enclosure, \$200. Robinson 16-in. Transcription Turntable, \$33 and 78 r.p.m., \$50. Write Box CM-2, AUDIO.

SELL: ALTEC 604B with network, like new. \$110. George Heap, 3435 South Utah, Arlington, Virginia.

TANNOY SPEAKERS, coaxial, available NEW YORK area. Call (New York) Plaza 7-8569 (evenings REgent 7-2642) for opportunity to hear one in high-fidelity custom music installation. You will be impressed. BOHN MUSIC SYSTEMS.

SEND for free data on battleship-built Williamson amplifiers and 30-20,000 cps systems. Nicely Associates, Kenton, Ohio.

TRADE AUDIO IN MID-MANHATTAN. Announcing the opening of our new Mid-Manhattan Audio and Record Showrooms—where you can buy all nationally advertised new audio components for low cash prices or with gigantic trade-ins on your used equipment—where you may choose from a large selection of reasonably priced but warranted used equipment—where LP record prices for Hi-Fi discs are unbelievably low—where all your audio problems and repairs can be handled.

Opening Specials: 30-watt Ultra-Linear Williamson, (\$120 value), with KT-66's, Partridge, \$77; 50-watt Laboratory Amplifier, (\$159.95 value), with 1614's, 6AW4's, \$90.95. Famous tape recorder, 7 1/2" and 15-in. speeds, takes 10 1/2-in. NAB reels, (\$350 value), \$290. All above equipment brand new, full warranties; mail orders also cheerfully filled. Famous make 3-way speaker systems in Mahogany corner horn (a \$275-net value), you pay only \$180. Specials to Record Collectors: Famous Westminster Hi-Fi LP's, 1/2 price—\$2.98 per 12-in. record, \$2.00 per 10-in. record. Free postage. All other LP's except price-fixed labels, 40% off List. Add 75¢ per shipment for postage.

INTERNATIONAL AUDIO and RECORD EXCHANGE
1101 Lexington Ave., New York 21, N. Y.
One flight up—Hours: 12 to 9 p.m., 6 days.
Phones: REgent 7-8334 MOUNT Vernon 7-4184

WANTED—Magneocorder tape recorder or Magneodette semi-professional. Microphone to 15,000 cps. State accessories, price and condition. Clarence W. Smith, 812 S.W. Washington, Portland 5, Ore.

HALLICRAFTER S-47-C, AM-FM-SW receiver. Will sell to best offer. Dr Nicely, Kenton, Ohio.

TELCOA (Audio Equipment Exchange) We sell all types of new guaranteed audio equipment. Highest trade-in values throughout the world. Increasingly liberal trade-in allowances with cumulative purchases. Azurelee Dome, Malibu, California.

GLOBE 6-2611

BELL TONE SOUND CORPORATION

ALBANY

NOW in UPSTATE
New York

the finest

AUDIO EQUIPMENT

is available

These Leading Lines:

McIntosh	Fairchild
Concertone	Audak
Browning	Weathers
Brook	Pickering
Fisher	Bozak

And All Others

ON DISPLAY
IMMEDIATE DELIVERY

Visit Our Studio • Mail inquiries invited

BELL TONE SOUND CORPORATION

11 N. PEARL ST., ALBANY, N. Y.

Telephone 5-4665

PROFESSIONAL DIRECTORY

FULL DIMENSIONAL SOUND



THE ULTIMATE IN
HIGH FIDELITY
RECORDING



Look for this symbol on record albums you buy!

"WE HAVE IT"
HI-FI COMPONENTS EXCLUSIVELY

HOLLYWOOD ELECTRONICS
7460 MELROSE AVE.
HOLLYWOOD 46
CALIFORNIA
WEBSTER 3-8208

HIGH-FIDELITY HOUSE

Offering the World's Finest Home Music Systems, created by experts with years of experience.

High Fidelity is our only business—not a sideline. Complete stock of every worthwhile component at all times. 536 South Fair Oaks, Pasadena 1, Cal. SY 5-4118 RY 1-8171

"EVERYTHING IN HIGH FIDELITY"

From Primary Components to Completed Custom Audio Equipment

KIERULFF
Sound Corp.

820 West Olympic Blvd. • Los Angeles 15, Calif.
Richmond 7-0271 Zenith 0271

Custom-Built Equipment

U. S. Recording Co.

1121 Vermont Ave., Washington 5, D. C.
Lincoln 3-2705

HI-FI AUDIO RESISTORS

Low-noise, deposited-film type, 1% guaranteed tolerance, WE licensed, beautiful appearance, brand new. Enough resistors for Williamson or several pre-amps. Kit: 2-50K 2W, 2-20K 1W, 2-470K 1/2W, 1-47K 1W, 2-100K 1W. A \$6.50 net value for only \$4.39 P.P. Air Mail add 15¢. Money back if not completely satisfied.

SOUTHERN ENGINEERING
Dayton Pike Rt. 5 Chattanooga 5, Tenn.

Industry People...

Lewis Newman, president of The Daven Company, announced last week the appointment of **J. P. Smith**, formerly Daven's chief engineer, as Director of Engineering—**Walter Voelker**, formerly of Day & Zimmerman, Inc., and Bell Telephones Laboratories, replaces Smith as chief engineer—**Lawrence R. Thielen**, formerly with RCA Service Company, is new sales engineer in the New York office of the Ampex Corporation—appointment announced by **Harrison Johnston**, Ampex general sales manager... **Oscar Kraut**, formerly assistant manager of Arrow Audio Center, New York, is new addition to sales staff of G & H Wood Products—will handle sales of Cablnart line in New England area.

The industry gets a touch of glamor in the appointment of **Miss Lorraine Webb** as the first distaff sales engineer—she will represent Arrow Electronics, Inc., New York, in the New Jersey area... **Walter S. Holmes, Jr.**, acting controller, has been elected controller of Radio Corporation of America—**Robert G. Bach**, formerly in charge of TV sales for Federal Telecommunication Laboratories, is new assistant sales and advertising manager of Fairchild Recording Equipment Company... **Vito Macanelli** has been named advertising manager of Chicago Standard Transformer Corporation—came to Stancor from Edward C. Kennedy Company, Chicago ad agency.

New distributor sales manager for V-M Corporation is **Merle (Bud) Cain**—formerly assistant TV sales manager for Hallicrafters... **John G. Leitoh**, vice-president in charge of engineering for Philadelphia station WCAU, awarded a silver platter in recognition of 25 years of service—presentation made by **Donald W. Thornburgh**, station president, at the famous Racquet Club... **William A. Ready**, formerly president of The National Company, has been elected to the Board of Directors of Browning Laboratories, Inc.,

Walter Jablon, industry pioneer, has been named sales manager of the Home Instruments Division of the Freed Electronics & Controls Corp., New York—will concentrate on Freed-Eisemann line of high-fidelity equipment which will be introduced publicly at an early date. **Raul H. Frye**, formerly manager of the Special Products Division of Raytheon Television and Radio Corp., has been appointed vice-president in charge of engineering for The National Company, Malden, Mass... **James E. Lynch** has been named to vice-president in charge of sales by The Kelton Company, Boston, Mass.—other Kelton appointments include **James P. Bray**, **Robert E. Evensen** and **William S. Nebe**, sales managers in the West, Mid-West, and New England, respectively... **John Jipp**, formerly with Motorola, Inc., has joined Ampex Corporation as manager for instrumentation recorder sales.

Twenty-five years of service by three company employees was commemorated recently by **A. D. Davis**, president of Chicago's Allied Radio Corporation, with the presentation of gold watches to **Pete Picciolini**, **Bill Rudnick**, and **Fred Schnurstein**—award was made before the annual dinner-meeting of the Allied 20-year Club. About 25 per cent of Allied's 400 full-time employees have been with the company five years or more—a record matched by few other firms of similar size and age.

the audio exchange exchanges audio
the audio exchange exchanges audio
the audio exchange exchanges audio
the audio exchange exchanges audio

Information on trading HI-FI components on request. Write or call for free catalog AE

the audio exchange exchanges audio
the audio exchange inc.

159-19 Hillside Avenue • Jamaica 32, N. Y.
Olympia 8-0445

Now Ready for Immediate Delivery

The New

MT-1 PRESTO-SPLICER
for WELDING TOGETHER
1/4" acetate tapes without cement or adhesives

- Diagonal cut capable of withstanding 3 pound pull
- Inaudible with playback amplifier gain at maximum



\$65 F.O.B. Factory

For Milar Tape, add \$2

Sample splice and brochure on request.

PRESTOSEAL MFG. CORP.
3727 33rd st., Long Island City 1, N.Y.

Enjoy building it in just a few hours... then enjoy a lifetime of superb sound reproduction!

Philmore
hi-fi



20 WATT AMPLIFIER KIT
including Pre-amplifier

DeLuxe Model, 20 to 30,000 cycles flat response $\pm .5$ Db., (using Alltec-Lansing Peerless S526F High Fidelity Output Transformer). Up-to-date circuiting, featuring the latest and best in High Fidelity amplifier design, with emphasis on simplicity, economy, and ease of construction.

Compact chassis, 12x8x3", complete with all tubes, parts, and famous Philmore "Step-by-step" Instructions. Net \$51.95

Available at your local jobber — or write for FREE LITERATURE, to Philmore Mfg. Co., Inc., 113 University Place, N. Y. 3.

PHILMORE MFG. CO., INC., 113 University Place, New York 3, N. Y., Dept. A3. Please send Amplifier Kit literature at once to:

NAME
ADDRESS
CITY STATE

At Last!

THE SPEAKER THAT PRODUCES

No Sound

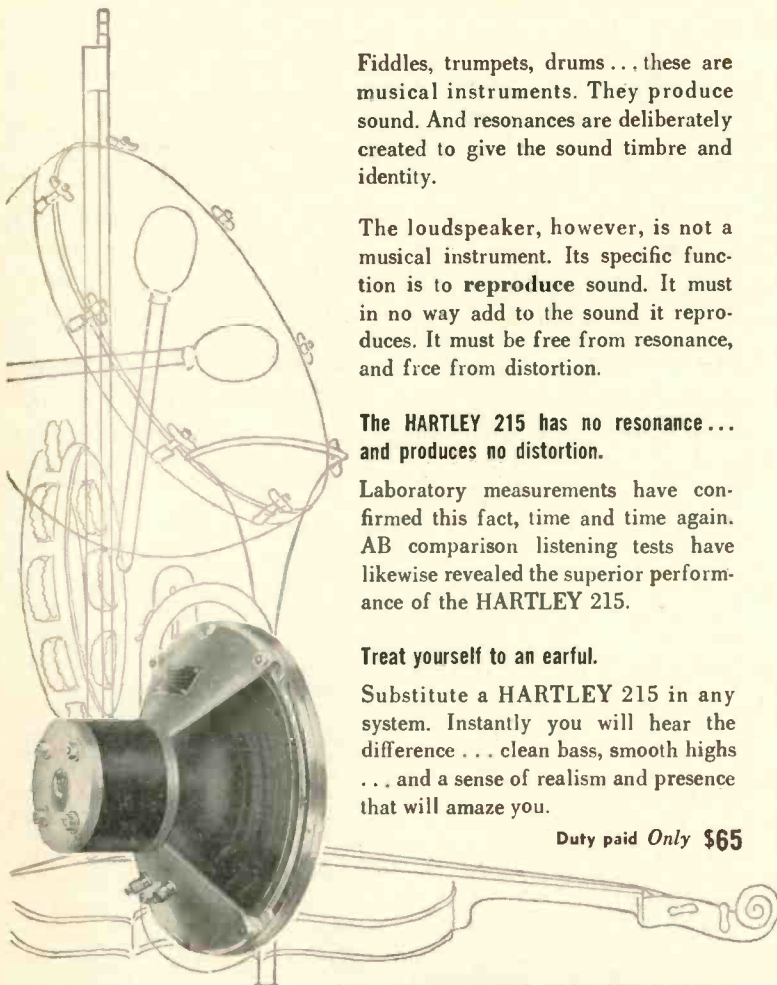

Fiddles, trumpets, drums... these are musical instruments. They produce sound. And resonances are deliberately created to give the sound timbre and identity.

The loudspeaker, however, is not a musical instrument. Its specific function is to reproduce sound. It must in no way add to the sound it reproduces. It must be free from resonance, and free from distortion.

The HARTLEY 215 has no resonance... and produces no distortion.

Laboratory measurements have confirmed this fact, time and time again. AB comparison listening tests have likewise revealed the superior performance of the HARTLEY 215.

Treat yourself to an earful.

Substitute a HARTLEY 215 in any system. Instantly you will hear the difference... clean bass, smooth highs... and a sense of realism and presence that will amaze you.

Duty paid Only \$65

NOTE: Because the new Hartley 215 has no resonance, a non-resonant baffle should be used. The bass-reflex and other conventional enclosures are tuned resonant systems. For best results the Hartley BOFFLE Enclosure is recommended... available in single, dual, and 4-speaker models. Priced from \$50.75.

THE NEW
HARTLEY 215

At franchised dealers or write to:

H. A. HARTLEY CO., INC.
521 EAST 162nd ST., BRONX 51, N. Y.
LUDlow 5-4239

ADVERTISING INDEX

Allied Radio Corp.	38
Altec Lansing Corp.	45
American Phenolic Corp.	16
Amplifier Corp. of America	58
Arnold Engineering Co.	5
Audak Co.	35
Audio Devices, Inc.	Cover 2
Audio Exchange, Inc.	63
Bell Telephone Laboratories	18
Bell Tone Sound Corp.	62
Camera Equipment Co.	47
Capitol Records, Inc.	63
Carter Motor Co.	61
Chicago Standard Transformer Corp.	41
Cinema Engineering Co.	6
Classified Ads	62
Collins Audio Products Co., Inc.	44
Commissioned Electronics Co.	62
Cook Laboratories	50
Duotone	57
Electro-Voice, Inc.	7
General Electric Co.	46, 51
Goodmans Industries, Ltd.	53
Gray Research & Development Co., Inc.	17
Hartley, H. A., Co., Inc.	64
Harvey Radio Co., Inc.	49
Heath Co.	37, 50
High Fidelity House	63
Hollywood Electronics	63
Hughes Research and Development Laboratories	2
Hycor Co., Inc.	60
Institute of Radio Engineers, The	13
Interelectronics Corporation	52
Kierulff Sound Corp.	63
Kingdom Products, Ltd.	1, 55
Krohn-Hite Instrument Co.	40
Leonard Radio Inc.	43
Magnecord Inc.	36
Orradio Industries, Inc.	Cover 3
Partridge Transformers, Ltd.	61
Philmore Mfg. Co., Inc.	63
Pickering and Company, Incorporated ...	15
Precision Film Laboratories, Inc.	12
Presto Recording Corporation	9
Prestoseal Mfg. Corp.	63
Professional Directory	63
Radio Corporation of America	39
Rauland-Borg Corporation	56
Reeves Equipment Corp.	47
Reeves Soundcraft Corp.	11
Rek-O-Kut Company, The	3
Rockbar Corporation	53
Shure Brothers, Inc.	4
Stromberg-Carlson	33
Terminal Radio Corp.	59
Triad Transformer Corp.	57
Tung-Sol Electric, Inc.	8
Turner Co., The	10
United Transformer Co.	Cover 4
U. S. Recording Co.	63

The Tape That Mirrors the Original Sound

SOUND RECORDING



irish

BRAND

GREEN BAND Professional



THE FINEST TAPE YOUR RECORDER CAN USE

Just as the reflection of a perfect mirror is faithful to the original image, in every detail, so too does IRISH Green Band RECORD, RETAIN and REPRODUCE the original sound with flawless fidelity.

This can be confirmed by tests. Instruments will reveal that IRISH Green Band offers lower noise level, uniform sensitivity, minimum amplitude variation, less distortion. But instrument tests are only the landmarks

of good design and production. The final proof is in the hearing. Therefore, to know and appreciate the quality of IRISH Green Band Tape, it must be used, listened to, and compared with other tapes on the same recorder.

You will find that the only limitation to IRISH Green Band quality is the limitation of the tape recorder itself: it is the finest tape your recorder can use.

irish
BRAND
GREEN BAND
Professional

is fast becoming the choice of audio engineers in broadcast stations, recording studios and wherever sound quality is of paramount importance.

1200 feet on plastic reel.....\$3.30 users net

2400 feet on metal reel..... 7.71 users net

One day you will surely use IRISH . . . so write today for free test sample reel.

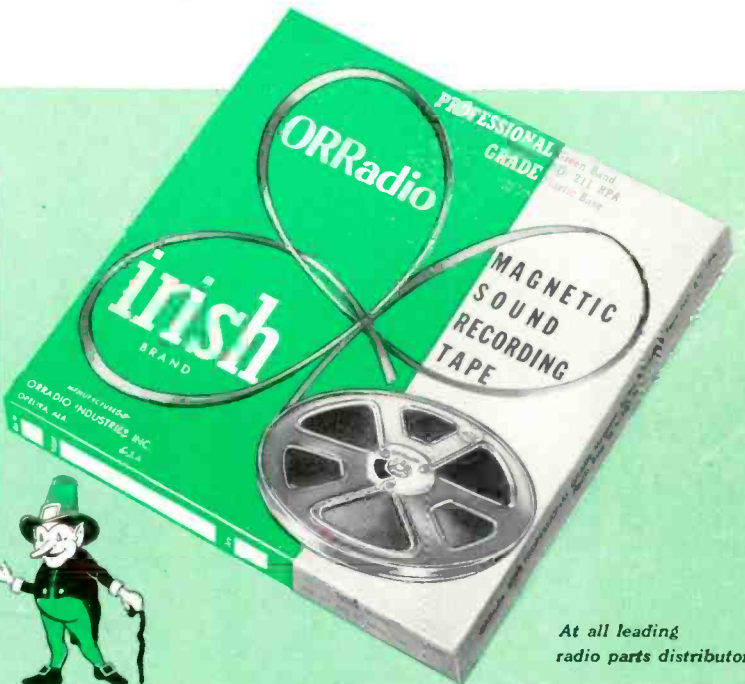

At all leading
radio parts distributors

irish BROWN BAND for Popular Priced Recorders:

IRISH Brown Band, expressly designed for home and office recorders. Reproduces with true fidelity the frequency range from 100 to 8000 cycles. A high quality, plastic base tape for the price of ordinary paper tape!

1200 feet, plastic base, on plastic reel. \$2.50 users net



ORRADIO INDUSTRIES, INC.

OPELIKA 8, ALABAMA

World's Largest Exclusive Magnetic Tape Manufacturer

EXPORT DIVISION: Morhan Exporting Corp., New York, N. Y.

Pioneering NEVER STOPS AT A FEW 1954 PREVIEWS



From the time UTC engineers thought up the first hmbucking transformer or the ounce type transformer . . . concepts now standard in the industry . . . UTC has always led in transformer engineering and production. This doesn't come easy. Our development laboratories and engineering staff are largest in the industry. Planned programs of research and development are constantly improving existing products, and perfecting new design concepts.

Illustrated below are a few typical new developments . . . soon to be released by UTC.



Filter Development Laboratory



Development Tests
1/2 cycle Filter



Humidity — Temperature
Aid:ude Testing



Pulse Transformer Development



Audio Development Laboratory

A FEW VIEWS OF THE
UTC LABORATORIES



HERMETIC VARIABLE INDUCTORS

The UTC VIC variable inductors have long filled a need in the electronic industry. Culminating an extensive development program, a new series will provide . . . greater reliability thru hermetic sealing . . . higher Q factor . . . and smaller size.

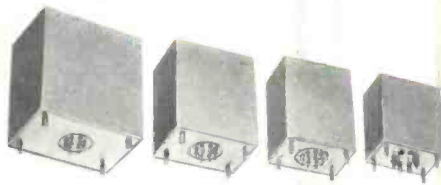

HIGH-STABILITY MAG-AMPS

High gain magnetic amplifiers used in servo motor applications usually show some instability in use, tending to effect low frequency oscillation. A thorough study of this condition has made possible the development of a new series of mag-amps for motors from 4 watts to 20 watts, with a much higher order of stability.



TRANSISTOR TRANSFORMERS

Reducing the size of conventional transformers to that comparable with transistors results in very low power handling ability and high distortion. A revolutionary approach to this problem has resulted in designs which, in the same volume, provide many times the power rating . . . plus a physical structure of exceptional reliability.

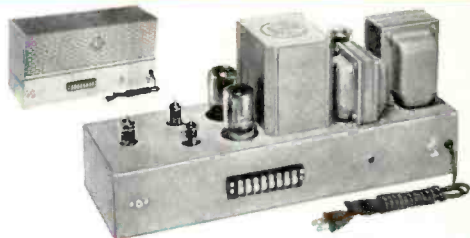

ADVANCED DESIGN HIGH FIDELITY AMPLIFIER KIT

While UTC does not manufacture audio amplifiers, an audio application group provides customer service in this field. Their investigation into high fidelity circuits has indicated unrealized weaknesses in most current amplifier designs. To correct these weaknesses, a new circuit will shortly be made available in an amplifier kit of advanced design, both electrically and in the mechanical stability provided by latest printed circuit thinking.

United Transformer Co.

150 VARICK STREET

NEW YORK 13, N. Y.

EXPORT DIVISION: 13 EAST 40th STREET, NEW YORK 16, N. Y.

CABLES: "ARLAB"