

AUDIO

APRIL, 1954

ENGINEERING MUSIC SOUND REPRODUCTION

50c

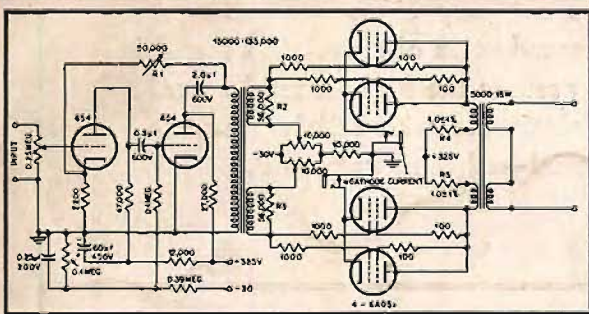

Excellent performance may be obtained with miniature tubes, claims one author. He proves his contention with this push-pull-parallel 6AQ5 amplifier, and still more convincingly with one using four 6S4's in parallel. See page 19.



A caricature of Richard Wagner "enlarging the human ear so that it can comprehend his Music of the Future" prophetically anticipates in 1869 a "hearing problem" of our time. See The Right Ear for Music, page 25.

FOR THE NEW HOBBYIST: AT HOME WITH AUDIO
SOME EXPERIMENTS WITH MINIATURE POWER TUBES
THE RIGHT EAR FOR MUSIC
PLANNING YOUR HOME MUSIC INSTALLATION (Part 2)

NEW HOT-SLITTING PROCESS

GIVES **audiotape** EXTRA STRENGTH

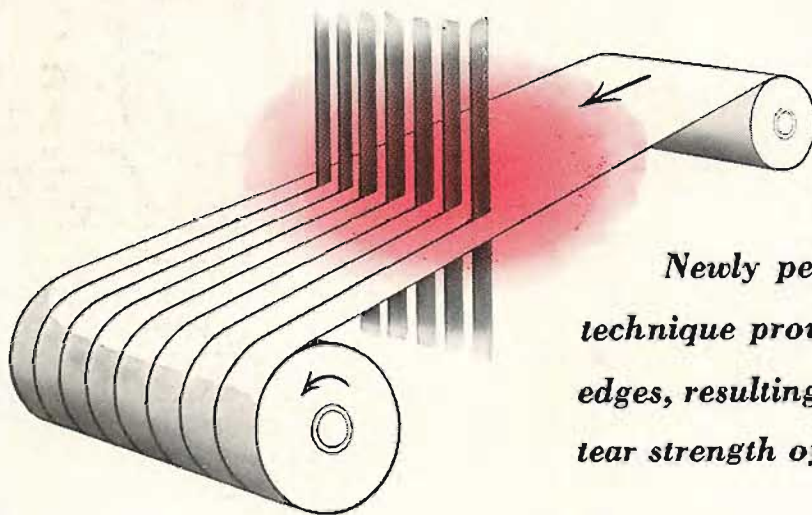

Newly perfected thermal-slitting technique provides smoother, cleaner edges, resulting in increased break and tear strength of plastic base Audiotape

IN THE manufacture of Audiotape, particular care has always been given to the slitting operation, in which the processed tape is cut into reel-size widths. Precision straight-line slitting has been one of the reasons why Audiotape tracks and winds perfectly flat and has no fuzzy edges to impair frequency response.

Now, however, even this superior slitting operation has been still further improved by precisely controlled heat application. The result, though not visible to the naked eye, is a significant increase in tape strength.

For thermal slitting avoids the formation of the microscopic cracks and irregularities which result, in varying degrees, from any cold slitting process. Each such defect is a source of weakness and a potential tape break.

The thermal treatment in no way alters Audiotape's *balanced performance*. Hence Audiotape not only offers you the most faithful reproduction of the original sound, but also assures the highest mechanical strength obtainable with cellulose acetate base material—all at *no extra cost*.

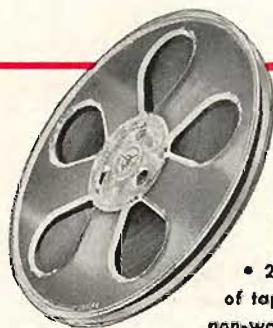

Audiotape is now available on this
NEW 7" PLASTIC REEL

- 2½ inch hub • more area for labeling • less chance of tape spillage • greater protection to tape • rugged, non-warping construction • distinctive, modern design

... and in colors, too!

Audiotape 7" reels can now be obtained, for special applications, in red, blue, green, yellow or clear plastic. And Audiotape is also being offered on either blue or green colored plastic base, in addition to standard red. These distinctively colored tapes offer interesting possibilities for specialized recording and filing applications. Write for further details.

AUDIO DEVICES, INC.

Export Dept., 13 East 40th St., New York 16, N. Y., Cables "ARLAB"

444 Madison Avenue,
New York 22, N. Y.

audiodiscs • audiotape • audiofilm • audiopoints

AUDIO

ENGINEERING MUSIC SOUND REPRODUCTION

C. G. McProud, Editor and Publisher
 Henry A. Schober, Business Manager
 Harrie K. Richardson, Associate Editor
 Edgar M. Villehur, Contributing Editor
 Florence Rowland, Production Manager
 Edgar E. Newman, Circulation Director
 S. L. Cahn, Advertising Director
 H. N. Reizes, Advertising Manager



Representatives

H. Thorpe Covington, Special Representative
 7530 North Sheridan Road, Chicago 26, Ill.
Sanford R. Cowan, Mid-West Representative,
 67 W. 44th St., New York 36, N. Y.

West Coast

James C. Galloway *J. W. Harbison*
 816 W. 5th St., Los Angeles 17, Calif.

CONTENTS

Audio Patents— <i>Richard H. Dorf</i>	2
Coming Events	6
London Letter— <i>Richard Arbib</i>	8
Letters	12
About Music— <i>Harold Lawrence</i>	14
Editor's Report	16
Some Experiments With Miniature Triodes— <i>Geoffrey H. Grey</i>	19
Stereophonic Reproduction— <i>R. Vermeulen</i>	21
Planning Your Home Music Installation— <i>In Two Parts, Part 2—</i> <i>Irving Greene and James R. Radcliffe</i>	22
The Right Ear For Music— <i>Rudo S. Globus</i>	25
Handbook of Sound Reproduction— <i>Chapter 18—Edgar M. Villehur</i>	26
At Home With Audio— <i>Lewis C. Stone</i>	28
Equipment Report— <i>Radio Craftsmen C-800 and C-500</i>	32
Record Revue— <i>Edward Tatnall Canby</i>	34
Tops in Hi-Fi Pops— <i>Robert Sylvester</i>	40
Employment Register	41
Audio ETC— <i>Edward Tatnall Canby</i>	42
New Products	44
New Literature	47
Industry Notes and People	63
Advertising Index	64

AUDIO (title registered U. S. Pat. Off.) is published monthly at 10 McGovern Avenue, Lancaster Pa. by Radio Magazines, Inc., Henry A. Schober, President; C. G. McProud, Secretary, Executive and Editorial Offices: 204 Front St., Mineola, N. Y. Subscription rates—United States, U. S. Possessions and Canada, \$3.00 for one year, \$5.00 for 2 years; elsewhere \$4.00 per year. Single copies 50c. Printed in U. S. A. All rights reserved. Entire contents copyright 1954 by Radio Magazines, Inc. Entered as Second Class Matter February 9, 1950, at the Post Office, Lancaster, Pa. under the Act of March 3, 1879.

RADIO MAGAZINES, INC., P. O. Box 629, MINEOLA, N. Y.



*Industry
 "Workhorse"*

635
**BROADCAST
 DYNAMIC
 MICROPHONE**

USED ON
TV
 AND
BC



Uniform high quality performance day-after-day in studio and remote pick-ups has proved the rugged dependability of the "635". Exclusive E-V Acoustalloy diaphragm assures smooth, peak-free response 40-15,000 cps. Output is -55 db. 50-250 ohms impedance selector. Tilttable head. 5/8"-27 thread. Cannon XL-3 connector. 18 ft. cable.
List Price \$75.00
 Normal trade discount applies.
 See your Authorized E-V Distributor or Write for further information.

NO FINER CHOICE THAN

Electro-Voice
 BUCHANAN • MICHIGAN

TO THE
E. E.

OR

PHYSICS

GRADUATE

WITH EXPERIENCE IN

RADAR

OR

ELECTRONICS

HUGHES RESEARCH AND DEVELOPMENT LABORATORIES ARE ENGAGED IN A CONTINUING PROGRAM FOR DESIGN AND MANUFACTURE OF ADVANCED RADAR AND FIRE CONTROL SYSTEMS IN MILITARY ALL-WEATHER FIGHTERS AND INTERCEPTORS.

THE GREATEST advancements in electronics are being made in this sphere because of military emphasis. Men now under 35 years of age will find this activity can fit them for future application of highly advanced electronic equipment.

YOU WILL serve as technical advisor in the field to companies and government agencies using Hughes equipment.

TO BROADEN your field of experience in radar and electronics you will receive additional training at full pay in the Laboratories to become thoroughly familiar with Hughes radar and fire control equipment.

AFTER TRAINING you will be the Hughes representative at a company where our equipment is installed; or you will advise in the operation of Hughes equipment at a military base. (Overseas assignments, single men only.)

HUGHES

RESEARCH AND DEVELOPMENT LABORATORIES

SCIENTIFIC AND ENGINEERING STAFF

Culver City, Los Angeles County, Calif.

Assurance is required that relocation of the applicant will not cause disruption of an urgent military project.

AUDIO PATENTS

RICHARD H. DORF*

READERS OF THIS DEPARTMENT have frequently evidenced a strong interest in electronic musical instruments and this is partly responsible for our selection of this month's first patent. The other part of the responsibility stems from our own deep interest in the subject, soon to be evidenced by publication of a book entitled, "Electronic Musical Instruments." This book, authored by the present writer, will be published within the next few months by Radio Magazines, Inc., which also puts **AUDIO** in your hands every month. The writer strongly suspects, therefore, that Editor McProud will not blue-pencil this mention.

The patent in question is No. 2,665,379, and the inventor is George H. Hadden, Chief Engineer of the firm which produces the Minshall electronic organ, to whom the patent is assigned. It covers the extremely interesting and novel frequency-divider circuit used in the Minshall. This and the other Minshall circuits are described thoroughly (with all parts values) in the aforementioned book, but enthusiasts who are not familiar with this unusual divider will be interested in the following description of its principles.

The tone-coloring ideas in the Minshall organ are based solidly on the theory of formants, which says that tone color differences occur primarily because certain portions of the audio spectrum are emphasized and others attenuated. The spectrum portions concerned remain fairly constant, no matter what the fundamental frequency of any individual tone. And of course the portions of the spectrum involved change from one to another tone quality.

To achieve tone-color variations, therefore, the organ generates sawtooth waveforms for all its notes. The sawtooth contains all harmonics (theoretically) in even progression, and simple filters can be used to secure the desired tone qualities. The problem is to generate the sawtooth tones in the first place cheaply and reliably.

Each of twelve chassis contains a master oscillator plus a string of dividers which produce the rest of the octavely related tones. Each divider must produce sawtooth output at a frequency half that of the input synchronizing signal. For economy and reliability only one triode should be necessary per divider and no inductors or transformers should be necessary. Furthermore,

the divider stage should not be capable of oscillation in the absence of an input signal so that false frequencies cannot be produced and trouble is easily located.

The circuit of one divider stage is shown in *Fig. 1*. The output is not actually the voltage drop across the plate resistor, as is true in most amplifier and oscillator circuits, but the charge and discharge voltage of C_1 . In essence, the tube is cut off, allowing C_1 to charge from the plate supply through R_1 , then the tube suddenly conducts, its low plate resistance quickly discharging C_1 . The result is, of course, the characteristic sawtooth voltage across C_1 .

We can analyze the operation now in a detailed manner. *Figure 2* shows waveforms at various points in the circuit. The input waveform shown at (A) is a sawtooth from the previous divider. If we assume initially (leaving the proof until later) that the tube conducts during the peak period of every other input wave, then the plate-current waveform is as shown in B, with pulses at half the input frequency. The solid line at C shows the plate voltage, which is the voltage across the charging and discharging capacitor C_1 .

The sawtooth voltage appearing across C_1 is a complex wave consisting of a fundamental and harmonics. Because the output load (C_1) is capacitive, the fundamental component of the output sawtooth lags almost 90 deg. behind the pulse of plate current shown at (B). This fundamental component (which cannot actually, of course, be seen with an oscilloscope) is shown by the dashed line in (C). It is important because of feedback.

Feedback from the plate takes the path through C_2 , a large-value blocking capacitor with negligible reactance, and the series combination of R_2 and C_2 . The R_2 - C_2 combination is obviously a low-pass filter or simple integrating network, and it has two effects. The harmonic content of the fed-back sawtooth is attenuated so that what appears across C_2 —and the grid—is almost a sine wave. This sine wave is the fundamental component of the plate sawtooth as shown in the dashed line at (C) in *Fig. 2*. Second, it introduces an additional lag of almost 90 deg., so that the voltage actually reaching the grid is of the shape and phase indicated in (D).

* Audio Consultant, 255 W. 84th St., New York 24, N. Y.

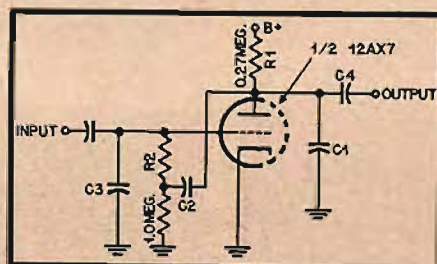

Fig. 1.

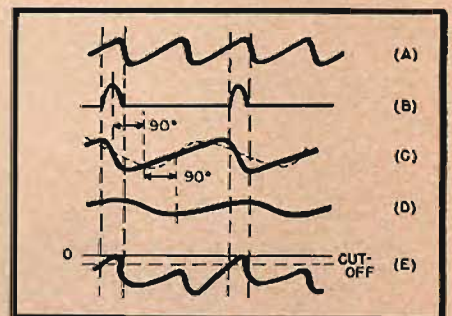

Fig. 2.

BY

LEAK



ONLY \$109.50 NET FOR A TRUE HIGH FIDELITY AMPLIFIER
MODEL TL/10 COMPLETE WITH "POINT ONE" REMOTE CONTROL PRE-AMPLIFIER
 Most economical combination ever built by LEAK, manufacturer of Britain's finest audio equipment!

This great amplifier maintains, in every respect, the world-renowned Leak reputation for precision engineering, custom assembly and fastidious wiring. It is a superior product through and through, built by conscientious craftsmen, to give flawless performance over many years, with complete satisfaction to the home listener and professional communications engineer alike. Model TL/10 incorporates the newest, ultra-linear 10-Watt Circuit, including two of the latest type KT-61 beam power output tetrodes in push-pull. The high damping factor of 23, and the low hum level of minus 76db. below full output, are ordinarily found only in far more expensive amplifiers.

Since low harmonic distortion is far more important and difficult to obtain than high power output (not a major factor in home music reproduction), the effect of the achievement of reducing distortion to an insignificant two tenths of one percent at 1000 cycles, for a power output of 8 watts, can readily be imagined, and will become apparent in listening to this fine amplifier.

MODEL TL/10 AMPLIFIER



Bottom view of TL/10 chassis, showing all components mounted on terminal board for easy servicing... as in the most expensive scientific laboratory and government equipment.

This is a new improved design of the famous Leak unit which set unmatched performance standards at the B.B.C. and other world-renowned broadcast studios and laboratories. In its new version, it is the ideal electronic complement to the TL/10 amplifier. It is a two-stage feedback unit of distortion so low as to be virtually unmeasurable, and in which resonant circuit filters are NOT used. The "Point One" unit will operate from any phonograph cartridge now available, including Audak, Electro-Voice, Fairchild, General Electric, Pickering, Sonotone; from any microphone; from any radio unit or tuner; and with the greatest convenience, from any tape recording machine. It provides the best features of all previous models, and every desirable refinement suggested by users in Britain and the U. S. These include the greatest variety of equalization adjustments ever provided on a Leak amplifier... all that are required, without unnecessary flourishes, for fullest satisfaction in listening to today's wide range of recordings under home acoustic conditions.

All controls on a handsome, highly polished gold escutcheon plate with jeweled pilot light. The entire plate removes for panel mounting, when desired.

REMOTE CONTROL "POINT ONE" PRE-AMPLIFIER, WITH MASTER CONTROL UNIT



Amplifier Dimensions: 11" wide x 9" deep x 6 1/2" high.
 Pre-Amplifier Master Control Unit Dimensions: 10" wide x 3" high x 2 1/2" deep.
 Power: 105 Volts-125 Volts, 50 to 60 Cycles AC.

FOUR MASTER CONTROLS plus tape recorder jacks (input and output) on handsome front panel for listener's convenience



Control #1 Input selector
 Six positions: Tuner, Tape, AES, NARTB, FFR, COL. LP. The latter four positions provide equalization for all records.



Control #2 Treble
 Eight Indicated stages... over a 23 db range, without distortion.



Control #3 Bass
 Eight indicated stages... over a 23 db range... all without boominess.



Control #4 Volume
 Continuously variable gain... plus "On-Off" switch.



Tape Recording Jacks
 An Exclusive Feature!
 Readily accessible jacks, for recording and playing back tape, are provided, on front panel for instantaneous use.

The Leak TL/10 amplifier is a product of the British Industries Group... and carries the Seal of B.I.C. endorsed quality... British Industries Corporation is an American Company, whose function is to seek out the finest Audio Products made in Britain, import and introduce them, and keep them welcome in homes throughout America. B.I.C. is the oldest and largest company of its kind, and offers you its own endorsement of the quality of each product it sponsors. In addition, and even more important... the extensive B.I.C. service and parts facilities are always at your disposal, so that you can purchase any British Industries endorsed product with at least the same assurance as if it were made in the U. S.

All valves replaceable with Standard U.S. tubes.

Prices and specifications subject to change without notice.

WRITE FOR A COPY OF "SOUND CRAFTSMANSHIP"

16 pages illustrating and describing Britain's finest music reproducing equipment... facts you'll want for planning improvements and additions to your set.

BRITISH INDUSTRIES CORPORATION
 164 DUANE STREET • NEW YORK 13, N.Y.

British Industries Corporation 164 Duane Street, New York 13, N.Y.
 Dept. A-4

Send my copy of Sound Craftsmanship.

Name _____
 Address _____
 City _____ Zone _____ State _____



SHURE

To simplify microphone placement in even the most difficult acoustic applications for Recording . . . Broadcasting . . . P.A.—install the

UNIDYNES 55s, 556s

the only small size, moving-coil Dynamic Microphones with Ultra  Cardioid pickup pattern. Both models reduce the pickup of random noise energy by 67%! Indoors—will improve recordings, broadcasts and P. A. performance in reverberant locations. Outdoors—will lower background noise to a minimum and will effectively reduce wind noises. Because of these outstanding features the "UNIDYNES" are used the world over—more than any other microphones regardless of size, class or cost!



Model 55s
"Sound-Systems" Unidyne
List Price \$76.50



Model 556s
Broadcast Unidyne
List Price \$110.00
(with built-in
Shock-Mount and
Broadcast Connector)

SHURE BROTHERS, Inc. ☆

225 West Huron Street
Chicago 10, Illinois
Cable Address: SHUREMICRO

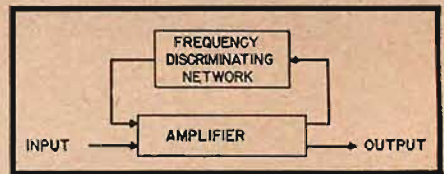

Fig. 3.

Note the relation between wave (A), the input signal, and fed-back voltage (D). The fed-back voltage reaches its negative peak at the same time the input signal reaches every other crest. Combining the input and fed-back voltages gives the waveform of (E), which is what the grid actually sees. Every even crest is negatively displaced, preventing it from bringing the tube to conduction. Every odd input crest is displaced positively, causing the tube to conduct. It is obvious, therefore, that our original assumption—that the tube conducts only on alternate peaks of the input signal—is justified, and there is a frequency division.

C_1 , C_2 , and C_3 are the frequency-sensitive elements of the circuit and vary with the position of the particular divider in the string. However, a particular divider, with optimum capacitor values, will operate over half an octave or more. In practice, a particular set of values is used for a range of only three semitones so that parts with standard tolerances can be used.

Feedback Equalizers

The writer, perhaps in common with many other people in the audio business, had thought that feedback equalizers were common and in the public domain. According to a patent issued in November of 1953, they may not be in the public domain and it was thought worth while to point out the patent concerned.

Its number is 2,658,958, and it is issued to Lawrence V. Wells and assigned to Wilcox-Gay. It covers equalization of the generalized form illustrated in Fig. 3. As long as the phase and frequency response of the feedback loop are flat the over-all amplifier gain is reduced at all frequencies equally. To make an equalizer circuit of it, frequency discrimination is introduced in the feedback path, with the result that the character of the over-all frequency response is complementary to the response of the feedback path. Much greater slopes can be obtained in this way than with filters directly in the forward path.

The writer had thought that all this was well known for a very long time. However, it appears that the patent covers at least some important applications of the idea, and anyone planning to incorporate it in commercial equipment had better check.

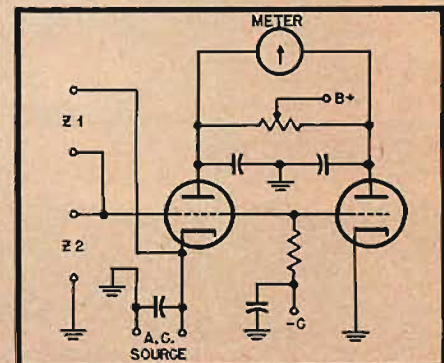

Fig. 4.

QUALITY IN MINIATURE!

Langevin PLUG-IN

AMPLIFIERS and POWER SUPPLIES



**MINIATURE PLUG-IN
PRE-AMPLIFIER OR BOOSTER
AMPLIFIER TYPE 5116**

Miniature plug-in two stage, low noise pre-amplifier or booster amplifier. The smallest high performance amplifier of its type that exceeds FCC requirements. Small size, excellent design and plug-in features make type 5116 ideal for installation in consoles and equipment racks. Push button metering facilities and gold plated plugs are standard at no extra cost.

Langevin-engineered to
IMPROVE PERFORMANCE!

Miniature-designed to
SAVE PANEL SPACE!

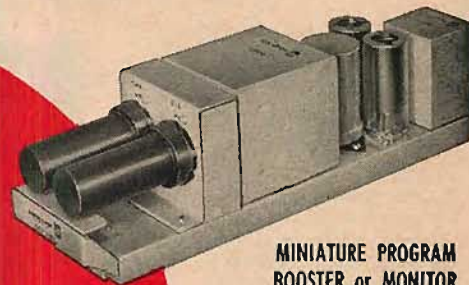

**MINIATURE PROGRAM
BOOSTER or MONITOR
AMPLIFIER TYPE 5117**

A plug-in two stage, push-pull, fixed gain audio amplifier. The most compact amplifier available for this service. Outstanding quality recommends type 5117 for applications requiring outstanding performance and maximum availability. Push button metering facilities and gold plated plugs are standard at no extra cost.

**-for Radio and
Television Broadcast,
Recording Studios
and Sound Systems**

**AVAILABLE
IMMEDIATELY
FROM STOCK**

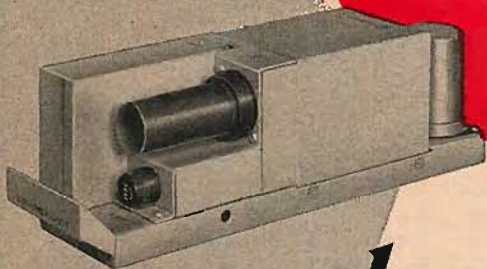

**PLUG-IN POWER
SUPPLY TYPE 5208**

A miniaturized power supply of extremely compact design. Built of highest quality component parts throughout, type 5208 is designed for continuous service. Capable of supplying power for 10 Type 5116 pre-amplifiers or lesser combinations of types 5116 and 5117. Overall length 10 1/4"; width 2 5/8"; height 3".

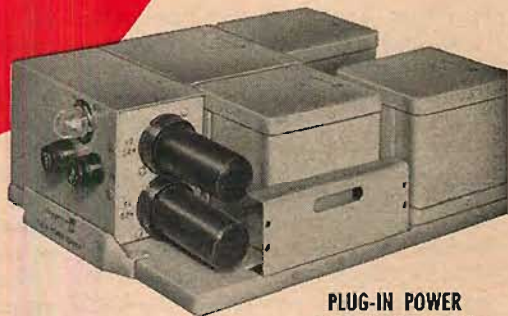

**PLUG-IN POWER
SUPPLY TYPE 5206**

Designed for use with Langevin Miniature Amplifiers. Provides AC for amplifier filaments and well filtered DC for amplifier plate. One unit provides adequate power to operate up to 22 Type 5116 Amplifiers or lesser combinations of Types 5116 and 5117 with separately fused filament and plate supplies.

Langevin

**-the name synonymous with quality in
audio equipment and components since 1923**

NEW! File Catalog for broadcast engineers and sound technicians available without obligation. Request your copy today—just call or write, on company letterhead, to:

LANGEVIN MANUFACTURING CORPORATION
37 WEST 65th STREET, NEW YORK 23, N. Y.
A SUBSIDIARY OF THE W. L. MAXSON CORPORATION



EXPORT DISTRIBUTORS: INTERNATIONAL STANDARD ELECTRIC CORPORATION, 50 CHURCH ST., NEW YORK CITY

Precision Prints

**YOUR PRODUCTIONS
BEST REPRESENTATIVE**

CLOSE CHECK ON PROCESSING

Picture and sound results are held to the closest limits by automatic temperature regulation, spray development, electronically filtered and humidity controlled air in the drying cabinets, circulating filtered baths, Thymatrol motor drive, film waxing and others. The exacting requirements of sound track development are met in PRECISION'S special developing machinery.

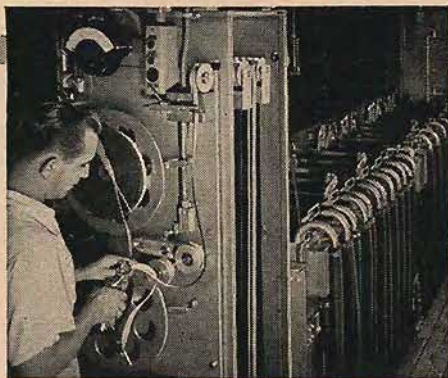

YOUR ASSURANCE OF BETTER 16mm PRINTS

16 Years Research and Specialization in every phase of 16mm processing, visual and aural. So organized and equipped that all Precision jobs are of the highest quality.

Individual Attention is given each film, each reel, each scene, each frame — through every phase of the complex business of processing — assuring you of the very best results.

Our Advanced Methods and our constant checking and adoption of up-to-the-minute techniques, plus new engineering principles and special machinery enable us to offer service unequalled anywhere!

Newest Facilities in the 16mm field are available to customers of Precision, including the most modern applications of electronics, chemistry, physics, optics, sensitometry and densitometry — including exclusive Maurer-designed equipment — your guarantee that only the *best* is yours at Precision!

Precision Film Laboratories — a division of J. A. Maurer, Inc., has 16 years of specialization in the 16mm field, consistently meets the latest demands for higher quality and speed.



Impedance Comparator

Figure 4 is a schematic diagram of a simple device which will compare two a.c. impedances and is quite sensitive—it will show the difference between two impedances very close together in value. It is the invention of John A. Field of Wiltstead, England, and is assigned to Cutler-Hammer. The patent is No. 2,660,705.

Impedances Z_1 and Z_2 are to be compared; probably one of them is known. A low-impedance source places a.c. across the two impedances in series and also across the cathodes of both triodes. The junction between the impedances is connected to both grids. If the a.c. source impedance and voltage are low and the grid-leak resistor is sufficiently high in value to avoid shunting Z_2 , appreciably, the distribution of the a.c. voltage between the impedances corresponds to their values and corresponding plate currents will flow through the tubes. Then adjustment of the plate-circuit potentiometer will restore the zero-center meter to zero. Either the meter or the potentiometer may be calibrated. It would seem that the tubes must be perfectly matched or a zeroing adjustment provided, but that could probably be done in several different ways. The inventor points out that one impedance can be grounded and suggests that that makes the circuit especially suitable for measuring impedances (probably meaning capacitances) to ground in transmission systems.

If you care to go into any of these patents more thoroughly, a request to the Commissioner of Patents, Washington 25, D. C., accompanied by 25 cents, will secure a copy of any of the more than two and a half million so far issued.

COMING EVENTS

Apr. 5-9—International Inventors Show. 211 Market Street, Paterson, N. J.

Apr. 12-14—Symposia on Information Networks. Engineering Societies Building, 33 West 39th Street, New York City.

Apr. 24—Spring Technical Conference, Cincinnati Section, IRE.

May 3-14—British Industries Fair. Olympia and Earls Court, London, and Castle Bromwich, Birmingham.

May 5-7—IRE Seventh Region Conference and Electronic Exhibit. Multnomah Hotel, Portland, Ore.

May 7-8—New England Radio Engineering Meeting, IRE. Sheraton Plaza Hotel, Boston, Mass.

May 25-27—Eighth NARTB Broadcast Engineering Conference. Palmer House, Chicago, Ill.

Aug. 25-27—Western Electronic Show and Convention. Ambassador Hotel, Los Angeles, Calif.

Sept. 30, Oct. 1-2—1954 High-Fidelity Show, International Sight and Sound Exposition. Palmer House, Chicago, Ill.

Oct. 4-6—National Electronics Conference. Hotel Sherman, Chicago, Ill.

Oct. 13-16—The Audio Fair, Hotel New Yorker, New York City.

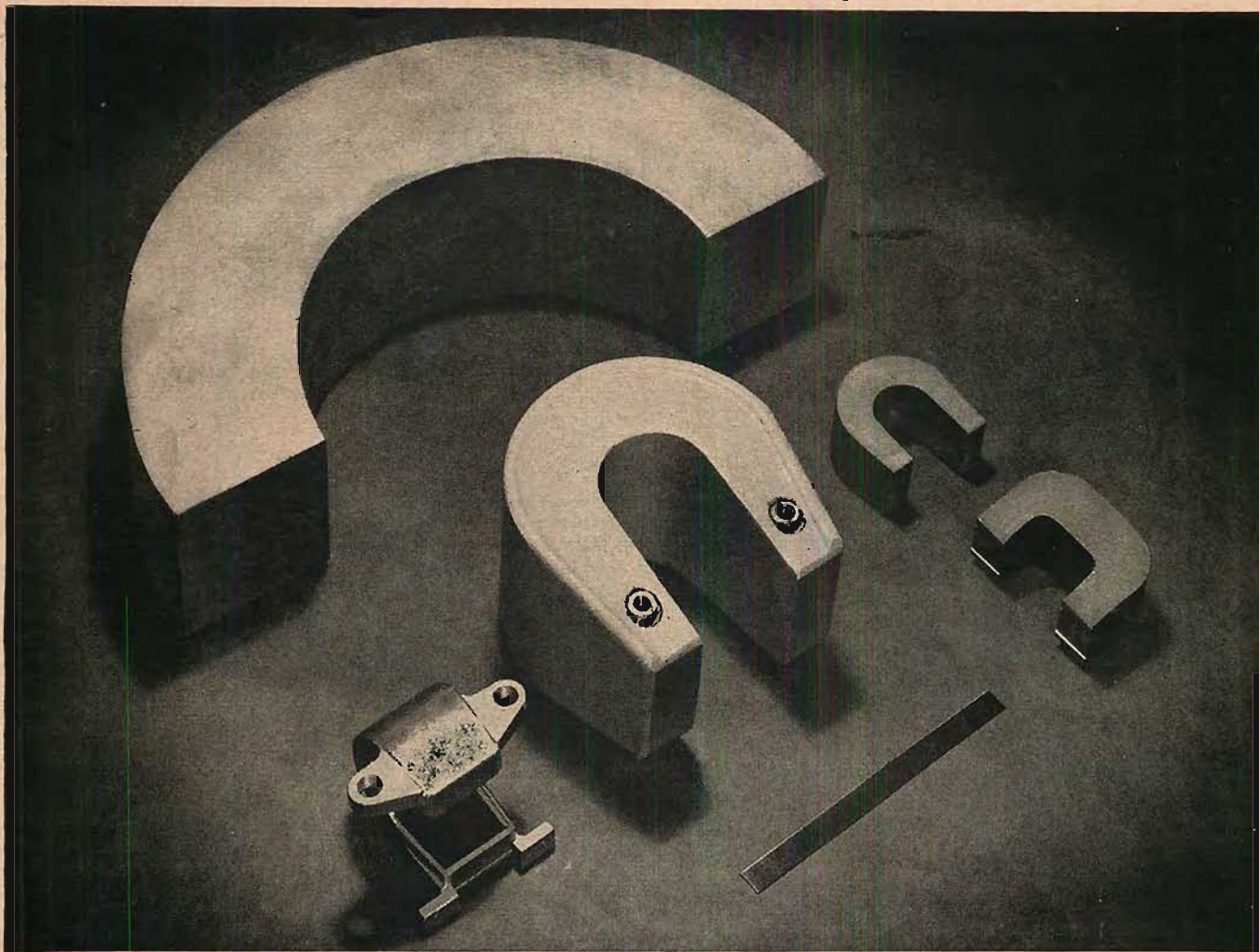

PERMANENT MAGNETS and ASSEMBLIES for Magnetrons and Traveling Wave Tubes

The group of magnets illustrated above, weighing from a fraction of a pound up to 75 pounds, are indicative of the wide range of Arnold production in this field. We can supply these permanent magnets in any size or shape you may need, with die-cast or sand-cast aluminum jackets, Celastic covers, etc. Complete assemblies may be supplied with Permendur, steel or aluminum bases, inserts and keepers as specified . . . magnetized and stabilized as desired. • *Let Arnold handle your magnetron and traveling wave tube permanent magnet requirements.*

WAD 4696

THE ARNOLD ENGINEERING COMPANY
 SUBSIDIARY OF ALLEGHENY LUDLUM STEEL CORPORATION
 General Office & Plant: Marengo, Illinois
 DISTRICT SALES OFFICES . . . New York: 350 Fifth Ave.
 Los Angeles: 3450 Wilshire Blvd. Boston: 200 Berkeley St.



*Made to your
Specifications*
 . . . ANY SIZE, SHAPE
 OR COATING REQUIRED
 ★ *We'll welcome
your inquiries*

THE SYMBOL OF
Quality
IN TRANSFORMERS



**dollars
AND
sense...**

Triad quality costs no more, and those who buy Triad Transformers get what they pay for.

Superior design—finer materials—precise workmanship—distinctive appearance—continuous and unflinching service. All these contribute to the recognized value of Triad products.

Industry expects and gets—from Triad the finest transformers made.

Triad Transformers are sold by select jobbers in principal cities. Write for Catalog TR-53F.



4055 Redwood Ave., Venice, California



London Letter



RICHARD ARBIB*

SOME AUDIO readers have written to ask me why when they receive tapes from England and play them on their own machines they appear to be hearing Chinese rather than English. They explain that the pitch of the voice seems to be correct, and consequently believe that they are playing the tapes at the correct speed.

Knowing that all British tape machines have not the same arrangement of recording heads I consulted Dick Merrick, Managing Director of Wright & Weaire Ltd., who has probably been more closely associated with high-quality tape recorders in England longer than anyone else. Mr. Merrick explained that whereas in America all tape machines have the same standard in regard to arrangement of the recording heads, there is in Europe an International standard, which is the same as the American but which, unfortunately, has not been followed by manufacturers of some British and Continental tape recorders. The "Ferro-

graph" recorder made by Mr. Merrick's firm, which is a high quality instrument, and the "Wearite" tape recording decks also made by his Company, comply with the International standard, whereby a dual track is used, and the recording is made on the upper track. Some British firms, including E.M.I., use single track machines, and recordings made on these machines will reproduce satisfactorily on double track machines made to the International standard, and *vice versa*.

Do Not Alter Head Positions

U.S.A. tape recordists who have received tapes from England which sound like Chinese probably have tapes which have been recorded on the German "Grundig" tape machine which has recently been imported or partially made in England, and where the sound is recorded on the lower track.

In one American publication it has been suggested that enthusiasts receiving tapes from Europe should adjust their recording heads to re-position them so that they can

* *Multicore Solders, Ltd., Hemel Hempstead, Herts., England.*

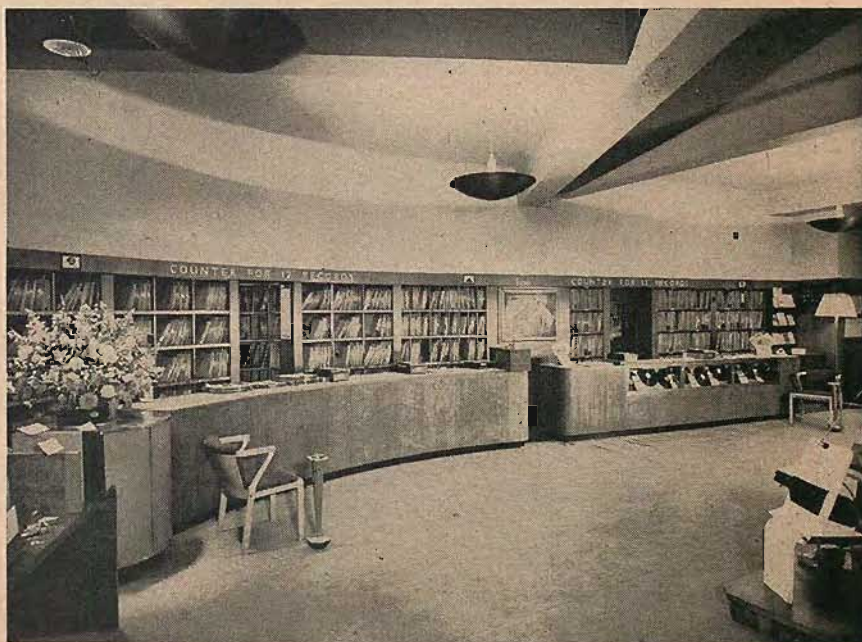

A section of the ground floor of the H.M.V. shop in Oxford Street, London, which is probably the largest store in Europe specially built for the sale of records and reproducing equipment. About 100,000 records are held in stock.

**ULTIMATELY,
EVERY PERSON WHO OWNS OR PLANS TO OWN
A FINE HOME MUSIC SYSTEM MUST FACE THIS QUESTION:**

“Shall I buy a Turntable or a Record Changer?”

The following statement represents the point of view of one of America's leading manufacturers of professional recording and playback equipment.

The choice between record changer and turntable is, for the most part, entirely personal to the user. It depends upon what he wants. If it is merely the physical comfort of hearing hours and hours of just music, without manual intervention, then the choice would be a record changer. On the other hand, if it is his desire to enjoy the utmost in sound quality, then a quality turntable is certainly indicated. In broadcast studios, for example, where reproduction quality is of prime importance, turntables are used exclusively.

The Record Changer

The record changer is an extremely clever device, and much ingenuity has gone into its complex mechanism. It originated in the days when 78 rpm was the only popular record speed, and the playing time of a 12-inch record was only about 4 minutes per side. A complete 40 minute musical composition required at least 10 sides or 5 records. The record changer made it possible for these records to be played automatically, without the need for getting up every three or four minutes to change records.

The Long Playing Record

The long-playing, microgroove record has changed all of this. Each side of a

12-inch long-playing record disc provides about 25 minutes of music. The same 40 minute composition now requires only two sides of a 33 $\frac{1}{3}$ rpm 12-inch record. The long-playing record has also brought tremendous improvements in the quality of recorded sound. As a result, the older 78s are rapidly becoming obsolete among serious music lovers.

The High Quality Turntable

The turntable is basically a simple device. A manufacturer who desires to create a high quality instrument can devote all of his engineering skill to the one important function of the turntable: its rotating motion. A Rek-O-Kut turntable, for example, offers the closest approach to perfect motion; with virtually no rumble, wow, flutter, or other mechanical distortion.

There are other important advantages to the turntable. Once the angle between the stylus and record is established, it remains constant for all time. In the case of the record changer, this angle varies, depending upon the number of records stacked underneath the record 'in play'.

A turntable has a 'live' spindle, meaning that it rotates with the table and the record. The spindle of most changers remain stationary so that

there is an element of wear introduced whereby the spindle hole of the record may become enlarged, and cause off-center wow. Similar wear can result as the record is dropped, and it slides down the long spindle.

A third advantage peculiar to Rek-O-Kut is that the turntable itself is machined from aluminum castings. Aluminum is unaffected by magnetism, and therefore, the turntable exerts no 'pull' when used with a magnetic cartridge. With steel and other magnetic materials, the magnetic pull may actually cause the stylus to 'ride the groove' with a pressure considerably greater than recommended.

Conclusion

High fidelity is rapidly becoming a part of our home life. This is expressive of the typically American desire for the enjoyment of finer things. As specialists in the field of professional sound reproduction, and having served this field for years, we welcome the fact that this wonderful experience is now being adopted in the American home.

Rek-O-Kut precision turntables are among the finest in the world. Every detail of their construction is carefully engineered to provide the finest quality record reproduction. Whether you now own or plan to own a music system, we urge you seriously to consider one of the several Rek-O-Kut turntables. You will find that it makes all the difference in the world.

Literature on Request

Export Division: MORHAN EXPORTING CORP.
458 Broadway, New York 13, N. Y.
Cable: MORHANEX
In Canada: ATLAS RADIO CORP., Ltd.
560 King Street, W., Toronto 28.



THE REK-O-KUT COMPANY

*Makers of Fine Recording and Playback Equipment
Engineered for the Studio • Designed for the Home*

Dept. LD-1, 38-01 Queens Boulevard, Long Island City 1, New York

The *FIRST STEP* in

**HIGH
FIDELITY**

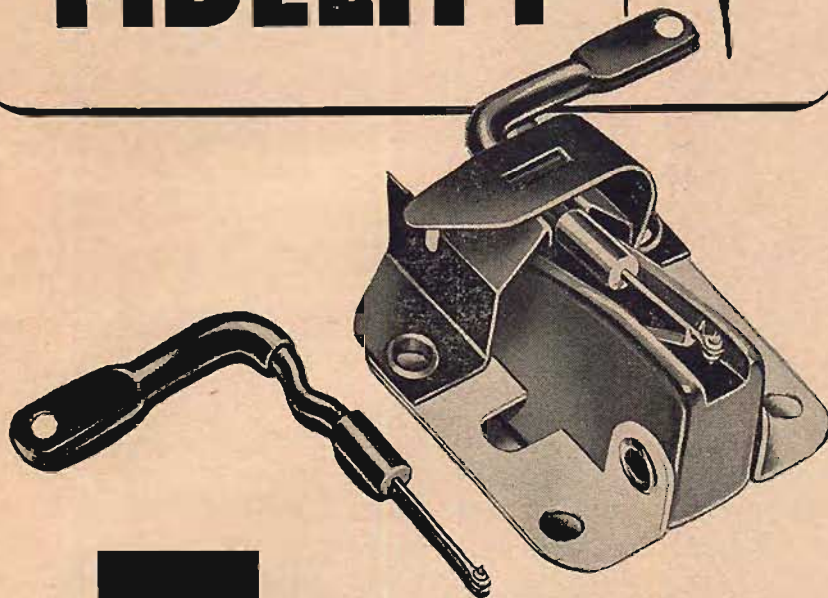

TITONE

CERAMIC CARTRIDGE

There is no wiser investment a phonograph owner can make than a TITONE ceramic cartridge.

Costing no more than ordinary "replacement" cartridges, TITONE gives a world of difference in results — an entirely new experience in true high-fidelity sound, no matter what the make of phonograph.

And only *two models* will replace most present-day installations!

No other cartridge gives all these features!

No preamplifier or equalizer needed • Unaffected by moisture or temperature • Wide frequency range • Outstanding response • High sensitivity • Low distortion • High compliance • No hum pickup • Superior tracking ability • Wide adaptability • Proper groove fit • Only needle rotates • Simple to replace

Used by America's foremost manufacturers of high-fidelity phonographs, TITONE is an original discovery and development of the Sonotone laboratories. Literature available.

ELECTRONIC APPLICATIONS DIVISION
SONOTONE CORPORATION

Elmsford, New York

reproduce on the lower track instead of the upper track. Mr. Merrick emphasises that anyone possessing a tape machine who is interested in high-quality reproduction rather than just hearing sound should under no circumstances alter the setting of the recording or reproducing heads. In his factory extreme care is taken in lining up the recording heads to ensure that they are absolutely vertical. Test tapes are made on a master machine, which is set dead level on a concrete base, when a pure tone is injected. The recording characteristic conforms to the standards of sound recording adopted by the C.C.I.R. 7th Plenary Assembly (London 1953) for the International exchange of programmes on magnetic recording tape. This may at first appear to be unusual in a commercial recorder sold at so modest a price, for in England the "Ferrograph" costs no more than, for example, the German "Grundig."

The great handicap with the "Ferrograph" is the difficulty in obtaining one. Ever since the first model was introduced, four years ago, there has been a delay in delivery which has varied between three and eleven months. On the rare occasions used models have been offered for sale the price has often been more than a new one.

Using Tape at the Office

U.S.A. tape recording enthusiasts who wish to extend their activities from their homes to their offices will learn with interest how one of Britain's greatest gasoline organisations—Shell-Mex & B.P. Ltd.—have used tape machines at their English Head Offices at Shell-Mex House, which is probably London's largest office building. Shell's telecommunications engineer, E. E. Fidler, has spent seven years in devising a recording system to reduce typing staff. The methods (which are now considered to be perfected) obtain an average output per girl of 90 letters or memoranda a day, and the record is 140. Mr. Fidler estimates that tape recording has trebled the output of the typing pool.

(Continued on page 48)



The basement floor of the H.M.V. shop where a self-service sales system is provided for popular records. The twenty-four-channel press button system for the most popular hits can be seen on the left.

New
**UHF & VHF
 LEAD-IN**

Thousands of separately sealed tiny cells, filled with inert gas, make this waterproof cable stable and efficient electrically.

ADVANTAGES:

- 1 Lowest losses at UHF and VHF frequencies.
- 2 Great abrasion resistance and mechanical strength.
- 3 No time-consuming end seal required; easy to install.
- 4 No internal moisture to cause signal loss.
- 5 No kinking when used with antenna rotors.
- 6 Resistant to snow, ice, rain, and wind.
- 7 Resistant to ultraviolet rays from the sun.
- 8 Uses Belden Weldohm conductor for long conductor life.
- 9 Can be clamped tightly in stand-off insulators without crushing. No special fittings required.
- 10 Conductor spacing is constant even when the lead-in is transposed.
- 11 No stripping problem for attaching the conductor.

...Cuts
SIGNAL LOSS

This heavy wall of brown virgin polyethylene protects the cable against mechanical abuse and damage from ultraviolet sun rays.

This completely new 300-ohm line results from the development of a new cellular plastic core where each separate cell is filled with an inert gas to make an efficient cable with the lowest possible losses at both UHF and VHF frequencies. With this absolutely waterproof cable, no sealing of the ends is necessary. Celluline cable can be fixed in stand-off insulators without crushing. The thick outer wall of polyethylene serves to protect the cable from abrasion and sun damage.

By fusing *only* virgin polyethylene, the wall can be made smooth—absolutely free from rough spots—to prevent the adherence of dust and other impurities which would increase the losses.

The copper-covered steel strands, which make up the conductors, assure 49% greater resistance to breaking from flexing or stretching than any all-copper conductor.

8275 CELLULINE[®]
 TRANSMISSION LINE

by **Belden**
 WIREMAKER FOR INDUSTRY

Thousands of engineers and audio enthusiasts have improved Hi-Fi performance with DUBBINGS' tests. Here is what Audio Experts are saying about our latest development:

HAROLD D. WEILER, author of "Hi-Fidelity Simplified" in his forthcoming book states:

"The Dubbings' Test Tapes are an absolute must for anyone interested in obtaining and maintaining peak performance from his tape recorder . . ."

ROBERT J. MARSHALL, Chief Engineer, Fairchild Recording Equipment Co.:

"Dubbings' new Test Tapes are welcome companions to that company's series of fine Test Records . . . Getting all the important tests on a single reel is a tribute to advanced engineering know-how."

the first and only comprehensive

ON ONEREEL — ALL MAJOR TESTS FOR PERFECT ADJUSTMENT OF:

WOW AND FLUTTER

HEAD ALIGNMENT

FREQUENCY RESPONSE

30 to 7,500 cps at 7½ ips
30 to 15,000 cps at 15 ips

SIGNAL LEVEL

SIGNAL TO NOISE RATIO

TAPE SPEED

A complete instruction book, "Tape Recorder Maintenance", is enclosed



no costly voltmeter needed... the simplified D-500 TEST LEVEL INDICATOR is noted for accuracy (use with both test tape and records) . . . only \$3.95

the accepted standard in audio tests

DUBBINGS'

TEST RECORDS

ORDER WITH CONFIDENCE . . . UNCONDITIONAL MONEY BACK GUARANTEE

a long-awaited aid for tape recordists
DUBBINGS'

"The Measure of Your Tape Recorder's Performance"

TEST TAPE

D-110, 5" REEL 7½ IPS

D-111, 7" REEL 15 IPS

individually recorded on REEVES SOUNDRAFT

LIFETIME
professional tape!

D-100 TEST RECORD

"Measure of Your Phonograph's Performance." The test record for:

FREQUENCY RESPONSE RUMBLE AND HUM WOW AND FLUTTER TRACKING STYLUS COMPLIANCE

D-101 TEST RECORD

"Measure of Your Phonograph's Equalization." The only record with each of these response curves:

COLUMBIA LP AES NARTB
RCA's "New Orthophonic"

Enclosed find CHECK MONEY ORDER

NAME _____

ADDRESS _____

CITY _____ ZONE _____ STATE _____

The DUBBINGS CO., Inc. Dept. 44 TA
41-10 45th St., L. I. C. 4, N. Y.

Quantity		Amt.
<input type="checkbox"/>	D-110 5" Reel 7½ ips @ \$12.50	_____
	INTRODUCTORY TILL MAY 15 @ \$10.95	\$ _____
<input type="checkbox"/>	D-111 7" Reel 15 ips @ \$17.50	_____
	INTRODUCTORY TILL MAY 15 @ \$15.95	_____
<input type="checkbox"/>	D-500 TEST INDICATOR @ \$3.95	_____
<input type="checkbox"/>	D-100 TEST RECORD @ \$3.50	_____
<input type="checkbox"/>	D-101 TEST RECORD @ \$4.95	_____
	Postage & Handling \$.50	_____
	TOTAL	\$ _____

Please Print

LETTERS

Cobra

SIR:

You have done a fine job of describing our old Cobra cartridge in your February issue. This is the one used from 1946 to 1953. The new one is far superior, with a response of 25 to 20,000 cps matching the NAB curve. It is a barium titanate crystal made for us by Electro-Voice, with a very small mass and high lateral compliance.

R. C. WALLACE
Merchandise Manager
Zenith Radio Corp.
Chicago, Ill.

Dog

SIR:

Your correspondent in the January "London Letter" is in error in saying that it was the artist's idea to use the picture of the dog as a trade mark. The artist, Francis Barraud, offered the picture only for use in dealer window displays as a matter of interest. It was my father, the late Emile Berliner, who conceived the idea of using the picture as a trade mark, and he was the first to so use it on gramophones and records, registering it as a trade mark in the U. S. and Canada. It was not used in England and on the continent until later.

EDGAR M. BERLINER
1007 N. Roxbury Drive
Beverly Hills, Calif.

SIR:

In the January issue of AE, Mr. Leung Cho Yuk has proposed that a "perfect loudspeaker" might be designed by imitating the characteristics of the basilar membrane of the inner ear. Should anyone be tempted to attempt construction of a bigger and better basilar membrane, I should like to note some differences between Mr. Leung's conception of the structure and function of this organ and what is actually known concerning its structure and function.

Mr. Leung's notion that the basilar membrane is composed of many tightly stretched fibers each tuned to a different frequency is, in effect, the resonance theory of hearing originally proposed by Helmholtz in 1863 to explain the manner in which the components of complex sounds are distinguished by the ear. In their authoritative description of the mechanical properties of the ear, Békésy and Rosenblith state that Helmholtz assumed that the partition dividing the cochlea into two channels had a "piano-chord structure. At the very least this implied the presence of a membrane that was more tightly stretched crosswise than longitudinally. Unfortunately for the theory, no such structure was found in the inner ear. This then led to the formulation of a number of alternate theories, none of which has yet received complete experimental verification.

That the basilar membrane is the primary receptor organ for hearing is, however, generally agreed.

The basilar membrane is a part of the partition that divides the cochlea, a snail-shell-like structure which is the inner ear, into two major perilymph filled channels. The cochlear partition is formed of a relatively transparent, jellylike substance which tears under a very light touch. The basilar membrane forms the lower part of this partition and appears to be composed of thin radial fibers. Longitudinal fibers, constituting the tympanic covering layer, lie upon the lower radial fibers at right angles. The basilar membrane, contrary to what one might expect, is somewhat broader near the apex of the "snail shell" than at the outer

Outstanding Value

PRESTO SR-II STUDIO CONSOLE TAPE RECORDER

For the first time . . . a precision Presto tape recorder complete with amplifier in studio console cabinet for less than \$1000. Here are the facts about this amazing value:

The R-II* Mechanism Here is the smooth operating, sleekly designed tape transport unit that drew engineers acclaim when it was introduced last year. Embodies the exclusive Presto capstan drive unit where pressure pulley and solenoid are mounted on a single sub-assembly for easy maintenance. Capstan and motor are interconnected by a belt. Two torque motors, each including its own brake system (external contracting type) assure smooth, positive action without the usual hazard of tape breakage. If tape does break, an automatic safety switch instantly stops the mechanism.

The Amplifier Actually there are two separate chassis for amplification. One contains the recording and reproducing channels. The second is the power supply located at the base of the console. This arrangement reduces noise and keeps operating temperature down.

The Console Cabinet Presto's designers have given particular attention to accessibility of every part of the SR-11. The top panel swings upward on a sturdy hinge to expose the underside of the tape mechanism, while the amplifier opens from the front and turns over on gimbals for access to tubes.

Ask your Presto distributor to order your SR-11 today. You'll never match it in value or performance.

*formerly RC-11

\$995 COMPLETE
with amplifier
in console cabinet

PRESTO RECORDING CORPORATION
PARAMUS, NEW JERSEY

Export Division: 25 Warren Street, New York 7, N. Y.
Canadian Division: Walter P. Downs, Dominion Square Bldg., Montreal

WORLD'S LARGEST MANUFACTURER OF PRECISION RECORDING EQUIPMENT AND DISCS

- Three triple shielded magnetic heads
- Frequency response: 50 to 15,000 cps. (15"/sec.)
- 55 db signal to noise ratio (at 2% distortion)
- Flutter: less than .15% (15"/sec.)
- Push button function switches
- Will accommodate reels up to 10½"



CINEMA'S

tape and film

Degausser



TYPE 9205 DEGAUSSER

Noise and program erasure accomplished in moments by Cinema's bulk-tank type Degausser 9205. Economically priced.

Buy yours today.



CINEMA ENGINEERING CO.
DIVISION AEROVOX CORPORATION
1100 CHESTNUT STREET • BURBANK, CALIF.

FACTORY REPRESENTATIVES
THROUGHOUT THE NATION

EXPORT AGENTS: Frazar & Hansen, Ltd.
301 Clay St. • San Francisco, Calif. • U.S.A.

ABOUT MUSIC

HAROLD LAWRENCE*

IN THE RECORDINGS SECTIONS of newspapers and magazines and in the company of music lovers, an unofficial campaign is currently being waged against what has been termed the Hi-Fi cult. A typical cartoon depicts the audiophile relaxing in his sling chair while a battery of speakers blares at him from corner, wall, bookcase and closet; amplifier, preamplifier, changer, and tuner are placed helter-skelter on table, shelf, and mantle (exposed, of course); and a tangled mess of cable litters the floor like the aftermath of a wild spaghetti dinner. And what is the reason for the listener's rapt attention—music? Not really. Our intemperate Hi-Fi enthusiast is in quest of the rattle of a gargantuan kettledrum in the slow movement of Haydn's *Military Symphony*, the clang of several large iron chains in Schönberg's *Gurrelieder*, the tinkle of triangle brought to the foreground in the third movement of some new version of Brahms' Fourth, or the 30-cps note in an organ recording guaranteed to shatter every pane of glass in the house.

Hi-Fi cultists have been accused of bandying about a language hitherto restricted to sound laboratories. Their conversations are studded with such expressions as "impedance input, cathode-follower output, clean watts, bass resonance, and negative feedback." They are seldom found inside a concert hall where the sound of a "live" orchestra may come as something of a shock. There is the by now familiar story of the audiophile in Carnegie Hall who, after the first few bars of Strauss' *Don Juan*, complains to his neighbor, "But they don't have any highs!"

At home, the audiophile can make up for "deficiencies" in live music with

a twist of the treble knob. But that is only the beginning. The closer the control panel of his amplifier resembles that of a DC-7 the better he likes it. Music becomes more and more a question of matching (or guessing at) recording curves.

The layman is quite understandably intimidated by this picture of Hi-Fi society and deduces from it all that the audiophile is simply not interested in music—an assumption that will be bitterly resented by readers of this publication.

The average audio devotee, the latter claims, is being made the butt of articles, cartoons, editorials, and anecdotes whose real target is the lunatic fringe. Sound for sound's sake will eventually wear thin, they say, and fail to satisfy the discriminating listener. But the hard truth of the matter is that some of the criticism applies to the audiophile in general.

Music Appreciation

In his search for new and better tonal reproduction, the audiophile has inevitably focused his ears and attention on sound at the expense of music. Now there is nothing wrong in appreciating pure, naked sound. After all, the notes of the scale and timbres of instruments are to the composer what form and color are to the painter, and words to the poet. Tones, colors and words, however, are merely springboards to creative expression. To a certain extent, the audiophile has not grown beyond the fundamental, sensuous stage of musical awareness. He often savors the full acoustical radiance and dynamic scope of a fine recording while the music itself sinks into a shadowy vagueness.

The purpose of this column is

(Continued on page 39)

*26 W. 9th St., New York 11, N. Y.

ABOUT LAWRENCE

Harold Lawrence, who will conduct this column as a regular monthly feature henceforth, is Director of Recorded Music at WQXR—long a listening standby for New Yorkers—a pianist, a composer presently working on a string quartet, and writer and lecturer on music. He has been a contributor to the *New York Times*—both in the regular Music Department and in the Sunday Book Review Section—*The Reporter*, and *Vogue*. He has lectured in the School of General Studies of Brooklyn College, and for the *New York Times* in cooperation with the New York City Board of Education. He has worked in recording sessions, and he formerly managed the imported record department of NY's Liberty Music Shop during the heyday of the postwar* shellac era. AUDIO hopes you will like him.

* Post World War II, that is.

Quality is an elusive thing. Engineers measure it... copywriters glorify it... salesmen describe it. But the final test is actual performance. If a product is the best in its field, those who know quality will accept no other.

That is the story of Pickering's new 260 Turnover Cartridge.

Introduced only months ago, it is already a leader among magnetic cartridges. It has won that position because it is the nearest thing to perfection yet produced. Here are the combined advantages it offers:

The nearest Thing to Perfection

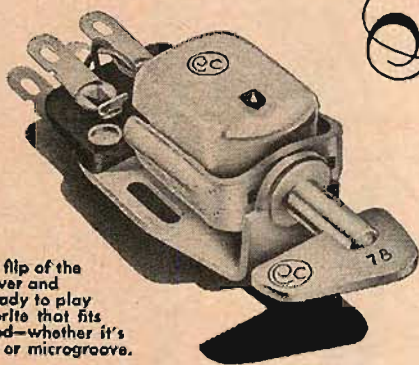

A simple flip of the handy lever and you're ready to play any favorite that fits your mood—whether it's standard or microgroove.

1. HIGHER OUTPUT—Better overall signal-to-noise ratio.
2. LOWER OVERALL DISTORTION—Less intermodulation distortion with wider frequency response.
3. MINIMUM TRACKING FORCE—Lowest practical tracking force for both microgroove and standard recordings.
4. HIGHER COMPLIANCE—Compliance of moving elements is the highest practical, consistent with best-quality transcription arms and changers.
5. LOWER MOVING MASS—Lowest of any comparable magnetic cartridge.
6. TWO DIAMOND STYLI—For longer record and stylus life and greatest economy.

These design features have real meaning to those who understand that quality reproduction depends on components which meet professional standards. If you want the best that high fidelity can offer, ask your dealer to demonstrate the new 260 Turnover Cartridge. You, too, will hear the difference!

PICKERING and company incorporated • Oceanside, L. I., New York



PICKERING PROFESSIONAL AUDIO COMPONENTS

“For those who can hear the difference”

... Demonstrated and sold by Leading Radio Parts Distributors everywhere. For the one nearest you and for detailed literature, write Dept. A-4

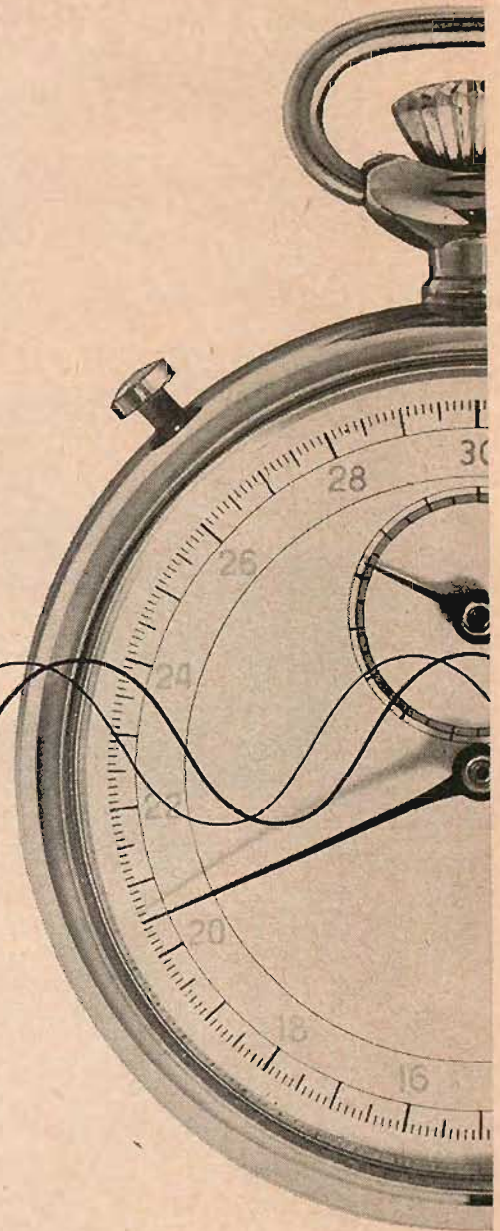

WHAT TIME IS GREEN ?

In color television, the colors on the screen are determined in a special way. A reference signal is sent and then the color signals are matched against it. For example, when the second signal is out of step by 50-billionths of a second, the color is green; 130-billionths means blue.

For colors to be true, the timing must be exact. An error of unbelievably small size can throw the entire picture off color. A delay of only a few billionths of a second can make a yellow dress appear green or a pale complexion look red.

To ready the Bell System's television network for color transmission, scientists at Bell Telephone Laboratories developed equipment which measures wave delay to one-billionth of a second. If the waves are off, as they wing their way across the country, they are corrected by equalizers placed at key points on the circuit.

This important contribution to color television is another example of the pioneer work done by Bell Telephone Laboratories to give America the finest communications in the world.



To keep colors true in television, signals must be kept on one of the world's strictest timetables. Equalizers that correct off-schedule waves are put into place at main repeater stations of the transcontinental radio-relay system.

BELL TELEPHONE LABORATORIES
IMPROVING TELEPHONE SERVICE FOR AMERICA PROVIDES CAREERS FOR
CREATIVE MEN IN SCIENTIFIC AND TECHNICAL FIELDS.



Some Experiments With Miniature Power Triodes

GEOFFREY H. GREY*

The author's experiments with miniature-tube amplifiers yield one circuit with push-pull 6AQ5's and—more interesting—a single-ended 6S4 unit with even better performance, along with a noteworthy set of conclusions on the all-but-forgotten single-ended vs. push-pull controversy.

SOME TIME AGO, being rather bored by the limited possibilities of the old but unreplaced 2A3 family, and not especially impressed with the 6AS7 (mainly because of the unreasonably low amplification factor), the author decided to try out a few ideas on the uses of miniature tubes as power-amplifier triodes.

Until very recently there were no really satisfactory miniature power triodes—none which could properly be called power tubes, that is—and the best possibilities seemed to lie amongst the pentodes. Of these, unfortunately, there were very few, and only two types, the 50B5 and the 6AQ5, appeared to be worthy of test. The former was distrusted because of the a.c.-d.c. aroma—heater troubles, etc.—and the latter was chosen for use as a triode.

Examination of curves for the 6V6, an equivalent, showed a triode-connected amplification factor of 9, a transconductance of 3000 μ mhos, and a plate resistance of 3000 ohms (approximate figures), for a 320-volt plate supply and 25 ma of cathode current. The corresponding bias, -24 volts, indicates a drive problem about half as bad as that of a 2A3 and a fifth of that of a 6AS7.

The official plate dissipation of the 6AQ5 is 12 watts, while the screen is rated at 2 watts or the same as for a 6V6. However, and very wisely, the manufacturers recommend using the miniature tube at lower ratings than the GT version. In practice, it has been found that for normal audio use and construction, 8 watts (triode-connected) was about as much as one could reasonably expect to dissipate. Even at this level the shields, which are used for mechanical reasons, get very hot indeed, while at 10 watts they turn brown. No trouble has ever been experienced by the author, on this and other jobs, with 6AQ5's operated at 8 watts dissipation.

The expected efficiency of 25 per cent meant that each tube would yield 2 watts of useful power, and four tubes would thus provide the 8 watts which was deemed suitable, on the basis of experience, for the speakers, the room, and

the music. The obvious circuit to use, since this was merely a tube-testing project, was the rather unimaginative but thoroughly reliable push-pull-parallel, so that the power-stage input requirements became 320 volts at 100 ma.

The purpose of the experiment was to try out the tubes on a long-term, living-room basis, and not to display ingenuity in circuitry. Part of the purpose included economy. An interstage and an output transformer were on hand from previous adventures, and the design accordingly settled into the familiar pattern of single-ended driver, phase splitting by transformer, and push-pull power stage. While lacking many features generally held in esteem, such as feedback around the power stage, the amplifier was intended to be built without much test equipment and yet offer stable, long-lived performance of satisfactory quality in small rooms and at medium power levels.

The finished amplifier, diagrammed in Fig. 1, uses 6S4's as voltage amplifiers, which is somewhat unusual (they are really power tubes, of which more later). 12AU7's were originally used, but were removed when it was decided to use only two stages of voltage gain. An attempt was made to build a good driver by using a feedback loop (roughly 20 db in the midband con-

trolled by R_1) around both 6S4's, in view of previous troubles with driver distortion when dealing with the lower- μ tubes.

Loading the interstage transformer (R_2 and R_3) to flatten the response at the high end, helps control of the feedback system, and the customary resistors in the grid and screen circuits of the paralleled power tubes also aid in the avoidance of oscillation.

To permit good balancing of the power stage, both milliammeter jacks and precision resistors R_4 and R_5 (for null readings) were provided. All important circuit junctions were made at small pin jacks which serve as test points and tie points alike, so that there is no need to take the unit out of its rack for inspection. The finished amplifier is pictured in Fig. 2.

Performance is quite satisfactory for such a standard circuit. The frequency response at 4 watts output as about that of the output transformer alone, or substantially better than ± 1 db from 20 to 20,000 cps. At the primary of the interstage transformer the response was down only 1 db at 60 kc, which shows how the power stage and its transformer limit the high-frequency performance. The voltage gain is 5.0 from input line to voice coil at 1000 cps, when accompanied by 20 db of distortion re-

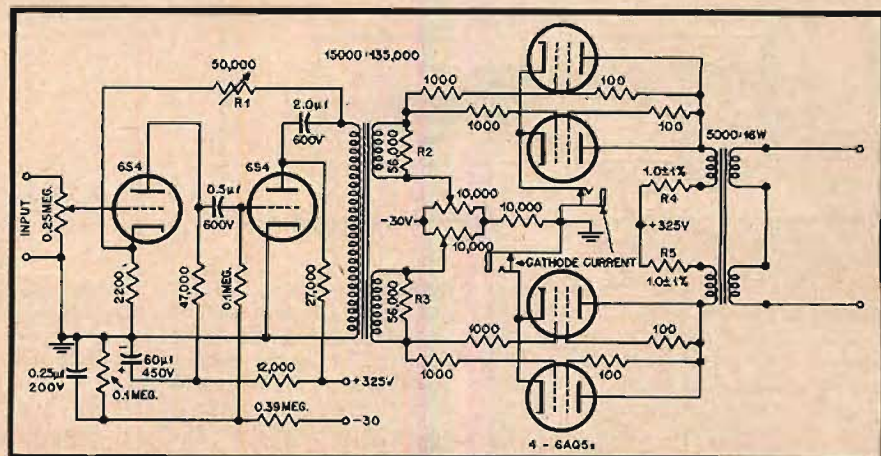

Fig. 1. This push-pull-parallel 6AQ5 amplifier proves that good performance can be secured from miniature tubes.

*1838 Chickasaw, Los Angeles 41, Calif.

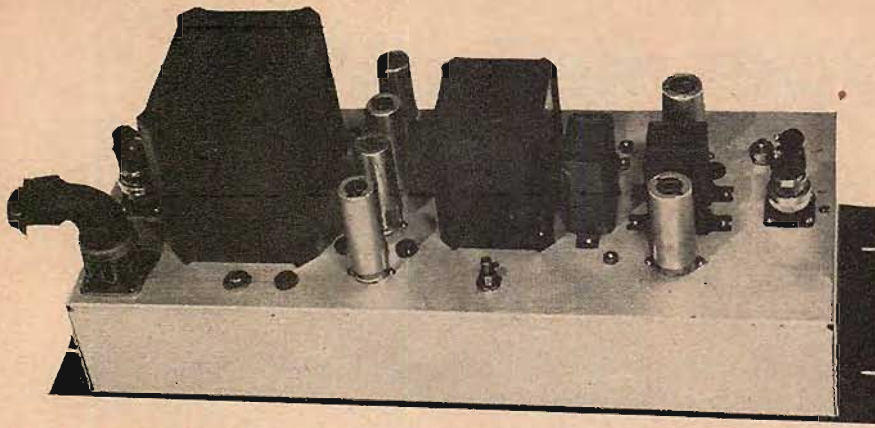

Fig. 2. The 6AQ5 amplifier, dish-mounted on a rack panel. Some of the pin jacks giving measurement access to important circuit points are visible.

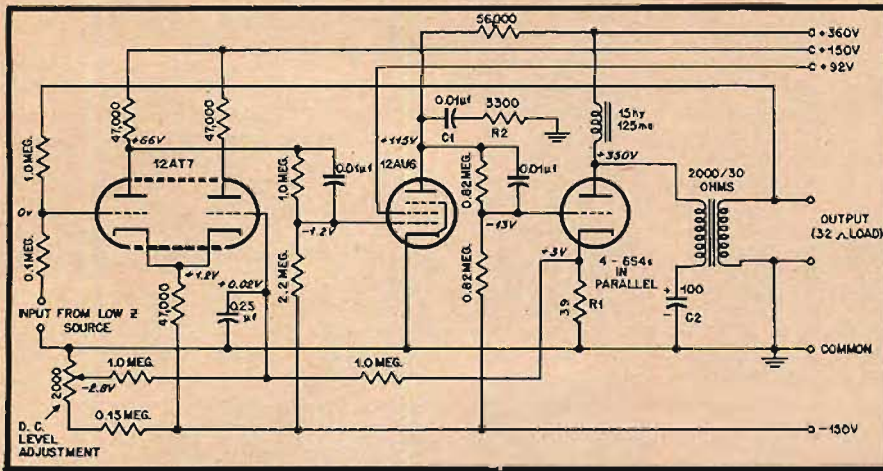

Fig. 3. The single-ended amplifier is direct-coupled and contains simple but ingenious d.c. and a.c. stabilization provisions.

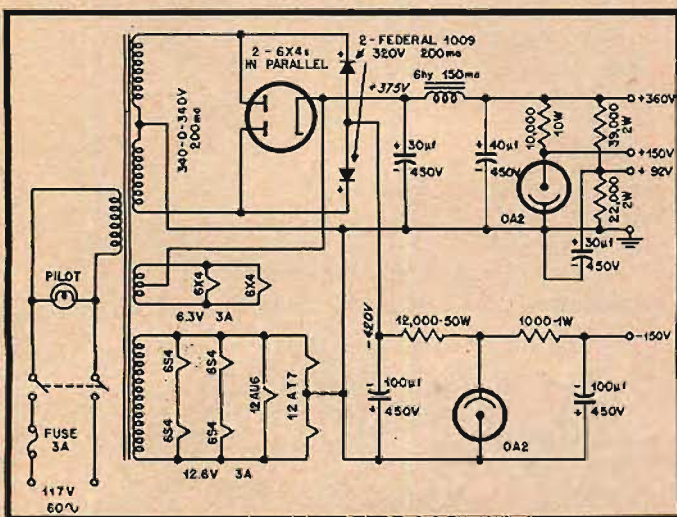

Fig. 4. This simple power supply is adequate for the 6S4 amplifier, despite the fact that electronic regulation is commonly supposed to be essential.

duction in the part of the circuit encompassed by the feedback loop. The overload characteristic is symmetrical and indicates that the power stage overloads first at 8 watts output.

Lastly, before dismissing this design, and moving on to better things, it is necessary to mention the output impedance. This is rather disappointing, being 70 per cent of rated load at 1000 cps. High

damping factor is not the strong point of this particular design, since there is no feedback around the power stage; it requires some care and skill to put any useful amount of feedback around the output transformer even if it is very good, and the use of an interstage transformer makes the problem far worse. Notwithstanding this lack of the "Williamson touch," the amplifier has

proven to be a successful and pleasant-sounding device.

Encouraged by the stability and freedom from tube failures (or other signs of glaringly poor design) experienced with the triode-connected 6AQ5, the field was again scanned for likely small triodes. The appearance of the 6S4 during the first experiment made the next step inevitable. Although not possessed of a spectacular plate power rating (better, however, in point of a larger structure, than the 6AQ5), the 6S4 looked very good indeed. After the 300-volt ratings of most earlier tubes, the 500-volt d.c. plate potential rating (2 kv peak allowable for television uses) was especially pleasing. The tube also has a 7.5 watt plate dissipation rating and reasonable characteristics.

Why Not A Single-Ended Amplifier?

While high- μ tubes are not commonly thought of as making good power triodes for audio use (the μ of the 6S4 is 16) the drive problems one has with the super-low- μ tubes had produced something of a movement in the other direction. In defense of the decision to use the 6S4 there is the fact that the final efficiency turned out to be about the same as (and certainly not less than) one would have obtained with other tubes of lower amplification factor operated in the same manner.

At about the same time as the 6S4 project began, there was a revival of discussion in certain circles of the single-ended power stage. Since the invention of the push-pull circuit, which permitted operation in class B and therefore made possible increased efficiency, the single-ended stage has been a lost cause for high-quality audio power amplifiers. There has been almost no discussion of really good single-ended power amplifiers in print since the war. Many people who might build, with distinction, a fine single-ended amplifier, fall prey to the lure of even-harmonic cancellation, and end by having an amplifier rich in all kinds of distortion.

The defects of the push-pull system are very plain. It depends for its proper operation on a precise balancing of tubes, resistors, capacitors, and (worst) transformers, and upon phase splitting which is both balanced as to amplitude (at all levels) and insensitive to frequency. The advantages are well-known: even-harmonic cancellation, avoidance of net d.c. magnetization in the transformer, and the permissibility of discontinuity of the individual plate currents (so that the added efficiency of class AB or B operation can be had with minimum penalty).

Even-harmonic cancellation is, of course, a very fine thing. It is to be seriously questioned, however, whether in practice it is anything like completely realized in units built with ordinary components and ordinary pains and skill.

The application of substantial amounts of inverse feedback to push-pull, trans-

(Continued on page 58)

Stereophonic Reproduction

R. VERMEULEN*

A few salient points on the mechanism of binaural and stereophonic phenomena as they affect the ear and are useful in reproduction.

THE DIFFERENCE BETWEEN binaural and stereophonic sound reproduction has been discussed extensively in *AUDIO ENGINEERING* but it appears that the work done in the Philips Laboratories by Dr. K. de Boer is not known, this being quite natural as he has published his results in his doctor's thesis in Dutch, and in the *Philips Technical Review* during and just after the war.¹ Although it is not possible to review his work here, some remarks may give a valuable contribution, now that more general attention is given to two-channel reproduction.

First of all, Mr. Tinkham (*Æ* Jan. 1953) suggests that the theory is rather simple and that measurements are difficult. We found, however, that the theory is not so simple at all and that measurements are not only feasible and illuminating but even make calculations feasible.

Mr. Canby (*Æ* April 1953) distinguishes three kinds of reproduction, "binaural," "stereophonic," and "dual-point," and he is quite right in this. Let us consider the two extremes. It will be clear that the ability to perceive two loudspeakers as separate point sources in a room is essentially the same function as the ability to do this binaurally via two microphones, two channels, and two headphones. That is, this is only possible with the two ears receiving different sound signals. But the same must hold for "stereophonic" reproduction. Only when the two ears receive different signals can the "stereophonic" effect be perceived, although it is something of a surprise that we can hear the source apparently placed in between the two loudspeakers, even when the sound at each ear does not come exclusively from the loudspeaker on that side.

Perception of Direction

What K. de Boer tried to find out was: what makes the perception of direction possible? First of all, he found that for steady sounds, and especially for pure tones, the perception of direction in a room is not only difficult but

often even false, because phase and amplitude of the tone are greatly changed by wall reflections and thus no longer have a fixed relationship to the location of the source. That is why he used mostly speech for his experiments. As is widely known, both growing differences in time of arrival of the sound at the two ears as well as growing differences in intensity can give the sensation of the sound source moving to one side. Therefore there are at least two different effects each of which gives rise to directional sensations. In his experiments de Boer found that a difference in time of arrival in milliseconds Δt has to be 5 times the difference in intensity in db ΔI , in order to give the same deviation of the apparent sound source.

In what way do these two effects combine? Is there a strengthening of the sensation by one effect confirming the other? What happens when they contradict each other? K. de Boer found that they neither strengthen nor contradict each other, but that they are additive. That is to say, with both a time and an intensity difference present, the deviation will be the same as if only, say, a time difference were present, equal to the sum of the one actually existing and one equivalent to the existing intensity difference. A remarkable consequence is that a time difference can be completely replaced by an intensity difference, with the same net effect a most helpful fact in stereophonic technique.

Now the question arises: how much does each effect contribute in ordinary listening? Under the conditions used by de Boer the intensity differences contribute 90 per cent and the time differences only 10 per cent. The time differences can never become larger than 0.6 millisecond, so it is a big surprise to find that even time differences of 3 milliseconds, never encountered in nature, are readily interpreted by the mind, although it can never have "learned" to associate them with any direction.

The Artificial Head

This astonishing capability is what makes "binaural" listening possible. For the signals picked up by two mikes from a source not too near differ very little in intensity, so that the sensation of a certain direction has to be produced by abnormally large time differences. No

wonder Mr. Canby finds that "binaurality" is "not literal, especially as to accurate direction." When, however, the microphones are placed on an "artificial head" the two channels are fed with signals differing both in timing and in intensity, thus improving the directional sensation.

Stereophony

We now have the elements to permit us to begin to understand something of how "stereophonic" reproduction is possible. Both loudspeakers produce sound at both ears but with different times of arrival, and owing to the diffraction by the head of the listener, also with different intensities. There surely must be some misunderstanding when Mr. Canby writes that sound-pressure is substantially equal on both sides of the human head for most significant frequencies regardless of direction. Measurements show differences of more than 6 db.² On the other hand he is quite right in pointing out that listening with loudspeakers gives a result different from direct or binaural listening, the sound image of the source being less sharp and not so well defined. The sound arriving at the left ear from the right loudspeaker and *vice-versa* does impair the definition of the sound image, just as wall reflections do in natural listening, but it does not make direction perception impossible. The addition of a third loudspeaker with its own channel may be useful when the two microphones are placed a long distance apart, to compensate for the smaller intensity on both microphones when the source is in the middle. But with an artificial head a third loudspeaker is not only superfluous but likely to add confusion.

The Curtain of Sound

This brings us to the theory of the "curtain of sound." The approximation of the reconstruction of this curtain with only two or three microphones and loudspeakers can only be so very crude that I do not see that it can explain much. It implies that the microphones should be placed as far apart as the speakers

(Continued on page 57)

* Philips Research Laboratories, N.V. Philips' Gloeilampenfabrieken, Eindhoven, Netherlands.

¹ *Philips Technical Review*, 4, 329 (1939); 5, 112 and 187 (1940); 6, 88 and 363 (1941); 8, 51 (1946); 9, 8 (1947).

² Sivian and White, *J. Acous. Soc. Am.*, 4, 288 (1933); Steinberg and Snow, *Bell Syst. Tech. J.*, 13, 245 (1934).

Planning

Your Home Music Installation*

IRVING GREENE** and JAMES R. RADCLIFFE***

In Two Parts—Part 2.

You'll save time and money if you plan at first for the system you will ultimately have. Even if there are empty spaces and blank panels, you won't have to rebuild later.

THE PLAN is the basic foundation of any project. It supplies a theme from which come forth harmonious results. With it everything seems to knit together at the finish; without it, there is always a gap to be filled because one thing or another was overlooked. In assembling and creating a high fidelity music system, planning is most important. Selecting components is one phase of the project—deciding on a suitable set of cabinets (or some form of housing) is another. To blend these two factors into the decor or makeup of one's home is the most important and sometimes the most aggravating task. Planning ahead will simplify this task and remove any element of acrimony.

Many music lovers are professional people. Hence they require a music system for use in their business or profession as well as purely for pleasure. An advertising executive may well have to follow the programs of his sponsors—clients on FM, AM, or TV, and at the same time record them for further study. He may have to entertain prospective clients in his home and so must have a complete setup to audition tapes or transcriptions that contain pertinent program material. On the other hand, a composer, in auditioning renditions of his works must have many facilities to record and reproduce music and sound at a professional level. Many other types of professional people are in fields which require music or sound recorded and kept for study, auditioning, or presentation at some future time. Planning is most essential for such people and if planning is done wisely, the resultant installation will serve two facets of their lives—professional and leisure.

Music for and After Business

300 years ago or so, William Beveridge penned a piece which he called "Music for 'After Business'"—it went like this:

"Music calls in my spirits, composes my thoughts, delights my ear, recreates my mind, and so not only fits me for after business, but fills my heart, at the present, with pure and useful thoughts; so that when the music sounds the sweetest in my ears, truth commonly flows the clearest into my mind . . ."

In August of 1952, Mr. Deems Taylor requested a design of a hi-fi music installation that was to be used for and after business in his apartment on Fifth Avenue.

Mr. Taylor, a distinguished musician, is renowned as a composer, author, critic and commentator of the musical arts. He required a system which would provide the professional quality demanded by his work and at the same time afford his family a simple-to-operate home music system. Further, the appearance had to blend into the decor of the room since space for added cabinets was not available. The layout of the room, Fig. 1, shows the furniture arrangement and the part of the room in which Mr. Taylor regularly worked, in front of two large windows. The long

walls were graced with a fireplace and bookcase along one; the other had a long sofa between two windows. The part of the room used for work had a piano, work-desk, and large window.

The only remaining part of the room which would serve our purposes was a wall, along which was a doorway, a floor-to-ceiling bookcase, and another doorway. Actually, the floor-to-ceiling structure contained a section for books which was less than half of its capacity. The remainder was purely decorative except for a shallow group of shelves behind two doors in the lower center section as seen in the left of Fig. 2. The depth of the wall unit was not great enough to house the required equipment and we had to build out part of the unit to realize sufficient space for our requirements. The right drawing of Fig. 2 shows how this modification was planned. For the loudspeaker system, the center section of the upper part of the unit was extended 4 inches, inside dimension, to provide a depth of 16 inches. Although we had planned to build two shelves for books above the speaker compartment, as indicated in the original plans shown in Fig. 3, they were moved to the bottom below the speaker compartment so that we could design a method of removing and replacing the speaker baffle grille from the front since there was no access to the rear of the enclosure. This same facility had to be incorporated into the design of the panels of the sections containing the radio tuner, tape recorder, television tuner and power amplifier.

Note in Fig. 2 that the entire lower section was extended outward to provide an inside depth of 25 inches for the TV chassis, which afforded sufficient depth for the transcription player to be installed in the upper right section of the modified wall unit. Below this player assembly an automatic record changer was installed for use with 78-r.p.m. or long-playing records. On the left of the unit a tape recorder was installed at a height that is comfortable for operation. Below it the radio tuner-control unit was located, where a comfortable chair was placed.

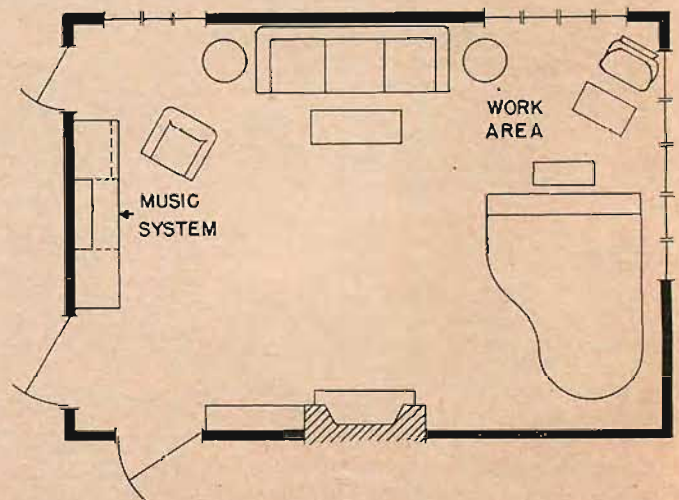

Fig. 1. Floor plan of Mr. Taylor's apartment. Note furniture arrangement in relation to site for the music system on left wall of room. Work area is on right of room where piano is placed.

* Excerpted from "The High Fidelity Handbook" by Irving Greene and James R. Radcliffe, to be published by Crown Publishers, Inc. in the Fall of 1954. Copyright 1954 by Irving Greene and James R. Radcliffe

** 17-49 166th Street, Whitestone 57, New York

*** 170 Twin Lane North, Wantagh, New York

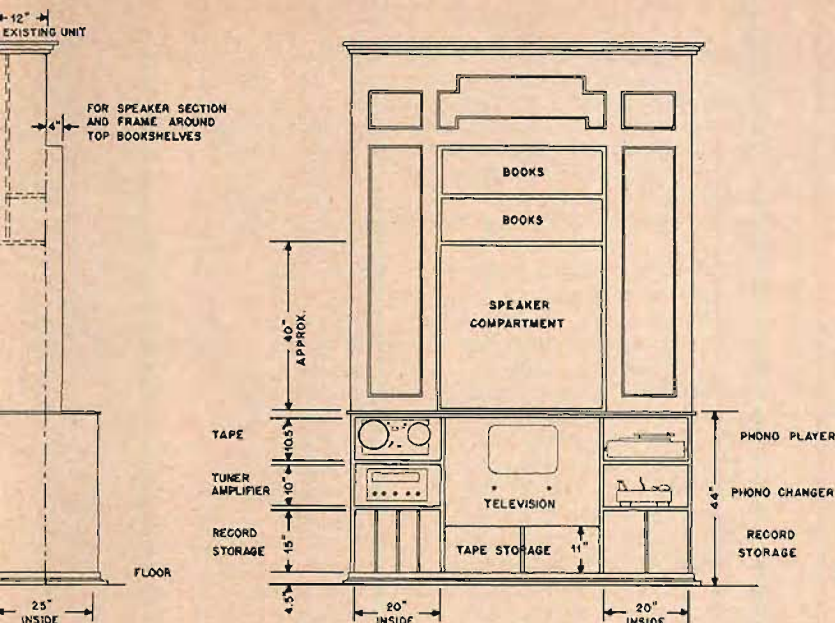
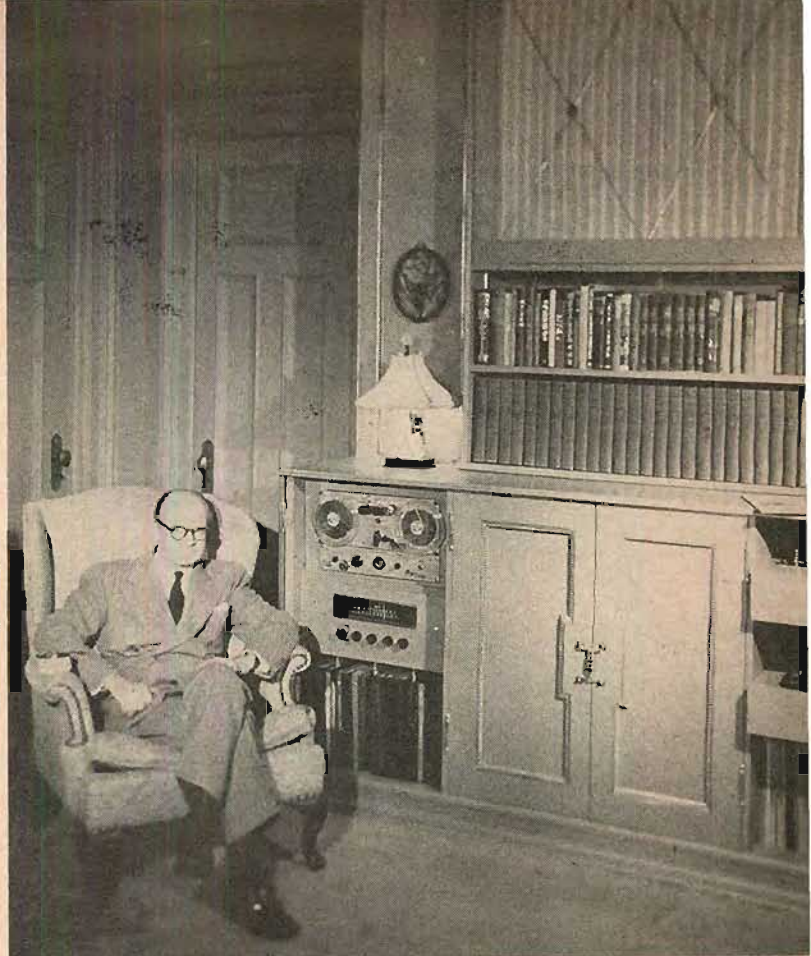

Fig. 2 (above, left). Lower part of original wall structure with single pair of doors in the center. On the right is a side view of the structure as it will look after it has been modified.

Fig. 3 (above, right). A plan view of the completely modified wall unit.

Fig. 4 (at right). The completed installation as constructed from the plans in Figs. 2 and 3. Note convenience of operation of the controls from the chair beside the unit.



Ample storage area for all types of records and for 7- and 10-inch tape reels was provided along the bottom section of the wall structure. The tape recorder "drawer" pulls out so that Mr. Taylor can attach adaptors for the 10-inch tape reels when they are required. This "pull-out" feature in all of the compartments enables a service technician to make any required adjustments or repairs easily. Mike recording is readily done as all connections are made from the front of the unit and the recording level indicator is in line with the piano seat where it can be seen easily.

The loudspeaker commands the attention of the entire room and the television screen can be viewed from any part of the room with ease. *Figure 4* illustrates the completed installation with the side doors opened and set back from the structure.

A Career in Music

A serious music student, in planning his career, wisely included a complete system for the recording and reproduction of sound. With the future in view, binaural facilities were provided in addition to complete flexibility of monaural equipment that is so helpful to the study of music.

The results of this type of planning can be seen in *Fig. 5*. Everything essential to the needs of the student-composer is made a part of his living-study room. Ample storage space is provided behind sliding doors. The desk is combined within the well designed units that contain books, a work area, and files for reference material. Everything is within reach of the desk. At the left is one of the two loudspeaker enclosures, separated from the desk by a bookshelf-storage unit.

To the right is the main console which is built into the wall unit. At waist level, the music student can make disc or tape recordings from a radio broadcast—either AM or FM—a phonograph record, or a reel of tape. *Figure 6* shows the compact arrangement of this equipment. Note the convenient height of the radio tuner, audio control, and the various filter units. On the extreme right is an electric

timer which permits automatic tape recordings of radio programs during the student's absence. The work table on the right is convenient for making notes, editing tape, etc. The second loudspeaker enclosure is located between the two wall units, with the tape recorder console on the extreme right of the wall unit.

The circuitry used to provide patching and switching of the components in this system is simple in design, construction, and operation. It was designed with binaural in mind and wires and connectors to include binaural at a future date were installed and built into the compact switching and control panel. A close-up of the main console in *Fig. 7* shows the layout of units and the switch-control panel set into the front of the console. The assembly is made from a square of black Micarta framed with natural birch. The function of the switches is to patch the various inputs and outputs to the tape recorder when it is rolled close to the wall console for dubbing from tape to disc or *vice versa*, although the tape recorder may be operated in its normal location.

Both turntables are mounted on a Micarta-topped motor-



Fig. 5. A complete study room for a student of music. Here everything for the recording and reproduction of sound is within convenient reach.



Fig. 6. A view of the work corner where all components are within reach for ease in operation. Note tape recorder console on the right.

board. The pickup arm is mounted so that it can be used on either turntable if desired. The master switch controlling the electric power is located in the wall of the console under the radio tuner. A plug-in type of recording-level meter has been set behind the cutter mechanism. This meter can be plugged into the front panel and set in full view of the student when he is at work in another part of the room or at his desk. Ample space for storage of recording tape above the console is provided. Note that "file" type drawers were used for record storage. Since LP record jackets (protective sleeves) contain all information on the face of the jacket, this is a most practical manner of storing them.

The tape-recorder console was especially designed to house the chassis of what was once a portable unit. The drive mechanism is covered by a glass-topped lid affording protection from dust and permitting inspection when the unit is in operation with the lid closed. The recording amplifier was mounted at a slight angle for maximum visibility. The lower section of the console has a removable front panel of standard radio relay-rack dimensions to permit installing equipment built into a rack-mounting panel. Figure 8 shows the recorder console. With rubber casters in the base, this console can be moved anywhere in the room. At the present, this installation with its flexibility provides excellent facilities for monaural recording and reproduction of sound. With the two loudspeakers and the wired cables and connections, binaural can be added with a minimum of work and time. It's not difficult to accomplish installations such as this if careful planning is exercised from the start.

Not every music lover has a fireplace or a spacious home. Nor does he have a closet or much wall space . . . in fact the conditions may very well be that he has not only an apartment of limited area but a limited budget as well. Fortunately, there is adequate flexibility in selection and purchase of hi-fi equipment so anyone may assemble a system in almost every price bracket and do it one unit at a time. The music lover who has any type of music system can improve it by replacing one unit at a time until he has a complete new system.

Marginal Buying

On the other hand, if the music lover should happen to have a taste for the finest and discovers that the system he has chosen is too expensive, he can realize his aims in getting the ultimate in equipment by *marginal buying*, which

is a method of assembly starting with a *basic system* which contains all of the components needed for just radio or phonograph music reproduction. The extent of the basic system varies with the amount of existing equipment on hand. For example, if a music lover wants to start assembling a modern hi-fi system and he has a three-speed record changer a few years old, he may get a good-quality amplifier and speaker. If he also has a reasonably good speaker, he will just get an amplifier, leaving plenty of *margin* in his budget to get each component one at a time, yet get the best possible quality.

In this manner, the music lover can realize equipment he would normally think too expensive to get at one time, yet it is possible to assemble a complete system in this quality bracket—a piece or two at a time—over a period of a few months or at the most a year. This plan is feasible and practical for any individual, rich or poor.

An example of a system assembled in just such a manner is illustrated in Fig. 9. Initially, this music lover wanted a complete system from pickup to professional tape recorder. In order to get the quality of components he wanted, he would have to sacrifice on the cabinets and the loudspeakers. Not to stint on cabinetry or loudspeakers, he began the project on the basis of marginal buying. He initially purchased a radio tuner with audio controls, a power amplifier, a record player and a coaxial loudspeaker. After installing the components in a cabinet built to match the existing furniture in his home, he made plans for the other components and cabinet he would add at a later date.

In the first cabinet, provision was made for tuner, amplifier, and record player, with a limited amount of space for record storage. The entire left section of the cabinet was devoted to the loudspeaker. The inner structure was built in strict accordance with plans recommended by the speaker manufacturer. The cabinet was designed with a single sliding door, using fiber tracks to eliminate vibration noises. The door was backed with perforated masonite and covered with Pandanus cloth so that it matched the speaker grille and would not impede the sound when it was moved in front of the speaker as the controls were adjusted.

Now, with high-quality components in a cabinet of his choice, this music lover enjoyed music at its then best until he could afford to expand the system. This he did a few months later when he purchased another speaker of the same make and model and another cabinet to match the

(Continued on page 46)



Fig. 7. A close-up of the main console. Note timing clock and switch and patch panel below the table.

The Right Ear for Music

The unfortunate "listener" is paying the price for years of bad listening habits in this new period of sound.

RUDO S. GLOBUS

DURING THE SECOND WORLD WAR, the joyous period spent in induction centers by the millions of G.I.'s was further enlivened by a little *divertissement* subtly called the "rhythm test." After the first day, marked by miseries both physical and mental, the inductee was afforded the opportunity to determine whether his perception of rhythm was good, mediocre, or just plain lousy. This was done by way of a recording, previously tested in the school systems. The avid listener hears series of beeps in various combinations and he was gently requested to indicate whether parallel series were the same. The winners of this exciting competition were favored with transfer to the Signal Corps and the once-in-a-lifetime chance of learning code and operating a key.

Prior to this time, the test had been devised as a means of determining musical aptitudes and I can remember hearing discussions and seeing papers reporting on the wealth of undiscovered talent in the schools and colleges of the country. Unfortunately, it has dawned on the researchers that an ear for rhythm means that and that alone. The precise foot-tapper is no longer considered to be a budding Gieseking, Heifetz, or Toscanini. And no group of tests yet discovered can predict musical genius. What they can do, however, is reveal deficiencies. A few months ago, we discussed this problem with a well-known musician-teacher who is on the faculty of one of our major music schools. He called attention to the problem of ear training:

"In Europe, from early childhood on, the future musician, professional or amateur, is given a thorough schooling in solfege. This makes possible an acute ability to think and listen in terms of pitch, the relationship between notes, etc., which heightens musicality a thousandfold. Here, we tend to think of the individual with perfect pitch—or, for that matter, relative pitch—as an uncommon freak, born with supernatural talents. Furthermore, the basic European musical experience is a direct one. The live performance represents basic musical contact and the radio and records are secondary. Here, it's the exact opposite. I have questioned over three hundred students carefully on this point and find that sixty percent and more of their music listening from childhood up has been to radio and records. This occasionally produces disastrous results."

While it is an acceptable proposition that recordings and radio performances have widened the possibilities of music experience, (and here we might mention the fact that one authority claims that the high ratio of successful scores in the army rhythm

tests was due to the omnipresent experience with popular music and a familiarization with steady, pronounced beats), there are grave limitations. In order to understand them, we went to a group of authorities whose primary concern is with the nuts and bolts of music—the content, what is heard. We have reduced the combined information received from them to a compilation of collective questions and answers. Sit up and take notice, for their opinions put a new slant on the situation:

Q. In your experience with students, audiences, etc., what would be your estimate of the present level of music consumption in the United States?

A. It would be impossible to make a general statement. All we can do is cite some examples from our own experience of problems as we see them. We find that the act of listening to music has been corrupted by a number of factors. There is no clear-cut conception of the sound value of individual instruments. This not only applies to subtle cases, as the sound distinctions between an oboe and an English horn, but between brass and winds, etc. There are too many cases where people have been trained to listen to the gross product—the total sound made by an orchestra, rather than to the components. Radio listening and record listening have apparently contributed greatly to this. Some of the most important elements in the listening experience—shades of coloration, timbres, etc.—are overlooked, and dynamics, rhythm, and melodic line serve as the basis for musical enjoyment.

Q. How does this "gross listening" affect the ultimate enjoyment of and comprehension of music?

A. It depends on the given cases. We would venture to guess that in some compositions it doesn't much matter. Where the music is unsubtle and simplified—or even in more important compositions which depend almost exclusively on a rather obvious melodic line and broad dynamic and rhythmic treatment, it doesn't matter at all. But where the orchestration becomes complicated, where the listener isn't spoon fed, where his ear must become accustomed to listen for inner harmonies, shadings, mixed tempi, etc., he is at a serious disadvantage. He ultimately ends up by saying he doesn't care for that kind of music.

Q. Does specific training supply the necessary answer to this problem?

A. It all depends on what you mean by training? There is no reason why almost anybody can't broaden his musical horizons. While it is important to know what to listen for and why such and such a thing is done, this type of training is meaningless

unless the listener can actually hear what he has been taught . . . in its proper perspective. And proper enjoyment demands that he shouldn't have to be on guard, straining to hear. If his ear is properly trained, he will hear these things spontaneously, automatically. With some of the more difficult compositions, the subtle re-echoing of a theme by one of the orchestral sections behind a dominant passage is as important to the work as a whole as the blaring brass that dominates a grosser section. You can hear these things in a concert hall or in a fine recording played back on fine equipment. You can't hear them in proper perspective on a cheap radio or on cheap equipment.

Q. Since it is clear that recordings have become the basic factor in listening today, what can be done via records, etc., to retrain badly trained ears?

A. A great deal. Many recent recordings are excellent insofar as sound quality, balance and so on are concerned. Some record companies have actually gone out of their way to make every orchestral section completely articulate. Some have gone overboard in this direction. Facilities for playing records are remarkable—although we must caution against the wrong kind of ear training here as well. Too much brilliance, too much resonance, an unfortunate desire that every performance sound exactly the same way (the test record attitude), are hazards in the other direction. The manufacturers of equipment have provided the consumer with phenomenal flexibility and control over the way he listens to music. Precisely because his ear has been improperly trained to begin with, this flexibility and control doesn't necessarily help him and he will use his equipment to conform to some arbitrary but fixed standard of his own (or one provided by friends) which robs him of as much as did the cheap radio and record player. His musical horizons, his taste, his enjoyment of music will be forever restricted until he is given an opportunity to train his ear so well that he needn't develop a neurosis in trying to turn the bass up or down, adjust the treble, the volume control, etc.

Q. Can we take it that you're completely satisfied with modern recordings?

A. No. We have heard too many recordings in which clarinets sounded like French horns or saxophones to give our blanket approval. We have heard recordings in which it was impossible to determine how the work was orchestrated because of the welter of confused sound. It all depends on the given recording. Some are excellent,

(Continued on page 62)

Handbook of Sound Reproduction

EDGAR M. VILLCHUR*

Chapter 18. Testing and Measurement.

This concludes the informative series which has been appearing in the magazine for almost two years. The entire series will be available in book form in September of this year.

OBJECTIVE TESTING AND MEASUREMENT occupies a critical place in the design and evaluation of audio components and systems. Such testing has on occasion been derided on the grounds that one doesn't listen to curves or to technical data, but to music, and that the only infallible test of a system is the subjective impression it creates, that is, how it sounds. The writer disagrees with this view on two counts:

1. Such a view incorrectly assumes that there are contradictions between subjective results and the results of properly designed objective tests. The purpose of the objective measurement is not to supersede, but to sensitize the subjective evaluation, so that defects in reproduction which may not be apparent at first can be revealed. The subjective impression remains the final determining factor, but in an indirect way—by validating or invalidating the test procedure. If a system passes test procedure *X* with flying colors but sounds terrible, it does not mean that figures lie, or that objective testing is invalidated, but that test procedure *X* has not been applied to the subjectively significant factors properly.

For example, two amplifier manufacturers may list almost identical technical specifications for their products, while their amplifiers do not sound alike at all. This does not indicate that one of these assemblies of tubes and circuit components has had some mysterious, unmeasurable quality breathed into it by its designer that the second lacks. It does indicate that the descriptive specifications that have been presented are incomplete and do not go to the heart of the matter. A well-known amplifier designer, D. T. N. Williamson, after describing rather stringent technical standards of amplifier performance, states that any amplifier conforming to such standards will sound as good as any other amplifier.¹ An amplifier which has somewhat lower standards of distortion may sound the same in the beginning, but may be more tiring to listen to over a period of time.

2. How a reproducing system "sounds" is a function, not only of the objective quality of the system, but of the kind of person listening, the date of

the last live concert he heard, the audio system he is used to, and what he had for lunch. Once we have validated objective criteria for evaluating reproducing systems by correlating the results with many subjective judgments, we have a more reliable index of quality than the direct subjective judgment of a particular individual or group.

The test procedures described here will be those that have been found to predict accurately subjective evaluation of the performance of the components involved. Emphasis is placed on procedures involving limited equipment—test records, voltmeters, and oscilloscopes—rather than signal generators, harmonic distortion analyzers, and intermodulation analyzers. This will mean limited accuracy and sensitivity, but it will also mean that the testing will not be restricted to professional laboratories. For the over-all system the test record has an advantage over the signal generator, in that the mechanical and electro-mechanical components of the record player are included in the test.

Measurement procedures described (or back-referenced to an earlier chapter) will involve:

- Power output
- Hum
- Harmonic and intermodulation distortion
- Frequency response
- Source impedance and damping factor
- Pickup tracking error
- Vertical stylus force
- Pickup tracing capability
- Turntable r.p.m. and regulation.

Measurement of Power Output

The power output of an amplifier is very much dependent upon the load presented to the output stage. We have seen that the impedance reflected back into the output stage by the loudspeaker may

vary with frequency by as much as five or six times, the magnitude and phase of the speaker impedance depending upon the value of the motional impedance and of the voice-coil inductive reactance at a particular frequency. Power-output measurements are therefore normally made with a resistive load substituted for the speaker, of a value equal to the nominal impedance of the speaker, and of a wattage rating sufficient to insure that the value of the resistance will not change due to heat dissipated during the test.

A test setup for measuring power is illustrated in Fig. 18—1. The amplifier is excited with a sine-wave test signal (either from a test record or from a signal generator) and the r.m.s. value of the voltage across the resistor load is measured. The square of this voltage, divided by the value of the resistance in ohms, is equal to the power output in watts. The voltage across the resistor is also monitored visually by an oscilloscope, so that unwanted power components such as spurious oscillations or noise, which may upset the accuracy of the reading, may be observed and discounted.

But the above procedure is not wholly satisfactory. It does not reveal the output capabilities of the amplifier when the latter is connected to load impedances of higher than rated value, a condition which exists over the major part of the frequency spectrum. An amplifier may, for example, be capable of delivering 10 watts at 60 cps, within a given distortion percentage, to an eight-ohm resistor, but may be incapable of the same performance when loaded by a loudspeaker of nominal eight-ohm impedance, a load whose actual impedance at 60 cps is typically closer to 40 ohms. The resistor-load rating does not tell us how the amplifier behaves under operating conditions.

Fortunately there is a mitigating factor; modern loudspeakers are designed for constant acoustical output with constant-voltage electrical input rather than constant power input, and the increased impedance at 60 cps means that a correspondingly smaller amount of electrical power will be required of the amplifier. When the power measurements are being tied to frequency vs distortion measurements, as is often the case, the writer prefers to connect the amplifier back to the loudspeaker for the frequency run after the reference power

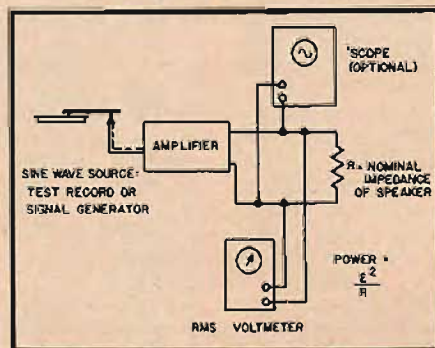

Fig. 18—1. Method of measuring amplifier power output.

* Contributing Editor, AUDIO.

¹ D. T. N. Williamson and P. J. Walker, "Amplifiers and superlatives," *Wireless World*, Sept. 1952, p. 357.

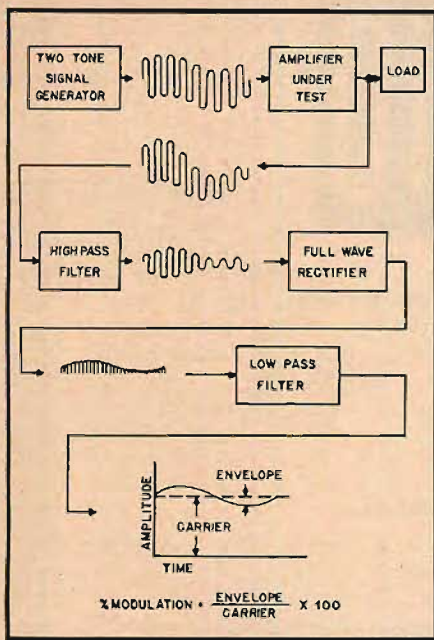

Fig. 18—2. Elements of intermodulation testing, using intermodulation analyzer.

level at, say, 400 cps has been measured. Such distortion readings cannot be presented as having been taken at a particular amplifier power output, but at a particular voltage across the loudspeaker, the power level having been set at so many watts at 400 cps. These readings do, however, more closely represent amplifier performance under operating conditions.

Hum power can be measured in the same way as signal power, except that a very sensitive voltmeter is required for measuring voltage across the output transformer secondary. The increased hum power that will be developed in the resistor load, compared to the actual power drawn by the loudspeaker, does not have much significance here because the hum rating is a relative one, compared to the full signal power rating. The hum should be measured at several settings of the volume control, from minimum to the maximum position that will be used.

When a sensitive voltmeter with a millivolt scale is not available, the hum voltage can be measured across the output transformer primary, as described in Chapter 16. The square of the primary voltage, divided by the product of the load resistance and the impedance ratio of the output transformer windings, gives the hum power. In making such low-power readings it is especially important that the waveforms being measured be monitored by an oscilloscope, so that it is possible to see just what a.c. voltages the meter is responding to.

Harmonic Distortion

Harmonic distortion ratings, which relate the amplitude of spurious harmonics to the amplitude of the fundamental signal by percentage, are tied to given power outputs. Harmonic analyzers may read total harmonic distortion (the vector sum of the magnitudes of the various harmonic orders) or they may measure the different harmonic orders

separately. The latter procedure has better correlation to the annoyance value of distortion, since a much smaller percentage of high-order harmonics can be tolerated than of low-order harmonics. It has been suggested that each order of spurious harmonic be weighted—the terms $n/2$ and $n^2/4$ have been variously proposed as weighting factors by which the amplitude of a harmonic of the order n is to be multiplied.

In order to use a harmonic analyzer the amplifier is fed by a pure sine-wave signal and its output is connected to the input of the analyzer. (The analyzer does not load down the circuit, and the amplifier must be loaded by its speaker or by a dummy resistor.) The fundamental component of the amplifier output signal is filtered out, and the remainder of the signal is either subjected to harmonic analysis or measured as a lump sum on an r.m.s. voltmeter. This meter has been calibrated to read in percentage of the input signal amplitude.

Harmonic distortion can be detected to a limited degree by observing the oscilloscope waveform of the amplifier output signal when a sine wave has been applied to the input. The lower orders of harmonic distortion are more difficult to detect; the lower limit that can be detected visually is probably at least 5 per cent. Higher orders of harmonic distortion in the 2 to 3 per cent range can often be observed without difficulty.

Intermodulation Distortion

Intermodulation distortion is usually both a more sensitive and more significant distortion measurement than that involving the direct measurement of spurious harmonics. With typical test signals the intermodulation percentage is in general from 3 to 4 times the harmonic distortion. This facilitates the measurement of low values of distortion, especially when noise is also present in the signal.

The method of measuring intermodulation distortion with an intermodulation analyzer is illustrated in Fig. 18—2. The diagram shows the various components through which the signal is passed, and the form of the signal at various stages of the analysis.

It is also possible to make an approximate measurement of intermodulation distortion using only test records, an oscilloscope, and a simple network of

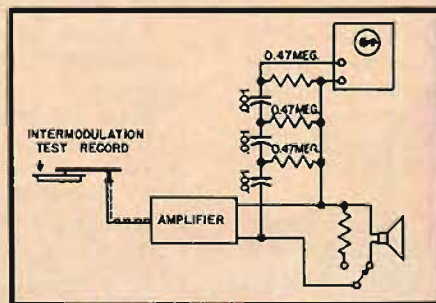

Fig. 18—3. Method of indicating intermodulation distortion approximately. The values of resistance and capacitance are appropriate for typical test-signal frequencies such as 100 and 7,000 cps.

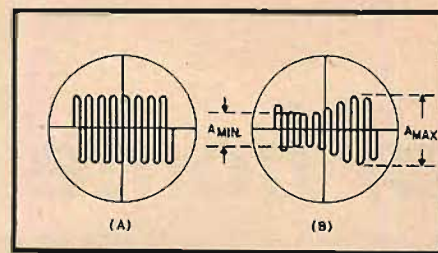

Fig. 18—4. A—Screen pattern in test setup of Fig. 18—3, in which no intermodulation is indicated. B—Screen pattern in test setup of Fig. 18—3, in which approximately 33 per cent intermodulation distortion is indicated.

resistors and capacitors.^{2, 3} This measurement technique is illustrated in Fig. 18—3. The two-tone signal is provided by an intermodulation test record; the output of the device under test is passed through a filter that removes the low-frequency component, and the signal is then projected on an oscilloscope screen.

If there has been no intermodulation, only the high-frequency component will appear on the screen. With the sync frequency control of the oscilloscope adjusted to display many cycles of this high frequency signal, the undistorted signal output will appear as a flat band of sine waves, as illustrated in A of Fig. 18—4. On the other hand, with intermodulation present, the high-frequency component will be amplitude modulated at the fundamental and harmonic frequencies of the low-frequency component, and will appear as illustrated in B of Fig. 18—4. The percent of intermodulation is estimated from this pattern as the percentage relationship between the average amplitude of the high-frequency carrier and the depth of the "notch" or depression below this average amplitude.⁴ This percentage is most easily calculated as the difference between the maximum and minimum amplitudes, divided by the sum of the maximum and minimum amplitudes, and multiplied by one hundred, that is:

$$\frac{A_{max} - A_{min}}{A_{max} + A_{min}} \times 100.$$

The above method must be considered as approximate only, since over and above the lack of precision in reading, it does not adequately take into consideration the waveform of the modulating envelope and the different sidebands that are formed.

Frequency Response

Frequency-response test records come in two common types, the steady-tone and the sweep record. The steady-tone record has sine-wave signals of progressively increasing or decreasing frequency, recorded with given equalization. (Continued on page 52)

² C. G. McProud, "Simplified intermodulation measurement," *AUDIO ENGINEERING*, May 1947, p. 21.

³ John M. van Beuren, "Simplified intermodulation measurements," *AUDIO ENGINEERING*, November 1950, p. 24.

⁴ J. G. Frayne and H. Wolfe, "Elements of Sound Recording," John Wiley and Sons, Inc., 1949, p. 407.

at home with

AUDIO

LEWIS C. STONE

In this department for the amateur audio constructor, things to do and how to do them will be described, staff written and contributed. It can well be—and we must depend on our readers for that—a clearing house of ideas, experiences, and information for, by, and from men and women whose enthusiasm for achieving musical re-creation in the home leaves them no alternative but to seek the best in components and whose budgets may frequently mean “do it yourself.”

Your questions and your problems and their solutions with respect to hi-fi music in the home should be aired here, with us. This goes for anything that has to do with component selection and purchase, or construction; methods of wiring and hookup; variations on the theme of housing the equipment, and so on.

Report to us your inspired solutions to routine or unusual problems or situations—preferably your experiences with hi-fi at first hand. Your communications will be most welcome in this department.

WE TAKE AS OUR TEXT a passage from a communication submitted by reader William H. Burke, who describes his adventures in building a front end for his amplifier in *AUDIO ENGINEERING* for November, 1953. Mr. Burke is satisfied that he has apparently accomplished the impossible. For so it had earlier been considered by Messrs. Sarser and Sprinkle in their article, “Gilding the Lily,” included in the *2nd audio anthology*, page 10. Said they, speaking of front ends, that generally there is an “. . . almost insurmountable obstacle to the amateur constructor in achieving the appearance of a factory-built unit. . . .”

Having but recently completed just such an undertaking, Mr. Burke rose to the occasion and to the defense of the amateur. Brandishing, one might say, a coat-of-arms with screwdriver and soldering gun rampant, amplifiers and turntables couchant, he asserted in his article: “. . . With all due respect to those eminent gentlemen, I wish to dissent. The obstacle is nowhere near insurmountable.

“I am an amateur constructor—as amateur as they come—but I built a front end that is handsome and professional in appearance. And so can you, if you have the equipment and the know-how. . . .”

“I have never tried anything like it before,” continues Mr. Burke. “I have no unusual talent for that sort of thing; neither am I all thumbs. In short, I am just like you. . . .”

There was a time, Mr. Burke admits, when he did feel a bit timorous thinking that for looks, he just had to buy a manufactured front end for the amplifier he was building (an Ultra-Linear version of the Williamson, inspired in

turn by an article on the subject by Hafler and Keroes, included in the *2nd audio anthology*, page 8). But as budget shrank before the onslaught of cost, so did correspondingly spirit rise to accept the inevitable challenge of “DO IT YOURSELF!” In his article, “Making a ‘Front End’ Handsome,” Mr. Burke has revealed to us, at first hand, just why and how the serious music lover turns amateur audio technician, and makes a good job of it.

Music Lovers vs. Baseball Fans

Of the new importance of music to the masses, Mr. Virgil D. Reed (vice president, J. Walter Thompson Company) writing in *Think* for November 1953, says: “With the growth of musical appreciation, which has spread like wild-fire during the last twenty-five years or so, there has come new creation of music and the organizations, instruction, and institutions out of which wider appreciation and new creations are born. . . . Many universities now have excellent schools of music. Last year there were more than 8,800 college degrees conferred here for music studies. . . .”

“Much as we love baseball, it will astonish many to know that last year paid admissions to hear serious music exceeded the gate receipts of our baseball stadiums by \$5 million. That year over 30,000,000 people paid to hear good music. . . .”

The music lover's name, it seems, is truly legion. And from this could be inferred a like dimension for the numbers of music lovers who are turning amateur constructors of audio equipment, hooking up their own systems for hi-fi musical re-creation in their homes.

We are moved, then, to celebrate the spirit of the amateur venturer, by organizing a special niche for him in *AUDIO*. “At home with *AUDIO*” is our department for the amateur worker in hi-fi home musical equipment. It is for those who willingly invest their time, effort and ingenuity as their major currency to achieve those fine results which otherwise they could scarcely, if ever, attain.

The Amateur Takes a Tool

You have been listening for music—you want to hear it better reproduced—*re-created*, beyond the range offered by commercially contrived expedients. The best in hi-fi results is truly in your hands to attain, and we counsel you to use them.

Consider that working with tools can be therapeutic in value, having its compensations in terms of both psychic and physical satisfactions. The fun of doing things yourself is in having the fun, all the way. (Let us say, also, that much of the fun can be missed, if what you do is done uncomfortably.)

The act of driving a screw home, with the right size and type of driver for the screw head, and the right length of handle for best driving leverage for the length of the screw is, by and of itself, doubtlessly a pleasurable thing to do. It should leave one untired, ready to go ahead with the next screw and the next. There are quite a few to be done, as you will find when you undertake to secure *bracing* strips to the back panel of the bass reflex, or fasten down the speaker along the circumference of the round opening you have cut out for it in the front panel (from 3/4-inch plywood, with a Stickleback drill saw or keyhole saw, most likely).



Fig. 1. What the amateur audio constructor should have handy in tools and accessories. Note the reel of resin core solder and insulating tape. Item to left of long-nosed pliers is a wire-stripper. Stickleback saw is between the keyhole saw and wire stripper.

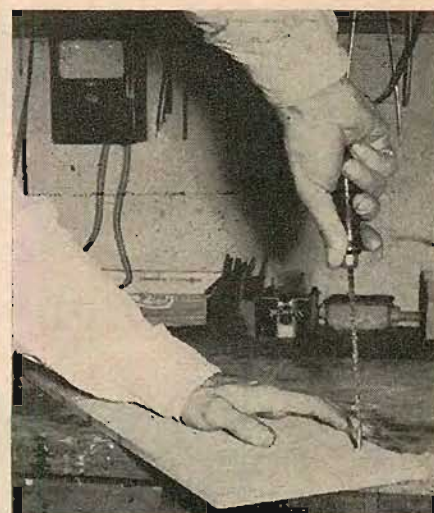

Fig. 2. Demonstration of use of Stickleback saw to make starter hole for keyhole saw. This "saw" is capable of drilling its own hole—with it, a person could literally saw his way out of a box.

Satisfying as you may find using the screwdriver (or any of the other tools) efficiently, you may yet miss extracting from it the full measure of pleasure that could come with such an experience. We say so advisedly. Your enjoyment to the full of what you may be doing depends, for example, on where you place your work bench. Space is a factor. Good lighting is vital. And last, but not least, the height of the working surface.

This height is not necessarily to be measured from the floor. If we did only that, we would probably settle for either the accustomed table or desk heights and find, thereupon, that we are not comfortably positioned to do the things we have been pleasurably anticipating, with a full measure of pleasure.

A knowledgeable home experimenter—Editor McProud, in fact—seems to have found a reasonable answer. He suggests firmly that the height of the work bench should be established in proportion to the height of the man who will work at it. As near as he can boil it down to a sort of rule-of-thumb, the top of the work bench (for work on audio equipment) should be 8 inches below the tip of the elbow. At that level, he asserts, most of us should find greatest ease in handling the tools needed.

And again, in a purely pragmatic way, our learned expert has found to be perfectly adequate a length of 30 inches and a width of 18 inches for the dimensions of the work bench top. This he has made up of two pieces of 3/4-inch plywood, to a total thickness of 1-1/2 inches, and rigid enough to sustain the work load. The mate to this work bench is a cabinet for miscellaneous parts and small tools, size 24 inches by 12 inches, the top covered with linoleum and a raised molding around it to keep things from falling off. In fact, the work bench can well be on the top of the cabinet.

The Blooming Tool Chest

As our greenness with tools wears off, and our appreciation of their possibilities grows keener, we endlessly find cause to acquire more and more tools, even unto triplicates. If you run true to form, your cabinet will before very long hardly be sufficient to house your blooming tool arsenal. But just about sufficient unto your beginning steps as a home audio experimenter should be the following tools thereof:

Coping saw, keyhole saw, Stickleback drill saw
Hand drill and drills—from 1/16 inch up to 1/4 inch

Brace and bits—from 1/4 inch up to 1 inch
Standard screwdrivers—heavy, medium, small
Phillips screwdrivers—medium and small
Slip-joint pliers, diagonal cutting pliers, long-nosed pliers (with no cutting edges), wire stripper
Set of box wrenches or open-end wrenches
Carpenter's rule and square, carpenter's pencils
Repairman's tapered reamer
Estwing claw hammer
Vise and wood clamps, scribe compass
Soldering iron, rosin-core solder.

Most of them are pictured in Fig. 1. As you can see, there are a lot of carpentry tools you will be handling, and some tools a carpenter rarely, if ever, gets to handling. Which should make you, in time, possessed of a sure ambivalence in 'shop work' equal to the requirements of almost any operation—than which few other hobby achievements can give satisfactions greater or deeper.

Operation Hi-Fi

Now "you're in business." You will find this inventory of tools to be more than adequate for the job of putting together the basic components to make a complete hi-fi audio installation in your home. The tuner and amplifier; the speaker; the automatic record changer; the preamplifier; the reluctance cartridge (diamond stylus for LP, perhaps a sapphire one for 78's).

One such installation has just been completed. We used the frames of two cabinets previously used as bedroom pieces, fitted with tambour doors. One to house the equipment, the other for the speaker. The record player on the top shelf, mounted on sliding tracks, the AM-FM tuner on another shelf next under it, and the amplifiers on the bottom frame of the cabinet.

The following description of what was done and how it was done is put in "how to" language for a clearer statement.

Mount the Record Changer

The base mounting for the record changer should be prepared by using the template supplied by the manufacturer to cut out the top board of the base, to fit the player mechanism on its resilient spring supports, (Fig. 3.) Leave a minimum of 4-1/2 in. clear under the lowest point of the mounting plate mechanism to allow the moving parts of the changer to move freely, and for air circulation.

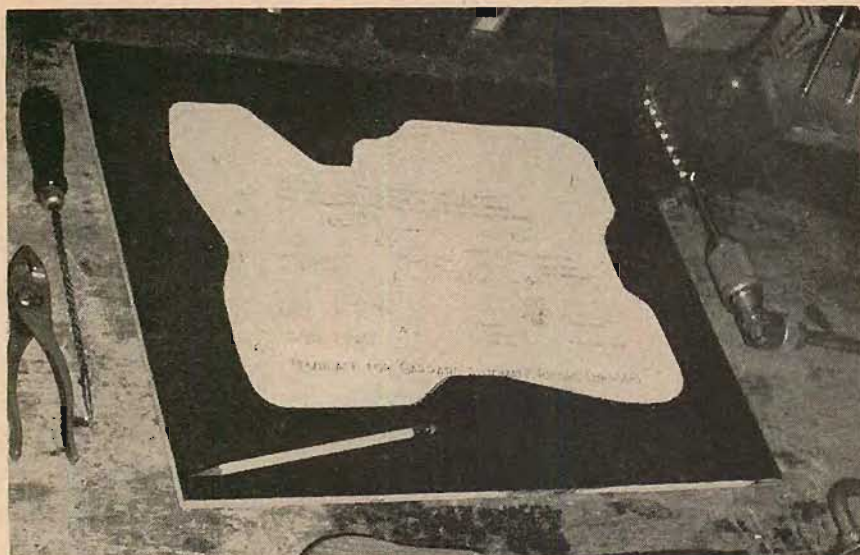

Fig. 3. Base-board for record changer has been cut out to contours indicated on template supplied by Garrard, the makers. Tools used are also shown.

Use the keyhole saw to cut the contours of the opening, first boring a hole with a 3/4-in. bit within the area marked to be cut. This hole is the starter for the saw-cutting operation. (See *Figs. 2 and 4.*) You will need brace and bit also to cut holes in the mounting board perimeter where the template indicates, for bolting the changer mechanism plate. Now use the brace and bit to make openings in the back panel of the base frame to allow the power and signal cords to pass through from the changer to connecting terminals on the tuner. Some technicians say that this is not necessary, as there is ample space for the wires to pass through under the player base, as the sliding tracks raise it sufficiently above the cabinet shelf to permit it.

Unless you have a cabinet with a lift lid in the top, the best way to mount the record player is on sliding tracks. These should be of steel heavy enough to give rigid support to the player when at full slide-out extension. This is important, for you will be loading the records onto the spindle when the player is in extended position, and the mounting should be rigid enough to hold the instrument firm and level with the full record load on. You have your choice of two sizes of tracks, either 12- or 15-in. (*Fig. 5.*)

Secure the top members of the track to the bottom of player base with 3/8-in. wood screws, turned down tightly.

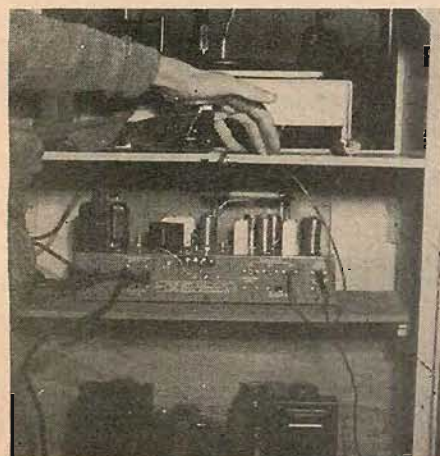

Fig. 5. Rear view of cabinet shows record changer mounted on sliding tracks secured to top shelf. One of the tracks is seen to right of outspread hand.



Fig. 6. Cabinet with tambour doors parted to show record changer on top shelf; tuner with controls on middle shelf; amplifier unit below it. Speaker is in separate cabinet.

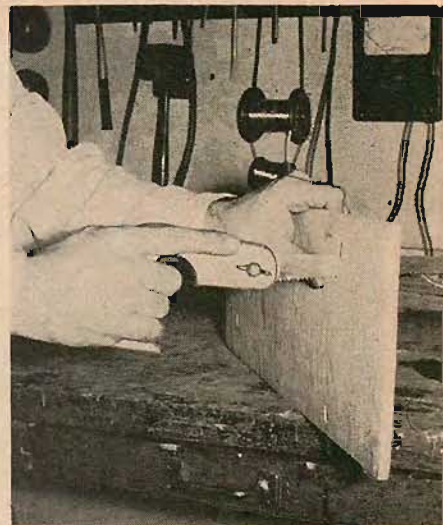

Fig. 4. Keyhole saw is inserted in hole precut with Stickleback saw to make necessary cut-out in plywood panel.

Bottom members of track should be secured in like manner to the top of the cabinet shelf on which the player base will rest. Make sure that top and bottom members are parallel and line up accurately so that you will get smooth in-and-out movement, and absolutely firm positioning when the turntable is extended for loading or unloading records. Be sure to lubricate the sliding members now and then, using a light grease such as Lubriplate.

To Mount the Equipment

The tuner used rests on the middle shelf; all the controls are mounted integrally with the face plate. Secure the tuner to its shelf or base by using a hole indication template to mark off exact locations of bolts or screws. Use the bolts supplied by the manufacturer to fasten the tuner base to its shelf, as in *Fig. 6.*

Use a wood awl to make hole locations, and a 3/8-inch bit to bore the holes. To secure the bolts, use a large screwdriver if they come with slotted heads, or one of the open-end wrenches if the bolts are hex-headed.

Mount the amplifier unit under the tuner. The amplifier used here is without control knobs, the entire installation being operated from the tuner controls.

When mounting this apparatus, use the 3/8-in. lip flange at both ends, which are drilled for easy mounting with four

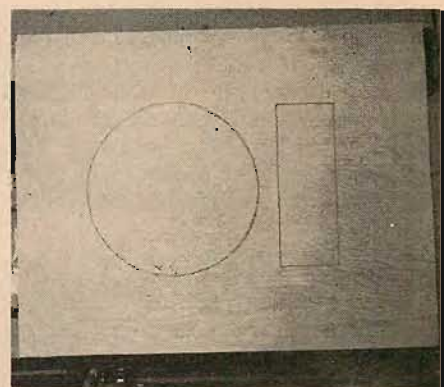

Fig. 7. Speaker baffle is roughed out with scribe-compass for cutting of round speaker opening; carpenter's square was used to mark location of rectangular port opening below it. Cutting is started with either Stickleback saw or hand drill, completed to outlined shape with keyhole saw.

1/2-in. wood screws. Use a wood awl to scratch the hole spot, then set screws down firmly; use medium screwdriver.

Preparing the speaker mounting panel calls for use of the scriber compass. There are two cutouts to be made. One for the speaker, the other for the port opening below it. To cut the round opening for the speaker, use a scriber compass to define the circle, which should be the same diameter as the inside of the felt or cardboard mounting ring of the speaker cone frame, to give the fastening screws plenty of wood to bite into. Go over the scribing with a soft pencil to make the cutting easier to follow. (Fig. 7.)

With a 1/2-in. bit, or with the Stickleback drill saw, make a hole anywhere within the scribed circle, as a starter for the keyhole saw operation, as you did earlier for cutting out the record player baseboard. Cut along the circumference of the scribed-pencilled circle with the keyhole saw to complete the full opening. The cut should be fairly clean, the edges of the circular opening fine sandpapered to a reasonable smoothness. This we counsel under the heading of forming the habit of good workmanship, for the opening will not be clearly seen, if at all, as it will be covered over when the plastic mesh is spread over the entire face of the speaker panel board.

If a port is a part of your speaker baffle, make the opening for it at the same time. Generally it is located about 4 or 5 inches below the speaker opening. Make the opening for the port slightly larger than needed. This should be approximately one-half the area of the round speaker opening. To play it safe, add another ten square inches to the port cutout area.

Cut the opening, which you have outlined and placed accurately with a carpenter's square and a wood marking pencil. Use a 1/2-in. bit to drill a starter hole in any corner of the rectangle, and from there saw out the marked-off area with the keyhole saw to make the port opening. How to tune this port is described later.

To mount the speaker on the baffle, use flat-headed, square-shanked bolts, secured with nuts along the rim of the speaker shell. Wood screws, at least 1-1/2 in. long, may be used instead but are not preferred. The square-shanked bolts, however, which pass through the wood and through the holes in the rim of the speaker frame can be secured firmly with the nuts, and thus you can avoid the possibility of the cone vibrating against the baffle on heavy bass passages. (Fig. 8.)

In securing the speaker baffle to its cabinet, screws should

be placed 6 in. apart. The procedure with the bass reflex cabinet used in this system (of 6 cubic feet volume) is substantially as follows: Line the bottom, back and one side (minimum) so that no two parallel sides are uncovered, and the sound can bounce freely between these surfaces. Use Ozite, Kimsull or other sound deadener material, approximately 1 in. thick. (Fig. 9.)

The cabinet should be fully enclosed, with the back panel well glued into the body of the cabinet and securely held with screws. For bracing, use 2x3 wood stiffeners across the center of inner faces of side and back panels and on front panel, in the space between the speaker and port openings. (For a detailed study see "Vibration reduction in loudspeaker enclosures," by G. B. Houck, *AUDIO ENGINEERING*, December 1953.)

Cover the entire face of the speaker baffle with Saran plastic (Lumite), which does not obstruct sound emission from the speaker.

This also covers the wood-working and nuts-and-bolts phase of the hi-fi installation. Now to establish an electrical-electronic relationship between the parts we have mounted in their respective location for best results.

The Hook-Up—as Simple as it is Vital

Now go ahead with making these connections: 1. Cable from speaker to amplifier. 2. Cable from amplifier to tuner. 3. Cable from record player to tuner. 4. Cable from AM-FM antenna to tuner antenna strips.

Figures 10 and 11 show the components and the wiring used to hook them up.

1. Speaker to Amplifier

Use "zipcord" standard gauge, 16-18 stranded. The length of cord here is not critical up to a distance of 75 feet between components and speaker. Beyond that distance you suffer line losses, which would have to be offset with line transformers. This is a contingency rarely met in the average home installation.

Since the PM speaker used here has an 8-ohm voice coil we attach one end of our cable to the amplifier, to terminal marked "ground" with one of the wires, the other is run to the terminal marked "8." The other end of the cable goes to the speaker terminals. Either of the two wires can be connected to either terminal screw, since these wires are not polarized. Use medium or small screwdriver.

(Continued on page 50)

Fig. 8. Demonstration of fastening of speaker to its baffle. Note long screwdriver for ample leverage to drive screws home for absolutely firm fit. Bolts are recommended, to avoid risk of speaker frame working loose in time and vibrating against baffle when in operation.



Fig. 9. Back panel of speaker cabinet is braced with 2x3 wood stiffeners at top, bottom and through the middle. Note sound absorbing backing (1-inch fibreglass) between wood braces. Wharfedale speaker is mounted on Lumite faced baffle; edges of the plastic show where stapled along inside edges of baffle. Use carpenter's glue and wood screws to fasten back panel to cabinet.

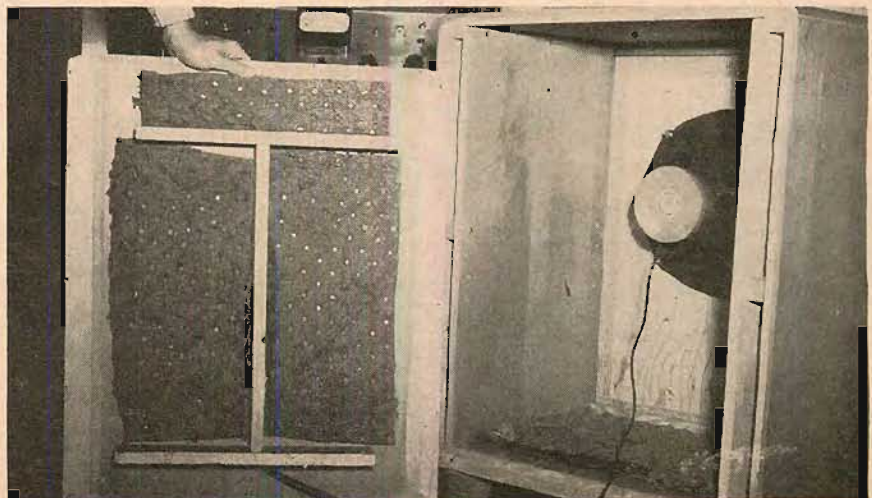

Equipment Report

Radio Craftsmen C-800 Tuner and C-500 Amplifier

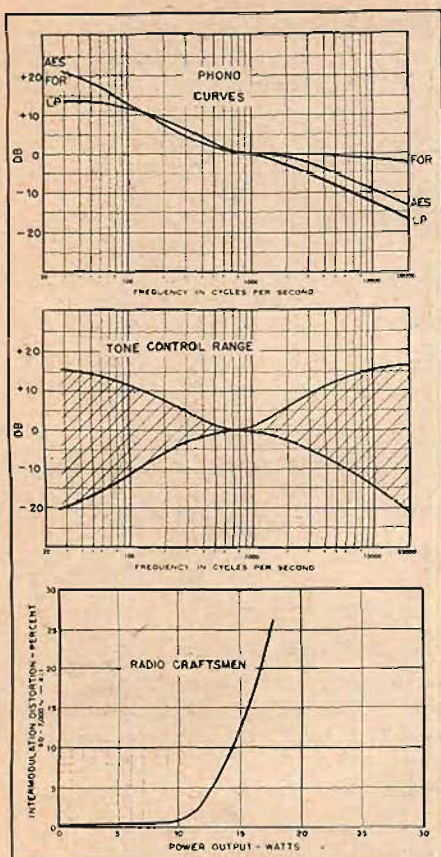

Fig. 1. Performance data for Craftsman C-800 tuner and C-500 amplifier.

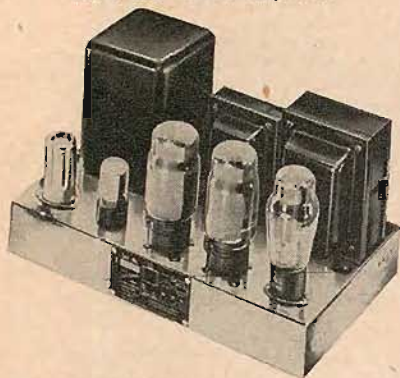

Fig. 2. The Craftsman amplifier.

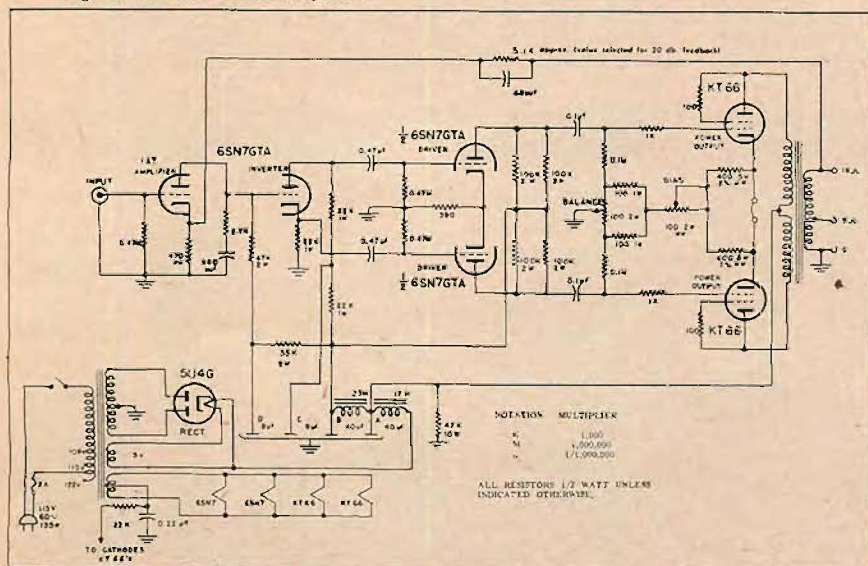

Fig. 3. Schematic of the C-500 amplifier.

MORE AND MORE manufacturers are beginning to provide an entire complement of material for the home music system. Heretofore it has been felt that most of the FM-AM tuners which provided tone controls were equipped with circuitry which was not considered as satisfactory as that used in preamp-control units usually available. However, this is not the case with the Radio Craftsmen C-800 tuner, for its tone controls compare favorably with those used on most separate control units, and the phonograph equalization is adequate for any records that will be encountered today.

The tuner offers excellent sensitivity—somewhat better than 5 microvolts on FM, it appears. The controls are conveniently arranged, with the selector on the left, followed by bass, volume, treble, and tuning. The volume control is a dual unit, which eliminates the possibility of overloading the first stage by signals of high level, and also aids in keeping the hum level to a satisfactory minimum. Two outputs are provided—one ahead of the tone controls labeled “Detector,” so that it is possible to connect a tape recorder at this point permanently without any possibility of recording a program with the tone controls improperly set; conversely it is possible to use the tone controls to assist in correcting the frequency response to make up for deficiencies in the recorder without affecting the program being reproduced in the speaker at the same time.

One good feature of the Craftsman tuners has always been the ease of mounting—a single rectangular opening and five holes for the knob shafts. The escutcheon fits close to the panel and any imperfections in cut-

ting the opening are thoroughly obscured. Dial calibrations were accurate in the model tested, and the tuning indicator—a 6AL7—gave an excellent indication of the correct tuning point. Special mention should be made of the switching between various inputs—there were no “pops” which can be so damaging to tweeters.

The Power Amplifier

The C-500 amplifier, FIG. 2, is an excellent embodiment of the Williamson-type circuit in a commercial product. It has a sensitivity of 1.45 volts for rated output (12.5 watts), and hum and noise level (measured) of 50 db below zero level (.001 watts). This corresponds to 92 db below maximum output, which is better than average. On the 16-ohm tap the output impedance measured 0.47 ohms, which is a damping factor of 34.

The schematic of the amplifier is shown in FIG. 3. Note that the power supply has a choke input, and that there are two filter chokes to minimize hum. Heaters of all four tubes in the amplifier are biased about 40 volts above ground as a further step toward reducing hum. Both balance and bias adjustments are provided, and the amplifier is fused.

Physically, both amplifier and tuner are of attractive appearance, the chassis being finished in chromium plate, and the transformers and chokes in black. This is not considered important in many installations, but most audiophiles take pride in attractive equipment and would enjoy exhibiting the “insides” of their cabinets when equipped with Craftsman components.

Figure 1 shows the measured performance data, plotted in accordance with AUDIO's standard practice. The table below gives the pertinent facts about sensitivity, tuner output, and so on. Measured IM distortion of the amplifier output was 0.98%; at 0.5 volts output it was 0.32%.

CRAFTSMEN C-800 TUNER

Input voltage for 1-volt output

Input Setting	“Amplifier” Out	“Detector” Out
LP	.0065	.035
AES	.0059	.032
EUR	.0054	.030
TV and SPARE	0.19	1.06

**NOW...try the
revolutionary new
Soundcraft**

MicroLac[®]
RECORDING DISCS

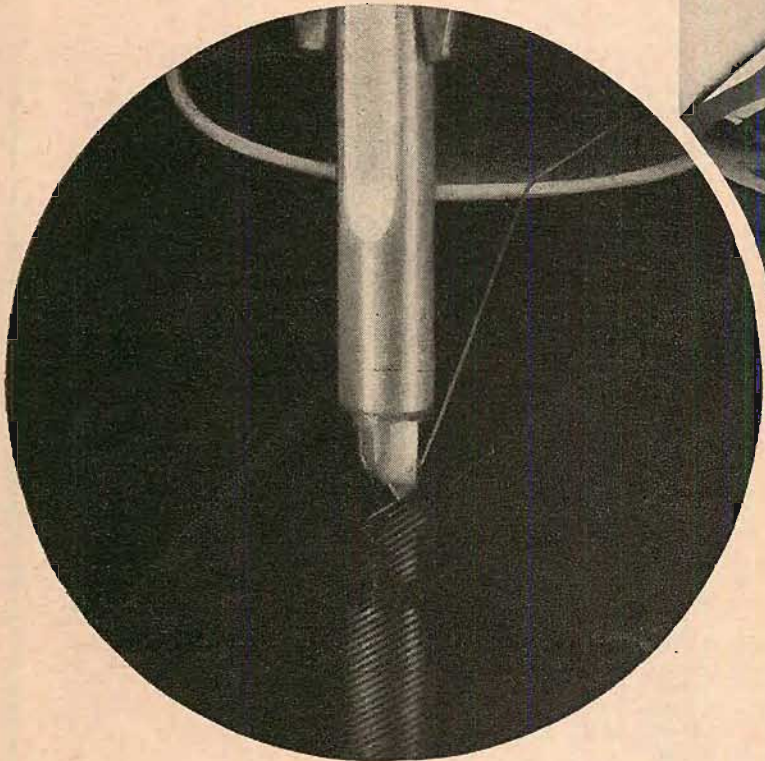

proved best
throughout the
recording cycle

After months of exhaustive pre-testing in leading recording studios throughout the country, Soundcraft brings you its all-new MicroLac Recording Discs. These revolutionary new discs:

1. Are unmatched for play-back perfection.
2. Carry a far quieter, wider range signal straight through from your cuttings to your final stampers.

Check these qualities to see why the new MicroLac Discs are the finest high-fidelity recording discs in the world:

- Noise level well below that of your own recording equipment.
- Perfected thread throw, especially for microgroove recordings.
- Quieter with cold stylus than most discs with hot stylus.
- Unsurpassed silvering qualities, for finer masters, mothers and stampers.
- Mirror-flat surfaces providing . . .
- Constant depth of cut, with or without advance ball.

Soundcraft MicroLac Discs are made on the finest aluminum bases, optically tested for flatness and smoothness . . . degreased for permanent lacquer adhesion . . . deburred for perfect edge seal.

Their new lacquer coating is forced through eight stone filters to a maximum particle size of less than one micron. It is applied automatically in a 250-foot-long sealed tunnel in which four air conditioners in series, each with a Precipitron, remove the last possible traces of dust.

Revolutionary as the new MicroLac Discs are their brand new, high strength, parcel post and tumble tested shipping containers. They deliver your discs factory new. They open easily as a drawer. They make ideal permanent storage chests, with numbered spaces for individual disc titles.

Try the sensational new Soundcraft MicroLac Discs right away. See and hear for yourself why we believe them to be the world's finest!

REEVES SOUND CRAFT CORP.
Dept. 84, 10 East 52nd Street, New York 22, N. Y.



EDWARD TATNALL CANBY*

Voices—Past vs. Present

SUCH A VOLUME of old acoustical recordings is on tap for reissue by RCA Victor that I'm usually forced to let them pass by—but a new series now arriving is well worth signaling. First—the Extended Play "EP" is being used for 45-r.p.m. reissues that hold a good deal more on them than the earlier ones and are thus a useful adjunct to the LP. For instance, a "name" series now coming out includes solo 45 EP's of Bori, Ponselle, Caruso (in Puccini), McCormack. Some of these are early electrical recordings. Four old-type sides on each.

Secondly, RCA is cutting its pie in a new way this month, combining for the first time its older recordings with musically comparable new ones—an excellent idea and very interesting in the listening. Of course we've always had the privilege of making our own comparisons when and as we want, but to have the actual recordings together on one disc is a convenience that is irresistible. Two of these are at hand, as hereby listed, one an LP and the other a 45 EP.

Four Tenors . . . Same Aria; Puccini's Tosca: Recondita Armonia. ^aCaruso, ^bGigli, Jan Peerce, Tagliavini.
RCA Victor 45 ERA-181

A novel experiment which surely should be repeated as repertory allows. It's not easy to put aside the vast differences in technical quality here, but even so the differences in style between the four are decided. From Caruso's faraway but steel-strong tenor to the rather sweet and not overly forceful Jan Peerce is a big step, and the highly dramatic Gigli is unlike all the rest. Tagliavini the modern sensation, seems to me vocally lacking in color, especially as to diction; his vowels somehow have an oatmeal quality.

Not an exciting aria and quite short, but with—paradoxically—a beautiful orchestral accompaniment.

¹Roberta Peters—Youngest Member of a Great Tradition. (With ^aTetrazzini, ^bGalli-Curci and ^cLily Pons.)
RCA Victor LM 1780

This is a tough test for Peters and not, I'd say, quite cricket, unless RCA honestly believes critically that she is the equal of the older members of this great tradition of coloratura. (Next thing you know they'll have Sumac in there.) I'm not so sure myself, which is no condemnation of a young singer thrown up against the heaviest competition in (recorded) history. Peters doesn't equal either Tetrazzini or Galli-Curci, but then I don't think anybody does now.

How the technique of singing has changed! Tetrazzini was well along (1908) when she sang the "Mignon" excerpt on this disc, but what a fabulous accuracy of pitch, what ease with which she hops and jumps about, without a trace of slide or glide! The modern coloratura (and this includes Pons) uses a new kind of false accenting, a kind of bounce to get her fast notes out—a sort of "yuyuyuyuyuh" sound, each note a small punch. Tetrazzini's fast notes are as even and flat as those of a fiddle, as though so many separate keys were being pressed rapidly. Each is entirely on its correct pitch from beginning to end. An extraordinary muscular control, and the overall sureness of tone production (even to the unabashed use of her low "baritone" chest tones!) is really remarkable. So, too, with Galli-Curci.

Luca, Galli-Curci, Gigli, McCormack, Ponselle, Schipa, Tibbett, Thomas.)

RCA Victor LCT 1138

If you want more than the separate 45 EP discs give you, above, take on this one; it repeats some of the material in the singles. Note that early electrical recordings are more and more being mixed with the familiar "old records" of the acoustical era. Electrics of 1927 to 1930 are pretty "old" now, when you come down to it. They give a much better idea of the voices of the past than the acoustics—but they sound very far away, some of them, even so. Hi-fi marches on.

SOME MODERNS

American

* Copland: Billy the Kid. Schumann: Undertow. Ballet Theatre Orch., J. Levine.
Capitol P-8238

¹ Copland: Music for the Theatre. Weill: Kleine Dreigroschenmusik (Suite from "Three Penny Opera"). M-G-M Orch. Izler Solomon.
M-G-M E-3095

Capitol has a musical gold mine in the Ballet Theatre Orchestra. Music for actual dancing, as every dancer of any sort knows, must be rigorously danceable—of the right tempo with the right phrasing and "lift," the proper spirit. Many a line conductor, fiddler, pianist, is at a loss when faced with real dance music, and this applies in exactly the same way to ballroom, square dance or ballet.

This orchestra makes the repertory ballet scores dance for you. "Billy the Kid" is not only colorfully played but throughout there is the ballet "feel" that comes from danceable playing and an exact sense of style. Schumann's more difficult score, "Undertow," gets comparable treatment. A good rather dry hi-fi sound, well suited to the music.

Copland's early work of 1925, the outrageously brash and joyful "Music for the Theatre"—full of nose thumping jazz effects, is given an academic and not very joyous reading here. Though beautifully recorded the performance can't compare with Howard Hanson's old 78-r.p.m. version for RCA Victor, with the Eastman-Rochester Orchestra. And—horrors!—this version primly omits that gorgeous flutter-tongue trumpet blat that so delights us at the very beginning of the old set. Too bad.

Kurt Weill's "Three Penny Opera" is a far tamer sort of jazz adaptation, sounding now as a very much dated bit of imitation, amusing mainly for its oom-pah early jazz sound but minus nine tenths of the tremendous energy that belonged in 1920's jazz. (It was a German work; Weill came to America in the mid-thirties.)

^b Copland: Appalachian Spring Suite; El Salon Mexico. Boston Symphony, Koussevitzky.
RCA Victor LCT-1134

A fine LP reissue of two much beloved older 78 albums, the recorded quality plenty good enough for musical listening.

KEY

- * Outstanding recorded sound for the type of music.
- ^a From acoustical originals.
- ^b Heavy bass end (European-type low turnover); adjust accordingly.
- ^d Distortion in the sound.
- ^{dd} Distortion in inner grooves.
- ^e Extra-sharp pre-emphasis of highs. Use more roll-off.
- ^f Flatter-than-average high end. Use less roll-off.
- ^h Highs are edgy, sharp, miked close-to.
- ⁱ Intimate, close-up recording in good liveness.
- ^L Big liveness, somewhat exaggerated effect.
- ^o From older 78-rpm electrical originals.

Today's voices, I'm sure, are basically no less good than fifty years—or 100 years—ago. But training is different. Extreme physical control and accuracy is no longer taught to the old extent, and perhaps more important, musical accuracy, a sense of super-exact musical pitch, an "ear" is not so often demanded. Lily Pons, even in 1930, was of the new generation and Roberta Peters, though she sings easily as high and as fast as the old gals, does not have a comparably trained instrument—yet. Her voice is rather edgy in the higher end and the tones are not as pure and limpid as they could have been in 1910. But is there anything better nowadays? Make your own comparisons. (The Peters sections of this record are "New Orthophonic" hi-fi, the Galli-Curci and Pons both electrical; only Tetrazzini is acoustically recorded.)

^{oa} Ten Unforgotten Stars. (Bori, Caruso, de

THERE'S NO SPEAKER SYSTEM LIKE IT...

the **deMARS**
Loudspeaker system

**AUTHENTIC BASS REPRODUCTION
AND GENUINE CONCERT HALL QUALITY
IN A COMPACT DIRECT
RADIATION SPEAKER SYSTEM.**

"I have developed a new loudspeaker system incorporating the "Styrocone" speaker, capable of reproducing the sounds of musical instruments from the lowest bass notes through the entire tonal spectrum, into the highest frequencies. This unit is distinguished by naturalness of sound reproduction and resulting excellence of musical definition, which permits listening at concert volume without fatigue. These characteristics are obtained in a unit so compact that it is eminently suitable and practical for home use."

Paul A. de Mars

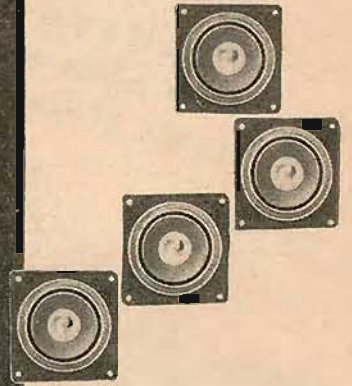
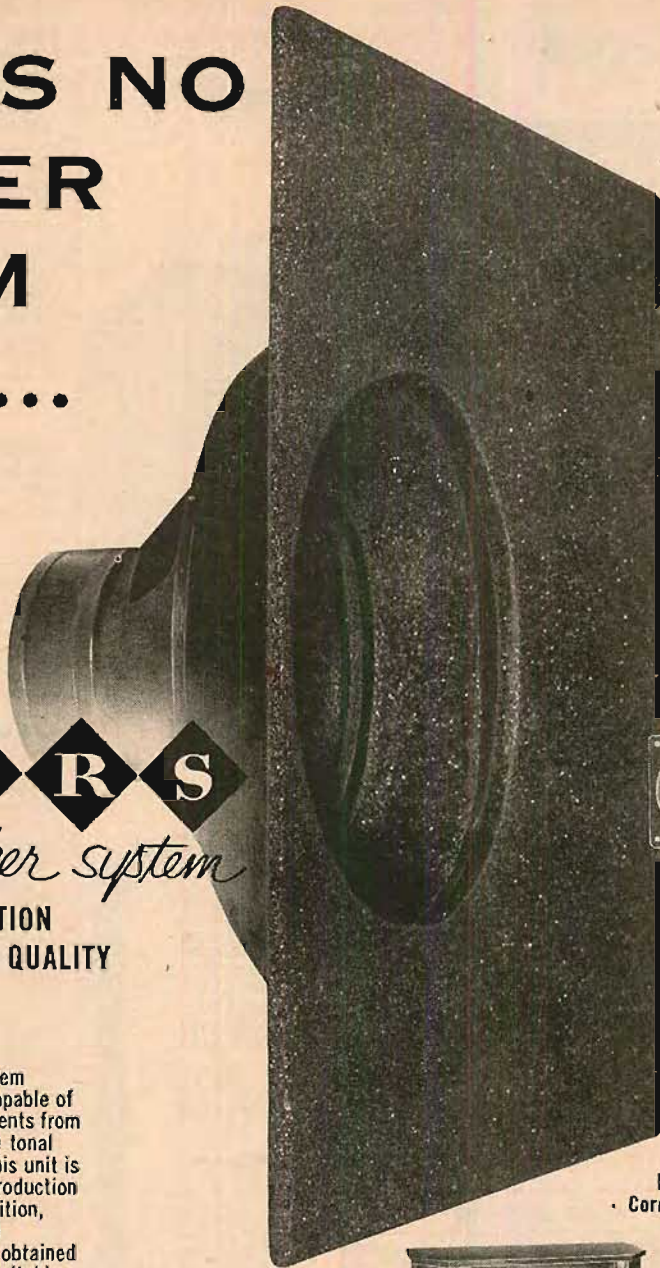

**Model S
Basic System
\$250***

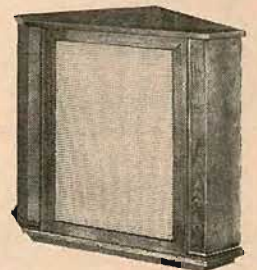

**Model SC
Corner Style
\$450***

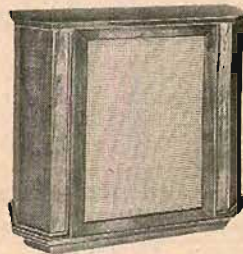

**Model SW
Wall Style
\$450***

Basic system is mounted on wooden baffle board 22" x 32". Enclosures are custom-built of finest, genuine solid furniture woods, all hand-finished in mahogany, walnut, or blonde, to your preference.
*FOB Lawrence, Mass.

deMARS ENGINEERING & MFG. CO. · 360 Merrimac Street · Lawrence, Mass.

<p>Q. What is the deMars speaker system?</p> <p>A. A multi-cone system with a single voice coil mechanism, supported by an array of very high frequency direct radiators.</p>	<p>Q. What kind of loudspeaker system is the deMars?</p> <p>A. It is a direct radiation system as distinguished from acoustic coupling devices, such as horn types or acoustically baffled systems.</p>	<p>Q. What is the opinion of the critics?</p> <p>A. The new deMars system has been tested under many and varied room conditions. Critics have been unanimous in their enthusiasm.</p>
<p>Q. How does the deMars system achieve better reproduction?</p> <p>A. Through the multi-cone principle, which presents the optimum vibrating surface for each area of frequencies over the tonal spectrum.</p>	<p>Q. Why was this new type of direct radiation system required?</p> <p>A. To obtain authentic bass response in the home within acceptable sized enclosures, and independent of location in the living room.</p>	<p>Q. Is the deMars system available, and what does it cost?</p> <p>A. Yes... it is available now, in three models, each built under Mr. deMars' personal direction. The basic system comes pre-assembled and mounted... can be installed quickly and without difficulty by simply connecting 2 wires.</p>
<p>Q. What distinguishes the deMars system from all others?</p> <p>A. It incorporates a new device, called the "Styrocone", which enlarges the vibrating surface beyond that of any other single multi-cone type unit known today... much larger than any other direct radiation system on the market.</p>	<p>Q. What is the advantage of a direct radiation system, such as the deMars?</p> <p>A. It performs better than other types of speakers, except when they are coupled with horns or baffles of prodigious size... and, it is much more flexible and practical for economical installation.</p>	

— MAIL COUPON TODAY —

deMars Engineering & Manufacturing Co.
360 Merrimac Street,
Lawrence, Mass.

Gentlemen:

Enclosed is my check — money order — for style.....

Send me your illustrated literature on the deMars Speaker System.

Send information as to where I can hear the deMars Speaker System.

Name _____

Address _____

City _____ Zone _____ State _____

AE-4

IN STOCK NOW!

at **CHICAGO**

hermetically sealed
**400 CYCLE
TRANSFORMERS**
that meet MIL-T-27:
CLASS B* specifications



*85° Ambient—40° Rise.

These rugged, compact transformers have been designed in close cooperation with organizations directly concerned with the development of standards for aircraft communication, guided missile and related equipment. They are engineered to meet future, as well as current requirements for 400 cycle power supplies.

POWER TRANSFORMERS (All primaries 105/115/125 V., 380-1000 cycles)

HIGH VOLTAGE A.C. Volts	SECONDARY D.C. Ma.	RECTIFIER Volts	FILAMENT Amps.	OTHER FILAMENTS Volts	OTHER FILAMENTS Amps.	CATALOG NUMBER
270-0-270	55	5.0	2	6.3 CT	2	4PHC-55
335-0-335	70	5.0	2	6.3 CT	3	4PHC-70
375-0-375	120	5.0	3	6.3 CT	4	4PHC-120
440-0-440	165	5.0	3	6.3	7.5	4PHC-165
				6.3	3	
				6.3	3	
450-0-450	200	5.0	2	6.3	0.6	4PHC-200A
				6.3	4	
				6.3	4	
				6.3	0.6	
550-370-75-0- 75-370-550	300	5.0	6	6.3 CT	5	4PHR-300
				6.3 CT	1	

FILTER REACTORS

INDUCTANCE (henries)	MAXIMUM D.C. Ma.	D.C. RESISTANCE (ohms)	INSULATION VOLTS RMS	CATALOG NUMBER
2.0	55	160	2,500	4RH-255
2.0	70	240	2,500	4RH-270
2.0	120	105	2,500	4RH-2120
2.0	165	80	2,500	4RH-2165
2.0	200	77	2,500	4RH-2200
2.0	300	49	2,500	4RH-2300

FILAMENT TRANSFORMERS (All primaries 105/115/125 V., 380-1000 cycles)

SEC. VOLTS	SEC. AMPS.	INSULATION VOLTS RMS	CATALOG NUMBER
6.3 CT	3	2,500	4FH-63
6.3 CT	5.5	2,500	4FH-65
6.3 CT	10	2,500	4FH-610
6.3 CT	20	2,500	4FH-620

Write for Chicago Bulletin #32 listing more complete specifications on these units, specially designed for 400 cycle, high-temperature operation.



CHICAGO

the World's Toughest Transformers

CHICAGO STANDARD TRANSFORMER CORP.

3501 ADDISON STREET • CHICAGO 18, ILLINOIS

Virgil Thomson: Variations on Sunday School Tunes. Sessions: Four Chorale Preludes. Marilyn Mason, organ.

Esoteric 522

Here is an interesting organ disc, of two important and very unlike present-day composers. The Sessions music is the more solid and potentially that which will move you the most though it is uncompromising and difficult at first hearing. Not unlike the Bach organ chorale preludes outwardly and those who know and love that sort of music will have a good entree to Sessions. Thomson's variations are, as commonly with him, more subtle than they seem. The flat-footed old fashioned gospel hymn tunes are given some humorous treatment including a number of organ squawks and blats sufficiently undignified to please any lover of the 1920's—when these were written. Organ of St. Paul's Chapel, Colum-

*** Contemporary American Music: (Barber: Adagio. Diamond: Rounds. Copland: Quiet City. Creston: Two Choric Dances.) Concert Arts Orch., Golschmann.**

Capitol P-8245

It's time we all got over those shivers of distaste that have always occurred at the word "contemporary." There really isn't anything in this disc to hurt the sensitive ear of 1954—nothing remotely as violent or as dissonant as the run of popular music and film or TV jazz that most of us hear every week. Barber's Adagio is as juicy as you could wish, Copland's "Quiet City" is a beautifully contemplative night scene (nocturne) with trumpet and English horn solos; the Diamond "Rounds" is one of those slickly made folksy ballet-type scores, full of cowboy synco-pations, easy enough to listen to, if (to my ear) somewhat drier than dry. The Creston Dances feature ultra-rich harmonies and a rather pompous exposition, like a masculine Delius, merging at the second Dance into a vaguely primitive mumbo-jumbo sort of rhythm (in fives) that may remind you of a good Hollywood African head-hunter's scene. Skillful writing and interesting textures.

But how nobly in comparison does Copland's short "Quiet City" stand out above these other works, as music! It's not a great work, but it is good, sincere, simple, expressive, humble, economical, unassuming, honest; whereas most of the rest of this LP seems to me to be mainly a vast quantity of highly expert sound, impressive, complex, signifying not very much, in view of the effort.

What a huge quantity of such writing it takes to develop a style, a way of musical thinking matured enough for a genius to appropriate! There'll be a lot more of this before we acquire an American Mozart or a Palestrina or a Josquin Des Pres (top composer of the 15th century). It's always been that way, though. Every age produces a million so-so art works, polishing up the technique, experimenting, working out procedures, setting up the "system," for every really top work that survives.

of Morton Gould: Interplay; Spirituals for Orchestra. Cor de Groot, pf.; Hague Philharmonic, van Otterloo.

Epic LC 3021

Gould is one of our bigger musical talents. This stuff, out of the same general background as the above, is a lot more intense and expressive than the Diamond or Creston items and better music, in spite of that pervading sense of frustration that seems to attend Gould in his more "serious" works—the same frustration which evidently drives him back to the facile "pops" stuff, so slick and so empty, for which he is best known. A real musician born at the wrong time or the wrong spot or into the wrong body, and one feels the great struggle in every measure of his music.

An odd performance, by the way; these Dutchmen go at the typically American sounds of these scores the way the Germans and English often play American jazz—with a sort of bewildered expression on their faces. Maybe this is the best way to prove to yourself how really American our musical expression has become—and how American you are. Just listen here. The Dutch playing is assiduous, expressive, expert—but it just doesn't roll. They don't get the sense of it. Morton Gould knew exactly what he was doing, and the odd thing is that you will too, immediately, when you hear what these players, for all their good intentions, don't do!

Technical note: The Epic habit of promoting big bass and flat highs, at odds with most other LP's is typified here. This is a fine disc provided you (a) play it with no roll-off at all in the highs and (b) with the bass response considerably reduced from average. But why? Granted, we don't have agreement as to recording curves yet; but this sound is far out of balance with most U.S. records as now made.

Somebody at Epic ought to be able to ferret out the original European tape (disc) curves and equalize them for production over here. Or even simpler, somebody should use his or her good ear, and curves be d—d, to balance the music up for a good sound at normal U.S. playback curves.

Try this disc and the Capitols above with the same equalization if you want to hear for yourself.

*L Bloch: **String Quartet #2 (1945)**. Musical Arts Quartet.

Vanguard VRS-437

Ernest Bloch's very romantic, Hebraic works stand in considerable contrast to most contemporary music, for though they are "modern" in the sense of dissonance, at the same time they have practically none of the snazzy sharpness, the percussion, the dryness that we are accustomed to in today's music. Bloch has been held in top respect by even the more extreme "modernists"—he's no old-fashioned escapist. But if you prefer the atmosphere of, say, Sibelius to that of Copland, Bernstein, Stravinsky, then you'll be attuned to Bloch from the beginning.

This late quartet is not easy but it is passionate in expression and both more dissonant and more concentrated in content than the more familiar earlier works—the first quartet, "Schelomo." Like many a Romantic work, it is very long.

Vanguard's quartet recording outdoes even Westminster's in fullness of effect; it is hard to believe there are merely four instruments here. An exaggerated sound and not really suitable for chamber-style music, but in this case it seems to me well enough suited to the "big" feel of this particular work.

Franco-Russian

*L Stravinsky: **L'Histoire du Soldat (with narration in French)**. Instr. Ensemble cond. Oubradous.

Vox PL 7960

If you've heard the purely musical versions of this jazzy little Stravinsky work on earlier discs you'll be in for a surprise here, for this is the complete work, a cross-breed affair which was intended to be "read, played, and danced," as well as acted; here we have the entire sound including the narrator and the several characters who speak, as well as the music. A super-hi-fi job, too, the musical parts (seven players) filling a big liveness the voices ultra-clear and highly understandable if you know a bit of French. (No text included.)

I have had the ancient and excessively dry Stravinsky 78 recording of this, made in the 1930's, ever since I was too young to know what it was all about. I won't ever forget the time I finally heard and saw an actual stage performance of the work, with Mitropoulos—for the dry bones came startlingly to life in the context of the symbolic and tragic-humorous story of the little soldier returning from the wars with his violin who gets mixed up with the devil in disguise. (This was written in 1918.) Here on this new disc—if you know French—the best of the work is decidedly available. The slangy, casual high-speed French is modern low-brow stuff, the action easily followed in spite of symbolism. And the interlocking of music and words is so important that you'll see how incomplete a purely musical version is.

The big liveness is perhaps a bit too golden for the ultra-dry, crackling music (though it is pleasing enough in effect) and the voices, on a hi-fi system, are too loud in the balance—a common complaint in narration-style recording. (Fine on small systems where the music is kept down.) Otherwise, this rates as a top quality recording.

*Lehdd Stravinsky: **Apollon Musagète (1928); Pulcinella (1920-23)**. Vienna Chamber Orch., Hollreiser.

Vox PL 8270

"Apollon," for string orchestra, is one of Stravinsky's most gracious and likeable scores,

AT
ALLIED

**high fidelity
is NOT expensive**



the
Golden Knight

**24-WATT DELUXE
HI-FI AMPLIFIER**

±0.75 db

20 to 40,000 CPS

**UNCONDITIONALLY GUARANTEED
FOR ONE FULL YEAR**

THE FINEST FOR LESS. This is the amplifier designed to provide optimum performance in limited-budget home music systems. Delivers very wide response with extremely low distortion; has plenty of reserve power for authentic reproduction of peaks. Important features include: specially designed output transformer with interleaved windings for virtually distortionless output; input for mike; selector switch for proper loading of G.E. or Pickering cartridges; equalizer for accurate playback of all records; separate bass and treble tone controls.

Specifications. Rated output: 24 watts. Frequency response: ±0.75 db, 20 to 40,000 cps at rated output. Harmonic distortion: less than 1% at rated output. Intermodulation: less than 0.5% at normal listening level, less than 2% at rated

output (60 cps and 7 kc tones; 4:1 ratio). Hum and noise: 80 db below rated output. Speaker out. imp.: 8 and 16 ohms. 4 inputs: 1 magnetic phono, 1 high-imp. mike, 1 tuner, 1 aux. (for crystal phono, tape, TV, etc.). Controls: Off-on-volume; Bass (calibrated from +16 to -16 db); Treble (+16 to -16 db); Input-Equalizer Selector (Aux, Tuner, Mic, Flat, AES, and NARTB). Controls at top of chassis: G.E.-Pickering input switch; also bias, output balance, hum balance controls (screw-driver type). Tubes: 3-12AX7, 2-6L6; 5U4G rect. Entire chassis is beautifully finished in satin-gold. Size: 8 x 14 x 9" deep. Complete with tubes, connectors, instructions; with control shaft extenders and removable lucite panel. For 110-130 v., 50-60 cy. AC. Shpg. wt., 30 lbs.

93 SX 321. Net. \$79.50

"GOLDEN KNIGHT" HIGH FIDELITY MUSIC SYSTEMS

COMPLETE PHONO SYSTEM

A super-value, true high fidelity phono system, ready for custom installation. Includes color-coded cables, plugs, hardware and instructions for quick, easy hookup. The complete system includes: the "Golden Knight" amplifier (described above); the famous Electro-Voice SP12-B 12" Radax Speaker (with built-in "Whizzer" high-frequency radiator); the precision-built Garrard RC-80 3-speed record changer, and the General Electric RPX-050 triple-play cartridge with dual-tip sapphire stylus. These top-quality matched components form a superb high fidelity installation at a truly modest price. For 110-120 volts. 60 cycle AC. Shpg. wt., 60 lbs.

94 SX 127. Net, only. \$161.75

FM-AM-PHONO SYSTEM

Same as above, but includes the new KNIGHT Model 727 FM-AM High Fidelity Tuner for complete radio-phono entertainment. Tuner has dual built-in antennas, FM RF stage, minimum drift. Shpg. wt., 76 lbs.

94 SX 128. Net, only. \$214.50



FREE 268-Page Catalog

Write today for ALLIED'S complete guide to the world's largest selection of High Fidelity home music systems, amplifiers, tuners, speakers, changers, recorders and accessories. If it's anything in Hi-Fi, it's in stock at ALLIED. Send for our FREE Catalog today.



ALLIED RADIO
Everything in High Fidelity

ALLIED RADIO CORP., Dept. 17-D-4
100 N. Western Ave., Chicago 80, Ill.

- Send 24-Watt Amplifier Spec. Sheet
- Send FREE 1954 Catalog

Ship the following.

. \$ enclosed

Name

Address

City Zone State

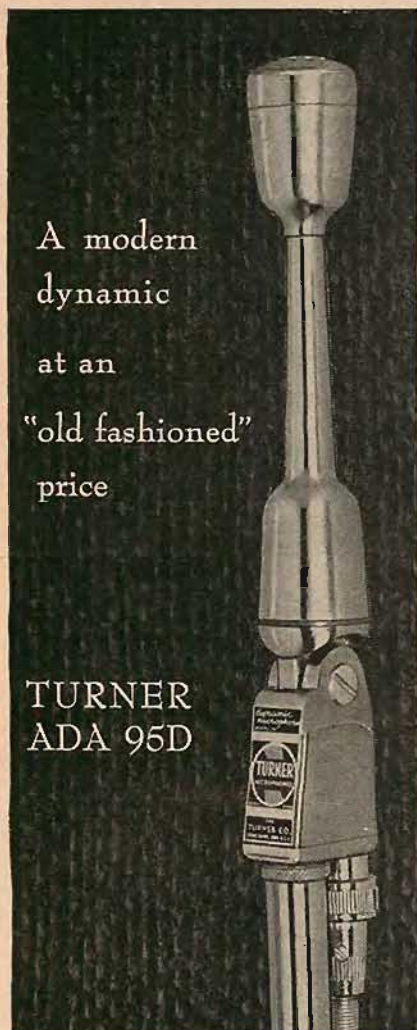

A modern
dynamic
at an
"old fashioned"
price

TURNER
ADA 95D

This is a modern dynamic microphone all right . . . with Alnico V Magnets and moving coils for maximum sensitivity to voice and music. Wide response range and outstanding sound characteristics make it ideal for tape recorder, PA, or commercial broadcasting use. Its design is certainly modern, too . . . trim, handsome, functional.

And about that price. We call it "old-fashioned" because it's so much lower than you would expect to pay in these expensive days. Only \$35.00 list.

Frequency response, 70 to 10,000 cps; output level, -58 db; 20 ft. removable grey plastic cable set; standard 5/8"-27 coupler; high impedance wired single ended (single conductor shielded cable); 50, 200, or 500 ohms wired for balanced line (two conductor shielded cable). About 8 1/2" high.

ADA 95D. List Price-----\$35.00

ADAS 95D. List Price
with slide switch-----\$38.50

THE TURNER COMPANY
929 17th St., N.E.,
Cedar Rapids, Iowa

CANADA: Canadian Marconi Co.,
Toronto, Ont. and Branches
EXPORT: Ad. Auriema, Inc.
89 Broad Street, New York 4, N. Y.

full of quiet melody, constantly varying in rhythm and texture, remarkably unassuming in nature, with a number of "catchy" tunes that will endear it to any listener after a playing or so. Being ballet music it dances, too, as only expertly managed strings can dance. The brash, jazzy dryness of "L'Histoire" is entirely missing here, ten years later.

"Pulcinella" is a unique work composed "after" music by the 18th century composer Pergolesi ("La Serva Padrona," "Stabat Mater," etc.). Again a ballet in the original, it was one of a number of revampings of older music instigated by the famous Diaghileff of the Paris Ballet Russe. Others were "The Good Humored Ladies" based on Scarlatti sonatas, and "Le Bourgeois Fier" (Rossini-Respighi), reviewed in the March AE. But these were confined to free orchestrations of the original music, whereas Stravinsky went much further; he re-composed the bits and pieces of Pergolesi into a new work in an idiom of his own. A strange and heady mixture it is, too, both composers, old and new, quite audible yet beautifully fused into a style that is both 18th century and modern all at once.

The suite, re-worked from the ballet, has a pleasant concerto-like instrumentation with numerous solo elements, some fine and very un-Pergolesi-like brass writing.

Both sides of the Vox disc have the same wide-range recording, a stumpy sound somewhat in the manner of the Vox with a huge liveness and at the same time a very sharp edge, close-to, to the fiddles and trumpet and the like. Not ideal for the music, but the sound is so gorgeous that I'm forced to give it a star (above) even so. Extreme pre-emphasis of the highs (perhaps aided by the sharp-edged microphoning) requires a lot of roll-off and the inner grooves tend to distort, aided in turn by the sharp and highly complex sound of loud strings, close-up. A good stylus will get through to the end with reasonable safety.

ld Stravinsky: "Pulcinella". Respighi: Old Dances and Airs for the Lute (Suite #3). Orchs. of Radio Berlin, Rother, Lange. Urania URLP 7093

This radio performance of "Pulcinella" is an excellent one too—perhaps all in all a shade better than the Vox though both are good. This one is crisper, drier, more controlled and, I suspect, nearer to Stravinsky's concept as of the 1920's. The recording is, like so many of the Radio Berlin issues, so-so in quality with slight distortion throughout but the microphoning is significantly different—and better—than the Vox in that it is closer, more intimate, the solo instruments sounding a normal solo size without enlargement. Frankly, I couldn't make a clear decision on the two as to a "better" version; instead I find the differences in interpretation and mike effects so fascinating that I'm glad to have both around. You may want to try too.

The Respighi arrangements of lute music for string orchestra, one of numerous similar restorations by this man, is to my feeling pretty far out in the direction of bad taste, especially a couple of items here for elaborate double-stop swipes in the whole mass of strings. Pretty elephantine stuff if you know the original lute sound, closely related to the guitar as played by such as Segovia Elephantiasis of the lute!

Stravinsky: Music for Two Pianos and Piano Duet. (Concerto for Two Pianos Soli; Sonata, Trois Pièces Faciles, Cinq Pièces Faciles) Bartlett and Robertson. M-G-M E 3038

An interesting collection technically well recorded. (How different is the sound of two pianos from that of a single instrument!) The big works here are two, the Concerto of 1935 and the Sonata of 1941. The Concerto is a tremendous and utterly original piece, using the two pianos almost literally as one instrument—the musical lines of notes actually run back and forth from one player's part to another, a single bracket striking right out across the page. How two pianists ever learn the stuff I don't know, but it has been done often enough. This work the equivalent of a mighty work for orchestra (not unlike the Bartok Concerto for Orchestra in its concept of the whole mass of two pianos and twenty fingers as both "orchestra" and "solo") is toughest in the first movement, which to my ear doesn't come off well here. Bartlett and Robertson don't get the sense of it. But the wonderfully drawn-out second movement, full of glittering trills and runs and short, pungent ideas over a leisurely foot-tapping bass, is very well

done and the following variations, powerfully dissonant as only a monster piano can be, are as potent to the ear as any dose of modern jazz brass.

The short, sweet Sonata for two pianos is utterly different, a little gem as transparent as Mozart, a kind of modern "Kleine Nachtmusik," with the sweetest dissonance you ever heard. (Maybe it'll take a few plays to get that idea over, but I assure you it's in the music.)

The other items are trifles, little pieces written at odd moments (1915 and 1917) between bigger works. One piano, two players, one a "learner." These are from the earlier nose-thumbing witty period—it started in France long before we caught it in the 1920's—and you'll find some exhilarating blats and squeaks and a lot of good French tunes decorated with saucy dissonance. Some Petrouchka-like touches, too. Altogether a fine disc for indoctrination.

* Album Prokofieff (Piano Concerto #3, Visions Fugitives, Toccata in D Minor). Samson Francois, pf., Paris Conserv. Orch. Cluytens.

Angel 35045

If you're curious as to the more rigorous aspects of Prokofieff (as compared with the familiar "Peter," "Classical Symphony," and the like) here's an album full of his early-middle music, from the teens of this century. Though we know him best as a rather gentle and very human melodist, Prokofieff had his period of "primitive" or "mechanistic" music, along with the others of his age; the best known examples are the Scythian Suite and the first violin concerto, both now often heard, dating from the World War I era.

The 3rd Concerto (1921) is a cluttered work full of a vast number of piano notes that never seem to slacken off; not by any means his easiest opus for most ears. The violent Toccata is a tour de force of "piston-like" pianism, quite effective in its way the "Visions Fugitives" more nearly the better known P. with a good touch a graceful impressionism. (He was an expert pianist himself, and played all of these.) The long-haired Samson Francois is a competent but not an overwhelming exponent of this music—which takes a controlled ferocity like Horowitz' and fingers like Rachmaninoff's. Excellent full-bodied piano recording, with fine bass.

* Shostakovich: Concerto for Piano, Trumpet and Strings (1933). Piano Sonata #2. Menahem Pressler, pf.; Harry Glantz, trumpet, M-G-M Orch., Bloomfield.

M-G-M E 3079

M-G-M does it again, as the old phrase goes! First, it's a top ranking technical job, beautifully balanced for piano, trumpet, strings, with just the right degree of hard edge to suit this music plus a big fullness of reverberation that is not, however, overblown and forced as in so many recent discs. Truly an ideal sound for the type of music.

The concerto is one of Shostakovich's most effective works, modern and dissonant and all that but with the catchy, showy dramatic impact of his earlier music, before he got himself involved in those huge and inflated symphonies of the later years. This work is a good cross between the popular Fifth Symphony and the neatly tailored First, to my ear a better work than either as to content. The combination of big piano and occasional trumpet solo is most attractive, against expertly managed strings.

The long Sonata (piano solo) is much tougher stuff, but the astonishing persuasiveness of Menahem Pressler's piano will get the sense of it to you even so. Pressler is for my ear the finest new young pianist now recording and one of the most sensitive musicians I can remember hearing. M-G-M is lucky to have him.

* André Jolivet: Piano Concerto (1950); Concertino for Trumpet, Piano and Strings (1948); Andante for Strings (1934). L. Descaves, S. Baudo, pfs., Roger Del Motte, trumpet, Orch. du Th. Champs-Elysees, Bour.

Wesminster WL 5239

Another concerto here for the same combination as the Shostakovich, trumpet and piano, though the resemblance is superficial. Also, the most appallingly violent concerto I've ever heard played, the Piano Concerto of 1950. Jolivet is a middle-aged Frenchman whose development was

"arrested" by the last war. His position now as a "new" composer is somewhat like that of the thousands of elderly college students who have been going through our colleges since the war, for similar reasons. He's just beginning to move.

The Trumpet Concertino, though it is far more modern than the Shostakovich—more thoroughly dissonant, nearer to the atonal less tongue-in-cheek—has, strangely, an almost old-fashioned flavor, as though it ought to have been written in the 1930's but got delayed. The typical brittle, shrug-of-the-shoulder French eloquence is here—serious but always with a touch of acid humor. The trumpet part is fiendishly demanding.

The bigger Piano Concerto of 1950 is another story. Scored for a menacing triple battery of heavy percussion as well as the standard orchestral force, it is in truth, a menacing work, full of furiously honest violence not by any means for mere entertainment—for it surely expresses to the hilt that feeling of sick, hard desperation that so much of the world shares at this moment. Phew! Enough to make anybody's spine shiver. The early Adagio for Strings, 1934, is an intense and dissonant piece but it fairly reeks of lyricism compared to the 1950 concerto.

What is music? A lot of honest Americans think it should be sweet (and escapist) entertainment. Some of us do not, myself included. This thunderous concerto puts our theory to a pretty dismal test, for if this is as well written and cogent in design as it seems to be, then its terrifying violence is no more than a legitimate expression of the violence all of us would like so much to put out of our minds, if we could only afford to do so. I'm all for honest, wide-awake expression without escapism—but I don't find it one little bit pleasant to face, as here. Neither is life itself very pleasant today, as one reads the morning papers.

ABOUT MUSIC

(from page 14)

manifold: (1) to encourage a "back-to-music" movement among audiophiles who are perhaps a trifle jaded with gorgeous sound and require a new perspective in listening; (2) to take a long view at the mushrooming LP repertoire, covering fields that for obvious reasons cannot be tackled in the capsule review; (3) to point up the effects of recording techniques upon musical values; and (4) to uncover trends—parallel or opposing—in the worlds of music and recording.

Turning from general to specific objectives, here are some of the ideas I plan to discuss in forthcoming issues: The stream of pre-Bach music pouring into the LP catalogue promises to become a flood; this might be the time for an evaluation of the recordings at hand. Must it be complete?—the advantages and pitfalls of the "unabridged" edition. . . . Mayhem in the control booth—turning quartets into string orchestras, and triangles into cowbells. . . . The question of piano vs. harpsichord.

These and other aspects of the LP repertoire ranging anywhere from Gregorian Chants to the latest scores of Edgar Varèse will be explored primarily from the musical standpoint, but fully conscious of the audio implications.

The success of these articles could be measured in proportion to the frequency with which the reader will get up from his easy chair, walk over to his record cabinet, and grant another hearing—or in some cases a reprieve—to many related sections of his library. By sharpening his critical observation, the audiophile will automatically expand his musical horizon and derive more enjoyment from his record collection, both present and future.

db's

by L. H. Bogen
Member, Audio Engineering Society
Vice President, David Bogen Co., Inc.



VIVE LA DIFFERENCE!

Consider for a moment the different conditions that will affect the relationship between you and your amplifier:

The different equalization curves used by the various record manufacturers.

The difference in room acoustics.

The difference in taste and hearing sensitivity of the listeners in the room.

And especially, the difference in what you can hear at different volume levels. (The Fletcher-Munson curves show that, as you turn the volume down, your ear tends to lose the highs and lows more quickly than the middle registers.)

This explains why critical listeners soon begin to think in terms of an amplifier offering extreme flexibility of control, such as the Bogen DB20.

This factor alone, we felt, called for the flexibility of a separate and accessible Loudness Contour Control.

In addition, the Bogen DB20 has a 7-position record compensator for LP, AES, NAB, AM78, EU78, FFRR and Pop records. Of course, it also offers wide-range treble and bass controls.

Performance is brilliant: 20 watts with a distortion of only 0.3%, and a response of 20 to 20,000 cps ± 0.7 db.

When you discover that the price of the DB20 amplifier is only \$99, you will readily understand why it is a best seller in its class.



Companion FM-AM Tuner is the Bogen R604

This unit fills a real need in the market for an FM-AM tuner with solid circuitry and excellent performance to sell for under \$100. Sensitivity is 5 microvolts for 30 db quieting. FM frequency response is 50-15,000 cps ± 1 db. Stability is exceptionally good, with Automatic Frequency Control and temperature-stabilized oscillator effectively preventing drift and eliminating warm-up period. Price: \$97.35.

A different approach to the loudness-contour problem

The Bogen DB20 features a separate Loudness Contour Selector developed by our own engineers, which permits you to select the properly-compensated frequency response for each volume level. Five step-type positions are provided, corresponding to the Fletcher-Munson curves.

I would like to tell you why our engineering department decided to develop a separate Loudness Contour Selector instead of using the customary type of selector which is activated by the volume control.

We felt, for one thing, that the combined loudness compensator and volume control did not adequately take into consideration the problem of non-standardization in the recording industry. Record manufacturers display the same rugged individuality in the matter of record output level as they do in equalization curves. There are readily apparent audible differences in output level not only in records of the different companies, but even between records bearing the same label.

Have you sent for a copy of "Understanding High Fidelity"?

Louis Biancolli and I have written this 48-page book with the idea of providing, in about 2 hours' reading time, a theoretical and practical ground-work for the man who is serious about custom hi-fi. For a copy of "Understanding High Fidelity", mail the coupon and 25¢. (If you already know your theory and application, send for the free Bogen catalog.)



David Bogen Co., Inc., Dept. NK
29 Ninth Ave., New York 14, N. Y.

Send "Understanding High Fidelity" (for which I enclose 25¢), and free catalog.

name _____

address _____

city _____ zone _____ state _____

Send free catalog only.

Bogen
ELECTRONIC EQUIPMENT

here is how Audax's new Stylus-Disk works

"... As months went by, total ignorance as to the playing conditions of my diamonds began to plague me. The STYLUS-DISK has effectively removed all my worries. Now I am intrigued no end—how does it work? Thank you again for making this simple, inexpensive device available..." (from a letter)
This is in answer to the letters asking how STYLUS-DISK works.

No jewel point is permanent, therefore, periodic checking of the jewel styli is necessary if good reproduction and the records themselves are to be preserved. The great variation in durability of jewel-points gives extreme importance to the ever present question... WHEN TO CHANGE THE STYLUS?

A microscope shows a tiny flat on any diamond (much sooner on sapphire) after 40 hours or so of play; yet the jewel is in normally good playing condition. The detection of actual cutting edges is what matters vitally. Thus a microscope (\$15.00 to over \$100) is useless to an untrained observer. He can see, but he cannot judge. It is too late to discover suddenly, that a stylus is worn. That means records already ruined.



Ingenious CAM-ACTION

Everyone knows that when a stylus reaches a certain degree of wear, it starts on a rampage of record destruction. If such a stylus were used on a record made of soft material, abrasion would show up much sooner. With "Cam-action" grooves, as in STYLUS-DISK, the slightest wear on the stylus will scrape and visibly change the color of the STYLUS-DISK grooves, long before it would be visible on any hard commercial record. THIS IS THE TIME TO CHANGE THE STYLUS.

STYLUS-DISK POINTERS

1. Gives VISUAL warning of ruinous needle-wear, at its inception.
2. Will test—AT HOME—any type of stylus, in any type of pickup—33-1/3, 45 and 78 rpm, in a jiffy.
3. Neither stylus nor the cartridge need be removed for the test.
4. Only a few grooves are used for each test and the same grooves may be used over and over again, until finally a defective needle scrapes and changes the color of the groove-walls. Should last for years.

ONLY \$3.90 net

Be sure to write for descriptive literature concerning the novel and record-saving

STYLUS-DISK

AUDAK COMPANY

500 Fifth Avenue New York 36

Creators of Fine Audio-Electronic apparatus for over 25 years

"The Standard by Which Others Are Judged and Valued"

TOPS IN HI-FI POPS

ROBERT SYLVESTER

AS THINGS ARE PROGRESSING in the popular jazz fields, the main idea currently seems to be not how well you can record a tune but how long you can keep recording it. One new outfit recently came up with an 8-inch LP with only one song on each side—a 12 minute session of variation and riff for each—and there are several new exhibits on which no song is played for less than six minutes.

The idea is sound enough and has things solidly in its favor. The standard 3½-minute version which was an iron-clad rule with the standard recordings of yore can be improved, very probably, only by added choruses and riffs. If a 3½-minute orchestration is badly played, for instance, there's at least a chance it will get better if the musicians can get rolling in extra time. And if a 3½-minute orchestra, vocal, or combo solo is good, 3½ minutes is more of a teaser than a satisfactory performance.

The most brilliant of the current new extra-chorus items is a 12-inch Columbia release of the pianist Erroll Garner. Long a legendary figure in the jazz world, Garner has recently caught the ear of music critics and concert maestros as well. On his newest release he does a 6½-minute *Will You Still Be Mine* and a 7-minute *Caravan* which will surely go down as keyboard milestones in jazz history at least. And probably elsewhere.

These two selections he treats with his incredible speed, his wonderful invention, and advanced virtuosity. In each of these songs he goes off on riffs which, while staying within the basic frame of the composition, are melodic improvements on the tempo and theme of the original. The two long specialties are varied with *No Greater Love*, done in his older style of slow, gentle, full chords; *Memories of You* with its extended scale and his familiar chime and Chinese effects in the treble; an almost military beat behind *Avalon* and the modern bop classic, *Lullabye of Birdland*.

In the past five years Garner has made literally hundreds of records, most of which were badly recorded, badly balanced and—alas!—often carelessly played. But the new Columbia effort catches him at his best—which is just about the best there is.

A new label in the jazz field is called Vanguard Jazz Showcase and its first experiments are both interesting and promising. Vanguard's publicity explains that it records with only a single, full-scale microphone, keeps engineers in a separate room and unseen, puts together

jazz musicians who have rarely if ever played together and thus hopes for the real, backroom jazz "sound."

The most unusual of the new Van-guards (all are LP's) is Mel Powell, the legendary Benny Goodman pianist and arranger who turned from jazz to the classics, teamed with such solid Dixie-landers as Edmund Hall, Buck Clayton, Jimmy Crawford and others. The boys do a breezy *S'Wonderful*, a melodic *It's Been So Long* and rough *I Must Have That Man* on one side. But it is the other which is the killer.

This side starts out with a brassy, gamy, two-beat jazz tune called *Lucky To Me* and sounds about as it should. Then, without much warning, the rest of the side is given over to a long, three-part *Piano Sonatina* by Poweil. It's delicate, intricate, timid and mild enough to have been written for the harpsichord.

Vanguard has issued two LP's fronted by Vic Dickenson, a trombonist who can play any style in the world. With one group of Chicago-style jazzmen he devotes one whole side to *Jeebers Creepers* and the other side to *Russian Lullaby*. Needless to say, everybody gets a chance at his share of choruses. On the second Dickenson disc, the maestro is particularly fine and mellow in a low register with the standard *I Cover The Waterfront*—also a 12-minute bit.

Vanguard does the jazz fans a further favor by presenting Sir Charles ("Case") Thompson, a Negro pianist long unsung in his own 12-minute riff called *For The Ear* and on three progressive-school items called *Bop This*, *Memories of You*, and *Oh, Joe*.

As for the more conservative record producers, Victor offers its two heavy-weight male singers on separate platters. On a standard 78, Eddie Fisher does *I Need a Girl* and *Anema E Core*. Fisher is, of course, on a Mulberry Street kick and both songs have Italian overtones and partial Italian lyrics. Behind him, as usual, the orchestra of Hugo Winterhalter fills in every niche and lifts things up whenever they need lifting.

Victor's other champ, Perry Como, attempts a much tougher and more unusual effort and carries it off with style. Under the title *I Believe*, he sings nine religious songs ranging from *Eli, Eli* in Yiddish to the rarely heard church chant *Act of Contrition*. As usual, he sings with taste and sincerity and the record might very likely open a whole new market for both singer and producer.

Victor also offers the four Ames Brothers in pops and standards which will doubtless be juke box favorites.

Their best pitch, in this opinion, is the bouncy *It's Gotta Be This or That* and their worst is tough to choose between *Of Man River* and *Noche de Ronde*. They sing close harmony and seem to understand each other. There's no reason why brothers shouldn't, of course.

Decca is sure it has a new male star in Georgie Shaw on a standard 78 which backs up *Till We Two Are One* and *Honeycomb*. On *Till We Two Are One* Shaw reveals himself as a sort of strong boy with a wail, an echo chamber, and some sensible phrasing. The song will probably climb right up there with the leaders. It has all the popular elements and not a bad lyric. *Honeycomb* is one of those comic hill billies which I refuse to analyze.

Capitol also has its big man on tap with Nat King Cole doing a standard 78 of *Answer Me, My Love* and *Why*. Both are good Cole with *Answer Me* sung in his neat and sure ballad style and *Why* a lighter item handled with ease and gaiety.

If you're in the mood for a little more piano, this department has just caught up with a Roost Record and a Prestige release, both LP's, by Billy Taylor. Taylor is familiar to night club music buffs on both sides of the town. He is one of the most accomplished musicians we have and both records—each with eight songs—prove his amazing versatility. His work, as ever, shows education and unique personal imagination and he is unqualifiedly recommended to the bigger record companies with better distribution and promotion.



Employment Register

Personnel may be listed here at no charge to industry or to members of the Audio Engineering Society. For insertion in this column, brief announcements should be sent to Chairman, Employment Register Committee, P. O. Box 628, Mineola, N. Y. before the fifth of the month preceding the date of issue.

★ Positions Open

● Positions Wanted

★ **Young Audio Technician** for high fidelity servicing. Capable of handling tools and mechanical work for cabinet prefabrications. Write resume of experience and state salary expected. Must live in Metropolitan New York. Box 401, AUDIO.

● **Audio Engineer:** Interested in position beginning on or after April 15. Well versed in electrical and mechanical design of high quality amplifiers and associated instruments; experienced in recording procedure. Broad knowledge of acoustics ranging from speaker enclosures to pipe organs. Resume sent on request. Box 402, AUDIO.

● **Audio Design and Development Manager:** Twenty years experience in audio, including operation of recording studio, direction of research and development on equipment projects, engineering and production on tape recorders. Available within 30 days. Box 403, AUDIO.

SEE LEONARD RADIO . . . FOR THE FINEST IN TAPE RECORDING!

Here's the second in our "Monthly Product Series" designed to bring you the finest! Remember . . . both the HFP-1 and the 9T-3M have been subjected to rigid testing in our laboratories!



PENTRON HFP-1 Recording Preamplifier with Illuminated Meter

SPECIFICATIONS: SIZE: 10³/₈" w x 4⁷/₈" h; FREQUENCY RESPONSE: 50-15,000 cps ± 3 db flat; INPUTS: Mike, .001 high impedance, Radio-Phono 1 volt high impedance; OUTPUT: 1 volt-10,000 ohms or better; SIGNAL TO NOISE RATIO: 40 db; TUBES: 2-6AU6, 1-12AT 7, 1-12AU 7, 1-6X4; CONTROLS: Volume control and power switch, Record or Playback switch, motor power switch, compensation control switch.

5950



PENTRON 9T-3M Two Speed Tape Mechanism

SPECIFICATIONS: 2 speeds (3.75" and 7.5" per second; push-pull speed change; up to 2 hours play, separate record-erase heads with removable pole pieces; rewind-forward speed 1200 ft. in 40 seconds; flutter; 0.3% at 7.5", 0.5% at 3.75"; 4 shaded pole, self-starting induction type balanced motor; 105-125 volt, 60 cycle AC; available for 220 volt, 50-60 cycle AC.

5975



PENTRON HT 225 3 speaker High Fidelity Tape Recorder

~~Reg \$225~~ **168⁷⁵** net.

Special Pentron Features:

- External "Tweeter" with individual volume control
- Two internal "woofers"
- Complete LC crossover network at 1000 cycles
- External "Woofer" can be used with "Tweeter" by plugging into speaker jack on front panel
- Lid can be closed and Pentron operated with 7" reels

PENTRON 9T-3C Multi Speed Portable Tape Recorder

~~Reg \$189.50~~ **139⁵⁰**

Here is an all new, portable, multi-speed tape recorder that outplays and outperforms any other recorder in its price class! Complete with push-button speed change for 3³/₄" or 7¹/₂"; super speed in forward and rewind; unique editing key and many more exclusive features.

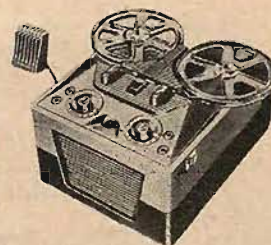

Mail and Phone Orders Filled. 25% Deposit, Balance COD.

LEONARD RADIO, INC.

69 Cortlandt St.

New York, New York

Cortlandt 7-0315

Buy PEERLESS
and you buy
the BEST!

Insist on Peerless 20-20
And 20-20 Plus transformers.

Consistent quality.
Uniform response.

Smooth roll-off.
High efficiency.

Low distortion.
No dips, no peaks.

When your amplifier is equipped with a Peerless 20-20 Transformer (20-20,000 cycles) you can be confident of high quality performance. Rigid adherence to stringent specifications and tight quality control are reflected in the outstanding performance of Peerless 20-20 transformers—surpassed only by the 20-20 PLUS line.

When superlative performance is desired, the Peerless 20-20 PLUS is the answer. The 20-20 PLUS has all the famous features of the 20-20 line PLUS wider frequency range, PLUS improved efficiency, PLUS smaller size, PLUS increased power rating, PLUS greater value. You can depend on Peerless for the best.

Write today for the Peerless Catalog



PEERLESS
Electrical Products

A DIVISION OF



9356 Santa Monica Blvd., Beverly Hills, Calif.
161 Sixth Avenue, New York 13, New York

AUDIO ETC.

Edward Tatnall Canby

LETTER-LEDGER

I'VE JUST SPENT a couple of afternoons tunneling through the lower regions of downtown New York on the search for a better record storage device—preferably on roller suspensions. I'll pass on to you the useful remnant of the vast amount of mostly useless information I acquired. I wanted a container to file away LP records in quantity—dirt-free, moveable rather than built-in, accessible both as to height and light, where the records would *face towards me* rather than offer their edges to the private gaze. Sliding containers would be best. In other words, a good old-fashioned filing cabinet.

But unfortunately the standard file drawer, letter size, isn't the right size. Not high enough for 12-inch discs though the ten-inchers will fit. Somebody had suggested legal size files (there are numbers of them army-surplus now being advertised at very low prices) but these too are wrong. Too wide, sometimes not high enough.

After looking at a dozen miles or so of second hand filing cabinets (the whole of lower New York's sub-surface vaults seem to be lined with them. I hate to think what a 21st-century archeologist might make of these underground acres of stacked drawers, all completely empty!) I found that there is indeed a size of file cabinet that takes LP records perfectly. Its official title is LETTER-LEDGER—that is, LETTER width and LEDGER height. It will take any 12-inch LP and jacket with a half inch or so extra on top for indexing tabs if you want them. But there are complications and you'd better check measurements ultra-carefully before you rashly order a batch:

1. Width. The LETTER stands for the ordinary width common to a million office-type filing cabinets. But the measurements, alas, are not exact. Older files tend to be somewhat narrower than newer ones and the difference for records is crucial.

Any file drawer of LETTER width that has a *minimum* inside measurement of 12¼ inches is OK for all but a handful of LP record jackets. (A few Uranias I had along wouldn't quite fit.) However, many older LETTER size files were made about 12½ inches wide and they will exclude a good many of your LP's—which vary in size too—unless you shave the edges of the cardboards off. Newer files are generally up to the 12¼-inch minimum; some are almost 12½ inches, by my personal measure-

ment. (Nothing like investigating for yourself.) So much for width.

2. Second, height. The ordinary letter file drawer is only slightly over ten inches high inside. It will take your ten-inch LP's, though they'll slither sidewise, but no big LP's. Hence the LEDGER height, a special size which varies (as I measured) from slightly under 13 inches to nearly 14 in inside height. Anything over 12½ inches is OK.

LETTER-LEDGER files are, it seems, used fairly frequently in banks and for other uses where an extra top space is needed. But as a special size they cost a lot when bought new. On the other hand as used merchandise they tend to be white elephants on the second-hand dealer's hands and if you play *your* hand astutely you may get them at a bargain. That is, until everybody begins mobbing the office furniture dealers looking for record storage cabinets. Not one dealer I went to had ever had a call for LETTER-LEDGER files for records before. At worst you should get the used ones for something less than half the new price, usually with a new spray of paint in the bargain.

3. Final note: Be sure your files are (a) on suspensions—so that the drawers roll out easily, (b) that they are heavily built and strong, since 100 or so LP records constitutes a very heavy load, and (c) that, if the drawers come in separate units, they may be clamped firmly together; otherwise the top drawer may upset when the full weight of the records is slid out. Some single drawers have clamps that slide into slots on the drawer beneath. Check for strength. Check (d) on the sliding follower blocks inside. You'll need them.

Tweeter Ballet

I've just been to the ballet, twice, with some interesting experience of the problems we face in natural sound as a by-product. The first evening found me in first balcony seats, at \$2.40. After that evening, thanks to a certain horn tweeter that was suspended beneath the second balcony on the ceiling some ten feet above and front of me, I hastily moved upstairs and out from under—and was able thoroughly to enjoy the second evening at \$1.80—and the music had what my Westminster calls *natural balance*. Sound in the raw, just as it came from the orchestra.

That tweeter gave me one of the most

unpleasant evenings of musical confusion I've yet had, though I hasten to absolve the excellent New York City Ballet which, without a doubt, has a mean problem in the dead spots that occur in the hall in which it operates.

The interesting part of all this was the uneasy blending of natural and reproduced sound which reached me at the particular point where I was seated. A whole series of factors were involved, I decided, after a few minutes of mental torture.

There were a dozen-odd tweeters, all the way across the stretch of the first balcony, fixed to the low ceiling of the balcony above and pointing more or less at the upper middle portion of the sandwiched audience. The hall is large, and first of all, there was a disastrous time lag between the arrival of the tweeter sound and that of the natural one. Moreover, the "real" orchestra was down *below*, at a distance, the tweeter-produced orchestra came from directly *above* and was very close-to. (The mikes were also very close-up—down below—and so the sound in effect originated only a dozen feet away from us.) The separation was, to say the least, painfully marked. But more—the mikes were evidently set up near the strings and one or two other instruments that happened to be nearby. Since the tweeter reproduced no bass anyhow, this effectively split the musical sound in two. The brass and the lower instruments came entirely via natural propagation—from below and afar. The strings came entirely from above, and close-to. The bass arrived late—enough so that in a number of places one half the music was horribly out of time with the other half.

On top of all these cumulative "distortions" was the most unfortunate of all: the tweeter volume was so high that the (distant) bass of the music was barely audible in the more forceful string passages. As everybody knows, an unbalance between highs and lows makes for a seeming distortion as the ear hears it—so these fine, expensive tweeters, complete with super-tweeters as well, screeched at us from over our heads like a batch of sick cats up a row of trees!

I'm not sure I could suggest a perfect way to solve the devilish acoustical problems that beset that particular first balcony. I presume the sound engineers installed only tweeters on the well known theory that the low tones propagate evenly, filling all of a large room space, whereas the higher tones may beam or reflect to form odd dead spots. Fill in the highs artificially and the low tones will take care of themselves. Could be—if other factors were OK, which they were not in this case.

My interest as a listener was in the strange musical unbalances that were created by this sound reinforcement, the intense conflict between the "live" sound and the reproduced tones. Music, you'll note, is far more sensitive in these respects than speech. Speech reinforcement is an altogether different matter—the primary aim is intelligibility and nobody really cares where the voice "comes from" as long as it can be understood with ease.

I'd summarize the conflicts in this particular situation thusly: The unbalances and conflicts were attributable to (a) *direction*—a serious confusion between the

tweeter overhead and the "woofers" (the bass instruments) down below; (b) *distance*—an even greater disparity between the distant orchestra and the nearby tweeter, made worse by the close-up mike pickup we heard from the tweeter, putting the higher instruments only a few feet away from us; and (c) the trouble intensified by the unbalance of *volume* between the loud tweeter and the relatively faint orchestra.

It may be that reinforcement with tweeters alone is practicable for music. If so, I am sure, first, that the directional factor would have to be much less obvious, either more indefinite (less of the point source effect) or else the units would have to be more directly in line with the source of the natural sound. It was the overhead source

that I found most bothersome. Secondly, the tweeter units should be as distant as possible from the listeners, to lessen the distance-disparity. Even better, I'd suggest that a more distant mike pickup would help; for then an illusion of distance and space could be reproduced through the tweeters. That's no more than a special application of the usual factor of liveness in musical microphoning.

Finally, the volume balance should be tested with the greatest care so that the pervasive natural bass tones are in balance with the reproduced highs. It's only too easy to blow up the highs (in the supposed interests of greater intelligibility) and so destroy the whole of the musical effect.

A touchy business, this technique of sound reinforcement!

PERFECT COMBINATION



to put live quality into transcriptions

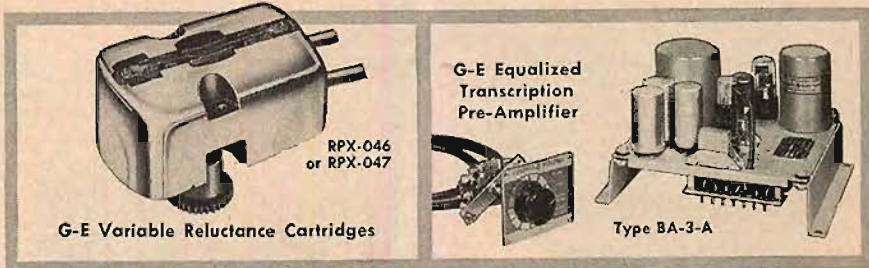

HIGH-QUALITY reproduction demands this preferred equipment. Broadcasters use it to realize fully the superior play-back performance achieved with *General Electric Variable Reluctance Pickups!* Note these and a host of other outstanding features: Four position switch controls high-frequency response • Headphone cueing circuit • Full "NAB" low frequency response • Feeds directly into mixer systems.

Send for **FREE** Transcription Accessories booklet now!

GENERAL ELECTRIC

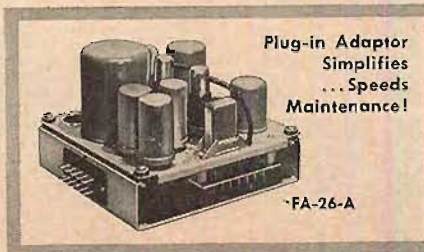

Plug-in Adaptor
Simplifies
... Speeds
Maintenance!

FA-26-A

General Electric Company, Section X4444
Electronics Park, Syracuse, New York
Please send me free bulletin ECB-18B.

NAME.....
ADDRESS.....
CITY..... STATE.....

NEW PRODUCTS

• **Loudspeaker Cabinet.** The "Fold-a-Flex," a new speaker enclosure for high-fidelity sound systems, recently introduced by Stephens Manufacturing Corporation, Culver City, Calif., incorporates characteristics of all three of the more popular types of speaker cabinets. Simple mechanical

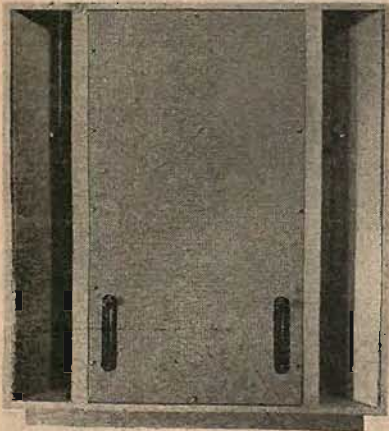

adjustments are provided for making the enclosure into an infinite baffle, bass reflex, or a folded horn. Choice of the enclosure type is determined by the listener on the basis of room acoustics and his particular listening criteria. The new three-in-one cabinet contains three ports whose openings may be varied to achieve desired enclosure characteristics. Dimensions are 36" h x 38½" w x 17½" d.

(We described this enclosure in March but some readers objected to standing on their heads to scan the upside-down photo.)

• **Improved Plastic Tape Reel.** Chief among the improvements in the new 7-in. magnetic tape reel recently added to the Audio-tape line of recording equipment is a 2¼-in. hub which provides essentially the

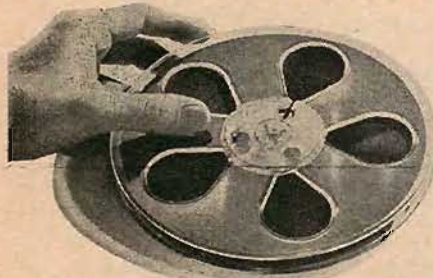

same accuracy of timing and freedom from tension stresses as the previous 2¼-in. hub, but provides additional storage space which eliminates the tendency of outer turns to slip off the reel. The new model holds 1200 feet of tape with ample capacity for adding long leaders at both ends and between recorded selections. Flanges on the new reel have larger solid web areas which provide more space for labeling and give greater protection to the rolled tape. Audio Devices, Inc., 444 Madison Ave., New York 22, N. Y.

• **Tape Recorder Preamplifier.** An illuminated VU meter is included among the fea-



tures of the new Model HFP-1 recording preamplifier recently introduced by the Pentron Corporation, 221 E. Cullerton St., Chicago 16, Ill. Frequency response is 50 to 12,000 cps within ±3 db. When used with the matching Pentron 9T-3M tape transport mechanism, the new unit provides a recording and playback system comparable in many respects to professional equipment. All controls are jet black giving distinctive contrast to a panel finished in brushed copper.

• **Wide-Range Laboratory Amplifier.** With frequency range extending from below 10 cps to approximately 250 kc, the new



General Radio Type 1206-B Unit Amplifier is ideal for laboratory applications requiring a general purpose amplifier with low power output. Since less than one volt input is required for rated three-watt output, the amplifier may be operated directly from the output of many electro-acoustic and electro-mechanical devices to actuate graphic recorders. Harmonic distortion of the unit is less than one per cent with two watts output and less than two per cent with three watts output from 20 cps to 40 kc. The 1206-B is designed for operation with the GR Type 1203-A power supply which can be attached to the amplifier to form a single rigid assembly. General Radio Company, 275 Massachusetts Ave., Cambridge 39, Mass.

• **Flutter Meter.** A valuable instrument for use in motion picture and sound recording studios is the new Gaumont-Kalee Flutter Meter, designed to measure small

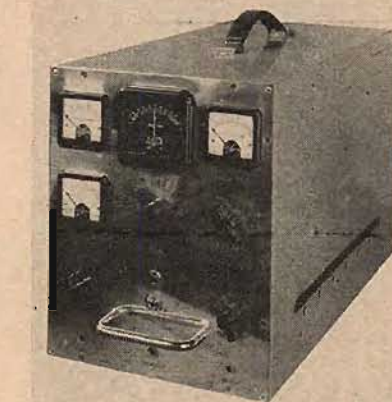

frequency variations of a given carrier frequency. In operation the meter is supplied with a signal of correct frequency and suitable amplitude from a film sound head, for example, and gives visual indication of variations from constant speed. The instrument operates at a nominal carrier frequency of 3000 cps, but will tolerate up to five per cent variation, thus enabling measurements to be made of machines which are running off speed. It consists of a narrow-band amplifier, a limiter, a discriminator and detector, and a metering system, the entire unit being self-contained with built-in power supply. Distributed exclusively in the United States by S. O. S. Cinema Supply Corp., 602 W. 52nd St., New York City, N. Y.

• **Communication Microphones.** Virtually every requirement of commercial communication is satisfied by the new 501 series of hand-held microphones recently intro-



duced by American Microphone Company, 370 S. Fair Oaks Ave., Pasadena 1, Calif. Including five dynamic and four carbon types, the series varies widely in impedances and switching arrangements. Frequency range of all units is 300 to 3000 cps. Output of the dynamic and carbon models is -54 db and -10 db respectively. Weight is only ten ounces exclusive of cord and plug. Further information on the 501 series will be mailed on request.

• **Binaural Clip-On Conversion.** The Clip-On is an inexpensive bracket which permits mounting two pickup cartridges on a single tone arm for playing Cook binaural recordings. Equally suitable for use with single players or with automatic changers, the device does not interfere with the normal playing of single-track

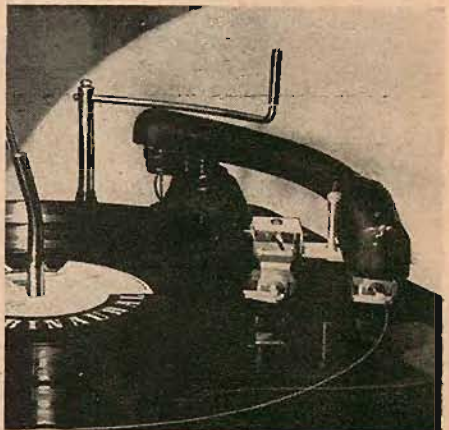

recordings. Some types of changers when equipped with the Clip-On will change binaural records automatically. Further information is available on request from Cook Laboratories, Inc., 114 Manhattan St., Stamford Conn.

(Continued on page 56)

hrc HARVEY the House of Audio

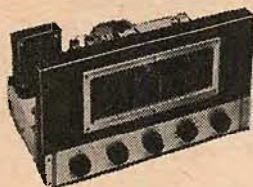

The New **FISHER** Model 70-RT FM-AM TUNER with Preamp-Equalizer, Tone and Loudness Controls

The Fisher Model 70-RT is a complete, self-contained high fidelity front-end system. Not only does it provide the means for the finest reception of both FM and AM radio broadcasts, but embodies the necessary pre-amplification for use with high quality magnetic phono pickups. The equalizer control with 4 compensating positions enables matching to the characteristics of all record types. Frequency response: 20 to 20,000 cycles ± 1 db. Other features include: Variable AFC Control Switch, Broad and Sharp AM, Auxiliary Input, Continuously variable Bass and Treble controls permit up to 15 db boost or attenuation at 50 and 10,000 cycles respectively.

Complete with tubes..... **\$184.50**

THE NEW **CORONATION** 30-watt Supra-Linear AMPLIFIER

An advanced version of the Williamson with several important circuit modifications. Through the use of matched, high-quality components, and an output transformer, specially designed and wound for the unit, the Coronation has achieved unusually fine performance.

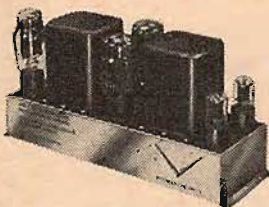

Frequency Response: 10 to 100,000 cycles ± 1 db. Power Response: 20 to 20,000 cycles ± 25 db. Intermodulation Distortion is less than .15%, and Harmonic Distortion less than .1%, at 15 watts. Class A-1 operation. Power supply is self-contained, with outlet for furnishing power to a pre-amp unit. Uses KT-66 output tubes.

May be operated from tuner, preamp, high-level pickup, tape recorder, or other sound source. Operates any speaker system, 8-16 ohms. Hum and noise level is 96db below full output. Dimensions: 15 x 4 3/4 x 7 1/4 inches.

Complete with tubes..... **\$92.50**

WESTERN ELECTRIC 755-A SPEAKER (8" PM) Provides full frequency range coverage and wide angle high-frequency distribution. SPECIAL \$24.60

RIVER EDGE MATCHED HI-FI CABINET and SPEAKER ENCLOSURE

Good taste, construction and audio design combined to give the user top appearance and performance at low cost. The cabinet is designed to accommodate record player or changer, tuner, preamplifier and amplifier. The speaker enclosure may be ordered for either a 12-inch or 15-inch speaker. Both are fine examples of beautifully finished cabinet-craft. Maple and birch construction, in your choice of finish: Riviera blond, maple, fruitwood, mahogany or walnut. The dimensions of each unit are: 24" w. x 37 1/2" h. x 17" d.

Cabinet #F2224..... **\$75.00**
Speaker Enclosure #S2224 (for 12-inch or 15-inch speaker)..... **\$50.00**

Visit the HARVEY AUDIOTorium
If you want to See and Hear the finest... the widest selection of high fidelity equipment... be sure to visit the HARVEY AUDIOTorium. It will thrill you.

NOTE: Prices Net, F.O.B., N.Y.C. Subject to change without notice.

The **JENSEN** **DUETTE** Model DU-202 PORTABLE



A truly portable, 2-way, high fidelity loudspeaker system with 'big speaker' performance. Ideal for tape recorders, electronic musical instruments, lecturers, record players, and other uses away from studio or home.

The Duette is built into handy, black leatherette-covered case weighing only 21 pounds. It is equipped with a special 8-inch heavy-duty 'woofer', a compression driver 'tweeter' with multi-cell horn, and built-in cross-over system. Power rating is 20 watts. Two receptacles permit use with either 4-ohm or 8-ohm source. Dimensions: 11 x 23 1/4 x 11 1/4".

Model DU-202 complete with 25-foot cable..... **\$89.50**

Model DU-201 Similar to Model DU-202, but in red leatherette covered case designed for use on bookshelf..... **\$9.50**



GRAY Model 108-B Viscous-Damped Arm

A transcription arm of radically new design. Provides perfect tracking for all records: 33 1/3, 45, and 78 rpm. Has stylus pressure adjustment from 5 grams. Mechanical resonance is virtually eliminated. Prevents damage due to drooping. Accommodates most makes of magnetic cartridges, and permits instant interchange from one type to another. Can be used for records up to 16" in diameter.

Gray 108-B Arm..... **\$56.00**

FAIRCHILD Moving Coil PICKUP CARTRIDGES



Designed to professional quality standards, these playback cartridges permit the highest quality record reproduction thus far attained. Unusually high lateral compliance has reduced tracking error distortion to an absolute minimum. Each Fairchild cartridge has a carefully selected diamond stylus. The moving coil design provides a linear, smooth, wide-range response. Dimensions are such to permit ready installation in most pickup arms and record changers. The Fairchild cartridge is used with conventional preamp-equalizers. Its impedance and output are designed to work into a high quality transformer, such as the Fairchild Models 823-A and 826-A.

The Model 823-A is a fully shielded transformer with multi-tap primary. It is intended for use with pre-amplifiers where an all-purpose input transformer is desired. The Model 826-A is a special transformer of small dimensions designed for use between Fairchild cartridges and a grid input preamp. (Illustrated)

Cartridge Model 215-A for microgroove records..... **\$37.50**
Cartridge Model 215-C for standard groove records..... **37.50**
Transformer Model 823-A..... **13.85**
Transformer Model 826-A..... **8.75**

The New **ELECTRO-VOICE** Model 15TRX TRIAxIAL 3-WAY REPRODUCER

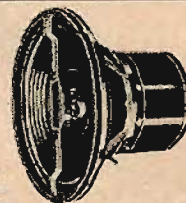

The 15TRX is EV's latest contribution to the advancement of high fidelity sound. It is an effective 3-way speaker system with the added advantage that each of the reproducers are concentrically mounted and provide the smoothness of response associated with a single source. Frequency response extends from 30 cycles to 15,000 cycles. Two crossover points are employed: one is mechanical at 2000 cycles, and the other at 3500 cycles utilizing an electrical network. The free-air resonance point is 38 cycles. The entire unit weighs 44 pounds and its rated impedance is 16 ohms.

Model 15TRX complete with 'Brilliance Control'..... **\$135.00**

HARVEY RADIO
COMPANY, INC.
103 W. 43rd Street, New York 36, N. Y. JUdson 2-1500



NOW... enjoy luxurious hi-fi remote control!



with the beautiful *Rauland*

LIBRETTO remote control



NOW you can have complete remote control of your present High Fidelity Music System with the LIBRETTO! This amazing control is completely self-powered and capable of operation several hundred feet from the amplifier. Uniquely fashioned in the form of a luxuriously bound book (only 8 3/4 x 11 x 2" thick). Backbone lifts for easy access to controls. Operates in either horizontal or vertical position. Controls: 1. Crossover; 2. Roll-off; 3. Volume; 4. Bass; 5. Treble. Adapter available for simple connection to your present system. Gives you the ultimate in luxurious Hi-Fi.

See your Hi-Fi Dealer for a thrilling demonstration of LIBRETTO remote control operation.



Awarded the Medal of Merit, International Sight and Sound Exposition, Chicago



the ultra-fidelity *Rauland* 1805 custom amplifier

This truly superb unit is designed for optimum performance in the finest High Fidelity systems. Ideal for use with the LIBRETTO Remote Control (adapter not required). The specifications below speak for themselves, but the ultimate proof of quality is in the thrilling listening experience.

- Rated Power Output... 20 watts.
- Frequency Response... ± 0.3 db, 20 to 40,000 cps at rated output.
- Harmonic Distortion... less than 0.5% at rated output, less than 0.3% at 10 watts.
- Intermod. Distortion... less than 0.4% at 1 watt (home level), 0.7% at rated output—measured at 60 and 7,000 cycles, 4 to 1 ratio.
- Hum and Noise Level... 80 db below rated output.
- Output Impedance... 8 and 16 ohms.
- Input Selector... 4-position on 5-ft. extension cord: No. 1, magnetic pickup; No. 2, crystal pickup; Nos. 3 & 4, auxiliary.

See your Hi-Fi Dealer or write us today for full details

RAULAND-BORG CORPORATION
3515 W. Addison, Dept. G, Chicago 18

PLANNING YOUR INSTALLATION

(from page 24)

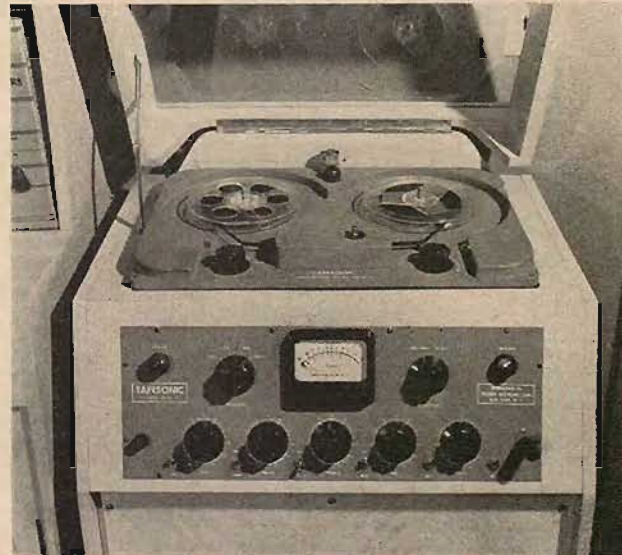

Fig. 8. A close-up of the tape-recorder console. Note glass-topped lid which permits visual observation during recording.

original. This time the speaker compartment was placed on the right of the cabinet and the left designed to hold three shelves of records. The new cabinet matched the original in every respect and was placed alongside it as a twin console. Here was the benefit of top-quality music system with two high-quality loudspeakers, which improved performance immeasurably. Here, too, was room for further expansion—a tape recorder, facilities for both binaural and monaural reproduction at a later date, and many other features which can be added so long as the budget permits.

Whether your installation will be

housed in a small chairside cabinet or a pretentious breakfront, planning will provide gratifying results. There is no need to buy your system twice or to rebuild a cabinet because of a hasty decision. No matter who builds the cabinet, you or a cabinetmaker—get the facts from your audio dealer. Ask for measurements—width, height, depth. Don't buy too many knobs. Keep the controls simple—the thrill of twisting knobs soon wears off!

Note: Photos for Figs. 5 to 9 through courtesy of Asco Sound Corp., New York. Figures 5 to 8 taken at the residence of James Goodfriend in New York City.



Fig. 9. An installation with the future in view. Here is sensible marginal buying of a high fidelity system.

NEW LITERATURE

• **Automatic Electric Company**, 1033 W. Van Buren St., Chicago 7, Ill., in a newly published 6-page illustrated brochure titled "The P-A-X Code Call Service," describes how executives and key employees can be quickly paged in plant or office by means of a special signalling device which is part of an internal business telephone system. Copy of the brochure will be mailed on request.

• **Magnecord, Inc.**, 225 W. Ohio St., Chicago 10, Ill., describes the company's complete line of tape recording equipment and accessories in two new catalogs—one a general full-line catalog for professional use, the other a booklet designed primarily for the high fidelity market. Irrespective of the nature of your interest in tape recording, one or both of these publications should be in your technical library. Magnecord is herewith accorded a well-deserved bow for the excellence of these catalogs. Copies may be obtained by writing direct to the company.

• **Electro-Voice, Inc.**, Buchanan, Mich., is making available to music lovers an extremely worth-while 16-page booklet on high fidelity titled "Tools for Building Temples of Tone." In one section the booklet points out how the human ear hears musical sounds, and contrasts the performance of an ordinary commercial radio-phonograph with that of extended-range hi-fi equipment. Also included is an explanation of the various forms of distortion in music reproduction. Another portion of the brochure tells how to choose the components for a hi-fi system. Illustrated is a typical home installation and a suggested home entertainment center. Requests for copy should specify Bulletin No. 216 and must include ten cents in coin or stamps to cover postage and handling.

• **Kingdom Products, Ltd.**, 23 Park Place, New York 7, N. Y. covers the entire line of Lorenz speakers and Kingdom cabinets and audio accessories in a new 6-page folder. Included are performance specifications and prices.

• **Cords Limited Division, Essex Wire Corporation**, 121 Dodge Ave., DeKalb, Ill., combines coverage of its wire cordage types and cord set components in a new 30-page 2-color catalog which has just been published. An engineering data section contains 118 separate dimensional drawings of various Cords Ltd. products. Requests for copy should be sent direct to the address shown.

• **Audio & Video Products Corporation**, 730 Fifth Ave., New York 19, N. Y., has just released a new 6-page tape recording accessories catalog. Of equal interest to professional and amateur users of tape recording equipment, the catalog includes such diverse listings as program equalizers, variable filters, preamplifier-equalizer units, AM-FM tuners, microphones, etc. Copy will be mailed, without charge, on request.

• **Insulation Manufacturers Corporation**, 565 W. Washington Blvd., Chicago 6, Ill., has recently published a 32-page catalog which contains complete technical data, descriptions, and information on applications, sizes, stocks, and uses of silicone materials for high-temperature Class H electrical insulation. Manufacturers and repairers of electrical and electronic equipment will find this booklet one of the more complete sources of information ever published on silicone insulation materials. Requests for copy, which will be mailed without charge, should be addressed to the Publications Department.

• **The Hammerlund Manufacturing Company, Inc.**, 460 W. 34th St., New York 1, N. Y., illustrates and describes with careful detail its newest communications receiver, the HQ-140X, in a 4-page 2-color bulletin which may be obtained by writing direct to the address shown above. Built for both professional and amateur use, the HQ-140X covers the frequencies from 540 kc to 31 mc in six bands. The bulletin contains complete specifications as well as operating procedure.

6 REASONS WHY HI-FI FANS DEMAND THE FAIRCHILD SERIES 215 DIAMOND CARTRIDGE WITH HIGH COMPLIANCE

Instantly — there's a startling improvement in sound when record collectors switch to the FAIRCHILD Series 215. Listeners who have just discovered high-fidelity — and seasoned audiophiles both hear a new presence in recordings.

Only FAIRCHILD's moving coil design can give such unequalled performance. Compare — and you too will agree that the start of any high-fidelity system must be the high Compliance FAIRCHILD Series 215.

- 1 — Brings true-to-life color to high piano chords.
- 2 — Releases new low frequency tones.
- 3 — Smooth linearity — lower apparent surface noise.
- 4 — Reduces tone arm resonance greatly.
- 5 — Preserves record quality — reduces stylus wear.
- 6 — Eliminates — completely — listening fatigue caused by tracking distortion.

All of this at an unbelievably low price — \$37.50



And investigate these FAIRCHILD products, too!



The NEW Model 240 Balanced-Bar Preamplifier-Equalizer offers typical FAIRCHILD quality, a wide latitude of control, extreme operating simplicity, correct record equalization and decorator styling. Net to user — \$98.50

The NEW Model 280 Plug-In Type Pickup Arm brings professional quality into the home with minimum size, unusual pivoting method, low bearing friction and accepts all standard makes of cartridges. Net to user — \$29.50



SEE YOUR AUDIO DEALER or for free folder write:

FAIRCHILD RECORDING EQUIPMENT

NINTH AVENUE & 154th STREET, WHITESTONE, L. I., N. Y.

CUSTOM CABINETS

Elegance

for TV and Hi-Fi
at LOW COST!



FRENCH PROVINCIAL
Closed View



FRENCH PROVINCIAL
3 Way Combination

You get far more for your cabinet dollar when you buy *Standard*. Beautiful fidelity styling, choice select-grain woods, careful construction, functional design, acoustical correctness — all to the acknowledged *finest standards* of the industry.

Compare — Write now for FREE Catalog **AES** showing our entire line.

Standard Wood Products Corp. / 47 West 63rd Street, New York 23, N. Y.

FM — TV — HI-FI



The C-12 Microphone consists of a cylindrical metal shell approximately 1 7/8" in diameter and 15-3/16" long including the connector, and contains the condenser head, a 12AY7 tube, and an output transformer, being connected to the power supply by a 65-ft. multi-conductor cable which may be extended to 600 ft. if necessary. Another cable leads from the power supply to the switch box.

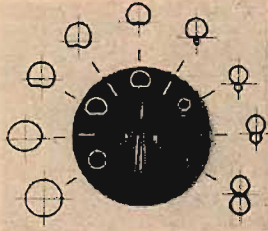

A NEW ERA IN PICKUP TECHNIQUE

The polydirectional characteristics of the microphone are controlled by a separate switch box which may be located in the control room. The sound engineer can select the most suitable pattern for each phase of the program in progress. Changes may be made during program pickup so as to adjust the microphone to the reverberation of the individual studio, or for such effects as varying the apparent distance of the artist from the microphone. Frequency response—30-15,000 cps ± 3 db. Front-to-back discrimination (cardoid pattern)—15 db. Output level — 34 dbm for a sound field of 10 dynes per square centimeter.

Akustische und Kino-Geräte

Ges. m. b. h.

Nobilegasse 50, Vienna XV, Austria

Sole U. S. Agents

Electrovert, Inc., 489 Fifth Avenue,

New York 17, N. Y.

Authoritative and Enlightening . . .

AUDIO

*Acknowledged the Leading Publication
in the Field of Sound Reproduction*

If you are novice, hobbyist, experimenter, or engineer . . . if you are a lover of music . . . and in pursuit of sound, undistorted . . . AUDIO will be your faithful, reliable companion all the way. You will find no more pleasureable and stimulating reading than there is in AUDIO; absorbingly interesting material, valuable and authentic data, workable detailed instructions . . . all comprehensively and yet practically presented.

"What to Do" and "How to Do" will guide your every move through this thrilling experience we call Audio.

Each new issue brings New Ideas, New Slants, and Latest Developments . . . month in and month out . . . twelve times a year.

BE SURE to get your copies REGULARLY.

MAIL this
Coupon
NOW

AUDIO

Box 629, Mineola, N. Y.

Enclosed is Check Money Order for \$ _____
Please send a copy of each new issue of AUDIO for the next
 12 months; 24 months to:

Please Print

Name _____

Address _____

City _____ Zone _____ State _____

Subscription Price: U.S.A., Canada and Pan American Union: 1 year . . . \$3.00 2 years . . . \$5.00. Other countries: 1 year . . . \$4.00 2 years . . . \$7.00.

LONDON LETTER

(Continued from page 10)

During the years of experiment his organisation has learnt many 'wrinkles,' which are applicable to smaller offices. At Shell-Mex House any member of the staff can dictate a letter by lifting the inter-office telephone, dialling figure 7, and after having heard a voice telling them to record, they do so by merely speaking into the telephone mouthpiece. The letter which they are answering is then sent down to the typing pool. If necessary the person dictating the letter can hear it back on the telephone, but this practice is discouraged because it wastes time.

In the central typing pool ten girls are each equipped with two tape recording machines. When an executive wishes to dictate a letter it is one of these girls who answers the house telephone, and by pressing a switch connects it to the tape machine. Whilst the girl is transcribing from one machine, the other machine is recording a letter. Automatic switching of the telephone system transfers the call from the executive to a girl who has an unoccupied machine. The girls wear light earphones, and type the letters straight back from the recording tapes.

The tape machines used have been specially developed for office dictation by one of the smaller communications firms—E. Shipton & Co. Ltd.—who have worked closely with the Shell organisation during the last four years. The machines are so successful that they are now being offered generally for sale. They use 300-ft. reels of tape, record at 1 7/8" per second, and both the unused reel and the used one are housed in a cassette. The individual reels of tape are never handled manually, and during the course of operation never have to be re-threaded on to the reels. Outside representatives carry tape machines with them, dictate their reports, and post the cassettes back to Head Office for typing.

Mr. Fidler emphasised that experience had shown conclusively that the majority of people were reluctant to use recording machines which necessitated talking into the conventional microphone with a recording apparatus actually in front of them. As everyone was accustomed to using a telephone they did not mind dictating into a telephone instrument. Experiments in his organisation had shown that the present system was the ideal one, and it was better not to have more complicated recording instruments, which obviated the human element.

Originally, when executives dialled a recording channel they heard six pips, after which they knew they had to commence recording. It was found that a human voice telling them when to start was much more satisfactory than relying on a comparatively complicated equipment, which saved a very small amount of manpower.

Use a Telephone for Dictating

Tape recording enthusiasts wishing to extend their activities to the office, but only having a small office organisation might well consider it worth while building their recording microphone into a telephone hand

Tangibly Great Sound Reproduction

IS WHAT YOU'LL HEAR AND FEEL
WHILE LISTENING TO POPULAR OR
CLASSICAL MUSIC THROUGH A

BROOK
HIGH QUALITY
AUDIO AMPLIFIER



Model
22A

— handsomely compact 10-watt
single-chassis combination.
Quality sound, at cost so low
any music lover can afford it.



Model
12A4

— combining famous BROOK
12A power amplifier, and flexible
4B pre-amplifier, at moderate
cost.

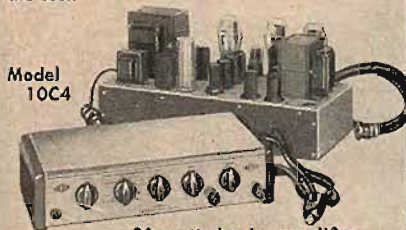

Model
10C4

— 30-watt basic amplifier —
remote control pre-amplifier
combination; higher power for
full-bodied orchestral passages.



Model 7

— Self-powered pre-amplifier
perfect complement to any good
basic amplifier.

Every BROOK Amplifier is built to the
highest possible standards of quality.

Write for full information on the complete
BROOK line; also name of your
nearest dealer. Dept. AE-4

BROOK ELECTRONICS, INC.

First in the High Quality Audio Field Since 1934
34 DeHART PLACE, ELIZABETH, N. J.

set and, if possible, locating the recording machine by their typist in another room rather than having it in their own office.

It has also been proved that it is better to have girls always taking letters from recording machines rather than using a secretary who sometimes takes letters in shorthand and on other occasions uses a machine.

London "Hi Fi" and Record Stores

Some readers of AUDIO who are coming to Europe in the summer have asked me for particulars of "hi fi" and record shops they could visit in London. I hope during forthcoming letters to mention the various establishments which are situated in the West End of London. The most elaborate record shop (but, unfortunately, not holding the most comprehensive stocks) is the H.M.V. shop in Oxford Street. This is probably the largest store in England which has been specially built for the sale of records, phonographs, television, etc. The original shop was burnt down in 1938, and a completely new building was finished in 1939, just before the outbreak of War.

This store is owned by the E.M.I. Organisation, and stocks every record which is on the English catalogue of His Master's Voice, Columbia, Parlophone, Regal-Zonophone, and M.G.M. catalogues of 78, 45, and 33 r.p.m. A special section called Cosmopolitan holds stocks of all Continental records which are pressed in the English factory at Hayes, Middlesex. Two floors of the building are devoted to records, and one floor to T/V, reproducers, and a recording studio. Although the Company does not reveal the number of records stocked in this store, it is believed to be nearly 100,000. It is a pity this store does not stock competitive records, such as Decca, Philips, for it would then probably have the most comprehensive stock of records in Europe.

U.S.A. visitors who intend to buy records in England should remember that most of the leading stores (including the H.M.V. shop) can supply records without Purchase Tax providing they are bought with currency coupons or delivered direct to the plane or ship.

The sales plan adopted by the H.M.V. shop is that on the ground floor all records of all the E.M.I. trade marks are served by 26 assistants, and would-be purchasers can hear the records either in audition rooms or in record kiosks. The basement floor is devoted to popular records, i.e. dance and film hits, etc., and a new self-service system has recently been installed. So that would-be purchasers requiring to hear the latest hits quickly need not even bother to ask for a record, a press button listening system is available whereby the twenty-four best selling hits of the day can be heard by the visitor picking up an earphone, pressing a button, and hearing the record immediately. This system is operated by having the twentyfour most popular records playing continuously on twentyfour record changers which have been converted to repeat the records.

AUDIO readers who would like a personally conducted tour of this unique store should make themselves known to George Fenwick, the genial Manager, who has been associated with His Master's Voice for more than forty-four years.

THE New SUPER-ROYAL

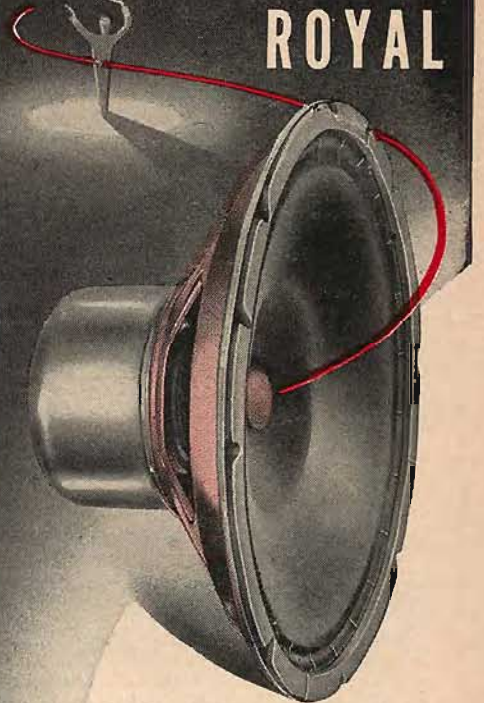

High Fidelity Speakers

BY
Permoflux

WITH THE

**Famous Treated Slotted Cone
FOR LOW RESONANCE**

This exclusive Permoflux feature, plus New design in magnetic structure, utilizing heavy Alnico 5 ring magnet, results in extended distortion free, low frequency response.

The specially designed single cone radiator reproduces both high and low frequencies with exceptional clearness, and avoids the inherent distortion of coaxial or 2 way systems.

See and hear the
Super Royal at your
High Fidelity Dealer

Available in 3 sizes
8, 12 and 15 inch.

For descriptive
literature write to . . .

Permoflux CORPORATION
4902 Grand Ave., Chicago 36, Ill.
West Coast Plant
236 S. Verdugo Rd., Glendale 5, Cal.

AT HOME WITH AUDIO (from page 31)

2. Amplifier to Tuner

This is a more exacting job, quite critical, electronically speaking. Use microphone connecting cable only, of any good grade. This is a double conductor, composed of an outer layer of insulation, then a layer of braided shielding, then another layer of insulation, then the center stranded wire conductor. The center wire conducts the signal; the braided wire serves as ground as well as shield. You will need some pin-type connecting plugs. (Fig. 12.)

With side-cutting pliers or wire-stripping tool, strip a 1-in. length of insulation from each end of the cable, to bare the layer of braided wire. Now unravel the braid with a wood awl or scribe, then pull off only 3/4-inch of the inside layer of insulation. This is shorter than the full inch of outer insulation you removed, and keeps the braid away from the inner stranded wire, eliminating risk of shorting.

How to Solder

Exposed wire ends are prepared for soldering to the pin plugs by first tinning their tips. Without the tinning operation, the stranded wire will tend to remain loose and frizzy, impossible to work with in the tight dimensions of the hollow shaft of the pin plug. Proceed as follows:

a) Use soldering iron to tin the exposed tip of the center conductor by running solder onto heated wire. The wire is heated by contact with "dry" soldering iron tip.

b) Twist tightly the unravelled portion of the braided wire and tin this end also.

c) Now hold the cable with tinned wire ends in one hand, soldering iron in the other. The solder strip is firm as you unwind it from its reel. Leave reel in the carton it came in, and draw out a length of the strip, "goose-necking" it down so it is positioned between soldering iron and the wire. Insert pin plug over the wire, with the center conductor going up through the center of the hollow pin of the plug. (Fig. 13.)

Hold the soldering iron tip along the outside of the pin portion of the plug as you insert solder into pin. Heat from the iron will cause solder to flow, securing the inserted wire within the hollow shaft of the pin. Let this cool for a few seconds to firm the solder inside the pin. Then solder the outer braided wire (which you have previously tinned) anywhere along the rim of the shell portion of the pin plug.

Repeat the same steps at the other end of the cable. Now

the cable is prepared with identical pin plugs, secured at both ends. One end is ready for insertion to the input of the amplifier, the other goes to the tuner output.

3. Player to Tuner

Prepare another cable with pin type plugs, as above. This cable will carry the signal from the record player pickup to amplifier, to the position marked "phono input." The player power cord leads from the motor under the turntable, and plugs in to the receptacle on the back of the tuner marked "AC."

4. Antenna

For indoor FM antenna, use a 6-foot length of 300-ohm parallel lead-in wire (it's flat). Cut off a piece 51 inches long and then cut one of the wires at the exact center and attach the lead-in to it. This lead-in is formed from the remaining 21-in. piece. When you cut the longer piece at the center you will have two ends. Strip off the insulation for about 1/4 in. on each of the ends; do the same on the two wires of the short piece. Then twist the ends you have made by cutting the long piece with the two wires on the short piece. Finally, strip off the insulation for about 1/2 in. on each end of the long piece and twist the two wires together at each end. Solder all of the twisted joints, taking care to do it as quickly as possible so as not to melt too much of the insulation. When this is completed, you will have a letter T with a short leg, and the circuit then extends from end of a wire on the short leg up to the crosspiece, thence to one end of the crosspiece, back to the other end along the second wire, back to the junction, and down to the end of the short piece. Seems just like a short circuit, but that is the correct way to make an FM antenna.

The entire antenna can then be stapled along the upper back edge of the cabinet, with the lead-in connecting to the antenna terminals on the tuner.

All of the equipment is now connected up and we are now ready to proceed with the tuning of the speaker cabinet port.

How to Tune the Port

Tune the port for the bass tones. The quality of the bass depends upon the speaker. If, for example, a 35-cps note is desired (for the average bass reflex) play a Cook frequency record on your turntable. Play the 35-cps tone. Stand in front of, but as far away as possible from the speaker. Have someone hold a flat board across the front of the port opening and move it up and down while you listen very carefully to the tone. You will hear the tone come progressively lower in volume as the board is moved across the opening. The point at which the sound you hear no longer goes lower indicates the "frequency doubling point."

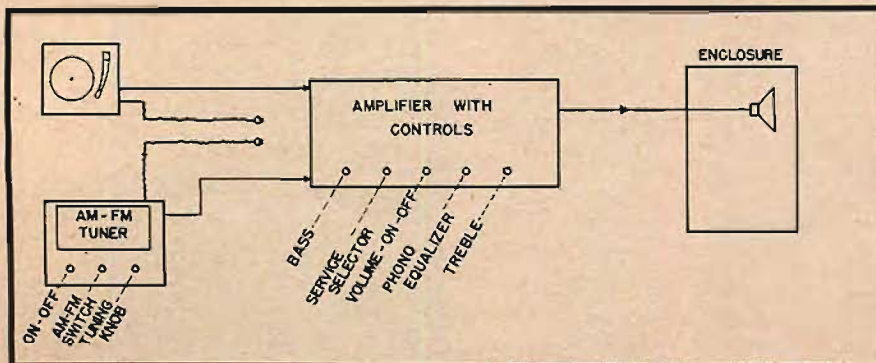

Fig. 10. The typical home music system consists of a record changer or a turntable, a tuner, and an amplifier with controls. With complete controls on the amplifier, the tuner should be "stripped"—that is, without any but the tuning control, the AM-FM switch, and possibly an ON-OFF switch, although this can be eliminated.



Fig. 12. How the pin type plug should look when attached to cable end. Note ground wire soldered to rim of shell. Pin carries signal wire soldered into its hollow shank.

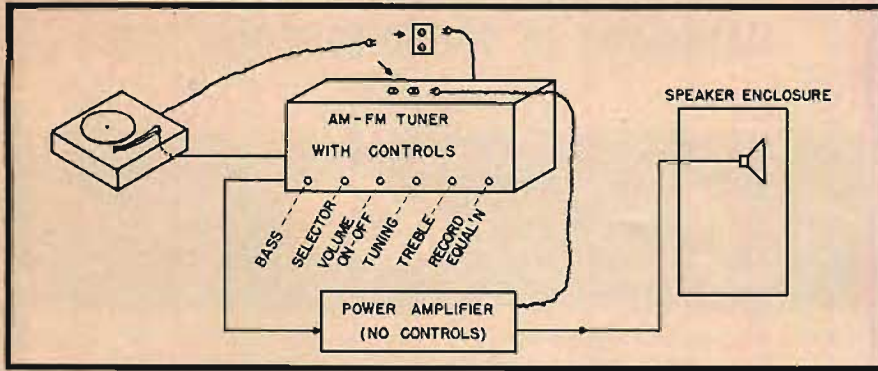

Fig. 11. Another popular installation—now that tuners are available with excellent tone control circuits—employs a phono turntable or changer, an AM-FM tuner with controls, and a basic power amplifier.

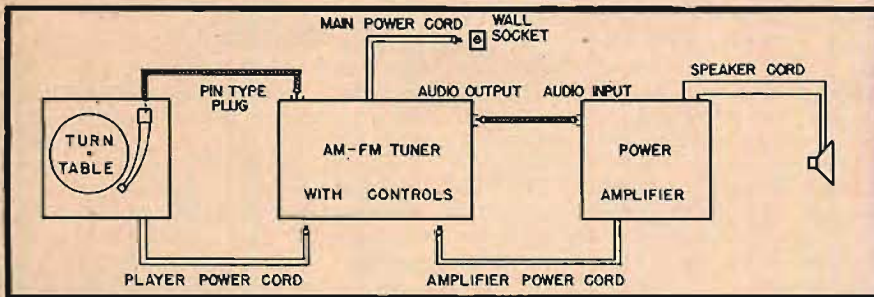

Fig. 14. Types of connecting leads used in assembling a typical home music system.

Have the board held to its position at this point, which is where frequency doubling disappeared. A part of the port opening has been covered over with the moving board. Now mark this position with pencil on the board. Then place the board at this mark inside the cabinet and behind the port opening, thus reducing the opening to the right size for a properly tuned port. Fasten the board securely to the baffle with wood screws 1-1/4 inches long. Gluing is not necessary. Finish the face of the speaker baffle with plastic covering, as described earlier in this article.

... The Better to Hear With

Many of us have become what I shall term "cycle-insensitive," accustomed to listening to the limited range of conventional phonographs and radios. What could we hear in the old acoustic discs—

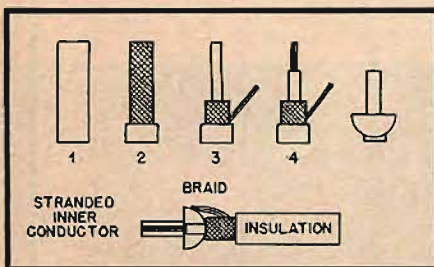

Fig. 13. How pin plug terminals are soldered onto end of double conductor cable. Center wire passes into the shank of the pin plug and soldered; outer braided wire is soldered to rim of shell portion of the plug. (See also Figure 12.) To keep both hands free for soldering, you can "goose-neck" the solder from its carton.

and even those made fifteen years ago? It was a pretty low high we heard (hardly more than 4,500 cps on pre-war players); and likewise a pretty high low.

It is quite possibly true that serious music lovers who may be familiar with the score of a musical composition, or when fresh from attending a live concert where the composition was heard with full "presence"—show signs of frustration when listening to its rendering on conventional playback equipment. Their attuned ear misses hearing notes and whole chords (because they are totally unreported by the equipment), and they are excruciatingly aware sometimes of individual instruments missing altogether from the recorded spectrum of sound.

With the turn to hi-fi equipment you can hear, at last, a full-bodied sound—issuing, it is true, from "boughten" parts—yet curiously enough, a thing of your own making, in the sense that it is you who have put the basic units of player, preamp, power amp, tuner, and loudspeaker together. You're the one who kept the record player within four feet of the preamp-control unit to hold lead capacitance at a minimum. You it was who positioned the pickup cartridge not less than 12 in. away from the preamp, and at least 18 in. from the power amplifier, to avoid hum. The speaker you placed in an enclosure of at least 6 cubic feet volume should give you bass response down to about 40 cps and highs up to about 15,000 cps, if the speaker itself is good enough.

You have gotten yourself a high-fidelity system which should comprise a veritable treasure-trove of music listening pleasure.

NOW! A Hi Fi Speaker System that is HEARD... NOT SEEN

LORENZ
SOUND CORNER
OFF THE FLOOR and OUT OF THE WAY



Solves the Problem of SOUND - SPACE - COST

The Lorenz SOUND CORNER—the amazing corner-wall two way speaker system is an ingenious horn design of triangular cross section which uses the walls of a room corner as two of the three rigid boundaries, the speaker baffle being the third. The SOUND CORNER uses no floor space... is as easy to install as hanging a picture on the wall, and is perfectly low-priced to harmonize with any budget.

QUALITY COMPONENTS PLUS SOUND DESIGN



Built around the LP 215 "Woofers" loudspeaker, famous for its clear tonal quality, and the brilliant high frequency LP 65 "Tweeter", the SOUND CORNER reproduces the full range from 31 to 16,000 cycles with breath-taking Concert Hall "Presence." From the smooth fundamental bass of the Organ Pedals to the sparkling "highs" of the Piccolo, the SOUND CORNER adds the Miracle of Life to the Magic of Music—a superlative complement to the finest high fidelity equipment and custom installations.

The SOUND CORNER blends deftly with any decor... can be painted easily to harmonize with any color scheme. If desired, a lamp mounting can be added with little effort to provide indirect lighting. With an overall height of only 31", the SOUND CORNER tapers down from a top width of 27 1/2" to a mere 11 3/4" at its base.

SCL SOUND CORNER—complete ready for connection to your amplifier. Available in Blonde wood only. net **\$59.50**

Write for Detailed Specifications

KINGDOM PRODUCTS, Ltd.
23 Park Place, New York 7, N. Y. • WORTH 4-8585

In **CANNON**
"UA" Audio
PLUGS



gold-plated
contacts
really
pan out!

UA-3-11 Plug



UA-3-14 Wall Mounting Receptacle



UA-3-32 Wall Mounting Receptacle



UA-3-42 Microphone or Panel Mounting Receptacle



UA-3-13 Wall Mounting Receptacle



UA-3-31 Wall Mounting Receptacle



UA-3-12 Plug

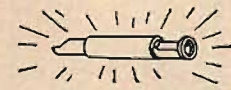

Yes! You get immense satisfaction from gold in any form...and particularly from the performance of the gold-plated contacts in Cannon's modern "UA" audio Series connectors.

Contacts are heavily gold-plated over silver plate...not just "flashed" with a light coating of gold. You get maximum protection from oxidation and deterioration...maximum protection to vital audio circuits...absolute reliability.

Cannon's thumb-pressure LATCH-LOCK prevents accidental disconnect. Available through Cannon distributors.

WRITE FOR
RJC BULLETIN!

Refer to Dept. 109

CANNON ELECTRIC COMPANY, 3209 Humboldt St., Los Angeles 31, Calif. Factories in Los Angeles; New Haven; Toronto, Canada; London, England. Representatives and distributors in all principal cities.

CANNON ELECTRIC



HANDBOOK OF SOUND REPRODUCTION

(from page 27)

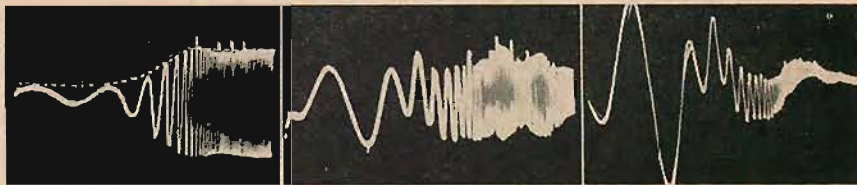

Fig. 18—5. Oscilloscope patterns produced by sweep-frequency test records. The oscilloscope may be placed directly across the speaker voice-coil. (After Johnson.)

tion characteristics. These frequencies are usually identified in some way, perhaps by voice breaks, and the output voltage of the system or of one particular component can be measured over the frequency range, converted to decibels and plotted on a semi-log graph. The readings must be taken with the normal speaker load connected to the amplifier, and should be measured with the system delivering a known power output, so that the frequency response is tied to a specified power rating. When the output of the full system is being measured the readings are taken across the speaker voice-coil.

The use of such a frequency record in an aural test has little if any value except perhaps in the determination of gross deficiencies. The combination of the variation in hearing sensitivity over the frequency spectrum, and the existence of acoustic resonances in the room, make it impossible, with this method, to judge frequency response by ear with any significant accuracy.

A meter or oscilloscope must be used to check the electrical output of the system under test. It must be remembered that the measured frequency response curve will not be flat if the reproducing unit does not equalize correctly for the recording characteristics of the test record.

The sweep-frequency record is more convenient to use, since it does not require a frequency run, but plots the frequency response of the system on the oscilloscope screen instantaneously.* It does not, however, allow for as careful an examination of the reproduced output signal at particular frequencies as does the steady-tone record.

The sweep record has a spectrum of sine waves over a given frequency range (such as 70-10,000 cps, or 10-15 kc) swept across at some low-frequency rate, perhaps 20 times per second. If the oscilloscope is synchronized to the low sweep frequency, one succession of sine waves will be displayed on the screen. The frequencies at various points of the sweep spectrum may be indicated by marker pips, and the relative amplitude of the system's output at different frequencies can be read from the height of the screen pattern. This height represents signal voltage, and the read-

ings must be converted to decibels by the formula:

$$db = 20 \log \frac{E_t}{E_r}$$

or by a decibel chart. For example, if the height of the pattern at a particular frequency is half of the reference height, the response at this frequency is down 6 db.

Figure 18—5 illustrates several sweep-frequency oscilloscope patterns produced by test records. As in the case of the steady-tone record, the reproducing system must match the bass turn-over and treble pre-emphasis characteristic of the sweep record.

Transient Response

Extended and uniform frequency response predicts good transient response in both attack and decay. This transient response may be checked directly by using a pulse-type input stimulus such as a square wave. The accuracy with which the steep front is reproduced, and the tendency to oscillation in the horizontal portion (created by the sudden break in the signal) is observed. The tendency towards high-frequency ringing may also be checked with the sweep-frequency test record, by expanding the oscilloscope pattern horizontally and examining the low-frequency wave form just after the break from the high-frequency signal and marker pip. Ringing will be apparent as a damped oscillation occurring over the beginning of the first low-frequency cycle, as illustrated in Fig. 18—6.

A method of checking the hangover tendency of a loudspeaker system, by displaying on an oscilloscope the back-e.m.f. generated by the voice coil after

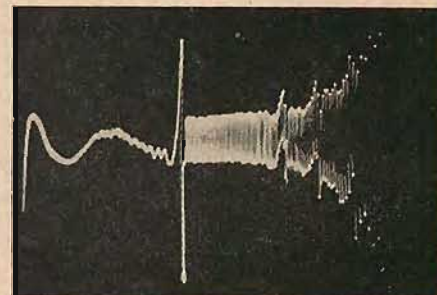

Fig. 18—6. Indication of ringing in first low-frequency cycle of sweep record. Horizontal gain control of oscilloscope is advanced to provide expanded pattern. (After Johnson.)

* Wayne R. Johnson, "Analyzing sweep frequency transcriptions," AUDIO ENGINEERING, October, 1947.

stimulation from a battery and circuit breaker arrangement, was described in Chapter 11.

White-noise test records⁴ may be used to indicate resonant emphasis of selected frequencies from a uniformly distributed (on an arithmetic basis) noise spectrum, and the attendant ringing. *Figure 18-7* illustrates oscilloscope screen patterns produced by audio components when reproducing such a white-noise record. Experience will correlate the amount of sine-wave ringing displayed visually with audio quality.

Source Impedance of the Amplifier Output Stage

The open-circuit output signal voltage of an amplifier, as we have seen, is ap-

⁴ Emory Cook, "White-noise testing methods," *AUDIO ENGINEERING*, March 1950, p. 13.

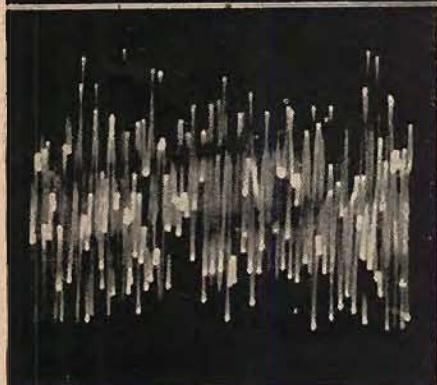
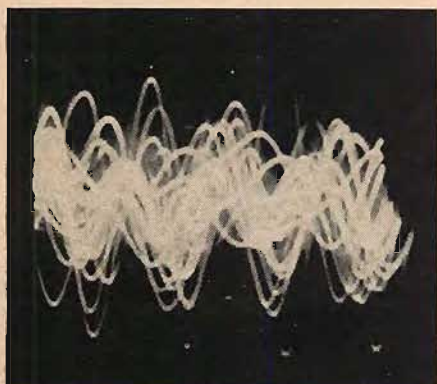

Fig. 18-7. Screen patterns produced by white-noise record. Top to bottom: acoustic output of headset, showing pronounced ringing (oscilloscope sweep rate 2,000 cps); acoustic output of high-quality 2-way horn speaker; acoustic output of 8-inch speaker, the pattern indicating intermodulation (sweep rate 30 cps); and reference electrical output of amplifier.

HYCOR TYPE 4201 PROGRAM EQUALIZER



Features . . .

- **LOW HUM PICKUP** through the use of toroid coils.
- **Switch contact noises** are inaudible even at microphone levels.
- **Low frequency equalization** peaked at 40 cycles and 100 cycles in 2 db steps up to 12 db.
- **High frequency equalization** peaked at 3 kc, 5 kc and 10 kc in 2 db steps up to 12 db.
- **Low frequency attenuation** in 2 db steps at 100 cycles and has a maximum attenuation of 16 db.
- **High frequency attenuation** in 2 db steps at 10 kc and has a maximum attenuation of 16 db.

\$195.00

General Specifications . . .

- DIMENSIONS:** Standard rack panel, slotted, 3½" high. Maximum depth 7½".
CIRCUIT: Bridged "T" constant impedance.
IMPEDANCE: 500/600 ohms, in-out.
INSERTION LOSS: 14 db constant.
CONTROLS: Low and high frequency selector switches. Low and high frequency controls in 2 db steps, in-out key.
FINISH: Engraved panel, medium gray baked enamel. (Special colors and finishes upon request.)

Send for Bulletin E

Representatives:

- BEEBE ASSOCIATES**
1155 Waukegan Road, Glenview, Illinois
BURLINGAME ASSOCIATES
103 Lafayette Street, New York City
HARRISON J. BLIND
1616 Cord Street, Indianapolis 24, Indiana
G. M. HOWARD & ASSOCIATES
734 Bryant Street, San Francisco 7, California

HYCOR SALES COMPANY of California

11423 VANOWEN STREET
NORTH HOLLYWOOD, CALIF.

AVAILABLE ONLY IN THESE KIT COMBINATIONS

- W-2 with Peerless transformer or W-3 with Acrosound transformer (be sure to specify) includes Williamson type amplifier, separate power supply and WA-P2 preamplifier kit. Shipping weight 39 pounds. Shipped express only. \$69.50
W-2M with Peerless transformer or W-3M with Acrosound transformer (be sure to specify) includes Williamson type amplifier and separate power supply. Shipping weight 29 pounds. Express only. \$49.75
W-4 with Chicago "super range" transformer includes single chassis, main amplifier and power supply with WA-P2 preamplifier kit. Shipping weight 39 pounds. Express only. \$59.50
W-4M with Chicago "super range" transformer. Single chassis, main amplifier and power supply. Shipping weight 29 pounds. Express only. \$39.75
WA-P2 preamplifier kit only. Shipping weight 8 pounds. Express or parcel post. \$19.75



TRUE High FIDELITY

HEATHKIT WILLIAMSON TYPE AMPLIFIER KIT



Here is the famous kit form William type high fidelity amplifier that has deservedly earned highest praise from every strata of Hi-fi music lovers. Virtually distortionless, clean musical reproduction, full range frequency response and more than adequate power reserve.

OUTPUT TRANSFORMERS — Three truly fine output transformers available for your selection. Peerless and Acrosound transformers specified for two chassis combinations W-2 and W-3 (main amplifier and power supply). New Chicago "Super range" transformer used in low priced single chassis Williamson type model (W-4). Response characteristics of all models virtually equal.

NEW PREAMPLIFIER — The exciting new WA-P2 preamplifier provides full control through its 5 individually controlled input circuits, 4 position turnover and roll-off switches — separate bass and treble tone controls. Attractively styled, beautiful appearance, baked gold enamel finish, functional in design. Will operate with any Heathkit Williamson type amplifier.

BUILD IT YOURSELF — Combined with brilliant performance of these units is the amazingly modest investment required and the fun of building it yourself. Detailed step-by-step construction manual complete with illustrations and pictorials insures success for even the most non-technical audio enthusiast.

Complete specification and schematic sheet available upon request.

HEATH COMPANY, BENTON HARBOR 25, MICHIGAN



Volume control with special printed electronic circuit by Centralab.

SENIOR COMPENTROL
with level-set
There's nothing else like it!
C2-100 - - - Net Price, \$4.50

JUNIOR COMPENTROL
 $\frac{1}{2}$ or 1 Meg. less Switch - - - - \$2.50 Net
 $\frac{1}{2}$ or 1 Meg. with Switch - - - - \$3.00 Net

Order from your Centralab distributor
Write Centralab, Dept. 933D, Milwaukee 1, Wisconsin,
for your "Compentrol Booklet".

*Trade Mark for Centralab's Compensated Volume Control. B-2554

Nearly everybody reads the
audio anthology
and
the 2nd audio anthology

The original audio anthology is still being ordered by people who have worn out their first copy or who have just learned about the book. Contains reprints of 37 articles which appeared in AUDIO ENGINEERING from May 1947 through December 1949. An invaluable reference work on audio in the home.

the 2nd audio anthology continues from where the first left off and contains reprints of articles from January 1950 through July 1952. In both books the articles were brought up to date, corrected where necessary, and assembled by subject. the 2nd a a may still be had with board cover.

CUT OUT — MAIL TODAY

Book Division, Dept. 3V,
Radio Magazines, Inc.,
P. O. Box 629, Mineola, N. Y.

Sirs: Enclosed is check money order for \$..... Please send me
..... copies of **audio anthology** (paper cover) @ \$2.00 each
..... copies of **the 2nd audio anthology** (paper cover) @ \$2.00 each
..... copies of **the 2nd audio anthology** (board cover) @ \$3.00 each

Name (please print)
Address
City Zone State

plied to a voltage divider consisting of the internal or source impedance and the external load impedance. The effective value of this internal impedance may therefore be measured and calculated by a simple application of elementary circuit theory.

With a given sine-wave input the r.m.s. value of the signal voltage across the output-transformer voice-coil winding, no load connected, is measured as in Fig. 8—8-A. This voltage is equivalent, neglecting the shunt impedance of the output transformer, to the open-circuit voltage of a generator. (Since no signal current flows, the internal impedance cannot drop the voltage. IR must equal 0 when $I=0$, no matter what the value of R .) The no-load output voltage reading, then, gives the magnitude of the voltage that will divide between internal and external impedances.

A load resistor of value equal to the nominal speaker impedance is connected to the voice-coil winding, and the output voltage measured again as in B. We can then draw an equivalent circuit to the output stage, as in C with a known voltage (the open-circuit voltage) being applied to a voltage divider, the lower arm and the voltage across this arm also being known. The ratio between the values of the load resistance and the resistance of the total divider is equal to the ratio of the voltage across the load to the open-circuit voltage, and the internal impedance is equal to the difference between the open-circuit and load voltages, divided by the load voltage and multiplied by the value of the load resistance.

$$Z_{int} = \frac{Z_L}{E_L} (E_o - E_L)$$

where Z_{int} = internal impedance,

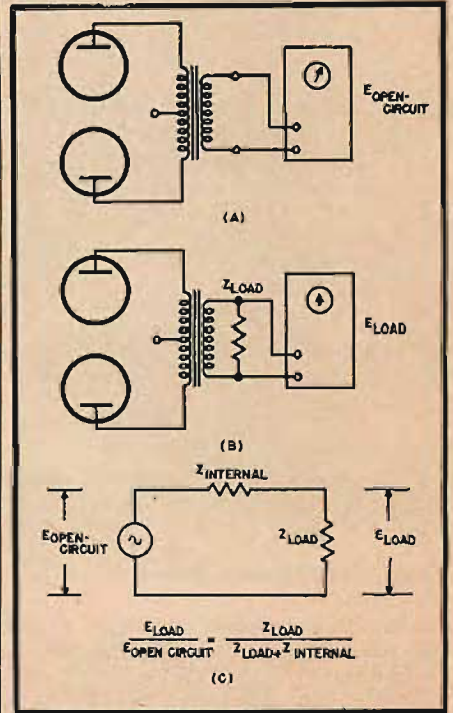

Fig. 18—8. Method of measuring source impedance of amplifier output stage.

Z_l = load impedance,
 E_l = voltage across load,
 E_o = open-circuit voltage.

For example, if connecting a given load to the open circuit makes the output voltage drop from 4 volts to 2 volts, the internal impedance is taking up half of the open-circuit voltage, and must be equal in value to the load impedance. The damping factor would thus be one. If the load does not change the output voltage the source impedance is zero and the damping factor infinite. Methods of calculating rather than measuring the source impedance and damping factor, and the significance of these values, are discussed in Chapter 12.

Acoustic Measurements

All the methods of examining electrical signals that have been described may be applied at various stages of the reproducing system or of the amplifier, to pin the guilt for some defect on a particular component or amplifier stage. However, no method of acoustical measurement has been discussed. This is because accurate acoustical measurements require far more complicated and expensive equipment, including specially built anechoic chambers or free-field set-ups, and can be performed in only a small number of laboratories. Low-frequency acoustic measurements of limited scope and accuracy can be made by placing a loudspeaker in the middle of a large open field and placing a microphone or sound-level meter in front of the speaker. It is the writer's experience that ground reflections are not troublesome in the bass, but tend to invalidate measurements in the mid-range or treble.

Measurements of Pickups and Arms

A method of measuring pickup tracking error to within a degree or so, using a triangle and protractor, is described in Chapter 16.

Vertical stylus force may be measured with a variety of scales sold commercially, which include instructions for their use. The measurement should be made precisely at the stylus tip.

A method of checking tracing distortion by the intermodulation method has been outlined.⁷ Assuming a correctly shaped stylus, improper tracing as a cause of distortion may be checked by temporarily placing an added weight on the pickup while observing distortion readings. If such increase of vertical stylus force reduces the distortion, improper tracing is indicated.

Turntable R.P.M. and Regulation

Turntable r.p.m. may be measured with a stroboscope card. This is placed on the turntable and illuminated by an a.c.-excited light. Such a light is blinking at twice the line frequency, so that one of the stroboscope dots or bars can move into the position formerly occupied by its neighbor during the period of relative darkness. If each bar ad-

vances, every 1/120th of a second, a distance equal to the distance between bars, the pattern of bars will appear stationary. The pattern is calibrated to the desired r.p.m., and indicates whether the turntable is on speed (pattern stationary), slow (pattern turning counterclockwise), or fast (pattern turning clockwise). When the pattern is shifting it is possible to follow one bar image around the turntable for one revolution of shift and to calculate the absolute r.p.m. from the time taken for this revolution. If, for example, it takes 60 seconds for one revolution of forward shift, the turntable is revolving at 1 r.p.m. more than the standard to which the stroboscope card is calibrated; if it takes 30 seconds for one revolution of shift the turntable is 2 r.p.m. fast.

The constancy of turntable revolution may be observed very roughly by the steadiness of the pattern's motion or lack thereof. For this test it is very important to see that the card is not warped and is lying perfectly flat.

Turntable regulation, or the constancy of r.p.m. under changing load, may be checked by comparing the stroboscope pattern taken with one record on the turntable, the pickup playing the inner record grooves, with the stroboscope pattern appearing with four or five records on the turntable, the pickup playing the outer grooves. (Under the latter condition the retarding force of the stylus is applied to the turntable with maximum mechanical advantage.) There should be no significant observable change in r.p.m.

A cheap turntable may cause a record album to be reproduced with lowered musical pitch for the concluding records. Variations in absolute turntable speed from the standard, however, of the order of one r.p.m., have little effect. The degree of variation in absolute r.p.m. that can be tolerated depends upon the sensitivity of the listener to slight changes in tempo and pitch from the original. There is a much greater tolerance to a fast turntable than to a slow one.

The American RMA standard for turntable speed is 78.26 r.p.m. for standard records and 33 1/3 r.p.m. for LP, with recording turntables required by NAB standards to be accurate to $\pm 0.3\%$. The British standards are, respectively, 77.92 and 33 1/3 r.p.m., with recording turntables required to be accurate within $\pm 0.5\%$.

Postscript

It is with feelings of both relief and regret that I conclude this series, and take up the task of revision of the material for the book form. I would like to take this opportunity to express my appreciation and indebtedness to all the authors of books and articles, both listed and unlisted, upon which this work so heavily rests; to Mr. C. G. McProud, Editor of AUDIO, for his helpful, patient, and tolerant editings; to Dr. Edward Lippmann, for his valuable aid with the chapters on music and psychoacoustics; and to those who have been so kind as to write me about the Handbook.

MORE! Terminal SOUND VALUES



ANGLE GENESEE MODEL 31 Corner Speaker Cabinet

For superlative sound reproduction and smart decor, choose this beautifully styled, table height, corner enclosure. Adjustable horn baffles permit easy matching to the speaker system and room. Unique matching-angle shape permits use in corner or flat against wall. Made by master craftsmen with attention to every detail that assures quality and performance worthy of the finest equipment. Available in Modern and Traditional styling in all standard and special finishes. Size: 30 3/4" high, 39 3/4" wide, 18 1/2" deep.

STANDARD FINISHES: Traditional Style—Dark Mahogany. Modern—Limed Oak, with cutout for 12" or 15" speaker. Net \$108.50

SPECIAL FINISHES: Blonde Mahogany, Cherry Mahogany, English Brown Mahogany, Natural Mahogany, Walnut, Fruitwood, Birch, Wheat, Ebony. 10% Extra



STROMBERG CARLSON Model RF-475—15" Coaxial Speaker System

The ideal speaker for discriminating music lovers who want the finest sound reproduction from their home music system. Also suitable for auditoriums, music halls and chapels. Coaxial placement of the high and low frequency units as originated by Stromberg-Carlson and further perfected in this extremely powerful speaker, adds greatly to its high degree of audio fidelity in the reproduction of both voice and music with realism and listening enjoyment. Exceedingly uniform throughout the full range from the lowest notes of the organ bass to the elusive tinkle of the triangle. Frequency response 30 to 16,500 cps. Ample reserve for any crescendo. Easily handles 40 watts.

LOW FREQUENCY CONE: 15" diam. with 3" voice coil. Resonance in free air—38 cps. HIGH FREQUENCY UNIT: 2" moulded plastic diaphragm with 1 1/2" voice coil.

DIMENSIONS: Overall—Diameter 15", depth 10 1/2"
 WEIGHT: 40 1/2 lbs. net, 50 lbs. packed for shipment. Net \$179.95

SEE, HEAR AND COMPARE The Latest Audio Equipment at TERMINAL Sound Studios.

Radio • Audio • Video • Electronic Equipment

Phone: WOrth 4-3311

Terminal
RADIO CORP.

85 Cortlandt St. • New York 7, N. Y.

⁷ H. E. Roys, "Determining the tracking capabilities of a pickup," AUDIO ENGINEERING, May 1950, p. 11.

Free

to your friends

a copy of

AUDIO

Don't give your copy away. Let us send one to each of your friends—no obligation, of course. Fill out this coupon and send to

RADIO MAGAZINES, INC.

P. O. Box 629 Mineola, N. Y.

Please send a free copy to the names given below . . .

with my compliments

omitting my name

Signed

Address

City and State

Name

Firm

Address

City and State

Name

Firm

Address

City and State

Name

Firm

Address

City and State

Name

Firm

Address

City and State

Name

Firm

Address

City and State

NEW PRODUCTS

(from page 44)

• **Multiple Tape Recording Adapter.** With the S-O-S (Sound-on-Sound) adapter, the owner of a Concertone tape recorder can combine several music tracks—played or sung by the same person, for example—on a single magnetic tape. Previously such

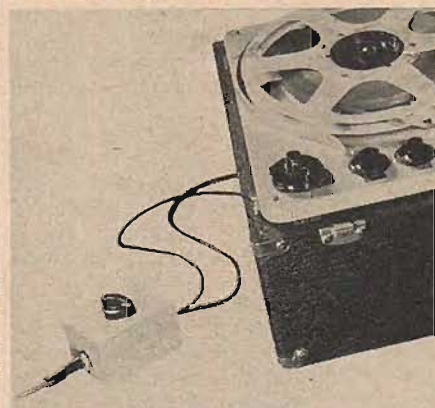

sequential recordings, popularized originally by Les Paul and Mary Ford, have been possible only through the use of two or more recorders plus a multi-channel mixer. Other uses for the S-O-S adapter include adding commentary to previously recorded tracks or, conversely, adding music or sound effects to narration. Although designed specifically for use with the Concertone recorder, the device may be used similarly with other recorders equipped with three separate magnetic heads. Berlant Associates, 4917 W. Jefferson Blvd., Los Angeles 16, Calif.

• **Tiny Pillow Speaker.** Developed primarily for use in hospitals, the new Telex pillow speaker can be used with any radio receiver or amplifying system to provide



comfortable listening through a pillow without disturbing people nearby. The unit weighs but 2.6 ounces and has a maximum thickness of only 5/8 in. It is molded in a single integral unit which is not affected by changes in temperature or humidity. The diaphragm is made of alloy steel and is hermetically sealed against dust and moisture. The speaker may be easily sterilized by submerging in standard alcohol solution. Flexible cord is detachable. For literature and price information write Department KP, Telex, Inc., Telex Park, St. Paul, Minn.

• **Miniature Plug-In Power Supply.** Introduced as a companion unit to the Langevin 5000 Series of miniature amplifiers, the Type 5206 power supply is designed for single or group mounting in equipment racks and consoles, and provides a. c. for filaments as well as highly-filtered d. c. for plates. A single unit will adequately power twenty-two Type 5116 or 5117 amplifiers. Two rectifiers are operated in parallel, both of which may be replaced without unplugging the unit. A neon pilot lamp indicates blown plate fuses for quick localization of trouble. Continuous-operation

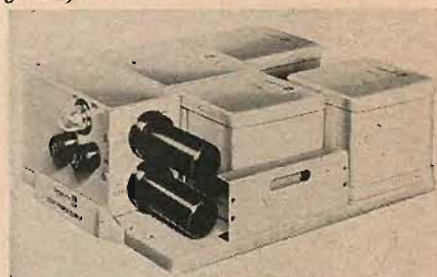

ratings are: 300 volts d. c. at 210 ma, and 6.3 volts a. c. at 6.5 amps. Ripple is less than 10 mv at 300 volts. Technical information available on request from Langevin Manufacturing Corporation, 37 W. 65th St., New York 23, N. Y.

• **Ten-Watt Leak Amplifier.** The new Leak Model TL/10 amplifier is built around an Ultra-Linear circuit whose output stage

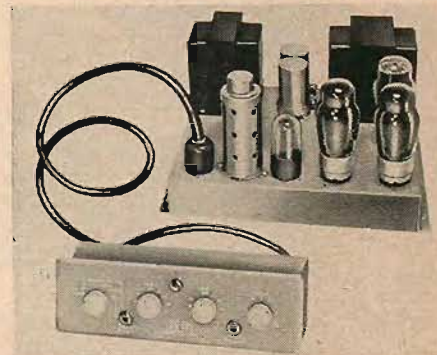

comprises two KT-61 beam-power tetrodes in push-pull. Harmonic distortion is only 0.1 per cent at 1000 cps for power output of 8 watts. Damping factor is 23, while hum level is 76 db below rated output. All components are mounted on a terminal board for easy servicing. The remote-control "Point One" preamplifier which is included in the TL/10 combination contains separate bass and treble controls, each of which affords a 25-db range in eight indicated steps. Inputs permit operation from any phonograph pickup now available, as well as from tuner and magnetic tape recorder. Tape recorder jacks, both input and output, are front-panel-mounted for immediate accessibility even when the amplifier is permanently mounted. All controls appear on a handsome gold escutcheon with jeweled pilot light. British-made tubes in the TL/10 are replaceable by standard American counterparts. Literature and complete information may be obtained by writing Dept. LP-2, British Industries Corporation, 164 Duane St., New York 13, N. Y.

• **FM-AM Tuner.** Re-designed to meet the changing requirements of home music systems, the new Altec Lansing Model 303C tuner offers increased sensitivity, greater



latitude in controls, and many improvements in circuitry. A.f.c., which may be disabled at will, assures freedom from annoying drift. Built-in preamplifier, together with simplified crossover control, permits playing of any type record. Spare input is provided for TV or tape recorder. Separate bass and treble controls permit both rise and droop. Altec Lansing Corporation, 161 Sixth Ave., New York 13, N. Y.

Stereophonic Reproduction

(from page 21)

are to be spaced. Our contention is that we must not try to reconstruct the original sound field, but to deliver the correct sound to each ear to simulate a sound source from a certain direction. Therefore, the distance between microphones need not be the same as the distance between our ears or between the loudspeakers, and the artificial head need not be of exactly the same form and of the same dimensions as the human head.

We found for stereophonic reproduction the following rule of thumb: Let ϕ be the angle in degrees between the extreme sources as seen from the mikes and let a be the distance between the two microphones in cm. Then $\phi a = 6000$. For an artificial head of diameter D cm, the relation should be $\phi D = 2000$. Thus a head of 22 cm will not give a true reproduction of the whole of the studio, but will place all sources with an azimuth of more than 45 degrees in the loudspeakers themselves, and a head of 11 cm is needed to cover the 90 degrees to each side.

Much the same is true for binaural reproduction. When using an artificial head, it will be clear that this must have the same diameter as the human head. But with free microphones the time differences have to be exaggerated, and a larger distance should be used.

Head Movements

Even true binaural listening with phones has its drawbacks. One of them is that the whole acoustical world is coupled to the head and moves with it. This may be the reason why the image is located behind the listener. Moving the artificial head in accordance with the head of the listener brings the image definitely in front of the listener. The very small involuntary and imperceptible movements of the head play an important part in the location of a source, especially as to its angle of elevation. De Boer calculated this effect and found his results confirmed by experiments.³

The most difficult problem in stereophony is to place the loudspeakers in such a way that an undistorted sound image is heard all over the auditorium. When we move over to the left the sound from the left loudspeaker will arrive too early and the image moves with us to the left. This has to be compensated by a reinforcement of the sound from the right loudspeaker.

To conclude, all three types of two-channel sound reproduction mentioned by Mr. Canby rely on the same properties of our sound perception, although the methods of simulating the difference in sound received by the two ears vary, as do the results regarding separation, sharpness, and definition of the sound images.

³ Koenig, *J. Acous. Soc. Am.*, 22, 61 (1950).

AXIETTE *High* FIDELITY OF SOUND

MADE IN ENGLAND

AXIETTE 101 8" Single Cone Loudspeaker



The need for a reasonably-priced and medium sized high-fidelity loudspeaker has been met by the Research Laboratories of Goodmans Industries who are constantly in touch and, indeed, in sympathy with the requirements of the high-fidelity enthusiast. To a certain extent this demand can be related to the present-day restrictions on living space and the fact that enthusiasts are seeking a loudspeaker which, when suitably housed, will occupy the minimum of space, and yet still faithfully reproduce their particular choice of music.

From the start it was decided that the new loudspeaker would be housed on an 8 in. chassis and to set a really new trend, a special hyperbolic cone was designed.

BRIEF SPECIFICATION

Frequency Range - - -	40-15,000 c/s.
Fundamental Resonance - -	65 c/s (nominal)
Voice Coil Impedance - - -	15 ohms.
Flux Density - - -	13,500 gauss
Nett Weight - - -	3½ lbs. (1.47 kgs.)

AUDIOPHILE NETT PRICE

\$21.30

Exclusively distributed by:—

EAST: Goody Audio Center Inc.,
235 West 49th St., New York 19, N. Y.

WEST: Hollywood Electronics
7460 Melrose Avenue, Los Angeles 46, Cal.

SOUTH & SOUTH-WEST: High Fidelity SSS,
606 Peachtree St., N.E., Atlanta, Ga.

CANADIAN SALES OFFICE:
A. C. Simmonds & Sons Ltd.
100 Merton St., Toronto 12



GOODMANS

GOODMANS INDUSTRIES LTD., AXIOM WORKS, WEMBLEY, MIDDX. ENGLAND

FOR THOSE WHO SEEK THE ULTIMATE IN HIGH FIDELITY CABINETS

*Custom-Styled
by Cabinart*

*for the
complete
music system*



Model 21 and 22 mirrors the elegance and beauty of the finest furniture . . . superior craftsmanship that challenges comparison. These twins of modern design are indicative of the luxury styling inherent in the entire G&H Wood Products Line.

Available in select oaks, walnuts and mahogany finished in french mahogany, limed oak, honey walnut and black lacquer.

* Slightly higher west and south

Model 21
equipment
cabinet

\$117*
NET

Model 22
speaker
cabinet

\$69*
NET

Precision Manufactured High Fidelity Cabinets of Character

G & H WOOD PRODUCTS CO.

75 NORTH 11th STREET, BROOKLYN 11, N.Y.



by **Cabinart**

PIONEERS IN RADIO FURNITURE FOR HIGH FIDELITY EQUIPMENT



FOR
MAGNETIC
RECORDING

BRUSH REDHEADS GIVE TOP PERFORMANCE

The high fidelity performance of Brush Redheads has won them wide acceptance from makers of magnetic recording equipment. The record-reproduce head, designed for dual-track recording on 1/4-inch tape, has unusually high resolution, which provides an extended frequency range. The Redhead is dimensionally stable, is unaffected by moisture, and provides freedom from

microphonics. The companion erase head has the same basic construction, and is outstanding for efficient operation at very low power consumption.

For information on the complete line of Brush magnetic heads—single and multi-channel, write Brush Electronics Company, Dept. ZZ-4, 3405 Perkins Avenue, Cleveland 14, Ohio.

BRUSH ELECTRONICS

INDUSTRIAL AND RESEARCH INSTRUMENTS
PIEZO-ELECTRIC MATERIALS • ACOUSTIC DEVICES
MAGNETIC RECORDING EQUIPMENT
ULTRASONIC EQUIPMENT



COMPANY

formerly
The Brush Development Co.
Brush Electronics Company
is an operating unit of
Clevite Corporation.

TAKE CARE

OF YOUR RECORDS



Your records represent an important investment, and they deserve the best treatment possible if you are to have the many hours of enjoyment you are entitled to, unmarred by increasing noise and distortion. Records may be irreparably damaged by continuing to use worn styli in playing them—though they may still be "unbreakable."

In this booklet the author gives the results of comprehensive tests on the various types and materials of styli—information which should be in the hands of everyone who plays phonograph records. His tests are the result of thousands of hours of playing—during which time he wore out hundreds of LP records and dozens of styli.

You will want this book as a guide to the proper treatment of your records—how to take care of them, how to clean them, how to store them—everything you need to know to give you satisfactory record reproduction. Order it now!

Price \$1.00 postpaid

RADIO MAGAZINES, INC.,

P. O. Box 629

Mineola, N. Y.

POWER TRIODES

(from page 20)

former-coupled amplifiers is not easy, and it involves work, test equipment, and skill. The usual dilemma is this: you either have to run a single-ended loop around too many stages for comfort, or run a balanced, push-pull loop around too few stages, so that there just isn't enough gain inside the loop.

The single-ended amplifier confronts its builder with fewer decisions of this sort, and a single-ended (of course) loop from input to output (or, if you like, *vice versa*) is the normal, inevitable, and easy way to apply the feedback. For the same amount of pains, it is possible to get a great deal more feedback with a single-ended amplifier, although there is no theoretical argument which makes this inevitable; it is just a working rule.

It is not unusual to find single-ended power amplifiers which are stable with 80 to 100 db of feedback at low audio frequencies, but it is not common to find push-pull amplifiers with such large degeneration. It has been the author's experience that it is possible to put perhaps 20 more db of feedback around a single-ended amplifier than would have been possible with a push-pull amplifier of the same type or purpose, for the same amount of effort and skill. Generalizations are difficult in matters of this sort. It is not hard, though, to use amounts of distortion reduction due to feedback which greatly overshadow those likely to be realized by the even harmonic cancellation of the push-pull system. It is just that it seems hardly worthwhile to worry about a few per cent less even-harmonic distortion in the basic amplifier at the expense of a more complicated circuit when you are planning to reduce the even and odd distortion by, say, 100 to 1.

One can argue for the push-pull system by saying that it is not possible to get an actual 60 db, say, of feedback at 10,000 cps even with a single-ended amplifier, and that even 40 db is very tough (especially with a transformer), while 10 to 20 db is the more usual figure. This is very true. In order to have 20 db of feedback at 10,000 cps while maintaining the low-frequency performance as usual, a very fine transformer is necessary. However, it is questionable how much distortion cancellation actually occurs at the higher frequencies with the push-pull system. There is such a thing as capacitive unbalance and phase splitters are often full of it. When one considers that the odd harmonics are still with us when we use the push-pull system, so that feedback is necessary in virtually the same proportions for equal over-all results with either a single-ended or double-ended amplifier, the advantages of the more complex arrangement look dubious.

Elimination of the direct current from the primary of the output transformer may be accomplished in a variety of ways. In this particular case it was decided to use the old-fashioned choke and

capacitor shunt-feed system. There are three or four better ways to do it.

The push-pull circuit is, naturally, required for class B work. It is only class A which is being discussed here, as it is felt that except for purposes where economy and, therefore, efficiency are essential and dominate the design, class A is the proper way to build good-quality audio equipment. There is something very disturbing about the thought of discontinuities in the plate current of the power tubes for a real musical amplifier, even in the light of some notable advances in the minimization of the difficulties of these discontinuities. A really good system for reproducing sound will be very heavy and expensive, and the small economies one achieves by the use of class B—or AB—are not worthwhile in non-commercial equipment.

The 6S4 Amplifier

To test the 6S4 and to try out some single-ended ideas the amplifier of Fig. 3 was constructed. It is entirely single-ended, using 10 tubes in all including the power supply shown in Fig. 4, and was built with permanence of performance in mind. The finished job appears in Fig. 5.

The central idea governing the design of the circuit as a whole is the direct coupling of all stages, save only for the plate circuit of the power stage, which involves a shunt-fed transformer. Only in this manner was it possible to avoid trouble with the large amounts of feedback used, since the loop is from voice coil to input grid. By building the voltage amplifiers in direct-coupled form it is possible to reserve most of one's time and ingenuity for the really taxing problems which are often to be found at the high end of the audio spectrum, leaving the low end as "solved." (This is an oversimplification, of course, since it is only in the more elementary and less demanding circuits that one can

toss off the low-frequency problem so blithely. It is not implied that this instrument has optimum very-low-frequency response, but simply that it is, in this respect, quite satisfactory for its purpose.) By direct coupling of all or most of the stages, it is possible to greatly simplify one's problems, although it is sometimes at the expense of an elaborate power supply that one does.

With a multistage d.c. amplifier it is necessary to provide some means of controlling the various tubes so that they always operate at the proper potentials and currents. In this case it was found that the power stage remained either saturated or cut off unless substantial d.c. feedback was employed. A resistor R_f was placed in the cathode lead of the power stage and the voltage appearing across it sampled, filtered to subtract a.c. components, compared with a reference voltage, and the result applied to the grid of a differential amplifier, the second 12AT7 triode. Any tendency on the part of the output stage to depart from a certain optimum quiescent plate current is fed back to the differential grid in degenerative fashion. Another way of looking at this is to say that there is roughly speaking no voltage gain for d.c. from input grid to output transformer primary so that there is very little d.c. drift in the output tube plate potentials. All that is required in this type of amplifier is that the d.c. drift be small enough not to limit significantly the maximum a.c. power output. Unless drastic damage occurs, such as tube failure, the large amount of d.c. feedback ensures that each tube is, if capable of even poor performance, doing as well as it can in the circumstances. The amplifier will go on working reasonably well under very adverse circumstances, such as failure of most of the power stage tubes. When dealing with the usual a.c. power amplifier, one is never too sure without meters that all is well, while with this method of de-

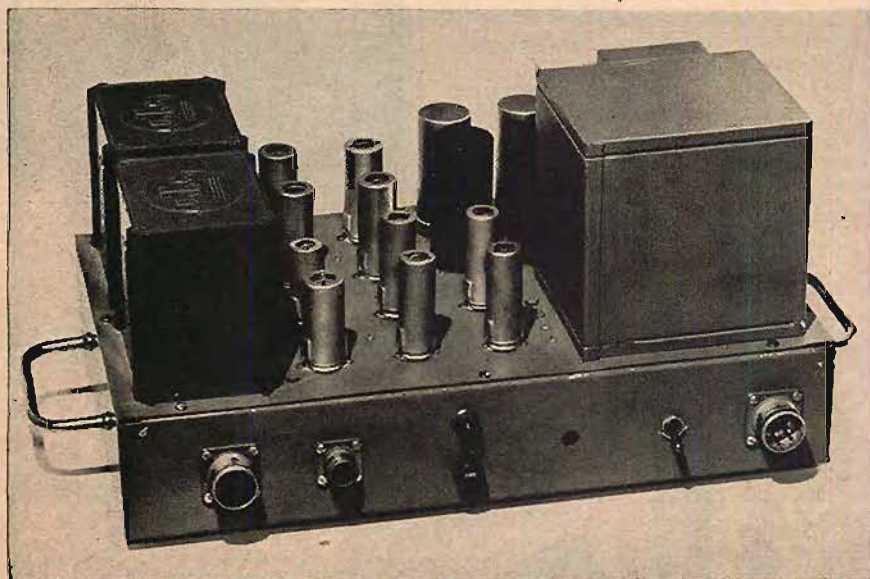

Fig. 5. The 10 tubes and other components of the 6S4 amplifier are mounted on this not-oversize chassis without crowding, sacrificing neat appearance and good separation of tubes for heat dissipation.

You'll find the
BEST BUYS in HI-FI
at HUDSON!



TERRIFIC

**HARMAN
KARDON**

**FM-AM
TUNER**

\$49.50
With Tubes

It's NEW—it's WONDERFUL!
This tuner provides performance to satisfy the most critical, yet is budget priced for every purse!

Many unique features: Professional type Flywheel Tuning... AFC Defeat Switch in Tuning Control... Really simple Cabinet installation... novel, highly effective AM Loopstick. Separate AM and FM front ends. Brushed copper front panel. 7 3/4" H, 11" W, 7 1/2" D. For 115 V 60 cy.

Famous FERRANTI



**RIBBON
PICKUP**

Designed by D. T. N. Williamson, designer of world famous Williamson Amplifier. Brilliant realism of reproduction is matched by quiet elegance of its style. Completely integrated design from stylus to arm mounting gives flat response from 20-20,000 cps., with extremely low distortion and negligible record wear.

FW-10—Pickup Arm	\$29.50
FW-11—Head with 1 Mil Diamond Stylus ..	\$37.50
FW-125—Head with 2.5 Mil Diamond Stylus	\$37.50
FA-21—Matching Transformer	\$ 9.95

Price Slashed!

DIAMOND SAPPHIRE STYLUS

For G.E. Cartridge. DIAMOND Tip (.001") for Microgroove; SAPPHIRE Tip (.003") for 78 rpm. Perfect, guaranteed! Limited Quantity—hurry!

No. S-5120 Each **\$12.95**

List \$31.00

**VISIT THE WORLD'S FINEST
AUDIO COMPARISON STUDIOS**

At all 3 Great Hudson Salesrooms, you can SEE, HEAR, and COMPARE all the World's Finest High Fidelity Audio Equipment and Accessories by Pushbutton Control.

FREE Hi-Fi CATALOG

1954 Edition, just out, the Buying Guide for Audiophiles... has Everything in Sound Equipment and Parts. Send for your FREE Copy. Dept. D-4



Hudson
RADIO & TELEVISION CORP.
ELECTRONIC & SOUND EQUIPMENT

Adjoining Radio City 48 West 48 St. New York 36 Circle 6-4060	Downtown New York 212 Fulton St. New York 7 Circle 6-4060	New Jersey 35 William St. Newark, N. J. Market 4-5151
--	--	--

SAVE
33 $\frac{1}{3}$ %



This is our
GROUP SUBSCRIPTION PLAN

You and your friends and co-workers can now save up to \$1.00 on each subscription to **AUDIO**. The more men in a Group, the more each saves. If you send 6 or more subscriptions for the U.S.A., and Canada, they will cost each subscriber \$2.00, 1/3 less than the price of a regular 1-year subscription. Present subscriptions may be renewed or extended as part of a Group.

AUDIO is still the only publication devoted entirely to

- Audio
- Broadcasting equipment
- Acoustics
- Home music systems
- Recording
- PA systems
- Psychoacoustics

(Please print)

Name

Address

Position Company

Name

Address

Position Company

Name

Address

Position Company

Name

Address

Position Company

Name

Address

Position Company

Name

Address

Position Company

U. S., Possessions, and Canada only.

RADIO MAGAZINES, INC.
P. O. Box 629, Mineola, N. Y.

sign reassurance may be had—if needed—by a single meter reading. If the output tubes are operating with, say, the proper quiescent cathode current, then the whole of the rest of the circuit is very probably all right.

The first stage of this particular design uses a 12AT7 as a symmetrical differential amplifier. The differential amplifier is convenient as an input stage, since it provides a high-impedance point—the differential grid—to which d.c. feedback can be applied. It was expedient in this case to use the main input grid for a.c. feedback, and the differential grid for d.c. feedback, in this way obtaining an input circuit at d.c. ground potential, and avoiding problems of mixing a.c. and d.c. feedback voltages.

Symmetry of this differential stage is important. There is a possibility of 6 db more stage gain and hence that much more feedback, if the differential plate is returned to a well-regulated source of +60 volts or even to the +150 v. from the 0A2. It was not possible, however, to do this, without trouble with d.c. regeneration. The power supply, not being regulated, has a finite output resistance, and common to four stages (counting the differential stages as two), in spite of assistance from the upper 0A2 (Fig. 4). Full electronic regulators are, of course, almost a necessity with multistage d.c. amplifiers, and it was only a firm desire for simplicity, economy, and compactness which dictated the simple—but effective—supply used here. No trouble with d.c. instability has been experienced when reasonable symmetry of the 12AT7 circuit was attained, and commercial tolerances of parts have proven to be quite adequate. There are no selected, matched, or premium-quality components.

The driver stage was made a pentode for reasons of gain, at least 40 db of a.c. feedback being sought. A 12AU6, one of the higher-performance 12-volt tubes, was chosen. (A heater winding of that voltage happened to be the most convenient to use of the windings available on the transformer.)

The 12AU6 is operated at a screen potential of about 100 volts, which is a fair compromise between the higher gains obtained at lower voltages, and

The 2199-B
High Fidelity Amplifier
by
BELL



A member of a proud family! Model 2199-B is just one of the many exceptional high fidelity instruments bearing the Bell name, and combines moderate cost with features usually found in only the highest priced amplifiers.

Specifications: 12 watts at one-half of 1%, 20 to 20,000 cps flat frequency response, six inputs, five controls including continuously variable loudness control, three convenience outlets, pilot light socket.

Write today for information on the complete Bell line of high fidelity and audio equipment.



A Subsidiary of Thompson Products, Inc.

559 Marion Rd., Columbus 7, Ohio

Export Office: 401 Broadway, New York 13, N. Y.



non-directional

By changing plug-in capsules, available separately or both capsules with this unit.

and/or cardioid.

for the most difficult studio pick-up problems . . .

S-T condenser microphone!

Amazing new features in CM-51 provide a uniform frequency response over a range of 30-18,000 cycles and a wide dynamic range . . . pick-up flexibility . . . used in strong AC fields . . . not effected by temperature or humidity changes. Write for more detailed information.



reeves equipment corp.

10 East 52nd Street, New York 22, N. Y.

the larger output swings made possible with higher voltages. The screen was run at +150 volts for some time and the only difference was a little less feedback.

The network in the plate circuit of this tube (R_1-C_1) is designed to reduce the gain of the stage at a 6 db-per-octave rate, from 300 to 5000 cps, so that the driver is not contributing to the rolloff in the critical 10-100-kc region where the transformer is letting down. High-frequency oscillation is thus avoided.

The final stage is made up of four 6S4's in parallel, using a 15-hy (nominal at 125 ma d.c.) shunt-feed choke, and a 100- μ f coupling capacitor. A stock transformer, not of the largest size (which does control low-frequency results), was used to present the 32-ohm speaker load to the power tubes, so that they see 2000 ohms total, or 8000 ohms per tube, which seems about right. The 6S4 has a stated plate resistance of 4000 ohms at typical operating conditions, and the load here used is probably not too far from optimum. Tests at other loads have not contradicted this. More power might have been had with special components more exactly suited to the job, but a compromise was necessary, and without, it is felt, too great a penalty.

The interstage networks are designed to pass d.c. voltages with 3 to 6 db loss, and to pass a.c. (above 20 cps or so) with negligible loss. Feedback, of course, produces a flat over-all response.

The measured value of feedback, at its maximum, was 47 db at 250 cps. It is reduced at a 6-db-per-octave rate beyond this frequency, due to the network in the 12AU6 plate circuit. Less and less feedback is required for musical reproduction as frequency increases, for amplitudes become less and distortion is generally less serious, even without feedback. The average speaker system will not pass harmonics of (fundamental) frequencies over 6,000 cps, although it may generate its own distortion signals anywhere in its spectrum.

The a.c. feedback path is dependent on having a low-impedance source—a cathode-follower of the usual sort seems adequate—to drive the amplifier. Since it is usual to terminate preamplifiers in cathode-follower output stages or their feedback "equivalents," this is not a

great disadvantage. Under this stipulation, the over-all gain of the amplifier is set by the ratio of the 1-megohm and 100,000-ohm resistors at 10.

The large value, 100 μ f, of coupling capacitor C_1 was used because it was a convenient and readily available size, and more important, because it was intended to avoid resonating with the choke. The reactance of the capacitor remains low while the choke begins to let down at the low end of the spectrum, so that low-frequency stability is obtained.

The power supply of Fig. 4 is of the simplest kind. As rectifiers 6X4's are used on the positive side and selenium rectifiers, for instant starting, on the negative. By the use of an instantaneous negative supply we ensure longer life for the power-stage tubes. Except for a sharp, short transient, there is no chance for the power stage to draw excessive current on warm-up.

Performance Data

Performance of this unit was quite satisfactory for its size. Square-wave tests showed a slope down of 40 per cent at the 10-cps repetition rate, and there was the usual set of dips and peaks amounting to 15 per cent of the total amplitude in the 10,000-cps square wave (due to transformer resonances, which are inevitable).

Sine-wave response was down 0.1 db at 20 cps, and 0.5 db at 20 kc. (Unless a special transformer is found it is extremely difficult to do much better than this, with tolerable stability and reasonable lack of care in construction, when about 50 db of feedback is involved.)

Phase shift was less than 10 deg. at 8 cps and at 10,000 cps, and less than 1 deg. from 40 to 1000 cps. (Frequency response runs, as to both phase and amplitude, were run at about 1 watt output.)

Maximum power was 7.5 watts from 100 to 10,000 cps, and 2.7 watts at 20 cps. The low-frequency power was limited by the iron-cored components.

Hum and noise amounted to 4 mv, referred to the output, or 72 db below full power, quite a reasonable figure.

Comparison of the two amplifiers (both of them highly experimental in the sense that they were not intended to be the constructor's last word on the subject) shows a clear superiority of performance and of ease of construction (with a reasonable amount of equipment) for the single-ended 6S4's. Better results were more easily obtained with the "unorthodox" circuit, even though performance was limited by the use of small sizes of iron-core components.

Acknowledgment must be made of the many arguments in favor of single-ended, direct-coupled amplifiers for audio use presented by Mr. George W. Downs, which led to the construction of the 6S4 amplifier described. As a result of the confirmation of these arguments in this and other projects the author is unlikely to build a push-pull amplifier again unless paid to do so!

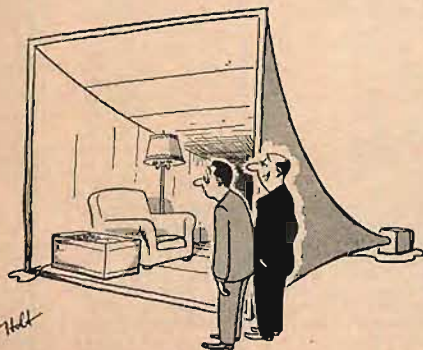

... and this is my listening room

RECORDING TAPE

(PLASTIC BASE)

at NET PRICES

in Cartons of 12

WASHINGTON, D. C.: WHERE ELSE WOULD THERE
Magnetics
BE MORE RED ^ TAPE!

- 1200 ft. plastic tape with plastic reel.
- Choice of nationally famous top quality brands such as:
Webcor (2906) 3.20; Reeves (SPN-12) 3.20;
Audio (1251) 3.23; Scotch (111-A) 3.25;
Panacoustic (711-A) 3.25; Irish, Professional grade (211 RPA) 3.30.

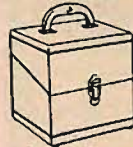

FREE! A 7.95 tape carrying case included with purchase of 12 new tapes.

- Recording studios, schools, radio stations and other large quantity users—write for bulk price.

★★★★★★★★★★★★★★★★★★★★
USED RECORDING TAPE (PLASTIC BASE)



1.99 for 7"—1200 foot
.99 for 5"—600 foot
.59 for 4"—300 foot
.29 for 3"—150 foot
Plastic reels included with all above sizes.

New empty plastic reels in boxes for easy labelling. 3" 10¢; 4" 22¢; 5" 24¢; 7" 29¢; 7" Professional reel (2 1/4" hub) 39¢ ea. EMPTY BOXES: 3" 3¢; 4" 5¢; 5" 5¢; 7" 10¢ ea.

We carry all brands of new tape, recording blanks, tape recorders, etc. at low prices. PLEASE INCLUDE SUFFICIENT POSTAGE.

COMMISSIONED ELECTRONICS CO.
2503 Champlain St., N.W., Washington 9, D. C.

Speed up
BUYING
RESEARCH
PRODUCTION

GET INTO THE MASTER HABIT!

RADIO'S MASTER
NEW! 1954 EDITION

- 1370 pages
- Over 85,000 items
- Over 8,000 illus.
- Completely indexed

\$1.95 at your parts distributor
Publisher's price \$6.50

Make component buying simple and ease the problem of product specification. Have complete access to the many thousands of items vital to electronic research, design and production. You'll find them all in the Master with thoroughly complete descriptions, specs, illustrations and prices . . . all systematically organized in 18 big sections for instant reference. For jiffy comparison of products . . . use the Master, the only Official Buying Guide for the TV-Radio-Electronics industry. It contains unabridged catalog data direct from the manufacturers. The Master gives you all the needed facts in a single volume.

Over 100,000 in active daily use. Get into the Master habit. Order your copy today!

Just a few of the products included: Tubes — Test Equipment — Tools — Transformers — Capacitors — Resistors — Relays — Coils — A-Hennas — Recording & PA Systems — Hardware — Transmitters — Receivers — Kits — Wire — Cable . . . and thousands of allied products!



Eliminate Incomplete Small Catalogs and Loose Literature

UNITED CATALOG PUB., INC.
110 LAFAYETTE ST., NEW YORK 13, N. Y.

Easier Reading VU METER

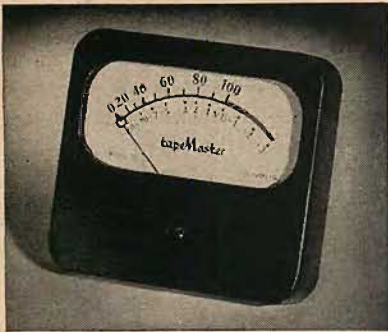

MAKES IT SIMPLE FOR ANYONE TO VISUALLY MONITOR ANY RECORDER

Permits quick, more positive reading of average power. Makes it easy for anyone, even the unskilled recorder, to visually control recording level, prevent distortion, emphasize or de-emphasize any passage—the professional way—on any recorder. Standard VU scale and sensitivity. Color-differentiated scale. Dual impedance. 3½" rectangular semi-flush mounting. Complete with instructions.

MODEL 10 VU METER. NET \$17.00

MODEL 10 L. Same with internal illumination. . . . NET \$19.00

Write for Bulletin No. 110



13 W. HUBBARD ST. CHICAGO 10, ILL.

The Magnemite*



Battery-Operated Spring-Motor Portable Recorder

Field recordings can now be made with equivalent quality and with as little effort as studio console recordings. Smaller than a portable typewriter (11½ x 10 x 8 inches) and weighing 15 lbs. including the dry-cell batteries that last 100 operating hours, the Magnemite* is easily carried and operated anywhere.

Here are truly professional specifications:

- Model 610-SD (7½ ips, 50 to 7500 cycles meets NARTB standards.
- Model 610-E (15 ips, 50 to 15,000 cycles) meets primary NARTB standards.
- Dynamic range 50 db.
- Flutter ± 0.1%.
- Constant speed governor-controlled.
- Monitoring and playback facilities.

Write for complete technical literature and direct factory prices to Dept. AE:



AMPLIFIER CORP. of AMERICA

398 Broadway, N. Y. 13, N. Y.

*Trade Mark Reg. Pat. Pend.

THE RIGHT EAR

(from page 25)

some are atrocious. It is time that some standards were imposed to try and present the music without benefit of dressing up and dressing down.

Q. Then it is your considered position that what is needed is a means of training the listener's ear to hear instruments, sections, whole orchestras, and music in general as it exists and they exist in reality.

A. Yes. It is particularly important, especially during the present period of composition. A well trained ear, an ear equipped to hear spontaneously the full complexity of sound with ease and accuracy is a guarantee of greater enjoyment as well as a broader base for music in this country.

We humbly recommend to a recording company—to all recording companies—that it would be well worth their while and would represent a great contribution to the public and eventually to their own coffers if a series of records were produced carefully aimed at ear training. Such a recording effort would include individual instrument sounds, combinations of all kinds, etc. Together with such a recording would come instructions as to how it was to be played back—assuming first class equipment in the first place. Equalization, tone controls, perhaps a guide to determine whether the listener's rig was properly set for ideal playback (one could easily be devised—sic the various frequency test records, etc., with their ingenious tricks). The more people whose ears are finally prepared to accept what is at present unpalatable through no fault of their own, the more records that will be sold and the more diverse the base of music.

LETTERS

(from page 12)

or vestibular end. Best measurements available indicate that the basilar membrane has a width of about 0.5 mm at the apex and about 0.1 mm at the vestibular end. It has a length of about 35 mm in the 2¾ turns of the cochlea. On its surface are complex formations of cells, the most important of which is the organ of Corti which includes the hair cells which are thought to generate impulses in the auditory nerve when set in motion.

Thus, if a loudspeaker were built following the model of the basilar membrane, it would not consist of 24,000 rigid discs each resonant to a separate frequency as Mr. Leung has suggested. The loudspeaker would consist, rather, of a sheet of fairly soft gelatine suspended after the manner of the basilar membrane in a sealed, coiled tank of water or other liquid. A conventional electro-mechanical driver could be attached so as to transmit the sound to the fluid medium via a mechanical stirrup attached to a membrane covering an opening at the outer end of the tank.

JOSEPH J. ANTONITIS
Asst. Professor
Dept. of Psychology
University of Maine
Orono, Me.

CLASSIFIED

Rates: 10¢ per word per insertion for noncommercial advertisements; 25¢ per word for commercial advertisements. Rates are net, and no discounts will be allowed. Copy must be accompanied by remittance in full, and must reach the New York office by the first of the month preceding the date of issue.

AUDIOPHILES wanted for part or full time work. Technical or secretarial experience desirable. Location: north suburban Philadelphia. Send resume of education and experience to Box CA-1, AUDIO.

TELCOA (Audio Equipment Exchange) We sell all types of new guaranteed audio equipment. Highest trade-in values throughout the world. Increasingly liberal trade-in allowances with cumulative purchases. Azurelee Dome Malibu, Calif. Globe 6-2611.

PRESENCE—Enjoy the realism of a Williamson-type amplifier at reasonable cost. Write the Long Island Sound Co., 19 Bennett Place, Amityville, N. Y.

FOR SALE—COLLINS 32V3, \$590; 75A3, \$430; both nearly new. Sacrifice both for \$985. Altec 604B in 606 Mahogany enclosure, \$200. Robinson 16-in. Transcription Turntable, 33 and 78 r.p.m., \$50. Write Box CA-2, AUDIO.

FM ANTENNAS. Standard and custom designs. Installation accessories. Wholesale Supply Co. Lunenburg 10, Mass.

SELL: HEWLETT-PACKARD 200B audio oscillator, exc. cond., \$75; Sylvania #132 7-in. scope, like new, \$100; Electro-Voice V1A ribbon mike, new, \$17; Rider Chanalyst, like new, \$55; Western Electric audio amplifier, Class A 40-watts, with limiter-compressor, excellent PA, \$75. DiSavino, 625 18th St., Union City, N. J. UNION 3-4454.

MANUFACTURER'S SURPLUS
60-note triple-stacked shunt keying mechanisms. Octave wired isolating resistor to each palladium contact. Two types—Great 16'-8'4' and Swell 8'-4'-2 2/3'. Make your own electronic organ with these basic units. \$10 each. Minshall-Estey Organ, Inc., P. O. Box 537, Brattleboro, Vermont.

AUDIO ENGINEER. Interested in position beginning on or after April 15. Well versed in electrical and mechanical design of high-quality amplifiers and associated instruments; experienced in recording procedure. Broad knowledge of acoustics ranging from speaker enclosures to pipe organs. Resume sent on request. Box CA-3, AUDIO.

CUSTOM radio-phonographs, audio systems, installed, repaired and sold anywhere in Greater New York area. Telephone: Independence 1-2503. S. Friedland, 140-35 Franklin Ave., Flushing 55, N. Y.

30% DISCOUNT on factory-fresh, guaranteed LP records. Send 10 cents in coin for complete catalogue.

SOUTHWEST RECORD SALES, Dept. A,
4710 Caroline, Houston, Texas

39-B PRESTO 3-channel rack mount, high-quality mixer-microphone preamplifier, UTC transformers, input selector switches for 50-200-500 ohms. Output can be strapped for 50 to 500 ohms. Daven potentiometers. Frequency response 40 to 15,000 cps ± .75 db. Gain, 43 db. Used less than ten hours. \$252 value for \$150. Details upon request. Hamme Recording Service, 508 West Eighth St., Erie, Pa.

FISHER 50-R AM-FM tuner, 50-CH control unit, 70-A amplifier, 50-F filter, all perfect, \$259. Audak L-6 cartridge, \$12; No. 16 arm, \$12. Weathers LP pickup set complete, \$27. Rek-O-Kut LP-743 turntable, \$42. H. Skalam, 435 E. 74th St., New York 21, N. Y.

ALTEC 600B, \$30; 603B in Stephens baffle, \$80. RCA Varacoustic microphone, \$35; MI-4875-G pickup, \$100. Presto 92A amplifier, \$250; 50-A AM tuner, \$35. Pilot FM tuner, \$25. Reco-Art, 1305 Market, Philadelphia, Pa.

WANTED: Bargain Hunters. Have large stock of brand new tubes, transformers, condensers, and resistors for sale at fractional prices. Write Roland Bond, 6255 Desco, Dallas 25, Texas, for tremendous list.

TRADE your unwanted electronics equipment for finest new audio components at Audio Laboratories, 2111 Camden Ave., Los Angeles, Calif.

PROFESSIONAL DIRECTORY

FULL DIMENSIONAL SOUND



THE ULTIMATE IN
HIGH FIDELITY
RECORDING



Look for this symbol on record albums you buy!

"WE HAVE IT"

HI-FI COMPONENTS EXCLUSIVELY

**HOLLYWOOD
ELECTRONICS**

7460 MELROSE AVE.
HOLLYWOOD 46
CALIFORNIA
WE8TER 3-8208

HIGH-FIDELITY HOUSE

Offering the World's Finest Home Music Systems, created by experts with years of experience.

High Fidelity is our only business—not a sideline. Complete stock of every worthwhile component at all times.
536 South Fair Oaks, Pasadena 1, Cal.
SY 5-4118 RY 1-8171

"EVERYTHING IN HIGH FIDELITY"

From Primary Components
to Completed Custom Audio Equipment

KIERULFF

Sound Corp.

10 West Olympic Blvd. • Los Angeles 15, Calif.
Rm. 107 • BU 7-0771 ZEmth 0271

the audio exchange exchanges audio
the audio exchange exchanges audio
the audio exchange exchanges audio
the audio exchange exchanges audio

Information on trading HI-FI
components on request. Write
or call for free catalog AE

the audio exchange exchanges audio

the audio exchange inc.

159-19 Hillside Avenue • Jamaica 32, N. Y.
Olympia 8-0445

FOR RATES

in this column, write:

AUDIO, P. O. Box 629, Mineola, N. Y.

Industry People...

Lunch with **Jim Pickett**, New York factory representative, brings forth the information that **Floyd Bell** of Bell Sound Systems, Inc., is planning monumental advances in hi-fi equipment for the near future . . . **Harold Weinberg**, formerly of Hudson Radio & Television Corporation, is newest addition to audio sales staff of Harvey Radio Company, both New York . . . **Karl Kramer**, engineering executive of Jensen Manufacturing Company, Chicago, visiting Manhattan on company business . . . **Paul deMars**, radio pioneer from 'way back, is introducing a new speaker which departs widely from convention in constructional features—outer flare of cone assembly is square rather than round—impressed hundreds of music critics, record reviewers, and audio engineers in its initial public showing at New York's Hotel Commodore.

Robert F. Martini, formerly with Ampex Corporation, has joined Radio Shack Corp., Boston, as application and sales engineer—will specialize in Ampex stereophonic sound equipment for theaters which have been converted to CinemaScope . . . Personnel changes at Hudson Radio & Television Corporation, New York, find **Lester Klein**, formerly in charge of the firm's downtown store, appointed manager of the main store; **Edward Saunell**, formerly Klein's assistant, has been promoted to manager in his place—**Joseph F. Frestia** has been appointed manager of Hudson's recently-opened store in Newark, N. J. . . . **John J. Corcoran**, with Tung-Sol Electric, Inc., since 1950, has been appointed sales representative and commercial engineer on the West Coast—will headquarter in Culver City, Calif.

Edward S. Miller and **John Narrace** have been promoted by The Radio Craftsmen, Inc., to vice-president and chief engineer, respectively . . . **Max Baume**, sales manager for Brook Electronics, Inc., Elizabeth, N. J., has expanded sales representation of the Brook amplifier to include Mexico and Cuba—has just returned from extensive sales trip South of the border . . . New Ampex Corporation appointments include **Bob Paulson** who joins the New York district office as manager of audio sales, and **Bill Shantz** who has been named to the executive staff of the firm's sales division.

S. I. Neiman, president of Chicago's International Sight & Sound Exposition, has acquired an interest in Owen H. Smith Company, manufacturers' representatives **Gus Galta** has joined the staff of Cinema Engineering Company as sales engineer in its Burbank, Calif., plant . . . **Seymour Mintz**, formerly vice-president of the Admiral Corporation, Chicago, is new president of CBS-Columbia, receiver manufacturing division of The Columbia Broadcasting System, Inc. . . . **Robert J. Cannon**, president of Cannon Electric Company, Los Angeles, announces appointment of Willard G. Gregory and Charles A. Hanson, former president of the all-industry Electronic Parts Show, has been appointed manager of the distributor division of Gramer Transformer Corporation, Chicago.

Harold Weller, author of "High Fidelity Simplified," has completed a new book on the wear and care of records and still—contains much information never before published in book form (See adv. on page 53.) . . . **Robert L. Parrish** has been appointed manager of the new plant being constructed by Sprague Electric Company at West Jefferson, N. C. . . . **B. F. Valliere** recently named vice-president and general manager of the F. W. Sickles Division of General Instrument Corporation . . . **Gordon Gow**, sales manager, McIntosh Laboratory, Inc., highly pleased over results of nationwide contest to name the new McIntosh amplifier.

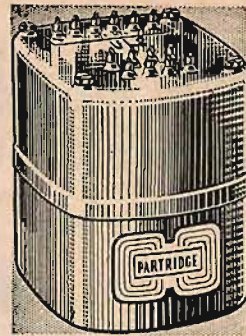

THE **UL2**
A 'C' CORE
TRANSFORMER

A NEW
PARTRIDGE

Now for \$25 duty paid you can have this p.p. transformer, for high quality audio equipment. Hermetically sealed in a deep drawn case, it has these salient features:—

REFERRED PRIMARY LOADING. Covers requirements of all popular tubes. Each half primary is brought out separately to posts and tapped at 43% of the turns. Peak 50 watts at 60 c.p.s. or 14 watts at 30 c.p.s. for less than 0.5% harmonic distortion without feedback.

LEAKAGE INDUCTANCE . . . 10 mH. SELF CAPACITY . . . 500 pF. full primary.

Type CFB 'C' core Audio Transformer. Series leakage induct. 10 mH. Coupling between primaries—leakage induct. for one half (other shorted) 30 mH.D.C., resistance per half primary 88 ohms; Power up to 60w from 22 c/s to 30 Kc/s; distortion less than 1 per cent with no negative feed back. \$40 duty paid.

Type WWFB Williamson Audio Transformer available in varied range of impedances. Secondary windings are brought out to eight separate sections of equal impedance. Stock types comprise 0.95 ohm, 1.7 ohm, 3.6 ohm and 7.5 ohm sections. \$26 duty paid.

AVAILABLE NOW! From your jobber or write direct. Fullest data rushed airmail on request.

PARTRIDGE
TRANSFORMERS LTD.
TOLWORTH · SURREY · ENGLAND



NEW HOPE in the battle against CANCER

THE FIGHT against man's cruellest enemy is far from won. If present rates continue, 23 million living Americans will die of cancer—230,000 this year. And thousands of these will die needlessly—through cancer that could have been cured if treated in time.

ALL THE SAME, there have been victories. Thousands who once would have died are being saved—thanks, in part, to your donations to the American Cancer Society.

AND, LAST YEAR, the Society was able to allocate \$5,000,000 of your donations to research aimed at finding the ultimate cure for all cancer. That's more money than ever before.

MUCH MORE, of course, remains to be done. So please make this year's gift a really generous one!

Cancer

MAN'S CRUELEST ENEMY

Strike back—Give

AMERICAN CANCER SOCIETY



Custom-Built Equipment

U. S. Recording Co.

1121 Vermont Ave., Washington 5, D. C.
Lincoln 3-2705

At Last!

THE SPEAKER THAT PRODUCES

No Sound

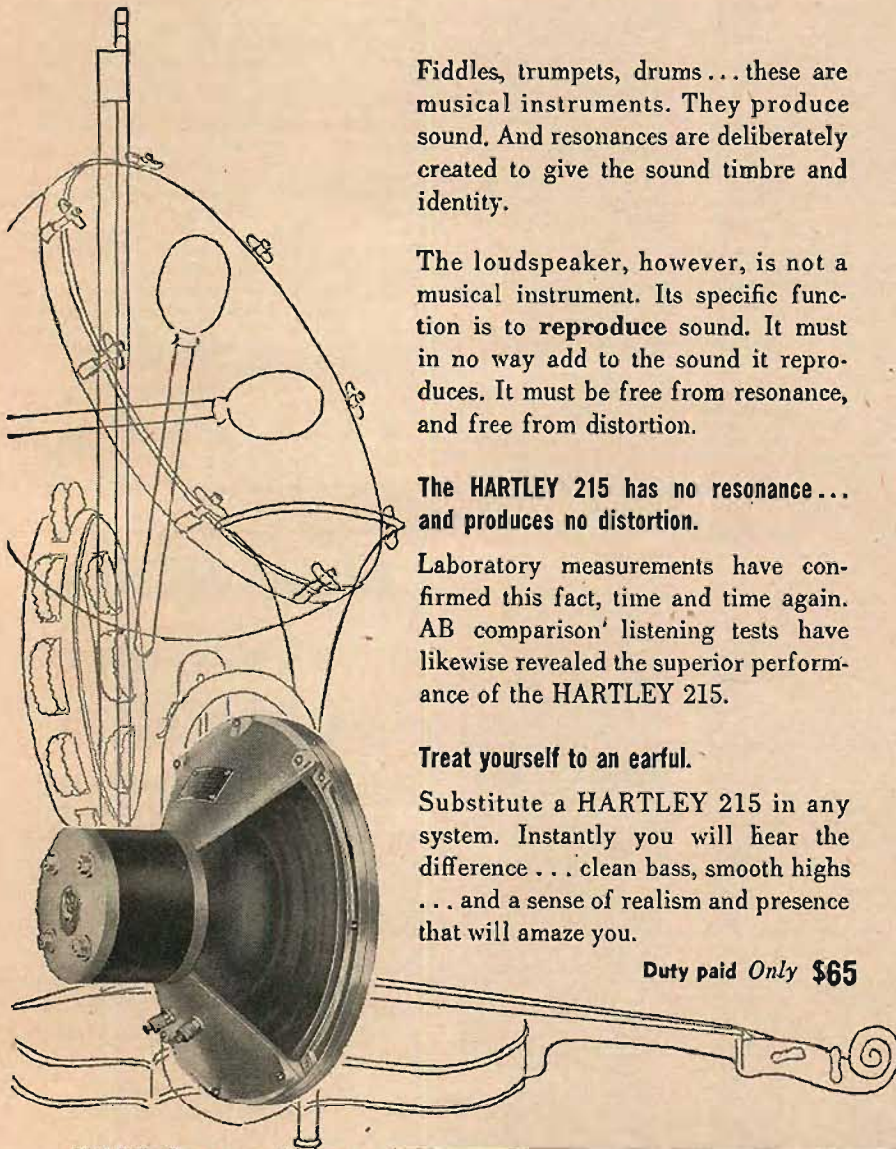

Fiddles, trumpets, drums... these are musical instruments. They produce sound. And resonances are deliberately created to give the sound timbre and identity.

The loudspeaker, however, is not a musical instrument. Its specific function is to **reproduce** sound. It must in no way add to the sound it reproduces. It must be free from resonance, and free from distortion.

The HARTLEY 215 has no resonance... and produces no distortion.

Laboratory measurements have confirmed this fact, time and time again. AB comparison listening tests have likewise revealed the superior performance of the HARTLEY 215.

Treat yourself to an earful.

Substitute a HARTLEY 215 in any system. Instantly you will hear the difference... clean bass, smooth highs... and a sense of realism and presence that will amaze you.

Duty paid Only \$65

NOTE: Because the new Hartley 215 has no resonance, a non-resonant baffle should be used. The bass-reflex and other conventional enclosures are tuned resonant systems. For best results the Hartley BOFFLE Enclosure is recommended... available in single, dual, and 4-speaker models. Priced from \$50.75.

THE NEW HARTLEY 215

At franchised dealers or write to:
H. A. HARTLEY CO., INC.
521 EAST 162nd ST., BRONX 51, N. Y.
LUdlow 5-4239

ADVERTISING INDEX

Akustische und Kino-Cerate	48
Allied Radio Corp.	37
Amplifier Corp. of America	62
Arnold Engineering Co.	7
Audak Co.	40
Audio Devices, Inc.	Cover 2
Audio Exchange, Inc.	63
Belden Mfg. Co.	11
Bell Sound Systems, Inc.	60
Bell Telephone Laboratories	18
Bogen, David, Co., Inc.	39
British Industries Corp.	3
Brook Electronics, Inc.	49
Brush Electronics Co.	58
Cannon Electric Co.	52
Capitol Records, Inc.	63
Centralab Div., Globe Union, Inc.	54
Chicago Standard Transformer Corporation	36
Cinema Engineering Co.	14
Classified Ads	62
Commissioned Electronics Co.	61
deMars Engineering & Manufacturing Co.	35
Dubbings Co., Inc., The	12
Electro-Voice, Inc.	1
Fairchild Recording Equipment Corp.	47
General Electric Co.	43
G & H Wood Products Co.	57
Goodmans Industries, Ltd.	57
Gray Research & Development Co., Inc.	15
Hartley, H. A., Co., Inc.	64
Harvey Radio Co., Inc.	45
Heath Co.	53
High Fidelity House	63
Hollywood Electronics	63
Hudson Radio & Television Corp.	59
Hughes Research & Development Laboratories	2
Hycor Co., Inc.	53
J K M Incorporated	62
Kierulff Sound Corp.	63
Kingdom Products, Ltd.	51
Langevin Mfg. Corp.	5
Leonard Radio Inc.	41
Partridge Transformers, Ltd.	63
Peerless Electrical Products	42
Permoflux Corp.	49
Pickering and Company, Incorporated ...	17
Precision Film Laboratories, Inc.	6
Presto Recording Corporation	13
Professional Directory	63
Rauland-Borg Corporation	46
Reeves Equipment Corp.	60
Reeves Soundcraft Corp.	33
Rek-O-Kut Company, The	9
Rockbar Corporation	Cover 3
Shure Brothers, Inc.	4
Sonotone Corp.	10
Standard Wood Products Corp.	47
Terminal Radio Corp.	55
Triad Transformer Corp.	8
Turner Co., The	38
United Catalog Pub., Inc.	61
United Transformer Co.	Cover 4
U. S. Recording Co.	63



IT MAKES Good Sound ... AND Good Sense, too

You buy good records so you can enjoy good sound. You fondle these records, and handle them ever so gently, because you know that once the surfaces are marred, the quality will be gone to you forever.

You must realize then, that your record changer becomes an all-important factor in the matter of record quality. It must treat with your records even more gently than you could yourself, and it must contribute nothing which might impair the quality of the sound. Its tone arm must track at

light stylus pressures and with free lateral compliance to protect the groove walls from wear.

Its speed must be constant for correctness of pitch, and to avoid 'wow'. It must be free from rumble, and from audible resonances. It must retain and reproduce all of the quality in the record, protect it for future plays, and it must contribute no distortions of its own.

In the light of these requirements, examine the features of the COLLARO, and see if they don't meet all the exacting specifications that make this

The High Fidelity Record Changer for High Fidelity Reproduction

Model 3/532—Fully Automatic Intermix Model

List Price.....\$65.00

Model 3/531—Fully Automatic Non-Intermix Model

List Price.....54.50

Record Changer Base —

Wood, Mahogany Finish, Heavy Construction.

List Price..... 9.50



ONLY THE *Collaro* INTERMIX 3/532 HAS ALL THESE HIGH FIDELITY FEATURES:

Intermixes 10 and 12 inch Records at All Speeds.

Steady, Constant Speeds—No Rumble or Wow.

Weighted, Rubber-matted, Rim-driven Turntable.

Four Pole Motor with Self-aligning Oilite Bearings.

No Hum Pickup.

Molded Rubber Drives—No Belts to Slip or Replace.

Automatic Muting Switch.

Stylus Pressure Adjustment—Tracks at as little as 3 grams.

Absolutely Jam-proof Operation.

Ball-bearing Mounted Turntable and Tone Arm.

Automatic Shut-off after Last Record.

Tone Arm Clamp for Portable Applications.

Base Dimensions: 14 3/4" x 12 1/4"

Depth Below Base: 2 1/2"

Complete Service and Replacement Facilities Maintained for your Convenience.



Record Player 3-Speed Model 3/534 List Price \$33.60

Collaro

Fully Automatic INTERMIX

3-SPEED RECORD CHANGER

FOR 7, 10, AND 12 INCH RECORDS

At Leading Distributors, or Write for Literature.

ROCKBAR CORPORATION

211 EAST 37th STREET • NEW YORK 16, N. Y.



for QUALITY TRANSFORMER COMPONENTS

The bulk of UTC industrial transformer production is to customer's specifications for such organizations as G. E., Westinghouse, RCA, etc. However, a standardized line of approximately 700 stock items for industrial and communication service are available. A few of these types are illustrated here.

STEP DOWN AUTO-TRANSFORMERS

With 6 foot cord and female receptacle 220-240 to 110-120 Volts—50/60 Cycles

Type No.	Application	L	W	H	Wgt. Lbs.
R-41	85 watt capacity	2 $\frac{3}{8}$	2 $\frac{5}{8}$	3 $\frac{1}{8}$	4
R-42	125 watt capacity	3	3	3 $\frac{1}{2}$	5
R-43	175 watt capacity	3 $\frac{1}{4}$	3 $\frac{1}{4}$	3 $\frac{7}{8}$	5 $\frac{1}{2}$
R-44	250 watt capacity	3 $\frac{7}{8}$	3 $\frac{1}{4}$	3 $\frac{7}{8}$	6 $\frac{1}{2}$
R-45	500 watt capacity	4 $\frac{1}{8}$	3 $\frac{7}{8}$	4 $\frac{5}{8}$	12
R-46	1200 watt capacity	6 $\frac{3}{8}$	3 $\frac{7}{8}$	4 $\frac{5}{8}$	18
R-64	2500 watts, no cord	10 $\frac{1}{2}$	4 $\frac{3}{4}$	6 $\frac{3}{4}$	30



ISOLATION TRANSFORMERS

Ideal for isolating line noise, AC-DC sets, etc. Excellent electrostatic shielding. 1500 volt breakdown test. Six foot cord and male receptacle.

Primary 110-120 volts, 50/60 cycles—Secondary 110-120 volts

Type No.	Rating	L	W	H	Wgt. Lbs.
R-72	40 watts	2 $\frac{3}{4}$	2 $\frac{5}{8}$	3 $\frac{1}{8}$	4
R-73	100 watts	3 $\frac{3}{8}$	3 $\frac{1}{4}$	3 $\frac{3}{8}$	6
R-74	250 watts	4 $\frac{3}{8}$	3 $\frac{7}{8}$	4 $\frac{5}{8}$	12
R-75	600 watts	6 $\frac{7}{8}$	3 $\frac{7}{8}$	4 $\frac{5}{8}$	20
R-76	1200 watts	8 $\frac{3}{8}$	4 $\frac{1}{2}$	5 $\frac{5}{8}$	30
R-77	2500 watts (no-cord)	12	7	9	70



LINE VOLTAGE ADJUSTERS WITH METER

The perfect answer to abnormal or fluctuating line voltage. Adjust switch so that meter reads at red line and you know that your equipment is working at correct voltage.

These units combine a tapped auto-transformer with a switch and meter in a compact, rugged assembly. The nine tap switch provides for line voltages of 60 to 140 volts on 115 volt output models and 160 to 240 volts on 230 volt output models.

All units are designed for 50/60 cycle service and come complete with 6 foot input cord and plug and outlet receptacle.



Type No.	Primary Voltages	Sec. Volts	Watts	L	W	H	Wt. Lbs.
R-78	60, 70, 80, 90, 100, 110, 120, 130, 140	115	150	7	4	4 $\frac{3}{4}$	6
R-79	60, 70, 80, 90, 100, 110, 120, 130, 140	115	300	7	4	4 $\frac{3}{4}$	9
R-80	60, 70, 80, 90, 100, 110, 120, 130, 140	115	600	10 $\frac{1}{4}$	4	4 $\frac{3}{4}$	13
R-81	60, 70, 80, 90, 100, 110, 120, 130, 140	115	1200	10 $\frac{1}{4}$	4	4 $\frac{3}{4}$	21
R-83	160, 170, 180, 190, 200, 210, 220, 230, 240	230	150	7	4	4 $\frac{3}{4}$	6
R-84	160, 170, 180, 190, 200, 210, 220, 230, 240	230	300	7	4	4 $\frac{3}{4}$	9
R-85	160, 170, 180, 190, 200, 210, 220, 230, 240	230	600	10 $\frac{1}{4}$	4	4 $\frac{3}{4}$	13
R-86	160, 170, 180, 190, 200, 210, 220, 230, 240	230	1200	10 $\frac{1}{4}$	4	4 $\frac{3}{4}$	21

EXPORT VOLTAGE ADAPTER

Complete with cord and plug and special locking switch providing for line voltages of 105, 115, 125, 135, 150, 210, 230, 250 volts; 42 to 60 cycles. Output voltage 115.

Type No.	Rating	Wgt. Lbs.
R-47	85 watts	4 $\frac{1}{2}$
R-48	150 watts	5 $\frac{1}{2}$

TV VOLTAGE REGULATOR

Complete with cord, plug, and special locking switch. Permits operation of 115 volt 50/60 cycle TV sets on line voltages of 85, 90, 95, 100, 105, 110, 120, 125 V.

Type No.	Rating	Wgt. Lbs.
R-49	350 Watts	5

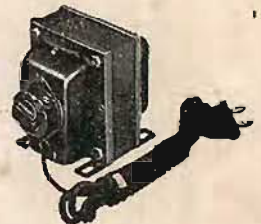

SIGNALLING AND CONTROL TRANSFORMERS

Primary 110-120 volts, 50/60 cycles—Secondary 110-120 volts

High power transformers suitable for operating relays, sirens, horns, gongs, etc. from 115 V. 50/60 cycle line. These units have four secondary terminals providing 4, 8, 12, 16, 20 and 24 volt output. The volt ampere rating is based on the 24 volt secondary tap with corresponding reduction at the lower voltages. Underwriters' approved primary leads are employed, and screw-type binding posts.

TYPE	WATTS	OVERALL DIMENSIONS	MTG. DIM.	WEIGHT LBS.
SC-3	50	3 x 3 $\frac{1}{2}$ x 3-9/16	1 $\frac{7}{8}$ x 2 $\frac{1}{4}$	3
SC-4	100	3 $\frac{1}{4}$ x 4 x 4	2 $\frac{1}{8}$ x 2 $\frac{1}{2}$	5
SC-5	250	4 x 5 x 4 $\frac{3}{4}$	3 $\frac{1}{4}$ x 3	10



United Transformer Co.

150 VARICK STREET

NEW YORK 13, N. Y.

EXPORT DIVISION: 13 EAST 40th STREET, NEW YORK 16, N. Y., CABLES: "ARLAB"