

AUDIO ENGINEERING

DECEMBER
1952
35c



THE WORLD OF SOUND

www.americanradiohistory.com

NEW 7" REELS OF audiotape* give you **EXTRA VALUE**

at no extra cost!

GUARANTEED SPLICE-FREE

SPLIT-SECOND TIMING with New 2 $\frac{3}{4}$ " Hub

Improved reel design reduces timing errors by decreasing tension and speed changes throughout the winding cycle. Ratio of OD to hub diameter is the same as on the standard NAB 2500-ft. reel.



PERFECTED ANTI-FRICTION PROCESS.

Reduces head wear—eliminates annoying tape "squeal" — prevents "tackiness" even under extreme temperature and humidity conditions.

MAXIMUM UNIFORMITY OF OUTPUT.

All 7" and 10" reels of plastic-base Audiotape are guaranteed to have an output uniformity within $\pm \frac{1}{4}$ db — and reel-to-reel-variation of less than $\pm \frac{1}{2}$ db. What's more, there's an actual output curve in every 5-reel package to prove it.

With Audiotape, all of these extra-value features are *standard*. There's no extra cost — no problem of separate inventories or variations in tape quality.

For there's *only one* Audiotape — the finest obtainable anywhere. Test it — compare it — let Audiotape speak for itself.

The new 7-inch plastic reel with large diameter hub for greater timing accuracy is now being supplied on all orders unless otherwise specified. Because of increased hub diameter, maximum reel capacity is slightly over 1200 feet. Older style Audiotape reels with 1 $\frac{3}{4}$ " hub and 1250 feet of tape will continue to be furnished on request at the same price.

*Trade Mark

AUDIO DEVICES, Inc.

444 Madison Ave., New York 22, N. Y.

Export Department, 13 East 40th St., New York 16, N. Y., Cables "ARLAB"

audiodiscs • audiotape • audiofilm • audiopoints

New Portable Battery-Operated Spring-Motor Tape Recorder



The Magnemite*

For all field recording without AC power! Smaller and lighter than a portable typewriter, the Magnemite* actually makes field recordings that can be played on any studio console equipment. Completely self-powered, the Magnemite* does away with bulky and cumbersome generators, storage batteries and rechargers.

Just check these unusual features:

- Noiseless and vibrationless governor-controlled spring-motor assures constant tape speed.
- 100 operating hours per set of inexpensive flashlight-type dry cell batteries.
- Earphone monitoring while recording, and earphone playback for immediate quality check.
- Operates in any position, and is unaffected by movement or vibration during operation.
- Warning indicator tells when to rewind, and shows when amplifier is on.
- Broadcast models weigh 15 pounds. Slow-speed models weigh only 10 pounds.
- Requires no more desk space than a letterhead, measuring only 11 x 8½ x 5½ inches.

There's a choice of 5 different models for any recording need. High fidelity units, meeting primary and secondary NARTB standards, which record and play back frequencies up to 15,000 cycles, are available for broadcast stations, critical music lovers, and scientific research. For investigation, missionaries, reporters, and general dictation while traveling, there are units which play up to 2 hours per reel of tape.

Write today for complete descriptive literature and direct factory prices.



**AMPLIFIER CORP.
of AMERICA**

398 Broadway, N. Y. 13, N. Y.

The Mark Reg

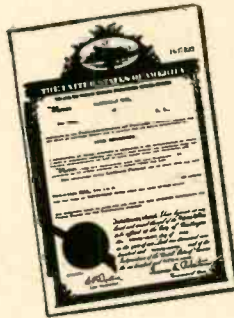

AUDIO PATENTS

RICHARD H. DORF*

VOLUME compressors are not usually used in high-quality home reproducing equipment but they are very definitely needed in other systems, such as broadcasting and recording, where the normal dynamic range of program material must be compressed to fit the capabilities of the recording or transmission medium. Theoretically, the ideal compressor varies its gain instantly in exact accordance with signal level, with only sufficient delay to integrate at the lowest audio frequencies to prevent the action from following the contours of individual audio cycles.

Unfortunately most compressor designs do not allow that because a sudden change in level, such as would occur with the ideal compressor, produces a steep-wavefront transient resulting in a momentary cutoff of signal. The sound is quite objectionable, and most designs compromise by providing a longer delay, so that the changes in gain are comparatively slow. That delay, however, defeats in part the purpose of the compressor. A sudden signal peak can easily go through the system at full amplitude, with compression beginning after the damage has been done.

Another fault with most designs results from the use of a variable-mu pentode as the control tube, with controlling bias derived from rectified and filtered signal taken from later stages. As the controlling bias varies, so does the control-tube screen voltage, often taking it out of the region of maximum curvature of the tube characteristic and reducing the control action.

Both these major difficulties seem to have been solved by David E. Roberts of Chicago, Ill., in his patent No. 2,596,510, assigned to Motorola. The patent describes the compressor shown in the diagram, which is said to allow very fast action without clicks or thumps and has a stabilized screen circuit. The principle allowing the fast action is the clipper tube V_2 . The undesirable transient has a level many times greater than that of the signal. V_2 clips the transient and removes the thump without disturbing the desired signal. It also stabilizes the control-tube screen.

Input signal goes to the grid of V_1 (which is a variable-mu pentode) through conventional blocking capacitor C_1 . R_1 is the grid leak, bypassed to ground by C_2 . Signal from a later stage of the amplifier is fed through C_3 to a fairly conventional rectifier and filter circuit which includes R_4 and R_5 as well as C_4 and C_5 . This serves to produce d.c. and to reduce the ripple to a frequency below the audio band. Thus, while the d.c. will rise and fall with over-all signal level, it cannot rise and fall with individual audio cycles. The d.c. output of the rectifier-filter is applied to the grid of V_1 , through R_6 , and controls the tube's gain. So far the idea follows standard compressor practice, except that the time constant of the d.c. filter is as short as possible to allow fast compression.

R_7 is the V_1 plate load resistor and R_8 - C_6 is a power-supply decoupling network of the usual kind. The output signal of V_1 is fed through C_7 to the following amplifier.

* 255 W. 84th St., New York 24, N. Y.

[Continued on page 45]

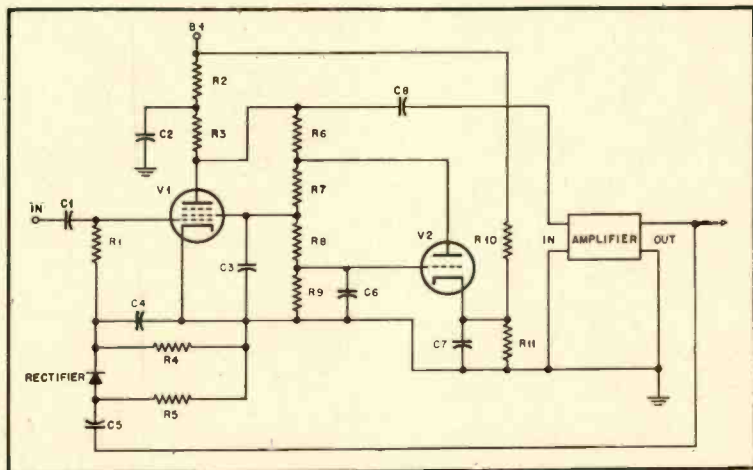

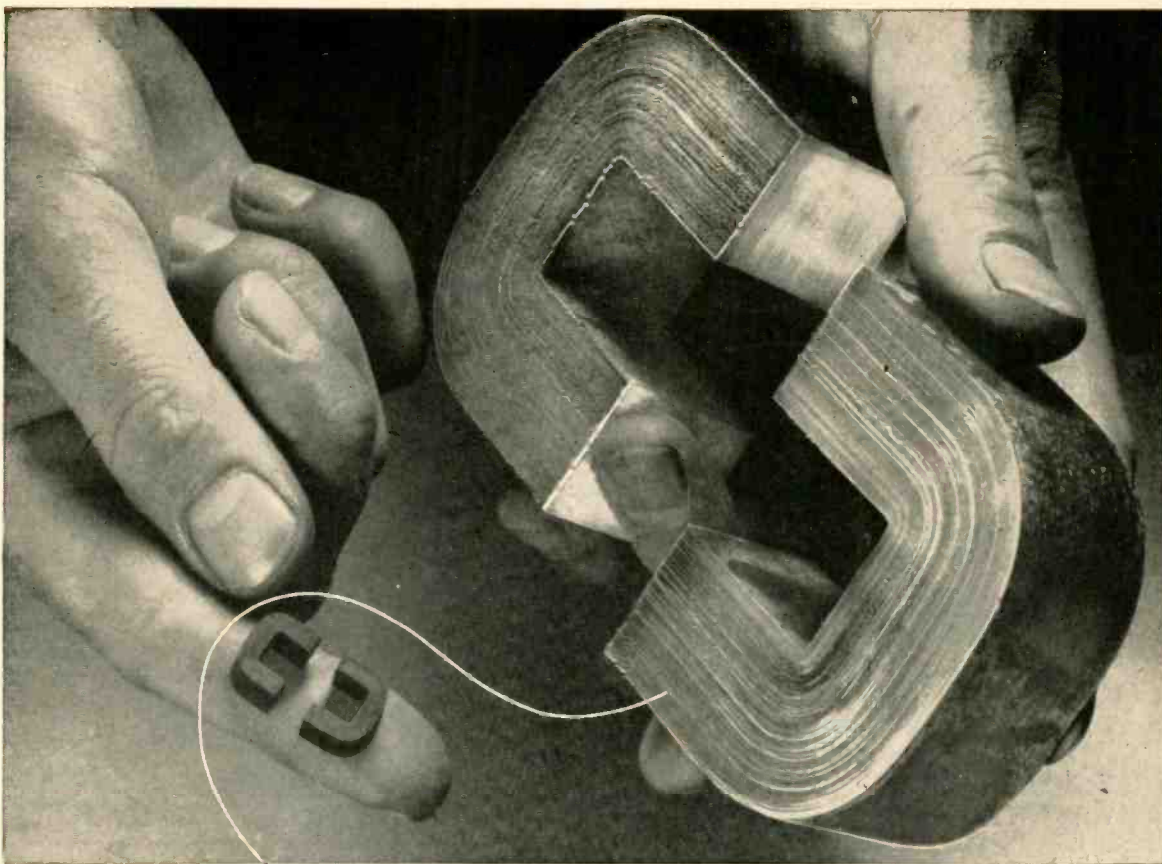

SILECTRON C-CORES... **BIG** or LITTLE

...any quantity and any size

*Wound from
precision rolled
oriented silicon
steel strip as thin
as .00025"*

For users operating on government schedules, Arnold is now producing C-Cores wound from 1/4, 1/2, 1, 2, 4 and 12-mil Silectron strip. The ultra-thin oriented silicon steel strip is rolled to exacting tolerances in our own plant on precision cold-reducing equipment of the most modern type. Winding of cores, processing of butt joints, etc. are carefully controlled, assuring the lowest possible core losses, and freedom from short-circuiting of the laminations.

We can offer prompt delivery in production quantities—and size is no object, from a fraction of an ounce to C-Cores of 200 pounds or more. Rigid standard tests—and special electrical tests where required—give you assurance of the highest quality in all gauges. • Your inquiries are invited.

THE ARNOLD ENGINEERING CO.



SUBSIDIARY OF ALLEGHENY LUDLUM STEEL

General Office & Plant: Marengo

WAD 4363

here's

absolute reliability

for heavy duty
audio
amplification

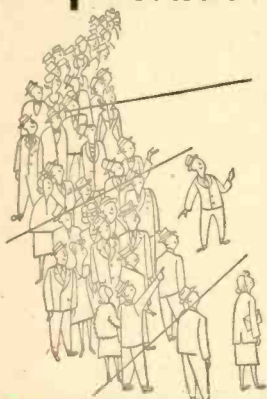

TUNG-SOL

5881

**BEAM
POWER
AMPLIFIER**

If you've been looking for an audio output tube that's stable under the most severe conditions—completely dependable—then this is it! The Tung-Sol 5881 is rugged both mechanically and electrically—and directly interchangeable with the 6L6.

In creating the 5881, Tung-Sol engineers have made lavish use of the design and production techniques which have proved themselves over the past fifteen years—zirconium coating over the carbonized metal plate and pure barium getter to effectively absorb gas for the life of the tube—gold plated wire to minimize grid emission. These are but a few of the major design improvements in the 5881.

Tung-Sol produces the 5881 under laboratory conditions, to assure peak efficiency and maximum uniformity. You'll find this tube has the stuff to take the whole range of audio service requirements from protracted standby periods to repeated heavy overloads. So, if absolute reliability is essential in your audio circuits, the Tung-Sol 5881 is a "must." Order it from your regular supplier.

Write for characteristics and performance data

TUNG-SOL ELECTRIC INC., NEWARK 4, N. J.

Sales Offices: Atlanta • Chicago • Culver City (Calif.)
Dallas • Denver • Detroit • Newark

Tung-Sol makes All-Glass Sealed Beam Lamps, Miniature Lamps, Signal Flashers, Picture Tubes, Radio, TV and Special Purpose Electron Tubes.

LETTERS

The Ravanastron

SIR:

Wishing to contribute with additional enlightenments concerning the Ravanastron—the forerunner of the violin—mentioned in the article by Mr. Albert Preisman in your September issue, we ask permission to quote the well known work of Albert Lavignac¹ "La Musique et les Musiciens," 1919 edition, in which the author states:

"I have had the occasion of hearing the Marquis of Tseng, then ambassador from China in Paris, playing a Ravanastron, or Chinese violin, of my property. The instrument is peculiar in the fact that the bow remains constantly tied to, i.e., interlaced between the two strings, which are tuned in fifths. To play the Ravanastron one has to move the bow backwards or forward, rubbing it against either string.

"Saint-Saëns heard the Ravanastron at will in China, even trying to play it, but without success. He finds a charm in this primitive instrument, 'essentially Chinese,' to which the listeners quickly adjust themselves. Saint-Saëns wrote to me: 'It is often barbaric but not discordant.'"

We wish to add that the drawing which illustrates Mr. Preisman's article, besides showing the bow detached from the instrument, fails to include the bridge upon which the strings rest and which transmits their vibrations to the membrane of the sound box. The Ravanastron has all the essential elements of the violin, namely: strings made of gazelle guts, bridge, sound box, finger board, pegs, and bow.

PERY DE CAMPOS
FRANCISCO M. D. LEAO
Sao Paulo, Brazil

¹ Albert Lavignac, professor of Harmony at the Paris Conservatory. See Grove's Dictionary of Music and Musicians.

Stylus Force or Stylus Pressure?

SIR:

It seems to me that writers who discuss stylus and record wear confuse the terms "force" and "pressure." The force of friction which may dislodge particles from either the stylus or the record is that portion of the weight of the pickup arm that is supported by the stylus, multiplied by the coefficient of friction. This coefficient is determined by the nature of the record surface and the speed of the turntable. Obviously the only numerical values we know are the turntable speed and the weight of the arm assembly. That it is absurd to assign a value to the pressure can be shown by the following consideration:

Assume a perfect record and a perfect stylus. Then the stylus rests in the groove along a line normal to the groove, the area of which approaches zero as a limit. Since the pressure is equal to force divided by area, the pressure approaches infinity as long as the arm assembly weighs anything at all. Assume a little wear and the pressure is anything between zero and infinity.

ERVIN J. LAGER
221 South Tenth East,
Salt Lake City, Utah.

These Complex Fruddians

SIR:

I do not know whether you value readers' opinions (*definitely*, Ed.) or even have the time to read them. However, I will state that I frankly can do without such articles as "The Frudd Audio System." It doesn't strike me as even humorous and the rest of your material is so very good. Even the ads are informative.

THOMAS W. CRANE,
31 Haven Road,
South Portland, Me.

SIR:

After reading the item about the Frudd Audio system, I must protest. This type of humor is too close to a very considerable percentage of your more serious efforts. Consider the following examples:

Your November cover is a classic. The equipment would undoubtedly have even higher fidelity if the tuning knobs were located on the bottom of the box.

Recently you have published a humorously-large number of articles on the Williamson amplifier. The one by Kiebert in the August issue is an outstanding example. After bringing this amplifier up to date, Kiebert gets 7.23 watts output at 1 per cent distortion without feedback and 8.8 watts with feedback. Williamson (*Wireless World*, May 1947) got 16 watts output at 1 per cent distortion without feedback and at 0.15 per cent distortion

here's Christmas
treasure for life long
pleasure!



SOUNDCRAFT MAGNETIC RECORDING TAPE



in the TAPE-CHEST*

5 Reels of Soundcraft Recording Tape In a Permanent, Handsome Cabinet

Recording tape enthusiasts would be happy to get Soundcraft high fidelity Tape for Christmas. But imagine their joy, their delight, when they receive 5 reels of Soundcraft tape—neatly stored and attractively packaged in the Soundcraft Tape-Chest!

The Tape-Chest is the ideal way to file and

protect recording reels. It's sturdily constructed, for long-lasting durability. It stores either 5" or 7" reels, each in a separate drawer. And it's yours for the giving at **no extra cost**, with the purchase of 5 reels of high-fidelity Soundcraft Tape.

So make this a very Merry Christmas for the tape fans on your gift list. Visit your nearest dealer, and ask for Soundcraft Tape in the convenient Tape-Chest!

Write for complete information to:

REEVES

SOUNDCRAFT CORP.

10 East 52nd Street, N. Y. 22, N. Y.

THE ONLY RECORDING MATERIALS PERFECTED
AND MANUFACTURED BY RECORDING SPECIALISTS

PAT. APPLIED FOR

Coming Up- Perfect Precision Prints

"SELECTIVE PRINTING FOR EVERY SCENE"

This is one of the essential departments at Precision which doesn't depend on automatic machinery. Only intelligence and skill can be depended on to select a timing value for the correct printing of essential elements. That's what you get in a Precision timed print — a selective printing exposure for every scene.



YOUR ASSURANCE OF BETTER 16_{mm} PRINTS

15 Years Research and Specialization in every phase of 16mm processing, visual and aural. So organized and equipped that all Precision jobs are of the highest quality.

Individual Attention is given each film, each reel, each scene, each frame — through every phase of the complex business of processing — assuring you of the very best results.

Our Advanced Methods and our constant checking and adoption of up-to-the-minute techniques, plus new engineering principles and special machinery

Precision Film Laboratories — a division of J. A. Maurer, Inc., has 14 years of specialization in the 16mm field, consistently meets the latest demands for higher quality and speed.

enable us to offer service unequalled anywhere!

Newest Facilities in the 16mm field are available to customers of Precision, including the most modern applications of electronics, chemistry, physics, optics, sensitometry and densitometry—including exclusive Maurer-designed equipment—your guarantee that only the best is yours at Precision!



tion with feedback. Kiebert claims to have improved the noise level of the amplifier by 12 db by using a wire-wound resistor in the plate circuit of the first stage, but that no significant change resulted from the same procedures in the following phase-splitter stage. This is funny, because the audio levels are about the same in both stages. In any case, he must be talking about noise levels which are humorously below the point of significance.

In conclusion, let me say that I find every issue of your magazine interesting and entertaining much more so than that other well known New York humor magazine called "-----"

HARVEY KEES,
3312 Lake Drive,
Evansville Indiana

SIR:

This letter is being written to compliment Mr. D. B. Frudd on his article in the November issue of *Æ*.

We are enclosing our latest bulletin on the Tri-Stable Two-Stage Caloriferer with Biased Viewpoint Adjustment which might prove of interest to you.

R. T. FISHER, Pres.,
Sigma Instruments, Inc.,
70 Pearl St.,
So. Braintree,
Boston 85, Mass.

SIR:

I noted the little item on the Frudd System with a big grin on my face. It created quite a bit of comment here among the wheels at Hazeltine. We thought it was pretty good. Shades of the Flewelling System—may both he and his system rest in peace. . . .

TED POWELL,
42 Nassau Road,
Great Neck, N. Y.

SIR:

After reading with interest Dr. D. B. Frudd's article on the epitome of audio systems, I proceeded with the construction of an amplifier to his specifications. Having just completed and tested this instrument, I wish to offer a few comments thereon. . . .

Regarding the construction itself, I felt that merely a solid aluminum chassis would not provide the ultimate stability for which all audio enthusiasts thirst. Therefore, I tried a large steel block mounted upon concrete piles, with gratifying results. To those readers who do not wish to smelt steel to order for the amplifier, I suggest the use of the motor block from an old automobile engine. . . .

Bernard A. Engholm,
Oak Ridge National Laboratory,
P. O. Box P.,
Oak Ridge, Tenn.

(One stage in each cylinder? Good shielding, that, ED.)

SIR:

. . . Aluminum was unavailable and I happened to use stainless steel, which I do not recommend as it is hard to work with the small hand tools, consisting of nail file and letter-opener, which were at my disposal. Actually I was so fatigued by this operation that when I found I had omitted cavities for the seventeen internal and three external loops I decided to simply wrap them about the chassis. This is not a neat job, but it serves very well, and is

[Continued on page 52]

1902-1952



**ELECTRICAL AND ELECTRONIC
WIRES AND CABLES**

*—For the Automotive, Applied
Radio, and Television Industries*

**Belden Manufacturing Company
Chicago 80, Illinois**

New Pressure Microphone

TV style!



BK-1A
All-New
Pressure Microphone
AM, FM and TV

THIS IS THE NEW MICROPHONE that made broadcast and television history at the political conventions. It includes every outstanding characteristic of the RCA 88-A, which it replaces, plus new advantages found in no other microphone in its price range or class. Check the facts!

- Type BK-1A is unobtrusive, even in the "close-ups." New styling, non-reflecting finish blends right into the TV picture
- Type BK-1A is absolutely insensitive to air blast and vibration—ideal for "close-ups"
- Type BK-1A has a frequency characteristic that is independent of distance from the sound source
- Type BK-1A has uniform response over the essential audio range
- Type BK-1A can be used in any kind of weather
- Type BK-1A detaches from base for hand-announcing (it can also be mounted on floor stands)
- Type BK-1A is equipped with a ball-and-swivel mount—can be turned in any direction
- Type BK-1A is only 8 inches high; weighs just 19 oz. (less base and cable)

For details and delivery information on this new remarkable semi-directional microphone, call your RCA Broadcast Sales Representative

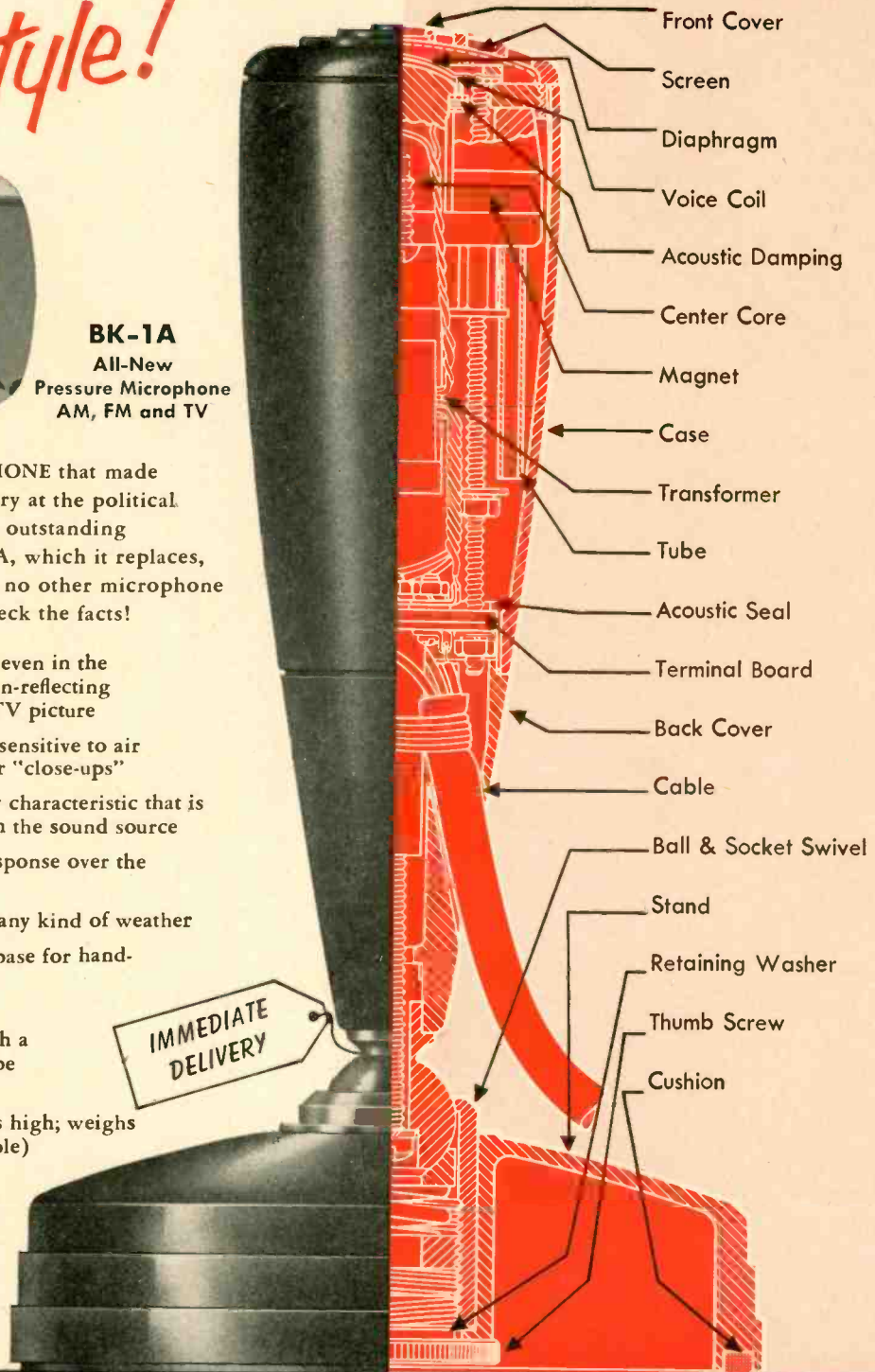

RADIO CORPORATION of AMERICA
ENGINEERING PRODUCTS DEPARTMENT
CAMDEN, N.J.

NEW LITERATURE

• **Peerless Electrical Products Division** of Altec Lansing Corporation, 9356 Santa Monica Blvd., Beverly Hills, Calif., recently released a new 15-page transformer catalog which contains 50 per cent more product listings than the last previous issue. Also shown and described are the company's facilities for design and manufacture of Class A, B, and H transformers built to military specifications. Available on request.

• **General Electric Company**, Schenectady 5, N. Y., describes the basic characteristics and applications of copper-oxide rectifier stacks in a new two-color 8-page booklet designated GEA-5699A. Remarkably complete, the booklet contains charts, graphs, and tables which illustrate the characteristics, manufacture, circuit design, and function of copper oxide rectifiers.

• **DeMornay-Bonardi, Inc.**, 3223 Buton Ave., Burbank, Calif., is now distributing a 134-page catalog which combines listings of the company's microwave products with a great deal of worthwhile technical information on microwave engineering. Opening pages of the book graphically explain the basic concepts of microwave communication. Included are graphs, charts and drawings.

• **Communication Products Company, Inc.**, Marlboro, N. J., describes electrical and chemical properties of Q-max lacquer and cement in Bulletin 752, which will be mailed on request. Included are the results of studies which will be of exceptional interest to all engineers whose work calls for the use of viscous insulating solutions.

• **Stevens-Arnold, Inc.**, 22 Elkins St., South Boston 27, Mass., illustrates and describes a new line of d.c.-a.c. choppers in catalog sheet 280B which will be mailed on request. Choppers shown have a 10-500 cps frequency range, are equipped with gold contacts, and have a life rating based on 1½-volt-d.c. 1-ma contact operation. All ratings are nominal and may be exceeded by as much as 50 per cent without damage.

• **Tech Laboratories, Inc.**, Palisades Park, N. J., has just issued a new 38-page catalog describing the complete line of precision electrical resistance instruments and electronic devices as currently manufactured. The catalog is bound in a handsome loose-leaf folder, and describes attenuators, T-pads, potentiometers, matching networks, and gain sets, together with a number of measuring instruments useful in a communications laboratory. Copies will be furnished without charge to interested readers writing on company letterhead.

• **Bausch & Lomb Optical Co.**, 650 St. Paul Street, Rochester 2, N. Y., offers a brochure on optical instruments for quality control. The eight-page booklet is illustrated with photographs, drawings, and technical data, and describes the use of contour measuring projectors, stereo-microscopes, toolmaker's microscopes, thickness gages, and other optical instruments that may be used as separate units or built into present equipment for rapid inspection and measurement of a multitude of tooling and production items. Copies may be obtained without charge by requesting Catalog D-22.

• **Aircraft-Marine Products, Inc.**, 2100 Paxton Street, Harrisburg, Pa., offers two new illustrated booklets which present the highlights of the industrial films "All's Well That Ends Well" and "By the Millions." These pocket-size books are intended primarily for distribution to audiences preceding the showing of the films, but they are also useful and instructive in their own right. The first of these films demonstrates the use and application of solderless terminals with precision hand tools, and the second shows how solderless terminals in strips fed from reels can be applied to wire at rates up to 4000 per hour with automatic machines. Both the booklets and the films were prepared for distribution and presentation before meetings of scientific and technical societies, trade associations, industrial groups, and engineering and technical schools, as well as for customers and prospects. Requests for copies of the booklets and for further details regarding the films will receive prompt attention.

to the

ELECTRICAL ENGINEER

or

PHYSICIST

with experience in

RADAR

or

ELECTRONICS

Hughes Research and Development Laboratories, one of the nation's leading electronics organizations, are now creating a number of new openings in an important phase of their operations.

Here is what one of these positions offers you:

THE COMPANY

Hughes Research and Development Laboratories, located in Southern California, are presently engaged in the development and production of advanced radar systems, electronic computers and guided missiles.

THE NEW OPENINGS

The positions are for men who will serve as technical advisors to government agencies and companies purchasing Hughes equipment—also as technical consultants with engineers of other companies working on associated equipment. Your specific job would be essentially to help insure successful operation of Hughes equipment in the field.

THE TRAINING

On joining our organization, you will work in the Laboratories for several months to become thoroughly familiar with the equipment which you will later help users to understand and properly employ. If you have already had radar or electronics experience, you will find this knowledge helpful in your new work.

WHERE YOU WORK

After your period of training—at full pay—you may (1) remain with the Laboratories in Southern California in an instructive or administrative capacity, (2) become the Hughes representative at a company where our equipment is being installed, or (3) be the

Hughes representative at a military base in this country or overseas (single men only). Compensation is made for traveling and moving household effects, and married men keep their families with them at all times.

YOUR FUTURE

In one of these positions you will gain all-around experience that will increase your value to our organization as it further expands in the field of electronics. The next few years are certain to see large-scale commercial employment of electronic systems. Your training in and familiarity with the most advanced electronic techniques now will qualify you for even more important future positions.

How to apply:

HUGHES

RESEARCH AND
DEVELOPMENT LABORATORIES

Engineering Personnel Department
Culver City,
Los Angeles County, California

If you are under thirty-five years of age, and if you have an E.E. or Physics degree, write to the Laboratories, giving resumé of your experience.

Assurance is required that relocation of the applicant will not cause disruption of an urgent military project.

EDITOR'S REPORT

EXHALE

THE FOURTH AUDIO FAIR has come and gone, and those of us who were there throughout the four days can finally take a breather. With an attendance of slightly over 13,000 people—many of whom were there two, three, or even all four days of the show—there was anything but calm and quiet in the exhibit rooms and corridors of Hotel New Yorker. But we loved every minute of it.

We are pleased to note that a great number of the exhibitors reduced demonstration volume to levels which were more in keeping with that at which the average listener would employ in his own home. We also noticed that the disparity between the most elaborate systems and the more modest ones is less apparent than it was in past years, especially with average program material. When particularly fine program material was used, the differences were still noticeable.

The Audio Fair idea is certainly established as the logical method of demonstrating audio equipment—where sound is as important as sight. With this year's attendance exceeding 1951's by nearly 5000, the New York event may well be said to have "arrived."

Closely following on its heels will be the Audio Fair-Los Angeles, which takes place on February 5, 6, and 7 at the Alexandria Hotel in the City of the Angels. In some respects the Alexandria will be better than the New Yorker—its rooms are larger and the ceilings are higher. We are certain, however, that—better or only just as good—the Audio Fair-Los Angeles will be well attended, and will bring new interest in audio to the Pacific Coasters.

LOUDNESS CONTROLS

The time has come to discuss one feature of the loudness control that seems to have escaped general notice. A study of the Fletcher-Munson equal loudness contours will show that the ear is less sensitive to frequencies above about 3000 cps than over the range from 1000 to 3000, and that the curves for all levels are almost identical above this point. Some loudness controls have been proposed which correct progressively for this deficiency, on the assumption that as over-all level is lowered, the high frequencies should be increased in addition to the lows.

May we point out that the human ear is less sensitive to these high frequencies at *all* levels, and that it is with these same ears that we listen to live music. Thus if the music is reproduced with a flat system (above 3000 cps)

it should be presented to the ear just as it is from a live source, since the F-M curves are almost exactly the same in the high-frequency range. We submit, therefore, that no correction should be applied to the loudness control except that for the low frequencies.

This observation is addressed to those who go for the idea of the loudness control, and may be overlooked by those who do not. However, we still prefer them.

AT LAST—THE R-J STORY

In last December's issue, we carried a story about the R-J speaker, but offered no constructional information. Since that time, the unit has become commercially available and because of this we have been unable to offer any further information—particularly regarding its construction. This is a matter which has caused some concern among several hundred of *Æ*'s readers—as well as among our own staff.

We are firmly assured, however, that we will have the R-J story in time for the January issue, and we know that many of you will be pleased at this news. In fact, we are extremely pleased ourselves to be able to get off the hook on this particular subject. So look for a thorough exposition of the R-J speaker next month, in an article by William Joseph and Frank Robbins.

SUBSCRIBE JUST ONCE MORE— IF YOU WISH

Over a lunch at the Audio Fair, it was suggested that we should offer Life Subscriptions so that *Æ*'s readers could avoid the necessity of renewing their subscriptions every so often. The first person we encountered after the discussion jumped at the chance, and while he was putting down his name, another joined up, followed shortly thereafter by a third "lifer." Since this idea seemed to be snowballing, a conference was deemed necessary with the Business Manager—who, after all, has to make ends meet each month—with the result that those of you who like *Æ* can now take advantage of this opportunity. For further details, we respectively refer you to the top of page 44. But before you turn the page, the Editors and Staff of Audio Engineering wish you

**A Merry Christmas and
A Happy New Year**

"For those who can hear the difference"

Listen....

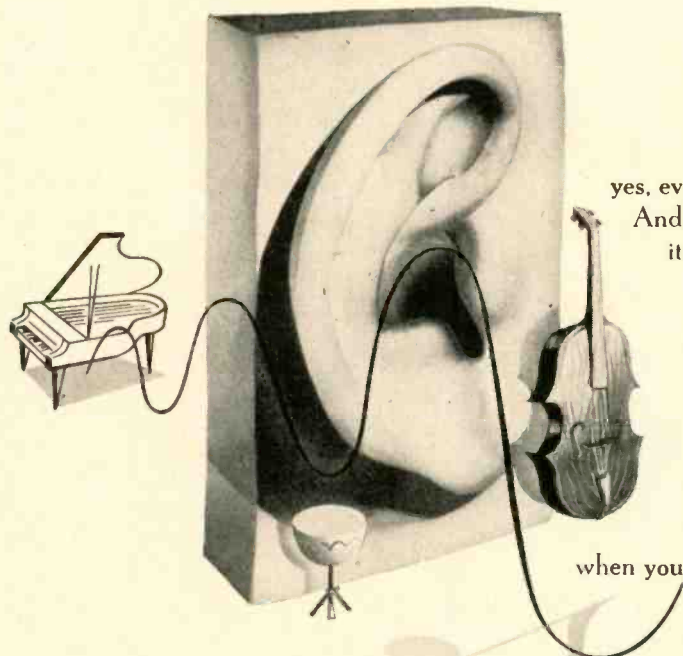

... it comes to you
in the subtle shading of a piano ...
in the clean brilliance of violins,
the purity of a flute. Your ear detects
the sweet mellowness of cellos,
the roundness of a clarinet ...
yes, even the iridescence of clashing cymbals.
And, as the symphony swells to crescendo,
its dynamic energy adds a flood of color
to your musical canvas.

For those who can hear the difference,
these are the elusive pleasures
that often remain hidden
in the grooves of fine recordings.

These are the thrilling
new listening experiences
that are released for your enjoyment
when you use quality components by Pickering.

PICKERING COMPONENTS

"for those who can hear the difference"

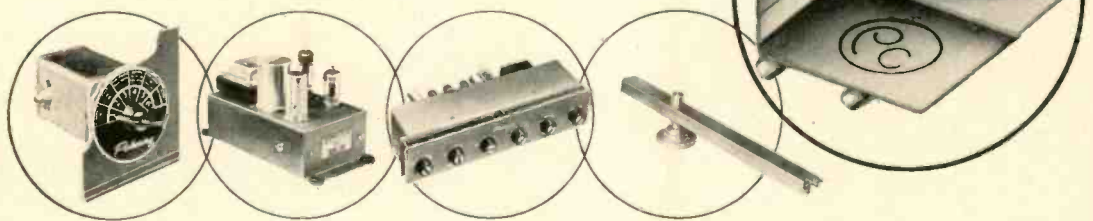

PICKERING and company, incorporated

- Pickering High Fidelity Components are available through leading Radio Parts distributors everywhere; detailed literature sent upon request. Address Department A 1

Oceanside, L. I., New York



*Eliminate
Redesign*



*by using
TRIAD
"HS" and "HSM"
Transformers*

The Triad "HS" and "HSM" Series of hermetically sealed transformers are particularly applicable to military and commercial uses, where long life and top performance are prime factors. Because they are designed to meet MIL-T-27 specifications, their use in prototypes will eliminate redesign at the production stage.

Such features as "Climatite" Treatment, Wide Frequency Range, Reduced Field Pickup, Small Size, Low Distortion, Low Temperature Rise, Sturdy Terminals and Attractive Grey Finish, make these transformers the obvious choice for all high quality electronic equipment.

Offered as a complete line in matching construction, Triad "HS" and "HSM" Series Transformers are available at all Triad jobbers.

Write for Catalog TR-52F



AES News

Society Announces Award Winners, 24 Fellowships, 21 Sustaining Members

DURING THE EXTREMELY successful Fourth Annual Convention, held at Hotel New Yorker from October 29 to November 1 inclusive, the Audio Engineering Society announced the winners of the two annual awards—the Society's Award for outstanding service to the organization, and the John H. Potts Award for outstanding achievement in the field of audio engineering—and also made public the names of the twenty-four Fellow awards and twenty-one Sustaining Memberships.

The Society's Award was presented to Ralph A. Schlegel, the citation reading "for his devotion and efforts in originating and carrying on the important work of the office of Treasurer." Mr. Schlegel was first elected to the office of treasurer in 1948, and has served continuously since that time. The award, in the form of a certificate, was presented at the Annual Banquet of the Society, held on the evening of October 30, at which Harold Burris-Meyer was toastmaster.

Also announced at the same time was the winner of the John H. Potts Memorial Award, which is given annually in the form of a plastic-embedded medal. This award was given "to Frank L. Capps, posthumously, for development and manufacture of high-quality sapphire recording styli. This award is double earned because his daughter, Isabel Capps, who receives it, has carried on his work and has herself made many valuable contributions to this art." Miss Capps, herself a member of the Society since its formation, accepted the medal and citation, both of which were presented by John D. Colvin, a member of the Awards Committee who acted on behalf of Chester A. Rackey, committee chairman, who was on the Pacific Coast on business.

Fellow Awards

The list of Fellows created at the Convention is as follows:

W. LINDSAY BLACK, for his work in broadcast audio transmission systems, standards, and measuring techniques.

H. BURRIS-MEYER, for his work in the application of audio sound effects in theatrical production.

ISABEL CAPPS, for her work in development and manufacture of high-quality recording styli.

JAMES Y. DUNBAR, for his work in design of acoustic treatment, soundproofing, and vibration control.

PRICE E. FISH, for his work in the application of magnetic tape recording to radio broadcasting.

ERNEST W. FRANCK, for his work in the development of high-quality lacquer recording blanks and magnetic tape.

LEWIS S. GOODFRIEND, for pioneering in

development of audio engineering courses and for his work on artificial reverberation.

JOHN K. HILLARD, for his work in film recording and reproduction and for development of intermodulation testing techniques in film recording.

WILLIAM F. JORDAN, for his pioneering and continued activity in newsreel recording operations.

SAMUEL F. LYBARGER, for his work in development and standardization of hearing aids.

JOHN T. MULLIN, for his work in promotion, development, and practical application of magnetic tape recording.

DR. HARRY F. OLSON, for his extensive research and development in the fields of acoustics and audio engineering, and for authorship of leading texts on these subjects.

NORMAN C. PICKERING, for his work in development and manufacture of high-quality disc reproducing equipment and for investigation in intermodulation testing.

JOHN PRESTON, for his work in research and development of microphones and loudspeakers.

ALBERT A. PULLEY, for his work in development and practical application of commercial recording and pre-processing techniques.

RICHARD H. RANGER, for his work in the general field of audio engineering and the development and design of magnetic tape recorders.

HILLEL I. REISKIND, for his work in development and design in the general field of disc recording and production processing.

CARLETON R. SAWYER, for his work in development of film, disc, and magnetic tape recording systems.

HERMON H. SCOTT, for his work in development and manufacture of sound level meters and audio noise suppressors.

J. P. SMITH, JR., for his work in design and development of audio attenuators and measuring equipment.

S. EDWARD SORENSEN, for his work in system design in disc and magnetic tape recording.

W. EARL STEWART, for his work in design of commercial high-quality audio equipment and systems.

MYRON J. STOLAROFF, for his work in development and design of high-quality magnetic tape recording equipment.

WILLIAM J. TEMPLE, for his work in the science of speech.

Sustaining Members

During the past year, a number of manufacturers and distributors have contributed substantial sums to forward the work of

[Continued on page 51]

SKATING RINKS



FUNERAL PARLORS



DANCE STUDIOS



STEAMSHIPS



AMUSEMENT PARKS AND RECREATION CENTERS

strikes a **NEW NOTE** in continuous performance playback music

INTRODUCING THE

AMPEX 450

- *Up to eight hours of uninterrupted performance — day after day, year after year*
- *Requires no attention during operation*
- *Lowest cost per hour*

The new AMPEX 450 gives you hours of high-quality background music delivered at *lowest cost per hour* of any musical reproduction system. With the AMPEX there are no interruptions, no records to change and no attendants since it *needs no attention* during operation. It plays at the touch of a button and keeps on playing for as long as eight hours without repetition. Because tape doesn't lose quality with repeated playings, music is always scratch-free and pleasant, with less background noise and distortion.

The Model 450 is engineered to rigid AMPEX standards and is capable of delivering thousands of hours of service with no breakdowns and minimum maintenance.

For further information, write to Dept. B

IF YOU PLAN FOR TOMORROW, BUY AN AMPEX TODAY

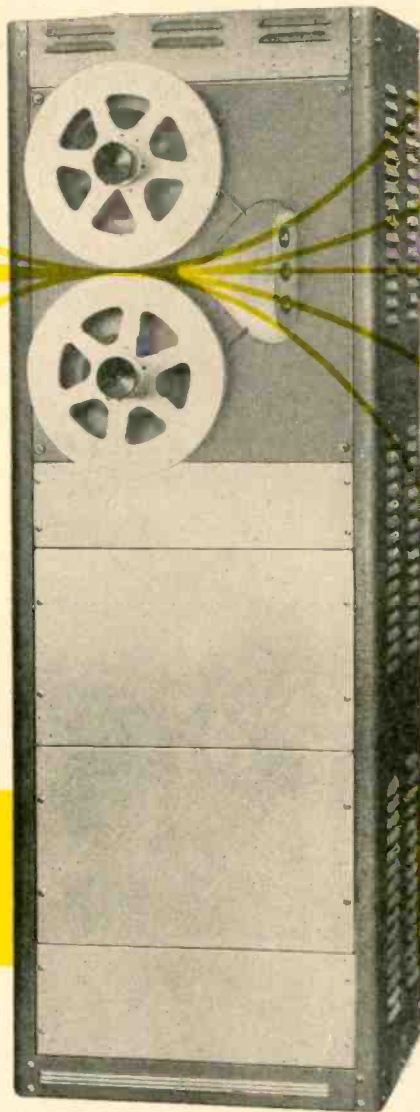

*Model 450 rack-mounted.
Also available in portable or console mount.*

FEATURES

- 50 to 7500-cycle frequency response at 3¾ inch tape speed
- Standard NARTB reels up to 14 inches
- Pushbutton controls
- Automatic reverse control available as an accessory permits full eight hour program without interruption.

AMPEX

MAGNETIC RECORDERS

AMPEX ELECTRIC CORPORATION
934 CHARTER STREET • REDWOOD CITY, CALIF.

It splits seconds even faster

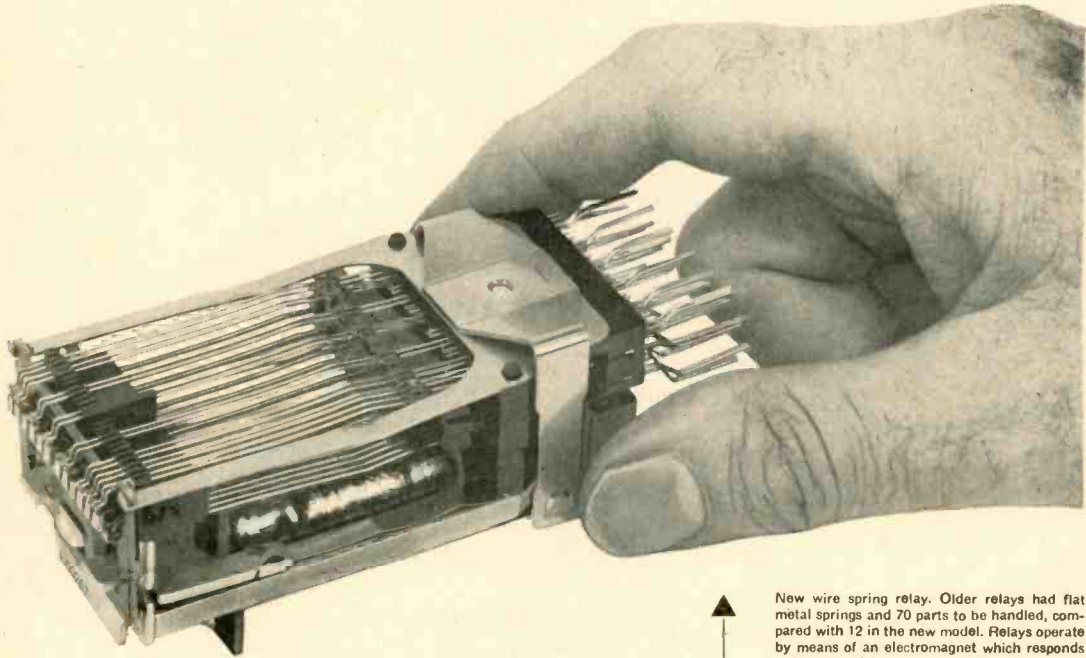

IN A split second, relays, which are high-speed switches, set up dial telephone connections. Then they are off to direct the next call. Yet even this speed is too slow for Bell Laboratories scientists in quest of still faster switching.

Scientists and engineers devised a new relay — the wire spring relay — and worked out the production problem with Western Electric, manufac-

turing unit of the Bell System. This is twice as fast, uses less power and costs less to make and maintain.

With speedier relays, switching can be done with less equipment . . . and calls go through faster. The wire spring relay is a practical example of how Bell Telephone Laboratories and Western Electric pool their skills to improve telephone service while keeping its cost down.

New wire spring relay. Older relays had flat metal springs and 70 parts to be handled, compared with 12 in the new model. Relays operate by means of an electromagnet which responds to high-speed pulses.

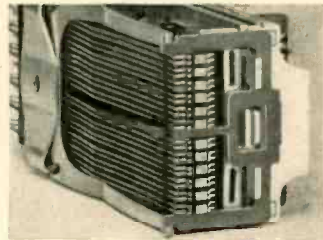

New relays must be able to operate one billion times—equal to once-a-second for 30 years. Employing a sound recorder as a precision vibrator, Bell scientists learned to evaluate the effect of sideways motion on relay life. Such rubbing motion is limited to one-thousandth of an inch in the new relays.



Dynamic Fluxmeter, developed by Bell Laboratories, indicates flux build-up in intervals of 25 millionths of a second. Precise information like this was essential to higher speed operation.

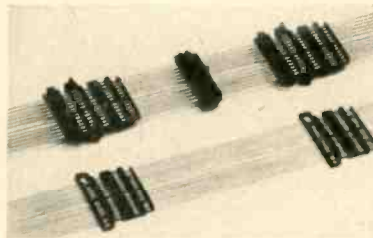

Relay springs as they come from Western Electric molding machine, before being cut apart for use. Molding technique saves time and money . . . makes possible the maintenance of precise adjustment.

Bell Telephone Laboratories



IMPROVING TELEPHONE SERVICE FOR
AMERICA PROVIDES CAREERS FOR CREATIVE
MEN IN SCIENTIFIC AND TECHNICAL FIELDS

Nominating Convention Organ Installation

SERGE L. KRAUSS* & KARL KRAMER**

Providing a high-power organ installation to be used only for two weeks presents some rather unusual engineering problems—which were solved readily by use of electronic and electro-acoustical equipment.

THE PRODUCTION OF MUSIC for large audiences has been greatly facilitated by the development of the modern electronic organ and wide-range, high-efficiency loudspeakers. The Connsnata organ installation for the recent Presidential nominating conventions in Chicago is an excellent example of the type of performance that can be attained with this combination.

The International Amphitheater, site of the conventions, had no organ of any kind, and the Connsnata was selected to fill the need for this traditional type of music. The auditorium capacity is twelve thousand people; in addition to the permanent seating space (main floor and balcony) there is a clear central floor space (arena) 123 by 236 feet that was used for the main speakers' platform. The clear height over this space is 73 feet. It was apparent that in order to dominate, supplement, or over-ride with music the "noise" level occasioned by the customary enthusiastic demonstrations of so many people in so large a room, considerable undistorted acoustic power would be required.

The temporary installation on short notice of a pipe organ with sufficient power for this purpose would have indeed been an enormous project. The single problem of space for such an organ would probably have precluded its use. In contrast to this possibility was the use of a modern, flexible and easily portable electronic organ, with its tone generators enclosed in the organ console and with only loudspeakers and their associated amplifiers as additional equipment for meeting the requirements of the large auditorium.

The floor space allotted for the installation of the organ console and bench and the speaker amplifiers was limited to less than 45 square feet. It is interesting to note that there was room enough left over in this small space for a number of chairs. The reproducer assemblies were suspended from the ceiling in the middle of the auditorium and did not detract from the seating capacity.

The Connsnata used was a standard stock model 2C2 with separate manual

* Design Engineer, Electronics Division, C. G. Conn, Ltd., Elkhart, Indiana.

** Technical Service Manager, Jensen Manufacturing Company, Chicago, Illinois.

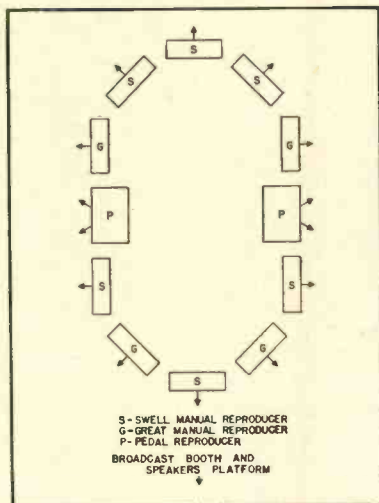

Fig. 1. Plan of the reproducer gondola showing the arrangement of the various speakers.

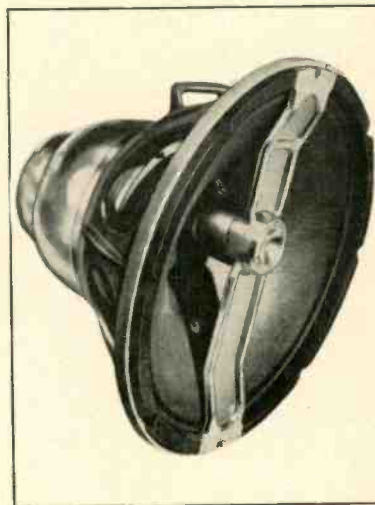

Fig. 3. Triaxial unitary 3-channel loudspeaker system.

and pedal audio channels; the specifications are given in Table 1. Independent channels are advantageous in that the speakers can be designed for maximum efficiency in the spectrum covered. The pedal tone spectrum is from 32 to a few thousand cps and each manual spectrum is from 64 to above 12,000 cps. Having a separate pedal channel avoids the application of tones in the octave from 32

to 64 cps on the manual speakers and thus keeps the "Doppler" distortion at a minimum. With independent manual channels the amplifier-reproducer equipment can be divided in proportion to the sound power necessary for the desired musical balance for the type of music played. It is also possible, with separate manual channels, to provide an effective echo organ feature by switching the

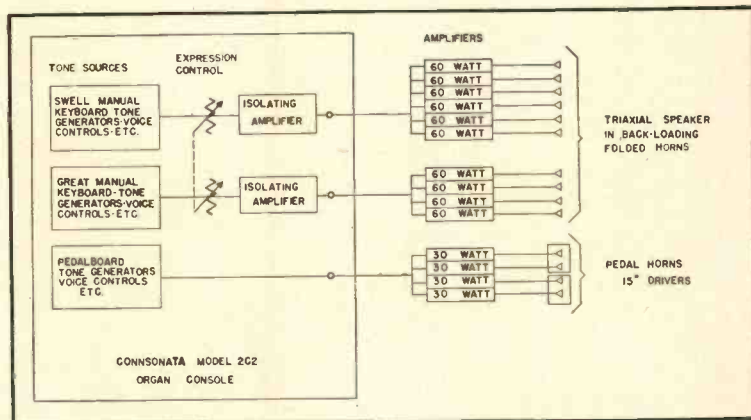

Fig. 2. Block diagram of the complete organ reproducing system.



Fig. 4. Complete assembly of speaker unit in back-loading cabinet for use as manual reproducer.

swell manual channel to reproducers located at a distance from the main reproducer.

The possible number of individual, non-interlocked fundamental tones produced simultaneously by an organist on each playing manual exceeds 60. In addition, many harmonics of these tones are present in the pulse (string) signals. The instantaneous peak power of such a complex signal is several times the average power, so the amplifiers used must be capable of handling these high signal peaks without distortion. The amplifiers used for the convention installation were operated at approximately one third their normal continuous undistorted power output capacity. To keep the power requirements within bounds, efficient reproducers are essential for large installations.

The initial decision was to install the loudspeakers at the end of the auditorium behind the speaker's platform and facing most of the audience. Installation of the radio-television control booth in this location prevented this and resulted in choice of a central location near the ceiling. The loudspeaker array is shown in Fig. 1. Six reproducers were assigned to the swell manual channel and four to the great manual channel. Each manual reproducer was excited by an amplifier of 60-watt rating. The two pedal horns each had two driver units and each driver unit was excited by an amplifier of 30-watt rating. A block diagram of the installation is shown in Fig. 2.

The application of individual amplifiers for each reproducer allows the use of stock amplifiers with tube complements that are readily obtainable. The maintenance of such a system is simple, for in case of a component failure only

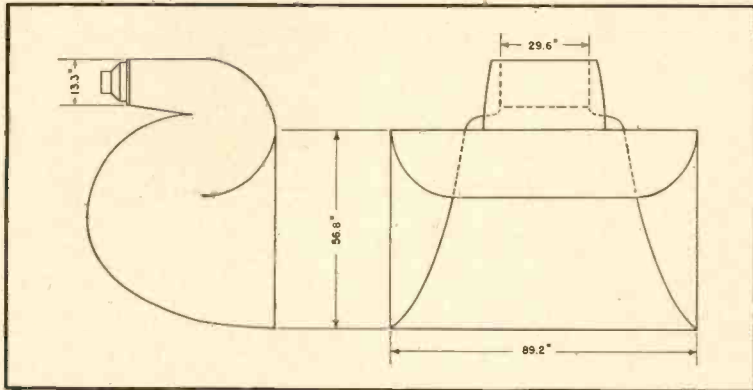

Fig. 5. Specially constructed exponential horn used for the pedal reproducers.

a small fraction of the system is disabled and repairs can be made without disrupting the program. The reliability of the installation under discussion was proven in that no maintenance at all was required throughout the two strenuous sessions.

Interference with broadcast facilities was avoided by arranging the loudspeakers so that little sound energy was radiated directly toward the control booths. Conversely, the organ installation was checked for possible influence from pack transmitters, television signals, etc., and was found completely free from pickup.

Great and Swell Manual Reproducers

All ten of the reproducers assigned to the great and swell manuals were identical multiple-channel loudspeaker systems. Each was comprised of a Jensen G-610 Triaxial 3-channel unitary loudspeaker system¹ installed in a large back-loading folded horn.² Figure 3 shows

the unitary loudspeaker system and Fig. 4 shows this Triaxial speaker installed in the horn to form the complete reproducer.

As the name implies, this type of horn loads the back of the 15-inch direct-radiator diaphragm up to a frequency of about 300 cps. Above this point the horn radiation is negligible but radiation from the front of the same 15-inch diaphragm occurs with high efficiency. For frequencies above 600 cps the constant resistance dividing network diverts the electrical input to a compression-type

¹ Karl Kramer, "A three-channel loudspeaker." *FM-TV Radio Communication*, Sept. 1951, p. 40.

² "A back-loading folded horn for 15-inch loudspeakers." *Jensen Technical Bulletin No. 1*, available without charge from Jensen Manufacturing Company, 6601 South Laramie Avenue, Chicago 38, Illinois.

[Continued on page 47]



Fig. 6 The reproducer gondola just before hoisting to its operating position.

A Discussion of Dividing Networks

J. P. WENTWORTH*

Presenting two simple dividing networks—one of which provides a connection point for negative voltage feedback which will equalize over-all amplifier-speaker response.

IT IS GENERALLY ACKNOWLEDGED that a single loudspeaker unit can not reproduce optimally the entire audible frequency range. For clean reproduction of high-fidelity music, at least two speakers are required, each transducing signals in a limited frequency band. To insure that each speaker receives only signals within its own frequency range, it is customary to use a dividing network or networks to distribute the signal among the speakers.

Perhaps the neatest way to accomplish such signal distribution would be to separate the frequency bands at a low power level, and to use an individual power amplifier for each speaker. However, since the output stage and transformer represent a considerable part of a high-quality amplifier, in terms of cost, power consumption, and weight, it is usually more expedient to make the separation at the secondary side of the output transformer.

An ideal multispeaker system would give the impression that the sound emanated from a single super-speaker, which was able to handle all frequencies. To accomplish this aim, the dividing network should satisfy the following criteria:

1. The network must so distribute the signal among the speakers that the acoustic power output at every frequency is the same as that radiated by the single hypothetical ideal speaker.
2. All frequencies should be radiated with the same phase relationships as those that would exist in the case of the single ideal speaker. This objective is a rather minor consideration in minimizing phase distortion; however, if inverse feedback voltage is to be taken from the

speaker voice coils, it becomes a requirement of paramount importance.

3. The speaker system should present to the amplifier a constant and purely resistive impedance, in order to minimize distortion in the output stage of the amplifier.

4. In the interest of economy of power, it is desirable that the network be non-dissipative; i.e., that it be made up of purely reactive impedance elements.

5. In order to provide effective damp-

[Continued on page 49]

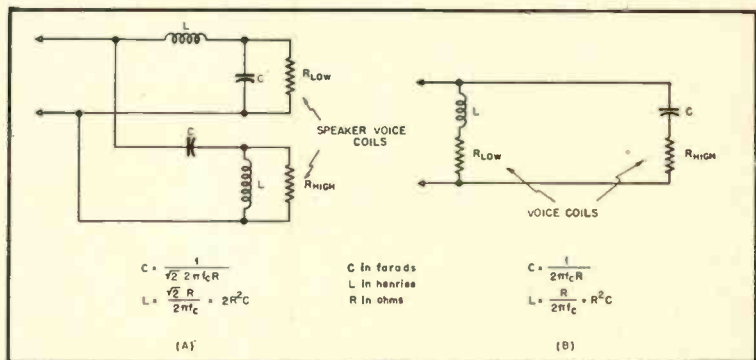

Fig. 1. (A) Parallel network, constant resistance type, giving a cut-off slope of 12 db per octave; (B) Half-section network giving cut-off slope of 6 db per octave.

* 2058 E. 81st St., Cleveland 3, Ohio.

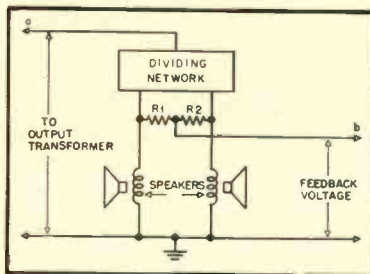

Fig. 2. Circuit arrangement for obtaining feedback voltage from voice coils of two-speaker system.

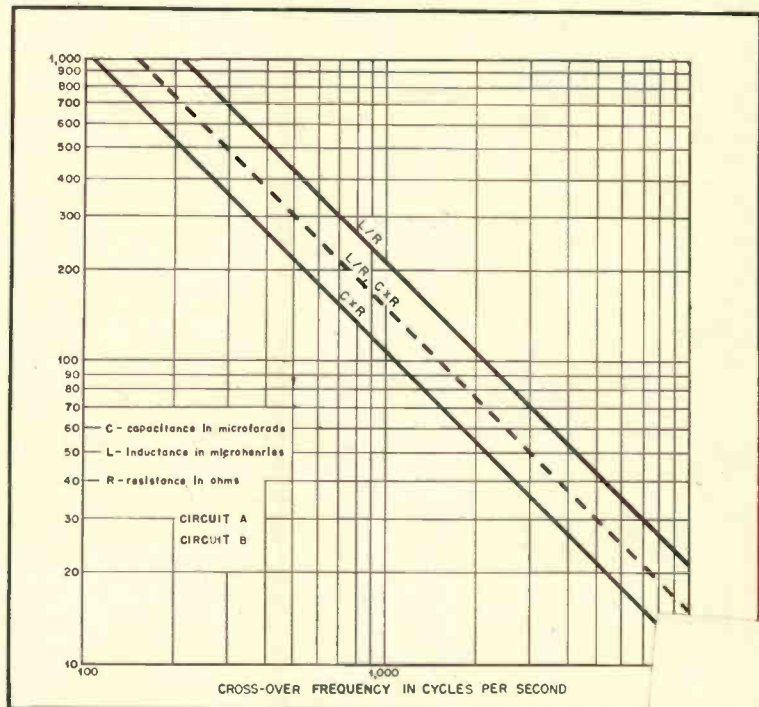

Fig. 3. Chart for determining values for L and C in networks of Fig.

Simplified Equalizer Design

GEORGE A. DOUGLAS*

Charts and tables to reduce complication—and construction hints to ease building.

Applications requiring exact modifications of the audio spectrum, constant-resistance equalizers are capable of doing the job with maximum efficiency and convenience. The correction of cutter peaks and tape droop at the high end, the incorporation of pre-emphasis, and numerous other alterations of response can readily be accomplished with the design data that follows, and which involves only simple arithmetic to calculate values of components; or, with the use of a reactance chart, a few steps of multiplication.

Figure 1 shows the four configurations with their transmission characteristics used to cope with the equalizer problems commonly met in audio work. The circuits of (a) and (b) are shelf suppressors, or conversely, low and high boost; (c) and (d) are peaking equalizers. As it is inadvisable to use

more than 20 db of attenuation in a single equalizer, it will be seen that the shelf suppressors serve where a gradual curve is required not exceeding 6 db per octave. Networks may be cascaded to obtain a steeper characteristic, but

this requirement is usually met by applying (c) or (d), in which case it is possible to control the slope.

The first step in the design of an equalizer is to draw on logarithmic paper the actual and desired response of

Fig. 2. Method of adding pre-emphasis to recording characteristic to eliminate a cutter peak, for example. Curve A represents normal response, while curve B represents desired response. The required equalization is represented by the difference between the two curves.

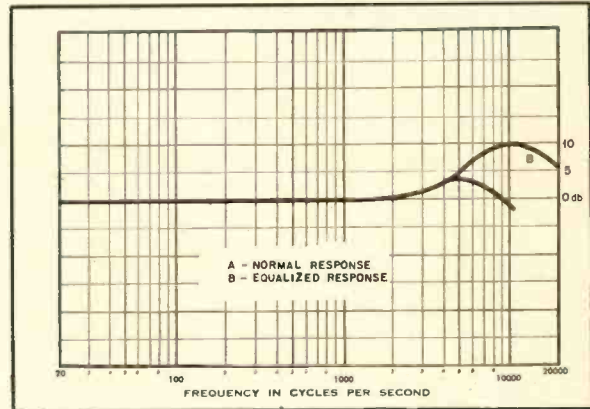

* 51 E. 42nd St., New York 17, N. Y.

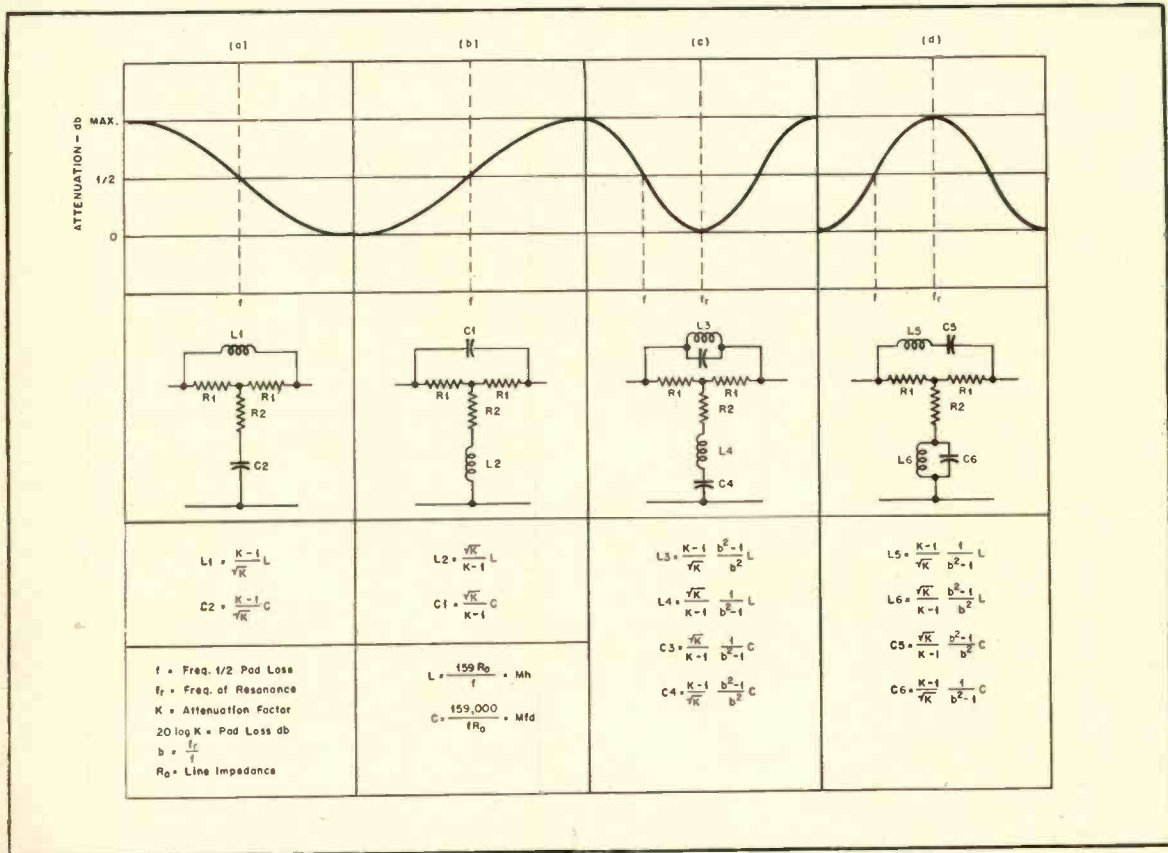

Fig. 1. Chart showing the configurations of four different types of equalizers, together with formulas for determining the reactive elements.

the equipment requiring modification or correction. This will furnish information to construct the transmission characteristic of the equalizer. On this curve note the design frequency on the transmission characteristic at the line of half the total attenuation. With the design frequency f and the impedance of the line in which the equalizer is to work, calculate L and C , or take their values directly from a reactance chart. L_1 to L_6 and C_1 to C_6 may now be ascertained by substituting in the equations figures taken from the accompanying tables.

For the shelf suppressors only Table 1 is used. The values for $\frac{K-1}{\sqrt{K}}$ and $\frac{\sqrt{K}}{K-1}$

and for R_1 and R_2 for an impedance of 1 ohm, are located opposite the degree of attenuation desired. For other values of R_1 and R_2 , multiply by selected R_0 . The data in Table 2 determines the slope of equalizers (c) and (d). The ratio in column 1 corresponds to f_r/f (the resonant frequency divided by the frequency of one half the attenuation). Opposite this are found the solutions of $\frac{b^2-1}{b^2}$ and $\frac{1}{b^2-1}$.

Example:

Curve (A) of Fig. 2 depicts a typical cutter response above 1000 cps. It is desired to design a 600-ohm equalizer for a recording characteristic with 10 db of pre-emphasis at 10,000 cps. Ordinarily the low-frequency shelf suppressor could be used, but in this case the cutter peak would be undesirably increased. It is apparent that the rising slope of the peak can be continued to the 10,000-cps, 10-db point; therefore the obvious solution is to design the equalizer with the configuration of (d) with a resonant frequency of 10,000 cps, and an attenuation¹ of 10 db. From the curve, the point of half the attenuation, or 5 db, is found at 7000 cps, the design frequency. L and C can now be ascertained:

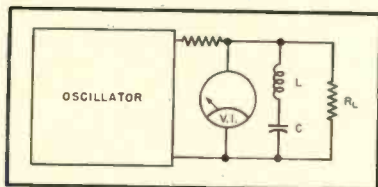

Fig. 3. Circuit arrangement for determining resonant frequency of LC combination.

¹ While the term "attenuation" usually refers to a loss, it has a slightly different meaning when used with an equalizer of any of these types. In the case of equalizers (c) and (d), attenuation refers to the difference in the transmission at the resonant frequency to that at frequencies remote from the resonant frequency. For those equalizers of types (a) and (b), attenuation refers to the difference in transmission at the two extremes of the frequency spectrum. In both cases, this "attenuation" is determined by the loss in the resistive network, which is normally referred to as an attenuator or pad.

$$L = \frac{159 \times 600}{7000} = 13.62 \text{ Mh}$$

$$C = \frac{159,000}{7000 \times 600} = .038 \text{ } \mu\text{f}$$

Now, since

$$L_5 = L \frac{K-1}{\sqrt{K}} \frac{1}{b^2-1}$$

$$L_6 = L \frac{\sqrt{K}}{K-1} \frac{b^2-1}{b^2}$$

$$C_5 = C \frac{\sqrt{K}}{K-1} \frac{b^2-1}{b^2}$$

$$C_6 = C \frac{K-1}{\sqrt{K}} \frac{1}{b^2-1}$$

From the tables:

$$\frac{1}{\sqrt{K}} = 1.213 \quad \frac{f_r}{f} = \frac{10}{7}$$

$$\frac{K-1}{\sqrt{K}} = .824 \quad \frac{b^2-1}{b^2} = .512$$

$$R_1 = .520 \quad \frac{1}{b^2-1} = .952$$

$$R_2 = .704$$

Substituting, we now have:

$$L_5 = 13.62 \times 1.213 \times .952 = 15.7 \text{ Mh}$$

$$L_6 = 13.62 \times .824 \times .512 = 5.8 \text{ Mh}$$

$$C_5 = .038 \times .824 \times .512 = 0.16 \text{ } \mu\text{f}$$

$$C_6 = .038 \times 1.213 \times .952 = .043 \text{ } \mu\text{f}$$

$$R_1 = .520 \times 600 = 312 \text{ ohms}$$

$$R_2 = .704 \times 600 = 423 \text{ ohms}$$

For many applications in the upper frequency range, r.f. chokes can be utilized, providing the d.c. resistance is not excessive. The photographs, Figs. 4 and 5, show a completed equalizer with 5-mh. coils of about 15 ohms. To provide proper inductance, select capacitor(s) of correct value for C in Fig. 3. Set the oscillator to the desired resonant frequency, with more inductance in the circuit than is needed, and remove turns until maximum attenuation occurs.

Coil resistance can be compensated

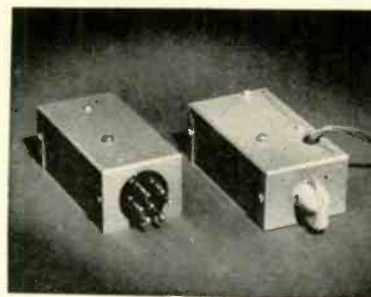

Fig. 4. Two equalizers constructed by the author—left, a plug-in unit employing a fixed amount of equalization, and right, a unit providing step-switch control of attenuation.

for to some extent by including it in the pad. Thus, when an inductance appears in the shunt arm, its d.c. resistance should be deducted from R_2 , and a resistor selected which has an actual

[Continued on page 51]

TABLE 2
EQUALIZERS

$\frac{f_r}{f}$	$\frac{b^2}{b^2-1}$	$\frac{1}{b^2-1}$
$\frac{10}{9}$.187	4.348
$\frac{10}{8}$.359	1.785
$\frac{10}{7}$.512	.952
$\frac{10}{6}$.637	.568
$\frac{10}{5}$.750	.333
$\frac{10}{4}$.840	.190
$\frac{10}{3}$.910	.099
$\frac{10}{2}$.960	.042

TABLE 1
EQUALIZERS

db	$\frac{K-1}{\sqrt{K}}$	$\frac{\sqrt{K}}{K-1}$	R_1	R_2
1	.113	8.833	.057	8.68
2	.232	4.307	.114	4.32
3	.345	2.902	.171	2.84
4	.468	2.135	.226	2.20
5	.586	1.705	.280	1.646
6	.709	1.410	.332	1.34
7	.826	1.193	.382	1.118
8	.949	1.053	.430	.946
9	1.082	.923	.476	.812
10	1.213	.824	.520	.704
11	1.356	.737	.560	.602
12	1.500	.667	.598	.536
13	1.644	.608	.634	.472
14	1.790	.558	.668	.416
15	1.949	.513	.700	.368
16	2.116	.453	.728	.310
17	2.285	.437	.752	.268
18	2.461	.406	.776	.246
19	2.654	.376	.798	.224
20	2.848	.351	.818	.202

Handbook of Sound Reproduction

EDGAR M. VILLCHUR*

Chapter 7—History of the Phonograph

The recording of sound has been of interest to inventors for nearly a hundred and fifty years, although means of reproducing it is only seventy-five years old. Some of the earliest instruments are described by the author.

IN 1877 THOMAS EDISON, for the first time in history, succeeded in reproducing sound mechanically from a recorded pattern. The inventor played back his own recitation of *Mary Had a Little Lamb* on an instrument that was

* Contributing Editor, AUDIO ENGINEERING.

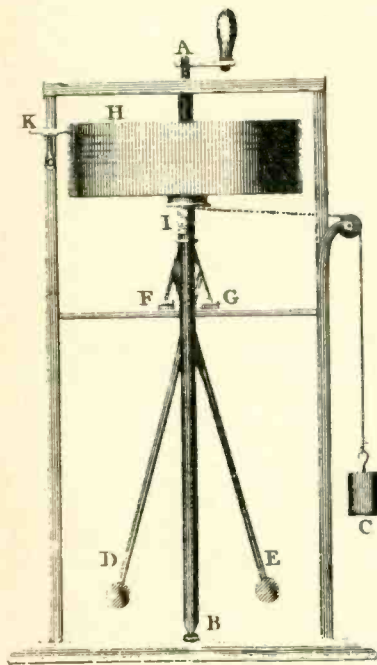

Fig. 7-1. Young's sound recorder and chronometer of 1806 (from a copper engraving of that date). The original caption reads: "The axis AB being turned, either by the handle A or by the weight C, the balls D, E, fly out, and carry the weights, F, G, further from the axis; in consequence of which the increased effect of friction retards the motion when it becomes too rapid. The barrel H is turned in the meantime, with the axis, and is allowed to descend as the thread at I is uncoiled, so that the point K, which is pressed against it by a spring, describes on it a spiral, which is interrupted whenever the pin K, is touched." From: A Course of Lectures on Natural Philosophy and the Mechanical Arts, 1807.

ingeniously conceived, but which was largely modeled on a basic earlier design, one that had been used in sound recorders over a period of seventy years.

Thomas Young, the British physicist who introduced the modulus of elasticity in current use, described a device in 1806 which was able to make a graphic record of sound waves. The vibratory nature of sound was known, and the use of a time vs. pressure graph to represent sound vibrations was familiar to workers in acoustics. This device made such a graphic record automatically; the stylus was actuated by the sound itself rather than by the hand of a draftsman.

Young's description of the principle of sound recording is as clear and valid today as it was then, and it may serve us here:

"The situation of a particle at any time may be represented by supposing it to mark its path, on a surface sliding uniformly along in transverse direction. Thus if we fix a small pencil in a vibrating rod, and draw a sheet of paper along, against the point of the pencil, an undulated line will be marked on the paper, and will correctly represent the progress of the vibration."

The recorder in which this principle was first applied is illustrated in Fig. 7—1, a reproduction of the original copper engraving in the 1807 edition of Young's "A Course of Lectures on Natural Philosophy and the Mechanical Arts." The recording stylus K, which was held pressed against the cylinder by spring tension, had to be touched by a "sounding body" in order to have vibrations induced in it. The traced line or groove was varied transversely rather than in depth; this is the type of recording known today as *lateral*.

Sound recorders were constructed by several other experimenters, such as Duhamel and Wertheim, during the first half of the 19th century. All of these devices, like the apparatus illustrated in Fig. 7—2, required direct connection between the source of sound and the recording stylus. The immediate ancestor of the modern phonograph is therefore considered to be the instrument built in 1856 by Léon Scott de Martinville, whose recorder was the first to receive its energy through acoustical rather than mechanical coupling to the source.

Sound to be recorded on Scott's instrument was directed through a horn

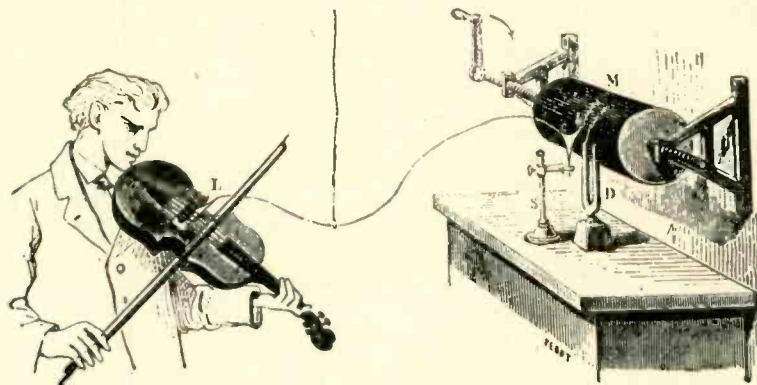

Fig. 7-2. Early experiments in sound recording. No intermediary diaphragm was employed, as in the phonograph, between the source of sound and the recording stylus. From: *Telephones et Phonographes*, Alfred Niaudet, 1878.

against a parchment diaphragm and attached hog-bristle stylus. The point of the stylus pressed against a cylindrical surface treated with lampblack, so that the path of displacement produced by stylus vibrations was scratched into the lampblack, revealing the white paper underneath. The traced line was made to travel along the time axis of the graph by continuous rotation of the cylinder past the point of stylus contact, and a feed screw moved the cylinder longitudinally, creating a helical rather than a circular trace.

This device was called, appropriately, the phonautograph, from *phone* (sound), and *autograph* (self-writing). It was manufactured commercially by the Paris firm of Koenig as a laboratory instrument for measuring and recording, a mechanical oscilloscope. (See Fig. 7-3). The translation of acoustic vibrations into a frozen engraving of their wave forms thus ceased to be a purely experimental technique. Within its limitations the phonautograph could capture the characteristics of frequency, overtone structure, and dynamic range of any given group of sounds. There remained only the final step of devising a method to recall the sound from its symbolic state.

The process of recall had to reverse the recording sequence exactly, that is, to produce mechanical and then acoustical vibration by dragging a compliant stylus through a rigidly engraved graph of recorded sound. The stylus would then be forced to vibrate in a similar manner to the recording stylus which had received the original sound energy, and imitative acoustic waves could be set up through an attached reproducing diaphragm. Scott predicted that the day would come when recorded sound could be re-created, but it was more than twenty years before an instrument of recall was built. Although the principle was known, the quantitative problem of creating a groove rigid and deep

enough to direct the motion of a reproducing stylus had to be solved.

Strange as it may seem, "talking machines" already existed; these were pneumatic devices designed to produce intelligible speech rather than musical tones. The keyboard controlled speech organ (Fig. 7-4) constructed by Josef Faber of Vienna was considered the most perfect of the robots. It could be made to speak by means of a complicated and ingenious mechanism, artificial vocal apparatus consisting of bellows, valves, adjustable air cavities, a little fan wheel to roll its r's, and rubber lips and tongue. Such devices, mechanical forerunners of the modern electronic *voder*, were the outcome of a different branch of acoustical research than Scott's, but they probably stimulated thought in terms of sound reproduction.

A machine to perform the reversal of Scott's recording process was suggested by several writers in periodical literature, and in April, 1877, Charles Cros deposited with the French Academy of Sciences a sealed packet containing the description of a complete reproducing system. Cros planned to make metal records of phonautograms by photo-engraving after the lampblack groove had been traced.¹

The first working model of a sound reproducing machine, however, was made in the laboratory of Thomas Edison later that year. Edison drew up the plans shown in Fig. 7-5 and assigned a worker in his laboratory, John Kruesi, to build a "phonograph" within a budget of eighteen dollars. Like Cros, Edi-

¹ (Translated excerpt from Cros' paper) "Speaking generally, my process consists in obtaining traces of the movement to and fro of a vibrating membrane, and in using this tracing to reproduce the same movement, with its intrinsic relations of duration and intensity, either on the same membrane, or on one adapted to give out the sounds which result from this series of movements.



Fig. 7-3. The phonautograph of Leon Scott de Martinville. (Courtesy The Smithsonian Institution).

son realized that the engraving had to be stiff enough to force the stylus to follow the recorded convolutions. He solved this problem by producing a deep embossing in tinfoil, a medium with a compromise degree of hardness. The embossing stylus was mounted so that it could indent, in varying degree, a sheet of tinfoil wrapped on a pre-grooved brass cylinder. The depressions of the cylinder's threads accepted the indented material, and although each playback deformed the shape of the groove, enough of the original form was retained to reproduce speech intelligibly. This retention was made possible by the very poor efficiency of re-

"It is therefore necessary that an extremely delicate tracing, such as may be obtained by passing a needle over a surface blackened by fire, should be transformed into a tracing, capable of sufficient resistance to guide an index which will transmit its movements to the membrane of sound. . . . By a well-known photographic process, a transparent tracing of the modulations of the spiral can be represented by a line of similar dimensions on some resisting substance—tempered steel, for example. . . ."

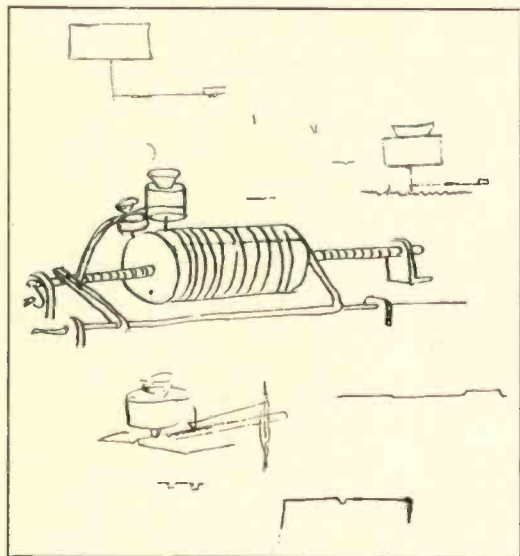

Fig. 7-5. Edison's original working sketches for the phonograph. From: *The Life and Inventions of Thomas Alva Edison*, by Dickson, 1894.

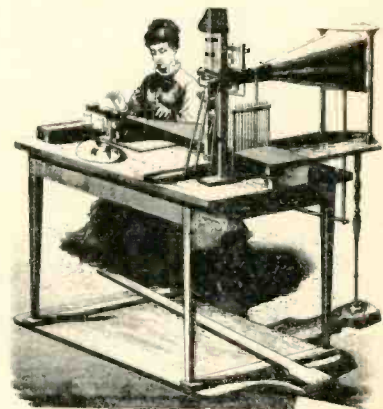

Fig. 7-4. The Faber speech organ. speech could be "played" from the in front of the bellows. From: *Zeitschrift für Allgemeine Sprachwissenschaft*, 1884.

production; the resistance presented by the playback stylus was far less than the original recording force.

The phonograph was demonstrated before various scientific groups. When, in 1878, it was presented at the *Académie des Sciences*, it was received by several members with suspicion, and the suggestion was even made that the operator of the machine seemed to be "grimacing" like a ventriloquist. One Academy member who was more realistic remarked that Edison's invention, while valid, consisted of the sheet of tinfoil. In any case the use of a recording medium with an in-between degree of hardness was a successful but inefficient solution to the problem of reproduction. Charles Tainter and Chichester Bell (a cousin of Alexander G.) took out a patent in 1886 which corrected this feature and which went a long way towards making the phonograph practical. Embossing was discarded for cutting (the recording stylus was given a sharp edge), and the record was protected from damage during playback by the rounded shape of the reproducing stylus tip.

Commercial Development of the Phonograph

During the next few years recording was advanced to a point where it could be exploited commercially. At first the reproduction of sound found its main application in office dictating machines. Edison himself listed the reproduction of music only fifth in a tabulation of proposed uses, with the recording of family records and "the last words of dying persons" a close sixth. An 1892 phonograph instruction manual showed various models of industrial cylinder recorders being manufactured, differing mainly in the type of motive power used. They were driven by treadles, water motors that worked through connection to the faucet, or electric motors, both battery and line operated, as pictured in Fig. 7-7. All of these systems were later superseded by the governor controlled spring motor, which was adopted almost universally for both office and home machines until the house current motor was revived.

Record players were quite expensive, too costly for the ordinary home. Machines for entertainment were provided in coin-operated public phonographs which would play a selection into one or more stethoscope-type hearing pieces or through a horn. Records had to be

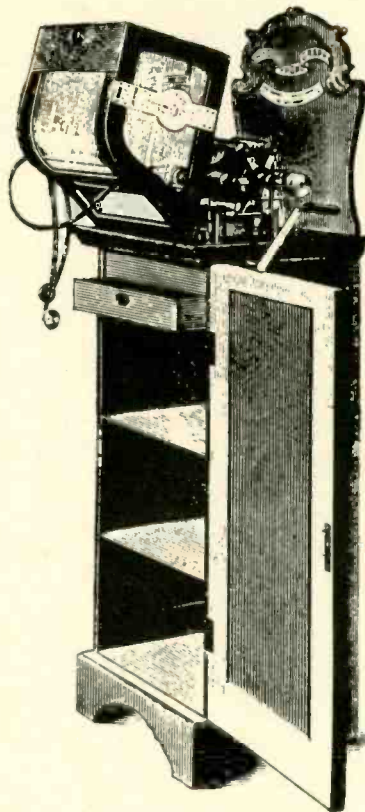

Fig. 7-8. A 1900 juke-box—the Edison "Hydra-Phonograph," a six-cylinder coin-operated player. From: *Die Modernen Sprechmaschinen*.

changed manually, but the modern record changer was foreshadowed by a repeating mechanism that brought the reproducer back to the start of the record and started the needle in the grooves automatically. A dealer trade magazine, *The Phonogram*, warned that the success of talking machines in the entertainment field was ephemeral, and might be bad for the growth of the phonograph industry. An editorial in this periodical stated, in 1891:

"There is danger of too much attention being given . . . to the 'coin-in-the-slot' device (Fig. 7-8) at the expense of the more legitimate business of the companies, of introducing the phonograph into general use among business men. The exhibition of the phonograph for amusement purposes . . . is calculated to injure the phonograph in the opinion of

these seeing it only in that form, as it has the appearance of being nothing more than a mere toy, and no one would comprehend its value or appreciate its utility. . . ."

But despite the editors of *The Phonogram*, and also despite the recriminations and patent suits and countersuits that raged among manufacturers, the phonograph emerged as a popular instrument whose main function was entertainment in the home.

Techniques for the mass production of records from a single master mold, developed by Emil Berliner (who started his researches by successfully carrying out the proposals of Cros) made records for home entertainment possible, and in addition introduced problems of standardization which had not existed when the same machine did both the recording and the reproduction. Early record buyers had to be advised, for example, to adjust the motor speed during the opening announcement until "the tones of voice seem to be in a natural key, and neither too high and shrill nor too low and heavy."

It did not take long for manufacturers to achieve mechanical excellence and reasonable cost in their record players. An Edison phonograph at the turn of the century was a nickel-plated joy to behold, well designed and rugged.² The pickup, then called a speaker, produced only a small fraction of an ounce pressure on the cylinder groove, and had a permanent sapphire needle mounted in it. (See Fig. 7-9) The quality of the reproduced sound, however, was very poor. Distortion was high, blasting occurred at those parts of the music which found sympathetic resonance in the reproducing apparatus, and frequency response—besides being very irregular—was so restricted that all fundamental tones represented by the lower half of a piano keyboard were missing, except as they could be detected by their harmonics. The absence of bass, together with the severely limited volume, gave the sound the characteristic tinny quality associated with old players.

In an effort to obtain increased sound output, many unique systems were employed. Among them there was

[Continued on page 39]

² Many are still in good playing condition.

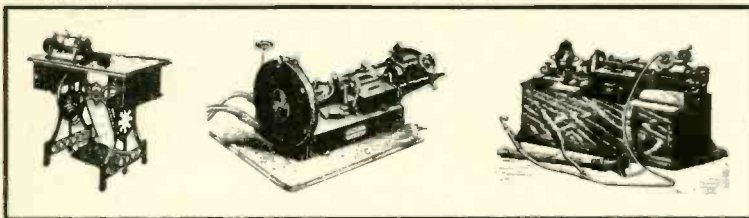

Fig. 7-7. Three commercial products of the 1890's. Left to right, the Tainter treadle Graphophone, the water-motor Edison Phonograph, and the electric Edison Phonograph, available for battery use or "wound for the incandescent current." From: *A Short History of the Talking Machine Industry*, Columbia Graphophone Company, 1913; *The Phonograph and How to Use It*, National Phonograph Company, 1900; and *Die Modernen Sprechmaschinen*, 1902.

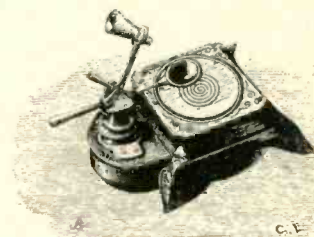

Fig. 7-6. Edison disc phonograph. From: *The Telephone, the Microphone, and the Phonograph*, 1879.

Speaker Treatment for Improved Bass

CAMERON BARRITT*

A simple method of lowering the effective low-frequency limit of inexpensive speakers, but not one that is recommended for high-quality woofers.

A DESIRABLE FREQUENCY RESPONSE characteristic for an audio reproducing system requires adequate lows as well as highs. Amplifiers are available which can handle the necessary range, but the loudspeaker is the bottleneck in the drive toward more perfect audio reproduction. The problem of rendering sufficient highs can be met by various means such as the employment of "tweeters"—some of which can go close to the upper limit of human audibility—but the low-frequency speakers or "woofers" usually fall far short of the lower limit. Sound is propagated at frequencies as low as 16 cps, and 20 cps is usually considered as being audible. LP records are capable of going down to 30 cps, by way of further example, but not many speakers go this low.

The lower limit of a properly baffled speaker is determined by the mechanical resonant frequency of the vibrating piston or cone. A certain amount of propagation occurs below this frequency but response falls off rapidly beyond. The resonant frequency of a mechanical vibrating system is determined by the mass and the compliance—the inverse of stiffness. These two are the electro-mechanical analogs of inductance and capacitance. The mechanical resonant frequency formula is $f_r = 1/2\pi\sqrt{m/C}$. The mass of a speaker cone is determined for the most part by constructional requirements for rigidity, and is not readily altered. Furthermore, if one were to increase the mass very much in order to lower the resonant frequency, phase response would suffer and poor transient response might result. For best reproduction of transients a low m/C ratio is required. On the other hand, the compliance of the speaker depends on the "give" in the cone suspension or mounting and no undesirable consequences will result from increasing its value.

* 1200 Susquehanna Ave., W. Pittston, Pa.

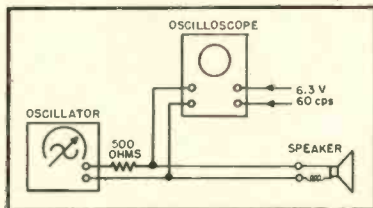

Fig. 3. Circuit arrangement used to determine resonant frequency of loudspeaker.

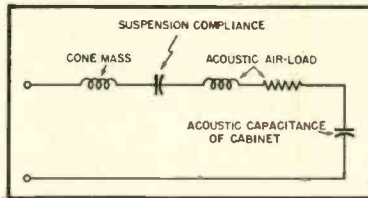

Fig. 1. Equivalent electrical circuit of a loudspeaker mounted in a baffle.

The total compliance or capacitance of the speaker system also depends on the acoustic capacitance of the air volume in the baffle if it is the totally enclosed type. The equivalent electrical circuit¹ of a loudspeaker mounted in an enclosed baffle is shown in Fig. 1. Notice that the two analogical capacitances are in series. If the baffle is made as large as possible, it will be so much larger a capacitance than the cone compliance that the limiting value will be in the suspension. The remaining reactance—the inductance representing the quadrature component of the speaker's air load—is usually small enough to be ignored (except in the case of the R-J speaker enclosure where it is exalted to make possible a smaller speaker enclosure). Consequently that

¹ Harry F. Olson, "Elements of Acoustical Engineering." McGraw-Hill.

leaves just the cone suspension compliance on which to work in improving the bass range of a speaker.

Since the baffle is of no concern, one can use the "free-space resonant frequency" of the speaker as the working criterion. Although the mass of a speaker cone can not be controlled enough to vary this frequency very much, the cone suspension can be treated to make it more compliant and this would lower the resonant frequency the same as would increasing the capacitor in an electrical "tank" circuit. There are two methods of doing this, and by utilization of both it is possible to lower the frequency response limit 30 per cent or more. A relatively inexpensive 8-inch speaker treated by this system can be made equal in bass-range capability to a good quality 12-inch speaker.

Methods of Increasing Compliance

The first method is called "slotting" by the makers of Permoflux loudspeakers. As shown in Fig. 2, the speaker is made less stiff by radial incisions in the suspension. The improvement derived from this treatment depends on the merit of the suspension design beforehand. The suspension area of some good modern speakers is extremely thin, as can be

[Continued on page 54]

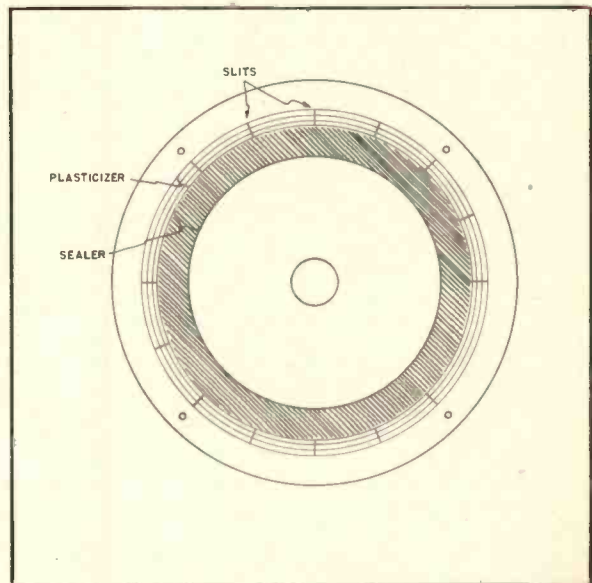

Fig. 2. Method of slotting cone, as described by the author, and location of shellac sealing ring.



AUDIO engineering society

Containing the Activities and Papers of the Society, and published monthly as a part of AUDIO ENGINEERING Magazine

OFFICERS

F. Sumner Hall President
 Jerry B. Minfer Executive Vice-Pres.
 C. J. LeBel Secretary
 W. S. Pritchard Central Vice-Pres.
 R. L. Burgess Western Vice-Pres.
 Ralph A. Schlegel Treasurer

P. O. Box 12, Old Chelsea Sta.,
 New York 11, N. Y.

Wide-Angle Dispersion of High-Frequency Sound

ABRAHAM B. COHEN*

A description of the design of a series of high-frequency horns with improved performance in the horizontal plane and a minimum of diffraction in the vertical plane.

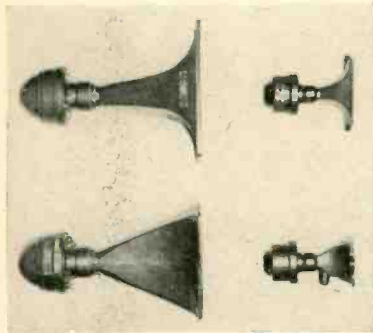

Fig. 1. Two commercial horns which employ the reverse-flare principle described.

Summary:

A high degree of wide-angle dispersion in one plane may be achieved by means of a compound horn in which the primary section allows wave expansion only into the undesired plane. This creates a pressure gradient along the horn walls defining the desired plane. The built up pressure is subsequently allowed to expand into the desired plane by reversal of the direction of flares of the horn walls. This reverse-flare device in conjunction with a square horn mouth provides wide-angle radiation free from phase cancellation and mouth diffraction effects.

AN ESSENTIAL REQUISITE of a tweeter radiator is that the high-frequency energy be distributed over a wide horizontal angle. Failure to attain such a characteristic results in off-axis loss of level of the high frequencies. How-

* University Loudspeakers, Inc., 80 S. Kensico Ave., White Plains, N. Y.

Responsibility for the contents of this paper rests upon the author, and statements contained herein are not binding upon the Audio Engineering Society.

ever, wide-angle dispersion by itself is not the optimum solution to high-frequency radiation. The following three attributes must prevail simultaneously.

- Maintenance of the sound pressure of the entire frequency range of the tweeter over the entire angular coverage desired.
- The over-all efficiency of the horn must not be sacrificed in making the horn a wide-angle radiator.
- The angular response shall be free

of irregular energy lobes as the frequency changes.

Figure 2A compares graphically these characteristics of merit for the three types of tweeter horns commonly known as the multicellular type, the pie-wedge type, and the recent University "Reverse Flare" type. The multicellular characteristic shows regions of extreme energy fluctuation. Such fluctuation dependent upon frequency and angle, is

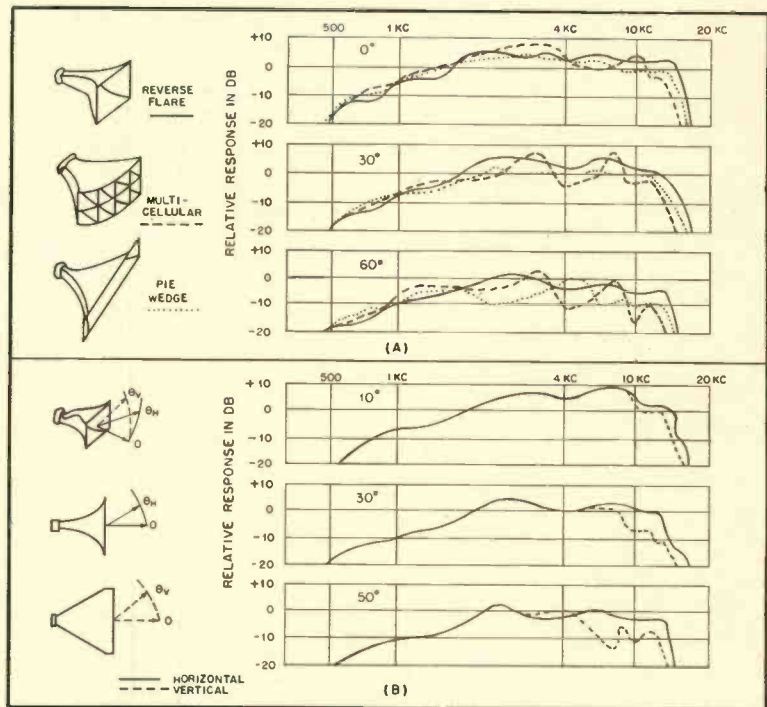

Fig. 2. (A) Comparison of performance of reverse flare, multicellular, and pie-wedge horns. (B) Relative angular response in horizontal (solid lines) vs. vertical (dotted lines) radiation in reverse-flare horn.

due to the phase cancellation of energy from the several individual sources of radiation from the multicellular mouths. Where multicellular sources are absent, as in the pie-wedge type of horn and in the reverse flare horn, there is no evidence of these phase discriminatory cancellations. However, it will be noted that the pie wedge exhibits considerable energy loss in the mid-band-pass region for increasing angle. The conventional narrow vertical dimension of the mouth of this type of horn gives rise to excess diffraction of energy into the vertical plane which is tantamount to energy loss in the horizontal plane.

Where neither multicellular nor wedge-mouth devices are used, as in the reverse flare horn, high horizontal efficiency performance is obtained, and there are no phase cancellation regions, as Fig. 2A indicates. The favorable ratio of horizontal to vertical radiation for this type of horn is illustrated in Fig. 2B.

The reverse flare horns illustrated in Fig. 1 show that this type of horn first expands rapidly in the vertical direction, and as the mouth of the horn is approached it begins to expand also in the horizontal direction. Hence the name "Reverse Flare" horn. The second feature of this horn is its square mouth configuration (in contrast to the narrow slit type). This combination of reverse flare and square mouth shape prove especially effective in giving the horn its desirable performance.

It is often stated that high frequencies project in a narrow beam, while low frequencies spread out in a wide beam. The truth of the matter is that all sound spreads out in ever widening circles regardless of frequency, provided there is no restriction or obstruction in the way. For instance, a pulsating sphere will give rise to a perfectly spherical wave front regardless of the frequency of pulsation. On the other hand, a twelve-inch cone type speaker beams the higher frequencies because of the radiation characteristics of the diaphragm shape and construction. It is the combination of radiator size, radiator configuration, and frequency which determines how loosely or how tightly a particular high-frequency sound will be dispersed. Following the same laws of physical acoustics, the horn size and shape will play an im-

portant part in the dispersion of the high-frequency energy radiated from the mouth of the horn.

Horn Pressures

All horns, including the reverse flare type, are pressure controlling devices. At the throat of the horn (the narrow end), the sound pressure is the greatest, while at the mouth of the horn (the wide open end), the sound pressure is the least. At any point along the axis of the horn between the mouth and the throat, the sound pressure is of some intermediate value. The actual manner in which the sound pressure throughout the horn varies depends upon the rate of growth of the area of cross-section of the horn. This cross-sectional growth is determined by the law under which the particular horn expands.

One of the most efficient of horn expansions is the exponential type. This horn is remarkably efficient as an impedance matching device between the source of sound at the throat of the horn and the atmosphere into which the mouth of the horn radiates. Its cross-sectional area expands according to the "natural law of growth," expressed by

$$\frac{A_2}{A_1} = e^{0.000366 f_{co} x}$$

where f_{co} = the designated cut-off frequency of the horn in cycles per second

x = the distance in centimeters between two points within the horn and along the horn axis

A_2, A_1 = the areas of cross-section of the horn at the two designated points along the axis

e = base of natural logarithms, 2.71828.

By choosing the cut-off frequency f_{co} desired, the physical expansion of the horn may be laid out. From this equation it is seen that for a given distance x between two points, and for low values of cut-off f_{co} , the exponential factor $e f_{co}$ is smaller than for large values of cut-off frequencies. Consequently, the ratios of areas at these points along the axis are smaller for low-cut-off horns than for high-cut-off horns. This means

that the horn designed for low cut-off expands slowly, while the horn designed for high cut-off expands rapidly.

This provides a means of determining in what geometric manner the sound pressures within the horn are distributed. For instance, in a horn with a high cut-off frequency which will necessarily expand and flare out quickly, the fast flaring walls of the horn allow the wave front to spread out rapidly in a direction transverse to the axis. Consequently, the total pressure of the wave front will be distributed quickly over the enlarged area between the fast flaring walls. This will result in a rapidly diminishing pressure per square unit of the wave front surface. On the other hand, in a horn with a low cut-off frequency where the walls expand slowly, the wave front development in a direction transverse to the axis will be restricted. Accordingly, the per unit area pressure distribution on the wave-front surface will diminish slowly. Thus a knowledge of the cut-off frequency of the horn will determine the

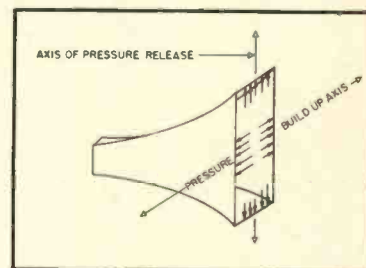

Fig. 4. Internal horn pressure configuration. The flaring upper and lower walls allow wave-front expansion which reduces the pressure on these walls. The non-flaring vertical walls restrict wave expansion causing build up of pressure against these walls.

fashion in which the sound pressures in the horn are geometrically controlled.

Sound Radiation

To perform useful acoustic work, these internal sound pressures must eventually emerge from the horn into space. In making this transition, the sound pressures cross the mouth of the horn, which is its threshold into space. The mouth of the horn then becomes in essence the *sound radiator* for the energy reaching it with a particular pressure variation dependent upon the horn flare. Thus the size and configuration of the horn mouth, the horn flare, and the frequency involved will determine the degree of wave-front dispersion. Standard functional analysis of exponential horns shows that in this combination of factors, fast flare means wide-angle dispersion for highs, and large mouth means narrow-angle dispersion for lows (provided the mouth diameter is at least one third the wave length of the sound being radiated).

In the practical application of these guiding factors of horn design, the reverse-flare horn finds it possible to strike a unique balance between horn flare and mouth size. In brief, this is accomplished as follows. By first restricting wave expansion in one plane

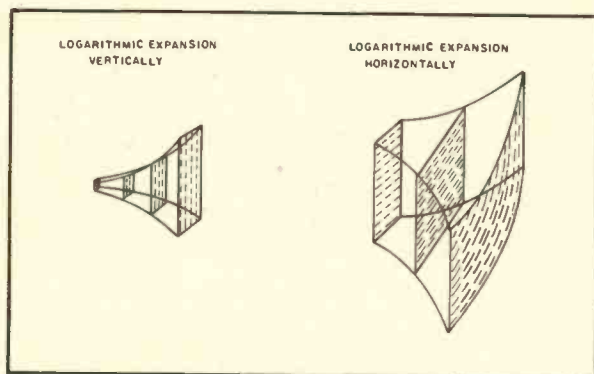

Fig. 3. Cross-sectional area development of reverse-flare horn. One area progresses from the preceding area according to the exponential expansion for a given cut-off frequency.

The 1952 Audio Fair in Review

A return in retrospect to the greatest audio show of all. Until next year, that is.

HARRIE K. RICHARDSON

IF YOURS WAS NOT the good fortune to attend the 1952 Audio Fair, you missed witnessing the culmination of the maturing process which has transformed the audio industry from a loosely-bound package of diverse interests into a monolithic mass which welds together in common objective many of the basic arts and sciences.

Of course, this is but another way of saying that audio has grown up—a thought we have been hearing for years on end. And we don't question the correctness of its expression in the past. On the other hand, we feel that the time has come to broaden its meaning—to give it the absolute quantity which prevails when an industry achieves the stability that comes with self-sufficiency.

Impressive proof that the audio industry has reached this stage was displayed in abundance at the 1952 Fair. Even the most casual analysis of visitors verified the belief that today's audio fan is far removed from the pattering individual whose chief satisfaction—whether in audio or anything else—lies in putting things together and taking them apart again. In the space of but a single year the character of the audio fan has undergone the transformation which the industry itself is now reflecting. Simply speaking, audio manufacturers today are serving individuals who are interested in audio chiefly because of its ability to add to the richness of their existence, and who care little, if at all, about audio because of its technical enchantment.

It is for these reasons that we believe audio has at last achieved maturity in the fullest meaning of the word.

Among the 13,000 visitors who attended the 1952 function were hundreds of prominent persons, including the distinguished Dr. E. H. Armstrong, inventor of FM broadcasting, whose presence lent both dignity and authority to the Fair as the accepted meeting place of the audio industry.

Following is this reporter's annual effort to convince you that, until you've thrilled to an Audio Fair, you just ain't been around.

Success on a national scale was clearly evident in the impressive display of Philadelphia's **Aero Products Company**. In addition to the now-famous **Aerosound** output transformers which were first introduced at the 1951 Fair, there were shown many new devices with which the company is making its bid as a leading manufacturer of audio components.

Packaged sound systems in highly original casework, together with an excellent switching system for A-B testing, made the exhibit of **Allied Sound Corporation**, New York, both inviting and satisfying. In both respects it reflected the firm's lavish new sound studios in midtown Manhattan. Newest of the

country's major distributors of fine audio equipment, **Allied Sound** has gone all out in providing music lovers and audio fans with the industry's most pretentious demonstration facilities.

As in previous years, **Alpha Wire Corporation** graced the Fair with an informative showing of wire and cable for practically every conceivable audio application. The importance audio is assuming in the general field of electronics is well exemplified by the annual participation of **Alpha**—major supplier to the entire electronics industry—in the Fair.

The title of **Altec Lansing Corporation's** exhibit might well have been "The Three Sixes", judging from the tremendous

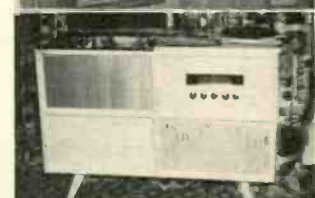
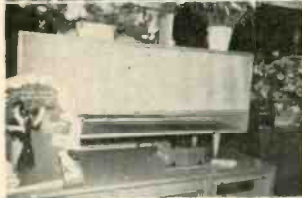

Counterclockwise—Hal Blumenstein with Mrs. and Dave Haffler of Acro-Allied Sound Corp.—Altec Lansing Corp.—Ampex Electric Corp.—Amplifier Corp. of America—Dave Sarser and sister Sebe for Audak Company—Audio Center of Arrow Electronics—Audio Devices—Alpha Wire—Berlant Associates—H. A. Hartley with H-T speaker—Cook Labs and Bozak Speakers—Bohn Music Systems—David Bogen Company—Bell Sound Systems, Inc.—T. Robinson-Cox of Beam Instruments—Audio-Video Products' Instrumentation Exhibit—C. J. LeBel and L. S. Goodfriend of Audio Instrument Co. Inc.—Audio Exchange teamed with Jeff Markell Associates with touch of humor, and the much needed aspirin.



interest shown in the company's new 601A, 602A, and 604C coaxial speakers. Still another six might enter the picture if we afforded due attention to the 600A corner speaker enclosure. Although other Altec products—including the famous 21B microphone and Peerless transformers—were displayed, The Three Sixes won the battle for attention hands down. This was the first public showing of the new Altec speakers in the East.

The growing interest of music lovers in professional tape recorders for home use was evidenced in the Ampex Electric Company display of the famous Ampex Type 400 recorder housed in a handsomely finished mahogany cabinet. Also shown were the latest Ampex models for broadcast stations and recording studios, including the new stereophonic portable.

Interest in the Amplifier Corporation of America exhibit was easily captured by the new Electro-Magnemite tape recorder. Weighing only 12 lbs. and moderately priced, the Magnemite offers every feature of the most expensive disc-type office dictating machine. Available also are such useful accessories as remote-control microphone, typewriter control box, and voice-actuated starting mechanism. From where this observer sits, it appears that the Electro-Magnemite may well pace the field in the switch from disc to tape for office dictation.

Eloquent proof that audio fans are susceptible to life's more earthy aspects was found in the exhibit of New York's Arrow Electronics' Audio Center. Surrounded by a representative display of equipment was a large jig-saw puzzle with one piece missing. Several hundred odd pieces were placed in a box immediately below the puzzle, and visitors were permitted to select a piece at random in the hope that it would fit the open space. Those who succeeded were given a trade certificate good for merchandise in the Arrow sound room. Thousands of participants proved the success of the puzzle gimmick in bringing the name Arrow to their attention.

If we had to name a single most popular display at the Fair, it is a certainty that The Audak Company exhibit would be the probable choice for top honors. Maximilian Well, Audak president, long known for his virtuosity in the field of pickup design, gave graphic evidence that his reputation as a capable showman is equally well deserved. Two noted musicians—David Sarsar, violinist with the NBC Symphony and co-designer of the famous Musicians Amplifier, together with his lovely sister Sebe, enlisted with the City Center Opera Company—gave half-hourly performances in the Audak exhibit, demonstrating the fidelity of the new Audak Chromatic reproducer. Prior to the Fair, Dave and Sebe made a series of recordings; the demonstration consisted of playing these recordings, with the

live performers taking over at unannounced intervals. So excellent was the reproduction that any distinction between the two was largely a matter of guesswork. Adding to the demonstration's dramatic proportions was the fact that both musical instruments employed were Stradivari, valued at well over a hundred thousand dollars. Strictly big time.

As might be expected, Audio Devices, Inc., provided one of the Fair's more interesting showings of recording materials. Bryce Haynes, ad manager, and Bob Browne, who handles the A-D account for Rickard & Company, advertising agency, were on hand to receive their annual congratulations from prominent industry figures for publication of another fine directory of tape recorders in "The Audio Record." Herewith we tender our own thoughts of appreciation for a job well done—one which is of distinct value to the audio industry.

Living evidence that audio fans are not without a sense of humor was offered by The Audio Exchange, Jamaica, N. Y., with a prominently displayed sign bearing the message, "Another Audio Exchange Service—FREE ASPIRIN." Sharing this suite with The Audio Exchange was Jeff Markell Associates, New York, who presented an unusual showing of custom cabinetry. There was no exhibit more satisfying to the true music lover—the person who thinks of audio as an adjunct to his living room which is both functional and decorative.

Precision audio equipment for specialized professional usage was the keynote of the Audio Instrument Company exhibit. Design and development engineers landed here as a sort of unofficial headquarters. On hand to explain and demonstrate the phenomenal instruments shown was the "dean" of the audio industry, C. J. LeBel, company president, founder and secretary of the AES, and vice-president of Audio Devices, Inc.

Entry of Ampex into the field of multidimensional sound reproduction held the spotlight in the exhibit of Audio & Video Products Corporation, New York. Superb program material and excellent switching facilities permitted listeners to A-B high-quality single-track recordings with Ampex's new "Stereophonic Sound." Interesting to note, incidentally, the tremendous growth of Audio & Video Products since last year's Audio Fair. In addition to operating one of the country's most complete recording studios, recording and distributing pre-recorded tape through its subsidiary A-V Tape Libraries, Inc., Audio and Video has formed an Instrumentation Division and a Commercial Products Division, both of which are among the nation's leading purveyors of audio equipment to industry.

This was the second appearance at the Audio Fair of two British products—Acoustical Q.U.A.D. amplifiers and Tannoy dual-con-



Counterclockwise—Æ featured by British Industries Corp.—The Carduners of British Industries, Leonard and Gene—Æ's Sandy Cahn with Vic Brociner—Brook Electronics—Browning Laboratories—Cook Laboratories' binaural disc played with special Livingston arm—Cinema Engineering Co.—Collins Audio Products' kits and tuner—Lucite enclosure shown by Jensen—Kelton speaker—C. G. Barker of Magnecord with new synchronizing device—General Electric Co. with diamond styli—Mrs. and Mr. E. J. Cately, Jr. with new corner speaker—Jim Parks of Fisher Radio Corp.—over-size Fairchild dynamic pickup—Electronic Workshop's small new speaker enclosure—Electro-Voice's display well populated, Willard Wilson of Wilmington (Del.) Electrical Specialty Co. in foreground—Daven prexy Louis Newman—Danby Radio Corp. speaker enclosures.



centric loudspeakers. Shown under the auspices of **Beam Instruments Corporation**, New York, both units were demonstrated in conjunction with the very American Weathers capacitance pickup. An altogether impressive example of really fine audio quality.



Excellently portrayed in the exhibit of **Bell Sound Systems, Inc.**, were the many forward steps the company is taking to make high-quality audio equipment available to homes of modest income. More than average attention was accorded the new Bell amplifier Model 2200—a truly remarkable combination of superb performance and moderate price. Also the target of great approval was the improved Bell tape recorder.



Represented by its able and gracious president Emanuel (Bert) Berlant, **Berlant Associates, Inc.**, repeated its success of former years with one of the Fair's more interesting and complete displays of **Concertone** tape recorders for both home and industry. The rapid growth of interest in the tape recorder as an integral component in home music systems was clearly reflected in the enthusiasm of many company executives, Mr. Berlant being no exception.



The Fair offered no better example of aggressiveness and expansion in the audio field than that shown by **David Bogen Company, Inc.** Within the past year Bogen has added a new FM-AM tuner, several new high-quality amplifiers, and a remarkable wireless intercom system to the line of equipment it manufactures. All of these items helped to make the Bogen exhibit completely satisfying.



Custom-built music systems with a capital C were shown in the display of **Bohn Music Systems Company, N. Y.** Taking part in the Fair this year for the first time, Bohn, on the strength of its striking display, may well be expected to achieve a position of leadership in the field of custom building.



Combined in bringing binaural disc recording to the audio public for the first time were **Cook Laboratories** and **R. T. Bozak & Company**. Surprising indeed was the fact that the records and equipment shown were commercial entities in every respect—not laboratory models as might have been expected—and are already available as stock items from a number of progressive jobbers. The recordings were made by Cook and are designated as binaural editions of the firm's **Sounds-of-Our-Times** series. In the Bozak-Cook exhibit reproducing equipment included two Bozak multi-unit speakers, and a dual-pickup tone arm made by Livingston.



Commendation is due **British Industries Corporation** for the excellent taste which prevailed in an effective showing of Garrard record changers. Leak high-quality amplifiers, Wharfedale speak-

ers, and R-J speaker enclosures. This was an exhibit strictly for the music lover, with demonstration records carefully chosen for their esthetic value as well as for their technical characteristics. Although strictly an American company, **B. I. C.** until recently confined its activity to the distribution of English-made products. Not long ago, however, through a subsidiary it began distributing the American-manufactured R-J speaker enclosure.



High fidelity without compromise was demonstrated by **Brociner Electronics Laboratory**. Introduced was the new Brociner Model 4 corner horn and the A100 preamplifier-equalizer. It is the contention of Victor Brociner, company president, that a loudness control per se is not the answer to the need for complete compensation in an amplifier—that the control itself must be adjustable if complete compensation is to be achieved. It naturally follows that the preamp made under the Brociner name includes such a feature.



If, by any chance, you've been wondering just how many equalizing positions a preamplifier should have in order to compensate for all of today's commercial recordings, you may find the answer in the new Brociner Model 4. Shown for the first time publicly in the exhibit of **Brook Electronics, Inc.**, this handsome-appearing unit came in for a far higher-than-average percentage of oohs and ahs from Fair visitors. The presence of charming Ann Hall, Brook sales executive, lent an air of urban gentility to the Brook display which was well in keeping with the superior quality of the equipment shown.



Tuners, tuners, and tuners—including the new Model RV-31—provided the principal interest in the display of **Browning Laboratories, Inc.** This newest Browning model offers an exceedingly high standard of performance, yet is designed for installation in cabinets where limited space is available. Present and accounted for was the Browning high-quality audio amplifier, but without question the tuners captured the show.



Recording engineers whose only criterion is perfection found a rewarding experience in their visit to the exhibit of **Frank L. Capps & Co.** In addition to the precision recording equipment for which the Capps organization is renowned, there was introduced a new condenser microphone which may well blaze a trail toward general improvement in commercial recording.



Strictly professional audio equipment—ranging from complete amplifiers to wire-wound precision resistors—was shown by **Cinema Engineering Company**. Clearly shown was the fact that Cinema has attained a position of enviable leadership in the supply of precision devices to recording studios, broadcast networks, and manufacturers.

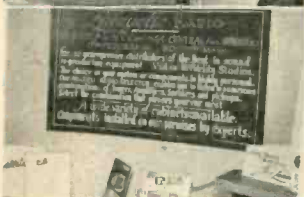

Counterclockwise—Gray Research's pickup arms—Edward Gray of Grayline with Phono-Gard—Harrison Radio Corp.—Harney Radio Co. Inc.—Hudson Radio & Electronics Corp.—Karlson speakers—Klipsch with large photo of typical living-room installation—Lafayette Radio, of New York—new McIntosh corner speaker—Pilot, new hit with tuners—Revere tape recorder—Peerless transformer display—Newcomb amplifiers—Music Masters' displaying record making facilities—Mark Simpson Mfg. Co.'s C. Leonard Werner with latest product—peace at last, in Measurement Corp.'s exhibit—Leonard Radio, of N. Y.—Jim Lansing speakers—happy Langevin Mfg. Corp. salesmen.

ONLY THE
Collaro
 INTERMIX 3/522
 HAS ALL THESE
HIGH FIDELITY
 FEATURES:

- Intermixes 10 and 12 Inch Records at All Speeds.
- Steady, Constant Speeds — No Rumble or Wow.
- Weighted, Rubber-matted, Rim-driven Turntable.
- Four Pole Motor with Self-aligning Oilite Bearings.
- No Hum Pickup.
- Molded Rubber Drives—No Belts to Slip or Replace.
- Stylus Pressure Adjustment — Tracks at as little as 3 grams.
- Absolutely Jam-proof Operation.
- Automatic Muting Switch.
- Ball-bearing Mounted Turntable and Tone Arm.
- Automatic Shut-off after Last Record.
- Tone Arm Clamp for Portable Applications.

Base Dimensions: 14 3/4" x 12 1/4"
 Depth Below Base: 2 1/2"

LIST PRICE \$65.00

Audio engineers and audio enthusiasts all agree that the quality of any sound reproducing system is the sum total of all of its components units. One weak link in the chain dooms the entire system to mediocrity.

In a record reproducing system, the record changer is the first consideration. If high fidelity is to be attained, the record changer should be the finest obtainable.

Consider the COLLARO. The COLLARO Intermix 3/522 was planned for perfection, and was engineered to the most exacting quality standards. It is truly the high fidelity record changer, and the perfect complement to any high fidelity system.

Complete service and replacement facilities maintained for your convenience.



Model 3/522
Collaro
Fully Automatic INTERMIX
3-SPEED
RECORD CHANGER
 FOR 7, 10, AND 12 INCH RECORDS

Model 3/521 Fully Automatic
 Non-Intermix Model
 LIST PRICE \$54.50

● The High Fidelity Record Changer
 for High Fidelity Record Reproduction

At your Distributor or Write for Details:

ROCKBAR CORPORATION
 211 EAST 37th STREET, NEW YORK 16, N. Y.



Tuner kits which afford remarkable performance, yet are priced surprisingly low, were featured in the display of **Collins Audio Products Company**. Formerly a manufacturer of high-priced tuners, Collins has been a leader in bringing custom quality within range of the modest budget.



Philadelphia's **Danby Radio Corporation** diversified its display to include custom-built components as well as complete music systems. Emphasized was the company's ability to perform with equal agility in the design of high-quality amplifiers and fine cabinetry.

The **Daven Company** presented an impressive display of precision devices ranging from audio attenuators to wire-wound resistors. Clearly evident was the fact that Daven is maintaining without blemish its leadership in the field of precision equipment.



If the Fair offered an award to the exhibitor displaying the greatest number of individual products, **Electro-Voice, Inc.** would win hands down. A single quotation from the official Fair directory, in which is listed the products shown by various manufacturers, indicates the completeness with which E-V is blanketing those phases of the audio industry in which it competes—"low, mid, high, and super-high frequency drivers." Evidence of the company's stature in the loudspeaker field may be found in the fact that E-V speakers were chosen for reproducing the binaural program from WQXR and reproduced at the Society's annual banquet. Items seen in the E-V display ranged from tiny pickups to the massive Patriotic four-way speaker system.



Completely packaged sound systems comprised the display of **Electronic Workshop Sales Corporation**, New York. Center of attention was the unique assembly first described in the article titled "On a Budget" in the May, 1952 issue of *AE*. Striking cabinet design made the E-W exhibit one of the Fair's more intriguing.



Even a casual description of the equipment shown by **Fairchild Recording Equipment Corporation** would occupy far more space than this review affords. Principal interest of music lovers was concentrated in the new 215 Series high-compliance pickup cartridge. Bordering on the fantastic was the Fairchild-developed device for lip-synching magnetic tape with silent film for TV broadcasts. A bit more realistic was the standard Fairchild tape recorder which sells for somewhere around twenty-seven hundred dollars. Realistic?—did we say. Yikes!



Avery Fisher, president, **Fisher Radio Corporation**, took a well-deserved bow for the new Fisher 40-watt all-triode amplifier and preamp-control unit. Shown in conjunction with the Concertone tape recorder, for which Fisher is exclusive Eastern distributor, the



new amplifier assembly was deeply impressive.

The Super Horn, a new patented corner speaker enclosure, was the center of interest in the exhibit of **Gately Development Laboratory**, Clifton Heights, Penn. Many and favorable were the comments regarding its performance.

First of the major manufacturers to enter the high-fidelity field, **General Electric Company** gave monolithic evidence of its intention to retain a position of leadership. Introduced as a companion item to the well-known GE variable-reluctance pickup was a new phono equalizer. Tom Nicholson, GE sales executive, assured this observer that the company will make an announcement of major importance to audio enthusiasts ere the passing of many moons.

You can always count on **Gray Research and Development Company** for equipment displays which are both entertaining and informative. Although Gray is highly involved these days in the production of various gadgets for use in TV broadcasting, evidence that the company's first love is not forgotten was shown by an impressive exhibit of tone arms and equalizers.

Making its initial Audio Fair appearance, **Grayline Engineering Company**, Chicago, introduced a record demonstrator which is certain to capture the attention of music dealers everywhere. Surprisingly compact (it's about the size of a portable phonograph), the Phono-Gard record player is virtually automatic in that it does not require manual placement of the tone arm on the record to be demonstrated. This, together with other automatic features, practically removes the element of damage to records.

Any doubt prevailing in the minds of Fair visitors concerning the truthfulness of the slogan "Harrison Has It", was dispelled beyond question by the display of the slogan's originator, **Harrison Radio Corporation**, New York. An interesting display of the equipment of practically all leading manufacturers.

In his second Audio Fair appearance, **H. A. Hartley Co., Ltd.**, London, England, duplicated the success with which he first greeted his American friends last year. In his own words, Mr. Hartley's display contained "speakers, speaker housings, amplifiers, pickups, motors, record-changers, and all kinds of cabinet components, of a quality beyond criticism to please and permanently satisfy every man who is beginning to think that the quest for realism in reproduction is a will-o-the-wisp forever leading him into extravagances of price and bulk."

Harvey Radio Company, Inc., New York, introduced for the first time publicly two recording instruments which, unquestionably, will blaze a trail of success in



Counterclockwise—Pentron recorders draw interest—Permoflux binaural exhibit always crowded—new Pickering turnover cartridge—Grommes amplifier of Precision Electronics—Presto Recording Corp.—Jules Bressler beaming over Radio Craftsmen preamp—Rangertone studio recorder—Reeves Soundcraft tape in handy 5-drawer boxes—Stromberg-Carlson shows exquisite cabinetry—W. L. Brooks, tapeMaster chief Engineer, with lab model of new hi-fi recorder—Sonocraft covers the field—Sun Radio stresses balanced systems—Stephens Mfg. Corp. shows speaker cabinets, with Stephens speakers installed—G & H Wood Products teamed with Electronic Workshop to create Sound Workshop—Soundcrafters, Manhattan dealer—H. H. Scott—Collaro record changer being shown by Jack Willson—River Edge Industries cabinets—Rek-O-Kut line of disc equipment.



"This new 'Scotch' Brand 7-inch professional reel cuts machine maintenance costs!"

Extra-large hub gives new "Scotch" Brand reel exclusive advantages

- ✓ **LOWER ROTATIONAL SPEED** produced by new larger hub means less vibration, decreased machine wear. Recording equipment stays on the job longer with fewer stops for repairs and adjustments. The new 2 3/4" hub gives this 7" reel approximately the same ratio of outside diameter to hub diameter as the standard NARTB 10 1/2" metal reel. Rewind speed is actually 10% faster than the ordinary 7" reel despite the slower rotating speed.
- ✓ **CUTS TIMING ERRORS 50%!** By reducing tension changes as tape is spooled off, this new reel reduces timing errors to a minimum.
- ✓ **REDUCES PITCH CHANGES!** Using this new reel, you can splice recordings of long musical programs with far greater stability of pitch.

SEE YOUR DISTRIBUTOR FOR A SUPPLY OF "SCOTCH" BRAND 7" PROFESSIONAL REELS AND NEW DRY LUBRICATED TAPE!

The term "SCOTCH" and the plaid design are registered trademarks for Sound Recording Tape made in U.S.A. by MINNESOTA MINING & MFG. CO., St. Paul 6, Minn.—also makers of "Scotch" Brand Pressure-sensitive Tapes, "Underseal" Rubberized Coating, "Scotchlite" Reflective Sheeting, "Safety-Walk" Non-slip Surfacing, "3M" Abrasives, "3M" Adhesives. General Export: 122 E. 42nd St., New York 17, N. Y. In Canada: London, Ont., Can.



Tape on new reel is improved 4 ways!

- 1 "DRY LUBRICATING"** process gives you a tape that practically eliminates sticking, squealing and cupping . . . a completely dependable tape that turns in a flawless performance in extremes of heat and humidity.
- 2 100% SPLICE-FREE!** Tape supplied on the new "Scotch" Brand 7" professional reel is guaranteed to be completely free of splices.
- 3 THINNER CONSTRUCTION** allows a full 1200 feet of tape to be wound on the new reel despite its larger hub. Magnetic properties of this new tape are identical with "Scotch" Brand #111-A, the industry's standard of quality.
- 4 GUARANTEED UNIFORMITY!** Output variation of tape wound on the new reel is guaranteed to be less than plus or minus 1/4 db at 1000 cps within the reel, and less than plus or minus 1/2 db from reel to reel.

REG. U. S. PAT. OFF.
SCOTCH
 BRAND
MAGNETIC
TAPE

their respective fields. One, a miniature wire recorder known as the Minifon, is no larger than an average novel, is battery-operated, and permits up to 2½ hours of uninterrupted recording. The other, a portable tape recorder known as the Cub-Corder, also is battery-operated, resembles a small brief case in appearance, and opens an entirely new field of informal interview to broadcast reporters thanks to its portability. Widespread publicity

accorded both of these instruments by the daily press made the Harvey exhibit one of the Fair's focal points.

The Fair offered no better display of the equipment of all leading manufacturers than that afforded by Hudson Radio & Television Corporation, New York. Only one year ago Hudson was battling to overcome the handicap of a change of company name. So thoroughly has the battle been won that it's a safe bet that you can't recall the firm's former monicker.

Magnificent is the only word which will describe with adequacy the performance of the new Jensen Triplex speaker system, shown to a Fair audience for the first time by Jensen Manufacturing Company. Naturally, other Jensen speakers were on display, but it must be admitted that the Triplex stole the show.

Three speaker enclosures, lined up side-by-side, and set up for A-B testing, permitted visitors to see for themselves that the new Karlson cabinet is not critical as to the driver with which it is used. Containing an Altec 601A, an Altec 602A, and a Jensen G-610, the three enclosures shown by Karlson Associates, Brooklyn, are the first to strike the market with a gun-proof Formica finish.

Good performance from a speaker enclosure of small dimensions was demonstrated by The Kelton Company, Cambridge, Mass. Internal constructional features gave the impression that the Kelton enclosure was built in keeping with the so-called M. I. T. speaker, designed by professors Baruch and Lang, although it did not require corner installation for optimum performance.

Sharing honors with the fabulous Klipsch speaker system was its inventor, Paul Klipsch, in the exhibit of Klipsch Eastern, Inc. In one of his infrequent visits to the East, Klipsch, who prefers Ilope, Arkansas, to the big city, satisfied many visitors with a truly authentic explanation of how and why the Klipsch system through the years remains the standard of comparison with thousands of audio connoisseurs.

Lafayette Radio, Inc., demonstrated graphically the reasons for its longevity as one of the industry's oldest mail-order houses. Displayed was the equipment of practically all leading manufacturers. Attendants were quick and able to explain why Lafayette offers ready delivery to mail order buyers, as well as to customers who visit any one of the company's three stores in Newark, Boston, or New York.

Long known in the audio industry, the name Langevin once more is achieving the eminence which it relinquished several years ago. Evidence to this effect was graphically afforded by the impressive exhibit of Langevin

Manufacturing Company. Devoted largely to plug-in preamplifiers, power amplifiers, power supplies, and transformers for a wide variety of professional applications, the display clearly brought home the company's great accomplishments under its competent president, Donald Morgan.

James B. Lansing Sound, Inc., introduced a new runner in the perpetual race for the title of "best" of loudspeaker systems. It is the new Model D-31050, a massive corner system which is truly remarkable in its ability to deliver superb audio performance. Shown also were the various Lansing driver units—from the 15-in. D-130A woofer to the 175-DLH tweeter-lens assembly—which have secured for Jim Lansing a position of leadership in the speaker field.

The Fair offered no more complete display of the audio equipment of all leading manufacturers than that afforded by New York's Leonard Radio, Inc. Featured was a showing of the new Tape-Sonic tape recorder, which Leonard first announced publicly through its advertisements in *AE*.

Newsworthy indeed was the exhibit of Magnecord, Inc., not alone for its showing of fine tape recording equipment, but for the public introduction of MaVoTape, a new full-range pre-recorded tape library. Tape recordings under the trade name "Magnecordings by Vox" are now available in both single- and dual-track at 7½ ins./sec. recording speed. MaVoTape, Inc., producer and distributor of the new tape library, is owned jointly by Magnecord and Vox productions.

Something new was added to this year's showing of McIntosh Engineering Laboratory. In addition to the world-renowned McIntosh amplifier there was displayed for the first time the new McIntosh speaker. A corner enclosure, the new McIntosh development may well be expected to diversify the leadership which is maintained by the name McIntosh in the audio industry.

Under a colorful sign which bore the intriguing invitation, "Rest Your Ears—Silence is Golden", Measurements Corporation, Inc., built a display of test equipment which gave liberal attestation to the company's worldwide reputation. Presided over by genial Jerry Minter, Measurements Corp's chief engineer, this exhibit was one of the Fair's high spots for designers of precision audio equipment.

Emphasized in the exhibit of Mark Simpson Manufacturing Company was the new Masco Concert Master 20-watt remote-control amplifier. First described publicly in last month's issue of *AE*, the Concert Master, although moderate in price, is superb in the quality of its performance. Sharing honors with the new am-

plifier were improved models in the Masco line of moderately-priced tape recorders.

No exhibitor showed greater signs of company expansion since last year's Fair than did Music Masters, Inc., New York. In 1951—a modest display centered largely around LP recordings; in 1952—one of the Fair's more interesting displays of everything from pickups to amplifiers. More than normal attention was accorded the firm's dubbing service—an economical means of preserving rare recordings on acetate discs.

Thankful to the West were Fair visitors for giving them the fascinating display of fine audio equipment shown by Hollywood's Newcomb Audio Products Company. A broadened line of high-quality amplifiers and portable public address equipment, plus improved distribution among leading dealers, has established Newcomb as one of the nation's leading manufacturers engaged in producing top-flight audio equipment.

An accessory stole the show in the exhibit of Permotone Corporation. Many prospective buyers of tape recorders for home use were heard to decide that the recorder to buy was the one which permitted the use of 10-in. professional reels, just in case they might enter the advanced stages of their hobby. And, it goes without saying, that the standard Permotone tape recorder, when fitted with the Model X-302 Adapter Kit, is the only unit in its price range which will handle the big spools.

Despite the excellence of Permotone speakers and enclosures, the Permotone Corporation exhibit was dominated this year as it was last year by the magnificent tonal reproduction of the company's high-fidelity dynamic headphones. A solid testimonial to the high quality of these phones lay in the fact that, with one exception, wherever binaural equipment was demonstrated, they were chosen to provide listeners with the full dynamic impact afforded by multi-dimensional sound. Speaking informally and personally, those phones are really something.

No question about Pickering and Company presenting one of the Fair's high spots—introduction of the new Model 260 turn-over-type diamond-styl cartridge. High-fidelity enthusiasts have long awaited a cartridge of this type from Pickering, and are certain to welcome it with thousands of encouraging orders. Pickering, also to his many friends who visited the Pickering exhibit was the presence of gentle and competent Norman Pickering, company founder and prominent audio pioneer.

[Continued on page 60]

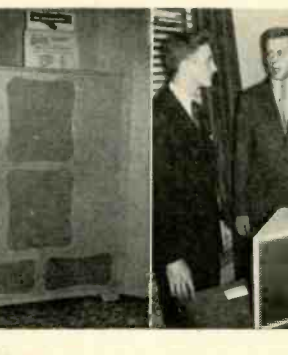

Down and across—Fred Cunow with Telefunken microphone—two-motored Thorens changer, plays top and bottom—Tung-Sol tubes make new friends—V-P Sam Baraf of United Transformer Co.—attractive display of V-M record changers—Waveforms, Inc. display always crowded—Webster-Chicago with disassembled Web-Cor changer—Terminal Radio Corp. spotlighted Tapak portable tape recorder—University Loudspeakers Inc. in new cabinet—Ultrasonics' 2½ cu. ft. corner speaker—Paul Weathers with his capacitance pickup.

HARVEY First with Audio's Finest! . . . as shown at the Audio Fair!

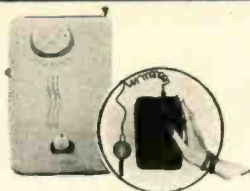

The NEW MINIFON Miniature, Portable WIRE RECORDER

Measuring only 1 3/8 x 4 3/4 x 6 1/2, and weighing only 2 lbs. 7 ozs., the Minifon is just about the world's smallest sound recording instrument. Records, rewinds, erases, and plays back through either a pair of stethoscope type earphones or an external amplifier. Capacity 2 1/2 hours uninterrupted recording. Powered by 1 1/2 v. A battery, standard 30 v. B battery, and 7 Mallory RM-4Z mercury batteries. An ideal tool for executives, engineers, doctors, and wherever there is need for recording notes, interviews, and other data.

Complete with microphone, stethoscope type earphones, 1 hour spool of wire, tubes, batteries, and instructions. **\$250**

Morocco Leather Zipper Case **\$7.50**
Transformer-rectifier Unit for operation of motor from 117 v. AC line **\$20.00**

RECORDING WIRE On spools, in dust-proof plastic containers, suitable for mailing.
1/4 hour **\$5.00** 1 hour **\$9.00**
1/2 hour **7.00** 2 hour **17.00**
2 1/2 hour **21.50**

The NEW CUB CORDER Portable TAPE RECORDER



Weighs only 12 lbs. 14 ozs., and no larger than a portable typewriter. Completely battery-powered, and performs all functions of a professional unit. Dynamic microphone "doubles" as earphone for playback. Has output for external amplifier. Two 2-speed models available: 3 3/4" and 7 1/2"/sec. or 1 3/4" and 3 3/4"/sec., in either single or dual track.

Complete with microphone/earphone, 5" reel of tape, rechargeable wet cell, 67 1/2 v. B battery, take-up reel, tubes, and instructions. **\$295**

HARVEY is FIRST to Sponsor a Series of **BINAURAL BROADCASTS** utilizing the combined facilities of Radio Stations WQXR-AM and WQXR-FM. Consult your local papers for time.

ACROSOUND OUTPUT TRANSFORMERS

Carefully engineered for high fidelity amplifiers. The Model TO-290 is for Williamson type circuits, the Model TO-300 for the Ultra-Linear and the Ultra-Linear-Modified Williamson, and the Model TO-310, for the Ultra-Linear 6V6. Other models available for immediate delivery.

TO-290 **\$15.75** TO-300 **\$24.75**
TO-310 **\$18.75**

HARVEY is the HOUSE of AUDIO

Whatever it is in the field of Audio, you can be sure to find it at Harvey . . . in stock, and ready for immediate delivery wherever you may be. Your inquiries are invited.

Note: Prices Net, F.O.B., N.Y.C. and subject to change without notice.

The NEW McINTOSH LOUDSPEAKER SYSTEM



Housed in an attractive enclosure for either flat-wall or corner location. Provides a response ± 3 db. from 40 to 10,000 cycles/sec., and a useful response from 30 to 20,000 cycles/sec. Four 12" speakers are used for low frequencies, an 8" speaker for the mid range and four tweeters for high frequencies. Nearly 4 square feet of diaphragm area are thus provided for more efficient acoustical coupling, more closely approaching linearity in excursions, thereby reducing low frequency distortion to a minimum. Over-all width of the enclosure is 43 inches, and the height is 30 inches. Front width is 22 1/2 inches. Power Rating: 50 watts continuous operation. Impedance: 8 ohms.

Model F100 (blond finish) **\$374.50**
Model F100A (Mahogany finish) **374.50**

McINTOSH PHONO PREAMPLIFIER and EQUALIZER



An extremely flexible, quality unit. Has 5 inputs and selector switch for magnetic pickups, crystal pickup, FM-AM tuner, low level microphone, as well as a 3-position selector switch for correct compensation to match recording characteristics. Features bass and treble boost and attenuation. Power is obtained from main amplifier. Furnished complete with tubes and connectors.

C104A—In Mahogany-finish Cabinet **\$57.50**
C104—Less Cabinet **49.50**

On Demonstration at the Harvey AUDIOrorium The Newest AUDIO DEVELOPMENT!



LIVINGSTON BINAURAL ARM

Less Cartridges **\$35.00**

The latest contribution to the new field of stereophonic, binaural reproduction. A practical transcription arm which plays either binaural or standard discs, and uses standard cartridges. Already several record manufacturers are in production making binaural recordings.

Complete Line of Livingston Arms, Loudness Control, and Pressure Gauge, in Stock

Partial List of COOK BINAURAL RECORDS—Now Available

12 inch Microgroove . . . 12 min. Playing Time per Side
No. 10518N—Michael Cheshire Organ Selections
No. 10368N—Frank Glazer Paganini-Liszt Variations, Piano
No. 10928N—Hufstader Singers Choral Selections **EACH \$5.95**
No. 12213/48N—Wilbur DeParis Rompart Street Ramblers (Modern Dixie)
. . . and others

Series 30 Binaural Test Record — for Synchronization and Stylus Spacing **\$2.00**



HARVEY RADIO COMPANY, INC.

103 W. 43rd Street, New York 36, N. Y. • LUXemburg 2-1500

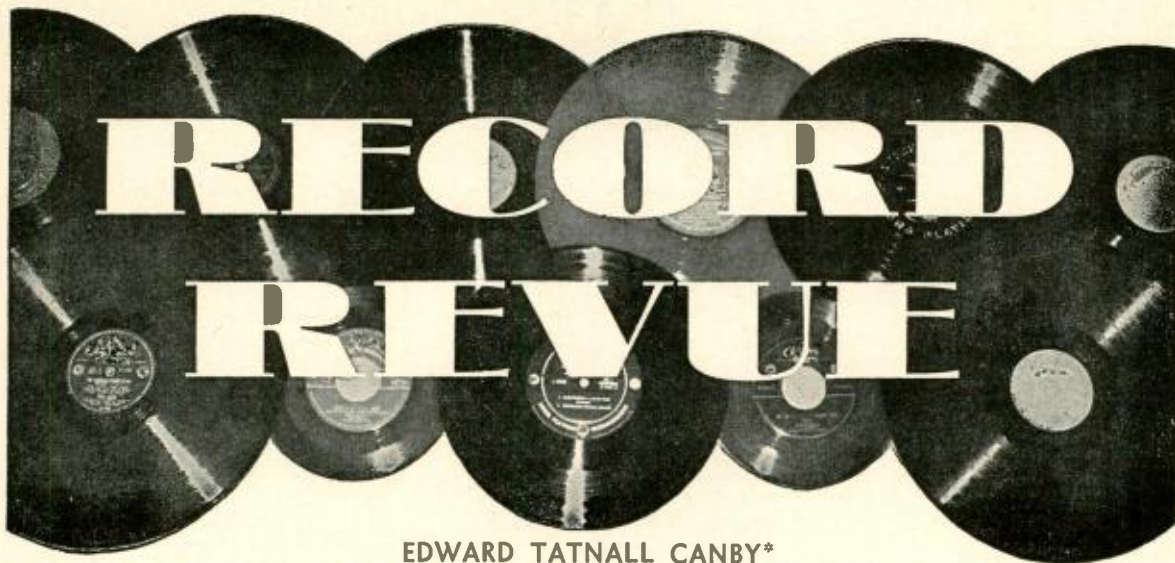

EDWARD TATNALL CANBY*
Music Hath Complications

HOW MUCH is music worth, per minute? How much will the public pay—for what? An elusive business this, yet every single move that is taken in the record field now—musical or technical—is a new thrust towards the ultimate answer, in cash returns. Record making, we sometimes forget, is a business.

The developments are now coming along thick and fast. We have left behind the post-record-war area and are moving into new situations. The musical market, flooded with incredible masses of recorded stuff these last years, is still far from glutted, but things are tightening up. Competition for that carefully priced musical minute is becoming really tough; ingenuity, shrewdness, calculating technology and musicology are more and more necessary.

The record industry moves simultaneously on the technical and the musical fronts. The two are intimately related to a fascinating degree. On the one hand, new types of records can be launched, newly priced versions of the old types; on the other hand, the musical offerings can be juggled about, tied into new technical combinations, combined, separated re-recorded in new versions. The possible combinations of price, record type, and music are infinite.

Since last month's mention of the RCA extended play 45, Columbia has quickly followed with its own extended play 45. Both big companies now have launched low priced labels, Blue Bird for RCA and Entre (the most unpronounceable title I've yet run into) for Columbia; all this in addition to the experimenting in "short" semi-pops LP lines that was an early move in the present shifting.

It's not easy to separate technical from musical factors in all this—but, for this month, I'll look mostly in the technical direction. Let's put aside the touchy question of music itself. What music (at what price, on what sort of record)? That needs separate discussion. Here's what's been going on, as I see it, since the Record War ended in 1949.

*780 Greenwich St., New York 14, N. Y.

Flash Back

Stage One, as I see it, in the post-record-war history (i.e., after RCA began making LP's and Columbia began making 45's) was the settling into place of the two speeds. LP won hands down in the classical department. No one could now question that, though 45 continued to hold a place in the semi-popular classics. The 45, however, had it all over LP in most other areas, where short compositions, tied to the billions of 78's and their three-minute formats, were the rule. Popular, juke box, show tune, hill-billy and the rest.

Stage Two, at least in the classical end of things (and that's my biz) came when the discovery that European music could be had cheaply and easily for efficient LP processing in this country led to the extraordinary expansion of small LP record companies, by-passing the 78 altogether as the big companies could not yet do. A big advantage, and the results were really sensational. Thanks to LP-only, a microscopic record company, taping in Europe, could put out music to compete with the big outfits who could neither desert their expensive U.S. musical contracts nor their two-speed and three-speed duplication.

Stage Three was an offshoot of all this. If small business on LP could succeed in the face of the big companies, how about a big operation using similar material—conveniently simple tape operations among the European musicians? Inevitable, in our business-opportunity world, and Remington was merely the first to try, while the big companies were still tied up in their multiple speeds. And so the first radically lower priced LP records appeared, other companies soon following along, using every means of cost cutting, good and questionable, to get out a maximum of music on LP at a minimum price.

And simultaneously there came the now familiar 30-per-cent-off development on standard LP record sales—another one of those inevitable business-opportunity matters, bound to work—even though, from some points of view, also questionable. Mass LP selling, no listening booths (which mean crawling sales), a liberal return policy. Clever, and so far pretty

much foolproof. Here was another pressure on the large companies.

Small LP-only concerns, larger cut-rate LP makers, discount sales, all working towards lowering the cost-per-minute of music on records. Stage Three, without a doubt, involves some of the most questionable maneuvering in record history. Many a shady deal was involved, such as the blatant pirating that for awhile caused sensational news, the deliberately faked labels on some releases, the trumped-up orchestras and performing groups. Still goes on, though perhaps the worst is over. Nevertheless, right or wrong in detail, this Stage Three, the pressured lowering of record prices, could not have been stopped and in the end, I feel, will have benefited music lovers and the trade as a whole in the old competitive way.

Stage Four? Here we are, up to date. Stage Four is the Big Company Reaction. So far the list prices for records have held. Instead, the answer from these leaders has been indirect, in the new lines of records now appearing and in the dropping of the 78—a fabulous weight removed and a great new freedom gained.

Big Company

How does the big company bring out competitive music? The moves originate now with one, now the other, but since there are no restrictions placed on the competing types of records (in 1901 the various companies almost killed themselves off in a patent war that tied up the entire record field) the other big companies follow along as they please. Look at the current offerings:

1. The "short" LP, low priced. Large numbers of popular overtures, ballet works, etc. verging on the light semi-popular.

2. With the 78 eliminated—full-length operas and other colossal works, to compete at last with the LP-only offerings of the small companies. Until 78 duplication went out the big companies were helpless in this vital area. Now they can offer their fancier artists, bigger names. (But the small companies have good stuff here; the competition is really stiff.)

3. With the 78 eliminated—the extended

Musical Milestone

Wall Street Journal News Story (FRONT PAGE, Oct. 30th, 52)

WEIL's Milestone:

Record vs. Live Music

NEW YORK—How close has the modern phonograph come to perfection?

Inventor Maximilian Weil, maker of the first commercial electronic phonograph pickup in 1926 and holder of some 260 patents in the field, provides an answer at the Audio Fair in New York this week.

The Audak Co., of which he is president, has on hand one of Toscanini's NBC Symphony violinists and a cellist from the New York City Opera, both playing instruments made by the renowned Stradivari. Intermittently they put down their bows—and the music is carried on by a phonograph recording made by the same musicians. *The switch, to most listeners, is not discernible.*

"This is the type of sound reproduction we've dreamed of almost since the inception of the phonograph," says Mr. Weil. "It's a major milestone."

Thousands of music lovers waited in long lines for a chance to hear, for the first time in their lives, this daring side-by-side comparison with the actual artists.

The audience heard, at first hand, the reasons for the universal acclaim of the Audax Chromatic pickup. The superb performance of the Audax CHROMATIC reproducer (magnetic) gave the

listeners irrefutable proof that, in music, listening quality is everything. And the Audax CHROMATIC Diamond reproducer alone, has just that quality.

Listen to the Audax CHROMATIC and discover, for yourself, how close the modern phonograph has come to perfection.

- ✓ CONVERT your (L-6) POLYPHASE with a replaceable Audax Chromatic Diamond stylus, now available at your dealer.
- ✓ One single magnetic pickup plays all home records—replaceable Sapphire or Diamond styli.

- ✓ Available to fit the new compass-pivoted AUDAX arms and record changers.
- ✓ Be sure to get your 1953 ELECTRONIC PHONO FACTS from your dealer, today.

AUDAK COMPANY

500 Fifth Avenue

New York 36

Creators of Fine Audio-Electronic apparatus for over 25 years.

The Standard by Which Others Are Judged and Valued.

And
Now...

TECH-MASTER

HIGH FIDELITY

AUDIO AMPLIFIER KITS

Tech-Master... first name in custom-built TV receivers and Kits... announces its entry into the field of audio. Tech-Master products have always been built to a standard—where price does not control quality. They are the result of advanced engineering and the honest determination to produce the optimum in performance!

The new Tech-Master ultra linear Williamson Type Amplifier Kit and the Tech-Master Pre-amplifier Kit are made with the same "custom-quality" attention. There have been no compromises... every component used is the finest obtainable... workmanship is meticulous.



Tech-Master TM-15A
Ultra Linear
Williamson Type Amplifier Kit
Famous WILLIAMSON circuit with modification for high fidelity reproduction at increased power output. Features specially wound Aitec Lansing PEERLESS audio output transformer. Frequency response flat and smooth beyond the two extremes of the audible range, and distortion is less than .25% at normal listening levels, with excellent transient characteristics. Kit furnished complete with punched chassis, transformers, tubes and all other components, and detailed wiring and assembly instructions.

Power Output.....15 watts undistorted
Output Impedances.....4-8-16 ohms
Input Impedance... High for crystal pickups, tuners pre-amps, etc.
Input Voltage.....1.1 VRMS (for 15W out)

Intermodulation and Harmonic Distortion
.....25% at 2W .45% at 5W
Hum and Noise Level 70 db below rated output
Response: 5 Watts 8 cps to 80,000 cps \pm 1 db
10 Watts 12 cps to 56,000 cps \pm 1 db
Tube Complement... 2 6SN7 2 5881 1 5V4G
Power Requirements: 117 V, 50-60 cyc., 120-w
Dimensions9" x 12" x 6½"
Net Price (KIT of Parts)\$49.95

DELUXE AMPLIFIER KIT, model TMD-15A, completely factory assembled, all major components mounted in place on chassis, ready to wire\$59.95



Tech-Master TM-15P
Four Channel
Pre-Amplifier Kit
Four inputs and selector switch. Three position equalizer switch permits selection of turnover and roll-off to match recording characteristics. Two continuous controls provide bass and treble, boost and attenuation. Power obtained from main amplifier and associated equipment to be controlled by master switch.
Kit furnished complete with punched chassis (pre-printed with pictorial diagram for easy assembly), all components, tubes, cabinet and detailed instruction.

4 Input channels
1—Low level-high gain, 3—Hi-impedance
Bass and Treble Frequency controls
 \pm 15 db boost or attenuation at 20 cycles and 20 KC

EQUALIZATION CONTROL

POSITION	TURNOVER	ROLL-OFF
1.....	300 Cps.....	none-flat
2.....	500 Cps.....	none-flat
3.....	400 Cps.....	12 db at 10 KC for 33½ and 45 RPM

Tube Complement.....1-12AX7, 1-12AU7
Power Requirement
125 volts DC at 6 ma, 6.3 volts at 600 ma
Dimensions10¾" x 4" x 4"
Net Price (Kit of Parts)\$19.95

DELUXE PRE-AMPLIFIER KIT, Model TMD-15P, completely factory assembled, all major components mounted in place on chassis, ready to wire\$29.95

That the ultra linear, Williamson Type Amplifier is one of the really great circuits available, is now too well established to require repetition. This is the first time, however, that the world-famous qualities of this practically distortion-free amplifier has been brought within reach of every audio enthusiast, through leading jobbers at the price of only \$49.95.



TECH-MASTER PRODUCTS CO.

443-445 BROADWAY, NEW YORK 13, N. Y.

play 45, as of this month, looks as though it would fit neatly between the straight three-minute juke-box-popular area and the light classic stuff now appearing on the "short" 10-inch LP. The new 45 will take anything that runs 6 to 8 minutes comfortably; whereas the "short" LP can run from there up to the full 15 minutes, according to need. Definitely a useful advance.

4. Tackling from another angle, the big companies now launch their low-priced lines—Blue Bird, Entre, and others no doubt to come. This is the old accepted method of meeting a price-lowering pressure; we had it back in the 1930's as well. The new and intriguing twist to it is (a) the scope of the second-line offering is now vastly increased and (b) the competitive situation, what with the fighting array of small companies and the wide-open tape opportunities still existing in Europe, is far more complex.

It's a delight to me, for instance, to find the old Harty version of Handel's Water Music suite, the original and still the best performance, now on LP. (It was one of the early "X" sets—remember? X-13.) So much the better that it is at lower-than-standard price, in the Entre line. Much excellent 78 material will be, so to speak, forced back on the market in improved form through this development. Good! Wider fields will be covered in newer recordings, too; RCA's early Blue Birds evidently exploit the British HMV connection for a new range of British-made performances.

5. One final slant to big-company operations today—the Limited Edition, which Decca is now testing out. The complete Beethoven violin sonatas, limited to 2500 sets. Limited editions have been successful in the past in many forms, notably the old 78 "society" recordings, launched through big companies. Perhaps there's a new place for them in today's complex picture.

Complicated? Bewilderingly so. Did we once have but two new types of record, the LP and the 45? We still have the two systems, now reconciled to an unforeseen degree thanks to the universal three-speed players (and the new separate spindles for 45, originated by Garrard and now spreading to other brands of machine). But the two speeds proved to be merely the beginning of the subtle and spreading developments now going on. What next? When the present juggling of prices, music, and record types reaches its full tide, we'll get some new and radical technical development. I've heard rumors—but all this will be for later.

BEETHOVEN SYMPHONIES

Beethoven, the man of extreme contrast—terrific tension and utterly sweet relaxation—is seldom performed to the full in both these aspects. Few of the well known conductors can approach the whole picture, portraying the extraordinary tension in the music and "letting down" at the crucial moments of relaxation, at the same time holding the whole structure together in the perfection of detail that is the greatest Beethoven characteristic of all. An almost impossible job and, for my money, only one man now can come near the perfect, Bruno Walter. In his performances the inner structure is limpidly clear, each detail treated to perfection; he realizes the majestic tensions of the big moments and there is no one who can bring forth the sweetness in contrast as expressively, as deeply, as he.

Beethoven, Symphonies #2, #4. N. Y. Philharmonic, Bruno Walter.

Columbia ML 4596

Beethoven, Symphony #2. Vienna Philharmonic, Schuricht. London LL 629

Schuricht's Beethoven is good. He is able to relax, allow Beethoven to sing, without letting down too much on the tensions which must be there. This version of the 2nd is most enjoyable, well recorded and sympathetically played. But the Walter Beethoven, on direct comparison, is better still. Greater tension, greater relaxation; a higher lyricism, a more pure, more perfectly shaped line with details more accurately chiseled, melodies shaped for more expression. The comparison shows a certain informal softness in Schuricht, a minute inaccuracy, an informality of detail that would scarcely be noticeable without the Walter example.

Walters 2nd is on a single side, gets somewhat fuzzy near the end. But there's room for the 4th symphony on the other side, a typically fine reading of a work that is remarkably hard to perform intelligibly and so is not too often heard. The wider spacing on the London disc allows higher level—too high in some parts; the pre-emphasis seems sharp and the quality is that brilliant, close-to sound, in a big liveness, that characterizes frr.

Beethoven, Symphonies #1, #9. NBC Symphony, Robert Shaw Chorale, soloists, Toscanini. RCA Victor LM 6009 (2 LP's)

Beethoven, Symphony #9. Vienna Philharmonic, Gesell. der Musikfreunde, soloists, Kleiber.

Beethoven, Symphony #1. Vienna Philharmonic, Schuricht. London LS 631

A three-way comparison that's worth a day's work in itself. The Schuricht First, companion to the Second above, is similarly excellent, a jovial, genial, solidly filled out performance bringing out the meat in this symphony; my only criticism, again, is a slight unevenness in the detail work. (The Bruno Walter competition on Columbia is an early LP, though a good one.) Toscanini's First is done as Toscanini does his Italian overtures—the violence with which the louder parts are played, the tautness of the lyric portions are to the best of my judgment wholly inappropriate to the spirit of the music, even if impressive in the listening. The Schuricht is a mile ahead.

The ever-insurmountable Ninth? I would not take either of these hi-fi versions on to my desert isle (equipped, of course, with a convenient a.c. outlet). The Kleiber Ninth is a strange one and unaccountable; the details are all there, the playing accurate, but the music plods. All the parts but no Whole. No drama. The climaxes seem absent-minded, somehow, though there is nothing immediately wrong, in the notes.

Part of it might be in the recording—a large amount of close-to work, individual instruments standing out in places not usually heard, a distracting kind of busy-ness that emphasizes slight inaccuracies, detracts from the grand over-all conception. Part, too, is plain lack of shape in the strong detail, as in the famous two-note opening idea which here is soggy and characterless, affecting the entire first movement. There is a pounding march quality which comes of imperfect rhythmic phrasing. Not a good performance.

Toscanini's Ninth is utterly different. I find it far less endurable still—but in no weak way; it is, as one can imagine, a tower of strength, if misguided strength. There is no Beethoven in which the extremes of tension and lyricism are more directly contrasted than here. Toscanini's tension beats anyone else's—it is unbearable because it is utterly relentless, savage; there is no lyric contrast. The softer parts are almost hastened through, the great climaxes thunder with the roar of a hundred demons. A great experience any way you look at it, but by no stretch of my imagination, at least, the music that Beethoven conceived. It is hard, cold music, harsh, incredibly powerful. Try it for yourself if you don't believe me. And compare with the Walter Ninth on Columbia or the ancient Weingartner, now reissued also on Columbia, if you want the best.

CANNON PLUGS

for hermetic sealed applications

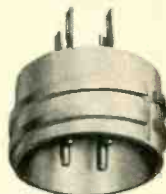

KH



RKH

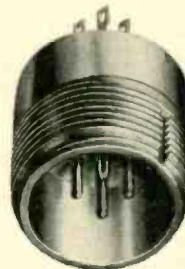

GS02



GS06

HERMETIC SEALED Type RKH Plugs and KH Receptacles mate with their corresponding Cannon RK and K standard fittings. The basic construction of fused vitreous insulation around the contacts is same as GS type. Shell materials and finish are likewise similar. Various types of flange or hex-bulkhead styles may be made to order.

Refer to KH-1 Section in K Bulletin.



SUB-MINIATURE receptacles of the new Cannon "U" Series are used on miniature switches, relays, transformers, amplifiers, and other sealed components, requiring a true hermetic seal or a connector of sub-miniature size with performance superiority.

"U" plugs have a steel shell and "SILCAN"® insulator, cable relief and moisture resistant sleeve.

Bayonet-type locking means prevents vibration failure. Rated 1700v. d.c.; 5a. Available in 3, 6, and 12 contact arrangements with one plug style and two receptacles.

*Cannon Electric's special silicone resilient material.

Refer to U-2 Bulletin

GS Types mate with standard AN(MIL) types. These highly successful hermetically sealed plugs (GS06) and receptacles (GS02) pioneered this field and are top quality fittings. Fused vitreous insulation provides a true hermetic seal for relays, position indicators, etc. Shells are steel, finished in cadmium plate and bleached Iridite; coupling nut on plug is natural finish Dural. Eyelet or solder pot terminals.

Built to resist thermal shock, -300°F. to +600°F., surpassing MIL Spec. GS02 Types will withstand operation temperatures 400°F. to 600°F., and pressures as high as 200 to 900 psi; specials to 7500 psi. GS Types approximate AN voltage and current ratings. Wide range of AN layouts available.

See GS-3 section in AN-8 Bulletin for details.

COMING: TYPE "DH" HERMETIC SEALED CONNECTORS SIMILAR TO PRESENT DA-15P



CANNON ELECTRIC

Since 1915

Factories in Los Angeles, Toronto, New Haven, Benton Harbor. Representatives in principal cities. Address inquiries to Cannon Electric Co., Dept. L-109, P.O. Box 75, Lincoln Heights Station, Los Angeles 31, Calif.

Yours for the Asking

76 PAGE

ANTENNA CATALOG SECTION
as reprinted from Radio's Master

Antennas • Boosters • Accessories

Catalogs the products of 32 leading
Antenna and Accessory Manufacturers

FREE! See coupon



Actual size 8" x 10 1/4"

Represented in RADIO'S MASTER 76 page ANTENNA and ACCESSORIES Booklet are the products of the following manufacturers:

- Alliance Manufacturing Co.
- Allprodo, Inc.
- American Phenolic Corp.
- Baker Manufacturing Co.
- Birnback Radio Co., Inc.
- Blonder-Tongue Labs., Inc.
- Brach Mfg. Corp.
- Columbia Products
- Cornell-Dubilier Elec. Corp.
- Electro-Voice, Inc.
- Hi-Lo TV Antenna Corp.
- Insuline Corporation of Amer.
- J. F. D. Manufacturing Co., Inc.
- LaPointe Plascomold Corp.
- Master Mobile Mounts, Inc.
- Mosley Electronics
- Peerless Products Industries
- Penn Television Products Co.
- Premax Products
- Radelco Manufacturing Co.
- Radiart Corporation
- Radio Corporation of Amer.
- Radio Merchandise Sales, Inc.
- Regency Division I.D.E.A., Inc.
- Walter L. Schott Co.
- South River Metal Prod. Co.
- Spirling Products Co., Inc.
- Technical Appliance Corp.
- Tel-A-Ray Enterprises, Inc.
- Telrex, Inc.
- Triferact Products
- Ward Products Corporation

You can obtain without cost or obligation, a complete 76 page antenna catalog section as reprinted from the Industry's Official, 1220 page Radio's Master, 17th edition.

Whether you buy, sell or specify, you will find this handy booklet extremely helpful for quick reference. It catalogs in detail the products of the leading Antenna and Accessory manufacturers with complete descriptions, specifications and illustrations.

This offer is made possible by a special arrangement between Audio Engineering and the publishers of RADIO'S MASTER. Fill in the coupon NOW and a copy will be sent you by return mail.

CLIP and MAIL TODAY!

AUDIO ENGINEERING
P. O. BOX 629, Mineola, N. Y.

Please send me, without cost or obligation, the 76 page ANTENNA and ACCESSORY Booklet reprinted from Radio's Master.

Name

Address

City Zone State

BEETHOVEN PIANO SONATAS

A more specialized interest for audio fans, these sonatas have been so extensively recorded these last months that a brief mention is in order—beginning with the renewed observation that piano recording via tape and LP is now fabulously improved over the first wavering, flutter-ridden peaky piano LP's that so shocked the record collectors. Most of the Beethoven sonatas, though varying in sound, are remarkably fine in the technical rendering of piano tone.

The Complete Beethoven Piano Sonatas. Wilhelm Kempff.
Decca (14 LP's, separately available)

The rules of the Beethoven symphony apply to these works too—and few pianists can build the precise and multitudinous details of these works into the proper imposing musical Whole, preserving again the lyric and the dramatic intensity as well. Kempff is not as outwardly dramatic as most players of Beethoven—you'll be disappointed on first hearing at what seems a lack of "staginess," of the big effect. He is quiet and mousy. But the musical details are so superbly realized here, the structure grows so inevitably from them into inevitable and impressive wholeness that these are the records you can listen to again and again with growing pleasure, where other pianists seem flashy and fake.

Piano tone is a bit wooden and hard (Kempff has an uncompromisingly hard touch at best, it would seem), with some bad surface noise here and there; a few sonatas flutter, though not painfully. Not tops in recording.

Beethoven, Piano Works. (Lighter sonatas, rondos, etc.) Hugo Steurer. Urania LP's.

Steurer is a genial, pleasing player who goes in for no histrionics, plays most (so far) the lighter Beethoven. His piano has a bassy, big, full sound (mike under piano?), his records nicely fill out the in-between areas. Some of the music is seldom heard.

Beethoven, Piano Sonatas. (Projected complete cycle). Kurt Appelbaum.
Westminster LP's

A nervous, high strung sound, with too many eccentricities of rhythm to suit most Beethoven listeners. A strong pianistic personality—which gets in the way of Beethoven's even stronger one. Good piano, a bit thin and hard in tone. (Recorded by Columbia.)

Beethoven, Piano Sonatas. Wilhelm Backhaus. London LP's

A fiery, old fashioned Romantic in his Beethoven, playing in an almost Paderewski style. If you like Beethoven played as of the Liszt-Wagner school, this is it, and good too, if slightly anachronistic! Excellent piano quality, at least in the recent LPs.

BROWSING FARE

Scarlatti-Tommasini, The Good Humored Ladies. Poulenc, Les Biches. Paris Conservatory Orch., Desormière. London LL 624

Two lightly related ballet suites. The Ladies derive from several Scarlatti harpsichord sonatas, ingeniously (and too cutely) orchestrated. Nice variant to Handel's Water Music and the like. Les Biches are just what you think, though we in our slightly less direct English might better speak of "The Hens" in the hen-party sense. A nose-and-thumb, jazzy bit of music from 1924—like most music of the '20's it makes wonderful hi-fi stuff! The best of frr.

Shaw, Don Juan in Hell. The First Drama Quartet. (Boyer, Laughton, Hardwicke, Moorehead.) Columbia SL166 (2LP's)

Not music but words—the complete show as it has been given the country over. Excellent, except that the audience laughs are strangely—if you've been to it—missing. I'm inclined to think they should have had a studio audience; a radical experiment on records I'll admit, but it might work as well as it does in radio and TV on comedy shows. This is a comedy, to put it mildly. Better get up your own audience of at least a half dozen before you play it through. That'll fill in the laughs. Super hi-fi speech recording, natch.

Bizet, Jeux D'Enfants. Chabrier, Suite Pastorale. Royal Opera House Orch., Braithwaite. M-G-M E3000 (12")

M-G-M's publicity does its best to scare away the classical listener—one might think that nothing but film-style popular classics would ever hit the yellow label, if and when. Yet this is an excellent item for any good collection, the two best French Romantic composers in really first rate lyric music, very sympathetically played and beautifully recorded. And—M-G-M be praised—the notes on the back of this LP by Edward Cole are among the best I've read lately. Really thought-out ideas, not just carbon copy stuff. Do it again, M-G-M!

Mozart, 21 German Dances. Frankland State Symphony, Kloss. Lyrichord LL 31 Beethoven, 12 German Dances; Schubert, 6 German Dances, Mozart, 6 German Dances. (Paris Radio Orch.), Paris Philharmonic, Leibowitz. Esoteric ES 512

It's not often we are reminded that an orchestra is a group of disparate individuals, each blowing his own horn; M. Leibowitz' Schubert with the Paris Philharmonic is a painful example—here is a group of players apparently sight reading, their noses buried in their music, oblivious of all else! A fine illustration of bad ensemble—poor team work—under a conductor whose hand must be as precise and as mechanical. Soulless playing.

The Frankland version of the Mozart, by contrast, is very musical; its only trouble (aside from lack of highs) is lack of a sense of humor—some of Mozart's dances are delightfully droll—this group plays them all dead serious.

Casals Festival at Perpignan, vol. 1: Mozart. (Kleine Nachtmusik, Sinfonia Concertante K. 354, Violin Concerto #5, Divertimento #11, Oboe Quartet K. 370.) Perpignan Festival Orch., Casals; soloists. Columbia SL 167 (5 LP's)

I distrust festivals. Especially when centered about some world-famed figure such as the quite worthy Pablo Casals, master cellist. There is a built-up hysteria, a hero worship, connected with these events that is fine for those present—but doesn't come over at all well on records. What does come over, too often, is a kind of distraught, tense playing, a host of petty mistakes, roughnesses, that are unimportant at the scene but noticeable in recorded form, evidence of poor mike placement under duress and blatant evidence of poor (recording) acoustics—above all, the evidence that the composers, at the moment, were far less in the forefront than the performers. That is not good on records.

All of which is illustrated again in vol. 1 of this second Casals Festival. (The first was the Prades Festival.) There's good playing here, but not tops; hardly an item in the set but can be topped by another and clearly better performance on records. But the worst drag is the dead pall of room sound, enough to kill any music and quite uncharacteristic of Columbia's usual work. Add to this a 5-LP set in which two discs have half-filled sides with gaping blank areas, and the last disc—believe it or not—one entire side devoted to an "inscription" by Casals, a few words of wisdom scratched into an acetate, the other side taken up by all of 7/8 of an inch of Casals cello, the rest being blank... you can't miss the Festival atmosphere! Does one pay for this sort of thing?

SOUND HANDBOOK

[from page 22]

the mechanical friction amplifier, Fig. 7—10 which involved a mechanical means of increasing diaphragm movement, and compressed-air amplifiers, Fig. 7—11 which employed a pneumatic relay arrangement for the same purpose.

But standards of fidelity may involve subjective factors. The early commercial records and home machines were received by an audience as yet unsophisticated in the matter of comparing musical tones with their mechanical

the **AUDIO "BUGS"** know best



they're using

CHICAGO

for quality



Audio Amplifier with "Presence"

Described in Radio News, Nov. 1951. Heart of the amplifier is the CHICAGO full-frequency BO-6 output unit, with other "Sealed-in-Steel" transformers incorporated in the separate power supply chassis for top audio results.



An Unusual P.A. Amplifier

An unusually compact 20-watt P.A. amplifier of exceptional audio fidelity. CHICAGO full-frequency range transformers are used exclusively for exceptional audio quality coupled with small size and light weight.



Audio Modulator

Described in Radio News, June 1951. An efficient audio testing instrument suitable for precise lab analysis or for subjective quality tests. CHICAGO "Sealed-in-Steel" input, output and power transformers are incorporated.

Wherever audio quality is a "must"—the experts specify and use CHICAGO "Sealed-in-Steel" Transformers



talk about full frequency—
CHICAGO Output Transformers
really deliver for you...

.2 db 30-20,000 CPS

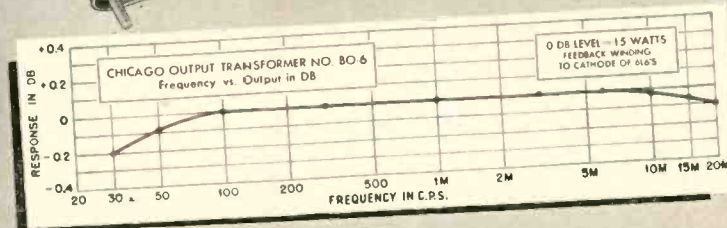

No. BO-6

For use in high fidelity amplifiers. Couples push-pull 6L6's (7500 ohms, C-1) to 6/8 or 16/20-ohm voice coil. Center-tapped tertiary winding provides 15% inverse feedback to reduce harmonic distortion to a minimum. In drawn steel case, 4 1/4" x 3 3/4" x 3 1/4", with mounting studs and convenient pin-type terminals.

No. BO-7

For matching 600 or 150-ohm line to 6/8 or 16/20-ohm voice coil. Frequency response within plus or minus 1 db. at full rated output—maximum power level, 30 watts. Mounted in compound-filled drawn steel case, 4 1/4" x 3 3/4" x 3 1/4". Mounting studs and pin-type terminals same as No. BO-6 illustrated above.

There's a **CHICAGO** Transformer for Every Audio Application

CHICAGO "Sealed-in-Steel" Transformers (the world's toughest) are available in 3 complete ranges for every type of audio requirement: Full Frequency, Public Address, and Communications. Whatever the application, it's wise to choose CHICAGO audio transformers for that extra margin of dependability under all operating conditions.



Free "New Equipment" Catalog

Get the full details on CHICAGO's New Equipment Line—including "Sealed-in-Steel" transformers designed for every modern audio application. Write for your Free copy of this important catalog today, or get it from your electronic parts distributor.

CHICAGO TRANSFORMER

DIVISION OF ESSEX WIRE CORPORATION

3501 ADDISON STREET • CHICAGO 18, ILLINOIS



NOW YOU CAN ENJOY THE FINEST AND SAVE TOO!



Cabinart BASS REFLEX CABINET KITS

Both kits above include all 5/8" fir plywood cut to size, all hardware, glue, kimsul, acoustic cloth, pre-cut baffle for 12" or 15" speaker, assembly and finishing instructions. Equipment cabinet will house all standard changers or manual players, as well as any combination of standard tuners or amplifiers.
Tuner compartment dimensions: 20" H, 21 3/4" W, 15 1/4" D. Bass reflex cabinet volume: 6 cu. ft.
Cabinet dimensions: 33 1/2" H, 23" W, 16" D.

- CABINET KITS (Ready For Assembly)
MODEL 80 (Equipment cabinet kit) **27.00**
MODEL 8012 (12" Speaker kit) **18.00**
MODEL 8015 (15" Speaker kit) **18.00**
ASSEMBLED CABINETS (Sanded for finishing)
MODEL 70 (Equipment cabinet) **36.00**
MODEL 7012 (12" Speaker cabinet) **24.00**
MODEL 7015 (15" Speaker cabinet) **24.00**

(Other Cabinart literature on request)

Arrow Audio Center makes it possible for you to enjoy what you want most — the best audio equipment — at savings you never dreamed possible! You'll enjoy your equipment even more, when you've had a hand in its building. A few pleasant hours, following simple directions and you've built yourself first-quality professional units you'll be proud of — your purse will appreciate your new, light touch, too.

TECH-MASTER DE LUXE AMPLIFIER KITS . . . COMPLETELY ASSEMBLED

TECH-MASTER TMD-15A Ultra Linear Williamson-Type Amplifier Kit

A superb new kit by Tech-Master, world famed for great kits in Radio, TV and Audio. True high fidelity reproduction from the famous Williamson circuit with unique ultra-linear modifications. Complete with specially wound Altec-Lansing PEERLESS output transformer. Wire it in a few short hours, enjoy the finest listening quality you've ever heard. Flat response to beyond both extremes of the audible range. Less than .25% distortion at normal listening levels, excellent transient characteristics, 15 watt output. Completely assembled, with 2-6SN7, 2-5881, 5V4G, ready to wire. 9 x 12 x 6 1/2". 27 lbs.

MODEL TMD-15A — De Luxe Williamson Kit **59.95**
MODEL TM-15A — As above, not assembled **49.95**

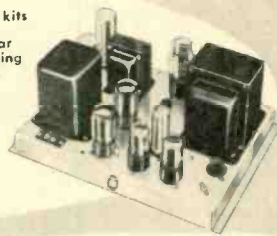

TECH-MASTER TMD-15P 4-Channel Pre-Amplifier Kit

Companion front end to the TMD-15A above, provides 4 input channels and selector switch for FM-AM or TV Tuner, crystal pickup, reluctance type cartridge, tape or wire recorder, or other signal source. Built-in pre-amp for any reluctance cartridge; 3-position equalizer switch. Separate bass and treble controls, for ±15 db boost or droop. Powered by main amplifier. Completely assembled, with handsome cabinet, 12AX7 and 12AU7, ready to wire. 10 3/4" x 4" x 4". Wt. 4 lbs.

MODEL TMD-15P — Pre-Amplifier Kit **29.95**
MODEL TM-15P — As above, not assembled **19.95**



ARROW ELECTRONICS

Audio Center

BEAUTY IN SOUND
65 CORTLANDT ST., NEW YORK 7, N. Y., DIGBY 9-4714

facsimiles. One does not critically feel the texture of miraculous cloth, and the phonograph (various commercial models of which were also called the graphophone, the gramophone, the talking machine, and the phonet) was judged by blunted senses. Below is another estimate of the Edison phonograph, written in 1900 by the manufacturer:

"Mr. Edison has perfected the Phonograph. Beginning with the early tinfoil machine, Mr. Edison has developed the Phonograph step by step, until to-day the Phonograph stands on the pinnacle of perfection. It perfectly reproduces human voice; just as loud—just as clear—just as sweet. It duplicates instrumental music with pure toned brilliancy and satisfying intensity. Used with Edison Concert Records, its reproductions are free from all mechanical noises; only the music or voice is heard. It is strong and vibrant enough to fill the largest concert hall. It is smooth and broad enough for the parlor."

Advertising copy writers in the phonograph industry soon recognized the dramatic possibilities in the concept of musical reproduction indistinguishable from the original. A series of talking machine ads of 1908, one of which

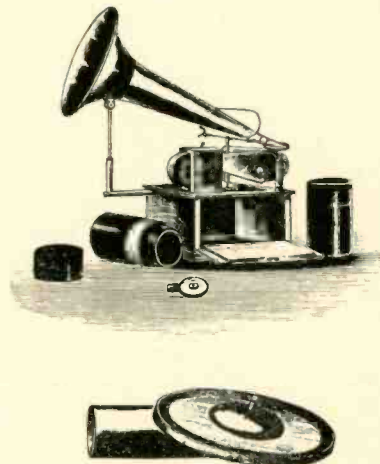

Fig. 7-9. Parzer-Muhlbacher "Sprechmaschine," Berlin, about 1900. The ball stylus and diaphragm are shown below. From: Die Modernen Sprechmaschinen.

is reproduced in Fig. 7-12, boasted that one couldn't tell the difference between hearing opera stars sing and hearing their records played. This optimism was caught up by the copy writers of competing companies, and it seems to have remained to this day.

Standardization of the Reproducing System

The phonograph industry had not reached agreement on basic design features. The woes of the modern purchaser of records, who may complain about the three types of records in use, are more than matched by the troubles of record fanciers of the Nineteen Hundreds, who had to choose between three types of cylinder records (5 in. Concert diameter, 2 1/4 in. standard diameter,

and standard diameter with fine-line grooves) and two types of disc records (lateral cut and vertical cut), each of which required its own special player or adapting attachment. It was many years before standardization of basic features was adopted.

The main issues to be settled were: whether to use cylinder or disc records, vertical or lateral recording, and standard or fine-line grooves.

Use of the disc record simplified the problem of casting many copies from a master. Cylinder records had at first to be laboriously re-recorded from the master one at a time, by a special pick-up-recorder unit with a playback stylus

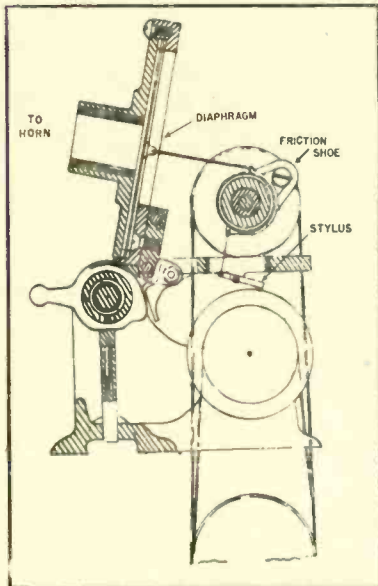

Fig. 7-10. Columbia cylinder Graphophone with mechanical friction amplifier. From: The Reproduction of Sound, H. Seymour, 1918.

on one side and a cutting stylus on the other. On the other hand cylinder records do have a certain advantage over the disc, in that the longitudinal velocity of the stylus relative to the groove remains the same throughout the record, while the groove-stylus velocity in a disc record is constantly reduced with the smaller radius of each successive groove. The difficulties of mass production of cylinder records were finally overcome by a process which made pressings from a master cylinder possible—a record material was chosen which shrank after hardening so that it could be slipped out of the mold. But the simplicity of the disc system won out, and the disc came to be used universally except in dictating machines.

It was more or less natural for cylinder records to employ the vertical cutting system and disc records the lateral, although this pairing did not always occur. Edison referred to lateral recording in his 1877 patent, but credit for developing the system in practice goes to Berliner. Figure 7-13 illustrates the different way in which the groove is shaped for the two types of recording.

only ALTEC manufactures a complete line of high fidelity equipment!

Attempts to adapt unmated parts together into a home music system are often unsuccessful. Buy Altec and you not only get the highest quality but you get components designed to work together. Each unit plugs into the others. Easy to install. Designed for eye as well as ear appeal. In home installations as in all other audio fields, the Altec name is your assurance of the best.



AM-FM TUNER

303B — The best tuner money can buy for audio quality... wide band super het AM... superlative FM... equalized phono preamp... extra input for tape... record cross-over frequency selection... equalization for LP records... bass and treble rise and drop... built in power supply... more dependable features than any other tuner.

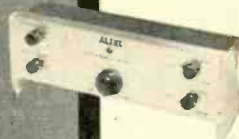

REMOTE AMPLIFIER

A-433A — Beautiful compact control unit for use with phono when 303A tuner is not required. Contains VR phono preamp and all of the novel features found in the 303A tuner... three inputs... perfect for reproduction from records, tape and radio tuners.



POWER AMPLIFIER

A-333A — The power amplifier without a peer... 15 watts with less than 1/2% harmonic distortion... 27 watts with less than 5% distortion... flat from 20-20,000 cycles... completely controlled from 303A tuner or A-433A remote amplifier.



LOUDSPEAKER

DUPLEX — The exclusive Altec "duplex" loudspeakers are the only speakers guaranteed from 30 to 22,000 cycles. Available in three sizes and power capacities.

820A — Altec's new corner speaker system... the concert grand of the loudspeaker world... two 15" woofers... high frequency speaker and multicellular horn in a furniture cabinet provide famous Altec "Voice of the Theatre" quality for the home.

SEE YOUR DEALER
OR WRITE TODAY

9356 SANTA MONICA BLVD., BEVERLY HILLS, CALIF.

141 SIXTH AVENUE, NEW YORK 13, NEW YORK

ALTEC

LANSING CORPORATION

Lafayette

Presents



STROMBERG-CARLSON
Custom Four Hundred
WIDE RANGE · HIGH FIDELITY

High Fidelity Components for
Your Custom Installation

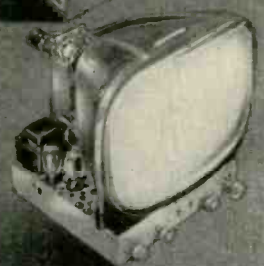
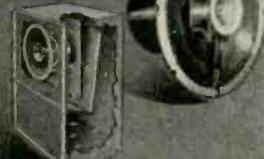

You'll want to see and hear this outstanding equipment. Yes, get to know the Stromberg-Carlson line. Write for more information about the numbers listed below or order direct from Lafayette, famous for High Fidelity for 30 years.

STROMBERG-CARLSON AM-PM Tuner SR-401 has a sensitivity of 5 micro-volts on both bands. AM circuit has wide and narrow selectivity. Frequency response 20 to 20,000 cps $\pm 1\frac{1}{2}$ db. Harmonic distortion less than 1%. 12 tubes plus rec-tifier and tuning eye. AFC switch on front panel. Completely ready to install with all hardware. Silver gray finish. Size $11\frac{1}{4}'' \times 6\frac{1}{2}'' \times 11''$. Shp. Wt. 12 lbs. 139.95

STROMBERG-CARLSON III-F 10 Watt Amplifier AR-410. The AR-410 Hi-Fi Amplifier provides 10 watts from a single chassis. Frequency response 20 to 20,000 cps with less than 1% distortion. Response flat, ± 1 db. Six input connections are provided for front panel selection. Treble control provides 5 db boost and 15 db droop at 10,000 cps; bass control provides 15 db boost or droop at 50 cps. Loudness control follows Fletcher-Munson curves. Gray panel matches tuner. Size $11'' \text{ W} \times 7'' \text{ H} \times 8'' \text{ Deep}$. Shp. Wt. 25 lbs. 79.95

STROMBERG-CARLSON De Luxe Amplifier AR-425. 25 watts. Designed as a dual chassis, controls are located on the pre-amplifier. Response 20 to 20,000 cps, less than 1% harmonic distortion; hum 80 db down. Tone controls provide 15 db boost and 20 db droop. 5-position brilliance control, 3-section loudness control. Input selector controls 7 positions; microphone, FERR, LP, AES, radio, TV, tape or crystal phono. With 6' interconnecting cable. Sizes: Power amplifier $16'' \times 8\frac{1}{4}'' \times 7''$; Pre-amp $12\frac{1}{4}'' \times 5'' \times 5\frac{1}{2}''$. Finish brown mahogany. 189.95

STROMBERG-CARLSON SPEAKERS. RF-475 15" coax speaker provides exceptional wide range response of 30 to 16,500 cps, with a distribution angle of 90° vertical and horizontal. Capacity 40 watts of program material. Low frequencies are fed to 15" seamless cone with a 3" vc. The 5" tweeter in a parametric horn with acoustic lens. Input impedance 16 ohms, 8 lb. Alnico V magnet. Wt. 50 lbs. 179.95

RF-471 12" coax speaker provides exceptional performance. The $3\frac{1}{2}''$ seamless tweeter is suspended in Charpinchoe leather to eliminate violent peaks and dips in high frequencies up to 15,000 cps. The tone range down to 30 cps through a 12" seamless low frequency cone with a voice coil of $1\frac{1}{2}''$ diameter. Power capacity 32 watts of program material. 8 ohm impedance. Wt. 15 lbs. 49.95

STROMBERG-CARLSON Labyrinth RL-485. With the RL-485 Exponential Acoustical Labyrinth Kit, any speaker cabinet, of sufficient size, can be converted to the famous Stromberg-Carlson Labyrinth. Will fit any cabinet with the following minimum inside dimensions: 39" H 24" W 20" D. Kit contains all necessary material and installation hardware and instructions. 20.00

STROMBERG-CARLSON Model TV-421 TV Chassis. The TV Tuner Chassis TV-421 features a bright, well-contrasted picture and exceptional performance in fringe areas. Equipped with a 21" picture tube and designed to receive channels 2 through 13 (adaptable to U.H.F. channels). The chassis is supplied with 19 tubes plus 3 rectifiers, plus mask and all mounting hardware. Size $20\text{-}11\frac{1}{8}'' \text{ W} \times 23\frac{1}{4}'' \text{ D} \times 21\frac{3}{4}'' \text{ H}$ (including picture tube) Shp. Wt. approx. 75 lbs. 299.95
Send for free High Fidelity catalog and further information on the Stromberg-Carlson Inc. Write.

Lafayette
Radio

NEW YORK	100 SIXTH AVE.
BRONX	542 E. Fordham Rd.
NEWARK	24 Central Ave.
BOSTON	110 Federal St.

The Edison company continued to use vertical cutting in their heavy disc records for many years, but lateral cut records, the type made by the old phonograph, finally became the standard for all home discs.

Grooves in the first records were slightly wider than the modern standard groove, cut 100 to the inch. Playing time for a cylinder was about two minutes. This time was increased by the introduction of "microgroove" technique, which used a groove of approximately the same width as the modern LP groove and increased the number of grooves per inch to 200, not much less than the pitch of contemporary microgroove records. "Long-playing" records of the first decade of the twentieth century were accompanied by the same advertising acclaim as those of the sixth. Ads for Edison fine-line cylinder records give one the feeling of a visitor to an ancient site who finds things strangely familiar. But the microgroove record lost out until many years later.

There was not too much room for improvement in the acoustic phonograph. The reproducer head was made as sensitive as possible, and the "morning glory" horn, so named because of its

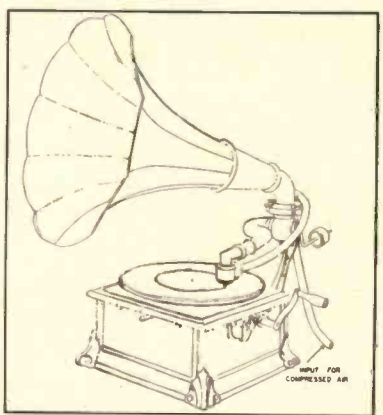

Fig. 7-11. French Phonograph (Pathé, about 1905) with compressed air amplifier. From: Le Génie Civil, 1906.

exponential flare, was substituted for the conical one. Then the outside horn was replaced by a folded horn in the cabinet, rigid with respect to the cabinet but connected by a flexible joint to the hollow tone arm, which itself formed part of the flare. Larger horns housed in console cabinets made the coupling between the diaphragm and the air of the room more efficient, particularly in the bass, producing more volume, fuller tone, and a decrease in distortion.

The Phonograph Amplifier

Direct recording and reproduction has severe limitations. It is difficult if not impossible, with this technique, to radiate enough energy into the room to create an adequate intensity of sound. Even if the reproducing styus were so well loaded acoustically that the vibrations produced by the record groove did produce the desired intensity level, the

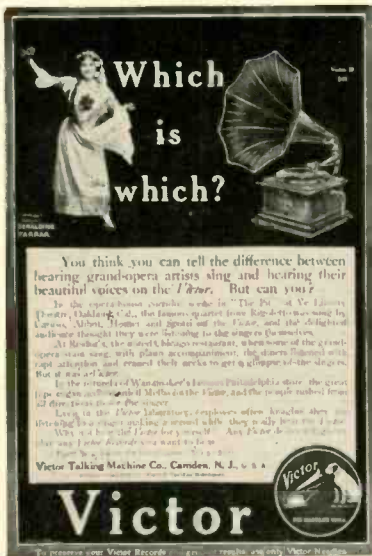

Fig. 7-12. "High Fidelity" in 1908.

groove walls would be so strained that they would probably crumble. In addition the natural resonances of the system are very prominent. Suppression of the violence of resonant behavior by damping, and by the design which places the resonant frequencies out of the audible range, reduces the efficiency further. The use of very light loading on the stylus has a similar effect. Such measures as these are made feasible, however, by amplification. The reduced power shaped by the record groove instead of being used for direct acoustical radiation, is employed to control an independent source of greater energy.

Edison had developed a pneumatic amplifying or "relay" system which he called the *aerophone*, but it was designed as a public address system for speech rather than for records. A successful phonograph amplifier was employed in the British auxetophone, the idea for which was first patented by Short in 1898 and developed further by Parsons soon after. This device contained a pneumatic system like that of the aerophone; the vibrations induced in the reproducing system were used to throttle periodically a steady flow of filtered air furnished by a motor-driven compressor. The reproducer head contained a stylus-actuated pneumatic valve which released bursts of air in the proper form and sequence to imitate the recorded sound. Short directed the air bursts against a reproducing diaphragm, but Parsons found that the modulated air stream could be released directly into the room. A contemporary critic of the auxetophone wrote that it was suited only to public halls, because of a constant hissing produced by the air flow and because the volume was too great. (!)

Another type of amplifier used commercially was purely mechanical in nature. The stylus was coupled to the

Brighter, Sharper TV Reception



WITH THE **TURNER**

MODEL TV-2 BOOSTER

You get clearer, sharper pictures with a minimum of annoying interference and snow even in weak signal areas with the TURNER TV-2 Booster. It's designed with an eye to beauty as well as outstanding performance. The rich, mahogany plastic cabinet is a handsome addition to any room... the high quality cascode circuit reduces noise and snow, producing an excellent picture even in extreme fringe areas.

The TURNER Booster is simple in operation. A single tuning knob permits fine adjustment for best reception of picture and audio over all 12 TV channels. The unit is quickly and easily installed on any television set. Get the best possible TV reception... get the TURNER Model TV-2 Booster!

The **TURNER** Company 929 17th St. N.E. Cedar Rapids, Iowa

IN CANADA:

Canadian Marconi Company, Toronto, Ont., and Branches.

EXPORT:

Ad. Auriema, Inc., 89 Broad Street, New York 4, N.Y.



**SUBSCRIBE
TO**

**AUDIO
ENGINEERING**

for LIFE

THE LASTING CHRISTMAS PRESENT

Now you can eliminate the bother of renewing every year or so. If you live in continental United States, you can subscribe for life at the new rate of only \$25.00 and receive € from now on. If you are a subscriber now, we will refund a pro-rated amount based on your remaining term, or you can transfer it to a friend. Pocket "membership" card given as your receipt.

This offer is good only in the U. S. and applies only to subscriptions entered by sending your check or money order direct to

RADIO MAGAZINES, INC.
P. O. Box 629 Mineola, N. Y.

LET YOUR OWN EAR TELL YOU



This Revolutionary, New General Hi Fi

**Baruch-Lang
HIGH FIDELITY SPEAKER**

COMBINES: AMAZING PERFORMANCE
SENSATIONAL LOW COST
UNUSUAL SMALL SIZE

\$24⁹⁵ complete
Nothing else
to buy

Bring to Your Home a New High In Authentic Sound Reproduction. Hear Fine Music as it is Originally Played or Recorded

CONCERT HALL CLARITY . . . Now enjoy true, mellow tone and life-like performance at NEW LOW COST! Inexpensive enough to use as an auxiliary extension in other rooms, many speakers can be attached to one amplifier, without distortion or power loss.

EASY TO INSTALL . . . New triangular shape and light weight allows easy ceiling corner mounting, usually impossible with larger, bulkier speakers. Four identical speakers housed in a handsome, mahogany veneer cabinet—in your choice of four modern decorator finishes to blend with every decor.

DELUXE MODEL

The Baruch-Lang speaker is also available in this deluxe model, with a handsome frame and grill cloth for added beauty. Available in the same luxury finishes . . . Blonde Modern, Rich Mahogany, Chinese Black, and Natural Unfinished, only \$29.95



CHECK THESE LUXURY FEATURES

- Excellent tone and additional power when needed
- Smaller and lighter for limited areas
- Triangular, for easy corner mounting
- Quick and simple to attach
 - Four fine decorator finishes
 - Complete in fine wood housing that requires no additional cabinets

AVAILABLE AT LEADING DEALERS or write to GENERAL HI FI Co., Studio H-4-12, 799 Broadway, New York 3, N. Y. for the name of your nearest dealer and FREE INFORMATION.

reproducing diaphragm via a string and friction shoe which passed over a rotating wheel, and extra energy was picked up through friction with the surface of the wheel. The principle was the same as that of the ship's capstan. When motion of the stylus caused it to tighten up on the string, frictional coupling to the wheel was increased, and diaphragm displacement was augmented by wheel motion. When the stylus loosened tension on the string the diaphragm returned to its normal position due to elasticity.

The most revolutionary advance in phonograph technique after the introduction of the Bell-Tainter system was the marriage of recording and elec-

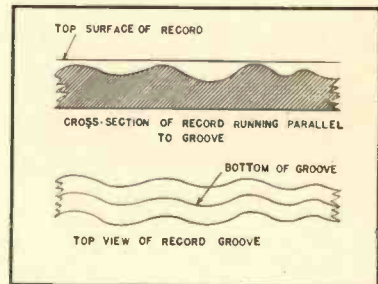

Fig. 7-13. (A) Vertical or hill-and-dale recording, originally known as the "phonograph cut." (B) Lateral recording, originally called the "gramophone cut."

tronics. Electrical recording and reproduction had been experimented with since the earliest days of the phonograph, and was mentioned in Edison's original patent application, but the development of amplifying tubes and superior electro-mechanical equipment was necessary for realization of its advantages. In electrical recording, sound was no longer impressed directly onto the record cutting head, but was first converted to an electrical signal through a microphone and amplifier. This signal, whose electrical wave form corresponded to the acoustic wave form of the sound, was fed to an electric cutting head. The cutting stylus was displaced by the electrical power applied to it rather than by acoustic power.

An electrical cutter is basically a motor. Playback had to involve a reverse electro-mechanical process, using a pickup head which acted as an electrical generator. Playback stylus displacement induced voltages in the pickup of the same wave form as that of the groove, and these voltages were amplified and converted into sound by a loudspeaker.

Electronic amplifiers can now be built whose degree of fidelity to the input signal compares favorably with the degree of accuracy with which the human ear can judge distortion. This is not true of electro-mechanical and electro-acoustic apparatus; the greatest obstruction in the path towards fidelity is still the pivoted or suspended mechanical device. We have not yet learned how to control the machine with the same precision with which we can control the electronic circuit. The problems of the contemporary audio engi-

neer are thus not as far removed from those of phonograph designers of the Nineteen Hundreds as one might think.

PATENTS

[from page 2]

V_2 , the key to the system, is a high- μ triode biased by R_{10} - R_{11} across the B-supply, with the cathode bypassed by C_7 . The grid is also bypassed for audio by C_8 . C_7 is the conventional screen bypass for V_1 . The triode normally has a high plate resistance and draws little current through R_1 and K_1 . It also has little shunting effect on the signal for this reason; the same is true for resistor string R_4 - R_7 - R_8 - R_9 . V_2 causes no degeneration of signal because its grid and cathode are bypassed.

The voltage on the plate of V_2 is essentially that on the plate of V_1 . When the V_1 plate voltage rises more than, say, 20 volts above its resting value (the result of a sudden negative control-bias rise on its grid) the heightened voltage on the plate of V_2 brings it into the low-resistance, high-plate-current region. The current of V_2 is drawn through R_3 , opposing the rise in voltage across R_2 (which is, of course, the output voltage of V_1) and keeping the undue rise down to negligible proportions. The effect is to clip the sudden transient and prevent unpleasant noises. As an illustration, an unchecked transient may cause a 100-volt peak; the clipper keeps it down to about 20 volts, well within the normal level. Negative V_1 plate swings tend to be slower and do not cause audible transients, so no negative clipping is required.

Screen compensation works this way: When a negative control voltage rises on the grid of V_1 , screen current through the screen dropping resistors R_6 and R_7 decreases and screen voltage becomes more positive. This rise appears on the grid of V_2 . The plate current of V_2 increases; since it is drawn through R_3 , it causes a greater drop across R_2 which tends to counteract the change in screen voltage.

Values of components and tube types are not given in the patent specification but, as usual, a little thought would indicate them.

A copy of any patent specification may be obtained for 25¢ from The Commissioner of Patents, Washington 25, D. C.

MAGNECORD and VOX Join With New Tape Library

"Magnecordings by Vox," first full-range recorded tapes for commercial sales featuring major orchestras with noted conductors and soloists, are rapidly being made available throughout the country.

These "Magnecordings" are offered as both full and half-track recordings on standard recording tape at 7½ in./sec., thus providing either hour or half-hour programs on a single 7-in. reel, depending on the type of recording desired. Special equalization in recording will give reproduction to 15,000 cps. Price for 7-in. half-track reel—one hour—is pegged at \$9.95.

Recordings will be made by Magnecord for MaVoTape, Inc. from the "master" tapes of Vox Productions, Inc., and will be distributed initially through Magnecord outlets. Plans call for six releases per month.

these TWO STANCOR TRANSFORMERS

are part of Stancor's extensive line of catalog part numbers, available for immediate delivery from your local electronic parts distributor

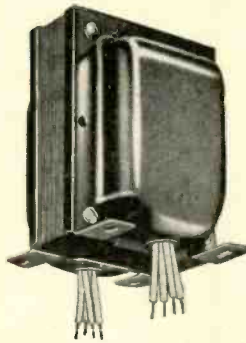

CATHODE RAY TUBE POWER TRANSFORMER, P-8151, for use with type 2X2 rectifier tubes in a conventional half-wave high voltage supply. Plate supply 2,400 AC volts, half wave, 5.0 DCMA. Rectifier filament 2.5 volts at 2.0 amps. Other windings, 2.5 volts at 2.0 amps. Height 4½", base area 3½" x 3¼".



HIGH-FIDELITY INPUT TRANSFORMER, WF-20, for low impedance microphone, pickup or line to grid. Primary impedance 50, 125/150, 200, 250, 333, 500/600 ohms. Secondary impedance 50,000 ohms. Frequency response 30-20,000 cps. ± 2 db. Negligible harmonic and intermodulation distortion. Grey enamel cast case with phenolic terminal board and tapped holes for flush mounting. 2" high by 1¼" square.

These units are examples of the many specialized transformers in the Stancor cataloged line . . . units that are regularly carried in stock.

Check the Stancor Catalog first when you need transformers for industrial, amateur, audio, radio, TV or any other electronic application. You're almost sure to find it there.

You can get your FREE copy from your Stancor distributor, or by writing Stancor direct.

STANDARD TRANSFORMER CORPORATION is one of the leading suppliers of industrial and military transformers built to the manufacturers specifications.

Stancor is your best source for hard-to-design, tough-to-build transformers. At Stancor you will have the services of experienced design engineers and a fully equipped test laboratory with complete facilities for in-plant testing of MIL-T-27 components. Your transformers will be built in the industry's newest transformer plant, using the most modern production and test equipment.



STANDARD TRANSFORMER CORPORATION

3568 Elston Avenue, Chicago 18, Illinois

NEW PRODUCTS

• **Portable Tape Recorder.** Performance based on NARTB specifications is afforded by the new Magnemite Model 610-SD battery-powered tape recorder with spring-wound motor recently introduced by Amplifier Corp. of America, 398-4 Broadway, New York 13, N. Y. Constant tape speed, with flutter content within ± 0.1 per cent over the full winding cycle of six minutes, is achieved by means of a patented centrifugal flyball governor on the spring motor. The motor may be rewound during operation without any perceptible effect on recording or playback. A triple-purpose indicator lamp signals 30 seconds before rewinding is necessary, shows if the power switch is accidentally left on, and indi-



ates any undue variation in tape speed. The 610-SD operates at a tape speed of $7\frac{1}{2}$ ins./sec., furnishing 15 minutes of continuous playing time on a standard 5-in. tape reel. Recordings may be played back on any standard studio equipment. Measuring only $11\frac{3}{4} \times 10 \times 7\frac{1}{2}$ ins., the Magnemite weighs only 15 lbs. complete with self-contained batteries which afford 100 operating hours without replacement. Technical specifications and prices will be supplied on request.

• **Sound Analyzer.** A new instrument which, in addition to measuring intensity, separates sound signals into their component frequency bands, has recently been added to the extensive line of noise-measuring devices manufactured by Hermon Hosmer Scott, Inc., 335 Putnam



Ave., Cambridge 39, Mass. Designated Type 420-A Sound Analyzer, the unit contains high- and low-pass filters which can be independently adjusted in steps of one-half octave. A simple interlock permits the pass-band width to be fixed in any multiple of one-half octave. The position of the pass-band can then be adjusted throughout the audible range by means of a single control. The 420-A exceeds all proposed specifications of the ASA for filter-type sound analyzers. The instrument is housed in a saddle-leather carrying case and may be used while the operator is walking about. Weight is 20 lbs. and dimensions are $10 \times 10 \times 6$ in. Bulletin will be mailed on request.

• **Multi-impedance Dynamic Microphone.** There is little to be required of a microphone, both in performance and flexibility, that is not present in the new Astatic unidirectional Model DR-11. Frequency



response is 40 to 10,000 cps and available impedances, achieved by means of a built-in transformer and selector switch, are 50, 200, 500 ohms and high. Output level is -54 db. The unit employs Astatic's sintered-metal method of acoustic phase shifting. Front-to-back pickup differential is approximately 15 db. Dynamic element is floated in rubber for structural stability and reduction of mechanical pickup. The DR-11 is finished in satin chrome with maroon trim, and is supplied with Amphenol connector and 18-ft. shielded cable: Astatic Corporation, Conneaut, Ohio.

• **Magnetic Tape Recorder.** Five piano-type pushbuttons permit selection of all operating functions, including fast forward, playback, stop, record, and fast reverse, in a new low-priced Knight tape recorder recently announced by Allied Radio Corporation, 833 W. Jackson Blvd., Chicago 7, Ill. Panel-mounted control affords choice of $7\frac{1}{2}$ or $3\frac{3}{4}$ ins./sec. recording speed. Frequency response at the higher speed is 70 to 8500 cps. Playback is by means of a built-in power-amplifier and speaker, with additional provision for feeding external equipment. Extremely compact, the new Knight re-



recorder measures only $14 \times 12 \times 7$ ins. It is housed in a sturdy, luggage-type carrying case. Carrying weight is less than 22 lbs. Supplied complete with crystal microphone, 600-ft. roll of tape, and 5-in. take-up spool.

• **Magnetic Tape Recorder.** Many improvements over earlier models are included in the new Elcor Model 230 tape recorder. Major design emphasis has been placed on functional styling, an example of which is the new "Finger-Flip" control arrangement which affords simultaneous switching of mechanical and amplifying systems. Built-in dual-speed capstan permits instant choice of $7\frac{1}{2}$ - or $3\frac{3}{4}$ -in. recording speed. Normally furnished for dual-track operation, the 230 features a plug-in recording head which can easily be replaced with a single-track head for applications which require editing and splicing. An automatically engaged pressure roller keeps tape in close contact with capstan for elimination of slippage



and consequent reduction of wow and flutter. Frequency response at $7\frac{1}{2}$ ins./sec. recording speed is 70 to 8000 cps within ± 3 db. Cover for portable case carries microphone, break-away power cord, and extra reels. Elcor, Inc., 1501 W. Congress St., Chicago 7, Ill.

• **High-Quality Amplifier.** Although extremely compact, the new Deco Type PTL-8 amplifier affords a calibre of performance normally expected of units considerably larger. Combining an equalizing preamplifier and a power amplifier on a single chassis, the unit has a rated power output of 9 watts with less than 1 per cent harmonic distortion. Intermodulation is said to be correspondingly low. Frequency response is 20 to 20,000 cps within ± 1 db. Hum level is 90 db below rated output. Panel controls include separate bass and treble controls, loudness control, and a combined input selector and phono-equalization switch which ac-

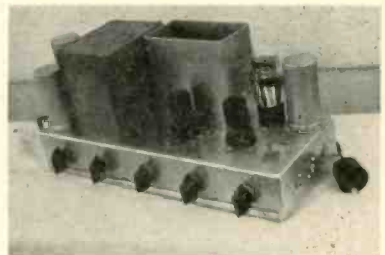

commodates all types of records when played with a variable-reluctance pickup. Dynamics Engineering Co., 234 W. Elm St., Oxnard, Calif.

• **Magnetic Tape For Instrumentation.** In view of the rapidly increasing usage of tape recording equipment for instrumentation and data analysis, Minnesota Mining and Manufacturing Co., St. Paul, Minn., is now producing Scotch tape preselected for telemetering and other instrumentation uses. The new tape is relatively free of nodule, or surface imperfections, and represents considerable improvement over standard tape for instrumentation applications, although it offers no superiority over regular Scotch tape for the recording of musical programs.

ORGAN INSTALLATION

[from page 16]

driver unit and associated horn. Similarly, above 4000 cps the dividing network again diverts the input to a unique horn-type unit designed especially for this very high frequency range.

It is apparent that such a system does not require the use of large and heavy multicellular horns and low crossover frequency thus substantially simplifying the system. As the frequency increases, progressively smaller sources are employed which can therefore have high efficiency in their limited band width (approximately three octaves) as well as improved polar characteristics. The resulting reproducer was found to have very low distortion at the maximum power levels encountered from the lowest notes of 64 cps to well beyond the 12,000-cps value specified. This low-frequency limit with wavelength of about 18 feet obviously simplified the problem, and the horn mouth size of 33 by 36 in. was entirely adequate. Overall dimensions of the reproducer are approximately 38 wide x 62 high x 24 in. deep.

Pedal-Channel Reproducers

The two pedal-channel reproducers each consisted of a large exponential horn driven by two 15-inch Jensen P15-LL special low-frequency direct-radiator type driver units. These horns had continuous exponentially flaring walls with design cutoff of approximately 30 cps. Mouth size was 57 x 89 in. yielding an area of about 35.2 square feet. The throat area was approximately 354 sq. in., giving excellent loading characteristics for the two 15-inch loudspeakers. Tests verified that no enclosing chamber was necessary over the back of the driver units. Figure 5 is a diagram of the pedal channel reproducers.

The wavelength at 32 cycles is about 36 feet, and there was no floor or similar reflecting surface adjacent to the horn mouth to increase its apparent size. However, with this excellent horn loading the electrical power handling capacity of the 15-inch drivers was easily in excess of the 30 watts specified. Reproduction of all pedal tones down to 32 cps met the requirements of high output and low distortion at the highest power levels encountered.

The Loudspeaker Array

Because of the necessity for suspending the entire loudspeaker array, it was imperative to obtain the maximum in efficiency and power handling capacity so that the number of reproducers could be kept at a minimum. The further requirements for low distortion and wide frequency range clearly indicated the necessity for high-quality loudspeakers.

The entire array of reproducers was supported on a platform and hoisted by power winch to a centrally located po-

By Popular Demand! Another Big Page in Leonard History!



PRESTO PT-920 TAPE RECORDER SYSTEM

Developed for fully professional work, the PT-920 is the ideal recorder for schools and university work. The unit consists of a 3 motor driven system; separate erase, record and reproduce heads; and 2 separate amplifiers . . . one for recording and the other for monitoring. Continuous recording may be had through the use of 2 RC 7 mechanisms and 1 amplifier with the use of the Presto SA 10 changeover switch. Complete specifications on request.

RC-7 \$425.00 net
A-920 324.00 net

FAIRCHILD 3 WAY TURRET HEAD ARM



Ideal for all types of records, this 3-way arm assures freedom from troublesome arm resonance and distortion. Stylus pressure is adjustable . . . spring tension set at factory for 15 grams standard; 6 grams micro-groove. Overall length: 18 1/2"; center pin of turntable to center of arm base: 13 3/8"; base diameter: 2 7/8".

\$65 net



FAIRCHILD 215B CARTRIDGE

Famous Fairchild HIGH COMPLIANCE reduces needle wear, stylus wear, needle talk, record hiss and arm resonance! You'll get improved low frequency and NO tracking distortion! Moving coil design . . . finest diamond stylus.

215B 2.5 mil stylus tip \$42.50 net
215C 3.0 mil stylus tip 42.50 net
215A 1.0 mil LP stylus 47.50 net

PRESTO 15G 3 SPEED MICROGROOVE & STANDARD TURNTABLE



Here's a top quality unit for all 33-1/3, 45 and 78 rpm reproduction. Easily connected to any radio or audio amplifier, the 15G boasts a heavy cast aluminum 12" turntable . . . precision idler wheels and motor pulley . . . and minimum "wow".

\$49.50 net



LEONARD-RADIO-INC.

69 CORTLANDT ST., NEW YORK 7, N. Y.

Audio Mart

Dept. A12

CORTLANDT 7-0315-9

The House Built on Service

sition near the roof. Figure 6 shows the complete array before hoisting. The individual reproducers were arranged on the periphery of the platform leaving sufficient working space in the center for all required operations. The platform was accessible from a catwalk just under the roof. All cable connections were completed after the array was raised into position. Each manual-channel reproducer horn was hinged to the platform at its back edge and could be tipped back to lie flat for access to the Triaxial loudspeaker driver unit. These reproducers were locked in normal position by latching to the next adjacent reproducers. The driver units for the pedal channel reproducers were directly accessible from the back.

As indicated in the block diagram

separate cables were used for each manual reproducer and for each driver unit in the pedal reproducers. These cables extended from the amplifiers, located adjacent to the console near one end of the auditorium, to the loudspeaker array. These 14-ga. cables with a length of approximately 300 feet were satisfactory for use with the 16-ohm load impedances, thus eliminating the need of additional transformers. Plug connectors at the loudspeaker array simplified installation.

All of the individual reproducers were oriented so that the "axes of radiation" all would lie in a horizontal plane directing the sound into the slanting (domed) roof. The sound was thus reflected downward into the audience adding a feeling of "expansiveness". This

procedure, while quite satisfactory for the reproduction of organ type music, is entirely contrary to the required procedure for public address systems where the sound must be directed to the audience and all reflection must be eliminated so far as possible. The deep balconies—usually the downfall of the PA system—proved no particular problem due to the high percentage of reflected sound energy in the auditorium. The reproduction was entirely satisfactory in all parts of the hall even for the high-frequency range.

With such an application as this there is no opportunity to test performance before the actual final operation because the system performance is dependent on the audience size and the ambient noise. Many doubts existed as to the adequacy of the system despite the favorable performance with an empty auditorium. However, the performance during the two conventions justified the careful planning of the system, and unsolicited praise from many of the official personnel verified the acceptability and adequacy of the system.

Unparalleled "PRESENCE"

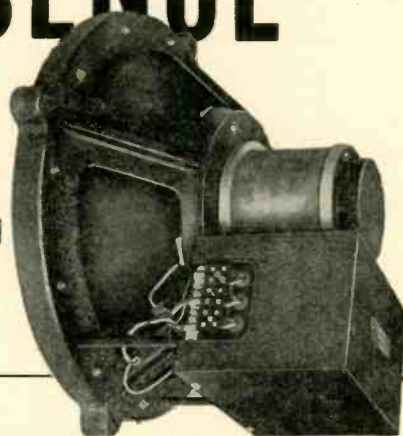
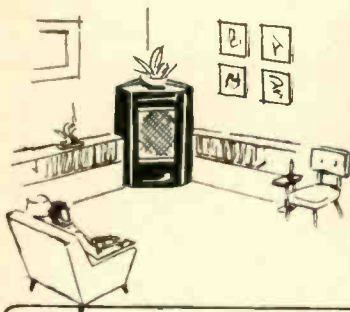

Famous
TANNOY
DUAL CONCENTRIC
LOUDSPEAKER SYSTEMS

**NOW AVAILABLE
IN AMERICA!**

Now experience the amazing listenability of wide range response in perfect balance. Hear the world famous Tannoy Dual Concentric Loudspeaker System, providing optimum fidelity at any level from the audibility threshold up to full room volume. Features of the Tannoy System include:

Substantially flat response from 40-20,000 cycles per second. Concentric sources for both HF and

LF components avoiding interference at crossover. HF horn formed by machined center pole and LF diaphragm, these combined with a special throat insure correct HF match. Intermodulation product less than two percent.

Hear it to appreciate it! Write for free brochure and name of nearest distributor today. 12" and 15" types, handling 15, 25 watts.

SOME DISTRIBUTORSHIPS STILL AVAILABLE

TANNOY

BEAM INSTRUMENTS CORPORATION
350 FIFTH AVENUE NEW YORK 1 NEW YORK

TABLE 1
SPECIFICATIONS FOR MODEL 2C2
CONNSONATA

Swell Manual: 61 Keys
Great Manual: 61 keys
Pedalboard (standard AGO): 32 notes

Stop list:

Great

- Open Diapason
- Melodia
- Gross Flute
- Dulciana
- Gamba
- Trumpet
- Great Union Off (8')
- Great 4'
- Swell to Great 16'
- Swell to Great 8'
- Swell to Great 4'
- Swell to Great 2'
- Great Tremolo Off

Echo

Echo and Main

General

- Tremolo—Light
- Tremolo—Medium
- Tremolo—Heavy

Pedal

- Major Bass
- Gedeckt
- Bourdon
- Dulciana
- Great to Pedal 8'
- Swell to Pedal 8'

Swell

- Geigen Diapason
- Harmonic Flute
- Gedeckt
- Echo Salicional
- Viola da Gamba
- Vox Humana
- Oboe
- Swell 16'
- Swell Union Off (8')
- Swell 4'
- Swell 2 2/3'
- Swell 2'
- Swell 1 3/5'
- Swell Tremolo Off

Balanced expression pedal controlling over-all volume of entire instrument

Off/On power switch with pilot light

Note: Tremolo is activated on entire organ by depressing any of the tremolo switches. Is cancelled on individual manuals by using Tremolo Off switches.

NETWORKS

[from page 17]

ing, the source impedance seen by each speaker should be as low as possible.

It is evident that conditions (1) and (2) will be implicitly satisfied if requirements (3) and (4) are met.

Two networks that will fulfill requirements (1) through (4) are shown in Fig. 1, where R is the impedance of the speaker, and f_c (the "crossover" frequency) is the frequency at which the radiated power is equally divided between the two speakers. The input impedance of either of these two networks is equal to R , and is independent of frequency, if the following conditions are met: (a) the impedances of the speakers must be equal, and (b) the impedance of each speaker must be a pure resistance.

Circuit A of Fig. 1 provides a considerably sharper frequency division of the signal than does circuit B; the power radiated by each speaker of circuit A falls off at a rate of 12 db per octave in the cut-off band, whereas the slope for circuit B is 6 db per octave. Which of these circuits is the more desirable depends on several factors. Use of the sharper slope, for instance, reduces the range of frequency over which any one speaker has to handle an appreciable amount of power. However, unless great care is exercised in locating the speakers, this same sharpness of crossover may destroy the illusion that the sound is being radiated from a single source, since the fact that the sound is being produced in two frequency bands is more obvious under these conditions.

Relative Advantages

From the point of view of the hobbyist, circuit B offers certain advantages over the more complicated circuit A. It is true that a saving in complexity of the circuit is probably of negligible importance, *per se*; and certainly any reduction in size and weight of the circuit will be a small percentage of the volume and weight inherent in the speakers themselves. However, there is a material saving in the cost of the components required—circuit B requires only about 36 per cent of the inductance, and some 70 per cent of the capacitance required by circuit A for a system having the same crossover frequency and the same speaker impedance. Since the capacitors used in a high-fidelity system must be of the high-quality, oil-filled variety, and since the values of capacitance required in a practical system are quite large, a reduction by 30 per cent in capacitance represents a very real reduction in cost. Moreover, use of a smaller inductance will result in a lower resistance in the inductors, with a slight resultant gain in efficiency, and with a concomitant improvement in damping.

In circuit B, any resistance in the in-

ductor winding can be written off as part of the speaker resistance, and can easily be balanced by addition of a padding resistance in the other half of the circuit. However, a reasonable amount of resistance unbalance can be tolerated, except when feedback is used from the voice-coil windings. In the latter case, phase shift may become excessive if balance is not maintained.

Similarly, inductance in the speaker winding can be regarded as part of the inductor in one branch of circuit B. Unfortunately, however, since this speaker is carrying the low-frequency components of the signal, the inductance in this speaker is of less importance than it is in the other speaker, which is not compensated by the cir-

cuit configuration. By application of Thévenin's theorem, one may see that it is possible to regard shunt capacitance around the high-frequency speaker as included in the series capacitor, although this capacitance should be negligible, even at the highest audio frequencies.

So far, nothing has been said about requirement (5) above, i.e., that the speakers should see a low-impedance source. Unfortunately, both of the above circuits are weak in this respect, circuit B perhaps having a slight advantage over circuit A. Moreover, the source impedance—and hence the speaker damping—will be a function of frequency. If speaker resonance occurs at a frequency at which the damping

No Competition...the Best!

"Triumph"
MODEL RC-80
Fully automatic
with automatic
stop!

**INCOMPARABLY
BETTER — YET
PRICED TO COMPETE
WITH THE ORDINARY!**

GARRARD

THE WORLD'S FINEST RECORD CHANGER

EVERY FEATURE TESTED FOR FINEST PERFORMANCE

 <p>PUSHER TYPE PLATFORM: It always works</p>	 <p>TWO INTERCHANGEABLE SPINDLES: Plays records as intended</p>	 <p>HEAVY DRIVE SHAFT: No wows, no wavers</p>	 <p>JEWEL MOUNTED TONE ARM: Disturbing resonance eliminated</p>
 <p>HEAVY DUTY SILENT MOTOR: Absolutely no rumble</p>	 <p>WEIGHTED TURNTABLE: Gives flywheel action</p>	 <p>MUTING SWITCH: Silence between records</p>	 <p>SIMPLE INSTALLATION: Fits former Garrard cut-outs</p>

For complete information write to Dept. AE-12

GARRARD SALES CORPORATION

164 DUANE STREET, NEW YORK 13, N. Y.

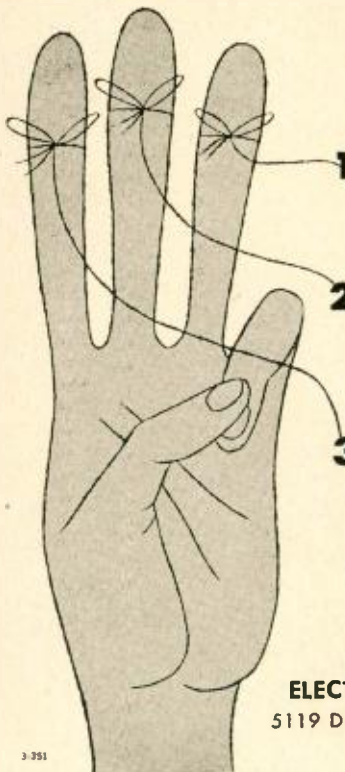

THERMADOR TRANSFORMERS BECAUSE:

- 1 Wide Selection...**
The new catalog line includes units for amateur, audio, broadcast, aircraft, television, geophysical, radio and radar applications.
- 2 Design and Testing Facilities...**
Thermador has complete facilities for designing and testing transformers for prototype equipment and compliance with JAN specifications.
- 3 Long Experience—Big Manufacturing...** Years of learning how and the West's largest transformer manufacturing facilities give you precision and quality in quantity.

THERMADOR

ELECTRICAL MANUFACTURING CO.
5119 District Boulevard, Los Angeles 22, Calif.

3 351

DC to AC Converters

Dynamotors

Genemotors

DEPENDABLE... COMPACT... EFFICIENT

Carter Rotary Power

Carter DC to AC Converters, Dynamotors, Genemotors, Magmotors, and Inductor Alternators (inverters) are made in a wide variety of types and capacities adaptable to communications, laboratory, and industrial applications, of many kinds. Widely used in aircraft, marine, and mobile radio, geophysical instruments, laboratory work, ignition, timing and many other uses.

Carter Motor Co.
2643 N. Maplewood Ave., Chicago 47
Sales Offices in Principal Cities

MAIL COUPON FOR CATALOGS

Please send catalogs containing complete information on Carter Rotary Power Supplies.

Name _____

Address _____

City _____ State _____

*Trade Mark Registered

Recorder Converters

Inductor Alternators

Magmotors

is ineffective, "muddy" performance is inevitable.

However, a low source impedance can be provided by applying the voltage across the voice coils as an inverse feedback signal. Feedback voltage may be developed by the circuit shown in Fig. 2. For "flat" output, R_1 and R_2 should be equal. A certain amount of tone control can be exercised by varying the ratio of R_1 to R_2 , thereby varying the relative outputs of the two speakers.

It is assumed that inductors will be wound especially for the circuit, since it is highly unlikely that the non-standard values of inductance required will be available commercially. The fact that L and C will resonate at the crossover frequency can be used to determine the required inductance. However, this method does not insure the relationship $L = R^2C$ (or $L = 2R^2C$), due to tolerances in R and C , and the voltage relationships in the circuit may deviate seriously from those predicted on a basis of the nominal values. A more satisfactory procedure would be to adjust the inductance to the actual resistance and capacitance values, absorbing the tolerances in these quantities in a slight shift of the crossover frequency. The proper inductance may easily be determined by use of the circuit shown in Fig. 2; if R_1 and R_2 are equal, the correct amount of inductance will provide a constant voltage gain from a to b , independent of frequency. Values of L and C , normalized with respect to R , are plotted against crossover frequency in Fig. 3.

If circuit A of Fig. 1 is used, care must be taken to maintain equal resistance, inductance, and capacitance in both branches of the circuit. R and C can be trimmed with the help of a simple bridge, but cut-and-try seems to be the only feasible way to insure balance of the inductances, at the same time satisfying the condition, $L = 2R^2C$. In this respect, the simplicity of circuit B proves to be a strong argument in favor of the latter circuit.

Either of the two circuits shown in Fig. 1 is readily adaptable to systems of three or more speakers. For a three-speaker system, a complete dividing network and its associated speakers may be substituted for one of the speakers indicated in Fig. 1—since the network with its speakers presents a constant resistive impedance, the original network will operate exactly as if working directly into a speaker.

E-V PURCHASES RME

Albert R. Kahn, president of Electro-Voice, Inc., announced recently that Radio Mfg. Engineers, Inc. (RME) has been purchased by E-V in keeping with an over-all program of meeting the needs of a great and expanding market in the audio-video field.

RME, a 19-year-old firm which manufactures communications receivers and accessories, will remain under the present management of E. G. Shalkhauser and Russ Planck, and all RME business will be conducted from its present offices at Peoria, Illinois.

EQUALIZER

[from page 19]

value equal to R_2 minus the coil resistance.

As a general observation, r.f. chokes can be used in applications requiring inductances of less than 15 mh. While a



Fig. 5. Internal construction of the equalizer shown at the right in Fig. 4.

high Q is desirable, it can nevertheless be discounted to the extent that it is possible to attain the necessary objective. For extremely "sharp" curves, best results can be obtained by the use of toroids, but for most applications it will be found that r.f. chokes can be used, and at considerably less expense.

AES NEWS

[from page 12]

the Society, and as a consequence have been elected Sustaining Members for the coming year, in accordance with the Constitution. These organizations are:

Altec Lansing Corporation
 Audak Company
 Audio & Video Products Corp.
 Audio Development Company
 Audio Devices, Inc.
 Bell Sound Systems, Inc.
 British Industries Corporation
 Cinema Engineering Company
 Columbia Records, Inc.
 The Daven Company
 Electro-Voice, Inc.
 Fisher Radio Corporation
 Harvey Radio Company, Inc.
 Magnecord, Inc.
 McIntosh Laboratory, Inc.
 Pickering & Company, Inc.
 Presto Recording Corporation
 Reeves Sound Studios, Inc.
 Reeves Soundcraft Corporation
 Rek-O-Kut Company
 Terminal Radio Corporation

Election Results

The results of the annual election were also announced at the Society's business meeting, October 29. The new officers for the year ending October 31, 1953, are:

"Compact Little Marvel of Tone"

THE NEW BOGEN DB10-1 HIGH FIDELITY AMPLIFIER

- 10 WATTS OUTPUT
- RESPONSE FLAT FROM 30 TO 18,000 CYCLES
- SHOCK MOUNTED PREAMPLIFIER
- INDIVIDUAL BASS & TREBLE CONTROLS
- VIRTUALLY HUMLESS
- UL APPROVED



C. G. BURKE
 WRITING IN THE SATURDAY REVIEW
 HOME BOOK OF RECORDED MUSIC HAS STATED:

"The Bogen DB-10 is a compact little marvel of tone... resourceful enough to compete over most of its range with amplifiers costing three times as much... It employs six tubes and is rated at ten watts... It has three input channels—one for strong-impulse magnetic pickups like the Pickering, one for weak impulse magnetic pickups like the GE, and one for tuner or crystal pickup... The tone controls—separate for bass and treble—are continuously variable providing both increase and diminution, and are capable of surprisingly efficient rectification of the idiosyncrasies of records..."

CALL OR WRITE FOR
 LITERATURE ON BOGEN
 HIGH FIDELITY EQUIPMENT



DAVID BOGEN CO., INC.
 29 NINTH AVE., NEW YORK 14, N. Y.

A Quarter Century of Electronic Equipment Specialization

NEW PERFORMANCE STANDARDS with the WEATHERS FM CAPACITANCE CARTRIDGE

20 to 20,000 Cycles Response

W-202 or
 W-202-C
 Cartridge
 Set



DO YOU REALIZE WHAT LOWER
 STYLUS PRESSURE CAN DO FOR
 REPRODUCTION FIDELITY AND
 RECORD LIFE?????

You can operate with stylus pressures
 down to one gram with the new WEATHERS
 Cartridge!

Get the NEW W-202-C Cartridge Set for your present
 record player (automatic or manual) to enjoy unexcelled
 high fidelity reproduction.



For the ultimate in record reproduction, with
 one gram stylus pressure, combine the standard
 W-202 Cartridge Set with the new WEATHERS
 W-12 or W-16 Reproducer Arm.



W-12
 Reproducer Arm

Change to the WEATHERS Cartridge NOW and preserve
 your records for the years to come.

See your dealer or
 write for literature

WEATHERS INDUSTRIES

Box 531 66 E. Gloucester Pike
 Barrington, N. J.



equalizers

PROGRAM . . .
Adjusts for equipment, pick-up and transmission line deficiencies. Constant "K" circuit. No variation over the entire range of equalization or attenuation.



DIAMETER . . .
Automatic equalization at any cutting head position. Fits all lathes without mechanical alteration.



PLAYBACK . . .
Adheres to the approved orthacoustic curve. Resistors, capacitors and inductances are all individually bridged and adjusted.



Write for Complete Catalog

N. Y. Stock:
Audio & Video Products Corp. • 730 Fifth Ave., Plaza 7-3091



CINEMA ENGINEERING COMPANY
1510 WEST VERDUGO AVENUE, BURBANK, CALIFORNIA

Export Agents: Frazar & Hansen, Ltd. • 301 Clay St • San Francisco, Calif. U.S.A.

F. SUMNER HALL *President*
 JERRY B. MINTER *Executive Vice-Pres.*
 W. S. PRITCHARD *Central Vice-Pres.*
 R. L. BURGESS *Western Vice-Pres.*
 C. J. LEBEL *Secretary*
 RALPH A. SCHLEGEL *Treasurer*

Three new governors were elected to fill expiring terms: C. R. Sawyer, Price E. Fish, and Jay H. Quinn. Albert A. Pulley was appointed by the Board of Governors to fill the unexpired term of Jerry Minter, who became executive vice-president. The remaining governors, with one year yet to serve, are W. Oliver Summerlin and John D. Colvin. C. G. McProud, retiring president, becomes a governor for one year in accordance with a provision of the Constitution which was adopted by vote of the membership, along with a number of other amendments to both Constitution and By-Laws. All of the changes submitted to the membership for vote were adopted, with no more than three dissenting votes on any particular section.

Copies of the Constitution and By-Laws as amended will be sent to all members as soon as they can be printed. For the first time in the Society's history, all 29 of the papers given at this year's convention will be assembled in a single volume, complete with illustrations, and furnished to members shortly after the first of the year. These collected papers will be available to non-members for a nominal charge.

LETTERS

[from page 6]

extraordinarily handy when picking up the amplifier. . . .

EDWARD H. BENNETT, JR., A.I.A.,
80 East Jackson Blvd.,
Chicago 4, Ill.

SIR:

. . . As for the chassis, it is quite agreed that absolute solidity is necessary but this was achieved much more easily than by hollowing out a solid block of aluminum, as suggested by Frudd. The parts were assembled, placed in a mould and molten aluminum poured around them.

Since the writer did not happen to have in his garage (he has no garage, as a matter of fact) an old turret lathe on which to wind the hyper-toroidal, sextifilar transformers (quadrifilar not being sufficiently absorptive of ergs) he was forced to have cores made in the shape of an old turret lathe, winding the coils on these. This was difficult, as might be suspected, but was deemed advisable.

The speaker system presented no problem, especially after reading Frudd's lucid account. It was, however, found necessary to connect at least one of the speakers electrically, a total of nineteen speakers being used.

FRANK S. LEVY,
Levy-Tathwell Company,
P. O. Box 1955,
Charlotte 1, N. C.

(Obviously, you can't please all of the people all the time. We appreciate the many comments on the Frudd System and the many constructive suggestions received, particularly since this was *Æ*'s first studied attempt at humor. But we can't understand why no one noticed Mr. Drenner's article in the same issue. Ed.)

Authoritative and Enlightening . . .



*Acknowledged the Leading Publication
in the Field of Sound Reproduction*

If you are novice, hobbyist, experimenter, or engineer . . . if you are a lover of music . . . and in pursuit of sound, undistorted . . . Audio Engineering will be your faithful, reliable companion all the way.

"What to Do" and "How to Do" will guide your every move through this thrilling experience we call Audio.

Each new issue brings New Ideas, New Slants, and Latest Developments . . . month in and month out . . . twelve times a year.

BE SURE to get your copies REGULARLY

MAIL this
Coupon NOW

AUDIO ENGINEERING

P. O. Box 629, Mineola, N. Y.

Enclosed is Check Money Order for \$_____

Please send a copy of each new issue of Audio Engineering for the next

12 months; 24 months to:

Please Print

Name _____

Address _____

City _____

Zone _____ State _____

Subscription Price: U.S.A., Canada and Pan American Union: 1 year . . . \$3.00 2 years . . . \$5.00. Other countries: 1 year . . . \$4.00 2 years . . . \$7.00.



A MONTHLY SUMMARY of product developments and price changes of radio electronic-television parts and equipment, supplied by United Catalog Publishers, Inc. 110 Lafayette Street, New York City, publishers of Radio's Master.

These REPORTS will keep you up-to-date in this ever-changing industry. They will also help you to buy and specify to best advantage. A complete description of most products will be found in the Official Buying Guide, Radio's Master—available through local radio parts wholesalers.

Miscellaneous Radio, TV, and Electronic Parts

ARGO ELECTRONICS—Introduced ceramic disc capacitor series CCD, CCDD, used primarily for coupling and by-pass in r.f. and higher-frequency circuits. are wax impregnated with low-loss phenolic coating. voltage rating 1500 v.d.c.t., 500 v.d.c.w. Also feed-through capacitor series CCF designed for high-frequency coupling with a minimum of inductive reactance through elimination of wire leads.

CREST LABS.—Added series MT, SMT, MMT transistor transformers.

GUARDIAN ELECTRIC MFG.—Discontinued the 25-cps a.c. coils in their relays No. 200-6A, 200-12A, 200-24A, 200-115A. Added No. 200-5 to their contact switch assembly series at \$3.35 net.

LITTELFUSE—Added No. 30307.5, 7 1/2 amp fuse in their 7AG fuse series and No. 312.187 to their 3AG fuse series.

MILLER CO., J. W.—Introduced No. 522, photo-oscillator coil at \$1.98 net. No. 112-H6, air-core midset transformer at \$1.59 net, and 4 other air-core transformers.

SOLA ELECTRIC—Discontinued 5 constant-voltage transformers, superseded by 5 new models.

Recording Equipment, Speakers, Amplifiers, Needles, Tape, Etc.

AMERICAN MICROPHONE—Introduced crystal lapel microphone No. CL-3 at \$28.45 list. frequency response 50-5,000 cps, output level - 55 db (0 db = 1 volt/dyne/cm²), diameter 2 1/4", depth 3/4", weight 6 1/2 ozs. Decreased price to \$3.60 net on No. CR-5, crystal cartridge, 1 volt output, 50-6,000-cps frequency range, weight 5 grams, supplied with one-mil-radius hemium tip needle.

ARGOS PRODUCTS—Discontinued No. PC-1, record changer carrying case.

ATLAS SOUND—Discontinued speaker support stand No. HM-2 and marine midset projector No. WX-5.

PERMOFLUX—Introduced No. CH-16B (blond) at \$86.10 net and No. CH-16M (mahogany) at \$74.70 net. Both are dual corner horn baffles with multiple arrangement of 8" speakers or an alternate mounting board for one 12" speaker.

RADIO MUSIC CORP.—Introduced Model TP 12E, turntable chassis with 12" platter, synchronous motor, at \$100.50 net.

TURNER CO.—Introduced Model C-3, microphone desk stand, 8 1/2" high, 4 3/4" diameter, 14 oz. weight, satin chrome finish. Model B-3 (same as C-3) with brown metal lustre finish. Model G-3 (same as C-3) with gunmetal lustre finish, all 3 models at \$2.01 net each. Also added Model TR2 at \$9.00 net, matching transformer, matches 30-50, 200-250, and 500-ohm lines to grid, wide frequency response: ± 1 db from 40-10,000 cps, one hole mounting, equipped with 3-contact locking connector and 7 ft. two-conductor shielded balanced line cable.

Test Equipment

G.E.—Discontinued Model YNA-4, industrial oscilloscope for reengineering purposes. Increased price on Model YW-3, industrial tube analyzer to \$628.97 net.

HICKOK ELECTRICAL INSTR. CO.—Increased price on Model 465, double-range d.c. kilovoltmeter. The leads and carrying case for this model are discontinued.

JACKSON ELECTRICAL INSTR. CO.—Added Model 707, cathode ray tube analyzer at \$419.50 net.

RADIO CITY PRODUCTS—Discontinued No. 322AK, tube tester kit. No. 322PK, portable tube tester kit. No. 323M, tube merchandiser. No. 450A, bi-megohm multimeter and No. 450AP, portable multimeter. Increased price on No. 453, Master Multimeter to \$49.50 net.

SCALA RADIO—Added Model BZ-123, a combination of Models BZ-1, BZ-2, BZ-3, containing a signal-tracing probe, a low-capacitance probe, and a 100:1 voltage-divider probe, at \$27.45 net. Also introduced Model BZ-C, a spare or replacement low-capacitance calibrated coaxial cable for any of the above probes.

New
WILLIAMSON TYPE

Heathkit AMPLIFIER KIT

AMPLIFIER Features

- First Williamson Type Amplifier supplied with matching preamplifier
- Uses Altec Lansing Peerless output transformer.
- Practically distortionless—Harmonic and intermodulation distortion both less than 1/2 of 1% at 5 watts output.
- Frequency response
 - ± 1 db from 10 cycles to 100 kc.
 - Output impedance 4, 8, or 16 ohms.

The new Heathkit Williamson type Amplifier kit is the best obtainable in amplifiers today—the choice of the really discerning listener. You can hear the difference and measurements actually back up the superb performance. Frequency response ± 1 db from 10 cycles to 100 kc allow you to hear the highs and lows with equal crispness and clarity. Harmonic and intermodulation distortion both less than 1/2 of 1% at 5 watts output eliminate the harsh and unpleasant qualities which contribute to listening fatigue.

The circuit is similar to the one published in Audio Engineering Magazine for November, 1949, and is considered by engineers throughout the audio field as one of the best ever developed. The Main Amplifier (which may be purchased separately) consists of a voltage amplifier and phase splitter using a 6SN7, a driver stage using a 6X4, and a push-pull output stage using a pair of 607 tubes. The output transformer is manufactured by the Peerless Division of Altec Lansing and is built to their highest standards. Output impedances of 4, 8, and 16 ohms are available. The power supply uses a separate chassis with heavy Chicago Transformer power transformer and choke, and 100V Mallory filters for long hum-free operation. A 5V4G rectifier is used.

The main amplifier and power supply are each on a chassis measuring 7" high by 5 1/2" wide by 11" long.

PREAMPLIFIER AND TONE CONTROL UNIT KIT

The preamplifier kit consists of a 12AX7 (or 12AY7) dual triode first amplifier stage with a turn-over control for LP or 78 record types, and a 12AU7 amplifier stage with individual bass and treble tone controls which each provide up to 13db of boost or attenuation. A switch on panel selects either magnetic, crystal, or tuner inputs. Preamplifier also is well suited to custom installations—it will operate in either vertical or horizontal position, and special notched shafts of the controls and switches allow a variety of shaft lengths to be selected. Dimensions: 2 1/4" high by 10 1/4" wide by 7 1/4" deep.

WRITE FOR
Free
CATALOG

The
HEATH COMPANY
BENTON HARBOR 25,
MICHIGAN

*You SAVE BY
ORDERING DIRECT*

WA-A1 Amplifier kit—Combination 1—(Main Amplifier and Power Supply) complete with WA-P1 Preamplifier kit. Total Ship. Wgt., 34 lbs. (Shipped Express only)..... **\$69.50**

WA-A1 Amplifier kit only—Combination 4—(Main Amplifier and Power Supply). Less WA-P1 Preamplifier. Total Ship. Wgt., 29 lbs. (Shipped Express only)..... **\$49.75**

WA-P1 Preamplifier Kit only. (Gess power supply) (Tubes included). Total Ship. Wgt., 7 lbs. (Shipped Express or Parcel Post)..... **\$19.75**

IT'S ALLIED FOR RCA

ELECTRON TUBES FOR INDUSTRY

Quick, Expert Service on RCA Tubes

ALLIED maintains in stock for quick shipment, the world's largest distributor inventory of RCA special-purpose tubes. We specialize in supplying the needs of industrial, broadcast, governmental and other users. To save time, effort and money—phone, wire or write to ALLIED. Fill all your electronic needs from one complete reliable supply source.

1953 ALLIED CATALOG

Refer to your ALLIED Catalog for all electronic supplies—parts, tubes, test instruments, audio amplifiers, accessories—available from the world's largest stocks. Write today for FREE 1953 ALLIED Catalog.

AUTHORIZED DISTRIBUTOR

RCA

ALL TYPES IN STOCK

- Vacuum Power
- Thyratrons
- Vacuum & Gas Rect.
- Ignitrons
- Cold-Cathode
- Phototubes
- Oscillograph Tubes
- Camera Tubes
- Monoscopes
- Special Types

FREE Interchangeability Directory

Valuable guide to selection of proper RCA tube type replacements. Lists 1600 tube types. Write today for this FREE RCA Guide No. 37-046.

Everything in Electronics FROM ONE RELIABLE SOURCE

ALLIED RADIO

833 W. Jackson Blvd., Dept. 17-M-2
Chicago 7, Ill.

FREE CATALOG!—Send for it now!

SOLVE your hi-fidelity problems with
University TWEETERS
WIDEST SELECTION, BEST VALUE, HIGHEST QUALITY!
HIGH FREQUENCY REPRODUCERS

MODELS 4408, 4409—600 CYCLE TWEETER. Response 600-15,000 cps. Ideal for 2 or 3-way systems as Tweeter or mid-range speaker where low crossover frequencies are desired. EXCLUSIVE "reciprocating flares" design results in wide angle distribution. Use with amplifiers up to 40 watts.



MODEL 4407 — COAXIAL SPEAKER ADAPTER. Converts conventional 12" cone speaker into a wide-range coaxial reproducer in a few minutes. Installation is extremely simple and results in a dual speaker system at relatively low cost. Model 4407 includes Model 4401 Tweeter.

MODEL 4401 — 2000 CYCLE TWEETER, response 2000-15,000 cps. Efficient and economical for extending the response of any good 8-15" cone speaker to 15,000 cps. EXCLUSIVE "reciprocating flares" design assures wide angle dispersion. Use in 2 or 3-way systems where crossover in the 2000-5000 cps range is desirable. For amplifiers up to 25 watts, woofers 6-16 ohms.



MODEL 4402 — WIDE ANGLE DUAL TWEETER. The most versatile reproducer ever available. Use of TWO independent drivers permit series or parallel connection for matching 4-16 ohm speakers. For amplifiers to 50 watts. Can be connected for medium or wide angle distribution. For 2 or 3-way systems. Response 2000-15,000.



CROSSOVER NETWORKS

MODEL 4405 — FREQUENCY DIVIDING NETWORK. An effective and economical unit preventing frequencies below 2000 cycles from entering the Tweeter circuit. Protects the Tweeter and reduces overlap in the crossover range. Includes built-in volume control.



MODELS 4410, 4420—L/C CROSSOVER NETWORKS. Segregates highs to the Tweeter and lows to the woofer. Reduces overlap response in Tweeter and woofer. Model 4410 for 600 cycle reproducers, 4420 for 2000 cycle tweeters. Can be used together as a network for 3-way systems. Volume controls included.



Write for literature describing 8", 12", and 15" extended range, coaxial and woofer type cone speakers. Address Desk A-12.

University LOUDSPEAKERS INC
80 SO. KENSICO AVE., WHITE PLAINS, N. Y.

SPEAKER TREATMENT

[from page 23]

seen when it is held up to a light, and the small amount of improvement possible is effected with a relatively small number of slits. In older speakers with stiff suspensions it appears that more slits are better. A wise approach is to make a small number of slits at first—about sixteen for example—then if the improvement is not what was anticipated, to try more between the first set. A pair of drafting dividers are used to space the slits evenly. They are set by trial so that when "walked" around the edge of the first corrugation they return to the same spot with integral spacing. Then they are walked around again allowing the points to prick the cone and thus mark the correct location for each incision. A sharp razor blade is used to slit carefully as close along a radial as possible, from the middle of the first corrugation (which is the cone edge) across the rim to the area where it is cemented to the "basket." The rim should not be torn and the cuts should go all the way to the bottom of the following corrugations. If the suspension at the apex of the cone, the so-called "spider," is also of the corrugated type, slitting here will afford an additional lowering of the resonant frequency. Often this is difficult or impossible to do, however, and might affect the high-frequency response.

The second means of improvement is called "plasticizing." Plasticizing is accomplished by applying a suitable chemical agent to the suspension to make the fibers more pliable and yielding. The plasticizing described herein was accomplished with Dibutyl Phthalate which can be obtained from large chemical supply houses.² Dibutyl Phthalate appears to be a good plasticizer in not drying out over a period of time; but it does have the marked disadvantage of "creeping," that is, spreading through the cone by capillary action. This would be disastrous if allowed as the whole cone instead of just the suspension would thus be made pliable and piston action would suffer, resulting in low efficiency and weakening of high frequencies. To prevent this condition the edge is first made impervious to capillary travel by sealing the pores with an application of shellac, varnish, or cement. This means the addition of a small amount of mass to the cone, and a further lowering of the resonance point is sometimes noticeable but rather negligible. A small soft brush is used to paint the cone in a swath about 3/4-inch wide (for large speakers) just inside the curvature of the first corrugation—on both sides of the cone. Clear shellac was used in most of the treatments attempted, and with a fair amount of success, but it tends to break down under reaction from the Phthalate if the cone is very well

² Eimer & Amend, New York City, for example.

AS NEW!



SONOCRAFT FM TUNER
\$89.95

Modern design throughout. Compact size (only 4 1/2" high x 10" wide) permits use as a replacement in almost any type of music system, bringing it up to present day standards.

DESIGN FEATURES

- Novel blackout tuning indicator in VTVM circuit
- Drift free—Automatic Frequency Control
- 5 Microvolts sensitivity
- AFC can be disabled in strong signal areas
- Full Armstrong circuit—completely shielded
- Exclusive design of dial plate provides for simple cabinet installation

NOW OPEN A new studio designed for you—right in the heart of New York City. America's finest and most flexible sound demonstration studio—At last you may experience the breathtaking realism of reproduced music.

FREE
WRITTEN FOR MUSIC LOVERS BY IRVING GREENE
124 pages — chock full of valuable information and listings of high fidelity components. Dept. EA

ALLIED SOUND CORPORATION
115 WEST 45 STREET (3rd FLOOR)
NEXT TO TIMES SQUARE
NEW YORK 36, N. Y. LUXemburg 2-1750

felted. Recent but rather inadequate experience with so-called "radio" cement would seem to recommend it because it does not appear to be affected by the plasticizer. It is important that a good job be done in blocking the creep of the Pthalate, because if it once gets started through, it is difficult to stop it. One should apply several coats of the sealer if inspection deems it advisable. When this operation is finished and the sealer is dry, the plasticizer may be applied with a cotton swab. Distributing it in even amounts around the periphery of the suspension is desirable, but there is no worry about spreading it laterally as the Pthalate spreads itself. If it should begin to work past the barrier after ageing, another swath of sealer may be applied to stop it.

Results Obtained

By utilizing one or both of these two methods of suspension treatment, the results shown in the chart may be obtained. The improvement in low-frequency capability is evident. We have thus far stressed only the advantages in bass, but no really deleterious effects to the higher ranges have been noted. It would seem that the slitting operation could conceivably cause edge effects resulting in irregularities in the middle frequency range. One of the most pronounced peaks of a speaker's middle frequency response

TABLE I

Speaker	Results of Speaker Treatment		Treatment
	Resonant Before Treatment	Frequency After Treatment	
3" Cinaudagraph P2A1	230	205	Eight slits
4" x 6" RCA 446S2	195	190	Sixteen slits
		155	Sixteen slits
		147	Thirty-two slits
		140	Same, plus cement sealer
5" x 7" RCA 257S1	110	130	Same, plus three applications of plasticizer, ageing after each
		80	Thirty-two slits
		75	Same, plus shellac sealer
6" x 9" RCA 269S1	100	58	Same, plus five applications of plasticizer, ageing after each
		80	Thirty-six slits
		72	Same, plus sealer and plasticizer
		70	Same, plus ageing
		63	Same, plus second application of shellac sealer and ageing
8" R&A (British) 880P	108	55	Same, plus four slits in spider and more ageing
		90	Twenty-five slits
		80	Fifty slits
		72	Same, plus plasticizer
		62	Same, plus second application
10" PM 10-12	75	58	Same, plus two more applications of plasticizer, and slitting spider
		63	Thirty-six slits
12" GE S-1201D	73*	48	Same, plus three applications of plasticizer and ageing
		70	Sixteen slits
		68	Same, plus plasticizer
		50	Same, plus four slits in spider, three more applications of plasticizer, and ageing. (Capillary travel is very marked in this cone.)

* Some speakers of this type come with a resonant frequency as low as 63 cps.

Everybody's Talking..

about the
sensational new
1953
Hi-Fidelity

PILOTUNER
FM-AM TUNER

An instant sensation. Captivates the most critical audience with its superior sensitivity, incomparable selectivity, true tone. Write for the full, exciting story of this matchless PILOTUNER... a "must" for every hi-fi enthusiast.

Also available... High Fidelity PILOTONE AMPLIFIER and PRE-AMPLIFIER, as companion units to the PILOTUNER. Truly the ultimate in superb electronic equipment.

Built by
PILOT RADIO CORP.
the name that has been a
by-word for the greatest in
precision communications
equipment since 1919.

Send NOW for free descriptive literature!

PILOT Radio Corp., 37-06 36th Street, Long Island City, New York

In Stock at...

HUDSON

RADIO & TELEVISION CORP.

The Newest and Finest
in High-Fidelity at Lowest
Money Saving Prices!



FREE!
NEW 1953
Hi-Fi
Catalog

Complete new buying guide . . . value-packed with the world's finest High-Fidelity and Audio Equipment . . . Amplifiers, Speakers, Tuners, Record Changers, Recorders, Packaged Systems, Custom Furniture, etc. for professional and home installation. Select from the largest stocks of ALL Standard Makes at **LOWEST PRICES!**

Send for your **FREE Catalog Today!**

HUDSON
RADIO & TELEVISION CORP.

New! BROWNING RV-31 FM TUNER

for those who expect the exceptional

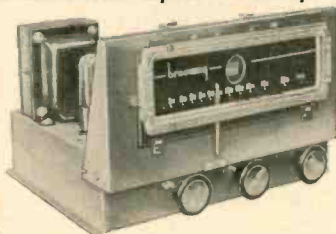

A new FM Tuner that gives you "real" realism, setting a new high in High-Fidelity reproduction. Genuine Armstrong Circuit with Automatic Frequency Control and temperature-compensated oscillator provides drift-free, accurate tuning under almost any conditions. Small and compact for mounting in limited spaces; offers these great new features: • New, all-triode RF section, for extremely low noise level • Higher sensitivity—3 microvolts for 20 db. quieting • Cathode follower output stage, to feed any high-fidelity amplifier at low impedance • Power outlets at rear. Has connection for phono, TV and recorder. 9 tubes plus tuning indicator and one rectifier. Dimensions: 6½" H., 11" W., 9" D. **Net \$97.50**

VISIT OUR SOUND STUDIOS

See! Hear! Compare! by simple push button remote control, over 15,000 combinations of nationally famous high-fidelity components.

Dept. D-12

48 WEST 48th ST. 212 FULTON ST.

New York 36, N. Y. New York 7, N. Y.

Circle 6-4060

is due to the resonance of the edge.³ The mechanical alteration of the edge might aggravate the peak somewhat on the less expensive speakers. A small change in frequency of some of the peaks in a loudspeaker's curve has at times been observed, but the extent of the variations has not been quantitatively ascertained because of the apparent inconsequence. The plasticizer, however, would have no pernicious effect as long as it is kept within its prescribed area. If one were treating a speaker intended only as a woofer, there is nothing to lose in the complete treatment and much to gain. If both methods are applied, the slitting operation must be done first because slitting a plasticized rim is quite difficult.

In checking progress the circuit shown in Fig. 3 has advantages. The 60-cps 'scope input is used to calibrate the audio oscillator, an operation which should be performed at frequent intervals, particularly with a beat-frequency oscillator. When working with low frequencies and such small increments, accuracy of calibration is important. By setting the oscillator to 60 cps and varying the calibration adjustment until a stationary one-to-one Lissajous figure is obtained (circle, ellipse, or inclined line, depending on phase), the oscillator can be set readily without much trouble. To find the resonant frequency of the speaker turn the 60-cps input gain to zero and hold the speaker up in the air. Vary the frequency of the oscillator until the maximum deflection is noted on the 'scope. The frequency indicated by the dial is the resonant frequency. In most cases it can also be detected audibly by noticing when the cone tends to chatter, which is caused by its greater displacement at resonance. The 'scope method, which depends on the rise in speaker impedance at its resonant frequency, is reliable and can also be used for a speaker mounted in a baffle thus serving to indicate the reduction in bass range that the enclosure might cause.

As a before-and-after test of this treatment, LP records with low organ notes⁴ are very useful. Often the improved speaker will bring out notes in the lower register which were not even noticed before treatment.

³ Corrington and Kidd—"Measurements on loudspeaker cones," *Proc. I.R.E.* Sept. 1951, p. 1021.

⁴ Columbia ML 4120: Saint Saëns, Symphony No. 3; Columbia ML 4329: Poulenc, Concerto in G Minor are good examples.

ERRATA

October issue, page 92

We are advised by Edward J. Gately, Jr. that the dimension along the top of the cabinet of Fig. 2 should be $y/\sqrt{2}$ instead of $\frac{1}{2}y$ as shown.

November issue, page 23

We are advised by George Ellis Jones, Jr. that the screen-to-ground resistor, R_m , associated with V_s should be 10,000 ohms instead of 1000 ohms as shown in Fig. 5. The correct value is shown in the parts list on page 79.

and now —

The 2nd Audio Anthology

Ready about November 1

No bigger, no better than the original Audio Anthology—in fact, it's just the same size and a perfect companion to the most authoritative book you now have on the subject of home music systems. But it contains all new material—reprints of over forty of the valuable articles which have most interested *Æ*'s readers during the past two and a half years.

Advance orders are now being accepted—so make sure that you get your copy from the first printing. The board-cover edition will be printed in only a sufficient quantity to fill the advance orders—after that, only the paper-covered edition will be available.

Customary discounts to distributors.

Board Cover \$3.00

Paper Cover \$2.00

-----CUT OUT-----MAIL TODAY-----

Book Division,
Radio Magazines, Inc.,
P. O. Box 629, Mineola, N. Y.

Sirs: Enclosed is my check money order for copies of the
2nd Audio Anthology.

(Please check one) Board Cover Paper Cover

Name (print carefully)

Address

City Zone State

WIDE-ANGLE DISPERSION

[from page 25]

and then suddenly releasing the wave front in that very same plane, it becomes possible to flare the horn more suddenly near its mouth, which will result in wider dispersion. Second, by choosing the point at which wave front restriction changes *direction*, it is possible to arrive at a vertical mouth opening of sufficient size to control the vertical directivity as desired.

Since the angular dispersion is a partial function of the geometric distribution of pressure within the horn, the reverse-flare horn must be examined geometrically. Figure 3 indicates the cross-sectional area distribution of the reverse-flare horn. The horn is, at all times, exponential. Regardless of the shape of the cross-section, one area progresses from the preceding area in a logarithmic fashion with distance x , bounded strictly by the cut-off frequency for which the horn is designed. Since these areas are the product of the vertical and the horizontal dimensions, the horizontal dimension may be chosen to have any desired value. This will permit primary restriction of the wave expansion to be made as severe as desired. If the horizontal dimension is to be kept unchanged from the smallest value as found at the throat of the horn, it will simply mean that the vertical height will do all the expanding. Or if it is desired to let the horizontal dimension expand slightly, then the vertical height need not expand as rapidly. The cross-sectional area may be proportioned in any way best suited to the desired result.

The purpose for the present is actually to *restrict* early horizontal spread of the wave front *within* the horn, but to allow the wave front to expand freely in the vertical direction, within the horn. Restriction of the wave front expansion from the horizontal plane gives rise to an area of high wave-front pressures against the restraining vertical walls. Conversely, freedom of the wave to expand in the vertical direction will result in minimum wave-front pressures against the fast flaring upper and lower walls. As an analogy, picture a cylindrical tube in which two inserted pistons confine a gas under pressure. When these pistons are stationary, the confined gas pressure is equally distributed over the walls of the tube and the piston faces. If the pistons are now suddenly pulled apart, the confined gas pressure will tend to expand toward the piston faces. If the pistons retreat fast enough, the expanding gas may never catch up to them. Consequently, these retreating pistons, which allow the gas to expand in their direction, will have minimum pressure exerted upon them, whereas the restraining walls of the tube will experience the greater gas pressure.

Returning to the horn walls, the difference in wave front pressures against the vertical walls and the top and bottom walls may be represented graphically,

as shown in Fig. 4. This pressure configuration represents the state of affairs concerning the internal pressures against the horn walls extending from the throat of the horn down to the point at which it may be desired arbitrarily to reserve the pressure distribution. For the moment, let any such point be chosen along the horn axis at which to introduce this pressure reversal.

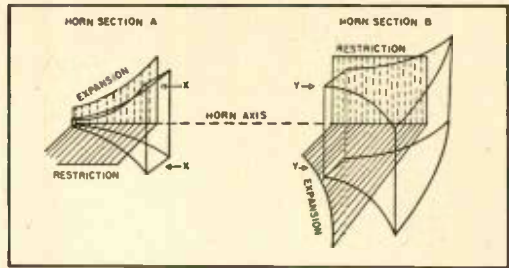
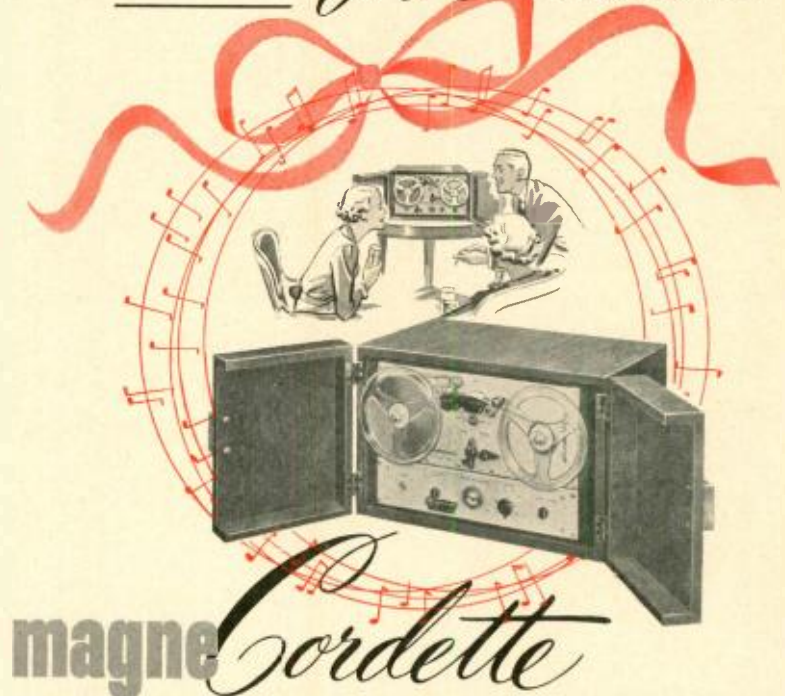

Fig. 5. Flare reversal of the horn walls turns the direction of the wave-front expansion from vertical to horizontal.

Such a desired pressure reversal may of the upper and lower walls which have been accomplished by restricting the flare been expanding, simultaneously flaring

It's HEAR for Christmas



professional tape recorders for home and office

Give your family the realistic brilliance of high fidelity tape recordings right in your own home! Your favorite AM and FM radio programs — the voices of your children and family friends — can be faithfully preserved and replayed for your listening pleasure. Professional in quality, yet priced within reach, MagneCordette represents the utmost in magnetic recording for the home. Start a family "sound library" today, for enjoyment in the years ahead.

New For the first time, MagneCordings by Vox, finest tape recordings by world-famous artists for replaying on your MagneCordette! Greater fidelity and tonal purity than could ever be obtained on disc recordings! Hear them at your MagneCord dealer's.



The *magneCordette* comes in a rich blond or rich, dark mahogany finish cabinet, to match any decor. Priced at only \$395. For a demonstration, see your Classified Telephone directory under "Recorders." **magneCord, inc.**

Dept. AE-12, 225 W. Ohio St., Chicago 10, Illinois

"WHOLESALE RADIO"
For ALL The BEST In

HI-FI

SENSATIONAL
High Fidelity
PACKAGE only **139.50**
SPECIAL COMPLETE

Complete! Nothing Else to Buy!

Famous
MEISSNER
9AJ AM-FM
TUNER

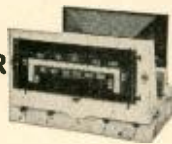

Identical to equipment built to sell for twice the price. Complete provision for phono input. All controls on front panel. High selectivity and sensitivity. Full audio fidelity. Drift proof FM. Full tone control. Built-in phono switching. Power outlet for phono motor. Air wound FM coils. Automatic volume control circuit. Almost unbelievable high fidelity and tonal richness. 7 miniature tubes plus power amplifier and rectifier.

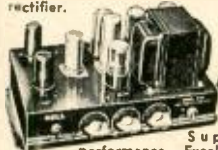

BELL
AMPLIFIER
Model 2122

Superb high-fidelity performance. Excellent for reproducing the extended range of microgroove records and FM. Frequency response 3/4 db 30 to 15,000 cycles with controls set for flat response. Four inputs: radio, crystal, and two magnetic pickups with built-in pre-amp for each Bass and treble boost with attenuation. Power: 17V. 60 cycles. Size: 7 1/2" deep, 6" high, 11 1/2" long.

VM Tri-O-Matic
3 speed
RECORD
CHANGER



VM model 951 GE with General Electric RPX-500 cartridge. Plays all records, all speeds, all sizes, all types completely automatically, and stops automatically after the last record. Records are lowered, not dropped on spindle shelf. No wobble, scrape, or slap . . . no center hole wear.

GENERAL ELECTRIC SPEAKER
Model S-1201-D



GE high fidelity 12" speaker to deliver true faithfulness from your Hi-fidelity system. Frequency response: 50 - 13,000 cps. Power handling capacity 25 watts. 8 ohms impedance. Alnico V. PM.

Address Orders To Dept AF 12
Write For Free F.Y.I. Folder

WHOLESALE
RADIO PARTS CO., Inc.
311 W. Baltimore St.
BALTIMORE 1, MD.

out the vertical walls which up to now have not been flared. This will permit the side thrust pressures which have been built up against these vertical walls, to suddenly burst out of their restraining shell, so to speak, and to be impelled actively along the direction of the new flare. This action is illustrated in Fig. 5. In Section A of the horn all the wave expansion is in the vertical direction, with wave restriction in the horizontal direction. At these restraining walls there is a resultant boundary of increased pressure. After section X-X, Y-Y, the portion of the horn indicated as B now flares rapidly in the horizontal direction, while in the vertical direction there is practically no flare. Because the wave front can no longer expand vertically, pressure will be built up against these upper and lower walls. On the other hand, since the wave is allowed to expand horizontally, the pressure will dissipate itself over the horizontal angle. Thus, the pressure reversal has been accomplished.

Because of this pressure reversal, the dispersion gain in the horizontal direction is two-fold. The first element of gain obtains from the manner that the B section of the horn is energized. It is quite permissible to consider section Y-Y as being the throat for a new horn B, and that the sound source which feeds this horn to be the mouth X-X of horn A. This new sound source X-X is one in which the driving pressure is greatest in the direction of ultimate dispersion, that is, in the horizontal direction. Thus the sound source is "matched" on a pressure configuration basis to the shape of the horn which is to disperse that pressure. Increased pressure dispersion is thus obtained as compared with the case where the throat of the horn is fed from a source of symmetrical pressure distribution.

The second element of gain stems from the much greater flare possible near the mouth of the horn, where it counts most. By allowing but little horizontal expansion prior to the point of pressure reversal, and suddenly limiting the vertical expansion severely after the point of expansion, it becomes possible

ADCOLA
REGISTERED TRADE MARK

SOLDERING
INSTRUMENTS

Any Voltage Range Supplied from 6/7 to 230/250 volts. Our instruments for 110 volts are superb in making

SOUND
JOINTS
for all

SOUND
EQUIPMENT

Supplied to leading British electrical manufacturers and H.M. and foreign government departments.

These soldering instruments are named instruments as they are such a complete departure in design from the usual solder bit or iron and are ideal for all modern assembly and maintenance work on telecommunications, radar, television, wireless, etc.

3/16" dia. bit Standard Models
3/16" Detachable Bit Type (Factory Bench Line)

- Heating time: 90 seconds
- Consumption: 25 watts
- Weight: 4 ozs.
- High temperature
- Handle unaffected by element temperature
- Length of instrument: 9"
- Equally suitable for daily or intermittent use
- Prices ex Works.
Standard 3/16" Bit Model \$3.60
Standard 1/4" Bit Model 4.00
Detachable 3/16" Bit Model 4.80

Catalogue sent free on request.

MADE IN ENGLAND

Registered Design (U.S.A., British, & Foreign Patents)

Write direct to sole manufacturers and suppliers:

ADCOLA PRODUCTS, LTD.
CRANMER COURT
CLAPHAM HIGH STREET
LONDON, S.W. 4, ENGLAND

Standard Model 3/16" Bit Illustrated



- 1220 pages
- 80,000 items
- 8,000 illustrations
- 8" x 11" - 5 lbs.

Publisher's price \$6.50—your price through your regular parts distributor **\$1.95**

The right part when you need it for production or laboratory requirements

This permanent, hard cover Official Buying Guide of the electronic-TV parts and equipment industry with its comprehensive detailed index, eliminates the need for maintaining files of small catalogs and manufacturers' literature. RADIO'S MASTER catalogs 90% of TV and electronic equipment. Not merely part number listings—complete descriptions, specifications and illustrations written and compiled by each manufacturer. Enables you to make comparisons or substitutions right now!



UNITED CATALOG PUBLISHERS, INC.
110 Lafayette St., New York 13

thereafter to throw all the desired exponential expansion into the horizontal direction near the mouth end of the horn. As a result of this terminal expansion, the horn will expand much faster in the horizontal direction than would be the case if the horizontal expansion were to have started back at the original horn throat. The end effect of this faster physical flare for the new short horn section is an increased dispersion angle for the high frequencies.

Having thus accomplished wide-angle dispersion of the radiated sound into the horizontal direction by means of flare control, one additional step may be taken to prevent undue dispersion or diffraction effects into the vertical direction. Such control may be obtained in two ways. Just as low flare will produce relatively narrow dispersion, so a large mouth will reduce diffraction. We already have a slow flare in the vertical direction because of the vertical flare restriction near the mouth of the horn. Consequently, half the problem of restricting the vertical dispersion is already taken care of. The second controlling factor, that of mouth size in the vertical direction, may be obtained if that dimension is permitted to become at least one-third of the wavelength of the lowest frequency to be radiated.

Such a condition is accomplished in these reverse-flare horns by locating the point of flare reversal where the vertical dimension is close to the desired vertical mouth height, and from this point on providing but slight vertical expansion. By such dimensional manipulation it is possible to terminate the horn in a square horn mouth, the vertical height of which is sufficiently large to reduce diffraction in the vertical plane to a minimum.

The end result of this flare reversal may be summed up as follows: The mouth end of the horn is transformed into a much faster flare in the horizontal direction; the pressure configuration within the horn is altered to match the flare distribution; the vertical mouth size is proportioned to provide minimum diffraction and dispersion. This three-way attack on the problem of high-frequency distribution produces a family of horns which exhibit a high degree of dispersion efficiency.

Book Review

HANDBOOK OF ENGINEERING FUNDAMENTALS, Second Edition, edited by Ovid W. Eshbach. 1270+x+52 pages, \$10.00. New York: John Wiley & Sons, 1952.

Readers may well wonder why a review of this 1332-page mine of information should find its way into the columns of their magazine. Little may they realize that nine of the 14 sections into which this book is divided have direct application upon their work.

Commencing with a formulary of mathematical and physical data, the treatment proceeds with a section on mathematics, followed by one on physical units and standards wherein are capably covered the dimensional system as it applies to electrical and physical units and mensuration systems. Then follow sections on the mechanics of rigid and deformable bodies, fluids, aerodynamics, and thermodynamics, electricity, radiation (covering light and acoustics), chemistry, metallic and non-metallic materials, and finally a most excellently presented discourse on engineering law completes the book, which is made easy to use by the 52-page index.

Much of the material has appeared in print before, both in the first edition of this book and in some other engineering texts, but the staff of experts under Mr. Eshbach's able guidance has done an outstanding job of revising it and making the data current. The mathematical treatment will be of great use to those who have forgotten some of the finer points learned in their school days, and to the engineer called upon to do some work in fields apart from his daily activities this text will lend a welcome helping hand. Coverage of such subjects as the radiation theories of light and sound, acoustic absorption and reflection, will come in handily in studio design as will those pages dealing with air conditioning, heating, and ventilation.

This is not a complete text, but it is certainly an adequate handbook—as such it well fulfills its mission. I would have preferred to see the use of continuous pagination rather than that used—namely, each section receiving its own series of numbers, but this is a minor criticism. To those who wish to augment their present libraries with a single volume embracing the broad aspect of engineering fundamentals for reference and daily use, this Handbook is well worth the cost and space it occupies.

—L. B. Keim

FULL TONAL REALISM

Super Horn
LOUDSPEAKER ENCLOSURES

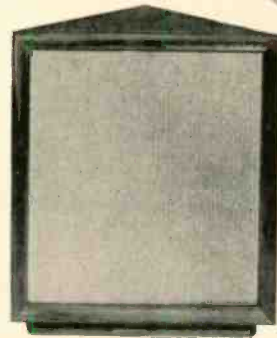

CLEANNES . . . reproduction without resonant peaks or distortion . . . is the keynote of SUPER-HORN engineering. Full bass down to 40 cps. is accurately reproduced by an exponential horn. Clear highs are radiated directly from the front of the speaker with no tuned cavities or ports to produce false bass or "boom".

GRACEFUL RIGIDITY is the keynote of SUPER-HORN construction. Classic beauty of line is combined with rugged durability. All panels are of 3/4 inch and 1/2 inch woods, internally braced to prevent vibration.

BLOND . . . 12" . . . \$80—15" . . . \$85

MAHOAGAN 12" . . . \$75—15" . . . \$80

All Prices Net

WRITE FOR TECHNICAL LITERATURE

GATELY
DEVELOPMENT LABORATORY
CLIFTON HEIGHTS, PA.

ORDER NOW! 1952 Bound Volumes—\$8.95

(Outside U.S.A. add 75 cents postage)

Over the years, **AUDIO ENGINEERING** has proven itself a valuable reference work, worthy of a permanent place in your library. Many 1952 issues are already exhausted but you may have a complete bound volume of new copies for the entire year if you order now.

For the years to come—

Subscribe to **AUDIO ENGINEERING** on the combination offer which includes a bound volume at the end of the year. Each month you receive the magazine by mail as usual—read it, cut out coupons to your heart's content, mark on the pages as much as you like. Around January 15, 1954, you receive a **fresh, new, bound volume of 1953 issues**—no creases, no dog-eared pages. The cost?—only \$10.00 per year, a saving of \$1.95 over the price of the bound volume and the one-year subscription. Same offer, for two years, **\$18.50**.

(Canada and Pan-American Union—1 yr. \$11.00, 2 yrs. \$20.00; all other foreign—1 yr. \$12.00, 2 yrs. \$22.00)

Dept SV,
AUDIO ENGINEERING,
P. O. Box 629, Mineola, N. Y.

This offer expires
February 1, 1953

Enclosed is my check (or money order) for \$..... for copies of the 1952 Bound Volume of **AUDIO ENGINEERING**, to be delivered about January 15, 1953.

Enclosed is my check (or money order) for \$..... for a new renewal subscription for one year, plus a 1953 Bound Volume which will be delivered without further charges approximately January 15, 1954.

Enclosed is my check (or money order) for \$..... for a new renewal subscription for two years, plus a 1953 Bound Volume which will be delivered without further charges approximately January 15, 1954, and plus a 1954 Bound Volume to be delivered about January 15, 1955.

Name

Address

City Zone State

AUDIO FAIR

(from page 32)

Entering the Fair for the first time, Pilot Radio Corporation gave graphic evidence of the reasons for its ascension to a position of leadership in the audio industry within the space of one short year. Obvious to the high-fidelity hobbyist and audio engineer were the excellent design and performance features of the new Pilotuner and Pilot amplifiers—just as obvious to contemporaries and competitors was the adroit sales management of Adolph Gross, long known as one of the country's more astute merchandisers of electronic equipment.

From out Chicago way came Precision Electronics, Inc., with a thoroughly interesting display of the company's well-known Grommes amplifiers. The Grommes Model 50PG, incidentally, is probably the country's top seller in its price bracket. Although remarkably performing were the Grommes amplifiers, equally impressive to this observer was the youthfulness of Precision's president, personable Bill Grommes. He, along with another Bill—Shrader of Washington—and Norman Pickering of Pickering and Company, are great morale builders because they make the rest of us feel timers in the audio industry feel that—perhaps, after all—we do have an out or two left.

Presto Recording Corporation, not too long ago known alone for its disc recording equipment, gave solid evidence that today its eminence in the tape recording field is just as pronouncedly, thoroughly satisfying exhibit of fine recording equipment—both disc and tape—which meets highest professional standards.

The long-awaited Model 300 equalizer-pre-amplifier was the highlight of The Radio Craftsmen, Inc., exhibit. Sharing honors was the new Model C-800 AM-FM tuner. John Cashman, president of Radio Craftsmen, Inc., is doing the audio industry a great service with a national advertising campaign designed to show the many advantages of high fidelity for the average home. The first of these ads, a two-page spread in the December issue of "House and Garden," features a statement by Deems Taylor, noted composer and critic. Would that more manufacturers emulated this gesture, by stressing the advantages of high fidelity in general, along with advertising the merits of their own products.

The pride of Col. R. H. Ranger was more than justified as he demonstrated the newest models of Rangertone tape recorders. As president of Rangertone, Inc., his is the guidance which has brought to the audio world a line of tape recording equipment which is unexcelled in the precision of its construction and the perfection of its performance. Strictly professional items, the Rangertone recorders are supreme examples of quality without compromise.

Diversity and expansion have been the year's keynote for Reeves Soundcraft Corporation—diversity in the sense that Magnastripe, the Reeves-developed motion picture film on which is placed an oxide strip for magnetic recording, is receiving increased sales effort, and expansion in the sense that sales of all Reeves products are on the upgrade. This exhibit tastefully displayed Magnastripe, as well as Soundcraft recording discs and tape—the overall emphasis being on the care and precision with which Reeves products are manufactured.

Even in an impersonal evaluation of exhibits, such as this is supposed to be, perspective demands that tribute be paid certain personalities who have done their share and more toward creating national consciousness of high fidelity and the wealth of enjoyment it affords the American home. And so it is that we mention here the name of George Silber, president, The Rek-O-Kut Company, who as host in his firm's exhibit, never let up on the fight he pioneered to make the nation high-quality-audio conscious. It goes without saying that the showing of Rek-O-Kut turntables, disc recorders, and portable record players was in keeping with the enviable reputation the company commands throughout the audio world.

Making its initial bow before an Audio Fair audience, Revere Camera Company created great interest with a complete showing of tape recorders suited essentially for adding sound to home movies. Special attention was accorded the new Model T-10, a moderate-priced unit which closely approximates the performance of many professional recorders. Among unique features of the T-10 is a built-in index counter which affords

quick location of any desired portion of a recorded reel.

Another Fair newcomer was River Edge Industries, River Edge, N. J. In every respect the River Edge display reflected the firm's advertising theme—"Audio's Finest Cabinetry." Formerly devoted entirely to the manufacture of TV cabinets, River Edge today is one of the country's major suppliers of fine enclosures for home music systems.

An introductory showing of the British-made Collaro record changer was featured in the display of Rockbar Corporation. Collaro's American distributor, Varion, models were arranged over mirrors, thus permitting visitors to inspect each changer through a complete playing cycle, and see for themselves the manner in which the Collaro operates.

Both professional and home equipment came in for just share of attention in the exhibit of Hermon Hosmer Scott, Inc. Audio and acoustical engineers gathered around the famous Scott Sound Level Meters and the new Type 140-A Decade amplifier, while music lovers found substantial interest in the various Scott amplifiers for home music systems. At the risk of being repetitious we are going to quote from last year's Audio Fair Review in which was expressed the thought that "the new Scott amplifiers are exceptional in the scope of equalization they provide for all types of recordings."

Probably the Fair's most varied display of tape recording equipment was that offered by Sonocrast Corporation, New York. Justified was the company's reputation as one of the country's leading distributors of tape recorders to home and industry, with particular emphasis on its representation among schools, colleges, and institutions. Sonocrast made many new friends through the graciousness of its competent and likeable president Herbert H. Borchardt.

"Packaged High Fidelity" was the theme around which was built the exhibit of The Sound Workshop, a new company recently formed by Electronic Workshop Sales Corporation, New York, and J. & H. Wood Products Company, Brooklyn. Introduced were completely-assembled high-fidelity home music systems which compete in price with conventional radio-phonographs.

Excellent loudspeakers in tastefully designed enclosures—in a nutshell that's how we can summarize the exhibit of Stephens Manufacturing Company. At least that's the story from the music lover's viewpoint. For the audio pros there was the Stephens "wireless microphone"—the little gadget which permits TV and stage performers complete freedom of movement, and the studio-model Stephens condenser microphone for high-quality recording.

Among the more newsworthy of the Fair's exhibits was that of the Stromberg-Carlson Company. Here was shown the complete line of amplifiers, speakers and tuners introduced by a major manufacturer as a mark of recognition to the growing importance of the market for high-quality audio equipment. No stranger to the high-fidelity field, Stromberg years ago held a position of unquestioned leadership. Until recently, however, the company's sound division has concentrated its production in public-address and industrial sound equipment. The superb performance of the new Stromberg units, developed under the able direction of chief engineer Frank Shymaker, proves once more the truth in the adage "old masters never lose their touch."

Striking custom-built cabinetry shared attention with a lavish showing of equipment in the suite occupied by Sun Radio & Electronics Company, New York. As if that weren't enough to assure a constantly-filled exhibit, Sun took no chances and provided its own crowd as well—the official program listing eighteen of the company's personnel as being in attendance. Thanks to an impressive display the presentation proved unnecessary—the SRO sign being in constant evidence.

Visitors to the tapeMaster, Inc., suite were treated to a preview of a newly developed wide-range tape recorder which will make its appearance in dealers' showrooms as quickly as production can be established. It was this reporter's good fortune to hear the new tapeMaster model in competitive tests with recorders covering all price ranges—and here-with is presented the consensus of one opinion that tapeMaster is coming up with a sure-fire winner.

In its initial Fair participation, Germany's Telefunken Company made news with an

inclusive display of radio receivers, amplifiers, speakers, and, of course, the noted Telefunken condenser microphone. Long known as a world pioneer in the science of sound, Telefunken exhibited equipment well in keeping with the company's brilliant reputation.

As a result of visiting the Terminal Radio Corporation suite shortly prior to the Fair's official opening, this observer finds himself in possession of the first distributed copy of what is by all odds the largest and most complete catalog ever devoted solely to audio equipment. Whether you be amateur or pro, music lover or recording engineer,—no matter if you need an intercom system or an inter-modulation meter—you are certain to find it in this new Terminal catalog. Messrs. Fuller, Miller, Simon et al are to be thoroughly congratulated on an unusual accomplishment. Terminal's equipment display gave feature billing to the new Travis Tapak portable tape recorder.

The record changer to end all record changers was observed in the exhibit of Switzerland's Thorens Company. Along with standard models which play records in the usually prescribed manner, there was demonstrated a two-motored unit which, in addition to intermixing, will follow almost any desired sequence. Thorens, you may recall, manufactured the changer which was used in the RCA Westminster series of radio-phonographs which were marketed several years ago.

Lone tube manufacturer to exhibit at the Fair was Tung-Sol Electric, Inc., whose Type 5881 is just about the hottest thing you can get in output tubes. Many visitors (present company not excepted) left the Tung-Sol suite considerably better informed on the subject of tube design as a result of discussion with the firm's engineers.

Ultrasonic Corporation, manufacturers of the small corner-speaker assembly designed by Drs. Branch and Lang of M. I. T., offered demonstrations designed to verify for listeners the remarkable measurements of the unit made in the M. I. T. lab. According to an interview with the inventors which appeared in the New York Times, M. I. T. measurements of the speaker are claimed to prove its ability to reproduce fundamentals as low as 40 cps, although it occupies a space of only 2½ cu. ft.

A new 20-watt version of the famous Williamson amplifier was featured in the exhibit of United Transformer Company. Quite naturally, it contained UTC transformers as did the 10-watt Williamson with which it was compared. In addition to completed amplifiers, there was displayed an impressive selection of UTC transformers for most every conceivable audio application.

Along with the hi-fi speakers for which the company is justly noted, University Loudspeakers, Inc., introduced a new line of speaker enclosures designed to complement both period and modern furnishings. With the introduction of the new cabinets, University becomes one of the country's leading suppliers of complete speaker assemblies as well as individual components.

Visitors to the suite occupied by V-M Corporation were rewarded by a display of record changers of most every size and type. Popular in exhibit, as it is in sales, was the V-M changer with the "Siesta Switch"—an automatic means of turning off an entire music system at the conclusion of the final record on the changer.

There's no better example of recent growth in the audio industry than that afforded by Waveforms, Inc., whose display included the high-quality amplifier and miniature audio oscillator for which the company originally became noted, as well as a number of new test instruments which have been developed within the past year.

New impetus was given sales of the Weathers FM pickup with a dramatic demonstration which emphasized the virtual absence of record wear due to the unit's 1-gran playing pressure. Conducted by company president Paul Weathers, the Weathers Industries exhibit was both effective and authoritative.

Webster-Chicago Corporation, in its initial Fair participation, displayed the firm's entire line of Webcor tape recorders, wire recorders, portable phonographs, and record changers. Pioneer in the science of wire recording, Webcor retains a position of industry leadership—well evidenced by the sales records being racked up by the Model 235 office dictation machine.

LOW NOISE, PRECISION RESISTOR KIT

for
Williamson-Type Amplifiers

Hard-to-obtain, low-noise 1% precision resistors at reasonable prices.

These resistors are of the highest quality fresh stock, manufactured under WE license. The resistance element is pyrolytically deposited carbon bonded to a ceramic core. The kit contains the following resistors and data sheet.

Quan.	Resistance	Wattage	Precision
1	47,000	1	1%
2	20,000	1	1%
2	0.47 Meg	1/2	1%
2	50,000	2	1%
2	0.1 Meg	1/2	1%

Price \$5.00

Include 15¢ for postage and handling.
No COD. Quick delivery!

EDWIN BOHR

Dayton Pike
Chattanooga 5, Tennessee

ELECTRONICS ENGINEER

Group leader required to take charge of an electronics laboratory engaged in analytical instrument development. Design ability in conventional circuitry as applied to a.c. and d.c. amplifiers, power supplies, light detection devices, thyatron circuits, discriminators, magnetic circuitry and fractional horse-power motors desirable.

Five years experience or advanced degrees in lieu of part of this experience required. The position is a permanent one with an old established instrument company who is a leader in the field.

Send resume with salary requirements to:
Personnel Manager
Fisher Scientific Company
717 Forbes St., Pittsburgh 19, Pa.

PROFESSIONAL DIRECTORY

Custom-Built Equipment

U. S. Recording Co.

1121 Vermont Ave., Washington 5, D. C.
Lincoln 3-2705

In Southern California it's HOLLYWOOD ELECTRONICS

(in The Audio Mile)
Distributors of Hi Fidelity
Components Exclusively
Webster 3-8208

7460 Melrose Ave. Hollywood 46, Calif.

Industry Notes--

AUDIO FAIR AFTERMATH . . . Amazing, the large number of Chicagoans, both observers and exhibitors who were seen parading up and down New York's corridors—to wit, . . . **Chet Wharfield**, director, Allied Radio Corporation sound department, who came to the Big City a couple of days before the Fair opened in order to visit jobber-friends . . . **John Margolin**, sales manager, Tapmaster, Inc., who also made advance appearance to acquaint distributors with new wide-range tape recorder for home music systems . . . **Bill Grommes**, president, Precision Electronics, Inc., who surprised New York correspondents with his youthfulness . . . **Maurice Meshoum**, prominent Windy City artist and true dyed-in-the-wool audio hobbyist, who came to town to listen, listened, and left with binaural bees buzzing in his bonnet.

John Boyers, Spec Barker, and **Dick McQueen**, all Magnecord, Inc., officials who were just about the busiest boys in town while arranging the binaural broadcasts on WQXR and associated FM Network . . . **Karl Kramer** of Jensen Manufacturing Company, who did his usual excellent job of selling the assembled multitude on the many virtues of Triaxial and Triplex . . . In other words, you could have called a meeting of the Windy City's audio leaders at any time, with little fear of not having a quorum.

N. Y. C. FAIR HIGHLIGHTS . . . **Larry Epstein**, president, University Loudspeakers, Inc., beaming with full justification over impressive appearance of company's new speaker enclosures—enthusiasm shared by **Walter Godfrey** whose River Edge Industries organization is handling the production chores . . . **Fred L. Cunow**, sales manager for Telefunken products in the U. S., reports greatly stimulated interest in the firm's condenser microphone as result of showing at The Fair . . . **Dave Ruark**, chief manager for Audio & Video Products Corporation, reverted to type (he's an ex-announcer) and narrated the demonstration tape for Ampex stereophonic sound—so far has been recognized by only 98 per cent of his friends . . . **Lew Goodfriend**, one of the nation's more young audio engineers, kept hopping by multi-duties—holding down a job, manning a Fair exhibit, and delivering technical paper before AES Conventions . . . **Ken Boothe**, director of Audio-Video's Instrumentation Division elated at new business originating at the Fair.

FAIR HIGHLIGHTS FROM CITIES HERE AND YON . . . **A. A. Ward**, executive vice-president, Altec Lansing Corporation, Hollywood, gave what was probably the Fair's most informal interview to **Gene Smith**, feature writer for the New York Herald Tribune—standing squarely between the sky-floor elevators and the registration desks; others who participated in the same article—although under less trying circumstances—were **Tony Schifano** of Stromberg-Carlson, **Tom Nicholson** of General Electric, and **Leonard Carduner** of British Industries Corporation . . . **Frank McIntosh**, an old competitor **Lincoln Walsh**, designers and manufacturers of the McIntosh and Brook amplifiers, respectively, surprised Fair visitors (and each other) when each introduced a new corner speaker . . . **Larry LeKashman** of Electro-Voice, Inc., Buchanan, Mich., used most effective means of introducing firm's new Lavalier microphone—wore one throughout the show.

MISCELLANY . . . Genial **Ed Cornfield** has joined sales staff of Adolph L. Gross Associates, Inc., New York factory reps—a nice guy never lived . . . **Edward H. Gillette**, executive vice-president of Allied Control Company, Inc., announces appointment of **E. A. Yates** as head of newly-formed new products division . . . **Major General Edmund H. Leavey**, U.S.A. (Retired), is newest vice-president of I. T. and T. . . **Edward A. Mallin** has been appointed manager of marketing for Components Department of General Electric Company . . . **William W. Dean** at one time contributor to columns of *AE*, has been appointed director of engineering of the Langevin Manufacturing Corporation . . . **Dr. Martin L. Klein**, former member of University of Pennsylvania and Stanford University faculties, is new addition to the engineering staff of Stancell-Hoffman Corporation . . . **George I. Long**, general manager of Ampex Electric Corporation, Redwood City, Calif., announces promotion of **Harrison Johnston** to general sales manager . . . **Dr. David B. Parkinson** is new production engineering head of Brush Development Company . . . **John Jacks** has joined sales staff in sound department of Chicago's Newark Electric Company—will assist **Carl James**, who heads up Newark's audio activities.

Air-Tone HEADQUARTERS FOR SOUND EQUIPMENT

COMPLETE LINE OF
COMMERCIAL AND
INDUSTRIAL SYSTEMS



McINTOSH 50 W-2
AMPLIFIER

Largest stock of
High Quality
Amplifiers, from
small single
units to large
rack installa-
tions

Air-Tone

SOUND AND RECORDING CO.
1527 CHESTNUT ST.
PHILA. 2, PA. • RI-6-8388

AMPERITE

Studio Microphones
at P.A. Prices

Ideal for
BROADCASTING
RECORDING
PUBLIC ADDRESS

"The ultimate in microphone quality," says Evan Rushing, sound engineer of the Hotel New Yorker.

- Shout right into the new Amperite Microphone—or stand 2 feet away—reproduction is always perfect.

- Not affected by any climatic conditions.
- Guaranteed to withstand severe "knocking around."



Models
RBLG—200 ohms
RBHG—Hi-imp.
List \$42.00



"Kontak" Mikes
Model SKM, list \$12.00
Model KKH, list \$18.00

Special Offer: Write for Special Introductory Offer, and 4-page illustrated folder.

AMPERITE Company, Inc.

561 BROADWAY • NEW YORK 12, N. Y.
Canada: Atlas Radio Corp., Ltd., 260 King St. W., Toronto

Audio Engineering—1952

SUBJECT INDEX

- AES Convention Program, Oct., 58.**
- AES Papers**
- Magnetic Audio Amplifier Fundamentals, A. M. Vincent. Sept., 42.
- No Coded Signals, H. S. Morris. Oct., 40.
- The Problems of Low-Frequency Reproduction, Saul J. White. Apr., 20.
- Wide-Angle Dispersion of High-Frequency Sound, Abraham B. Cohen. Dec., 24.
- Amplifiers**
- Commercial O-T-L Amplifier of Unique Design, Frank H. Gilbert. Aug., 46.
- Gilding the Lily, David Sarsar and Melvin C. Sprinkle. July, 13.
- Integrated Line of Hi-Fi Equipment, Frank H. Slaymaker. July, 26.
- The Maestro—a POWER Amplifier, David Sarsar and Melvin C. Sprinkle. Nov., 19.
- Magnetic Audio Amplifier Fundamentals, (AES Paper), A. M. Vincent. Sept., 42.
- Neutralizing Hum and Regeneration, Arthur L. Hammond. May, 22.
- New Medium-Cost Amplifier of Unusual Performance, C. Leonard Werner and Henry Berlin. Nov., 30.
- New Newcomb Line Features New Features, Aug., 40.
- The Output-Transformer-Less Amplifier, Victor Brociner and Gerald Shirley. June, 21.
- Speech Clipper Aids Station Performance, R. S. Houston. Nov., 50.
- Ultra-Linear Operation of a Williamson Amplifier, David Hafler and Herbert I. Keroes. June, 26.
- Universal Amplifier for Magnetic Tape Recorder, C. G. McProud. I, May, 17; II, June, 24; III, July, 22.
- Williamson-Type Amplifier Up-To-Date, M. V. Kiebert, Jr. Aug., 18.
- Amplifiers, Pre-**
- Preamplifier for Critical Listening, M. V. Kiebert, Jr. Sept., 21.
- Two Preamplifiers for Magnetic Pickups, George Ellis Jones, Jr. Jan., 24.
- Audio Fair, The**
- Exhibitor Directory. Nov., 54.
- The Audio Fair in Review. Dec., 26.
- The Audio Fair in Chicago. July, 24.
- Preview of 1952 Audio Fair. Oct., 58.
- Audio Techniques**
- Broadcast Short-Cuts, R. S. Houston. Apr., 34.
- Improved Cathode Bias Circuit Affording Fixed Bias, John A. Mulvey. Mar., 63.
- Book Reviews**
- Electrical Measurements, Forest K. Harris. May, 44.
- Handbook of Engineering Fundamentals, Edit. by Ovid W. Eshbach. Dec., 59.
- Make Music Live, Irving Greene, James R. Radcliffe, Robert Scharff. Feb., 39.
- Musical Engineering, Harry F. Olson. Aug., 9.
- Pianos, Pianists, and Sonics, G. A. Briggs. Apr., 8.
- Radio and Television Receiver Circuitry and Operation, A. A. Ghirardi and J. Richard Johnson. Apr., 8.
- The Recording and Reproduction of Sound, Oliver B. Read. May, 45.
- Television Engineering, Donald Fink. Oct., 17.
- Television Explained, W. E. Miller. Oct., 17.
- Television Principles, Robert B. Dome. Oct., 17.
- Time Bases, O. S. Puckle. May, 45.
- Ultrasonics, P. Vigoureux. Sept., 68.
- Vacuum-Tube Voltmeters, John F. Rider and Alfred W. Barber. Sept., 68.
- Broadcasting**
- Broadcast Audio Wiring Practices, W. Earl Stewart. Aug., 16.
- Broadcast Short-Cuts, R. S. Houston. Apr., 34.
- Planning and Building a Radio Studio, Eugene F. Coriell. I, June, 15; II, July, 19; III, Aug., 22; IV, Sept., 30; V, Oct., 30.
- Speech Clipper Aids Station Performance, R. S. Houston. Nov., 50.
- A Twin-Channel Utility Amplifier, R. S. Houston. Apr., 17.
- Binaural Sound**
- Stereophonic Reproduction, James Moir. Oct., 26.
- Cabinets and Enclosures**
- Cabinet Design for Hi-Fi Systems, Jeff Markell. May, 26.
- A Corner-Mounting Infinite Baffle, M. V. Kiebert, Jr. Oct., 32.
- Design and Construction of Horn-Type Loudspeakers, Wayne B. Denny. I, Mar., 22; II, Apr., 18.
- Design for Clean Bass, Edward J. Gately, Jr. Oct., 29.
- Design for Smooth Response, Vern Yeich. Jan., 15.
- Horn-Loaded Bass Speaker, Earl R. Meissner and L. K. Andrews. Jan., 22.
- New Approach in Loudspeaker Enclosures, John E. Karlson. Sept., 26.
- Components**
- How Good is an Audio Transformer, N. H. Crowhurst. Mar., 20.
- Measuring up an Audio Transformer, N. H. Crowhurst. Nov., 24.
- Some Pickup Design Considerations, P. G. A. H. Voigt. Oct., 64.
- Consonata Organ Installation for the 1952 Presidential Nominating Conventions, Serge L. Krauss and Karl Kramer. Dec., 15.
- Controls**
- Cathode-Follower Audio Control System, Gladden B. Houck. Nov., 32.
- The Design of Compensated Volume Controls, Emerick Toth. I, Jan., 13; II, Feb., 14.
- A Proposed Solution to the Loudness Control Problem, John R. Schjelderup. Sept., 34.
- Demonstration Techniques, Harrie K. Richardson. Oct., 84.**
- Distortion, Intermodulation, Richard C. Hitchcock. Oct., 21.
- Dividing Networks, Discussion of, J. F. Wentworth. Dec., 17.
- Equalizers, Design Simplified, George O. Douglas. Dec., 18.**
- Equipment Report**
- Altec A-333-A and A-433-A. Apr., 32.
- Bell 2145A. Mar., 30.
- Heathkit Williamson-Type Amplifier. May, 28.
- Exhibits**
- Audio Fair Exhibitor Directory. Nov., 54.
- Preview of 1952 Audio Fair. Oct., 58.
- The Audio Fair in Review. Dec., 26.
- The Audio Fair in Chicago. July, 24.
- The I.R.E. Show Review. Apr., 26.
- London Letter—British National Radio Exhibition, Leonard Carduner. Oct., 12.
- NARTB Conference and Exhibit. May, 30.
- WESCON Exhibitors. Aug., 26.
- Fantasy**
- The Frudd Audio System, D. B. Frudd. Nov., 12.
- The Golden Ear, Don V. R. Drenner. Nov., 81.
- Feedback**
- A Critical Feedback Analysis, Harold Klimpel. Oct., 23.
- It's Positive Feedback, Warner Clements. May, 20.
- Further Discussion on Positive Current Feedback, Ulric J. Childs. May, 21.
- Loudspeaker Damping with Dynamic Negative Feedback, Ulric J. Childs. Feb., 11.
- Filters, Record Improvement with H-F Cut-off; Elliott W. Markow. Nov., 27.**
- Handbook of Sound Reproduction, Edgar M. Villchur. I, June, 18; II, July, 15; III, Aug., 20; IV, Sept., 38; V, Oct., 36; VI, Nov., 40; VII, Dec., 20.**
- Home Music Systems**
- Audio in the Home, William C. Shrader. I, Jan., 18; II, Feb., 18; III, Mar., 47; IV, Apr., 24; V, June, 28; VI, July, 30; VII, Aug., 24.
- Be Your Own Custom-Builder, Jay Carver and Cliff Howard. Mar., 24.
- Cathode Follower Audio Control System, Gladden B. Houck. Nov., 32.
- How to Use Magnetic Pickups, Ulric J. Childs. Mar., 35.
- Music's the Thing, Irving Greene and Melvin C. Sprinkle. Jan., 20.
- On a Budget, Jay Carver and Cliff Howard. May, 24.
- Use Your Present Tuner, Ulric J. Childs. Apr., 29.
- Legal Problems**
- Trade Secrets and Their Protection, A. W. Gray. Nov., 29.
- Loudness Controls**
- A Proposed Solution to the Loudness Control Problem, John R. Schjelderup. Sept., 34.
- The Design of Compensated Volume Controls, Emerick Toth. I, Jan., 13; II, Feb., 14.
- Loudspeakers**
- A Corner-Mounting Infinite Baffle, M. V. Kiebert, Jr. Oct., 32.
- Design Considerations of Duplex Loudspeakers, Alexis Badmief. Sept., 28.
- Design and Construction of Horn-Type Loudspeakers, Wayne B. Denny. I, Mar., 22; II, Apr., 18.
- Design for Clean Bass, Edward J. Gately, Jr. Oct., 29.
- Design for Smooth Response, Vern Yeich. Jan., 15.
- Discussion of Dividing Networks, J. F. Wentworth. Dec., 17.
- Horn-Loaded Bass Speaker, Earl R. Meissner and L. K. Andrews. Jan., 22.
- Integrated Line of Hi-Fi Equipment, Frank H. Slaymaker. July, 26.
- Loudspeaker Damping with Dynamic Negative Feedback, Ulric J. Childs. Feb., 11.
- New Approach in Loudspeaker Enclosures, John E. Karlson. Sept., 26.
- New! The Super Tweeter, Ralph P. Glover and Karl Kramer. Apr., 22.
- The Problems of Low-Frequency Reproduction (AES Paper), Saul J. White. Apr., 20.
- Speaker Treatment for Improved Bass, R. Cameron Barritt. Dec., 23.
- Wide-Angle Dispersion of H-F Sound (AES Paper), Abraham B. Cohen. Dec., 24.
- Measurements**
- A Distortionless Oscillator, Dunford A. Kelly. Aug., 13.
- Intermodulation Distortion, Richard C. Hitchcock. Oct., 21.
- Linear-Scale A-F Wattmeter, C. G. McProud. Feb., 17.
- Theory and Construction of a Harmonic Distortion Meter, George Ellis Jones, Jr. Nov., 22.
- Microphone Technique—The Traveling Mike, N. H. Crowhurst. Feb., 16.**
- Musical Instruments—The Violin, Albert Preisman. I, Sept., 24; II, Oct., 34; III, Nov., 36.**
- Phonograph Records, The Best British of 1950—1951, H. A. Hartley. I, Mar., 28; II, Apr., 50.**
- Phonograph Reproduction**
- How to Use Magnetic Pickups, Ulric J. Childs. Mar., 35.

- Phono Facts—1952. Maximilian Weil. June, 30.
 Pickup Tracking Error, Edgar M. Villchur. Mar., 17.
 Record Improvement with H.F. Cut-Off Filters, Elliott W. Markow. Nov., 27.
 Some Pickup Design Considerations, P. G. A. H. Voigt. Oct., 64.
 Two Preamplifiers for Magnetic Pickups, George Ellis Jones, Jr. Jan., 24.
- Radio Tuners**
 Integrated Line of Hi-Fi Equipment, Frank H. Slaymaker. July, 26.
 Use Your Present Tuner, Ulric J. Childs. Apr., 29.
- Recording, Magnetic**
 Azimuth Film Calibration, Michael Rettinger. Apr., 15.
 Limitations of Magnetic Tape, William S. Latham. Sept., 19.
 Magnetic Tape in Southwest Monuments, T. B. Noble. Aug., 44.
 Tape Recorder Echo Effects, R. S. Houston. Oct., 52.
 Universal Amplifier for Magnetic Tape Recorder, C. G. McProud. I, May, 17; II, June, 24; III, July, 22.
 Using Hearing Characteristics in Tape Editing, Joel Tall. May, 15.
- Sound Reproduction, Handbook of.** Edgar M. Villchur. I, June, 18; II, July, 15; III, Aug., 20; IV, Sept., 38; V, Oct., 36; VI, Nov., 40; VII, Dec., 20.
 Stereophonic Reproduction, James Moir. Oct., 26.
- Television—The Two Types of Theatre Video.** John W. Sims. Jan., 16.
- Transformers**
 How Good is an Audio Transformer, N. H. Crowhurst. Mar., 20.
 Measuring up an Audio Transformer, N. H. Crowhurst. Nov., 24.
 The Violin, Albert Preisman. I, Sept., 24; II, Oct., 34; III, Nov., 36.

AUTHOR INDEX

- Andrews, L. K., and Meissner, Earl R.
 Horn-Loaded Bass Speaker. Jan., 22.
- Badmief, Alexis
 Design Considerations of Duplex Loudspeakers. Sept., 28.
- Barritt, R. Cameron
 Speaker Treatment for Improved Bass. Dec., 23.
- Berlin, Henry, and Werner, G. Leonard
 New Medium-Cost Amplifier of Unusual Performance. Nov., 30.
- Brociner, Victor, and Shirley, Gerald
 The Output-Transformer-Less Amplifier. June, 21.
- Carduner, Leonard
 London Letter—British National Radio Exhibition. Oct., 12.
- Carver, Jay, and Howard, Cliff
 Be Your Own Custom-Builders. Mar., 24.
 On a Budget. May, 24.
- Childs, Ulric J.
 Further Discussion on Positive Current Feedback. May, 21.
 How to Use Magnetic Pickups. Mar., 35.
 Loudspeaker Damping with Dynamic Negative Feedback. Feb., 11.
 Use Your Present Tuner. Apr., 29.
- Clements, Warner
 It's Positive Feedback. May, 20.
- Cohen, Abraham B.
 Wide-Angle Dispersion of H-F Sound (AES Paper). Dec., 24.
- Coriell, Eugene F.
 Planning and Building a Radio Studio. I, June, 15; II, July, 19; III, Aug., 22; IV, Sept., 30; V, Oct., 30.
- Crowhurst, N. H.
 How Good is an Audio Transformer. Mar., 20.
 Measuring up an Audio Transformer. Nov., 24.
 The Traveling Mike. Feb., 16.
- Denny, Wayne B.
 Design and Construction of Horn-Type Loudspeakers. I, Mar., 22; II, Apr., 18.
- Douglas, George O.
 Simplified Equalizer Design. Dec., 18.
- Drenner, Don V. R.
 The Golden Ear. Nov., 81.
- Frudd, D. B.
 The Frudd Audio System. Nov., 12.
- Gately, Edward J., Jr.
 Design for Clean Bass. Oct., 29.
- Gilbert, Frank H.
 Commercial O-T-L Amplifier of Unique Design. Aug., 46.
- Glover, Ralph P., and Kramer, Karl
 New! The Super Tweeter. Apr., 22.
- Gray, Albert Woodruff
 Trade Secrets and Their Protection. Nov., 29.
- Greene, Irving, and Sprinkle, Melvin C.
 Music's The Thing. Jan., 20.
- Hafler, David, and Keroes, Herbert I.
 Ultra-Linear Operation of a Williamson Amplifier. June, 26.
- Hammond, Arthur L.
 Neutralizing Hum and Regeneration. May, 22.
- Hartley, H. A.
 The Best British Records of 1950-1951. I, Mar., 28; II, Apr., 50.
- Hitchcock, Richard C.
 Intermodulation Distortion. Oct., 21.
- Houck, Gladden B.
 Cathode-Follower Audio Control System. Nov., 32.
- Houston, R. S.
 Broadcast Short-Cuts. Apr., 34.
 Speech Clipper Aids Station Performance. Nov., 50.
 Tape Recorder Echo Effects. Oct., 52.
 Twin-Channel Utility Amplifier. Apr., 17.
- Howard, Cliff, and Carver, Jay
 Be Your Own Custom-Builders. Mar., 24.
 On a Budget. May, 24.
- Jones, George Ellis, Jr.
 Theory and Construction of a Harmonic Distortion Meter. Nov., 22.
 Two Preamplifiers for Magnetic Pickups. Jan., 24.
- Karlson, John E.
 New Approach in Loudspeaker Enclosures. Sept., 26.
- Kelly, Dunford A.
 A Distortionless Oscillator. Aug., 13.
- Keroes, Herbert I., and Hafler, David
 Ultra-Linear Operation of a Williamson Amplifier. June, 26.
- Kiebert, M. V., Jr.
 A Corner-Mounting Infinite Baffle. Oct., 32.
 Preamplifier for Critical Listening. Sept., 21.
 Williamson-Type Amplifier Up-To-Date. Aug., 18.
- Klimpel, Harold
 A Critical Feedback Analysis. Oct., 23.
- Kramer, Karl, and Clover, Ralph P.
 New! The Super Tweeter. Apr., 22.
- Kramer, Karl, and Krauss, Serge L.
 Consonata Organ Installation for the 1952 Presidential Nominating Conventions. Dec., 15.
- Krauss, Serge L., and Kramer, Karl
 Consonata Organ Installation for the 1952 Presidential Nominating Conventions. Dec., 15.
- Latham, William S.
 Limitations of Magnetic Tape. Sept., 19.
- Markell, Jeff.
 Cabinet Design for Hi-Fi Systems. May, 26.
- Markow, Elliott W.
 Record Improvement with H. F. Cut-Off Filters. Nov., 27.
- McProud, C. G.
 Linear-Scale A-F Wattmeter. Feb., 17.
 Universal Amplifier for Magnetic Tape Recorder. I, May, 17; II, June, 24; III, July, 22.
- Meissner, Earl R., and Andrews, L. K.
 Horn-Loaded Bass Speaker. Jan., 22.
- Moir, James
 Stereophonic Reproduction. Oct., 26.
- Morris, H. S.
 No Coded Signals. (AES Paper.) Oct., 40.
- Mulvey, John A.
 Improved Cathode Bias Circuit Affording Fixed Bias. Mar., 63.
- Noble, T. B.
 Magnetic Tape in Southwest Monuments. Aug., 44.
- Preisman, Albert
 The Violin. I, Sept., 24; II, Oct., 34; III, Nov., 36.
- Rettinger, Michael
 Azimuth Film Calibration. Apr., 15.
- Richardson, Harrie K.
 Demonstration Techniques. Oct., 84.
 The Audio Fair in Review. Dec., 26.
- Sarser, David, and Sprinkle, Melvin C.
 Gilding the Lily. July, 13.
 The Maestro—a POWER Amplifier. Nov., 19.
- Schjelderup, John R.
 A Proposed Solution to the Loudness Control Problem. Sept., 34.
- Shirley, Gerald, and Brociner, Victor
 The Output-Transformer-Less Amplifier. June, 21.
- Shrader, William C.
 Audio in the Home. I, Jan., 18; II, Feb., 18; III, Mar., 47; IV, Apr., 24; V, June, 28; VI, July, 30; VII, Aug., 24.
- Sims, John W.
 The Two Types of Theatre Video. Jan., 16.
- Slaymaker, Frank H.
 Integrated Line of Hi-Fi Equipment. July, 26.
- Sprinkle, Melvin C., and Greene, Irving
 Music's The Thing. Jan., 20.
- Sprinkle, Melvin C., and Sarser, David
 Gilding the Lily. July, 13.
 The Maestro—a POWER Amplifier. Nov., 19.
- Stewart, W. Earl
 Broadcast Audio Wiring Practices. Aug., 16.
- Tall, Joel
 Using Hearing Characteristics in Tape Editing. May, 15.
- Toth, Emerick
 The Design of Compensated Volume Controls. I, Jan., 13; II, Feb., 14.
- Villchur, Edgar M.
 Handbook of Sound Reproduction. I, June, 18; II, July, 15; III, Aug., 20; IV, Sept., 38; V, Oct., 36; VI, Nov., 40; VII, Dec., 20.
 Pickup Tracking Error. Mar., 17.
- Vincent, A. M.
 Magnetic Audio Amplifier Fundamentals. (AES Paper.) Sept., 42.
- Voigt, P. G. A. H.
 Some Pickup Design Considerations. Oct., 64.
- Weil, Maximilian
 Phono Facts—1952. June, 30.
- Wentworth, J. F.
 Discussion of Dividing Networks. Dec., 17.
- Werner, G. Leonard, and Berlin, Henry
 New Medium-Cost Amplifier of Unusual Performance. Nov., 30.
- White, Saul J.
 The Problems of Low-Frequency Reproduction. (AES Paper.) Apr., 20.
- Yeich, Vern
 Design for Smooth Response. Jan., 15.



FAIR WEATHER AHEAD

The Audio Fair is over but its results will persist. To all those who helped to make our exhibit an outstanding success—our agents, our customers, and those who now want to be our customers—our very best thanks.

Our one and only problem is to bring about a very quick increase in production without impairing Hartley quality. The process has started and soon we shall be able to offer you, from stocks in the U.S.A., the most intriguing and complete range of audio equipment you could wish for.

The Fair showed that the 215 speaker still has nothing to fear from its more expensive rivals, but from all quarters we got the judgment that the Baffle is the most nearly perfect housing for a nearly perfect speaker. The Baffle is going into production in America.

So is our amplifier. We have not "plugged" it before since we are fundamentally speaker manufacturers; but again we have been told we must make it easy to acquire, because it is so good. That we shall do; and we think our prices for American produced equipment will be about the same as British. We consider this important for realistic audio should be within the reach of every man.

All on our mailing list will receive full details of our plans and products. The inception of American production will give us many opportunities for introducing new and exciting products. So, if your name is not on that list just send a postcard asking us to put it on.

You can no longer afford to be without Hartley Audio.

H. A. HARTLEY CO. LTD.
152, Hammersmith Road
London W.6, England

ADVERTISING INDEX

Adcola Products, Ltd.	58
Air Tone Sound & Recording Co.	61
Allied Radio Corp.	53
Allied Sound Corp.	54
Altec Lansing Corp.	41
Amperite Co., Inc.	61
Ampex Electric Corp.	13
Amplifier Corp. of America	2
Arnold Engineering Co.	3
Arrow Electronics Inc.	40
Audak Co.	35
Audio Devices, Inc.	Cover 2
Beam Instruments Corp.	48
Belden Mfg. Co.	7
Bell Telephone Laboratories	14
Bogen Co., Inc., David	51
Bahr, Edwin	61
Cannon Electric	37
Carter Motor Co.	50
Chicago Transformer Co.	39
Cinema Engineering Co.	52
Classified Ads	64
Daven Co.	Cover 3
Fisher Scientific Co.	61
Garrard Sales Corp.	49
Gately Development Laboratory	59
General Hi Fi Co.	44
H. A. Hartley Co. Ltd.	64
Harvey Radio Co., Inc.	33
Heath Co.	53
Hollywood Electronics Co.	61
Hudson Radio & Television Corp.	56
Hughes Research & Development Laboratory	9
Lafayette Radio	38
Leonard Radio, Inc.	47
Magnecord, Inc.	57
Minnesota Mining & Mfg. Co.	31
Pickering & Co., Inc.	11
Pilot Radio Corp.	55
Precision Film Laboratories, Inc.	6
Professional Directory	61
Radio Corporation of America	8
Radio's Master	38
Reeves Soundcraft Corp.	.5
Rek-O-Kut Co.	1
Rockbar Corp.	29
Standard Transformer Corp.	45
Tech-Master Products Co.	36
Thermador Electrical Mfg. Co.	50
Triad Transformer Mfg. Co.	12
Tung-Sol Electric Inc.	4
Turner Co.	43
United Catalog Publishers, Inc.	58
United Transformer Co.	Cover 4
U.S. Recording Co.	61
University Loudspeakers, Inc.	54
Weathers Industries	51
Wholesale Radio Parts Co., Inc.	58

CLASSIFIED

Rates: 10c per word per insertion for noncommercial advertisements; 25c per word for commercial advertisements. Rates are net, and no discounts will be allowed. Copy must be accompanied by remittance in full, and must reach the New York office by the first of the month preceding the date of issue.

THE AUDIO EXCHANGE, INC. buys and sells quality high-fidelity sound systems and components. Guaranteed used and new equipment. Catalogue, Dept. XE, 159-19 Hillside Ave., Jamaica 32, N. Y. Telephone OL 8-0446.

LONG ISLAND HIGH-FIDELITY HEAD-QUARTERS—Complete custom installations. Garrard changers, Bozak speakers, our own Williamson Amplifiers. Long Island Sound Co., 19 Bennett Place, Amityville, N. Y.

ANNOUNCING A NEW SERVICE—Highest quality discs cut from your tapes. All speeds—all sizes. Fairchild equipment, hot styl. Also monitoring off-the-air and special recording services. Reasonable rates. Write for prices. **GTE DUBBINGS CO.**, Dept. 12-AE-2, 41-10 45th St., Long Island City 4, N. Y.

FOR SALE: 30 rolls (800 ft.) single perforated Scotch Brand magnetic 16-mm film No. 116—new. University of Minnesota. Purchasing Department. Minneapolis 14, Minn.

FOR SALE—ALL NEW EQUIPMENT. 5 model PT-125 TapeMaster tape recording mechanisms, in case, \$40 each; 1 Altec M-11 condenser microphone system, \$175; 100 7-in. reels of 1251 plastic base Audiotape recording tape, never been used, \$2.50 per reel. Write Jack Brown, 3221 So. Acoma, Denver, Colo. or call SU 1-5001.

FOR SALE: New portable Presto 6-N recorder and 85-A amplifier, \$725. John J. Hanson, 3815 Trimble Road, Nashville 5, Tenn.

IMMEDIATE REFUND if you don't think our 30-watt Williamsons at \$89.50 beat anything up to \$150. Oil-filled capacitors, hermetically sealed 200-ma choke, dual chassis, all Peerless transformers. Dr. Nicely, Kenton, Ohio.

WANTED—FM tuner REL model G4-B or HARVEY model 193-R. Box CD-1. Audio Engineering, P. O. Box 629, Mincola, N. Y.

FOR SALE: PT63-AH Magnecord mechanism, never used, \$300, or for Concertone or Premier #70 Tapesonic or Custom Combination. Joseph Wargo, 291 Howland Ave., Rochester, N. Y.

AMPLIFIERS FOR SALE: Altec A-323, like new, \$50; Stromberg-Carlson, 10-watt, new, \$50; Amplifier Corp. of America ACA-1000, new, \$160; Scott amplifier with noise suppressor, \$150; Presto disc recorder, Model K, like new, \$180. H. Unfried, 33 Westfield Rd., Buffalo 21, N. Y.

PRESTO 16-in. RECORDER, Model "Y." Complete with two-channel inputs, two speeds 33 1/3 and 78, hi-fi amplifier, and cutting head. Good condition. Best offer over \$300. W. A. Karr, 6033 Woodlawn, Chicago 37, Ill.

Plan to attend the
**West Coast
AUDIO FAIR**
February 5-6-7, 1953
Alexandria Hotel
Los Angeles, California

OVER

90%

of the TRANSMISSION
MEASURING SETS

Used Today
Are Made by

DAVEN

Not only is the Daven Company the largest supplier of transmission measuring sets, but it is also a source for every needed type of instrument for the measurement of the transmission characteristics of communication systems. It furnishes units to check all types of broadcast equipment and audio devices for commercial and industrial use as well as for organizations such as utilities, telephone and power companies. Therefore, whatever your requirements are in this field, write to Daven for complete catalog material, and outline your own particular problems for specific assistance from our engineering staff.



THE **DAVEN** CO.

185 Central Ave., Newark 4, N. J.

DAVEN TRANSMISSION MEASURING SET 12A

The Type 12A Transmission Measuring or Gain Set is an AC operated rack mounted instrument designed for the measurement of voice transmission systems.

The oscillator consists of a 1000 cycle low distortion feed back type R-C oscillator and buffer and associated power amplifier. The output impedance is 600 ohms resistive. The output level is +10 to -35 Db.

The Receive Section consists of a high gain, wide range amplifier with two balanced inputs. The range of the amplifier is variable from +20 to -80 Db by utilizing the meter scale.



DAVEN TRANSMISSION MEASURING SET 11A

A moderately priced instrument for broadcast equipment. A simplified, accurate, direct reading instrument, designed to make measurements in accordance with FCC regulations.

FREQUENCY RANGE: 20 CY to 20 Kc.

ACCURACY: ± 0.1 db, 20 CY to 20 Kc.

RANGE OF LEVEL:

+ 4 to -110 db }
-10 to -124 db } in steps of 0.1 db.

APPLICATIONS:

- (a) Audio gain and loss measurements.
- (b) Measurements of matching and bridging devices.
- (c) Complex circuit measurements.
- (d) Measuring mismatch loss.
- (e) Frequency response measurements.

Available for Immediate Delivery

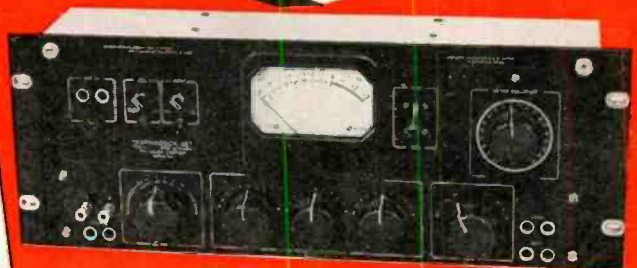



Linear Standard Units...

THE ULTIMATE IN QUALITY...

UTC Linear Standard Audio Transformers represent the closest approach to the ideal component from the standpoint of uniform frequency response, low wave form distortion, high efficiency, thorough shielding and utmost dependability.

UTC Linear Standard Transformers feature...

- **True Hum Balancing Coil Structure**... maximum neutralization of stray fields.
- **Balanced Variable Impedance Line**... permits highest fidelity on every tap of a universal unit... no line reflections or transverse coupling.
- **Reversible Mounting**... permits above chassis or sub-chassis wiring.
- **Alloy Shields**... maximum shielding from inductive pickup.
- **Hiper-M-Alloy**... a stable, high permeability nickel-iron core material.
- **Semi-Toroidal Multiple Coil Structure**... minimum distributed capacity and leakage reactance.
- **Precision Winding**... accuracy of winding .1%, perfect balance of inductance and capacity; exact impedance reflection.
- **High Fidelity**... UTC Linear Standard Transformers are the only audio units with a guaranteed uniform response of ± 1 DB from 20-20,000 cycles.



TYPICAL LS LOW LEVEL TRANSFORMERS

Type No.	Application	Primary Impedance	Secondary Impedance	± 1 db from	Max. Level	Relative hum-pickup reduction	Max. Unbalanced DC in primary	List Price
LS-10	Low impedance mke. pickup, or multiple line to grid	50, 125, 200, 250, 333, 500/600 ohms	60,000 ohms in two sections	20-20,000	+15 DB	-74 DB	5 MA	\$25.00
LS-10X	As Above	As above	30,000 ohms	20-20,000	+14 DB	-92 DB	5 MA	35.00
LS-12	Low impedance mke. pickup, or multiple line to push pull grids	50, 125, 200, 250, 333, 500/600 ohms	120,000 ohms overall, in two sections	20-20,000	+15 DB	-74 DB	5 MA	28.00
LS-12X	As above	As above	80,000 ohms overall, in two sections	20-20,000	+14 DB	-92 DB	5 MA	35.00
LS-26	Bridging line to single or push pull grids	5,000 ohms	60,000 ohms in two sections	15-20,000	+20 DB	-74 DB	0 MA	30.00
LS-19	Single plate to push pull grids like 2A3, 6L6, 300A. Split secondary	15,000 ohms	95,000 ohms; 1.25:1 each side	20-20,000	+17 DB	-50 DB	0 MA	26.00
LS-21	Single plate to push pull grids. Split primary and secondary	15,000 ohms	135,000 ohms; turn ratio 3:1 overall	20-20,000	+14 DB	-74 DB	0 MA	26.00
LS-22	Push pull plates to push pull grids. Split primary and secondary	30,000 ohms plate to plate	80,000 ohms; turn ratio 1.6:1 overall	20-20,000	+26 DB	-50 DB	.25 MA	32.00
LS-30	Mixing, low impedance mke. pickup, or multiple line to multiple line	50, 125, 200, 250, 333, 500/600 ohms	50, 125, 200, 250, 333, 500/600 ohms	20-20,000	+17 DB	-74 DB	5 MA	26.00
LS-30X	As above	As above	As above	20-20,000	+15 DB	-92 DB	3 MA	32.00
LS-27	Single plate to multiple line	15,000 ohms	50, 125, 200, 250, 333, 500/600 ohms	30-12,000	+20 DB	-74 DB	8 MA	26.00
LS-50	Single plate to multiple line	15,000 ohms	50, 125, 200, 250, 333, 500/600 ohms	20-20,000	+17 DB	-74 DB	0 MA	26.00
LS-51	Push pull low level plates to multiple line	30,000 ohms plate to plate	50, 125, 200, 250, 333, 500/600 ohms	20-20,000	+20 DB	-74 DB	1 MA	28.00
LS-141	Three sets of balanced windings for hybrid service, centertapped	500/600 ohms	500/600 ohms	30-12,000	+10 DB	-74 DB	0 MA	30.00

TYPICAL LS OUTPUT TRANSFORMERS

Type No.	Primary will match following typical tubes	Primary Impedance	Secondary impedance	± 1 db from	Max. Level	List Price
LS-52	Push pull 2A3, 250, 6V6, 42 or 2A5 A prime	8,000 ohms	500, 333, 250, 200, 125, 50, 30, 20, 15, 10, 7.5, 5, 2.5, 1.2	25-20,000	15 watts	\$35.00
LS-55	Push pull 2A3's, 6A5Q's, 300A's, 275A's, 6A3's, 6L6's	5,000 ohms plate to plate and 3,000 ohms plate to plate	500, 333, 250, 200, 125, 50, 30, 20, 15, 10, 7.5, 5, 2.5, 1.2	25-20,000	20 watts	35.00
LS-57	Same as above	5,000 ohms plate to plate and 3,000 ohms plate to plate	30, 20, 15, 10, 7.5, 5, 2.5, 1.2	25-20,000	20 watts	25.00
LS-58	Push pull parallel 2A3's, 6A5Q's, 300A's, 6A3's	2,500 ohms plate to plate and 1,500 ohms plate to plate	500, 333, 250, 200, 125, 50, 30, 20, 15, 10, 7.5, 5, 2.5, 1.2	25-20,000	40 watts	50.00
LS-6L4	Push pull 6L6's self bias	9,000 ohms plate to plate	500, 333, 250, 200, 125, 50, 30, 20, 15, 10, 7.5, 5, 2.5, 1.2	25-20,000	30 watts	50.00

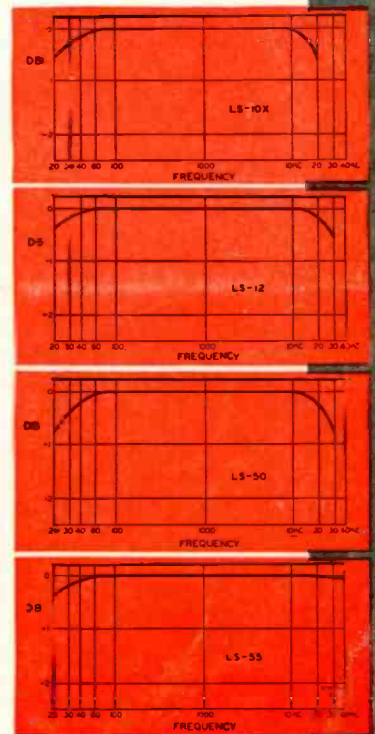

Write for our Catalog PS-520

United Transformer Co.

150 VARICK STREET

NEW YORK 13, N. Y.

EXPORT DIVISION: 13 EAST 40th STREET, NEW YORK 16, N. Y.,

CABLES: "ARLAB"