

AUDIO ENGINEERING

NOVEMBER
1951
35c

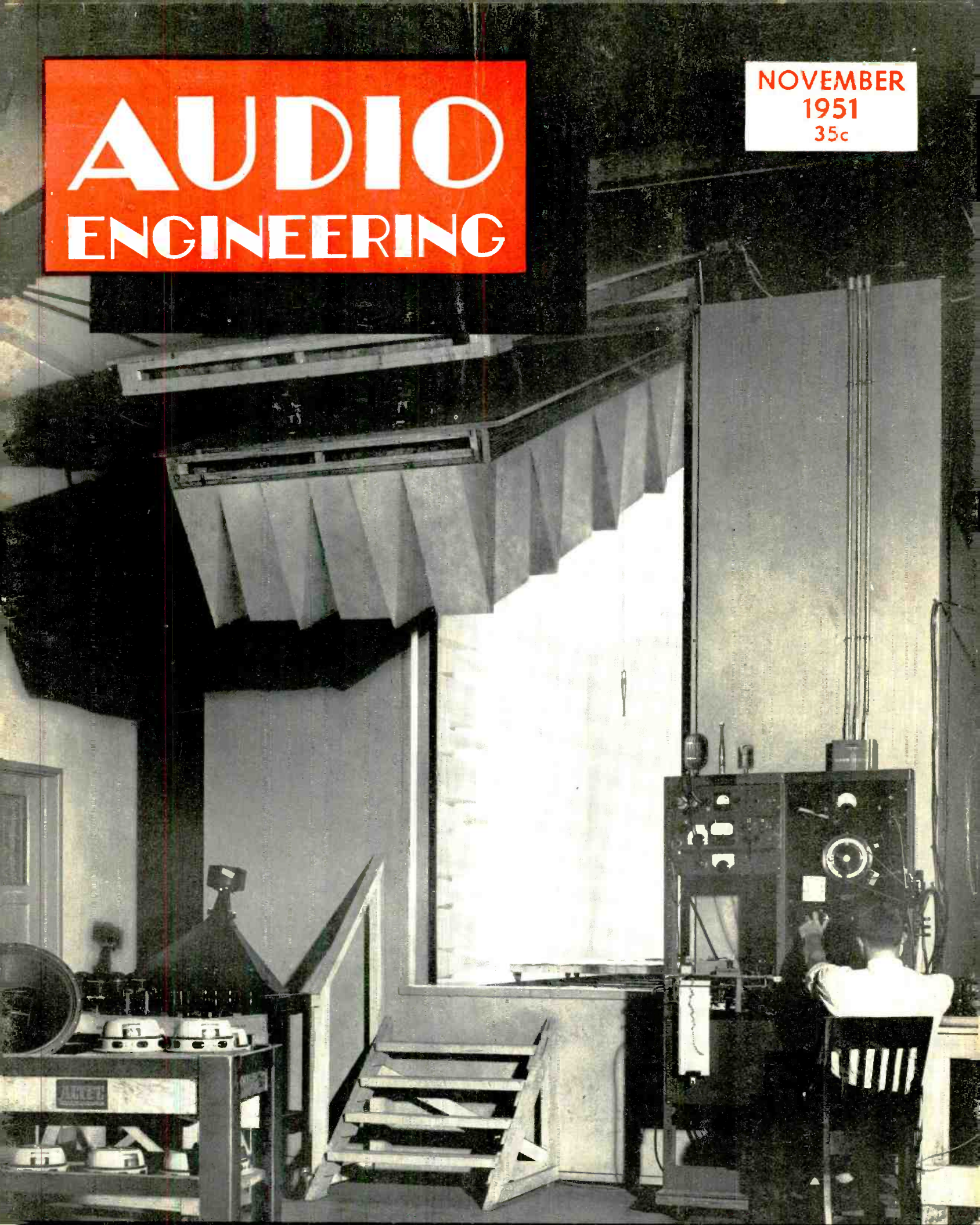

Published by RADIO MAGAZINES, INC.

www.americanradiohistory.com



You don't have to look, because
THERE ARE NO SPLICES
in **audiotape***

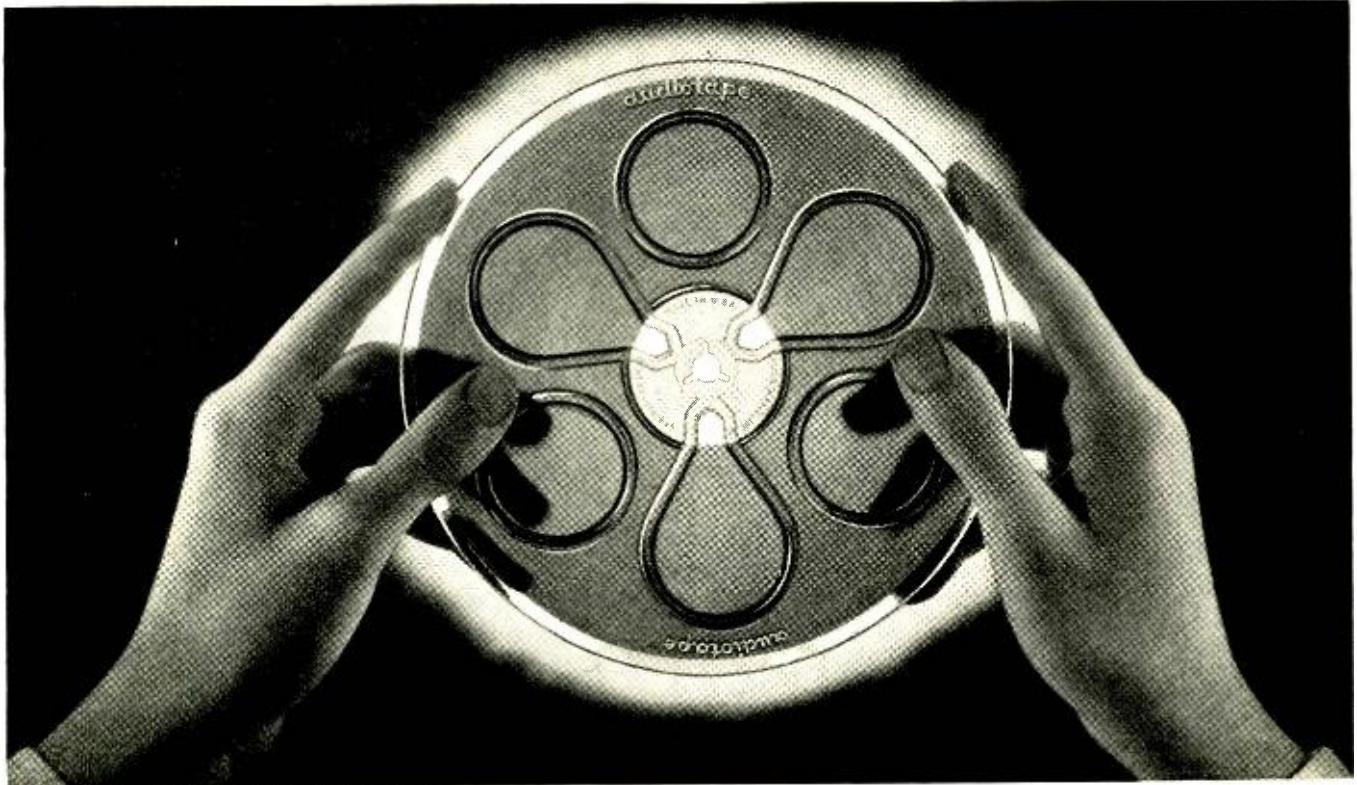

...but this "transparency test" shows some other important things about Audiotape quality

■ When you hold a reel of plastic base Audiotape up to the light, notice its extremely uniform translucency—free from dark rings or fuzzy areas. You can see your fingers right through it, sharply outlined against the light. This is proof of the clean, straight line slitting that makes Audiotape track and wind absolutely flat. There are no rough or turned-over edges which would lift the tape away from the heads, causing loss of high-frequency response. Of course this test also proves that the tape is entirely free from splices. But with Audiotape you can be sure of that without looking. For all 1250 foot and 2500 foot reels of plastic base Audiotape are *guaranteed splice-free!*

You can see the output uniformity of Audiotape, too. For every 5-reel package includes an Esterline-Angus output chart, showing the measured output of the entire length of one of the reels in the package. And since all 5 reels are slit from the same roll after coating, the chart actually measures the uniformity of all the tape in the package. This gives positive visual proof of Audiotape's unequalled output uniformity.

NO OTHER TAPE OFFERS YOU ALL OF THESE EXTRA-VALUE FEATURES:

- **Splice-Free Reels.** All 1250 and 2500 foot reels of plastic base Audiotape are *guaranteed* to be free from splices.
- **Unequalled Uniformity.** Plastic base Audiotape is guaranteed not to exceed $\pm 1/4$ db within the reel and $\pm 1/2$ db from reel to reel.
- **Output Curves** in every 5-reel package of plastic base Audiotape show actual measured output of the tape contained in the package.
- **Maximum Output with Minimum Distortion.** Oxide formulated to give high output at bias which results in low harmonic distortion.
- **Safe-Handling Package** for 2500 and 5000 foot reels permits loading onto turntable without danger of spilling tape from hub, simplifies attachment of reel flanges, and provides safe storage without flattening bottom of roll.

*Trade Mark

AUDIO DEVICES, Inc.

444 Madison Avenue, New York 22, N. Y.

Export Dept.: 13 East 40th St., New York 16, N. Y., Cables "ARLAB"

AUDIO ENGINEERING

Successor to **RADIO**

Established 1917



C. G. McProud, Editor

Ladd Haystead, Publisher

Harrie K. Richardson, Associate Editor

Luci Turner, Production Manager

S. L. Cahn, Advertising Director

Lucile Carty, Circulation Manager

H. N. Reizes, Advertising Manager

Editorial Advisory Board

Howard A. Chinn

John D. Colvin

C. J. LeBel

J. P. Maxfield

George M. Nixon

Representatives

H. Thorpe Covington, Special Representative
677 N. Michigan Ave., Chicago 11, Ill.

Sanford R. Cowan, Mid-West Sales
67 W. 44th St., New York 18, N. Y.

James C. Galloway, Pacific Coast Sales
816 W. 5th St., Los Angeles 17, Calif.

Technical Book & Magazine Co.
297 Swanston St., Melbourne, C. I.
Victoria, Australia

CONTENTS NOVEMBER, 1951 Vol. 35, No. 11

Audio Patents— <i>Richard H. Dorf</i>	2
Audio Techniques	6
Continuously Variable Scratch Filter	
Tape Recorder Remote Control	
Letters	10
Editor's Report	12
An Ultra-Linear Amplifier— <i>David Hafner and Herbert I. Keroes</i>	15
Something New in Remote Amplifiers— <i>Robert S. Houston</i>	18
A Simple Preamplifier and Tone-Control Unit— <i>David H. O'Brien</i>	20
Trends in Broadcast Audio Equipment— <i>W. E. Stewart</i>	22
Exponential Baffles for Custom Installations— <i>George Augspurger</i>	24
Listening Room Design— <i>Vern Yeich</i>	28

AUDIO engineering society SECTION

Third Annual Convention	30
AES Annual Election	30
Convention Program	32
Direct Radiator Loudspeaker Enclosures— <i>Harry F. Olson</i>	34
Record Revue— <i>Edward Tatnall Canby</i>	40
Audio Fair Exhibitors	46
New Products	56
Audio Engineering Society Membership Application	65
New Literature	68
Employment Register	69
The "Rep" and his Place in Audio	72
Industry People	78
Industry Notes	79
Advertising Index	80

COVER

The structure on the cover, an Anechoic chamber, is the largest and most elaborate of the four "dead" rooms designed and built by Altec Lansing Corp. for research and for the production testing and calibration of all microphones and loudspeakers. The chamber is a double-shell structure, the inner shell being composed of 21-inch fiberglass wedges covered with cheesecloth. Tests show that departure from free field conditions in this room is less than 1 db.

RADIO MAGAZINES, INC., 342 MADISON AVE., NEW YORK 17, N. Y.

AUDIO ENGINEERING (title registered U. S. Pat. Off.) is published monthly at 10 McGovern Ave., Lancaster, Pa., by Radio Magazines, Inc., D. S. Potts, President; Henry A. Schober, Secretary-Treasurer. Executive and Editorial Offices: 342 Madison Avenue, New York 17, N. Y. Subscription rates—United States, U. S. Possessions and Canada, \$3.00 for 1 year, \$5.00 for 2 years; elsewhere \$4.00 per year. Single copies 35c. Printed in U. S. A. All rights reserved. Entire contents copyright 1951 by Radio Magazines, Inc. Entered as Second Class Matter February 9, 1950 at the Post Office, Lancaster, Pa. under the Act of March 3, 1879.

AUDIO ENGINEERING • NOVEMBER, 1951

At Precision today
we're processing
the finest
ANIMATION FILMS
for nationwide
showings

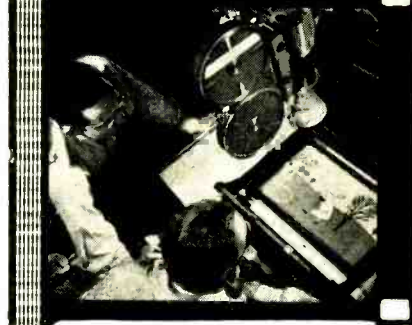

For your special 16 mm.
film requirements
use Precision . . .

- Over a decade of 16 mm. industrial film printing in black and white and color.
- Fine grain developing of all negatives and prints.
- Scientific control in sound track processing.
- 100% optically printed tracks.
- Expert timing for exposure correction in black & white or color.
- Step printing for highest picture quality.
- Special production effects.
- Exclusively designed Maure equipment.
- Personal service.

... no wonder more and more
of the best 16 mm. films today
are processed at...

PRECISION

FILM LABORATORIES, INC.

21 West 46th St.,

New York 19, N. Y.

JU 2-3970

ANOTHER SIGNATURE FIRST

Now!

A FULL ACOUSTICAL LENS FOR LOUD SPEAKER USE!



Distributing a uniform sound wave over the entire audio spectrum, the new Jim Lansing acoustical lens smooths out the high frequencies and gives them a mellowness that your ear will appreciate instantly. Unlike the multicellular horn, which performs well at some frequencies but beams or distributes very poorly at others, the new lens is not sensitive to frequency... because the band width is wider than the audio spectrum with which it is used. The new lens and horn is for use with the Jim Lansing #175 high frequency driver.

TRANSPARENCY CAN BE MEASURED!

Transparency or absorption in the new Jim Lansing acoustical lens is measured in the same way as it is in the optical lens — by index of refraction. The percentage of sound absorbed by the Jim Lansing acoustical lens is less than the percentage of light absorbed by the finest optical lens.

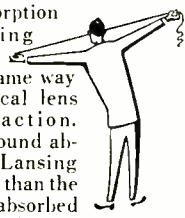

W-I-D-E DISTRIBUTION ANGLE!

The angle of distribution which is controlled by curvature and index of refraction can now be varied between wide limits... permitting the sound to be concentrated or diffused. The 175 DLH shown above (driver, lens and horn) distributes over a 90° solid angle.

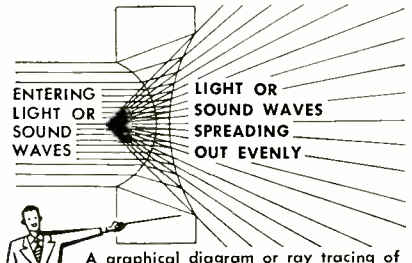

A graphical diagram or ray tracing of the operation of the Jim Lansing acoustical negative lens showing focal point and diffusion angle as controlled by curvature and index of refraction.

Ask your audio dealer for demonstration of the new Jim Lansing acoustical lens today!

JAMES B. LANSING SOUND, INC.
2439 FLETCHER DRIVE
LOS ANGELES 39, CALIFORNIA

FIRST IN FINE SOUND



AUDIO PATENTS

RICHARD H. DORF*

WITHOUT DETRACTING from the purpose of *Æ*, readers will probably not object to being reminded from time to time that the audio field is not occupied entirely with high-quality designs and equipment. Indeed, most of the men who make their livings in industrial organizations doing audio work probably find themselves designing and making audio devices which are a compromise between quality and cheapness, with a strong leaning in the direction of cheapness.

Many engineers will therefore, like the writer, find it refreshing to come across a record-playing system which is about as cheap as cheap can be, yet which is, if manufactured well, capable of a high degree of realism. Such an idea forms Patent No. 2,548,531, the holder of which, Albert E. ("Doc") Hayes, former editor of *CQ*, has assigned to Bendix. It is based on the old idea of the capacitance pickup, which has been knocked around by a great many people with, so far, negligible commercial success. The trouble so far has been a combination of the expense and annoyance of the necessary oscillator-demodulator or high voltage and high-gain amplifier, and the tendency of the gadgets to be critical of adjustment and in lead lengths.

Basically, a capacitance pickup is one of the cheapest possible kinds to make. It need consist only of a stylus on a reasonably compliant mounting and a fixed plate nearby. Hayes' solution of the problem of what to do with the capacitance variations once you have them appears schematically in Fig. 1.

In this setup the pickup is used as part
*Audio Consultant, 255 West 84th Street, New York.

of a standard AM radio receiver to make it into a radio-phonograph. With the three ganged single-pole double-throw switches S_1 , S_2 , and S_3 in the right-hand position, the circuit is recognizable as a simple, garden variety intermediate-frequency amplifier stage followed by a standard diode detector.

With the switches in the position shown, the capacitance pickup is brought into action. The pickup is shunted from the pentode plate to its grid, forming a feedback path which makes a tuned-plate-tuned-grid oscillator out of the stage. The grid return is switched away from the a.v.c. circuit and connected to the top of R_1 , a grid-leak resistor.

The variations of capacitance caused in the pickup by record modulation vary the degree of plate-grid feedback, thus the strength or amplitude of oscillation. Since the diode detector is tuned to the intermediate frequency, these changes are detected and converted into audio.

In addition, the grid leak R_1 is connected to the lower portion R_2 of the diode's audio load resistor. The variation in oscillation amplitude appears across R_1 as a variation in voltage (due to grid-current variation) at the audio rate. This a.f. voltage is transferred through the d.c. blocking capacitor C_2 to R_2 , appearing in series with the detected audio. The combined effects give a high enough a.f. output to drive the conventional audio amplifier which follows in the receiver. Probably a good idea would be the addition of another switch section to remove the incoming r.f. from the i.f. stage, possibly by taking power away from the previous i.f. stage or shorting its grid. In any case, calibration of the pickup's capacitance need not be precise, since it would have little harmful effect on oscillator frequency or percentage of modulation.

Oh, yes—there is still a drawback. In a receiver in which cheapness would be really important, the speaker would probably be too small to give any kind of fidelity!

Transient Peak Voltmeter

In some kinds of acoustic noise measurement, it is desirable to find the instantaneous maximum amplitude of a single transient noise peak. About the only ordinary practical way to do that is to photograph an oscilloscope trace, which takes time, expense, and bulky equipment. Clifford M. Ryerson, Milton H. Aronson, and Louis W. Erath have invented a meter for the purpose. The patent is #2,547,978. The circuit of their transient peak voltmeter appears in Fig. 2.

V_1 is an ordinary cathode-follower amplifier stage, to which is fed the output of the microphone, with, if necessary, preamplification. The pulsating d.c. voltage ap-

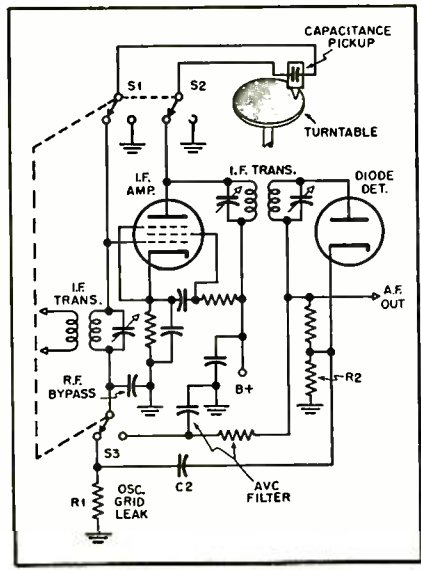

Fig. 1

[Continued on page 4]

Be Sure of Your Installations . . .

Use *Aptitude-Tested* **MULTIPLE CONDUCTOR CABLE**

• You know what you are doing when you use Belden Multiple Conductor Cables — they're aptitude rated. They are designed to provide desirable electrical characteristics, and rigid control assures constant quality.

Specify Belden Radio Wires.
Belden Manufacturing Co.
4689-R W. Van Buren St.
Chicago 44, Illinois

The image displays several Belden multiple conductor cables of different sizes and types. Each cable is shown with its jacket removed, revealing the internal conductors. The cables are arranged in a row, with some standing upright and others lying horizontally. Each cable has a label attached to it, providing specific technical details. The labels include the Aptitude Rating number, stranding, insulation thickness, jacket thickness, and nominal diameter. Some labels also mention Underwriters' Type and intended uses.

Aptitude Rating No.	Stranding	Insulation Thickness	Jacket Thickness	Nominal Diameter	Notes
8453	41x34	1/64"	1/32"	.265"	
8454	41x34	1/64"	1/32"	.265"	
8455	16x34 41x34	1/64"	1/32"	.280"	
8424	26x34	.020"	.040"	.305"	Also used as microphone cable.
8427	26x34	.020"	.040"	.370"	Interconnecting power cable for all electronic uses.
8425	26x34	.020"	.040"	.335"	Interconnecting power cable for all electronic uses.
8426	26x34	.020"	.040"	.355"	Interconnecting power cable for all electronic uses.
8452	41x34	1/64"	1/32"	.245"	Underwriters' Type SV
8888	41x34	1/32"		.114x.231"	Underwriters' Type POT-64

Belden
Radio WIRE The *Aptitude-Tested* **LINE**

* MAGNECORDER

Sound Performance



... from **PYONGYANG** ... to **PASADENA!** *

Magnecord Tape Recorders are on duty in Korea. Intelligence officers using Magnecorders record first-hand reports of jet pilots just back from front-line sorties. Used extensively by the Air Force, Magnecorders undergo extremes in field conditions and still record with dependable high fidelity.



At KXLA, Pasadena, Calif., portable Magnecorders make "remote" recordings of top professional quality, and do it so easily. On a fighter strip or in the studio you can handle delayed programs with complete assurance when you use Magnecorders, the first choice of radio engineers everywhere.

MORE FEATURES
PT7 accommodates 10½" reels and offers 3 heads, positive timing and pushbutton control. PT7 shown in console is available for portable or rack mount.

GREATER FLEXIBILITY
In rack or console, or in its really portable cases, the Magnecorder will suit every purpose. PT6 is available with 3 speeds (3¾", 7½", 15") if preferred.

HIGHER FIDELITY
Lifelike tone quality, low distortion, meet N.A.B. standards — and at a moderate price. PT63 shown in rack mount offers 3 heads to erase, record and play back to monitor from the tape while recording.

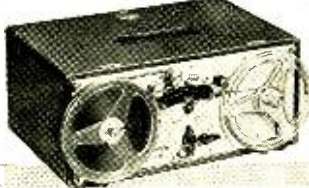

WRITE FOR NEW CATALOG
Magnecord, INC.

360 North Michigan Avenue
Chicago 1, Illinois, Dept. A-11

Send me latest catalog of Magnecord equipment.

Name.....
Address.....
City..... Zone..... State.....



peering across the cathode resistor R_1 is, of course, proportional to the amplitude of the input. Across R_1 is a series combination of V_2 , connected as a triode, and C . Switch S is open, as shown. V_1 is preferably a tube which will carry a fairly large current and one with low plate resistance. Capacitor C charges to a maximum value proportional to the amplitude of the input

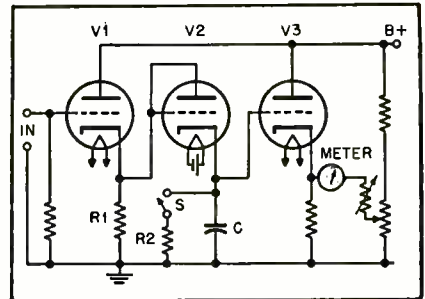

Fig. 2

to V_1 during the halves of the a.c. cycle when the cathode of V_1 is most positive with respect to ground. During the next half of the cycle, however, C cannot discharge, since current can flow in only one direction—the charging direction—through V_2 to C . C will, therefore, remain charged to a voltage corresponding to the peak voltage of the input during the period the meter is in operation. The tubes are acorn types, selected for low stray leakage paths, and the capacitor will remain charged to this value for several days.

The grid of V_3 is connected to capacitor C , and therefore has impressed on it the voltage to which C is charged. The meter circuit itself is a standard one of the bridge type, and it is calibrated to read input voltage.

To reset the meter to read a new peak, switch S is closed. Capacitor C discharges through resistor R_2 , and the device is again ready for use.

Variable Music Oscillator

Georges Jenny of Paris, France, has patented an oscillator suitable for use in monophonic electronic musical instruments; the number is 2,562,429. The circuit, shown in Fig. 3, is extremely simple—an R-C oscillator whose frequency is varied by changing the value of R_1 . The patent is titled "Cathodic Coupling Oscillator..." and

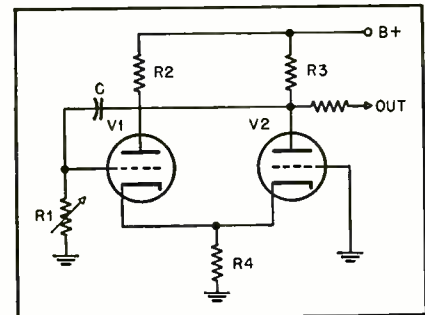

Fig. 3

the inventor appears to think that the common cathode resistor is a startling new feature. The first triode is a conventional amplifier, with some output appearing across an unbypassed cathode resistor. The second is a grounded-grid amplifier with cathode input. This circuit still has a new advantage, however, in that it has two fewer components than the usual circuit, since feed back from V_2 plate to V_1 grid

is obtained simply with a capacitor and there is no capacitor across the grid of V_1 . It also has the advantages of wide frequency range with variation of one resistor, and constant wave form.

Frequency is varied over a large range by varying R_1 . In a keyboard instrument this could be done very efficiently as shown in Fig. 4. The output waveform is com-

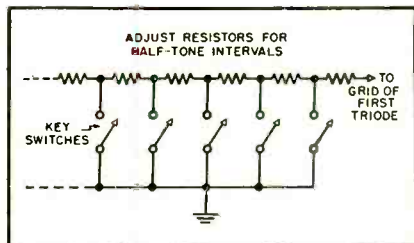

Fig. 4

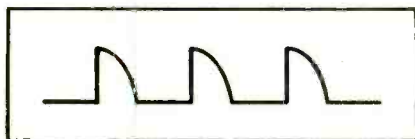
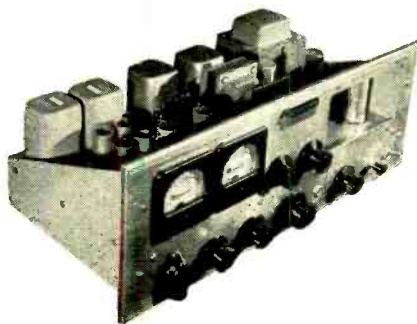

Fig. 5

plex, as indicated in Fig. 5, and does not vary with a change in R_1 , though output voltage does vary about 6 db over a three-octave range.

The writer made a simple experiment with the circuit, using a 500,000-ohm potentiometer for R_1 , 100,000 ohms each for R_2 and R_3 , about 30,000 ohms for R_4 , and .01 μ f for C . The tube was a 6SL7-GT. Output was taken from the cathodes rather than from a plate as the inventor has it. A comparatively small change in R_1 was needed to produce a 3-octave range and the scheme seems to work very nicely. The waveform is suitably complex for use with a formant-filter tone coloring system.

New Binaural Tape Recorder Makes Bow At Audio Fair



Shown above is the amplifier unit of the new Magnecord binaural tape recorder, stated by the manufacturer to be the first commercially available unit for binaural recording on standard quarter-inch magnetic tape.

Recording is accomplished by feeding two separate signal channels onto the tape, each signal occupying a half-track portion. The system will be demonstrated publicly for the first time in suite 604-6 at The Audio Fair, November 1, 2, and 3.

THE Aristocrat

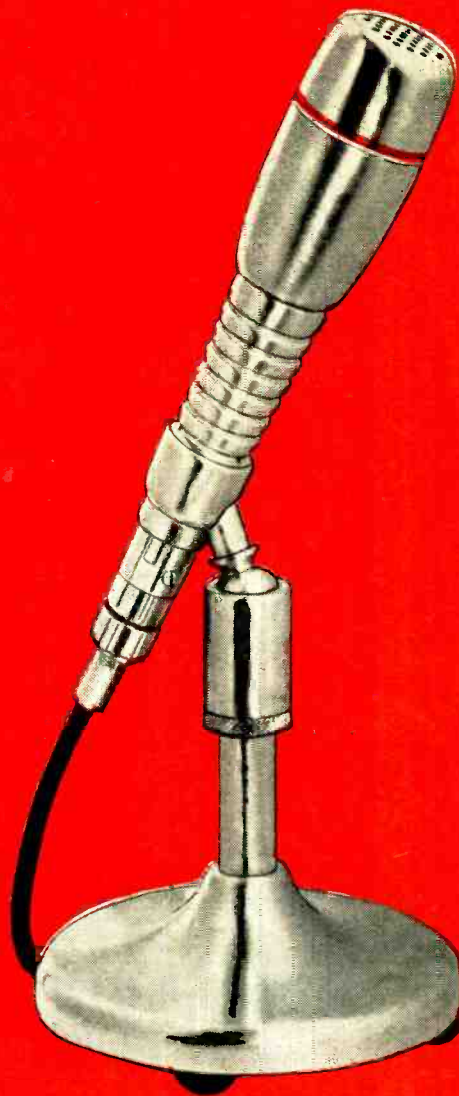

**WORLD'S FINEST
DYNAMIC MICROPHONE**

THE TURNER COMPANY

929 17th Street N.E., Cedar Rapids, Iowa

IN CANADA:
Canadian Magneco Co.
Toronto, Ont., and Branches

EXPORT:
Ad. Auriema, Inc.,
89 Broad Street, New York 4

A new model of Britain's best audio amplifier, with compensated settings for all recordings

LEAK "POINT ONE"

Distortion: 0.1%

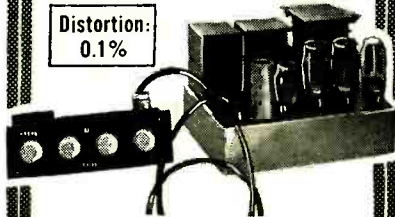

Leak "Point One" provides the ultimate in clarity and frequency response. Certified tests by British Nat'l Physical Lab. (equiv. U. S. Bureau of Standards) prove this triple loop power amplifier and pre-amplifier exceed manufacturer's performance claims.

In the TL/12 amplifier, hum and noise levels fall within -80 db and -72 db relative to 10 watts and are entirely inaudible. Feedback is taken from low side of output transformer and due to the magnitude of feedback, there can be no rise of voltage. The reproduction of transients, especially of low frequency, is astonishingly clarified.

At your dealer or write to
BRITISH INDUSTRIES CORP.
164 Duane St., New York 13, N. Y.

See Them at the
AUDIO FAIR
HOTEL NEW YORKER
ROOMS 652 & 653

Magnificent WHARFEDALE SPEAKERS

Inexpensive — but with remarkable response.

Assure clear, undistorted musical reproduction.



Built by Wharfedale Wireless Works under the direction of world-famous engineer, G. A. Briggs. Brilliant performance approaching living sound.

OUTSTANDING BOOKS by G. A. BRIGGS

Renowned authority on sound.

LOUDSPEAKERS
\$1.25

SOUND REPRODUCTION
\$2.25

Practical! Informative!

The only such books written expressly for the layman. Simple, easy-to-understand language and diagrams on principles important for every home audio system. At your jobber or send check or money order.

BRITISH INDUSTRIES CORP.
164 Duane St., New York 13, N. Y.

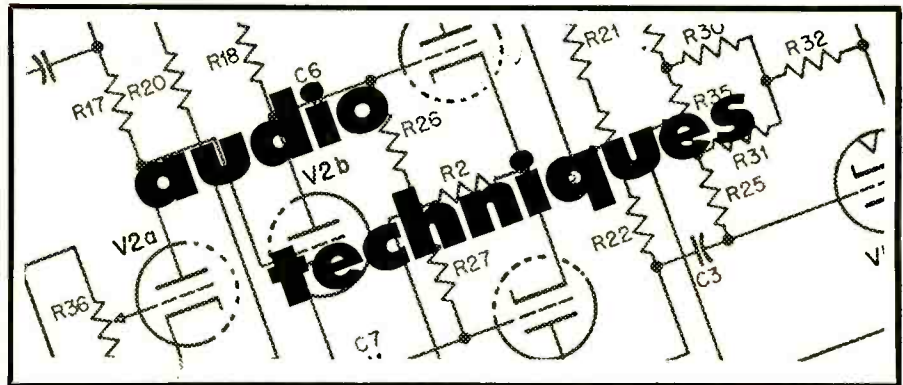

A Scratch Filter with Continuously Variable Cut-off Point

CHARLES J. LEVIN*

IN THE COURSE of experimenting and listening, most audio hobbyists have reached the conclusion that, although extended range and flatness are highly desirable in a record reproducing system, some type of cut-off at the high-frequency end is necessary to reduce the "hiss" present in certain recordings. Even though the owner of a system will become tolerant of high-pitched scratch as inevitable in wide-range reproduction, when the system is demonstrated to a casual listener, his remarks may pertain to the noise rather than the commendable qualities of the equipment.

Although a variety of familiar methods are used to effect high frequency roll-off, it is generally agreed that minimum degradation of tone quality results when a sharp cut-off L-C type filter is used; and this arrangement is found in the more expensive amplifiers, sometimes with a selection of several cut-off points.

The writer has found the circuit of Fig. 1 to be very effective. It is simple, is constructed with an easily obtained coil, thus permitting selection of optimum conditions for any degree of scratch. The inductor is a syncroguide type of horizontal oscillator coil used in many tele-

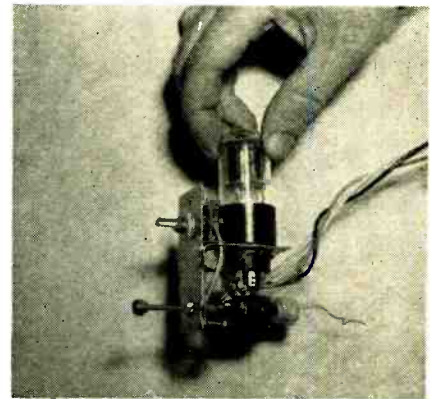

Fig. 2. View of scratch filter chassis ready for installation in existing amplifier.

vision sets mounted with the tuning slug shaft protruding through the control panel. The spring clip by which these coils are regularly mounted is used except that the portion of the clip which forms threads for the slug screw is filed away, permitting the slug to slide in and out freely. A small knob is then threaded and placed on the end of the shaft, as shown in Fig. 2, permitting selection of the cut-off point by moving the slug. The cathode follower circuit provides the low impedance required for the coil used

* 906 Dartmouth Road, Baltimore 12, Md.

[Continued on page 76]

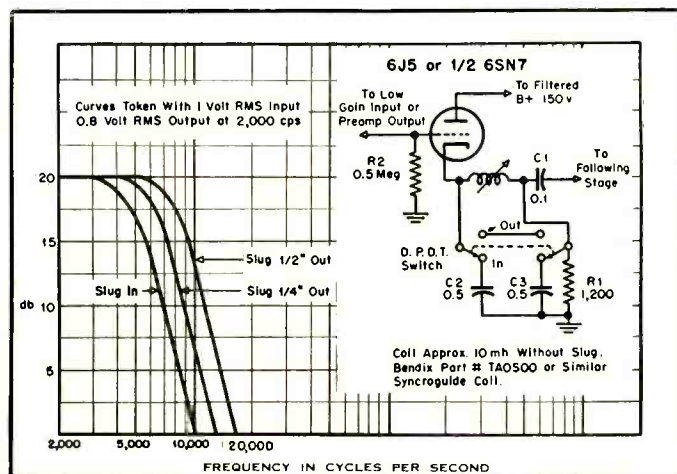

Fig. 1. Curves obtained by the use of the simple scratch filter circuit shown in the insert.

High Fidelity
requires

**A
RECORD
Changer**

NOT

**A
Record
CHANGER**

Distortion free reproduction! — That is why critical listeners prefer the GARRARD. Built with watch-like precision, it reproduces accurately the original tonal quality of the original performance. Features such as the heavy motor and drive shaft guarantee consistent playing quality—even at the critical low speeds—and eliminate wows and wavers. The exclusive Garrard tone arm mounting assures true-tangent tracking, prevents disturbing resonance. With the GARRARD, you'll find no variation from the original, no distortion in highs and lows. And, most important for true high fidelity... Where sensitive reluctance cartridges are used, there is no risk of objectionable hum because of the exclusive 4-pole motor and the steel plate welded on the top of the turntable, which acts as a shield...

... If you wish to enjoy all the musical qualities of your records — not a mere approximation of them...

the
features
that bring
fine
music
home



TWO INTERCHANGEABLE
SPINDLES



WEIGHTED TURNTABLE —
HEAVY MOTOR
No wows. No wavers.



PUSHER TYPE PLATFORM
always works.
SIMPLE 3 SPEED SETTINGS

AUTOMATIC STOP
at end of last record

GARRARD

THE WORLD'S FINEST RECORD CHANGER



Easily, inexpensively installed
in your present set.

Write for FREE FACT SHEET —
what to look for when purchasing
a 3 speed record changer.

GARRARD SALES CORP. Dept. 9F
164 Duane Street, New York 13, N. Y.

Play them on the **GARRARD**
THE WORLD'S FINEST 3 SPEED RECORD CHANGER!

VISIT US AT THE AUDIO FAIR — NOVEMBER 1, 2, 3 — AT THE HOTEL NEW YORKER — ROOMS 652 AND 653

SOUND TRANSLATION.

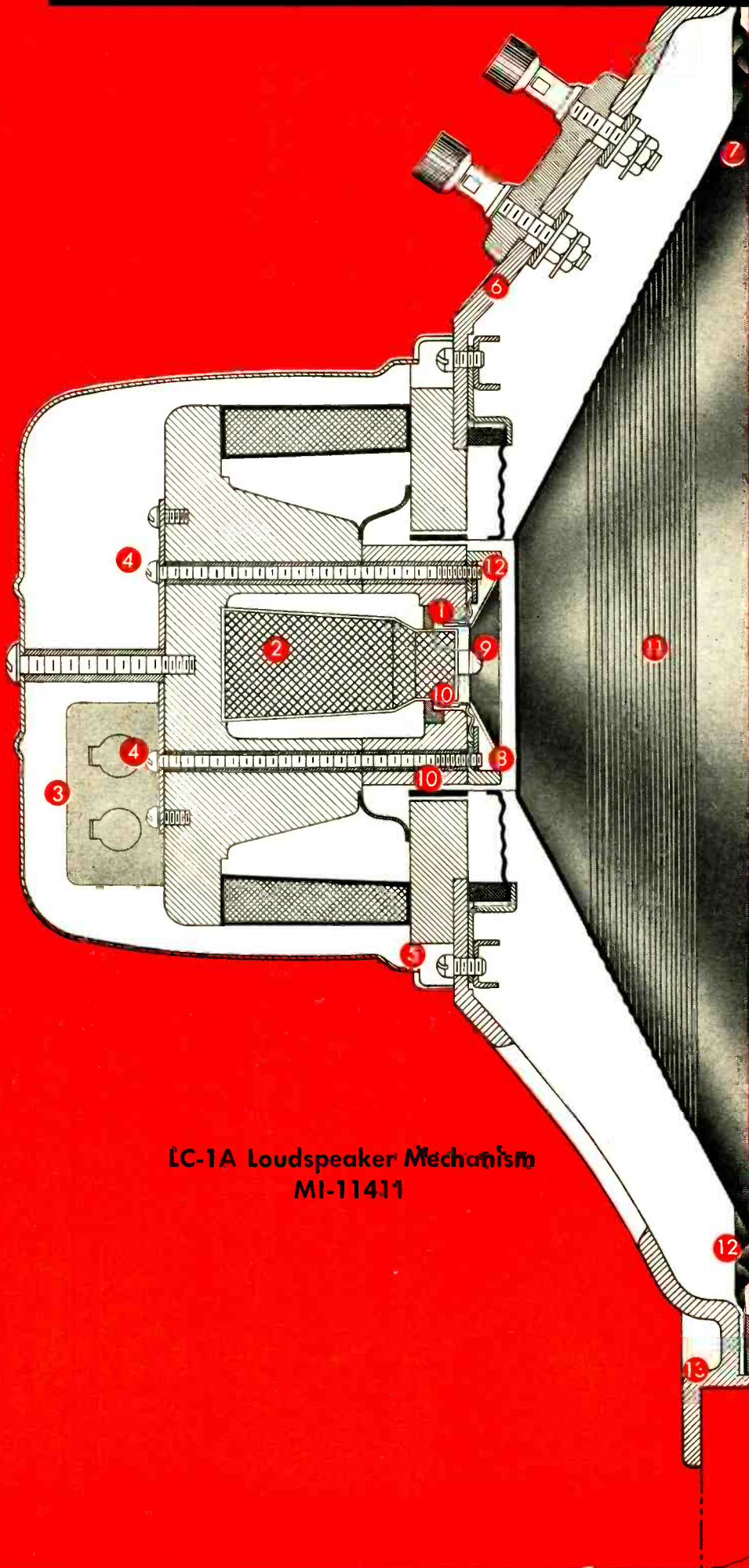

LC-1A Loudspeaker Mechanism
MI-11411

1 H-f voice coil, aluminum wire-wound, to deliver full h-f range

2 Heavy ALNICO V magnets

3 Cross-over condenser

4 Centering adjustment for h-f cone

5 Centering adjustment for l-f cone

6 Sturdy die-cast aluminum frame

7 Shallow cone for smooth response and greater angle of distribution

8 H-f and l-f cones coaxially-mounted, mechanically independent

9 H-f cone. Diaphragm diameter only 2 3/8". Wide-angle distribution to 15,000 cycles

10 Ample gap clearances

11 Massive 15" l-f cone. Bass response 35 to 2000 cycles at all volume levels

12 Cone rim treated to minimize edge reflections for smoother response

13 Offset mount eliminates front cavity — insures smooth response

..... **next to perfect!**

The Famous LC-1A Speaker

Among the great achievements of the RCA Princeton Laboratories is the development of the most advanced speaker in the world—the RCA Duo-Cone, Type LC-1A.

Expressly designed to give sound its true translation, this professional speaker is matched by no other high-quality sound reproducer.

Unique duo-cone design (originated by Dr. H. F. Olson of RCA Princeton Labs) provides a smooth response from 50 to 15,000 cycles—with no resonant peaks, harmonics, or transient distortion. Full power is radiated over 120-degrees at 15,000 cycles—makes it possible to enjoy high-fidelity sound *any place in the room!* Smooth crossover response around 2000 cycles eliminates all undesirable interference between the high-frequency unit and the low-frequency unit. Controllable “roll-off” at 5 and 10 kc... when used with the MI-11707 filter... restricts the h-f distortion and surface noises present in many recordings.

Today, more than 3000 of these speakers are serving in station control rooms, listening rooms, auditioning booths, lobbies, clients' offices, and private homes.

For more information, mail the coupon.



AUDIO BROADCAST EQUIPMENT
RADIO CORPORATION of AMERICA
ENGINEERING PRODUCTS DEPARTMENT, CAMDEN, N. J.

In Canada: RCA VICTOR Company Limited, Montreal

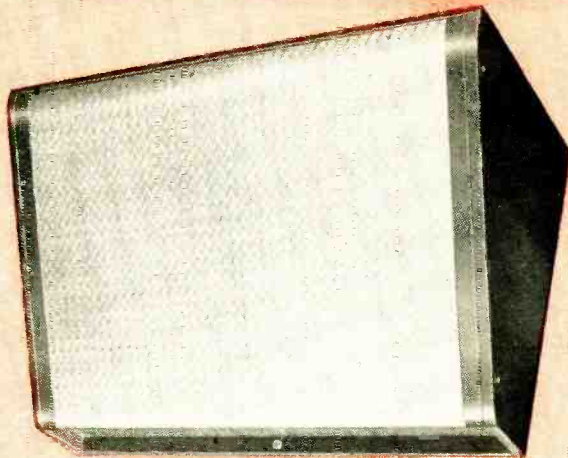

New Wall-Ceiling Housing for LC-1A

Ideal for sound reinforcement in control rooms, auditioning booths, hallways, talkback positions, elevators,

executive offices. Port provided for increasing bass response. Finished in harmonizing 2-tone umber gray.

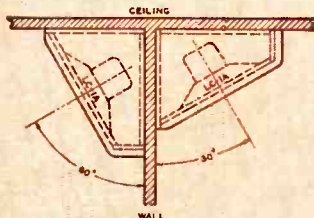

It's Easy to mount

The Wall-Ceiling Housing can be mounted for long or short “throws”—makes the wall and ceiling a part of the acoustical system.

The LC-1A Monitoring Speaker, with Console cabinet and MI-11707 filter

The finest reproducer in the business.
Finished in harmonizing 2-tone
umber gray.

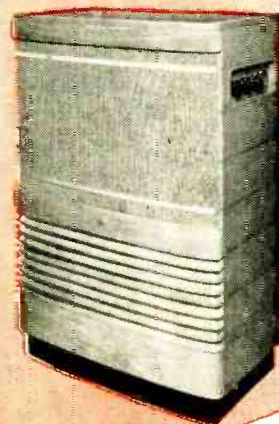

Department 16W
RCA Engineering Products
Camden, N. J.

Send me price and information on

- LC-1A Speaker Mechanism, MI-11411
- LC-5A Wall-Ceiling Cabinet, MI-11406
- LC-1A Speaker with Console Cabinet, MI-11411/11401

Name _____

Station or firm _____

Address _____

City _____ State _____

LETTERS

Terminology

Sir:

There seems to be a trend toward the practice of specifying the amount of inverse feedback in an amplifier as the sum of the individual feedbacks in each stage and the over-all feedback. While this often adds up to an impressive total in db, it is extremely misleading in terms of the performance of the amplifier. The degree of feedback is usually thought of as a direct indication of the amount of reduction of distortion as well as of the damping factor of an amplifier. When the individual feedbacks are added, this is no longer necessarily the case, as may be illustrated by an artificial extreme example:

Consider a 3-stage amplifier with 8 db feedback from the voice coil to the cathode of the first stage, and driven by a cathode follower using a high- μ tube. The phase inverter is of the split-load type. How much feedback have we? The cathode follower has unity gain instead of a normal gain of, say, 50, so we have here a reduction in gain of 34 db. The unbypassed cathode resistor of the first tube causes a gain reduction of 6 db more; that of the phase inverter 22 db more; and the over-all feedback 8 db. The total is 70 db, but what does it mean? The individual feedbacks are beneficial in a limited sense, but only the 8 db of over-all feedback is effective in improving the damping factor, and very little distortion results from the feedback in the cathode-follower stage or from the first stage following where the level is low and distortion is low anyhow.

Another misleading practice is the specification of hum level in equalized phonograph preamplifiers in such terms as "60 db below 1 volt." This means only that the hum level in the output is 1 millivolt, but it gives the impression that the signal-to-hum ratio is also 60 db. If this preamplifier has a gain of 26 db and is used with a pickup having an output of 10 mv, or 40 db below 1 volt, the hum referred to the input is 60+26, or 86 db below 1 volt, and referred to the input signal is 86-40, or 46 db and not 60 db.

Low-hum tubes are rated in terms of microvolts of hum referred to the grid. This is a legitimate method, but even this figure must be used with care. For instance, a 10- μ v figure is 60 db below the 10 mv output of the pickup used for the example given above. This gives an apparent signal-to-hum ratio of 60 db, which is marvelous. But it overlooks the fact that in a properly equalized preamplifier the gain at 60 cps is some 17 db higher than the mid-frequency gain (for a 500-cps turnover). Since the effective signal level is determined by the mid-frequency gain, the actual signal-to-hum ratio is not 60 db but 43 db. Incidentally, this is a good figure in itself in the present state of the art, but it does indicate that figures like 60 db are not obtainable even with special tubes, with a.c. on the heaters. (The argument assumes that most of the hum is at 60 cps); for 120 cps, a 6-db gain is obtained, but this is at least par-

[Continued on page 55]

We CHALLENGE the performance of any 12" speaker with a Permoflux ROYAL EIGHT"

SAYS-PERMOFLUX'S MR. HY-FY

This averaged laboratory response curve of the Permoflux 8T-8-1 proves that it compares with the finest speakers regardless of size or price.

PERFORMANCE CURVE PERMOFLUX 8T-8-1

RESPONSE

FREQUENCY IN CYCLES PER SECOND

Hi-Fi Fans the country over have accepted this challenge—have asked their "soundman" for a demonstration—then, have installed a Permoflux Royal Eight" in their own audio equipment. Now they possess a magnificent speaker at a reasonable price which reproduces sound with superior sensitivity and fidelity as well as tonal qualities which YOU too will want to add to perfect the excellence of your own equipment.

Send for beautifully illustrated catalog No. J201 to address listed below for further information including a full page devoted to correct baffling of Royal Eight" and other size speakers.



Servicemen!

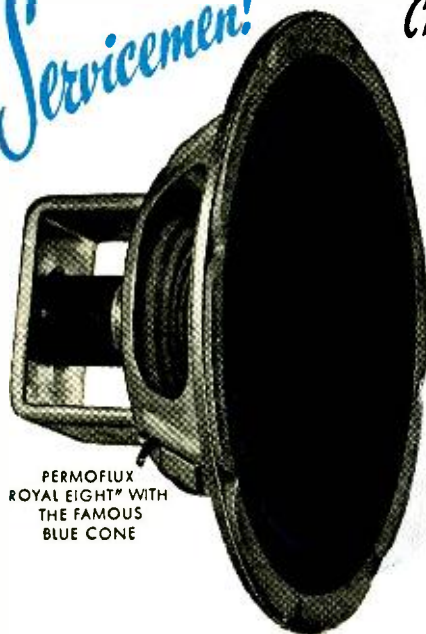

PERMOFLUX ROYAL EIGHT" WITH THE FAMOUS BLUE CONE

Check These Exclusive Features

Permoflux's exclusive slotted, treated cone gives the following results which makes their speaker comparable to any 12" speaker:

- Soft-suspended cone and extra-large spider provide extended low frequency response.
- Deeper, curvilinear cone greatly extends high-frequency response.
- High permeance yoke increases output.
- 8 ohm—10 watt voice coil.
- Big speaker performance in a small frame allows smaller more economical baffle.

Here's BIG SPEAKER performance—clean, brilliant, musical reproduction but at a sensible price level. Your customers will approve and buy.

ORDER FROM YOUR LOCAL INDEPENDENT PARTS JOBBERS

Hear the "AMAZING ROYAL EIGHT" SPEAKER demonstrated at the AUDIO FAIR, November 1, 2, 3. Hotel New Yorker—Suite 640.

TRADE MARK

PERMOFLUX

"SOUND IN DESIGN"

PERMOFLUX CORPORATION

4902 W. GRAND AVE., CHICAGO 39, ILL. • 236 S. VERDUGO RD., GLENDALE 5, CALIF.

Canadian Licensee . . . Campbell Mfg. Company, Toronto, Canada

Memo to the Trade:

THE ARNOLD ENGINEERING COMPANY
offers a complete line of
MAGNETIC MATERIALS
produced to the highest quality standards

PERMANENT MAGNET MATERIALS
.....

- Cast Magnets, Alnico I, II, III, IV, V, VI, XII, X-900
- Sintered Magnets, Alnico II, IV, V, VI, X-900, Remalloy*
 - Vicalloy* • Remalloy* (Comol)
 - Cunico • Cunife • Cast Cobalt Magnet Steel

HIGH PERMEABILITY MATERIALS
.....

TAPE WOUND CORES

- Deltamax • Supermalloy* • Permalloy* • 4750 • Mumetal

POWDER MO-PERMALLOY* CORES

PERMENDUR*, Cast and Forged

*Manufactured under license arrangements with WESTERN ELECTRIC COMPANY

Write for information on any of these Magnetic Materials

W&O 3689



THE ARNOLD ENGINEERING COMPANY

SUBSIDIARY OF ALLEGHENY LUDLUM STEEL CORPORATION

General Office & Plant: Marengo, Illinois

EDITOR'S REPORT

AES CONVENTION

THE THIRD ANNUAL CONVENTION of the Audio Engineering Society opens at 10:00 a.m. on November 1, and at present writing, all indications point to a bigger attendance than in either of the two previous meetings. The papers to be presented cover a wide range of subjects, and the Saturday morning session is devoted entirely to the hobbyist, thus permitting many to attend who would not otherwise be able to.

The over-all interest in audio is growing by leaps and bounds. At least three of the "home" magazines will have carried articles on built-in music systems by the end of the year; one hears radio programs stressing the advantages of assembling a high-quality system by the simple expedient of hooking up a number of readily available components; and the radio jobbers throughout the country are putting in special sound departments and issuing catalogs of equipment intended for home use.

\mathcal{A} feels a special pride in this swing to better audio, and while a natural step forward is in the direction of convincing radio set manufacturers that the public is fed up with midget chassis installed in large, boomy, open-back cabinets, it would detract from the need or desire of the individual to build his own system.

There are, of course, two classes of "hobbyists." The first, and most enthusiastic, includes those of us who would build another amplifier at the drop of a hat if someone even hinted that it was one iota better than the one we were using. And we might even drop the hat ourselves if no one else would. It is doubtful if we know whether we like to hear good music or if we just like to build equipment.

The second class of hobbyist is the one who gets the idea that he wants better sound quality and goes after it. Once his system is completed, he ceases to be a hobbyist, but simply listens to his handiwork. Of the two classes of hobbyist, \mathcal{A} is directed principally to the former, but it does make a conscious effort to keep a balance with articles which are of interest to the professional almost exclusively. The man who works in audio must keep abreast of new developments in recording, studio practice, instrumentation, and other technical aspects of the industry. In trying to keep this balance, there are sure to be occasional articles which are of little interest to one or the other class of reader.

\mathcal{A} is always well aware of the desire of many of its readers to build new equipment—either because they need it or just because they want to build something. We are, at present, beating out our own version of the

Ultra-Linear amplifier described on page 15. Not being content to follow anything slavishly, we are using a cross-coupled phase inverter, and we are adding some means to balance the plate currents of the output stage. To make satisfactory adjustments on this amplifier, we think we need a square-wave generator, so we searched for a likely one which was relatively simple. Some months ago, Sylvania's monthly bulletin had a circuit of a clipper-type generator which appears to fill the requirements, so we have been sidetracked for awhile. By the time this page is being read, it is probable that both will be working. This is the first equipment we have built for the home music system this year, although we have put together two amplifiers for tape recorders—one an extra simple unit with only one switch and one dial, and with the plugs and jacks arranged so the user cannot make a mistake in connecting microphone, amplifier, power supply, and recorder. The other one has everything on it but the kitchen sink, as the saying goes, and was planned to work from a home music system, or from low-impedance microphones, or as a remote amplifier for broadcast use, or as a synthetic reverberation unit—all with one small cabinet about nine inches square by six inches high. To make it difficult, it uses a standard VU meter—the big rectangular kind—and six tubes, three of them being dual triodes. The power supply is separate.

Articles on all of these items are scheduled for the next few months, beginning with the simple tape recorder amplifier in the December issue.

THE AUDIO FAIR

Along with the Society's convention, the Audio Fair holds the boards for three days, and will attract more visitors than the technical sessions. However, the audio bug can get in its bites in the wide variety of exhibits which make up the Fair, and we have an opportunity of making the acquaintance of more and more audio people at each showing. Increased facilities are provided for the registration of visitors, and it is hoped that the formalities of registering may be reduced to a minimum, with more time thus being available for the exhibits. To make it easy to join the Society—providing an entree to the inside of this fastest growing industry, an application blank is to be found on page 65. Fill it out, write a check, and send both in—and let yourself in for some hard work on the committees. Let's make 1952 Audio's Biggest Year.



**"Head chatter is no problem with
"SCOTCH" Sound Recording Tape
...it's lubricated!"**



Says **RALPH S. DAVIS**, Recording Supervisor,
WMAQ, CHICAGO

SHOWN IN the Daylight Saving delay recorder room at WMAQ are (l. to r.) Howard C. Lutgens, NBC Chicago Chief Engineer, Harry C. Kopf, NBC Vice President and General Manager of Stations WMAQ, WMAQ-FM, and WNBQ, and Ralph Davis.

More than 160 hours of recording on tape every month . . . that's the exacting schedule maintained at NBC's 50,000-watt outlet in the Chicago area, WMAQ. To assure faultless reproduction every time, WMAQ chooses the *lubricated* tape that glides past recording heads without a whisper . . . "SCOTCH" Sound Recording Tape. This versatile tape simplifies preparation of spot commercials, permits juggling of network programs to fit in with local schedules. It enables you to

dub in, make additions, lift recordings from tape to tape without loss of quality.

Our staff of 100 trained engineers located throughout the country will be glad to help you with any recording problem you may have. They work daily with radio station engineers, electronic engineers and industries using tape recording in process or quality control. Call your nearest 3M Service Representative, or if you prefer, write direct to Minnesota Mining & Mfg. Co., Dept AE-111, St. Paul 6, Minn.

"SCOTCH" SOUND RECORDING TAPE GIVES YOU THESE EXTRA CONSTRUCTION FEATURES

- **REEL TO REEL UNIFORMITY**—controlled coating assures consistent output
- **THINNER CONSTRUCTION**—resists temperature and humidity changes
- **NO CURLING OR CUPPING**—tape lies flat on recording head unaffected by humidity
- **UNIFORM TAPE SURFACE**—no "dropouts" on recordings due to surface irregularities
- **LONGER TAPE LIFE**—special lubricating process reduces friction
- **GREATER SENSITIVITY**—more output on your present machine setting



The term "Scotch" and the plaid design are registered trademarks for Sound Recording Tape made in U.S.A. by Minnesota Mining & Mfg. Co., St. Paul 6, Minn.—also makers of "Scotch" Brand Pressure-sensitive Tapes, "Underseal" Rubberized Coating, "Scotchlite" Reflective Sheeting, "Safety-Walk" Non-Slip Surfacing, "3M" Abrasives, "3M" Adhesives. General Export: Minn. Mining & Mfg. Co., International Division, 270 Park Avenue, New York 17, N.Y. In Canada: Minnesota Mining & Mfg. of Canada, Ltd., London, Canada.

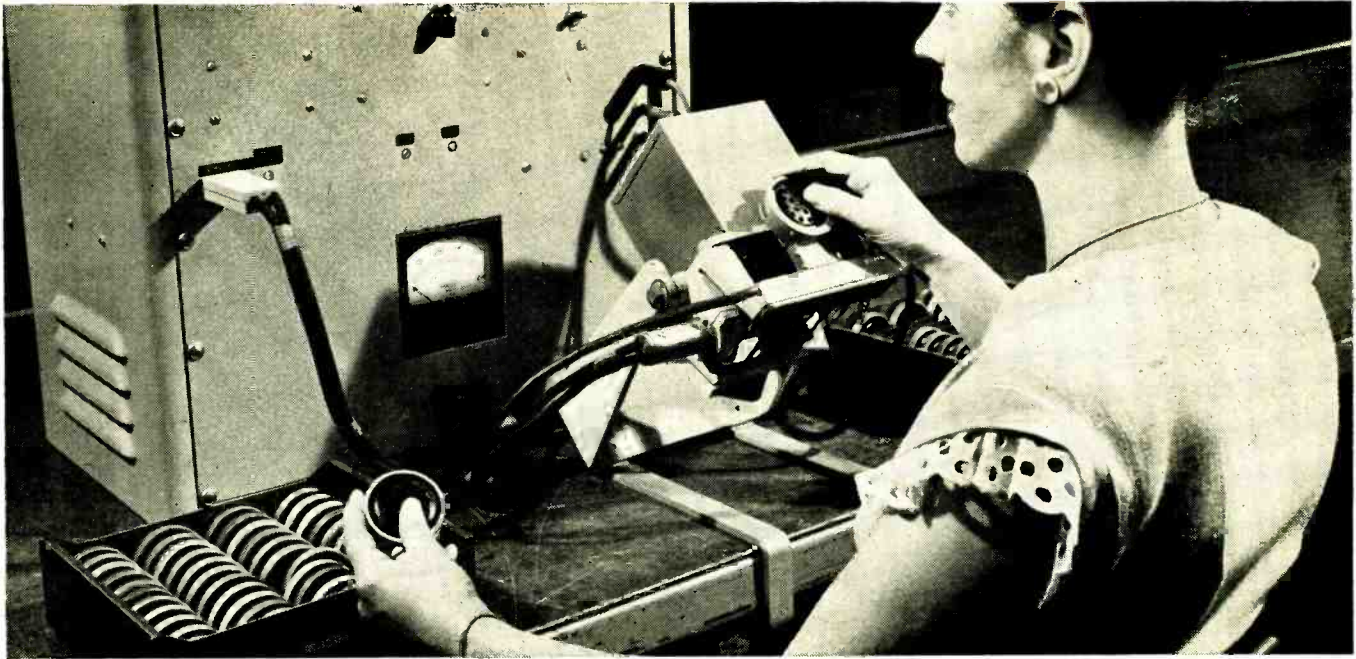

This Western Electric employee mounts a transmitter in the test fixture which is swung down to face an artificial mouth at 45-degree angle, just as transmitters are held in use. More than a million transmitters are tested each year.

This mouth speaks to millions

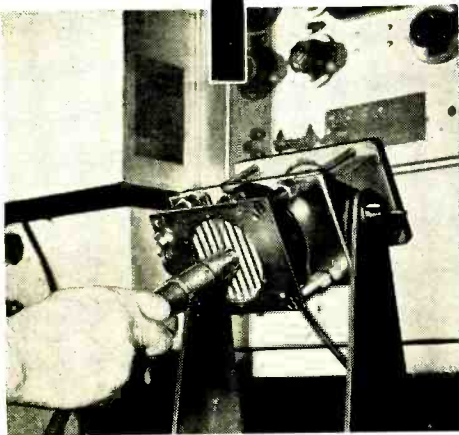

At Bell Laboratories a scientist employs a condenser microphone to check the sound level from another type of artificial mouth, used in transmitter research.

To serve the changing needs of telephone subscribers millions of telephone sets have to be moved each year. Before being put back into service most of them are returned to the Western Electric Company's Distributing Houses where they receive a thorough checkup.

Western Electric engineers needed a rapid method of testing transmitters over a range of frequencies. At Bell Telephone Laboratories, scientists had just the thing—a technique they had devised for fundamental research on transmitters. In co-operation with these

scientists, Western Electric engineers developed the practical tester in the illustration.

The transmitter is removed from the handset and put in front of an artificial mouth which emits a tone that swings several times per second over a band of frequencies. A signal lamp tells whether the transmitter is good. Each test takes 5 seconds.

This new tester illustrates how Bell Laboratories research and Western Electric manufacturing skill team up to maintain your telephone service high in quality yet low in cost.



BELL TELEPHONE LABORATORIES

• EXPLORING AND INVENTING, DEVISING AND PERFECTING, FOR CONTINUED IMPROVEMENTS AND ECONOMIES IN TELEPHONE SERVICE

An Ultra-Linear Amplifier

DAVID HAFLER* and HERBERT I. KEROES*

Presenting a new output-stage connection in an otherwise conventional amplifier which provides a degree of listenability which is well above average.

IT HAS BEEN CLAIMED that there is no more room for improvement of power output stages since other elements of a complete sound system—particularly the electro-mechanical ones—are far inferior. There is a prevalent belief that “one good amplifier is only marginally different from another.” The proponents of this line of thought imply that significant improvement in power amplifiers is extremely difficult to achieve, and with this idea the authors agree, but the authors disagree as to the need for further improvement. Obviously, the weaker links do need improvement, but this alone is no reason for abandoning the further development of stronger links in the chain of audio reproduction—the power amplifier and primarily the power output stage which is the prime generator of distortion in the purely electronic part of the audio system.

Present thinking is very parallel to the views of the 1935 era when it was felt that the principle need was for better program sources and that the transducers and audio amplifiers had reached a stage of near perfection which could hardly be improved. Now, what audiophile would be satisfied with the reproduction standards of sixteen years ago when playing the new LP's or high grade tape? By analogy, therefore, as well as for the never-ending search for a never-attainable perfection, we must continue to seek improvement in every link of the audio chain.

The old standards for evaluating amplifier quality have fallen into disrepute. It can be audibly demonstrated that a wide pass band and low harmonic content do not necessarily mean that the amplifier satisfies the critical listener. Newer criteria have been developed such as intermodulation distortion analysis and square wave testing, both of which simulate dynamic conditions to some extent and take into consideration that music and speech are not of a static nature. These new tests produce higher correlation between experimental data and listener preference. Therefore, modern amplifiers sound better than the ones of a few years ago as a general rule. However, these tests do not always separate the wheat from the chaff. Amplifiers which measure well do not necessarily sound well although an amplifier which shows up as poor on measurements will not sound well. Excellent measurements are a necessary but not a sufficient condition for quality of sound. This means that the listening test is the one of most

importance—it is the most stringent test of all.

On the basis of listening tests (definitely not on the basis of measurements) the audio school has been divided into two camps—triodes versus tetrodes. There has been shifting between the popularity of the two, but there has always been a distinct cleavage. When the triode-without-feedback was judged superior to the tetrode-without-feedback, the tetrode school added feedback and reaffirmed the merits of this tube type. This was again superseded by the triode-with-feedback, but the beam tetrode still has its followers, presently in the category of a defensive minority among the audio elite.

The very fact that each tube type has ardent supporters is evidence that each has definite points of merit. Possibly the devotees of each type listen for *different* qualities of reproduction, and this causes divergence of opinion. The triode fan usually emphasizes “smoothness” or “sweetness” of sound. The beam power advocates seek “crispness” or “clean sound.” Each group obviously desires sound which simulates the original, but each rejects the elusive and unmeasurable distortions which characterize the tube type preferred by the opposition camp. A new type of tube, none of which has been put on the market for many years, might be the thing which could reconcile these diverse views of listeners who all look for the same thing but seek it in different ways.

The requisites for such a new tube can be listed readily:

1. Low internal impedance, such as is offered by the triode.
2. High power sensitivity of the tetrode so as to minimize drive problems.
3. Lower harmonic and intermodulation distortion than either triode or tetrode at both high and low levels of operation.
4. Sufficiently high efficiency to permit adequate output without undue bulk or cost.

Since no such tube is available, the only recourse is to seek a mode of operation of existing type tubes to approximate the desired qualities and then to see whether the theory is justified by listening tests.

Linearizing the Output Stage

The physical difference between the triode and tetrode is, of course, the screen grid. This gives the tetrode its efficiency on the one hand, but also increases the plate resistance and contributes toward the “tetrode sound” which is so violently disliked by triode

favorers. Therefore, the screen grid seems to be the element which gives the tetrode its advantages and its disadvantages compared to the triode. In fact, when the screen is connected to the plate, the resultant tube is a triode which is excellent in many respects though handicapped by limited power output and low permissible dissipation. Control of the screen is a logical step toward ex-

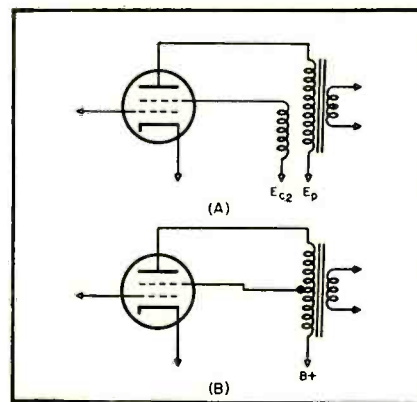

Fig. 1. Arrangements for energizing the screen grid to improve tube linearity.

tracting the favorable attributes of the tube and discarding the unfavorable.

Experimentally it was found that the goal of improved operation could be achieved through energizing the screen with d.c. through a special winding on the output transformer and combining the effects of both plate and screen current in the output transformer. This is illustrated at (A) in Fig. 1 with an alternative and simpler method shown at (B). It has been found that the screens must be fed from a low-impedance source or the benefits of this arrangement cannot be realized. This eliminates the possibility of doing the same job with resistive bridge networks or voltage dividers.

The screen load impedance is somewhat critical if optimum results are desired. As the ratio of screen load impedance varies from zero (tetrode operation) to unity (triode operation), important effects show up:

1. The internal impedance takes a sharp drop and then levels off.
2. Maximum undistorted output drops slightly at first, then decreases rapidly.
3. Intermodulation distortion at high level operation drops to a minimum and then soars upward.
4. Low level IM decreases somewhat and then holds almost level.

The situation is demonstrated graphically in Fig. 2 where it can be seen

* Acro Products Company, 369 Shurs Lane, Philadelphia 28, Pa.

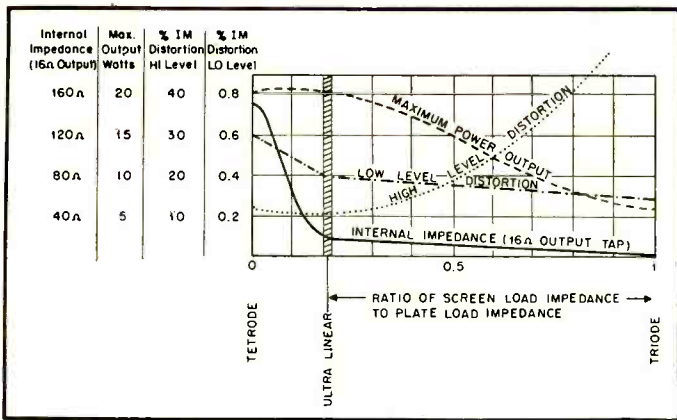

Fig. 2. Comparison of Ultra-Linear operation with triode and tetrode operation using a push-pull stage without feedback.

that over a narrow band of operation where screen load impedance is about 18.5 per cent of plate load impedance, the new arrangement provides the high power output of tetrodes with low internal impedance such as is normally obtained from triodes, while distortion figures are equal or better than the extremes of operation. We have achieved a new tube type without designing a new tube. This tube is neither triode nor tetrode, but its improved linearity over either of those types justifies the designation "ultra linear."

The Complete Amplifier Circuit

In applying the ultra-linear output arrangement to complete amplifier circuits, it was found that the simple version of (B), Fig. 1 could be used to advantage. By feeding d.c. to the screens through a properly placed tap on the primary of the output transformer, the operating conditions are preserved, and the close coupling between screen and plate is advantageous when feedback is carried around the stage. The disadvantage of this simpler arrangement is that screen and plate must operate at the same d.c. potential. In the particular arrangement used the screen and plate are operated at the same potential (350 volts plate to cathode) without exceeding dissipation requirements, either quiescent or at maximum output. This new output coupling arrangement reduces screen dissipation at high levels and is a safe mode of operation with respect to tube life.

A circuit arrangement has been designed to take full advantage of the ultra linear output stage. This circuit, Fig. 3, takes into account the necessity for complete stability under feedback conditions so as to eliminate tendencies toward transient instability under any type of load, including the varying impedance of loudspeaker systems.

This complete circuit offers linearity of operation of a very high order. It is based around a special output transformer, the Acrosound TO-300, which is 6600 ohms primary impedance and has taps at the optimum point indicated in Fig. 2. A special seven-section symmetrical winding arrangement placed on a substantial grain-oriented lamination of unique shape permits a ratio of primary inductance to leakage reactance in excess of 15,000 to 1. The response of the transformer alone is within ± 1 db

from 10 to 100,000 cps with extremely low phase shift and no resonances within this band.

The complete amplifier circuit is relatively simple, inexpensive, and efficient. With a 370-volt power transformer at 130-ma peak requirement, power output is almost as high as for a tetrode amplifier and twice that of a triode amplifier with cathode bias and the same power

Performance of the Amplifier

All stages of the amplifier have been adjusted for minimum intermodulation, and the IM curves based on sine-wave power output are shown in Fig. 4. These curves were run using frequencies of 40 and 2,000; 40 and 7,000; 40 and 12,000; 100 and 2,000; and 60 and 7,000, all mixed four to one. The IM is almost identical under all conditions of test indicating that it is completely independent of frequency, at least up to 20 watts output. This factor possibly accounts for the superlative listening quality of the amplifier.

Undistorted power, less than 2 per cent IM, is in excess of 20 watts. This power is delivered *undistorted* within 1 db over the range from 20 to 20,000 cps. This power curve (Fig. 5) is not a response curve run at high power level. Instead it represents *clean* power available at these frequencies. This is particularly important with today's program sources. The dynamic range of some of the best LP's is reputed to be in excess of 100 db. It is necessary to have power to handle this range, and this power is

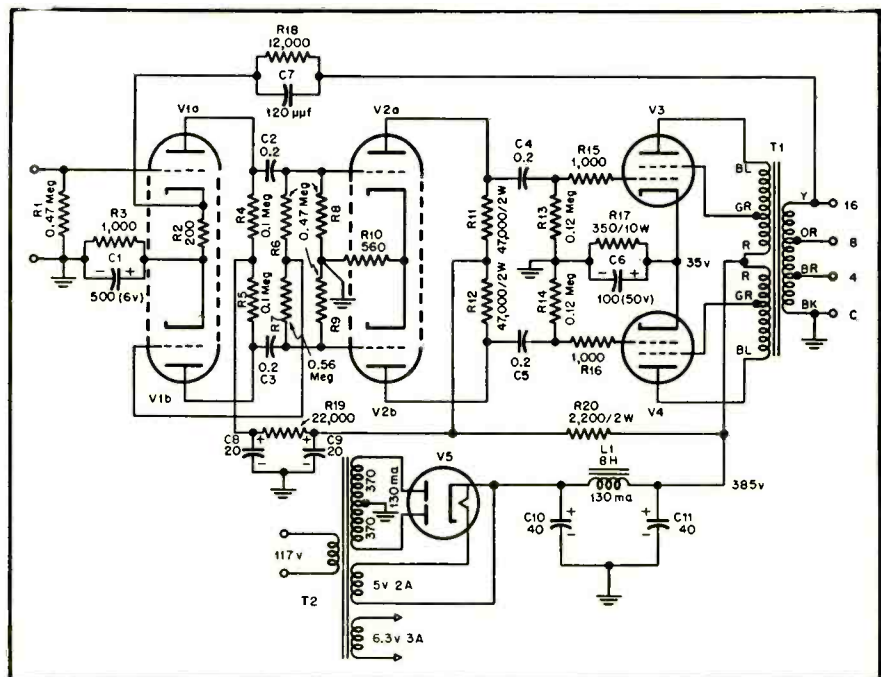

Fig. 3. Overall schematic of the Ultra-Linear amplifier and associated power supply.

supply. No adjustments are necessary for balance either of the phase inverter or of the output-stage plate current, and there are no critical values of capacitors or resistors required. The amplifier is driven to 20 watts of output with an input of only 0.7 volt.

Feedback is carried around the complete circuit in an external loop. There are 20 db of feedback in this loop as measured under load conditions (about 30 db based on open circuit gain), and a safe margin is maintained. A small capacitor across the feedback resistor increases the feedback in the region above 100 kc to smooth the high-frequency response. This capacitor is not required to keep the amplifier stable though it does add to the stability margin.

required over a wide frequency band. New standards of audio fidelity are rapidly making obsolete the five or ten watt amplifier which cannot even deliver its rated power at frequency extremes.

Another factor of considerable importance in evaluating amplifier performance cannot be seen from the curves. This is *overload characteristic*. The amplifier has been given listening tests under overload conditions with a pad on the output so as not to deafen the participants. Peaks which would require a 40-watt amplifier are transmitted without irritation even though the output can be seen to clip on the 'scope. The overload recovery is rapid and has no noticeable hangover, so a clipped peak has no time to penetrate the ear. Some amplifiers

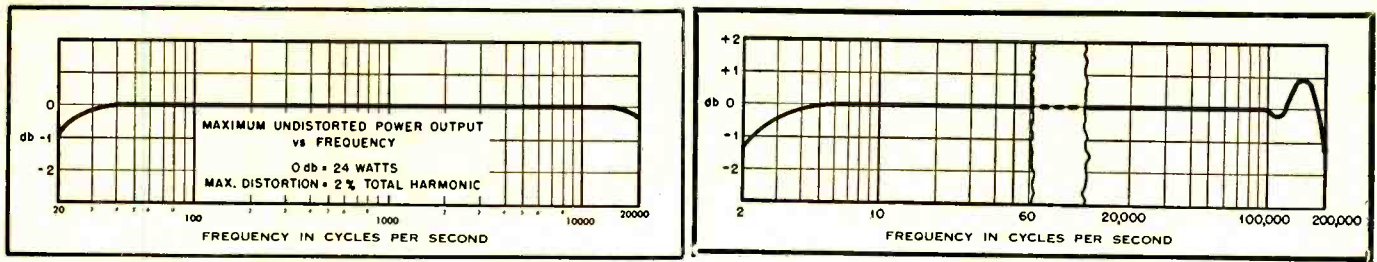

Fig. 5 (left). Undistorted power output vs. frequency. Fig. 6 (right). Frequency response, showing effects above and below the audible frequency range.

break up on a peak, and for seconds thereafter the sound is distorted badly because of poor recovery. In the ultra-linear amplifier transient instability has been eliminated—changes in amplifier characteristics caused by overload do not make the circuit unstable; and, therefore, recovery is almost instantaneous. Most feedback amplifiers fail miserably under overload listening tests.

Figure 6 shows the voltage gain versus frequency. Obviously, most present day amplifiers are flat through the audio band. However, it is the band outside of the audible region which makes some of the difference between one amplifier and another. In this circuit it is evident that smooth flat bandpass extends more than two octaves on each side of the traditional 20 to 20,000 band. This enormous band width is necessary to eliminate phase shift over the customary region and to provide good transient response.

The square wave performance of Fig. 7 testifies to the transient response. Evidently, a circuit with response flat within 2 db for a decade on each side of the audio band should show a presentable square wave at most frequencies. However, the low phase shift, fast rise time, and insignificance of ringing in this circuit as indicated by the square waves shows that more than just the frequency response is excellent. In addition, square waves were checked on a speaker load with practically identical results, thus demonstrating that performance of the amplifier is unaffected by a load of varying impedance.

Other circuit configurations can be used with this ultra-linear output stage. However, they should have a phase characteristic permitting substantial feedback, and they should have the lowest possible distortion for the early stages. The popular Williamson circuit has been

converted to this output arrangement with gratifying results. This conversion permits 30 watts of output plus the other benefits inherent in the increased linearity of the output stage.

Listening Tests

The majority of listeners agree readily to the superiority of this circuit. None felt that other equipment was better although some could not recognize differences on the program sources used. However, during the course of the tests, certain recordings were found which demonstrated differences vividly; and after this finding, even the less discriminating listeners could identify the ultra

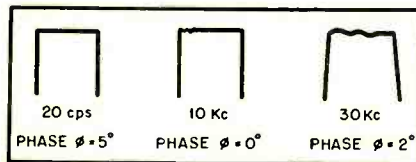

Fig. 7. Square-wave performance of the Ultra-Linear amplifier.

linear amplifier on "blind" tests and could recognize its superiority.

Listeners agree that the bass region is more articulate, better defined, and better damped than in other amplifiers. This damping is not a function of internal impedance alone but also relates to stability under dynamic conditions. For example, no low frequency cutoff is required in the preamplifier as no ill effects are audible due to momentary overloads from turntable rumble, switching thumps, and similar disturbances. Certain types of signals such as organ pedal tones combined with rumble will cause other amplifiers to break up even at levels as low as a few watts in the mid-frequencies.

Another audible feature in the bass range is that the amplifier does not have *more* bass, but it has *lower* bass. Other amplifiers, of good quality in terms of measurements, by comparison were generating harmonics and intermodulation products. This was also apparent on scratchy "dirty" recordings which cleaned up on the ultra-linear amplifier while remaining mushy and irritating on others.

In the treble region the consensus of opinion is that the amplifier sounds "smoother." The scratch level of shellac records is less irritating while the high frequency sounds, particularly of a percussive type, cut through the scratch and seem far more prominent. This seems due to the fact that intermodulation between scratch and music is diminished, and the two assume much more pleasant proportions.

The authors believe that for sheer listening pleasure the ultra-linear amplifier represents the best that can be achieved at the present state of the art. Others who have had an opportunity to hear and try the circuit agree with this; and these beliefs will not be shaken until something comes along which *sounds* better, or at least sounds as good and can be built for lower cost.

PARTS LIST

C_1	500 μ f, 6 v. electrolytic
C_2, C_3, C_4, C_5	0.2 μ f, 600 v. paper
C_6	100 μ f, 50 v. electrolytic
C_7	120 μ f, mica
C_8, C_9	20–20 μ f, 450 v. electrolytic
C_{10}, C_{11}	40–40 μ f, 450 v. electrolytic
R_1, R_6, R_8, R_9	0.47 meg, $\frac{1}{2}$ watt
R_2	200 ohms, $\frac{1}{2}$ watt
R_3, R_{15}, R_{16}	1000 ohms, $\frac{1}{2}$ watt
R_4, R_5	0.1 meg, 1 watt, 5%
R_7	0.56 meg, $\frac{1}{2}$ watt
R_{10}	560 ohms, $\frac{1}{2}$ watt
R_{11}, R_{12}	47,000 ohms, 2 watt, 5%
R_{13}, R_{14}	0.12 meg, $\frac{1}{2}$ watt
R_{17}	350 ohms, 10 watt
R_{18}	12,000 ohms, $\frac{1}{2}$ watt
R_{19}	22,000 ohms, 1 watt
R_{20}	2200 ohms, 2 watt
T_1	Acro TO-300 output transformer. Primary: 6600 ohms plate to plate, tapped for screen; secondary: 16, 8, and 4 ohms.
T_2	Power transformer: 370–0–370 v. at 130 ma; 5 v. at 2 a; 6.3 v. at 3 a.
L_1	Filter choke, 8 Hy at 130 ma.
V_1	6SL7
V_2	6SN7
V_3, V_4	6L6
V_5	5V4

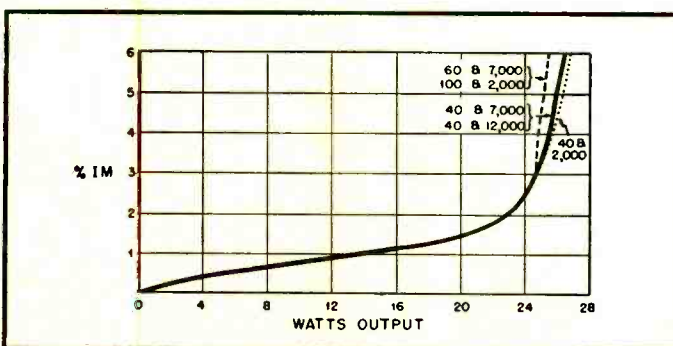

Fig. 4. Intermodulation distortion, using several test frequencies with a constant ratio of 4:1.

Something New in Remote Amplifiers

ROBERT S. HOUSTON*

For those remotes where an attendant engineer is not otherwise necessary, this unit which may be turned on or off from the studio is exceptionally well adapted.

THE AMPLIFIER described herein and the method of operation, are to the best knowledge of the author, completely original. It evolved, like most such special devices, out of a need for doing something better. In this case it was felt desirable to have a better system of getting unattended remotes on the air with greater efficiency and less chance of failure under the various conditions met on a remote pickup. The amplifier was originally intended to be a super-portable a.c. amplifier, designed to be stowed away in a closet, or out of reach of the inexperienced personnel who usually participate in unattended remote broadcasts. However, there was often trouble finding a reliable a.c. outlet near the broadcast site, or someone would forget to turn on the power, or worse, someone would turn it off inadvertently during a broadcast. Hence a more fool-proof system was needed. Inasmuch as the whole amplifier did not require any a.c., or any voltage over ninety, the thought of feeding the power over the phone line occurred. Simplex circuits are in use in stations all over the country, so this use would be nothing new in that respect.

In using the phone line as a source of power, it automatically precludes program interruption from causes other than line failure. As long as the line is connected to the amplifier, everything is provided for going on the air. If the line becomes disconnected through some mishap, there would be no audio connection, and the program would be lost anyway. The use of each side of the line for respective poles of the power source, rather than using a ground for the return, eliminates the problem of finding a good ground, and along with it, the possibility that it will become disconnected. Although some stations use battery amplifiers, and relays controlled from the studio to operate the amplifier, batteries are often dead when needed. The system described herein circumvents the use of batteries.

Circuit Discussions

An inspection of the diagram of Fig. 1 would reveal some interesting variations in circuitry. It is not claimed that this is necessarily designed around good high-fidelity engineering principles, but field tests have proven it entirely satis-

factory for any ordinary use, such as speeches, sports, churches, and even dance bands. The choice of tubes was mostly on the basis of high gain. Since they are miniatures, there is not too great a selection of these. Filament drain was another important factor. Since they are in series, they must all draw equal current. Also, due to the length of phone lines, too great a current cannot be drawn, without expecting a large voltage drop. Hence, 50-ma. tubes were selected. This, along with the 10 ma. for the plate circuit drain, keeps the line loss at a minimum.

With series-connected, directly heated cathodes, biasing becomes somewhat of a problem, since all the cathode returns are at different voltages above ground. The two 1U5's solve that problem, for they make use of contact potential bias. This allows the first stage grid to be returned directly to ground, and avoids raising the cathode above ground to obtain bias. In the second stage, the grid is returned directly to the cathode, thus isolating the grid circuit from any filament circuit drop. This drop is utilized, however, for biasing the 3V4. This stage requires $7\frac{1}{2}$ volts, so the combined drop of the other two filaments, plus a resistor, furnishes the bias. In this case, the

grid is returned to ground, and the voltage divider R_8 and R_9 , in the cathode circuit of the 3V4 is to bypass the ten mil drain of the plate circuit to prevent too great a drop through the 1U5 filaments. The 1U5 plates draw about 0.5 ma. and this can be neglected in the plate drain calculation. The control grid, screen grid, and plate resistors are manufacturers' recommended values. Inasmuch as the resistance in the grid circuit of the second stage must not change, the volume control must be installed as shown.

Transformers

The input transformer was a midget unit with only a single 50-ohm winding. A slight mismatch here is permissible, so it will match approximately any of the standard mikes in use today. The output transformer must have a split secondary so the two halves of the line can be separated for transmission of the plate and filament current. A simplex circuit could be used without splitting the winding, if there is a good ground available, but as pointed out earlier, this will reduce the operating efficiency of the system. A 1- μ f capacitor between the two halves of the secondary provides an

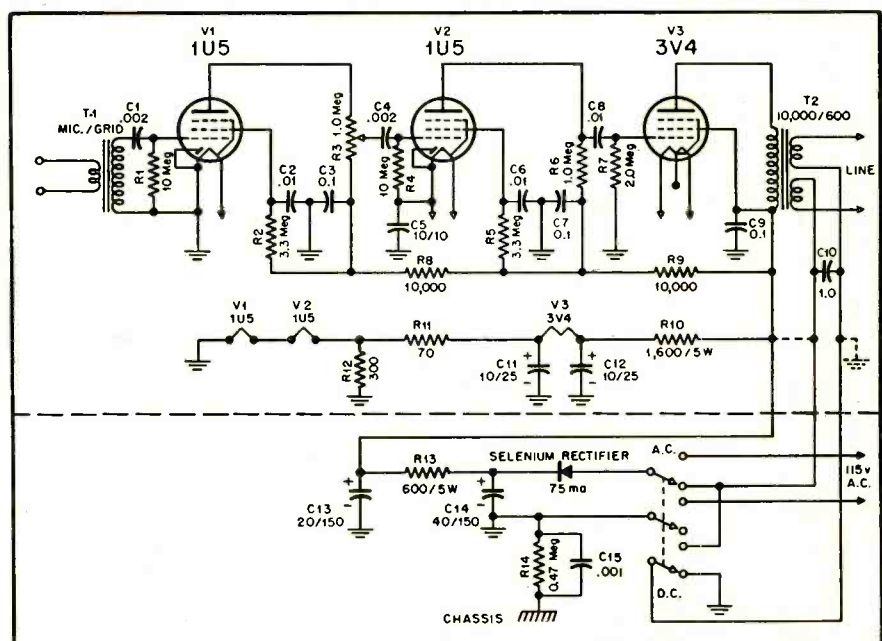

Fig. 1. Schematic of remote amplifier with power supply for a.c. use when desired. If the power supply is not needed, eliminate the portion below the dashed line and connect the line circuit to ground and B+ as shown by the dotted lines.

* Transmitter Engineer, Station WTUX, Wilmington, Del.

audio path through the transformer. More bypassing than necessary is provided, but if electrolytic filters are used, they may create a certain amount of noise which will be filtered out in the bypasses. It is especially important to have sufficient bypassing at the second and third stage cathodes, since here instability, and motorboating may develop. If this amplifier is to be used on a.c. on some occasions, the supply shown in Fig. 1 will furnish all the necessary operating voltages. Due to the directly heated cathodes and the selenium rectifier, warm-up is instantaneous. Since the filaments stay quite cool and there are no other heat producing components, continuous operation is possible—such as from a news room—without danger of overheating or breakdown of parts. The filaments are heated by connecting them in a bleeder circuit across the 120-volt d.c. supply. This type of circuit is similar to that used in many types of three-way portable receivers, and elaborate discussion should be unnecessary.

Studio Power Supply

When the amplifier is to derive its power from the 'phone line, the d.c. power source must be located at the studio. Power is transmitted at 150 volts. Although the amplifier uses only 120, this extra voltage allows for line drop. The amplifier draws 60 ma. in normal operation. The power must be transmitted as d.c. to prevent interference of the supply voltage with the program. While it is perfectly possible to use any supply with the minimum requirements, there may be some difficulty in obtaining a transformer with such high current at the low voltage necessary. A transformer must be used in any case to isolate the power line from the rest of the supply, since neither side of the phone line can be grounded. The circuit shown in Fig. 2, while unusual, will provide excellent results without bothering with a special transformer, or one too big for the job. Two identical transformers supplying just twice the voltage, at half the current, are used. The high-voltage secondaries are paralleled to give the proper current. To bring the voltage down to that required, the primaries are then connected in series. Analysis will show that the power handling capacity of the two transformers is still the same, and full power can be drawn from each unit. To operate a five volt rectifier, the two 5-volt windings (which are now supplying 2.5 volts) are connected in series. It is essential that the two units be identical, to insure proper balance. The transformers must be correctly phased to avoid a burnout, since their voltages will be in series with no load. Since there would be no output from the supply as a whole, this particular trouble might go unsuspected. To insure proper phasing, the following procedure will help: Connect the primaries in series, at random. Take one wire from each of the two 5-volt windings and connect them. Measure the voltage between the two remaining wires. There should be voltage present. If there is none, reverse one of the wind-

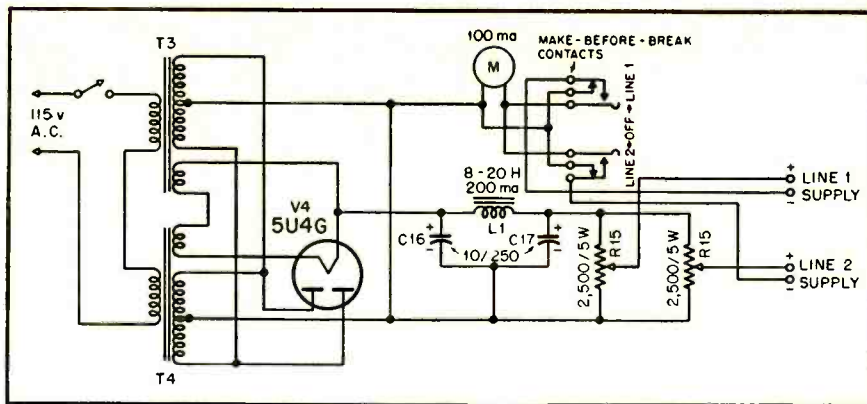

Fig. 2. Schematic for studio power supply. T₃ and T₄ secondaries: 600 volts (or more) center-tapped, at 75 to 100 ma.; 5 volts at 2 amps. Note that primaries are connected in parallel. This circuit is useful if a suitable single transformer is not readily available.

ings. The same process follows for the high-voltage windings, except that there should be no voltage present. In this case, the voltage is taken from the two junctions of the windings. When phasing the high-voltage windings, it might be advisable to reduce the primary voltage to about 5 volts, to reduce the danger of shock from the high voltage.

Metering

A milliammeter in series with the supply lead is used to indicate proper adjustment of the current being fed to the amplifier. When the correct voltage of 120 volts is present at the input terminals of the amplifier, it will draw 60 ma. A wire-wound potentiometer used as a bleeder-voltage divider provides the needed control of current. Dual outputs are provided in the event there are two consecutive remotes to be aired with this system. While a key switch is shown, to prevent paralleling of the two circuits through the meter, simple push button switches could be used with care. The line terminating coils at the studio end must have split primaries, and the voltage is fed to them in a manner similar to that used in the amplifier. Most commercial transformers are supplied with split windings, facilitating this operation. The coupling capacitor, if large enough, will not affect the equalization of the line. However, if the capacitor is made small enough, it will make the line self equalizing, by providing a high reactance to the low frequencies.

Construction Kinks

Since it is felt that the reader's individual requirements and design techniques would vary the physical layout to suit his needs, those details have been omitted. These units were built on a 4" x 6" x 1 1/2" aluminum chassis mainly because they were available in quantity on the surplus market. All the parts fitted on nicely without crowding. Although this size has been very convenient, it could be made smaller if need be. The two transformers were the only items of any size. If this amplifier is to be used only with the remote supply, the local power supply and its components can be eliminated, decreasing the size still further. The use of a remote supply

was an afterthought, so these had been built originally as locally powered units. The only switch serves to change over from the remote power supply to the local supply. It will serve also as an on-off switch on a.c. operation. The 3-pole switch is necessary to isolate the phone line from the a.c. supply voltage when using the local supply. Note that there is no actual chassis ground except through 0.5 meg. resistor. This is to eliminate the a.c. line potential from being on the chassis. All other grounds indicated are actually a buss or terminal point. With the switch in the d.c. position, the a.c. line is completely disconnected from the circuit.

Operating Technique

With the initial setup, two men, working at each end of the line can determine the proper current and line polarity. When voltage is first applied, and a mike is connected, a signal should be heard at the studio. On a new setup, the voltage should be started at a low value, and increased to the correct setting. The setting of the control should be noted on a chart along with equalizer settings, etc. Should the polarity of the supply be incorrect, there will be no signal heard, and the correct current will not be obtained. It would be best to reverse the line connections at the amplifier, in the interests of uniformity, if the line is terminated on a patch bay. This will insure that patch cords on all lines may be inserted in the same direction. If the line comes in to a key, the line could be reversed at either end. In the determination of polarity, the circuit placement of the selenium rectifier can be very useful. It can be put either ahead of the a.c.-d.c. switch, as shown, or behind it, with different results. If it is connected as shown in Fig. 1 there will be no current flowing if the line is connected backward. Simple reversal of the line would correct this, and operation should then be obtained. If a tube filament should open, there would be no current, or only a few mils through the 3V4 cathode resistor. This will indicate trouble in later operation. On the other hand, if the lines are excessively long, it may be necessary to

[Continued on page 67]

A Simple Preamplifier and Tone-Control Unit

DAVID H. O'BRIEN*

Details of a unit which can be constructed with a minimum of time and material and which was designed for use with the Musician's Amplifier.

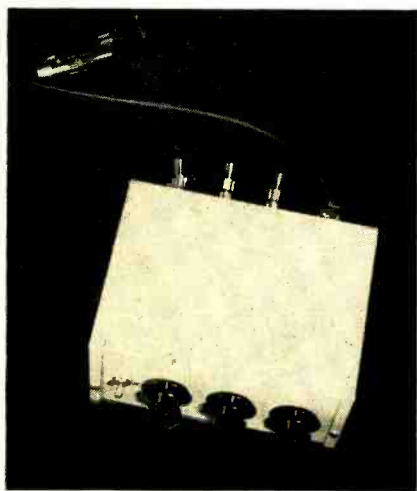

Fig. 1. External view of the author's embodiment of his tone control and preamplifier unit.

THE FAMOUS ENGLISH "Williamson" amplifier circuit, in its Americanized version called the "Musician's Amplifier," has become very popular in the United States during the last two years, and justifiably so. It is capable of ten watts output; it has extremely low distortion; and it has a low generator impedance, of the order of 0.6 ohms at the 16-ohm tap. These features combine to make an excellent power amplifier for driving a high-quality loudspeaker.

However, there has been one important link missing for this amplifier. As yet no good preamplifier and tone control circuit has appeared which would complement the excellent characteristics of the power amplifier, and which was designed especially for it.

This article deals with a tone control and preamplifier unit which uses only three tubes, or even two, as will be pointed out later, and does not contribute enough measurable distortion to mar the excellent characteristics of the power amplifier. This unit has been used and tested with four different versions of the Musician's Amplifier and has been found to work equally well with all of them.

Tone Control Section

The tone control section consists basically of a two-stage cascaded triode amplifier, as shown in Fig. 3, the output stage consisting of a 12AX7 with both

sections paralleled. These two cascaded stages have negative feedback applied over them, and by means of two frequency-selective networks in this feedback loop, it is possible to obtain bass and treble boosts of the order of 30 db at 35 and 20,000 cps without boosting the mid-range (1000 cps) over 1½ db.

The bass section consists of a selective T network with R_{17} across it to vary the effectiveness of the network. The treble section consists of a 0.25-meg. control, R_{21} , with its movable tap grounded. When the control is turned fully counterclockwise, C_{11} is then effective in a T network from the center point of the two 27,000-ohm resistors, R_{19} and R_{20} , to ground. This is actually a low-pass filter which, being in the feedback loop, prevents high frequencies from passing through and thus allows a high-frequency boost. When the control moves fully clockwise, the .001 μ f capacitor, C_{12} , bypasses the highs to ground.

The treble control originally used was a standard audio taper which was reversed in its connections relative to common practice in order to give smooth action on both boost and cut and also to have the mid position (50 per cent rotation) give flat response.

A reverse audio taper is preferred, since it will give the conventional clockwise boost and counterclockwise cut.

Resistor R_9 in series with the capacitor C_5 across the cathode resistor of V_2 , is a high-boost network—which exactly

compensates for the high-frequency droop caused by the capacitance of a 6-foot length of good rubber-insulated shielded cable which connects to the power amplifier. If the tone control unit is to be used on the same chassis as the power amplifier, and not as a remote unit, this network should be omitted.

Capacitor C_6 in series with the feedback loop prevents direct-current flow from the plate of V_3 to ground through R_{10} and the bass control circuit. Otherwise, noise is heard whenever the control is turned. Resistor R_{11} is also in series with this capacitor, and isolates the T network from the cathode when the bass control is set for flat response.

Resistor R_{16} in series with the output of the paralleled 12AX7, serves to isolate the feedback network from the high-frequency-cut capacitor in the first stage of the power amplifier. If this is omitted, the feedback will automatically compensate for the effect of the capacitor, resulting in no high-frequency cut and an increase in distortion.

The last stage of this tone control unit uses a 12AX7 with both sections in parallel because it was found that a 50 per cent reduction in distortion was realized over a single section. On a harmonic distortion test this unit with the controls set for flat response added only 0.1 per cent distortion to the overall amplifier at 10 watts output. If the increase in distortion could be tolerated, one could omit the 6AQ6 and replace it

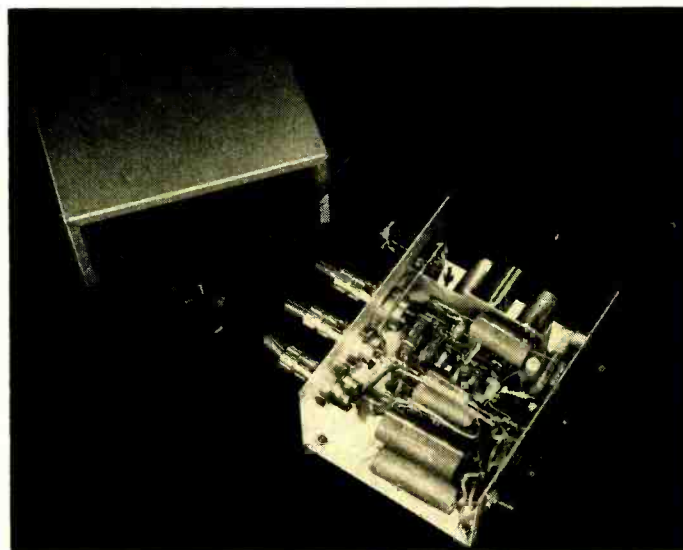

Fig. 2. Internal view of the unit shown in Fig. 1.

*West Wilson Rd., Worthington, Ohio.

with the other half of the 12AX7. The only changes needed in the circuit would be to increase the output section plate resistor to 0.1 meg. and increase the cathode resistor of the same stage to 2000 ohms, the correct values for a single section of a 12AX7.

The reluctance cartridge preamplifier is of the feedback type so common that it needs no description. The resistor R_1 should be selected in accordance with the recommendation of the manufacturer of the pickup to be employed. The phono-radio switch is of the conventional DPDT toggle type, with one half used to ground whichever channel is not being used, thus preventing crosstalk.

Construction

Construction practice must be left up to the individual as this unit may be built up in many physical forms. Figures 1 and 2 show how the author arranged the components in a small aluminum box. The power cable was separated from the output cable. Also all leads should be kept as short as possible, especially to the tone controls. The usual practice of grounding the circuit to the chassis at only one point near the high-gain input should be followed. One-watt resistors are recommended, as there is less chance of damaging them during soldering, and in high-gain circuits of this type, low noise is essential.

Fig. 4. Response curves of the tone control section.

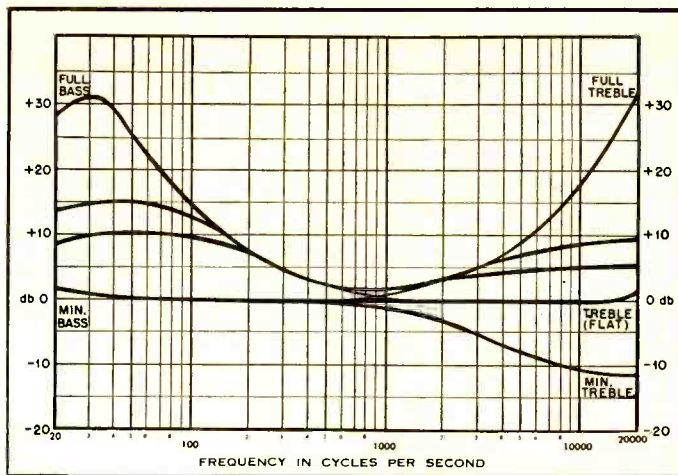

frequency compensation for LP records as well as approximating the new A.E.S. playback standard. The accompanying curve shows the typical response, measured at the voice coil, of a Pickering D-140S cartridge reproducing the 78-r.p.m. side of the Cook Series 10 test record. The curves of the action of the bass and treble controls are also shown.

It must be pointed out that when tone correction on the order of 30 db is available, it should be used carefully since it is easy to exceed power amplifier capabilities at the frequency extremes. However, when this unit is used with care it gives sufficient flexibility.

- | | |
|-----------------------|---------------------------------------|
| C_3 | .004 μ f, 600 v. paper |
| C_9, C_{10} | .015 μ f, 600 v. paper |
| C_{11} | .0068 μ f, 600 v. paper |
| C_{12}, C_{14} | .001 μ f, 600 v. paper |
| C_{15} | 0.1 μ f, 600 v. paper |
| $C_{15} a, b, c$ | 30-30-30 μ f, 450 v. paper |
| R_1 | See text |
| R_2, R_{10}, R_{11} | 3300 ohms, 1/2 watt |
| R_3, R_6, R_{12} | 0.1 meg, 1 watt |
| R_4, R_{13} | 1.0 meg, 1/2 watt |
| R_5 | 2200 ohms, 1/2 watt |
| R_7 | 0.12 meg, 1/2 watt |
| R_8 | 0.5 meg, audio taper potentiometer |
| R_9 | 120 ohms, 1/2 watt |
| R_{14} | 1000 ohms, 1/2 watt |
| R_{15} | 47,000 ohms, 1 watt |
| R_{16} | 47,000 ohms, 1/2 watt |
| R_{17} | 2.0 meg, audio taper potentiometer |
| R_{18} | 0.18 meg, 1/2 watt |
| R_{19}, R_{20} | 27,000 ohms, 1/2 watt |
| R_{21} | 0.25 meg, reverse taper potentiometer |
| R_{22} | 82,000 ohms, 1 watt |
| R_{23} | 22,000 ohms, 1 watt |
| R_{24} | 47,000 ohms, 2 watt |
| V_1 | 12AX7 |
| V_2 | 6AQ6 |
| V_3 | 12AX7 (both sections in parallel) |

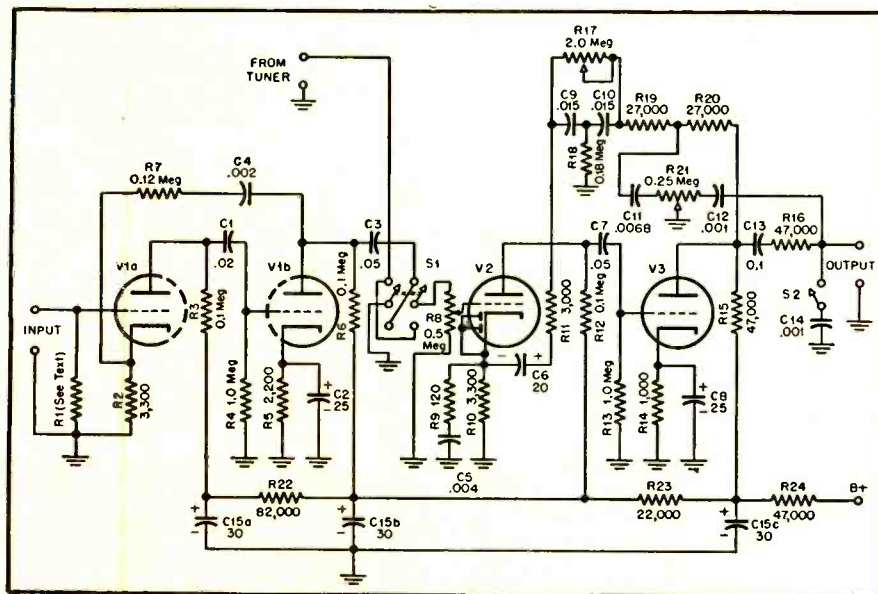

Fig. 3. Schematic of the preamplifier and tone-control which can be used with any suitable power amplifier.

No bass-cut circuit was included in this control unit as it would require a much more complicated circuit, and it also has been the author's experience that a bass cut is seldom, if ever, used in high-quality reproduction.

One note of special interest is that when the treble control is turned to full cut, the response from a Pickering, G. E., or Audax cartridge will reproduce the Cook Series 10 Test Record LP side within one db from 100 to 10,000 cps. This gives an accurate high-frequency

A 100-ohm hum balancing potentiometer was added to the original Musician's Amplifier circuit across the 6.3 volt winding in order to balance out a small amount of residual hum which originated as heater cathode leakage from the first stage of the magnetic cartridge preamplifier.

PARTS LIST

- | | |
|-----------------|--------------------------------|
| C_1 | .02 μ f, 600 v. paper |
| C_2, C_6, C_8 | 25 μ f, 25 v. electrolytic |
| C_5, C_7 | .05 μ f, 600 v. paper |
| C_4 | .002 μ f, 600 v. paper |

Fair Queen



The three B's—meaning Blonde Beauty with Brains—will be present at the 1951 Audio Fair in the person of Mary Mayo, well-known singing star. Miss Mayo will be "dubbed" Miss Audio Fair—1951, at the AES banquet on the night of November 1.

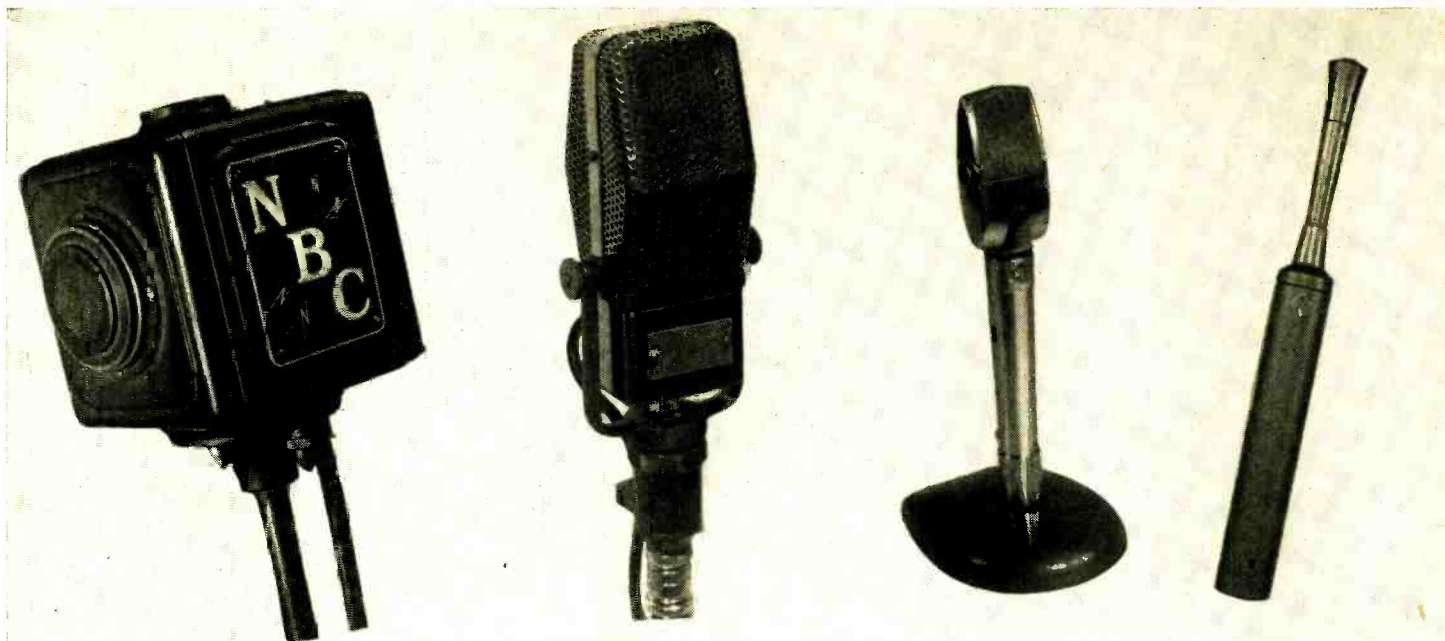

Broadcast Audio

W. E. STEWART*



THE AUDIO EQUIPMENT required to set up a satisfactory studio installation comprises an important part of the Broadcast Station's investment. Its purchase and installation is treated with serious study, and once installed it must serve for a long time. To discern trends, we must go back over 20 to 25 years of Broadcast history, since most of the installations of 10 to 15 years are still in use today.

The accompanying pictures have been chosen to illustrate the changes which have occurred during the last 25 years. Most of the early control room equipment was black, as was the power plant and even the automobile of 25 years ago. The first attempts to liven the appearance

of this equipment consisted of adding chrome plating. Color became more common as time went on, and manufacturers chose certain colors to make their equipment distinctive. As color became more popular, the chrome plating went out. For TV, the control room must be darkened, and dull surfaces, lighted meters and dials, and better vision over the control console was demanded. A well planned control room is now a show place for visitors, and the smooth lines of today give a better impression of efficiency than the gadgety racks universally used 15 years ago.

Microphones have had a different history. Because they are always out in front of the producer, they are subject to his demands. They were large and gaudy until TV came along—now they

* *Broadcast Audio Engineering* RCA Victor Division, Camden, N. J.

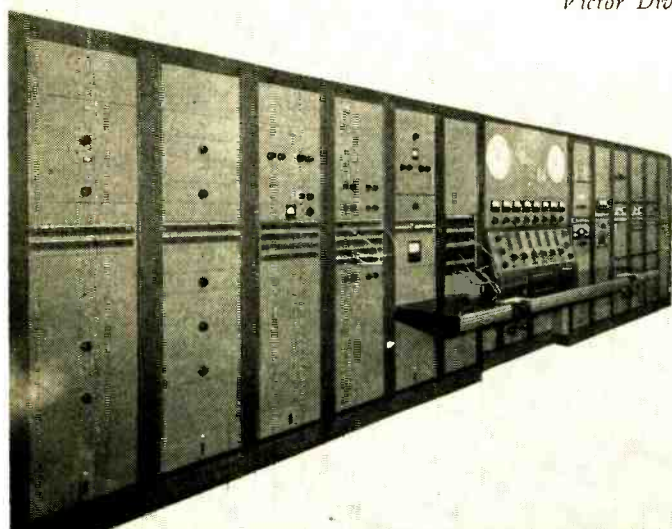

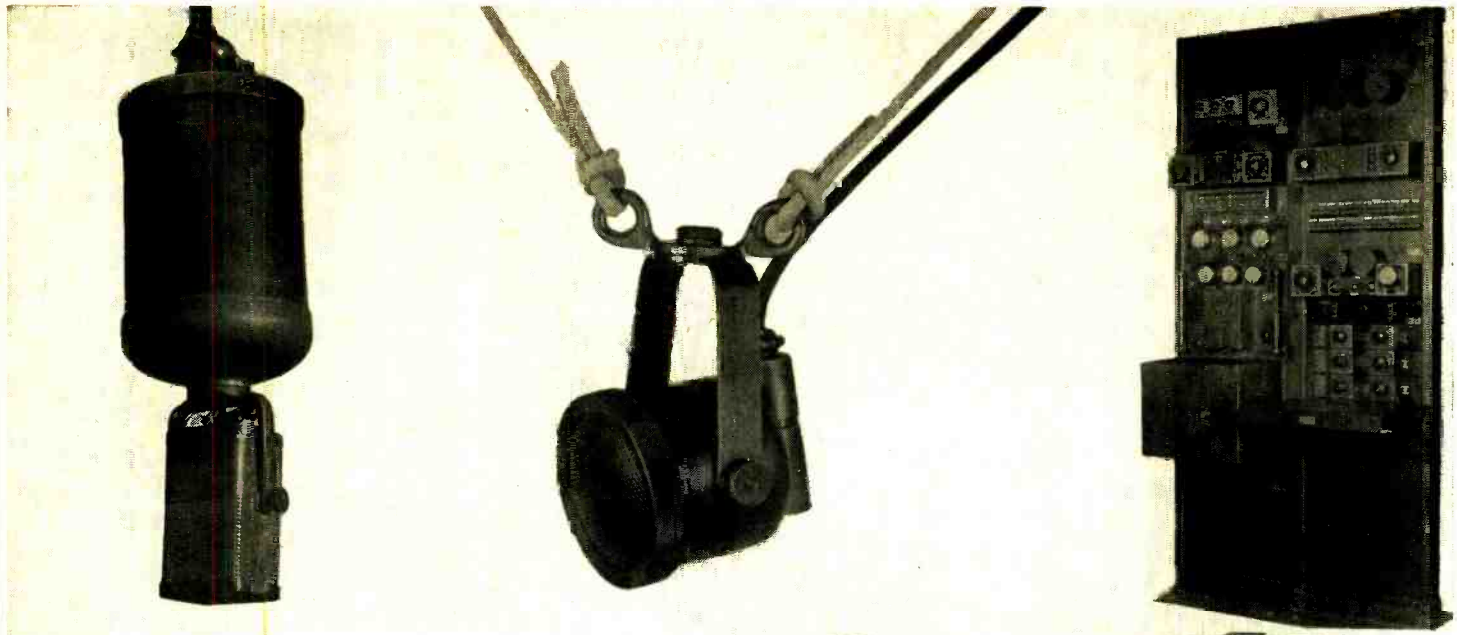

Trends

must suddenly become unobtrusive. They must have the glitter removed, lest it becomes a glint in the camera's eye. Smaller microphones, with dull finishes, have become the rule in TV work, and with equivalent performance, they are gradually moving into the radio field. Added impetus to their acceptance comes from their adaptability for use in interview work and on audience participation shows, but for straight radio shows, the old standbys are not being replaced unless they are actually worn out or damaged beyond repair.

In summary, it is seen that over-all trends indicate larger and more flexible installations, centralization of control, and the use of smaller components from microphone to control console. Styling and color have become strictly modern.



Exponential Baffles for Custom Installations

GEORGE AUGSPURGER*

A thorough discussion of the use of various types of horns—either built-in or in separate cabinets—for sound reproduction of the highest quality.

AN ENGINEER, proudly displaying a massive electronic organ, explained its complicated speaker arrangement as follows: "Those big boxes are designed to sort of beat up the sound before it goes into the church." A well built exponential unit could have given voice to the organ more efficiently and without the "beat up" quality so aptly described.

It is unfortunate that horn type speaker systems have dropped out of the high-quality realm in all but a few large theater installations. With today's growing opportunities in custom work, exponential baffles are often the most satisfactory answer to the speaker problem.

Properly speaking, there is a distinction between a horn and an exponential baffle. A horn consists of a vibrating element called the driver, a coupling chamber between this driver and the throat of the horn, and a flared horn of continuously increasing cross-sectional area. The exponential or parabolic baffle is a modification in which the coupling chamber is eliminated and a cone speaker used for a driver. The cone has sufficient area to move a considerable quantity of air directly so that no coupling chamber is necessary to load the vibrating system efficiently. Since the units to be described all use cone speakers, the terms "horn" and "exponential baffle" will be used interchangeably in the remainder of this article.

It is assumed that for optimum performance, a vibrating-piston sound source should have a diameter at least one quarter the wavelength of the lowest frequency to be reproduced. The ideal speaker, generating a 60-cps tone, would be about five feet in diameter. In practice, the problems of inertia, transient response, directivity, and cone suspension multiply so rapidly as size increases that the maximum practical diameter for a direct radiator is about 18 in.

Telefunken once made a 48-in. cone speaker, and 1/4-in. steel sheets moved by multiple voice coils were tried in this country, but these novelties have not received support from commercial interests.

The exponential horn can be considered a piston having a diameter equal to the mouth diameter of the horn. By using horn coupling, a tiny driver unit can move as much air as Telefunken's

4-ft. cone. Because of the laws of physics, the horn has one serious drawback—size. An exponential baffle using a 12-in. driver and assuming a 60-cps cutoff will be about 6 ft. long. It is easy to understand why horns have not been adopted as living room furniture.

If the length of the horn is reduced, the mouth area is diminished correspondingly, and the unit no longer behaves like its theoretical counterpart. The acoustic impedance of the mouth is now so different from that of surrounding air that reflections occur and the response curve looks like a picket fence. Several attempts have been made to reduce the length of the horn without incurring these unhappy results. Some high-frequency horns are made with a curve two-thirds exponential and one-third tractrix. Bass horns have been designed to use the corner of a room as an extension of the horn and thus reduce the physical size of the unit. The Klipsch horn, the Voight horn, and the writer's Integral Space Transducer are all variations of this idea.

An interesting design utilizing the entire solid angle formed by two walls and floor was described by W. E. Gilson and J. J. Andrea in the March, 1950, issue of *AUDIO ENGINEERING*, but it is not believed to be commercially available.

By designing an exponential baffle as a permanent part of the listening room, it is possible to obtain the advantages of a horn without spawning a monstrosity. Since the surge toward high-fidelity and custom-installed sound has become widespread, architects are glad to collaborate with sound engineers in integrating the music system to the architectural scheme. There are many design possibilities for wide-range horn-type speaker systems. Before evaluating specific ideas, however, the custom builder must familiarize himself with the basic design considerations of exponential speaker baffles.

The Exponential Curve

The term "exponential curve" is used since the most common cross sectional expansion in horn design follows the formula $S = S_0 e^{mx}$. For practical work it is helpful to simplify the expression to $Y = 2^x$, where Y is the multiplier of the throat area and x is given in basic length units, that is to say the length in which the cross-sectional area doubles. The constant 2 is chosen because

cutoff frequencies are easy to remember in terms of these basic length units. A 30-cps horn doubles its area every two feet, a 60-cps horn every foot, a 120-cps horn every 6 in., and so on. These values are only approximations, but they are easy to recall and the cutoff of a large horn is not so sharp as to demand closer accuracy.

An example of the use of the modified formula is shown in *Fig. 1*. Suppose that we want to build a horn using an 8-in. speaker with a cutoff at about

HEIGHT	x	y	AREA
0"	0	1	30
6"	0.5	1.414	42.4
12"	1.0	2	60
18"	—	—	84.8
24"	—	—	120
30"	—	—	169.7
36"	—	—	240
42"	—	—	339.4
48"	—	—	480
54"	—	—	698.7

Fig. 1. Chart showing expansion of cross-sectional area of a horn suitable for use with an 8-in. cone speaker as a driver.

60-cps as a driver. The actual cone area of most 8-in. speakers is about 30 sq. in. Since the cross sectional area doubles itself every foot, x will be given 12-in. units. At the throat of the horn x is zero and Y , according to the formula, is 1.

Six inches from the throat x is 1/2 unit and Y is therefore $2^{1/2}$, or 1.414. Thus the cross sectional area is 30×1.414 , or 52.5 sq. in. In plotting the curve at 6-in. intervals, the first two areas are the only ones that need be calculated from the formula. The remaining values for any horn length can be found by simply doubling the first two figures alternately. Once the cross sectional areas have been found for appropriate distances along the horn's length, these figures are translated into dimensions. Corresponding points are then plotted on the Masonite sheets to be used for the flare, and a natural spline of hardwood or spring steel tape is used to join the points with a smooth curve. Since this method of laying out exponential curves seldom involves anything more complicated than the square root of 2, it can be used by any builder without much chance of error.

The over-all size of a custom-designed horn depends upon three variables: the

* 7041 N. 14th Place, Phoenix, Arizona.

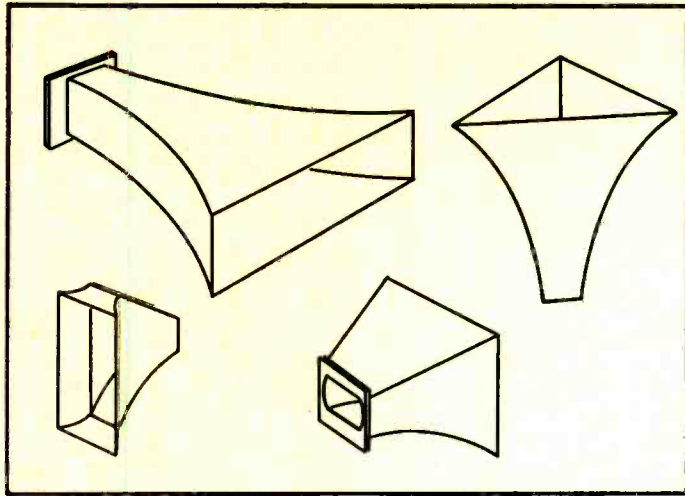

Fig. 2. Possible configurations of exponential flares.

mouth area, the cutoff frequency chosen, and the size of the driver unit. It is safe to say that the smallest mouth area permissible for 60-cps reproduction is 10 sq. ft. If a corner of a room is utilized, this figure may be reduced to 6 sq. ft. or even less. When smooth response to 30 cps is desired, the size of the horn is doubled. Once a mouth area is determined, the length of the horn depends upon the throat area. Unless a coupling chamber is used, the throat area equals the cone area of the driver unit employed. If a 60-cps horn is to be built using a 12-in. speaker as a driver, it must have an effective length of at least 4 ft.

These values are all thoroughly practical, if not exact. Computing acoustic impedance at the mouth of a horn is not a simple job. Since efficiency is not the main goal, and since these horns are to be used as extensions of existing cone speakers, a pragmatic or empiric approach is reasonable and satisfactory.

The material used in the construction of horn type speakers is too often ignored. Even Olson's *Elements of Acoustic Engineering* sidesteps the issue by remarking that, "The horn walls are taken to be rigid and non-absorbing." In short, theoretical calculations are based upon a horn made of stuff that neither absorbs nor transmits vibratory energy. It is a pity that it does not exist. Poured concrete is the closest thing to perfection, and for the "golden ear" it is not too much to ask for a masonry speaker baffle. In most cases this is out of the question. The material used must be light, easily worked, sturdy, and cheap.

Most authorities insist on boxes or horns made of heavy plywood. It is true that wood is satisfactory, provided that it is sufficiently thick, but even 3/4-in. plywood will not guide sound energy without injecting a highly noticeable timbre of its own. The effect is mainly due to the properties involved in transient transmission. Wood in a speaker baffle acts just as it does in a musical sounding board, and while the stuff will do nicely when reproducing Biggs' Diapason, it is too erratic to be trusted with Flagstad or Harry James.

At present, the most practical ma-

terial for horn construction is probably Masonite. The 3/16-in. untempered variety has a host of valuable features to recommend it for this sort of structure. It easily meets the requirements of lightness and cheapness. Moreover, it is sufficiently flexible to make true exponential curves practical. When reasonably strutted and backed with absorbent material, it runs close second to concrete in results obtained.

Flare Design

The cross section of a horn does not need to be regular or even symmetric, but when building large units of sheet material such as Masonite, one is limited to rectangular or triangular cross sections. The horn expansion can be governed by a curve in any or all of the sides. Figure 2 shows a few of the variations that might be used for specific applications.

The geometry of the flare as well as the shape of the mouth influences the directivity of the projected sound. The axis of projection can be plotted by extending the line made by joining geometric centers of several cross sections. The angle of radiation is governed by the height/width relationship of the horn mouth. The maximum angle of response is that taken in the plane of the smaller dimension. Because of this property, it is usually preferable to run the major axis of the mouth vertically. In a vertical corner horn, however, the wall surfaces influence the behavior of the waves to make the responses essentially uniform throughout the room except in the immediate region of the transducer.

In order to obtain decent results from folded or re-entrant designs, a long series of trial and error experiments must be made. The custom builder should consider two folds or bends as a maximum in any horn he builds and make sure that only one surface of each Masonite sheet is used as a horn boundary.

Figure 3 shows a typical folded horn that violates this rule. If the material of the partitions is capable of transmitting any vibrations at all, the sound is partially short circuited across the various folds in the expansion. This action is generally tacitly ignored, but it can ruin all calculated results by introducing

cross modulation and cancellation effects within the horn.

Another common practice in low-frequency systems is the use of manifold conic or tubular sections to approximate an exponential curve. Disregarding the merits of particular designs, it seems evident that, all other factors neglected, a true exponential curve is invariably preferable to an approximation, and a continuous curve is always preferred over a folded arrangement. Thanks to the flexibility of Masonite, there is no difficulty in building to a genuine exponential expansion.

Regardless of how carefully a horn is built, it is still only an acoustic transformer for its driver. Choosing a speaker from among the galaxy of models advertised is a real job in itself. A reproducer that sounds fine in a bass-reflex cabinet may slide to mediocrity when installed in an exponential baffle.

Cone sizes larger than 12-in. should ordinarily not be considered. High-quality small speakers cost less than good big speakers. Then too, if a large driver is used, its backwave is difficult to control. An 8-in. driver in a large horn, on the other hand, offers so little backwave difficulty that in many instances the rear half of the cone can be ignored.

Multiple drivers can be used to advantage with exponential baffles. A long narrow mouth, driven by half a dozen eight-inch cone speakers, may be just the solution for an awkward situation. Similarly, multiple horns can be built for greater axial distribution, but diffusion is generally easier to achieve by utilizing reflecting surfaces of some sort.

Driver Selection

Certain commercial speakers have given excellent results when used as

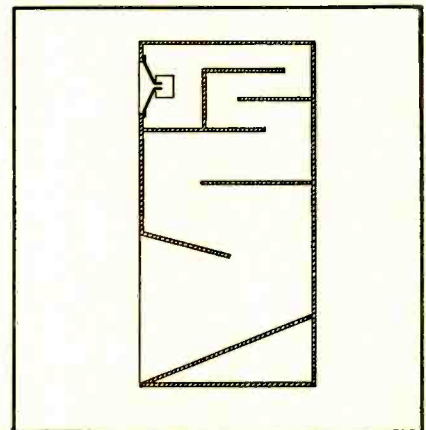

Fig. 3. Conventional acoustic labyrinth which utilizes a folded horn for the back wave.

drivers for exponential systems. At the top of the list is the Lowther PM-2. This is a beautifully built 8-in. cone speaker specifically designed to be used with a horn-type baffle. Its dual cones extend the range on both ends of the scale, and the highly compliant cone suspension lowers its fundamental resonance well below most 15-in. speakers.

Both the Altec 400B and the Jim Lansing number 208 are brilliant performers for moderate sized horns. Their 12-in. brothers will do equally commendable jobs with correspondingly larger systems. The Jensen extended-range line also provides excellent drivers at a decent price.

In general, speakers should be chosen that are ruggedly built and have a fairly stiff cone suspension. If enough data is known, a unit can be selected so that the compliance of the cone suspension supplies a mechanical reactance to balance the reactance of the horn near cutoff frequency. Olson's acoustic engineering text reports that this trick can smooth out the low-frequency response of a horn-type system to a remarkable degree.

Separate tweeters can be used as always, but the normal rule of superiority in low crossover frequencies requires expansion. If an "out of this world" system is contemplated using a full size bass horn, then the low crossover is desirable, provided three frequency bands are used instead of two. In a folded horn a low crossover is likewise at an advantage to prevent a muffled or strangled effect in the higher middle frequencies. With a straight horn and the usual dual crossover, the dividing frequency should be comparatively high so that the mid-frequencies will have the advantage of horn coupling. In any case, the crossover point should not be lower than that specified for the particular tweeter being used.

Since a horn-type speaker system can assume a limitless variety of weird shapes, the main qualities demanded of its designer are ingenuity and common sense. The one maxim which must be kept in mind as always is, "A reproducer must be considered as a part of the room in which it is placed." In a custom-built sound system, there is no excuse for

a sound source that is not both logical in placement and natural in quality—natural and logical for the ultimate listener as well as the designer. Too many engineers listen through a slide rule.

Speaker Location

The first choice of most experts for optimum speaker location is in a corner of the listening room. *Figure 4* shows the basic pattern for a vertical corner horn that can be built into existing rooms as well as incorporated into new structures. It has the advantage that a single air column emerges tangent to both walls and ceiling. This method of uniting the listening area and the sound source was first used by Ephraim over 17 years ago and is still probably the best method of matching a vibrating piston to a large enclosed air volume. A

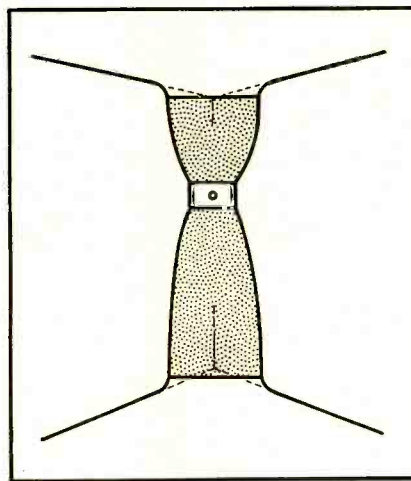

Fig. 5. Exponential horn designed as a corner of the listening room.

disadvantage does exist insofar as the apparent sound source exists at ceiling level. This can be corrected by positioning a separate tweeter system to give the desired source height.

The construction of such a horn is easily accomplished with Masonite and 1x2-in. strutting. After the horn flare is fixed in place, wire netting should be tacked to the struts and the Masonite sheet backed with about an inch of vermiculite aggregate plaster. This material stiffens the horn surfaces and eliminates any tendency toward panel resonances. The 45-deg. concrete block used to couple the speaker to the triangular horn is a device which has been used successfully by Paul Voigt in his horn-type reproducers. It is recommended as a foolproof coupling scheme wherever it is desirable to position the axis of the air column perpendicular to that of the driver.

The design can be further refined by confining the backwave in an enclosure whose volume can be varied to give the best response from the particular driver used. The horn can be designed into a corner cabinet arrangement which will provide room for the remaining components of the audio system. In a functional architectural scheme the flare

might well be made of exposed brick and the driver and backwave enclosure worked into a simple base cabinet. Carefully planned, the vertical corner horn can be aesthetically harmonious as well as audibly gratifying.

The corner itself could be built in an exponential form as in *Fig. 5*. We have never seen such an approach used, but it is certainly practical from an audio standpoint. The real trick here would be to find some way of treating the arrangement architecturally.

In spite of the obvious attractions of corner placement and its present popularity, corner design is not an automatic "best" for every design problem. In many situations it will be found preferable to provide a sound "stage" or "window," so to speak. *Figure 6* shows a straight horn that provides this sort of focused source and is readily adaptable for inclusion in new plans or for incorporation into existing buildings. It is the simplest possible design acoustically and assures high quality. The horn mouth may coincide with a doorway or alcove and the structure itself project into a large closet or some unused space. One of the big co-axial speakers makes an admirable driver for such a horn, or a cluster of smaller speakers can be used. The latter reduces the length of the horn and allows its construction in closets of normal depth.

Construction

Building such a straight horn is not difficult, but make sure that the unit is adequately strutted and that the horn walls are backed with plaster or some other stiffening-absorbing material. An

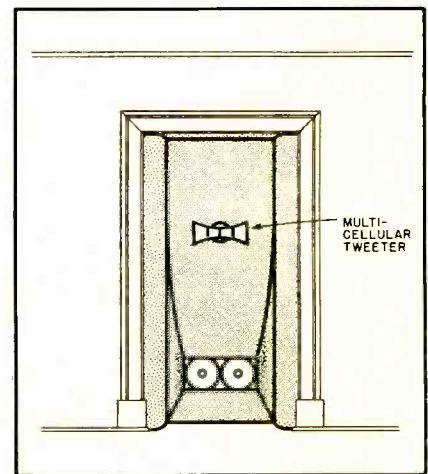

Fig. 6. Full-sized straight horn suitable for closet or doorway installation.

alternative method is to make the walls double by fastening additional Masonite sheets to the outside of the struts. The space between these two surfaces is then packed with rock wool, being careful to keep the stuffing isolated from the speaker because of the abundance of magnetic particles in the material.

This Masonite-and-plaster or Masonite-and-rock wool construction is practical for all types of speaker baffling arrangements. A double wall of Masonite

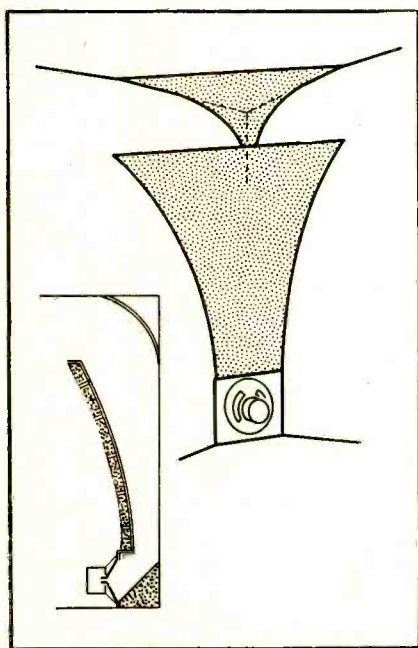

Fig. 4. Full-length corner horn with vertical axis and a triangular cross section.

is cheaper and no more difficult to build than one of heavy plywood. The main difference is that when both systems are completed, one sounds real, but the other still carries with it the taste of plywood in its performance.

Today's architecture often requires a great deal of built-in cabinetwork. When sound is planned for new buildings, the audio engineer will do well to specify that one of the correlated cabinets house a custom speaker system. For example, many modern homes use free-standing units to separate various areas of activity. *Figure 7* shows how an exponential horn can be adapted to one of these cabinet groups. The design has a vertical axis and is therefore non-directional. Such an affect is welcomed by those who use music for emotional background rather than for intensive listening. The observation that there are people who do not listen to recordings with one ear in the speaker and a score in their hands does not automatically relegate them to the caste of the untouchables—"tin ears." A non-directional source coupled with high quality and extended frequency range is welcomed by many music lovers as the answer to their particular listening preference.

The idea of incorporating speaker systems into custom cabinetwork ap-

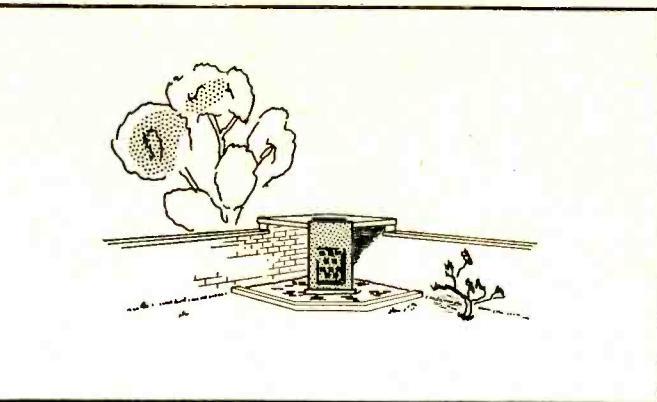
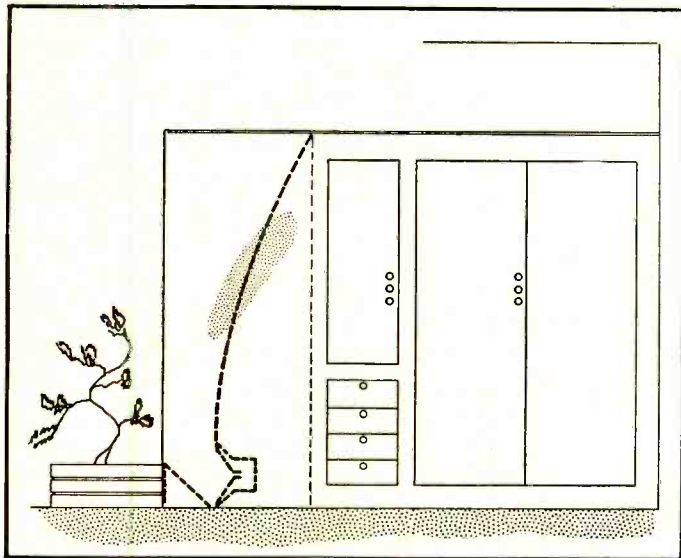

Fig. 8. Outdoor folded horn utilizing brick walls as a horn extension. Note reflecting pool used at base of structure.

peals to the architect for several reasons. Under such conditions, especially in the Southwest, an outdoor reproducing system is readily feasible. Many new homes are built with a patio as part of the living area, and for these, why not a full sized masonry horn in the patio? *Figure 8* is the sketch of a proposed brick horn for the author's back yard. The reproducer will be located in the far corner of the lawn from the terrace and have its axis beamed at the outdoor living area. There must be a sizable group of high-fidelity enthusiasts who would enjoy listening to the "Eine Kleine Nacht Musik" as it was intended to be heard.

handling ability. Using a large corner horn, sound effects and background music can be fed to the studio and picked up audibly instead of being electrically mixed with live program material. Performers, especially those with little broadcast experience, find their job far less nerve racking if they can hear the total of sounds and music that make up the whole program. Due to the physical matching properties of the horn, it provides a low-cost means of utilizing acoustic mixing with no noticeable loss of quality.

Schools and music instructors need the live quality of reproduction associated with exponential baffles. Many music appreciation classes use record playing equipment that is even inferior to that found in dealers' listening booths. Compare, in your own mind, the difference between hearing the "William Tell Overture" for the first time; first from a worn out crystal, a three-tube amplifier, and a five-inch speaker, and again through a high-fidelity system and exponential speaker unit. Recorded music could be a thrilling experience for children instead of a pathetic, gurgling, rattle of sound.

Large horn systems can often be worked into public address installations. The corner horn is a perfect design for sound reinforcement work because of its non-directional dissipation of sound energy and the life-like quality which can be achieved. The efficiency of horn matching is also important to P.A. men. Speakers used as driver in exponential baffles can easily be driven to and beyond their normal power handling capacity because of the damping offered by the expanding air column.

The electronic organ needs something besides the juke box speaker cabinets invariably furnished with moderately priced installations. Since "moderate" in the organ field means from five to ten thousand dollars, there is certainly no reason why the instrument must sound like a hoarse calliope. If massive 30-cps horns are connected to the average electronic instrument, the result is something that the factory would never recognize. Pedal notes, instead of resonant hints, can actually be heard. The possibilities of using horn type speakers for electronic organs are so promising and practical that no engineer or tech-

[Continued on page 67]

peals to the architect for several reasons. It does not necessitate the altering of actual building construction to conform to new and alarming ideas. Moreover, the job of making the horn is now in the hands of the cabinetmaker, a man who has had previous experience in building assorted contrivances for exacting clients. The carpenters and plasterers, on the other hand, become suspicious at the suggestion of anything more radical than a square corner, and the idea of an exponential curve is one that brings low mutterings and shaking of heads. Consequently, it is well to check the cabinetwork first and see if the proposed speaker system can be made to conform to the limitations of cabinet design.

Some listeners are lucky enough to have a good amount of space separating

For them, a full-range outdoor exponential speaker system is more reasonable than it might seem.

No specific dimensions have been given for any of the examples described because the practical limitations of any one of these ideas will depend upon the peculiarities of the particular situation involved, but the illustrations are sufficient to show what has been done and what can be done toward adapting the basic exponential horn to custom sound systems. It should be noted that the superiority of the exponential reproducer will be found valuable in many applications other than home music systems.

Professional Applications

Broadcast engineers will find full sized horns suitable for studio speakers because of their fidelity and power

Listening Room Design

VERN YEICH*

An introductory discussion of the elements involved in arrangement and construction of a living room for best listening qualities.

IN DESIGNING a living room around a sound reproducing system, the general considerations used in the design of the audience type broadcast studio¹ would undoubtedly apply. However, economy, tradition, aesthetics and utility are also to be considered in the living room counterpart. This article will attempt to assemble into one package some of the more useful principles to be found in various books. For a better understanding the reader should go to the sources indicated in the footnotes.

Since the listening room noise level, in a general sense, determines the lowest usable sound level, the dynamic range of a home music system is limited by the outside sounds which come in through partitions and windows. For this reason a well designed listening room will not have windows overlooking a noisy area, but is more likely to have a massive masonry wall or wall of good acoustic design between it and the noisy side of the house which is most often the road or street.

The room into which a loudspeaker works is as much a part of the acoustic system as the cone itself. Its transmission frequency response curve² is sometimes quite irregular with a multitude of peaks throughout the spectrum where standing waves occur between parallel walls. If two dimensions are equal as with a square floor plan, or if three dimensions are equal as with a cube shape, two and three sets of standing

waves occur at the same frequencies with comparatively fewer, but much more severe peaks in the transmission response of the room. It is therefore desirable to proportion the room dimensions by such ratios as $1:2\frac{1}{3}:2\frac{2}{3}$,³ which distribute the peaks three times in the octave and provide a reasonably smooth transmission characteristic. Ideally, we would want to distribute a great many damped room modes throughout the spectrum, making sure that one is at the lowest frequency to be reproduced. This means that if we would want to reproduce an organ pedal tone of 28 cycles, we would obtain best room gain for that tone if one dimension were at least one-half wavelength, or twenty feet, long.⁴

³ Ref. 3, p. 402.

⁴ Ref. 3, p. 136.

In order to excite all the room modes it is necessary to locate the loudspeaker in a corner at either the ceiling or the floor.⁵ No other position will positively excite all the modes. This position offers other advantages as well. It affords the best distribution of sound, and gives the speaker somewhat better acoustic loading due to the fact that it is radiating into only $\pi/2$ steradians,⁶ as against π steradians for a position in a corner halfway between floor and ceiling, and 2π steradians for a position in the center of a wall.

The general acceptance of the live end, dead end studio principle suggests its application to the listening room. However, with a corner-located speaker, and with its immediately adjacent walls functioning as part of the reproducing

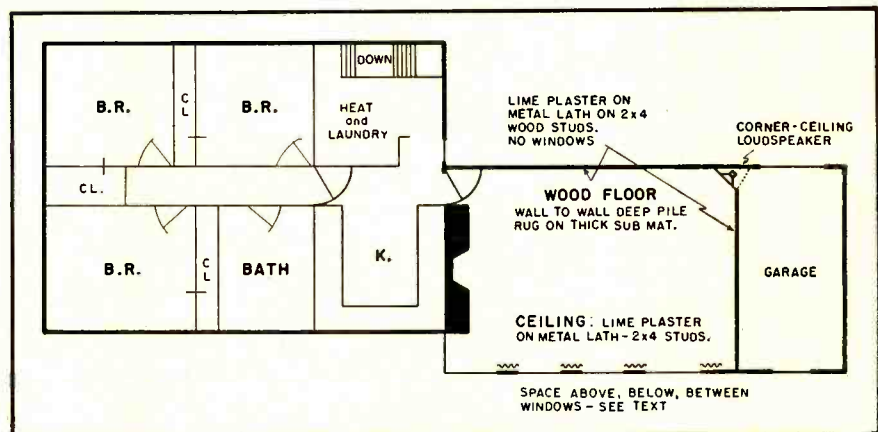

Fig. 2. Floor plan which fits the requirements outlined by the author.

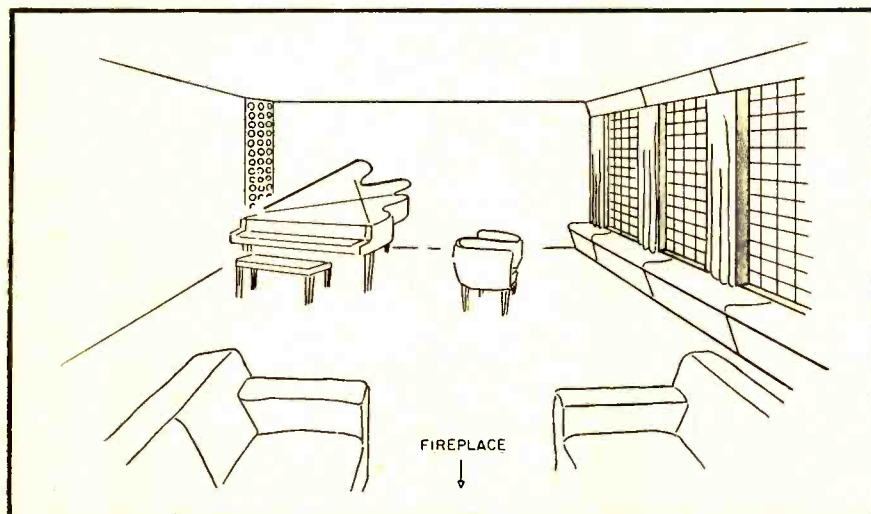

Fig. 1. Suggested arrangement of one type of living room for optimum listening.

system, it is desirable that we treat our listening room as a live-corner, dead-corner room. That is to say, the three room surfaces adjacent the loudspeaker should be live, devoid of doors or windows, and the three remaining surfaces should be dead, broken up with doors, windows, draperies or other details, and any acoustical absorbing material⁷ necessary to maintain a reverberation time of less than one second at 1000 cps.⁸ The alternate spacing of reflective windows and absorbant draperies or acoustic tile furnish a diffusion of sound much the same as do polycylindrical surfaces used in studio design.⁹ Con-

[Continued on page 70]

⁵ Ref. 2, p. 670.

⁶ Ref. 1, p. 28.

⁷ Ref. 7, p. 84.

⁸ Ref. 3, p. 368; ref. 1, p. 418.

⁹ Ref. 3, p. 140.

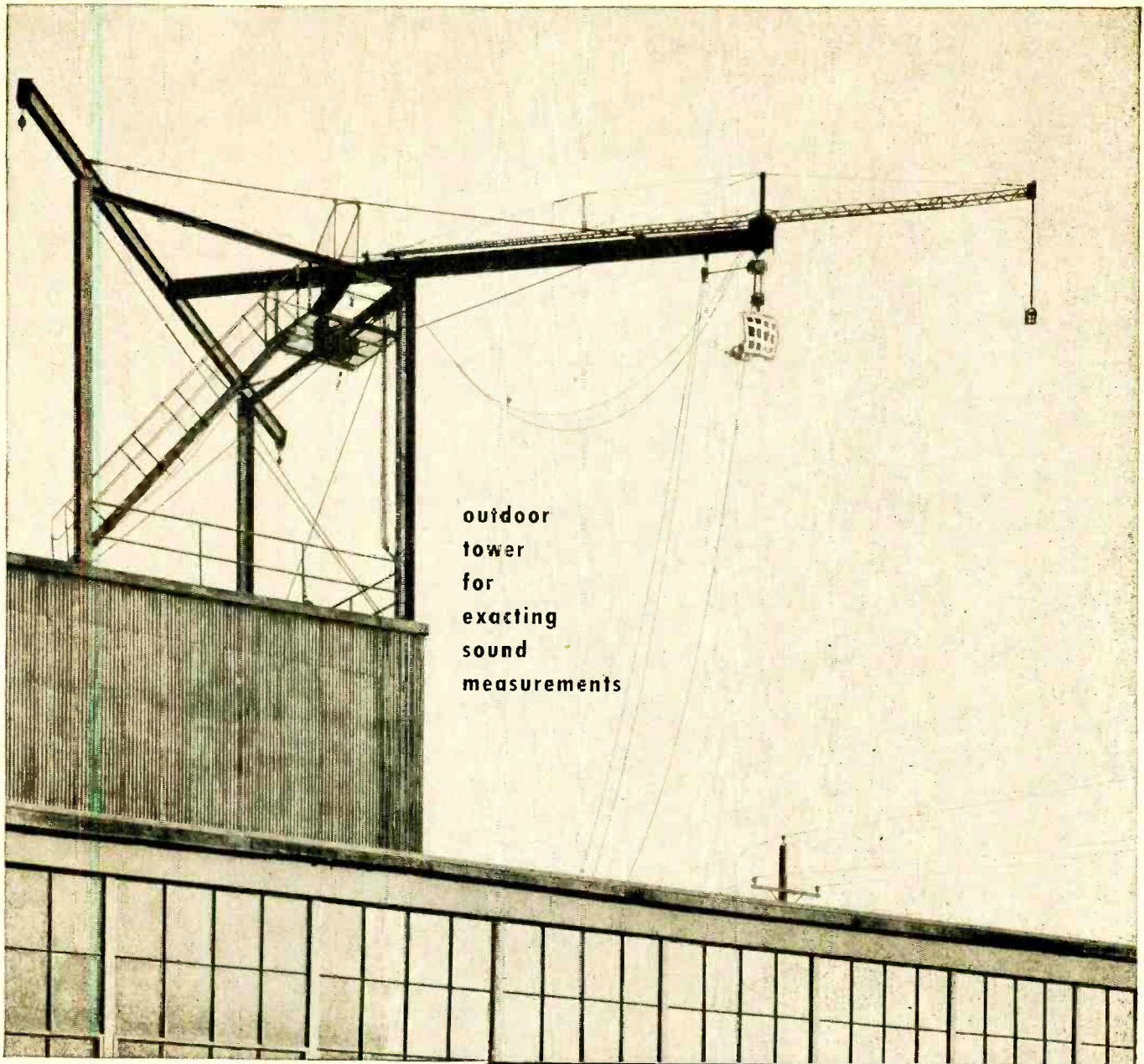

outdoor
tower
for
exacting
sound
measurements

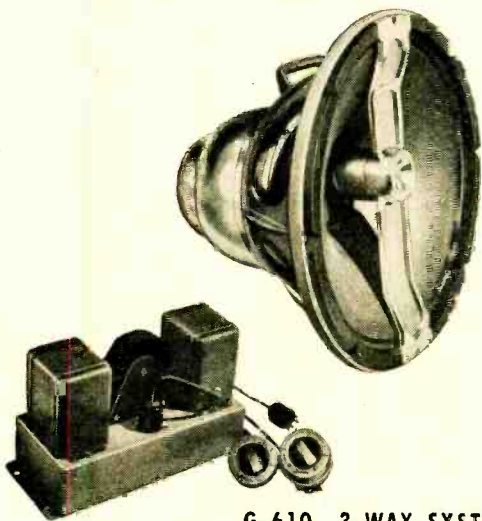

G-610 3-WAY SYSTEM
World's Finest Loudspeaker

Jensen

... foremost
in advanced-design loudspeakers

Jensen's history is the history of the sound reproduction art itself. Dedicated to the purpose of making fine loudspeakers, Jensen engineering has led in the introduction of new basic developments, types and models . . . has been first most often throughout almost 25 years of progress in sound.

Typical of the engineering tools brought to bear on loudspeaker research, is Jensen's outdoor tower . . . high in the air, away from reflecting surfaces . . . used for precise measurements of acoustic performance.

JENSEN MANUFACTURING COMPANY - 6601 S. LARAMIE, CHICAGO 38
Division of the Mule Company - Exposed Department of the Factory

BURTON BROWNE ADVERTISING



AUDIO engineering society

Containing the Activities and Papers of the Society, and published monthly as a part of AUDIO ENGINEERING Magazine

OFFICERS

C. G. McProud	President	Lloyd C. Wingard	Central Vice-Pres.
F. Sumner Hall	Executive Vice-Pres.	H. M. Tremaine	Western Vice-Pres.
C. J. LeBel	Secretary	Ralph A. Schlegel	Treasurer

P. O. Box 12, Old Chelsea Sta.,
New York 11, N. Y.

Third Annual Convention

THE END OF OCTOBER brings the annual Convention of the Audio Engineering Society, and with it, the "show of the year"—The Audio Fair. This year's list of exhibitors includes 81 separate names, although some are duplications because of two or more firms using the same facilities. Conservative estimates indicate that the probable attendance will be in the vicinity of 10,000—a reasonable increase over last year's 7500 visitors.

The program of technical sessions has been arranged with a view to making it possible for the visitor to take in all those papers in his particular field at a single session. The outstanding example of this grouping is the placement of all the papers in the "hobbyist" category on Saturday morning, on the assumption that engineers will be able to attend sessions on any of the three days, while those who are not professionally engaged in the audio field may not be able to absent themselves from their regular employment as easily on weekdays but could readily attend the Saturday morning session.

Under the Chairmanship of Melvin C. Sprinkle, himself a hobbyist although employed in audio work professionally, this session brings several papers of interest to anyone who enjoys audio. Daniel J. Plach, of Jensen Manufacturing Company, is presenting a paper on "The Performance of Loudspeaker Enclosures." He is followed by Frank Robbins who will give a description of the new R-J speaker enclosure, mentioned last month by Canby as the mighty wonder of the year as far as loudspeaker mountings go. The unit is scarcely larger than the 15-inch cone speaker it contains, yet the bass response from the device will compare favorably with any enclosure heretofore exhibited.

Predicated on the idea that when one visits the home of a hobbyist, he can immediately spot a "hi-fi" system because of the cabinet monstrosity which often confronts him, Jeff Markell gives a few pointers on the design principles which should be followed to make a piece of furniture out of what is too often just a means for physically enclosing the various units of equipment and the speaker.

R. D. Darrell, chairman of the AES

Committee on Test and Demonstration Records, offers a paper on the techniques of sound demonstration. In many instances the owner of a high-quality sound system is prone to exhibit his equipment on the basis of how loud it will play or how many highs it has. This is not always the best method of demonstration, according to Mr. Darrell, and a careful choice of musical material, loudness level, and frequency-response correction will give a more convincing demonstration than the hit-or-miss techniques usually followed.

Friday's Sessions

The session on Friday morning is devoted to industrial sound, with a strong slant toward the types of systems required for directing and warning large masses of people during emergencies. Currently this is one of the important commercial uses of sound equipment, and the four papers in this session are indicative of the work of three of the major companies in this field.

The recording session on Friday afternoon brings a variety of papers of primary interest to those working in this division of audio.

The two Thursday sessions are taken up with more general papers, those of the afternoon being more specifically in the field of instrumentation and the developmental aspects of audio. There is sufficient variety throughout the entire convention to provide everyone with some solid information in addition to the more easily assimilated data to be gained from a tour of the exhibit floors.

The Audio Fair Exhibits

The choice of a hotel for an exhibit of audio equipment has proved itself as the ideal arrangement. Although some of the exhibitors would prefer larger rooms, and although there is no denying that the exhibit floors are crowded from opening until closing, hotel rooms help to eliminate the pandemonium which would result from the display and demonstration of seventy or eighty separate sound systems in one large hall. Anyone who has attended an Audio Fair will testify that there is a lot of sound in the halls of Hotel New Yorker during the three days, but in comparison to what it would be with all of the exhibitors in a single

hall, there is no doubt that the hotel is a better place for an audio exhibit than anyplace else.

Thus with these few words about the Convention and the Fair, we bid you come and see for yourself. The Society is on the upswing, with more members joining every month. To make it easy to file an application for membership, a complete application form is to be found on page 65. There are three grades of membership—member, requiring actual experience in the audio field; associate, requiring only an interest in audio; and student, requiring that the applicant be enrolled in a recognized institution of learning. There is no initiation fee, and it is only necessary that the first year's dues accompany the application form.

AES ANNUAL ELECTION

The annual election of the Society was held as of October 1, 1951, and the Tellers Committee, under the chairmanship of Alexander Fisher of Commercial Radio-Sound Corporation reported the following results: for President, C. G. McProud; for Executive Vice-President, F. Sumner Hall of Audio Equipment Sales, 153 W. 33rd St., New York; for Central Vice-President, Lloyd C. Wingard, of WGAR Broadcasting Company, Hotel Statler, Cleveland, Ohio; for Western Vice-President, Howard M. Tremaine, 946 N. Mariposa Ave., Hollywood, California; for Secretary, C. J. LeBel of Audio Instrument Co., 133 W. 14th St., New York; for treasurer, Ralph A. Schlegel, WOR Recording Studios, 1440 Broadway, New York.

Three Governors were elected this year: John D. Colvin, Commercial Radio-Sound Corporation, New York; Jerry B. Minter, Measurements Corporation, Boonton, N. J.; and W. Oliver Summerlin, Audio and Video Products Corp., 1650 Broadway, New York. Each of these Governors will fill a two-year term.

At the October 4 meeting of the Board of Governors, V. J. Liebler of Columbia Records, Inc., 799 Seventh Ave., New York, was chosen to fill the unexpired term of Howard A. Chinn, Columbia Broadcasting System, 485 Madison Ave., New York, who resigned because of the press of work.

New 1952 HEATHKITS

Heathkit
TELEVISION
GEN. KIT \$39.50

Heathkit
ELECTRONIC
SWITCH KIT \$19.50

Heathkit
AUDIO GEN.
KIT \$34.50

Heathkit
CONDENSER
CHECKER KIT \$19.50

Heathkit
R. F. SIGNAL
GEN. KIT \$19.50

Heathkit
A.C. VOLTMETER
KIT \$29.50

Heathkit 5" OSCILLOSCOPE KIT

- New "spot shape" control for spot adjustment — to give really sharp focusing.
- A total of ten tubes including CR tube and five miniatures.
- Cascaded vertical amplifiers followed by phase splitter and balanced push-pull deflection amplifiers.
- Greatly reduced retrace time.
- Step attenuated — frequency compensated — cathode follower vertical input.
- Low impedance vertical gain control for minimum distortion.
- New mounting of phase splitter and deflection amplifier tubes near CR tube base.
- Greatly simplified wiring layout.
- Increased frequency response — useful to 5 MC.
- Tremendous sensitivity .03 RMS per inch Vertical .6V RMS per inch Hor.
- Dual control in vernier sweep frequency circuit — smoother acting.
- Positive or negative peak internal synchronization.
- Multivibrator type Wide Range Sweep Generator.

A brand new 1952 Heathkit Oscilloscope Kit with a multitude of outstanding features and really excellent performance. A scope you'll truly like and certainly want to own.

The kit is complete with all parts including all tubes, power transformer, punched and formed chassis, etc. Detailed instruction manual makes assembly simple and clear — contains step-by-step instructions, pictorials, diagrams, schematic, circuit description and uses of scope. A truly outstanding value.

MODEL O-7
SHIPPING WT. 24 LBS.

\$43.50

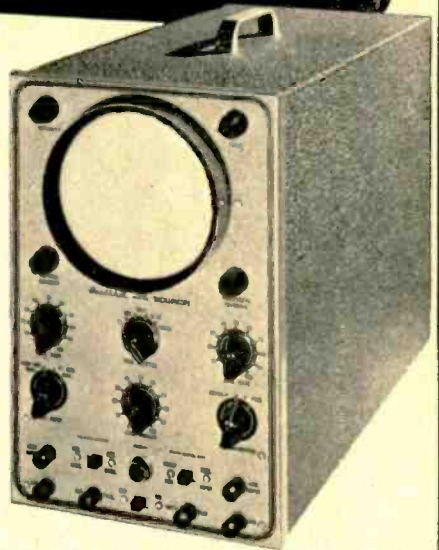

Heathkit VACUUM TUBE VOLTMETER KIT

- New styling — formid case for beauty.
- New truly compact size — Cabinet 4 1/8" deep x 4-1/16" wide x 7 3/8" high.
- Quality Simpson 200 microamp meter.
- New ohms battery holding clamp and spring clip — assurance of good electrical contact.
- Highest quality precision resistors in multiplier circuit.
- Calibrates on both AC and DC for maximum accuracy.
- Terrific coverage — Reads from 1/2V to 1000V AC, 1/2V to 1000V DC, and .1 to over 1 billion ohms resistance.
- Large, clearly marked meter scales indicate ohms, AC Volts, DC Volts, and DB — has zero set mark for FM alignment.
- New styling presents attractive and professional appearance.

The 1952 Model Heathkit Vacuum Tube Voltmeter! Newly designed cabinet combines style and beauty with compactness. Greatly reduced size to occupy a minimum of space on your work-bench. Covers a tremendous range of measurements and is easy to use. Uses only quality components including 1% precision resistors in multiplier circuit for greatest accuracy. Simpson 200 microamp meter with easy to read scales for fast and sure readings.

All parts come right with kit, and complete instruction manual makes assembly a cinch.

MODEL V-5
SHIPPING WT. 5 LBS.



\$24.50



Heathkit
SQUARE WAVE
GEN. KIT \$29.50



Heathkit
INTERMODULATION
ANALYZER \$39.50



Heathkit
AUDIO FREQ.
METER KIT \$34.50

YOU SAVE BY ORDERING DIRECT FROM MANUFACTURER

EXPORT AGENT
ROCKE INTERNATIONAL CORP.
12 E. 40th ST.
NEW YORK CITY (16)
CALL: ARLAB-N.Y.

The HEATH COMPANY

... BENTON HARBOR 25, MICHIGAN



Convention Program

THURSDAY, November 1, 1951

9:30 a.m. to 6:00 p.m.

Registration 5th and 6th Floor Foyers
Exhibits open 5th and 6th Floors
Advance Sale of Banquet Tickets . . Room 627

10:00 a.m. to 10:30 a.m. Business Meeting

Grand Ballroom
Installation of Officers
Committee Report

10:30 a.m. Technical Session

Grand Ballroom
C. G. MCPROUD, *Chairman*

TRANSIENT RECORDER FOR AUDIO FREQUENCIES

MARSHALL C. KIDD, *Radio Corporation of America, Camden, N. J.*

A tone burst of 4, 8, or 16 cycles, followed by an equal blank period is applied to the equipment under test. The resulting output transient from the equipment then has that portion corresponding to the original burst eliminated. The rectified average value of the remaining waveform is recorded as transient distortion. The steady-state and the transient distortion curves are drawn on the same sheet for comparison purposes. The transient distortion of networks and loudspeakers is measured directly while enclosures and microphones are measured indirectly since a loudspeaker must be used to test these units. Transient curves and oscillograms are shown for a number of different loudspeakers.

11:00 a.m.

EFFECT OF CATHODE CAPACITOR ON PUSH-PULL OUTPUT STAGE DISTORTION

ROBERT M. MITCHELL, *United Transformer Company, New York, N. Y.*

The influence of the cathode bypass capacitor in a push-pull output stage with a common cathode resistor is discussed. Results are given for total harmonic, individual harmonic, and intermodulation distortion with and without such a capacitor. The roles played by the individual tubes, the unbalanced current, and the operating points are shown.

11:30 a.m.

THE PROPAGATION OF HIGH-INTENSITY SOUNDS

SAUL J. WHITE, *University Loudspeakers, Inc., White Plains, N. Y.*

This paper summarizes various experimental studies on the transmission characteristics of high-intensity speech over distances of several miles. Transmission of amplified speech is subject to wide variations in observed effects due to the lack of homogeneity in the atmosphere. Since results vary from day to day, it is impractical to evolve a useful formula for computing range of audibility. This paper discusses early experiments with gunfire, explosives, foghorns, etc., and more recent tests with high-powered loudspeakers. The author uncovers explanations for the severe refraction and dissipation of the sound, the reasons for skip distances, abnormal audibility regions, and the persistence of sub-audible frequencies.

12:00 noon to 2:00 p.m. . . Lunch Recess

2:00 p.m. Technical Session

Grand Ballroom

INSTRUMENTATION

HERMAN H. SCOTT, *Chairman*

PROBLEMS OF NEW ULTRA-SPEED RECORDING TECHNIQUE

C. J. LEBEL, *Audio Instrument Company, New York, N. Y.*

Need for ten-fold improvement in pen speed of high-speed level recorders is emphasized,

and prior efforts are reviewed. New ultra-speed technique is shown, giving pen speed of 10,000 db per second. Factors controlling stability, linearity, and transient response are discussed, and need for coordination of design of parts of system is pointed out. Results of measurement of transient performance of commercial high-fidelity amplifiers are shown, with suggestion that this factor may explain unpleasant sound of some systems.

2:30 p.m.

ROOM REVERBERATION BY ULTRA-SPEED RECORDING

JAMES Y. DUNBAR, *Wm. J. Scully Acoustic Corporation, New York, N. Y.*

Studies of reverberation decay characteristics of certain rooms involving use of ultra-speed recording equipment developed by C. J. LeBel indicate that acoustic aberrations may be detectable by this means. These studies make use of standard sound sources as well as multiple tone groups.

3:00 p.m.

MAGNETIC TAPE RECORDING FOR INSTRUMENTATION AND DATA STORAGE

KENNETH B. BOOTHE, *Audio & Video Products Corporation, New York, N. Y.*

The purpose of this paper is to show how improvements in the technique of magnetic tape recording have opened up new applications in the field of recording and reproducing scientific data. Particular emphasis will be placed upon the successful and proven applications of magnetic tape in recording FM-FM intelligence for aircraft and other mobile testing. Since this is a basic system which can be and has been readily adapted for other uses, several modifications will be discussed which permit the recording of digital pulse code, PWM systems, transient data, and other types of information which may be required for a wide variety of instrumentation work.

3:30 p.m.

SOME PROPERTIES OF N-P-N TRANSISTORS

R. L. WALLACE, JR., *Member of the Technical Staff, Bell Telephone Laboratories*

Recently developed n-p-n transistors have shown a number of properties which make them very interesting, particularly for audio applications. Among them are: relatively low noise, high efficiency, high gain, and the ability to work with exceedingly low power consumption. These properties will be described, and some of them will be demonstrated.

4:00 p.m.

MAGNETIC AUDIO FREQUENCY FUNDAMENTALS

A. M. VINCENT, *Lt. Cdr., BuShips, U. S. Navy*

A brief history of magnetic amplifier development is given, with a preliminary description of the operating principles. Comparisons between electron-tube amplifiers and magnetic amplifiers are made, and a number of basic circuits are shown. The advantages and disadvantages with respect to conventional tube amplifiers are listed, with indications of future advances in the art.

7:00 p.m. . . THIRD ANNUAL BANQUET

Grand Ballroom

Presentations of the Society's Annual Award and of the John H. Potts Memorial Award.
Entertainment

FRIDAY, November 2, 1951

9:30 a.m. to 9:00 p.m.

Registration 5th and 6th Floor Foyers
Exhibits open 5th and 6th Floors

10:00 a.m. Technical Session

Grand Ballroom

INDUSTRIAL SOUND

JOHN D. COLVIN, *Chairman*

"NO CODED SIGNALS—"

H. S. MORRIS, *Altec Lansing Corp., New York*

The requirement "No Coded Signals" is beginning to appear in important bid specifications. It announces recognition of the fact that only voice sound systems can

(a) cope with the increased variety of emergency situations which hazard modern life, and

(b) deliver the organizing directions necessary to efficient industrial operation.

The shortcomings of simple signalling devices such as sirens, gongs, whistles, and howlers are discussed, and the requirements are outlined which the audio engineer must meet if voice sound systems are to take over these important emergency, security, and organizational responsibilities.

10:30 a.m.

EQUIPMENT FOR SURVIVAL SOUND SYSTEMS

JOHN K. HILLIARD, *Altec Lansing Corp., Beverly Hills, Calif.*

This paper discusses the vital components such as amplifiers and loudspeakers. The initial and maintenance cost of a large number of medium-powered amplifiers is compared with that of a smaller number of high-powered amplifiers which give an equivalent amount of total power output.

Projection and general quality of sound of various types of loudspeakers is analyzed, along with recommended frequency characteristics to be used in the presence of noise.

A new Altec driver unit having increased efficiency and power output, and designed for multicellular horns, is discussed.

11:00 a.m.

LOUDSPEAKERS FOR SPECIAL INDUSTRIAL APPLICATIONS

ROBERT S. REISS, *University Loudspeakers, Inc., White Plains, N. Y.*

The problems of providing public address and intercommunicating facilities in industrial applications are often complicated by unusual physical and acoustical requirements. These might involve submergence-proofing, explosion-proofing, etc. Loudspeakers have been developed to resist severe physical impacts, to resist the application of live steam and acid spray, to operate in dust laden and rarefied atmosphere, and to provide unusually high sound levels, etc. How these and other conditions are met with specialized equipment will be discussed.

11:30 a.m.

CIVIL DEFENSE ELECTRONIC WARNING AND COMMUNICATION SYSTEM

R. C. C. DuBois, *Radio Corporation of America, Camden, N. J.*

A discussion of the EWACS system developed by the Radio Corporation for the District of Columbia, including design features, costs, and installation data.

The system uses vhf radio to turn on and to transmit various warnings to the public, and includes the feature of a city-wide public-address system. The talk will be illustrated by slides of typical installations and equipment as used in this Federally approved civil defense warning system.

12:00 noon to 2:00 p.m. . . . Lunch Recess

2:00 p.m. Technical Session

Grand Ballroom

RECORDING

THEODORE LINDENBERG, *Chairman*

[Continued on page 44]



VARIABLE RELUCTANCE CARTRIDGE

**"OUTSELLS ALL OTHER
MAKES COMBINED!"**

Reports **ARNOLD DEUTSCHMANN**
Vice President, **RADIO SHACK Corporation**
Boston, Mass.



"MORE customers ask us for G-E than for all other cartridge brands combined. In our business that's an important tip-off because people who come to us usually know exactly what they want in audio performance. They demand that we stock the best. We handle every commercial cartridge—and G-E Variable Reluctance units outsell them all by at least 4 to 1!"

Famous the world over as a "quality" store for audio accessories, Radio Shack on Boston's Washington Street, is typical of finer dealers everywhere in its

support of General Electric parts and components.

Every stylus in every G-E cartridge is double-damped to absorb virtually all mechanical noise. Diamond or synthetic sapphire tips are available for standard or microgroove records.

A Sales Point to Remember—Replace with a G-E stylus and you get the equivalent of a whole new pickup! Here's why:—General Electric's single-package stylus assembly contains stylus, cantilever, and damping blocks—the only parts of your pickup that are affected by time and use. No other cartridge gives you this advantage.



SPEAKER PERFORMANCE THAT SELLS—

and stays sold! Lew Kornfeld and Arnold Deutschmann, Radio Shack experts, agree that G.E.'s 27 sizes of speakers bring quality sound within the range of every taste and budget.

**SEND FOR THIS
NEW BOOKLET!**



General Electric Company, Section 44111
Electronics Park, Syracuse, New York

Yes—send me new booklet with complete information on General Electric diamond styli.

NAME
ADDRESS
CITY STATE

You can put your confidence in

GENERAL  ELECTRIC

Direct Radiator Loudspeaker Enclosures

HARRY F. OLSON*

A comprehensive analysis of the effect of cabinet configuration on the sound distribution pattern and overall response-frequency characteristics of loudspeakers.

THE PRINCIPAL FACTORS which influence the performance of a direct-radiator loudspeaker are the mechanism itself, the acoustical impedance presented to the back of the mechanism by the enclosure, and the outside configuration of the enclosure. The major portion of the work involving cabinet research, development, and manufacture has been directed towards the acoustical impedance presented to the back of the loudspeaker mechanism by the enclosure. The volume of the cabinet and the internal damping means play the most important role in determining the acoustical impedance presented to the back of the loudspeaker. In other words, most of the considerations concerning the design of cabinets for direct-radiator loudspeakers have involved the volume or overall dimensions of the cabinet which—together with the mechanism—determines the low-frequency performance. The third factor, namely, the exterior configuration of the cabinet, influences the response of the loudspeaker system due to diffraction effects produced by the various surface contours of the cabinet. The diffraction effects are usually overlooked and the anomalies in response are unjustly attributed to the loudspeaker mechanism. Therefore, in order to point up the effects of diffraction, it appeared desirable to obtain the performance of a direct-radiator loudspeaker mechanism in such fundamental shapes as the sphere, hemisphere, cylinder, cube, rectangular parallelepiped, cone, double cone, pyramid, and double pyramid. It is the purpose of this paper to present the results of the diffraction studies made upon these fundamental shapes. The response-

frequency characteristics of a direct-radiator loudspeaker mechanism mounted in these different housings yield fundamental information regarding the effect of the outside configuration of the cabinet upon the performance of this combination. From this study it is possible to evolve a cabinet shape which has the least effect in modifying the fundamental performance of a direct-radiator loudspeaker mechanism.

Characteristics of the Sound Source

In the experimental determination of the performance of direct-radiator loudspeaker mechanisms in various shaped

angle α to the pressure for an angle $\alpha=0$,

J_1 = Bessel function of the first order,

R = radius of the piston, in centimeters,

α = angle between the axis of the piston and the line joining the point of observation and the center of the piston, and

λ = wavelength, in centimeters.

The upper frequency limit for this investigation will be placed at 4000 cps. The reason for selecting this limit is that the enclosures which will be used

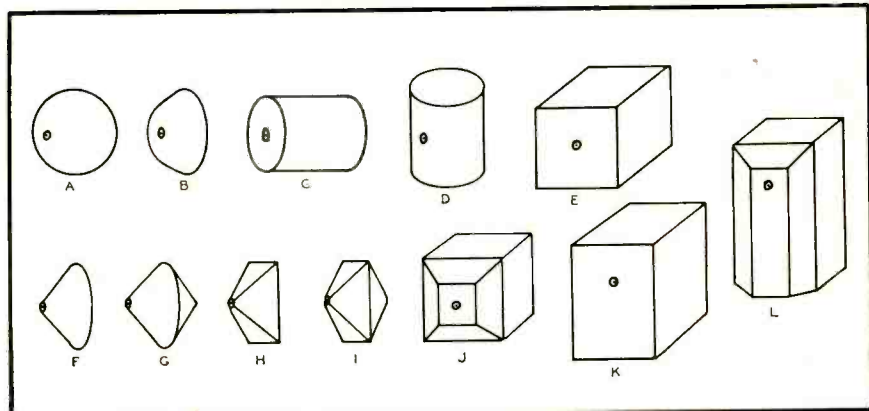

Fig. 2. Direct-radiator loudspeaker mechanism enclosures. The small circle with the dot in the center represents the speaker unit.

enclosures, some consideration must be given to the radiating system. These considerations include the directional characteristics of the sound source and the sound power output characteristics of the sound source as a function of the frequency.

In order to obtain the true diffraction effects which are produced by the different enclosures, the radiation emitted by the sound source must be independent of the direction. Since the diaphragm of the direct-radiator loudspeaker mechanism used in these tests is relatively very small, it can be assumed that it is a piston source. The directional characteristics of a piston source are given by

$$R_\alpha = \frac{2J_1\left(\frac{2\pi R}{\lambda} \sin \alpha\right)}{\frac{2\pi R}{\lambda} \sin \alpha} \quad (1)$$

where R_α = ratio of the pressure for an

are relatively large. For example, the linear dimensions are eight to ten wavelengths at 4000 cps. It will be stipulated that the radiation from the cone of the loudspeaker mechanism at this frequency shall be down not more than 1.0 db for $\alpha=90$ deg. as compared to $\alpha=0$ deg. This insures a reasonably nondirectional sound source even at the upper end of the frequency range, that is, at 4000 cps. Of course, at lower frequencies the response discrepancy with respect to angle is much less. To satisfy the above requirements, the diameter of the diaphragm or cone must be $\frac{7}{8}$ in. Accordingly a small direct-radiator loudspeaker mechanism employing a cone $\frac{7}{8}$ in. in diameter was designed, built, and tested. A sectional view of the loudspeaker mechanism is shown in Fig. 1. Measurements indicated that the directional performance agreed with that predicted by equation (1).

The next consideration is the sound

* RCA Laboratories, Princeton, New Jersey

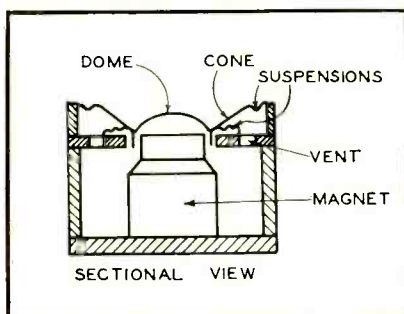
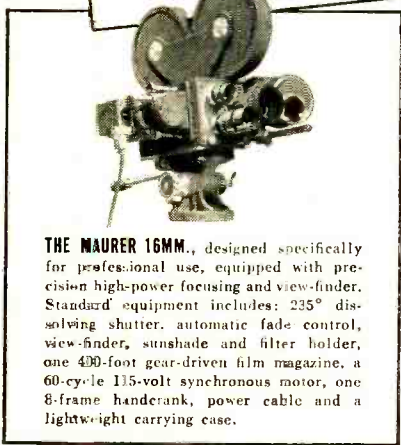

Fig. 1. Sectional view of the loudspeaker mechanism.

VERSATILE PERFORMERS



THE MODEL F PRIME RECORDING OPTICAL SYSTEM AND GALVANOMETER. A complete light modulating unit for recording sound photographically upon standard film, requires no special servicing or spare parts (other than recording lamp).



THE MAURER 16MM., designed specifically for professional use, equipped with precision high-power focusing and view-finder. Standard equipment includes: 235° dissolving shutter, automatic fade control, view-finder, sunshade and filter holder, one 400-foot gear-driven film magazine, a 60-cycle 115-volt synchronous motor, one 8-frame handcrank, power cable and a lightweight carrying case.



THE 16MM. SOUND-ON-FILM RECORDING SYSTEM combines the highest fidelity in 16mm. recording practice with wide flexibility and extreme simplicity of operation.

Filming marionettes for an educational film is but one of the many daily jobs of the Maurer 16mm. Professional Camera. If your film shooting demands the maximum in accuracy, quality and simplicity of camera operation, your camera is the Maurer — first choice in the professional field.

For details on this and other Maurer equipment write:

J. A. MAURER, INC.
 37-01 31st Street, Long Island City 1, New York
 850 South Robertson Blvd., Los Angeles 35, California



CABLE ADDRESS: JAMAURER

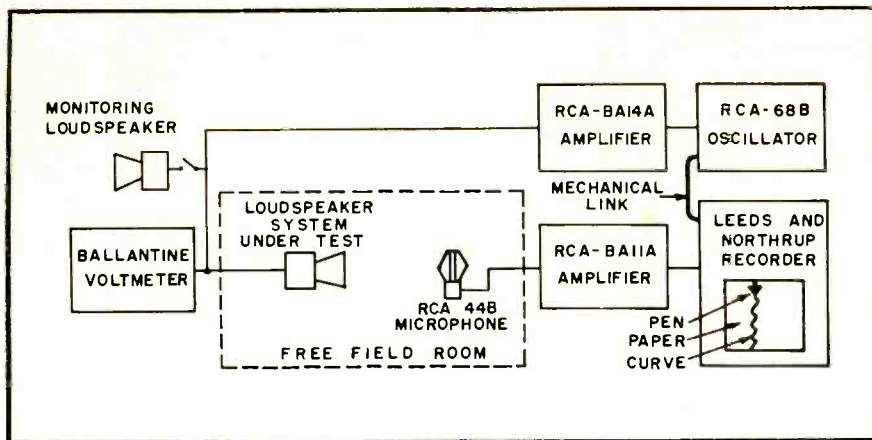

Fig. 3. Schematic diagram of the apparatus for obtaining the response-frequency characteristics of loudspeakers.

power output calibration of the sound source. The sound power output of a piston sound source radiating into 4π solid angles and operating in the frequency region in which the diameter of the piston is less than one-quarter wavelength¹ is given by

$$P_T = \frac{\rho\omega^2}{4\pi c} S^2 \dot{x}^2 = \frac{\rho\omega^2}{4\pi c} \dot{X}^2 \quad (2)$$

where ρ = density of air, in gms./cu. cm.,
 c = velocity of sound, in cm./sec.,
 $\omega = 2\pi f$,
 f = frequency, in cps,
 S = area of the diaphragm, in sq. cm.,
 \dot{x} = r.m.s. velocity of the diaphragm, in cm./sec., and
 \dot{X} = r.m.s. volume current produced by the mechanism, in cu. cm./sec.

Equation (2) shows that the sound power output P_T of the sound source will be independent of the frequency f , if the velocity \dot{x} , of the piston is inversely proportional to the frequency. The characteristics depicted in this paper have been reduced to a sound source of this type, namely, that when it radiates into 4π solid angles the sound power output will be independent of the frequency. Since the directivity pattern of the sound source is independent of the frequency, the sound pressure, under these conditions, will also be independent of the frequency.

It may be mentioned in passing that, in the case of a direct-radiator loudspeaker mechanism operating in the frequency range below the ultimate acoustical radiation resistance, the velocity of the cone must be inversely proportional to the frequency in order to obtain constant sound power output, because the acoustical radiation resistance is proportional to the square of the frequency. In order to obtain this type of motion, the system must be mass controlled, which is the natural state of affairs in the direct-radiator type of loudspeaker mechanism above the funda-

¹ If the upper frequency limit is placed at 4000 cps, the diameter of the $\frac{7}{8}$ -in. cone will be less than one-quarter wavelength in the frequency range below 4000 cps.

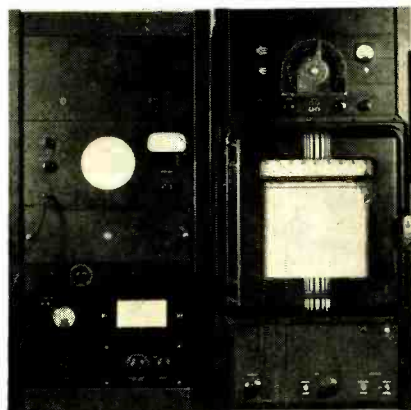

Fig. 4. Equipment set-up for obtaining the response-frequency characteristics of loudspeakers.

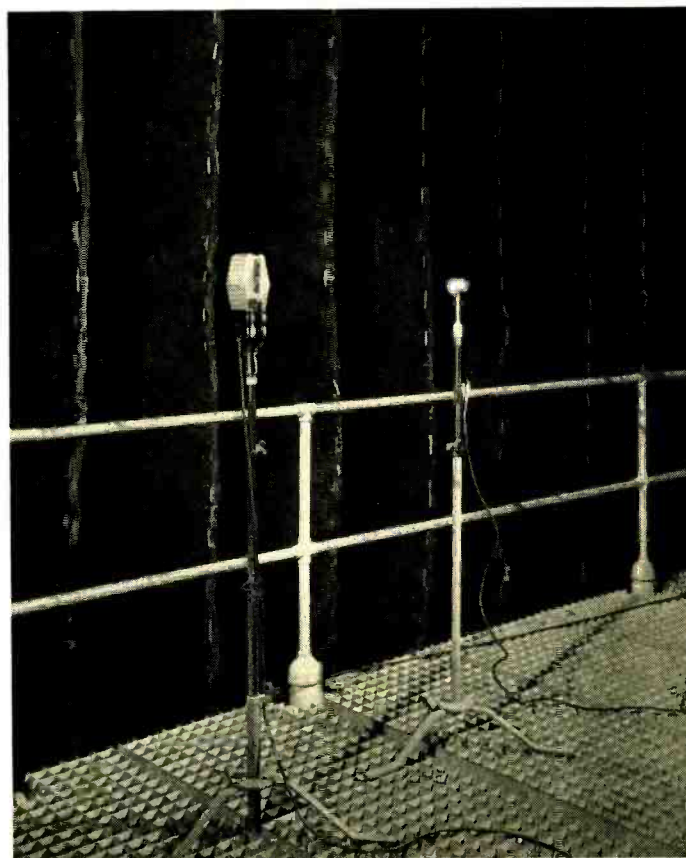

Fig. 5. Microphone and small direct-radiator loudspeaker mechanism of Fig. 1 under test in the free-field room.

mental resonant frequency of the system. In other words, the performance characteristics depicted in this paper are, for all practical purposes, the characteristics which will be obtained if conventional direct-radiator loudspeaker mechanisms are used in these enclosures.

Enclosures

The enclosures used in these experiments are depicted in Fig. 2. The sheet metal sphere shown at (A) is 2 ft. in diameter. The loudspeaker mechanism is mounted with the cone approximately flush with the surface. The sheet metal hemisphere shown at (B) is 2 ft. in diameter with the back closed by a flat board of hard wood. The loudspeaker mechanism is mounted upon the zenith of the hemisphere with the cone of the loudspeaker mechanism approximately flush with the surface. The sheet metal cylinder shown at (C) is 2 ft. in diameter and 2 ft. in length. The ends of the cylinder were closed by plywood boards of hard wood. The loudspeaker mechanism is mounted in the center of one end with the cone of the loudspeaker mechanism mounted flush with the surface. The cylinder shown at (D) is of the same size as that of (C). In (D) the cone of the loudspeaker mechanism is mounted approximately flush upon the cylindrical surface midway between the ends. The sides of the wood cube shown at (E) are 2 ft. in length. The loudspeaker mechanism is mounted in the center of one face with the cone flush with the surface. The base of the sheet metal cone shown at (F) is 2 ft. in diameter. The height of the cone is 1 ft. The base of the cone is closed by

PICKERING

RECORD PLAYING EQUIPMENT

*For flawless reproduction
of the works of the masters*

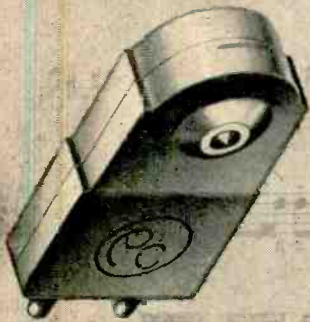

Pickering diamond stylus pickups and related components are the exclusive choice of musicians and lovers of music who insist upon the finest. Engineers acknowledge Pickering audio components as the best available. In every test and performance comparison, they demonstrate their superiority; recreating all the music pressed into modern recordings with the fidelity and realism of a live performance.

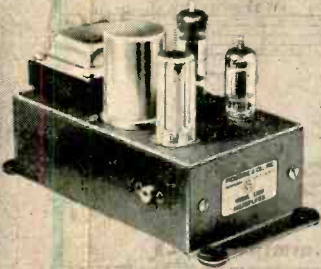

Pickering components are created for listening pleasure by Audio Engineers who know music and who know the tastes of discriminating listeners.



Pickering diamond cartridges have no equal. The wear and fracture resistance of the diamond styli in these cartridges is many times greater than that of styli made of sapphire, the next hardest material. Because resistance to wear preserves the precise shape of the stylus point, the life and quality of your valuable record collection is insured.



Don't impair the musical quality of your priceless records.

Use Pickering diamond stylus cartridges . . . they not only wear longer *but, more important*, they preserve the musical quality and prolong the life of your record library.

By all measures, Pickering diamond stylus cartridges are more economical.

PICKERING & COMPANY, Inc.
Oceanside, L. I., N. Y.



Pickering High Fidelity Components are available through leading Radio Parts distributors everywhere; detailed literature sent upon request. Address Department A

a board of hard wood. The loudspeaker mechanism is mounted in the apex of the cone. The cone was truncated to accommodate the small loudspeaker mechanism. The double cone of (G) consists of two cones, each of the same size as that of the single cone of (F), with the bases placed edge to edge. The loudspeaker mechanism is mounted in the apex of one of the cones. The length of the edges of the square base of the wood pyramid shown at (H) is 2 ft. The height of the pyramid is 1 ft. The base of the pyramid is closed by a board of hard wood. The loudspeaker mechanism is mounted in the apex of the pyramid. The pyramid was truncated to accommodate the small loudspeaker mechanism. The double pyramid of (I) consists of two pyramids, each of the same size as that of the single pyramid of (H), with the bases placed edge to edge. The loudspeaker mechanism is mounted in the apex of one of the pyramids. The truncated pyramid of (J) is mounted upon a rectangular parallelepiped. The length of the edges of the truncated pyramid is 1 ft. The height of the truncated pyramid is 6 in. The lengths of the edges of the rectangular parallelepiped are 1 ft. and 2 ft. The loudspeaker mechanism is mounted in the center of the truncated surface. The lengths of the edges of the rectangular parallelepiped of (K) are 2 ft. and 3 ft. The loudspeaker mechanism is mounted midway between two long edges and 1 ft. from one short edge. At (L) a rectangular truncated pyramid is mounted upon a rectangular parallelepiped. The lengths of the edges of the rectangular parallelepiped are 1, 2, and 3 ft. The lengths of the edges of the truncated surface are 1 ft. and 2½ ft. The height of the truncated pyramid is 6 in. One surface of the pyramid and one surface of the parallelepiped lie in the same plane.

Measurement Apparatus and Techniques

The small loudspeaker mechanism of Fig. 1 was mounted in the enclosures shown in Fig. 2. In obtaining true diffraction effects it is important that reflection effects produced by room in which the response-frequency characteristic is obtained be reduced to a negligible minimum. Therefore, all the response-frequency characteristics depicted in this paper were obtained in the free field room^{2, 3} of the Acoustical Laboratory of the RCA Laboratories. A schematic diagram of the apparatus used for obtaining the response-frequency characteristics, along with detailed designations of the components are shown in Fig. 3. The complete recording system—including the RCA-44B velocity microphone, BA1A amplifier, and Leeds and Northrup Speedomax recorder—was calibrated by the free

[Continued on page 59]

² H. F. Olson, *J. Acous. Soc. Am.*, Vol. 15, No. 2, p. 96, 1943.

³ Olson, *Elements of Acoustical Engineering*, D. Van Nostrand Company, New York, 2nd Edition, 1947, p. 359.

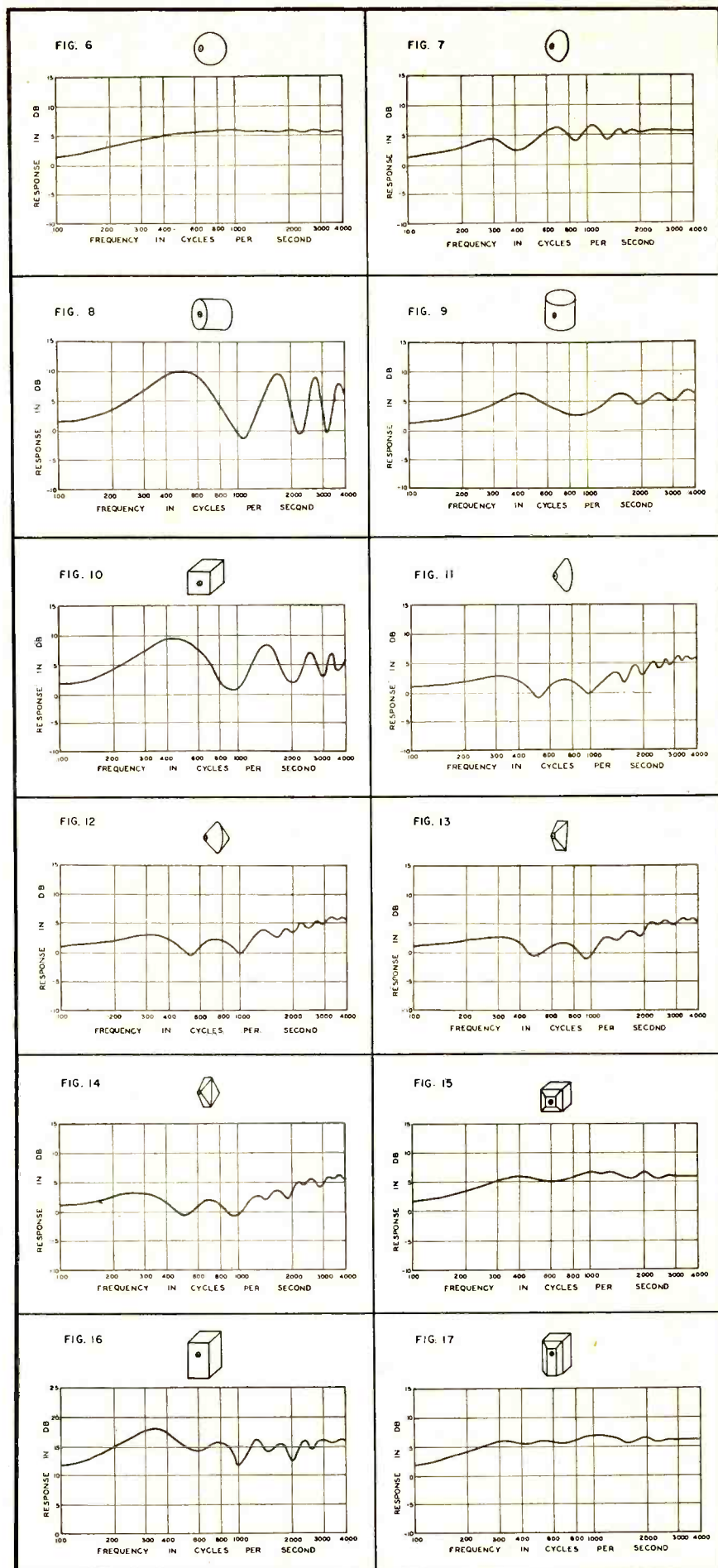

Figs. 6 to 17. Response-frequency characteristic of a small direct-radiator loudspeaker mechanism mounted in the enclosures of Fig. 2.



Enjoy the Ultimate in
HIGH-FIDELITY MUSIC
from radio or records

select your custom components at

ALLIED

Now you can enjoy brilliant high-fidelity reproduction of radio and recorded music. It's simple to assemble your own fine custom audio components to gratify your personal listening desires and to blend beautifully with your home decor. Look to ALLIED—high-fidelity custom specialists—to help you select the proper components at very substantial savings. We carry the world's

largest stocks of high-fidelity audio equipment—amplifiers and speakers in all famous makes, all leading FM and AM radio tuners, the latest 3-speed record changers, custom furniture and complete accessories. Write today for complete FREE Catalog, or visit our High-Fidelity Studio for actual comparative demonstrations through ALLIED's famous Hi-Fi Auditor.

world's largest stocks of all famous makes

- | | |
|-------------------|------------------|
| ALTEC LANSING | MAGNECORD |
| AUDAX | MARKEL |
| AUDIO DEVELOPMENT | MASCO |
| BELL | MEISSNER |
| BOGEN | McINTOSH |
| BROOK | PFANSTIEHL |
| BROWNING | PICKERING |
| CLARKSTAN | PRESTO |
| CONCERTONE | RCA |
| CRAFTSMEN | REK-O-KUT |
| ELECTRO-VOICE | H. H. SCOTT |
| GENERAL ELECTRIC | STEPHENS |
| GROMMES | THORDARSON |
| JENSEN | UNI-MODE |
| KNIGHT | UNIVERSITY |
| JIM LANSING | V-M CORP. |
| LEAK | WEBSTER-CHICAGO |
| LIVINGSTON | WESTERN ELECTRIC |



ALLIED'S famous Hi-Fi Auditor

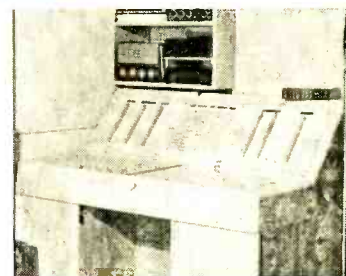

we are specialists in high-fidelity

Photo above shows our Hi-Fi Auditor, a push-button controlled console capable of demonstrating more than 350,000 combinations of audio components. All equipment is subjected to complete tests by ALLIED engineers. Our staff of Hi-Fi specialists is ready at all times to assist you in selecting audio components to meet your individual requirements. Whether you are planning a new custom installation or modernizing old equipment—write us for complete information.



FREE 1952 CATALOG

Write today for our complete Buying Guide listing the world's largest selection of High-Fidelity components. Obtain all of your audio equipment from one dependable supplier, with the specialized knowledge and experience that will help bring you optimum high-fidelity reproduction. If it's Hi-Fi, you'll find it in your ALLIED Catalog. Send for it.

ALLIED RADIO

ALLIED RADIO CORP., Dept. 17-L-1
 Chicago 7, Illinois

Send FREE 1952 ALLIED Catalog.

I am interested in the following equipment:

.....

Name.....

Address.....

City.....State.....

RECORD REVUE

EDWARD TATNALL CANBY*

AUDIO FAIR exhibitors will no doubt receive this sheet just as they arrive at Hotel New Yorker and are in the midst of unpacking the bags and the packing cases and trunks. Not exactly a good time to suggest a settling down to read further here—but it's now or never. May I raise the proverbial still, small voice at this crucial moment to suggest that you dig out *Æ* for December, 1950 and glance hastily over my disquisition therein, entitled TOWARDS AUDIO FAIR III. The detailed comment in that issue, needless to say, applied to the grand and glorious event which is about to occur (and which many of us privately thought might not ever happen, because of the War clouds), the 1951 Audio Fair.

For those who aren't exactly in a position to dig up back numbers at the moment, a brief summary.

The business of Audio is music. When you come down to it, almost all audio equipment is devoted to the reproduction of music—and what's more, these days a very large part of that music is "classical." Makes better hi-fi stuff.

The Fair is host, naturally, to hundreds of buyers, sellers, engineers, designers—the people who are in the business themselves, in the field, and want to see what's going on in their own special world. They're interested in what they see—in facts, in information, specs, prices. There are also a large number of more or less expert gadgeteers at the Fair, professional or amateur or semi-semi, who delight in mixing in with the men in the field, who are there both to absorb and to argue and shoot the breeze. They, along with the audio people themselves, are right up in front in every display room, having a time and talking a blue streak.

But—the business of Audio is music—and the business of Audio is not merely to sell audio to itself, so to speak, but to a far larger market than the intra-trade one. It's all very well to catch up on what's going on. But keep in mind that in the back of every display are those large numbers of silent and curious people, acting mousy, who have come to the Fair to find out what will give them the best in MUSIC. Maybe they don't know anything about audio—or if they do, they prefer to keep mum. But

* 279 W. 4th St., New York 14, N. Y.

Audio, 1951

they listen and pass judgment. They'll buy music.

No music-lover worth his salt will listen to more than *one* source of music at a time.

No music lover worth his salt gives a hoot about decibels, highs, lows, peaks and the rest, if in the demonstrating, violence is done to music itself.

Every music lover worth etc. etc. will judge audio equipment on its ability to reproduce music. Your demonstration succeeds or fails on this alone.

Demonstration Suggestions

And so, a summary of the practical suggestions I made last December, for those who would like to please the audio-minded music lover who will be at the Fair in swarms—and who is your ultimate interest, from the viewpoint of expanding your market.

1. Keep your exhibit door closed, or devise a sound trap. So that *one* source of music, no more, is audible at a time. (*Don't* rely on the drowning-out-with-superior-decibel-power principle!)
2. Study room acoustics—deadened one or two walls with cloth, and add both good looks and improved sound quality. Room acoustics count tremendously in the musical result.
3. Place speakers carefully—in a corner if possible, and at a distance from spots where visitors congregate. Don't place your speakers where legs and bodies block off the sound.
4. Respect the music-lover's (unspoken) interest—keep the *average* loudness level down low; save your big volume for *short* demonstrations. A good 30-second burst at full volume will impress your audience; a steady pounding will drive 'em away in droves. Did last year, anyhow.
5. Use good records, brand new ones, and be sure to treat them with *visible* respect. Owners of hi-fi audio equipment are morbidly sensitive about this and will be deeply shocked to see piles of dusty, dirty, scratched discs sitting around. Give your records loving care—in front of their noses.

6. *Equalize*. Yes, plenty of audio fans want highs, transients, lows, and the rest. But most want, above all, good music—which, need I say, means correct and balanced reproduction. Your equipment will never sound the worse for proper equalization. As in 4 above, show off your highs or your super-lows in short, dramatic bursts—but return to correct equalization in between. (Note in addition—that the proper procedure is:

a) Equalize electrically as closely as possible for the known or guessed-at record curve.

b) *Re-adjust to match room acoustics*. Your room set-up may require 3 or 4 db extra roll-off on everything, after equalization, to balance hard reflections. Or if yours is a padded, rug-filled, plush-sofa suite, you may have to add an equivalent. Small rooms need low-bass roll-off to avoid nasty low-frequency room resonances.

7. If it's not too late when you read this—be armed with plenty of the right records*, the right tapes. Too many exhibitors in the past (in the frantic rush to ready their technical equipment) have arrived with nothing to play at all. Once more and finally, the business of Audio is music. You will be wise to devote time to finding really good test records; you will be wise to provide good music, too, and to show it prominently. Don't give the impression that you are a tin-ear outfit. Get the help of someone who knows. There are plenty of these in your audience.
8. Since a large number of the Fair's music lovers will be reading this, too—how about speaking up. You're the favored object of a good deal of this show; if you like things, say so, and if you don't, if you are in danger of aural murder, put in your two-cents in favor of what you want. Don't let us audio people drown you out. Most audio exhibitors will be only too glad

[Continued on page 42]

* See suggestions that follow.

75 years of destruction and distortion

at last, brought to an end!

Thousands of Audax users are acclaiming the POLYPHASE reproducer as indispensable for superb performance from disc-recorded music. Not since the advent of the first commercial Electronic pickup itself (built by Audax back in 1926) has there been anything like it.

**Never before such EAR-QUALITY, such
FAITHFUL REPRODUCTION**

This remarkable achievement is now crowned by the development of the CHROMATIC Diamond stylus-system which, for the first time in 75 years, totally eliminates the ugly factors that have caused untold record destruction and distortion.

Because . . . you and ONLY YOU can decide what sounds best and most pleasing to you . . . see it, HEAR it, compare it with any reproducer anywhere . . . and you be the judge . . . with it all POLYPHASE costs less than ordinary pickups.

room 629

at the AUDIO FAIR

*Write for editorial reprint
on POLYPHASE Principles*

*Be sure to obtain a copy of
PHONO FACTS from your distributor*

AUDAK COMPANY

500 Fifth Avenue New York 18

*"Creators of Fine Electro-Acoustical apparatus
for over 25 years."*



World Premiere

of the New Concertone NETWORK Tape Recorder

"just like being there"

See and hear this superlative instrument at

Audio Fair
Room 529
Hotel New Yorker
Nov. 1, 2, 3

The Concertone Network Recorder combines simplicity, dependability, flexibility and performance never before attained in any tape recorder at any price.

It represents in the broadcast and studio field an achievement comparable to that of the Concertone 1401 in its price class.

Write for free Brochure NWR-1

Manufactured By

Berlant Associates

4917 W. Jefferson Blvd. Los Angeles 16, California



RECORD REVUE

[from page 40]

to get your reactions and the more positive these reactions, the more genuinely helpful they are. The Audio Fair will be an even greater success if it can contribute to the getting together of minds, person-to-person, between the makers of audio and the consumers. Remember, audio people are as likely to be floundering about in the musical end of things as you are in the technical end.

Demonstration Records for the Audio Fair

Having challenged myself in the above, I've been rummaging around through 1001 LP's with the idea of choosing a brief list of useful records that Fair exhibitors can rush out at the last minute to buy up. (Other interested parties can eavesdrop on the list at will.) Thought it would be a simple job—but after a good part of a day's tearing of hair and littering of the floor with piles and piles of possibles, I come forth, the worse for wear, with the following somewhat larger list, the compiling of which has merely served to drive into my head what I can't always really believe—that really good records come in droves, from certain companies, mostly small ones; that good, but definitely *not* tops, material is rampant from more big companies than you can believe. Faced by the rigid test of sound needed in a demonstration, many a record that's perfectly good listening and fine music could not pass. Bad surface, distortion, above all poor microphoning that robbed the sound of the presence and brilliance of a really good recording.

As a plain matter of fact, be it noted that I had to sweat to find acceptable records from several of the major companies (remember—I recommend these at my own "risk") and, oppositely, for each Westminster, Haydn Society, etc. recommended I could easily have listed a dozen or several dozen more as good. Plain facts and I challenge anyone to figure it any other way.

With one qualification: To survey the entire LP stock for these listings would take anyone months of time; the present lists are therefore what was available in the time I could spend on the project. Many another disc of equal merit is not mentioned—this is no elimination contest! Take it as no more than a list of good records for the purpose in mind.

Furthermore, I've tended (a) to emphasize mostly recent releases, though including some worthy older items; and (b) I have deliberately gone afield, to widen the scope of your choice, since there are a number of well known hi-fi discs that most people already know about. Strictly practical. No point listing them all over again.

If your pet love isn't there, please give me your indulgence. Doin' the best I can, on short notice. And good luck with your auditors at the Fair.

Exhibitors Demonstration Records

Semi-pops—light

Grandma Moses Suite

Columbia ML 2185 (10")

Leroy Anderson Conducts

Decca DL 7509 (10")

Classical Juke-Box (Anderson)

RCA Victor LM 1106

Heavy-Orchestra pops selections

Twilight Programs I, II (Rodzinski)
Columbia ML 4311, 4337
Carnegie Pops II
Columbia ML 2
Victor Olof Orchestral Concert
London LLP 225

Showers of highs

Dukas, Sorcerer's Apprentice
London LPS 193 (10")
Ravel, La Valse
Capitol L-8145 (10")
Bartok, Deux Images for Orch.
Bartok 305 (10")
Bartok, Dance Suite for Orch.
Bartok 302 (10")
North, Filmusic from Streetcar Named Desire

Organ-with-bass

Bach, Pr. & Fugue in D flat,
Tocatta in F, etc. (Biggs)
Columbia ML 4097
Poulenc, Concerto, Organ & Strings;
Franck, Organ Music (Biggs)
Columbia ML 4329
Saint-Saëns, Symphony #3 with Organ
Columbia ML 4120

Impressively classic—brilliant

Bach, Brandenburg Concerto #4
Westminster WL 5067
Haydn, Symphonies #100, #95
Westminster WL 50-45

Modest classic—top recording

Haydn, Symphonies #43, #50
(Danish rec.)
Haydn Society HSLP 1041
Mozart, Sinfonia Concertante
Westminster WL 50-20
Mozart, Symphony #32
Capitol H-8131 (10")

Exotic—super-hi-fi

Varèse, Ionisation, etc.
EMS 401
Bartok, Music for Strings,
Percussion, Celesta
Capitol L-8048 (10")

Symphonic-ballet

Tchaikowsky, Swan Lake; Nutcracker.
Capitol P-8142
Stravinsky, Petrouchka
London LLP 130
Strauss, Also Sprach etc.
London LLP 232
Schubert, Symphony #7 (Walter)
Columbia ML 4093
Dvorak, Violin Concerto
RCA LM 1147
Beethoven, Symphony #7
London LLP 240

R-J Speaker At Audio Fair

First public showing of the new R-J speaker, described at length by Edward Tatnall Canby in the October issue of *AE*, will take place in Suite 501 at The Audio Fair.

Since Mr. Canby's article appeared, the R-J unit has been the subject of great anticipation throughout the audio industry. Frank Robbins and William Joseph, the speaker's designers, will be in attendance during the course of the Fair to conduct demonstrations.

There's a NEW SILHOUETTE
on the Broadcast Horizon . . .

THE NEW
**ULTRA-CARDIOID
DYNAMIC**



MODEL 556s
List Price \$100

The new "Small Broadcast" is approximately only half as large as the Standard Broadcast

SMALL
Broadcast
MICROPHONE

► Reduces pickup of random sound energy by 67%

► Solves problems of background noise, reverb, and room reflection

**BIG IMPROVEMENTS
HAVE BEEN MADE ON THIS
ALL NEW MICROPHONE!**



Model 556s
"Small Broadcast"

Cannon Electric-type Connector XL-3-11

Model 556s "Small Broadcast"
Code: RUDOV List Price \$100.00

Patented by Shure Brothers, Inc.

It is new on the inside as well as outside. This mighty, though little, Microphone is the *only* small-sized uni-directional moving-coil Broadcast-type Dynamic Microphone. The 556s "Broadcast" achieves new, extended high-fidelity response with an ultra-cardioid directional pattern. It is especially constructed to meet the requirements of radio and television broadcast studios, with close tolerances in frequency response and directivity.

The internal unit is based on the Shure-patented "Uniphase" principle. The moving-coil system has a high over-all efficiency and smooth extended frequency response. Large air-gap clearances and a rugged coil construction provide immunity of the moving coil system to abnormal atmospheric conditions and severe mechanical shocks. The 556s is provided with an additional isolation unit of live rubber construction and a built-in Cannon Connector.

The true uni-directional characteristics of the Model 556s provide an easy solution to the background noise and feedback problem in reverberant locations, facilitate orchestral placement, permit best utilization of space in small broadcast studios, and provide practically complete exclusion of unwanted noises.



SHURE BROTHERS, Inc. ★ MANUFACTURERS OF MICROPHONES AND ACOUSTIC DEVICES
225 W. Huron St., Chicago 10, Illinois ● Cable Address: SHUREMICRO

for the *Finest*
Listening Pleasure
 the new **ALTEC AM-FM TUNER**

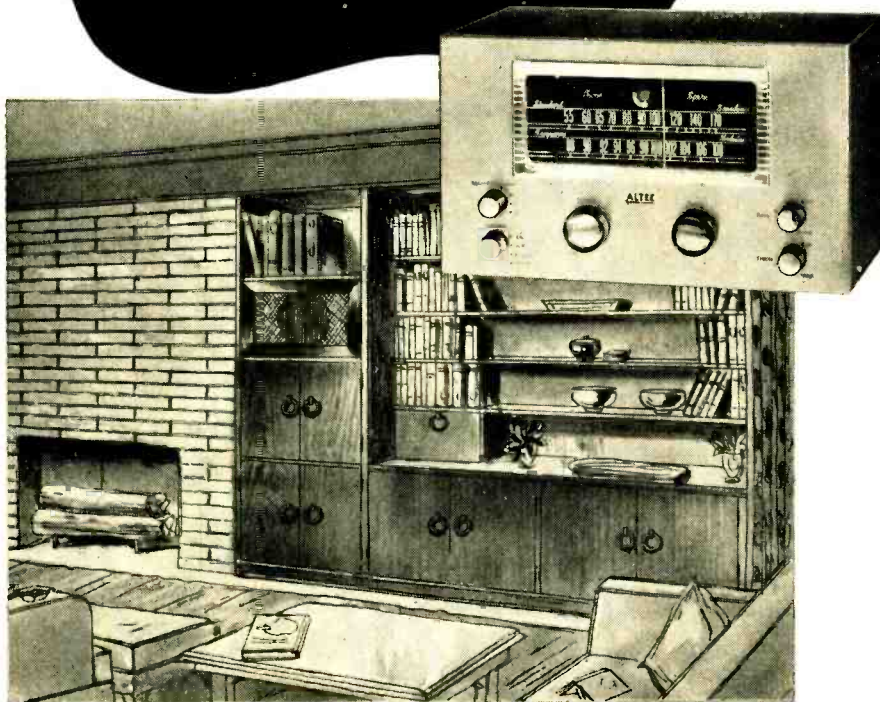

...better quality than ever before...higher sensitivity...greater selectivity... a really wide band super-het...new and better in every way. This new Altec tuner, finished in brushed brass, has FM and AM reception, a preamplifier for variable reluctance phonograph pickup and a spare input for television sound or a tape machine. There are controls for the selection of the proper record equalization and crossover, and separate controls for bass and treble variable rise and droop.

Since it now contains a built-in power supply, this new Altec tuner can be used with any quality amplifier. Of course, with the new Altec A-333A amplifier and the famous Altec 604B or 820A loudspeaker you can be sure of the finest sound reproduction possible.

ALTEC...always the finest!

9356 Santa Monica Blvd., Beverly Hills, Calif.
 161 Sixth Avenue, New York, New York



CONVENTION PROGRAM

[from page 32]

PARAMOUNT PICTURES LIGHT-WEIGHT MAGNETIC FILM RECORDING MACHINE

BRUCE H. DENNEY, *Paramount Pictures Corporation, Hollywood, California*

A light-weight magnetic film recording system having some revolutionary and unique features will be described. It contains all the facilities necessary for high-quality motion picture production recording, and still is compact, portable, and easy to maintain.

2:30 p.m.

SYNTHETIC REVERBERATION TECHNIQUES

LEWIS S. GOODFRIEND, *Audio Instrument Company, Inc., New York, N. Y.*

Several systems for generating synthetic reverberation have been proposed during the past fifteen years, but few of them are used in commercial installations. Only two types of instruments, meeting the basic design criteria, are being marketed on any scale. The criteria developed here are that the frequency range be at least half as wide as the usual program channel, and that the time delay be no longer than fifty milliseconds. The merits and faults of the various systems as applied to broadcast standards of life, maintenance, and reliability of service are also discussed.

3:00 p.m.

A MODERN RECORDING INSTALLATION THAT EMPHASIZES TAPE

W. OLIVER SUMMERLIN, *Audio-Video Recording Co., Inc., New York, N. Y.*

A detailed and illustrated description of the Audio-Video Recording Company's facilities which were recently designed and constructed by the author. The objectives of this particular installation are shown, as are the means taken to overcome the technical problems involved. The paper includes a description of the five diversified studios, control rooms with special consoles, private tape editing rooms, tape and disc mastering rooms, the unique multiple tape duplication equipment, and the facilities for film sound track recording.

3:30 p.m.

INJECTION MOLDING OF RECORDS

JAMES S. WILSON, *Bestway Products, Inc.*

The development of the injection molding process for phonograph records was first conceived to reduce the cost of manufacturing 6-inch children's discs. With the aid of the Bakelite Corporation, a special styrene has been formulated so it is now possible to mold microgroove discs which compare more than favorably with conventional compression-molded records. The advantages—aside from cost—are discussed, and a description of the molding operation is presented.

9:15 p.m. WABF BROADCAST

Grand Ballroom
 (Doors close at 9:05 p.m.)

AUDIO IN THE HOME

One of the series on this popular subject now being carried on FM station WABF on Friday nights, this half-hour broadcast offers the program's listeners an opportunity to discuss audio problems on the air.

SATURDAY, November 3, 1951

9:30 a.m. to 4:00 p.m.

Registration 5th and 6th Floor Foyers
 Exhibits open 5th and 6th Floors

10:00 a.m. Technical Session

HOME MUSIC SYSTEM EQUIPMENT

MELVIN C. SPRINKLE, *Chairman*

PERFORMANCE OF LOUDSPEAKER ENCLOSURES

DANIEL J. PLACH, *Jensen Manufacturing Company, Chicago, Illinois*

The low-frequency performance of a loudspeaker is shown to be critically dependent upon its acoustic load, and therefore, its acoustic environment. Factors that must be considered in the evaluation of performance at low frequencies are distortion, damping and frequency response. The use of a flat baffle or a total enclosure of adequate size makes possible good sound pressure response down to the resonant frequency of the loudspeaker. The use of the bass reflex principle makes possible improved performance with respect to distortion and response, since the port has no non-linear elements associated with it. The horn-loading enclosure is shown to be the logical choice where high efficiency combined with low distortion is important. Transient response also is greatly improved.

10:30 a.m.

THE R-J LOUDSPEAKER ENCLOSURE

FRANK ROBBINS and WILLIAM JOSEPH, *The R-J Company, New York*

Hardly larger than the fifteen-inch "woofers" it contains, this enclosure produces fundamental bass down to 20 cps. The back of the speaker is completely enclosed within a small stiff cavity. The front operates through an acoustic loading arrangement so that the speaker is loaded on both sides. Excellent damping and transient characteristics result. Modified Helmholtz theory is employed in design.

11:00 a.m.

CABINET DESIGN FOR RESIDENTIAL HIGH-FIDELITY SYSTEMS

JEFF MARKELL, *"New Horizons" Furniture, Inc., New York, N. Y.*

A discussion of cabinet-type enclosures as distinguished from built-in enclosures for high-fidelity systems. On the basis of a survey of existent components, a set of suggested minimum space allowances is offered which will be generally applicable. Placement of components is discussed from the point of view of both function and visual effect of the finished cabinet. Materials, construction, styling, and finish are considered in addition.

11:30 a.m.

SOUND DEMONSTRATION TECHNIQUES

R. D. DARRELL, *Chairman, AES Committee on Test and Demonstration Records*

The ultimate goal of audio-equipment design and construction is actual performance to listeners' satisfaction. Yet "display" operation is notoriously unable to command any degree of audience unanimity. The present paper is a "primer" approach to this complex problem and an attempt to develop more effective practical procedures. Limitations and potentialities of various specific types of demonstrations are discussed. The significant factors involved are tabulated and means suggested for coping with such non-engineering elements as psychology, musical aesthetics, environmental effects, and listeners' previous aural conditioning. Stress is laid on the importance of "first" impressions and of factors under some control by the demonstrator—either indirectly (as in the selection of program materials and their presentation sequence), or directly (as in manipulation of loudness levels, acoustic balances, and frequency-response characteristics).

Really Smooth—Outstandingly Quiet—Fully Dependable

MANY TYPES AVAILABLE FROM STOCK and through Shallcross parts distributors

Shallcross Precision ATTENUATORS

ALL STANDARD FIXED AND VARIABLE TYPES

LADDER AND BALANCED LADDER CONTROLS

"T" CONTROLS

BALANCED "H" CONTROLS

POTENTIOMETERS

VARIABLE IMPEDANCE MATCHING NETWORKS

V.U. METER RANGE EXTENDING ATTENUATORS

STANDARD AND SPECIAL FIXED PADS

SPECIAL NETWORKS

RESISTORS — INSTRUMENTS — SWITCHES — ATTENUATORS

Perhaps you've noticed how frequently Shallcross attenuators now appear in the finest audio or communications equipment? Or how often they are chosen for replacement purposes?

There's a reason! Improved design, materials and production techniques have resulted in a line that sets new, higher standards of attenuation performance for practically every audio and communications use.

Shallcross Attenuation Engineering Bulletin 4 gladly sent on request.

Shallcross Manufacturing Co.
Dept. A-111 Collingdale, Pa.

B&W Precise AUDIO TESTING

for designing, production checking,
research or "proof of performance"
FCC tests for broadcasters.

A low-distortion source of audio frequencies between 30 and 30,000 cycles. Self-contained power supply. Calibration accuracy $\pm 3\%$ of scale reading. Stability 1% or better. Frequency output flat within 1 db, 30 to 15,000 cycles.

MODEL 200 \$138



**AUDIO
OSCILLATOR**

For fundamentals from 30 to 15,000 cycles measuring harmonics to 45,000 cycles; as a volt and db meter from 30 to 45,000 cycles. Min. input for noise and distortion measurements .3 volts. Calibration: distortion measurements ± 5 db; voltage measurements $\pm 5\%$ of full scale at 1000 cycles.

MODEL 400 \$168



**DISTORTION
METER**

Combines RF detector and bridging transformer unit for use with any distortion meter. RF operating range: 400 kc to 30 mc. Single ended input impedance: 10,000 ohms. Bridging impedance: 6000 ohms with 1 db insertion loss. Frequency is flat from 20 to 50,000 cycles.

MODEL 404 \$85



**LINEAR
DETECTOR**

Speeds accurate analysis of audio circuits by providing a test signal for examining transient and frequency response . . . at a fraction of the cost of a square wave generator. Designed to be driven by an audio oscillator.

MODEL 250 \$10



**SINE WAVE
CLIPPER**

The instruments of laboratory accuracy

Bulletin AE-11 gives complete details

Barker & Williamson, Inc.
237 Fairfield Avenue • Upper Darby, Pa.

Audio Fair Exhibitors

THE ACOUSTICAL MFG. CO., LTD. 602

Huntingdon, Hunts., England
Products: Acoustical Corner Ribbon Loudspeaker; Acoustical Quad amplifier.

IN ATTENDANCE

J. B. Smyth M. D. Collier
P. J. Walker

ACRO PRODUCTS COMPANY 549

369 Shurs Lane, Philadelphia, Pa.
Products: Acrosound output transformers; Acrosound linear amplifier circuit.

IN ATTENDANCE

David Hafler Herbert I. Keroes
Daniel Greenfield

ALPHA WIRE CORPORATION 638

430 Broadway, New York 13, N. Y.
Products: Wire and cable.

IN ATTENDANCE

Peter Bercoe A. E. Bernadik
Samuel Schaeffer Howard B. Saltzman
Donald Rappaort Sidney Manners

ALTEC LANSING CORPORATION 618-619

161 Sixth Ave., New York 13, N. Y.
9356 Santa Monica Blvd., Beverly Hills, Calif.

Products: Power transformers and chokes; amplifier kits; broadcast type capacitor and dynamic microphones; high-quality audio amplifiers; preamplifiers and power amplifiers; loudspeakers; high-quality FM/AM radio tuner.

IN ATTENDANCE

H. S. Morris L. D. Netter
C. S. Perkins Red Pierce
Mel Sprinkle Marty Wolf
Jim Connally Al Byers
Tom Gullatin

AMPEX ELECTRIC CORPORATION 614-615

Redwood City, California
Products: High-quality portable, console, and rack mounted magnetic tape recording equipment.

IN ATTENDANCE

H. Johnston Kevin Mallen
C. E. Rynd R. O. Hudson
K. B. Boothe W. H. Hazlett
L. A. Wortman

AMPLIFIER CORP. OF AMERICA 532

396 Broadway, New York 7, N. Y.
Products: Magnetic tape recorders, high-fidelity phono amplifiers, electrical test equipment.

IN ATTENDANCE

N. M. Haynes R. Epstein
M. R. Ellis Sidney Karr
Frank Kosinski E. Heller
P. Marino H. Robbins

ARROW ELECTRONICS, INC. 650

82 Cortlandt St., New York 7, N. Y.
Products: Latest developments in audio equipment.

IN ATTENDANCE

Maurice Goldberg Charles Ray
Jack Kirschbaum Walter Steiges
Harold Weinberg

AUDAK COMPANY, INC. 629

500 Fifth Avenue, New York 18, N. Y.
Products: Electronic-acoustical apparatus.

IN ATTENDANCE

Maximilian Weil Geo. V. Sullivan
Al Weberg A. T. Adams

AUDIOM, INC. 641

Great Barrington, Mass.
Products: High-Fidelity Magazine; Radio Communication magazine; demonstration FAS audio system and other high-fidelity equipment.

IN ATTENDANCE

Charles Fowler Milton B. Sleeper
George Ball Priscilla Ball

AUDIO DEVICES, INC. 651

414 Madison Ave., New York 22, N. Y.
Products: Audiodiscs (recording discs); Audiopoints (recording and playback points); Audiotape (magnetic recording)

Audio Fair Exhibitors

tape); Audiofilm (magnetic recording film).

IN ATTENDANCE

William C. Speed Bryce Haynes
Herman Kornbrodt

AUDIO ENGINEERING SOCIETY 617

P. O. Box 12, Old Chelsea Sta., New York 11, N. Y.

IN ATTENDANCE

Officers and Governors of the Society.

THE AUDIO FAIR 627

342 Madison Ave., Rm. 920, New York 17, N. Y.

IN ATTENDANCE

Harry N. Reizes, *Fair Manager*

AUDIO INSTRUMENT CO., INC. 630

133 W. 14th St., New York 11, N. Y.
Products: Bridgers, Loggers, Disc-noise meters, Intermodulation sets, Intermodulation meters, Galvanometer protectors, Kellogg midjet condenser microphones, preamplifiers for condenser microphones, ultra-speed recording systems.

IN ATTENDANCE

C. J. LeBel F. M. Coate
Alan Block Lewis S. Goodfriend

THE AUDIO MASTER COMPANY 639

341 Madison Ave., New York 17, N. Y.
Products: Recording equipment, microphones, playback machines, miscellaneous audio equipment.

IN ATTENDANCE

Herbert Rosen Rose Weissman

AUDIO & VIDEO PRODUCTS CORPORATION 614-615

730 Fifth Ave., New York 19, N. Y.
Products: Complete line of high-quality audio components: Altec, Ampex, Cinema, EdiTall, Langevin, Lansing, Fairchild, McIntosh, Minnesota Mining & Mfg. Tapes, Teleflex, loudspeakers, amplifiers, equalizers, recorders, playbacks, pickups, etc.

IN ATTENDANCE

Charles E. Rynd Russell O. Hudson
Kenneth B. Boothe William Hazlett
Leon A. Wortman Jerry Kelly

A-V TAPE LIBRARIES, INC. 614-615

730 Fifth Ave., New York 19, N. Y.
Products: Tape recording and recording services; pre-recorded magnetic tape library of music.

IN ATTENDANCE

Percy L. Deutsch Joseph F. Hards
Leon A. Wortman

BELL SOUND SYSTEMS, INC. 524

555 Marion Road, Columbus 7, Ohio.
Products: High-fidelity amplifiers and tape recorders.

IN ATTENDANCE

F. W. Bell H. H. "Pete" Seay, Jr.
Ed Sisson Sandy Martin

BERLANT ASSOCIATES 529

4917 W. Jefferson Blvd., Los Angeles, Calif.

Products: Concertone tape recorder.

IN ATTENDANCE

Emmanuel Berlant Avery R. Fisher

DAVID BOGEN CO., INC. 646

663 Broadway, New York 12, N. Y.
Products: High-fidelity amplifiers and systems, high-fidelity cabinets and enclosures.

IN ATTENDANCE

Sidney Harman Mortimor Sumberg
David Pear

R. T. BOZAK 647

90 Montrose Ave., Buffalo 14, N. Y.
Products: Bozak quality loud speakers.

IN ATTENDANCE

R. T. Bozak

NOW THERE ARE 3

They do everything you want!

They make tough jobs easy!

E-V Slim-Trim DYNAMICS

for TV... Broadcasting... Recording... PA

... for wide range high fidelity response ... for fixed position or man-in-motion ... for ruggedness and versatility ... for exclusive Acoustalloy diaphragm ... for pop-proof pick-up indoors and outdoors

You see ... and hear ... the E-V Slim-Trim on network and local telecasts and broadcasts. You find it in studios and on remote hook-ups. You find it on important PA jobs, too. And you know it's there *because* it has met the most exacting tests ... *because* it serves so superbly in every way for voice and music. *First* in dynamic, it has features only *Electro-Voice* can provide. 3 models meet every need!

Ask your E-V Distributor or Send for Full Facts Now!

FOR TELECASTING-BROADCASTING

"655"—Response 40-15,000 c.p.s., ±2.5 db. Power rating -53. Omnidirectional. Changeable low impedance. Removable swivel. List \$200

"654"—Response 50-14,000 c.p.s., substantially flat. Power rating -55. Omnidirectional. 50-250 ohm impedance selector. Swivel head. List \$90

FOR PUBLIC ADDRESS

"636"—Response 60-13,000 c.p.s., substantially flat. Power rating -55. Omnidirectional. High or low impedance. Swivel head. List \$65

Electro-Voice

400 CARROLL ST. • BUCHANAN, MICHIGAN

Export: 13 E. 40th St., N.Y. 16, U.S.A. Cables: Arlab

MICROPHONES • PHONO-PICKUPS • HI-FI SPEAKERS • SELF-TUNING TV BOOSTERS





NO. BO-11

The new CHICAGO No. BO-11 output transformer is now being used effectively in 40 to 60 watt high-fidelity amplifiers with outstanding success. Designed particularly for use with 807's, 3C33's (dual triode), WE300's, 6AR6's and similar tubes. Frequency response is essentially flat—with in .5 db—from 20 to 20,000 cycles.

NEW CHICAGO

**40-60 WATT
FULL FREQUENCY
Output Transformer**

.5 db 20-20,000 CPS
for use with 807's,
3C33's, WE300's, 6AR6's
and similar type tubes

SPECIFICATIONS

Primary*—3000/2500 ohms CT
Secondary*—600/16/8 ohms CT and
150/4 ohms

*Split and balanced windings

Operating level—40 to 60 watts. Mounted in one-piece drawn steel case, 4 1/8" x 4 1/8" x 5 1/8" high; with mounting studs and convenient pin-type terminals. Weighs 9 1/2" pounds.

There's a CHICAGO Output Transformer for Every Full Frequency Use

Cat. No.	Application	Impedance	Max. Power
BO-1	Single Plate to line	Pri.—15,000 ohms at 0 to 10 ma d-c *Sec.—600/150 ohms CT.....	+20 dbm
†BO-4	P.P. Plates to line	Pri.—7,500 ohms CT *Sec.—600/150 ohms CT.....	+43 dbm
BO-5	P.P. Plates to line	Pri.—10,000 ohms CT *Sec.—600/150 ohms CT; 16/8/4 ohms.....	+37 dbm
†BO-6	P.P. Plates to voice coil	Pri.—7,500 ohms CT *Sec.—8/20 ohms.....	+43 dbm
BO-9	P.P. Plates to line or voice coil	Pri.—5,000/3,000 ohms CT *Sec.—600/16/8 ohms CT; 150/4 ohms.....	+42 dbm

†Tertiary winding provides 15% inverse feedback. *Split and balanced windings

**HIGH Q
CHOKES**

for Dynamic
Noise Suppression Circuits



Two precision-built chokes with inductance values of .8 and 2.4 henrys respectively—accurate to within ± 5% with up to 15 ma d-c. Units have a minimum Q of 20. Remarkably compact, 1 1/8" x 2 3/8" x 1 1/8".

No.	Inductance
NSI-1	.8 h
NSI-2	2.4 h

**Famous "Sealed in Steel"
New Equipment Line**

The units described above are typical of CT's New Equipment Line featuring transformer engineering that's ahead of the trends in circuit design. Get the full facts on the complete line now. Check the features, and you'll see why CT is called the "Engineer's Transformer." Check the prices; see how little more these advanced units cost over ordinary transformers.

Write for Complete "New Equipment" Catalog Today



CHICAGO TRANSFORMER

DIVISION OF ESSEX WIRE CORPORATION

3501 ADDISON STREET • CHICAGO 18, ILLINOIS



**Audio Fair
Exhibitors**

BRITISH INDUSTRIES CORP. 618-619

164 Duane St., New York 7, N. Y.
Products: Garrard record changers and phonograph motors, Wharfedale speakers, Vitavox speakers, Leak "Point One" amplifiers, KT66 tubes.

IN ATTENDANCE

Leonard Carduner Franklin Hoffman
Eugene Carduner Bill Lichter
Edward Kleeman James De Sio
William Carduner

BROCINER ELECTRONICS LABORATORY 540

1546 Second Ave., New York 28, N. Y.
Products: Dual-horn corner reproducer; Trio 3-channel corner reproducer; Ductflex coaxial speaker cabinet; phonograph pre-amplifier-equalizer; square-wave tester.

IN ATTENDANCE

Victor Brociner Robert Ellis

BROWNING LABORATORIES, INC. 645

750 Main St., Winchester, Mass.
Products: AM-FM tuners, audio amplifier.

IN ATTENDANCE

G. H. Browning R. L. Purrington
S. S. Egert Jack Fields
J. Mandel R. L. Gordon
P. Garfinkle

C & H WOODWORK CO. 511
(Cabinet Furniture Co.)

75 N. 11th St., Brooklyn 11, N. Y.
Products: Radio-phonograph and television cabinets.

IN ATTENDANCE

Sidney Herbstan George Getzels

COLLINS AUDIO PRODUCTS CO., INC. 539

Mountainside, N. J. (Mailing address—Westfield, N. J.)
Products: FM tuners, FM-AM tuners, FM tuner kit, Storecast receiver, miscellaneous small assemblies.

IN ATTENDANCE

W. H. Collins Herman Elste

COOK LABORATORIES 647

R 2, Stamford, Connecticut.
Products: Cook cutters, Cook feedback recording needs, Cook custom recording systems, "Sounds of Our Times" recordings.

IN ATTENDANCE

Emory Cook

COWAN PUBLISHING CORP. 627

67 W. 44th St., New York 18, N. Y.
Products: CQ, The Radio Amateur Journal, Radio-Television Service Dealer (Professional radio & TV man's journal).

IN ATTENDANCE

S. R. Cowan S. L. Marshall
O. P. Ferrell H. N. Reizes
S. L. Cahn

DANBY RADIO CORPORATION 549

100A S. 21st St., Philadelphia, Pa.
Products: Danby corner horn speaker systems, Danby custom amplifiers.

IN ATTENDANCE

Daniel K. Greenfield Herbert I. Keroes
David Hafler

THE DAVEN COMPANY 616

191 Central Ave., Newark 4, N. J.
Products: Attenuators; potentiometers; laboratory test equipment such as Transmission measuring sets, electronic voltmeter, output power meter, audio effects filters, RF & video components, resistors, switches, etc.

IN ATTENDANCE

Lewis Newnan K. K. Garrison
Richard J. Newnan J. P. Smith, Jr.
E. L. Grayson C. F. Scott

DUOTONE COMPANY, INC. 516

Keypoint, N. J.
Products: Magnetic recording tape, recording blanks, cutting sapphires, diamond

Audio Fair Exhibitors

replacement needles, phono accessories, phono needles, recording heads, and cueing devices.

IN ATTENDANCE

Stephen Nestor	Virginia Daniels
Paul Nichols	Perry Lohse
Carlos Auremia	Charles W. Pointent
Bob Sargeant	Walter Hustis
Herb Erickson	

ELECTRONIC WORKSHOP SALES CORP. 551

351 Bleecker St., New York 14, N. Y.
Products: Electronic Workshop Custom-Built radio-phonograph system; A-20-5 audio amplifier.

IN ATTENDANCE

Clifton M. Howard	Margaret Howard
Kenneth Wisner	Charles B. Graham
Edward Tatnall Canby	Milton D. Solomon
Ray Prohaska	

ELECTRO-VOICE, INC. 626

Buchanan, Michigan.
Products: Microphones, pickups, cartridges, loudspeakers, loudspeaker cabinets and enclosures, components, and TV boosters.

IN ATTENDANCE

A. R. Kahn	H. T. Souther
W. F. Soules	J. E. Willson

FEDERATED PURCHASER, INC. 543

66 Dey St., New York 7, N. Y.
Products: The newest audio equipment, including amplifiers, tuners, speakers, recorders, changers, and fine audio accessories.

IN ATTENDANCE

Max Epstein	Bill Kornhauser
John B. Patterson	Ed Hanson
Bassile Gurra	Jack Greenspan
Dan Seymour	

FISHER RADIO CORP. 529

41 E. 47th St., New York 17, N. Y.
Products: Concertone tape recorder; Fisher high-quality preamplifier, Model PR-4; Fisher high-quality receivers and amplifiers.

IN ATTENDANCE

James J. Parks	Avery R. Fisher
William Sailer	E. Berlant
Virginia Abbott	Harlan Thompson

GENERAL ELECTRIC COMPANY 531

Electronics Park, Syracuse, N. Y.
Products: Cartridges, loudspeakers, preamplifiers, tonearms, phono accessories.

IN ATTENDANCE

E. A. Malling	T. J. Nicholson
Mark Woodworth	P. E. Humphreys
R. Dally	

GRAY RESEARCH AND DEVELOPMENT CO. 550

16 Arbor St., Hartford, Conn.
Products: Gray transcription equipment.

IN ATTENDANCE

W. E. Ditmars	Richard E. Mathes
Chester B. Hayes	Chester A. Snow

HARRISON RADIO CORP. 523

225 Greenwich St., New York 7, N. Y.
Products: Wide-range music systems for the home, and components.

IN ATTENDANCE

Ben Pinz	Bil Harrison
Charlie Sarneck	Ben Snyder
Bert Schreiner	Jay Snyder
Eddy Beale	Herb Spingeld

H. A. HARTLEY CO., LTD. 533

152 Hammersmith Road, London W.6, England
Products: Hartley-Turner 215 Speaker, True-Bass Baffle (non-resonant box baffle), tone control preamplifier, 20-watt amplifier, audio components, and Selected Record Catalogue; pickups and phonograph motors, British 78 r.p.m. and LP records.

IN ATTENDANCE

H. A. Hartley, *Managing Director*

COME ON-A MY HOUSE!*

***ROOM 631 — AUDIO FAIR**

*We're not gon-na give you
apples or plums
or chewing gums*

*We're not gonna give you
anything
except*

a sight for your eyes...

Come on-a my house and SEE

AUDIO-COLOR

Won't you be our guest?



If you want to hear the very finest in Sound Equipment, visit Harvey's AUDIO-Torium... one of the most outstanding Sound Rooms in the country, featuring all of the top brands in the industry.

Telephone **hrc** LUxemburg 2-1500

HARVEY

RADIO COMPANY, INC.
103 West 43rd St., New York 18, N. Y.

For a Glorious
BIG TONE

ON ANY STRINGED INSTRUMENT

specify the Genuine

AMPERITE "KONTAK MIKE"

THE ONLY NO-DISTORTION "KONTAK MIKE"

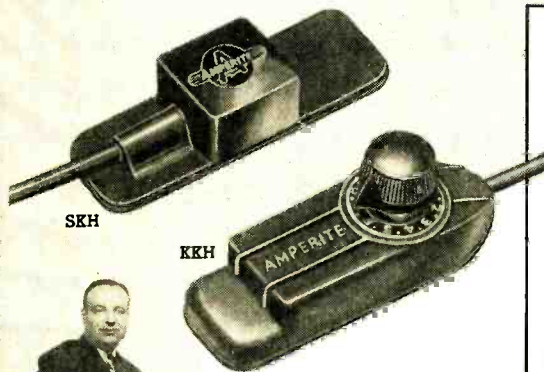

Anthony Antone, widely known as "the most versatile artist of the frets", is an enthusiastic user of Amperite Kontakt Mikes.

Used with most amplifiers, including most electric guitar amps.

No changes in amplifier, instrument, or strings. Attached without tools.

The Amperite "Kontak Mike" improves the tone and volume of any Stringed or Fretted Instrument — also Pianos, Accordions, Harmonicas, etc. It is the only "Kontak Mike" that does not introduce peaks or distortion.

Model SKH, hi-imp List \$12.00

Model KKH
(with hand volume control) List \$18.00

**AMPERITE
STUDIO MICROPHONES
at P. A. PRICES!**

Ideal for **CLOSE TALKING
or DISTANT PICKUP**

You can shout right into it, or stand away; in either case, the quality will be perfectly natural.

Model RBLG (200 ohms) List \$42.00
Model RBHG (hi-imp) List \$42.00



**AMPERITE CAROID
DYNAMIC MICROPHONE**

Models PGH-PGL List \$32.00

AMPERITE Company, Inc.

561 Broadway • New York 12, N. Y.

In Canada: Atlas Radio Corp., Ltd., 560 King St., W., Toronto 28

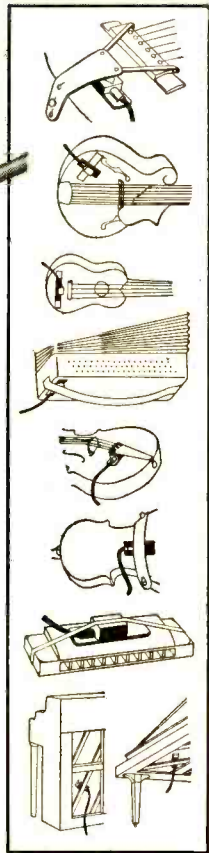

SPECIAL OFFER:
Write for Introductory Offer, and 4-page Microphone Folder S3-M.

**Audio Fair
Exhibitors**

HARVEY RADIO CO., INC. 631

103 W. 43rd St., New York 18, N. Y.
Products: High-quality music and sound reproducing equipment, tape recorders, microphones, turntables, amplifiers, reproducers, speakers, speaker enclosures, tapes, and allied equipment.

IN ATTENDANCE

Harvey E. Sampson Sam Findling
Roy Neusch George Zarrin
Anton Schmidt Gil Demsky
Leo Spizer

**HUDSON RADIO & TELEVISION
CORP.** 634-635

48 W. 48th St., New York 19, N. Y.
Products: All standard makes of high-fidelity equipment.

IN ATTENDANCE

Carl Carlson Adolph Gross
Lester Klein Sol Baxt

GATES RADIO COMPANY 542

Quincy, Illinois
Products: Broadcast station speech input equipment and accessories, amplifiers, etc.

IN ATTENDANCE

Fred O. Grimwood Norbert Yochem
Owen W. McReynolds Larry Cervonne

ISLAND RADIO DISTRIBUTORS, INC. 608

412 Fulton Ave., Hempstead, N. Y.
Products: Equipment of all major audio manufacturers.

IN ATTENDANCE

Jack Bussler Max Barnett
Gilbert E. Miller

**JENSEN MANUFACTURING
COMPANY** 518-519

6601 S. Laramie Ave., Chicago 38, Ill.
Products: Loudspeakers and accessories.

IN ATTENDANCE

Charles A. Hansen Karl Kramer
Horace L. White

**LAFAYETTE RADIO (RADIO-WIRE-
TELEVISION)** 643

100 Sixth Ave., New York 13, N. Y.
Products: High-fidelity tuners, amplifiers, speakers, and associated equipment.

IN ATTENDANCE

W. Rivkin Herman Holstein
J. B. Schocken J. A. Wohl
D. Scott M. Goyet

LANGVIN MANUFACTURING CORP. 530

37 W. 65th St., New York 23, N. Y.
Products: Amplifiers, power supplies, transformers.

IN ATTENDANCE

Donald S. Morgan George V. Rosenquist
Myron R. Coe Frederick K. Hankinson
Robert Winston Edward Sokolowski

JAMES B. LANSING SOUND INC. 604-605-606

2439 Fletcher Drive, Los Angeles, Calif.
Products: Speakers of quality.

IN ATTENDANCE

Leonard Larson Harry Miller

LEONARD RADIO, INC. 536

69 Cortlandt St., New York 7, N. Y.
Products: Complete high-fidelity audio equipment, components, and accessories.

IN ATTENDANCE

Sidney Schugar Arthur A. Priest
Norman Sanders Ellis Rosen

MAGNECORD, INC. 604-605-606

360 N. Michigan Ave., Chicago 1, Ill.
Products: Magnecord professional tape recording equipment, with all series of equipment, new models, accessories, and developments.

IN ATTENDANCE

C. G. Barker Otto Bixler
John S. Boyers Richard McQueen
John Hines

Audio Fair Exhibitors

MARK SIMPSON MFG. CO., INC. 603

32-28 49th St., Long Island City 3, N. Y.
Products: Magnetic tape recorders, transcription players, high-fidelity amplifiers, sound systems.

IN ATTENDANCE

Mark Simpson Miryam Simpson
 David Libsohn G. Leonard Werner
 Sale Naechtigall Henry Berlin

McINTOSH ENGINEERING LABORATORY 604-605-606

320 Water St., Binghamton, New York
Products: High-fidelity audio amplifiers.

IN ATTENDANCE

Frank McIntosh

MEASUREMENTS CORP. 527

Boonton, New Jersey
Products: Electronic test equipment: intermodulation meters, pulse generators, square-wave generators, standard signal generators, television signal generators, UHF radio noise & field strength meter, peak voltmeters, R.F. attenuators, megacycle meters, vacuum-tube voltmeters, special test instruments.

IN ATTENDANCE

H. W. Houek John M. Van Beuren
 Jerry B. Minter Nelson C. Doland, Jr.
 Edgar M. Weed John H. Redington

THE M.S.S. RECORDING CO. LTD. 602

Poyle Close, Colnbrook, Bucks., England
Products: M.S.S. Recorders (tape and disc) and discs.

IN ATTENDANCE

J. B. Smyth M. D. Collier
 P. J. Walker

OHIO STATE UNIVERSITY 547

Acoustics Dept., Columbus, Ohio
Products: Research and education; pulse-type audiometry and audiometers.

IN ATTENDANCE

Professor J. W. Black

PERMOFLUX CORP. 640

4900 W. Grand Ave., Chicago 39, Ill.
Products: Loudspeakers, dynamic headphones.

IN ATTENDANCE

L. M. Heineman Ray R. Hutmacher
 R. S. Fenton

PFANSTIEHL CHEMICAL COMPANY 620

104 Lake View Ave., Waukegan, Ill.
Products: Strain-sensitive phonograph pickup and related accessories, preamplifiers, tonearms, cartridge holders, needles, etc.

IN ATTENDANCE

Robert S. John S. George Sands
 Bruce Wight

PICKERING AND COMPANY, INC. 624-625

Oceanside, N. Y.
Products: Phonograph pickups, audio amplifiers, audio equalizers, pickup arms, loudspeakers.

IN ATTENDANCE

Walter O. Stanton George P. Petetin

PRESTO RECORDING CORPORATION 612

P. O. Box 500, Hackensack, N. J.
Products: Disc and tape recording and transcription equipment, amplifiers, and blank recording discs.

IN ATTENDANCE

George Saliba Thomas H. Aldrich
 M. M. Gruber Austin Sholes

RADIO CORPORATION OF AMERICA 632-633

Victor Division,
 Front & Cooper Sts., Camden 2, N. Y.
Products: 16-mm sound projectors (including the new 16-mm magnetic sound projector); speakers, amplifiers, broadcast audio equipment, studio turntable, tape recorder, microphones, LC-1A loudspeakers.

It's fun
 to be an
**AUDIO-
 PHILE!**



And HIGH-FIDELITY helps to make it more so, for this is the special magazine edited for people who enjoy fine musical entertainment at home.



MOST FOR YOUR MONEY: If you are planning your first hi-fi FM-phonograph installation, be sure to read the feature article: "Budget Your High Fidelity." It explains how to make a well-balanced selection in choosing your amplifier, turntable, pickup, and loudspeaker, so as to get maximum performance for whatever amount you plan to spend. (16 pages, 21 illustrations)

ABOUT TAPE RECORDING: With the new tape equipment, you can become a recording expert in a single evening. In your own home, you can make amazingly realistic recordings of everything from family conversations to instrumental music and singing, or make your own programs from radio shows (omitting commercials) by connecting the recorder to your radio receiver. (12 pages, 19 illustrations)



DECORATIVE APPEARANCE: When you walk in with an armful of hi-fi gear, if your wife greets you with, "Don't take that junk in the living room," get out HIGH-FIDELITY Magazine, and show her all the pictures of attractive installations in fine homes. Win her enthusiastic approval by getting her to help you plan a really beautiful FM-phonograph installation. (16 illustrations)

CHOOSING RECORDS: Maybe you like to sweat it out in music-shop listening booths, but you can save time, keep cool, and get a world of help in building your record library from "Schubert on Records," "Tops for the Juke Box," "The Music Between," and "Records in Review," by such leading critics and commentators as C. G. Burke, Carl Eaton, Edward Merritt, Jr., and John Indcox. (18 pages)



HIGH-FIDELITY is a big magazine, 8 3/4 x 11 5/8 inches, handsomely illustrated, with nearly 100 photos and drawings, and beautifully printed on fine paper. It is published quarterly in September, November, February and April.



High Fidelity

FOR PEOPLE WHO ENJOY FINE
 MUSICAL ENTERTAINMENT AT HOME

Published by Milton B. Sleeper

Check here if you want your subscription to start with the Summer Issue, a few copies of which are still available.

Mr. Charles Fowler, Editor, High-Fidelity
 24 Audio Bldg., Great Barrington, Mass.
 Please enter my subscription to High-Fidelity:
 \$6.00 for three years (SAVE \$6.00)
 \$3.00 for one year (SAVE \$1.00)

Name.....
 Address.....
 Add 50¢ per year in Canada, \$1.00 foreign

Floating Action!

for all TV Cameras

"BALANCED" TV TRIPOD

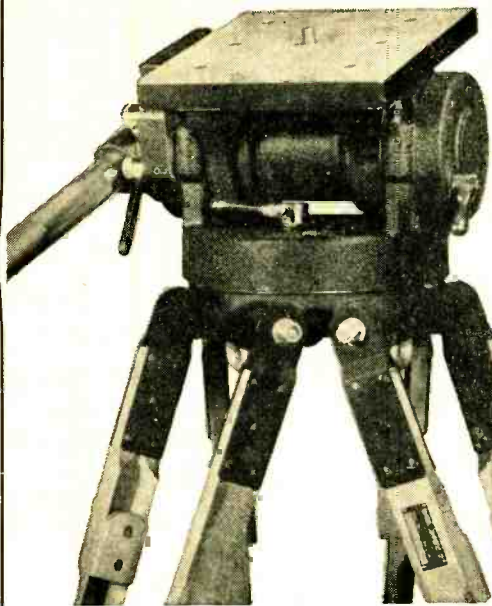

This tripod was engineered and designed expressly to meet all video camera requirements.

Previous concepts of gyro and friction type design have been discarded to achieve absolute balance, effortless operation, super-smooth tilt and pan action, dependability, ruggedness & efficiency.

Below:
3 wheel portable dolly with balanced TV Tripod mounted.

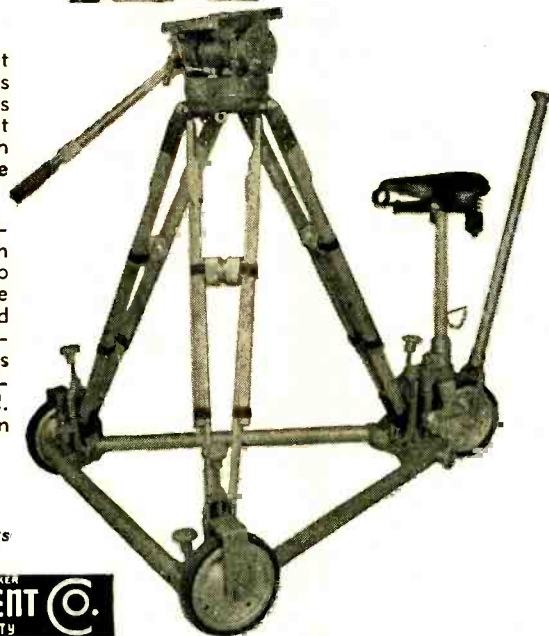

Complete 360° pan without ragged or jerky movement is accomplished with effortless control. It is impossible to get anything but perfectly smooth pan and tilt action with the "BALANCED" TV Tripod.

Quick-release pan handle adjustment locks into position desired by operator with no "play" between pan handle and tripod head. Tripod head mechanism is rustproof, completely enclosed, never requires adjustments cleaning or lubrication. Built-in spirit level. Telescoping extension pan handle.

Write for further particulars



THE NEWEST **AMPEX** MAGNETIC TAPE EQUIPMENT
IS BEING DEMONSTRATED AT THE AUDIO FAIR!

Rooms 614 & 615



Audio & Video

PRODUCTS CORPORATION

730 Fifth Avenue, New York 19, N.Y. • Plaza 7-3091

Exhibiting at the Audio Fair — Rooms 614 & 615

Audio Fair Exhibitors

IN ATTENDANCE

Radio Corporation of America (Cont'd.)

J. P. Taylor	Julius Haber
C. M. Lewis	W. O. Hadlock
L. T. LaPatka	W. L. Lawrence
L. LeKashman	A. K. Ward
R. H. Hooper	D. R. Deakins

THE RADIO CRAFTSMEN, INC. 521

4401 N. Ravenswood Ave., Chicago 40, Ill.

Products: AM-FM tuners, amplifiers, television tuners, complete television chassis.

IN ATTENDANCE

John H. Cashman Edward S. Miller
Howard J. Christianson

RADIO AND TELEVISION NEWS 515

RADIO-ELECTRONIC ENGINEERING
366 Madison Ave., New York 17, N. Y.

IN ATTENDANCE

Oliver Road	Wm. A. Stocklin
Harold Becker	Harold Kenne
Murray Goldman	Leonard L. Osten
W. Stanton Butler	Jerome Jacobs

RADIO MAGAZINES, INC. 627 & Foyer

342 Madison Ave., New York 17, N. Y.
Publishers of AUDIO ENGINEERING and the AUDIO ANTHOLOGY.

IN ATTENDANCE

C. G. McProud	D. S. Potts
Ladd Haystead	Harrie K. Richardson
Sanford L. Cahn	Harry N. Reizes
Sanford R. Cowan	

RADIO MUSIC CORP. 520

Port Chester, New York
Products: Pickups, broadcast reproducers, amplifiers, turntables, and pulse transformers.

IN ATTENDANCE

Lionel C. Cornwell, Pres.
J. Giannucci, Vice-Pres.
Harold Lown, Foreman

RANGERTONE, INC. 621

73 Winthrop St., Newark 4, N. J.
Products: Synchronous magnetic tape recorders.

IN ATTENDANCE

Col. R. H. Ranger	P. M. Brubaker
A. V. Colabella	C. H. Wirth
H. Gallina	J. Brett
W. Braun	

REEVES SOUNDCRAFT CORP. 546

10 E. 52nd St., New York 22, N. Y.
Products: Soundcraft blank recording discs, magnetic recording tape, and magnetic recording film "Magnastripe."

IN ATTENDANCE

Don E. Ward William H. Deacy
David Ruark

REK-O-KUT COMPANY 636-637

38-01 Queens Blvd., Long Island City 1, N. Y.

Products: Challenger recorders, Rhythmaster variable speed phonographs, Recitalist 3-speed phonographs, 16" cutting mechanisms, transcription and recording turntables, record players.

IN ATTENDANCE

George Silber Sydney Simonson
Fred Moulin

"THE REPRESENTATIVES" 528

New York Chapter, New York
Products: "Representatives" Hospitality.

IN ATTENDANCE

New York Chapter "Reps."

HERMON HOSMER SCOTT, INC. 628

385 Putnam Ave., Cambridge 39, Mass.
Products: High-fidelity amplifiers; laboratory amplifiers; Dynaural amplifiers, noise suppressors, converters, and preamplifiers; equalizer-preamplifiers; sound level meters; vibration meters; noise generators; miscellaneous high fidelity and laboratory equipment.

IN ATTENDANCE

H. H. Scott
D. R. von Recklinghausen
Victor H. Pomper
Edmund G. Dyett, Jr.

Audio Fair Exhibitors

J. B. SMYTH 602

3440 Schute, Montreal, Canada
Products: Acoustical Quad amplifier; Acoustical corner ribbon loudspeaker; M.S.S. tape and disc recorders and discs; Wirek portable tape recorders.

IN ATTENDANCE

J. B. Smyth M. D. Collier
 P. J. Walker

SONOCRAFT CORP. 623

115 W. 45th St., New York 19, N. Y.
Products: Sound and recording equipment and accessories—tape, disc, and wire—professional, industrial, and educational; transcription players.

IN ATTENDANCE

Herbert H. Borchardt
 Gerhard M. Behrendt
 Elton Nachman
 Joe Gschaar
 Harold H. Oppenheimer
 Fred M. Lissa
 Bert Gedzelman

STEPHENS MANUFACTURING CORPORATION 642

8538 Warner Drive, Culver City, Calif.
Products: Loudspeakers, microphones, speaker systems and components.

IN ATTENDANCE

Robert L. Stephens Frank H. Gilbert

SUN RADIO & ELECTRONICS CO. INC. 601

122-124 Duane St., New York 7, N. Y.
Products: Loudspeaker systems featuring the following: Altec Lansing, Sun Radio, Stephens Trusonic, Electro-Voice, Tannoy, Acoustical, Jim Lausning.

IN ATTENDANCE

Samuel Schwartz	Samuel N. Gerard
Irving Greene	Robert Smith
Irving Hodas	Carrol Hobart
Morris Brown	Joseph Greenfield
Ozzie Reiter	Walter Zuckerman
Al Goldberg	Arthur Liebschutz
Charles Matluck	George Ortiz
Sam Abrams	Joseph Schwartz
Joseph Kroll	

TECH LABORATORIES, INC. 609

Bergen & Edsall Blvds., Palisades Park, N. J.
Products: Attenuators, potentiometers, switches, bridges, precision attenuators, reverberation generator, and EdiTall tape splicing block.

IN ATTENDANCE

M. Bjordal	E. Bjordal
G. Van Baaren	G. D. Harris
H. Kovarik	W. Richards

TERMINAL RADIO CORPORATION 526

85 Cortlandt St., New York 7, N. Y.
Products: Latest and best high-quality audio equipment and components, comprising amplifiers, loudspeakers, record players and changers, pickups, tone arms, pre-amplifiers and equalizers, styli, speaker housings and enclosures, and other quality audio accessories.

IN ATTENDANCE

Robert Corenthal	Jack Simon
Maury Freeman	Irwin Levy
Nat Sinreich	

THE TETRAD CORPORATION 622

62 St. Mary St., Yonkers, N. Y.
Products: Diamond phonograph needles and other audio manufacturers' products utilizing diamond styli.

IN ATTENDANCE

Morton V. Marcus	Edward Weinberger
Emanuel J. Marcus	Edward P. Delaney
Jeanne M. Axelrod	

TRIAD TRANSFORMER MFG. CO. 607

2254 Sepulveda Blvd., Los Angeles, Calif.
Products: Transformers, reactors, and hermetic terminals; toroidal coils, high-fidelity amplifier kit.

IN ATTENDANCE

L. W. Howard	Ernest Clover
George Clark	Harry Miller
Bob Finlay	Dan Greene

Announcing

ADVANCED SERIES 400 RECORDERS

MODEL 400-A

with
 Half-Track Head

MODEL 401-A

with
 Full-Track Head

15 & 7 1/2
 Inches Per Sec.

Full REMOTE CONTROL

Solenoid operated mechanisms for all mechanical motions.



Simultaneous
 ERASE
 RECORD
 PLAYBACK

also Featuring

- **UNIFORM RESPONSE** . . . to 15,000 cps at 7 1/2 ins. per sec.
- **LOW NOISE & DISTORTION LEVEL** . . . signal-to-noise ratio over 55 db at either tape speed (as defined by NARTB).
- **PUSH BUTTON OPERATION**
- **LONG LIFE** . . . precision built.
- **LOW MAINTENANCE** . . . even with continuous use.



4 to 1 TAPE SAVING

The valuable tape saving ability of Series 400 Recorders is clearly illustrated above — the young lady holds four reels which contain the identical program formerly requiring the sixteen reels shown on table. No other recorder can give this remarkable tape saving because no other recorder is capable of 15,000 cycle performance at 7 1/2 ins. per sec., on but half the width of the tape!

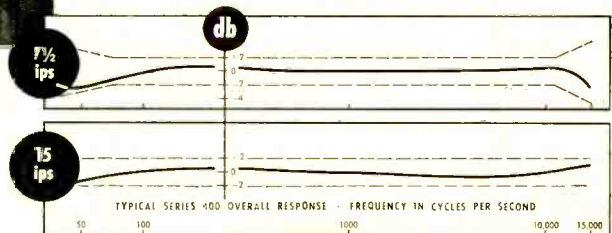

PORTABLE IN SINGLE CASE or for RACK MOUNTING

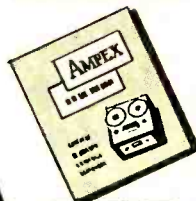

ASK FOR BULLETIN A-211

... gives complete description and specifications of the Series 400 Ampex Magnetic Tape Recorders.

AMPEX Magnetic RECORDERS



AMPEX ELECTRIC CORPORATION
 Redwood City, California

Distributors in Principal Cities

**Today's Popular Priced
Fast Selling
Hi-Fidelity
AMPLIFIER**

Model 2122A-R

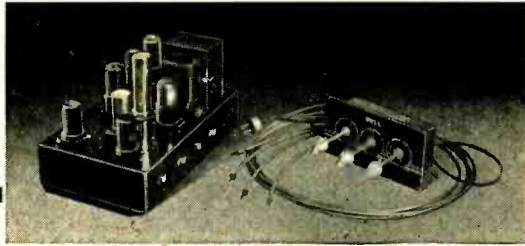

Expressly designed for music lovers—for any type built-in or custom job—who are seeking a medium priced, high quality, high fidelity amplifier. In addition to having inputs for a radio tuner and any Crystal pickup, it contains two special inputs for the new type Magnetic pickups. Built-in pre-amplifiers and individual equalization of each of these Magnetic in-

puts assures proper match and response. Bass and Treble boost, plus attenuation, makes it possible for the operator to adjust the tone to his most exacting tastes. Adjustable output impedance permits proper matching to most types of speakers. Model also available without remote controls. Write today for bulletin.



BELL SOUND SYSTEMS, INC.

599 Marion Road, Columbus 7, Ohio
Export Office: 4900 Euclid Avenue, Cleveland 3, Ohio

**OVER 9000 COPIES SOLD
AND STILL GOING STRONG!**

**audio
anthology**

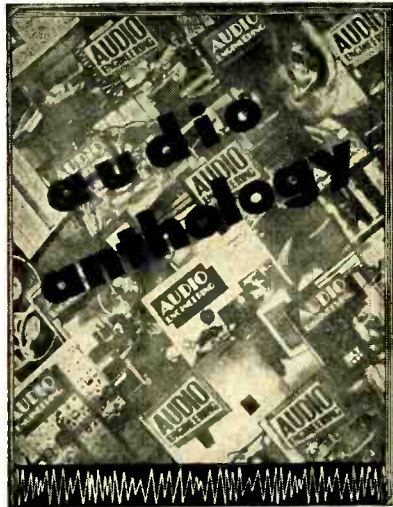

Paper cover . . . \$2.00

Distributors write for quantity discount

The long awaited compilation of reprints from early issues of **AUDIO ENGINEERING**, most of which are unobtainable.

Contains 37 articles on the following subjects:

- Amplifiers
- Speakers
- Noise Suppressors
- Phonograph Equipment
- Tone and Loudness Controls
- Dividing Networks

These articles have been of great interest to readers of **AUDIO ENGINEERING** over the past three years. Assembled in one volume, they comprise the most authoritative reference work for the audio hobbyist.

-CUT OUT-MAIL TODAY-

Book Division, Dept. A9
Radio Magazines, Inc.
342 Madison Ave., New York 17, N. Y.

Sirs: Enclosed is my check money order for _____ copies of the Audio Anthology.

Name (print carefully)
Address
City Zone State

**Audio Fair
Exhibitors**

UNIVERSITY LOUDSPEAKERS, INC. 611

80 S. Kensico Ave., White Plains, N. Y.
Products: 1-way, 2-way, and 3-way high-fidelity speaker systems which may be constructed by the audio enthusiast at unusually low cost; public address speakers of all types.

IN ATTENDANCE

Irving Golin Larry Epstein
Bob Reiss Saul White
Sidney Levy Abe Cohen
Arthur Blumenfeld Seymour Blumenfeld

**U. S. NAVAL SCHOOL OF AVIATION
MEDICINE** 547

Acoustic Laboratory
Naval Air Station, Pensacola, Florida
Products: Audiometric research, pulse type, relative to hearing losses due to noises; Audiography.

IN ATTENDANCE

Professor J. W. Black

UNITED TRANSFORMER COMPANY 522

150 Varick St., New York 13, N. Y.
Products: Transformers, amplifiers, kits, and filters.

IN ATTENDANCE

S. L. Baraf Bob Mitchell
Joe Barecca S. Mannville
Hank Russell Ted Craig

WAVEFORMS, INC. 552-553

333 Sixth Ave., New York 14, N. Y.
Products: High-fidelity amplifiers, audio oscillators, tuners, education equipment, horn-loaded speaker enclosure.

IN ATTENDANCE

Howard T. Sterling Ben Bell
W. W. Chamberlin George Shapiro
Edgar Judefind

WEATHERS INDUSTRIES 541

510 Richey Ave., W. Collingswood, N. J.
Products: Wide-range FM pickup, high-quality audio system.

IN ATTENDANCE

Paul Weathers

New Lenkurt Executive



Wallace R. MacGregor, formerly common-carrier engineer on the staff of the FCC, has joined Lenkurt Electric Sales Co. to handle government sales for carrier telephone and telegraph systems. His immediate function is management of two new branch offices in Washington, D.C. and Monmouth County, N. J.

LETTERS

[from page 10]

tially negated by the greater value of hearing sensitivity at this frequency.

Victor Brociner,
Brociner Electronics Laboratory,
1546 Second Avenue,
New York 28, N. Y.

The "Wanted" Department

Sir:

Here is an outstanding example of "what I don't know about it would fill a book." I would like to see some good down-to-earth expositions, complete with curves and 'scope traces, on the following subjects. Possibly some other non-engineer readers would, too.

Square-Wave Analysis—You design an amplifier that is flat as a board from 20 to 20,000 cps, has graceful overload characteristics, etc., and then you put a 10,000-cps square wave through it and come face to face with the facts of life. You see either a slanted leading edge due to slow rise time or a fast rise time with overshoot; you see damped oscillations starting at the leading corner and superimposed on part of the top of the square (?) wave, or undamped oscillations across the entire top; you see any number of strange phenomena. Now, what do you do?

FM Quality—What is the relative quality of the various types of FM "detectors" from the standpoint of frequency response, IM and harmonic distortion, and what parameters affect them?

A.F. Filters—High-pass, low-pass, and rejection filters are useful for various types of measurements. For those without professional equipment, how can we make them, how should we use them, what about terminations, etc.

Feedback—There seems to be considerable information (or misinformation) on this subject, particularly by the "as much as it will stand" school. What effect does feedback have on stages ahead of those included in the feedback loop? How do we apply both current and voltage feedback over a single stage, and what would happen if we did? What values of feedback resistors should be used with voltage-feedback stages in comparison with the plate and following-grid resistors? How should we use RC networks in a feedback loop for frequency corrections, including the necessary cautions, values, curves, etc.

Miscellaneous—What are the advantages and methods of cross-neutralizing in audio amplifiers? How do we determine what value of cathode resistor is correct with different values of load and following-grid resistors? Is there a nomograph for this? The whole subject of operating tubes under other than published conditions should be explored.

And so it goes, but I'd better sign off before you suggest that I switch to some other activity where my ignorance is not quite so abysmal.

Charles M. Schaefer,
433 Oakridge Avenue,
North Plainfield, N. J.

(We accept the challenge. We will get some of this material, just for you. And if anyone else wants to read it, he may do so. Ed.)

WHEN QUALITY OF RECORD REPRODUCTION IS ALL-IMPORTANT SPECIFY ASTATIC'S

CAC-J CRYSTAL CARTRIDGES

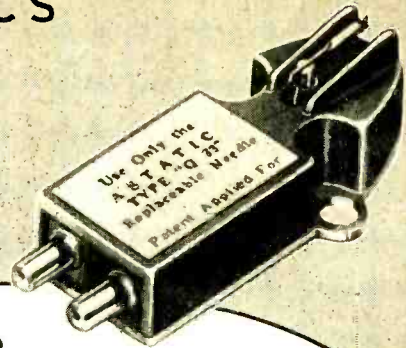

SOME FOLKS are just plain critics . . . others are super-critical in the sense

that they have to have the best there is, no matter what . . . and still others want the best in record playing equipment merely because they can't stand serious music served up any other way.

Regardless of which type they are, you are bound to please the fussiest with Astatic's CAC-J Crystal Cartridge. This is the cartridge which has been so highly praised in print by professional critics. Astatic developed the CAC-J in conjunction with the Engineering Research and Development Department of CBS to match the recording characteristics of LP records. Output is approximately 0.6 volt at 1000 c.p.s. on Columbia No. 103 test record, 1.0 volt on RCA 12-5-31-V test record. The resulting performance quality . . . with equal fidelity on either 33 $\frac{1}{3}$ or 45 RPM records, truly sets today's standard of perfection.

ALSO AVAILABLE IN MODEL FOR 78 RPM RECORDS

Model CAC-78-J has 3-mil needle for 78 RPM records, incorporates the same engineering advancements, and offers the same performance superiority of the CAC-J.



NOTE: Both CAC models are available with Diamond as well as Sapphire styli.

THE
Astatic
ASTATIC CORPORATION
CONNEAUT, OHIO
IN CANADA: CANADIAN ASTATIC LTD., TORONTO, ONTARIO

Astatic Crystal Devices manufactured under Brush Development Co. patents.

NEW PRODUCTS

● **Transmission Measuring Set.** Designed essentially for the measurement of voice transmission systems, the new Daven Type 12A transmission measuring set is an a.c. operated, rack-mounted instrument equipped with d.c. blocking capacitors in source output and receive input circuits to prevent interference with operation of dial telephone equipment. Output impedance is 600 ohms resistive with level adjustment from +10 to -35 db in 1 db

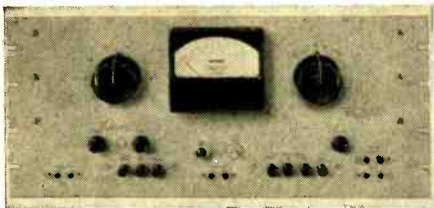

steps. Distortion and noise out are approximately 45 db below signal level and are held at a constant ratio irrespective of output level. Controls permit adjustment of 1000-cps oscillator frequency ± 30 cps. The receive section of the 12A consists of a high-gain wide-range amplifier whose range is variable from +20 to -60 db at full scale meter reading in steps of 10 db. By utilizing the meter scale the range is extended to -80 db. Two balanced inputs are provided, 600 ohms terminating and 600 ohms bridging. The Daven Company, 191 Central Ave., Newark, N. J.

● **FM-AM Tuner.** Custom builders of high-quality home music systems will welcome the new 303A FM-AM tuner recently announced by Altec Lansing. Equally well-suited for industrial and broadcast applications, the 303A contains a built-in



power supply and a multistage audio amplifier including a preamplifier for magnetic-type pickups. Controls include four-position channel selector, three-step equalizing selector for record crossover frequencies, continuous control for rise and droop in both treble and bass, and volume control. Cathode-follower output stage permits up to 50-ft. separation of the tuner and the power amplifier with which it is used. Panel is tastefully finished in brushed brass. Both AM and FM sections of the 303A incorporate AVC and make use of a magic eye for precise tuning. Altec Lansing Corporation, 9356 Santa Monica Blvd., Beverly Hills, Calif.

● **Remote-Control Amplifier.** Newest entry in the field of high-quality audio equip-

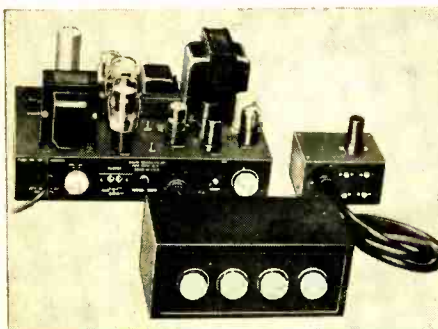

ment is the Bogen Model HO10 power amplifier and Model RXPX remote control and preamplifier. An all-triode unit rated at 10 watts, the HO10 delivers full output with less than 1.3 per cent distortion. Frequency range is 20 to 20,000 cps. The Model RXPX remote unit provides full control at distances up to 25 feet from the power amplifier. Controls provided include separate bass and treble adjustment, volume control, and a 7-position selector switch. The selector switch is unusual in that its four phonograph positions are marked in terms of turnover frequencies, thus providing instant front-panel adjustment for most any given recording. Remaining three positions are for tuners. Detailed specifications will be supplied on request by David Bogen Company, Inc., 663 Broadway, New York 12, N. Y.

● **Low-Voltage Variable Transformer.** The ever-present laboratory need for a controllable source of low-voltage 60-cps power is satisfied with the new Type 71-A Variac transformer, recently announced by General Radio Company, 275 Massa-

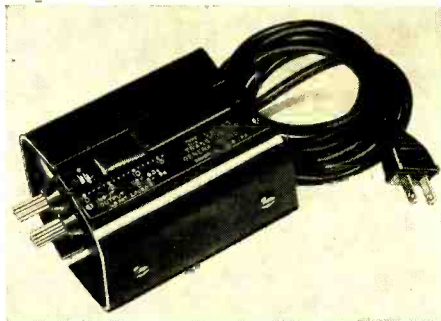

achusetts Ave., Cambridge 39, Mass. The unit is unique for transformers of this type in the fact that the secondary winding is isolated. Insulation between coils and to the core will withstand a 1250-volt breakdown test. The transformer is supplied with attached cord and plug for 115-volt input. Continuous output current rating is 5 amps with a voltage range from zero to 13 volts.

● **Two-Speed Portable Tape Recorder.** Improved operating flexibility and remarkable economy are inherent in the new Pentron portable tape recorder-reproducer. Completely re-styled by a well-known firm of industrial designers, it is also excep-

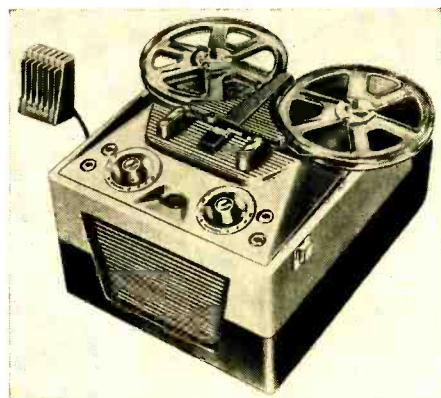

tional in appearance. It features push-button speed change for either 3 3/4 or 7 1/2 in./sec., automatic equalization for either speed, and a push-button editing key which permits correction of recordings while tape is playing. Level indication is by means of the conventional magic eye. Interlock switch prevents accidental erasure. Supplied with crystal microphone. Jacks provided for microphone, tuner, auxiliary speaker, and amplifier. Available with single-track head on special order. Complete unit with all acces-

sories weighs 27 lbs. Literature will be supplied free on request to the Pentron Corporation, 221 E. Cullerton St., Chicago, 16, Illinois.

● **Transcription-Type Turntable.** Type 201B/3 is an improved version of the Garrard governor-controlled transcription-type motor-and-table assembly. It is a



self-starting induction-type unit which operates at either 33 1/3 or 78 rpm. Featured is one-shot lubrication, the only maintenance required being occasional lubrication of bearings through a single oiling point located in the top of the spindle. Speed regulator is mounted on an extension arm which permits adjustment while 16-in. records are playing. Garrard Sales Corporation, 164 Duane St., New York 11.

● **Metal-Surfaced Dielectric.** Many uses in the printed circuit field are predicted for Chemelec Multi-Bond, a new series of metal-surfaced dielectric materials available from the Fluorocarbon Products Division of United States Gasket Company, Camden 1, N. J. Dielectric materials include pure fluorocarbon resins such as Teflon, and mixtures of fluorocarbon resins with various other materials such as asbestos, mica, glass, ceramics, and quartz. Available metal surfaces include aluminum, copper, Alnico, Monel, lead, mu-metal, tin, magnesium, iron, Nichrome, bronze, and the precious metals. Sheets

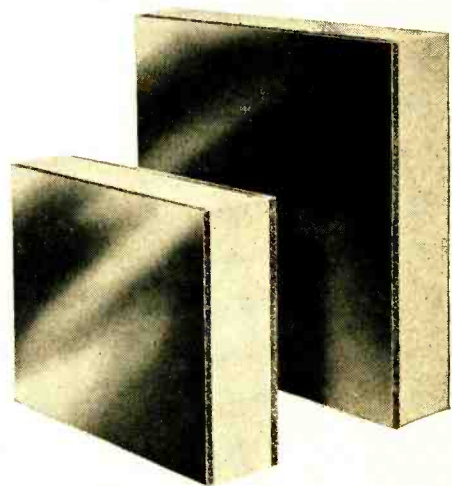

may be metalized on one or both surfaces. Standard thicknesses of the dielectric material range from .030 in. to 1.5 in., and of the conducting metal surfaces from .004 to .25 in. Standard sheet sizes are 8 x 8 in., 12 x 12 in., and 36 x 36 in.

● **Tiny Power Resistor.** Remarkably high power rating for given size is a feature of the new Dalohm line of resistors manufactured by Dale Products, Inc., Columbus, Nebraska. Available in power ratings from two to fifty watts, and in resistance values from 1 to 12,000 ohms, the Dalohm resistors supplied with standard tolerance of one per cent. Resistance elements are sealed with a silicone material, making them impervious to moisture. Tempera-

[Continued on page 58]

The Discriminating Eventually Come to Leonard's

S
T
U
D
I
O
A



O
N
E
O
F
T
H
R
E
E

APPROVED • ASTATIC • ATLAS • AUDAK • AUDIO DEVELOPMENT • BELL • BOGEN • BOZAK • BROOKS • BROWNING • BRUSH • CHALLENGER • ELECTRO-VOICE • JENSEN • ESPEY

PENTRON • PICKERING • RACON • RADIO CRAFTSMEN • REK-O-KUT • H. H. SCOTT • SHURE • SONAR • UNI-MODE • UNIVERSITY • V.M. • WEBSTER - CHICAGO • WEBSTER ELECTRIC

"near-perfect service to the largest purchaser . . . and nothing less to the smallest."

• We, at Leonard's, take justifiable pride in our growth. Yet, in a sense, we feel that the responsibility lies mostly with you—our customer. It is you who have been quick to realize that Leonard's offered something in return for your patronage—an added service. Our sincere desire to assist you—whether it be for a stylus or a complete audio system—was quickly recognized. For that we thank you; and pledge assurance that we shall continue to serve your every need—small or large. That is our creed.



The Famous
Bogen
DB 10

What Do You Look For in a Popular Priced High Fidelity Amplifier?

The magnificent performance and versatile adaptability of the DB 10 are the main reasons why it has established an unmatched record for sales and acceptance throughout the world. Incorporating a built-in preamplifier with inputs for all high fidelity pickups and extremely effective bass and treble controls, it is considered by discriminating critics to be without peer in the popular price range. Power Output—10 watts at 3%. Peak—15 watts. Frequency Response—30 to 18,000 cps. ±1 db.

NET \$53.36

**AUDIO
FAIR
HEADQUARTERS
SUITE 536**

Leonard
Radio inc.

As an introduction, we are giving away absolutely free as a door

TELEPHONE: CORTLANDT 7-0315

prize one latest model AT-3C Tape Recorder.

**WRITE FOR
OUR LATEST
HI FI
CATALOGUE**

**the house
built on
SERVICE**

69 CORTLANDT ST., NEW YORK 7, N. Y.

RIGHT!

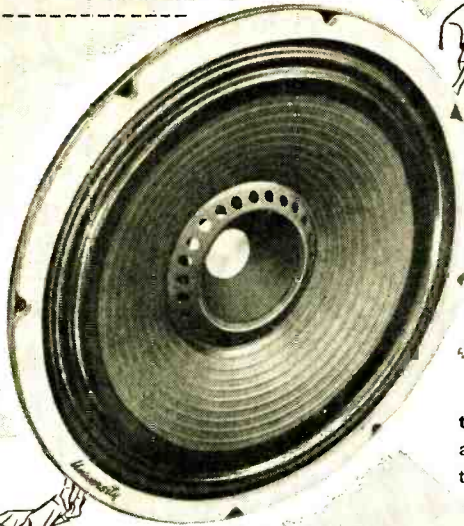

— from
any
angle

A challenging answer to low cost, wide-angle high fidelity reproduction. Diffusicone-12 is a newly engineered speaker with exclusive dual concentric cone design, which diffuses the normally beam-like high frequencies. Results in exceptionally uniform response . . . assures full range reception over the entire listening area.

Write today for Bulletin 62N73
— address inquiries to Desk 22.

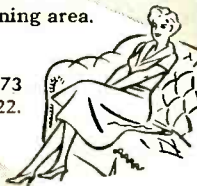

THE NEW

University DIFFUSICONE-12

An Engineering Achievement of UNIVERSITY LOUDSPEAKERS INC.
80 So. Kensico Ave., White Plains, New York

* BE SURE TO SEE THE UNIVERSITY DISPLAY AT THE AUDIO FAIR—ROOM 611, HOTEL NEW YORKER

USED AND PRAISED BY SONOTONE*

PANORAMIC'S AP-1 COMBINATION

G-2

* SONOTONE SAYS . . .

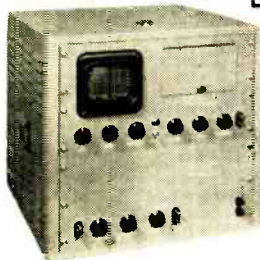

Panoramic Sonic Analyzer AP-1

Automatically separates frequency components of audio waves; measures frequency and amplitude. AP-1 tunes repetitively, once per second, through a frequency range from 40 to 20,000 cps.

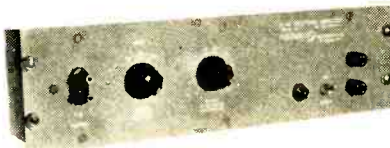

Panoramic Sonic Response Indicator G-2

Determines amplitude vs. frequency characteristics of systems between 40 and 20,000 cps. Used for research development or production line testing of amplifiers, speakers, filters, transmission lines, receivers.

PANORAMIC CAN FACILITATE YOUR PRODUCTION! WRITE FOR COMPLETE DETAILS TODAY.

8-14 S. 2nd Ave., Mt. Vernon, N. Y.
Mount Vernon 4-3970



NEW PRODUCTS

[From page 56]



ture coefficient is substantially flat, resistance shift being less than 0.00002 per cent per degree centigrade.

• **Time-Delay Generator.** Developed essentially for laboratory and experimental work, the Model A-4 time-delay generator is a device for producing delays variable in interval from 10 microseconds to 10 seconds. Its range of usefulness includes



measurement of unknown delay intervals, generating specific delays for simulation of sonar ranges, and providing delayed sweep for synchrosopes. Rutherford Electronics Co., 3707 S. Robertson Blvd., Culver City, Calif.

• **High-Quality Headphones.** Exceptional frequency range and low distortion combine to build acceptance for the new Type BA Brush headphones wherever there is need for fidelity in headphone reproduction. Of particular interest is the fact

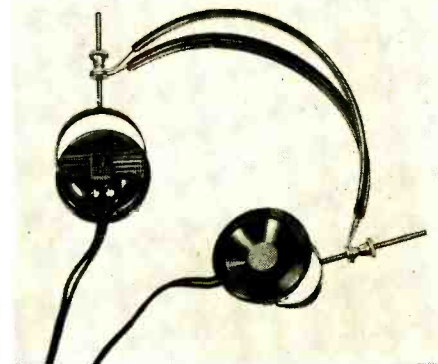

that the phones are equipped with a Metalseal crystal element to provide freedom from problems caused by high humidity. Available as double headset, single headset, or in lorgnette style. Brush Development Company, 3405 Perkins Ave., Cleveland 14.

LOUDSPEAKER ENCLOSURES

[from page 38]

field reciprocity method.^{4, 5} A sinusoidal input was applied to the loudspeaker system under test by means of the combination RCA-68B beat-frequency oscillator and a BA-14A amplifier. The voltage applied to the loudspeaker system was measured by means of a Ballantine voltmeter. The measuring apparatus is shown in Fig. 4, and the microphone and the small loudspeaker mechanism of Fig. 1 under test in the free field sound room are shown in Fig. 5. The response-frequency characteristics illustrated and described in the sections which follow were obtained by means of the apparatus and arrangements described above.

Sphere

The first consideration will be the combination of the direct-radiator loudspeaker mechanism of Fig. 1 and the spherical enclosure as shown at (A) in Fig. 2. The axial response-frequency characteristic thus obtained was corrected so that the volume current produced by the mechanism was inversely proportional to the frequency, as previously described. The response-frequency characteristic^{6, 7} of the combina-

⁴ H. F. Olson, *RCA Review*, Vol. 6, No. 1, p. 35, 1941.

⁵ Olson, *Elements of Acoustical Engineering*, D. Van Nostrand Company, New York, 2nd Edition, 1947, p. 345.

⁶ The response-frequency characteristics depicted in this paper were obtained on enclosures having the dimensions given. The response-frequency characteristics for enclosures of other dimensions can be obtained by multiplying the ratio of the linear dimensions of the enclosure given in this paper to the linear dimensions of the new enclosure by the frequency of the response-frequency characteristic given in this paper. For example: if the linear dimensions of the new enclosures are two times those of the enclosures described, the frequency scales of Figs. 6 to 17 inclusive should be multiplied by one-half.

⁷ The theoretical and experimental sound pressures on a sphere as a function of the frequency for an impinging plane wave of constant intensity have been investigated by G. W. Stewart, *Phys. Rev.*, Vol. 33, No. 6, p. 467, 1911, S. Ballantine, *Phys. Rev.*, Vol. 32, No. 6, p. 988, 1928 and Muller, Black and Dunn, *J. Acous. Soc. Am.*, Vol. 10, No. 1, p. 6, 1938. The results reported by these investigators agree with those depicted in Fig. 6. This is to be expected from the reciprocity theorem which states that under appropriate conditions the source and observation points may be interchanged without altering the response frequency characteristics of the system. See Olson, *Elements of Acoustical Engineering*, D. Van Nostrand Company, New York, N. Y., 1947, p. 21.

SONOCRAFT

Headquarters for
SOUND & RECORDING
EQUIPMENT & ACCESSORIES



- ALTEC-LANSING
- AMPRO
- ASTATIC
- ATLAS
- AUDAK
- AUDIO DEVICES
- BELL
- BOGEN
- BROOK
- BROOKS
- BRUSH
- CALIFONE
- CAPPS STYLI
- CARTER
- ELECTRO-VOICE
- GARRARD
- GRAY
- MAGNECORD
- MASCO
- McINTOSH
- MINNESOTA MINING
- PENTRON
- PICKERING
- PRESTO
- PROCTOR
- RADIO CRAFTSMEN
- RECOTON
- REK-O-KUT
- REVERE
- SHURE
- SOUNDCRAFT
- TELEX
- TURNER
- V-M
- VOCATRON
- WEBSTER-CHICAGO
- WEBSTER ELECTRIC
- WESTERN ELECTRIC
- WILCOX-GAY AND OTHERS

SONOCRAFT

CORPORATION

3rd floor • 115 West 45th Street, New York 19, N. Y.
Next to Times Square

LUxemburg 2-1750

Performance Plus!

with the Peerless hi-quality 18 watt TRIODE output amplifier kit. Heart of this kit is the Peerless S-240-Q output transformer, conclusively proved superior to all competition in square wave tests. Amplifier's response is flat from 20 to 20,000 cps for radio input. Phono input is equalized for variable reluctance pickup. Simple modification adapts amplifier for use with microphone. Kit contains all basic components and instructions for assembly.

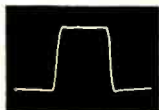

SQUARE WAVE TEST
PROVES PEERLESS BEST

10722
Triode
Amplifier
Kit



PEERLESS Electrical Products

Division



9356 Santa Monica Blvd., Beverly Hills, Calif
161 Sixth Avenue, New York 13, New York

Sixteen years serving the Audio Industry

PROFESSIONAL AUDIO EQUIPMENT

Controls, Attenuators, Amplifiers, Equalizers, Audio
Accessories, and Magnetic Recording Components.

Factory Representatives

New York Area	Michigan-Ohio Area	Wisconsin-Iowa Minnesota Area	New England States Area
G. Curtis Engel P. O. Box 569 Ridgewood, N. J. Ridgewood 6-7878	Edwards-Lohse & Co. 2123 E. 9th St., Rm. 510 Cleveland, Ohio Tower 1-5753	A. J. Warner Co. 5022 29th Ave., So. Minneapolis, Minn. Drexel 1895	Samuel Hooker 397 Highland Ave. Winchester, Mass. Winchester 6-2745
Northern California	Pacific Northwest		
David Ross, 1355 Market St. San Francisco, Calif., Klondike 2-3038	Jas. J. Backer Co., 2321 Second Ave. Seattle 1, Wash., MAin 8811		



CINEMA ENGINEERING COMPANY
1510 WEST VERDUGO AVENUE, BURBANK, CALIFORNIA

Export Agents: Frazar & Hansen, Ltd. • 301 Clay Street • San Francisco, Calif., U. S. A.

tion of a small direct-radiator sound source in which the volume current is inversely proportional to the frequency and a large spherical enclosure is shown in Fig. 6. It will be seen that the response is uniform and free of peaks and dips. This is due to the fact that there are no sharp edges or discontinuities to set up diffracted waves of a definite phase pattern relation with respect to the primary sound emitted by the loudspeaker. The diffracted waves are uniformly distributed as to phase and amplitude. Therefore, the transition from radiation by the loudspeaker mechanism into 4π solid angles to radiation into 2π solid angles takes place uniformly with respect to the frequency. It will be noted that the sound pressure increases uniformly in this transition frequency. The ultimate pressure is 6 db higher than the sound pressure where the dimension of the sphere is a small fraction of the wavelength.

Hemisphere

The axial response-frequency characteristic of the loudspeaker mechanism of Fig. 1 mounted in the hemispherical enclosure of (B), Fig. 2, is shown in Fig. 7. The sharp discontinuity at the boundary of the spherical and plane surfaces produces a strongly diffracted wave. There is a phase difference between the primary and diffracted waves which results in peaks and dips in the response-frequency characteristic corresponding to in and out of phase relationships between the primary and diffracted sound. A physical explanation of the phenomena is as follows: The sound flows out in all possible directions from the sound source. The sound which follows the contour of the spherical surface encounters a sudden change in acoustical impedance at the intersection of the plane and spherical surface. A reflected wave is sent out at this point in all possible directions. The distance from the diaphragm of the loudspeaker mechanism to the circular diffracting edge is $\pi/2$ feet. The distance between the plane of the diaphragm and the plane containing circular diffracting edge is 1 ft. Therefore, the difference in path between the primary and the diffracted wave at the observation or measurement point on the axis is $(\pi/2 + 1)$ ft. The sound wave which follows the contour of the spherical surface encounters a decrease in acoustical impedance at the boundary of the spherical and plane surfaces, and the diffracted or reflected wave suffers a phase change of 180 deg. Therefore, when the distance $(\pi/2 + 1)$ ft. corresponds to odd multiples of one-half wavelength, there will be maxima of response because the primary and diffracted waves are in phase. The maxima will occur at 215, 645, 1075, etc. cps. It will be seen that this agrees with experimental results. When the distance $(\pi/2 + 1)$ ft. corresponds to multiples of the wavelength, there will be minima in the response because the

primary and diffracted waves are out of phase. The minima will occur at 430, 860, 1290, etc. cps. It will be seen that this agrees with the experimental results.

Cylinder

The axial response-frequency characteristic⁸ of the loudspeaker mechanism of Fig. 1 mounted in the center of one end of the cylinder of (C), Fig. 2 is shown in Fig. 8. The sharp boundary at the intersection of the plane and cylindrical surface introduces a strongly diffracted wave. The distance from the mechanism to the circular boundary is 1 ft. Therefore, since the diaphragm and the edge lie in the same plane, the path difference between primary and diffracted wave is 1 ft. Following the explanation of the preceding section, there should be maxima of response at 550, 1650, 2750, 3850, etc. cps, and there should be minima of response at 1100, 2200, 3300, etc. cps. It will be seen that there is remarkable agreement with the experimental results of Fig. 8. It is also interesting to note that the variations in response are very great, being of the order of 10 db.

The axial response-frequency characteristic of the loudspeaker mechanism of Fig. 1 mounted in the cylindrical surface of the cylinder of (D), Fig. 2, is shown in Fig. 9. Again the sharp boundary between the cylindrical and the plane surfaces produces a diffracted wave. However, the path difference between the primary and diffracted wave is not confined to a single discrete distance. Therefore, the maxima and minima of response are not as pronounced as in the case of (C), as shown in Fig. 8. From the response frequency characteristic of Fig. 9, it would appear that the effective distance between the primary and diffracted wave is about 1.17 ft. As would be expected, this means that the forward portion of the diffracting edge plays the predominant part.

Cube

The axial response-frequency characteristic⁹ of the loudspeaker mechanism of Fig. 1 mounted in the center of one of the faces of the cube (E), of Fig. 2, is shown in Fig. 10. The sharp boundary at the edges of the cube produces a strongly diffracted wave. The average path between the mechanism and the

⁸ The theoretical and experimental sound pressures on the center of the face of a cylinder as a function of the frequency have been investigated by Muller, Black and Dunn, *J. Acous. Soc. Am.*, Vol. 10, No. 1, p. 6, 1938. The results reported by these investigators agree with those depicted in Fig. 8. This is to be expected from a consideration of the reciprocity theorem. See footnote 7.

⁹ The theoretical and experimental sound pressures on the center of a face of a cube as a function of the frequency have been investigated by Muller, Black and Dunn, *J. Acous. Soc. Am.*, Vol. 10, No. 1, p. 6, 1938. The results reported by these investigators agree with those depicted in Fig. 10. This is to be expected from a consideration of the reciprocity theorem. See footnote 7.



GOODMANS

HIGH FIDELITY - 12" P.M.

\$65.
LIST

TWIN CONE AXIOM 150

This 12-in. high fidelity unit has a twin-curvilinear diaphragm (British patent No. 451754). A carefully designed magnet assembly using anisotropic material provides a total flux of 158,000 maxwells on a 1½-in. pole. The back centering device is a dustproof bakelized linen disk with concentric corrugations. The combination of these features gives this precision-built instrument an outstandingly wide coverage from 40 to 15,000 c.p.s. free from bass modulation effects. An ideal high fidelity reproducer for the record enthusiast and the connoisseur of wide range musical reproduction, it gives exceptionally fine transient and frequency response.

SPECIFICATION

- Frequency Coverage 40/15,000 c.p.s.
- Overall Diameter 12 in.-31.3 cms.
- Overall Depth 6 in.-17.6 cms.
- Fundamental Resonance 55 c.p.s.
- Voice Coil Diameter 1¾ in.-4.4 cms.
- Voice Coil Impedance 15 ohms at 400 c.p.s.
- Maximum Power Cap. 15 Watts Peak A.C.
- Flux Density 14,000 gauss
- Net Weight 12 lbs. 13 ozs. (5810 grs.)
- Finish—Grey Rivelling Enamel.

U. S. NATIONAL SALES
WILLGOLD ELECTRONICS SALES CORP.

350 Fifth Avenue, New York, N. Y.

New England Office
Harold A. Chamberlin
31 Milk St., Boston 9, Mass.

Chicago Office
Harry Halinton Co.
612 N. Mich. Ave., Chicago 11, Ill.

Pacific Coast Office
Perlmuth-Colman & Associates, Inc.
1335 Flower St., Los Angeles, Calif.

Canadian Office
A. C. Simmonds & Sons, Ltd.
100 Merton St., Toronto 12, Can.

Manufactured by:

GOODMANS INDUSTRIES LIMITED
WEMBLEY MIDDLESEX ENGLAND

In New York...

products of the
CINEMA ENGINEERING COMPANY

are distributed by



Audio & Video

PRODUCTS CORPORATION

730 Fifth Avenue, New York 19, N. Y. • Plaza 7-3091

Exhibiting at the Audio Fair — Rooms 614 & 615

"towards perfection..."

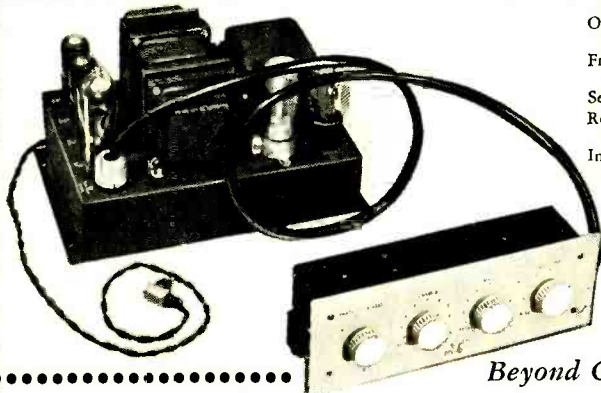

Output: 10 watts at less than 1% distortion.
 Frequency Response: 20 to 40,000 cps \pm 1 db.
 Selector switch for phono and radio.
 Remote control panel incorporating pre-amplifier.
 Infinitely variable bass and treble controls.

Listen to Arrow's radio program—WABF, 9 to 10 every Friday night.

Beyond Comparison at \$99.50 NET

The MA10 has been designed and built by Lowthers of England specifically for the discriminating American audio-ophile, using standard parts and American tubes. As everything Arrow sells, it has undergone rigid laboratory tests. Results show its value to be unsurpassed... its reproduction to be far above any other amplifier in the 10 watt class... its stylish remote control unit to be ideal for custom-building.

Arrow has in stock and on demonstration, in its large modern sound studio, a complete selection of fine high fidelity equipment of all manufacturers.



Beauty in Sound

Write for catalogue #7-A
ARROW ELECTRONICS, INC.
 82 CORTLANDT ST., NEW YORK 7, N. Y., DIGBY 9-4714

Visit Arrow at the Audio Fair, Room 650, Hotel New Yorker, Nov. 1, 2, & 3.

FILTER VERSATILITY

Check your filter problems at Lenkurt. Lenkurt combines filter know-how—gained from years of carrier engineering—with the most modern facilities for molding precision magnetic parts, winding toroids in a wide range of sizes and sealing assemblies for maximum life.

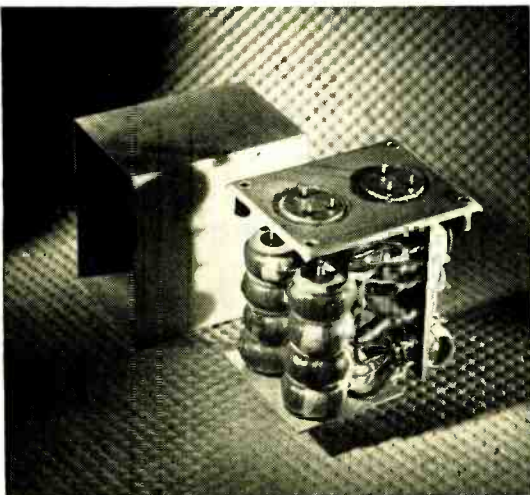

Small-sized hermetically-sealed unit illustrated contains two filters: a low-pass and a band-pass, designed for single sideband carrier application. Other types to your specifications. Write:

LENKURT ELECTRIC CO.
 SAN CARLOS • CALIFORNIA



edges is about 1.2 ft. Therefore, since the diaphragm and the edges lie in the same plane, the path difference between the primary and diffracted waves is 1.2 ft. Following the explanations of the preceding sections, there should be maxima of response at 460, 1380, 2300, 3200, etc. cps, and there should be minima of response at 920, 1840, 2760, etc. cps. There is reasonably good agreement with the experimental results of Fig. 10.

Cone

The axial response of the loudspeaker mechanism of Fig. 1 mounted in the apex of the cone, (F) of Fig. 2, is shown in Fig. 11. The sharp boundary at the base of the cone produces a diffracted wave. The distance from the mechanism to this edge is 1.3 ft. The distance between the plane of the diaphragm of the mechanism and the plane of the base is 0.95 ft. Therefore, the difference in path between the primary and diffracted waves is 2.25 ft. Following the explanations of the preceding sections, there should be maxima of response at 250, 750, 1250, etc. cps. and there should be minima of response at 500, 1000, 1500, 2000, etc. cps. There is very good agreement with the experimental results of Fig. 11. Another interesting fact is that the average magnitude of the response does not increase as rapidly with frequency as in the case of the examples in the preceding sections. This is due to the fact that the free space subtended by the loudspeaker mechanism is 2.6 steradians as compared to 2π steradians for most of the other systems considered in the preceding sections. Therefore, the ultimate sound pressure occurs at a higher frequency than in the case of enclosures in which the loudspeaker subtends 2π steradians.

The axial response of the loudspeaker mechanism of Fig. 1 mounted in the apex of the double cone, (G) of Fig. 2, is shown in Fig. 13. The sharp boundary at the bases of the cones produces a diffracted wave. The phase differences between the primary and diffracted waves are the same as those of the single cone. The performances of the single and double cone are about the same, as will be seen by comparing Figs. 11 and 12.

Pyramid

The axial response of the loudspeaker mechanism of Fig. 1 mounted in the apex of the pyramid, (A) of Fig. 2, is shown in Fig. 13. The sharp boundary at the base produces a diffracted wave. The average distance from the mechanism to this edge is 1.6 ft. The distance between the plane of the diaphragm of the mechanism and the plane of the base is 0.95 ft. Therefore, the difference in path between the primary and diffracted waves is 2.55 ft. Following the explanations of the preceding sections, there should be maxima of response at 220, 660, 1100, etc. cps, and minima at 440, 880, 1320, etc. cps. There is very good agreement with the experimental results of Fig. 13. The shape of the response-

frequency characteristics is similar to that of the cone of a preceding section. As in the case of the cone, the ultimate response occurs at a relatively high frequency.

The axial response of the loudspeaker mechanism of Fig. 1 mounted in the apex of the double pyramid, (I) of Fig. 2, is shown in Fig. 14. The sharp boundary at the base of the pyramid produces a diffracted wave. The phase differences between the primary and diffracted waves are the same as those of the single cone. The performance of the single and double cone are about the same, as will be seen by comparing Figs. 13 and 14.

Truncated Pyramid and Rectangular Parallelepiped Combination

From the preceding examples, it will be seen that wide variations in the response-frequency characteristics occur when there is a sharp boundary or edge upon the surface of the enclosure which produces a strongly diffracted wave. The diffracted wave is further accentuated when all paths from the mechanism to the boundaries or edges are the same. The truncated pyramid and rectangular parallelepiped combination shown at (J) in Fig. 2 is designed with the object of reducing sharp boundaries on the front portion of the enclosure. Furthermore, the distances from the mechanism and the edges are not all the same. The response frequency characteristic of the loudspeaker mechanism of Fig. 1 mounted in the enclosure (J) is shown in Fig. 15. It will be seen that the response is quite uniform and free of large maxima and minima. This bears out the idea that the reduction of sharp boundaries on the surface of the enclosure and the elimination of equal path lengths from these boundaries to the mechanism will yield smoother response frequency characteristics.

Rectangular Parallelepiped

The rectangular parallelepiped in all its possible variations in dimensions is the most common direct-radiator loudspeaker enclosure. One of the obvious reasons for this state of affairs is that this shape is the simplest to fabricate. This is unfortunate, because the rectangular parallelepiped produces diffraction effects which adversely modify the response-frequency characteristic of a direct-radiator loudspeaker mechanism. The response-frequency curve of Fig. 16 was obtained with the loudspeaker mechanism of Fig. 1 mounted in the rectangular parallelepiped of (K), Fig. 2. The pronounced minima in the response at 1000 and 2000 cps are due to shorter distances from the mechanism to the upper and side edges. The minimum in response at 500 cps is due to the longer distance from the mechanism to the lower edge. The variations in response, due to diffraction effects by the cabinet, are of the order of 6 to 7 db. The response frequency characteristic of Fig. 16 is typical of the response obtained with this type of enclosure. Therefore, this cabinet shape is unsuitable for housing a direct-radiator loudspeaker



...A "Sound" Impression...

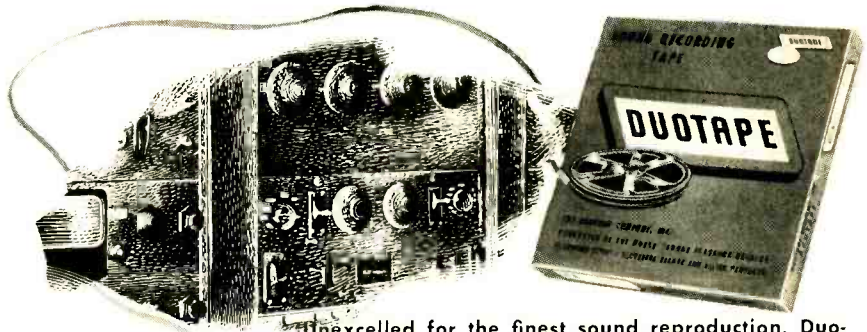

Unexcelled for the finest sound reproduction, Duotone magnetic recording tape now costs no more than store brands. And now DUOTAPE gives you an extra 25 feet per reel at no additional cost. Note its extra tape recording efficiency and fidelity! Compare the distinctive constructive features of DUOTAPE!

CHECK:

1. *Low Friction-Long Life. Special film coating protects homogeneity of oxide to insure low surface friction for longer head life.*
2. *High Output - Minimum Background. Uniformity of oxide dispersion and laboratory control of polish eliminates irregularities.*
3. *Constant Tracking and Winding. Special shearing insures no troublesome curling.*
4. *No Snarls or Backlash. Accurate cut and low inertia wheel makes ideal combination for smooth running tape.*



DUOTAPE is available in either plastic or kraft paper base. Plastic base is tough with high tear strength and special smooth finish for uniform coating. Kraft bases are super-calendered for perfect surfacing without fillers.

For complete data on Duotone standard and special tapes for every recording need call or wire for illustrated catalog.

Canadian Representative: CHARLES W. POINTON, TORONTO. Export Division: AD. AURIEMA, INC., NEW YORK

Music . . .

Pre-Recorded On Magnetic Tape!

The new A-V Tape Libraries catalog of magnetic tape recordings is now available.

See it! Hear it!

at the Audio Fair . . . Rooms 614 & 615

A-V Tape Libraries INC.

730 Fifth Avenue, New York 19, New York. PLAZA 7-3091



SAVE

THAT GOOD LOOKING OLD CONSOLE—
REPLACE YOUR OBSOLETE RADIO

with a modern, easily installed

ESPEY AM/FM CHASSIS

and your favorite console is "right-up-to-date"

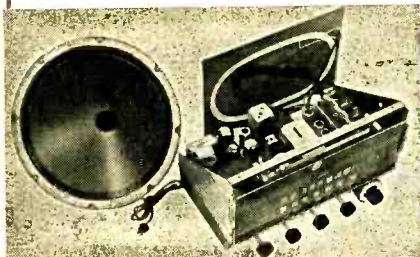

NEW FEATURERS—Improved Frequency modulation circuit, drift compensated • 12 tubes plus rectifier, and pre-amplifier pick-up tubes • 4 dual purpose tubes • High quality AM/FM reception • Push-pull beam power audio output 10 watts • Switch for easy changing to crystal or variable reluctance pick-ups • Multi-tap audio output transformer supplying 4—8—500 ohms.

Write for literature AE-11 for complete specifications on Model 511-B and others.

Makers of fine radios since 1928.

ESPEY
MANUFACTURING COMPANY, INC.
528 EAST 72nd STREET, NEW YORK 21, N. Y.

Rated an excellent instrument by America's foremost electronic engineers. Fully licensed under RCA and Hazeltine patents. The photo shows the Espey Model 511-B, supplied ready to play. Equipped with tubes, antenna, speaker, and all necessary hardware for mounting.

We're interested in REALISM

—Are YOU?

AUDIO ENGINEERING has always been in the forefront of the drive for true realism in reproduction—it has always steered you away from the "high-futility" type of sound system for the home—it has always emphasized the best in amplifiers, speakers, and other components for your reproduction system.

EVERY MONTH—twelve times a year—you get the latest and best in technical articles—you get record reviews slanted toward the technical quality of the recordings, but with a solid musical background.

AUDIO ENGINEERING

342 Madison Avenue, New York 17, N. Y.

Enclosed is my check money order for \$..... for my subscription to AUDIO ENGINEERING FOR 1 yr 2 yrs.

Subscription Price in U. S. A. and Canada and Pan American Union: 1 yr—\$3; 2 yrs—\$5. Add \$1. per year for foreign subscriptions.

Name (please print)

Address

City Zone State

Occupation (give title and department)

Firm name

mechanism, because of the wide variations in response produced by diffraction from the sharp edges of this cabinet.

Rectangular Truncated Pyramid and Parallelepiped Combination

From the data given the preceding sections it is possible to devise many cabinet shapes which will reduce the effects of diffractions in modifying the response frequency characteristics of the loudspeaker mechanism.

An example of the application of the principles outlined in this paper is shown at (L) in Fig. 2. In this cabinet the diffraction effects have been ameliorated by the reduction of abrupt angular discontinuities on the surface of the cabinet and the elimination of equal paths from these discontinuities to the mechanism. At the same time a practical exterior configuration has been retained which is not undesirable from an esthetic standpoint. The response-frequency characteristic of the loudspeaker mechanism of Fig. 1 mounted in the enclosure (L) is shown in Fig. 17. It will be seen that the response-frequency characteristic is quite smooth.

Conclusions

The response-frequency characteristics, which depict the performance of a direct-radiator loudspeaker mechanism in various enclosures of fundamental shapes, show that the outside configuration plays an important part in determining the response as a function of frequency. For example, in some of the enclosures the variation in response produced by diffraction exceeds 10 db.

All of the response-frequency characteristics depicted in this paper were taken on the axis of the loudspeaker mechanism and enclosure combination. In this connection, it should be mentioned that the variations in response are mitigated for locations off the axis. The reason for using the axial response is that the reference response-frequency characteristic of a direct-radiator loudspeaker is always taken on or near the axis. Practically all serious listening to direct-radiator loudspeakers is carried out on or near the axis.

The response of a loudspeaker in an enclosure will be modified by the directivity pattern of the mechanism, because the diffraction effects are influenced by the direction of flow of sound energy from the diaphragm. However, the performance in the frequency range in which the dimensions of the cone are less than a wavelength will not be markedly different.

The experiments described in this paper show that the deleterious effects of diffraction can be reduced by eliminating all sharp boundaries on the front portion of the enclosure upon which the mechanism is mounted, so that the amplitude of the diffracted waves will be reduced in amplitude and by making the distances from the mechanism to the diffracting edges varied so that there will be a random phase relationship between the primary and diffracted sound waves.

AUDIO engineering society

P. O. Box 12, Old Chelsea Station, New York 11, N. Y.

MEMBERSHIP APPLICATION

I desire { admission into advancement in } the Audio Engineering Society. Grade desired

Print or Type Name in Full

Born at
City State Country Date Age

Residence
Street City State

Mail Address
Street City State

Occupation
Position Names and Address of Concern

Present Duties
State in Detail (Students give school and course)

Past Experience
Give Companies, Years and Positions

Member of Other Societies
Give Names or Abbreviations, and Grade of Membership

EDUCATION

SCHOOL ATTENDED	FROM	TO	COURSE	DEGREE

ADMISSION REQUIREMENTS

A member, according to the constitution, may be any person active in audio engineering who has an academic degree or its equivalent in scientific or professional experience in audio engineering or in a closely related field or art. Such a person shall, upon election, be entitled to all the rights and privileges of the Society.

An associate member may be any person interested in the objectives of the Audio Engineering Society and, upon election, shall become entitled to all the rights and privileges of the society except the right to vote or to hold office or chairmanship of standing committees.

A student member may be any student interested in audio engineering and enrolled in a recognized school, college or university. A student member is not eligible to vote or to serve on committees except in his own local chapter.

Three references are required with application for the member grade, two for associate membership and one for student membership. References should be familiar with your work; they need not be members. Yearly dues are \$7.50 for member, \$6.00 for associate and \$3.00 for student, each of which is halved if the date of application is between April 1st and September 30th. Payment must accompany application.

REFERENCES

Name	Company and Address	Title or Position
1.
2.
3.

Signature of Applicant

Medal of Honor



*Sergeant Travis Watkins,
Gladeswater, Tex.—Medal of Honor*



*Private First Class Melvin Brown,
Mahaffey, Pa.—Medal of Honor*



*Lieutenant Frederick Henry,
Clinton, Okla.—Medal of Honor*



*Major General William F. Dean,
Berkeley, Calif.—Medal of Honor*



*Sergeant Charles Turner,
Boston, Mass.—Medal of Honor*

This is the season when you think of stars. The one over Bethlehem. The ones on Christmas trees.

But this year remember another star, too—the one on the Medal of Honor. And make a place in your heart for the brave, good men who've won it. Men who, oftener than not, made the final, greatest sacrifice—so that the stars on your Christmas tree, and the stars in your country's flag, might forever shine undimmed.

Right now—today—is the time to do something

important for these men who died for you.

You can, by helping to defend the country they defended so far "above and beyond the call of duty."

One of the best ways you can make defense *your* job, too, is to buy more . . . and more . . . and more United States Defense Bonds. For your bonds help strengthen America. And if you make this nation strong enough you'll create, and keep, the peace for which men died.

Buy Defense Bonds through the Payroll Savings Plan where you work or the Bond-A-Month Plan where you bank. Start today!

Peace is for the strong...Buy U. S. Defense Bonds



The U. S. Government does not pay for this advertisement. It is donated by this publication in cooperation with the Advertising Council and the Magazine Publishers of America as a public service.

REMOTE AMPLIFIERS

[from page 19]

put the changeover switch *after* the rectifier, thus removing it from the circuit on remote power operation. Since it would add some drop to the supply voltage, it might lower the output voltage down too much to be compensated at the studio. However, there are no critical circuits and they will operate over a wide margin of voltages. A possible disadvantage of having the rectifier connected before the switch is the possibility of having incorrect polarity go undetected. The filaments would light with either polarity, but the plates would draw no current. With the first setup, or with personnel unfamiliar with the operation of the system, the tendency might be to increase the current to normal with the potentiometer, and look elsewhere for the trouble when no signal is heard. In any case, checking well in advance of air time will allow trouble to be corrected without program delay. The volume control should be set to give the correct level at the studio with the average sound level that will be used at the remote point.

Over regular broadcast telephone pairs, this system has given excellent service, without failure. It eliminates the possibility of non-technical personnel forgetting to turn on an amplifier where there is to be no engineer present. And since it is also independent of the power lines, there need be no fear that someone will throw a switch unwittingly, or that a fuse will blow. With a few trials, members of the engineering staff would familiarize themselves with the operation of this amplifier, and thereafter the excellent results that have been found by the author should be obtained.

EXPONENTIAL Baffles

[from page 27]

nician should allow a church installation to be completed without at least investigating the opportunities of a custom-built speaker arrangement.

The designs shown and applications discussed are just a starting point for the interested engineer or custom installation expert. Wide-range exponential speaker designs deserve attention. While their size prevents them from being used in many audio situations, the desirable qualities of acoustic matching, efficiency, true bass response, and low distortion are attractive enough to make horn systems a first consideration for the better than average sound installation.



± 1 db
40 TO 20,000 CPS

new
Rauland
MODEL 1810
HIGH-FIDELITY
PHONOGRAPH AMPLIFIER

Custom Quality
FOR LESS!

SPECIFICATIONS

Output: Measured at 100, 400 and 5000 cps—10 watts at 3% harmonic distortion. Percentage intermodulation distortion at 60 and 7000 cycles with 4 to 1 ratio—2 watts 1.5% (home level), 5 watts 3%, 10 watts 5%.

Gain: Magnetic phono input 103 db (10,000 ohms), crystal pickup (aux.) input 80 db (500,000 ohms), 73 db (100,000 ohms).

Frequency Response: ± 1 db 40 to 20,000 cycles per second.

Tone Controls: Separate boost type controls. Bass + 13 db to -7 db at 40 cycles; treble + 10 db to -20 db at 15,000 cycles.

Output Impedances: 4, 8 and 16 ohms.

Hum and Noise Level: 45 db below rated output (unweighted) on phono; 75 db below rated power output (unweighted) on aux.

Tubes: 1-6SC7, 1-6SQ7, 1-6SL7, 2-6V6GT, 1-5Y3GT.

Power Consumption: 75 watts, 117/130 volts, 60 cycles. Chassis is finished in handsome light-green hammerloid. Size: 10½" x 6½" x 6" high overall.

THE IDEAL LOW-COST HI-FI UNIT FOR CUSTOM INSTALLATIONS

Here's a high-quality adequately powered unit capable of the finest high-fidelity reproduction, and available at *really* low cost. The RAULAND 1810 10-watt High-Fidelity Phono Amplifier is equipped with 3-position input selector switch for magnetic or crystal pickup and high level auxiliary input. Features include: built-in preamp for magnetic pickup, separate boost type bass and treble tone controls, and compensated volume control which increases lows when volume is reduced. There's nothing on the market comparable for features, performance and value. Available for immediate delivery from stock. Get the full details today!

See your RAULAND-BORG Distributor for full information on the RAULAND 1810 High-Fidelity Phono Amplifier. Compare its features and price! Have custom quality for less.

Electroneering is our business

SOUND
EQUIPMENT

Rauland

INTER-
COMMUNICATION

RAULAND-BORG CORPORATION • 3523-L Addison St., Chicago 18, ILL.

FAIRCHILD RECORDING EQUIPMENT CORPORATION

Synchronous Disc Recording & Playback Units

are available from



Audio & Video

PRODUCTS CORPORATION

730 Fifth Avenue, New York 19, N.Y. • Plaza 7-3091

Exhibiting at the Audio Fair — Rooms 614 & 615



HOW LEADING NETWORKS USE Carter CONVERTERS

Photo above shows NBC's Tommy Bartlett and Universal Recording Company engineers making transcriptions from STORAGE BATTERY POWER by means of Carter Frequency Controlled Converter.

Wherever 115v. line voltage is not available, or hard to get, Carter Converters supply dependable AC power to make on location recordings. Operates from storage batteries. . . . Used by leading networks, broadcast stations, and program producers.

Recommended by Brush and Magnecord

One model operates both Brush and Magnecord equipment. Delivers clean 60 cycle AC power. Requires no filtering. Frequency control feature compensates for 10% input voltage variation. Available for 6, 12, 24, 28, 32, 64, and 115v. DC input voltage. Size 8 1/2" x 5 1/2" x 7 1/2" high. Weight only 15 1/2 lbs. Performance Guaranteed!



MAIL COUPON FOR FREE CATALOG

New Converter catalog illustrates entire line of Carter Rotary Converters for recording, TV, sound projection and transcription players. SELECTOR CHART included tells model to suit your purpose. Mail Coupon now for your copy and name of nearest Carter distributor.



Carter MOTOR COMPANY

2648 N. MAPLEWOOD AVE., CHICAGO 47

Carter Motor Co.
2648 N. Maplewood Ave.,
Chicago 47, Ill.

Please send catalog #349 with information on Frequency Control Converters, and name of nearest distributor.

Name

Station or

Company

Address

NEW LITERATURE

• **Triad Transformer Mfg. Co.**, 2254 Sepulveda Blvd., Los Angeles 64, Calif. uses Bulletin 451 to announce a new miniaturized line of transformers for portable equipment. Stressed is the use of 380 to 1500 cps line frequencies for power equipment to permit notable reduction in size of transformers and reactors. Included in the bulletin are specifications, illustrations, and prices. Copy will be supplied on request.

• **Aircraft-Marine Products, Inc.**, 2100 Paxton St., Harrisburg, Pa. presents much of interest to designers, electrical engineers, and wire foremen in a new 78-page technical manual covering the subjects of solderless terminals, precision tools, and simplified wiring devices. Included are actual case studies to show the time and labor saved by use of solderless terminals on various applications. Tensile curves and photomicrographs are used to augment text.

• **American Standards Association, Inc.**, 70 E. 45th Street, New York 17, N. Y. has recently published an authoritative dictionary of acoustical terminology which will be of great value to all engineers engaged in the recording and reproduction of sound. Development of this standard was sponsored by the Acoustical Society of America in cooperation with the Institute of Radio Engineers under procedures of the American Standards Association. This is a book every engineer in the audio field should have. Requests for copy should specify Bulletin Z24.1-1951, and must include remittance of \$1.50.

• **International Nickel Company, Inc.**, 67 Wall St., New York 5, N. Y. is distributing without charge a new 44-page booklet on the fusion welding of nickel and high-nickel alloys. Both electric-arc and gas welding are covered in more than 20 chapters and sections. Other important information includes the boiler code of the American Society of Mechanical Engineers, as well as articles on pickling, testing, and inspection safety methods. Requests should specify Technical Bulletin T-2, and should be mailed to Technical Service Section at the above address.

• **Lenkurt Electric Company**, San Carlos, Calif. has recently published a folder describing a stackable single-sideband suppressed-carrier communication system designed for channelizing point-to-point radio communication links. Designated Form 33B-P, the literature gives a concise description of system arrangement and operation.

• **Shallcross Manufacturing Company**, Colingdale, Pa. is issuing Bulletin L-12, a listing of the Company's line of low-resistance test sets and milliohmmeters. Included are several new models which have not been described in previous literature. Among uses of the instruments are measuring contact resistance of switches, relays and circuit breakers, resistivity of heavy conductors, and bar-to-bar resistance of commutators.

• **The Helipot Corporation**, 916 Meridian Ave., South Pasadena, Calif. reaches an exceptionally high standard of industrial publishing with its new three-color 38-page catalog covering the Company's entire line of precision potentiometers. The manual contains a great deal of technical material which is considerably above and beyond the average product information expected of a commercial catalog. From every standpoint this booklet is thoroughly commendable.

• **Technology Instrument Corporation**, 531 Main St., Acton, Mass. is now circulating Laboratory Report No. 3 which includes a descriptive article on a new analog computer, and Part 1 of a technical monograph titled "A Production Test Method for the Determination of the Linearity of Precision Potentiometers." Will be mailed on request.

• **The Richardson Company**, 2730 Lake St., Melrose Park, Ill. is distributing a new 24-page two-color booklet titled "Facts About Plastics." Designed to give the layman a basic introduction to the many different plastics now available, methods of production, and their uses, the manual serves its purpose admirably. Subjects covered include: history of plastics, plastics advantages and limitations, design suggestions, differences in thermosetting and thermoplastic materials, and industrial and consumer applications. Copy must be requested on company letterhead.

McIntosh

WORLD'S FINEST AUDIO AMPLIFIER

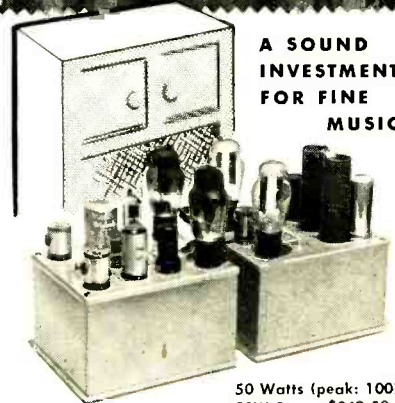

A SOUND INVESTMENT FOR FINE MUSIC

50 Watts (peak: 100)
50W-2 . . . \$249.50

McINTOSH, the world's most advanced amplifier, is unequalled for quality reproduction of any sound source. Highest Efficiency — over 65%; Less Than 1% Distortion at Peak Power; Dynamic Range: Over 70 db; Frequency Response: 20-20,000 cps.

AE-2 Amplifier
Equalizer . . . \$74.50



SEND FOR *Free* CATALOG Dept. A-4

McINTOSH ENGINEERING LABORATORIES, INC.
320 Water St., Binghamton, N. Y.

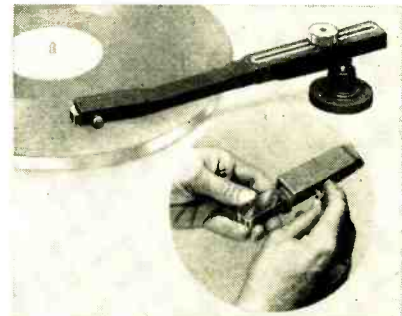

THE ARM WITH A HAND

Has "SLIDE-IN" Cartridge Holder

This fine quality Clarkstan tone arm features a special Slide-In cartridge holder that accommodates all standard cartridges, including the General Electric RPX-050. It's easy to use . . . no soldering . . . just twist a thumb screw and the cartridge is securely held in place. Positive electrical contact is assured by silver plated spring-loaded plungers. Accurate balance is easily maintained by a quick weight adjustment that gives proper needle force. The Clarkstan Arm plays all LP, microgroove and standard records. Comes in two sizes for records up to 12" and 17". See your jobber or write for bulletin #172-E

CLARKSTAN
CORP.

ELECTRONICS DIVISION 6A
11921 W. PICO BOULEVARD
LOS ANGELES 64, CALIFORNIA



Employment Register

POSITIONS OPEN and AVAILABLE PERSONNEL may be listed here at no charge to industry or to members of the Society. For insertion in this column, brief announcements should be in the hands of the Secretary, Audio Engineering Society, Box F, Oceanside, N. Y., before the fifth of the month preceding the date of issue.

★ Positions Open ● Positions Wanted

★ **Electronic Engineer.** Experienced in audio and test equipment circuitry. Degree not essential, but position requires initiative and ability to take responsibility for details. Box 1101, Audio Engineering.

★ **Top Recording Engineer.** Knowledge of agency work essential, of music desirable. Must be thoroughly experienced in tape, disc, editing, and maintenance. Large N.Y.C. studio. Our staff knows of this ad. Replies will be held confidential. Box 1102, Audio Engineering.

★ **Electrical Engineer.** New transformer and electronic specialty firm located in upstate New York has opening for young electrical engineer to grow with the company. Applicants should have BS in EE, and an interest in instrumentation. Box 1103, Audio Engineering.

★ **Military Training Instructors.** The Signal School, located at Fort Monmouth, N. J. has a number of attractive civilian openings for military training instructors in communications and electronics, such as theory of electricity, mobile and fixed station radio, microwave radio relay, repeater and carrier, radar, and motion picture techniques.

Current vacancies are at all levels ranging from trainee positions Grade GS-5 to senior instructors Grade GS-9. Attractive salaries and good promotional opportunities are offered.

★ **Physicists, Scientists, and Engineers.** The Signal Corps Engineering Laboratories also has openings for physicists, electronic scientists, electronic and mechanical engineers in research, development, design, modification, and testing of electronic equipment in the fields of radio and wire communications, radiological detection, meteorological instruments, facsimile, television, photography, and communication systems. Current vacancies are at nearly all professional levels.

★ **Technical Writers.** Positions as Technical Writers are also open at the Signal Corps Center at Fort Monmouth. Current needs are at several professional levels from trainee to senior writer, with attractive salaries and good promotional opportunities. These writers and editors will write, edit, and revise technical and scientific manuscripts, handbooks, pamphlets, circulars, instruction books, etc. on radio, radar, electronics, communication, sound ranging, and position finding equipment and similar material as used by combat units of the U. S. Army.

For any of these three positions with the Signal Corps, secure Standard Form 57 from any first or second class postoffice and mail to Civilian Personnel Division, Fort Monmouth, N. J.

How Good Are REK-O-KUT Turntables?



Here's the Answer!

At the 1950 Audio Fair, the following Leaders in the Sound Equipment Industry used REK-O-KUT Turntables and Phonographs to bring out the best reproduction in demonstrating their own components.

ALTEC LANSING
AUDAK COMPANY
BELL SOUND SYSTEMS
ELECTRONIC WORKSHOP
HARVEY RADIO CO.
HUDSON RADIO & TV

LEONARD RADIO
MARK SIMPSON MFG. CO.
McINTOSH ENG. LABS.
PANORAMIC RADIO PROD.
PICKERING & COMPANY
RCA-VICTOR DIVISION
REEVES SOUNDCRAFT

SAT. REVIEW OF LIT.
STEPHENS MFG. CORP.
SUN RADIO & ELECTRONICS
TETRAD CORP.
TRIAD TRANS. MFG.
UNIVERSITY LOUDSPEAKERS

AND AGAIN AT THE 1951 AUDIO FAIR history repeated . . . The Industry's Leaders again turned to REK-O-KUT TURNTABLES for the same purpose.

-nuff said?

See and hear the entire line of REK-O-KUT Turntables, Phonographs and Disc Recorders, Rooms 636 & 637, at the Audio Fair, and at leading Music Stores, Radio Parts Distributors and Audio-Visual Dealers. Write for literature.

REK-O-KUT CO. 38-01 Queens Boulevard
Long Island City 1, N. Y.

NEED BACK ISSUES?

- | | |
|---|---|
| <input type="checkbox"/> June 1949 | <input type="checkbox"/> July 1950 |
| <input type="checkbox"/> September 1949 | <input type="checkbox"/> August 1950 |
| <input type="checkbox"/> December 1949 | <input type="checkbox"/> September 1950 |
| <input type="checkbox"/> January 1950 | <input type="checkbox"/> March 1951 |
| <input type="checkbox"/> February 1950 | <input type="checkbox"/> April 1951 |
| <input type="checkbox"/> March 1950 | <input type="checkbox"/> May 1951 |
| <input type="checkbox"/> June 1950 | <input type="checkbox"/> June 1951 |

1949 issues—\$1.00 each, 1950 issues—50¢ each, 1951 issues—35¢ each

Payment must accompany order.

Circulation Dept., Audio Engineering, 342 Madison Ave., N. Y. 17, N. Y.

McIntosh

... designed for the Audio Enthusiast
with the Professional Ear...

available from



Audio & Video

PRODUCTS CORPORATION

730 Fifth Avenue, New York 19, N. Y. • Plaza 7-3091

Exhibiting at the Audio Fair — Rooms 614 & 615

The World's Largest Distributor

of

Minnesota Mining & Mfg. Magnetic Tape

is the



Audio & Video

PRODUCTS CORPORATION

730 Fifth Avenue, New York 19, N. Y. • Plaza 7-3091

Exhibiting at the Audio Fair — Rooms 614 & 615

STATEMENT OF THE OWNERSHIP, MANAGEMENT, AND CIRCULATION REQUIRED BY THE ACT OF CONGRESS OF AUGUST 24, 1912, AS AMENDED BY THE ACTS OF MARCH 3, 1933, AND JULY 2, 1946 (Title 39, United States Code, Section 233) of AUDIO ENGINEERING, published monthly at Lancaster, Pa., for October 1, 1951.

State of New York }
County of New York } ss.:

Before me, a Notary Public in and for the State and county aforesaid, personally appeared Ladd Haystead, who, having been duly sworn according to law, deposes and says that he is the publisher of AUDIO ENGINEERING, and that the following is, to the best of his knowledge and belief, a true statement of the ownership, management, etc., of the aforesaid publication for the date shown in the above caption, required by the Act of August 24, 1912, as amended by the Act of March 3, 1933, and July 2, 1946 embodied in Sec. 34.38, Postal Laws and Regulations, to wit:

1. That the names and addresses of the publisher, editor, managing editor and business manager are: Publisher: Ladd Haystead, Wallkill, N. Y.; Editor: Charles G. McProud, 7 Peter Cooper Rd., New York 10, N. Y.; Managing editor: None; Business Manager: Henry A. Schober, 35 Dail St., New Hyde Park, N. Y.

2. That the owners are: Radio Magazines, Inc., 342 Madison Ave., New York 17, N. Y.; Dorothy S. Potts, 11 Madelyne Pl., Fairlawn, N. J.

3. That the known bondholders, mortgages, and other security holders owning or holding 1 per cent or more of total amount of bonds, mortgages, or other securities, are: None.

4. That the two paragraphs next above, giving the names of the owners, stockholders and security holders, if any, contain not only the list of stockholders or security holders as they appear upon the books of the company, but also, in cases where the stockholders or security holder appears upon the books of the company as trustee or in any other fiduciary relation, the name of the person or corporation for whom such trustee is acting, is given; also that the said two paragraphs contain statements embracing affiant's full knowledge and belief as to the circumstances and conditions under which stockholders and security holders who do not appear upon the books of the company as trustees, hold stock, and securities in a capacity other than that of a bona fide owner; and this affiant has no reason to believe that any other person, association, or corporation has any interest direct or indirect in the said stock, bonds, or other securities than as so stated by him.

(Signed) LADD HAYSTEAD, Publisher.

Sworn to and subscribed before me, this 5th day of October, 1951.

(Seal) HARRY N. REIZES, Notary Public.

State of New York, No. 24-3249550, Qualified in Kings County, Certs filed with Kings & N. Y. Co. Clk. Off. & Kings Co. Reg. Off. Commission expires March 30, 1953.

ROOM DESIGN

[from page 28]

timing with the same idea, absorbing furniture should be placed in the dead corner and reflecting furniture in the live end.¹⁰ Now it is apparent that the ideal listening position will be in the general vicinity of the dead corner and that this is the appropriate location for the room's center of interest such as a picture window, or a fireplace.

This design encourages a certain amount of reflection and diffusion to modify the loudspeaker's point-source effect, but not so much diffusion as to destroy a sense of direction necessary for realism. At the same time it promises good transient response with smooth growth and decay envelopes¹¹ by virtue of its simplicity and well considered proportions. *Figure 1* shows a possible listening room arrangement with a valence, and long upholstered window seat effectively "breaking up" this "dead" wall.

Many of the best reproducing systems use infinite baffles for speaker mounting. In this case it is desirable to vent the back wave into a separate room. This brings up special problems, and they should be considered at the time the floor plan of the house is being drawn up. The backwave room should be proportioned in the same way as the listening room so as to minimize standing waves. However, none of its dimensions should, for best performance, be equal to, or be even-submultiples of the listening room dimensions. It should, moreover, be treated with acoustic tile or some similar material to create as dead a volume as possible. Its volume should be great enough so that the reactance does not add stiffness to the moving system. Temperature and humidity should be maintained close to that of the living room, and it should be a seldom used room such as a garage, closet, storage, or heating plant room. The plan in *Fig. 2* shows one possible arrangement. It provides good sound insulation for the rest of the house through use of closets between rooms, acoustic wall treatment and oblique termination of hall, and massive masonry fireplace wall.

Admittedly there is much more that could be done to improve growth and decay envelopes. Walls could be arranged in non-parallel fashion, polycylindrical surfaces introduced to augment diffusion,¹² but one should remember this, the originating concert hall is introducing the same kind of distortion and the immediate audience is tolerant of it and would, in fact, miss it if it were not there. The relatively small amount of distortion that a well designed living room introduces can be tolerated

¹⁰ Ref. 3, p. 369.

¹¹ J. Moir, "New acoustic theories," FM-TV, Nov. 1950; also ref. 2, p. 794.

¹² Ref. 3, p. 399.

in the same light, because we are now fully aware that the orchestra is not sitting in our living room, but in a concert hall just outside our living room window.¹³

It seems reasonable to expect that the above treatment, though not extravagant, would produce a fully satisfactory room from the standpoint of acoustics, and meet as well the requirements of a modest home.

REFERENCES

1. Olson, "Elements of Acoustical Engineering."
2. Beranek, "Acoustic Measurements."
3. Knudsen, "Acoustic Design in Architecture."
4. Knudsen, "Architectural Acoustics."

ADDITIONAL READING

R. H. Tanner, "Impact of acoustics on music," *AUDIO ENGINEERING*, Nov. 1950.
 Beranek, (Ref. 2): Decay rate and envelope, Chap. 18; energy due to reverberations vs. distance from source, p. 673.
 Olson, (Ref. 1): Chapter 12; radio performance in a living room, p. 427.
 Knudsen, (Ref. 3): Reverberation in coupled spaces, p. 161; random spacing of studs behind wood panels, p. 345.

¹³ P. G. A. H. Voigt, "A controversial idea," *AUDIO ENGINEERING*, October, 1950.

Quietest 16-mm Camera Introduced in Hollywood



So quiet is the new Auricon 16-mm sound-on-film camera that red signal lights are required to indicate to the cameraman and performers that it is in operation. No "blimp" or other soundproof enclosure is required.

Designed for use where highest professional standards prevail, the "Super-1200" is available both as a picture-taking camera only, and equipped with recording galvanometer and amplifier for making high-quality single-system sound-in-film, recording the sound track and picture simultaneously.

Optical features include three separate finder systems and variable shutter for fades and exposure control. Film capacity is 1200 ft., permitting 33 minutes of continuous running time.

Sylvania Offers FULL-LINE of High Quality Sockets

Sylvania now offers a full line of sockets for military and civilian requirements, manufactured in accordance to JAN and RMA specifications. Available in General Purpose and Low Loss Phenolics and Steatite, with any combination of contact materials.

Available types include 7- and 9-pin Miniature, Turret, Octal, Duo-Decal, etc., sockets. For complete descriptions write today for new illustrated catalog to: Sylvania Electric Products Inc., Dept. A-1311, Parts Sales Division, Warren, Pa.

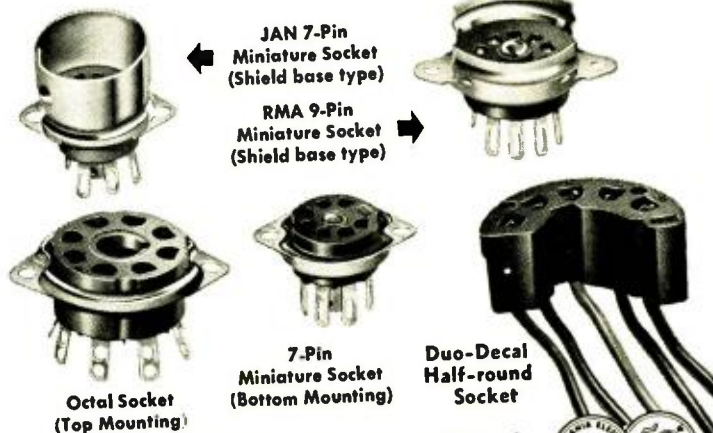

SYLVANIA
 RADIO TUBES; TELEVISION PICTURE TUBES; ELECTRONIC PRODUCTS; ELECTRONIC TEST EQUIPMENT; FLUORESCENT TUBES, FIXTURES, SIGN TUBING, WIRING DEVICES; LIGHT BULBS; PHOTOLAMPS; TELEVISION SETS

ANNOUNCING

Unusual Opportunities in SOUTHERN CALIFORNIA

Senior men with degrees and several years of proven accomplishment may achieve further personal growth by working with some of the nation's outstanding scientists in the West's largest laboratories.

CHALLENGE AND OPPORTUNITY

for physicists and engineers in the fields of electron tubes, computers, precision electronics, solid state, system analysis, servo-mechanisms, radar, guided missiles, microwaves.

HUGHES LABORATORIES OFFER

- New Air-Conditioned Buildings With the Finest Modern Laboratory Facilities and Equipment.
- Solid Long-Range Plans For a Continuing Future.
- Intriguing Vital Defense Projects Plus a Strong Program For Advanced Development of New Peacetime Products.
- Company-Sponsored Program For Advanced Education.
- Excellent Employee Benefits.
- Frequent Salary Reviews.

AMPLE GOOD HOUSING AVAILABLE

Send Resume To

HUGHES RESEARCH AND DEVELOPMENT LABORATORIES
 Culver City, Calif.

JULES J. BRESSLER

MANUFACTURERS' REPRESENTATIVE

Representing

The Radio Craftsmen, Inc.

Hi-fidelity T.V. and

Hi-fidelity Tuners

Atlas Sound Corp.

Mike Stands and Horns

Rauland-Borg Corp.

Hi-fidelity Amplifiers

The Rauland Corp.

Hi-Fidelity TV Tubes

1780 Broadway

New York 19, N. Y.

PLaza 7-2689

Carduner-Lichter Co.

Manufacturers' Representatives

Intensive coverage of
New York Metropolitan Area

Specialists
in Audio Equipment Sales

William Carduner

Eugene Carduner

William Lichter

Edward Kleeman

164 Duane St.

New York 13, N. Y.

BARclay 7-0210

The "Rep" and his Place in Audio

THE PHENOMENAL GROWTH of public interest in high-quality reproduction of music, and the resultant expansion in the market for audio equipment, is due in no small measure to the efforts of the manufacturers' representative. Strictly a behind-the-scenes operator—seldom seen by the ultimate consumer of the equipment he sells—the "rep" is the man who engineers the placement of new speakers, amplifiers, tuners, and the like, on jobbers' shelves, then works shoulder-to-shoulder with each jobber's own salesmen in developing a demand for them.

Because the representative relieves the manufacturer of sales overhead he is one of the industry's great economy factors. Without his presence the manufacturer would be forced to carry a large sales payroll which, in the long run, would be reflected in higher prices to the consumer. This in turn would result in reduced sales volume and a corresponding loss in manufacturing efficiency. It can be seen from this that the "rep" is truly an essential entity if economical merchandising is to be achieved.

Listed below are prominent representatives in metropolitan Eastern markets.

CONNECTICUT

Andover

Seyd, Ernest K.
Long Hill Road

East Haven

Steel Associates, Joseph R.
22 Green Garden Court

Hartford

Hatton & Company, Arthur T.
955 Asylum Street

Kahn & Company, Irving J.
3324 Main Street

H.D.Q. & H. V. Neff
66 Deerfield Avenue

Meriden

Lavin Associates, Henry
P. O. Box 196

Ridgefield

Hustis, Walter C.
Florida Road

Stamford

Biggs & Co., J. Alan
Overbrook Drive

MARYLAND

Baltimore

Goodman, Sol W.
32 W. Biddle Street

Martin, Ed
1105 Barclay Street

Willou Sales Engineering Co.
Maxalea Drive, Maxalea Village

Silver Spring

Lienau, Charles W.
10203 McKenney Avenue

Taylor Co., Morris F.
8416 Georgia Avenue

Towson

J-H Electronic Sales Co.
P. O. Box 6844

MASSACHUSETTS

Arlington

Goss Company, Jack
26 Gloucester Street

Beverly

Kelly & Company, Wm. T.
90 Lothrop Street

Boston

Akerboyd, Arthur E.
John Hancock Building

Anderson Sales Company
172 State Street

Chamberlin, Harold A.
31 Milk Street

Gerber Sales Company
30 Boylston Street

Gibson Engineering Company
1018 Commonwealth Avenue

Green, Dan

2311 John Hancock Building

Hannigan, Walter T.
43 Leon Street

How, Inc., J. Duncan
Statler Office Building

Parker, Blair H.
610 Atlantic Avenue

Perron Company, Ray
131 Clarendon Street

Reynolds Company, Harrison
313 Washington Street

Scheele, George R.
Hotel Bradford

Segel Company, Henry P.
143 Newbury Street

Sturgeon, Paul R.
25 Huntington Avenue

Thacher Brothers
458 Statler Office Building

White Sales Company
10 High Street

Cambridge

Holliday-Hathaway Company
238 Main Street

Roxbury

Herman, Norm
55 Lawrence Avenue

Scituate

Hendrickson, William A.
1st Parish Road

Waltham

Waters, Inc., Robert A.
4 Gordon Street

Wellesley Hills

Pray Sales, W. B.
18 Brewster Road
Scott Company, Michael
90 Edmunds Road

NEW JERSEY

Camden

Foley, Andrew A.
640 Federal Street

Keefe Electronic Sales Company
539 Market Street

Haddonfield

Schottenberg, Ray T.
152 Merion Avenue

Hoboken

Simberkoff, S. W.
68 Hudson Street

Newark

Ceri & Company, Art
744 Broad Street

Gawler-Knoop Company
1060 Broad Street

Miller, Harry
1180 Raymond Boulevard

For

intelligent and sincere

DISTRIBUTOR and

INDUSTRIAL

representation

Covering metropolitan New York
and northern New Jersey

WILLGOLD
ELECTRONICS SALES CORP.
7806 Empire State Bldg.
New York 1, N. Y.

Schenck, LeRoy
31 Clinton Street

Ridgewood
Finlay, Robert
104 Brookside Avenue

Rutherford
Sanford-Schermerhorn
202 Woodland Avenue

NEW YORK

Bayside
Turney & Beale
40-08 Corporal Kennedy Street

Binghamton
Kimstark
3 Mather Street

Buffalo
Costello, J. V.
547 Ellicott Square Building
Farber, Maury
157 Hartwell Road
Fillmore & Fillmore
259 Delaware Avenue
Hansen, Bert A.
1124 Prudential Building
Mitscher Company, R. W.
487 Ellicott Square Building
Wink, Willis
235 Hendricks Boulevard

DeWitt
Taylor Company, Inc., Frank W.
P. O. Box 316

Fayetteville
Andrews, Martin P.
Matt Road

Jackson Heights
Landis & Associates, Cliff
81-11 Roosevelt Avenue

BLAIR STEINBERG COMPANY

Manufacturers Representatives

Specializing in Sound for Over 20 Years

Seven men covering
New York State, Metropolitan New York, New Jersey,
Eastern Pa., Delaware, Maryland, Washington, D. C.
and Virginia

Can we serve you

BLAIR STEINBERG COMPANY

395 Broadway

New York 13, N. Y.

WOOrth 4-7321-2-3-4

SERVICE IS OUR BUSINESS
In The Six New England States



Henry Lavin Associates
ELECTRONIC SALES ENGINEERS



P.O. Box 196, Meriden, Conn., Phone 7-4555
Branch: Needham, Mass.

MICHAEL SCOTT CO.

NEW ENGLAND

Representative For

Audax
POLYPHASE
reproducers

*"The Standard by which Others
are Judged and Valued"*

GARRARD

3 SPEED RECORD CHANGER



David Bogen

db **CO., INC.**

663 BROADWAY, NEW YORK 12, N. Y.
AMPLIFIER SYSTEMS & ACCESSORIES

PEERLESS TRANSFORMERS

MANUFACTURERS:

Seeking excellent representa-
tion for your sound equipment
in the New England states?

Contact

MICHAEL SCOTT CO.

90 Edmunds Rd.

Wellesley Hills 82, Mass.

Wellesley 5-0102

FREE!

Send Now! FOR
NEW HIGH FIDELITY
GUIDEBOOK

Full of Solid
Information!

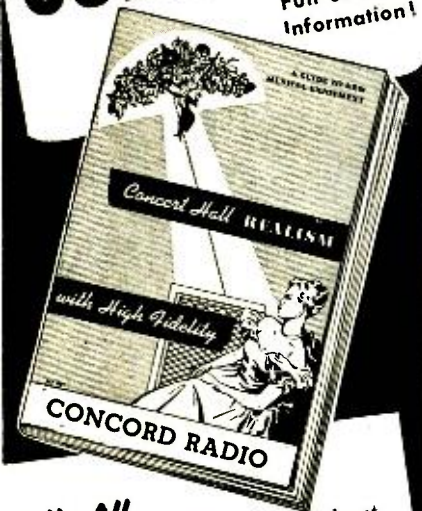

Tells All
the things you want to know about High Fidelity! Explains how to bring concert hall realism into the home. Tells what makes a real Hi-Fi Music System. Explains how to select individual components or complete ensembles. Pictures various types of installations — shows how easily you can have your own custom Hi-Fi System at modest cost! Illustrates and describes a complete range of the finest nationally known Hi-Fi units on the market. Prepared for the new enthusiast and for the advanced High Fidelityist. • Send for your FREE Hi-Fi Guidebook today!

GET BIG NEW 1952 CATALOG



OF TV • RADIO • ELECTRONICS
Concord's all-new, complete Buying Guide will save you time and money! Brings you page-after-page of the latest values in world-famous guaranteed parts and equipment for every need! Send today for your FREE copy!

CONCORD
RADIO CORPORATION
901 W. JACKSON BLVD. • CHICAGO 7

CONCORD RADIO CORP., Dept. AL-51
901 W. Jackson Blvd., Chicago 7, Ill.

- Rush FREE High Fidelity Guidebook
 Rush FREE Big, New 1952 Catalog

Name _____

Address _____

City _____ Zone _____ State _____

Long Island City
Hicks, William M.
23-09 Bridge Plaza No.

New York City
Aaron, Paul D.
120 Liberty Street
Adelman Company, Leon L.
25 Chittenden Avenue
Bialek Associates, Samuel
205 E. 42nd Street
Blittan Company, D. R.
53 Park Place
Blair Steinberg Company
395 Broadway
Bressler, Jules J.
1780 Broadway
Brown, Jack
1631 Walton Avenue
Burlingame Associates
103 Lafayette Street
Camber, Marty
30 Dongan Place
Carduner Sales Corporation
164 Duane Street
Cooper-DIBlasi
259 W. 14th Street
Egert & Fields Company
11 Park Place
Erde, S. S.
130 Lafayette Street
Forslay, John M.
27 Park Place
Freed & Company, Leo
420 Lexington Avenue
Friedman Company
220 E. 23rd Street
Hughes, Kenneth E.
17 W. 60th Street
Joseph, Ben
551 Fifth Avenue
J.T.L. Sales Company
120 Liberty Street
Kopple Associates, John J.
60 E. 42nd Street
Land-C-Air Sales Company
1819 Broadway
Mack, Kaelbar & Mack
1270 Broadway
Maslin Company, O. F.
17 E. 42nd Street
Morse, Irv
150 Broadway
Pickett, James M.
12 E. 78th Street
Progressive Marketers
41 Union Square
Rockbar Corporation
13 E. 40th Street
Rutt, William
401 Broadway
Roye Sales Agency
11 Warren Street
Sachs, M. A.
15 E. 26th Street
Saffler, Perry
53 Park Place
Schmitt Company, F. Edwin
136 Liberty Street
Schwartz, Adolph
220 Broadway
Shaw Company, S. A.
101 Park Avenue
Skidmore & Company, W. K.
20 Vesey Street
Smith, Howard F.
259 W. 14th Street
Sonkin, David
1775 Broadway

CLASSIFIED

Rates: 10c per word per insertion for noncommercial advertisements; 25c per word for commercial advertisements. Rates are net, and no discounts will be allowed. Copy must be accompanied by remittance in full, and must reach the New York office by the first of the month preceding the date of issue.

FOR SALE: New American Amplifier, Model AC-DC 100, \$180; new Stromberg-Carlson amplifier, Model 37, at \$45; Presto Recorder, Model K, like new, \$200; Altec 604B Loudspeaker in console cabinet, \$180; Universal Professional magnetic cutting head, only \$60. John Unfried, 33 Westfield Rd., Buffalo 21, N. Y.

RAYTHEON console RR-30 three-channel mixer and program amplifier with separate supply unit for news and auxiliary control. Perfect condition, \$265. National Academy of Broadcasting, 3338 16th St., N.W., Washington 10, D. C.

FOR SALE: Rek-O-Kut 743 three-speed turntable, used only 20 hours, perfect condition. Price \$40. WANTED: W.E. 794 driver and W.E. 754A speaker. Tony Hofmann, 48 Myrtle Ave., Cambridge, Mass.

THE AUDIO EXCHANGE buys, sells, exchanges, or lists used tuners, amplifiers, speakers, changers, recorders, etc. of high quality in perfect condition. Catalogue on request. 159-19 Hillside Ave., Jamaica 32, New York. Olympia 8-0445.

PICKERING EQUIPMENT, 15% DISCOUNT! Skalamera, 435 E. 74th St., New York 21, N. Y.

FOR SALE: Altec 604 Duplex Speaker in 605 cabinet. Excellent condition, \$150; cost \$330. H. Goddard, Fitzwilliam, N. H.

FOR SALE: Brush Magnetone BK 303, 3-hour wire recorder, demonstrator, \$295. Air-Tone Sound & Recording Co., 1527 Chestnut St., Philadelphia 2, Pa.

STEPHENS 108 tweeter, new, unused, \$45. Rauland 25-watt hi-fi amplifier, 3 months old, excellent condition, with front end and equalizer, \$60. R. Bennis, Box CV-1, Audio Engineering.

HELP WANTED

See Employment Register
page 69

PROFESSIONAL DIRECTORY

C. J. LEBEL

AUDIO CONSULTANT

Development, Test, Custom Equipment,
Complete Laboratory and Shop Facilities

133 WEST 14TH STREET
NEW YORK 11, N. Y.
CH 3-8082

Custom-Built Equipment

U. S. Recording Co.

1121 Vermont Ave., Washington 5, D. C.
Lincoln 3-2705

Sussman, Jules & Company
130 Lafayette Street
Tobias & Company, D. F.
30 Church Street
Weber Associates, Jack
154 Nassau Street
Wesharp Sales Corporation
225 W. 34th Street
Willgold Electronic Sales Corporation
7806 Empire State Building
Woolf Associates, Irving W.
135 Liberty Street

Orchard Park
Ball Associates, Inc.
58 E. Quaker Road

Rochester
Wolfe-Marsey Sales Company
74 Park Avenue

Syracuse
Allen, Inc., Leonard D.
2401 S. State Street
Andrews & Andrews
521 Cumberland Avenue
Swank, Wally B.
400 Cherry Road

PENNSYLVANIA

Glenside
McKinley Company, J. E.
549 Crescent Avenue

Havertown
Fairbanks, Howard J.
1733 Academy Lane

Jenkintown
Hilliard, Dixey M.

Narbeth
Jeffries, Samuel A.
105 Forrest Avenue

Philadelphia
Braddock, Edward
825 Western Savings Fund Building

Connor Company, Dan J.
1036 Broad Street Station Building
Estersohn, Harry
395 E. Cliveden Street

Friedman, Martin
1006 Western Savings Fund Building

LeBan, Albert D.
218 Lloyd Lane

Lewis, Herman
1622 68th Avenue

Lowery, Inc., L. D.
1343 Arch Street

MacDonald, Inc., S. K.
1531 Spruce Street

Maguire & Company, J. A.
522 Drexel Building

Orsi, John F.
605 Manhattan Building

Peckham & Densham
1414 S. Penn Square

Stratton Company, C. H.
2601 N. Broad Street

Technical Representation
506 Wyndmoor Avenue

Trinkle, Wilmer S.
2601 N. Broad Street

Pittsburgh
Burke Electrical Equipment Company
416 Maple Avenue

Clark Company, Russell F.
1404 Clark Building

Podolny, James H.
4716 Coleridge Street

Stover Company, S. H.
5495 Penn Avenue

Tanner & Covert
600 Grant Street Building

Weller Agency, Roy
620 Penn Avenue

MEET THE FINEST audio amplifier ever built, at any price. Its name: the Craftsman 500, with the famous Williamson all-triode circuit. We had to invent a new word to describe its 99.99%* distortion-free performance. The word is ULTRA-FIDELITY. Hear the "500" and you'll know why.



C500 Amplifier Features

* Freq. response: ± 0.1 db., 20 cps to 20,000 cps; ± 2 db., 5 cps to 100,000 cps.
* Power response: 12 watts ± 2 db., 10 cps to 50,000 cps.

* Total H Distortion: Less than 0.1% at 10 watts, at mid-freqs.

* 0.01% at av. listening level below 1 watt.

* Tube complement: (2) 6SN7GTA; (2) KT66 power output; 5Y4G rectifier.

for information, write

THE RADIO

craftsmen

INCORPORATED

Dept. A-11, 4401 N. Ravenswood Ave., Chicago 40, Ill.

STILL AVAILABLE

ULTRASONIC FUNDAMENTALS

By S. YOUNG WHITE

The rapid increase in the use of ultrasonics during the last few years makes it natural that the well-informed sound engineer should want to learn something of the applications and potentialities of this amazing new field. But interest in ultrasonics is not confined to the sound engineer—it is of still greater importance to the industrial engineer for he is the one who will visualize its uses in his own processes.

Elementary in character, ULTRASONIC FUNDAMENTALS was written originally as a series of magazine articles just for the purpose of acquainting the novice in this field with the enormous possibilities of a new tool for industry. It serves the double purpose of introducing ultrasonics to both sound and industrial engineers. The list of chapter headings will indicate how it can help you.

CHAPTER HEADLINES

Too Much Audio. Opportunities in Ultrasonics. Elements of Ultrasonics. Experimental Ultrasonics. Coupling Ultrasonic Energy to a Load. Ultrasonics in Liquids. Ultrasonics in Solids. Testing by Ultrasonics. High-Power Ultrasonics. Notes on Using High-Power Ultrasonics. Applications of Ultrasonics to Biology. Economics of Industrial Ultrasonics.

The applications of ultrasonics have already extended to many industries, and as its possibilities are explored they will increase a hundredfold. To keep abreast of its growth, engineers in all fields must know what they may expect from ultrasonics, how it is used, how the energy is generated, and the techniques of applying ultrasonic treatment to many processes.

ULTRASONIC FUNDAMENTALS

By S. YOUNG WHITE

36 pages, 40 ill., 8½ x 11, paper cover \$1.75

Book Division, Dept. A
RADIO MAGAZINES, INC.
342 Madison Avenue New York 17, N. Y.

Leon L. Adelman
COMPANY

SINCE 1921 . . .
representing leading
manufacturers in
Metropolitan New York

The TOP QUALITY
in Audio Lines:

PICKERING—Cartridges

PERMOFLUX—Speakers

AM-FM ESPEY—Tuners

Baffles—LOWELL

L & T Pads—CLAROSTAT

Carried in stock by
the BEST DISTRIBUTORS

25 Chittenden Avenue
New York 33, N. Y.
TOMPkins 7-1145

Midtown office: 205 E. 42nd St.
Room 1404, MURray Hill 9-2518
MORRIS FISCHel—GEORGE HIGGINS

**SAVE
33 1/3%**



**This is our
GROUP SUBSCRIPTION PLAN**

You and your friends and co-workers can now save up to \$1.00 on each subscription to AUDIO ENGINEERING. The more men in a Group, the more each saves. If you send 6 or more subscriptions for the U.S.A. and Canada, they will cost each subscriber \$2.00, 1/3 less than the price of a regular 1-year subscription. Present subscriptions may be renewed or extended as part of a Group.

AUDIO ENGINEERING is still

- The only publication devoted entirely to Audio—
- Recording
- Broadcasting equipment
- Acoustics
- Home reproduction systems
- PA systems
- Psychoacoustics

(Please print)

Name

Address

Position Company

Name

Address

Position Company

Name

Address

Position Company

Name

Address

Position Company

Name

Address

Position Company

Name

Address

Position Company

Add \$.50 to each Foreign subscription ordered

RADIO MAGAZINES, INC.

342 Madison Ave., N. Y. 17, N. Y.

audio techniques

[from page 6]

and R_1 loads the filter properly to prevent a peak before cut-off begins. R_2 may be a fixed resistor or a volume or loudness control.

The enclosed curves, taken with a

Hewlett-Packard audio signal generator and a Ballantine meter, show the possible variation. The circuit can be inserted in any amplifier at the low gain input point. If a reluctance pickup is used, this tube can follow the pre-amp stage. It is also adaptable to a control stage located remotely from the main amplifier since the cathode follower permits a long line without loss or hum pickup.

Tape Recorder Remote Control

RAYMOND LUCIA*

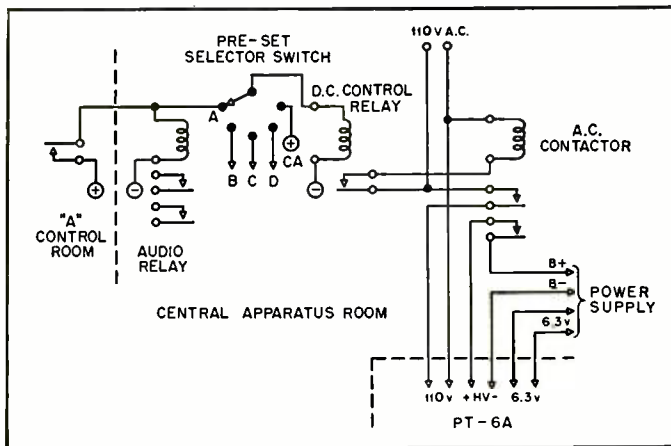

Fig. 1. Schematic of method of arranging controls to start tape recorder remotely.

A RADIO BROADCAST STATION, to operate "in the public interest, convenience and necessity" must be prepared to broadcast during disasters of fire, flood, storm or in event of failure of power or wire lines. Sometimes, things happen so quickly that circuits cannot be cleared for immediate broadcast, and in this event, tape recorders are particularly valuable to take down the emergency program, news flash, or unanticipated special event.

To aid in better serving our listeners, WHAM has installed two rack-mounted PT6A Magnecorder Tape Recorders which can be remotely controlled from any control room in the studio building, or which might be operated manually from the Central Apparatus Room. The recorders are fed through the proper equalizers directly from the audio dis-

* Audio Engineer, WHAM, Rochester, N. Y.

tribution system and, thus, can be placed under control of the control room distribution key switches.

The two recorders are kept loaded

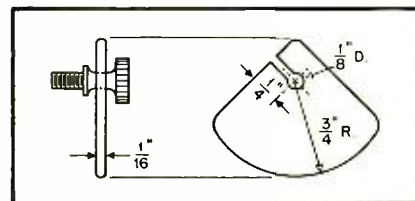

Fig. 2. Details of cam used to hold pressure roller off the capstan until machine is started.

with tape, ready to go at any time. When the proper key in the control room is thrown to feed audio to a recorder, d.c. is also fed through a selector switch to operate a control relay, which in turn, actuates an a.c. contactor, supplying



Fig. 3 (left). Cam in "ready" position on Magnecorder. Fig. 4 (right). Cam in idling position after machine is started.

THE



High Quality
AUDIO AMPLIFIER . . .

ALL TRIODES

Distortion and intermodulation extremely low

Wide frequency range, flat from 20 to 20,000 cycles within .5 db

Attractive remote-control pre-amplifier

Compensation for various inputs; Phono, Tuner, Television or Microphone

Exclusive BROOK circuits and transformers

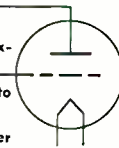

YES, ALL THESE FEATURES . . . but primarily LISTENING PERFORMANCE heretofore not achieved



Write for free Technical Bulletin, detailed Distortion Analysis & booklet "Better Listening"

BROOK ELECTRONICS, INC.

34 DOWART PLACE, ELIZABETH 2, NEW JERSEY Dept. AL-1

1st choice

STEPHENS FINE COMPONENTS FOR 2-WAY SYSTEMS

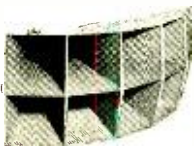

Those who demand the finest in sound reproduction...who want true-to-life tones, specify Stephens Tru-Sonic high fidelity components in their two-way systems. Custom set builders, manufacturers of fine sets and theatres rely on Stephens because there's such a wide selection of components to fit every space requirement and price range. Stephens Tru-Sonic components are available in crossover frequency ranges from 400 to 3500 cps. The low frequency driver, high frequency driver, crossover network and 2x5 horn shown here are only a few representative items available under the Stephens brand.

See you at Room 642 N. Y. Audio Fair

Write for catalog K-1 and installation instructions.

STEPHENS MANUFACTURING CORPORATION
TRU-SONIC

Pioneer name in high fidelity reproducing equipment

8538 WARNER DRIVE, CULVER CITY, CALIFORNIA

both power to the recorder and plate voltage to the biasing oscillator, as shown in Fig. 1.

For remote control, the PT6A control knob must, of course, be left in the "forward" position, which normally would cause the rubber pressure roller to press against the drive capstan. To guard against damage to the roller when left in this position for long periods, during which the recorder is ready for immediate use, a small aluminum cam is used. Its dimensions are as shown in Fig. 2. The cam is attached to the screw on the pressure roller by slotting the aluminum just enough to slip on the screw and then pinching it together again. This allows it to swing loosely on the pressure roller mounting screw. When the recorder is set up for stand-by with the control knob in the "forward" position, the cam rests as is shown in Fig. 3. Its dimensions are such that, in this position, the rubber roller is lifted from the capstan. When the recorder is remotely started, the capstan rotates clockwise, causing the cam to roll out, dropping the pressure roller into contact with the capstan for normal drive as shown in Fig. 4. After the recording is completed, it is necessary to rewind and remove the tape. The recorder is then manually set up again in the stand-by position. The shape and weight distribution of the cam is such that when the control knob is turned to the "stop" position, it falls between the two centers of rotation, ready to hold the rubber roller away from the capstan when the control knob is again thrown to "forward."

This little device, together with the circuit arrangements, is another example of how broadcasters fit many commercial products to their own particular needs. Similar arrangements can undoubtedly be fitted to other types of recorders with the exercise of a little mechanical ingenuity.

Sprinkle Visits Rainless South



Notwithstanding a record heat wave, the SRO sign went up wherever Melvin C. Sprinkle, prominent audio engineer, appeared during a recent speaking trip through the South.

Mr. Sprinkle, who is associated with the Peerless Transformer Division of Altec Lansing Corporation, made the tour to promote interest in high-quality audio. He is shown above addressing the electronic engineering department of the Navy Mine Station in Pensacola, at a session arranged by Floyd Grice, Florida jobber.

Air-Tone
HEADQUARTERS FOR SOUND EQUIPMENT

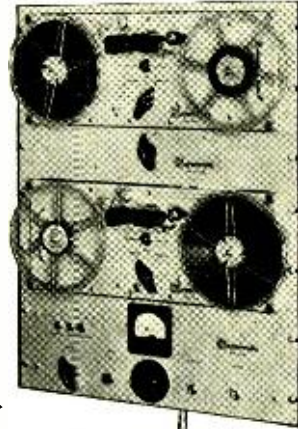

MAGNECORD RECORDER & AMPLIFIER

Complete Systems from \$564.00
In stock model PT6-S Portable Power Supply \$251.00 NET



NEWCOMB AMPLIFIER

Complete line of High Quality Amplifiers, from small single units to large rack installations



ELECTRO-VOICE SPEAKERS
From \$27.00 to \$756.00 NET

Air-Tone
SOUND AND RECORDING CO.
1527 CHESTNUT ST.
PHILA. 2, PA. • RI-6-8388

Acrosound ★

ULTRA LINEAR AMPLIFIER CIRCUIT

(as described on Page 15)

WILL BE DEMONSTRATED AT
THE AUDIO FAIR IN THE

Acro Products Co.
exhibit (Room 549)

The Ultra Linear Circuit *plus* the Finest Output Transformer ever designed, the Acrosound TO-300*, provide the finest quality reproduction in every respect — by measurement or listening tests!

* Acrosound TO-300—\$24.75 net

Potted in seamless steel
gray hammerloid case.

Price F.O.B. Phila.

25% deposit
with C.O.D.'s

* Pat. Pending

Acro Products Company

369 Shurs Lane, Roxborough, Phila. 28, Pa.

Industry People...

Herman Holstein, formerly with Hudson Radio & Television Corp., is now ad manager of Lafayette Radio—first assignment is production of new Sound catalog in time for distribution at The Audio Fair . . . **Walter O. Stanton**, president of Pickering & Company, announces appointment of **George F. Petetin** as assistant sales manager . . . **M. J. Yahr** is new manager of RCA Sound Products Sales Group—formerly theater sales rep in Chicago area . . . **Harrison Johnston**, formerly with GE, has joined Ampex Electric Corp. as manager of newly-created Product Engineering Division.

National Research Corp. has engaged **Dr. Thomas R. Steadman** as member of Petrochemicals Research Department . . . **Otto H. Schade** of RCA Tube Department awarded David Sarnoff Gold Medal Award at semi-annual SMPTE convention—winner of Progress Award is **Earl I. Sponable** of 20th Century Fox—Journal Award shared by **A. B. Jennings**, **W. A. Stanton** and **J. P. Weiss** . . . **Paul Eckstein**, Hallcrafters sales manager, has resigned to open own manufacturers' rep organization with offices in Pure Oil Building, Chicago.

Capt. A. Lyson has completed one-year tour of duty with Army and returned to T.A.B. Engineers, Inc. as sales manager . . . **Russell O. Hudson**, president, Magna-Crest Corp., announces appointment of **George Hamill, Jr.** as sales executive . . . **Joseph A. Tannev**, head of S.O.S. Cinema Supply Corp. enjoying month's combined vacation and business trip covering entire country.

New York chapter of "The Representatives" has elected **James M. Pickett** president for the coming year—other newly-elected officers are **Harry Finkelstein**, vice-president, and **Wally Shulan**, secretary-treasurer . . . Chicago chapter of same group announces election to membership of **Roger Clark**, **Dave Dolin**, **Ralph Sullivan**, **Wesley Wilson** and **Frank Gassner** . . . **Palmer Craig** is new vice-president-engineering of the Television and Radio Division of Philco Corp. . . . New works manager for Potter and Brumfield is **Dale Cropsey**, formerly with Standard Coil Products, Inc.

Henry P. Argento has been upped to assistant vice-president of Raytheon Manufacturing Company—will function as assistant manager of Power Tube Division . . . **C. G. Barker** has been named as president of Magnecord's new international subsidiaries . . . **M. A. Chapman**, president, Mica Insulator Co., elected to head Mica Fabricators Association at annual meeting—vice-presidents are **Julius Cantor** of Mica Fabrication Co. and **Sidney A. Montague** of Spruce Pine Mica Co. . . . Stockholders of Scott Radio Laboratories, Inc., have elected **R. C. Freytag**, vice-president, as fifth member of company's board of directors—additional officers chosen at annual meeting are **John S. Meck**, president; **L. M. Sandwick**, v.p. and sales manager; **R. G. Eggo**, secretary, and **P. E. Schuecking**, treasurer.

John F. (Jack) Pero is new addition to sales staff of Blair-Steinberg Co. . . . GE has appointed **J. B. Parr** manager of sales training for Receiver Department, and **R. M. Lutz** supervisor of co-operative advertising . . . **Dr. Raymond C. Machler** is new director of research and member of the executive committee of Leeds & Northrup Co. . . . **Dr. Harry G. Mitchell** has been recalled to his World War II post as chief, Carbon Products Section of NPA—on indefinite leave from Speer Carbon Co. . . . **Samuel J. Spector** sets longevity record by rounding out full thirty years as president of Insuline Corp. of America.

Sylvania announces election of **Barton K. Wickstrum** to post of v.p. and director of sales—succeeds **Robert H. Bishop** who has resigned to join E. P. Drew & Co. in executive capacity—**Charles A. Burton** takes over Wickstrum's old job as general sales manager of Lighting Division . . . **John Martin**, chief CBS producer for color TV, back from Paris where he masterminded demonstration for French notables . . . **V. E. Wolfgang**, formerly chief buyer for Webster Electric Co. has joined Oxford Electric Corp. as general sales manager . . . **Harold R. Terhune**, formerly v.p. of Mycalex Tube Socket Corp. is new administrative engineer at Federal Telecommunication Laboratories.

Charles A. Hansen, president of Radio Paris & Electronic Equipment Shows, announces committees for the 1952 Parts

Electronic Engineers

Electronic Engineer Section Head

- Audio Experience Required with a B.S. in E.E.
- Prefer man with several years design in amplifiers, networks, equalizers and control circuits
- Section Head must have had previous supervisory experience

Excellent positions open in our laboratories for qualified personnel

Send complete resume to

Personnel Department
GRAY MANUFACTURING CO.

16 Arbor Street
Hartford, Conn.

Originators of the Pay Station Telephone

BRITISH IMPORTS

ADVANCE AUDIO GENERATOR

Sine and square wave. 15 to 50,000 cps \pm 1% or 1 cps in 3 ranges. Output Sine-Wave 20 μ v. to 20 v. \pm 1 db, under 1% distortion. Square Wave 40 μ v. to 40 v. with rise to 90% of peak in 3 μ secs. This generator has the performance of many costly laboratory instruments. Price \$115.00

BAKERS LOUD SPEAKERS

Information on new 12" and 18" speakers will soon be released.

PARTRIDGE TRANSFORMERS

Output transformers CFB and WWFB now available from stock. \$35 and \$25, respectively, post prepaid.

WILLIAMSON AMPLIFIERS

An announcement will be made shortly regarding this amplifier and control unit.

PUBLICATIONS

"The Williamson Amplifier" 30-page manual \$1.00
Annual subscriptions to Wireless World \$4.50

For Orders or Further Information
apply

BRITISH RADIO INDUSTRIES

Importing Agency

ONE THOMAS CIRCLE, WASHINGTON 5, D. C.
TELEPHONE METROPOLITAN 6564

1952 Edition Ready!
Sun Radio's Original
"Audio Equipment Handbook"

FREE

- *Most Widely Read
- *Most Widely Imitated
- *Most Widely Requested

Again, SUN RADIO brings you a new edition of this valuable handbook acclaimed by thousands of Music Lovers as the "Bible" for high-fidelity home music reproduction.

New down-to-earth information for the audio enthusiast. NEW IDEAS -- NEW SYSTEMS -- NEW METHODS.

First distribution at the Audio Fair, Nov. 1st, 2nd, 3rd, Hotel New Yorker, N. Y. C.

SUN RADIO'S EXHIBIT IN ROOM 601.

Sun Radio
& ELECTRONICS CO. INC.

122-K Duane St. • New York 7, N. Y. • BRclay 7-1840

Open Daily 9-6, Sat. 9-4:30,

WHY WILL YOU CHOOSE YOUR TAPE RECORDER?

Q. Higher Fidelity and Smoother Performance?

A. THEN BUY TWIN-TRAX!*

Q. Longer Continuous Playing Time?

A. THEN BUY TWIN-TRAX!*

Q. Professional Specifications at Popular Price?

A. THEN BUY TWIN-TRAX!*

Q. Wider Selection of Models?

A. THEN BUY TWIN-TRAX!*

No matter which of these features you consider most important. You'll find them all—and many other exclusive features—in our Twin-Trax Recorders. Send today for your free copy of our Catalog #5272. *Reg. U. S. Pat. Off.

AMPLIFIER CORP. OF AMERICA

398 Broadway, New York 13, N. Y.

If you are moving, you must notify our Circulation Department at least 5 weeks in advance. The Post Office Dept. does not forward magazines sent to wrong destinations unless you pay additional postage, and we can NOT duplicate copies sent to you once. Please give old and new addresses.

RADIO MAGAZINES, INC.

342 Madison Ave.
New York 17, N. Y.

No other Mike Stands
OFFER SO MUCH AS
ATLAS

*the COMPLETE
STUDIO LINE*

MAXIMUM STABILITY: Maximum base mass is concentrated at outer periphery. Bases are self-leveling, shock-absorbing, anti-tip, anti-scratch.

MAXIMUM QUIET AND EASE: Special Full-Grip, Valve-Action clutches, inner-lined with wear-proof locking coils, function smoothly at slight pressure, yet cannot creep, jam, rasp, jolt or jor.

MAXIMUM WEAR: Heavy oversized tube assemblies are super-chrome plated for highest durability.

MAXIMUM VARIETY: Floor or table, boom, orchestra or collapsible types—there's an ATLAS stand for your every studio need.

COMPARE ATLAS at your distributor TODAY. See why more studios specify ATLAS than any other line. Write NOW for FREE latest Catalog 551.

ATLAS also leads in the manufacture of public address loudspeakers and accessories.



ATLAS SOUND CORP.

1448-39th Street, Brooklyn 18, New York
In Canada: Atlas Radio Corp. Ltd., Toronto, Ont.

Show to be held in Chicago week of May 18—Credentials: Arthur C. Stallman, Sam L. Baraf, Herbert W. Clough, H. E. Ruble, L. W. Waelterman, John H. Cashman—Budget: Lew W. Howard, Arthur C. Stallman, Jerry Kirshbaum, W. D. Jenkins, George Wedemeyer, Herbert W. Clough—Entertainment: W. D. Jenkins, Sam L. Baraf, Jerome J. Kahn, Aaron Lippman—Housing: John H. Cashman, Lew W. Howard, Arthur C. Stallman, Byron C. Deadman—Publicity: Jerry Kirshbaum, J. J. Kahn, W. D. Jenkins, Anthony Dybowski—Educational: Jack A. Berman, A. W. Green, W. D. Jenkins, Jerry Kirshbaum, J. J. Kahn, L. W. Waelterman, H. E. Ruble, Lew W. Howard.

Industry Notes...

Newark Electric Co., Inc., of New York has changed its name to **Hudson Radio & Television Corp.**—Adolph Gross and David Ormont remain as sole stockholders and officers—address of Hudson's main store, general office, and warehouse is 48 W. 48th St., and branch is located at 212 Fulton St., both New York. . . . **General Electric Co. Tube Department** has leased 50,000 sq. ft. building in Clifton, N. J., for warehousing—also plans to use plant as headquarters for the department's eastern commercial service operations. . . . **Battery Division of P. A. Mallory & Co., Inc.**, is doubling manufacturing facilities in North Tarrytown, N. Y.—expansion expected to be complete by end of year. . . . Capital stock of **A. W. Haydon Co.**, Waterbury, Conn., has been purchased by **The North American Philips Co., Inc.**—address will remain 232 N. Elm St., and personnel will not be altered. . . . Semi-annual convention of **Society of Motion Picture and Television Engineers** brought big turnout October 15-19 in Hollywood—highlights included sessions on magnetic recording and high-speed photography. . . . **Newark Electric Company**, Chicago, has leased five-story building at 223 W. Madison St., which will more than double area of present location—will take possession during early part of 1952. . . . **Daystrom Electric Corp.**, Poughkeepsie, N. Y., has named Sigurd A. Sollie, famed audio pioneer, as manager, according to announcement of James F. Brehm, president. . . . **Acro Products Co.**, Philadelphia, maker of Acro-sound transformers, has moved administrative and production divisions to newly acquired building at 369 Shurs Lane, Roxborough, Philadelphia 28. . . . **Peerless Camera Stores, Inc.**, New York, franchised by **A-V Tape Libraries, Inc.**, as exclusive photo supply house outlet for pre-recorded magnetic tape in Bronx and Manhattan boroughs. . . . **Lindberg Instrument Co.**, Berkeley, Calif., has taken over larger manufacturing facilities and is beginning full-scale production of the **Fluid Sound** pickup cartridge. . . . **Arthur D. Little, Inc.**, Cambridge, Mass., has opened office in Mexico City to serve growing number of Latin American clients—headed by Richard W. Plummer. . . . **Radio Receptor Co.**, Brooklyn, is expanding plant capacity to manufacture germanium diodes. . . . **Westinghouse Electric International Co.** has received order for sixteen 3-kw high-frequency transmitters from Indian government—will be equipped with multiplex enabling each unit to handle four radioteletype messages simultaneously. . . . "Instrumentation" has been chosen as the theme of the annual technical conference sponsored by the **Kansas City Section of the Institute of Radio Engineers**. . . . **Airborne Instruments Laboratory**, Mineola, N. Y., celebrated its sixth anniversary with formal ground breaking ceremony for new Engineering and Production Division building. . . . **Plaskon Division of Libby-Owens-Ford Glass Company** announces addition of W. W. Womack to sales force. . . . **The Joseph Racker Company** has been organized to provide radar consulting and editing service—headed by Joseph Racker, former assistant to division chief of **International Telephone and Telegraph Co.** and author of many articles on microwaves—address is 67 W. 44th St., New York 18. . . . **New Ampex Electric Corp.**, plant in Redwood City, Calif., affords production facilities five times greater than former factory.

NEW IMPORTANT BOOK FOR

- SOUND TECHNICIANS
- AUDIO ENGINEERS
- CUSTOM BUILDERS

VOLUME 3! HOWARD W. SAMS' "AUDIO AMPLIFIERS"



Full Analysis of
50 Important
Audio Amplifiers
and 22 Popular
FM & AM Tuners
Based on Actual
Study of the
Equipment

Covers Latest Audio Equipment

Latest volume in the SAMS' "AUDIO AMPLIFIERS" Library. Provides detailed, clear, uniform analysis of 50 important audio amplifiers, and full coverage of 22 FM and AM tuners, produced during 1950. Each unit is thoroughly analyzed in from 4 to 10 pages; includes circuit diagrams, design data, parts information, full technical coverage described in uniform detail and profusely illustrated by photographs and diagrams. Based on study of the actual equipment. Entirely new material, continuing audio equipment coverage begun in Vols. 1 and 2 (see below). Never before available in a single complete, accurate compilation. Indispensable to public address and sound technicians, custom installers, BC engineers and students—a "must" for everyone in the field of Sound. 362 fact-packed pages; 8½ x 11"; sturdily bound.

ORDER AA-3. Only \$3.95



VOLS. 2 and 1
"AUDIO
AMPLIFIERS"

VOL. 2. Covers 104 well-known audio amplifiers and 12 important tuners produced during 1949. Includes uniform, detailed circuit and design data based on original lab study of the actual equipment. Profusely illustrated. 368 pages; 8½ x 11"; durably bound.

ORDER AA-2. Only \$3.95

VOL. 1. This is the initial volume covering audio equipment produced after the war, through 1948. Covers 102 audio amplifiers and FM tuners, plus data on important wire and tape recorders. 352 pages; fully illustrated; in sturdy binding, 8½ x 11".

ORDER AA-1. Only \$3.95

OWN ALL THREE VOLUMES FOR A
COMPLETE, AUTHORITATIVE SOUND LIBRARY

HOWARD W. SAMS & CO., INC.

Order from your Parts Jobber today, or write direct to HOWARD W. SAMS & CO., INC., 2201 East 46th Street, Indianapolis 5, Ind.

My (check) (money order) for \$ enclosed. Send the following books:

AA-3. AA-2. AA-1. \$3.95 each

Name

Address

City Zone State



DEMONSTRATING REALISTIC REPRODUCTION

As we said last month, Hartley and Hartley-Turner reproduction will be on show and in hearing at the Audio Fair. If nothing gets lost on the way, we shall exhibit the 215 speaker, the tone-control preamplifier, the 20-watt amplifier, and a satisfactory pickup. We shall demonstrate what we think is realistic reproduction, using LP records selected for good performance and good recording.

Not all of you will be able to come, but we hope that many of you will. For several reasons. The first is that whatever we say in these ads, the skeptical can always come back with some comment as, "Well, the Hartley ads are subtle as compared with the usual run of copywriting, but after all they are just ads."

We have just had a letter—"May I congratulate you on your advertisements in 'Audio Engineering.' I look upon them as being in a class with the Editor's Report, Record Revue, etc., and read them with as much interest as the body of the magazine." So, then, we shyly take up a place behind Mr. McProud and Mr. Canby, but now you can prove to yourself if Hartley is factual or merely fanciful.

The second is that we have always had rather odd ideas about what sort of sound a speaker should make. The 215 doesn't sound like any other speaker you have ever heard, and whether you like it or not, when you hear it you will agree with that. What we want to find out is whether you think the different sound of the 215 is different because it is realistic rather than hi-fi. You can tell us.

The third is that over the past two years we have made very many "pen pals." Your letters to us have always been interesting and sometimes warm-hearted. When you have become a 215 user, they have verged on the lyrical. O.K. We want to meet you, and you can check up if the results you are getting are the results we want you to get, for we believe in service after sale.

So, then, a warm welcome to all of you, customers, potential customers, dealers, jobbers—and competitors—in room 533.

* * * *

We are having a "hamfest" for music lovers and those interested in hi-fi in Massachusetts after the Fair. Those who would like to come should get in touch with Mr. John H. Walker, 66 Coolidge Avenue, Needham 92, Mass.

H. A. HARTLEY CO. LTD.
152, Hammersmith Road
London W.6, England

ADVERTISING INDEX

Acro Products Co.	78
Adelman, Leon L., Co.	75
Air-Tone Sound & Recording Co.	77
Allied Radio Corp.	39
Altec Lansing Corp.	44, 60
Amperite Co., Inc.	50
Ampex Electric Corp.	53
Amplifier Corp. of America	79
Arnold Engineering Co., The	11
Arrow Electronics Co.	62
Astatic Corp., The	55
Atlas Sound Corp.	79
Audak Co.	41
Audio Devices, Inc.	Cover 2
Audio & Video Products Corp.	52, 61, 63, 67, 69, 70
Barker & Williamson, Inc.	46
Belden Manufacturing Co.	3
Bell Sound Systems, Inc.	54
Bell Telephone Labs	14
Berlant Associates	42
Blair Steinberg Co.	73
Bressler, Jules J.	72
British Industries Corp.	7
British Radio Industries	78
Brook Electronics, Inc.	77
Camera Equipment Co.	52
Carduner-Lichter Corp.	72
Carter Motor Co.	68
Chicago Transformer Co.	48
Cinema Engineering Co.	60
Clarkstan Corp.	68
Classified Ads	74
Concord Radio Corp.	74
Duotone Co., Inc., The	63
Electro-Voice	47
Espey Mfg. Co., Inc.	64
Garrard Sales Corp.	7
General Electric Co.	33
Goodman Industries Ltd.	61
Gray Mfg. Co., The	78
Hartley, H. A., Co. Ltd.	80
Harvey Radio Co.	49
Heath Co., The	31
High-Fidelity Magazine	51
Hughes Res. & Dev. Labs	71
Jensen Mfg. Co.	29
Lansing, James B., Sound, Inc.	2
Lavin, Henry, Associates	73
Leak Amplifiers	6
LeBel, C. J.	74
Lenkurt Electric Co.	62
Leonard Radio, Inc.	57
McIntosh Engineering Labs., Inc.	68
Magnecord, Inc.	4
Maurer, J. A., Inc.	35
Minnesota Mining & Mfg. Co.	13
Panoramic Radio Products	58
Partridge Transformers Ltd.	80
Permoflux Corp.	10
Pickering & Co., Inc.	37
Precision Film Labs, Inc.	1
Professional Directory	74
Radio Corp. of America	8, 9
Radio Craftsmen, Inc., The	75
Rauland-Borg Corp.	67
Rek-O-Kut Co.	69
Sams, H. W., & Co., Inc.	79
Scott, Michael, Co.	73
Shallcross Mfg. Co.	45
Shure Brothers, Inc.	43
Sonocraft Corp.	59
Standard Wood Products Corp.	80
Stephens Mfg. Corp.	77
Sun Radio & Electronics Co., Inc.	78
Sylvania Electric Products, Inc.	71
Terminal Radio Corp.	Cover 3
Turner Co., The	5
U. S. Recording Co.	74
United Transformer Co.	Cover 4
University Loudspeakers, Inc.	58
Wharfedale Speakers	6
Willgold Electronics Sales Corp.	73

PARTRIDGE WILLIAMSON OUTPUT TRANSFORMER BUILT TO THE ORIGINAL SPECIFICATION

De-luxe potted model now available from stock from all important Radio Stores throughout the U. S. A. (Price \$26.00 duty paid)

This transformer is now accepted as the most efficient in the world. According to "Audio Engineering," Nov. 1949, there is no U. S. equivalent.

Thousands already sold in the United States. A "must" for every high fidelity enthusiast.

New York Stockists:

Harvey Radio Co. Inc.
103 West 43rd Street

Terminal Radio Corporation
85 Cortlandt Street

If you are unable to purchase Partridge transformers in your city, write to us and mention the name of your dealer.

Fulltest data, including square wave tests, distortion curves, etc., together with list of U. S. stockists rushed Air Mail to you.

PARTRIDGE TRANSFORMERS LTD.
TOLWORTH, SURREY, ENGLAND

For Highest Quality and Profits—
it's STANDARD WOOD

AUDIO & TV CUSTOM CABINETS

Model RX Bass Reflex Speaker Cabinets (top)

for 15" & 12" speakers. Approximately 10,000 cubic inch capacity. Wider frequency & angle distribution higher power-handling capacity. Lumite grille cloth; no sag or stain. **Model RF**

Radio-Phono Cabinets

(bottom): perfect companions to Model RX. Top panel for all FM-AM tuners, middle pull-out drawer for all record changers (positions interchangeable); bottom compartment for amplifiers.

Both Models: sturdy ¾" stock, latest acoustic design; rich authentic furniture styling in lustrous Mahogany, Cordovan Mahogany, Walnut, Ebony, Blonde, or Unfinished.

★ ★ ★

Custom-Builders everywhere praise our full line of Custom TV Cabinets! Fit all 630 & similar chassis, all Tubes. In Mahogany, Walnut, Ebony, Blonde.

See these beautiful Cabinets at your jobber **TODAY**. Special discounts for quantity TV Cabinet buyers. Write **NOW** for free latest Catalog A.

**STANDARD WOOD
PRODUCTS CORP.**

43-02 38th St., L.I.C. 4, New York

In Every Way, You Get SOUND VALUE at **TERMINAL**, the Headquarters for New York's Audio Fans!

RCA 15" DUO-CONE SPEAKER

with full weight ALNICO V magnet

This full-size 15" RCA loudspeaker provides the listener with full depth of bass and clear natural upper register. The unique magnetic structure and Duo-Cone arrangement with two voice coils accounts for its smooth frequency response from 40 to 12,000 cycles. Power capacity is 25 watts. 16 ohm input impedance. Weighs 15 lbs. RCA 51551.

29⁹⁵
NET

RADIO CRAFTSMEN RC-10

FM-AM TUNER with Built-in Preamplifier

Compensated for G.E., Pickering and crystal phono cartridges. Continuously variable bass and treble controls with flat response from 20 to 20,000 cycles. Automatic frequency control entirely eliminates station drift.

131⁵⁰
Net

RC-2 Wide Range Amplifier

Companion unit for the RC-10 AM-FM tuner, or any high fidelity application. Over 10 watts output with less than 1% distortion. 20 to 20,000 cycles frequency response.

42⁹⁰
Net

NEW!

Model A-800

INPUT AMPLIFIER

Here in one compact unit is a four-stage preamplifier with inputs for fine wide-range phono cartridges such as G.E., Pickering and Collaro; radio tuner input and crystal cartridge. Has separate bass and treble tone controls. Especially designed for high quality amplifier power stages, such as the famous Williamson.

37⁵⁰
Net

UTC-WILLIAMSON Amplifier Kits

Incomparable audio reproduction in an easy-to-build style! Chassis are drilled and punched for all components. Only UTC's famous linear standard transformers used in audio section. Wired sample on demonstration in our Sound Department. Chassis and transformer kit priced at

44¹⁰
Net

Instruction manual 25¢

GARRARD "Triumph" RC-80 RECORD CHANGER

The Garrard RC-80 fully automatic record changer is distinguished by its watch-like construction, fastidiously machined and finished. Concert quality reproduction for all records—33½, 45 and 78 rpm—regardless of diameter (7" — 10" — 12") or size of spindle hole. Shuts off automatically after last record is played. 15½" W, 13½" D; requires 5¾" clearance above, 3½" clearance below base. Supplied complete with mounting hardware, 2 plug-in shells (less cartridges) and mount-
ing template.

39⁸⁰
NET



- RC-80C—Same as above, but equipped with turnover dual crystal cartridge. **44.90**
- RC-80PD—With special matched pair Pickering cartridges equipped with laboratory ground diamond styli for years of finest reproduction. **64.70**
- RC-80PS—With matched pair Pickering cartridges using sapphire styli. **100.70**
- RC-80R2—With standard Audak polyphase pick-up head, equipped with two sapphire styli. **64.70**
- RC-80L6—With precision Audak polyphase studio head equipped with two sapphire styli. **56.85**
- RC-80GED—With pair of G.E. variable reluctance cartridges incorporating precision diamond styli. **63.73**
- RC-80GE—With pair of G.E. variable reluctance cartridges equipped with sapphire styli. **79.66**
- RC-80GES—Equipped with G.E. RPX-050 sapphire double-needle cartridge for standard and microgroove. **48.00**

VISIT
TERMINAL'S
FAMOUS
SOUND
DEPARTMENT!

PRICES
SUBJECT TO
AUTHORIZED
CHANGES

PERMOFLUX Roya' Blue 8" PM Speaker

Model BT-8-1. The magnificent speaker that amazed visitors at the Audio Fair! Response is 50 to 12,000 cps, 8 watts. Efficiency high, distortion low! 8" diameter, 8 ohm voice coil.

13²³
Net

UNIVERSITY 6201 12-inch Coaxial Speaker

Full-range 25 watt coaxial speaker, 45 to 15,000 cps. Complete with 2000 cycle cross-over network and high frequency attenuator. A wonderful buy!

44¹⁰
Net

FREE!

Sylvania stroboscope to test the speed of your phono turntable! Sorry, no mail or phone orders on this item!

Have you heard of Terminal's P.D.Q.? Send for Terminal's P.D.Q. Bulletin!

TERMINAL'S new UTILITY KORNER-KABINETS

Terminal's Korner-Kabinets will make an amazing improvement in the reproduction of any loud-speaker. The full size enclosed reflex chamber uses the walls of the room as a gigantic horn extension for enhanced bass response. Sturdy construction of ½" thick plywood throughout, properly reinforced to eliminate resonance and give true tone. Unfinished exterior, ready for painting. Supplied with movable speaker mounting board, sound absorbing pads and hardware.

- KK-8 For 8" speakers. 24" high, 32" across, 23" each side. **18.00**
 - KK-12 For 12" speakers. 36" high, 32" across, 23" each side. **21.00**
- Also available for 15" speakers

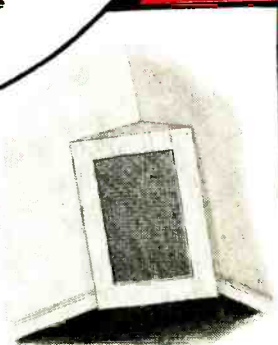

All equipment furnished for operation on 105-120 volts, 60 cycle's AC.

Terminal Radio Corp.

85 CORTLANDT STREET, NEW YORK 7, N.Y.
WOrth 4-3311



Linear Standard Units...

THE ULTIMATE IN QUALITY...

UTC Linear Standard Audio Transformers represent the closest approach to the ideal component from the standpoint of uniform frequency response, low wave form distortion, high efficiency, thorough shielding and utmost dependability.

UTC Linear Standard Transformers feature...

- **True Hum Balancing Coil Structure**... maximum neutralization of stray fields.
- **Balanced Variable Impedance Line**... permits highest fidelity on every tap of a universal unit... no line reflections or transverse coupling.
- **Reversible Mounting**... permits above chassis or sub-chassis wiring.
- **Alloy Shields**... maximum shielding from inductive pickup.
- **Hiper-Alloy**... a stable, high permeability nickel-iron core material.
- **Semi-Toroidal Multiple Coil Structure**... minimum distributed capacity and leakage reactance.
- **Precision Winding**... accuracy of winding .1%, perfect balance of inductance and capacity; exact impedance reflection.
- **High Fidelity**... UTC Linear Standard Transformers are the only audio units with a guaranteed uniform response of ± 1 DB from 20-20,000 cycles.



TYPICAL LS LOW LEVEL TRANSFORMERS

Type No.	Application	Primary Impedance	Secondary Impedance	± 1 db from	Max. Level	Relative hum-pickup reduction	Max. Unbalanced DC in prim'y	List Price
LS-10	Low impedance mike, pickup, or multiple line to grid	50, 125, 200, 250, 333, 500/600 ohms	60,000 ohms in two sections	20-20,000	+15 DB	-74 DB	5 MA	\$25.00
LS-10X	As Above	As above	50,000 ohms	20-20,000	+14 DB	-92 DB	5 MA	35.00
LS-12	Low impedance mike, pickup, or multiple line to push pull grids	50, 125, 200, 250, 333, 500/600 ohms	120,000 ohms overall, in two sections	20-20,000	+15 DB	-74 DB	5 MA	28.00
LS-12X	As above	As above	80,000 ohms overall, in two sections	20-20,000	+14 DB	-92 DB	5 MA	35.00
LS-26	Bridging line to single or push pull grids	5,000 ohms	60,000 ohms in two sections	15-20,000	+20 DB	-74 DB	0 MA	30.00
LS-19	Single plate to push pull grids like 2A3, 6L6, 300A. Split secondary	15,000 ohms	95,000 ohms; 1.25:1 each side	20-20,000	+17 DB	-50 DB	0 MA	26.00
LS-21	Single plate to push pull grids. Split primary and secondary	15,000 ohms	135,000 ohms; turn ratio 3:1 overall	20-20,000	+14 DB	-74 DB	0 MA	26.00
LS-22	Push pull plates to push pull grids. Split primary and secondary	30,000 ohms plate to plate	80,000 ohms; turn ratio 1.6:1 overall	20-20,000	+26 DB	-50 DB	.25 MA	32.00
LS-30	Mixing, low impedance mike, pickup, or multiple line to multiple line	50, 125, 200, 250, 333, 500/600 ohms	50, 125, 200, 250, 333, 500/600 ohms	20-20,000	+17 DB	-74 DB	5 MA	26.00
LS-30X	As above	As above	As above	20-20,000	+15 DB	-92 DB	3 MA	32.00
LS-27	Single plate to multiple line	15,000 ohms	50, 125, 200, 250, 333, 500/600 ohms cycles	30-12,000	+20 DB	-74 DB	8 MA	26.00
LS-50	Single plate to multiple line	15,000 ohms	50, 125, 200, 250, 333, 500/600 ohms	20-20,000	+17 DB	-74 DB	0 MA	26.00
LS-51	Push pull low level plates to multiple line	30,000 ohms plate to plate	50, 125, 200, 250, 333, 500/600 ohms	20-20,000	+20 DB	-74 DB	1 MA	28.00
LS-141	Three sets of balanced windings for hybrid service, centertapped	500/600 ohms	500/600 ohms	30-12,000	+10 DB	-74 DB	0 MA	30.00

TYPICAL LS OUTPUT TRANSFORMERS

Type No.	Primary will match following typical tubes	Primary Impedance	Secondary Impedance	± 1 db from	Max. Level	List Price
LS-52	Push pull 2A5, 250, 6V6, 42 or 2A5 A prime	8,000 ohms	500, 333, 250, 200, 125, 50, 30, 20, 15, 10, 7.5, 5, 2.5, 1.2	25-20,000	15 watts	\$35.00
LS-55	Push pull 2A3's, 6A5G's, 300A's, 275A's, 6A3's, 6L6's	5,000 ohms plate to plate and 3,000 ohms plate to plate	500, 333, 250, 200, 125, 50, 30, 20, 15, 10, 7.5, 5, 2.5, 1.2	25-20,000	20 watts	35.00
LS-57	Same as above	5,000 ohms plate to plate and 3,000 ohms plate to plate	30, 20, 15, 10, 7.5, 5, 2.5, 1.2	25-20,000	20 watts	25.00
LS-58	Push, pull parallel 2A3's, 6A5G's, 300A's, 6A3's	2,500 ohms plate to plate and 1,500 ohms plate to plate	500, 333, 250, 200, 125, 50, 30, 20, 15, 10, 7.5, 5, 2.5, 1.2	25-20,000	40 watts	50.00
LS-6L1	Push pull 6L6's self bias	9,000 ohms plate to plate	500, 333, 250, 200, 125, 50, 30, 20, 15, 10, 7.5, 5, 2.5, 1.2	25-20,000	30 watts	50.00

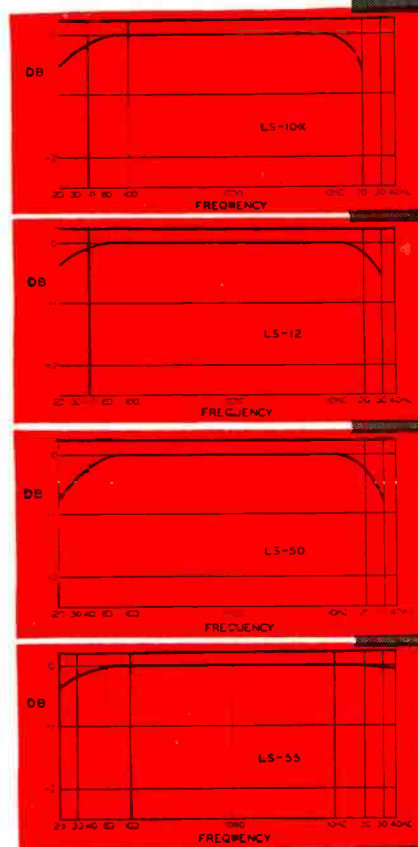

Write for our Catalog PS-510

United Transformer Co.

150 VARICK STREET NEW YORK 13, N. Y.
EXPORT DIVISION: 13 EAST 40th STREET, NEW YORK 16, N. Y.. CABLES: "ARLAB"