

DECEMBER
1951
35c

AUDIO ENGINEERING



THE WORLD OF SOUND

discs or tape
it's **audio** for
consistent, uniform
quality



audiodiscs* For more than 12 years, Audiodiscs have consistently set the standards for the finest professional performance in instantaneous and master disc recording. Their flawless perfection, wide-range frequency response, extremely low surface noise at all diameters and complete freedom from humidity effects are just a few of the reasons why Audiodiscs are first choice with professional recordists from coast to coast. They know from long experience that they can depend on Audio for the *consistent, uniform quality* that is so essential in modern sound recording work.

audiotape* Wherever professional-quality magnetic recordings are made, the trend is to Audiotape. That's because Audiotape is made *by* audio engineers *for* audio engineers — with the right combination of properties for finest performance in any tape recorder. Produced on Audio's highly specialized precision coating machines, Audiotape has achieved unequalled *uniformity* of output — plus maximum output with minimum distortion at practical bias range. What's more, it's less sensitive to bias changes, has no audible low-frequency modulation noise, and is guaranteed *splice-free* in both 1250 and 2500 ft. sizes, plastic base. In every respect, Audiotape meets the exacting standards of quality and performance which have characterized Audiodiscs for more than a decade.

audiofilm* extends the advantages of finest quality magnetic recording to motion picture and TV applications. Available in 16mm, 17½mm and 35mm sizes.

audiopoints* are precision matched recording and reproducing styli available in types and sizes to meet the precise requirements for every phase of disc recording work.

NEW Free
Handbook on
The Fundamentals
of Magnetic Recording



This completely new and up-to-the-minute technical manual contains 50 pages of valuable information on basic magnetic principles and tape performance. Professional recordists will find it extremely interesting and helpful — an important addition to their reference files. A request on your business letterhead will bring you a free copy by return mail.

Write to Audio Devices, Dept. A3.



*Trade Mark

AUDIO DEVICES, Inc.

444 MADISON AVE., NEW YORK 22, N. Y.
 Export Dept.: 13 East 40th St., New York 16, N. Y., Cables "ARLAB"

Audiodiscs are manufactured in the U.S.A. under exclusive license from PYRAL, S. A. R. L., Paris

Successor to **RADIO** —Established 1917

AUDIO ENGINEERING

INCLUDING



C. G. McProud, Editor
 Harrie K. Richardson, Associate Editor
 Luci Turner, Production Manager
 Lucille Carty, Circulation Manager
 Ladd Haystead, Publisher
 S. L. Cahn, Advertising Director
 H. N. Reizes, Advertising Manager

Editorial Advisory Board

Howard A. Chinn
 John D. Colvin
 C. J. LeBel
 J. P. Maxfield
 George M. Nixon



Representatives

H. Thorpe Covington, Special Representative
 677 N. Michigan Ave., Chicago 11, Ill.
 Sanford R. Cowan, Mid-West Sales
 67 W. 44th St., New York 18, N. Y.
 James C. Galloway, Pacific Coast Sales
 816 W. 5th St., Los Angeles 17, Calif.
 Technical Book & Magazine Co.
 297 Swanston St., Melbourne, C. I.
 Victoria, Australia

CONTENTS **DECEMBER, 1951** **Vol. 35, No. 12**

Audio Patents—Richard H. Dorf	2
Letters	6
Editor's Report	10
The Interview Amplifier—C. G. McProud	13
An Analysis of the Split-Load Phase Inverter—George Ellis Jones, Jr.	16
The R-J Speaker Enclosure—William Joseph and Franklin Robbins	17
A Tape Editing and Duplicating Machine—Robert P. Ledbetter	18
Loudspeaker Damping by the Use of Inverse Feedback—J. P. Wentworth ..	21
Intermodulation Testing—Pierce J. Aubry	22
Audio Fair Review—Harrie K. Richardson	24
Record Revue—Edward Tatnall Canby	32
New Products	34
Employment Register	50
New Literature	51
Industry People	53
Annual Index—1951	54
Advertising Index	56

COVER

Ladd Haystead, publisher of *Æ*, with the Interview Amplifier described on page 13, and the balance of the equipment used on his treks all over the United States in making short radio interviews with agricultural authorities. The amplifier mounts an RCA KB-2C microphone, and normally feeds the Magnecorder. Hi-fi Permoflux headphones complete his equipment—and also keep ears warm.

RADIO MAGAZINES, INC., 342 MADISON AVE., NEW YORK 17, N. Y.

AUDIO ENGINEERING (title registered U. S. Pat. Off.) is published monthly at 10 McGovern Ave., Lancaster, Pa., by Radio Magazines, Inc., D. S. Potts, President; Henry A. Schober, Secretary-Treasurer. Executive and Editorial Offices: 342 Madison Avenue, New York 17, N. Y. Subscription rates—United States, U. S. Possessions and Canada, \$3.00 for 1 year, \$5.00 for 2 years; elsewhere \$4.00 per year. Single copies 35c. Printed in U. S. A. All rights reserved. Entire contents copyright 1951 by Radio Magazines, Inc. Entered as Second Class Matter February 9, 1950 at the Post Office, Lancaster, Pa. under the Act of March 3, 1879.

AUDIO ENGINEERING • DECEMBER, 1951

TRIAD
 High-Fidelity
 Output
 Transformers
 Give you Highest
 Performance at
LOW COST!

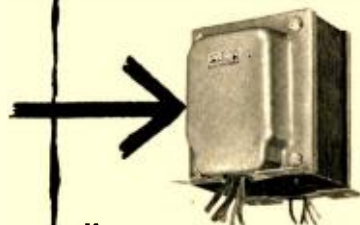

HIGHEST PERFORMANCE is assured when using Triad high-fidelity output transformers through the use of highest quality core material and interleaved windings of low resistance. **LOW COST** is maintained by use of mass produced die-stamped cases and flexible leads. Coils have a frequency response within 1 db from 30-15,000 cycles; deliver full-rated output within 3 db over entire frequency range. These transformers, having high open circuit inductance and low leakage reactance, may be used in feedback circuits having as much as 30 db of neg. feedback.

Compare these Specifications and Prices

Type No.	Primary Impedance	Secondary Impedance	Output Watts	List Price
S-31A 8000 C.T.	4-8-16		15	10.50
S-32A 8000 C.T.	500/250/125		15	11.00
S-33A 3000 C.T.	4-8-16		15	10.50
S-35A 5000 C.T.	4-8-16		18	11.50
S-36A 5000 C.T.	500/250/125	20	12.00	
S-38A 9000 C.T.	4-8-16		25	15.20
S-39A 9000 C.T.	500/250/125		25	16.00
S-40A 2500 C.T.	4-8-16		30	15.20
S-42A 4500 C.T.	4-8-16		50	21.25
S-45Z 4000/2000/4-8-1000/500			10	5.80
S-46A 2000/1000/4-8-16-500/250			20	12.95

These Triad High-Fidelity Output Transformers afford a standard of performance second only to Triad's "HS" Series.

Write for Catalog
TR-51



2254 Sepulveda Blvd.
 Los Angeles 64, Calif.

Air-Tone

HEADQUARTERS FOR SOUND EQUIPMENT

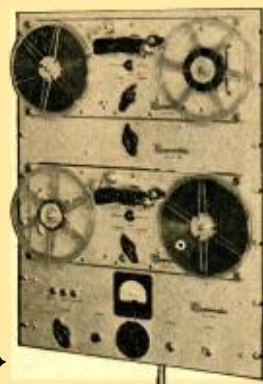

MAGNECORD RECORDER & AMPLIFIER
Complete Systems from \$564.00



NEWCOMB AMPLIFIER
Complete line of High Quality Amplifiers, from small single units to large rack installations



ELECTRO-VOICE SPEAKERS
From \$27.00 to \$756.00 NET

Air-Tone
SOUND AND RECORDING CO.
1527 CHESTNUT ST.
PHILA. 2, PA. - RI-6-8388



AUDIO PATENTS

RICHARD H. DORF*

ONE OF THE MORE INTERESTING patents we have received recently is a novel distortion meter which differs appreciably from those commonly in use, although one commercially available unit—the RCA 69A Distortion and Noise Meter—utilizes some of the same principles. It is a simple device and any reader who wants to see what it does should have little difficulty in selecting parts values and trying it in an hour or so. The inventor is Norman B. Saunders and the patent, No. 2,561,234, is assigned to the U. S. as represented by the Secretary of the Air Force.

The principle is to take the two voltages, one representing the input to an amplifier and the other the output, invert the phase of one, than combine them and read the difference. If their waveforms are exactly similar (and the amplitudes alike) they should cancel and there should be no resultant voltage. If the amplifier has distortion, the output waveform will not be like the input and when combining the two out of phase it will not be possible to obtain complete cancellation. The amplitude of the resultant voltage is a direct indication of the total distortion.

The method takes into account about every kind of distortion that can exist, all in one lump, so it would be difficult to evaluate the resultant voltage in terms of a specific percentage of any kind of distortion, but in make final adjustments on a newly designed amplifier, or in comparing two

amplifiers, the relative readings are good indications of over-all performance.

There is one definite advantage to the method: the waveform of whatever generator is used for the test is of no importance—it does not affect the readings. In fact, this method would probably be one excellent way to evaluate transient distortion in terms of relative figures instead of oscilloscope-eye estimates. The trick would be to use a square wave for the test. The amplifier input wave (from the generator) would have nice, smooth tops, but if the amplifier output had damped "ringing" waves across the square-wave tops the device would be unable to produce complete outphasing and the difference reading would indicate how much of a damped oscillation was being created atop each wave.

The circuit appears in Fig. 1. The original signal from the generator is fed to the amplifier under test, and in parallel to the generator signal input in Fig. 1. The input stage V_1 is a cathode follower with a high-value cathode resistor R_1 , so its loading effect on generator or amplifier input is negligible. Because of the high value of R_1 , the grid of V_1 is much too negative. It is therefore connected, through isolating resistor R_2 , to voltage-divider R_3-R_4 , across the B-supply; R_3 and R_4 are so proportioned that the grid voltage is reduced to the correct value for bias. C_1 is a heavy bypass across the lower section of the divider.

The cathode-follower output is connected [Continued on page 4]

* Audio Consultant, 255 W. 84th St., New York 24, N. Y.

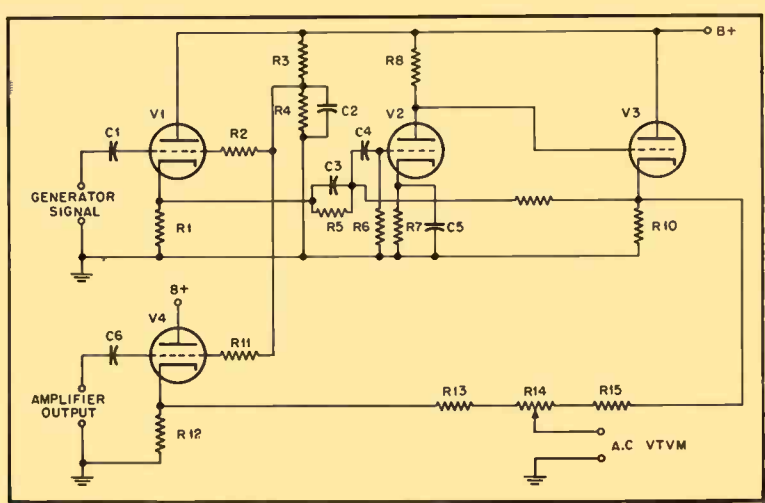

Fig. 1

PERMENDUR*

*gives
you*

- ☆ High Magnetic Saturation
- ☆ High Permeability at very high Flux Densities
- ☆ High Value of Positive Magnetostriction
- ☆ Design Possibilities for Savings in Weight, Space and Materials

**Typical use of Permendur
in the ADL ELECTROMAGNET**
(ARTHUR D. LITTLE, Inc.)

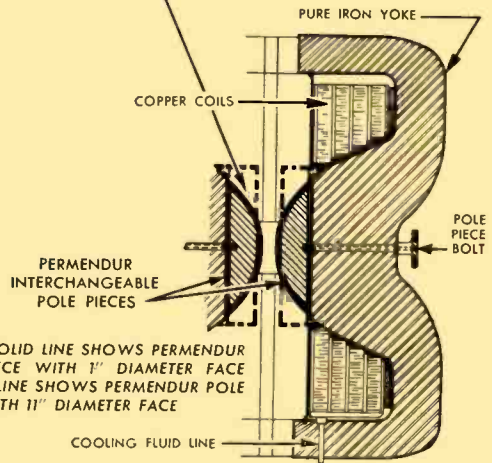
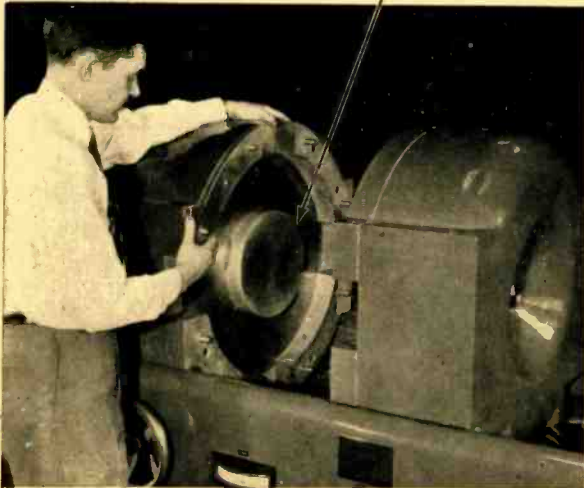

Sectional Detail of Yoke Half

Permendur is available in Forgings, Castings, Hot-Rolled Bars and Plates to meet your design needs for form or shape. *Write for information*

*Manufactured under license arrangements with Western Electric Co.

W&D 3929



THE ARNOLD ENGINEERING COMPANY

SUBSIDIARY OF ALLEGHENY LUDLUM STEEL CORPORATION

General Office & Plant: Marengo, Illinois

for OPTIMUM P.A. PERFORMANCE at moderate cost!

Specify

CHICAGO

Public Address Range Audio Transformers

These famous CHICAGO "Sealed-in-Steel" Output Transformers are the choice of many leading makers of high-quality amplifiers. Unmatched for service in the Public Address range, they have a frequency response within .5 from 50 to 10,000 cycles, and will deliver their full rated output over this entire range.

Line and voice coil impedances used in the design of these output units are those recommended by RMA. All have tertiary windings to provide 10% inverse

feedback. Output and matching drivers are fully enclosed in one-piece drawn-steel cases. Available in choice of two dependable constructions: with wire leads—at surprisingly modest cost; with solder lug terminals, at slightly higher cost. Order from your electronic parts distributor. Be sure to ask for CHICAGO P.A. Range Audio Transformers.



OUTPUT TRANSFORMERS

Catalog No.	Typical Output Tubes	Class	Impedance Primary-Secondary	Max. D-C in Pri.	Power Level	List Price
PCO-80 PSO-80	P-P 6B4G's, 6L6's P-P 6V6's, 6L6's	A1 AB	Pri: 5,000 ohms CT Sec: 600/150/ * 16/8/4 ohms	120 ma.	20 watts	\$12.10 16.50
PCO-150 PSO-150	P-P 6V6's, 6F6's P-P 6K6's	AB AB1	Pri: 10,000 ohms CT Sec: 600/150/ * 16/8/4 ohms	200 ma.	15 watts	10.45 14.85
PCO-200 PSO-200	P-P 6L6's P-P Parallel 6V6's	B AB†	Pri: 6,000 ohms CT Sec: 600/150/ * 16/8/4 ohms	250 ma.	30 watts	13.75 18.15

DRIVER TRANSFORMERS

Catalog No.	Typical Driver Tubes	Primary Impedance	Max. D-C In Pri.	Ratio Pri./1/2 Sec.	List Price
PCD-10 PSD-10	P-P 6N7's, 6A6's, 6J5's, 6C4's, etc.	20,000 ohms CT	10 ma.	3:1	\$5.50 7.95
PCD-25 PSD-25	P-P 6N7's, 6A6's, 6J5's, 6C4's, etc.	20,000 ohms CT	25 ma.	3:1	5.20 7.70
PCD-100 PSD-100	P-P 6B4G's, 45's, 2A3's, 6L6's, etc.	5,000/10,000 ohms CT	100 ma.	5:1	9.35 13.20

* Has tertiary winding to provide 10% inverse feedback. † For low distortion, use fixed bias.



Write for "NEW EQUIPMENT" TRANSFORMER Catalog

The units described above are typical of CHICAGO'S New Equipment Line featuring engineering that sets the transformer trend in circuit design. Get the full facts on the complete line now. Check the features, check the quality. Check the price: see how little more these tougher, better units cost. Write for your free copy of the CHICAGO New Equipment Line Catalog today.

CHICAGO TRANSFORMER

DIVISION OF ESSEX WIRE CORPORATION

3501 ADDISON STREET • CHICAGO 18, ILLINOIS



AUDIO PATENTS

[from page 2]

to the grid of V_2 , a straight, cathode-biased (R_7 and C_3) voltage-amplifier stage. C_3 is a small compensating capacitor which offsets the grid-cathode interelectrode capacitance of V_2 to maintain frequency linearity. C_4 is a d.c. blocking capacitor and R_6 a high-resistance grid leak.

The plate a.c. output of V_2 is fed to the grid of V_3 without a blocking capacitor. V_3 is a second cathode-follower with a high-value cathode resistor R_{10} to keep the gain up and to make for a high input impedance. There is, of course, a d.c. drop across R_{10} ; the resulting positive voltage offsets the high negative bias imparted by the high-resistance of R_{10} to give V_3 the correct bias. To help the linearity of this three-tube amplifier some feedback is taken from the cathode of V_3 through R_8 to the grid circuit of V_2 .

Note that there is one phase reversal between the input of the amplifier and the cathode of V_3 . When the alternation of signal on the grid of V_1 is positive, the cathode of V_1 is positive, as is also the grid of V_2 . The plate of V_2 and the grid of V_3 are negative, and so is the cathode of V_3 .

V_4 is a functionally separate single-stage cathode-follower amplifier, to the grid of which is fed the signal from the output of the amplifier under test. Like V_1 and V_2 , its cathode resistor R_{11} has a high value and positive voltage for a resultant correct grid bias is obtained from the voltage divider R_5 - R_1 through isolation resistor R_{12} .

Now we have both signals—generator output and tested amplifier output—appearing on the two cathode-followers V_4 and V_5 , in opposing phase and without any additional distortion added by the instrument of Fig. 1. If the amplitudes and waveforms at these points are exactly equal and we connect the two cathodes with R_{13} , R_{14} , and R_{15} , we can connect an a.c. vacuum-tube voltmeter as indicated and, by setting the slider on R_{14} to the exact center point, obtain a zero reading. Even if the amplitudes are not equal we can obtain a zero reading by adjusting the position of the R_{14} slider in the direction of the weaker-signal tube.

If the waveforms are not alike, however, no zero can be reached. The minimum voltage which can be obtained for the best position of the slider indicates in comparative terms how much waveform difference exists—that is, how much distortion has been added to the signal by the amplifier under test. For convenience, the two signals should be presented at roughly the same amplitude so that R_{14} can be made small with respect to R_{13} and R_{15} for ease in making fine adjustments. If, in actual practice, it turns out that the voltmeter readings are too low for convenience with usual values of distortion, a stage or two of amplification can be placed between the slider of R_{14} and the meter.

It seems obvious from reading the patent that the inventor did not work with audio amplifiers specifically in mind—he seems to have been interested in measuring distortion in amplifiers carrying sawtooth waves.

(EDITOR'S NOTE: It would seem that it would be necessary to provide means for making a finer balance of phase than is herein provided, and it is doubtful if this circuit will be of much advantage in making tests on audio equipment. The reader is referred to the RCA 69A Distortion and Noise Meter for a workable circuit of this type for audio use.)

Bass-Treble Tone Control

Ronald A. Makepiece is the originator of the equalizer circuit which appears in Fig. 2. The patent is numbered 2,559,988 and is assigned to Northern Electric Company of Canada.

The purpose of the device is to allow smooth adjustment of both boost and attenuation of treble and bass with two controls.

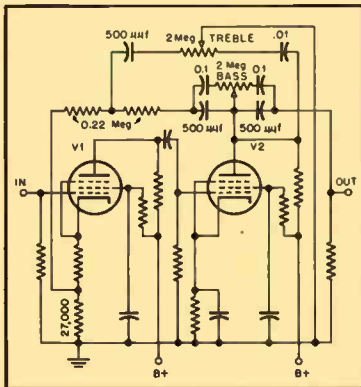

Fig. 2

According to the inventor, bass can be brought up or down 12 db and treble can be raised 15 db and depressed 12 at 10 kc.

The V_1 - V_2 circuit is essentially a simple two-stage voltage amplifier. There is, however, a feedback loop between the plate of V_2 and the cathode of V_1 (at the junction between the two cathode resistors). Bass feedback is through part of the 2-meg. bass potentiometer and the left 0.1- μ f capacitor. As the potentiometer arm is moved to the left, bass fed through the capacitor and the two 0.22-meg. resistors to the cathode of V_1 is increased, so that the over-all bass response goes down. As the arm is moved to the right, feedback of bass is decreased and more signal passes through the right 0.1- μ f capacitor to the output.

Treble passes through the 0.1- μ f capacitor, the 2-meg. treble potentiometer, and the 500- μ f capacitor, thence through one of the 0.22-meg. resistors to the V_1 cathode. The potentiometer arm is grounded. As it is moved left the signal path to the V_1 cathode is more nearly grounded so that highs in the feedback path are bypassed and over-all treble response is up. When the arm is moved to the right the plate of V_2 is bypassed to ground for treble and response falls off.

The resistor between the output point and ground is the following stage grid resistor. The values shown are those given in the patent. Values for other components may be chosen in accordance with standard practice for voltage amplifiers.

A copy of any patent may be had by sending 25 cents, along with the correct number of the patent, to the Commissioner of Patents, Washington 25, D. C.

* MAGNECORDER



Official Marine Corps Photo

FOR FIDELITY AND DEPENDABILITY ... on the beach-head ... for the broadcast *



Going in for a landing with the Marines takes rugged dependability. Magnecord tape recorders meet this requirement and provide split-second-precision recording on the beach-head. Serving all over the world in vital communication assignments, Magneorders undergo the severest conditions and still continue to record with high fidelity right at the moment they are needed.

At KIRO, Seattle, Wash., delayed programs and "on location" remotes are handled with complete confidence since Magneorders were installed. In the field or at the station, Magnecord professional tape recorders are the first choice of radio engineers everywhere.

FEATURES



PT7 accommodates 10 1/2" reels and offers 3 heads, positive timing and bushbutton control. PT7 shown in complete console model is available for portable or rack mount.



FLEXIBILITY

In rack or console, or in its really portable case, the Magneorder will suit every purpose. PT6 is available with 3 speeds (3 3/4", 7 1/2", 15") if preferred.

FIDELITY

PT63 shown in rack mount offers three heads to erase, record, and play back to monitor from the tape while recording.



WRITE FOR NEW CATALOG

Magnecord, INC.

360 N. Michigan Avenue
Chicago 1, Ill., Dept. A-12

Send me latest catalog of Magnecord Equipment

Name.....

Address.....

City.....Zone.....State.....



Here's why those in the know

—demand

CANNON PLUGS

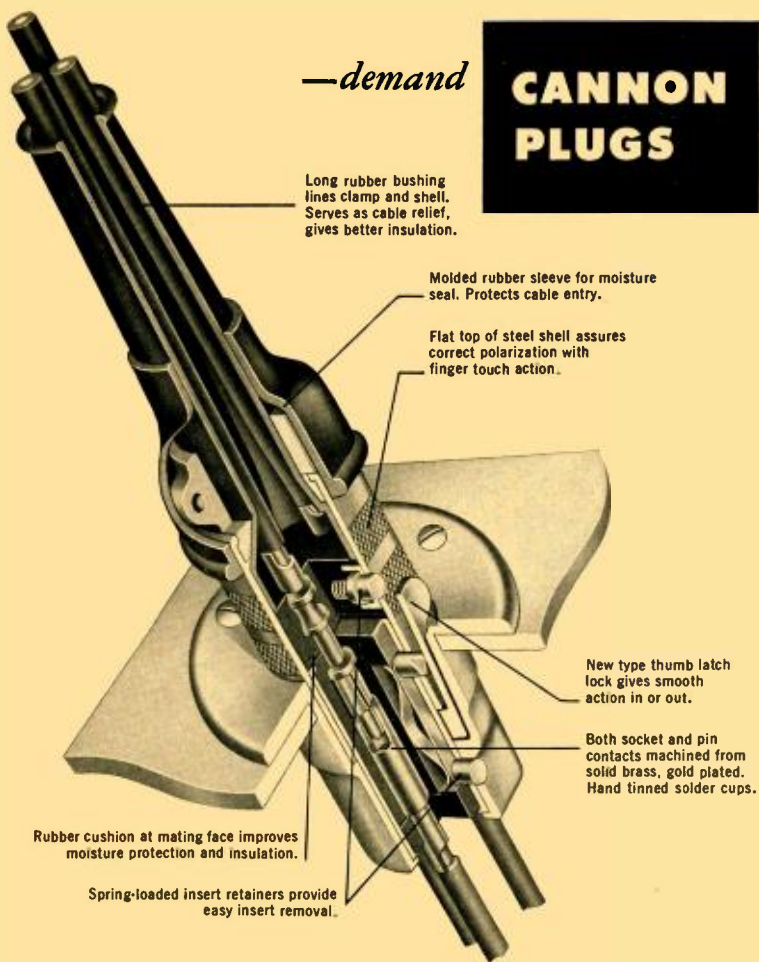

The Cannon Electric UA Plug was designed to answer the R. M. A. request for the ideal audio plug. It is the *ultimate* in a quick disconnect for low level sound and related circuits. Incorporating a wealth of design and construction know-how resulting from Cannon's many years of pioneering in this field, the Type "UA" Series typifies the close attention to important detail that distinguishes every type of Cannon Plug—the world's most complete line. The UA Series is sold through selected franchise distributors. Engineering bulletins sent free on request.

The Cannon UA Series consists of 2 plug types and 5 receptacles, all having 3 gold-plated contacts for 1500 cycle service. Socket contacts are full-floating. The "G" contact engages first, breaks last for "no noise" grounding or shielding purposes.

CANNON ELECTRIC

Since 1915

CANNON ELECTRIC COMPANY, LOS ANGELES 31, CALIFORNIA
Factories in Los Angeles, Toronto, New Haven. Representatives in principal cities.
Address inquiries to Cannon Electric Company, Department L-109, P. O. Box 75,
Lincoln Heights Station, Los Angeles 31, California.



LETTERS

More Butter, Anybody?

Sir:

More butter on the popcorn. The "popcorn" in this case is the fare dished out to the audio experimenter—it has been lacking a lot of butter lately. As my interests lie entirely in how a residence music system may sound better, I resent being fed a steady diet of high-type engineering.

The slide-rule boys like to dive off the theoretical springboard into the really deep problems, but of late I've found myself bewildered by a maze of mathematical formulas that would do credit to an Einstein. Can't you cater a little less to the slip-stick kids by slanting the math towards the guy that is awed by it all?

Please, a little more butter on my popcorn.

Morgan Kennedy, Jr.,
16 Monroe Street,
New York 2, N. Y.

(We do try to keep a balance—but we're working on the more-butter angle. Ed.)

Pickup Tracking

Sir:

I am unable to play LP's on my changer with the recommended stylus pressure as the needle runs to the center of the record. Recently I have had trouble on 45's which may mean that the effect increases with wearing of styli and records. In general, the difficulty appears to increase with record size, being worst on 12-in. LP's. I tried inclining the turntable in such a way as to improve tracking but with little effect at reasonable angles. A counterbalance spring, as I see it, should be in the form of a toggle so as to decrease the force as the center of the record is approached, if my observations are correct.

However, there is a question as to whether the user of supposedly top-quality equipment should have to resort to such makeshift arrangements. I am afraid record changer manufacturers have gone too far in reducing size and shortening pickup arms. I am sending copies of this letter to the manufacturers and hope to get their comments.

Ben Simmons, Jr.,
215 E. 5th St.,
Long Beach, Mississippi

Problems for Custom Builders

Sir:

Why doesn't someone solve Aunt Minnie's problem? She yields to nobody in the enjoyment of music, and she just loves to listen to that three-way speaker give out with the tubas and triangles. But run the monster herself? No!!!

She tried it once—after taking a concentrated course in controls—and that's when the little rubber wheels on the changer developed flat spots, and came down with the "wows." She thought the main power switch turned everything off.

This is only one facet of the growing traffic problem arising from the multiplicity of power and audio circuits that must be controlled in many residential systems. Consider an average system. The radio tuner, the turntable, and the amplifier each have their own power switches. One must select radio or records as the source of sound.

It is true that most of this can be accomplished by one switch having an "off"

[Continued on page 8]

In Every Way, You Get SOUND VALUE at **TERMINAL**, the Headquarters for New York's Audio Fans!

RCA 15" DUO-CONE SPEAKER

with full weight ALNICO V magnet

This full-size 15" RCA loudspeaker provides the listener with full depth of bass and clear natural upper register. The unique magnetic structure and Duo-Cone arrangement with two voice coils accounts for its smooth frequency response from 40 to 12,000 cycles. Power capacity is 25 watts. 16 ohm input impedance. Weighs 15 lbs. RCA 51551.

29⁹⁵
NET

RADIO CRAFTSMEN RC-10

FM-AM TUNER with Built-in Pre-amplifier

Compensated for G.E., Pickering and crystal phono cartridges. Continuously variable bass and treble controls with flat response from 20 to 20,000 cycles. Automatic frequency control entirely eliminates station drift.

131⁵⁰
Net

RC-2 Wide Range Amplifier

Companion unit for the RC-10 AM-FM tuner, or any high fidelity application. Over 10 watts output with less than 1% distortion. 20 to 20,000 cycles frequency response.

42⁹⁰
Net

NEW! Model A-800

INPUT AMPLIFIER

Here in one compact unit is a four-stage preamplifier with inputs for fine wide-range phono cartridges such as G.E., Pickering and Collaro; radio tuner input and crystal cartridge. Has separate bass and treble tone controls. Especially designed for high quality amplifier power stages, such as the famous Williamson.

37⁵⁰
Net

UTC-WILLIAMSON Amplifier Kits

Incomparable audio reproduction in an easy-to-build style! Chassis are drilled and punched for all components. Only UTC's famous linear standard transformers used in audio section. Wired sample on demonstration in our Sound Department. Chassis and transformer kit priced at

44¹⁰
Net

Instruction manual **25¢**

GARRARD "Triumph" RC-80 RECORD CHANGER

The Garrard RC-80 fully automatic record changer is distinguished by its watch-like construction, fastidiously machined and finished. Concert quality reproduction for all records—33 $\frac{1}{3}$, 45 and 78 rpm—regardless of diameter (7" — 10" — 12") or size of spindle hole. Shuts off automatically after last record is played. 15 $\frac{1}{2}$ " W, 13 $\frac{1}{2}$ " D; requires 5 $\frac{3}{4}$ " clearance above, 3 $\frac{1}{2}$ " clearance below base. Supplied complete with mounting hardware, 2 plug-in shells (less cartridges) and mounting template.

39⁸⁰
NET



- RC-80C—Same as above, but equipped with turnover dual crystal cartridge. **44.90**
- RC-80PD—With special matched pair Pickering cartridges equipped with laboratory ground diamond styli for years of finest reproduction. **64.70**
- RC-80PS—With matched pair Pickering cartridges using sapphire styli. **100.70**
- RC-80R2—With standard Audak polyphase pickups using sapphire styli. **64.70**
- RC-80L6—With precision Audak polyphase studio head, equipped with two sapphire styli. **56.85**
- RC-80G6D—With pair of G.E. variable reluctance cartridges incorporating precision diamond styli. **63.73**
- RC-80GE—With pair of G.E. variable reluctance cartridges equipped with sapphire styli. **79.66**
- RC-80GES—Equipped with G.E. RPX-050 sapphire double-needle cartridge for standard and microgroove. **51.44**

VISIT
TERMINAL'S
FAMOUS
SOUND
DEPARTMENT!

PRICES
SUBJECT TO
AUTHORIZED
CHANGES

PERMOFLUX Royal Blue 8" PM Speaker

Model 8T-8-1. The magnificent speaker that amazed visitors at the Audio Fair! Response is 50 to 12,000 cps, 8 watts. Efficiency high, distortion low! 8" diameter, 8 ohm voice coil.

13²³
Net

UNIVERSITY 6201 12-inch Coaxial Speaker

Full-range 25 watt coaxial speaker, 45 to 15,000 cps. Complete with 2000 cycle cross-over network and high frequency attenuator. A wonderful buy!

44¹⁰
Net

TERMINAL'S new UTILITY KORNER-KABINETS

Terminal's Korner-Kabinets will make an amazing improvement in the reproduction of any loudspeaker. The full size enclosed reflex chamber uses the walls of the room as a gigantic horn extension for enhanced bass response. Sturdy construction of $\frac{1}{2}$ " thick plywood throughout, properly reinforced to eliminate resonance and give true tone. Unfinished exterior, ready for painting. Supplied with movable speaker mounting board, sound absorbing pads and hardware.

- KK-8 For 8" speakers. 24" high, 32" across, 23" each side. **18.00**
 - KK-12 For 12" speakers. 36" high, 32" across, 23" each side. **21.00**
- Also available for 15" speakers

All equipment furnished for operation on 105-120 volts, 60 cycles AC.

Sylvania stroboscope to test the speed of your phono turntable! Sorry, no mail or phone orders on this item!

Have you heard of Terminal's P.D.Q.? Send for Terminal's P.D.Q. Bulletin!

Terminal Radio Corp.

85 CORTLANDT STREET, NEW YORK 7, N.Y.

Worth 4-3311

Announcing

ADVANCED

SERIES 400

RECORDERS

MODEL 400-A

with
Half-Track Head

MODEL 401-A

with
Full-Track Head

15 & 7 1/2
Inches Per Sec.

Full REMOTE CONTROL

Solenoid operated mechanisms for all mechanical motions.



also *Featuring*

- **UNIFORM RESPONSE** . . . to 15,000 cps at 7 1/2 ins. per sec.
- **LOW NOISE & DISTORTION LEVEL** . . . signal-to-noise ratio over 55 db at either tape speed (as defined by NARTB).
- **PUSH BUTTON OPERATION**
- **LONG LIFE** . . . precision built.
- **LOW MAINTENANCE** . . . even with continuous use.



4 to 1 TAPE SAVING

The valuable tape saving ability of Series 400 Recorders is clearly illustrated above — the young lady holds four reels which contain the identical program formerly requiring the sixteen reels shown on table. No other recorder can give this remarkable tape saving because no other recorder is capable of 15,000 cycle performance at 7 1/2 ins. per sec., on but half the width of the tape!

PORTABLE IN SINGLE CASE or for RACK MOUNTING

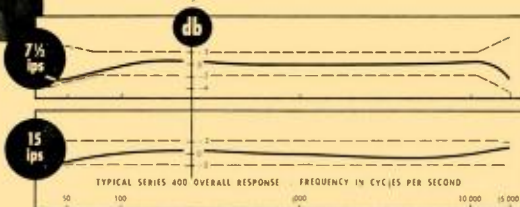

PERFORMANCE . . . beyond comparison!

Published specifications of Ampex Recorders are conservative as these typical check-out graphs on Series 400 show. Ampex check-outs always exceed guaranteed performance but even the guaranteed performance is sufficient to make Ampex the world's finest recorder!

INTERCHANGEABILITY OF TAPES . . . another unrivalled superiority of Ampex. This means that recordings made on any Ampex can be played back on any other Ampex (of like speed) with identical high fidelity and timing.



ASK FOR BULLETIN A-211

... gives complete description and specifications of the Series 400 Ampex Magnetic Tape Recorders.

AMPEX

Magnetic



AMPEX ELECTRIC CORPORATION
Redwood City, California
Distributors in Principal Cities

RECORDERS

position, but that solution introduces an embarrassment of power switches. Even with individual switches on the various units, there is the main switch—the only one that must be “on” if the system is to work at all—out of sight in the turntable drawer. Let someone unthinkingly turn off either of the others, though, and we are sure to miss the first few bars of the music, come the next Toscanini broadcast.

It is beside the point to observe that there are other types of record changers available, or that a transcription turntable ought to be used instead. A more general solution is needed, because we have been considering here only the simplest form of the problem. If there is a TV set and a good amplifier anywhere in the same room, the chances are that the two are destined to get better acquainted in an a.f. sense. Now add a tape playback unit or a tape recorder and where do we stand? This reader, at least, isn't far ahead of Aunt Minnie. If others have explored this subject, it would be interesting to know the results.

Richard K. Snively,
Planned Productions, Inc.,
250 Park Ave.,
New York 17, N. Y.

English Audio—Version II

Sir:

I have just been reading the most recent “Audio in England” by H. A. Hartley in the October issue, and would like to cite the following in evidence that many of the statements made are not in accordance with fact:

TELEVISION—He makes out that British television is almost limited to the 12-in. tube due to lack of enterprise, whereas the main reason for the limitation of size is the purchase tax of 66-2/3% which makes equipment with bigger tubes too expensive for the average buyer. There are plenty of sets which are fitted with 15- or 16-in. tubes, and several firms, such as Mullard and Decca, offer projection types with quite large screens.

B.B.C.—The average transmission of music is of excellent quality. Most audiophiles prefer the quality to commercial recordings because of its excellent transient response, which is often of far more importance than mere frequency response.

AUDIO—Wright and Weaire may not have reproduced an oboe with their tape recorder, but they *did* install a piano which visitors could play and then listen to an immediate playback through the recording and reproducing equipment. Those Americans (all six of them) who have read my latest book “Pianos, Pianists, and Sonics,” will agree with me—I am sure—that recording and reproducing the piano is a far more stringent test than the oboe. I think Wright and Weaire deserve full marks for their enterprise. In another direction, Cecil Watts has recorded bird songs (for Cambridge University) and grasshopper vibrations at frequencies up to 20,000 cps with such realism that when produced on a suitable h.f. loudspeaker the females of the species respond to the call.

CO-AXIAL SPEAKERS—It was stated that we have no models of the concentric tweeter-woofer type. In point of fact these models are made here by Parmeko and Tannoy, and the W. B. Duplex is of similar design. Goodmans produce a free-edge unit with a very wide response. While I have no wish to blow the trumpet on behalf of my competitors, I think it is unfair to ignore the special types of speakers made by Goodman and by W. B. in addition to their “mass-produced” models.

[Continued on page 52]

VERSATILITY!



New *Gray* 108-B Arm for all records has new suspension principle . . . for perfect tracking without tone arm resonances

Perfect tracking of records and virtual elimination of tone arm resonances are only two advantages of this versatile, specially-designed arm — the finest yet developed! It satisfies every requirement of LP reproduction, permits instant changing from 78 r.p.m. to LP (micro-groove) or

45 r.p.m., and *assures correct stylus pressure automatically*. GE or Pickering magnetic pickup cartridges are interchangeable and slip into place quickly and easily. Maintains perfect contact with bad records, accommodates records up to 16" in diameter.



106-SP Transcription Arm —

Assures fidelity of tone for every speed record. Three cartridge slides furnished enable GE 1-mil, 2½ or 3-mil, or Pickering cartridges to be slipped into position instantly, with no tools or solder. Low vertical inertia, precisely adjustable stylus pressure.

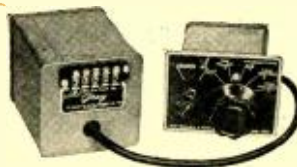

Gray Equalizers —

Used as standard professional equipment by leading broadcast stations, these specially-designed equalizers assure highest tonal quality . . . new record reproduction from old records . . . constant velocity frequency response for conventional or LP records. Uses GE or Pickering cartridges.

Please write for bulletin RA-12, describing the above equipment.

GRAY RESEARCH

and Development Co., Inc., 16 Arbor St., Hartford 1, Conn.

Division of The GRAY MANUFACTURING COMPANY—Originators of the Gray Telephone Pay Station and the Gray Audograph



Walter E. Ostrowski
President

EDITOR'S REPORT

AUDIO IN AMERICA, 1951

THE YEAR 1951 has seen a great growth in the general acceptance of Audio as a requisite for good living. Music—evidenced by the popularity of pianos as home furnishings and instruments of entertainment, by early phonographs, and more recently by the radio-phonograph combination—has always had its place in the home. But people are gradually learning that it is no longer necessary for the phonograph to sound as it did in 1913. The concert hall can now be brought directly into the home by way of recorded music—if the listener really wants high quality.

The December issue of *House and Garden* brings to the lay home an idea of what can be expected, and how to go about getting superlative musical quality into the home—without the need for pseudo-styled cabinets which have offended decorators and discerning home-makers for years. *House and Garden* has devoted no less than twenty pages to music in the home—ten to that from electronic sources, and ten to the traditional music-makers. Naturally, we of *Æ* are pleased because of our small part in assembling the information about electronic reproduction of music, but above and beyond a personal satisfaction, we are pleased that the torch we have been carrying has finally set fire to something.

For those of our readers who may have met with resistance or downright opposition from the chairman of the board of home directors, we suggest that a copy of the December issue of *H & G* be left surreptitiously in a prominent place in the home. It may be that the desired new amplifier, record player, speaker housing, or even the tape recorder may show up, come the 25th, or at least the resistance may become zero or slightly negative. Try it and see.

THE AUDIO FAIR, 1951

The December Editor's Report would be amiss if the most recent Audio Fair were not mentioned, and this year shall be no exception. With its third appearance at Hotel New Yorker, the Fair has taken off its overalls and donned at least a business suit, if not yet tails. More and more of the exhibitors tried acoustic treatment of their rooms this year, and the general sound level was somewhat more normal, in spite of the opinion of a Midwest reader who probably did not attend either of the first two Fairs. This reader, an M.D., thinks that if speakers "were played at a lower volume a greater appreciation would be enjoyed by many people, especially the women folks." He opines further that "of course, loud volume doesn't bother me as I don't mind it but it sort of drives the family out."

All right—we agree. And we submit further that if we heard perfect reproduction under demonstration conditions we would not be satisfied. It is only by boosting bass, treble, and over-all volume that we succeed in creating an impression, even though the resulting sound may not be anything we would want to live with in the home week after week.

But—if the impression is created, and if the equipment is capable of providing too much volume, too much bass, and too much treble, the ultimate user *can* choose as much as he wishes and be satisfied. Sooner or later he will arrive at a balance and level which is somewhat realistic. The important thing is to create the impression in his mind—to make him realize that better sound can be his if he wants it. After that, nature will take its course.

With that thought, we leave you with one last word for this year—

Merry Christmas & Happy New Year

from all of us to all of you



"NO WORRIES ABOUT LEVEL CHANGES WITH 'SCOTCH' SOUND RECORDING TAPE"

Says Glenn Flynn, Asst. Chief Engineer, Station WOW, Omaha, Neb.

"You're always sure of uniform output when you're using 'Scotch' Sound Recording Tape," says Mr. Flynn. "Thanks to its unvarying coating you can

switch from reel to reel without worrying about level changes." Flynn is shown with the recording equipment he used on WOW's recent East Coast Farm Study Tour, a 6000-mile tour of farming areas taken by a large group of Nebraska farmers.



FIVE RECORDED INTERVIEWS daily were made by Mal Hansen during WOW's Farm Study Tour. The recordings were air-mailed to the studio for broadcast on WOW's daily Farm Service Reporter program. "Scotch" Sound Recording Tape captures every sound, reproduces it with a fidelity unmatched by any other recording medium.



SMOOTHLY-PACED PROGRAMS are guaranteed, production problems simplified with "Scotch" Sound Recording Tape. Changes can be made and dubbed in without re-assembling the entire cast; shows can be recorded a portion at a time; fluffs and miscues can be edited out; recordings can be lifted from tape to tape without noticeable loss of quality.



EIGHTY 3M SOUND ENGINEERS in the field—backed by 20 technical experts in the 3M laboratories—stand ready to give you technical assistance with any recording problem you may have. Call your local 3M Service Representative, or write us direct: Dept. AE-121, Minnesota Mining & Mfg. Co., St. Paul 6, Minn. No obligation, of course.

"SCOTCH" SOUND RECORDING TAPE GIVES YOU THESE EXTRA CONSTRUCTION FEATURES

- **REEL TO REEL UNIFORMITY**—controlled coating assures consistent output.
- **THINNER CONSTRUCTION**—resists temperature and humidity changes.
- **NO CURLING OR CUPPING**—tape lies flat on recording head unaffected by humidity.
- **UNIFORM TAPE SURFACE**—no "dropouts" on recordings due to surface irregularities.
- **LONGER TAPE LIFE**—special lubricating process reduces friction.
- **GREATER SENSITIVITY**—more output on your present machine setting.



IMPORTANT: There's more than one brand of sound recording tape. Insist on the "SCOTCH" brand, the lubricated tape that gives matchless fidelity, clarity of reproduction, freedom from distortion. Used by all major networks and for master recording by record companies.

The term "SCOTCH" and the plaid design are registered trademarks for Sound Recording Tape made in U.S.A. by MINNESOTA MINING & MFG. CO., St. Paul 6, Minn.—also makers of "Scotch" Brand Pressure-sensitive Tapes, "Underseal" Rubberized Coating, "Scotchlite" Reflective Shooting, "Safety-Walk" Non-Slip Surfacing, "3M" Abrasives, "3M" Adhesives. General Export: Minn. Mining & Mfg. Co., International Division, 270 Park Avenue, New York 17, N.Y. In Canada: Minn. Mining & Mfg. of Canada, Ltd., London, Canada.

They're headed for new frontiers

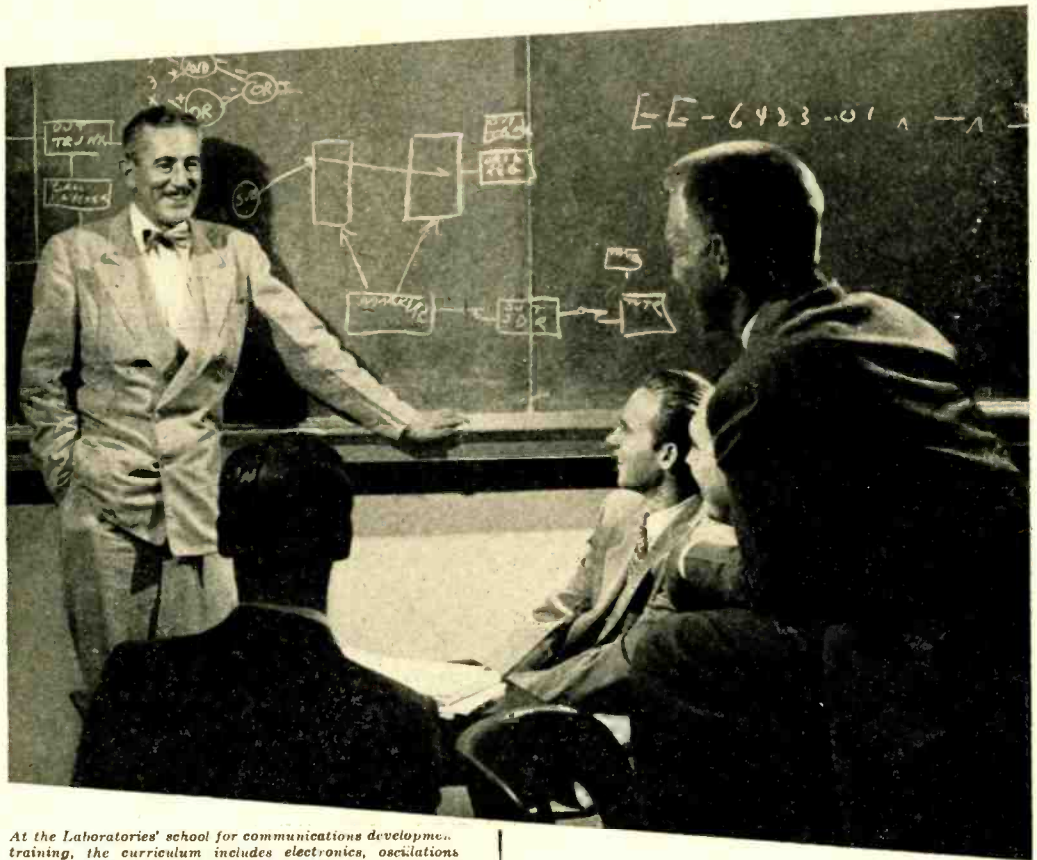

At the Laboratories' school for communications development training, the curriculum includes electronics, oscillations and waves, switching and transmission. Each subject is directly keyed to the latest fields of telephone research.

EACH year the Bell System selects hundreds of engineering graduates from technical schools, to find the answers to communications problems through the application of science and technology. A specifically qualified group joins Bell Laboratories to develop tomorrow's telephone system — also, in the present emergency, more powerful electronic devices for the armed services.

They come — thanks to the competence of our nation's educators — with an excellent grounding in fundamentals. To equip them still further, the Laboratories operate a school at graduate level for advanced communications.

The new men receive an intensive course in the latest theory and techniques. At the same time they take their places as members of the Technical Staff doing responsible work which, with their classroom instruction, reveals where they can make the most of their aptitudes.

More than ever America's future must depend on men and women who are trained to think far ahead in technology whether for tomorrow's telephones or national defense. By helping them, Bell Telephone Laboratories help make America's telephone system the world's best, help the armed forces keep our country strong.

BELL TELEPHONE LABORATORIES

Exploring and inventing, devising and perfecting, for continued improvements and economies in telephone service.



The Interview Amplifier

C. G. McPROUD

Design and construction of a small amplifier intended for use with a standard tape recorder for one specific use—interviews.

SOME MONTHS AGO it became necessary to instruct a non-technical writer and radio commentator in the intricacies of operating a standard tape recorder. It was planned to use this recorder to interview agricultural authorities throughout the country on subjects of interest to the farmer for later broadcasting. This individual happens to be the publisher of *Æ*—one Ladd Haystead, who in his more lucrative moments serves as counselor to the Committee on Agriculture of the American Petroleum Institute, in addition to handling public relations work for a number of other important clients.

Mr. Haystead—an outstanding authority on agriculture—is a complete stranger to electronic devices. His preoccupation with the mechanics of maintaining a satisfactory recording level, operating the necessary controls and push switches, and watching the VU meter, detracted from his role as interviewer to the extent that he was almost unable to “draw out” his speaker, usually a man not familiar with the microphone. Since the equipment was to be used for only one purpose, it seemed desirable to arrange a unit which served essentially as an enlarged microphone stand, yet incorporated the amplifier, the VU meter, a gain control, and as few other controls as possible.

Fig. 1. External view of the amplifier unit with attached microphone on ball-and-socket swivel head.

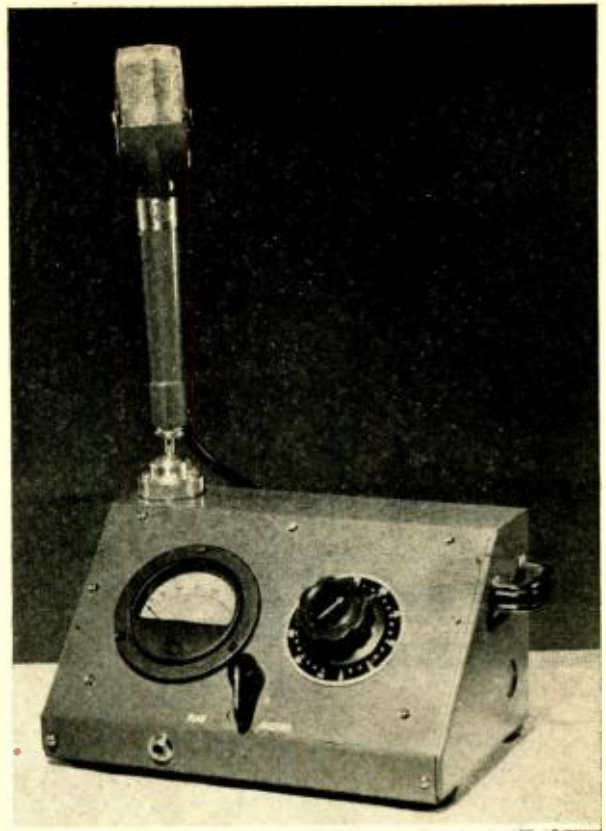

The equipment to be described fulfills these requirements satisfactorily. Including the recorder mechanism, it is still too large for convenience, but it is capable of producing high-quality tapes which are dubbed to disc masters, pressed, and heard over some 325 stations. In addition to providing an easily-controlled amplifier unit, the device is so arranged that it is relatively impossible to make any mistakes in interconnecting the three separate units.

Units of System

The basic equipment consists of a standard tape recorder, without any modifications. This unit—a Magnecord PT6-AH—is in wide use throughout the country, and in case of failure of any kind, it was thought that the nearest broadcast station could serve as a repair center. To date the only trouble

encountered is the loosening of the function switch knob—which was duly tightened at a Santa Fe, New Mexico, station. The amplifier consists of three stages, the VU meter, and switching to permit recording or playback. A Magnecord equalizer is used for recording, and the playback equalization is incorporated in the first stage of the amplifier in a manner almost identical to the amplifier normally used with the Magne recorder. Since the recorder is used only at the 7½-in. speed, the equalizer is “permanently” mounted in the amplifier case. The function switch arranges the circuits for the desired operation; for recording, the microphone is connected to the input transformer, the output is fed through the equalizer to the tape head, the VU meter is connected across a part of the output winding, and the speaker is disconnected. For playback, the VU meter is disconnected, the head is connected to the input transformer, the frequency response is modified to provide the necessary bass boost, and the speaker is turned on.

Physically, the amplifier is mounted in a cabinet 9 in. wide, 6 in. deep, and 5 in. high, furnished as a standard unit by The Langevin Co. The RCA ribbon microphone, type KB-2C, is mounted on a ball-and-socket joint originally intended as a swivel head for a camera tripod, but modified somewhat for this purpose. When in use, the microphone is raised to an upright position; for carrying, it is folded down against the case and held secure by the drawstring of a small velvet bag being tied to the case handle. The carrying case for the amplifier contains the power supply,

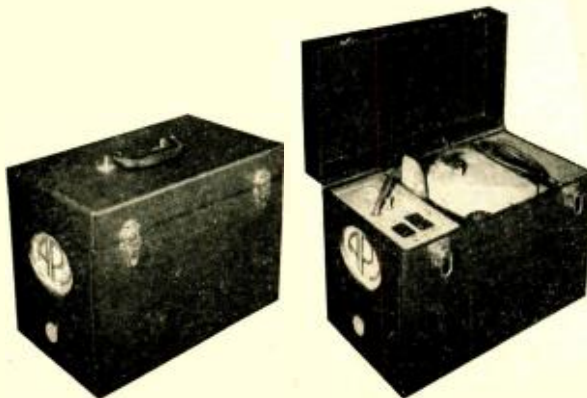

Fig. 2. The carrying case provides space for power supply, amplifier, tape reels, monitor phone, etc.

space for the amplifier unit, and a compartment for several reels of tape, the monitor headphones, and a stop watch. *Figure 1* shows the amplifier unit in operating position, and *Fig. 2* shows two views of the carrying case. The speaker is built into the power supply box, and the grille in the end of the case protects the cone from damage. The cabling consists of a short lead from the microphone to the amplifier, a lead from the amplifier to the recorder, and power cables from both recorder and amplifier. Power is furnished from 115-volt a.c. lines.

Electronic Requirements

In the record position, the amplifier was required to have adequate gain to work from the microphone. Since the recording head is specified as having an impedance of 60 ohms, it was most convenient to use the microphone strapped for 50 ohms output, and to use a 30 to 50-ohm winding on the input transformer. The output impedance designed to feed the Magnecord equalizer and the head is 500 ohms and the necessary recording equalization is most readily obtained from a standard equalizer, which can be changed from

one speed to another without too much trouble in case such a change becomes necessary. It is not expected that such a change will be made in the field, and neither the extra equalizer nor the 15-in.-per-sec. capstan and idler roller is carried with the equipment.

For playback, the input impedance remains at 50 ohms, a satisfactory match for the 60-ohm head. The gain needed for playback is of the same order of magnitude as that for recording, but the low end must be boosted appreciably. This boost is about 20 db from 1000 cps to 100, following the 6 db/octave slope. The speaker used has a voice-coil impedance of 3.2 ohms, and it is fed from a 2-ohm tap on the output secondary.

Since there is no need for using the amplifier as a public-address system, the function switch has only two positions—record and playback. In either position, all circuit switching is accomplished with one operation. No provision is made to indicate on the amplifier panel as to whether or not the recorder is turning, since it is normally used in the same room with the amplifier—usually within six or eight feet of the amplifier. The standard VU meter is connected across a portion of the output second-

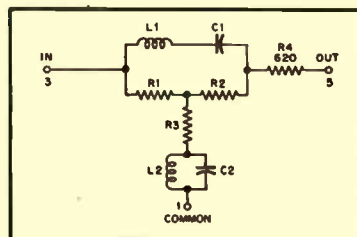

Fig. 4. Schematic of high-frequency equalizer used for recording. Low-frequency equalization, provided in amplifier, is used for playback.

ary to give the correct indication without the use of any multiplier.

The power supply provides the necessary plate and filament voltages for the amplifier as well as for the bias oscillator in the recorder case. The function switch feeds voltage to the bias oscillator only in the record position. Separate filter circuits in the power supply provide adequate isolation and improve regulation of the amplifier voltage in the two conditions of operation.

Amplifier Design

The amplifier is of straightforward design, being simplified from the basic Magnecord PT6-J amplifier unit. Less power is required than is provided by the original unit, so the output stage is a single 6V6. It is driven by a 6J7 with the gain control in its grid circuit, while the first stage is a low-noise pentode, the 5879. The over-all schematic of amplifier and power supply is shown in *Fig. 3*.

By measurements on the original amplifier provided by the manufacturers of the recorder, it was observed that when the VU meter indicated "zero" level, a 3.0-volt signal was supplied to the input terminals of the equalizer, with a response curve which was essentially flat to that point. The required equalization—of the high end only—is furnished by the fixed equalizer, having a constant-impedance configuration, as shown in *Fig. 4*. The equalizer consists of a series resonant circuit and a parallel resonant circuit combined with three resistors to fix the amount of equalization, which is of the order of 22 db. The equalizer is followed by the "constant-current" resistor of 620 ohms, and the entire unit is encased in a housing with a 6-pin plug in the base. To isolate the output tube from the equalizer, an 8-db pad was inserted between the transformer and the equalizer socket.

The output transformer used is provided with taps at impedances of 8, 15, and 500 ohms. Between the 8 and 15-ohm taps, the impedance is 2 ohms. To simplify the switching, the 8-ohm tap is grounded, and the VU meter is connected from the "0" tap to the 15-ohm tap, using the conventional 3900-ohm resistor between the transformer and the meter to preserve ballistic action.

Checking the calculations, it is seen that at zero on the meter, 3.0 volts should be applied to the input terminals of the equalizer. Having determined the necessary output connections to simplify the switching, a few calculations are in

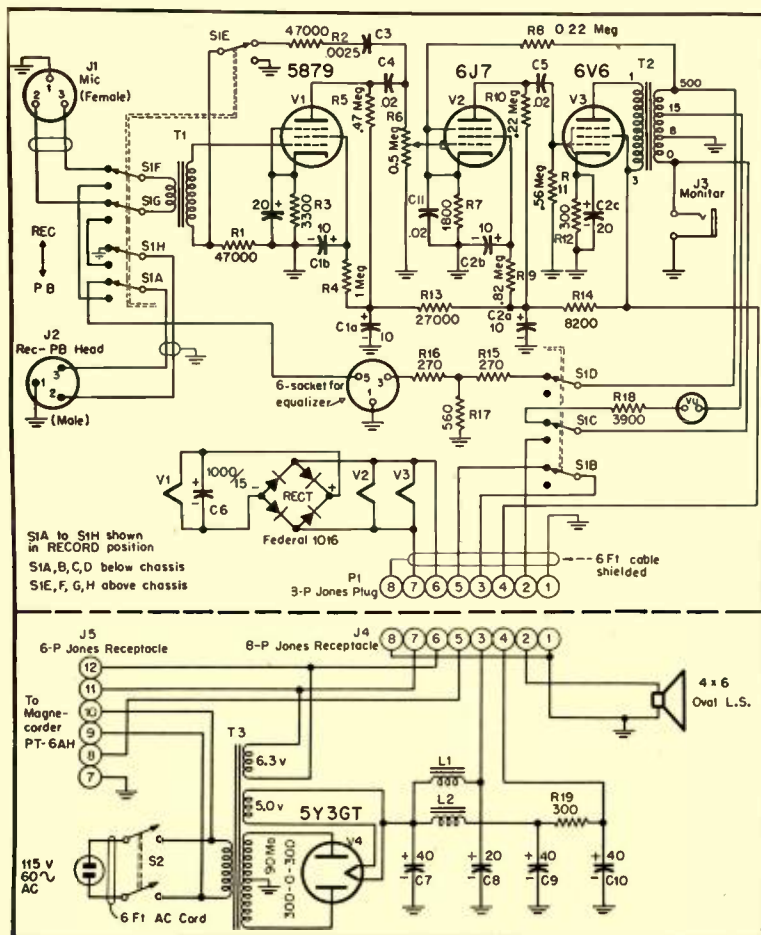

Fig. 3. Over-all schematic of amplifier and power supply.

order to complete the output circuit. The impedance between the 8- and 500-ohm taps is

$$\begin{aligned} Z_x &= (\sqrt{500} - \sqrt{8})^2 \\ &= (22.40 - 2.83)^2 = 19.57^2 \\ &= 382 \text{ ohms.} \end{aligned}$$

When the standard VU meter indicates zero on the scale, the voltage applied to its terminals through a 3900-ohm resistor is 1.228 volts (using a steady tone). With this voltage appearing across the 15-ohm winding, the voltage across a 382-ohm winding is determined by the following means.

$$\begin{aligned} \frac{E_1}{E_2} &= \frac{\sqrt{Z_1}}{\sqrt{Z_2}} \\ E_1 &= \frac{E_2 \sqrt{Z_1}}{\sqrt{Z_2}} = \frac{1.228 \sqrt{382}}{\sqrt{15}} \\ &= \frac{24.0}{3.88} = 6.2 \text{ volts.} \end{aligned}$$

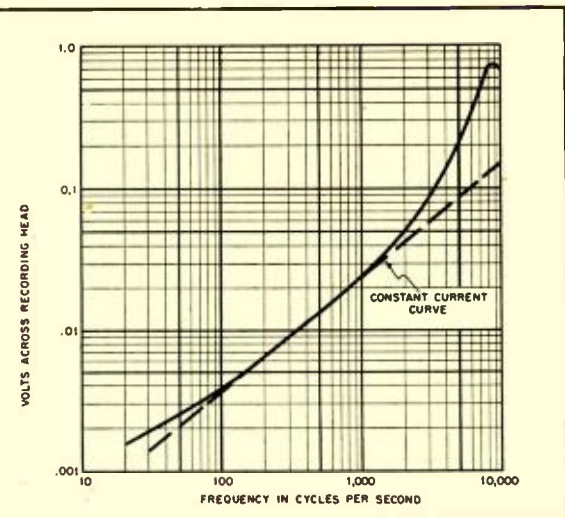
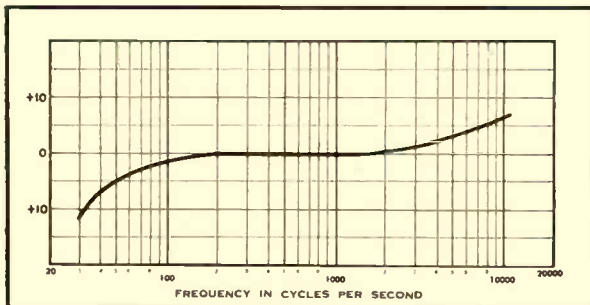

Fig. 6. Voltage across recording head for constant zero indication of VU meter.

382-ohm secondary, the signal across the primary is

$$\begin{aligned} E_p &= \frac{7.0 \sqrt{5000}}{\sqrt{382}} \\ &= 25.3 \text{ volts.} \end{aligned}$$

Fig. 5. Frequency response, input to tape output. This involves the amplifier for two operations.

The ratio between the required 3.0 volts and the indicated 6.2 volts is 2.064, which represents 6.3 db. There is, however, a mismatch between the 500-ohm pad provided between transformer and equalizer, and the voltage appearing across the 500-ohm load and the 382-ohm source is somewhat higher than that calculated, being some 7.4 db higher than the required 3.0 volts. The 8-db pad was assembled from standard preferred-

value resistors to approximate the necessary loss and impedance. Final matching of VU meter indication and the signal voltage at the input of the equalizer may be done by small changes in the series VU-meter resistor. In this particular instance, however, the 3900-ohm resistor gave a zero indication with 3.05 volts at the equalizer.

The rated primary impedance is 5000 ohms—normal for the 6V6. With a 7-volt signal being required across the

In calculating amplifier gains, it is usual to assume a gain of approximately 15 times for a pentode output stage. Thus the signal voltage required at the grid of the 6V6, for normal output, is 25.3/15, or 1.69 volts. To determine the needed gain for the first and second stages, it is first necessary to start with the available input signal. The average microphone has an output of the order of -52 db, according to the specifications, for a sound pressure of 10 bars. Normal speech is somewhere in the vicinity of 0.4 bars, however, which is 28 db below 10 bars. Thus the voltage output from a microphone is about 52 + 28, or -80 db, based on a reference of 1.73 volts across 500 ohms, presumably. Referred to 30 ohms, for the microphone to be used, the reference zero is

[Continued on page 36]

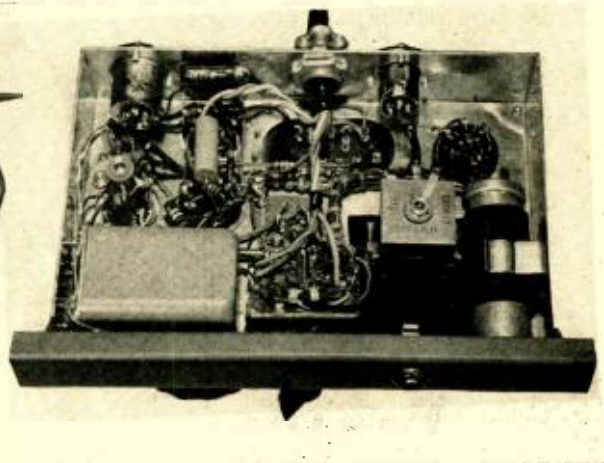

Fig. 8 (left). Top view of amplifier chassis, to show placement of major components. Fig. 9 (right). Under-chassis view of the amplifier.

An Analysis of the Split-Load Phase Inverter

GEORGE ELLIS JONES, JR.*

A mathematical proof of the characteristics of the cathodyne phase inverter which has often been the subject of discussion as to its balance over the frequency range from lows to highs.

DESIGNERS often avoid using the split-load phase inverter due to a rather widely held impression that its high-frequency response is very poor. Using but one triode, it has a very high input impedance and is readily balanced at low frequencies to give an over-all gain of slightly less than two.

Referring to Fig. 1, it may be seen that the prejudice against this inverter grows from the apparent differences in source impedance seen by the plate and cathode output loads. The cathode source impedance, being that of an amplifier with degenerative voltage feedback, is low. At the plate terminal an amplifier with degenerative current feedback is seen, and here the source impedance is high. The shunting effects of inverter tube capacitances, wiring capacitances, and input capacitances of the following stage are then supposed to reduce the high-frequency gain more rapidly at the plate than at the cathode terminal. However, since these capacitances shunt both terminals simultaneously, the actual situation is rather favorable.

Based on the preceding discussion, we may make the following analysis. Where:

- R_b = plate load resistance
- R_k = cathode load resistance
- r_p = dynamic plate resistance
- μ = amplification factor
- A_{pg} = grid to plate gain
- A_{kg} = grid to cathode gain
- Z = source impedance

$$A_{pg} = \frac{-\mu R_b}{r_p + (\mu + 1)R_k + R_b}$$

$$A_{kg} = \frac{+\mu R_k}{r_p + (\mu + 1)R_k + R_b}$$

$$Z_p = r_p + (\mu + 1)R_k$$

$$Z_k = (r_p + R_b) / (\mu + 1)$$

$$R_b = R_k = R$$

$$A_{pg} = -A_{kg} = \frac{-\mu R}{r_p + (\mu + 2)R}$$

Often the two output terminals are shunted by approximately equal impedances. This will occur if the subsequent stage involves un-neutralized triodes so that their input capacitances

* Instructor, Chemical Engrg. Dept., The University of Pittsburgh, Pittsburgh 13, Pa.

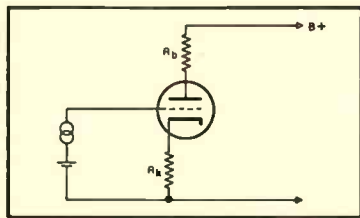

Fig. 1. Typical cathodyne split-load phase inverter circuit.

(which will be similar) make trivial the much smaller and mutually different wiring and inverter input capacitances.

C_p = plate shunting capacitance

C_k = cathode shunting capacitance

$C_p = C_k = C$

$X_c = 1 / 2\pi f C$

$$A_{pg} = \frac{-\mu \frac{R_b j X_c}{R_b + j X_c}}{r_p + (\mu + 1) \frac{R_k j X_c}{R_k + j X_c} + \frac{R_b j X_c}{R_b + j X_c}}$$

$$= \frac{-\mu R}{r_p + (\mu + 2)R} \times \frac{1}{1 + \frac{r_p}{\mu + 2} R \left/ \left(\frac{r_p}{\mu + 2} + R \right) \right.} + \frac{R_k j X_c}{R_k + j X_c}$$

$$A_{kg} = \frac{+\mu \frac{R_k j X_c}{R_k + j X_c}}{r_p + \frac{R_b j X_c}{R_b + j X_c} + (\mu + 1) \frac{R_k j X_c}{R_k + j X_c}}$$

$$= \frac{+\mu R}{r_p + (\mu + 2)R}$$

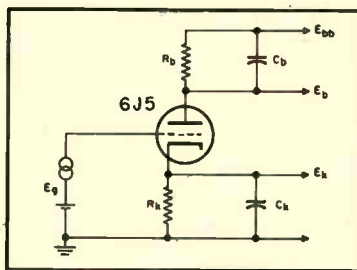

Fig. 2. Schematic of test set-up used to check calculations.

$$\times \frac{1}{1 + \frac{r_p}{\mu + 2} R \left/ \left(\frac{r_p}{\mu + 2} + R \right) \right.} + \frac{1}{j X_c}$$

It is seen that the gain from grid to either cathode or plate output is identical, and with equivalent capacitances as would normally be encountered, the frequency response is the same at both outputs.

The high-frequency roll off will be the same for both plate and cathode outputs and the gain will be down 3 db from the mid-frequency value at:

$$f_o = \frac{1}{2\pi C \frac{r_p}{\mu + 2} R \left/ \left(\frac{r_p}{\mu + 2} + R \right) \right.}$$

To verify this derivation the experimental set-up shown in Fig. 2 was used.

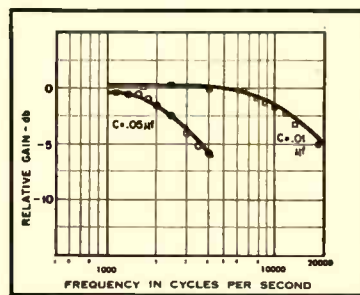

Fig. 3. Frequency response of test set-up under various conditions.

Relatively large values for C_k and C_p were inserted to minimize the unbalance created by the connection of test probes and also to bring the calculated 3 db frequency down to a convenient range.

Conditions of the experiment were as follows:

$E_{bb} = 255$ volts

$E_b = 165$ volts

$E_k = 96.5$ volts

$E_g = 92.5$ volts

$R_b = R_k = 68,000$ ohms $\pm 10\%$ (matched)

$C_b = C_k =$ either 0.05 mfd or 0.01 mfd $\pm 20\%$ (matched)

Inspection of tube handbook curves

[Continued on page 40]

The R-J Speaker Enclosure

WILLIAM JOSEPH, P. E.* and FRANKLIN ROBBINS*

A presentation of the principles involved in a revolutionary new speaker housing design which reduces cabinet volume to around twenty per cent of normal bass-reflex enclosures.

IN THE EARLY STAGES of developmental work on the R-J speaker enclosure, the following were first set forth as objectives to be met by an ideal enclosure system.

- (1) Smooth frequency response.
- (2) Extension of the bass range without resonant humps.
- (3) Accomplishment of objectives (1) and (2) without the use of a bulky and clumsy enclosure.

Careful consideration of objective (1) led to the conclusion, almost inescapable, that the back of the speaker must be totally enclosed if the multiple reinforcements and cancellations which the back wave perpetrates upon the front wave are to be eliminated. While it is true that the popular bass-reflex cabinet utilizes this very principle to extend the frequency range downward, it is also indisputable that there are varying differences in phase relationship between the direct and port-emitted sound waves throughout the frequency range, and the result shows up in ragged response curves. Likewise, theory shows that the extension of bass output cannot be accomplished smoothly. Today, with modern speakers affording loaded cone resonances of around 30 cps and below, extremely large bass-reflex cabinets are required to tune properly. In practice, the result generally obtained with enclosures of average size is a response curve with two low-frequency resonant humps, one produced by speaker cone resonance and another at a higher frequency produced by the cabinet air resonance. Between these two humps lies a trough, the depth and length of which depends on just how low the cabinet air resonance can be brought down by the use of large cabinet volume and careful port tuning. Within this trough the speaker cone loses air loading and the transient response suffers.

One fault which stands out and which has pointed up the shortcomings of the bass-reflex principle is the progress made by speaker manufacturers in lowering the basic cone resonance of speakers. Loaded cone resonances of 30 cps and below are readily available today, and the importance of this factor may be appreciated when it is recalled that response of a speaker in an infinite baffle falls off at the rate of 12 db per octave below the resonant frequency, and for doublet action (as in bass-reflex cabinets) at 18 db per octave. Consequently, the modern well-designed speaker has a tremendous potential for low, natural-

sounding bass response if somehow it can be backed up, but the question remains as to how this may be accomplished without the use of long and large horns. To return to objective (1), if a speaker is installed in a closed box, what may be expected? With the back wave completely suppressed, adequate cabinet lining provided, the desired smooth frequency response is attained because sound pressure output above the resonant

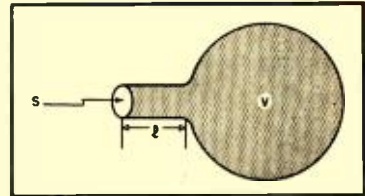

Fig. 2. Basic arrangement of Helmholtz resonator.

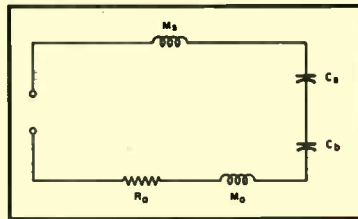

Fig. 1. Equivalent circuit of the acoustic network of a speaker within an enclosed box.

frequency for such a system is independent of frequency. However, a rise in system resonant frequency considerably above that of the speaker cone resonance is now noted. To help explain this phenomenon, the electrical equivalent of the acoustic arrangement is shown in Fig. 1. In this diagram the mass of the speaker cone and suspension is represented as inductance M_s . The compliance of the speaker cone and suspension is shown as capacitance C_s and the compliance of the box as C_b (the reciprocal of the box stiffness). The acoustic air radiation is represented as resistance R_a and the mass of air load is shown as inductance M_a . The electrical resistance and inductance of the voice coil and the mechanical resistance of the speaker suspension are here neglected.

As can be seen, the compliances C_s and C_b are in series so that the resulting compliance C is reduced. Consequently, the resonant frequency of the series circuit expressed by $f = \frac{1}{2\pi} \sqrt{\frac{1}{LC}}$ has been raised by the use of the closed box. The compliance of a closed box is expressed by the formula:

$$C_b = \frac{V}{\rho c^2 S_c^2}$$

where V is the volume.
 ρ is the air density.
 c is the velocity of sound.
 S_c is the cone area.

From this formula it may be appreciated that the smaller the volume of the box, the smaller will be C_b and the higher the resonant frequency of the system. The inherent advantage purchased in a good speaker with low resonance is swamped out by the box stiffness. Olsen² shows a speaker with a fundamental resonance of 30 cps installed in a 2' x 2' x 8" box with a resulting system resonance of about 70 cps. Increasing the box size to 2' x 2' x 18" lowers the system resonance to about 50 cps.

From the above it was concluded that the closed box, while it produces smooth response, is in conflict with the size desideratum of objective (3), which is aimed at meeting the space conditions of the modern small apartment and home. This objective was considered to be most important and not, in the author's opinion, to be compromised. Therefore the decision was made to retain the small closed box, in spite of the small compliance C , and some other means should be explored to achieve lower system resonance.

Steps in Further Development

While the resulting development to be described was brought about through a series of experiments and theoretical analyses, the basis of the development may perhaps be most clearly illustrated by analysis of the circuit of Fig. 1. Since a small compliance C has been adopted as a fixed condition, the only way the circuit resonant frequency may be lowered is by increasing the system mass. Naturally, as the mass of the speaker system M_s cannot be increased, nor is this desirable, there remains to be considered only the mass of air M_a in the circuit. To increase this mass of air without resorting to long horn arrangements became the objective and this was finally accomplished within the desired space limitations by methods which were found to best lend themselves to analysis by the Helmholtz resonator principle.

*The R-J Co., 10 W. 86th St., New York 24, N. Y.

¹Olsen, "Elements of Acoustical Engineering" second edition, pp. 153, 155.

²Ibid., p. 152.

[Continued on page 46]

A Tape Editing and Duplicating Machine

ROBERT P. LEDBETTER*

Details of a system arranged for flexibility of operation in a studio where recording, playback, copying, and duplicating are the regular order of the day.

THE ECONOMY AND FLEXIBILITY of magnetic tape as a medium for a transcribed-program network is inviting. John Woodworth, program director of the radio department of Oklahoma A. & M. College, originally suggested a transcription service using discs, and the author followed by suggested magnetic tape because it is reusable. Other advantages were to develop later—such as finding that the shipping carton for 400-foot rolls of 16-mm motion picture film is a perfect fit for two 7-inch reels of

magnetic tape. The ease of editing and correcting the tape—both electrically and by cutting—is unequalled by any other medium of recording.

The author proposed a rack containing several tape units, each capable of recording or reproducing program material. "On the Spot" tape recordings and other material previously recorded at the convenience of the participants could be combined with studio narration to build a variety of fast-moving programs. Then the same equipment could be set up to duplicate the tape copies. Each equipment was subsequently designed and

built. It has been successful to the point that the author suspects he built a monster. A block diagram of the equipment is shown in Fig. 1.

Major Units

The tape mechanisms are high-quality, rack-mounted units, each with a self-contained bias oscillator.¹ The number of units employed should depend on the planned use of equipment.

Three types of amplifier units are used: record-playback, duplicating, and cueing. The record-play units contain an

*Radio Supply Co., 724 N. Hudson, Oklahoma City, Okla.

¹ Magnecord PT6-AH.

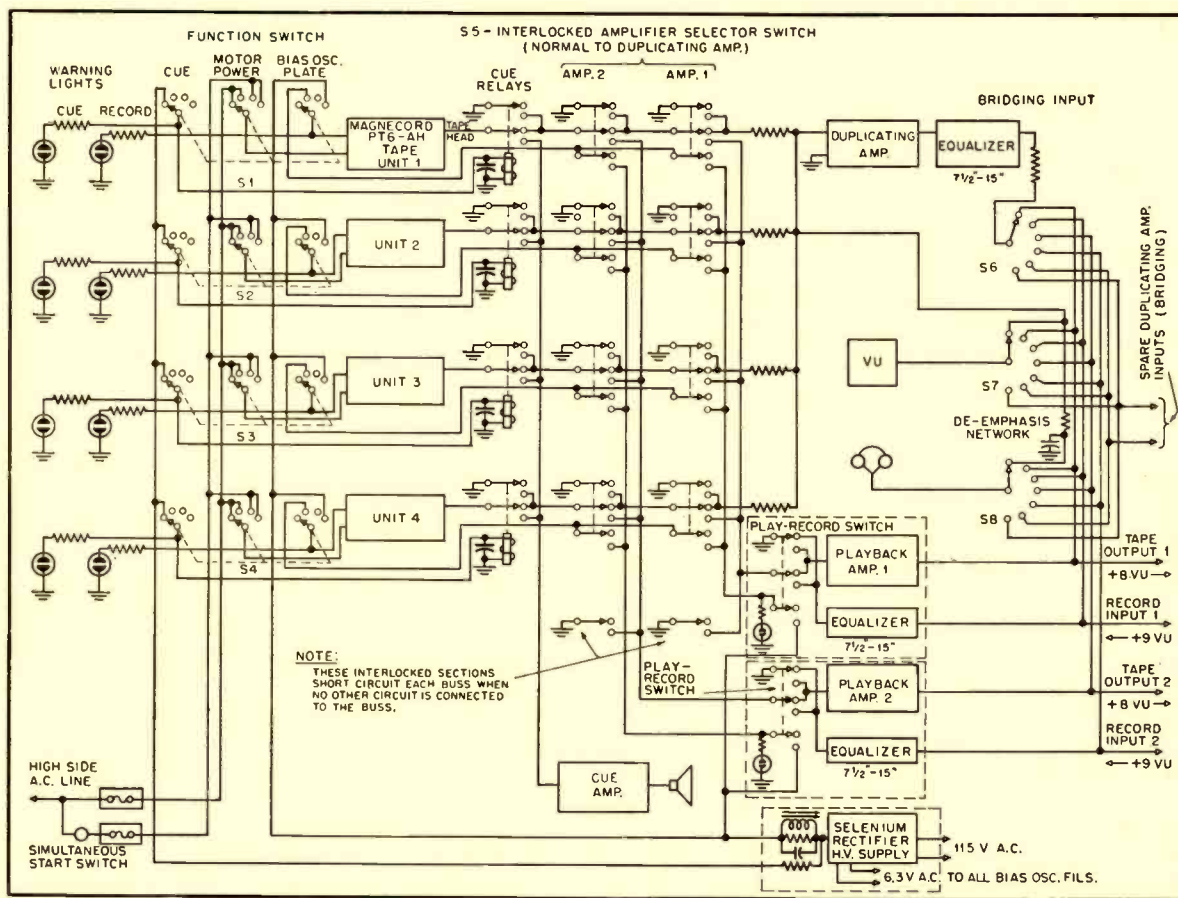

Fig. 1. Block schematic of entire duplicating, copying, and recording installation. For details of amplifier selector switches, see Figs. 4 and 5.

amplifier for playback and equalizers² for recording from an external source. In the record position a recording input level of +9 VU is fed directly to the tape equalizers, producing the maximum recording level on the tape. It should be noted that only passive elements are used in the rack for recording a single tape. This arrangement improves the signal-to-noise ratio, which is quite important when the material is to be copied once or twice before appearing on the final tapes.

The first two stages of the playback amplifier produce the necessary equalization, as shown in Fig. 2. The complete

feed the tape heads. If four tape heads are supplied from a 500-ohm output, each tape head should be connected through a 2000-ohm series resistor. This will result in a load of approximately 500 ohms across the transformer secondary since the actual head impedance is low compared to the resistance value. When a tape head is switched out of the duplicating amplifier circuit, the resistor alone is connected across the secondary, resulting in a nearly constant load impedance on the amplifier.

This amplifier has been designed with a maximum output capable of saturating



The author and the monster (monster on right).

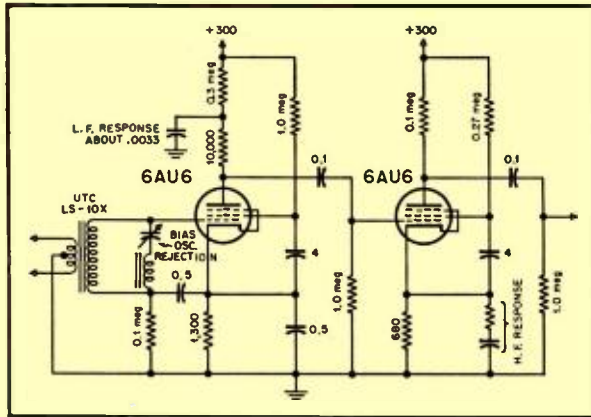

Fig. 2. Schematic of first two stages of the playback amplifier to show the method of obtaining the required equalization.

amplifier produces an output level of +8 VU. Equalization of this amplifier should be very carefully adjusted, as the same program material may be copied more than once through the same playback amplifier. The major equalization is of the low frequencies, and takes place in the plate circuit of the first stage. This amounts to almost 30 db increase over the mid-range gain. A slight equalization of the high frequencies is necessary to maintain uniformity in the high-frequency response of the copies. It is a boost of about 3.5 db at 15 kc. Without this, a tape copied twice—once in editing and once in duplicating—will be down 7 db at 15 kc. Thus if the response is not uniform, the irregularities will be emphasized more each time the material is copied.

A rejection filter consisting of a high-Q series resonant circuit is located at the grid of the first stage. Its purpose is to reject the stray r.f. resulting from the bias oscillator or oscillators in use.

The duplicating amplifier and its associated circuits are shown in Fig. 3. The equalizers were constructed from selected capacitors and one-half watt resistors. Standard iron-core r.f. chokes³ were unwound to the correct value. The amplifier proper has a relatively large amount of inverse feedback to stabilize the output voltage against changing load conditions and to reduce internal noise to a minimum.

The line-impedance output is used to

² Magnecord 6910-15 and 6911-7.5 equalizers.

³ J. W. Miller Co. No. 959 and 957.

the tape heads with the aid of the bias oscillators; thus the heads may be demagnetized easily with the use of an external audio oscillator.

The cueing amplifier is a small high-

quality amplifier similar to the playback amplifiers. It drives a loudspeaker and is equalized to produce a uniform acoustic output from the speaker.

Switching Circuits

Three line bridging switches are used. They are located together since most lines go to all three. The VU meter and headphones can be bridged across all the duplicating-amplifier inputs and, in addition, the duplicating-amplifier output. The VU meter indicates the pre-emphasized duplicating-amplifier recording level rather than the volume level heard by the ear. The duplicating-amplifier output is then de-emphasized for audible monitoring through crystal headphones.

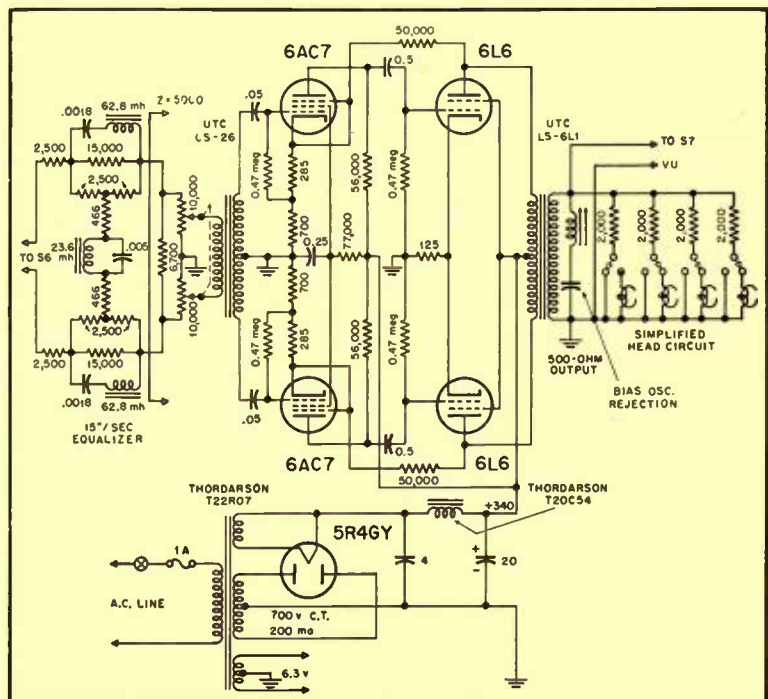

Fig. 3. Schematic of the duplicating amplifier.

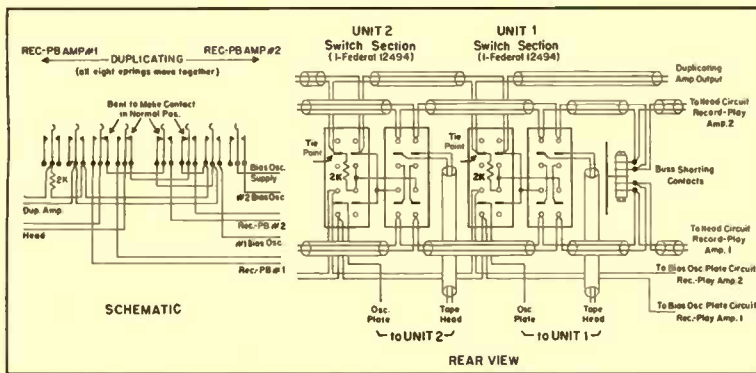

Fig. 4. Schematic and wiring diagram of amplifier selector switch.

Square duplicating-amplifier inputs should be provided for external rack units, such as another similar rack unit.

Each tape mechanism has two switch systems associated with it—the function switch, and the amplifier selector switch. A function switch, along with two warning lights, is located above each tape unit. Each switch is fed with cueing, bias oscillator plate voltage, and drive-motor power. The four switch positions are as follows:

Position 1—Cue. The cueing relay is energized, connecting the tape head directly to the cueing amplifier and overriding all other circuits. A warning light is on to indicate the switch position.

Position 2—Normal. This position is used for all recording and playback of one tape at a time, such as editing and building of a master tape, or recording, or playback of a program for broadcast. This position connects the bias-oscillator plate to the amplifier section switch. The switch is left in this position when the unit is not in use.

Position 3—Master. The bias oscillator plate is disconnected and the motor power is fed from the simultaneous-start buss so that all machines may be started at once in the duplicating process.

Position 4—Copy. Same as position 3

except that bias oscillator is energized for recording.

The second warning light indicates at all times when the tape unit will erase and record if turned on.

The second switch system—the amplifier selector switch S_5 —is concerned with the tape-head circuits and, when record-play amplifiers are used, the oscillator plate circuit.

All tape-head circuits are carried through the cue relays and amplifier switch as balanced lines. All playback input circuits are balanced and all record circuits are fed from unbalanced sources; that is, one side of the duplicating amplifier output is grounded at one point and the other side feeds all tape heads through separate series resistors. The value of these resistors is high in relation to the head impedance, as previously indicated.

A three-position lever-action switch⁴ is used for each unit. The wiring diagram of this switch is shown in Fig. 4. The contact springs have been bent so that in the center switch position the tape head is routed to the duplicating-amplifier output. The duplicating amplifier is

⁴One Federal 12494 8PDT switch for each unit.

left off except during actual duplication, so this is normally an off position.

As the switch is moved to the upper position, the tape head is connected to one record-play amplifier and the bias oscillator supply is connected to the same record-play amplifier through the normal position of the function switch. The contact springs have been modified mechanically so that the switch is spring-return to the center position. A steel pin is mounted on the back side of each switch lever. This pin is used with a latching system to retain the switch in its actuated position as shown at A in Fig. 5. The switch may be moved back to the center position, slipping the latch, as at B. If another switch is depressed to the same side, the original switch will be released to the center position by the latching system. Thus the amplifier selector switches for each tape unit are interlocked in a manner similar to the com-

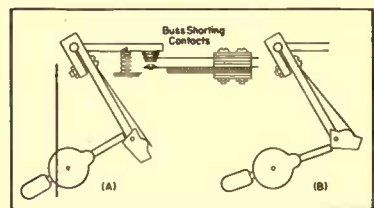

Fig. 5. Details of latching mechanism built for the amplifier selector switch.

mon push-button switch. Each side being connected to a separate record-play amplifier is separately interlocked, so two latch mechanisms are required.

If no switches are depressed to one of the record-play amplifiers, the buss connected to that amplifier is shorted by the contacts mechanically linked to the latch. In other words, these contacts are opened by the latching of any of the amplifier selector switches to the buss.

Sequencing of the amplifier selector switch should be carefully adjusted. The duplicating amplifier output should be

[Continued on page 44]

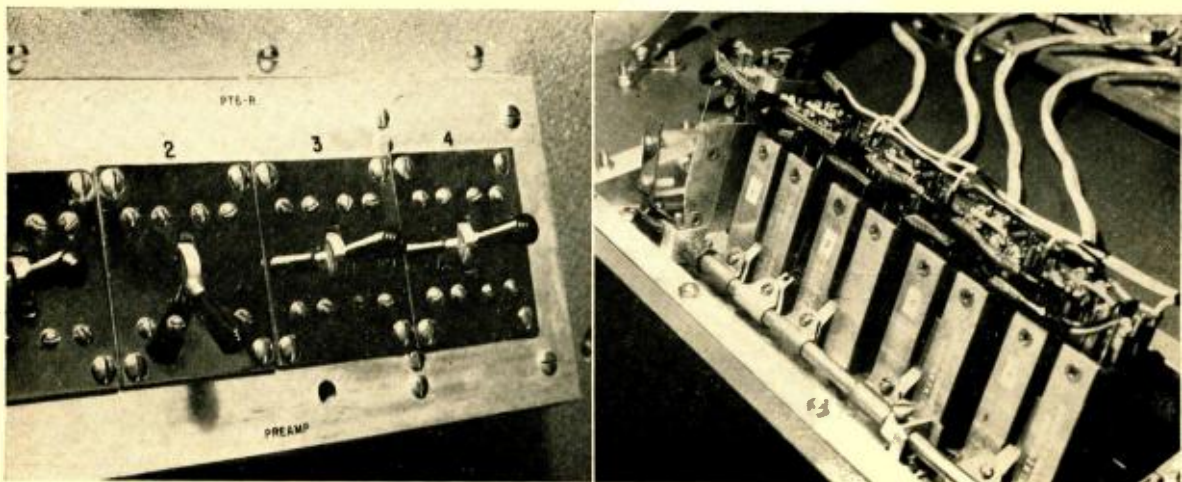

Front view (left) and rear view (right) of the interlocking amplifier selector switch. Schematic and wiring diagrams are shown in Fig. 4, while a cross section of the latching mechanism is shown in Fig. 5.

Loudspeaker Damping by the Use of Inverse Feedback

J. P. WENTWORTH*

Further discussion of the use of some positive current feedback in addition to negative voltage feedback to improve loudspeaker damping.

MUCH ATTENTION has been given recently to loudspeaker damping as a factor in the improvement of transient response and in the reduction of speaker resonance effects. It is generally agreed that the most satisfactory way to achieve speaker damping is to reduce the impedance of the driving circuit to infinitesimal values, thereby to provide a "stiff" source of driving voltage, with a damping action similar to dynamic braking of an electric motor. The search for a low-impedance source has given rise to considerable discussion among audio men as to the relative merits of triodes, pentodes-with-feedback, and cathode followers as the output stages of amplifiers. Most are agreed, however, on one basic point—that low impedance is a *sine qua non* for good damping.

But there is a point beyond which reduction of the source impedance

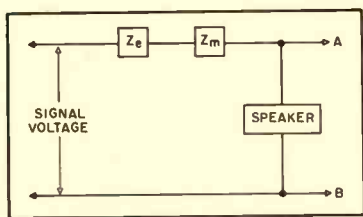

Fig. 1. Equivalent electrical circuit of loudspeaker system.

produces no appreciable improvement in speaker damping, due to the presence of impedances inherent in the speaker system itself. The phrase "speaker system" is used here because the effective impedance is not determined solely by the speaker, but by the acoustic "circuit" into which the speaker delivers power, as well. The speaker system can be represented as electrically equivalent to a circuit made up of the transducer SP, its electrical impedance Z_e , and the mechanical impedances of the system Z_m , as shown in Fig. 1.

It is apparent that reduction of the source impedance below a certain fraction of the impedance of the speaker system will result in no significant improvement in damping. Perfect damping, indeed, could be achieved only by one of the following expedients: (1) by applying voltage from a "stiff" source directly to the transducer, as at points A and B of Fig. 1, or (2) by reducing Z_e and Z_m to zero, and then applying the driving

*937 Fourth Street, Santa Monica, Calif.

Fig. 2. Circuit for obtaining e .

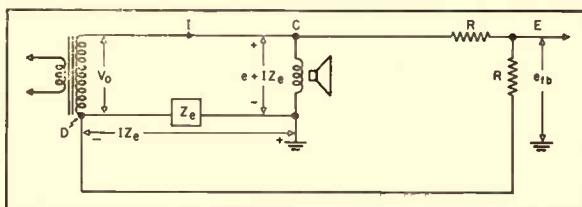

voltage to the entire system from a low impedance source. The first expedient seems impossible, as it is not feasible physically to separate the transducer proper from its impedance components, as has been done, on a circuit basis, in the diagram. Let us then examine the alternative solution—that of reducing the impedance Z_e and Z_m .

Z_e is a function of the materials and geometry of the speaker voice coil, with some lesser effects due to the motion of the speaker—the hysteresis and eddy current impedance effects. This impedance could perhaps be reduced somewhat by changes in speaker design, but only at great cost, and quite possibly at the expense of some compromises in the transducing qualities of the speaker. In any case, reduction of this impedance can not be carried on without limit—if the speaker is to exist physically, it will have a finite Z_e .

Z_m is a function of the speaker cone

Fig. 3. Push-pull feedback circuit.

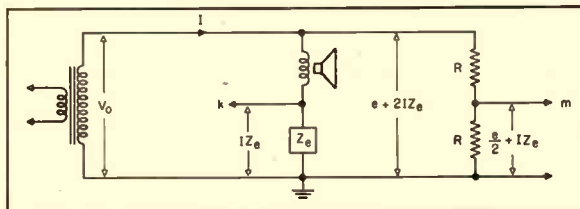

material and shape, of the speaker baffle characteristics, of the room acoustics—of every single item, apart from Z_e , that affects the speaker sound power output, as a function of electrical power input. As may be surmised, this impedance is extremely complex and difficult to control. Nevertheless, with care in designing the speaker and its baffle, it is possible to reduce Z_m to some extent, though, as in the case of Z_e , not to zero.

Limitations

Here, then, we see the limitations of this method for achieving speaker damping. Moreover, this method requires control of speaker design. This control is

not available to most audio hobbyists—in fact, very few of us have the knowledge that would be necessary to exercise such control intelligently.

Let us back off for a moment, and approach the problem from another point of view. Let us examine that which is our primary interest, the sound itself. The criterion for a high-quality speaker system is that the sound intensity be exactly proportional to the audio signal. Acoustic power, of which sound intensity is a function, is equal to the product of sound pressure and particle velocity. Since sound pressure and particle velocity are related to each other by the acoustic impedance of air, which is nearly constant, sound power is a function of the sound pressure or of the particle velocity. This situation is directly analogous to the case of power in a communication circuit, which can be determined by measuring either volt-

age or current, the two being mutually related by the circuit impedance.

Behavior of the sound after it leaves the loudspeaker is a function of room (and baffle) acoustics, which are beyond the scope of this paper. We shall insure only that the velocity of the air at the loudspeaker, i.e., the velocity of the speaker diaphragm, is a faithful reproduction of the signal in the amplifier.

As the speaker vibrates, there is induced in the voice coil a voltage, according to the familiar law, $e = N \frac{d\phi}{dt}$. This induced voltage is the counterpart of the back e.m.f. in a direct-current motor.

[Continued on page 43]

Intermodulation Testing

PIERCE J. AUBRY*

A simple intermodulation test set which can be duplicated easily by the serious experimenter is described by the author, along with methods of use and typical measurement results.

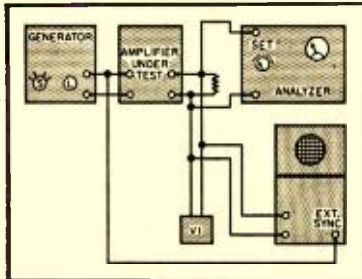

Fig. 1. Block schematic of typical test set-up.

DURING THE COURSE of building amplifiers for high-quality reproduction, it became evident that the usual methods of checking distortion did not always result in ones that sounded "good." Amplifiers that showed little distortion when single-frequency signals were used as the source, were frequently characterized as sounding "woolly" or "fuzzy" when program material was reproduced.

Hilliard and others have reported the results obtained when the source contained more than one frequency, mixed and fed simultaneously to the equipment being tested. The results have agreed remarkably well with aural checks using speech and music. All of this has been reported in the literature at various times.

To review, briefly, the method consists of feeding mixed frequencies, one usually between 40 and 100 cps the other between 3000 and 12000 cps, to the amplifier being tested, in ratios from 1:1 to

4:1, depending on whether h.f. or l.f. distortion is to be predominant in the measured results.

Various opinions have been expressed as to the method of measuring the mixed signals. It has been shown that the r.m.s. value, as indicated on most meters, is not a true indication of the magnitude of the resulting mixture. In this article, a simple method of determining the equivalent power was adopted and used. It appears accurate enough for the measurements made, and has the virtue of simplicity. It will probably vary with the particular meter used.

The intermodulation generator and analyzer used are homemade and contained in one portable unit. The generator permits selection of 4000 cps alone; 60 cps alone; or both in 1:1 and 1:4 ratio. This permits flexibility in adjusting the analyzer and in setting the levels used.

Output Level Measurement

The method of determining the levels of output power are as follows, and criticisms are welcome. The selector is set on 4000-cps position and fed to the amplifier input. The signal is increased until a level indicator connected across the load resistor will show no further increase. The level is read and noted. The selector is now switched to 1:1 ratio and the process is repeated. There is a difference of about 1.8 db, between the two measurements, that with the 1:1 ratio being the lower. This figure is used as a correction factor, and is added to all readings made with the 1:1 ratio to determine the equivalent power. It checks well on actual measurements. When using the 1:4 ratio, the difference is of the order of 0.2 db, and is neglected,

except where large power levels are concerned.

A typical test setup is shown in Fig. 1. The scope is included in the setup as a check on the calibration of the IM meter circuit, and the method has been described by McProud and LeBel. As a matter of fact, these methods may be used alone, although they are somewhat less convenient than the analyzer. For the LeBel method a suitable high-pass filter is shown in Fig. 2.

Typical Test Results

The amplifier under test is an all-triode version, based on the Williamson

* 941 E. 36th Place, Tulsa 5, Okla.

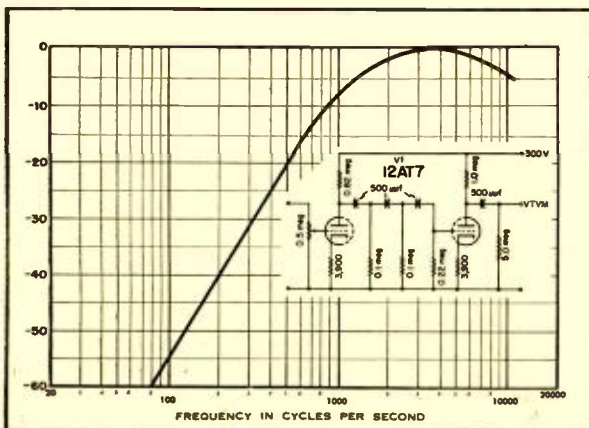

Fig. 2. Schematic of high-pass filter, and response curves.

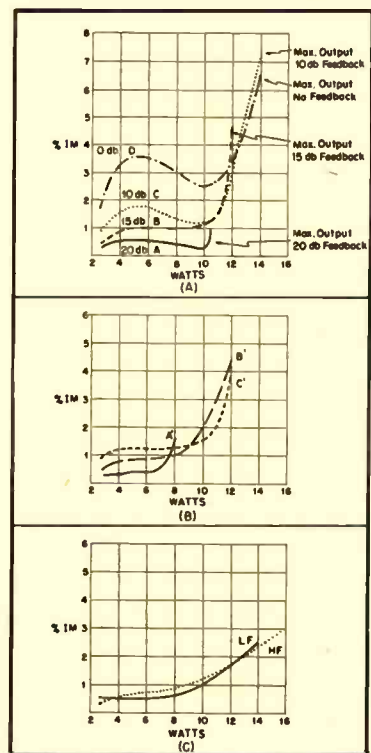

Fig. 3. Distortion curves made on Williamson-type amplifier. (Top) With 1:4 frequency ratio; (center) with 1:1 frequency ratio; and (bottom) with 1:4 ratio and amplifier adjusted for optimum listening conditions with 10 db of feedback.

circuit, but with fixed bias on the output tubes and regulated 300-volt supply for the preliminary stages. These stages have self-bias, with adjustable bias resistors in the experimental model. To minimize hum pickup in the low level

stages, there is no filter choke. It does not appear to impair the power capabilities.

After preliminary adjustment of the bias values, based on experience or intelligent guesswork, and several IM checks were made at a number of output powers from 2 to 14 watts. Bias for the output stage is adjusted for minimum IM at the greatest power output.

This amplifier has a Partridge WWFB/0-1.7 output transformer, and the adjustable feedback resistor was set to provide 20 db of feedback. The results, as checked with 4000 and 60 cps at a ratio of 1:4 are shown on curve A, Fig. 3. It will be noticed that the power output "folds up" at 10.5 watts. Other curves made with various amounts of

Fig. 4. Panel appearance of completed unit.



these tests, that it is desirable to find a combination of feedback and bias that will result in approximately the same amount of distortion at high and low

frequencies for optimum listening performance. It is reasonable to assume that a sudden increase in distortion would be more noticeable in the case of low general distortion and limited power output than in the case of slightly greater general distortion, gradually increasing at higher levels.

It has been shown, in the case of this particular amplifier, that it is possible to reduce the h.f. and l.f. distortion to a point almost as low as that of the l.f. distortion alone, by reducing the amount of feedback and adjusting the output bias. The available power is also increased at the expense of a slight increase of distortion. These adjustments, being interdependent, would be very tedious to make without the intermodulation equipment.

Equipment

For those serious experimenters who may wish to construct the combination generator and analyzer used to make these measurements, its description follows. While the instrument, shown in Fig. 4, is built on a single 7x13x2 chassis in one cabinet, it is, in reality, two separate devices. The power supply is common to both sections, and is shown

[Continued on page 41]

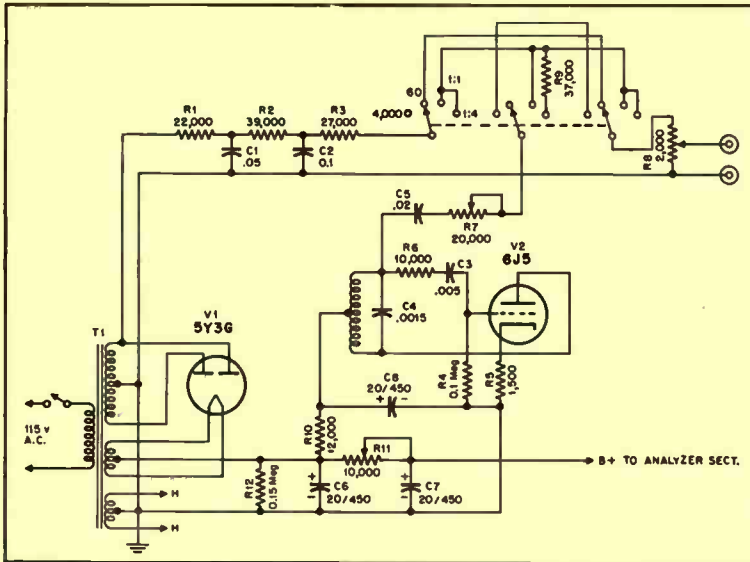

Fig. 5. Schematic of power supply and generator section of IM test unit.

feedback, using the same frequencies and ratios, are also shown on Fig. 3.

Measurement vs. Listening

The curves indicate that the 20-db feedback condition is the best on the basis of the least amount of distortion. But listening tests did not bear out this contention, so a series of additional IM measurements were made, using the same frequencies, but with a 1:1 ratio.

The first of these, using the same set-up, and 20 db of feedback, is shown in curve A'. It will be noted that the distortion is low, but the amplifier "quits" entirely at 8 watts. The remaining curves, B' and C' indicate increasing distortion and increased output, a condition to be expected.

Listening tests indicated that 10 db of feedback resulted in the cleanest reproduction, so the adjustments were made to give this value, and several checks made with varying values of grid bias on the output tubes. Optimum adjustment resulted in reasonably low values of both h.f. and l.f. distortion, as shown by the curves marked HF and LF.

It would appear, from the results of

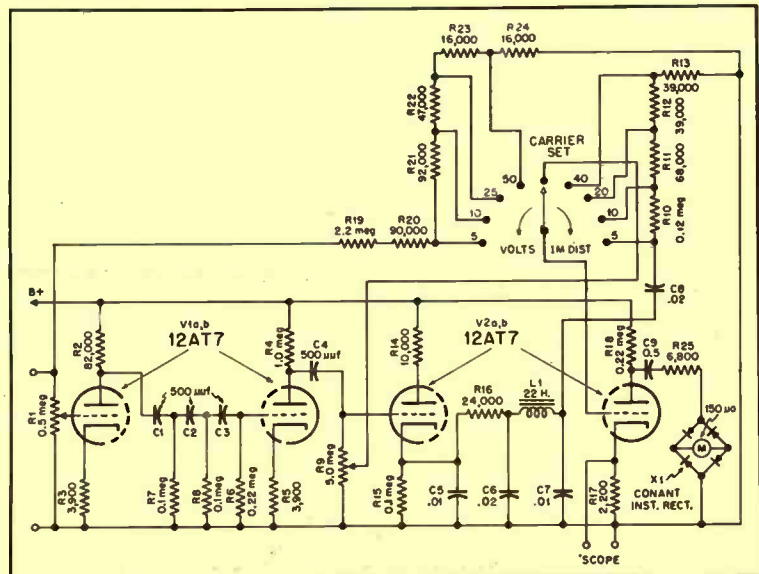

Fig. 6. Schematic of analyzer section of test unit.

The 1951 Audio Fair in Review

A brief word sketch of what was shown and by whom at the most successful Fair to date. Designed to bring a tinge of reminiscence to those who attended—a touch of regret to those who did not.

HARRIE K. RICHARDSON

AS EACH AUDIO FAIR passes into history and becomes a chattel of the ages, there appears the traditional trend of second-guessers to sound off and make with the big noise about what they think should be done to improve Fairs of the future. This is exactly as it should be, and engagement of audio enthusiasts in this strictly American art is to be credited for the rapid resolution of the Fair into a scientific forum and trade exhibit of world-wide prominence.

The Fair and the event with which it coincides, the annual Convention of the Audio Engineering Society, have in three short years brought to fruition an accomplishment without equal in the lineage of scientific assemblies. A registered attendance of more than 8000 visitors for 1951, who attended the show through three days of weather that could be called awful only with flattery, solidly entrenched the Fair as one of the country's two largest annual electronic events, the other being the yearly convention of the I.I.E. with its many years of background.

This reporter brings out these facts principally to drive home to members of the audio fraternity the monumental stature which has been achieved by their annual convention and trade show. The story of the Fair would probably carry greater dramatic impact if it included an Horatio-Alger-like chapter about a small group of dedicated individuals in whose hearts burned the torch of audio, striving against insurmountable opposition to achieve the impossible. But such just ain't the facts.

If ever there was a monument to industry co-operation—up and down and through and through—the Audio Fair is it. Only because the original Fair in 1949 received equal recognition and approval—and second-guessing—from manufacturers, engineers, and hobbyists alike, does the Fair of today exist. So, no matter which category you fall into, stick out your chest in justifiable pride—you have helped put over the touchdown, the homerun, the setpoint in the game of Audio.

Below and beyond we record for posterity the studied reflections of one happy, though bushed, observer.

Acoustical Manufacturing Co., Ltd., Huntingdon, Hunts, England. Acoustical made an auspicious impression in its initial effort to enter the American market with an animated display of the much-discussed corner-type speaker embodying a ribbon-type tweeter with frequency range extending above 30,000 cps, also with a line of high-quality amplifiers and accessories which were entirely unique in appearance and in mechanical design. One of the Fair's more striking demonstrations was the playing of a recording of breaking glass, in which the Acoustical speaker and amplifier combined to produce an illusion of reality so complete that listeners figuratively searched for Band-Aids to repair slit fingers.

Aero Products Co., Philadelphia, Pa. Newly introduced output transformers which afford ultra linearity in various high-quality amplifier circuits were featured in the Acrosound display. Along with a transformer which permits im-

proved performance from the conventional Williamson circuit, there was displayed a unit designed to give optimum performance in the circuit described under the title "An Ultra-Linear Amplifier" in the November issue of *Æ*.

Alpha Wire Corp., 430 Broadway, New York City. Here was shown with graphic emphasis the extent to which Alpha has kept pace with component and equipment manufacturers in the development of wire and cabling to meet every requirement of advanced electronic design. Stressed was the company's ability to work with customers' engineers in the design of new products.

Altec Lansing Corporation, Beverly Hills, Calif. The new Altec Lansing AM-FM tuner and Type A-333A remote-control amplifier shared honors with the Type 820A corner-type speaker in producing one of the Fair's more exciting examples of high-quality audio performance. Visitors were deeply impressed by the inclusion of crossover and equalization controls within the tuner for various types of recordings. In addition were displayed the Type 323-A amplifier, the entire line of Altec Lansing and Western Electric speakers, including the famous 604B coaxial, and the 21B condenser microphone.

Ampex Electric Corporation, Redwood City, Calif. Increasing interest of consumers in equipment which until recently has been regarded as purely professional in character was sharply evidenced in the Ampex exhibit of high-quality tape recorders. Ogled particularly was the Type 400 portable model introduced not too many months ago. Excellent source material made the Ampex demonstration one of the Fair's more enjoyable and effective.

Amplifier Corp. of America, New York City. The thoroughness with which ACA has embraced the tape recording field was well evidenced by an attractive exhibit which included a wide variety of recorders ranging from a small battery-operated model with spring-motor drive to a large rack-mounted unit which affords 24-hour continuous recording for airport control towers. It goes without saying that the ACA display also presented a number of models for home use and for conventional industrial applications. Along with the tape units were shown the well-known ACA direct-coupled amplifiers.

Arrow Electronics, Inc., New York City. Nostalgia was the theme of this display which was formally titled "Audio Yesterday and Today." Thoroughly intriguing was the collection of phonograph reproducers which included the complete lineage of such devices, beginning with an ancient hand-turned cylindrical-record player and extending through the modern light-weight magnetic cartridge. By and large, audio veterans had a field day talking over old times in the Arrow suite, and many newcomers learned for the first time that there was an age when records had to absorb a needle pressure of six ounces and like it.

Audak Company, Inc., New York City. As in previous years, Audak scored a distinct hit by demonstrating the company's products to a seated audience behind a closed door. Although the total attendance at an exhibitor's suite may be somewhat restricted by this means of demonstration, the effectiveness with which visitors are impressed is a compensating factor. Especially striking was the demonstration in which the amplifier volume control was turned to zero during the playing of a

fortissimo passage on a recording. The resulting silence dramatized the low needle talk of the new Audak Chromatic diamond-stylus system.

Audio Devices Inc., New York City. Although the Audio Devices display of magnetic tape recording discs, styli, and magnetic film was deeply interesting, the exhibit's chief appeal seemed to lie in the availability of the current issue of *The Audio Record*, the company's widely-circulated customers' house organ. Because it contains the most complete directory of tape-recorders published to date, the current *Audio Record* has already achieved a circulation of 50,000 with requests still pouring into the company's offices. At last reports copies were still available and if you have any interest in tape recording it is this reporter's suggestion that you get in line. Truly a fine piece of publishing, and furthermore, it's free.

Audio Instrument Co., Inc., New York City. No company in the electronics industry has made greater strides than Audio Instrument in the two years of its activity, and the reasons for this remarkable growth were soundly evidenced by an impressive display of precision equipment for many types of audio test functions. Particularly attention of engineers seemed directed toward a moderate-priced intermodulation meter and a new ultra-speed level-recording system.

The Audio Master Company, New York City. Portable transcription-playing equipment was accented in this exhibit. Also shown were microphones, recording devices, and a wide variety of miscellaneous audio items for which the company is distributor.

Audio & Video Products Corporation, New York City. The great diversity of high-quality audio equipment assembled in the Audio-Video exhibit which, incidentally, was conducted in conjunction with the firm's subsidiary, A-V Tape Libraries, Inc., made this suite far and away one of the Fair's more popular gathering spots. Although such impressive monickers as Ampex, Fairchild, Langevin, Cinema, and the like, were represented by their newest developments in the field of audio, they were pressed to compete for attention with A-V's pre-recorded library of magnetic tape. Also coming in for more than casual interest was a greatly improved version of the Wagner recorder. This device permits 30 minutes of recording on a disc approximately five inches in diameter at a speed of 16 r.p.m. While the frequency response of the Wagner recorder is somewhat restricted when compared with wide-range equipment, it is startling when the size of the disc and the low recording speed are considered.

Bell Sound Systems, Inc., Columbus, Ohio. Along with Bell's notable advance in remote-control amplifiers, the Model 2145-A, this exhibit was enhanced by the introduction of a new moderate-priced tape recorder. The emphasis on quality—both in construction and performance—which has motivated Bell's recent strides in the high-quality-audio industry was clearly evidenced by all of the equipment on display. Engineers and hobbyists alike were impressed by the steps Bell is taking to make excellent audio performance available at prices well in keeping with modest incomes.

Berlant Associates, Los Angeles, Calif. No doubt about the center of attention in this suite—by all odds the new Concertone network tape recorder. In presenting the

it's red hot!



hundreds of PRESTO

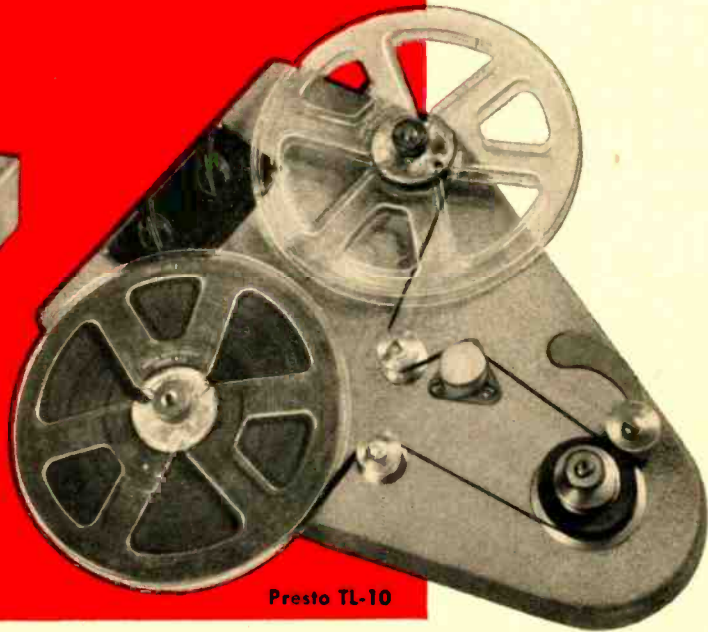

Turntable Tape Reproducers sold in the past six months!

Since its introduction last spring, sales of the new PRESTO TL-10 have surpassed even our expectations. The reason . . . it's an *inexpensive instrument that fills a definite need* in the nation's stations and recording studios. Look at the advantages listed below—then join the ranks of the hundreds of satisfied TL-10 users by calling your PRESTO dealer today.

- Reproduces tape quickly and efficiently—without tying up a regular tape recorder.
- Easy to attach and remove from any standard 16" turntable.
- No motor—turntable acts as motor.
- Can be plugged into any standard speech input equipment.
- Speeds of 7½" and 15" per second, response up to 15,000 cps.
- Easy to operate and maintain.
- Costs only \$140.00 complete, but has reproduction quality and fidelity of a high priced machine.

The TL-10 is an exclusive PRESTO product—made by the world's largest manufacturer of recording equipment and discs.

PRESTO RECORDING CORPORATION
PARAMUS, NEW JERSEY

Export Division: 25 Warren Street, New York 7, N. Y.

Canadian Division: Walter P. Downs, Ltd., Dominion Square Bldg., Montreal

WORLD'S LARGEST MANUFACTURER OF PRECISION RECORDING EQUIPMENT AND DISCS

network model, Concertone more-or-less reverses the usual trend which sees manufacturers of professional recorders invading the home-recording field. In Concertone's case, the firm's reputation was built on a recorder for home use, which, because of its impressive performance, has paved a smooth and ready path for the new professional model. A newly-improved version of the original Model 1401 Concertone also received a great deal of approbative observation.

David Bogen Co., Inc., New York City. If conclusive proof was needed to show that excellent reproduction of sound does not necessarily entail high cost, the Bogen suite was an ideal place to find it. Bogen's efforts have gone a long way toward popularizing the hobby of custom building home music systems, and this exhibit gave solid indication of the company's intention to intensify its endeavors in the future. Popular as usual were demonstrations of the Model PH-10 and DB-10 low-cost wide-range amplifiers.

R. T. Bozak, Buffalo, N. Y. Featured here was a corner speaker employing the "kettledrum" principle which is exclusive with Bozak. The unit contains four standard Bozak woofers and six tweeters. Music from high-quality recordings was reproduced with a degree of realism which was truly astounding. For perfectionists, the Bozak suite, which was shared by Cook Laboratories (see below), was one of the Fair's high spots.

British Industries Corp., New York City. Here was assembled one of the most inclusive showings of fine equipment in the entire show. Thoroughly commendable was the demonstration technique applied to Garrard record changers, the Leak "Point One" amplifier, and Wharfedale and Vitavox speakers. If there was a point of centered attraction in the B.I.C. exhibit, it was possibly the new Wharfedale Model W12/CS/AL speaker which received solid approbation from engineers and music lovers alike. The entire Vitavox line of speakers also scored a direct hit in their first public appearance in the U.S.

Brociner Electronics Laboratory, New York City. Clearly evident in this exhibit were the results of the pioneering efforts of Brociner to make the American public high-quality-audio conscious. Demonstrated were the Brociner phonograph preamplifier-equalizer which, incidentally, was the first one to be manufactured on a commercial basis, as well as the expanding Brociner line of high-quality speakers. For engineers there was shown a new square-wave tester which will have many applications in the field of audio design and development.

Browning Laboratories, Inc., Winchester, Mass. Emphasis in the Browning exhibit was placed on the necessity for a precision-built tuner, particularly one which offers high sensitivity and freedom from drift, to achieve satisfactory F.M. reception. It goes without saying that the Browning tuner is built with these requirements in mind. Along with tuners there was displayed the Browning audio amplifier.

Cabinart Furniture Co., Brooklyn, N. Y. The growing compatibility between cabinet artistry and the audio industry was well illustrated in this showing of enclosures which combined beauty of appearance with acoustical correctness. It was interesting to learn that cabinets giving every impression of having been built-to-order are available as stock items, and their prices are pleasantly low.

Collins Audio Products Co., Inc., Westfield, N. J. Collins, identified heretofore with tuners in the higher price range, used its Fair exhibit to introduce a new group of components which accented the economy factor, also to display a new Storecast receiver. Special interest of visitors appeared to center around a new F.M. tuner kit.

Cook Laboratories, Stamford, Conn. If truly remarkable recordings are your forte, your loss is great indeed if you didn't visit the Cook suite. Adept as they are at entering controversy, and creating

controversy where none exists, audio engineers reached a basis of amiable consensus in their agreement that the Cook records were really something to write home about. There is little doubt that this was one of the Fair's more satisfying demonstrations of true high quality.

Danby Radio Corporation, Philadelphia, Pa. Participating in the Fair for the first time, Danby exhibited a corner horn speaker system and a high-quality audio amplifier for custom-built installations. Both drew forth a great deal of favorable comment.

The Daven Company, Newark, N. J. Within the past year, Daven has introduced a number of new test instruments for various audio applications, many of which were shown in the company's suite at the Fair. Largely professional in character, the Daven exhibit had as its basic theme the precision and quality which are inherent in all of the company's products.

Duotone Company, Inc., Keyport, N. J. The expanding diversity of Duotone items in the audio field was emphasized in this display. Formerly known principally for its needles, Duotone now supplies jeweled stylus for both cutting and reproduction, recording blanks, magnetic tape, recording heads, and cueing devices. The display was enhanced by a mural-type blow-up of three micrographs portraying the extent of wear on stylus of different materials after a given number of playings. The pictures left no doubt of the superiority of diamond over sapphire and osmium.

Electronic Workshop Sales Corp., New York City. Striking custom-built cabinets, in whose design esthetic values and audio performance received equal consideration, were spot-lighted in this exhibit. The company has secured duplication rights to a number of cabinets designed and executed originally on an exclusive basis for discerning clients, and is now able to offer a choice of these unusual units on order.

Electro-Voice, Inc., Buchanan, Mich. One of the more heartening sagas of the audio-equipment industry in recent years has been the impressive growth of Electro-Voice. And if there were any doubt about the reasons underlying this growth, a visit to the company's Fair exhibit would remove it once and for all—excellent products—effective merchandising—truthful advertising. Available for demonstration was the complete line of Electro-Voice speakers and enclosures, ranging from the massive 4-way Patrician to a small corner cabinet containing a single 8-in. driver. Exceptional source material added to the effectiveness of the demonstration.

Federated Purchaser, Inc., New York City. This interesting display served well as an indication of the increasing attention being directed toward audio by jobbers who formerly concentrated their selling efforts in the industrial electronics field. Federated is still enjoying the growth which resulted in its occupation of an attractive new building and showroom a few months ago.

Fisher Radio Corp., New York City. Fisher had the distinction of being the only exhibitor at the Fair, aside from the inventors, to display the controversial new R-J speaker. This speaker, together with new models of the Concertone tape recorder and Fisher's own high-quality receivers and amplifiers jelled into a handsome display which was both informative and entertaining.

Gates Radio Company, Quincy, Ill. Directed essentially toward broadcast and recording engineers, the Gates display proved to be of equal interest to hobbyists and music lovers. The answer to this paradox may be found in the respect for precision and beauty of design that is inherent in even the most uninformed observer. Gates has made great strides in the broadcast equipment field in recent years, and if there be any question as to the reasons for these advances, an inspection of the equipment the company is producing will remove all doubt.

General Electric Company, Syracuse, N. Y. GE, among the first of the major

manufacturers to recognize the growing demand among consumers for improved audio quality in commercial receivers, built its display around the famous RPX-050 variable reluctance pickup and the 1201 speaker. These two items, along with the GE preamplifier, played no small part in creating the initial impetus which is so evident in the market for high-quality audio equipment today.

Gray Research and Development Co., Hartford, Conn. Although Gray is concentrating the bulk of its activity these days toward development of various gadgets for use in television broadcasting, eloquent proof that the company has not forgotten its first love entirely was evidenced by an interesting display of precision tone arms and professional equalizers.

Harrison Radio Corp., New York City. Never a dull moment here—what with a genuine wheel of fortune that paid off with a free record with every lucky spin. However, there was one major distinction that set this particular wheel apart from the usual variety—it cost nothing to play. Surrounding the wheel, which served as the exhibit's focal point, Harrison created a handsome showing of equipment.

H. A. Hartley Co., Ltd., London, England. This was the first American appearance of the Hartley 215 speaker, an event of considerable anticipation to those readers of the unique Hartley advertising which appears with regularity on the last page of *Æ*. Along with the 215, Mr. Hartley, who made his initial visit to our shores solely to participate in the Audio Fair, demonstrated the True-Bass Baffle about which he has written so frequently, and a number of other audio components which are being marketed under his auspices.

Harvey Radio Company, Inc., New York City. An illuminated screen on which flashing lights varied both in intensity and color in response to changes in volume and frequency of an audio signal was the attention-getting gimmick which kept the Harvey suite crowded to capacity. Although the unit is nameless, is still in the developmental stage, and was not shown with commercial exploitation as a prime motive, there was hardly a visitor who didn't express serious curiosity about when and where it could be purchased. As demonstrated it was tied in with a high-quality music system. The resultant effect made the Harvey exhibit one of the most talked-about spots at the Fair. Harvey gets an "A" for effort and originality.

Hudson Radio & Television Corp., New York City. Hudson carried out the theme of its handsome new Sound department with an impressive showing of high-quality equipment from most major manufacturers. Featured was a display of the one-millionth Webster record changer—gold plated throughout as a tribute to the distinguished milestone it represents in the company's history. Note: Hudson is striving to eliminate the confusion that remains in the wake of the company's recent change of name. Let this note be proof of this reporter's desire to be ever helpful.

Island Radio Distributors, Hempstead, N. Y. No better attestation of audio's growth as a market could be unearthed than the fact that a suburban distributor of equipment found it profitable to exhibit at the Fair alongside his metropolitan competitors. Island, in engaging space at the Fair, proved that even a segment of a large city provides enough audio equipment business to warrant advertising on a major scale. In addition to audio components, the Island exhibit included an impressive mural which emphasized the firm's custom building facilities.

Jensen Manufacturing Company, Chicago, Ill. Cutaways were in order in the Jensen suite, and visitors were able to see for themselves just what goes into speaker construction. Although displays of this type are of relatively little interest to professional engineers, they mean a great deal to neophytes in the audio field, and Jensen is to be highly commended

NEW SOUND LEVEL METER

Improved Design

Accurate · Simple to Use

The new Type 1551-A Sound-Level Meter is very easy to handle. It weighs only 11 pounds, including its battery power supply. It is simple to operate requiring only the switch selection of the appropriate response characteristic, and then the adjustment of a single attenuator switch until the indicating meter stays on scale. The sound level is the sum of the attenuator and meter readings.

When not in use, the microphone folds back into the instrument panel, automatically turning off filament and plate voltages.



Type 1551-A
Sound-Level Meter.. \$360.00



MEETS ALL STANDARDS of the American Standards Association, the A. I. E. E. and the Acoustical Society of America

PORTABLE — weighs only 11 pounds, with batteries

SIMPLE TO OPERATE — non-technical personnel can make just as accurate measurements as can anyone

COMPLETE BATTERY OPERATION from standard batteries, readily available

VERY WIDE RANGE of 24 to 140 db; will measure practically any noise level found in industry

EXCELLENT STABILITY — improved negative feedback amplifier circuits

NON-DIRECTIONAL CRYSTAL-DIAPHRAGM MICROPHONE

TWO-SPEED INDICATING METER for steady or rapidly fluctuating sounds

EXCELLENT ACCURACY — frequency response curves within current A.S.A.-specified tolerances; when amplifier sensitivity is standardized absolute accuracy of measurement is within ± 1 db for average machinery noises

INTERNAL CALIBRATING CIRCUIT — sensitivity can be standardized at any time from any 115-volt a-c line

WIDE FREQUENCY RESPONSE of amplifier and panel meter — 20 cycles to 20 kilocycles

LOW TEMPERATURE & HUMIDITY EFFECTS — readings independent of both over normal room conditions (within 1 db)

READILY USED WITH ACCESSORY INSTRUMENTS such as graphic-level recorders, frequency and wave analyzers, magnetic-tape recorders

MANY ACCESSORIES AVAILABLE for special applications; included are special microphones for high fidelity measurements, for reproducible standards and for use at end of long cable.

STROBOSCOPES · VARIACS · SOUND-LEVEL METERS

VIBRATION METERS · IMPEDANCE BRIDGES

SIGNAL GENERATORS · OSCILLATORS

WAVE ANALYZERS · DISTORTION METERS

IMPEDANCE STANDARDS · VACUUM-TUBE

VOLTMETERS · FREQUENCY STANDARDS

BROADCAST MONITORS · PARTS AND ACCESSORIES

GENERAL RADIO Company

275 Massachusetts Avenue, Cambridge 39, Massachusetts, U. S. A.

80 West Street NEW YORK 6

920 S. Michigan Ave. CHICAGO 5

1000 N. Seward St. LOS ANGELES 38

Since 1915—Designers and Manufacturers of Electronic Test Equipment

addition to wide-range distortion-free reproduction, the new Scott amplifiers are exceptional in the scope of equalization they provide for all types of recordings.

Sonocraft Corporation, New York City. This company, which has been making great strides toward achieving leadership in the distribution of sound equipment to educational organizations, conducted one of the Fair's most inclusive displays of moderate-priced recording equipment. Evidence of the firm's reputation in the educational field was apparent in the large number of representatives from schools and colleges who made the Sonotone suite virtually their Fair headquarters.

Stephens Manufacturing Corporation, Culver City, Calif., attracted a great deal of attention with an introductory showing of a new two-way speaker equipped with 500-ohm voice coils for direct-from-line operation. Highly efficient, the new speaker will effect many economies wherever lines are available for carrying power-output levels. Wired-music systems for sprawling industrial plants offer but one possible application where savings would be substantial. Also shown effectively were the full line of Stephens high-quality speakers with conventional voice-coil characteristics, and the Stephens miniature microphone.

Sun Radio & Electronics Company, Inc., New York City, once more justified its reputation as one of the country's most aggressive distributors of fine sound equipment. Fortunately, Sun's new sound catalog came off the presses in time for the Fair and thousands of copies were presented to visitors. The Sun exhibit included representative equipment from practically every well-known manufacturer in the audio industry.

Tech Laboratories, Inc., Palisades Park, N. J. Here's a company that is really making a name for itself in the broadcast field. At last year's Fair it captured attention with the Artificial Reverberation Generator—this year it came up with another synthetic source of sound effects, the Pistol Shot Generator. The title really tends toward understatement, because the gadget is capable of simulating a shot (or shots) of any type, ranging from a twenty-two rifle to a rapid-firing machine gun. So realistic is the effect that sounds

created by the generator have it all over the real McCoy for broadcast transmission. Reduced danger to studio personnel is another of the Generator's virtues.

Terminal Radio Corporation, New York City. Terminal deserves great credit for effectively driving home the fact that high-quality audio does not necessarily require expensive equipment. The Terminal exhibit, built around an economy-in-audio theme, offered dynamic proof that fine music is available to homes with even the most modest incomes. It's high time that the audio industry as a whole recognizes the great market potential represented by the millions of homes without music systems—and takes steps to wipe out the impression that high quality and high cost go hand in hand. Terminal, pioneer that it is in the field of sound, has taken a forward step which will be of value to the entire industry.

The Tetrad Corporation, Yonkers, N. Y. It is a safe bet that thousands of visitors, uninformed upon arrival, left the Tetrad display with an expert knowledge of stylus, thanks to one of the Fair's truly educational demonstrations. Various types of stylus were placed under binocular microscopes so that effects of wear could easily be observed. Tetrad is to be commended for its thoughtfulness in providing enough of these set-ups for all who were interested to have a careful unhurried examination. Visitors were downright lavish in their praise of the precision with which Tetrad grinds diamonds to a 1-mil diameter without observable imperfection.

Triad Transformer Mfg. Co., Los Angeles, Calif. The quality inherent in Triad transformers was evidenced with dramatic impact in this exhibit. Upon first entering the Triad suite, visitors were aware of a tastefully-prepared backdrop which displayed such respected trade names as Concertone, McIntosh, Magne-cord, Lear and Presto—all users of Triad transformers or coils. Closer inspection revealed a group of cutaways which displayed the care and precision with which Triad products are manufactured. Triad is an excellent example of the impressive growth of the electronic industry on the Pacific Coast.

University Loudspeakers, Inc., White Plains, N. Y., gave impressive evidence of

the reasons underlying the company's phenomenal growth with a showing of speakers for every conceivable type of application. Hobbyists displayed particular interest in the 6200 and 6201 series, both of which played prominent parts in bringing high-quality audio into homes with modest income. Animating the University exhibit was a tape recording which explained the facts of life of high-quality audio. Exceedingly well-handled, the recording escaped the pitfall of academic approach which claims so many ventures of this kind, and presented an adult discussion of interest to both engineers and hobbyists.

United Transformer Company, New York City. If anyone entered this suite wondering about the industry importance of the familiar initials UTC, you can be certain that ere he departed all doubt was removed. Thoroughly impressive was the display of UTC audio transformers built into working demonstrations of a number of high-quality amplifiers. Exceptionally attractive arrangement of the various items on display, together with well-prepared illustrative material stressing the quality and the broad range of UTC products, made this exhibit one of the Fair's most effective.

Waveforms, Inc., New York City, created a stir with an improved version of the tiny audio oscillator which was first introduced at the 1950 Audio Fair, and with a new tuning system which permits dialing of FM stations from a remote point. As improved, the oscillator covers a frequency range of 20 to 200,000 cps. The new remote tuner is of the crystal-control type, with a separate crystal for each station's frequency. Switching of fixed-tuned circuits is accomplished by a motor-driven switch.

Weathers Industries, West Collingswood, N. J. Here was one of the Fair's exhibits that can be classed only as revolutionary. Displayed was the new Weathers capacitance-FM pickup. Among the unusual qualities of this new pickup are 1-gram stylus pressure wide frequency range, and exceptional freedom from distortion. Keep your eye on this one—you will be hearing a lot more about it as it achieves national distribution.

AES Convention Covered by National Press

The impressive stature which has been achieved in the field of scientific forums by the annual Convention of the Audio Engineering Society, was revealed emphatically by the great interest displayed in the 1951 meeting which was held in November coincidental with The Audio Fair. Beginning with the installation of officers on the morning of November 1, continuing through the climactic banquet on the same evening, on through to the final technical session on November 3, the Convention was a constant center of coverage by the trade press, principal daily newspapers and wire services, and by a number of national magazines whose stories will appear in the months to come.

At the business meeting, which was the Convention's first official function, Alexander Fisher, chairman of the board of tellers, announced results of the 1951 election. John Colvin, departing president, expressed gratitude to the membership for the cooperation accorded him while in office, and tendered the gavel to C. G. McProud, newly-elected president. opened his term by introducing other newly-elected officers.

Presented were: F. Sumner Hall, executive vice-president, C. J. LeBel, secre-



Hermon Hosmer Scott, winner of the John H. Potts Memorial Award for 1951. Known principally for his development of the Scott dynamic noise suppressor and the Scott sound level meter, he is also credited with many other distinguished accomplishments in the field of audio engineering.

tary, and John Colvin, Jerry B. Minter, and W. Oliver Summerlin, members of the Board of Governors. Ralph A. Schlegel was re-elected treasurer. Lloyd C. Wingard of Cleveland, and Howard M. Tremaine of Hollywood, Central and Western vice-presidents respectively, were unable to be present.

Highlight of the Convention was the Society's annual banquet, toastmastered by Arthur W. Schneider, which filled the Grand Ball Room of the Hotel New Yorker to capacity. In keeping with custom, the banquet provided occasion for the annual awards. Recipient of the John H. Potts Memorial Award, granted for "outstanding achievement in the field of audio engineering" was Hermon H. Scott. The Audio Engineering Society Award, given each year for efforts in behalf of the Society, was received by F. Sumner Hall. Both presentations were made by Dr. Harry F. Olson in his capacity as chairman of the Awards Committee. Following dinner and presentation of the awards, a vaudeville program featuring Carson J. Robison, one of the truly great singers of folk music, was presented through courtesy of the National Broadcasting Company.

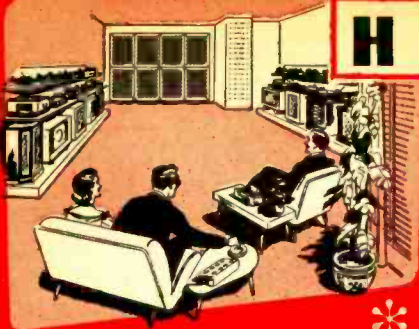

HUDSON has the RIGHT COMBINATION for Your Complete HI-FI Satisfaction!

- ALL FAMOUS HIGH FIDELITY EQUIPMENT IN STOCK
- NEWEST, PUSH BUTTON AUDIO-COMPARISON SOUND STUDIOS
- EXPERT TECHNICAL ASSISTANCE
- LOWEST POSSIBLE PRICES

The Only True High Fidelity—High Performance Tape Recorder in the Popular Price Field!

FAMOUS

Concertone TAPE RECORDER

By Any Standard of Comparison It Is The Best Buy In The Tape Recorder Field!



The Concertone meets all professional requirements, yet is priced Exceptionally Low! Equalization conforms to NAB Recommended Broadcast Standards. Extended Frequency Response is 50 to 15,000 cps \pm 2 db at 15" per second speed. Tape Speed down to random level. Also has 7.5" per sec. Speed. Pre-aligned heads quickly interchangeable for

Dual or Single Track Recording. Total Harmonic Distortion less than 2% at normal maximum signal level. Has 3 dynamically balanced motors, separate heads for recording, erase, and playback. Simultaneous monitoring from tape while recording. Instant choice of 7.5" or 15" per second speeds. Fast Forward, Rewind, and Reverse (2500 ft. per min.). All controls are interlocked to prevent spillage or tearing of tape. Size of basic recorder: 22 x 14 x 5" mtg. depth below panel. Use with any good quality amplifier.

AVAILABLE AS BASIC UNIT WITH CARRYING CASE OR CONSOLE CABINET

BASIC RECORDER, 1401D: Drive mechanism, power supply, erase, record, and playback preamplifiers, mounted on base plate, ready for installation. **\$345.00**
With Dual Track Heads. No. A16147, Net

Model 1401S, same with Single Track Heads, Net \$345.00

FAMOUS COLLINS HI-FI TUNERS

High Fidelity At Its Best!

All the technical skill and craftsmanship possible have been incorporated into Collins Audio Products. As a result these units closely approach custom-built quality, which is apparent upon inspection and demonstration.

COLLINS FM-11 FM TUNER. Surpasses the performance of any unit in its price class. 9 miniature tubes, plus tuning eye and rectifier. 19 1/4 x 12 x 7 1/4".

No. A3001 NET **\$59.50**



RADIO CRAFTSMEN 500 AMPLIFIER

Williamson All-Triode Circuit
99.999% Distortion-Free

Terrific Performance! This new 12-watt "Ultra-Fidelity" amplifier uses the famous Williamson All-Triode circuit to set a new high in audio fidelity. Frequency response: \pm 0.1 db, 20-20,000 cps. \pm 2 db 5 to 100,000 cps. 12 watts \pm 2 db, 10 to 50,000 cps. Total harmonic distortion less than 0.01% at average listening level below 1 watt. Tubes: 2-6SN7GT, 2-KT66, 5V4G rectifier. One chassis, uses the finest component to produce unexcelled listening quality with practically no distortion. At this price there's nothing better!

No. A10964, List \$166.00..... Net **\$99.50**



Amazing Performance! Truly Sensational Value!

Exclusive at HUDSON

audio-pacific

TRUE HIGH FIDELITY AMPLIFIERS

Startling Performance at a price everyone can afford! These famous amplifiers give a new concept to the phrase Hi-Fidelity. They have been rated "Superb" by sound engineers who know!

Leading consumer research organizations have found them very conservatively rated! The frequency response is from 18 to well beyond 20,000 cycles within .1 Db. Presence effect is truly astounding, reproduction is rich, brilliant and crisp. Noise, hum and harmonic distortion have been reduced to the vanishing point, — 85. Db. below 20 watts.

Harmonic distortion is only 1/2% at 19.6 watts (40 watts peak), with 40 Db feed back. Hum, and noise measure less than 1 millivolt across a 10 ohm load.

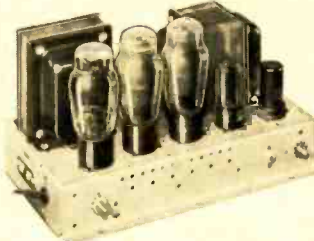

MODEL 4 LH—The basic amplifier of medium gain for use with tuners and as studio monitors, etc. Expressly designed for tuners incorporating bass and treble controls and pre-amplifier stage for phono. Tube complement: 1-6J5, 1-6SN7, 2-6L6G, 1-5U4. Size 7" W x 8" H x 11" L. Net price **\$64.00**



MODEL 4—Same as above with with remote control panel on which is located a master level control, four position selector switch, and a low level listening control designed to allow full round, rich tone at whisper levels. Tube complement: 1-6J5, 1-6SN7, 2-6L6G, 1-5U4. Size as above.

Net price **\$68.00**



MODEL 3—Same as 4 LH but with an additional 1-6J5 for the bass and treble boost controls which are incorporated. Size same as Model 4 LH. Net price **\$85.00**

ALL FAMOUS MAKES IN STOCK

GE S1201D 12" High Fidelity Speaker..... Net \$19.95
Western Electric 728B 12" Speaker..... Net 35.70
RCA 515S1 15" Duo-Cone Speaker..... Net 35.57
RCA 515S2 15" Duo-Cone Speaker..... Net 48.50
Altec-Lansing 604B 15" Dia-Cone Spkr..... Net 140.00
Altec-Lansing 603B 15" Dia-Cone Spkr..... Net 75.00
University 6201 12" Coaxial Speaker..... Net 44.10
New Bell 2122A Amplifier..... Net 49.45
New Bell 2145A Amplifier..... Net 175.52
Brook 12A3, 10 Watt Amplifier..... Net 198.00
All Preamps, Equalizers, Cartridges, Arms in Stock!

WE STOCK AND DEMONSTRATE ALL STANDARD MAKES OF ELECTRONIC AND AUDIO EQUIPMENT
... High Fidelity Tuners, Amplifiers, Speakers, Pickup Arms and Cartridges, Accessories, Record Changers, Tape and Disc Recorders, Cabinets, Replacement Parts, Tubes, Television Chassis and Components, etc. by such famous names as

- ALTEC-LANSING
- ASTATIC
- AUDAK
- BELL
- BOGEN
- BROOK
- BROWNING
- COLLINS
- CLARKSTAN
- ESPEY
- GENERAL ELECTRIC
- HALLICRAFTERS
- MARCEL
- PICKERING
- RADIO CRAFTSMEN
- H. H. SCOTT
- UNIVERSITY
- WEBSTER
- WESTERN ELECTRIC, Etc.

NEW! BOGEN Model HO-10 TRIODE POWER AMPLIFIER

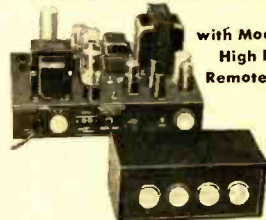

with Model RXPX High Fidelity Remote Control

Features HO-10: 10 Watt Triode Amplifier. Distortion—1.3% at rated output 20-20,000 CPS—35% at 1000 CPS. Cathode follower, damping factor 25.

Features RXPX: Used as remote up to 25 ft. Provides remote control of Power, Selector, Volume and Separate Bass and Treble. Pre-amplifier inputs for all magnetic cartridges. Ho-10: 10 75 db, with RXPX at 80 db. Frequency response at 10 watts: HO-10 .02 db from 10 to 20,000 CPS. HO-10 with RXPX 1.5 db from 10 to 20,000 CPS. Tubes (8): 1-6SL7GT, 2-6SF5, 1-6SN7GT, 1-6B4B, 1-6X5GT, 1-5V4G.

Output impedance—12 ohms. HUM FUND.—70 db MAX.—60 db.

NET PRICE MODEL HO-10... **\$94.08**

NET PRICE MODEL RXPX... **\$53.37**

HUDSON RADIO & TELEVISION CORP.

Formerly Newark Electric Co., Inc. of New York

REVOLUTIONARY NEW SOUND STUDIOS!

UPTOWN:
48 West 48th St., New York 19, N. Y.

DOWNTOWN:
212 Fulton Street, New York 7, N. Y.

PHONE Circle 6-4060

Our uptown store features the most advanced installation anywhere! Relax in an easy chair, select and operate ANY combination of world famous high fidelity components by PUSH-BUTTON Remote Controls. Every music lover, engineer, sound technician and high fidelity enthusiast will be fascinated by this new ingenious approach to audio-comparison. Sound studios at Both Stores.

RECORD REVUE

EDWARD TATNALL CANBY*

Word Traps

A LOT OF FINAGLING was done with the RJ enclosure principle between the time I wrote about it here—early August—and the showing at the Audio Fair. The idea itself is flexible as to detailed application, and every few days there seemed to be a new shape, a new rearrangement of insides. My projected 9-in. cube grew, in the interests of optimum experimental performance, to the huge size of 12×12×14 in., enclosing a single 8-in. Permoflux, which then gave forth with bass flat to slightly below 60 cps. Quite something. For the Fair, a corner speaker was evolved which looked even smaller than the original box in area, though it was not. But the most important development as far as what I had to say was concerned was an arrangement whereby the center-emanating highs from any single speaker or from any coaxial may be accommodated to perfection. This answers my objection, as of October, that quality could be had only via a separate tweeter. The method of high propagation is utterly simple, extremely ingenious, and not to be mentioned, at least as of this writing.

As many readers will have discovered, the RJ, though using a tuned resonance, is not merely another organ-pipe system; it has virtually no measurable peak at the resonant point, mainly, I gather, because of the stiffness of the relatively small body of air in the enclosed space to the rear of the speaker, whereas resonant systems with larger air areas develop large peaks and valleys.

Point Source

A paragraph in my October RJ disquisition, by the way, brought up an interesting side-point. A good engineer friend remarked that I was very thoroughly off the beam in speaking of a slot as a means of avoiding a point source of music; it is, in fact, virtually a point source.

Quite true. In this area, explored by this department, that impinges both on music and on engineering with a good parcel of psychology, physiology, and what-not included, we must be wary of word-traps. Far too many heated arguments go on among audio-followers that, in the last analysis, boil down to matters of word definition or coverage. And the fact that most

of us use many terms in an accepted, yet slangily inaccurate way only complicated the problem. I often speak of "classical" music though I could not as a musician defend it, because it is too far entrenched a term to dislodge now. Taken in its vague and yet accepted meaning, it is a good starting point in music for an exploration towards more specific and meaningful terms. So with many another word.

And so with "point source." Observe two senses in which it is used. First, and accurately, it is to the engineer a source of sound which actually emanates from a point or a relatively small area. A section of sixteen violins in an orchestra is no point source, but a single oboe is. An organ pipe is more of a point source than a piano. A slot in front of a loudspeaker is a point source in one plane and a near-point source in the other, if you wish.

However—look at the other, less accurate but still legitimate usage of "point source," legitimate when you take the viewpoint of a listener to music, which is strictly subjective. What may be called the point-source *effect* is that unpleasant form of sound distortion that brings most of the reproduced sound of music to the ear from one place, in a direct beam. (Distortion, that is, when the original sound was widely distributed in source—the actual sources and/or the reflected liveness. A point-source original, without reflected liveness, would be undistorted.) Distortion of music via point-source reproduction has been celebrated in these columns before, and, as they say, needs no introduction. A point source, to a listener, is one that *sounds* like a point source, and no other.

Take a true point source, then, such as any normal loudspeaker, and contrive, either via the mounting and enclosure of the speaker or via reflection in the listening room—liveness—to distribute the sound after it leaves the point, so that it does not arrive directly in a straight line. You have then avoided the point-source *effect*, though not the point source itself! Every good listening set-up must accomplish this diffusion or disguising of the point of origin to some degree; some rooms are live enough to accomplish it even though the speaker aim baldly straight at the listener,

other spots may require all sorts of contrived reflection to abolish the point-source *effect*. But of course the original point source itself is always there, if a 15-in. cone may be called, relatively speaking, a point in a large room.

Pointless distinction? Not at all, since more than one argument has raged on just such a misunderstanding. A slot is a point source, but it is also an excellent means of avoiding point-source *effect* in the listening because of its wide distribution of the emitted sound waves.

Liveness

Another and more significant example of the same sort of word-confusion hit me recently—the term "liveness." It's one thing to talk of a "live" studio or concert hall, and another, not so legitimate, to speak of the liveness of a hall. In fact, to be accurate we should never use the term that way at all. Liveness, properly, is an effect in *reproduced sound*; the liveness we hear in a recording is a combination of hall characteristics and of mike placement and balance. As we all should know by this time, one and the same hall can give numerous liveness results, according to the mike technique used, and one record can be as unlike another made in the same hall as night and day.

We would be seriously in error, then, if we did not make clear in our minds the distinction between the sound of a hall itself—a static, fixed quality—and the liveness *effect* as heard in a recording or a broadcast. The Maxfield formula for liveness in broadcasting is clearly and rightly concerned with the transmitted sound, not the fixed room characteristics.

In liveness, then, the engineer is concerned with the liveness *effect*; whereas with the point source, he considers not the effect but the fixed origin of the sound.

Shall we make a strict rule? Impossible. People are going to use both of these terms in both ways, until kingdom come. The answer is simple: in all cases we should make clear by the context, or by added words, the meaning we have in mind. Hence my belatedly added word, *effect*. No use trying to stop the march of slang and semi-slang. Language grows and lives through slang, through new and changing uses for old words, and I'm all for it. But you can keep

[Continued on page 47]

* 279 W. 4th St., New York 14, N. Y.

They

fought

to hear it!

Those who were at the Audio Fair know how the AUDAX exhibit was mobbed by people who wanted to hear the renowned POLYPHASE and were unexpectedly rewarded by hearing the new CHROMATIC POLYPHASE. Although the AUDAX exhibition room was the largest ever used by this company, it had never been so mobbed by eager, interested music lovers.

Here is just one letter from the many already received, congratulating us on the astonishing realism of the new CHROMATIC POLYPHASE.

"I was never so happily mobbed in my life. As I passed the AUDAX exhibit room I heard what seemed to be the actual voice of Ezio Pinza singing. I too pushed my way into the crowded room, and there I was treated to the finest exhibition of recorded music it has ever been my pleasure to hear. I visited all the exhibits but came back to hear POLYPHASE again and again. That's how good it is. . . ."

**Never before such EAR-QUALITY,
such FAITHFUL REPRODUCTION**

When used on LP only, point pressure
may be as low as 2 grams.



*with Compass-pivoted AUDAX
Arms and for Record Changers.*

Because . . . you and ONLY YOU can decide what sounds best and most pleasing to you . . . see it, HEAR it, compare it with any reproducer anywhere and . . . you be the judge . . . yet, POLYPHASE COSTS LESS THAN ORDINARY PICK-UPS.

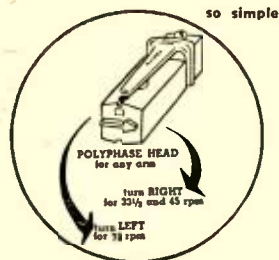

*Write for editorial reprint
on POLYPHASE Principles*

*Be sure to obtain a copy of
PHONO FACTS from your distributor*

AUDAX COMPANY

500 Fifth Avenue New York 18

*"Creators of Fine Electro-Acoustical apparatus
for over 25 years."*

NEW PRODUCTS

● **Two-Frequency Oscillator.** Carrying out a policy announced some months ago to expand its "unit" line of inexpensive laboratory instruments, General Radio has introduced the Type 1214-A unit oscillator. Output frequencies of 400 and 1000 cps at 200 mw make the unit ideal as a modulating source for the GR Types 1208-A and 1209-A unit oscillators, as well as for bridge measurements and general laboratory applications where fixed frequencies are called for. Frequency tolerance is



+ 2.0 per cent and distortion is below three per cent. Open-circuit output level is approximately 80 volts at 8000 ohms impedance. Toggle switch is provided to select either 400-cps or 1000-cps frequency output. The 1214-A differs from other GR unit instruments in that it contains its own built-in power supply. Manufactured by General Radio Company, 275 Massachusetts Ave., Cambridge 39, Mass.

● **Crystal Cartridge.** Astatic's new Model L-12-U pickup cartridge employs a removable capacitor harness to permit a choice of 4- or 1.2-volt output at 1000 cps. Thanks to this innovation the unit may be used as a replacement for 125 different models of 78-r.p.m. pickups now in service. This greatly reduces inventory requirements of servicemen and jobbers. The cartridge is

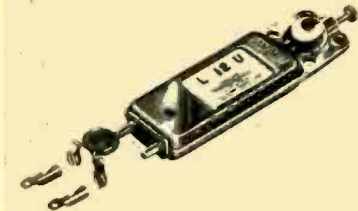

supplied with a tiny capacitor in place for low output. Output is raised by slipping the capacitor off the terminals. A second feature of the L-12-U is a means of restricting chuck motion to protect against rough handling. Cut-off frequency of the cartridge is 5000 cps and minimum needle pressure is one ounce. Astatic Corporation, Conneaut, Ohio.

● **Self-Locking Anchor Nuts.** This new product, recently introduced by Kaynar Mfg. Co., Inc., Los Angeles, Calif., incorporates many new features never before inherent in a standard lock nut. Made of spring steel, the unit is lower in height and lighter than any comparable lock nut.

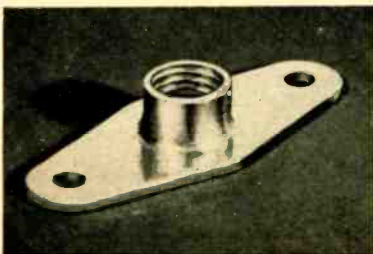

Extreme elasticity provides exceptional locking torque uniformity even with large variations in bolt diameter. Static load tests reveal axial strength considerably above that of conventional nuts and well above most stringent JAN requirements. According to the manufacturer, the nut is made on high-production stamping equipment which places it in a low cost bracket.

● **High-Precision Synchronized Motion Picture Camera System.** A long-sought goal in the field of scientific photography—accurate operation of a series of motion picture cameras taking pictures simultaneously to close tolerance—is realized with the new Maurer Servo-Sync Camera Drive System. Maximum possible deviation of shutter position in this system, which utilizes circular rotating camera shutters, is less than one degree, which

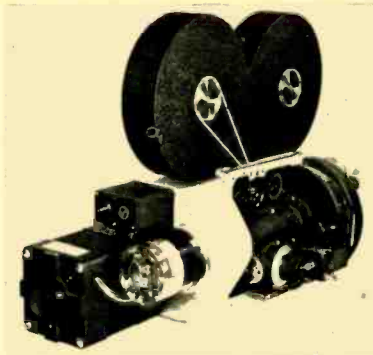

at 12 frames per second is equivalent to a time tolerance of 230 microseconds. Use of the system is not limited to any one type of camera. It has been applied with equal efficacy to a large number of stand-and motion picture, scientific, and ribbon-frame cameras. The bulk of its effectiveness will be felt in applications where two or more sources of information must be recorded at essentially the same time. Designed by Origins, Inc., Saybrook, Conn. for Wollensak Optical Co., Rochester, N. Y., the system is manufactured by J. A. Maurer, Long Island City 1, N. Y.

● **Line-Matching Transformers.** Designed for high efficiency and ease of installation, the new Atlas weatherproof line-matching transformers permit matching of Atlas speakers to either constant-voltage (70-volt line) or constant-impedance sound systems. Frequency response of the transformers covers the entire range of public-



address requirements. Power handling capacity is 12 watts. Full technical details of available models will be supplied by the manufacturer, Atlas Sound Corp., 1449 39th St., Brooklyn 18, N. Y.

● **Magnetic Tape Recorder.** The Tape-master is a tape-transport mechanism and matching preamplifier with bias-erase oscillator designed for use with any standard basic amplifier or radio-phono

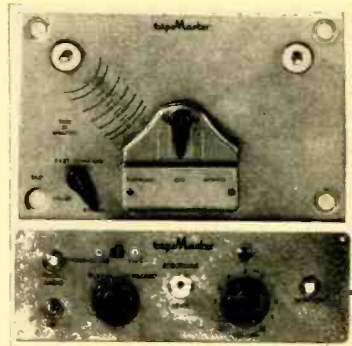

combination. The drive assembly operates at a tape speed of 7 1/2 in./sec., incorporates fast forward and rewind, single-switch control, and exceptional freedom from vibration. The preamplifier chassis contains built-in power supply, is fully wired, and incorporates inputs for microphone and radio-phono, outputs for amplifier and headphones, and neon recording-level indicator. Monitoring jack is panel-mounted. Manufactured by Tapemaster, Inc., 13 W. Hubbard St., Chicago 10, Ill.

● **Record-Reproduce Head.** Growing interest in the use of magnetically sound-stripped motion picture film motivated the design of this new Stancil-Hoffman record-reproduce head. Small enough to mount in existing projectors, actual size of the new unit is 3/8" x 3/16" x 3/8" deep, including a triple lamination hum shield. The head

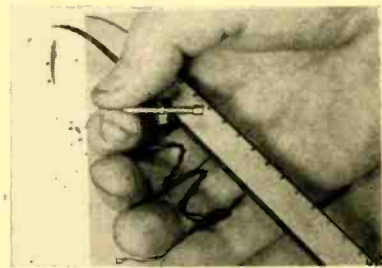

will be supplied in two models, each available in kit form. The first will be a head making possible the use of the standard photo-electric-cell amplifier in most projectors. The second kit will include a recording amplifier and an erase head to permit recordings to be made directly on the projector. Stancil-Hoffman Corporation, 1016 N. Highland Ave., Hollywood, Calif.

● **Deposited-Carbon Resistors.** Carb-Ohm is the trade name of a new line of resistors being manufactured by the Phaostron Company, 151 Pasadena Ave., South Pasadena, Calif. Designed essentially for high-frequency applications, Carb-Ohms also meet the need for closely matched units in computer networks, and are of particular advantage in equipment which is

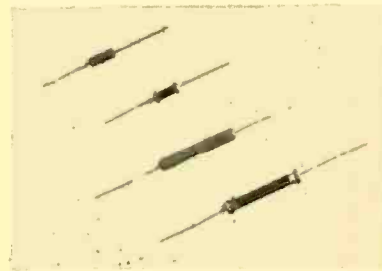

subjected to extremes of temperature. They are available hermetically sealed in glass or clad in a humidity-impervious casing. Power ratings range from one-third to two watts, and resistance ratings are 20 ohms to 200 megohms. Illustrated brochure will be mailed on request to the manufacturer.

● **Record Changer.** The V-M record playing mechanism is unique in its ability to play 10- and 12-in. records intermixed in any desired sequence, and in its incorporation of the "Siesta Switch", a switch for turning off any appliance plugged into an outlet mounted on the changer, after the playing of the last record. Other



features of the new V-M changers include jam-proof mechanism, and considerable reduction of moving parts. All models are three-speed, of particularly rugged construction, and bear the seal of the Underwriters' Reexamination Service. V-M Corporation, Fourth & Park Sts., Benton Harbor, Mich.

● **Portable Record Player.** Announced recently as an addition to the company's extensive line of audio equipment, the Model RC-12 record player, manufactured by Newcomb Audio Products Company, Hollywood 38, Calif., features a 5-watt



amplifier, Web-Cor 3-speed changer, and a 6" x 9" Alnico V speaker. Volume and tone controls and pilot light are mounted on front panel. Sturdy carrying case is solid plywood covered with durable fabricoid. Total weight is 31½ lbs. Carries UL seal.

● **Acoustic Lens.** Beaming of sound waves is reduced to a minimum with the Model 175 DLH acoustic-lens-and-horn assembly recently announced by James B. Lansing Sound, Inc., 2439 Fletcher Drive,



Los Angeles 39, Calif. Designed for use with the Lansing Model 175 high-frequency driver, the lens, because of exceptionally wide bandwidth, affords equal distribution to all tones.

APPROVED • ASTATIC • ATLAS • AUDAK • AUDIO DEVELOPMENT • BELL • BOGEN • BOZAK • BROOKS • BROWNING • BRUSH • CHALLENGER • ELECTRO-VOICE • JENSEN • ESPY

The Discriminating Eventually Come to Leonard's!



RADIO CRAFTSMEN

"WILLIAMSON" MODEL C-500

Here at last is the famous Williamson amplifier with all the outstanding features, available not in kit form, but as a complete unit. Those who know Radio Craftsmen for their famous Tuners, Amplifiers, and

TV Chassis are fully aware of the superb performance of these very fine units. Now, Radio Craftsmen is proud to announce this new addition to its very popular family.

SPECIFICATIONS

POWER OUTPUT: 15 watts nominal

FREQUENCY RESPONSE: ± 0.1 db, 20 cps to 20,000 cps; ± 2 db, 5 cps to 100,000 cps.

POWER RESPONSE: 12 watts, ± 1 db, 10 cps to 50,000 cps.

TOTAL HARMONIC DISTORTION: Less than 0.1% at 10 watts at mid-freqs.

HUM AND NOISE LEVEL: -90 db (22,000 ohm input source).

OVERALL GAIN: 70 db (470,000 ohm input resistance).

OUTPUT IMPEDANCE: 8 and 16 ohms nominal.

TUBE COMPLEMENT: 6SN7GTA amp. & inverter, 6SN7GTA push-pull driver, (2) KT66 power output, 5V4G rectifier.

NET \$99.50

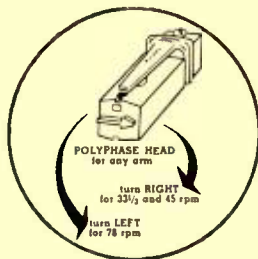

AUDAX POLYPHASE REPRODUCERS

This amazing reproducer has deservedly won the acclaim of thousands of users everywhere. Stylus are replaceable individually—as simply as you replace the ordinary steel needle. Frequency Response—20 to over 10,000 cps.

NET—L6 for all lateral recordings \$20.28

NET—R2 for all lateral recordings \$14.41

Both models available with adapters for Webster-Chicago or Garrard Changers. Also available with Diamond Stylus.



GARRARD "TRIUMPH" RECORD CHANGER MODEL RC-80

Completely automatic, this superb three speed record changer plays every type of record exactly as the manufacturers intended. Heavy-duty constant speed motor assures quiet performance—without "wows". You need not lift records over spindle when removing them from turntable—simply remove spindle from socket. Records may then be taken off turntable WITHOUT DAMAGE to record. Pick-up Arm is specially designed to eliminate resonance. Plug-in type heads for both standard and micro-groove recordings. Automatic shut-off. Special heavy-duty spindle for 45 rpm discs. Dimensions—1½" W x 1½" D x 5½" H.

NET (Less Pickup) \$39.00

Look for winner of Audio Fair PENTRON contest in January issue of AUDIO ENGINEERING.

CORTLANDT 7-6563

Leonard Radio inc.

the house
built on
SERVICE

69 CORTLANDT ST., NEW YORK 7, N. Y.

PENTRON • PICKERING • RACON • RADIO CRAFTSMEN • REK-O-KUT • H. H. SCOTT • SHURE • SONAR • UNI-MODE • UNIVERSITY • V-M • WEBSTER • CHICAGO • WEBSTER ELECTRIC

TAPE EDITORS—SOUND MEN

splice tape faster...
easier with the new

EDITALL

TAPE SPLICING BLOCK*

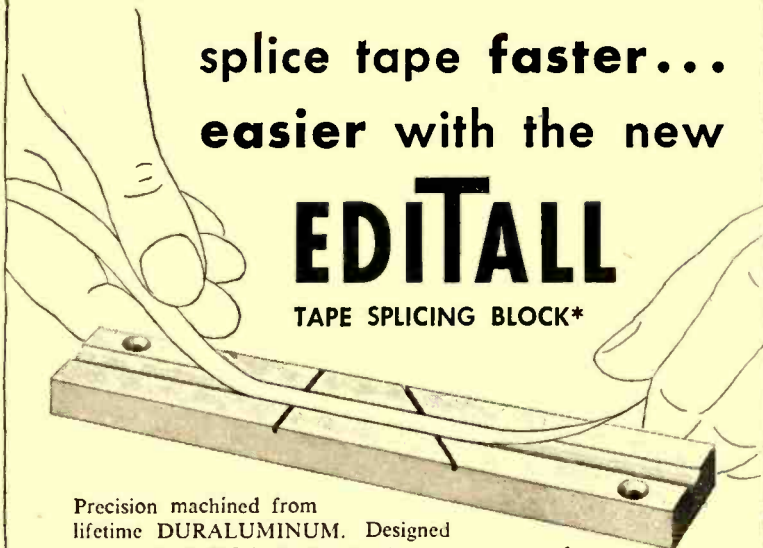

Precision machined from lifetime DURALUMINUM. Designed to give PERFECT SPLICES with a minimum of time and effort. Can be used in conjunction with any tape recorder using standard tape. Simple to use—no clips or mechanical devices to go out of order.

Price
\$6.50

DEVELOPED by Joel Tall, famous tape editor of C.B.S.; Instructor of Tape Editing at N.Y.U.

RECOMMENDED by Minnesota Mining and Manufacturing Co.

USED on the Famous Ampex Tape Recorder.



(Photo—Courtesy of Audio and Video Products Corp., New York)

● Ask for it at your local distributor

Manufactured exclusively by

TECH LABORATORIES, INC.

Box 148, Palisades Park, N. J. *PAT. APPLIED FOR

New York Distributors:

AUDIO & VIDEO PRODUCTS CORP.
730 5th Avenue
New York 19, N. Y.

HARVEY RADIO CO.
103 West 43rd Street
New York 18, N. Y.

INTERVIEW AMPLIFIER

[from page 15]

1.73 $\sqrt{30}/\sqrt{500}$, or 0.423 volts. Eighty db below this value is .0000423 volts, or 42 microvolts. The input transformer has a step-up ratio of 30/50,000 ohms, which gives a voltage gain of 40.8, the square root of the impedance ratio. Therefore, between the grid of the first tube and the grid of the output stage, it is necessary to have a voltage gain of 1.69/0.0172, or approximately 1000. This is easily obtained by using two pentodes, one the low-noise 5879, and the other a 6J7. This will allow for more than enough gain for recording, and for the addition of some inverse feedback. The signal from a playback head is somewhat less than that from a microphone, and an additional 20 db of gain is required for the low-frequency equalization, so both pentodes are used in circuits which give stage gains of approximately 100, as observed from amplifier charts in the Tube Handbook.

The low-frequency equalization is provided by a feedback loop around the first stage, as used in the Magnecord amplifier. The circuit is simple, and lends itself to minor modification, as required, to obtain the desired playback characteristic. The network C_3 , R_2 , and R_1 gives the necessary low-frequency boost by reducing feedback to a minimum at low frequencies. When the reactance of C_3 equals the resistance $R_1 + R_2$, the curve is 3 db from "flat," and above this frequency the response is essentially flat. One section of the switch disconnects the feedback network $R_2 - C_3$ from R_1 , and grounds the lower end of the input transformer secondary, removing all feedback from the first stage.

In order to provide direct current for the heater of the first stage, a selenium rectifier and a filter capacitor are mounted in the amplifier. In the circuit shown, the voltage at the heater terminals of the 5879 is 6.0 when the a.c. heater voltage is 6.3. The use of d.c. on this heater reduces the hum below audible modulation on the tape.

It is noted that there are quite a number of sections to the function switch. Since the input and the output of the amplifier both have to appear on the switch, some precautions must be taken to avoid unwanted oscillation. The switch is composed of two decks, being shielded by the section of the chassis between them. In the record position, the microphone receptacle is connected to the input transformer by S_{IF} and S_{IG} ; S_{IA} and S_{IH} connect the recording head to the output of the equalizer; S_{ID} connects the output transformer winding to the input of the isolation pad. The remaining two sections, S_{IO} and S_{IB} , connect the VU meter and apply B+ to the bias oscillator, respectively. In the playback position, the tape head is connected to the input transformer through switch sections S_{IH} , S_{IA} , S_{IF} , and S_{IG} —with the interconnections between the switch decks serving to provide isolation be-

tween input and output of the amplifier. S_{1B} connects the equalizing network around the first stage, and S_{1C} turns on the speaker. To reduce the number of wires in the interconnecting cable, the rectifier and filter for the d.c. filament supply to the 5879 are mounted in the amplifier case.

Interconnecting Cables

The cabling between the various units is arranged so that there is no possibility of making any incorrect connections. The microphone cable is just long enough to run from the microphone to the jack J_1 , and since the microphone remains permanently mounted on the top of the case, there is little reason for disconnecting this lead at any time during normal operation. The power cable from the amplifier to the power supply is attached to the amplifier chassis, and is plugged into the power supply receptacle, using an 8-prong Jones plug. The power supply cable from the recorder terminates in a 6-prong plug which mates with a receptacle on the power supply case. The remaining lead from the recorder terminates in a Cannon plug, which connects into the amplifier chassis.

The power supply cable from the amplifier is a 7-wire shielded cable, with the shield connected only at the plug end. A separate lead is used for the common ground connection. The 6-wire lead from the recorder carries ground, B+, 6.3 volts for the bias oscillator filament, and 115 volts for the recorder motors.

A rubber-covered a.c. line furnishes the main power connection from any convenient 115-volt outlet.

Construction

While any convenient case can be used, the one employed is available as a standard model, and is readily adapted to this application. The front apron is

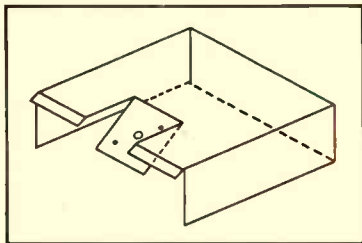

Fig. 7. Sketch of chassis arrangement to provide for shielding between two decks of record-playback switch.

cut down both sides and across the bottom so that a chassis can be slid into position. The front panel is made to overlap the bottom of the case, and the chassis is attached to the front panel permanently. The switch shield and mounting is made by cutting two saw slots and bending a portion of the top surface down, as shown in Fig. 7. This requires some nicety of calculation, because the spacing between the chassis and the front panel must be just right to mount the switch, using the spacers and tie bolts of the switch to hold it to



Enthusiastically acclaimed by engineer and music lover alike, the ALTEC 604B Duplex is still the finest loudspeaker of its type ever produced.

Its smooth frequency response, fine musical qualities and exceptional efficiency make it the choice for professional monitoring, auditioning, and for those whose critical tastes demand the best for home music installations. On one frame, the 604B Duplex incorporates independent high and low frequency reproducing units, designed to function without distortion-producing interaction. Built-in multicellular horn properly loads high frequency unit and permits optimum dispersion of "highs." Frequency response of 30 to 16,000 cps more than spans the FM range.

**ASK FOR A DEMONSTRATION
DEALERS EVERYWHERE**



9356 Santa Monica Blvd., Beverly Hills, Calif.

161 Sixth Avenue, New York 13, New York



High-Fidelity

THE NEW MAGAZINE FOR AUDIO-PHILES*
*People Who Enjoy Fine Musical Entertainment at Home

offers you an opportunity to get a
\$690 hi-fi installation absolutely

FREE

OR ONE OF FIFTEEN CASH AWARDS

As a means of encouraging hi-fi enthusiasts, eight of the leading manufacturers of fine audio equipment have joined the publishers of HIGH-FIDELITY Magazine in offering the following awards, to be presented on February 29, 1952. These are:

1st AWARD: Complete equipment for a hi-fi installation, comprising a Browning FM-AM tuner, Scott amplifier, Pickering tone arm with 2 diamond-stylus pickups, Rek-O-Kut turntable, Garrard changer with Audak Polyphase pickup, Altec 604B coaxial speaker, and Workshop FM antenna.

2nd AWARD

One hundred dollars in cash

4th AWARD

Twenty five dollars in cash

3rd AWARD

Fifty dollars in cash

5th to 16th AWARDS

Each ten dollars in cash

Complete information will be found in the Winter Edition of HIGH-FIDELITY.

HIGH-FIDELITY Magazine is published for the rapidly increasing number of people whose hobby is getting hi-fi reproduction from audio, records, and tape. You don't have to know trig and calculus in order to understand and make use of articles published in HIGH-FIDELITY. At this Magazine, there's a rule against using anything beyond simple arithmetic, and not too much of that. On the other hand, every article in HIGH-FIDELITY is based on the very latest engineering techniques and professional practices, presented in terms of the average hobbyist's skill and the facilities available in a kitchen-table workshop.

**For the
non-professional
audio enthusiasts
who want
professional
audio performance**

**Your hi-fi
installation can be
as handsome in
appearance as it
is in audio
performance**

AS A HI-FI ENTHUSIAST, you can share the enjoyment of your hobby with all your family and your friends. But be careful not to sound a note of discord in your home by turning your living room into an acoustic laboratory! Your radio, phonograph, tape machine and TV set can be housed attractively in a simple, decorative cabinet, built into a modern music wall, or concealed in a conventional furniture piece. You'll find over 30 photographs in the Winter issue of HIGH-FIDELITY showing the details of professional custom installations which reflect the latest in advanced engineering and decorative appearance.

TAPE RECORDING is the newest field of activity for audio enthusiasts. What makes it particularly interesting is the fact that it offers the opportunity to combine fun and profit. At home, a tape recorder is the audio equivalent of a movie camera for recording family history. It's a wonderful means of entertaining friends, because everyone likes to hear his own voice! Among many other uses is that of making up musical programs from off-the-air recordings. And you get back the cost of the equipment by making recordings for others. The new HIGH-FIDELITY explains in detail how to make recordings of professional quality.

**Information
about the use of
tape recording
equipment for
entertainment
and for profit**

**Hear the
HIGH-FIDELITY
program on WABF
New York, each
Thursday, 10:00;
Sunday, 8:30**

A most useful feature of HIGH-FIDELITY is its complete report on new phonograph records, prepared by leading critics, and now presented in a special 16-page section. If you live in New York, listen for HIGH-FIDELITY Magazine's programs on station WABF, at 99.5 mc. Check the performance of your audio equipment by tuning in, because these musical programs are from original 15,000-cycle tape recordings of musical masterworks.

Use coupon to order a subscription. If you request, we'll start with the April issue, if still available.

A large-size magazine,
with over 100 illustrations,
handsomely printed on fine paper

High-Fidelity

Published by Milton B. Sleeper
25 Audio Building, Great Barrington, Mass.

Mr. Charles Fowler, Editor, High-Fidelity
25 Audio Bldg., Great Barrington, Mass.

Please enter my subscription to High-Fidelity:

\$6.00 for three years (SAVE \$6.00)

\$3.00 for one year (SAVE \$1.00)

(Published Sept. 15, Nov. 15, Feb. 1, Apr. 15)

Name.....

Address.....

Add 50¢ per year in Canada, \$1.00 foreign

the bent-down portion of the chassis, and with the mounting bushing of the switch being just flush with the underside of the front panel. While this may sound difficult, it must be remembered that the spacers between the switch section and the chassis may be cut readily to make the switch fit properly.

The input transformer is mounted under the chassis on a bracket, making the connections reasonably near the switch for ease in wiring the playback equalizer components. The gain control is above the chassis, and permits a short lead direct to the grid of the 6J7, as shown in Fig. 8. The coupling capacitor C_1 is in the small space between the gain control and the front of the chassis.

The general underchassis arrangement may be seen in Fig. 9. The 5879 heater supply is under the VU meter, which requires some odd cut outs in the chassis to miss the terminals. In planning for the parts placement, the original drawings were made in three dimensions, with the case angles projected, so that everything clears—but not much. Most of the wiring is made directly from point to point, with resistors and capacitors connected to socket terminals where possible.

The capacitor C_2 is the one visible on the corner of the chassis in Fig. 8. R_{10} , R_{17} , and R_{18} are mounted on the three unused terminals of the 6-hole socket for the equalizer. The socket for the 5879 is a Vector, 1½ in. high, and mounts R_3 , R_4 , and R_5 . This socket is riveted to a metal electrolytic capacitor mounting plate, and is flexibly mounted on the chassis by means of four grommets, using the Amphenol kit available for this type of mounting. When a socket is so mounted, flexible leads must be used to make connections to it—the so-called "antenna hank" is ideal for this purpose. R_7 is directly mounted on the input transformer terminal panel.

The microphone is mounted on the ball-and-socket camera tripod top by means of an adapter, since the microphone handle has a 5/8-27 thread and that of the swivel is 1/4-20. The lower part of this type of ball-and-socket unit is removed and discarded. Four holes are drilled in the ring for 3-48 screws, and the unit is then attached to the top of the case, with a coil spring under the ball. This spring is of the type used for spring mounting a record changer, and is about 5/8-in. in diameter. There is enough friction to hold the microphone in any position it is placed, yet it can be laid down against the case for carrying. A slot in the ring of the ball-and-socket head permits the microphone to be laid flat against the case in only one position; in all other directions, the microphone can only be lowered to about 30 deg. from horizontal.

The power supply is enclosed in the 3½ x 6 x 8 "Minibox," most parts being mounted on a shelf attached to the case. The 4 x 6-in. oval speaker is in this case, and protected by ¼-in. hardware cloth, as shown in Fig. 10. To conserve space, the half-shell of the transformer extends outside the case. Two ventilating plugs are installed on the bottom of this

case, and one on the top over the rectifier tube. To permit free flow of air, another is installed in the carrying case directly below the speaker grille. The carrying case was made to order, and the power supply is simply dropped into the compartment provided—making a fairly tight fit. Since it was decided that it might be possible to damage the recorded tape if it were too close to the power transformer and chokes, the compartment for the amplifier is at the center of the case, with the tape being



Fig. 10. External view of power supply case.

spaced away from the power supply by the amplifier. Since this arrangement places the two heavier sections at the center and the end, it is advisable to order the case without a carrying handle. After determining the center of gravity, the handle can then be mounted. The case may not appear symmetrical, but it does carry easier.

Performance

The unit as constructed has already been across the country four times, and has made quite a number of recordings by this time. There is sufficient gain for all microphone work within the requirements of interview service—the gain control normally being used at about 20 on the dial plate, which is a standard attenuator scale used to give this unit a professional appearance. Actually, the calibrations of this scale approximate the attenuation of the volume control, in db. Adequate gain is also provided for playback, and the response is essentially flat from 100 to 7500 cps. Figure 5 shows the response from microphone input to tape output—with a rise at the high-frequency end to provide crispness in the speech. The curve of Fig. 6 shows the actual voltage across the recording head for constant zero-level indication on the VU meter. This curve shows the effect of the equalizer in its deviation from the 6-db/octave curve which would result from a constant-current feed of the recording head.

The amplifier unit, with its power supply and carrying case, has proven its value for use by non-technical personnel, and therefore justifies this particular design. All flexibility has been eliminated to make the operation as straightforward as possible and to reduce the possibility of error. However,

HARVEY'S Famous AUDIO-TORIUM

Your One-Stop Center for the Best in Sound!

Complete Stocks! All Brands! Fast Service!

To Help You In Your Selections
We List A Few Suggestions

PHONO-RADIO COMBINATIONS

HARVEY has a Combination for Every Taste and Purse!

- **Phono Combination Type "A"**
- Bell #2122 Amplifier
- V-M #950 G. E. Changer with
- Dual G. E. Cartridge
- University #6200 Speaker **\$102.95**
- **Radio-Phono Combination Type "B"**
- Bell #2122 Amplifier
- Meissner 8CC Tuner
- Electro-Voice SP12B Speaker
- V-M #950 G. E. Changer
- with Dual G. E. Cartridge **\$156.75**
- **Hi-Fi Phono-Radio Combination Type "C"**
- Espey 511B Radio Chassis
- University #6201 Speaker
- V-M #950 G. E. Changer
- with Dual G. E. Cartridge **\$192.90**
- **Hi-Fi Phono-Combination Type "D"**
- Bell #2145 Amplifier
- Webster #100-27 Changer with Dual
- G. E. Cartridge
- University #6201 Speaker **\$255.75**
- **Hi-Fi Phono-Radio Combination Type "E"**
- Meissner 8CC Tuner
- Bell #2145 Amplifier
- Webster #100-27 Changer with Dual G. E.
- Cartridge
- University #6201 Speaker **\$303.75**
- **Super Phono Combination Type "F"**
- Brook 12A3 Amplifier
- Webster #100-27 Changer with G. E.
- Dual Cartridge
- Altec #604 B Speaker **\$385.90**

- **Complete Hi-Fi Radio-Phono Combination Type "G"**
- Radio Craftsmen RC-10 Tuner
- Radio Craftsmen RC-2 Amplifier
- University #6201 Speaker
- V-M #950 G. E. Changer
- with Dual G. E. Cartridge **\$247.75**
- **Super Hi-Fi Radio-Phono Combination Type "H"**
- McIntosh 20W2 Amplifier
- McIntosh AE2A Preamp
- Webster #100-27 Changer with Dual
- G. E. Cartridge
- Collins FM-11 Tuner
- Altec #604 B Speaker **\$469.25**
- **Super Deluxe Radio-Phono Combination #1 Type "I"**
- McIntosh 20W2 Amplifier
- McIntosh AE2A Preamp
- Browning RV10A Tuner
- Garrard RC80 Changer with Pickering or
- Audak Sapphire Cartridges for Both 78
- and LP Records
- Altec #604 B Speaker **\$531.75**
- **Super Deluxe Radio-Phono Combination #2 Type "J"**
- Altec #101 B Tuner
- Altec Tuner Power Supply
- McIntosh 20W2 Amplifier
- Garrard RC80 Changer with Pickering or
- Audak Sapphire Cartridges for Both 78
- and LP Records
- Altec #604 B Speaker **\$552.50**

WILLIAMSON HR-15 AMPLIFIER KIT

The famous Williamson HR-15 amplifier circuit... now available with the original Partridge transformers built to Williamson's specifications. Build this kit in 3 hours or less, and enjoy sound of a quality you never heard before. The HR-15 is a 2-Chassis power amplifier for use with tuner or other front ends having own volume and tone controls. All American triodes, 2-65N7GT, 2-807 or 6B6G6 in PP output, 5V4G rectifier. Response $\pm .5$ db. 10-100,000 cycles. Output impedances 1.7 to 109 ohms in 8 steps. Absolute gain 70.8 db. of feedback around 4 stages and the output transformers. Kit is Complete with Tubes, Punched Chassis, Pre-wired Resistor Board, Sockets, Genuine Partridge Output Transformer, and All Necessary Parts. \$75.00



HR-15T A Williamson Kit with all TRIAD TRANSFORMERS... including power transformer, chokes and specially designed output transformer which is completely sealed in tar. ± 2 db. 10-100,000 cps. Harmonic Distortion less than .1% — 10 watts output. Output impedances 4-8-16 ohms \$69.50 Both HR-15 and HR-15T Kits available with KT-66 tubes at \$3.00 additional.

VISIT THE AUDIO-TORIUM

Come in and visit our new sound department... all these items and many more on working display at all times.



NOTE: In view of the rapidly changing market conditions, all prices shown are subject to change without notice and are Net, F. O. B., N. Y. C.

since there are no modifications to the standard Magnecorder, it is obvious that this amplifier could be used for specific applications where its simplicity and compactness was desirable, yet the recorder can be brought back to the studio and used with the standard amplifier whenever necessary.

PARTS LIST

- C_1, C_2 10-10-20/450-450-25, electrolytic
- C_3 .0025 μ f, mica
- C_4, C_5 .01 μ f, 600 v. paper
- C_6 1000 μ f, 15 v. electrolytic, with insulating tube and mounting clip
- C_7, C_8, C_{10} 40 μ f, 450 v. electrolytic
- C_9 20 μ f, 450 v. electrolytic

- C_{11} .02 μ f, 150 v. hearing aid type, paper
- J_1 Cannon XL-3-13 receptacle
- J_2 Cannon XL-3-14 receptacle
- J_3 Single-circuit jack
- J_4 Jones S-408-AB receptacle
- J_5 Jones S-405-AB receptacle
- L_1, L_2 Choke, 8 H. at 40 ma. Thor-darson T-20C52
- LS 4 x 6 in. loudspeaker, 3.2-ohm voice coil
- M VU meter, B scale, Simpson Model 45
- P_1 Jones P-408-CCT cable plug
- R_1, R_2 47,000 ohms, $\frac{1}{2}$ watt
- R_3 3300 ohms, $\frac{1}{2}$ watt
- R_4 1.0 meg, 1 watt
- R_5 0.47 meg, 1 watt
- R_6 1-meg volume control, audio taper
- R_7 1800 ohms, $\frac{1}{2}$ watt

- R_8 0.22 meg, $\frac{1}{2}$ watt
- R_9 0.82 meg, 1 watt
- R_{10} 0.22 meg, 1 watt
- R_{11} 0.56 meg, $\frac{1}{2}$ watt
- R_{12}, R_{13} 3000 ohms, 5 watt, Ohmite Brown Devil
- R_{14} 27,000 ohms, 1 watt
- R_{15} 8200 ohms, 2 watt
- R_{16}, R_{17} 270 ohms, $\frac{1}{2}$ watt
- R_{18} 560 ohms, $\frac{1}{2}$ watt
- R_{19} 3900 ohms, 1 watt
- RECT Federal 1016 Selenium Rectifier
- S_{1A-U} 8-pole, 2-pos. wafer switch, Centralab 1418
- S_2 DPST toggle switch
- T_1 30/50,000 input transformer, shielded, Triad HS-5
- T_2 Output transformer, secondary impedances 500, 15, 8, 2 ohms, UTC S-14
- T_3 Power transformer, 300-0-300 v. at 90 ma; 5 v. at 3 amps; 6.3 v. at 2.5 amps.

- Case for amplifier Langevin Remote Control Cabinet, Type 1-A
- Case for power supply Bud Minibox, CU-2109

THEY ALL
Sound
BETTER WITH A

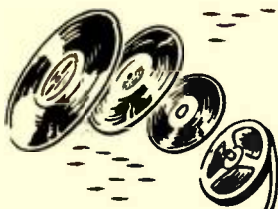

McIntosh

WORLD'S FINEST AUDIO AMPLIFIER

50 WATT AMPLIFIER

50 WATTS
(peak: 100)
50W-2
\$249.50



Unequaled for quality reproduction of any sound source, the McIntosh is the most advanced amplifier of the day. Its unique, compact design offers: HIGH-EST EFFICIENCY—over 65%; LESS THAN 1% DISTORTION AT PEAK POWER; DYNAMIC RANGE: OVER 70 db; FREQUENCY RESPONSE: 20-20,000 cps.

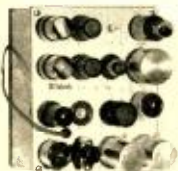

20 WATTS (Peak: 40)
20W-2 - \$149.50

AE-2 Amplifier
Equalizer - \$74.50



SEND FOR *Free* CATALOG Dept. A-5

McINTOSH ENGINEERING LABORATORIES, Inc. 320 WATER STREET BINGHAMTON, N.Y.

PHASE INVERTER

[from page 16]

indicate that:

- $\mu = 18$
 - $r_p =$ from 15,000 to 20,000
 - $f_o \approx 3,000$ to 4,000 cps ($C = 0.05$ mfd)
 - $f_o \approx 15,000$ to 20,000 cps ($C = 0.01$ mfd)
- With an input to the inverter grid of about 2 volts (rms) results, Tables I and II, were obtained and plotted in Fig. 3.

TABLE I

Frequency (cps)	Relative Gain in db	
	$C = .01 \mu f$	$C = .05 \mu f$
1090	0	-0.4
1350	0	-0.6
1550		-0.8
1740		-1.1
2000		-1.6
2400	0.1	-2.4
2950		-3.6
3400		-4.7
4000	-0.1	-5.9
6300	-0.5	
7600	-0.9	
8600	-1.1	
10000	-1.6	
11100	-2.1	
12300	-2.3	
14000	-2.8	
18400	-5.1	

TABLE II

Shunt Capacitance	"3-db" frequency	
	Calculated	Observed
.05 μ f	3200 - 4230	2700
.01 μ f	16000 - 21100	14200
200 μ f	$3 \times 10^4 - 4 \times 10^4$	no data

It was found that the high frequency roll off was the same for both cathode and plate terminals. The calculation using 200 μ f should be representative for the loading presented by a triode in the subsequent stage.

It is believed that these results are

valid only when the peak a.c. grid signal is of the less magnitude than the quiescent grid bias since greater excitation will tend to cut off the inverter tube, making the dynamic plate resistance infinite. However, when loaded with substantially equal impedances and driven at a relatively low level, the high-frequency roll-off of this inverter is about the same as that of a cathode follower; and the roll-off is the same for both plate and cathode terminals.

INTERMODULATION TESTING

[from page 23]

with the generator section in Fig. 5. The low frequency, 60 cps, was chosen for convenience; it is believed sufficiently low to give an accurate check on amplifiers with output transformers of known high quality. This frequency is taken from one plate of the rectifier tube and dropped to a value of slightly over 3 volts, maximum, through a filter to reduce the higher harmonics in the line voltage. The 4000-cps oscillator uses a 6J5 triode and a tapped coil. A 150-mh r.f. choke will tune over a considerable range with a tap soldered at about one third out from center. The selector switch is set on 60 cy and a suitable voltage reading taken at the output terminals. Resistor R_7 is then adjusted so as to give the same voltage after switching to 4 kc. If desired, a 'scope can be used, but the foregoing is simple and accurate. Resistor R_9 across two contacts on the selector switch is for the purpose of setting the 4/1 ratio. CAUTION: The output potentiometer must be in the circuit at all times when these adjustments are made. The selector switch loads the circuit to the same extent in all positions, if connected as shown. The oscillator output can be adjusted over a wide range by means of the bias resistor. The generator as shown, will provide slightly over three volts of mixed signal. The separate 60- and 4000-cps cycle signals are convenient for general testing, and for checking the analyzer.

Analyzer Section

In the analyzer portion of the instrument a level control is used for setting the carrier to a predetermined equivalent of 100 per cent and is connected to the input jacks, as shown in Fig. 6. These pin type jacks are located adjacent to the generator output jacks so that the analyzer may be checked for operation by means of one short piece of bus bar bent to bridge both upper jacks. The large knob is used for selecting the appropriate functions. The voltmeter circuit used is sufficiently linear to warrant the assumption that it is so. It will read input levels of 5, 10, 25 and 50 volts, full scale, and was calibrated against an r.m.s. meter. The particular meter used, in the circuit shown, reads 0.25 volts, full scale, with the signal applied to the grid of the associated section of the 12AT7 tube. The right section of the selector switch permits measuring full

MAKING BOOSTER HISTORY THE TV-1



THE Turner Television Booster Model TV-1 has been on the market for less than a year, but already is making booster history. Reports from fringe areas all over the country are loud in their praise of the consistently superior performance of the TV-1. Wherever boosters are compared the Turner TV-1 produces the sharpest, clearest picture... the crisp, natural sound TV viewers seek.

Turner's advanced electronic engineering, plus solid, quality construction make the difference. The low-noise-level Cascode circuit stabilizes the picture, reduces noise and snow to a minimum, and produces an excellent picture under fringe area receiving conditions that nullify the best efforts of many other boosters.

Single knob continuous tuning permits fine adjustment for best possible reception of both picture and sound. Three position control switch turns on TV set only, TV set and booster, or shuts off both set and booster. The TV-1 also may be used to amplify FM, mobile and aviation radio signals.

The unit is quickly and easily installed. Attaches to any television set. Attractive styling and neutral finish harmonize with any furniture design.

Contact your Turner representative or write direct.
List price ----- \$57.50

For the best possible TV reception, turn to

THE TURNER BOOSTER

THE TURNER COMPANY

000 17th Street N.E., Cedar Rapids, Iowa

IN CANADA:
Canadian Marconi Co.,
Toronto, Ont., and Branches

EXPORT:
Ad. Auriema, Inc.,
89 Broad Street, New York 4

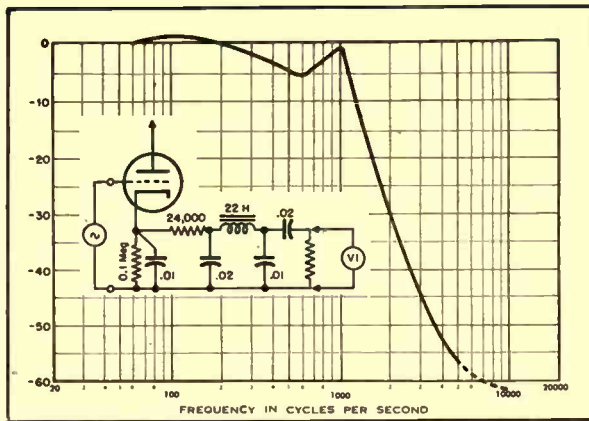

Fig. 7. Low-pass filter circuit, and response curve.

scale intermodulation percentages of 5, 10, 20 and 40. Should the latter value appear somewhat pessimistic, be assured that there are amplifiers with this value of distortion. The first section of one 12AT7 amplifies the applied signal mixture from the amplifier under test. The signal is then fed through a high-pass filter, which removes the original 60 cps, or at least reduces the level to less than 0.1 per cent. Frequencies 1000 cps on either side of the 4000-cps signal are attenuated less than 1 db. The signal is now composed of the 4000 cps. plus intermodulation products, consisting of sum-and-difference frequencies generated in the equipment being tested and a small amount of intermodulation in the analyzer. In the equipment being described this latter is of the order of 0.1 per cent. This composite signal is amplified by the second section of the first 12AT7 and applied to the grid of the demodulator, thence to the low-pass filter, where the carrier, or 4000-cps component is removed, but the low-frequency intermodulation products are retained. A curve of this filter characteristic is shown in Fig. 7.

Calibration of the carrier set or "CAL" is probably done most readily by the method outlined by LeBel in the July, 1951 issue of *AUDIO ENGINEERING*, and checks closely with the previous calibration made by the writer. Assuming a full-scale deflection of 0.25 volts for the meter and tube, as shown, it will require a potential of five volts at the top end of R_p for the meter to indicate 5 per cent full scale. This voltage is applied, preferably using a transformer or other low-impedance source, and checked with a meter of known accuracy. The potentiometer is then adjusted so that the 1M meter indicates full scale on the 5 per cent position of the selector switch. This may be checked by the LeBel method by producing a notch depth of 50 per cent and juggling the CAL control and meter-adjusting controls until the meter indicates full scale on both CAL and 10% 1M positions of the selector switch. It is easier done than described.

This instrument should be of considerable help to those constructing quality equipment for critical listeners, and, although no claims are made as to its absolute accuracy it is extremely useful, if only as a means of relative measurement. It is not particularly difficult to build, but the usual precautions necessary in building high-gain, low-noise-level amplifiers, such as a common ground point or bus, proper shielding where necessary, and location of the choke in the low-pass filter for minimum hum pickup, are definitely essential. The resistor values were selected so as to produce the minimum of intermodulation in the analyzer itself.

Presenting

GOODMANS
HIGH FIDELITY - 12" P. M.
TWIN CONE AXION 150
\$65.00 LIST

This 12-in. high fidelity unit has a twin-curvilinear diaphragm (British patent No. 451754). A carefully designed magnet assembly using anisotropic material provides a total flux of 158,000 maxwells on a 1½-in. pole. The back centering device is a dustproof bakelised linen disk with concentric corrugations. The combination of these features gives this precision-built instrument an outstandingly wide coverage from 40 to 15,000 c.p.s. free from bass modulation effects. An ideal high fidelity reproducer for the record enthusiast and the connoisseur of wide range musical reproduction, it gives exceptionally fine transient and frequency response.

U. S. NATIONAL SALES
WILLGOLD ELECTRONICS SALES CORP.
350 Fifth Avenue, New York, N. Y.

New England Office
Harold A. Chamberlin
31 Milk St., Boston 9, Mass.

Pacific Coast Office
Perimuth-Colman & Associates, Inc.
1335 Flower St., Los Angeles, Calif.

Chicago Office
Harry Halinton Co.
612 N. Mich. Ave., Chicago 11, Ill.

Canadian Office
A. C. Simmonds & Sons, Ltd.
100 Merton St., Toronto 12, Can.

Manufactured by:

GOODMANS INDUSTRIES LIMITED
WEMBLEY MIDDLESEX ENGLAND

SPECIFICATION

- Frequency Coverage 40/15,000 c.p.s.
- Overall Diameter 12 in.-31.3 cms.
- Overall Depth 6 in.-17.6 cms.
- Fundamental Resonance 55 c.p.s.
- Voice Coil Diameter 1¾ in.-4.4 cms.
- Voice Coil Impedance 15 ohms at 400 c.p.s.
- Maximum Power Cap. 15 Watts Peak A.C.
- Flux Density 14,000 gauss
- Net Weight 12 lbs. 13 ozs. (5810 grs.)
- Finish—Grey Rivelling Enamel.

LOUDSPEAKER DAMPING

[from page 21]

Since the flux of the speaker magnet is constant, e is proportional to the velocity of the voice coil. If we can somehow maintain e at all times proportional to the audio signal voltage, we shall have achieved the ultimate in speaker fidelity. And this can be accomplished, very nearly, by using e as an inverse feedback signal.

But what has happened to Z_e and Z_m ? Z_e we will consider in a later paragraph; Z_m we have eliminated from the system in the following manner: Imagine a direct-current motor with a load that is some function of time. As the load increases, the motor will slow down, the back e.m.f. will decrease, and a higher current will be drawn from the power source. As the load decreases, less current will be drawn. This variation in load, then, can be represented as an equivalent impedance; indeed, this is exactly the nature of Z_m . Here, by referencing our calculations to e , we have eliminated the necessity for considering Z_m in our analysis.

Let us draw again on our d.c. motor analogy. The voltage applied to the motor is $e + IZ$, where Z (or R , in the d.c. case) is the impedance of the motor armature. In the case of the speaker, $V_o = e + IZ_e$. It is now obvious that one can obtain e by subtracting IZ_e from the voltage across the speaker. This can be done as shown in Fig. 2.

The circuit of Fig. 2 is the conventional transformer-speaker circuit, with an extra impedance element, equal to Z_e , placed between ground and D, the ground side of the transformer. The voltage at C with respect to ground, is now $e + IZ_e$, while the voltage at D is $-IZ_e$. The feedback voltage at F is the sum of the voltages at C and D, as follows:

$$e_{fb} = -IZ_e + \frac{R(e + 2IZ_e)}{2R} \\ = \frac{e}{2}$$

One can now see the possibility of applying this voltage degeneratively, thereby maintaining e , hence the velocity of the speaker diaphragm, very nearly proportional to the signal voltage.

Z_e is approximately equal to the static impedance of the voice coil, which can readily be measured with the speaker diaphragm clamped. In fact, a replacement voice coil for the speaker used would be an excellent approximation to Z_e . For an exact equivalent, one must include in Z_e the motional impedance components mentioned above. One could measure Z_e exactly, by forcing vibration of the speaker, causing the voice coil to act as a generator, and by measuring the open-circuit voltage and short-circuit current generated. Z_e could then be computed from the values measured, for the conditions under which the measurements were made. It is likely, however, that Z_e will be a function of frequency, amplitude, and waveform of the vibra-

tion, and that any lumped-constant equivalent impedance used must needs be a compromise.

Determination of Z_e .

If the above method is used to determine Z_e , the speaker field should be excited, of course, in the normal manner while measurements are being made. These measurements will be accurate only if the mechanical driving device is stiff (not a column of air, for instance), since short-circuiting the voice coil will apply a rather large damping force to the speaker motion. This method therefore requires the use of equipment not readily available to the average experimenter. It is probable, however, that the static impedance of the voice coil for Z_e will be an adequate approximation.

It is obvious that speaker damping by this method can be obtained only at the expense of some power dissipated in the extra impedance; in fact, the losses of the speaker will be almost doubled by the presence of this impedance in the circuit. However, this method of damping will not lower the over-all efficiency of the amplifier to an impracticable value.

One salient weakness in the expedient outlined above is worthy of note: the capacitance between the output transformer secondary and ground will appear as capacitance between point C and ground, referring to Fig. 2, and between point D and ground. These capacitances may cause enough unbalance to destroy the voltage relationships upon which the damping depends. It is likely, however, that these capacitances will be nearly

NEW! STANCOR



Here are three of the newest additions to the most complete transformer replacement line in the industry.



A-8124, VERTICAL BLOCKING-OSCILLATOR TRANSFORMER

A three winding transformer for replacement in Dumont models, 9 Crosley models and Stromberg-Carlson model TV-125. See Stancor Bulletin 384.

For use with picture tubes up to 24". Equivalent to RCA 202D2. See Stancor Bulletin 383.



FC-11, FOCUS COIL.



P-8163, TV POWER TRANSFORMER

Equivalent to RCA 75508 (971316-1), used in 28 RCA models. See Stancor Bulletin 388 for a complete list.

Your Stancor distributor has data sheets on these new Stancor TV transformers. Ask him for the latest Stancor Bulletins.

Other new Stancor TV components include DY-8, DY-9, and DY-10, 70" deflection yokes with ferrite cores, nylon coil bobbins and anti-astigmatic focusing (resulting from "cosine" distributed windings) for tubes up to 24". A-8131, an air core "flyback" for direct drive circuits, to be used with DY-10.

STANCOR TV TRANSFORMER CATALOG AND REPLACEMENT GUIDE lists transformer replacements for over 1500 TV models and chassis. Available FREE from your Stancor Distributor.



STANDARD TRANSFORMER CORPORATION

3594 ELSTON AVENUE, CHICAGO 18, ILLINOIS

★ To better serve Arizona, we are pleased to announce the opening of our **Phoenix office, 32 West Jefferson Street**, under the direction of **William R. Saxson, Field Engineer**.

NEELY ENTERPRISES
ELECTRONIC MANUFACTURERS' REPRESENTATIVES

MAIN OFFICE: HOLLYWOOD 7422 Melrose Avenue

ALBUQUERQUE	SAN FRANCISCO	SACRAMENTO
107 So. Washington St.	2830 Geary Blvd.	309 Ochsner Bldg.

equal in any normal circuit layout. If they are not equal, trimming capacitors can be added to restore the balance, though only at the cost of further loading of the transformer and the output amplifier stage.

If it is possible to inject the feedback voltage into a push-pull circuit, the output transformer may be grounded, as shown in Fig. 3. Here the feedback-voltage components are taken from points M and K, and the effective feedback voltage, the difference between the two components, is again equal to $e/2$. With this circuit, the voltages applied to the two push-pull channels will differ somewhat; however, this difference can be compensated for by the use of a signal-balancing circuit that has recently become popular.¹

In conclusion, it may be well to repeat an axiom familiar to all electronic circuit designers—*no amount of inverse feedback can ever make a poor circuit perform really well*. Good components, intelligent circuit design, and sound construction principles must be employed throughout, not only to achieve the low phase-shift necessary for the success of inverse feedback, but also to maintain the loop gain high enough over the entire frequency range to provide effective feedback action. It is obvious that, if the gain becomes too low (in the extreme, if it falls to zero) within the operating range, all the negative feedback in the world will be of no value whatsoever.

¹W. B. Fraser, "A 15-Watt Direct-Coupled Amplifier," *AUDIO ENGINEERING*, April, 1951.

University LOUDSPEAKERS
WITH A TRADITION FOR
Quality and Dependability

MODEL 6201 COAXIAL SPEAKER

You'll find no compromise in the model 6201—a true coaxial system, completely self-contained with LC network and attenuator, at a sensible price. Full range response 45 to 15,000 cps, power capacity 25 watts. Highest quality construction throughout—separate Alnico V tweeter driver, exclusive UNIVERSITY "W" shape Alnico V "woofer" magnet, special cone edge treatment for longer life, minimum distortion; and even the famous UNIVERSITY wide angle "Cobra" tweeter horn for uniform dispersion of the "highs." Variable attenuator adjusts "balance" to personal preference.

The 6201 must be heard to be appreciated

... designed by **PROGRESSIVE ENGINEERING!**

Every UNIVERSITY product is built to traditional standards of quality that have earned a world-wide reputation for absolute dependability. Highest quality materials, skillfully fabricated, result in unsurpassed performance and extra reliability. "Progressive Engineering" assures the latest design improvements in every piece of UNIVERSITY equipment.

Ask for your free copy of the TECHNOLOG

Handy technical catalog, published for engineers, installers, service men. Request yours today—write Desk 32

UNIVERSITY LOUDSPEAKERS, INC.
80 SO. KENSICO AVE., WHITE PLAINS, N. Y.

TAPE EDITING AND DUPLICATING MACHINE

[from page 20]

shorted before the head is switched; one head should connect before another is released, and the buss should be shorted before the last head is released. In addition, static discharge resistors may be necessary to remove the last trace of a click when switching from one machine to another in playback.

Special Problems

Some unusual problems arise from the operation of more than one bias oscillator at a time. With even the best isolation of two tape units in one rack, there is a trace of a heterodyne recorded when both units are in operation. When all of the machines are fed from one recording amplifier, it sounds like the 75-meter phone band on Sunday afternoon. Yet it is desirable to operate the oscillators associated with each unit rather than with a master oscillator for a number of reasons. No major revision of the tape units is necessary; each unit remains usable as portable recorder; and no high-level r.f. cable or switching is necessary.

This problem was successfully solved by locking the bias oscillators together and isolating the recording heads at the bias-oscillator frequency. To achieve the

oscillator locking, the oscillators were first tuned to the same frequency as closely as possible by substituting tank-circuit capacitors. Then the r.f. bypass capacitor in the plate supply of each unit was removed and an impedance common to all units was introduced into the plate supply. The common impedance consists of a parallel-resonant circuit shunted by a resistance just large enough to ensure consistent locking of the oscillators. At any time a bias oscillator is in use, it is supplied through this impedance.

It is still necessary to isolate the recording heads at the bias-oscillator frequency because r.f. coupled from one head to another may seriously affect bias level on the heads. This is accomplished by the resistance in series with each head and by the high-Q series resonant circuit shunting the common duplicating amplifier output as shown in Fig. 3.

A selenium rectifier high-voltage supply was used to furnish power to the bias oscillators and to the play amplifiers as shown in Fig. 6. A slow-acting fuse must be used in the primary circuit to with-

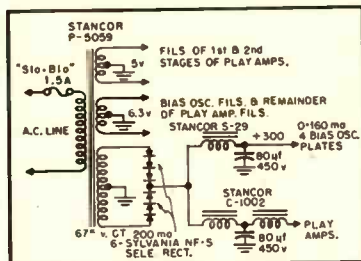

Fig. 6. Schematic of selenium rectifier power supply.

stand the initial charging current in the supply. Selenium rectifiers were chosen because they give better regulation under the varying bias-oscillator load and because they provide a more dependable supply for the playback amplifier.

Duplicating Speed

It should be noted that as long as the master and copies are to have the same playing speed, they can be duplicated at the highest speed available, using the correct equalizer for the duplicating speed. Thus 7½-inch-per-second copies can be produced from a 7½-inch-per-second master in half the time by duplicating at 15 inches per second, using the 15-in. equalizer. The copies will be identical to the master in actual playing speed, whatever that may be.

The equipment shown in the photographs has been used since August 1950 with an average of about 15 miles of tape going through the machines each week. Some evolution has taken place since the equipment was first constructed, as would be expected. One such evolution was the elimination of eight relays and a battery supply for their operation—the availability of the switch specified made this step possible.

This complete installation proves that tape recorders can do any number of useful operations—it is only necessary to think up a job for them, and then proceed to work out the method.



MIDGET CONDENSER MICROPHONE

For Precision Sound Measurements and High Quality Sound Recording

Built to give years of service without change in calibration. Even without dessicators, Kellogg Midget Condenser Microphones show no detectable drift in laboratory service. Proven in use for optimum performance for more than 15 years.

- RUGGED CONSTRUCTION
- EXCEPTIONAL CALIBRATION STABILITY
- UNAFFECTED BY VARIATIONS IN HUMIDITY

PRINCIPAL CHARACTERISTICS

	MODEL A	MODEL B
RESPONSE (Referred to 1 volt/dyne/cm ²)	-59 db	-55 db
FLAT TO WITHIN	± 3 db from 20 to 11,000 cps, for closed cavity without grille.	± 4 db from 20 to 15,000 cps with or without grille for perpendicular incidence in free field.

Users Include government laboratories, universities, audio development laboratories, sound studios and industrial plants manufacturing sound equipment.

● SEND FOR FULL SPECIFICATIONS TODAY! WRITE DEPT 27-L

KELLOGG

Established 1897

SWITCHBOARD AND SUPPLY COMPANY

MIDGET CONDENSER MICROPHONE

6650 South Cicero Avenue, Chicago 38, Illinois



IT'S ALLIED FOR RCA

Electron Tubes for Industry



Quick, Expert Service on RCA Tubes

ALLIED maintains in stock for quick shipment, the world's largest distributor inventory of RCA special-purpose tubes—of all types. We specialize in supplying the needs of industrial, broadcast, governmental and other users. To save time, effort and money—phone, wire or write to ALLIED. Fill all your needs quickly from the complete, dependable electronic supply source.

See Your 1952 ALLIED Catalog

Refer to your ALLIED Catalog for all electronic supplies—parts, tubes, test instruments, tools, audio amplifiers, accessories—available from the world's largest stocks. Write today for your FREE copy of the complete 212-page ALLIED Catalog.

FREE! Send for it now

ALLIED RADIO

833 W. Jackson Blvd., Dept. 17-M-1, Chicago 7, Ill.

ALL TYPES IN STOCK

- Vacuum Power
- Thyratrons
- Vacuum & Gas. Rect.
- Ignitrons
- Cold-Cathode
- Phototubes
- Oscillograph Tubes
- Camera Tubes
- Monoscopes
- Special Types

FREE Interchangeability Directory

Valuable guide to selection of proper RCA tube type replacements. Lists 1600 tube types. Write for FREE RCA Guide No. 37-046.

Everything in Electronics from ONE Source

LEADING ENGINEERS and MFRS. SPECIFY



PAR-METAL

Standardized **HOUSINGS**
for **ELECTRONIC EQUIPMENT**
because they're
MADE BY SPECIALISTS,
READY-TO-USE,
LOW IN COST!

CABINETS
CHASSIS
PANELS
RACKS

We manufacture Metal Housings for every purpose — from a small receiver to a deluxe broadcast transmitter. And the cost is low!

Because we specialize in the Electronics field, Par-Metal Products excel in functional streamlined design, rugged construction, beautiful finish, and economy.

Remember, Par-Metal equipment is made by electronic specialists, not just a sheet metal shop.

Made by
Electronic
Specialists!



PAR-METAL

PRODUCTS CORPORATION
32-62 — 49th ST., LONG ISLAND CITY 3, N. Y.
Export Dept.: Rocks International Corp.
13 East 40 Street, New York 16, N. Y.

WRITE FOR CATALOG!

R-J SPEAKER ENCLOSURE

[from page 17]

As shown in Fig. 2, the classical Helmholtz resonator consists of a cavity v , the compliance of which can be expressed by the formula given above, and a circular duct of length l and area s . The equivalent electrical circuit for this acoustical arrangement is the same series circuit as that of Fig. 1 where C represents the compliance of the cavity v and the inductance represents the mass of air in the duct (plus end corrections in refined calculations). The mass of air in the duct swings back and forth against the spring action of the air in the cavity. The simplified formula³ for the resonator frequency is expressed as follows:

$$f = \frac{c}{2\pi} \sqrt{\frac{S}{lv}}$$

where c is the velocity of sound.

After experimentation with various modifications, it was found that this development was eminently suitable. Not only can the resonant frequency of the system be reduced, but it is also controllable by manipulating s and l to attain almost any desired resonant frequency. Investigation of the practical aspects showed that the frequency of resonance could be lowered as required in face of the stiffest cavity met with, i.e., a cavity which was barely larger than the 15 in. speaker it contained, amounting to some 2200 cubic inches. Another aspect which developed was that the speaker stiffness almost completely dropped out of all the calculation; since the stiffness of the small box was so much greater than the speaker, this factor could usually be ignored in calculations. This has also been verified by experiment.

There remained finally objective (2); i.e., the desirability of accomplishing the extended bass response without resonance humps. It was soon found that with this development a concomitant advantage existed, in that the loading material, i.e., the air in the duct, is also the operating medium by which the acoustic results are obtained. In other words, the larger the mass of air used to offset the resonator stiffness, the more air is set in motion at the duct exit and the more acoustic radiation obtained by virtue of setting this air in motion.

Referring to Fig. 1, familiar series resonant circuit mathematics shows that increasing the resistance R_a (the acoustic radiation) will lower the Q of the circuit and flatten the resonance hump. This has been carried out in design, the resonance hump being controlled by varying the governing factors.

The efficiency of this system is approximately 4 db lower than bass-reflex and open back enclosures, mainly because of the 3-db loss resulting from complete suppression of the back wave. This loss is, of course, true with all infinite baffle

³ Stewart and Lindsay, "Acoustics," 1930, p. 49.

Over the years, **AUDIO ENGINEERING** has proven itself a valuable reference work worthy of a permanent place in your library. Many of our 1951 issues are already exhausted, but you may have a complete bound volume of new copies for the entire year if you order now.

1951 Bound Volumes . . . \$8.95

NEXT YEAR

This is an offer made but once a year. When you hear about it, we're sure you'll want to take advantage of it. Right now, you may subscribe or renew your present subscription for one year at the cost of \$10.00, which includes a bound volume delivered to you around January 1, 1953. Each month you will receive **AUDIO ENGINEERING**—read it, cut out coupons to your heart's content, mark on the pages as much as you want. At the end of the year, you receive a fresh, new bound volume of 1952 issues which you may keep as a permanent record. Stop trying to keep each issue neat and clean—use it. Then, at the end of the year, you'll receive a completely new set—no creases, no dog-eared pages.

Dept. SV
AUDIO ENGINEERING
342 Madison Ave.
New York 17, N. Y.

Name
Address
City Zone State

- Enclosed is my check (or money order) for \$8.95 for a 1951 Bound Volume.
 Enclosed is my check (or money order) for \$10.00 for a new renewal subscription, plus a 1952 Bound Volume, which I understand will be delivered about January 1, 1953.

arrangements. The other 1 db of loss is encountered in the acoustic loading chamber. The sound exit of the system has been arranged according to the slot principle⁴ so as to obtain distributed source effects as developed in Mr. Smith's article. While two-way systems have been mainly experimented with, a successful design for a one-way speaker system has also been completed. It is of interest to note that one such system has been built using an 8-in. speaker which reproduces fundamental bass to below 65 cps.

One of the important advantages of the small size of the R-J enclosure is the elimination of the need for bracing required with larger enclosures. Bricks, sand, and other dense panels are unnecessary, and vibration of the small sides is completely negligible. Because of this, the enclosure is also adaptable to console type of construction, for the bugaboo of vibration feedback is overcome. An economic advantage also operable is that the walls of the console cabinet may be utilized for practically the major portion of the enclosure.

A considerable part of the development of the R-J system has been devoted to determining the optimum arrangement of the various elements, both as to sound and as to construction and to the balancing of the air loading and acoustic radiation factors. It is expected that details, both as to design and construction, will be released shortly as soon as certain contractual arrangements have been completed.

The authors wish to express appreciation to Mr. E. T. Canby for his continued encouragement during the development period.

⁴ Smith, "Distributed source horns," AUDIO ENGINEERING, Jan. 1951.

RECORD REVUE

[from page 32]

slang in line, if you want to. I've always felt that slangy usages of words, though they are often vague and dangerously inaccurate to begin with, in the end usually turn out to be the best and most useful ways to put words to work when they have had a good chance to move around and make a new place for themselves.

Taped Piano

Another slight confusion of word usage got me into warmish water when I mentioned on the air that "tape was allergic to piano." Got quick objections from Joel Tall of CBS, who ought to know. I should have put it "piano is allergic to tape," maybe—still better would have been to say what I meant! Namely, that the piano, because of its peculiar combination of violent transient tones and absolutely even pitch the most difficult of all instruments to record, is the quickest to show up weakness in tape recording. It shows up weakness in any recording, of course. Transient response characteristics that will take care of a fiddle or a flute with ease fall down audibly on piano. Steadiness of pitch that seems entirely satisfactory for virtually any other kind of music will, for the ear, be far under par when the piano is recorded.

Sylvania Offers FULL-LINE of High Quality Sockets

Sylvania now offers a full line of sockets for military and civilian requirements, manufactured in accordance to JAN and RMA specifications. Available in General Purpose and Low Loss Phenolics and Steatite, with any combination of contact materials.

Available types include 7- and 9-pin Miniature, Turret, Octal, Duo-Decal, etc., sockets. For complete descriptions write today for new illustrated catalog to: Sylvania Electric Products Inc., Dept. A-1312, Parts Sales Division, Warren, Pa.

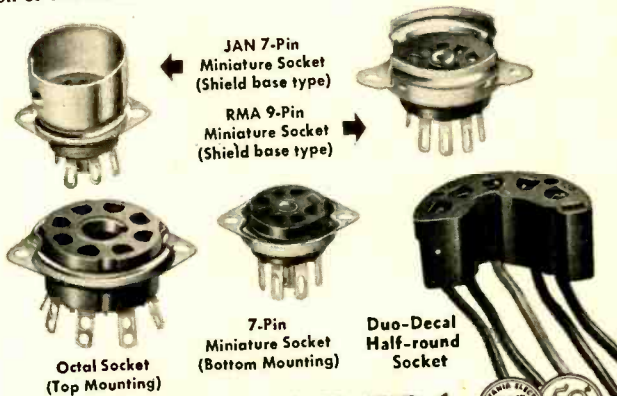

SYLVANIA
 RADIO TUBES; TELEVISION PICTURE TUBES; ELECTRONIC PRODUCTS; ELECTRONIC TEST EQUIPMENT; FLUORESCENT TUBES, FIXTURES, SIGN TUBING, WIRING DEVICES; LIGHT BULBS; PHOTOLAMPS; TELEVISION SETS

SONOCRAFT

NEW YORK HEADQUARTERS

for SOUND-RECORDING EQUIPMENT & ACCESSORIES

Feature of the Month



The BINAURAL MAGNECORDER
 The Sensation of the Audio Fair
 \$884²⁰

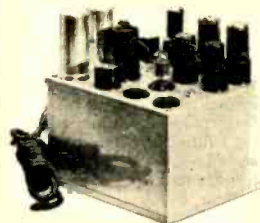

McINTOSH AMPLIFIER



JIM LANSING SPEAKER
 with the NEW LENS



SONOCRAFT CORPORATION

115 WEST 45th STREET, New York 19, N. Y.
 3rd Floor Next to Times Square LU 2-1750

The **TURNTABLE**
is the **HEART**
of your
HIGH FIDELITY
SYSTEM

You may own the finest pickup, amplifier and speaker that money can buy...yet you'll get poor reproduction if your **TURNTABLE** has excessive wow, hum or rumble!

REK--KUT

... offers a complete range of 12" Turntables, including models to match your individual amplification system and your individual pocketbook. Not every sound system requires the most expensive Turntable... your Turntable must be chosen to match your other equipment... Each REK-O-KUT Turntable Specification rates the DB Noise Level to enable you to select the appropriate Turntable to match your other components. The quality and workmanship of every REK-O-KUT machine, from our most economically priced model to our highest priced professional job is identical... price differential is dependent solely upon the type of materials used.



MODEL LP-743
3-Speed 12" Turntable
Induction type motor, designed for smooth, vibration-free operation. Instantaneous speed changes without stopping turntable or removing disc \$54.95 Net



MODEL CVS-12
All-Speed Continuously-Variable Turntable
Plays all records, 6" to 16" and broadcast transcriptions, not only at the three normal speeds, BUT AT ANY SPEED from 25 to 100 RPM. You play your records at the EXACT SPEED at which they were recorded, or at any variation of speed or pitch which gives you maximum pleasure. A "must" for serious music lovers, pro musicians, schools, dance studios, etc. \$84.95 Net

MODELS T-12H & T-43H

2-Speed 12" Turntables

The only 12" dual-speed turntables that meet the standards for speed regulation and WOW content specified by the National Association of Broadcasters.



Recommended for use with **ULTRA HIGH FIDELITY** Amplifiers and Speaker Systems.

MODELS	MOTOR	SPEED	PRICE
T-12 H*	Hysteresis Synchronous	78-33%	\$119.95
T-43 H*	Hysteresis Synchronous	45-33%	\$119.95
T-12	4 Pole Induction	78-33%	\$84.95
T-43	4 Pole Induction	45-33%	\$84.95

*Delivery limited to short supply of Hysteresis motors.

See...hear...compare REK-O-KUT Turntables, Phonographs and Professional Disc Recorders at leading Music Stores, Audio-Visual Dealers and Radio Parts Jobbers...or write for latest, free Catalogue.

REK-O-KUT CO.

3B-01 Queens Blvd., Long Island City, N. Y.

EXPORT DIVISION: 350 Broadway, New York City, U. S. A.
CANADA: 4145 RADIO CORP. LTD., 542 King St. W., Toronto 28, Ontario

Tape is an extremely difficult physical problem when it comes to steadiness in the drive, and piano recording on tape mercilessly shows up the minutest variation. Pianos have made the finest tape machines sound sour in spite of paper specifications that would seem to make it impossible. The biggest record companies have issued piano LP records that make a musician slightly sea sick. Many record collectors have sworn off tape-LP piano, vowing to stick to the good old 78 or nothing.

But since this subject was last mentioned hereabouts things seem to have been happening. Though it was officially impossible for audible wow *et al* to get into finished records right along and few people in the making end of records were admitting that piano wasn't as good as it could be, suddenly (or so it seems) during the last few months piano on LP has improved no end.

I had a feeling that those who insisted that there was no reason why taped piano shouldn't be as steady and as natural as any musician could ask were right. Just a matter of raising standards all along the line, but especially in the listening end. It takes a musical ear in the last analysis to pass judgment on a finished record as to its steadiness. The newer piano records on LP from both small companies and large are now showing a steadiness of pitch that is easily up to the best I've ever heard in 78 and in some respects a good deal better. Just proves it can be done. All the more reason for strenuous objections on our part to every record of piano that does not measure up to proper high listening standards of steadiness.

In a forthcoming issue there will be a renewed listing of recent tape-LP piano recordings, with especial emphasis on steadiness of pitch, for those who may be curious to test for themselves the quality of the best and latest in piano.

Pitch vs. Transients

Meanwhile, I'm still mulling over an interesting suggestion from Mr. Tall, who, if I got it straight, ascribes a good deal of what the average listener brands as pitch waver in piano recording instead to poor transient response. This makes sense. There are numerous piano records in which, as I've often noticed with perplexity, certain isolated tones seem to quaver and ring false—but *not* the whole body of tone, as should be the case with any sort of fixed mechanical irregularity. Mostly loud, percussive prominent notes. How come?

It stands to reason, I'd say, that in the microscopically short period of time in which the "head" of a piano tone, so to speak, passes by, our determination of pitch may be inaccurate or quite at a loss. (Pitch sense depends, as we know, on a relatively long "exposure" to a soundwave pattern.) Is it not possible that distortions in the "head" of a piano tone that are actually not of a pitch nature at all (i.e. not a mechanical wow) may communicate themselves by aural illusion to the rest of the duration of the note—so that we think we hear the whole note as false, when actually it is no more than the beginning that is wrong? (Play a piano tone backwards, recorded, and you'll hear how much the "head" has to do with the piano sound; backwards the music is more like some strange organ, minus percussion.) Clearly it would take a lot of mathematics and detailed waveform analysis to pursue this subject profitably—but I retain in mind the one impression, that perhaps not nearly as much of the false piano sound we hear is due to technical drive trouble as we ordinarily assume. Those banjo-like twangs that piano



Selected by broadcasters and sound studios as the best portable tape recorder for hi-fi recording.

Range—50 to 8000 cycles at 7 1/2"
50 to 5000 cycles at 3 3/4"

Push-Button Control for speed change.

Rewind • Forward—70 sec. for 1200 ft.

Amplifier—Auto. equalization at both speeds.

Heads—Single or dual track.

Editing Key—Erases or corrects recordings.

Weight—Only 27 pounds.

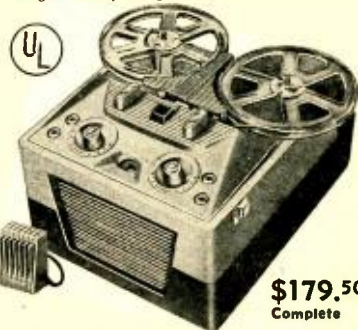

\$179.50
Complete

Write for Complete Specifications Today!

THE PENTRON CORPORATION

221-AE EAST CULLERTON ST., CHICAGO 16, ILL.
IN CANADA • ATLAS RADIO CORP., LTD., TORONTO

lovers hate so heartily could be largely electrical? An important point—because of the utterly different sources of these two types of trouble. How much is actually mechanical, how much that sounds mechanical is in fact electrical? Keep your ears open, and blame the tape transport only when you are sure.

RECORD LIST

Try these on your hi-fi outfit.

(Note: These are new LP's recommended as combining high quality on the technical side with good microphoning for the type of music, plus at least reasonably good musical performance. The factors may vary somewhat; at times the music is of most importance, in other cases the "hi-fi" aspect weighs heavily. Foot notes help elucidate. E.T.C.)

Bach and Vivaldi—Impressive Baroque, vocal and instrumental

^b**Bach, Cantata #51** (soprano); **Cantata #189** (tenor). M. Guillaume, sop. C. Stemann, ten. Bach Orch. of Stuttgart, Grischkat.

Renaissance X-35

^c**Bach, Easter Oratorio**, Vienna Chamb. Orch., Akademie Choir, soloists, Prohaska.

Bach Guild BG 507

^b**Vivaldi, Juditha Triumphans** (oratorio). Solos, Chorus and Orch. Scuola Veneziana, Ephrikan.

Period SPLP 533 (2)

^c**Bach, Variations, "Vom Himmel Hoch"; "O Gott, du frommer."** Robt. Noehren, organ (Sandusky, O.)

Allegro AL 116

Bach, English Suites #2, #3, Alice Ehlers, harps.

Allegro ALG 3017

Bach, Toccatas in D mi., C, Chromatic Fantasia; **Bach, Toccatas in E mi., D mi.** Fernando Valenti, harpsichord.

Allegro AL 105; 118

Bach, Italian Concerto; Four Duets; Aria with Ten Vars. Rosalyn Tureck, piano.

Allegro AL 117

^b**Bach, Three-piano Concerto in D mi.** Robt., Gaby and Jean Casadesus; N. Y. Philharmonic, Mitropoulos.

Columbia ML 2196 (1/2)

^d**Vivaldi, "Bullfinch" Concerto. Flute Sonata #6. Cello Sonatas #2, #6. Pastorale.** Kaplan, Mayes, Bodky (harps). Boston String Orch.

Allegro ALG 3009

Piano

(Note: Recent piano from tape is much improved as to flutter and distortion "twang." At best, taped piano as transferred to LP now can easily match the best disc piano.)

Early Romantic

^b**Schumann, Kinderscenen; Piano Sonata in G mi.** Jacqueline Blancard.

Vanguard VRS 415

^c**Schumann, Davidsbuedler Dances.** Ray Lev.

Concert Hall CHS 1104

Schumann, Carnaval; Chopin, Sonata in B minor. Guiomar Novaes.

Vox PL 6710

^d**A Chopin Piano Recital.** Arrau, Lili Kraus, Eileen Joyce.

Decca DL 8517

^c**Chopin, Four Ballades.** Earl Wild.

Concert Hall CHS 1401

^c**Chopin, Preludes.** Brailowsky. RCA Victor LM 1150

Audio's New LABORATORY INSTRUMENTS give you Precision Measurement at Moderate Cost

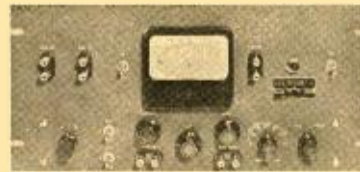

INTERMODULATION METER — Highest Professional Flexibility at Reasonable Cost.

Model 165 IM Meter is especially suited for laboratories, broadcasters, recording studios. Signal generator, analyzer, voltmeter in single case. Reads % IM, amplifier output directly on meter. Provides for use of scope to analyze & cure IM causes: full graphic instructions supplied. Wide range of low & high test frequencies: 60 cps internally, 40-200 cps externally; standard 2.7, 12 kc internally, 2-20 kc externally. Voltage ratio choices: for IF testing, 4:1; for more accurate HF testing, 1:1. 8 3/4 x 19" rack-type panel; 8 1/2" deep. Price \$250.00.

Negligible loading with the BRIDGER

In bridging measuring instruments across high-Z circuits, lowest possible circuit loading is vital. Model 100A's newly improved cathode follower and special double-shielded cable reduce cable capacitance and circuit leakage to the insignificant. Input Z: 70 megs, 5 mmf, with 3 ft. cable. Output Z: 200 ohms. Output/input voltage ratio: 0.99. Usable to several hundred kc. Price \$88.50.



Do you have the data on our new GALVANOMETER-PROTECTOR? Write NOW for Catalog A.



IN ORDER TO FIND IT— WHY NOT BIND IT?



Your reference library of AUDIO ENGINEERING can be up-to-the-minute by keeping your copies in an AUDIO Binder.

For convenience's sake, order a binder for your den or workshop, or wherever you do your experimenting. You will appreciate the appearance of the binder—deep blue DuPont Fabricord (stain-proof and washable) with the backbone gold-stamped with AUDIO ENGINEERING and any year you specify. You will also appreciate the many years of service your binder will give you. Toward this end, it has a rigid backbone with bound-in metal support and a center channel to keep magazines securely in place.

For only \$2.75, it's yours.* Send your check or money order to RADIO MAGAZINES, INC., 342 Madison Ave., New York, N. Y.

* (Foreign orders add 50¢ per binder)

For NATURAL Sound Reproduction

**BRONK High Quality
AUDIO AMPLIFIER**



Hear hi-fi equipment at its best in our modern, well stocked sound studio in our main store at 7th and Arch Streets. Listen to a variety of combinations. Master control panel helps you make comparisons of any combination of units. Choose the system most satisfying to your ears.

• frequency range—basic amplifier, flat from 20 to 20,000 c.p.s. within ±0.5 db.

• power output—10 watts

• THREE INPUT CHANNELS — For magnetic pickups, crystal pickups, and radio and TV tuners.

• Distortion and intermodulation extremely low.

\$198⁰⁰ net

**Radio Electric
SERVICE CO. OF PENNA., INC.**

7th & Arch Streets, Phila. 6, Pa.

Branches: Philadelphia—3412 Germantown Ave.
5930 Market St • Easton, Allentown, Wilmington

Write For The
RESCO Digest

Our Monthly House Organ

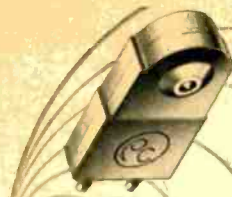

for flawless reproduction
**NO OTHER CARTRIDGE CAN
 PERFORM LIKE A PICKERING**

Pickering patented design
 provides **DYNAMIC COUPLING***
 throughout the entire audible range

*** DYNAMIC COUPLING ASSURES**

- constant stylus contact with the record grooves over the entire audio spectrum (20-20,000 cps)
- full frequency response
- full transient response

**NO RESONANCES
 NO MISTRACKING
 NO GRINDING OF GROOVE WALLS**

Pickering Cartridges transmit all of the sounds in the musical spectrum, without loss of definition, just as a fine optical lens passes all of the colors in the rainbow.

For literature address Dept. A

Well-informed engineers and technicians, schooled in the science of electro-mechanics, know that only wide-range frequency response provides full transient response; the electronic phenomena which enables the reproduction of orchestral music with all the subtle sounds that give each musical instrument its individual character.

Pickering engineers and designers have but one objective . . . to produce products that will please the music lovers' insatiable appetite for the flawless recreation of recorded music . . . for the utmost in quality insist upon Pickering Audio Components.



**PICKERING & COMPANY, INCORPORATED
 OCEANSIDE, NEW YORK**

We're not saying you MUST have AUDIO ENGINEERING

You could undoubtedly live without it if you had to.*

BUT our many readers think of AE as a sort of institution, a necessity for their interests and way of thinking. Our readers tell us they think AE is worth its price and much more.

IF YOU ARE interested in Audio (and who isn't, these days?), you know that **AE IS THE ONE MAGAZINE DEVOTED TO AUDIO AND NOTHING BUT AUDIO.**

IF YOU WANT to know what is happening in your field of work or how to better the sound equipment you are making for your living room, you'll want every issue of AE.

SO, before you miss one of the stimulating issues we have scheduled for the winter months ahead, fill out the coupon below. That one back issue you need most is generally sold out.

* At last count, only one subscriber had widowed his wife because he forgot to renew his subscription.

AUDIO ENGINEERING

342 Madison Avenue, New York 17, N. Y.

Enclosed is my check money order for \$..... for my subscription to **AUDIO ENGINEERING** FOR 1 yr 2 yrs.

Subscription Price in U. S. A. and Canada and Pan American Union; 1 yr—\$3; 2 yrs—\$5. Add \$1. per year for foreign subscriptions.

Name (please print)

Address

City Zone State

Occupation (give title and department)

Firm name

- *Beethoven, Piano Sonatas Op. 78; 14, #1; 110. Kurt Appelbaum. Westminster WL 5090
- Beethoven, Piano Sonatas Op. 22; Op. 27, #2 ("Moonlight"). Kurt Appelbaum. Westminster WL 5078
- *Chopin, Nocturnes. Artur Rubinstein. RCA Victor LM 6005 (2)

Pof-pourri

- *American Music Series: Reinagle, Gottschalk, Griffes, Palmer. Jeanne Behrend. Allegro ALG 3024
- *Encores. Artur Rubinstein. RCA Victor LM 1153
- *Eileen Joyce Piano Recital. Decca DL 9528

French and Spanish

- *Debussy, Children's Corner Suite. Schumann, Forest Scenes, Op. 82. Robert Casadesus. Columbia ML 4366
- *Debussy, Suite Bergamesque, Ravel, Gaspard de la Nuit. Frank Glazer. Polymusic PRLP 1005
- *Ravel, Gaspard de la Nuit; Le Tombeau de Couperin. Bernhardt Weiser. R.E.B. 8
- *Debussy, Images, sets 1 & 2. Walter Gieseking. Columbia ML 2188
- *Spanish Piano Music. George Copland. M-G-M E87
- "Meet the Composer"—Francis Poulenc Playing His Own Works; Piano Music of Satie. Columbia ML 4399

* Outstanding over-all sound, musical factors included. † Clumsy tape editing in spots. ‡ Excellent bass. § Thin bass. ¶ Rather heavily recorded. ¶ Oversize center hole. † Occasional slight flutter. § Some surface noise. ¶ Dead, close acoustics. ¶ Probably from older disc. ¶ Percussive resonances.



Employment Register

POSITIONS OPEN and AVAILABLE PERSONNEL may be listed here at no charge to industry or to members of the Society. For insertion in this column, brief announcements should be in the hands of the Secretary, Audio Engineering Society, P. O. Box 12, Old Chelsea Station, N. Y. 11, N. Y., before the fifth of the month preceeding the date of issue.

★ Positions Open • Positions Wanted

★ **Electronic Engineer — High-Fidelity Hobbyist.** Unusual opportunity to be employed with your hobby. Fast expanding, leading hi-fi chassis manufacturer has openings with a future in design, production, and sales. Location Chicago. Salary open. Send experience resume to Box 1201, Audio Engineering.

★ **Engineers and Physicists.** Unusual opportunities in Audio, Sonar, and Instruments with small, growing company. Permanent positions. In-on-ground floor opportunities. Send full resume to Personnel Department, H. H. Scott, Inc., 385 Putnam Ave., Cambridge 39, Mass.

THE Bogen BATON!

Model HO10 High Fidelity Amplifier and Model RXPX Remote Controller

YOU LEAD THE ORCHESTRA—from your favorite easy chair—with complete remote control of function selection, volume, tone and record equalization. Permits instant adjustment for maximum enjoyment of each selection on radio or phonograph. Handsome, compact remote control unit complements every decor.

Write for FREE catalog A-12

David Bogen CO., INC.

663 BROADWAY, NEW YORK 12, N. Y.

PIONEERS IN HIGH FIDELITY FOR OVER 20 YEARS



LOWELL SPEAKER BAFFLES

FURNISH  EAR LEVEL SOUND

EVERYWHERE! Lowell Speaker Baffles assure Uniform Sound Reproduction in all directions, give excellent low level response, have "floating conical action."

Lowell Speaker Baffles are easily installed, low in price, attractively designed and finished in any color lacquer to match surroundings.

Lowell Speaker Baffles are available in all sizes from 6" thru 15", in AL (for low ceilings) and BL (normal ceilings) Models, shown above.

Lowell manufactures a complete line of baffles, for all types of sound installations. For complete details and prices, write for new catalog.

LOWELL MANUFACTURING CO.
1531 Branch St., St. Louis 7, Mo.

NEW LITERATURE

● **Newcomb Audio Products Co.**, 6824 Lexington Ave., Hollywood 38, Calif. deserves high commendation for publication of a useful wall chart showing percentage of power loss and mismatch versus line length, wire size, and line impedance. Broken into two sections, the chart covers both high- and low-impedance lines. A valuable service to sound specialists and audio installation engineers, to whom it is offered free. Write for chart 106.

● **Concord Radio Corp.**, 901 W. Jackson Blvd., Chicago 7, Ill. has just issued Catalog 95, the firm's 1952 buying guide for industry, TV and broadcast stations, audio enthusiasts, schools, hams and experimenters. This latest edition more than lives up to the high standard established by Concord catalogs in the past. Everyone with an interest in electronics should have a copy. Will be mailed free on request.

● **Insulation Manufacturers Corporation**, 565 W. Washington Blvd., Chicago 6 Ill. is now distributing a 20-page illustrated bulletin which includes descriptions, specifications, and applications of Macallen built-up mica insulation products. Uses, sizes and grades of each type of built-up macallen mica product are tabulated. This bulletin is an excellent example of effective industrial publishing. Available without charge on request to Publication Department at above address.

● **Barber-Colman Company**, Rockford, Ill. will mail free on request an excellent 4-page illustrated bulletin titled "Air Distribution in Television Studios." Explained are methods for using the company's Uni-Flo, Venturi-Flo, and Line-O-Flow air distribution equipment to conquer such problems as are offered by extremely high heat loads and low noise-level requirements. In writing ask for Bulletin F-4712.

● **General Cement Mfg. Co.**, Rockford, Ill. is now circulating Catalog No. 155, a 64-page illustrated directory and price list of the company's extensive line of radio and TV accessories. This is probably the most complete listing of such items as radio chemicals, radio and T-V parts service aids, alignment tools, and radio hardware in the industry. Will be mailed to radio and T-V service men free on request.

● **G & H Wood Products Co.**, 75 N. 11th St., Brooklyn 11, N. Y. has recently published an impressive loose-leaf folder containing illustrations and dimensional drawings of the company's line of furniture for high-quality music systems. Formerly known as Cabinart Furniture Company, G & H is a pioneer in the custom-cabinet field, and manufactures enclosures in a wide range of styles to fit most standard amplifiers, speakers, record changers, and tuners.

● **Lafayette Radio**, 100 Sixth Ave., New York 13, N. Y. has just announced release of a 32-page illustrated manual devoted to high-quality-audio components of leading manufacturers, complete radio-phonograph systems, home installation, and custom-built cabinetry. Also included is a complete explanation of high-quality audio, the requirements of a high-quality system and its components, and how to plan such a system for the home. Lafayette is to be congratulated on the preparation of this book—the simplicity of its text is an excellent move toward bringing high-quality music into the average non-technical home. Requests for free copy should specify High Fidelity Guide.

● **S.O.S. Cinema Supply Corp.**, 602 W. 52nd St., will mail on letterhead request a 41-page supplement to the company's Catalog Sturelab 8A. The supplement lists and describes equipment for the professional cameraman, studio, and laboratory at current prices.

● **Dawe Instruments Limited**, 130 Uxbridge Road, Hanwell, London W7, England, summarizes in a new 6-page illustrated brochure the wide range of electronic measuring equipment manufactured by the company's instrument division. An exceedingly interesting listing of fine equipment. Will be mailed free on request.

● **National Bureau of Standards**, Washington 25, D. C. announces availability of a booklet titled "Selection of Hearing Aids" by Edith L. R. Corliss. The booklet is a practical guide to assist a person in selecting his own hearing aid, and is based on the Bureau's studies of the properties and performance of hearing aids of all types. Also discussed is the proper care of hearing aids, indications of impaired functioning, and means of reducing deterioration. Requests for copy must be accompanied by fifteen cents and should be addressed to Government Printing Office, Washington 25, D. C. specifying NBS circular 516.

ANOTHER SIGNATURE FIRST

Now!

A FULL ACOUSTICAL LENS FOR LOUD SPEAKER USE!

Distributing a uniform sound wave over the entire audio spectrum, the new Jim Lansing acoustical lens smooths out the high frequencies and gives them a mellowness that your ear will appreciate instantly. Unlike the multicellular horn, which performs well at some frequencies but beams or distributes very poorly at others, the new lens is not sensitive to frequency... because the band width is wider than the audio spectrum with which it is used. The new lens and horn is for use with the Jim Lansing #175 high frequency driver.

TRANSPARENCY CAN BE MEASURED!

Transparency or absorption in the new Jim Lansing acoustical lens is measured in the same way as it is in the optical lens—by index of refraction. The percentage of sound absorbed by the Jim Lansing acoustical lens is less than the percentage of light absorbed by the finest optical lens.

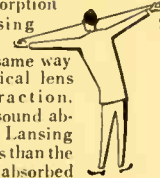

W-I-D-E DISTRIBUTION ANGLE!

The angle of distribution which is controlled by curvature and index of refraction can now be varied between wide limits...permitting the sound to be concentrated or diffused. The 175 DLH shown above (driver, lens and horn) distributes over a 90° solid angle.



A graphical diagram or ray tracing of the operation of the Jim Lansing acoustical negative lens showing focal point and diffusion angle as controlled by curvature and index of refraction.

Ask your audio dealer for demonstration of the new Jim Lansing acoustical lens today!

JAMES B. LANSING SOUND, INC.

2439 FLETCHER DRIVE
LOS ANGELES 39, CALIFORNIA



FIRST IN FINE SOUND

**FREE! INDUSTRIAL
TUBE
BOOKLET!**



**JUST
OFF
THE
PRESS!**

**Purchasing
Agents!
Engineers!**

Write today for this highly informative booklet. Complete technical specifications of all leading brands and types of tubes for all electronic applications—silicon diodes, germanium crystal diodes, thyristors, plectrons, kenotrons, phanotrons, photo tubes, xmitting tubes, etc. Lavishly illustrated. Address Dept. DA.

**Also COMPLETE STOCKS of ALL TYPES
RADIO-ELECTRONIC EQUIPMENT**

**MILO RADIO
& ELECTRONICS CORP.**

200 GREENWICH STREET, NEW YORK 7, N. Y.
Phone BEekman 3-2980 • Teletype NY1-1839

**PROFESSIONAL-TYPE
TAPE RECORDER
Uses Your Amplifier!**

**COMPLETELY
PORTABLE**



**The
tapeMaster**

**NET
\$89.95
LESS
MIKE**

Own a better tape recorder

—at a tremendous saving!

By using the tapeMaster with your own audio amplifier, you get professional-type performance—economically! Built to RMA standards. 7 1/2" per sec. tape speed. Fidelity equal to professional recorders. Fast forward and rewind. Complete master switching. Full monitoring. Inputs for Radio-Phone and Mike. Outputs to Amplifier and Headphones. Push-Pull Supersonic Bias and Erase. Neon Record Level Indicator. One Knob Mechanism Control.

ORDER NOW ON 15-DAY TRIAL

YOUR MONEY BACK if not fully satisfied within 15 days. We prepay transportation charges if you send remittance with order.

WEXCO, INC.

WEXCO INC.

Dept. AS1

54 Illinois St., Chicago 10, Ill.

Rush tapeMaster to me.

Enclosed \$..... Ship C.O.D.

Send full information on tapeMaster

Name

Address

City

Zone

State

LETTERS

[From page 8]

TWIN-UNIT SPEAKERS—Apart from widening the frequency range, separate speakers enable the designer to pay attention to transient response, and tests with square wave and pulse inputs reveal that very good results are possible with reduction of "ringing."

G. A. Briggs,
Wharfedale Wireless Works,
Bradford Road,
Idle, Bradford, Yorks.
England

Another Reader Wants—
Sir:

I'm an audio expert. Thanks to your magazine I can read schematics, interpret graphs, decipher dimensional drawings, and talk like the very dickens about what's behind the scenes in transformers, amplifiers, speakers, and all the other gadgets that make up an audio system.

Yes, you've made me a whiz with a slip-stick. Now how about a little book learning on how to use a screwdriver, a saw, and a glue pot. A little more space devoted to installation of a complete audio system within the framework of a conventional living room without making it look like Moe's Radio Service Shop—that's what I need.

How about giving it to me?

Thomas Abellera
4707 S. 30th St.,
Arlington, Va.

New Electro-Voice Official



Members of the entire audio industry were pleased with the recent appointment of Lawrence (Larry) LeKashman as vice-president of Electro-Voice, Buchanan, Mich.

Most recently associated with RCA as advertising and sales promotion manager of the Tube Department, LeKashman at one time was editor of *CQ*, formerly a sister publication of *AUDIO ENGINEERING*.

In addition to his professional activities, he serves as president of the Braille Technical Press, a non-profit organization which distributes technical information to the blind, and as radio consultant to the Boy Scouts of America.

CLASSIFIED

Rates: 10c per word per insertion for noncommercial advertisements; 25c per word for commercial advertisements. Rates are net, and no discounts will be allowed. Copy must be accompanied by remittance in full, and must reach the New York office by the first of the month preceding the date of issue.

FOR SALE: Rek-O-Kut 743 three-speed turntable, used only 20 hours, perfect condition. Price \$40. Wanted: W.E. 594 driver and W.E. 754A speaker. Tony Hoffmann, 48 Myrtle Ave., Cambridge Mass.

THE AUDIO EXCHANGE buys and sells quality high-fidelity sound systems and components. Guaranteed used and new equipment. Catalogue, Department AE, 159-19 Hillside Avenue, Jamaica 32, New York. OL 8-0445.

FOR SALE: Magnetape Twin-Trax continuous-play recorder, model 710B IV (portable), with VU meter; perfect condition; used fifty hours; \$375 shipping prepaid; W. J. Wolfe, I&E AFRS, APO 331, San Francisco, Calif.

PRESTO PT-900 tape transport mechanism, \$325. RCA 15-watt P.A. Amplifier 50 to 10,000. \$60. 16-in. transcription arm with G.E. cartridge \$25. RECO-ART, 1305 Market Street, Philadelphia, Penna.

FOR SALE: Two Fairchild Type 539-G1 portable broadcast disc recorders with only a few hours' use. Variable feed-screw pitch, latest low-pressure playback arms. Current cost \$1975, best offer over \$350 Wm. Scripps, 11738 Lake Ave., Lakewood 7, Ohio.

SACRIFICE: Altec Lansing 603-B speaker, 2000-lb. crossover network. University Tweeter 4409, ten hours' use. Custom-built Leuthertone bass-reflex cabinet. Individually or for \$135. Ralph Baerle, 2514 Yorkway, Baltimore, Md.

TAPE, WIRE RECORDERS, Accessories. Trades accepted. Free list. Sonic Equipment, 3029C Webster, New York 67, N. Y.

CUSTOM amplifier; triodes with feedback, UTC output, boost & cut controls, DC meter, handsome metal cabinet. Pickering; 23011 preamp, 132E record compensator, S-140S cartridge. Two GE "Broadcast" cartridges. Webster 356-27 changer, Modified FM Pilotuner. All okay. First \$125. Edward Burks, 7302 Birch Ave., Washington 12, D. C.

ELECTRO-VOICE Patricia five-way speaker, blonde mahogany cabinet. For specifications see *Audio Engineering*, May 1951. Superb condition after three months' careful use. Will take best offer over \$600. Elliott, 649 E. 14, New York 9, or Orlegon 7-1669, mornings or evenings only.

FOR THE FINEST Audio system, or improve your old one, call Arthur Levine, OLInville 2-8615.

FOR SALE: One PAS Air Coupler for 15-in. speaker, 6200 University speaker, custom crossover network. Livingston arm. Musicorner corner horn baffle. S. Levitt, 373 Utica Ave., Brooklyn 13, N. Y. SL 6-4845, evenings or Sunday.

FOR SALE: PRESTO Y-4 recorder, excellent condition, \$325. Wanted: W.E. 23-C Console, Walter B. Trepte, Box 158, San Diego 6, Calif.

Audio Perfectionists!

We are Headquarters for all

LONG PLAY RECORDS

Every Make—Every Label

Note:

We Sell New Records Only—
untouched until you take them
out of their jackets!

WRITE FOR OUR PRICE LIST!

Lowest prices anywhere for

Factory-Fresh LP Records.

MAIL ORDERS OUR SPECIALTY!

Record Collectors
EXCHANGE
76 W. 48th St., N.Y. 19

TWIN-TRAX* TAPE RECORDERS



...give you **more**

MORE MODELS

the most complete variety of recorders for professional, semi-professional and experimenter use.

MORE FEATURES

for better quality, smoother performance and easier operation.

MORE VALUE

because our direct sales policy saves you dealer markups.

Send today for our catalog 5109 which lists complete technical specifications and performance ratings for all recorder models and accessories. *Trademark Reg.

AMPLIFIER CORP. OF AMERICA

398 Broadway New York 13, N. Y.

ADDRESS CHANGES

Subscribers to **AUDIO ENGINEERING** should notify our Circulation Department at least 5 weeks in advance regarding any change in address. The Post Office Dept. does not forward magazines sent to a wrong destination unless you pay additional postage. We can NOT duplicate copies sent to your old residence. Old and new addresses **MUST** be given.

RADIO MAGAZINES, INC.

342 Madison Ave.
New York 17, N. Y.

PROFESSIONAL DIRECTORY

C. J. LeBEL

AUDIO CONSULTANT

Development, Test, Custom Equipment,
Complete Laboratory and Shop Facilities

133 WEST 14TH STREET
NEW YORK 11, N. Y.
CH 3-8082

Custom-Built Equipment

U. S. Recording Co.

1121 Vermont Ave., Washington 5, D. C.
Lincoln 3-2705

Industry People--

Arch Samuelson has been appointed district manager in the midwest by A. G. Schifino, general manager of Stromberg-Carlson's Sound Equipment Division. **Harold S. Stamm** is new manager of advertising and sales promotion for RCA Tube Department. He succeeds **Lawrence LeKashman**, who resigned to accept an executive post with Electro-Voice, Inc., Buchanan, Mich. . . . **T. Kevin Mallen**, board chairman of Ampex Electric Corporation, announces election of **George L. Long** as vice-president and general manager. Crest Transformer Corp., Chicago, in process of sales expansion, has appointed **Richard Hyde** as representative for radio and TV items. . . . will cover West Central states. . . . **H. A. Hartley**, London, made dual use of recent trip to these shores—conducted his firm's exhibit at the Audio Fair, and set up American distribution of Hartley products. . . . **Robert B. Anderson**, Boston, **Earl Dietrich**, Cleveland, **David Marshank**, Los Angeles, and **Harold KaDell** and **Steve Grimm**, Chicago, are all newly-appointed representatives for General Transformer Company, Homewood, Ill., according to announcement of **M. A. Golberger**, company president. . . . **Leonard Gardner** of British Industries Corp., New York, planning to leave December 21 for second trip within six months to visit English clients. This time he's taking family along to hear how Christmas carols sound on home grounds. . . . **D. E. Larson**, as manager for Hoffman Radio Corp., has been appointed publicity chairman for 1952 Western Electronic Show & Convention, formerly known as Annual Pacific Electronic Exhibit. Other officials of the 1952 Western event are: **Noel E. Porter**, Hewlett-Packard Co.; **Leon B. Ungar**, Ungar Electric Tool Co.; **Joseph H. Landells**, Westinghouse Electric Mfg. Co.; **Dr. W. D. Hershberger**, UCLA; **Dr. Leonard J. Black**, U. of C., Berkeley; **Heckert Parker**, show manager; **Richard G. Leitner**, Packard Bell Co.; **Richard G. Huggins**, Huggins Laboratories; **Howard G. Grove**, West Coast Electronics Co.; **Seymour Johnson**, Santa Barbara; **Alex W. Fry**, Electro Engineering Works; **Norman Neely**, Neely Enterprises, and **Frederick G. Sufeld**, RCA. . . . **Russell O. Hudson**, vice-president of Audio & Video Products Corp., New York, announces appointment of **William H. Hazlett** as eastern sales manager. Hazlett was formerly field representative for Fairchild Recording Equipment Corp. . . . **Max Baume** is new manager of Hudson Radio & Television Corp. sound department. . . . **C. J. Luten** has been upped to editorship of *Broadcast News*, succeeding **Bob Fenfield** who has been promoted to post as advertising and sales promotion supervisor.

President **James Pickett** made a big hit in role as principal speaker at annual stag dinner thrown for 325 members of the electronics industry by N. Y. Chapter of "The Representatives" of Radio Parts Manufacturers. The introduction was by **V. P. Harry Finkelstein**. Plaques expressing appreciation for pleasant relationships were presented by The Reps to members of NEDA and the Purchasing Agents. Acceptance speeches came from **Charles Olstein**, president of NEDA's N. Y. Chapter, and from **Bill Hegyl**, who heads the P.A.'s. Show was arranged by **Marty Camber**, **Jules Bressler**, **Cliff Landis** and **Sam Shaw**, entertainment committeemen, and **Bob Breuer**, **Leo Freed**, **Bill Geld**, **John Kopple** and **Wally Shulan** of the arrangements committee. Entertainment was straight from Broadway. Business talk was taboo, the atmosphere was stimulating, and a good time was had by all—with everybody surviving to live happy ever after. . . .

Good man for Sylvania personnel to know is **David G. Christie**, who will have charge of sales administration (?) in his new job as director of employee services. Appointment announced by **Howard L. Richardson**, V.P. in charge of industrial relations. . . . New director of jobber sales for Triad Transformer Co., Los Angeles, is **Ernest Clover**, formerly director of Triad's geophysical division. . . . **Jack Casey**, prominent Fairlawn, N. J. audio authority and distributor for Altec Lansing, reports increasing interest in high-quality audio among architects and builders—is doing a magnificent job of building a demand for custom-built installations in his area. . . . **E. P. Gertsch**, president of Gertsch Products, Inc., Los Angeles, reports that business is so good that the company's annual Christmas party will have two trees and two Santa Clauses. Leave us hope that this condition becomes everlasting.

AMPERITE

Studio Microphones
at P.A. Prices

Ideal for
BROADCASTING
RECORDING
PUBLIC ADDRESS



"The ultimate in microphone quality," says Evan Rushing, sound engineer of the Hotel New Yorker.

• Shout right into the new Amperite Microphone—or stand 2 feet away—reproduction is always perfect.

• Not affected by any climatic conditions.
• Guaranteed to withstand severe "knocking around."

Models
RBLG—200 ohms
RBHG—Hi-imp.
List \$42.00



"Kontak" Mikes
Model SKH, list \$12.00
Model KKH, list \$18.00

Special Offer: Write for Special Introductory Offer, and 4-page illustrated folder.

AMPERITE Company, Inc.

561 BROADWAY • NEW YORK 12, N. Y.

Canada: Atlas Radio Corp., Ltd., 560 King St. W., Toronto



Plays all speeds

GARRARD

"Triumph"

WORLD'S FINEST RECORD CHANGER

Fully automatic with automatic stop
Easily installed in your present set.

Write for FREE literature

GARRARD SALES CORP., Dept. 12E
164 Duane St., New York 13

Gentlemen:

I am interested in learning what to look for when purchasing a 3-speed record changer. Please send me, without obligation, your FACT SHEET.

NAME

ADDRESS

CITY

ZONE

STATE

Audio Engineering—1951

SUBJECT INDEX

- Acoustics**
Acoustical Balance in Recording, Eddison von Ottenfeld. Aug., 23.
Audio Engineering Society Papers
AES Standard Playback Curve. Jan., 22.
Direct Radiator Loudspeaker Enclosures, Harry F. Olson. Nov., 34.
Effect of Sound Intensity Level on Judgment of "Tonal Range" and "Volume Level," Stephen E. Stuntz. June, 17.
Loudspeaker Damping, Albert Preisman. 1, Mar., 22; 11, Apr., 24.
The Measurement of Audio Volume, Howard A. Chinn. 1, Sept., 26; 11, Oct., 24.
New Method of Measuring and Analyzing Intermodulation, C. J. LeBel. July, 18.
Toward a More Realistic Audio, Ross H. Snyder. Aug., 24.
- Amplifiers**
Analysis of Split-load Phase Inverter, George Ellis Jones, Jr. Dec., 16.
15-Watt Direct-Coupled Amplifier, William B. Fraser. Apr., 15.
How Far Can I Mismatch? Saul J. White, Jan., 15.
The Interview Amplifier, C. G. McProud. Dec., 13.
More About Mismatching, Robert M. Mitchell. Oct., 16.
Musician's Amplifier Senior, David Sarser and Melvin C. Sprinkle. Jan., 13.
New Approach to Loudspeaker Damping, Warner Clements. Aug., 20.
Positive Feedback for A-F Curve Shaping, L. P. Haner. 1, Feb., 16; 11, Mar., 15.
Something New in Remote Amplifiers, Robert S. Houston. Nov., 18.
Space-Charge-Grid Amplifier, Melvin C. Sprinkle. Sept., 15.
Studio-Controlled Remote Amplifier, Robert S. Houston. Sept., 24.
Survey of Audio-Frequency Power-Amplifier Circuits, Peter G. Sulzer. May, 15.
An Ultra-Linear Amplifier, David Hafler and Herbert I. Keroes. Nov., 15.
Versatile Amplifier from Junk-Box Parts, Curtiss R. Schafer. June, 22.
- A-M Radio**
Brief Review of Diode Detectors, Rudolph L. Kuehn. June, 11.
Characteristics of AM Detectors, W. E. Babcock. July, 9.
Receiver Bandwidth and its Measurement, Howard T. Sterling and Alan Sobel. Jan., 18.
- Attenuators**
Simple Attenuator Calculations, Jack D. Gallagher. Oct., 20.
Terminal Impedance of an Attenuator, Herbert I. Keroes. 1, Jan., 20; 11, Feb., 22.
- Audio**
Audio—Big Business, Leon Wortman. Oct., 17.
Audio in England—The 1951 Picture, H. A. Hartley. Oct., 40.
- Audio Techniques**
Scratch Filter with Continuously Variable Cut-Off Point, Charles J. Levin. Nov., 6.
Tape Recorder Remote Control, Raymond Lucia. Nov., 76.
- Broadcasting**
Broadcast Audio Trends, W. E. Stewart. Nov., 22.
Continuously Variable Equalizer, Wentworth D. Fling. Mar., 16.
New AM-FM-TV Studio Console, P. W. Wildow and G. A. Singer. Sept., 20.
New Broadcast Lightweight Pickup and Tone Arm, L. J. Anderson and C. R. Johnson. Mar., 18.
New Professional Tape Recorder, W. E. Stewart. Apr., 21.
Something New in Remote Amplifiers, Robert S. Houston. Nov., 18.
Studio-Controlled Remote Amplifier, Robert S. Houston. Sept., 24.
- Components**
Harmonic Distortion in Iron-Core Transformers, R. H. Eastop and T. Williams. Apr., 18.
The Measurement of Audio Volume, Howard A. Chinn. 1, Sept., 26; 11, Oct., 24.
Survey of European Sound Apparatus, John K. Hilliard. Aug., 32.
- Controls**
Simple Preamplifier and Tone-Control Unit, David H. O'Brien. Nov., 20.
Tape Recorder Remote Control, Raymond Lucia. Nov., 76.
Two-Tap Brass and Treble Compensated Volume Control, William O. Brooks. Aug., 15.
- Conventions**
AES Third Annual Convention Program. Nov., 32.
The Audio Fair Review. Dec., 24.
Whodathunkit—AE Was Born in California. Aug., 17.
- Decibels**
Adding Decibel-Expressed Quantities, Alfred L. DiMattia and Lloyd R. Jones. July, 15.
- Defense Effort**
Audio in the Armed Forces, Lt. George Marakas. Aug., 16.
Ultrasonics in the Loran Trainer, Philip D. Stahl. 1, May, 13; 11, June, 14.
- Distortion**
Expressions for the Reduction of Distortion and Output Impedance in Terms of db of Feedback, William J. Kessler and Sydney E. Smith. Oct., 13.
Harmonic Distortion in Iron-Core Transformers, R. H. Eastop and T. Williams. Apr., 18.
Equalizer, Continuously Variable, Wentworth D. Fling. Mar., 16.
Equivalent Circuits to Simplify Feedback Design, Richard S. Burven. Oct., 11.
- Exhibits**
Audio Fair Review. Dec., 24.
I.R.E. Show Review. May, 19.
- Feedback**
Expressions for the Reduction of Distortion and Output Impedance in Terms of db of Feedback, William J. Kessler and Sydney E. Smith. Oct., 13.
Positive Feedback for A-F Curve Shaping, L. P. Haner. 1, Feb., 16; 11, Mar., 15.
Loudspeaker Damping by the Use of Inverse Feedback, J. P. Wentworth. Dec., 21.
- Filters**
Effective Frequency Rejection Circuit, R. B. Nevin. Feb., 20.
Filter Design Simplified, Berthold Sheffield. 1, Mar., 13; 11, May, 26.
Scratch Filter with Continuously Variable Cut-off Point, Charles J. Levin. Nov., 6.
- Intermodulation**
Intermodulation Testing, Pierce J. Aubry. Dec., 22.
New Method of Measuring and Analyzing Intermodulation, C. J. LeBel. July, 18.
- Loudspeakers**
Design Data for a Bass-Reflex Cabinet, J. A. Youngmark. Sept., 18.
Design Elements for Improved Bass Response in Loudspeaker Systems, Howard T. Souther. May, 16.
Direct-Radiator Loudspeaker Enclosures, Harry F. Olson. Nov., 34.
Distributed Source Horn, Bob Hugh Smith. Jan., 16.
Efficiency of Direct-Radiator Loudspeakers, Vincent Salmon. Aug., 13.
Exponential Baffles for Custom Installations, George Augspurger. Nov., 24.
How Far Can I Mismatch? Saul J. White. Jan., 15.
Loudspeaker Damping, Albert Preisman. 1, Mar., 22; 11, Apr., 24.
Loudspeaker Damping by the Use of Inverse Feedback, J. P. Wentworth. Dec., 21.
Loudspeaker Enclosures, Daniel J. Plach and Philip B. Williams. July, 12.
More About Mismatching, Robert M. Mitchell. Oct., 16.
New Approach to Loudspeaker Damping, Warner Clements. Aug., 20.
R-J Speaker Enclosure, Frank Robbins and William Joseph. Dec., 17.
- Measurements**
Intermodulation Testing, Pierce J. Aubry. Dec., 22.
New Method of Measuring and Analyzing Intermodulation, C. J. LeBel. July, 18.
Square-Wave Testing Simplified, Harold E. Bryan. Oct., 14.
- Microphones**
Home-Made Parabolic Microphone, George H. Floyd. Feb., 13.
Networks, Constant-Resistance Dividing, Bob Hugh Smith. Aug., 18.
Phase Inverter, Analysis of Split-Load, George Ellis Jones, Jr. Dec., 16.
- Phonograph Records**
AES Standard Playback Curve. Jan., 22.
Technique of Record Processing, Lewis S. Goodfriend. Oct., 21.
- Phonograph Reproduction**
AES Standard Playback Curve. Jan., 22.
Effective Frequency Rejection Circuit, R. B. Nevin. Feb., 20.
New Broadcast Lightweight Pickup and Tone Arm, L. J. Anderson and C. R. Johnson. Mar., 18.
New Danish Playback Machine, Svend Anker-Rasmussen. Sept., 40.
Phono Facts, Maximilian Wiel. June, 20.
- Preamplifiers**
D.C. Heater Supply for Low-level Amplifiers, L. B. Hedge. June, 13.
15-Watt Direct-Coupled Amplifier, William B. Fraser. Apr., 15.
Mixer and Preamplifier for the Recording Enthusiast, G. H. Floyd. July, 16.
Simple Preamplifier and Tone-Control Unit, David H. O'Brien. Nov., 20.
- Psychoacoustics**
Effect of Sound Intensity Level on Judgment of "Tonal Range" and "Volume Level," Stephen E. Stuntz. June, 17.
Listening Room Design, Vern Yeich. Nov., 28.
The Measurement of Audio Volume, Howard A. Chinn. 1, Sept., 26; 11, Oct., 24.
Music and Mass Production, Jerome Goodman. Sept., 23.
Toward a More Realistic Audio, Ross H. Snyder. Aug., 24.
- Radio Receivers**
Brief Review of Diode Detectors, Rudolph

L. Kuehn, June, 11.
 Characteristics of AM Detectors, W. E. Babcock, July, 9.
 Receiver Bandwidth and its Measurement, Howard T. Sterling and Alan Sobel, Jan., 18.
Recording, Disc
 Acoustical Balance in Recording, Eddison von Ottenfeld, Aug., 23.
 AES Standard Playback Curve, Jan., 22.
 Continuously Variable Equalizer, Wentworth D. Fling, Mar., 16.
Recording, Magnetic
 Acoustical Balance in Recording, Eddison von Ottenfeld, Aug., 23.

Continuously Variable Equalizer, Wentworth D. Fling, Mar., 16.
 The Interview Amplifier, C. G. McProud, Dec., 13.
 Meet the Cinecruiser, Oct., 18.
 New Professional Tape Recorder, W. E. Stewart, Apr., 21.
 Tape Recorder Remote Control, Raymond Lucia, Nov., 76.
 Tape Editing and Duplicating Machine, Robert P. Ledbetter, Dec., 18.
Systems
 How Far Can I Mismatch? Saul J. White, Jan., 15.
 Industrial Survival Sound Systems, H. S.

Morris, May, 24.
 New Danish Playback Machine, Svend Anker-Rasmussen, Sept., 40.
 Survey of European Sound Apparatus, John K. Hilliard, Aug., 32.
 Television Studio Acoustics, M. Rettinger, Apr., 13.
Test Equipment
 Versatile Amplifier from Junk-Box Parts, Curtiss R. Schafer, June, 22.
 Transformers, Harmonic Distortion in Iron-Core, R. H. Eastop and T. Williams, Apr., 18.
 Ultrasonics in the Loran Trainer, Philip D. Stahl, I, May, 13; II, June, 14.

AUTHORS INDEX

Anderson, L. J. and Johnson, C. R.
 New Broadcast Lightweight Pickup and Tone Arm, Mar., 18.
 Anker-Rasmussen, Svend
 New Danish Playback Machine, Sept., 40.
 Aubry, Pierce J.
 Intermodulation Testing, Dec., 22.
 Augspurger, George
 Exponential Baffles for Custom Installations, Nov., 21.
 Babcock, W. E.
 Characteristics of AM Detectors, July, 9.
 Brooks, William O.
 Two-Tap Bass and Treble Compensated Volume Control, Aug., 15.
 Bryan, Harold E.
 Square Wave Testing Simplified, Oct., 14.
 Burwen, Richard S.
 Equivalent Circuits to Simplify Feedback Design, Oct., 11.
 Chinn, Howard A.
 The Measurement of Audio Volume (AES) I, Sept., 26; II, Oct., 24.
 Clements, Warner
 New Approach to Loudspeaker Damping, Aug., 20.
 DiMattia, Alfred L. and Jones, Lloyd R.
 Adding Decibel-Expressed Quantities, July, 15.
 Eastop, R. H. and Williams, T.
 Harmonic Distortion in Iron-Core Transformers, Apr., 18.
 Fling, Wentworth D.
 Continuously Variable Equalizer, Mar., 16.
 Floyd, George H.
 Home-Made Parabolic Microphone, Feb., 13.
 Mixer and Preamplifier for the Recording Enthusiast, July, 16.
 Fraser, William B.
 15-Watt Direct-Coupled Amplifier, Apr., 15.
 Gallagher, Jack D.
 Simple Attenuator Calculations, Oct., 20.
 Goodfriend, Lewis S.
 Technique of Record Processing, Oct., 21.
 Goodman, Jerome
 Music and Mass Production, Sept., 23.
 Haller, David and Keroes, Herbert I.
 An Ultra-Linear Amplifier, Nov., 15.
 Haner, L. P.
 Positive Feedback for A-F Curve Shaping, I, Feb., 16; II, Mar., 15.
 Hartley, H. A.
 Audio in England—The 1951 Picture, Oct., 40.
 Hedge, L. B.
 D. C. Heater Supply for Low-Level Amplifiers, June, 13.
 Hilliard, John K.
 Survey of European Sound Apparatus, Aug., 32.
 Houston, Robert S.
 Something New in Remote Amplifiers, Nov., 18.

Studio-Controlled Remote Amplifier, Sept., 24.
 Johnson, C. R. and Anderson, L. J.
 New Broadcast Lightweight Pickup and Tone Arm, Mar., 18.
 Jones, George Ellis, Jr.
 Analysis of Split-Load Phase Inverter, Dec., 16.
 Jones, Lloyd R. and DiMattia, Alfred L.
 Adding Decibel-Expressed Quantities, July, 15.
 Joseph, William and Robbins, Frank
 R-J Speaker Enclosure, Dec., 17.
 Keroes, Herbert I.
 Terminal Impedance of an Attenuator, I, Jan., 20; II, Feb., 22.
 — and Haller, David
 An Ultra Linear Amplifier, Nov., 15.
 Kessler, William J. and Smith, Sydney E.
 Expressions for the Reduction of Distortion and Output Impedance in Terms of db of Feedback, Oct., 13.
 Kuehn, Rudolph L.
 Brief Review of Diode Detectors, June, 11.
 LeBel, C. J.
 New Method of Measuring and Analyzing Intermodulation (AES) July, 18.
 Ledbetter, Robert P.
 Tape Editing and Duplicating Machine, Dec., 18.
 Levin, Charles J.
 Scratch Filter with Continuously Variable Cut-Off Point, Nov., 6.
 Lucia, Raymond
 Tape Recorder Remote Control, Nov., 76.
 Marakas, Lt. George
 Audio and the Armed Forces, Aug., 16.
 McProud, C. G.
 The Interview Amplifier, Dec., 13.
 Mitchell, Robert M.
 More About Mismatching, Oct., 16.
 Morris, H. S.
 Industrial Survival Sound Systems, May, 24.
 Nevin, R. B.
 Effective Frequency Rejection Circuit, Feb., 20.
 O'Brien, David H.
 Simple Preamplifier and Tone-Control Unit, Nov., 20.
 Olson, Harry F.
 Direct Radiator Loudspeaker Enclosures, Nov., 34.
 Plach, Daniel J. and Williams, Philip B.
 Loudspeaker Enclosures, July, 12.
 Preisman, Albert
 Loudspeaker Damping (AES) I, Mar., 22; II, Apr., 24.
 Rettinger, M.
 Television Studio Acoustics, Apr., 13.
 Salmon, Vincent
 Efficiency of Direct-Radiator Loudspeakers, Aug., 13.
 Sarsar, David and Sprinkle, Melvin C.
 Musician's Amplifier Senior, Jun., 13.
 Schafer, Curtiss R.
 Versatile Amplifier from Junk-Box Parts, June, 22.

Sheffield, Berthold
 Filter Design Simplified, I, Mar., 13; II, May, 26.
 Singer, G. A. and Wildow, P. W.
 New AM-FM-TV Studio Console, Sept., 20.
 Smith, Bob Hugh
 Constant-Resistance Dividing Networks, Aug., 18.
 Distributed-Source Horn, Jan., 16.
 Smith, Sydney E. and Kessler, William J.
 Expressions for the Reduction of Distortion and Output Impedance in Terms of db of Feedback, Oct., 13.
 Snyder, Ross H.
 Toward A More Realistic Audio (AES), Aug., 24.
 Sobel, Alan and Sterling, Howard T.
 Receiver Bandwidth and its Measurement, Jan., 18.
 Souther, Howard T.
 Design Elements for Improved Bass Response in Loudspeaker Systems, May, 16.
 Sprinkle, Melvin C.
 Space-Charge-Grid Amplifier, Sept., 15.
 — and Sarsar, David
 Musician's Amplifier Senior, Jan., 13.
 Stahl, Philip D.
 Ultrasonics in the Loran Trainer, I, May, 13; II, June, 14.
 Sterling, Howard T. and Sobel, Alan
 Receiver Bandwidth and its Measurement, Jan., 18.
 Stewart, W. E.
 Broadcast Audio Trends, Nov., 22.
 New Professional Tape Recorder, Apr., 21.
 Stuntz, Stephen E.
 Effect of Sound Intensity Level on Judgment of "Tonal Range" and "Volume Level" (AES), June, 17.
 Sulzer, Peter G.
 Survey of Audio-Frequency Power-Amplifier Circuits, May, 15.
 von Ottenfeld, Eddison
 Acoustical Balance in Recording, Aug., 23.
 Well, Maximilian
 Phono Facts, June, 20.
 Wentworth, J. P.
 Loudspeaker Damping by the Use of Inverse Feedback, Dec., 21.
 White, Saul J.
 How Far Can I Mismatch? Jan., 15.
 Wildow, P. W. and Singer, G. A.
 New AM-FM-TV Studio Console, Sept., 20.
 Williams, Philip B. and Plach, Daniel J.
 Loudspeaker Enclosures, July, 12.
 Williams, T. and Eastop, R. H.
 Harmonic Distortion in Iron-Core Transformers, Apr., 18.
 Wortman, Leon
 Audio—Big Business, Oct., 17.
 Yelch, Vern
 Listening Room Design, Nov., 28.
 Youngmark, J. A.
 Design Data for a Bass-Reflex Cabinet, Sept., 18.



AFTER THE FAIR

Our equipment was held up by the water-front strike, but we got it out in time for the Audio Fair, and that, we were told, was an unique achievement in recent New York history. If so, it is merely indicative of the fact that we allow nothing to stand in the way of serving our customers and those who would be our customers. We said we would be at the Fair, and we were.

Not having heard any American speakers in operation, we wondered if we could, in public demonstration, prove our original claim—that we would cheerfully put up the 215 at \$48.00 against any other speaker, no matter how dear, large, or complicated, and win through. From what was spontaneously told to us by large numbers of men who obviously knew what they were talking about, we think the answer is clear. And if you would like to know, just ask anyone who was there to hear for himself.

At this point we are not sure how far we intend to depart from our existing policy of distributing direct from London, except where we make contact with a really sensible and competent high-fidelity agent-dealer. We have some, and very glad we were to meet them in the flesh instead of on paper. Our existing agents will inform you that they are ready to render you real Hartley-Turner service, and further developments will be announced in this column from time to time.

Meanwhile, in reply to the enormous number who asked us where this rather wonderful speaker can be obtained, we say that where we have not got an agent our service from London is extremely good. If you write by Air Mail, so will we, and the delay is quite small. But we have appointed distributors, and they will be writing to you just as soon as ever possible.

The price of the speaker is \$48.00, and there are no extras except import duty of \$6.00 (which is not our fault, and has to be paid to the postman). An expenditure of that amount will bring you lasting pleasure of a kind that cannot be obtained in any other way, and a single subscription of \$1.00 will bring you a continuing supply of most useful technical data. In this connection, will all past and new subscribers please note that some extremely useful information will very shortly be posted.

Illustrated literature on request.

H. A. HARTLEY CO. LTD.
152, Hammersmith Road
London W.6, England

ADVERTISING INDEX

Air-Tone Sound & Recording Co.	2
Allied Radio Corp.	45
Altec Lansing Corp.	37
Amperite Co., Inc.	53
Ampex Electric Corp.	8
Amplifier Corp. of America	53
Arnold Engineering Co., The	3
Audak Co.	33
Audio Devices, Inc.	Cover 2
Audio Instrument Co., Inc.	49
Bell Telephone Labs, Inc.	12
Bogen, David Co., Inc.	51
Cannon Electric Co.	6
Chicago Transformer Co.	4
Classified Ads	52
Daven Co., The	Cover 3
Garrard Sales Corp.	53
General Radio Co.	27
Goodman Industries Ltd.	42
Gray Research & Development Co., Inc.	9
Hartley, H. A., Co., Ltd.	56
Harvey Radio Co.	39
Heath Co., The	29
High-Fidelity Magazine	38
Hudson Radio & Television Corp.	31
Kellogg Switchboard & Supply Co.	45
Lansing, James B., Sound, Inc.	51
LeBel, C. J.	53
Leonard Radio, Inc.	35
Lowell Manufacturing Co.	51
McIntosh Engineering Labs, Inc.	40
Magnecord, Inc.	5
Milo Radio & Electronics Corp.	52
Minnesota Mining & Mfg. Co.	11
Neely Enterprises	44
Par-Metal Products Corp.	46
Partridge Transformers Ltd.	56
Pentron Corp., The	48
Pickering & Co., Inc.	50
Presto Recording Corp.	25
Professional Directory	53
Radio Electric Service Co. of Penna., Inc.	49
Record Collectors Exchange	52
Rek-O-Kut Co.	48
Sonocraft Corp.	47
Standard Transformer Corp.	43
Sylvania Electric Products, Inc.	47
Tech Labs, Inc.	36
Terminal Radio Corp.	7
Triad Transformer Mfg. Co.	1
Turner Co., The	41
U. S. Recording Co.	53
United Transformer Corp.	Cover 4
University Loudspeakers, Inc.	44
Wexco, Inc.	52

PARTRIDGE WILLIAMSON OUTPUT TRANSFORMER Built to the original specification

De-luxe model now available from stock from all important Radio Stores throughout the U. S. A. (Price \$26.00 duty paid)

This transformer is now accepted as the most efficient in the world. According to "Audio Engineering" (Nov. 1949), there is no U. S. equivalent. Thousands already sold in the U. S. A.

Partridge CFB Output Transformer, accepted as without rival. Series leakage induct. 10 mh., primary shunt induct. 130 H., with "C" core construction and hermetically sealed. (Price \$40.00 duty paid)

New York Stockists:

Harvey Radio Co. Inc.
103 West 43rd Street.

Terminal Radio Corporation,
85 Cortlandt Street.

Sole Agents in Canada:

Atlas Radio Corporation,
560 King Street West,
Toronto 2B.

If you are unable to purchase Partridge transformers in your city, write to us and mention the name of your dealer.

Fullest data, including square-wave tests, distortion curves, etc., together with list of U. S. stockists rushed Air Mail to you.

PARTRIDGE TRANSFORMERS LTD.
TOLWORTH, SURREY, ENGLAND

STILL AVAILABLE

ULTRASONIC FUNDAMENTALS

By S. YOUNG WHITE

The rapid increase in the use of ultrasonics during the last few years makes it natural that well-informed sound engineer should want to learn something of the applications and potentialities of this amazing new field. But interest in ultrasonics is not confined to the sound engineer—it is of still greater importance to the industrial engineer for he is the one who will visualize its uses in his own processes.

Elementary in character, **ULTRASONIC FUNDAMENTALS** was written originally as a series of magazine articles just for the purpose of acquainting the novice in this field with the enormous possibilities of a new tool for industry. It serves the double purpose of introducing ultrasonics to both sound and industrial engineers. The list of chapter headings will indicate how it can help you.

CHAPTER HEADLINES

Too Much Audio. Opportunities in Ultrasonics. Elements of Ultrasonics. Experimental Ultrasonics. Coupling Ultrasonic Energy to a Load. Ultrasonics in Liquids. Ultrasonics in Solids. Testing by Ultrasonics. High-Power Ultrasonics. Notes on Using High-Power Ultrasonics. Applications of Ultrasonics to Biology. Economics of Industrial Ultrasonics.

The applications of ultrasonics have already extended to many industries, and as its possibilities are explored they will increase a hundredfold. To keep abreast of its growth, engineers in all fields must know what they may expect from ultrasonics, how it is used, how the energy is generated, and the techniques of applying ultrasonic treatment to many processes.

ULTRASONIC FUNDAMENTALS

By S. YOUNG WHITE

36 pages, 40 ill., 8½ x 11, paper cover
\$1.75

Book Division, Dept. A
RADIO MAGAZINES, INC.
342 Madison Avenue New York 17, N. Y.

PRODUCTS OF WORLD-FAMOUS

DAVEN

CREATIVE - ENGINEERING



TYPE T-330

DAVEN
ATTENUATORS

Exclusive Features:

1. "Knee-Action" Blade
 - Tamper proof
 - Uniform contact pressure and low contact resistance over the life of every unit.
 - Each rotor blade individually supported to give positive contact in operation under all types of conditions.
2. Brass Case of 2-Piece Construction
 - Greatly reduces clearance space required for removal of cover in rear of unit.
3. "Lock-Tite" Dust Cover
 - Held by positive, bayonet-type lock which prevents cover from falling off under stress of vibration.
4. Enclosed Roller-Type Detent Mechanism
 - For extra long life and positive indexing.
 - Addition of detent does not increase depth of unit.
5. Low-Loss Molded Terminal Board
 - For high resistance to leakage.
6. Rigidly Supported Resistor Strips
 - With air insulation.

YEARS AHEAD, CREATIVE-ENGINEERING

has always characterized Daven's efforts in the production of electronic components and equipment.

The unit illustrated above is only one in a complete line of Daven's world-famous attenuators. Because this Company has pioneered and created so many worth-while improvements in units of this type, you can do no better than to specify Daven Attenuators.

Daven's skilled staff of specialist-engineers is at your "beck and call" to help with your problems in the selection of the right attenuators for the equipment you are designing.

Write for complete catalog data.

THE **DAVEN** CO.

185 CENTRAL AVENUE
NEWARK 4, NEW JERSEY





MINIATURE COMPONENTS FROM STOCK...

SUBOUNCER UNITS

FOR HEARING AIDS...VEST POCKET RADIOS...MIDGET DEVICES

UTC Sub-Ouncer units fulfill an essential requirement for miniaturized components having relatively high efficiency and wide frequency response. Through the use of special nickel iron core materials and winding methods, these miniature units have performance and dependability characteristics far superior to any other comparable items. They are ideal for hearing aids, miniature radios, and other types of miniature electronic equipment. The coils employ automatic layer windings of double Formex wire...In a molded Nylon bobbin. All insulation is of cellulose acetate. Four inch color coded flexible leads are employed, securely anchored mechanically. No mounting facilities are provided, since this would preclude maximum flexibility in location. Units are vacuum impregnated and double (water proof) sealed. The curves below indicate the excellent frequency response available. Alternate curves are shown to indicate operating characteristics in various typical applications.

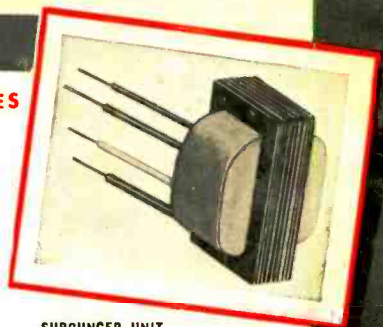

SUBOUNCER UNIT
Dimensions...9/16" x 5/8" x 7/8"
Weight......03 lb.

Type	Application	Level	Pri. Imp.	D.C. in Pri.	Sec. Imp.	Pri. Res.	Sec. Res.	List Price
*SO-1	Input	+ 4 V.U.	200 50	0	250,000 62,500	16	2650	\$6.50
SO-2	Interstage/3:1	+ 4 V.U.	10,000	0	90,000	225	1850	6.50
*SO-3	Plate to Line	+ 20 V.U.	10,000 25,000	3 mil. 1.5 mil.	200 500	1300	30	6.50
SO-4	Output	+ 20 V.U.	30,000	1.0 mil.	50	1800	4.3	6.50
SO-5	Reactor 50 HY at 1 mil. D.C.							5.50
SO-6	Output	+ 20 V.U.	100,000	.5 mil.	60	3250	3.8	6.50

*Impedance ratio is fixed, 1250:1 for SO-1, 1:50 for SO-3. Any impedance between the values shown may be employed.

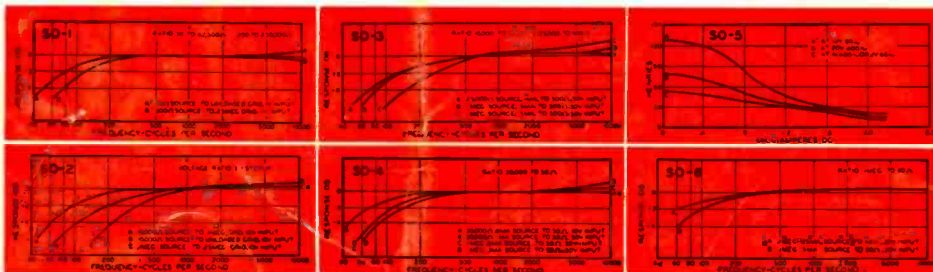

SUB-SUBOUNCER UNITS

FOR HEARING AIDS AND ULTRA-MINIATURE EQUIPMENT

UTC Sub-SubOuncer units have exceptionally high efficiency and frequency range in their ultra-miniature size. This has been effected through the use of specially selected Hiperm-Alloy core material and special winding methods. The constructional details are identical to those of the Sub-Ouncer units described above. The curves below show actual characteristics under typical conditions of application.



SUB-SUBOUNCER UNIT
Dimensions...7/16" x 3/4" x 5/8"
Weight......02 lb.

Type	Application	Level	Pri. Imp.	D.C. In Pri.	Sec. Imp.	Pri. Res.	Sec. Res.	List Price
*SSO-1	Input	+ 4 V.U.	200 50	0	250,000 62,500	13.5	3700	\$6.50
SSO-2	Interstage/3:1	+ 4 V.U.	10,000	0	90,000	750	3250	6.50
*SSO-3	Plate to Line	+ 20 V.U.	10,000 25,000	3 mil. 1.5 mil.	200 500	2600	35	6.50
SSO-4	Output	+ 20 V.U.	30,000	1.0 mil.	50	2875	4.6	6.50
SSO-5	Reactor 50 HY at 1 mil. D.C.							5.50
SSO-6	Output	+ 20 V.U.	100,000	.5 mil.	60	4700	3.3	6.50

*Impedance ratio is fixed, 1250:1 for SSO-1, 1:50 for SSO-3. Any impedance between the values shown may be employed.

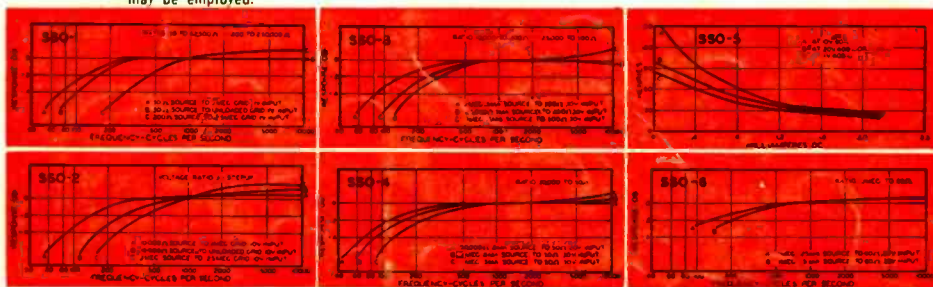

United Transformer Co.

150 VARICK STREET NEW YORK 13, N. Y.
EXPORT DIVISION: 13 EAST 40th STREET, NEW YORK 16, N. Y. CABLES: "ARLAB"