

# AUDIO ENGINEERING

JULY  
1950  
35c

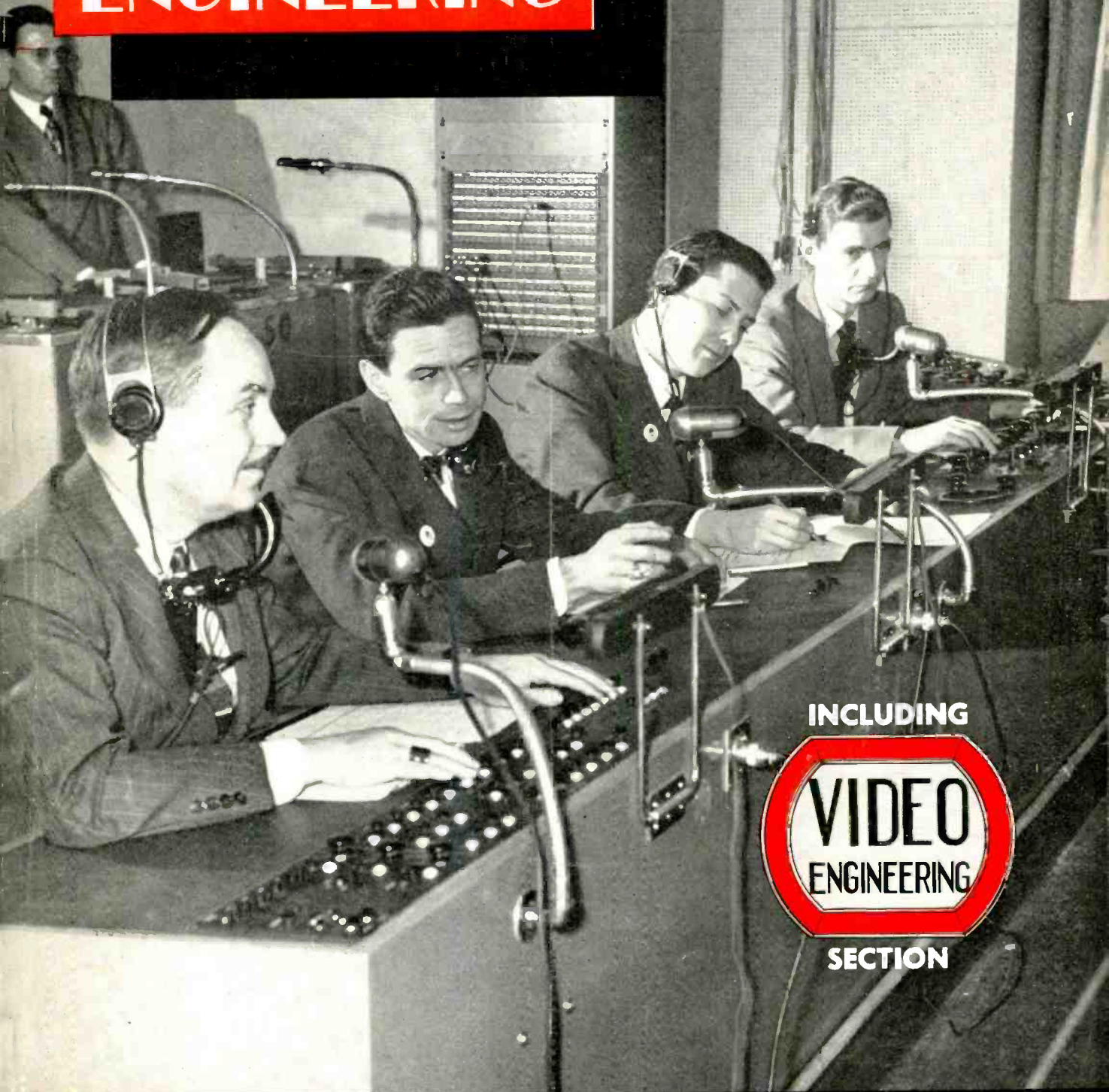

INCLUDING



SECTION

Published by RADIO MAGAZINES, INC.

Improved Lacquer Formulation gives

**audiodiscs**\*

**LOWEST SURFACE NOISE**



GEORGE M. SUTHEIM, *Audio's Chief Chemist*, has developed two major improvements in Audioidisc lacquer

First was the moisture-resisting lacquer, perfected in 1948. This made all Audioidiscs permanently resistant to humidity—put an end to the “summer troubles” that had plagued the recording industry from the very start. This was followed by his development of the improved, low-surface-noise lacquer—a significant contribution to recording quality.

Mr. Sutheim, a graduate of the Institute of Technology in Vienna, is a chemist of exceptional experience in the field of lacquers and emulsions. He authored “The Introduction to Emulsions” and contributed largely to Dr. J. J. Mattiello’s “Protective and Decorative Coating.” He has also written many articles on coatings, films, etc., for both French and English periodicals.

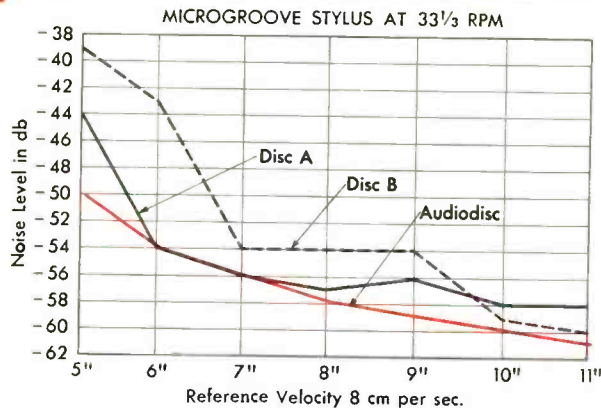
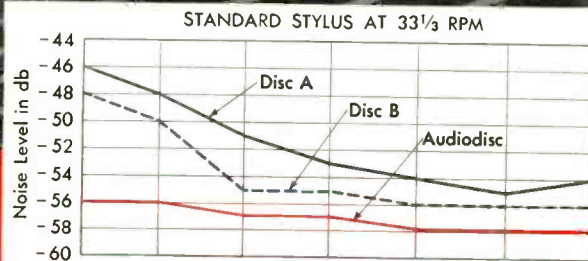

Plotted above are actual surface noise measurements made on an Audioidisc, and on two other makes of discs. Note particularly the *consistently lower noise level* of the Audioidisc.

This drastic reduction in surface noise is the result of an improved lacquer formulation—perfected last Fall, after almost 4 years of research. It has been gradually introduced into production, and since the first of the year, *all* Audioidiscs have been of the improved formulation.

Basically, it contains the same time-tested ingredients that have been used so successfully for the past decade. And it offers the same advantages of recording quality, uniformity, smooth cutting, long life and ease of processing.

The importance of this improvement will be appreciated by all professional recordists.

Audioidiscs are manufactured in the U.S.A. under exclusive license from PYRAL, S.A.R.L., Paris.

**AUDIO DEVICES, INC.**

444 MADISON AVE., NEW YORK 22, N. Y.

Export Dept.: ROCKE INTERNATIONAL, 13 East 40th St., New York 16, N. Y.

\*Reg. U. S. Pat. Off.





# Unsurpassed!

# Jensen Model 510

Coaxial Speaker

With its new high frequency driver . . . new high frequency horn . . . new low frequency unit . . . plus the new Jensen Acoustic Lens—all skillfully engineered into a coordinated unit, the H-510 gives you reproduction unsurpassed by any integral two-way system regardless of price!

Comparative tests have proved this time after time. Why? Because you instantly recognize the unusually satisfying, smooth, clean high fidelity performance . . . the easy-to-live-with quality that makes you *know* you want to own it *now*.

Ask for free booklet "Let Music Come to Life" and Data Sheet 152.

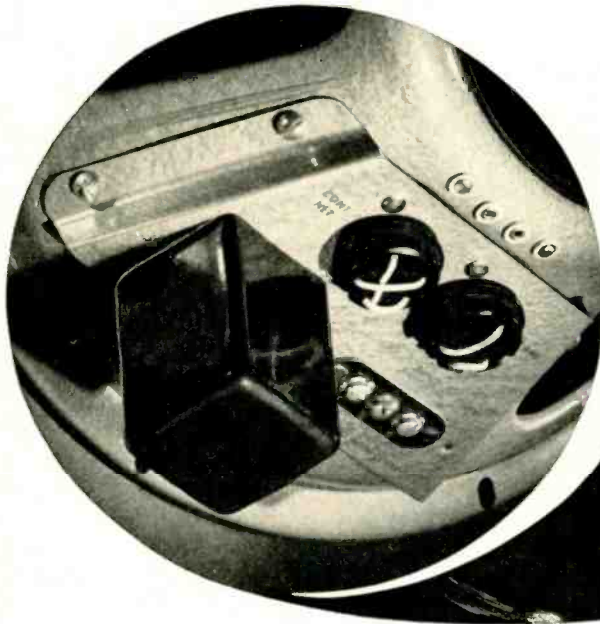

**JENSEN MANUFACTURING COMPANY** DIVISION OF THE MUTER COMPANY  
6633 South Laramie Avenue, Chicago 38, Illinois • In Canada: Copper Wire Products, Ltd., 351 Carlaw, Toronto  
AUDIO ENGINEERING • JULY, 1950

Be Sure of Your Installations...Next Year

Use *Aptitude-Tested*

**MIKE CABLE** *Now*

Now, you can be sure of your installations with Belden Microphone Cables. They are *Aptitude-Tested* and rated to give you safe and complete knowledge of their characteristics. Furthermore, Belden Mike Cables are built for maximum service. Put them to work for you now—and be sure . . . specify Belden.

Belden Manufacturing Company  
4689-R W. Van Buren Street  
Chicago 44, Illinois

No. 8424  
Use for Interconnecting power cable for all electronic uses. Also used as a microphone cable.

No. 8423  
Nominal Capacitance 54 mmf per ft. Use for carbon microphones.

No. 8411  
Nominal Capacitance 37 mmf per ft. Use for lapel microphone.

No. 8401  
Nominal Capacitance 25 mmf per ft. For crystal, ribbon, carbon microphones.

No. 8422  
Nominal Capacitance 32 mmf per ft. Use for carbon microphones.

No. 8410  
Nominal Capacitance 33 mmf per ft. Use for crystal, ribbon, and carbon microphones.

No. 8412  
Nominal Capacitance 68 mmf per ft. Use for carbon microphones.

**Belden**  
*Radio WIRE*

The  
*Aptitude-Tested* **LINE**



# AUDIO ENGINEERING

Successor to **RADIO**

Established 1917



**C. C. McProud, Editor**  
Luci Turner, Edit. Prod. Mgr.  
David Saltman, Production Manager  
E. E. Newman, Circulation Manager

**D. S. Potts, Publisher**  
S. L. Cahn, General Manager  
H. N. Reizes, Adv. Mgr.  
Harold Weisner, Asst. Circ. Mgr.

**Editorial Advisory Board**

Howard A. Chinn  
John D. Colvin  
C. J. LeBel  
J. P. Maxfield  
George M. Nixon

**Representatives**

Sanford R. Cowan, Mid-West Sales,  
342 Madison Ave., New York 17, N. Y.  
James C. Galloway, Pacific Coast Sales  
816 W. 5th St., Los Angeles 17, Calif.  
Technical Book & Magazine Co.  
297 Swanston St., Melbourne, C. I.  
Victoria, Australia

**CONTENTS JULY, 1950 Vol. 34, No. 7**

|  |    |
|--|----|
| Editor's Report .....  | 4  |
| Letters .....  | 6  |
| Audio Patents— <i>Richard H. Dorf</i> .....  | 8  |
| An Intermodulation Analyzer for Audio Systems— <i>Roy S. Fine</i> .....                  | 11 |
| Crossover Network for Unequal V. C. Impedances— <i>Watson F. Walker</i> ....             | 14 |
| Phase-Shift Method of Measuring Flutter— <i>Charles A. Hisserich and Art Davis</i> ..... | 15 |
| Unobtrusive Pressure Microphone— <i>Harry F. Olson and John Preston</i> .....            | 18 |
| Report on Speech Communication Conference at M.I.T.— <i>Leo L. Beranek</i> ..            | 21 |
| The Art of Tape Recording—III— <i>Joel Tall</i> .....                                    | 22 |
| <b>AUDIO engineering society SECTION</b>   |    |
| Heated Stylus Recording Technique— <i>Leon A. Wortman</i> .....                          | 24 |
| The Diamond as a Phonograph Stylus Material— <i>E. J. and M. V. Marcus</i> 25            |    |
| Audiana—The Miller Effect— <i>Lewis S. Goodfriend</i> .....                              | 28 |
| Employment Register .....  | 29 |
| Record Revue— <i>Edward Tatnall Canby</i> .....  | 30 |
| Pops— <i>Rudo S. Globus</i> .....  | 30 |
| New Products .....   | 34 |
| New Literature .....   | 47 |
| Advertising Index .....  | 48 |

**COVER**

Technical and production control group at NBC-TV, Studio 8G, Radio City.  
Left to right: Technical Director, Producer, Assistant Producer,  
Audio Control Engineer; upper left: Turntable Engineer.

AUDIO ENGINEERING (title registered U. S. Pat. Off.) is published monthly at 10 McGovern Ave., Lancaster Pa., by Radio Magazines, Inc., D. S. Potts, President; Henry A. Schober, Vice-President. Executive and Editorial Offices: 342 Madison Avenue, New York 17, N. Y. Subscription rates—United States, U. S. Possessions and Canada, \$3.00 for 1 year, \$5.00 for 2 years; elsewhere \$4.00 per year. Single copies 35c. Printed in U. S. A. All rights reserved. Entire contents copyright 1950 by Radio Magazines, Inc. Entered as Second Class Matter February 9, 1950 at the Post Office, Lancaster, Pa. under the Act of March 3, 1879.

# DISK Recording WITH TAPE Quality

**Fairchild Thermo-Stylus Kit**

- For maximum reduction of surface noise
- For quality recording at innermost diameters

**WHAT IT IS:**

A kit of special styli with miniature heating elements, a cutterhead adaptor and a heat control with calibrated meter.



**WHAT IT DOES:**

Applies thermoplastic principles to disk recording; eliminates mechanical loading of the cutter by the disk material.

**RESULTS:**

- Reduces basic surface noise at least 20 db.
- Minimizes frequency discrimination at innermost diameters.
- Eliminates most difficulties due to production differences in blank disks.

Recordings made with the Fairchild Thermo-Stylus Kit retain the esthetic listening appeal of original sound.

Write for illustrated details—specify your cutterhead.



**RECORDING EQUIPMENT CORPORATION**

154TH STREET & 7TH AVENUE  
WHITESTONE, NEW YORK FR-112

# EDITOR'S REPORT

## PLAYBACK STANDARDS

**T**HE WIDE VARIETY of recording characteristics which are in common use among record manufacturers is undoubtedly the result of a difference of opinion among those responsible for the curves selected. If one manufacturer believes that his product will have a slight selling "edge" over another's by virtue of the recording curve which he elects to use, he is by all means entitled to use that curve. Similarly, where else can the manufacturer of radio-phonograph combinations vary his product from another's except in tone quality or cabinet design?

It is conceivable, however, that one record manufacturer may elect to decrease the high-frequency response of his product in order to give that "mellow" sound. The set manufacturer adjusts his reproduction so that this particular product sounds right to him—which could easily result in a unit which had a predominance of highs. Records of another manufacturer might then sound shrill or screechy, depending on the recording curve employed. The result of this arrangement is certain to be a hodge-podge.

Actually, this is what has been happening for years. Only within certain limits have manufacturers standardized on a recording characteristic—each one, possibly, has adhered to his own standards, but not all to the same ones.

The Standards Committee of the Audio Engineering Society has submitted a proposal which has much merit, although in some particulars it is revolutionary. Let each record manufacturer choose what recording curve he considers optimum, but let him make that selection by listening to his product with a *Standard Playback Curve*. This does not mean that he is governed by any standards whatsoever—that is, he is free to accentuate bass or treble as much as he wishes. The only limitation is in the system used for playback.

The adoption of a standard playback system would not limit either record manufacturer or set designer. Either could make his product as "bassy" or as "toppy" as he wished. But the set manufacturer with the bassy set would know that bassy records would sound awful on his product; the record manufacturer with bassy records would know that his product would sound awful on a bassy set.

What would be the final result? Both sets and records would shortly arrive at a reproduction which was very close to the proposed curve, to the benefit of all. The user of custom equipment—like most of *Æ*'s readers—would know that the standard curve was the one used by

the record manufacturer in planning his product, and could safely settle on this curve for his own equipment, making such minor changes as might suit his own ear.

Technically, the proposed curve is symmetrical around 1000 cps, with low- and high-frequency turnover frequencies of 400 and 2500 cps respectively. This curve requires a 6-db per octave boost at the low end, with the 400-cps turnover frequency. The roll-off is also 6 db per octave, being down 12 db at 10,000 cps. This is somewhat less than the present NAB standard which requires a 16-db roll-off at 10,000 cps, but there is considerable evidence that the latter is too great. The FCC standard of 75 microsecond delay, selected for FM broadcasting, is in the direction of less pre-emphasis than that used in NAB transcriptions, and is cited as the principal authority for the desired change. The AES proposal is based on a delay of 63 microseconds.

It is believed that this standardization of the playback system would do more toward standardization of over-all record characteristics than any attempt toward securing a voluntary cooperation with standards for recording.

## INTERMODULATION

In the same vein, it is becoming increasingly important to have a definite standardization on the tests for intermodulation distortion. While there is a general agreement on the use of a low and a high frequency with a level difference of 12 db, there is no general agreement on the absolute values of the frequencies employed.

Roy Fine, in his article on intermodulation in this issue, describes an equipment which employs frequencies of 400 and 4000 cps, with definitely good reasons for their selection—namely that small speakers and mediocre amplifiers do not respond too well at the lower and higher frequencies used in measurements of professional equipment—usually 60 to 100 cps for the low frequency and 5000 to 8000 for the high.

Measured intermodulation distortion percentages are dependent on the frequencies used, so at present it is necessary to specify them. It is therefore proposed that two standards—primary and secondary—be set up for intermodulation tests: the Primary Standard, using frequencies of 60 and 7000 cps with a level difference of 12 db, would be used for measurements of professional and high-fidelity system components; the Secondary Standard, using frequencies of 400 and 4000 cps, would be used on phonograph records and pickups—for reasons offered by Mr. Fine—and on amplifier and speaker equipment of lower quality.



# WHY the All New Pickering Arm Is Unbeatable!

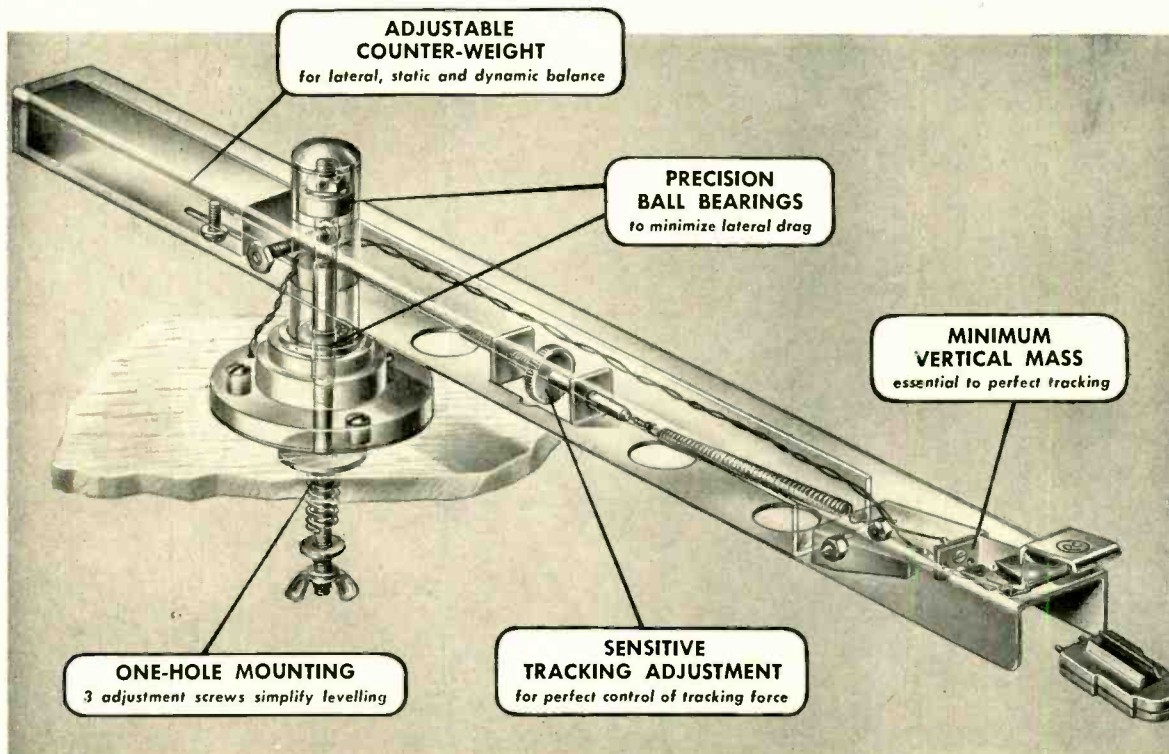

In achieving the kind of arm performance that our customers demand, we found it necessary to depart radically from established design practice. Experience with microgroove records has demonstrated the inadequacies of conventional arms. The new Pickering Arm embodies all of the features found to be essential for perfect pickup arm performance.

**We invite you to examine the phantom view demonstrating these all-important features, and to consider the following:**

- Cartridges are quickly and easily plugged in; no weight adjustment, no screws, no wires to connect.
- Ratio of vertical-to-lateral moment of inertia is as low as possible.
- Vertical mass has been minimized in order to track any record without imposing extra vertical load on grooves; badly warped records are played just as well as flat ones.
- No spurious arm resonance at any frequency.
- Pivot friction is lower than 3 gram centimeters and bearings are rugged and trouble-free.

- Arm is statically balanced about the vertical axis to eliminate tendency to jump grooves when subjected to bumping or jarring.
- Offset head reduces tracking error to less than plus or minus  $2\frac{1}{2}^\circ$ .
- Stylus point protected against contact with anything but record grooves; cannot strike the turntable mat or center-pin.
- Sensitive tracking force adjustment.
- Height adjustment for turntables from  $\frac{1}{2}$ " to 2" high.
- One-hole mounting and self-contained levelling screws.
- Magnetic arm rest.
- Stylus point completely visible for starting and cueing records.

**Pickering  
& Company, Inc.**

**Oceanside, N. Y.**

**For the finest quality specify Pickering audio Components**

Pickering High Fidelity Components are available through leading jobbers and distributors everywhere . . . detailed literature will be sent upon request.

# ASTATIC'S NEWEST HEADLINERS IN PICKUP CARTRIDGES and MICROPHONES

## "AC" SERIES CARTRIDGES



ACD-2J



ACD-1J

EVEN IN A DAY of comparatively small units, the perfection of sound reproduction from these miniature Astatic Cartridges is a surprising experience. Astatic engineers have accomplished a mechanical drive system with a new low in inertia, and which provides "AC" Cartridges with exceptionally smooth response. This same feature also helps achieve new tracking excellence, low needle talk, assures long life of both needle and record. The overall excellence of frequency re-

sponse is particularly superior in the high frequencies. "AC" Series Cartridges have housings of molded Bakelite, metal mounting brackets (fit standard 1/2" mounting centers) and needle guards. They use Astatic's Type "A" Needle, designed with the same successful holding principle as the famous Astatic Type "Q" Needle and easily changeable without tools. Nothing has been omitted which would give the "AC" Series higher performance values.

### SPECIFICATIONS

| Model                                 | List Price | Minimum Needle Pressure | Output Voltage 1000 c.p.s. 0.5 Meg Load | Frequency range c.p.s. | Needle Type                 | Application   |
|---------------------------------------|------------|-------------------------|---|------------------------|-----------------------------|---|
| AC-78-J                               | 8.90       | 6 gr.                   | 1.0*                                    | 50-10,000              | A-3 (3-mil sapphire tip)    | Standard 78 RPM Records   |
| AC-J                                  | 8.90       | 5 gr.                   | 1.0**                                   | 50-10,000              | A-1 (1-mil sapphire tip)    | 33-1/3 and 45 RPM Records                                       |
| AC-AG-J                               | 8.90       | 6 gr.                   | 1.0**                                   | 50-10,000              | A-AG† (Sapphire tip)        | 33-1/3, 45 and 78 RPM Records                                   |
| <b>DOUBLE NEEDLE TURNOVER MODELS:</b> |            |                         |   |                        |                             |   |
| ACD-J                                 | 9.50       | 6 gr. either needle     | 1.0**                                   | 50-8,000               | A-) and A-3 (sapphire tips) | For Record Changers Using Turnover Cartridge                    |
| ACD-1J                                | 9.50       |                         |   |                        |                             | (Same as ACD-J) except equipped with spindle for turnover knob) |
| ACD-2J                                | 10.00      |                         |   |                        |                             | (Same as ACD-J) except equipped with turnover bracket and knob) |

\*"ALL-GROOVE": Needle tip of special design and size to play either 33-1/3 and 45 RPM (narrow groove) or 78 RPM (standard groove) records.

†Audiotone 78-1 Test Record  
\*\*RCA 12-5-31V Test Record

## "SYNABAR" UNIDIRECTIONAL CARDIOID CRYSTAL MICROPHONE

NEWLY perfected unit employing special sintered metal which cancels out 15 db front to back, making it, for practical purposes, dead to sound from rear. Has truly excellent frequency range for its type and price class, 50 to 10,000 c.p.s., PLUS a Response Selector switch to provide choice of ideal pick-up characteristics for either crisp voice or general voice and music. Crystal element has special METALSEAL protection against moisture or dryness. Output level is —54 db, high impedance. Satin chrome finish, 20' single conductor shielded cable, with or without off-on switch. Recommended, without reservation, for highest quality reproduction and elimination of extraneous noise, in the widest variety of modern applications.



List Price  
DR-10—Code ASVFL . . . \$37.25  
DR-10-5\*—Code ASVFK . . . 39.95  
\* With off-on switch

Astatic Crystal Devices manufactured under Brush Development Co. patents



# LETTERS

## Tracking vs. Tracing

Sir:

In reference to the article "Determining the Tracking Capabilities of a Pickup" by H. E. Roys in the May issue, I should like to suggest that the word should be *tracing* not *tracking*. Maybe this is just another example of differences in British and American terminology; but if you are to use *tracking* for *tracing*, what word are you going to use for tracking, i.e. the arrangements for keeping the axis of rotation of the needle and armature parallel to the tangent of the groove at the needle point? By the way, from the photographs of pickups appearing in your magazine, it appears that not many manufacturers in the U. S. have heard of "two-point" tracking.

E. F. Good,  
R.R.D.E.,  
Malvern, Worcs.,  
England

## Cathode Followers, Detectors

Sir:

As a strict "cut and try" audio experimenter, I would like to see the following three items covered:

- (1) The theory of cathode followers as impedance matching devices and high-impedance bridges.
- (2) The cathode followers as a high-quality detector.
- (3) High-fidelity detectors in general.

The second and third items have been generally neglected in all forms of literature that seems to be available.

J. F. Anderson,  
2249 Bernard St.,  
Saginaw, Michigan

(We have had so many promises of articles on abovementioned items 2 and 3, but none of the authors has yet delivered.—Ed.)

## Choral Recording

Sir:

Mr. Canby's notes on choral recording and reproduction interested me greatly. When first attempting to provide sound reinforcement at large concerts, as a sound engineering associate of a 701-voice choir, the speakers were found to rattle and break up. It was proven that the units were not at fault, and the rest of the equipment was apparently blameless. We found that the choir produced signals in the sub-audible range of frequencies, being beat notes between voices and groups of voices. Normal p.a. amplifiers are easily distressed by these frequencies, and thus the distortion heard as a rattle. The cure from our point of view was better amplifiers with a much wider power pass band. Mr. Canby has found out that successful recordings are possible at a level lower than normal, because the offending frequencies are attenuated along with the rest and the amplifier is given a better chance. VU meters will not respond to these frequencies and thus you do not know they are there, but I suggested to Mr. C that he hook a scope across his recording microphone and watch those very low frequencies the next time his choir makes a record.

Haydon G. Warren,  
88 Wellington St.,  
Luton, Beds.,  
England



"I think Terminal's Sound Department is the best in the country" says leading audio authority\*

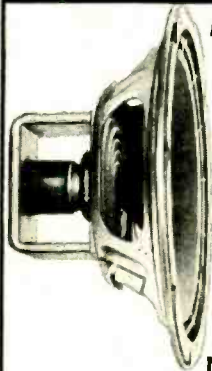

*New Permaflux*  
**ROYAL EIGHT**

A BARGAIN! The speaker that amazed 'em at the Audio Fair! Response 50 to 12,000 cps, 8 watts. Efficiency high, distortion low! 8" diameter, 8 ohm V.C.

Now only **8<sup>82</sup>**

**radio craftsmen chassis** as used in the finest custom installations

**RC-100A TELEVISION CHASSIS**

with built-in booster.

This is the finest! Use 19" or 16" square or round kinescopes. Less picture tube, amplifier, speaker



**230<sup>00</sup>**

**radio craftsmen RC-10 FM-AM tuner with built-in pre-amplifier**

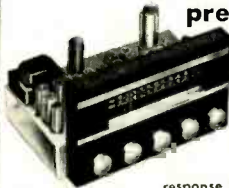

compensated for G. E., Pickering and crystal phono cartridges. Continuously variable bass and treble controls with flat response from 20 to 20,000 cycles. Automatic frequency control entirely eliminates station drift.

**119<sup>50</sup>**

**RC-2 wide range amplifier**

Companion unit for RC-10 tuner, or any high fidelity application. Over 10 watts output with less than 1% distortion. 20-20,000 cycles frequency response.



**39<sup>00</sup>**

Net

\*Richard H. Dorf, New York audio consultant and author of authoritative articles in leading radio publications

There is a **UNI-MODE** cabinet ensemble for every custom requirement!

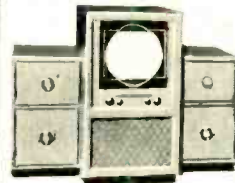

- RECORD CHANGERS
- TELEVISION CHASSIS
- TUNERS
- RECEIVERS
- PHONO AMPLIFIER SYSTEMS
- RECORD STORAGE

LOUDSPEAKERS RECORDERS

With Uni-Modes, you can create an entertainment center that will combine utility, beauty and allow for future expansion. It's easy and surprisingly moderate in cost! UNI-MODE is available in beautiful hand-rubbed Blonde and Cordovan Mahogany; also unfinished, if desired. Interiors are attractive Tarragon Green or Afghan Red.

See **UNI-MODE** in our sound catalog for pictures, sizes and prices.

**New UNIVERSITY 6200 Wide Range 12" Speaker**

30 watt FOCUSED FIELD wide range PM speaker! Advanced magnetic structure concentrates all of the magnetic force where it belongs — in the voice coil. Response of 45 to well beyond 10,000 cycles with amazing efficiency. Standard 12" mtg., 6 to 12 ohm voice coil.



A real buy, at only **20<sup>58</sup>**

**New Webster-Chicago series 100 3-speed Automatic Changers**



Terminal has the new Webster-Chicago record changers, available with Audak polyphase, General Electric reluctance, Pickering magnetic and standard crystal cartridges. Wide range cartridges with sapphire or diamond styli.

**Masterpiece in Cabinetry**

An ELECTRONIC DECORATORS creation

Artfully constructed of finest woods, scientifically planned layout for proper housing of TV, radio, amplifier, record changer, speaker and record storage.

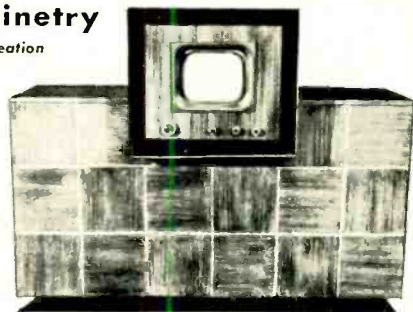
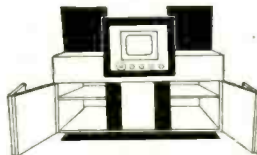

Dealers and installers — check with us for prices on your needs

**WRITE FOR OUR NEW SOUND CATALOG**

EVERYTHING IN AUDIO FOR THE STUDIO & CUSTOM BUILDER!



**TERMINAL**  
RADIO CORPORATION

Distributors of Radio & Electronic Equipment

85 CORTLANDT ST., NEW YORK 7, N. Y. • Worth 4-3311 • Cable: TERMRADIO

Investigate  
The Sound of Quality  
**NEWCOMB  
AMPLIFIERS**

If you haven't heard a Newcomb you haven't heard the best. Because in the business of sound reproduction a Newcomb amplifier has no equal. We invite you to investigate... let us tell you why each Newcomb amplifier is the best available in its particular field of operation. We ask you to listen to our claims... and listen to our amplifiers... then judge for yourself by any standards you choose. We know you'll agree that for technical perfection, for faithful sound reproduction, for actual listening pleasure... **THEY CANNOT BE SURPASSED!**

There's a Newcomb amplifier for every purse and purpose, from the low cost Standard Series, through the superb Deluxe Series, to the incomparable Custom Models.



Check equipment below  
for complete information

- Public Address Amplifiers
- Mobile Amplifiers
- Phonograph Amplifiers
- Musical Instrument Amplifiers
- Wired Music Amplifiers
- Portable Systems
- Portable Phonographs
- Transcription Players
- Rack and Panel Equipment

**NEWCOMB AUDIO  
PRODUCTS CO.**

Dept. T, 6824 Lexington Ave.,  
Hollywood 38, California

Please send information on equipment  
checked above.

Name \_\_\_\_\_  
Address \_\_\_\_\_  
Firm \_\_\_\_\_

Dealer  Jobber  Sound Specialist



**AUDIO  
PATENTS**

RICHARD H. DORF\*

**R**ESISTANCE-CAPACITANCE filters are generally considered inferior to LC filters in that their  $Q$  is low and it is usually impossible to attain sharp cutoffs or steep resonance curves. One of the better circuits for rejection of a single frequency is the twin-T, diagrammed in Fig. 1, often used in measurement work at radio frequencies and equally useful at a.f. It does completely reject one frequency but has fairly mild slopes, as the curve (A) of Fig. 2 shows.

The circuit of Fig. 3 is a negative feedback amplifier using the twin-T, often employed to pass a single frequency, since the twin-T in the feedback loop causes degeneration at all frequencies but that ( $f_2$ ) at which transmission through the twin-T is nil. The curve of response in this circuit is given at (B) in Fig. 2. Obviously, frequencies adjacent to  $f_2$  are not greatly attenuated. It is difficult to make a more selective circuit at audio frequencies—especially in the lower range—even with LC filters, because of core losses and low  $Q$ .

Charles E. Dolberg's Patent No. 2,495,511 shows an ingenious but quite simple method of combining the circuits of Fig. 1 and Fig. 3 to obtain a very sharply selective audio filter, so much so that in bridge measurements at 55 cps, for instance, it is possible effectively to exclude 60 cps from

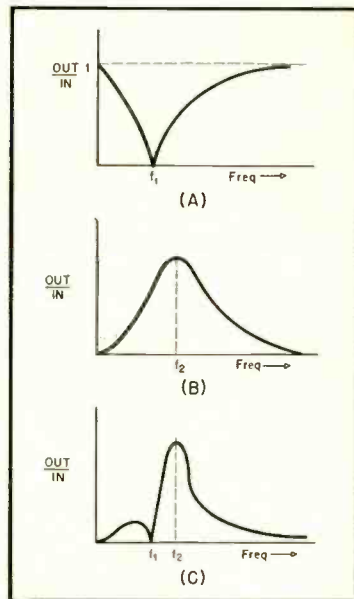

Fig. 2

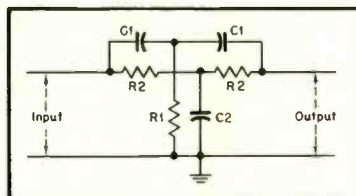

Fig. 1

the detector. Many other uses are apparent, beginning with the obvious one of distortion measurements.

Dolberg's basic circuit appears in Fig. 4. The input signal first passes through  $V_1$ . Between the  $V_1$  plate and the grid of  $V_2$  is a twin-T adjusted to reject completely a frequency  $f_1$  just below the frequency  $f_2$  which the designer wishes to pass through the entire system.  $V_2$  is a feedback amplifier similar to that of Fig. 3, adjusted for maximum transmission at  $f_2$ .

The result appears at (C) in Fig. 2 as the resultant of the curves (A) and (B). The twin-T between  $V_1$  and  $V_2$  gives the rejection (A) so that the lower side of the resultant curve is very steep, going to infinite attenuation at  $f_1$ .

The between-stage twin-T may, of course, be adjusted to a frequency above instead of below  $f_2$  to give steepness at the high end, or two cascade twin-T's may be used be-

tween stages to give steepness and cutoffs both above and below  $f_2$ . In each case, the cutoffs frequency can be extremely close to the passed frequency, giving a narrow enough bandpass for any conceivable purpose. A typical application might be to place the two-stage amplifier in a distortion detector, with two cascade and one feedback twin-T's adjusted for each harmonic to be measured and all networks available by switching.

The calculations for the twin-T were not in the patent, but were found in Terman's *Radio Engineers' Handbook*. They are here [Continued on page 36]

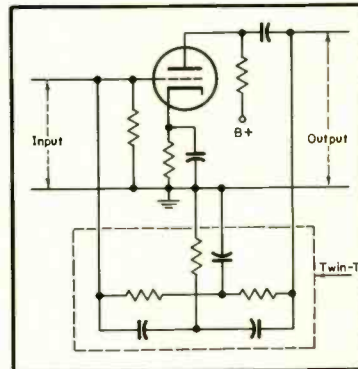

Fig. 3

\* Audio and Television Consultant, New York



**Want the World's Finest Tape Recordings?**



Multi-installation of PT6 Magne recorders

There's A  
**Magne recorder**

for every purpose  
... every purse!

*The Talk of the Shows!*

**THE NEW PT-7 SERIES**

3 Heads (erase, record, playback for monitoring from tape) in single housing, yet separately alignable, replaceable. New positive drive. 2 speed hysteresis synchronous motor. Push-button controls can be remotely operated. Uses 7" or 10 1/2" N.A.B. reels. 3 channel portable amplifier has high-level mixing.

PORTABLE  
RACK OR  
CONSOLE

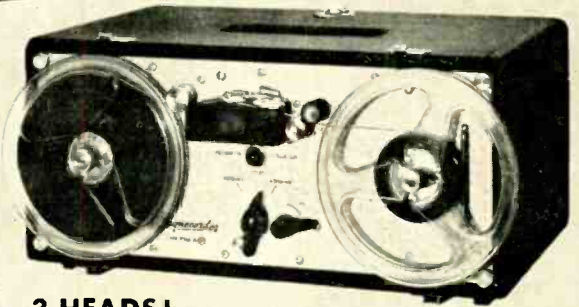
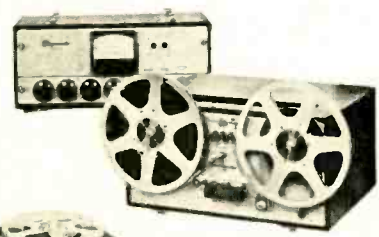

**3 HEADS!**  
**PT63-A to MONITOR YOUR MAGNE RECORDINGS**

Three separate heads — erase, record, and playback for monitoring from tape — prevent recording errors. Same high fidelity and flexibility as the Magne recorder PT6-A — the world's most widely used professional tape recorder. New PT63-J Amplifier has separate playback and recording amplifiers to monitor from the tape. Includes 10 watt audio amplifier which also will drive external speaker.

**OR CONVERT YOUR PT6-A TO MONITOR**

**KIT 101**

Conversion kit includes a three-head unit, monitor amplifier and power supply to modernize your present PT6-A. Head unit plugs into receptacles for present two-head unit.



Write for latest specifications and prices

**Magne cord, INC., CHICAGO 1, ILL.**  
360 NORTH MICHIGAN AVENUE

World's Largest and Oldest Manufacturer of Professional Magnetic Recorders

# The look that keeps telephone costs

# DOWN



Examining specimen on metallographic microscope at Bell Telephone Laboratories.

Through his microscope this Bell metallurgist examines a bit of material which is proposed for telephone use. From what he sees of grain structure, he gains insight into performance not provided by spectrum or chemical analysis. He learns how to make telephone parts stand up longer, so that telephone costs can be kept as low as possible.

The items which come under scrutiny are many and varied, ranging from manhole covers to hair-thin wires for coils, from linemen's safety buckles to the precious metal on relay contacts.

In joints and connections—soldered or welded, brazed or riveted—photomicrographs reveal flaws which would escape ordinary tests. They show if a batch of steel has the right structure to stand up in service; why a guy wire let go in a high wind or a filament snapped in a vacuum tube; how to make switchboard plugs last longer.

In their exploration of micro-structure, Bell Telephone Laboratories scientists have contributed importantly to the metallographic art. You enjoy the benefits of their thoroughgoing testing and checking in the value and reliability of your telephone system, and the low cost of its service.

Photomicrograph of white cast iron which is hard and brittle.

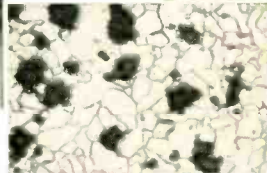
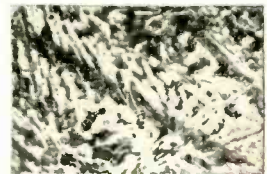

Same iron rendered malleable by heat treatment. Shows spots of nodular carbon.

## BELL TELEPHONE LABORATORIES



WORKING CONTINUALLY TO KEEP YOUR TELEPHONE SERVICE BIG IN VALUE AND LOW IN COST



# An Intermodulation Analyzer for Audio Systems

ROY S. FINE\*

A description of the circuits required in an instrument used for quantitative measurements of one form of distortion.

**T**HE INTERMODULATION-DISTORTION method of evaluating the quality of amplifiers, loudspeakers, and phonograph pickups is coming into increasing use. The analysis with respect to pickups is the immediate interest of this paper, although the equipment described herein can be used for intermodulation measurements on all audio systems. The design of this analyzer is the culmination of several years' work on the problem of correctly metering intermodulation distortion, and it is felt that the methods described are a good compromise for basically accurate measurements.

Let us look at Amplitude Modulation. Figure 1 represents an amplitude modulated carrier wave where

$A$  = amplitude of carrier  
 $a$  = amplitude of maximum modulation.

By definition, the percentage of modulation is  $(a/A)100$ .

If two modulating tones are used, the equation for the carrier wave is:

$(A + a_1 \sin \omega_1 t + a_2 \sin \omega_2 t) \sin \omega t$   
 where  $A$  = amplitude of carrier  
 $a_1$  = amplitude of one signal  
 $a_2$  = amplitude of other signal  
 $\omega_1$  = frequency of 1st signal  
 $\omega_2$  = frequency of 2nd signal

$$\text{percent modulation} = \frac{a_1 + a_2}{A} 100$$

The carrier and side frequencies are shown by Fig. 2.

If a low- and high frequency signal are passed through a nonlinear system,

\*Advanced Development Section, RCA Victor Division, Radio Corporation of America, Camden, N. J.

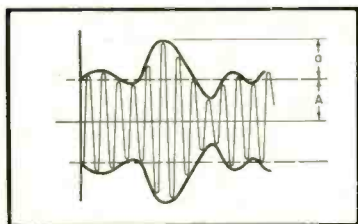

Fig. 1. Waveform of amplitude modulated carrier.

the low frequency and its harmonics will modulate the high frequency and its harmonics, giving rise to sum and difference frequencies about the higher frequency. In a nonlinear system let:

Input =  $a_1 \sin \omega_1 t + a_2 \sin \omega_2 t$   
 where  $\omega_1$  = low frequency  
 $\omega_2$  = high frequency  
 $a_1$  = amplitude of low frequency  
 $a_2$  = amplitude of high frequency

The output of this system will be:

$$\text{Output} = A_0 + \sum_{r=0}^{\infty} \sum_{s=-\infty}^{\infty} A_{r,s} \sin (r\omega_1 + s\omega_2)t$$

where  $A_0$  = amplitude of combination frequencies (intermodulation products)

$A_{r,s}$  = integers  
 $r$  &  $s$  = d-c component of the output

The frequencies of greatest interest, as shown in Fig. 3, are:

$\omega_2 \pm \omega_1$  whose amplitudes are  $A_{1,1}, A_{1,-1}$   
 $\omega_2 \pm 2\omega_1$  whose amplitudes are  $A_{2,1}, A_{2,-1}$   
 $\omega_2 \pm 3\omega_1$  whose amplitudes are  $A_{3,1}, A_{3,-1}$

When the modulation products come into phase, they will add arithmetically.

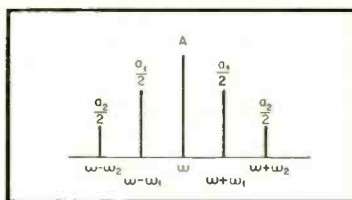

Fig. 2. Signal amplitudes of amplitude modulated carrier.

Intermodulation distortion is defined in this analysis as the arithmetic sum of the amplitudes of the "in phase" modulation products divided by the amplitude of the high-frequency carrier. Therefore:

$$\text{Per cent Intermodulation} = \frac{A_{1,1} + A_{1,-1} + A_{2,1} + A_{2,-1} + \dots}{A_{1,0}} 100$$

In order to measure the sum of these voltages accurately, it is necessary to use a peak-reading voltmeter. This type will measure the arithmetic sum of the

amplitudes of the modulation products involved with no discrimination against the weaker of these modulation products. This is an advantage over the root-mean-square or average-reading type of voltmeter, since all frequencies are given equal attention.

According to the above definition of per cent intermodulation, a root-mean-square voltmeter will not give the proper reading when two or more modulation products are present simultaneously, since its indication depends on the square root of the sum of the squares rather than the arithmetic sum of the amplitudes. The distortion readings utilizing a peak-reading voltmeter are therefore more critical and will present

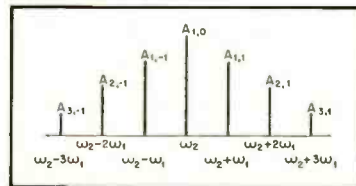

Fig. 3. Amplitudes of carrier and modulation products.

a larger "Per cent Intermodulation" figure than will a root-mean-square indicator.

## Intermodulation Analyzer

The analyzer to be described is for use primarily with frequencies of 400 and 4000 cps, although it will accommodate frequencies differing slightly from these, since the filters are flat over a considerable range. These particular frequencies were chosen for a number of reasons, the primary consideration being that almost all amplifiers, loudspeakers, and pickups have response in this range. If the equipment utilized a high frequency of 7000 cps, for instance, it could not be used on a 5000-cps amplifier or a loudspeaker with a sharp cutoff below 7000 cps. And, if the low frequency were 100 cps, for instance, a 4- or 5-inch loudspeaker could not be checked. Also, these frequencies are usually between the resonant peaks in pickups and are located in the range of high energy. These conditions, to-

gether with the fact that wide variations in results are not obtained when higher or lower frequencies are used, have led us to this choice of frequencies. It has been found that almost 100 per cent correlation exists between intermodulation measurements and listening tests. This is quite noticeable in the case of pickups.

The analyzer consists of a number of circuits, as can be seen from the block diagram of Fig. 4 and the circuit diagram of Fig. 5. Typical waveforms at each section are also noted.

#### Preamplifier and High-Pass Filters

The preamplifier serves two purposes: to present a high-impedance input and to make possible the measurement of small voltages without the use of external equipment. There are two voltage amplification stages (6BF6's) and one cathode-follower stage (6AQ5's) matching the input impedance of the high-pass filter. A switch selects the cathode-follower stage with an option of one or both of the preceding amplifiers in addition. Since this is a high-gain circuit, care must be taken to ground the grid of the amplifier stages when not in use as well as to provide adequate shielding of leads. In order to keep distortion of this preamplifier at a minimum, it is necessary to use a parallel combination of tubes in the cathode follower.

The high-pass filter (Curve A in Fig. 6) is necessary to remove the original 400 cps. This filter must be capable of passing the 4000-cps signal plus sum and difference frequencies arising from the 400-cps modulation, i.e., 3200, 3600, 4400, and 4800 cps with sharp rejection of the original 400 cps.

#### Voltage Amplifier and Rectifier

The signal at this point is amplified and fed to a full-wave rectifier. This rectifier is conventional, but care must

be taken in selecting the tube to insure maximum possible permeance.

The original carrier is then filtered out in the low-pass filter which must be capable of passing the intermodulation products (400 and 800 cps) and sharply rejecting any carrier components (3200, 3600, 4000, 4400, and 4800 cps), as shown by curve B in Fig. 7. The carrier meter, located at the output of the low-pass filter, gives a reading which is almost entirely dependent upon the level of the high-frequency signal introduced to the analyzer. The signal at this point contains only the intermodulation products generated in the equipment under test.

#### Voltage Amplifier and Peak-Reading Vacuum-Tube Voltmeter

At this point, the signal is amplified again and fed to a selector switch which for purposes of reading intermodulation inserts a voltage divider to provide two scales on the dial of the PER CENT INTERMODULATION potentiometer. This potentiometer is in series with the selector switch and sets the signal level presented to the peak-reading voltmeter circuit. In this circuit the amplified a.c. modulation products are rectified by a 1N34 germanium crystal. The time constant of the RC combination in this circuit is such that the capacitor charges up to almost the peak value of the rectified voltage. This d.c. is impressed on the grid of the 6AU6 which in its static state is biased to a point where the tube draws maximum plate and screen current (about 6.0 ma). With an increase in the negative voltage on the control grid, the tube approaches cut-off and the meter reading decreases. The PER CENT INTERMODULATION control determines the amount of this negative grid voltage. This control is calibrated in such a way that a certain predetermined fixed reading on the voltmeter (5 ma) indicates the magnitude of the intermodulation

products as read on the potentiometer dial.

#### Calibration Circuit

A calibration circuit is incorporated in the analyzer to determine the level of the incoming signal. In the CALIBRATE position of the selector switch, a pure 60-cps signal is inserted at the rectifier. The rectified signal is measured by the CARRIER meter, amplified in a stage with adjustable "calibration gain," attenuated, and measured by the peak-reading voltmeter. The magnitude of the 60-cps signal is adjusted at the source to give the desired level at the voltmeter (5.0 ma). When the 60-cps signal is producing the 5-ma indication at the output, it is also producing an indication on the carrier meter (say 170 microamperes). At this point the selector switch is set to the 1-10% scale or the 3-30% scale, and the signal is applied to the input terminals and set by the input attenuator to give the same indication on the carrier meter. This assures that the filters, amplifiers, and rectifiers are running at the proper level. The PER CENT INTERMODULATION control is adjusted to give a 5.0-ma indication on the output meter, and the dial setting of this control then is a measure of the intermodulation distortion products.

To aid in observing the various phenomena taking place in the analyzer, oscilloscope connections are made at certain strategic points. The first (labeled INPUT) permits observation of the input signal and is located just after the preamplifier; the second (labeled MODULATED CARRIER) shows the modulated carrier and follows the high-pass filter; and the third (labeled OUTPUT) shows the actual intermodulation products and is located at the peak-reading voltmeter. These patterns allow the user to observe visually the various phases of intermodulation analysis.

When using the analyzer, it will be found convenient to use a signal generator providing several high- and several low-frequency signals with provision for mixing any two high and low frequencies and controlling their amplitude individually. A simpler generator would be one supplying only 400 and 4000 cps with the 400-cps signal 12 db higher than the 4000-cps signal.

It is advisable to use a regulated power supply to fulfill the requirements of the analyzer. This prevents sudden changes in calibration, as well as maintaining stability in the equipment.

#### Use of Equipment

When the equipment is used to make intermodulation measurements on amplifiers, the procedure is similar to that of making distortion measurements with other types of analyzers. The mixed output of the signal generator is im-

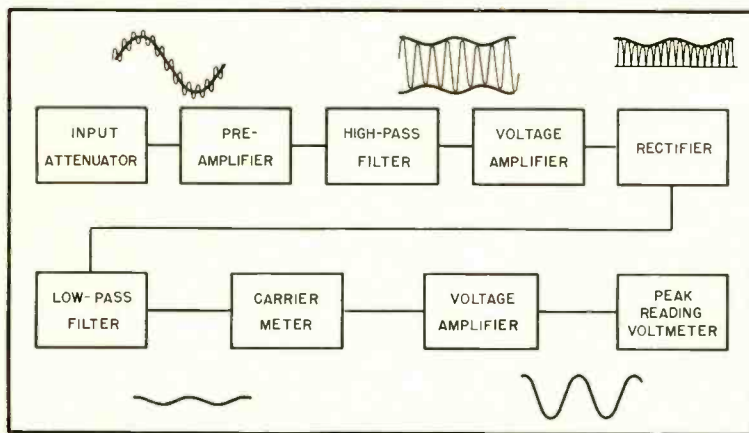

Fig. 4. Block diagram of intermodulation analyzer.





# Crossover Network for Unequal V. C. Impedances

WATSON F. WALKER \*

A method for using the output transformer to feed a frequency-dividing network for speakers of unequal voice coil impedances with results identical to the "constant resistance" network for speakers of equal impedances.

WITH THE PROFUSION of high-quality sound equipment that has appeared on the market in the past few years, many audio hobbyists have given serious consideration to the addition of an auxiliary high-frequency speaker to their present system. It is widely recognized that best results are obtained when a suitable dividing network is used between an amplifier and a multiple speaker system in order that each speaker operate over the frequency range to which it is best adapted. The standard designs for such networks usually require, however, that both the high- and low-frequency speakers have the same nominal voice coil impedance. Unfortunately, dividing networks of the "constant resistance" type do not maintain their desirable properties when connected to loads of other than their characteristic impedance. The prototype constant resistance circuit could be used, of course, if the impedance of one of the speakers could be made to equal that of the other. In almost all broad-band impedance matching problems, a transformer or the equivalent is required to change the general impedance level of a network if insertion loss is to be avoided. It is well known, however, that the addition of more audio transformers in a high-quality system may degrade performance in terms of frequency response and distortion. In any event, transformers of high quality degrade the pocket book. It is the purpose of this article to show how the output trans-

former can be used to perform this job along with its usual function.

### Constant-Resistance Network

The prototype constant-resistance circuit for frequency division and its design equations are given in Fig. 1. A circuit for use with speakers of different voice-coil impedances along with its equivalent circuit as seen from the primary of the transformer is shown at (A) and (B) in Fig. 2. The introduc-

The values of the input impedance  $R_0$ , the low and high frequency speaker impedances  $R_l$  and  $R_h$  respectively, and the crossover frequency  $f_0$  are chosen in accordance with the demands of the circuit external to the crossover network proper.

### Practical Application

In practice, the transformer used would be an output or line matching transformer and  $R_0$  would be the plate-

Fig. 3. Typical circuit arrangement for two speakers of unequal impedances.

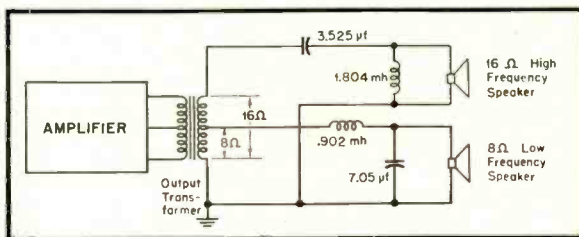

tion of the transformer into the circuit gives complete control over the values of the circuit elements in Fig. 2 (B) by virtue of the turns ratios of the transformers. Comparing the circuit of (B) with that of the prototype, the two may be made identical if the following relationships are obtained:

$$\left(\frac{n_3}{n_1}\right)^2 L_1 = L_0 = \left(\frac{n_3}{n_2}\right)^2 L_2 \quad (1)$$

$$\left(\frac{n_1}{n_3}\right)^2 C_1 = C_0 = \left(\frac{n_2}{n_3}\right)^2 C_2 \quad (2)$$

$$\left(\frac{n_3}{n_1}\right)^2 R_1 = R_0 = \left(\frac{n_3}{n_2}\right)^2 R_h \quad (3)$$

to-plate load impedance required for the output tubes or the line impedance.  $R_l$  and  $R_h$  are the nominal voice coil impedances of the two speakers and  $f_0$  can be whatever is required by the speaker characteristics.

Where it is desired to adapt this method to use with an existing amplifier, a simplification of the design procedure results because of the following relationship derived from Equation (3):

$$\frac{R_l}{R_h} = \left(\frac{n_1}{n_2}\right)^2 \quad (4)$$

In other words, where the output trans-

[Continued on page 37]

\* 1969 78th Street, Jackson Heights, New York.

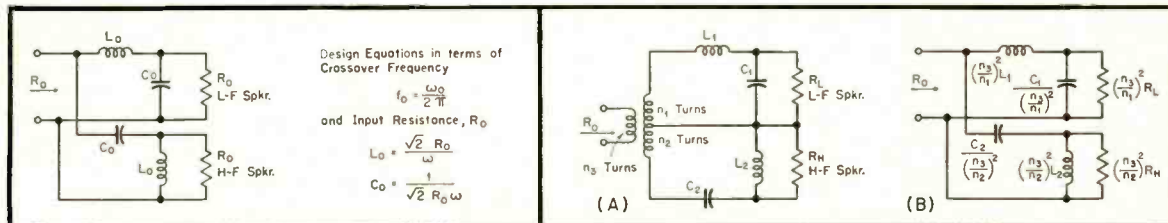
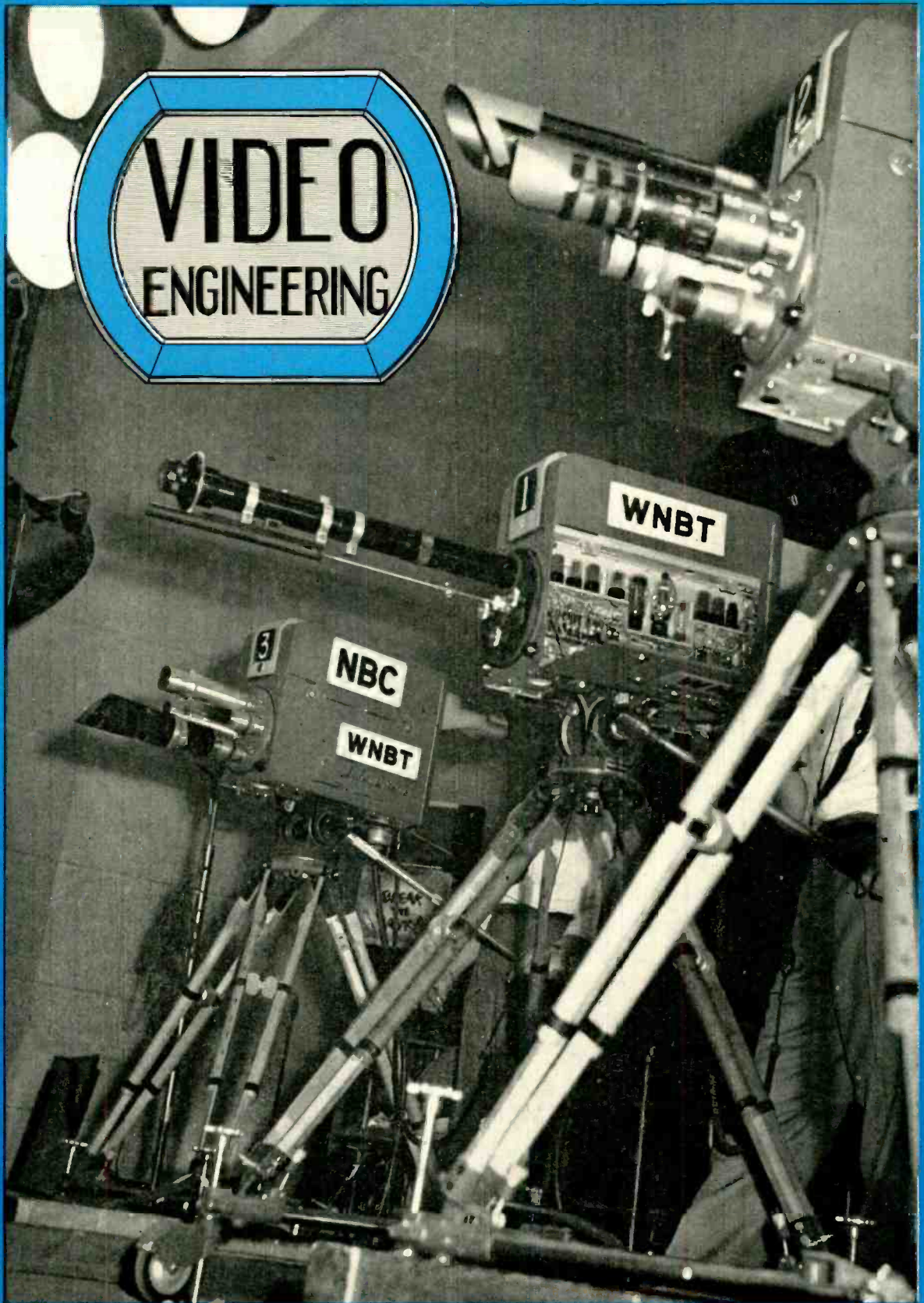

Fig. 1, left. Prototype constant-resistance crossover network, based on loads of equal impedances. Fig. 2, right. (A) Adaptation of prototype circuit for unequal impedances by the use of a transformer. (B) Method of proving that (A) provides correct loading.



# VIDEO ENGINEERING



FIRST

SLIM TRIM  
DYNAMIC for TV



- RESPONSE:  
40-15,000 C.P.S.  
± 2.5 DB
- POWER RATING: -53
- OMNIDIRECTIONAL
- ACOUSTALLOY  
DIAPHRAGM
- POP-PROOF HEAD
- CHANGEABLE  
LOW IMPEDANCE
- REMOVABLE SWIVEL
- 1/2" OR 3/8"-27  
THREAD MOUNTING
- CANNON XL-3  
CONNECTOR
- ALL PARTS  
PRECISION GROUND

- New '655' Microphone Provides Ultra-Wide-Range, High Fidelity Response
- More Rugged, More Versatile
- Stops Wind and Breath Blasts
- Individually Laboratory Calibrated

Here, for the first time, you have a slim, trim microphone with all the advantages of dynamic performance and utility! Only because of the ingenious Acoustalloy diaphragm and other E-V developments has it become a reality! Meets the highest standards of TV, FM and AM.

You can use the TV 655 on a stand, in the hand, or on a boom...or you can easily conceal it in studio props. No additional closely-associated auxiliary equipment is required! Provides effective individual or group pick-up. Reproduces voice and music with remarkable accuracy.

New E-V Blast Filter makes the 655 pop-proof. Acoustically-treated, strong wire-mesh grille head stops wind and breath blasts. Eliminates wind rumble in outdoor pick-up. Fully field tested and proved! Ideal, too, for recording and high quality sound amplification.

See for yourself! Write today for Bulletin No. 156 and full information on how you can try this amazing new microphone.

Model 655. List Price .....\$200



Shows TV 655 suspended on a boom. Omnidirectional polar pattern and firm swivel permits easy, diverse use.



Shows the popular Patsy Lee with the TV 655. Note how swivel permits aiming at sound source without hiding face.



Shows TV 655 in the hand with swivel removed. Note how convenient it is to handle for announcing or interviewing.

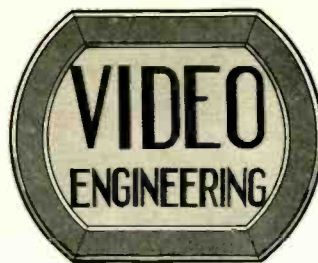

SECTION OF



C. G. McProud, Editor  
D. S. Potts, Publisher  
Luci Turner, Edit. Prod. Mgr.  
David Saltman, Prod. Mgr.  
E. E. Newman, Circ. Mgr.  
H. J. Weisner, Asst. Circ. Mgr.  
S. L. Cahn, Gen. Mgr.  
H. N. Reizes, Adv. Mgr.

Editorial Advisory Board

Howard A. Chinn                      Robert M. Morris  
Rodney D. Chipp                      Chester A. Rackey

Representatives

Sanford R. Cowan, Mid-West Sales  
342 Madison Ave., New York 17, N. Y.  
James C. Galloway, Pacific Coast Sales  
816 W. 5th St., Los Angeles 17, Calif.  
Technical Book & Magazine Co.  
297 Swanston St., Melbourne, C. 1.  
Victoria, Australia

CONTENTS                      JULY, 1950

Practical Television Lighting—  
C. A. Rackey ..... V3

Audio Co-ordination in Remote  
Television Broadcasting—  
W. I. McCord ..... V6

New Products ..... V8

COVER

Battery of RCA cameras at Radio City studios of NBC-TV. Center camera is shown with a Zoomar lens.

**Electro-Voice** INC.

401 CARROLL STREET • BUCHANAN, MICHIGAN

Export: 13 East 40th Street • New York 16, N. Y., U. S. A. • Cables: Arlab



# Practical Television Lighting

C. A. RACKEY

Part I. A discussion of the fundamental problems which must be considered in the planning of television studios.

**T**ELEVISION PICTURE QUALITY depends upon two factors, both of equal importance. One of these is the reproduction performance of the technical equipment itself; the other is the manner of illuminating the set and action.

The following material has been prepared to point out some of the basic operational and design factors involved in television lighting, and a special effort has been made to stress the practical aspects thereof in a manner that might be useful both to those intending to enter the television field, and to those now in television who contemplate improvements in lighting facilities.

## Comparison with Previous Pictorial Arts

Practical television being a new medium, its art forms and techniques are still largely in development. At the present time much is being borrowed, consciously or unconsciously, from the staging and lighting practices of the legitimate theatre, of still photography, and of motion pictures.

The experiences of these older media are a valuable background of reference but none of them provide, nor can they reasonably be expected to provide, a complete answer to television's own peculiar problems. Still photography gives, perhaps, the best purely artistic pictorial examples but achieves these by eliminating all motion and thus obtaining optimum lighting adjustment. Motion picture methods are not, at least at the present time, entirely suitable for television since their effects are obtained by considerable discipline and control of position and movements of the artists, insuring that only their best aspects are presented to the camera at those times when the audience is to be permitted a good look. This is an excellent technique but has two drawbacks: first, it requires more preparation time than is permissible in television production; second, it requires skills which are not yet available to television budgets.

The more elaborate television staging of today is a hybrid of theatre practice, yet this frequently falls short of being satisfactory when close-ups or moderately close shots are required, since theatre staging is based on the audience

being at a substantial distance from the action. That this is so is evidenced by the poor and sometimes even shabby appearance of an average stage set when viewed close up, compared to the relatively painstaking details used in motion pictures, where close-ups are an accepted feature. Artists on the legitimate stage are made up to an extent which appears grotesque except at a considerable distance. A particularly bad example of improper use of theatre technique, common on television, is the use of a spot light on a subject, which is then presented in a close-up. The effect, particularly on a female artist, is to add many years to her actual age. In the theatre, on the other hand, a spot concentrates attention, enhances appearance and color, causes the eyes to glisten and, in general, is a useful and proper tool. The concentration of attention by means of a spot in close-ups, is superfluous on television since this has already been accomplished by the picture framing.

## General Requirements and Procedures

A most important requirement for good pictorial effect in television is a reasonable amount of artistic sensibility on the part of those responsible for this detail of production. This, plus experience, can result in development of the skill required to achieve good picture quality, while a lack of some sense of art values will usually result in mediocre effects. By way of alleviating the impact of this fact upon engineers, it is necessary to point out that an art sense, possibly undeveloped and un-self-appreciated, is possessed by many, the point being that this aspect of the job of lighting should be nurtured and developed, and not deprecated, as it often tends to be among technically minded persons.

A second most important requirement is experience. Visual observation or written instructions must be supplanted with actual trial and error as is the case in other arts. As a guide, however, the following rules are offered:

**RULE I.** The *primary object* of television lighting is to reproduce, with beauty and with dramatic effect, the human form, especially that portion which is



Chester A. Rackey, Manager of Audio and Video Engineering, National Broadcasting Company.

Mr. Rackey is responsible for design, standardization, construction, and installation of audio and TV equipment, systems, and related physical properties at NBC. He is a senior Member of I.R.E., Governor of A.E.S., Chairman of R.M.A. Committee on Broadcasting Practices, member of R.M.A. Audio Facilities Committee, etc., and is on the Editorial Advisory Board for Video Engineering.

not clothed or otherwise covered. All else is secondary.

**RULE II.** Television lighting should never be in high contrast but, rather, comparatively flat, except for very special dramatic effects.

**RULE III.** The lighting should not be "toppy," i.e. directed from too high an overhead angle.

**RULE IV.** Avoid use of spots or "hard" light in close-ups.

The validity of Rule I should be obvious. A chair, for example, is recognizable as a chair with any type of lighting, but to ruin the good appearance, or the illusion of good appearance of a star performer, is to destroy a basic pictorial value.

Considering avoidance of high contrast, it may be stated that the image orthicon tends to provide its own contrast in that it seems to give its best effects in generally flat light. Contrast accents are definitely needed, but should be lightly applied. Under conditions of excessive contrast the image orthicon will reproduce the brighter spots of the picture as "highlight islands" or bordered areas, giving an unpleasant coarseness or artificiality to the picture. This

# PRACTICAL TELEVISION LIGHTING

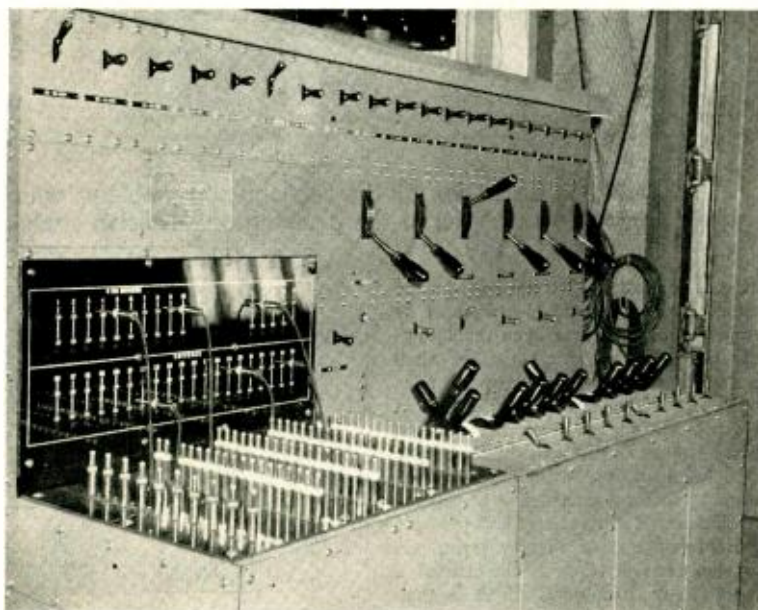

A permanent television lighting control position incorporating switching, transformer-type dimming, and patching. Plugs at left foreground connect to individual fixtures, jacks above them to switches and dimmers. Dimmer control handles are in banks at right of board; switches are in a line at the top.

effect is most noticeable in shots of highly polished or plated objects. To avoid this, it may be necessary not only to tone down the lighting, but also to experiment with highlight reducing coatings, as shellac or dull waxes.

Toppiness is probably one of the most common faults of present television lighting and results in heavy shadows under eyebrows, nose, lips, cheekbones and base of the throat.

High-angle lighting is the result of mounting practically all the lighting units overhead which, in turn, stems from the necessity of keeping the studio floor clear for camera travel and for disposal of bulky camera cables. It is difficult to insist upon the use of a substantial number of floor-supported light units, yet it is important that these, or their equivalent, not be entirely excluded. If the units are all to be of the overhead type, they should be capable of considerable downward extension, say to waist level, in order to obtain the necessary low angle of direction.

The effect of contrasty lighting is at its worst when the subject illuminated is a woman. This is the case when a "hard" light such as a single spot or other highly directional source is used, and the effect is to produce harsh shadows behind the slightest irregularity such as veins, wrinkles, or even a normally pleasing convolution, as, for ex-

ample, a dimple. The remedy is to surround the subject with light in such manner that the shadows are softened, and this can be done by using at least two, and preferably three or more light sources and directions. One light full on and one to either side would be an improvement, the object being not to wipe out the shadows but to soften them to eliminate the minor complexion irregularities that can cause a rough appearance. A perfectly diffused light must be used with considerable care since in many cases it would produce an effect utterly lacking in character or dramatic interest.

In lighting a male subject, a judicious amount of hard light is not nearly as objectionable, since it can be used to accentuate masculinity. If both a man and a woman are in the same close shot, however, the lighting of the woman must control.

Contrast is also a matter of the reflective characteristics of scenery, props and clothing. Dead white should always be avoided in favor of off-whites, greys and toned colors. The effects of a white gown or dress shirt are practically impossible to cope with in television. Experimentation with the actual transmission qualities of various paints, fabrics, and clothing materials in various colors, shades, and tones is definitely in order and will be instructive beyond any information to

be gained from reading published listings of reflective coefficients.

Procedure in actual set lighting is approximately as follows:

1. Arrange general illumination, principally from overhead, to provide basic overall lighting of the set. The amount of light used should be enough to produce a picture substantially above system noise level. With a lens stop of  $f/5.6$  this will vary from 20 to 80 foot candles depending upon the type of pickup tube in use. Note that in measuring incident light in this case, the face of the light meter (which should be of flat-face type) should be held vertically and facing the camera.

2. Correct general illumination by use of "fill" light, to remove undesirable shadowed areas not properly served by the general lighting.

3. Light the background so that it stands out with the degree of pictorial interest considered necessary, and also to assist in throwing in relief the performers in front of it in order to get perspective separation.

4. Determine the principal areas of action, locate performers or stand-ins therein and readjust the illumination, adding low-angle modelling light and back light to produce the pleasing or dramatic effect required. Aside from the general requirement of overall flat lighting, proper back lighting is perhaps next in importance. This technique consists, essentially, of locating hidden light sources behind, and to the side or overhead of a subject in such manner as to give a lighted outline of the body. Its purpose is to furnish further relief and separation from the background as heretofore mentioned. Another use of backlighting is to produce a "halo" effect of the hair, especially effective on a female subject.

5. Make provision for the position of the mike and boom, and its traverse, by suitably controlling and "cutting" the illumination to provide alleys in which the mike and boom can be manipulated without casting a shadow falling within confines of the picture.

Note that the best lighting effects on human subjects can be obtained only when position and camera angle are restricted. Subjects in motion require less care in lighting, and no special provision need be taken in such case.

It is assumed that, during the foregoing, the lighting units over areas requiring black-out or dimming have been connected through the proper switches and dimmers.

## Light Sources and Quality

This is a subject on which a voluminous treatise, far beyond the scope of this article, might be written. A great deal of investigation has been made of the relations between various light sources, reflecting characteristics of the human skin and other surfaces, and the response characteristics of various types of pickup tubes, most of which information is available in current literature. For the purpose of this article this can be summarized essentially as follows:

1. Modern television pickup tubes should, and do, trend toward approximately the response characteristics of the



human eye. Under these conditions, the camera sees the scene as the eyes see it and therefore no special system compensation or correction is necessary.

2. Incandescent light sources seem the most practical for general use.

Tests indicate that human skin reflects red light better than blue; therefore, in monochrome systems a source having substantial red and yellow components is essential. This—plus the fact that pickup tubes having a response similar to the human eye are presently available—makes the use of incandescent sources practical. These sources permit ease of control with respect to switching and dimming, are susceptible to good optical control (being nearly a point source), and are generally more compact and easily handled mechanically. Their chief disadvantage is low efficiency, which is not now a major factor owing to present high sensitivity of pickup tubes.

Fluorescent sources have the primary advantage of high efficiency and of a more diverse range of color temperature. They can also be used to produce, inherently, a diffused light and, having a low surface brightness, glare is reduced. They cannot, however, be optically controlled to any extent, nor can they be properly dimmed or switched, and thus must always be supported by incandescent sources. Another disadvantage is that they are comparatively bulky and therefore awkward to handle and to manipulate mechanically.

If ever television develops a proper technique of fixed set-ups for similar and repetitive programs, fluorescent lighting will probably come into its own. Such things as kitchen demonstra-

tions, interviews, news commentators, etc., could well use fixed lighting set-ups of fluorescent fixtures with but a few incandescent modelling lights in addition.

For general use, an incandescent color temperature of 2900° K, minimum, is desirable. Fluorescent sources should be 3500° K to 4500° K.

#### Types of Fixtures and their Use

Light units may be divided into two general classifications: those primarily intended to provide control and shaping of a beam, and those intended to provide diffused light. Both types vary to a great extent in the degree of control or diffusion obtained. Controlled types

make use of Fresnel lenses and either spherical or parabolic reflectors, with facilities for focussing. They may have, in addition, horizontal and vertical adjustable flaps or "barn doors" to shape the beam rectangularly, and may also have side guides or other arrangements to take diffusion screens or color gels. Some of the larger spots are equipped with iris diaphragms.

The diffused or uncontrolled classification includes such types as strips or borders, which are long troughs with the incandescent lamps arranged therein in a single long row and which can be used for general overhead illumination or to light backgrounds; loads, which

●  
**Portable dimmer board using auto-transformer dimmers and conventional theatrical-type plugs and receptacles.**  
●

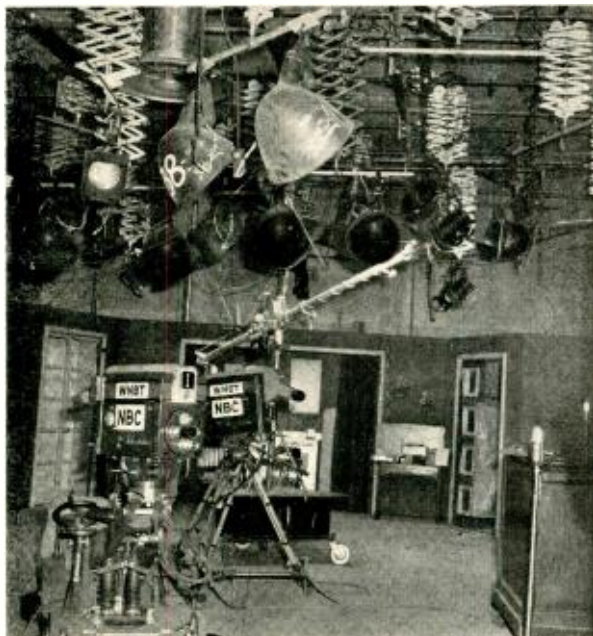
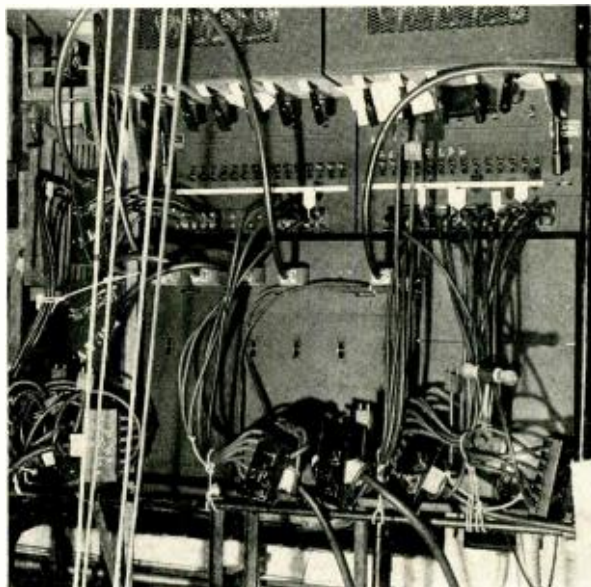

●  
**Set-up showing installation of extensible light-unit hangers of the pantograph type. These can be set at any vertical distance, down to camera height.**  
●

are groups of lamps arranged in several short rows to form a bank; ellipticals or "scoops" which provide a relatively soft light from a single lamp with a certain degree of area control; and footlights which are, in reality, strips or borders used at floor level and useful to counteract the topiness of overhead lighting.

Banks of lamps having internal reflectors ("Birdseye" type) are in considerable use and provide a light which is best described as semi-controlled, being generally less soft than from an elliptical or broad and having more of a directional characteristic. Various types of these lamps are available, both beam and flood, modifying the general characteristics of the units to some extent.

Present trends seem to be toward use of a preponderant number of controlled sources, obtaining diffusion by a multiplicity of these, rather than by a fewer number of diffused sources. The theory

[Continued on page V8]

# Audio Co-ordination in Remote Television Broadcasting



WDTV Telecruiser in action at an athletic event near Pittsburgh.

**T**ELEVISIONING A PROGRAM which originates remote from the studio is a big undertaking calling for careful planning and much preparation. Of course, the first consideration is the picture. Such factors as, "where to place the cameras," "will it be possible to obtain a position for the microwave picture relay transmitter from which we will have an unobstructed line of sight air path to the transmitter tower or other receiver location," must be considered. After these obstacles have been overcome the next question is, "what to do about the audio?" The usual procedure, of course, is to contact a local phone company, and arrange for a program line and an order wire to be run in. This is usually the most satisfactory solution if time permits and phone facilities are available. The order wire is especially essential and should be installed early enough so that it can be used for setting up and orienting the picture relay. During the program time it is essential to maintain contact between the transmitter studio and the remote location. Smooth program

continuity is possible only when there is close coordination between program director, T.D., (technical director or switcher), transmitter operator, remote audio man, studio audio man, and announcers. Accurate cueing and timing are essential to make sure that both audio and video are synchronized. The remote audio man should always be located in a position so that he can see either a picture monitor or air receiver. When the program requires only a running commentary, the audio man's job is simplified and becomes a matter of routine very similar to AM broadcast operations. It is preferable in this type of program for the announcer to describe the action directly from the picture on the television receiver, thus assuring that the audio description corresponds with the action as seen by the camera. In such instances, the audio man is usually located at ringside with the announcer or in the announcer's booth. Baseball games, boxing, wrestling, football, roller derbies, or similar sports are typical examples of this type of audio coverage. Sometimes these

programs require atmosphere or background sound (i.e., crowd noise, band music, etc.) necessitating additional microphones. Usually one of these microphones will be mounted in a parabolic reflector to focus distant sound, such as the crack made by the bat as it hits the ball, or the music from the band marching on the playing field.

The more difficult program is the multiple location pickup where two or more cameras are covering definite action, each requiring the associated sound. An example of this is a parade where cameras are located at various viewing points, or an event where one camera is covering action inside of a building while another is covering the outdoor action. In these instances, it is desirable that the audio man be located in close proximity to the program director and the camera control operator. The director can then cue the audio man for a switch at the same time he cues the picture switcher.

## Remote Pickup Facilities

The Du Mont Telecruiser has been designed with all of the problems of the audio man being considered as well as those of the video operators. An audio console has been built into the vehicle and is located in the control room area. When seated at this position, the audio man can see all of the picture monitors as well as the line/air receiver/monitors, making it possible for him to take visual cueing if necessary. The audio equipment consists of a portable remote amplifier unit with four-channel input and two line outputs. A bridging transformer across the line output provides signal to a monitoring amplifier which is used for internal speakers or, on some occasions, a public address system to feed external speakers. A patch panel with 24 dual plug positions is provided at the audio console and all audio program sound, cue lines, intercommunicating phones and PA amplifiers are controlled through this patch panel. Built-in telephones for audio position, video console and director desk, connect through this patch panel to external terminals and can be connected to telephone company lines or to remote field positions. Provision has also been made for the audio man and director to plug in headsets that will connect them into the talk circuit which is built into the camera chain equipment connecting



**Integration of both sound and picture pickup is shown to be necessary for smooth-working operations in the field.**

camera operators and video control operators. Arrangements have also been made for the installation of a radio-relay transmitter for program sound and a two-way transmitter/receiver for order-wire use. This equipment operates in the 450-452 mc. range which has been assigned for this type of service. The new Du Mont picture relay transmitter operating in the 2000 mc. range has a built-in diplexer so that the picture carrier can be pulse-time modulated with the audio signal, thus sending both picture and sound channels over the same relay unit. This feature considerably simplifies the problem of audio relaying.

In the Telecruiser the a.c., audio, and video wiring runs in concealed conduit to each position and to the exterior connector panels so that changes can be made easily if and when desired, and damaged cables can be replaced quickly. This prevents any improvised wiring and "haywire" hookups which are potential trouble makers.

Microphone inputs are provided to ac-

commodate either the Cannon or Hubbell variety and audio outputs are provided in binding posts and Amphenol connectors. All audio wiring, throughout the unit is of the shielded two-wire type. The audio remote amplifier and its power supply are mounted on shock mounting racks in such a manner that they can be released quickly when it is necessary to control the audio from a remote point. Each Du Mont Telecruiser is custom-built for specific requirements and the audio layout is designed to provide all of the desired features necessary to each particular type of operation. The unit shown in Fig. 1 has provision for disc and tape recorders, and a playback turntable. Two order-wire channels were specified, one for the engineering use and one for program use; in addition, a 50-w FM program relay transmitter was required. Facilities have been provided for the announcer to operate from the inside of the Telecruiser when necessary and a microphone input connection at the roof level was installed for use



Willis I. McCord is presently associated with the Allen B. Du Mont Laboratories, Inc., as the Manager of the Television Specialties Department of the Research Division.

He is the designer of the Du Mont Telecruiser and has designed many mobile units for Remote Television Broadcasting and other special applications. He is considered an authority in this field. McCord has also invented and developed other equipment for television studio operations. One of his inventions is the pulsed light motion picture projector for television broadcasting.

He is presently supervising the operation of a sales promotion Telecruiser which is touring the country with a crew of men doing demonstration work. This unit recently picked up the activities of Fiesta Week in San Antonio, which were broadcast over Station KEYL.

McCord received his engineering training at Rutgers University. He was Production Manager for Empire Electric Brake Company, Newark, New Jersey, and before joining Du Mont in 1944, he was Treasurer of Geo. B. Biggs, Inc., an advertising and sales engineering organization in New York City.

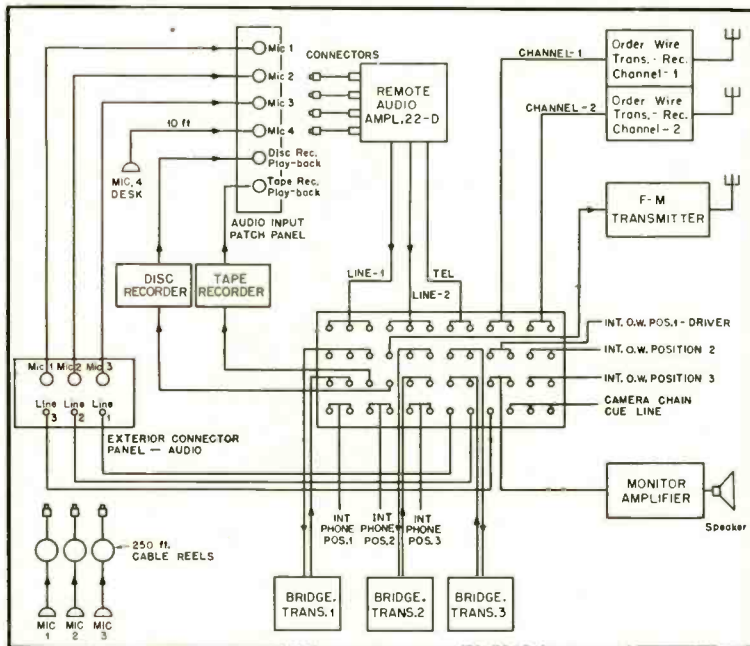

Fig. 1. Audio layout for completely equipped Telecruiser with facilities for disc and tape recording, as well as necessary relay transmitter.

when announcing from the roof deck.

The new Telecruiser with its 110-volt, 5-kw gasoline generator is a self-sufficient unit which can on short notice be dispatched for remote programming of an emergency nature for special event coverage. Without these features, it would normally require from 24 to 48 hours advance notice to arrange for phone service and a.c. power at specified locations.

To appreciate the importance of the audio man in television programming, merely walk over to your receiver some evening and disconnect your speaker. The reaction of the viewers will soon convince you that without audio, television would be reminiscent of the silent movie era minus the piano accompaniment.

(The author will discuss the video circuits of the Telecruiser in the September issue.)

[Continued from page V5]

behind the trend is, basically, that a controlled light is more flexible since it can be used to shape a beam, if that is required, in addition to providing a diffused effect by broadening the beam by defocussing or by the grouping of a number of such sources. A multiplicity of small sources seems easier to handle than fewer larger and bulkier units, while the larger number of scattered sources, though it multiplies shadows, reduces them to negligible contrast.

A comparatively recent and valuable

development in accessories is an extensible fixture hanger, counterbalanced or spring loaded, by means of which the fixture can be vertically positioned from within one foot of its hanger, (assuming a normal hanging position of from 10 to 12 feet) to within a few feet of the floor. The great advantage of these hangers is that a fixture can be hung from the ceiling, leaving the floor clear, and still have the advantage of floor stand mounting in that it can be pulled down to provide a low-angle source.

To be concluded in the September issue

# Floating Action!

## for all TV Cameras

### "BALANCED" TV TRIPOD

Pat. Pending

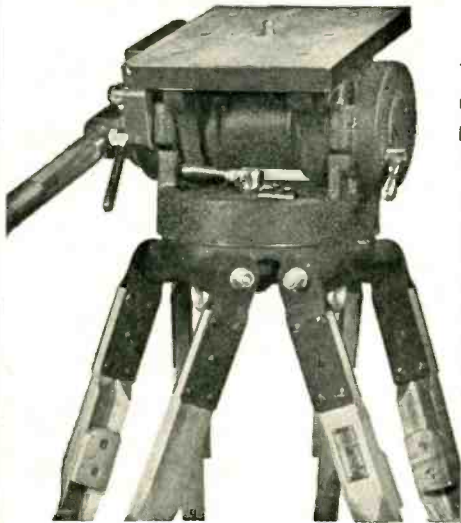

This tripod was engineered and designed expressly to meet all video camera requirements.

Previous concepts of gyro and friction type design have been discarded to achieve absolute balance, effortless operation, super-smooth tilt and pan action, dependability, ruggedness & efficiency.

Below:

3 wheel portable dolly with balanced TV Tripod mounted.

Complete 360° pan without ragged or jerky movement is accomplished with effortless control. It is impossible to get anything but perfectly smooth pan and tilt action with the "BALANCED" TV Tripod.

Quick-release pan handle adjustment locks into position desired by operator with no "play" between pan handle and tripod head. Tripod head mechanism is rustproof, completely enclosed, never requires adjustments cleaning or lubrication. Built-in spirit level. Telescoping extension pan handle.



Write for further particulars



## NEW PRODUCTS

● **Laboratory Tube Tester.** Television's exacting demands for accuracy are fully met in the new Hickok Model 539 tube tester. Among the instrument's unique features are: Separate meter for adjust-



ment of line voltage while tube is under test; provision for inserting millimeter to read plate current; provision for self-bias and for vernier adjustment of bias. Scale reads directly in micromhos. Model 539 is supplied in a sturdy portable carrying case with dimensions 17 x 18 x 18½ inches. Complete data may be obtained by writing The Hickok Electrical Instrument Company, 10617 Dupont Ave., Cleveland 8, Ohio.

● **Tube sockets** are a necessity in any electronic construction, and for optimum results it is desirable that losses be minimum and for the miniature tubes it is necessary that precise dimensions be maintained to ensure against breakage. Mycalex 410 was developed for applications requiring dimensional stability, and the loss factor is lower than with mica-filled phenolic. Further information may be obtained from Mycalex Tube Socket Corp., 30 Rockefeller Plaza, New York 20, N. Y.

● **Television Waveform Monitor.** Featuring a high degree of accuracy along with portability, the new Polarad Model TO-1 is a compact instrument designed for waveform analysis and amplitude measurement of video signals in television circuits. It is also well suited for many general-purpose applications because of its wide frequency response, high sensitivity, precision calibrating circuits, and unusually large symmetrical horizontal expansion. Visual presentation is on a 5-inch cathode-ray tube.



Model TO-1 is a companion instrument to the Polarad portable picture monitor Model 102-MPS. Full technical specifications may be obtained by writing Polarad Electronics Corp., 100 Metropolitan Ave., Brooklyn 11, N. Y.



# Phase-Shift Method of Measuring Flutter

CHARLES A. HISSERICH\* and ART DAVIS\*\*

A discussion of the effects of flutter, and the presentation of a simple and direct method of measuring it accurately with equipment available in any recording studio.

**T**RUE RECORDING and reproduction of sound requires, in addition to the electrical circuits involved, a mechanical means of moving the recording medium at essentially constant velocity. When this requirement is not met, several types of undesirable results are encountered.

The most common defect resulting from non-uniform motion is the familiar "wow" present in machines having long-period speed variations of high amplitude. However, this effect is probably the most familiar type because it is the most easily recognizable. Flutter is capable of an infinitude of variations, some of which are not readily identifiable. Small amounts of flutter, which may not be recognizable as such, cause the reproduced sound to be very "harsh." When the flutter frequency is high, the reproduced sound tends to appear distorted. Single-frequency flutter, such as that caused by sprocket holes in film, cause the reproduced sound to have a "bubbling" quality.

The above effects are caused by the fact that motional variations in an amplitude system based on constant velocity result in phase and/or frequency modulation of the frequencies present in the recorded material and the generation of phase shifts and/or side bands which are directly related to the frequency and amplitude of the speed variations.

When it is realized that these speed variations are usually different in the recording and reproducing machines, the complex results possible may be fully appreciated. It is possible for the motional variations in the reproducing machine to cancel partially those of the recording machine, and then during reproduction, or during succeeding reproductions, drift so that motional variations in the reproducer become additive to those in the original recording, thus creating a situation in which the quality of successive reproductions is a statistical probability.

The fundamental requirements of constant velocity has long been recognized, and probably the first steps taken to

meet this requirement were the elaborate governing systems and weighted turntables of the early spring driven phonographs. Many of the early disk recording machines were driven by means of the action of gravity on large weights in an attempt to obtain constancy of driving power.

With the advent of the electric phonograph, many approaches were tried; among them were the use of governed eddy current motors, planetary gear reduction motors, multi-pole slow speed motors, and others. The early "professional" disk recording equipment utilized massive turntables and attempts were made to "average out" discrepancies in the uniformity of the driving system by the use of multiple dental belt drives or, in the case of gear drives, by the use of laminated gears in which successive laminations were rotated and re-assembled after cutting.

## Synchronous Recording Systems

When the first equipment used in making sound pictures was developed,

this problem of securing constant velocity of the recording medium was further complicated by the fact that a synchronous recording was required, in order that the sound and picture could later be matched. At that time, it might be said that the research into the development of constant velocity drives was split into two fields, synchronous and non-synchronous.

The non-synchronous field, of which the modern phonograph is the outstanding example, has progressed to the point where the rim "drive" or "puck driven" turntable is almost universal. This method of drive is capable of yielding excellent results, providing that the eccentricity tolerances of the various elements involved are sufficiently rigid, and further, that these eccentricities are not accentuated by maintaining running pressure on soft idler rollers when the equipment is idle.

It should be noted that in the non-synchronous field, the development of constant-velocity drive systems has followed the trend toward the minimizing

Practical embodiment of mechanism diagrammed in Fig. 6. The flywheel has been removed from upper shaft to show spring assembly.

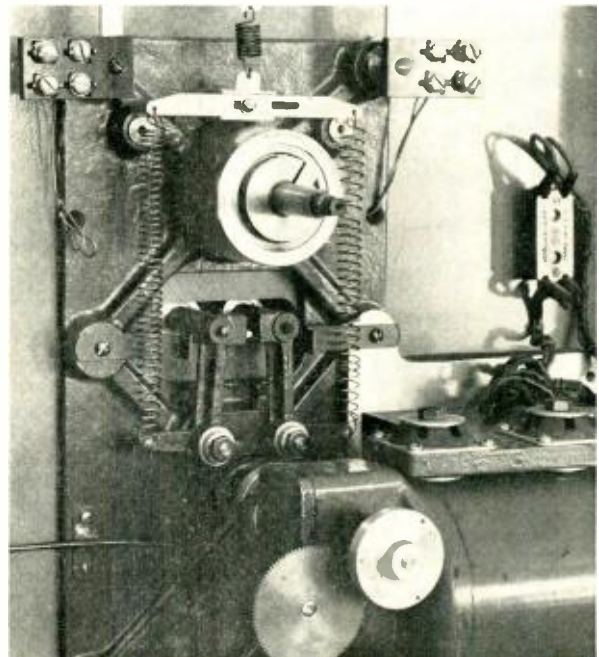

\* 954 Hancock Ave., Los Angeles 46, California.

\*\* Cinema Engineering Co., 1510 W. Verdugo Ave., Burbank, California.

of motional disturbances *at the source*, rather than the acceptance of a known amount of disturbance from belts, gears, etc., which require attenuation by elaborate mechanical filters.

The synchronous field, in which motion picture sound recording equipment is the leading example, was faced with a different fundamental problem which may be stated as follows: In synchronous recording it is necessary that the recording medium be driven by a positive indexing mechanism, thus necessitating the use of gears, silent chains, or some such device, each introducing known amounts of motional disturbance which must be attenuated by mechanical filtering systems.

The literature is abundant with details of the various mechanical filter systems used in synchronous sound recording and reproducing equipment, and it is not in the scope of this article to review them. A complete bibliography will be found at the end of this article.

It is known that motional disturbances in recording and reproducing machines

| Percent Flutter | Osc. Frequency (cps) | Percent Flutter | Osc. Frequency (cps) |
|-----------------|----------------------|-----------------|----------------------|
| 2.0             | 12.5                 | .2              | 125                  |
| 1.0             | 25.0                 | .1              | 250                  |
| .8              | 31.2                 | .08             | 312                  |
| .6              | 41.6                 | .06             | 416                  |
| .5              | 50.0                 | .05             | 500                  |
| .4              | 62.3                 | .03             | 833                  |
| .3              | 83.3                 | .025            | 1000                 |
| .25             | 100                  | .02             | 1250                 |

Fig. 1. Table showing the oscillator frequency used for peak flutter percentages corresponding to 90-deg. phase shift in 'scope pattern.

cause phase and/or frequency modulation of the recorded material, the difference being one of degree. It is also known that the measurement of phase shift by means of Lissajou figures on an oscilloscope is a simple process. Therefore, it is obvious that an investigation of these processes may be of use in determining their usefulness as a measuring tool for the study of motional disturbances.

#### Phase Shift

Consider a recorded frequency of 100 cps; a total speed variation of  $\pm 1$  per cent in the reproducing and recording equipment will cause this frequency to

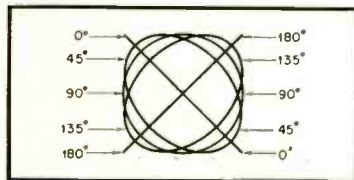

Fig. 2. 'Scope patterns resulting from phase shift of indicated angle.

be reproduced as 99 or 101 cps, depending on the sign of the speed variation. This deviation corresponds to a frequency shift of  $\pm 1$  cycle per second, and from this it is obvious that a speed variation of one quarter of this amount, or  $\pm 0.25$  per cent corresponds to a phase shift of  $\pm 90$  deg. or one quarter of a cycle.

Phase shifts of  $\pm 90$  deg. or less are easily capable of being determined quantitatively by means of Lissajou patterns on an oscilloscope. Also, as the amount of phase shift is directly proportional to the recorded frequency, the method of measuring motional disturbance to be

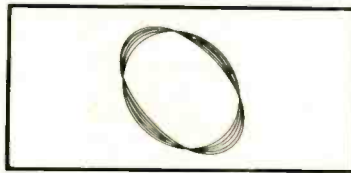

Fig. 3. "Hazy" pattern formed by high-frequency motional disturbances.

described is capable of a "full scale" sensitivity which may be varied from  $\pm 1$  per cent to  $\pm .0025$  per cent by the selection of a suitable recording frequency between 25 and 10,000 cps. A table of these values is shown in Fig. 1 with the percentage of "peak" motional disturbance or "flutter" corresponding to phase shifts of  $\pm 90$  deg.

The equipment necessary to measure "flutter" or motional disturbance by means of the phase-shift method consists of: (1) a stable oscillator covering the

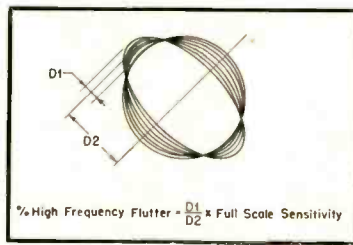

Fig. 4. Method of determining percentage of high-frequency flutter from "hazy" pattern of Fig. 3.

range between 25 and 10,000 cps (preferably one of the Wein bridge stabilized feedback type); and (2) an oscilloscope.

The method is as follows: Select a frequency which will give the required sensitivity from the table, Fig. 1. (A rough guide to this selection is the fact that good "professional" equipment will have a motional variation which is less than  $\pm 0.1$  per cent which may be read with a 250-cps frequency.) Record this frequency on the medium. Arrange to reproduce this recording with the reproduced signal applied to one set of

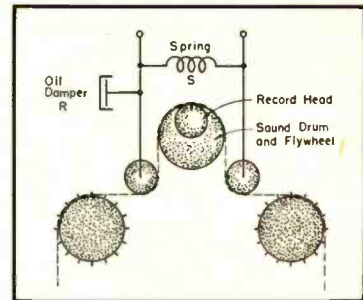

Fig. 5. Diagram of "tight-loop" drive employed in magnetic recorder.

plates of the oscilloscope and the signal from the oscillator from which the frequency was recorded applied to the other set of plates. Adjust the X and Y signals to equal amplitude on the oscilloscope. A Lissajou pattern will be formed on the oscilloscope, which may be brought to an approximation of the 90 deg. circular pattern shown in Fig. 2 by juggling the frequency of the oscillator slightly to compensate for the original time displacement. If there is a difference of absolute speed between recorder and reproducer, this oscillator adjustment will also correct the d.c. component of motional difference, and the value of this d.c. component may be computed by noting the shift in frequency necessary to cause the pattern to vary about the 90 deg. circular pattern and thus define only the a.c. component or "flutter."

#### Scope Pattern Analysis

Once the circular pattern is formed, several conditions may exist, depending on the degree and nature of the motional disturbances in the system.

If the pattern cannot be brought to an approximation of the circular 90-deg. trace without the "flip-flops" passing through the 0 and 180 degree ( $\pm 90$  deg.) points, then the motional variations are exceeding the full scale limits of the selected sensitivity and a lower frequency should be tried.

If the pattern formed is not defined by a sharp line but is hazy as shown in Fig. 3, then the motional disturbances are occurring at a high frequency and the amplitude of these high-frequency disturbances may be determined by means of the diagram shown in Fig. 4.

Low-frequency motional disturbances will be observed as deformations of the basic 90-deg. circular pattern toward either the 0 or 180-deg. straight line patterns, and these deformations will occur at the rate of the motional disturbance; thus it is often possible to audibly recognize the disturbing element in the machine under test while watching the oscilloscope trace by noting which of the various mechanical noises coincides with a major pattern shift.



Most of the modern film recording machines use the double-arm type of "tight loop" drive described by C. C. Davis.<sup>1</sup> This article is highly recommended for anyone interested in the problems associated with constant velocity drives as it covers the subject thoroughly and presents an analysis of the "tight loop" drive, a diagram of which is shown in Fig. 5.

It will be seen from the diagram that in the "tight loop" drive system mechanical feedback is applied around the sound drum, or flywheel, through the common spring *S*, in such a way that an instantaneous change in either the incoming or outgoing film tension is equalized by a corresponding change in outgoing or incoming film tension.

Such a linkage is by nature oscillatory at a frequency determined by the compliance and mass (*C* and *L*) of the system, and this tendency to oscillate is damped out by the resistance of the dashpot or "oil damper" *R*.

In the development of our Type 6309 Magnetic Recorder, it was thought that the necessity of damping a tight loop film drive system could be eliminated if the amount of mechanical feedback around the sound drum were reduced and the oscillatory system was connected to ground (frame) through a non-linear device tending to simulate the effect of damping.

This latter statement, that a non-linear device may simulate the effect of damping, may be subject to argument. The literature in the field of dynamical analo-

<sup>1</sup>"An improved film drive filter mechanism," *J. Soc. Mot. Pict. Eng.*, June 1946, p. 454.

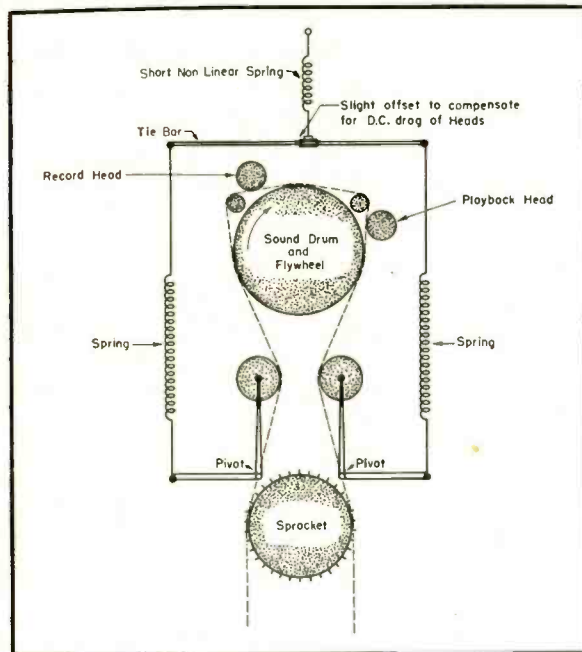

Fig. 6. Diagram of complete film-moving mechanism used in magnetic recorder.

gies does not deal with non-linear elements, possibly because such a device as a non-linear capacitor does not exist; a non-linear spring is readily obtainable, however, with a predictable degree of non-linearity.

As an example of the case of a non-linear element simulating the effect of damping, consider the oscillatory circuit shown in Fig. 7 consisting of inductance *L* and capacitor *C* with current *I* flowing. The energy in this circuit with the switch *S* closed is essentially in the magnetic field of *L* and is expressed as  $\frac{1}{2} LI^2$ .

This circuit may be represented by

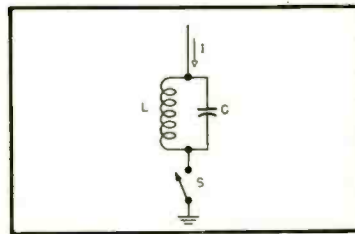

Fig. 7. Typical oscillatory circuit with energy concentrated in the inductance when current *I* flows, switch *S* closed.

analogy in the mechanical field by the representation shown in Fig. 8 in which a mass (corresponding to *L*) has a velocity (corresponding to *I*) in the direction shown. In order to simulate the capacitor (corresponding to a compliance), let the mass be compliant, as, for example, a springy hack-saw blade supported at *A*. The energy of motion of this mass may now be expressed as  $\frac{1}{2} mv^2$  (analogous to the electrical  $\frac{1}{2} LI^2$ ).

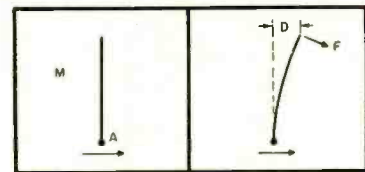

Fig. 8 (left). Mass and velocity analogy. Fig. 9 (right). Energy stored in spring due to displacement *D*.

Consider now that the switch *S* is opened, stopping the current in the circuit. The current in the coil does not immediately stop; as the field about *L* collapses and as the lines of force cut the turns of the coil a voltage is generated which causes current to flow in the *LC* loop and charge capacitor *C*. At the instant that the current has reached 0, the charge on the capacitor has reached maximum, and its potential energy is expressed as  $\frac{1}{2} CE^2$ .

In the analogous mechanical case, the velocity (corresponding to *I*) of the support point of the hack-saw blade is stopped, but the whole blade does not stop; the upper part springs as shown in Fig. 9 until its total mass is at rest. At this instant, its energy of motion has been converted to the potential energy of a stressed spring which may be repre-

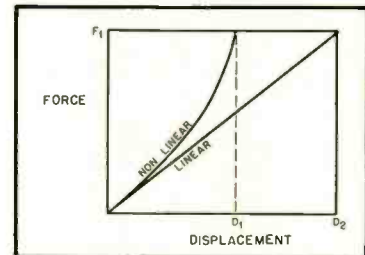

Fig. 10. Force-displacement curves for linear and non-linear springs.

sented by  $(F/2) \times D$  ( $\frac{1}{2}$  Force times Displacement), provided the force-displacement characteristic of the compliance is linear, as that is the only condition under which the average force is  $F/2$ .

The potential energy of the charged capacitor is analogous to the potential energy stored in the stressed spring. Consider the term  $\frac{1}{2} CE^2$ . *C*, or capacitance, is equivalent to the mechanical term compliance (or displacement per unit force) and is expressed as  $D/F$ . *E*, or voltage, is equivalent mechanically to force, *F*. Substituting in the expression,  $\frac{1}{2} CE^2$ , we have  $\frac{1}{2} \times D/F \times F^2$ , or  $DF/2$ , the expression being identical with the mechanical case.

From the preceding, it is obvious that in an oscillatory circuit containing linear *L* and *C* elements, or Mass and Compliance, the fundamental nature of

[Continued on page 38]

# Unobtrusive Pressure Microphone

HARRY F. OLSON\* AND JOHN PRESTON\*

The description of a new microphone design which offers the advantages of a ribbon-type transducer with small over-all size and high quality performance.

THE GENERAL TREND of microphones is in the direction of smaller units for the intimate type of sound pickup. One of the first high-quality units of this type was the small RCA-KB2C "Bantam" velocity microphone.<sup>1</sup> It was commercialized<sup>2</sup> more than two years ago. The characteristics of smooth response, high sensitivity, and small size of the Bantam velocity microphone have combined to make it an exceedingly popular and successful microphone. At the time that the development work on this microphone was being carried out, consideration was also given to other types of small microphones. It appeared that a small pressure-type microphone would be a useful sound pickup system, particularly for applications where the ambient noise level is not high relative to the useful sound level and directional discrimination is not required.

In these considerations of a pressure microphone, the type of transducer was evaluated from the standpoints of size, sensitivity, electrical impedance, frequency response, transient and nonlinear distortion, and directivity.

The electrical impedance of a microphone is important because in the case of certain transducers, it places a limitation upon the distance the signal output

may be transmitted over a line without prohibitive attenuation and frequency discrimination. In the case of low-impedance microphones, employing magnetic and dynamic transducers, there is no practical limitation upon the length of the lines, providing the transmission distances are confined to those normally used in studios. In the case of high-impedance microphones, employing condenser, crystal and electronic transducers, the distances over which signals can be transmitted without considerable attenuation and frequency discrimination are quite small and some expedient must be employed to make it possible to transmit usable signals over the length of lines normally used in studios. If a vacuum tube is used as a part of or directly adjacent to the transducer element, then electronic, condenser and crystal transducers may be used.

Several years ago the mechano-electronic transducer makes it possible to build a very small pressure microphone. At the time that the research on the mechano-electronic transducer was in progress, an exceedingly small pressure microphone using this transducer was

also developed. It appeared that this was a solution for the small pressure type microphone. However, field tests of the electronic microphone by engineers of broadcasting companies indicated that it was not desirable to locate a vacuum tube at the end of the line or the sound pickup point. They felt that, from an operational standpoint, the nuisance and complexity of running power lines for supplying heater and plate voltages made the vacuum tube system undesirable. As an example, a great majority of microphone failures are due to breaks in the cable. Conventional microphones use only two signal leads. This situation would be aggravated by the multiplicity of leads required for the signal, heater and plate power in microphones employing vacuum tubes at the end of the signal line or the sound pickup point.

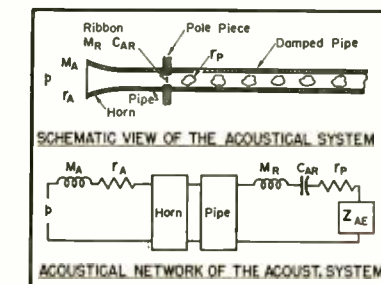

Fig. 3. Acoustical system and network of a pressure-type ribbon microphone with a horn coupled to a cylindrical pipe as the sound pickup means.

In the acoustical network:  $p$  = actuating sound pressure;  $M_A$  = inertance of the air load at the open end of the pipe;  $r_A$  = acoustical resistance of the air load at the open end of the pipe (the horn and pipe are represented as quadripoles);  $M_R$  = inertance of the ribbon;  $C_{AR}$  = acoustical capacitance of the ribbon;  $r_P$  = acoustical resistance of the pipe;  $Z_{AE}$  = acoustical impedance due to the electrical circuit.

also developed. It appeared that this was a solution for the small pressure type microphone. However, field tests of the electronic microphone by engineers of broadcasting companies indicated that it was not desirable to locate a vacuum tube at the end of the line or the sound pickup point. They felt that, from an operational standpoint, the nuisance and complexity of running power lines for supplying heater and plate voltages made the vacuum tube system undesirable. As an example, a great majority of microphone failures are due to breaks in the cable. Conventional microphones use only two signal leads. This situation would be aggravated by the multiplicity of leads required for the signal, heater and plate power in microphones employing vacuum tubes at the end of the signal line or the sound pickup point.

Quality is another consideration. Broadcast engineers like ribbon transducers because of the smooth response with respect to frequency, the freedom from nonlinear distortion, and the faith-

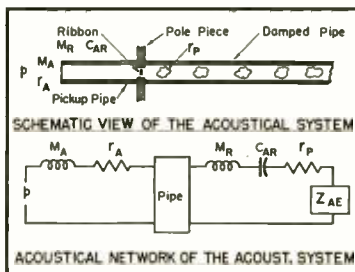

Fig. 2. Acoustical system and network of a pressure-type ribbon microphone with a cylindrical pipe used as the sound pickup means.

In the acoustical network:  $p$  = actuating sound pressure;  $M_A$  = inertance of the air load at the open end of the pipe;  $r_A$  = acoustical resistance of the air load at the open end of the pipe (the pipe being represented as a quadripole);  $M_R$  = inertance of the ribbon;  $C_{AR}$  = acoustical capacitance of the ribbon;  $r_P$  = acoustical resistance of the pipe;  $Z_{AE}$  = acoustical impedance due to the electrical circuit.

tronic transducer<sup>3</sup> was developed. It has been commercialized and is designated as RCA 5734. This is a very small transducer, being 5/16 inch in diameter and 1.3 inches in length. The mechano-electronic

\*H. F. Olson, "Mechano-Electronic Transducer," *J. Acous. Soc. Am.*, March 1947, p. 307.

\* RCA Laboratories, Princeton, N. J.

<sup>1</sup>L. J. Anderson, and L. M. Wigington, "The Bantam Velocity Microphone," *AUDIO ENGINEERING*, Jan. 1950, p. 13.

<sup>2</sup>*Broadcast News*, May 1948, p. 4.

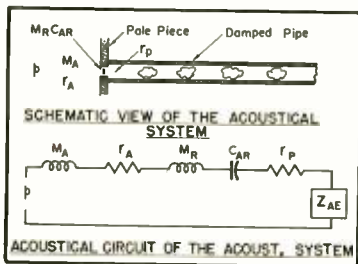

Fig. 1. Acoustical system and circuit of a pressure-type ribbon microphone.

In the acoustical circuit:  $p$  = actuating sound pressure;  $M_A$  = inertance of the air load;  $M_R$  = inertance of the ribbon;  $C_{AR}$  = acoustical capacitance of the ribbon;  $r_A$  = acoustical resistance of the air load;  $r_P$  = acoustical resistance of the damped pipe;  $Z_{AE}$  = acoustical impedance due to the electrical circuit.



ful response to transients. The low electrical impedance of ribbon transducers makes them absolutely immune to wide variations in temperature and humidity. As a matter of fact, the ribbon transducer can be operated under water<sup>4</sup> without any additional insulation or protection for the ribbon.

As a result of this background of research, development and field tests, it appeared that the ribbon-type transducer would be the logical one for a small pressure-type microphone. Furthermore, the response-frequency characteristic, output level, and electrical impedance characteristic would be comparable to existing ribbon-type velocity and unidirectional microphones.

It is the purpose of this paper to describe the development of a small, unobtrusive, pressure type ribbon microphone.

#### Development Considerations

The vibrating system of ribbon type pressure microphones is shown in Fig. 1. The first consideration is an analysis of the vibrating system.

The velocity of the ribbon, in centimeters per second, is given by

$$\dot{x} = \frac{p}{AZ_A} \quad (1)$$

where  $p$  = sound pressure, in dynes per square centimeter,  
 $Z_A$  = acoustical impedance of the vibrating system, in acoustical ohms,

$$= r_A + r_p + j\omega M_R + j\omega M_A + \frac{1}{j\omega C_{AR}} + Z_{AB}$$

where  $r_A$  = acoustical resistance of the air load, in acoustical ohms,  
 $r_p$  = acoustical resistance of the pipe, in acoustical ohms,  
 $M_A$  = inductance of the air load, in grams per centimeter to the fourth power,  
 $M_R$  = inductance of the ribbon, in grams per centimeter to the fourth power,

$C_{AR}$  = acoustical capacitance of the ribbon, centimeter to the fifth power per dyne,  
 $A$  = area of the ribbon, in square centimeters,

$$Z_{AB} = \frac{B^2 l^2 A}{Z_B}$$

$B$  = flux density, in gaussess,  
 $l$  = length of the conductor, in centimeters, and

$Z_B$  = electrical impedance of the electrical load on the ribbon, in abohms.

The problem is to develop a system with high sensitivity, uniform response, wide frequency range, and small size. Studies were made of different structures in an attempt to obtain a system which would

satisfy all the requirements. It appears that a ribbon length of about one inch would be required to obtain uniform response to 40 cps. With the ribbon length established, the next problem is the development of the magnetic structure.

The voltage, in abvolts, generated by the ribbon is given by

$$e = Bl\dot{x} \quad (2)$$

where  $B$  = flux density, in gaussess,  
 $l$  = length of the ribbon, in centimeters,  
 $\dot{x}$  = velocity, in centimeters per second.

The electrical resistance, in abohms, of the ribbon is given by

$$r_B = \frac{l}{td} K_r \quad (3)$$



Stand-mounted cradle holds microphone and permits immediate removal for hand-held use.

where  $t$  = thickness of the ribbon, in centimeters,  
 $d$  = width of the ribbon, in centimeters, and  
 $K_r$  = resistivity, in microhms per centimeter cube

The power output, in ergs per second, into a matched load is given by

$$P = \frac{r_B e^2}{4} \quad (4)$$

Using equations (2), (3), and (4)

$$P = K_r \frac{l^2 B^2 \dot{x}^2}{4td} \quad (5)$$

$K_r$ ,  $l$ ,  $t$  and  $\dot{x}$  are fixed under the preliminary assumptions, so that



Small size and neat contours of the unobtrusive microphone make it particularly for audience-participation shows.

$$P = C \frac{B^2}{d} \quad (6)$$

where  $C$  is a constant.

The problem is to maximize equation (6). This must be done in a certain space and geometrical configuration. The maximum diameter of the unit was fixed at 1 1/4 inches. The maximum weight was fixed at one pound. Under these conditions, the air gap,  $d$ , was determined to be .060 inch. The remaining problem is to design a magnet structure which will deliver the maximum flux density,  $B$ , to this air gap for the weight which can be allocated the magnet structure.

The diameter of the unit was fixed at 1 1/4 inches. Diffraction effects which govern the discrepancy between the free field sound pressure and the sound pressure on the surface of a cylinder begin at about 5000 cps for a cylinder of these dimensions. Therefore, a smaller pickup system is required in order to obtain a system free of wide fluctuations in response due to diffraction effects in the frequency range up to 15,000 cps. It has been shown that a pipe can be coupled to a ribbon unit as shown in Fig. 2, and smooth response-frequency characteristics obtained providing the surge acoustical impedance of the pipe is equal to the terminating acoustical

<sup>4</sup>Olson, Hackley, Morgan and Preston, "Underwater Sound Transducers" *RCA Review*, Dec. 1947, p. 698.

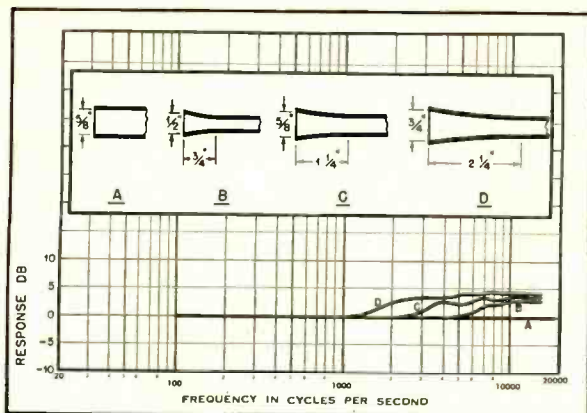

Fig. 4. Response-frequency characteristics of a cylindrical tube and three horns used as the sound pickup end of a pressure-type ribbon microphone.

impedance. This state of affairs can also be deduced from the acoustical network of the system. Fig. 2.

In a consideration of the response with respect to pickup angle, it appeared desirable to accentuate the response in the extreme high-frequency region. An increase in the response in the high-frequency region can be obtained by means of a horn as shown in Fig. 3. The response-frequency characteristics for a cylindrical tube and three different horns used as the sound pickup end of the pressure-type ribbon microphone are shown in Fig. 4. The characteristics of Fig. 4 show that it is possible to accentuate the high-frequency response by means of a horn. The magnitude and frequency region of the increased response depend upon the dimensions of the horn.

#### Construction

A detailed sectional view of the unobtrusive pressure ribbon microphone is shown in Fig. 5. A small horn is coupled to a cylindrical tube which in turn is coupled to the front of the ribbon by means of a round-to-rectangular connector of constant cross-section. The back of the ribbon is coupled to the damped folded pipe or labyrinth by

means of a rectangular-to-round connector. The ribbon impedance which is practically a pure resistance of 0.25 ohms is stepped up to a standard line impedance.

The microphone as a hand held unit is shown in one photograph, while the

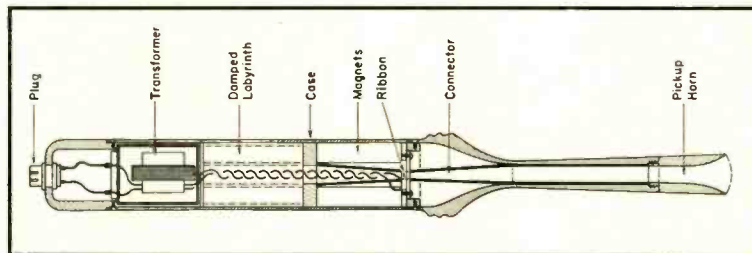

Fig. 5. A sectional view of the unobtrusive pressure microphone.

other shows the microphone mounted in a stand, which is equipped with a cradle for holding it. The cradle is tapped with a standard thread so that it can be attached to a conventional stand. With this arrangement, the microphone can be lifted in and out of the cradle, and thereby separated from the stand without the use of screws or other semipermanent fastening means. The cradle increases the usefulness of the microphone

when it is used intermittently either hand-held or as a stand microphone.

The bottom end of the microphone is also tapped with a standard thread so that the microphone can be mounted semipermanently on a conventional stand, if desired.

#### Performance

The response-frequency characteristic of the microphone for sound incident along the axis is shown in Fig. 6. The response is uniform from 50 to 15,000 cps. It will be seen that there is some accentuation of response in the high-frequency region due to the small pickup horn. The response for sound incident at 90 deg. with respect to the axis of the microphone is also shown in Fig. 8. Under these conditions, the response is uniform throughout the entire response range, the accentuation produced by the horn compensating for the loss by diffraction. It will be noted that the variation in response with angle is small.

This is due to the very small dimensions of the pickup tube.

It is thus shown that a microphone has been developed for sound re-inforcing, broadcast, and television pickup with the following characteristics:

1. A ribbon-type pressure transducer.
2. Diameter of body,  $1\frac{1}{4}$  inches; overall length, 12 inches; diameter of pickup point,  $\frac{5}{8}$  inch.
3. Weight, one pound.
4. Output, 110 microvolts per dyne per square centimeter for an output impedance of 250 ohms. The output is comparable to existing microphones.
5. Uniform response from 50 to 15,000 cps.
6. Nondirectional response.
7. Suitable for hand held or stand use.

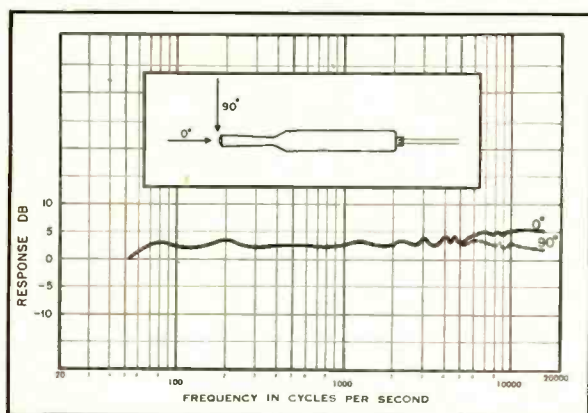

Fig. 6. Open-circuit voltage response-frequency characteristic of the microphone.

## THE AUDIO FAIR

— 1950 —

**October 26-27-28, 1950**

Hotel New Yorker  
New York City



## Report on

# Speech Communication Conference at M. I. T.

LEO L. BERANEK\*

**U**NDER THE JOINT AUSPICES of the Acoustical Society of America, the Carnegie Project for Scientific Aids to Learning at the Massachusetts Institute of Technology, and the Psycho-Acoustic Laboratory of Harvard University, a conference on speech communication was held at M.I.T., May 31 through June 3rd. Two hundred attended. The conference featured technical sessions on production of speech, analysis of speech, group communication, perception of speech, and theory of communication. Distinguished speakers from Europe contributed on the subjects of phonetics, the operation of the ear, and the conversion of the spoken word into written symbols.

In the opening address, S. S. Stevens of Harvard emphasized the basic importance of speech as a means of communication and some of its superiorities over vision. The voice is capable of expression emotion; the syllabic rate is higher than the rates of motion of the hands and fingers; speech goes around corners; and one can hear even when he is asleep. Stevens defined communication as the discriminatory response of an organism to a stimulus. He showed that this general definition includes several more familiar ones as special cases.

In the discussion that followed, Norbert Wiener of M.I.T. emphasized the importance of considering the efficiency of the overall communication system composed of the talker, the intervening equipment, if any, and the listener. He pointed out that at first sight one might think that it was possible to get more information from a message than was sent. For example, a mother receives a telegram from her son at Christmas. It says, "We are thinking of you today. We are all well. Merry Christmas." The only information sent over the telegraph system might have been the number 15 to indicate that particular message. The actual amount of information turned over to the mother was more because of the storage of information at the receiving end. In the same way the amount of information conveyed from a talker to a listener when certain words are uttered depends on the complete training of the listening individual. *Soul* and *socialism* are examples of words that mean quite different things to different listeners. Dr. Wiener pointed out that we must either speak in a limited way of the information transmitted over the communication system in terms of a mathematical analysis of the waveform or else we must consider the entire system including the

\*Massachusetts Institute of Technology, Cambridge, Massachusetts.

secular changes (e.g. learning) of the listener and the talker.

### Co-operative Effort

Alex Bavelas of M.I.T. described some interesting experiments involving the co-operative effort of a group of five people solving complex problems. The five people as a group were given puzzles to solve. There were three different arrangements of the group. In one case the five people were seated in booths arranged in a circle so that each person had someone on each side of him to communicate with. In another case the five people were arranged in a row and each was permitted to communicate only with his immediate neighbor(s). This tended to make the middle man be a leader. In the third case, four of the booths were arranged in a circle with the fifth at the center and each of four could communicate only with the person in the center. This made the person in the center definitely the leader. It was found that, in solving a problem, the group with definite leadership did the task most efficiently, especially after some experience, but the four men who were not leaders were unhappy about the ability of the leader. In the case of the circular arrangement of the booths, the task was done more slowly, but the group spirit was much better. When the problem to be solved was changed from an easy one to one very much more difficult, the group with a definite leader often did not even solve it and fell to bickering, while the group with circular arrangement eventually did solve the problem. The conclusion is that the arrangement of the communication channels in an organization, where joint effort is required to accomplish a task, may profoundly affect the performance of the group.

Two very interesting talking machines were demonstrated. One machine, described by F. S. Cooper of the Haskins Laboratories produced intelligible speech from celluloid strips on which white marks had been painted by hand. The other, demonstrated by H. K. Dunn of the Bell Telephone Laboratories, produced vowel and semi-vowel sounds like "ahh," "ee," "ooo." These machines at the present time serve to illustrate those characteristics of speech that are essential to intelligibility and suggest how we may eventually be able to transmit intelligible speech over a telephone system with a much narrower bandwidth by eliminating the unessential material in the speech wave.

J. Dreyfus-Graf of Geneva, Switzerland, described a machine that converts words and sentences *spoken* into it into shorthand-

type symbols. This machine is a mechanical stenographer. The inventor reports that he has had good luck in reading the symbols produced from his own voice and that he expects no trouble in reading symbols produced by voices of different dialects as long as the persons speak reasonably clearly.

### The Cochlea

Two theories of the acoustical action of the cochlea were presented in papers by O. F. Ranke of Erlangen, Germany, and J. Zwislocki of Basel, Switzerland. The cochlea is the snail-shaped inner ear. It contains the basilar membrane along which terminate the fibers of the auditory nerve. One end of the liquid-filled cochlea contains a little window covered by a thin membrane that vibrates in response to sound. According to Zwislocki, the liquid-immersed basilar membrane is the equivalent of a transmission line whose parameters change with distance along the line. For any particular frequency, a maximum of vibratory amplitude of the membrane occurs at a particular position along the membrane. Such a situation also exists on a transmission line with non-constant parameters, in that for each frequency a maximum of current will occur at some particular location along the line. The ear therefore perceives pitch according to which nerve fibers receive maximum excitation. Ranke's theory, in contrast to Zwislocki's, starts with the basic equation of hydrodynamics. The results of both theories are in good agreement with experimental data obtained by Békésy of Harvard. In other respects the theories differ. Each author expressed the opinion that the other's theory is basically incorrect.

### Speech Perception

Three papers were presented on the psychological and physiological aspects of speech perception. Robert Galambos of Harvard described experiments in which micro-electrodes were inserted into the nerve structure and electrical action currents of individual neurons were measured. These measurements indicate that whereas sounds of certain frequencies may excite a particular neuron to greater action than occurs when there is no external excitation, sounds of other frequencies reduce or inhibit the action of the neuron. Galambos reported that the rate of discharge of the neurons for the higher centers of the auditory system is very low. This argues against the idea that the frequency of discharge is a correlate of the subjective pitch, even for frequencies in the vicinity of 300 cps. W. A. Rosenblith described experiments on anes-

[Continued on page 40]

# The Art of Tape Recording—III

JOEL TALL\*

A discussion of one of the more important operations in the assembly of a completed tape-recording of a radio show.

**T**HE PROCESS OF RE-RECORDING, or dubbing, magnetic tape is intrinsically a simple operation. It is necessary, of course, to have at least two machines and to match, or bridge, the input of the recording machine to the output of the playback machine. Re-recording may be done before or after editing, depending on the reason a copy of the original tape is needed. In some cases re-recording may be wholesale, and a battery of recorders may be set up to make copies of a program for distribution to regional broadcast stations, or some system such as Minnesota Mining and Mfg. Co.'s method of "printing" copies for commercial purposes may be employed. Basically there is no loss of fidelity in re-recording and practically no noise is added to the copies. In some respects, copies can be considerably better than the original as we shall point out later on in this article.

## The Re-Recording Studio

The re-recording studio should be so laid out and equipped that the engineer can control the various processes with comparative ease and with a minimum of lost time. The following set-up for a re-recording studio should be sufficient to permit almost any re-recording operation that will be found necessary.

The studio should be equipped with at least three similar tape recorders, one of which should have a tape drive capable of being varied in speed so that tape recorded in the field at above or below normal speed may be re-recorded at the correct speed. (The turntables of this machine should be adaptable to any type of tape reel.) The method of arriving at the correct speed does not matter as long as the tape can be played back for re-recording at the speed at which it was originally recorded. The other two machines should be standard in all respects and should be identical. The frequency response and noise levels of all three machines should be exactly the same, both on record and playback positions.

A four-position mixer should be available, the output of which can be patched to the recording input of any one machine. The outputs of any two machines may then be patched into the mixer for

re-recording on the third. Each of the positions on the mixer has available in its circuit a variable equalizer filter, which can be either switched in or faded in on the mixer panel. Also, each mixer position has echo available, controllable in any degree. There should be a VU meter for each position, since a very close control of individual levels is indispensable in re-recording. The two spare positions are then used, when necessary, for live voices and for any other effect or sound—whether it comes from a third and fourth tape machine, from discs, or from nikes. The mixer should also have available the stopping, starting, record, and play controls of the recorders. In this setup the re-recording engineer has at his fingertips all of the ingredients for an excellent re-recording job (see Fig. 1).

At this point perhaps we had better stop to answer the obvious question, "Why all the emphasis on re-recording? Why should a description of this process consume so much space?" The answer has much to do with this engineer's conception of the future of radio broadcasting. One trend in broadcasting is to utilize top-grade artists on TV "live," if possible, and to record the audio for AM. Also, as explained before, some artists prefer to record their programs wholesale or at times and places that cannot be scheduled for direct air broadcast. The processes of re-recording and editing permit making TV audio palatable for AM use—plus any of the operations that follow.

## Correction of Off-Speed Recording

A tape recorded off-speed in the field or in countries where 60-cps a.c. supply is not available can be re-recorded in the studio from a variable-speed machine to a standard-speed machine. However, there is a limit to what can be done in correcting tape recorded at abnormal speeds. If the incorrect speed has been constant all through the recording, all will be fine. But if there has been tape slippage, no ordinary technique will do the job. A variable-frequency or variable-voltage power supply may be used to operate the drive motor at different speeds, depending upon whether it is a synchronous motor or a simple series-field motor. A variable-taper mechanical drive might also be used for varying the

capstan speed. But there is no real cure for a tape that has slipped during recording.

## Reduction of Noise and Hum

Occasionally tape will be recorded with a noise or hum component that was not heard during the recording session. Short-wave transmissions may contain a characteristic generator whine, or may have been filtered too much or too little by the communications companies concerned. In cases like these, re-recording through a variable equalizer can provide a usable recording. In general, overseas recordings may be advantageously re-recorded after filtering out everything below 150 cps and everything above 4000 cps. The engineer must use his own judgment and re-record for good intelligibility. The writer has improved recordings from overseas by using reverberation after filtering which added to the "apparent loudness" of the voice without accentuating the noise content. In some cases it is necessary to "roll off" low frequencies beginning at about 250 cps to get rid of the more flagrant hum harmonics.

Although the writer assumes that his confreres always will record at the proper level, as outlined in Part II, any lapse from normal may be corrected by re-recording. Material recorded at low level cannot be re-recorded at an increased level without also increasing the level of the noise. Therefore, if the re-recording is to be put on the air without going through a mixing studio, it would be better to "roll off" the more noticeable noise frequencies (about 6000 cps and up) during the dubbing operation. Remember to keep levels up. Wide dynamic range is a fine thing to theorize about, but a great majority of listeners want to hear plainly without straining and without twiddling at their receiver gain controls.

The uses of a properly designed equalizer in reducing noise and hum during re-recording has been discussed. The same equalizer may be used to advantage to bring dialogue in sharp focus or to change presence. It can be used to cut down or increase sibilance, as needed. A director may wish to change a musical recording so as to accentuate one band of frequencies or another or to simulate varied effects. He may want music "re-

\*Columbia Broadcasting System, New York.



verberated" and re-recorded or any combination of filter and reverberation may be used to gain an effect.

Present practice indicates that one of the chores of tape engineers will be that of recording TV audio for AM broadcast at another time. Due to many factors, some controllable and some not, TV audio quality does not always compare with that of AM or FM radio. With microphones out of camera range or hidden, filtered P.A. systems, actors' changing positions, etc., TV audio may have very little at the low end, a hump in mid-frequency, or over-accentuated high frequencies. Re-recording through an equalizer can prove effective in improving the quality of such a recording. It would be still better, and result in better signal-to-noise ratio, if the equalizing were done *before* recording in such cases.

#### Blending of Program Material

With the approaching standardization of tape recording machines, the assembly of taped programs from material recorded at different places and at different times will become commonplace. The dialogue may be recorded in Hollywood, the music in New York, and the commercials in Chicago. There need be no difficulty in blending all these ingredients into a good show provided that there is no audience. If there is an audience, its reactions and applause should be recorded only at one point, say New York, and enough "audience only" sound recorded to serve as background throughout the whole program. Announcements and commercials may thus be inserted in the tape before a "live" audience, no matter where recorded. This whole process requires a close control of timing, levels, and sound (filter and reverberation). The re-recording engineer will have to make use of a cue sheet and control every process accurately. Needless to say, the "blending" should be rehearsed adequately before re-recording the final tape.

One of radio's most used devices for indicating a change of place, time, or mood is the "bridge." A bridge may consist of music, sound effects, background sound, or absolute silence, or any combination of these four factors. Bridging is a technique that finds many interesting applications in tape re-recording and deserves full treatment here.

In Part II it was suggested that background sounds be recorded every time they change in character. These same sounds may be used for bridge material as indicated by the director. The obvious purpose of a bridge is to provide a vehicle for "carrying" the listener from one sequence to another. A good bridge establishes the idea it is meant to picture without being too obtrusive or

shocking. As ordinarily used, background sound bridges are smooth blends and may be made in the following manner: Suppose that you have recorded a program, one part of which takes place in a farmhouse and a second part in a railroad car. The transition requires at least three background sounds, possibly more. The minimum blend requires sound inside the house, outside the house, and the railroad car sound. An elaborate bridge could use these, plus auto starting, running, auto stopping, station sounds, train outside, train starting (perhaps with whistle), car inside, and then inside background with voices. The technique of making bridges effective requires that each sound registers in the listener's mind and establishes its intended meaning. The degree of level and the length of time necessary to establish a sound will vary according to the recognizability of the sound.

Where a bridge from one sequence to another is absolute silence, be careful not to mar the effect with any mechanical sound. Fade out completely and fade the new sequence in *after* starting the tape playback.

#### Procedure in "Matching" Sound

Suppose that five programs have been recorded from which one additional "warp-up" program is to be created. The program director and the engineer have listened to all the material and have noted variations in level, background, and reverberation. From the director's point of view the dramatic value of the program requires that a "dead" portion of recorded tape be placed between two "live" portions. The

engineer then must re-record the "dead" portion. It is possible to make a recording "live" by sending it through an echo chamber or a mechanical or tape reverberator. But it is not possible to make a "live" recording "lead." If the operation has been performed carefully, the tape portions will then all match and can be edited as needed. Suppose that one of the above programs had been recorded in a studio which had in it a smaller audience than normal. There might then be an apparent increase in "liveness," and the applause patterns would be entirely different. This situation could be partially cured by re-recording at a lower level than normal and by cutting off the extreme highs. If necessary, the applause could be doubled or quadrupled in "number of people applauding," by re-recording the applause two or more times. The first re-recording would be a simple copy of the applause. Then both "applause" dubs should be played back on two separate machines and their outputs recorded on a third machine. If the two "applauses" are started at the proper time interval, the resulting recording will sound like the applause of an audience twice as numerous as it actually was. An artistic job of re-recording will be entirely acceptable here; do not, however, mutilate the applause pattern. Applause bursts are rare. Ordinarily people begin to applaud in a scattered manner, build up to a crescendo and then taper off. One cannot easily duplicate the scattered applause effect, and it should not be attempted unless every other method is inapplicable. The hallmark of poor tape

[Continued on page 39]

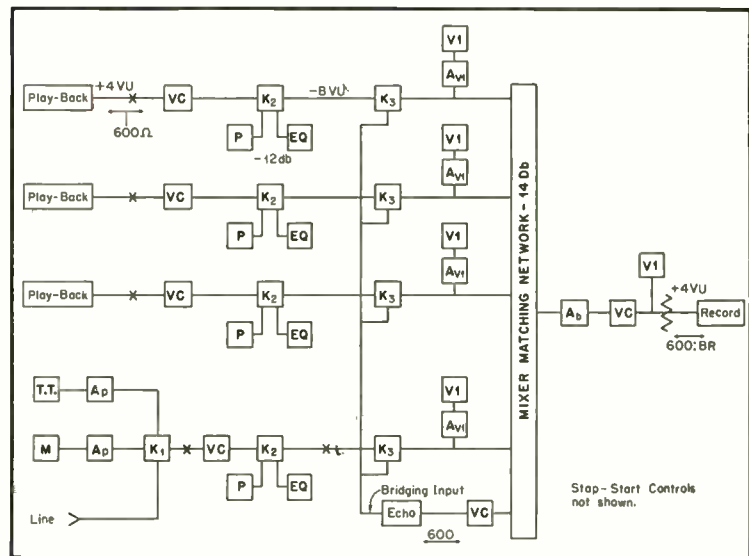

Fig. 1. Suggested block diagram suitable for the re-recording operation using several tape machines in conjunction with other sound sources.



Audio Engineering Society,  
Box F, Oceanside, N. Y.

# AUDIO engineering society

Containing the Activities and Papers of the Society, and published monthly as a part of AUDIO ENGINEERING Magazine

## OFFICERS

Theodore Lindenberg, President

J. D. Colvin... Executive Vice-Pres. John G. Frayne... Western Vice-Pres.  
Norman C. Pickering... Secretary Ralph A. Schlegel... Treasurer

## Heated Stylus Recording Technique

LEON A. WORTMAN\*

ON MAY 9TH a paper on the heated stylus recording technique, using the Fairchild Thermo-Stylus System, was delivered to the New York Section of the Audio Engineering Society. The speaker was Theodore Lindenberg, Engineer in Charge of the Disc Division of the Fairchild Recording Equipment Corporation. Some of the highlights of the question and answer period that followed the talk are given here.

**Q:** When using a heated, or, as you call it, "Thermo-Stylus" for cutting in lacquer, is there a noticeable difference in driving power required to the head?

**TL:** At middle and low frequencies there is very little difference. When a sharp jewel is used, somewhat less power is required; but the driving power required to record high frequencies is appreciably less.

**Q:** Would it be possible to obtain the heating effect by the use of radio frequencies, thus eliminating lead wires to the stylus?

**TL:** This might be possible if the cutting jewel, the sapphire itself, could be properly metallized and effectively isolated from the stylus shank to avoid conduction of heat to the cutterhead.

**Q:** Did you get any steady state measurements of the temperature at the tip of the stylus?

**TL:** Very frankly, no. We were very careful, of course, to determine what varying degrees of heat and steady-state tones would do to the response of the cutter and, of course, we did determine when the heat is carried to an extreme degree we were apt to affect the cutter performance somewhat. However, steady state measurements have not been made in this case.

**Q:** In your optical measurements, do you take your reading on a feather edge on the high frequencies or do you take it at the spectrum volume?

**TL:** That is a good question, because I think those who have done appreciable recording work have noticed that with some cutting jewels the feather-edge measurement is not the same as the measurement which is attained from the light reflected by the walls of the grooves themselves. However, as I stated before, the jewels must have flat sides; and if they do have flat sides, you can take your measurement from the pattern itself because that is the

measurement of the playback value. The feather-edge measurement in many cases will be the in-air pattern of the cutter. That has been our experience.

**Q:** What material have you used for the jewel?

**TL:** We have used sapphire.

**Q:** You heat the sapphire?

**TL:** Yes. We heat the sapphire directly. The coil is wound on the sapphire and is impregnated with refractory cement. The motive is to get the heat directly to the disc. If we heat the shank of the cutter, less heat will go to the disc and more to the head.

**Q:** Will it be possible to use a harder lacquer mixture which will give even a greater number of playbacks when cutting with the Thermo-Stylus?

**TL:** As far as being able to cut a harder lacquer, it probably is possible. I think Mr. LeBel of Audiodisc can give more information. Can you make lacquer harder, C. J.?

**LeBel:** Well, we can make lacquer as hard as you want it. (Laughter) The question is what will happen—well, I can give you a practical answer. After you get hot styli in use all over the country, it will be practical to make a hard lacquer, if you want harder lacquer. On the other hand, at the present time it would be out of the question to run hard lacquer infrequently, or on an interrupted schedule. The problem of changing over disc manufacturing systems is formidable. You have to scrub the equipment out, practically with a tooth brush.

**Q:** Do you get any modulation from the use of a.c. for heating the stylus in such proximity to the cutter?

**TL:** We have been unable to measure any in this case. In this particular cutterhead design the jewel is well separated from the magnetic field and the hum in the groove, if any, is unmeasurable.

**Q:** Can't the record be heated before you make the recording to accomplish the same result?

**TL:** Mr. Kettering of the Fairchild Recording Equipment Corporation told me he had done that a good many years ago to improve the cutting. That was in the early days of lacquer recording when the material was inclined to be rather difficult, and he had gotten away with it successfully. However, the real advantages of this Thermo-Stylus technique are gained by creating a rather high heat directly at the tip of the stylus. As I said, it is hard for us to tell just what the temperature is, but in the coil it runs anywhere from 400° to 600° F. It would be rather difficult to heat an entire disc to a temperature such

as that. We have found that much heat is necessary to achieve cutting where you get the lowest surface noise and minimum frequency deviation.

(Remark from audience: You'd better not be in the room when you heat the whole disc to 500°.) (Laughter).

**Q:** What effect do you notice on diameter equalization when you use the heated stylus? How much reduction in diameter equalization could you accomplish?

**TL:** The curve we showed you a moment ago indicated a loss at 8,000 cps at 4" diameter of about 5 to 5½ db, under standard methods, with standard cutting jewels of professional grade. When the heated stylus is used, where we also have the small face, that loss drops to less than 2 db, so, as you can see, there is about 3 db gain.

**Q:** How far up did you go in the frequency spectrum?

**TL:** In this particular case our measurements went to 10,000 cps. The channel used was flat to about 9,000 cps.

**Q:** Have you noticed the effect on temperature when the suction pipe is closer to the stylus or further away? Does that affect the temperature?

**TL:** I suppose it does to some extent. We have used suction in a good deal of the work. The effect is very noticeable on the leads that go to the coil. Under some conditions these leads are actually hot enough to become slightly incandescent. The vacuum, of course, tends to cool them; but there has been no noticeable effect on the noise level of the disc.

**Q:** You mentioned before that you start cutting first and then turn on the heat. What is the reason for that?

**TL:** The reason is that the chip becomes extremely limp and quite soft when the Thermo-Stylus is used. If you start the chip with the heat turned on, the chip will lie right down in the groove. Come around one revolution and you have some smoke that messes up the record. If you start the chip cold, it will throw in toward the center as it usually does. Once the chip is cleared and running, the heat can be turned on and the chip will lie perfectly.

**Q:** How is the coil held onto the stylus to prevent it from falling?

**TL:** The coil is encased in cement which holds it firmly so that it can neither vibrate nor slip down nor off the stylus.

**Q:** I presume it is a ceramic cement.

**TL:** It is a ceramic cement and soluble so that the coil may be removed to enable resharpening the stylus.

**Q:** What about the amount of groove echo?

[Continued on page 42]

\* Fairchild Recording Equipment Corp. Whitestone, New York.



# The Diamond as a Phonograph Stylus Material

E. J. and M. V. MARCUS\*

A thorough knowledge of the characteristics of diamonds is required in the preparation of phonograph styli. The authors show photographs which compare wear of different stylus materials.

**U**PON EXAMINING the physical properties of groups of raw materials found in nature, we generally find small increments in the values of these properties. Diamond is the outstanding exception to this rule in that it possesses durability and hardness values which exceed those of the closest comparable material—sapphire—by almost a hundred fold.

Diamond was recognized, even in antiquity, as possessing properties which have made it the most valuable material (except for some radio-active elements) on earth. These properties are durability, beauty, and rarity.



Fig. 1. Small fine industrials. Selected whole diamonds used in manufacture of playback styli. Preferred to cleavages due to greater structural strength. Weight before processing 0.2 gm; after processing, 0.04 gm.

For technical purposes, we are most concerned with the durability and hardness of diamond.

#### Formation and Occurrence of Diamond

Diamond is pure crystalline carbon occurring sparingly in volcanic rock. Carbon, trapped in molten lava and subjected to tremendous pressure and heat, crystallizes slowly to form diamond. Although it is supposed that all diamonds were formed in this manner, only in South Africa do we actually find large volcanic intrusions or "pipes" containing deposits of diamond. Diamonds found in

\* The Tetrad Corporation, Yonkers, N. Y.

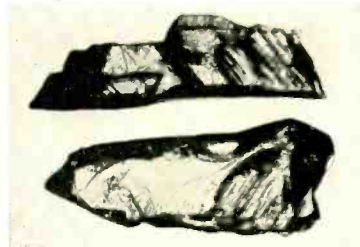

Fig. 2. Diamond cleavages, or chips from larger stones.

other parts of the world, the Belgian Congo, Brazil, India, Borneo and Australia, are found in alluvial deposits. The original volcanic sources remain undiscovered. Africa produces about 95 per cent of the world's production, which has amounted to as much as 13,000,000 carats yearly (one carat = 0.2 gms).

The diamond-bearing volcanic pipes in South Africa were discovered accidentally between 1866-1888. These pipes, called blue ground, contain approximately 1 part of diamond in 15,000,000 parts of rock. The soft blue ground is mined, crushed and washed in troughs containing grease pans. Diamond, having a great affinity for oil or grease, sticks to the grease in the pans, and the stones are then collected and sorted.

#### Classification of Diamond

There are various types of diamonds, and each has its specific application. The most valuable are the large, clear white, nearly flawless stones which are used for gem purposes. However, there are other types used for industrial purposes which possess the same physical and chemical properties but are unsuited for gems. Diamonds may be transparent, cloudy or opaque, clear white, or colored in various hues. The qualities of those diamonds suited for use as styli for audio equipment will be discussed in this paper. Commercial diamonds are classified in several groups, two of which are:

- (1) **Fine Industrials:** Diamonds unsuited for use as gem stones due to small size, color or presence of small inclusions. In

all other respects these stones are similar to the diamonds used for gem purposes.

- (2) **Cleavages or Splints:** Chips cleaved from larger stones, usually during gemstone production. Lack the structural strength of small fine industrials. Sometimes employed for use as phonograph styli due to the comparative ease of fabrication.

#### Fabrication of Diamond Styli

There are three principal methods of shaping diamond for industrial use, namely bruiting, lapping, and sawing. All other methods are usually variations of the three employing special fixtures.

All methods use diamond in some form to reduce the size or change the shape of another diamond. Diamond is the only material hard enough to cut diamond effectively. Large stones are sometimes cleaved along cleavage planes which can be determined by experts.

#### Bruiting

The bruiting operation is similar to freehand wood turning in a lathe, using a tool rest. The diamond to be worked is placed in a special holder, called a *dop*, and put in the lathe chuck. A diamond tool placed in a long-handled holder and braced under the arm is worked against



Fig. 3. Each diamond stylus must be inspected carefully on a shadowgraph.

the spinning diamond in the lathe. This method is quite effective for rapid removal and rough shaping of diamond cones.

**Lapping**

This is the term used to describe the polishing of diamond surfaces and usually means the generating of a facet on a stone. Lapping is done on a rapidly spinning, porous cast iron wheel which has been impregnated with a mixture of diamond powder and olive oil. The stone is held in the dop and placed in a removable arm called a *tang*. It is then placed against the lap or wheel. Diamond crystallizes in the cubic system and has three equal axes intersecting at 90 deg. Lapping can only be done along planes which have a definite relation to these axes. Under the usual lapping conditions, diamond will not polish or cut readily against the so-called *grain* or out of relation to these planes. Therefore, in the polishing of diamond facets it is necessary to orient the stone properly to obtain the lapping direction. In polishing a cone and radius on a diamond, it is evident that rotating the diamond cone will encounter grain running in several directions and that conventional polishing methods can not be used. It was found necessary to polish at extremely high speeds with very fine diamond powder to develop a high polish on the cone and radius of the stylus. The entire polishing apparatus must be free of vibration and exceptionally accurate.

**Sawing**

Diamond can be sawed with a thin phosphor bronze saw charged with diamond powder and olive oil. Diamond impregnated metal saws are also used. The diamond to be sawed is nicked with a sharp pointed diamond and moved into the saw. There are optimum sawing directions, depending upon the crystal structure of the stone.

**Chemical and Physical Properties**

Lavoisier discovered that diamond consisted of carbon when he burned diamond at high temperatures to form

carbon dioxide, CO<sub>2</sub>. Diamond can be burned in oxygen between 700° and 900° C.

Diamond is very resistant to strong acids and alkalis. Concentrated solutions are frequently used to clean the stones. A mixture of sulphuric acid and potassium bichromate can oxidize diamond slowly at 200° C. Diamonds are cleaned of foreign matter from the mines by storing in hydrofluoric acid. They are cleaned after processing by cooking in a concentrated solution of potassium hydroxide, usually followed by a second cooking in sulphuric and nitric acid. Aqua regia is sometimes used to clean diamonds.

Remarkable as diamond is in its resistance to chemical action, it is even more outstanding in its amazing physical properties. The compact arrangement of the carbon atoms in the diamond has resulted in an extremely durable and hard material.

The following is a list of physical properties of diamond compared with alternative materials:

|   |                                |
|---|--------------------------------|
| Resistance to abrasive wear (Rosiwal)                 | 90,000                         |
| Wear resistance, path of turning tool (Grodzinski)    | 1,250                          |
| Ratio of time required to saw given area (Grodzinski) | 100-300                        |
| Indentation Hardness (Knoop)                          | 6000-6300                      |
| Initial bearing friction (Shotter)                    | 0.70                           |
| Breaking load on a radius (Schuler)                   | 25                             |
| Compressibility (Williamson)                          | 0.18                           |
| Surface Finish (Kayser)                               | Better than any other material |
| Index of refraction-sodium                            | 2.419                          |
| Dispersion  | 2.465                          |

Note: Moh's scale (1820) which gives comparative but not quantitative hardness values of gem materials has been omitted. Moh listed gem materials in order of ability to resist scratch marks.

The question is frequently asked, "How hard is diamond?" This is a difficult question to answer, since hardness is a composite property embracing many characteristics. When one thinks of something as being hard, he is at the same time thinking of a number of properties such as resistance to wear, ability to resist indentation of a sharp point and non-compressibility. For ex-

ample if we say a piece of wood is hard, we mean it cannot be sawed or chopped easily, or that it is difficult to drive a nail into it. If we say a piece of metal is hard, we may mean that it cannot be filed, sawed, or bent readily. Therefore, an answer can only be given in terms of the job being performed by the given materials. Numerical results for comparative hardness and durability of materials will vary from one set of conditions to another. However, a glance at the table of comparative physical properties shows that diamond has a tremendous advantage over its next best alternative material in resistance to abrasive wear, breaking load on a radius, indentation hardness, and compressibility.

**Phonograph Stylus Wear Tests**

Tests have been conducted to determine the comparative durability of various stylus materials.

When a playback stylus touches a record groove, only a small area of the stylus tip actually makes contact with the groove walls. The pressure per

TABLE I

| Diamond                        | Alternative Material |
|--------------------------------|----------------------|
| 90,000                         | Sapphire 1,000       |
| 1,250                          | Carbide 12.5-20.5    |
| 100-300                        | Sapphire 1.0         |
| 6000-6300                      | Sapphire 1600-2000   |
| 0.70                           | Sapphire 1.13-1.60   |
| 25                             | Sapphire 5           |
| 0.18                           | Sapphire 0.38        |
| Better than any other material | Glass 1.426          |
| 2.419                          | Glass 1.532          |
| 2.465                          |                      |

square inch may amount to several tons. The dynamic forces acting on the stylus tip are several and severe. Hard record materials containing abrasive have a greater ability to wear styli, but soft record materials often become imbedded with abrasive particles which also can cause rapid stylus wear. Stylus wear is rapid at first, and then, as the contact area becomes larger and the pressure per square inch decreases, wear continues at a slower rate. This effect is noticed with new clean records; however, as records become worn and the grooves become progressively loaded with abrasive particles, the rate of stylus wear may continue at a comparatively rapid rate.

The softer stylus materials have a great tendency to load the record grooves with abrasive particles, as shown by G. A. Briggs. It is a fallacy that styli made of soft materials cause less record wear. Briggs's photomicrographs show steel flakes imbedded in the groove walls after only one playing of a new shellac disc by a steel needle. Another photomicro-

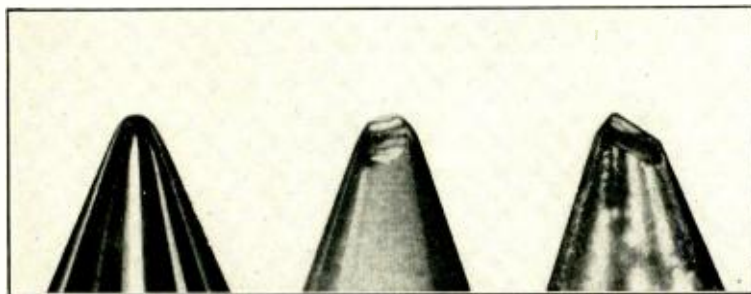

Fig. 4. Showing different 1.0-mil styli after fifteen plays on 12-inch Vinylite records with an 8-gram pickup. Left, diamond; center, sapphire; right, osmium.



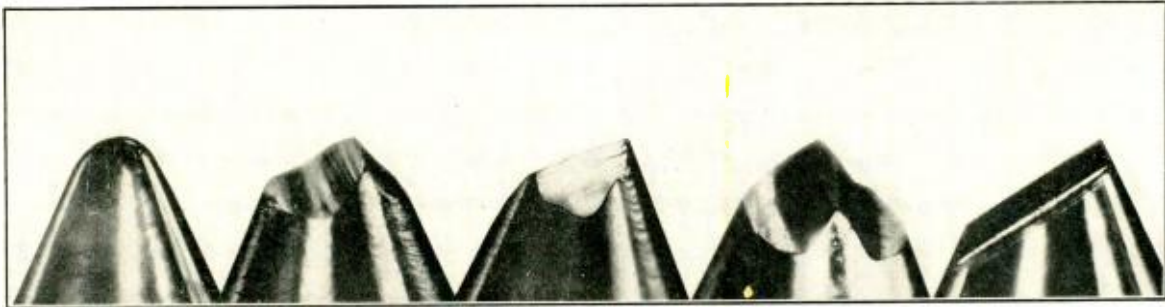

Fig. 5. 2.5-mil styli after 1000 plays on 10-inch Vinylite records with a 1¼-ounce pickup. From left to right: diamond; sapphire, front view; sapphire, side view; osmium, front view; osmium, side view.

graph shows a fibre needle completely abraded after one playing. These conditions lead to excessive record wear and poor response.

Our tests were conducted on Vinylite records, both standard groove 78 r.p.m., and microgroove 33⅓ r.p.m., using three stylus materials, diamond, sapphire, and osmium. The following conditions were observed for all styli under test:

we know that eventually even the diamond will begin to show wear.

The results of the micro-groove test were rather surprising. We found that after only 15 plays or 5¾ hours playing time, both the sapphire and osmium tips were very badly worn, and the test was stopped at that time. Again the osmium wore out faster than the sapphire. Photomicrographs and tracings

ing the resistance of various materials to corrosion. As the hardness of the powder used for the sand-blast was increased in going from quartz to sapphire to silicon carbide, the differences in the hardness values for the test materials become smaller. We observed corresponding results in our stylus wear tests. As we have already shown, the wear ratio between diamond and sapphire when played on Vinylite records is far above the Rosiwal 90-1 ratio, while this difference is not quite as great when these materials are used on shellac records.

Other results of our stylus and record wear tests showed that wherever there was excessive stylus wear it was always accompanied by excessive record wear. The badly worn styli are unable to track properly and have a tendency to chop off the high-frequency crests in the grooves. It was observed that stylus pressure, pick-up arms, and cartridges have a great effect on stylus and record wear. Considerable variation in rate of stylus wear was noticed in making wear tests on different types of equipment. For example, one professional arm caused 1.0 mil styli to wear out about five times faster than did other arms designed for amateur use.

Quality of response deteriorates gradually as stylus wear increases. This deterioration is noticed more readily on good quality audio equipment. On home-type equipment, with its narrower frequency range, stylus wear is usually not noticed audibly until it has become very bad. The gradual wear over a long period of time occurs slowly, and therefore the listener does not readily notice the change. He cannot remember how his equipment sounded six months before when the stylus was new. This has the unfortunate effect of causing excessive record wear by continuing the worn stylus in use.

[Continued on page 41]

TABLE II

|                  | Standard Groove | Microgroove             |
|------------------|-----------------|-------------------------|
| Record Material  | 10" Vinylite    | 12" Vinylite            |
| Record Player    | Garrard Changer | Webster 3 speed changer |
| Cartridge        | Astatic L 70    | G. E. RPX-041           |
| Pick-up weight   | 1¼ oz.          | 8 gms.                  |
| Radius of stylus | 2.5 Mils        | 1.0 Mil                 |

Test methods were made to conform to the severe playing conditions usually encountered with home-type equipment, and both tests were repeated twelve times to eliminate the possibility of error.

The results of the standard groove test showed that after 1000 plays, or approximately 50 hours playing time, wear on both the sapphire and osmium tips was very severe. Considerable wear was noticed as early as 100 plays. There was complete conformity to groove shape after 1000 plays. The diamond stylus did not show any wear after 1000 plays. Shadowgraphic tracings were made after each 100 plays and showed the progression of wear on the sapphire and osmium tips. Photomicrographs were taken of the stylus tips after 1000 plays. Two views were photographed, one parallel to the groove position and the other perpendicular to the groove.

Superimposing the osmium shadowgraph tracing over the sapphire tracing, we found the same amount of wear for sapphire at 1000 plays as for osmium at 400, or a 10-4 ratio. Since the amount of material removed from the diamond was so slight as to escape notice at 500 times magnification, the ratio of resistance to wear could be written: Diamond ∞, Sapphire 10, Osmium 4. However,

were made at the completion of the test. The diamond showed no sign of wear after 15 plays. The microgroove diamond was continued in use for a total of 100 plays or 37 hours. A slight flat was noticed on the diamond at the end of 37 hours.

Apparently, stylus wear is far more rapid on microgroove than on standard groove records. A rough estimate is about three times faster. The rate of wear of the 1.0-mil osmium and sapphire styli caused by microgroove playing is so rapid as to make these materials unsuited for continuous use on microgroove records.

To return now to the hardness values given in the table, we can see that it is necessary to conduct tests under the conditions of use before hardness values can be assigned to any materials.

If we could accurately weigh the stylus tips before and after the tests, it is quite certain we would find a difference between the diamond and sapphire in excess of the 90-1 ratio given by Rosiwal.

According to Ridgway and Eppler, the differences in relative mechanical corrosion hardness become smaller as the hardness of the material used for the corroding or abrading increases. They used a sand-blast technique in determin-

## The Miller Effect

**T**HE MILLER EFFECT, a frequently mentioned electronic phenomenon, is of importance in audio work, but is seldom discussed thoroughly. It results in large values of input capacitance at the grid of a three-element tube, or of a pentode with added grid-plate capacitance, when the tube is used in the conventional plate-loaded amplifier circuit. This capacitance is in addition to the grid-cathode capacitance caused by the geometry of the tubes, and frequently limits the high-frequency response of amplifiers in which such tubes are used.

Figure 1(A) shows the circuit of a triode with the interelectrode capacitances contributed by the tube geometry indicated by dotted lines. The equivalent circuit for this tube is shown in Fig. 1(B). If an alternating current signal  $E_g$  is applied at the input terminals, alternating currents will flow through the capacitors  $C_{gp}$  and  $C_{gk}$ . These currents together will be  $I_g$ . The amount of current  $I_g$  that flows through these capacitors is determined by the voltage and frequency of the alternating current input in addition to the gain and plate resistance of the tube and its load impedance. Examining the circuit, we see that the output voltage of the tube is effective-

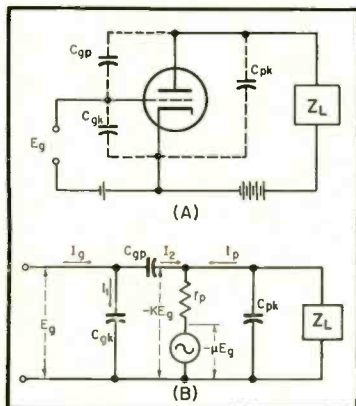

Fig. 1 (A). Typical tube circuit with inter-electrode capacitances indicated. (B). A.c. equivalent circuit at high frequencies.

tively in series with the input voltage and the capacitor  $C_{gp}$ . Therefore if we add the currents algebraically, the current due to the output voltage  $-KE_g$  is seen to aid the current due to the input voltage  $E_g$ .

To develop the full picture of what takes place it is best to use some simple mathematics and develop expressions for the gain of the amplifier stage and the

input admittance  $\left(\frac{1}{R+jX}\right)$  of the am-

plifier. With these figures we can determine quite closely the numerical value of the input capacitance of the stage.

From the equivalent circuit, we see that the output voltage is divided between the load  $Z_L$  and the plate resistance  $r_p$  and we may therefore write the expression for the output voltage

$$E_o = -\mu \frac{Z_L}{r_p + Z_L} E_g$$

and the gain, which is the ratio of input to output voltage across the load, is therefore

$$K = \frac{E_o}{E_g} = -\mu \frac{Z_L}{r_p + Z_L}$$

If the load is not a pure resistance it is possible to have a complex gain; that is, the output voltage can have a component that is more or less than the expected 180 deg. out of phase with the input voltage. When there is such a phase difference it will be indicated by  $\psi$ . In this case we shall have to express the gain as  $K/\psi$ . Examining Fig. 2 it can be seen that the output voltage will be  $-KE_g$ , and that the current through the capaci-

tor  $C_{gp}$  is  $\frac{KE_g}{X_{C_{gp}}}$  and that due to the input

voltage  $E_g$  is  $\frac{E_g}{X_{C_{gp}}}$ , where  $X$  is the re-

actance of the capacitor and may be expressed as  $\sqrt{-1} 2\pi fC$  or  $j\omega C$  or  $\omega C/90^\circ$ .

We can now determine the currents  $I_g$ ,  $I_1$  and  $I_2$  (disregarding the effect of  $C_{gp}$  on the gain of the tube, and any effects due to the a.c. plate current dividing between the load and  $C_{gp}$ . These are both

valid assumptions for audio frequency work) as follows:

$$\begin{aligned} I_g &= I_1 + I_2 \\ I_1 &= j\omega C_{gk} E_g \\ I_2 &= j\omega C_{gp} (E_g + KE_g/\psi) \end{aligned}$$

we may rewrite this last expression as  $I_2 = j\omega C_{gp} [E_g + KE_g (\cos \psi + j \sin \psi)]$  and get for the total current through the capacitive reactance

$$I_g = j\omega C_{gk} E_g + j\omega C_{gp} [1 + K (\cos \psi + j \sin \psi)] E_g$$

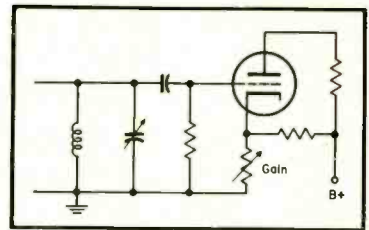

Fig. 2. Reactance control circuit based on the practical application of the Miller Effect.

The input admittance  $Y_g \left(\frac{1}{R+jX}\right)$  is then

$$Y_g = \frac{I_g}{E_g} = j\omega C_{gk} + j\omega C_{gp} [1 + K (\cos \psi + j \sin \psi)]$$

In those cases where the amplifier gain is not complex due to reactive elements in the load  $\sin \psi = 0$  and we will have the equation reduced to

$$Y_g = j\omega [C_{gk} + C_{gp} (1 + K)]$$

The input then appears to be loaded with a capacitance

$$C_i = C_{gk} + C_{gp} (1 + K)$$

This is the common case that exists when the output load resistance is large compared to the capacitive reactance in the output circuit.

It is easily seen that at some frequency the input admittance will be low enough to by-pass sufficient input voltage to affect the gain. Beyond this point the gain will drop with frequency increase at the rate of about 6 db per oc-



tive. The point at which the gain is down 3 db is the frequency at which the capacitive reactance is equal to the input resistance (or where the admittance is equal to the conductance).

#### Examples

The two examples worked out in the calculations of Fig. 3 show the effect on the high-frequency gain caused by a low- $\mu$  triode as exemplified by the 6J5, and by one section of the high- $\mu$  triode 12AX7.

The reduction in gain at high frequencies because of the effective capacitance has been termed the "Miller Effect," having been described in a paper by J. M. Miller of the Bureau of Standards in 1919. However the term should include all effects involving the effective grid-cathode capacitance such as the "Miller Effect" reactance control circuits, one of which is discussed below, and the Miller integrator much used in radar and computer circuits.

#### Inter-electrode Capacitance

Since the effective grid-cathode capacitance is a function of the grid-plate capacitance, the Miller Effect caused by pentodes is negligible, the grid-plate capacitance of most pentodes being of the order of .005  $\mu\text{mf}$ . This low value of capacitance is due to the shielding effect of the screen grid.

The grid-plate capacitance of miniature triodes is on the order of 1.6  $\mu\text{mf}$  while that for metal and octal base triodes varies from 2 to 4  $\mu\text{mf}$ .

It must also be noted that if there are sufficient phase shifts due to Miller Effect and reactive load elements in a number of audio stages around which there is negative feedback, there may be

some frequency at which the various phase shifts will give an overall phase shift around the loop of 360 deg. (or zero). At this frequency, energy is being fed back in phase and it is possible to get sustained oscillations. This situation is likely to occur if there are more than three high-gain stages cascaded with feedback around all three.

#### Miller Reactance Control Circuit

Since the effective input capacitance may be greatly increased by changing the gain of the stage, it is possible to control the capacitance by controlling some circuit condition which in turn controls gain. Also, if the geometric tube capacitances do not give enough range of control, additional capacitance may be added between grid and plate, externally. This circuit has several limitations when used as a reactance tube, the principal one being that the signal amplitude in the circuit across which the tube is used cannot exceed the permissible grid swing for the operating voltages used. Figure 2 shows the Miller arrangement used to tune an LC circuit. To obtain greater range of control it is also possible to use pentodes or the 6L7 mixer tube. In each case the gain may be controlled by varying the d.c. potential on the appropriate element. This control voltage may be derived from a potentiometer or from a comparison circuit in automatic tracking systems.

The discussion of Miller Effect which has been presented is intended to indicate a simple method for determining the effect of the grid-plate capacitance on the operation of audio amplifiers, and a method of utilizing the large effective grid-cathode capacitance caused by this effect.

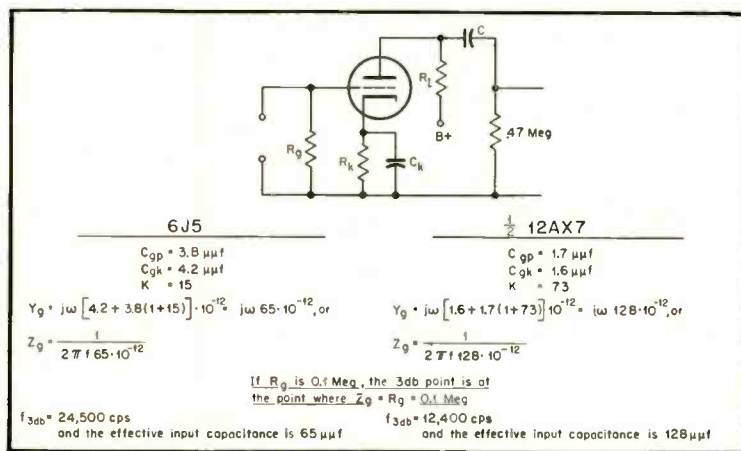

Fig. 3. Method of calculation employed to determine the effective capacitance reflected into the grid circuit of a vacuum tube. These calculations are included to compare the Miller Effect of low- and high- $\mu$  triodes.



## Employment Register

POSITIONS OPEN and AVAILABLE PERSONNEL may be listed here at no charge to industry or to members of the Society. For insertion in this column, brief announcements should be in the hands of the Secretary, Audio Engineering Society, Box F, Oceanside, N. Y., before the fifth of the month preceding the date of issue.

● **Radio Engineer Wanted:** by prominent Chicago electronic mfr. to design and supervise mfg. of full line of com'l amps. Must have engineering degree or equivalent, and minimum of 2 yrs. design exp. in commercial P.A. systems. Give details including age, education, experience, reference, availability and salary expected. Box 601.

● **Electrical Design Engineer Wanted:** By large, modern, Eastern manufacturing firm for experimental development work in industrial electronics. Applicant must have degree in electrical engineering with communications or electronic option or equivalent in 10-15 years practical experience. Give details, including age, education, experience, references, availability, and salary expected. Box 401.

● **Audio, TV Field Engineer.** 10 yrs practical experience in maintenance of professional audio, TV, and radar equipment; design and maintenance custom home music systems. Member AES; Assoc AIEE. Good tech. educ. bkngnd; exc. references; exp. customer relations; extremely conscientious. Presently mgr. TV service lab and field service technician, electronic organs. Desire field work hi-fi audio or TV. Prefer Washington, D. C. area; consider other. Box 701.

● **Audio Engineer.** BS in radio from NYU, 26, married. Well versed all phases comm'l disc and tape recd'g. Presently employed large NYC studio, but not happy. A "future position" more desirable than a "present job." 9 yrs audio exp; available immediately, NYC metropolitan area. Box 501.

● **Audio and Electrical Engineer:** MS in physics; MS in EE. 10 yrs research, development, and design experience with magnetic and disc sound recording, acoustic measurements, and transducers. Also experienced in magnetic recording systems for computer applications. In present position for 10 years, but desire change to smaller company or consulting firm. Box 402.

● **Audio Engineer.** BEE from CCNY, 25, married. Superior knowledge of music; some informal experience with magnetic recording. Desire position in audio. Salary and location secondary. Box 301.

## THE AUDIO FAIR

- 1950 -

October 26-27-28, 1950

Hotel New Yorker  
New York City



EDWARD TATNALL CANBY\*  
Better Audio — Gone Wrong

I RAN INTO a most interesting sales phenomenon in the field of retail home phonographs some months back that I am glad to pass on to readers as perhaps an eye opener in a controversial field.

We all—as audio engineers, “hi-fi” fans, and what-not—abominate the conventional home-style ready-made combination machine, and it is of course a badge of honor among most of us to have nothing to do with such stuff. We all know of the advantages of the separate-unit system, on every level from the simplest hook-up to the most elaborate professional installation. We deplore the emphasis on cabinetry and chrome that we know, somehow, sells poor audio to thousands of people every month. We insist every so often, in a routine way, that something ought to be done about it. The public should be educated, etc. etc. etc. And so it goes. Meanwhile, the standard home radio-phonograph set continues not too different than before, with the usual distortion rampant, and—taking all the people who buy any sort of audio in a given month—the poor stuff continues to be the largest selling aspect: the “hi-fi” stuff, in spite of great gains, still a very small minority.

This little story offers no solution to the consumer-education problem that will fundamentally change our audio way of life—far from it. But it does, perhaps, give you an idea of sales factors that we are overlooking when we say that present mass phono practices are wrong and should be changed.

#### Performance Test

According to my informant, who shall of necessity be nameless, some time last year a set of performance tests were run on a batch of fairly expensive commercial combination machines in the \$400-\$600 range. The intention was interesting. One of the big manufacturers had decided to try making a really good machine, audio-wise, top quality within the price range. That is, a clean break was to be made, experimentally, with the notoriously low existing standards for commercial audio: the tests were preliminary work, to find out just what was what in the current competition.

There are various ways of doing such a

\* 279 West 4th Street, New York 14, N. Y.

test. This one was fairly simple, even though as many as thirty measurements were made on each set. Dispensing with pickup complications, the experimenters used a standard signal generator feeding say, 100 and 2000-cps tones into the radio end, to be picked up at 1000 kc. The speaker reproduction went into a carefully tested mike and was then given the works via a new intermodulation test set.

Results, on the motley collection of fancy machines, was as might be expected. Most of them gave forth with some 25 per cent or so intermodulation distortion at around half of the rated output, even though the high minded test engineers felt rather strongly among themselves that 5 per cent would not exactly be a figure to be smiled about. Indeed, you might ask, why did they bother with all the testing—we all know about this kind of thing anyway and tests aren't going to make things any better. True, but wait.

#### End of a Hard Day

It seems, that after a long testing day one of the sets gave trouble; it sounded feeble, didn't seem to have anywhere near the umph it should. A slightly irritated argument broke out, I gather. The meter man insisted that it measured OK on his meter and the other arguer said the volume was way off and the thing just sounded puny. Upshot was postponement; something probably wrong in the test circuits.

But not a thing was wrong. The set which gave the puny sound was no weakening at all. Indeed, its output was entirely normal as the meter correctly showed. *And it measured less than two per cent intermodulation distortion.*

Get it? Well, if the light begins to blaze at this point, you may begin to see one clue to the lack of appreciation of good audio by the average customer, listening in the average radio store. But let's be more detailed.

The outfit making these tests got busy right away (side-stepping the disturbing fact that to the ear the good set sounded weak and impotent) to see what could be done for its own line of machines. The company managed to achieve results as good or better, by a mere 18 cents' worth of parts changes in an existing model, which had

[Continued on page 44]

## Pops

RUDO S. GLOBUS\*

AT THE MOMENT of this writing, the music of Stan Kenton in the form of “Artistry in Bolero” (or perhaps *vice versa*) is being blared at me by a station which not so long ago credited itself with being the only “jazzy network” in the U.S. All of which leads to a column which partially flows from and through the Kenton piece of last month and the comments some time back on electronics and pops.

Leave us begin at the beginning: There is no question whatsoever as to the importance of the last twenty years in the Audio World with respect to such problems as musical accessibility, audience range, etc. The first real musical revolution in the west was not pertinent to composition, instrumental changes, etc. We needn't platitudinize about the importance of radio and records. There is no need to point out that in the past twenty years the so-called musical cognoscenti have revealed the contemporary fact of musical life... radio and records are infinitely more important media than concert halls in terms of audience size. Whether we refer to jazz, pops, so-called serious, or classical music, the revolutionary phenomenon of our time is the fact that electronics with its compact biceps and potent right-cross licked the concert hall in much the same way as TV is currently said to be demolishing the boxing arena and the wrestling salon in terms of audience size, etc.

However, if you haven't noticed, we are now going through the second stage of the revolution, or, if you will, a totally new revolution. To a certain extent, serious music has been affected (more or less in a negligible way). We are not referring to the use of a phonograph record of a nightingale's song in Respighi's “The Pines of Rome” or some of Richard Strauss' favorite electronic novelties, such as the amplified wind-machine. We are speaking of the conscious affect of audio technology on the composer in terms of scoring, thematic content, etc., as well as the cumulative influence of

\* 960 Park Ave., New York 28, N. Y.



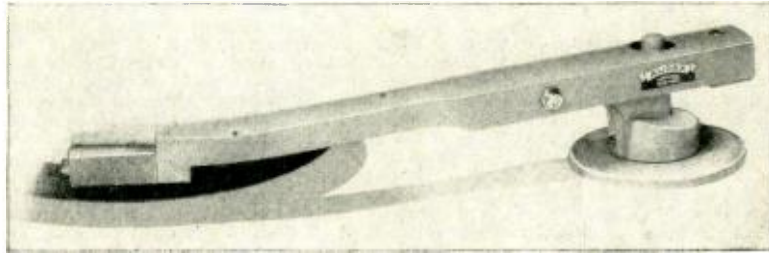

# HIGHLIGHTS

They came by the hundreds to visit the Audax exhibit at the recent Radio Show at Chicago. There were those who visited to pay their respects to AUDAX—"for designing such a remarkable unit." . . . Then, there were those who had been—"eagerly waiting to see and HEAR this astounding instrument."—AUDAX has exhibited in a great many shows but,—not since the advent of the electronic pickup itself, back in 1926, have we experienced so much genuine praise,—especially on the new POLYPHASE.

## Some of the show's highlights:-

1. A POLYPHASE demonstration just ended when up spoke a man, saying . . . "that was the RONDO CAPRICCIOSO, played by Francescotti."—The crowd broke into another round of applause, whereupon he took over, saying . . . "your 'HANGOVER' ad in AUDIO ENGINEERING greatly interested me. High-frequency-range has been stressed so much that many people think it synonymous with high-fidelity. . . . No one would buy a piano merely because it has a full-range key-board." . . . Then, believe it or not, he proceeded to hand out his cards to the crowd.—He is a music teacher.
2. The crowds were in and out but, an elderly couple retained their seats. When asked, they said . . . "we traveled over 200 miles looking for real music and we are not going to be denied now that we have found it."
3. A young man came back the following day with records of his own. Said he . . . "If my outfit sounded half as good, I would be more than satisfied. I am going to clear out my equipment and put in real stuff. . . ."
4. A Radio Station Engineer walked through the crowd to the demonstrator, saying . . . "I brought a record that was played more than 400 times with your L-6 POLYPHASE and it is still as good as new. Would you like to hear it?" . . . It was a really superb recording . . . and absolutely quiet.

Never before such EAR-QUALITY, such FAITHFUL RE-PRODUCTION . . . that is POLYPHASE.

**but...**

see it, HEAR it and compare it against any reproducer at any price—then you be the judge.

**AUDAK COMPANY**

500 Fifth Avenue

New York 18, N. Y.

"Creators of Fine Electro-acoustical Apparatus for over 30 years"

so simple

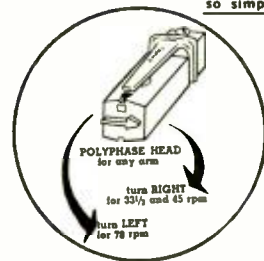

- One single high quality magnetic unit and same point pressure for all discs—6-8 grams.
- Sapphire styli (or diamond) replaceable individually, as simply as you replaced steel needles.
- Output about 20 m.v.
- Response 20 to over 10,000 cps.
- Needle-talk at vanishing point.
- Tracking phenomenal.
- High or low impedance.
- Flexible plug-in connectors.
- EAR QUALITY, par excellence.
- Available for GARRARD, WEBSTER, etc. changers.

The new AUDAX arms are sensitized to the nth degree in order to meet the extremely high compliance of POLYPHASE.

There's an Audax for every purpose . . . Studios, etc. including high output types.

Send for editorial  
reprint on  
POLYPHASE principles.

the "wondrous relays from mike to speaker" on performers. As indicated above, the effect on so-called classical music has been negligible for reasons pertinent to the problems of serious composing and performing.

In the case of pops, the situation is quite different. It is our contention that there is a direct, provable relation between the exquisite sophistication of modern audio techniques and the appearance of a totally new type of pop composer, performer, and general taste. It is this revolution which is fantastically responsible for a thoroughgoing change in one of our largest industries . . . so-called music business. In order to trace the change (and we're not fighting the battle of Local 802, the A.F. of M. or Jimmy "who's on third" Petrillo), we have to go back to the pre-revolutionary period and detail some of the simpler facts of pop history. We will not concern ourselves with classical jazz, which has, unfortunately, emerged unscathed in the audio blood bath of the past twenty years.

The major pop figures preceding the erection of the decibel guillotine were such as Vernon Duke, Johnny Green, Cole Porter, Richard Rodgers (not in terms of his modern, phony folk-music phase), Jerome Kern, George Gershwin, you name the rest. Allowing for variations in taste, the period from 1920 to 1940 encompasses the richest period in American pop history. All the above were turning out music which melodically (and even from the standpoint of orchestration) created an international pattern. French, English, German pop composers were either good or bad imitators. Even the redoubtable Noel Coward, with his narrow-nostripled aversion for the cultural products of the Hudson River area, owes a cultural debt which his tinkling fingers will never let him forget.

#### Early Pops History

What was the setup in the '20's and '30's? Despite radio and records, the great dozen or so wrote for two vehicles—musical comedy and night club (including cabaret, speakeasy, intimate bar, and so on down the line). We might even add the motion picture, which was pushing sound like mad before the golden moment came to an end. Effen you wanted to personalize the music, you bought sheet music. The pop business in records didn't amount to much until the end of the thirties. The disc jockey hadn't dared to poke his head out of the hole he came from until the record business had gotten into full swing, also the point around 1940. Radio featured live broadcasts and went off the air before the first-after-dinner belch. There were a lot of people outside of the metropolitan areas who, up to 1933-4, thought George Gershwin and ilk sold razor blades on the great milk route. No overstatement this, but a mere demonstration of the power of sonics. Audiences for the great dozen tended to be stereotyped in their demands . . . ranging from subtle innuendos to a melodic and harmonic style now referred to as "semi-classical pops," as exemplified by Gershwin, to cocktail lounge, as exemplified by Vernon Duke, etc. A blasé, demanding urban audience put the mark on pop composition and performance. Performers couldn't get away with the murder characteristic of our depressing moment in history. If their voices were no good, they had to be good looking. If they weren't good looking, they had to have voices. If they had neither, they survived through that nebulous thing called "personality," whatever that is. P.A. systems were rarely used . . . and were generally unnecessary. The above refers to instrumentalists as well. Take the case of one guy, who has survived the revolution and is still going strong, who couldn't play

the piano then and still can't. He still has the fifteen magical fingers plus a brilliant smile. The audiences then accepted the brilliant smile as a logical substitution for poor piano technique. Today, there is no way of telling. Recording engineers and P.A. systems play the bass while he plays the treble.

Nobody—that is, no reasonably sane body—would attempt to parallel the revolutionary period with the golden age. Neither would anybody attempt to push the argument that the 6L6 is responsible for the degeneration . . . in toto. The basic reasons for the degeneration fall into two general categories:

1. The new audience created by records and radio.
2. The extraordinary flexibility of present day recording techniques in compensating for defective music, defective performance, and, to make things unreasonably difficult, poor recording techniques.

To begin with the first category, from the peak of the Goodman craze to the present day (the approximate period of the revolution), the pop audience has grown enormously. The new audience is extremely diversified in taste and age level. Every possible range of taste preference is represented in the modern pop group. As previously indicated, the Golden Age audience tended to be remarkably homogeneous in terms of taste, age level, etc. Further, the age level of the average pop audience is totally different. The teen-age group has replaced the 30-35 age average of the 1920-1930 audience group. This is perhaps the most significant factor in the whole revolutionary mess. With respect to lyrics, the utter banality, the typical juvenile search for a meaningless, unintelligible language as represented by the weird entries into the *dementia praecox* linguistics of Mairzy Doates, Itsy Bitsy Boodle with a Honey Bunney Noodle, und-sow-eiter, etc. are directly attributable to the market of a citizenry whose maturity is still five to ten years off.

#### Current "Pops" Buyers

Despite the existence of a live, eager audience of a more discriminating nature, the people who buy records, who go to movies, who listen to bands at the local 2-for-1 show, who soothe the ulcered somas of our advertising industry, and give Jimmy Petrillo a hard time when they have to stay after school, are the 12 to 23 age group (approximate figures). It is this group that rejected jazz, that demanded, and got cheaper reproducing instruments, that killed and made hands, vocalists, composers, instrumentalists, radio stations, record companies . . . the whole kit and kaboodle. If this appears to be an exaggeration, study the figures as presented by every group concerned with the music business. *Variety*, *Billboard*, *Metro-nome*, *Downbeat* . . . every publication concerned with the business . . . have seen it approximately this way. We have attacked the record industry in these columns time and time again for what we consider poor musical and technical operation. But, give them their due, record manufacturers make their living in the pop trade and the pop trade is still pretty much the comic book coterie. We can hammer time and time again for technical improvement . . . the necessity for musical discrimination . . . but so long as the industry is beholden to the monstrosities of pre- and post-pubertal development, we might as well suggest LP's made of taffy and played by a sharpened cashew. Pops have to be limited in size, etc., because they have to fit the price range of John's Other Wife's Other Son. The industry has to regulate its musical policies according to the shifting pre-occupations of the teenagers.

And technical efficiency . . . for whom. The kids can only afford the cheapest possible players . . . hence conformity in the recording demands. Standardize the pops to suit the twenty buck player . . . an order which makes sense in terms of the market.

But there is plenty more. The second revolutionary phenomenon ties in with the above. Up to date recording techniques, and we shudder to think of same, make it possible to put this teen age industry on an unbelievable level of efficiency. The shifting demands of the kiddie-car army has created a new entrepreneurial group . . . the press-agent musicians. Quick money is to be had overnight in the business on the basis of the gimmick and the press agent to take advantage of it. A whole battalion of vocalists, band leaders, small combos, and soloists is the manpower of the revolution. The pop business, as a novelty trade, consists of this motley horde of untalented, ambitious musical yo-yo's. The new audience makes their living for them. But one other phenomenon is necessary. And the audio engineer supplied it. Efficient recording and amplification techniques (efficient in the peculiar sense indicated in the following) made it possible to compensate for poor voices, poor musicianship, and poor music. A throaty rasp becomes an endocrine stimulant, a bad piano technique becomes a stylization, a poor orchestration becomes an excursion into the future, poor music can be manipulated by a deft twist of the wrist into the echo of a final solution for an unhappy boredom (musically speaking). The echo chamber, the theremin, the modern mike, the whole bag full of tricks available to the recording engineer are the elements which have made the whole business possible.

If we go into the thing in detail, it is obvious how far reaching the revolution has been. The pop composer is an artisan in the novelty trade. He works in the context of the possibilities inherent in "technical orchestration." There is no need to bother with the problems of substantial composition. The tricky stuff can be played up by a competent knowledge of what can be done in the recording studio. In one of our columns we spoke of an "artificiality within an artificiality." Here is a detailed explanation. This is the most unreal business of them all. Its total lack of substance has been made possible, ironically enough, by technological advances in the recording industry which have made it possible to expand the range of musical involvement a million-fold.

You can figure out the rest for yourselves. It is merely an elaboration of the above. But is this the whole story? No! As we indicated earlier, the revolution created an enormously diversified audience. They have been taken care of to a greater or lesser extent . . . mostly lesser. The hill-billy addicts have their discs, the folk lovers have theirs, the cocktail lounge crowd, theirs. Our old columns were highly explicit as to the way jazz has been treated. The vicious circle involved in the dependency of a particular mass market can be broken by the recognition that at this stage of the post-revolutionary period, the market no longer determines the industry, the industry determines the market. The enormous drop off in business is symptomatic. The composers, the musicians, the over-all talent is still available. The kiddie market will remain as is, but the adult group deserves a break too. The guy who has the necessary bucks (not too many) available for the production of records of a satisfactory musical and technical level can make a killing at present. There is a notably big market waiting for the break. In the case of the classical market, the manufacturers who are making money, and also



determining the policies of the large, established companies, are the enterprising few who have done wonders technically and musically. The English firm disproved the disc company axiom that the war horses at the old recording level would do the trick. Whereas the diversity in taste is not as extreme in the classical market as in the pop, the same general rule applies.

## RECENT RELEASES:

Gems of Jazz

Decca DL 5134

At the opportune moment, Decca has released on LP a collection of "jazz classics" which helps to complicate matters as far as recording technique is concerned. The dub was made from a group of Parlophones which were especially recorded for the jazz intelligentsia in Great Britain and the Continent. What is particularly important is the fact that these babies were recorded in studios in New York and Chicago. Remember what these same studios were like some time back and then, considering things in general, figure out how the jobs came out as well as they did.

Three groups are represented on this platter: Gene Krupa and his Chicagoans (Nate Kazebier, trumpet; Joe Harris, trombone; Benny Goodman, clarinet; Dick Clark, tenor; Jess Stacy, piano; Allan Reuss, guitar; Gene Krupa, drums; Israel Crosby . . . for the most part all mainstays of the old Goodman band); Bunny Berigan and His Blue Boys (Bunny Berigan, trumpet; Eddie Miller, tenor sax and clarinet; Edgar Sampson, alto sax and clarinet; Cliff Jackson, piano; Ray Bauduc, drums; Grachan Moncur, bass); and Jess Stacy, both unaccompanied and with Gene Krupa and Israel Crosby, drums and bass respectively, backing him up.

With hardly any exception, this is a wonderful platter. Berigan is represented by some of the best moments in his thoroughly tragic career; Stacy's "Barrelhouse" on side two is both thoroughly exciting and genuine; the Krupa group demonstrates perfectly the uncommercial greatness of the old Goodman group.

But the musical excitement generated by this piece out of the "golden age" is insignificant as compared to the technical superiority of every band of this LP as compared to more recent jazz attempts. We have knocked ourselves silly over the problem of "presence." Here is a pretty good approximation of the critter. While in no sense high fidelity, the recordings (and we have to think of them in their individual, pre-dub state) represent what can be done by rational sound engineering. The immature equipment available, the horrible studios, alias orange crates, and the lack of modern know-how characteristically affected all other recordings emanating from this same period. Here is a great exception . . . and why? There were no secret weapons available, nobody was concealing exceptional equipment (remember the mikes?) . . . what everybody else had was available for these dates. Furthermore, there is that nebulous thing called psychological acoustics. There is a specific acoustical area which is just right for various combination sizes, styles, etc. No matter how good a jazz record in other technical details, without the proper acoustical control, balance, resonance, etc., it just isn't right. Every hand on this disc is specifically right. If you can get the Parlophone originals, by all means grab. For this purpose, a list of the singles:

1. Blues of Israel—Gene Krupa and His Chicagoans

[Continued on page 35]

# Let's can the bunk!



Nothing could be sweeter than GAUSSING your OERS-TED meter, but with Soundcraft tape you don't have to do it!

We production-test every running inch of recording tape against "magnetic holidays," keep it CONSTANT-OUTPUT within 1/2 db over the audio spectrum.



Sherlocking the signal-to-rasp ratio or silly-scoping dog-whistle frequency-responses may be exhilarating, but with Soundcraft discs you don't have to do it!

Our blank discs have made over three million broadcast-quality transcriptions, every coating-mix is pretested, each disc is individually inspected.

Steam heating a jewel-facet may well be a hot-cutting asset and you may perspire for a good sapphire, but with Soundcraft styli you don't have to do it!

Like other suppliers, Soundcraft has your sapphires made to NAB specifications, sees to it that, be they long, short, standard, or microgroove, they meet the specs.

### Tell-you-what-we're-gonna-do:

So many of our recording friends have been sending in sample-offer coupons in triplicate that we have decided that our stuff may even be good enough to stop giving it away.

Accordingly, for those genuinely interested in maybe using the same Soundcraft recording media the other experts use, we offer absolutely free (use the coupon) a brand new six-page three-color catalog and price list, each one of which set us back about 15 cents.

Secondly, we'll send you a list of convenient distributors one of which is sure to have the item you require out of the 79 regular and special types of discs and tape that Soundcraft manufactures.

Third, we'll put you on the Soundcraft propaganda list so you can read all the tripe that we are currently disgorging.

Dear Soundcraft:  
Please send us the stuff you offered in the ad.  
Name \_\_\_\_\_  
Address \_\_\_\_\_

REEVES — "20 YEARS WITH SOUND RECORDING MEDIA."

## REEVES Soundcraft CORP.

35-54 36th STREET, LONG ISLAND CITY 6, N. Y.

# NEW PRODUCTS

● **"Special" Transcription Arm.** Livingston Electronic Corporation has announced the new Livingston Special arm, an addition to their line of transcription arms. The Special arm is a carefully scaled-down version of the famous Universal model, and designed for use with the GE dual cartridge. The arm features pre-weighted construction, single-hole mounting, and a front end ready for in-



sertion of the cartridge. It is intended for all transcriptions and pressings except 16-in. diameters, and will sell for the same price as the A-16 model. Address the manufacturer at Livingston, N. J.

● **Number-Stamping Chase.** A new type chase, for use in stamping numbers and other information on name plates, has just been developed by M. E. Cunningham Co., 100 E. Carson St., Pittsburgh 19, Pa. The unique features consist of the method of locking the type into the chase and the means for holding the chase onto the bed of a press.

The unit is made from heat-treated tool steel, and assures evenness of stamping.

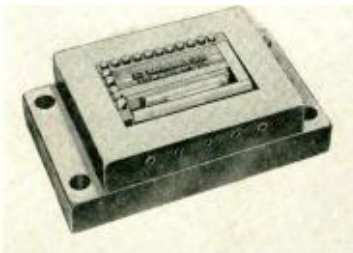

Easy positioning of the plates is made possible by a number of spring pins which retract during the stamping operation.

Data sheets and additional information may be obtained from the manufacturer.

● **Unique 8-Inch Speaker.** Characterized by a dark blue cone, the new Permoflux



Royal Eight speaker is said by the manufacturer to offer a degree of performance usually associated only with speakers much larger in size and higher in price. A special slotted cone edge developed by Permoflux provides extra soft suspension with resulting increase in low-frequency response. The curvilinear cone has been throat-treated to extend high-frequency range. Full technical information may be obtained by writing the manufacturer for booklet 8T-8-1. Permoflux Corp., 4900 W. Grand Ave., Chicago 39, Ill.

● **Utility Amplifiers.** Utility and low price are combined in the Newcomb "E" series of amplifiers, available in 10-, 17-, 25- and 50-watt models for mobile or portable operation. Construction includes molded-type coupling capacitors for added protection from heat and moisture. Etched metal panel is lighted for night



use. Frequency response is 40 to 15,000 cps  $\pm$  2 db. Full technical data may be secured by writing Newcomb Audio Products Company, 6824 Lexington Ave., Hollywood 38, Calif.

● **Dynamic Microphones.** The visual requirements of television and public-address applications are given equal weight with audio performance in design of Models D33 and D22 dynamic microphones, now being marketed by American



Microphone Company, 370 S. Fair Oaks Ave., Pasadena 1, Calif. The D33 is designed for television, AM and FM broadcasting and recording, while the D22 is suited for less critical application. Both microphones are of streamlined construction and are equipped with American's new one-inch-diameter head which permits unobstructed view of the performing artist or speaker. Pickup is omnidirec-

tional, output is minus 52 db. No pre-amplifier is required. Free descriptive folder may be obtained by writing the manufacturer.

● **Vacuum-Tube Voltmeter.** Although considerably lower-priced than the model it replaces, General Radio's new Type 1803-A VTVM meets the majority of a.c. voltage measurement requirements of



the electronics laboratory. Five ranges give overall coverage from 0.1 to 150 volts. Frequency error does not exceed  $\pm$  10 per cent at 120 mc. Meter is peak indicating and is calibrated in rms values of sinusoidal voltage. For complete technical description write General Radio Company, 275 Massachusetts Ave., Cambridge 39, Mass.

● **Mercury "A" Battery.** Designed essentially for use in hearing aids, miniature



radios, instruments, and penlights, the new Mallory RM-1C battery is said by the maker to permit higher current drain than any previous unit of comparable size. At a current drain of 250 ma, service life of approximately 10 hours is indicated. Complete data may be obtained from P. R. Mallory & Co., Inc., North Tarrytown, N. Y.

● **Hermetic seals** are described fully in a new 16-page catalog which covers what is said to be the most complete line of these products ever produced. The booklet illustrates both standard and custom-designed seals, and may be obtained from Hermetic Seal Products Co., 37 South 6th St., Newark 7, N. J.



## POPS

[from page 33]

2. Three Little Words—same as above.
3. Blues—Bunny Berigan and His Blue Boys
4. I'm Coming Virginia—same as above.
5. You Took Advantage of Me—same as above.
6. Chicken and Waffles—same as above.
7. In the Dark-Flashes—Jess Stacy
8. Barrelhouse—Jess Stacy with Krupa and Israel Crosby

If you can't find them (and I can guarantee trouble), the Decca LP is a fine dub. Either way, you can't go wrong.

### Modern Music for Clarinet

Artie Shaw **Columbia ML 4260**

We hate ourselves for doing this, but . . . Hershey Kay, one of the finest arrangers around, did most of the things on this date, ably abetted by Alan Schulman. Some of the finest instrumentalists in the U. S. played this date, including Harry Moskowitz and Julius Baker on flute, Ralph Lorr and Arthur Kubby on bassoon, Ralph Gomberg on Oboe, Johnnie Barrows and Ray Alonge on Horn, etc. Shaw sounded absolutely fine during the session, and from all indications a good date was on the way. Musically, everything is copacetic with the exception of a few moments. The "Man I Love" band is tricky and cute. The recording itself simply isn't up to par technically. Despite the use of supplementary mikes to make things easier for the horns, and a large, spacious studio, something went wrong. Balance is bad, with the clarinet predominating too heavily. The only thing that makes this session strange is the undeniably good work Columbia has been doing on their pop releases. Just one of those things!

Earl Hines **Mercury MC 25018**

This is another jazz dub that warrants comment. This used to be a collection of Keynote singles featuring the Earl Hines group. The very distinguished recording of "Thru For the Night" is included as well as stuff such as Rosetta, Father Cooperates, Blue Moon, Stardust, etc. The dub is superb, so we have no arguments with Mercury on the matter. But when dealing with the problem of the originals, our complaint is limited to a category discussed above . . . namely psychological acoustics. The recordings lack the sparkle and the liveness so necessary for jazz recording. The studio was a small one, complicating matters even further. Fathah's normal ebullience is lost to a certain extent . . . but what to do. The job is done and can never be repeated. The luscious work of such as Coleman Hawkins—the Hawk to you—Bill Coleman on trumpet, etc. . . . make this a must of sorts. Otherwise, the recording is adequate.

### POT LUCK:

Mercury has unearthed, dug up, an exact duplicate of the fantastic Theresa Brewer of London Records. Called Kay Brown, this one is a 16-year-old High School girl whose tantalizing recording of "Teasin'" on Mercury (Mercury 5427) is manifestly successful. While not in the classy category either technically or musically, it just goes to show what kind of state the record business is in these days. In the old days, the big boys stole music, styles, even particular personality characteristics. Nowadays, the above matters are trifles. The alchemists on the payroll of the manufacturers are able to duplicate to a tee complex phenomena like Miss Brewer . . . heaven help Pinza.

# New RACON Sound Equipment for Best Performance and Highest Profits!

## Only the New RACON DRIVER UNIT has all these Exclusives:

- Lowest List Price — \$37.50
- 25 Watts Operating Capacity
- 50 Watts Peak Capacity
- Completely Waterproof and Tropicalized
- Built-in Vacuum Impregnated Line Transformer
- Primary Terminals: 500, 1000, 1500, 2000 Ohms
- Secondary: 15 Ohms
- Alnico V Magnet
- Aluminum Wound Voice Coil for Maximum Efficiency
- Combined Solder Lug and Binding Post Terminals
- Frequency Range 90-6500 Cycles
- Thread Size 1 3/8" -18



Model PM-708TR \$37.50 List

## Here's Why New RACON COBRA LOUDSPEAKERS SUCCEED when ordinary speakers fail!



Model COB-2 \$82.50 List

Model COB-1 \$46.50 List

- Widest Sound Pattern (Adjustable from 120-240°)
- Designed for Voice Range: 370-6500 Cycles
- High Conversion Efficiency
- No Re-entrant Members
- 25 Watts Continuous Capacity
- 50 Watts Peak Capacity
- Completely Waterproof
- Tropicalized Driver Unit
- Vertical or Horizontal Adjustable Mounting
- Aluminum and Bronze Castings

## RACON CROSSOVER NETWORKS



Model CON-20, \$22.50 List.  
Highest quality LC network.

Model CON-15R, \$11.00 List.  
Efficient RC high-pass filter network.

## RACON TWEETER

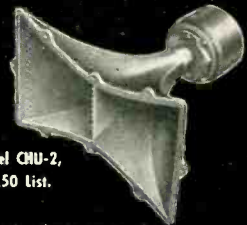

Model CHU-2,  
\$37.50 List.

Wide distribution pattern!  
Clean output to 15,000 cycles!  
When used with crossover network,  
handles amplifiers of 25-30 watts.

SOUND TECHNICIANS AND SERVICEMEN — For full details on our complete line of Public Address and Wide Range Loudspeakers, see your favorite parts jobber, or write for Catalog A

ALL RACON PRODUCTS ARE GUARANTEED FOR 18 MONTHS

Sound  
Equipment  
Manufacturers

ACOUSTICAL  EXCELLENCE

*Racon Electric Co., inc.*

52 East 19 St.  
New York 3,  
N. Y.

## AUDIO PATENTS

[from page 8]

simplified by rearrangement so that the components may be calculated individually:

$$R_1 = \frac{1}{2(\omega C_1)^2 R_2}$$

$$R_2 = \frac{1}{2(\omega C_1)^2 R_1}$$

$$C_1 = \frac{2}{(\omega R_2)^2 C_2}$$

$$C_2 = \frac{2}{(\omega R_1)^2 C_1}$$

### Musical Instrument Oscillator

Thomas H. Long is the inventor of an oscillator (Patent No. 2,496,244), a variation of which is used in C. G. Conn's *Connsonata*. This musical instrument uses 167 separate tone-frequency oscillators, one for each note of each manual and the pedal clavier, plus an extra 12 as octave couplers. There is no synchronization among octave oscillators to hold them in step (this would not allow a chorus effect) so the oscillators must be unusually stable.

The circuit appears in Fig. 5, and is essentially a series-fed Hartley. Output level is adjusted with the potentiometer across the transformer secondary. The output from the plate circuit is a good sine wave, corresponding musically to an organ flute-type tone.

A second output is taken from the top of the variable cathode resistor. When adjusted correctly, this resistor furnishes output of the same frequency as the plate, but the wave is rich in harmonics and approximates a string-type tone. The string and flute tones are mixed and filtered in later circuits to provide various combinations.

The most interesting part of this patent

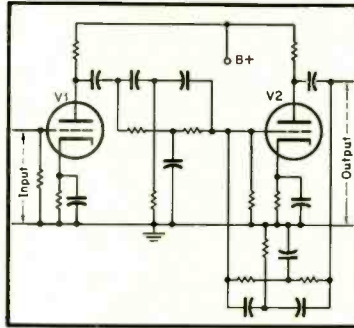

is the resistor  $R$  in the grid circuit. Correct selection of its value stabilizes the oscillator and eliminates, according to the inventor, about 98 per cent of the effects of changes in tube characteristics. The value range given in the diagram is for oscillators between about 60 and 120 cps. For other frequencies, the optimum resistor value varies inversely as frequency.

The oscillator is keyed in the grid circuit. The tube is normally biased to cutoff and the key grounds the bias.

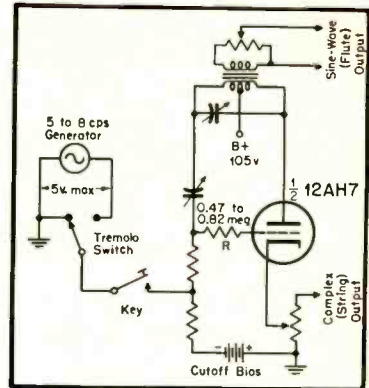

The two usual types of tremolo or vibrato used in electronic musical instruments are variation of frequency and of amplitude. In this patent, a quality vibrato is used. The value of the cathode resistor determines the quiescent bias, which in turn determines the degree of complexity of the signal taken from the cathode. The same effect is utilized to provide quality vibrato (for the string but not for the plate-circuit flute tone) by injecting about 5 volts of 5- to 8-cps tremolo-generator signal into the grid circuit. As the generator wave varies in amplitude, it varies the instantaneous bias and the harmonic output of the oscillator varies accordingly. Because of the great stability of the oscillator, frequency is not affected.

A copy of any U.S. patent may be obtained for 25¢ from the Commissioner of Patents, Washington 25, D. C.

BRITAIN'S BEST AUDIO AMPLIFIER

**LEAK** "POINT ONE"  
DISTORTION: 0.1%



### ENTIRELY NEW REMOTE CONTROL PRE-AMPLIFIER RC/PA

An entire new Pre-Amplifier with several features and modifications not incorporated in the original model.

- Two stages of low distortion triode amplification.
- Input switching for radio, magnetic pickup and crystal pickup.
- Pickup positions embody low frequency compensation plus an additional 15 db at 50 c/s in three steps.
- Three steps of treble loss are available for variation of roll off.
- Treble rise and bass loss also available.
- AC supply switch incorporated in volume control, enabling power amplifier to be switched off from the remote control preamplifier.
- Pilot light.

The unit will mount on motor-board through a cut-out of 10 1/8" x 3 1/8" or it can be bolted to the power amplifier, in which case it becomes portable when a top cover is used.

For use only with Leak Amplifier.

By check of the National Physical Laboratory (equivalent National Bureau of Standards) for TL/12 SPECIFICATION IS GIVEN HIGHER RATING THAN CLAIMS LISTED HERE.

Certificate available.

Address all inquiries to U. S. Agents:

**BRITISH INDUSTRIES CORP.**

164 DUANE STREET • NEW YORK 13, N. Y.

### TL/12 12W.

### TRIPLE LOOP POWER AMPLIFIER

A Leak triple loop feedback circuit, the main loop giving 26 db feedback over 3 stages and the output transformer.

- Push-pull triode output stage. 400 V. on anodes.
- No H.V. electrolytic smoothing or decoupling condensers.
- Impregnated transformers; tropically finished components.
- H.V. and L.V. supplies for preamp. and radio units.
- Distortion: at 1,000 c/s and 10 W. output, 0.1%; at 60 c/s and 10 W. output, 0.19%; at 40 c/s and 10 W. output 0.21%.
- Hum and Noise: -72 to -80 db on 10 W.
- Frequency response: ± 0.1 db, 20 c/s-20 kc/s.
- Sensitivity: 160 mV.

- Damping Factor: 20. Input impedance: 1 Meg. Output impedances: 2ω; 7-9ω; 15-20ω; 28-36ω. Phase margin 20° ± 10°.
- Gain margin 10 db ± 6 db.
- 25 W. model available.



# CROSSOVER NETWORK

[from page 14]

former provides taps for impedances equal to those of the speakers (e.g. both 16-ohm and 8-ohm taps to accommodate speakers of these impedances), the proper turns ratios are already available, and the following design equations are applicable:

$$L_1 = \frac{\sqrt{2} R_l}{\omega_o} ; C_1 = \frac{1}{\sqrt{2} R_l \omega_o} \quad (5)$$

$$L_2 = \frac{\sqrt{2} R_h}{\omega_o} ; C_2 = \frac{1}{\sqrt{2} R_h \omega_o} \quad (6)$$

As a practical example, suppose it is desired to use an 8-ohm low-frequency speaker with a 16-ohm high-frequency speaker with a crossover frequency of 2000 cps. We have then:

$$f_o = 2 \times 10^3 ; \omega_o = 2\pi f_o = 4\pi \times 10^3$$

$$R_l = 8 \text{ ohms} ; R_h = 16 \text{ ohms.}$$

$$L_1 = \frac{\sqrt{2} R_l}{\omega_o} = \frac{2\sqrt{2}}{\pi} \times 10^{-3} \text{ henries.}$$

$$= 0.902 \text{ millihenries}$$

$$C_1 = \frac{1}{\sqrt{2} R_l \omega_o} = \frac{1}{\sqrt{2} \times 8 \times 4\pi \times 10^3} \text{ farads}$$

$$= 7.05 \mu\text{f}$$

$$\frac{L_2}{L_1} = \frac{R_h}{R_l} ; L_2 = \frac{R_h}{R_l} L_1 = 2 L_1$$

$$L_2 = 2 \times 0.902 = 1.804 \text{ mh.}$$

$$\frac{C_2}{C_1} = \frac{R_l}{R_h} ; C_2 = \frac{R_l}{R_h} C_1 = 0.5 C_1$$

$$C_2 = 0.5 \times 7.05 = 3.525 \mu\text{f.}$$

and the circuit would appear as in Fig. 3.

It would be more convenient once these calculations were made to select stock sizes of capacitors such as 4  $\mu\text{f}$  and 8  $\mu\text{f}$  in this case, and readjust the values of  $L_1$ ,  $L_2$  and  $f_o$  in accordance with this change, since odd-size capacitors are not generally available. The resulting shift in the crossover frequency (approximately 13 per cent here) would ordinarily cause no difficulty. Design data for air-core inductances of the type required here are available in other standard reference works, as well as in these pages.<sup>1</sup>

This method of handling the crossover problem yields results identical with those wherein the speaker impedances are equal and costs no more to build than the conventional constant-resistance crossover network.

<sup>1</sup> "Practical Dividing Networks" AUDIO ENGINEERING, June 1947.

## Anyone Can build a HEATHKIT



**Heathkit SIGNAL TRACER KIT**  
\$19.50



**Heathkit VACUUM TUBE VOLTMETER KIT**  
\$24.50



**Heathkit TUBE CHECKER KIT**  
\$29.50



**Heathkit BATTERY ELIMINATOR KIT**  
\$22.50



**Heathkit AUDIO GEN. KIT** . . . \$34.50



**Heathkit ELECTRONIC SWITCH KIT**  
\$34.50



**Heathkit IMPEDANCE BRIDGE KIT** \$19.50



**Heathkit R.F. SIGNAL GEN. KIT** . . . \$19.50



**Heathkit HANDITESTER KIT** . . . \$13.50



**Heathkit 5" OSCILLOSCOPE KIT**  
\$39.50



**Heathkit TELEVISION GEN. KIT** . . . \$39.50

**HEATH COMPANY**  
BENTON HARBOR 25,  
MICHIGAN

EXPORT DEPT., 13 E. 40th ST., NEW YORK 16, N.Y. • • • CABLE ARLAB-N.Y.

Heathkits are beautiful factory engineered quality service instruments supplied un assembled. The builder not only saves the assembly labor cost but learns a great deal about the construction and features of the instrument. This knowledge aids materially in the use and maintenance of the equipment. Heathkits are ideal for and used by leading universities and schools throughout the United States. Each kit is complete with cabinet, 110V 60 cycle transformer (except Handitester), all tubes, coils assembled and calibrated, panel already printed, chassis all punched, formed with detailed instruction manual provided for assembly and use. Heathkits provide the perfect solution to the problem of affording complete service equipment on a limited budget. The basic three instruments — an Oscilloscope, Vacuum Tube Voltmeter, and Signal Generator can be purchased in Heathkits for \$83.50, about the cost of a factory-built VTVM alone. Write for complete catalog.



## With the New 3-Speed REK-O-KUT Recitalist

- You will hear authentic music reproduction.
- You will hear absolute tonal balance.
- You will hear a pleasing blend of brilliant highs with natural bass.

Whether the Recitalist is played for hundreds in an auditorium (with volume raised) or for you alone, while relaxing in the comfort of your living room (with volume greatly subdued) — you will feel the animated presence of the artists evoked for an enchanting and realistic visit.

Model  
RP-43C  
(Recitalist)  
**\$179<sup>95</sup>**

The Recitalist is a "flexible" instrument. A microphone input enables "mixing" of live music or voice, simultaneously with a recording being played on phono... or use as a high fidelity public address system. By connecting an FM or AM tuner in the radio input, the Recitalist becomes a superb broadcast receiver.

The POLYPHONIC SELECTOR, an engineering feature exclusive with REK-O-KUT, maintains tonal balance and equalization for the particular selection being played on any type of record, whether it be a standard pressing, high fidelity broadcast transcription, or long playing micro-groove — and whether of American or foreign make.

The REK-O-KUT Recitalist is the only full-range, three (3) speed portable phonograph that painstakingly balances the response characteristics of amplifier, speaker and speaker enclosure. By carefully compensating the natural resonances of these three components, undesirable reverberations are avoided.

### FEATURES

**TURNTABLE:** Precision machined aluminum. Three speeds (78, 45 and 33 $\frac{1}{3}$  RPM.) Neoprene idlers. Internal rim drive. Heavy-duty, dynamically balanced motor.

**PICKUP ARM:** 16" with dual stylus cartridge. Plays up to 16" broadcast transcriptions, standard commercial pressings and micro-groove records.

**SPEAKER:** 8" PM type, built to our exacting specifications with 6.8 ounce Alnico V magnet.

**AMPLIFIER:** Frequency response is controlled by Polyphonic Selector.

**Position #1:** Uniform within 1db from 50 to 15,000 cycles.

**Position #2:** Bass up 4db at 100 cycles, treble uniform above 5,000 cycles.

**Position #3:** Bass up 6db at 100 cycles, treble uniform above 5,000 cycles.

**Position #4:** Uniform from 50 to 3,000 cycles, increasingly sharp cut-off, 14db down at 10,000 cycles.

**Power Output** — 10 watts at less than 3% total harmonic distortion.

**Input Channels** — Three. High impedance microphone, radio, crystal phono-pickup.

**Input Gain** — Microphone, 120 db; phono-pickup, 80 db; radio 80 db.

**Output Impedance** — 6-8 ohms at speaker jack.

**Noise Level** — More than 50 db below rated output with all controls set at maximum.

**Controls** — Microphone gain; radio-phonograph fader; Polyphonic Selector.

Write for descriptive literature.

**REK-O-KUT CO., Inc.**

38-01 QUEENS BOULEVARD  
LONG ISLAND CITY, 1, N. Y.

## World-Wide Popularity

Since the inception of AUDIO ENGINEERING in May 1947, engineers and audio hobbyists have subscribed in ever-increasing numbers, not only in the 48 states and in all of the major foreign countries but in such places as Tasmania, Transvaal and Trinidad.

Each month AUDIO ENGINEERING covers the latest developments and practices in recording, reproduction and instrumentation for the entire audio field.

**Subscribe Now—Don't Miss an Issue! Back numbers are hard to get!**

AUDIO ENGINEERING  
342 Madison Avenue, New York 17, N. Y.

Sirs: Here is my  check (or  money order) for \$..... Enter my subscription order to AUDIO ENGINEERING for the next ..... issues. Subscription Price: In U.S.A., Canada and Pan American Union—12 issues \$3—24 issues \$5. All others \$4.00 per year. Please check one:  New Subscription  Renewal.

Name (please print) .....

Address .....

City ..... Zone ..... State .....

Occupation (give title and department) .....

Firm Name .....

## MEASURING FLUTTER

[from page 17]

the oscillation is such that a continuous change of state from "kinetic" to "potential" energy (and vice versa) occurs each quarter cycle. Also, the amplitude of oscillation under shock excitation is inversely proportional to the energy storage capabilities of the *L* and *C* elements, and the amplitude of succeeding oscillations is determined by the internal dissipation (resistance damping) of the circuit.

However, when a non-linear compliance is utilized in such a device, several beneficial results may be obtained. Figure 10 shows the force displacement curves for a linear and a non-linear spring. For a given force,  $F_1$ , the displacement of the non-linear spring shown is approximately one-half that of the linear spring. In the electrical case, this is analogous to a capacitor which decreases in capacitance (*C* or *D/F* becomes smaller) with increasing voltage, and such a device must dissipate considerable internal energy.

In concluding, it may be said that the introduction of a non-linear compliance into an oscillatory system "limits" or "cushions" the amplitude of oscillation by progressively decreasing the energy storage capabilities of the compliance with increasing amplitude, and in turn, the internal energy dissipation of the compliance is increased by "working it harder" in the non-linear region. The total result is an effective simulation of increased damping.

Figure 6 shows the elements of the mechanical system with the non-linear compliance coupled to the oscillatory system of the "tight loop" drive. The flutter of this machine remains consistently under .05 per cent while maintaining sufficient head pressure on two magnetic heads to preclude the possibility of high-frequency amplitude variations.

### BIBLIOGRAPHY

- T. E. Shea, W. A. MacNair, and V. Subrizi: "Flutter in sound records," *J. Soc. Mot. Pict. Eng.*, Nov. 1935, p. 403.
- W. J. Albersheim and D. MacKenzie: "Analysis of sound-film drives," *J. Soc. Mot. Pict. Eng.*, Nov. 1941, p. 452.
- E. D. Cook: "The technical aspects of the high-fidelity reproducer," *J. Soc. Mot. Pict. Eng.*, Oct. 1935, p. 289.
- E. W. Kellogg: "A review of the quest for constant speed," *J. Soc. Mot. Pict. Eng.*, Apr., 1937, p. 337.
- E. C. Wente and A. H. Muller: "Internally damped rollers," *J. Soc. Mot. Pict. Eng.*, Oct. 1941, p. 331.
- R. R. Scoville: "A laboratory flutter-measuring instrument," *J. Soc. Mot. Pict. Eng.*, Aug. 1937, p. 209.
- Harry F. Olson: "Dynamical Analogies." New York: D. Van Nostrand Co. Inc., 1943.



## TAPE RECORDING

[from page 23]

recording is repetitive applause which has palpably been dubbed from one single applause pattern.

You may occasionally become involved in the following operation: A program to be edited calls for a change in the ending, which was originally recorded over applause. It is obvious that the changed portion should be recorded in the same way. In order to do this an applause sequence of the proper length, taper, and timbre must be found. If necessary, it can be manufactured from short dubs of other applause sequences. The applause dub can then be recorded, mixed with the "live voice" or recorded voice, containing the new ending. Have the announcer use the same voice level as in the original. You may even have to accentuate the high frequencies in his voice, since most announcers' voices increase in pitch during applause that is heavy and sustained. It might be a good idea to play the applause through a loud-speaker in the same room with the announcer in order to duplicate the actual conditions under which he made the original announcement. Accoustical response must always match the original recording, however, no matter what method you use.

In recording on location, it is not possible to have full control of the surrounding sounds. A regular background sound that repeats itself at intervals may then have been recorded in back of voices. If the admonitions in Part II have been heeded, enough background sound will have been recorded in the clear to make a corrective operation easy to perform. Where a repetitive sound pattern, like the tick of a clock, will not be regular after the proposed editing, edit first and then dub in the repetitive sound at exactly the proper times and level.

For special effects that may be required in the production of a program, the tape engineer may rely on his own ingenuity. Voices may be modulated in air by propellers to simulate conversation in back of a plane. The duplication of a needed effect should be sought in the natural way first. If that is not possible, re-recording with sound effects in some combination will prove effective.

### Sound Library

The tape engineer should be provided with a library of tape recordings of background sounds, applause, laughter, and general "bustle" and audience sounds that can be used for simulating the needed background for re-recording.

# HARVEY presents

## MAGNECORD SERIES 6 RECORDERS AND AMPLIFIERS

PT6-JA Recorder and Amplifier...the only combination on the market today that offers such high professional quality at such a low price. Includes PT6-A Recorder plus Amplifier with low impedance microphone and bridging inputs, 10-watt audio amplifier with monitor, speaker and jock for external speaker, 600 ohms balanced line output terminal.



|   |          |
|---|----------|
| PT6-JA—Magnecord combination .....                      | \$499.50 |
| With high speed forward for cueing.....                 | 515.50   |
| PT6-A—Recorder .....                                    | 278.00   |
| PT6-AH—Recorder with high speed forward for cueing..... | 294.00   |
| PT6-J—Amplifier .....                                   | 221.50   |

## MAGNECORD PT7 PROFESSIONAL TAPE RECORDER 3 Separate Heads

A truly new design for the finest possible reproduction.

### Direct Monitoring During Recording!

Erase head...Record head...Monitor and Playback head. Each designed for maximum performance in its function. Provides greatest flexibility. For portable, rack or console installations.

Place your order now for early delivery.



### PT6-P—PORTABLE AMPLIFIER

A highly versatile, light weight, self-contained unit including a record-playback-remote amplifier and power supply for use with the PT6-A Recorder. 3 low-level, independently mixed mike inputs

plus bridging input. Power supply has monitor amplifier and speaker.

|                                |          |
|--------------------------------|----------|
| PT6-P—Portable Amplifier ..... | \$462.00 |
|--------------------------------|----------|

### HR-15 AMPLIFIER KIT

The wondrous Williamson amplifier circuit... now available for the first time with the Original PARTRIDGE transformer built to Williamson's specifications. Order this kit at once, build it in 3 hours or less and enjoy sound like you never heard before. The HR-15 is a 2-chassis power amplifier for use with tuners or other front ends having own volume and tone controls. All triodes, American tubes, 2-6SN7's, 2-807's or 6BG6's in p.p. output, 5V4G rectifier. Frequency response  $\pm .5$  db, 10-100,000 cycles. 5 db rise at 2 cycles, 2 db rise at 250,000 cycles. Harmonic distortion .025% at 10 watts at 400 cycles. Intermodulation distortion at 10 watts output less than  $\frac{1}{2}$ % using frequencies of 60 and 2000 cycles. Phase shift  $20^\circ$ ,  $\pm 10^\circ$ , 20-20,000 cycles. Output impedances 1.7, 6.8, 15.3, 27, 42.5, 61, 83, 109 ohms. Damping factor 50. Absolute gain 70.8 db. 20 db of feedback around 4 stages and the output transformer.

Kit is complete with tubes, punched chassis, prewired resistor board, sockets, genuine Partridge output transformer, and all necessary parts, \$75.00 net.

|  |         |
|--|---------|
| WESTERN ELECTRIC SPEAKER 8" — 755-A..... | \$20.60 |
|--|---------|

### ELECTRO-VOICE MIKES

|  |          |
|--|----------|
| E-V Model 655A, in stock for immediate delivery. Engineered for highest BC and FM standards..... | \$120.00 |
| E-V Model 650.....   | \$90.00  |
| E-V Model 645.....   | \$60.00  |

We have a complete stock of Jim Lansing Signature speakers.

WATCH...for the announcement of Harvey's new sound room...opening soon!

Telephone: 7-hrc LUXemburg 2-1500

All in stock for immediate delivery.

# HARVEY RADIO COMPANY INC.

103 West 43rd St., New York 18, N. Y.

NOTE: All prices are Net, F. O. B. N. Y. C. and are subject to change without notice.

Thus, by using the proper equalization and reverberation, he can match exactly the mood of the master recording. It is sometimes possible to dub, from the original tape, enough of applause and background to make two continuous "bands" of recorded tape. If these "bands" are then placed on two separate playback machines, they can be faded in from the mixer at the appropriate time and re-recorded, together with the needed "live" sequence, upon the master. There are two cautions about the foregoing operations:—

1. Pick out a background section that does not contain any noticeable varia-

tion so that it will not be repetitious.

2. Be extremely careful not to make the background level too high or too low. It must play back at exactly the same level as the "live" background in order to complete the illusion of "same place."

The operation of re-recording, in all of its complexities, calls for a degree of tonal perception on the part of the tape recording technician. It is quite useless, in most cases, to make a wide-range tape recording of transcriptions or commercial pressings when the final result will contain mostly distortion and noise. It

is wise to restrict what is re-recorded to the useful sounds only and to filter out the rest. In this way a recording will at least have the virtue of some degree of uniformity. The writer's experience, during the composition of the Columbia Record Album, the first "I Can Hear It Now," was that it was best to restrict the range of the better transcriptions to the approximate quality of that of the poorer, so that there will be no startling discrepancies in the tonal quality of the finished product.

Part IV of this series, to follow in next month's issue, will deal with the methods of editing tape and the exact procedure in editing various kinds of programs.

## SPEECH CONFERENCE

[from page 21]

thetized cats. After a loud sound is applied to the cat's ear the neural response is very weak. It returns to normal after about 15 minutes and then overshoots. This aspect of auditory fatigue occurs at the very lowest part of the auditory system and not at the cerebral cortex as has sometimes been postulated. Auditory fatigue is known to occur also in human beings, but in un-anesthetized man the recovery time is about twice as long as in the anesthetized cat. W. E. Kock of the Bell Telephone Laboratories described experiments that show that a person can hear speech in the presence of noise better when the signal and noise are in different locations in the room than when they come to the listener from the same location. The improvement in ability to hear the speech in the presence of noise is as great as 10 db for separate location of the noise and speech. He presented a theory to account for the effect.

Paul Menzerath of Bonn, Germany, discussed the statistics of language. He pointed out that French and English differ statistically. For example, French uses almost all the words of reasonable length that can be constructed from its basic sounds, whereas English has gaps: there are no such words as *pij*, *bis*, and *jik*. The entropy of French therefore is larger, which makes it a wonderful language for puns.

Robert Fano of M.I.T. gave a beautifully clear and simple exposition of the fundamentals of the Wiener-Shannon theory of information. He pointed out that the communication channels used in telephony have a bandwidth which is about 100 times as large as theory requires for the amount of information that is transmitted over them. However, when an attempt is made to compress the information into a smaller bandwidth, an information storage system must be employed. This means a delay in the transmission of the message. Because speech is transitory and conversation is most satisfactory when the listener can respond instantaneously, it is not possible to compress

**Advance Orders  
now being accepted!**

# audio anthology

Paper cover . . . \$2.00

Board cover . . . \$3.00

*Distributors write for quantity discount*

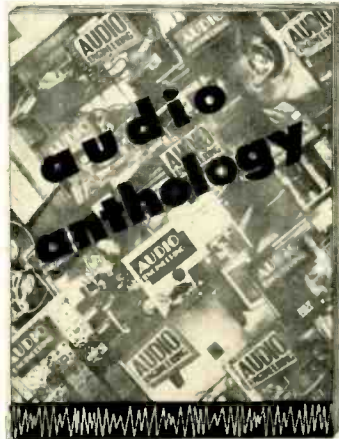

The long awaited compilation of reprints from early issues of AUDIO ENGINEERING, most of which are out of print and unobtainable.

Contains 37 articles on the following subjects:

- Amplifiers
- Speakers
- Noise Suppressors
- Phonograph Equipment
- Tone and Loudness Controls
- Dividing Networks

These articles have been of great interest to readers of AUDIO ENGINEERING over the past three years. *Assembled in one volume, they comprise the most authoritative reference work yet available to the audio hobbyist.*

-----CUT OUT-----MAIL TODAY-----

Book Division, Dept. A  
Radio Magazines, Inc.  
342 Madison Ave., New York 17, N. Y.

Sirs: Enclosed is my  check  money order for \_\_\_\_\_ copies of the Audio Anthology.

(Please check one)  Paper cover  Board cover

Name (print carefully) .....

Address .....

City ..... Zone ..... State .....



the bandwidth by anything like the theoretical amount if conversation is to be pleasant. Also, one desires to send more than just the factual content in speech. Emotion, inflection, speech traits reflecting sincerity and so forth must be transmitted. This demands a wider bandwidth than would otherwise be required. One can conceive of a transatlantic telephone system for which the personality traits of particular persons were stored on the receiving end. A keying signal would then ask for certain emotional properties to be injected into the reproduced speech, without having to transmit these qualities over the system in detail.

Norbert Wiener spoke on Speech, Language, and Learning. One of the interesting comments he made was that after attempting on a few occasions to make extensive searches in the library, he has come to the conclusion that one should go not to the library, but to the leaders in the field for information. When asked if there were not too many scientists for this to be a feasible proposition, he answered that the number of leaders was not too great.

G. A. Miller of Harvard described a science that does not exist—Language Engineering. He said that although there is now no such field, it will develop. Miller talked about the problem of the devising of an international language of the air. This problem he said, requires the combined efforts of physicists, statisticians, linguists, psychologists, and aviation experts.

The committee in charge of the program was composed of: W. N. Locke, Chairman; J. B. Wiesner, J. C. R. Licklider, and L. L. Beranek. The papers are to be published.

## THE DIAMOND

[from page 27]

record wear by continuing the worn stylus in use.

### BIBLIOGRAPHY

- G. A. Briggs: "Sound Reproduction," Wharfedale Wireless Works, Bradford Road, Idle, Bradford, York-shire, England.
- W. F. Epler: "Relative Mechanical Corrosion Hardness of Synthetic Corundum," *Industrial Diamond Review*, June 1945, pp. 121-125.
- P. Grodzinski: "Notes on the Cleaving and Sawing of Diamond," *Mineralogical Magazine*, London, Sept. 1944, pp. 46-50. Diamond Tools, N.A.G. Press Ltd. London, 1944.
- J. F. Kayser: *Industrial Diamond Review*, Vol. 4, 1944, pp. 2-4.
- F. Knoop: Research Paper 1220, 1939; *Industrial Diamond Review*, Vol. 1, 1940, pp. 292.
- R. R. Ridgway: "Hardness Values for Electrochemical Products," *Trans. Electrochem. Soc.*, Vol. 63, 1933, pp. 369-393.
- A. Rosival: Akad. d. Wissenschaften, Wien, 1893, No. 11 and 1917.
- Schuler and Dimpker: *Zeitschrift f. Instrumentkunde*, Vol. 55, 1935, p. 63.
- G. F. Shottler: Meter and Instrument Jewels and Pivots, 2nd report, 1944, p. 110. British Electrical & Allied Ind. Res. Assoc.
- A. Williamson: *Journal Franklin Institute*, Vol. 193, 1922, p. 491.

# Gray

RESEARCH

FEATURES IDEAL REPRODUCTION

## TRANSCRIPTION ARMS

### NEW VISCOUS-DAMPED 108-B ARM

For all records — 33 1/3, 45 and 78 r.p.m. Radically new suspension development on the viscous damping principle for perfect tracking of records and elimination of tone arm resonances. Instant cartridge change with automatic correct stylus pressure. Solves all transcription problems. Ideal for LP records. For Pickering, new GE (short), old GE (long) cartridges. Write for bulletin. Price, less cartridges, \$50.70



### MODEL 106-SP ARM

Designed to meet strictest requirements of modern highly compliant pick-up cartridges. 3 cartridge slides furnished enable GE 1-mil, 2 1/2-mil or 3-mil cartridges or Pickering cartridge to be slipped into position in a jiffy. No tools or solder! Superb reproduction of 33 1/3, 45 or 78 r.p.m. records. Low vertical inertia, precisely adjustable stylus pressure. Write for bulletin. Price, less cartridges, \$45.15



## EQUALIZERS

### MODEL 603 EQUALIZER

Latest of the universally adopted Gray Equalizers used, with Gray Tone Arms, as standard professional equipment by broadcast stations. High-frequency characteristics obtainable comprise 5 steps — flat, high roll-off, NAB, good records, poor records. For both GE and Pickering cartridges. Price, \$50.70



### MODEL 602 EQUALIZER

Has 4 control positions, highly accurate response curves. Price, \$49.50

Write for bulletins on Gray Equalizers.

**GRAY RESEARCH** and Development Co., Inc.  
18 Arbor St., Hartford 1, Conn.

Division of The GRAY MANUFACTURING COMPANY  
Originators of the Gray Telephone Pay Station and the Gray Autograph



# JACKS

New Low Prices—Newly Designed Jacks



1399-A Jacks (2 Circuit) ..... 63¢ net  
 1399-B Jacks (Normaling Type) ..... 69¢ net

Order your requirements to-day



**CINEMA ENGINEERING COMPANY**

1510 WEST VERDUGO AVENUE, BURBANK, CALIFORNIA

Export Agents: Frazar & Hansen, Ltd. • 301 Clay Street • San Francisco, Calif., U. S. A.

## DIAMOND PLAYBACK STYLI

Now available at last to audio enthusiasts and record collectors, a replacement service whereby you can have diamond tips of the highest quality custom-installed in your present stylus or cartridges, and at a price of only fifteen dollars for most models. (See article in this issue which explains why diamond stylus give the highest-fidelity reproduction, longest record life, and are actually cheapest in the long run.)

Our diamond styli, formerly available only to professional users such as broadcasting stations, are made from carefully selected whole stones—not splints. We guarantee them unconditionally.

Here is how the replacement service works: you send us a worn sapphire stylus which fits the cartridge you are using. If the stylus is non-removable you send the entire cartridge. Be sure to specify tip radius desired—one mil for LP, three mil for 78 rpm. When writing for information always give make and model no. of your cartridge(s).

As a further service, we also sell record changers, LP attachments and cartridges already equipped with diamond stylus. If you are thinking of buying phonograph equipment, why not buy it "right"—i.e., complete—right from the start?

**TELE VEX** 474 West 238th St., New York 63, N. Y.

## NEED BACK ISSUES?

*Only a few are available and  
 the supply is limited*

- |   |  |
|---|--|
| <input type="checkbox"/> August 1948    | <input type="checkbox"/> January 1950  |
| <input type="checkbox"/> September 1948 | <input type="checkbox"/> February 1950 |
| <input type="checkbox"/> November 1948  | <input type="checkbox"/> March 1950    |
| <input type="checkbox"/> December 1948  | <input type="checkbox"/> April 1950    |
| <input type="checkbox"/> June 1949      | <input type="checkbox"/> May 1950      |
| <input type="checkbox"/> September 1949 | <input type="checkbox"/> June 1950     |
| <input type="checkbox"/> November 1949  |  |
| <input type="checkbox"/> December 1949  |  |

### PRICES

|            |          |
|------------|----------|
| 1948, 1949 | 1950     |
| 50¢ each   | 35¢ each |

Payment must accompany order.

Circulation Dept., Audio Engineering, 342 Madison Ave., New York 17, N.Y.

## HEATED STYLUS

[from page 24]

TL: I might state that Mr. Fine of the Reeves Sound Studios has just put through some discs cut with the Thermo-Stylus and he remarked that there is a considerable decrease in echo, particularly in microgroove work.

Q: Has any work been done on finding out whether or not there is a reduction in modulation noise when the Thermo-Stylus is used?

TL: Modulation noise is very difficult to measure quantitatively. We all know that under high modulation, in particular, lacquer is subject to it. There have been some excellent articles written on the subject. I have observed the fact that, under a powerful microscope and with rather careful scrutiny using proper illumination, the groove is of a higher calibre when the Thermo-Stylus method is used than any I have previously observed, with the possible exception only in wax. I would imagine that the action of the heat practically eliminates the modulation noise as far as the original recording is concerned.

(The meeting was then adjourned, and the audience was invited to inspect Reeves Sound Studios, which uses the Thermo-Stylus technique in disc recording.)

## AN INTERMODULATION ANALYZER

[from page 13]

i.e., crystal, ceramic, variable reluctance and other magnetic types, etc. In order to eliminate such effects as rumble and tone arm resonance, a high-grade turntable and tone arm should be used, and the horizontal and vertical pivots of the tone arm should be as free moving as possible without being loose. Undue friction in these pivots will cause increased intermodulation readings.

To evaluate the tracking capabilities of a pickup by the intermodulation method, one must determine the band of the highest level that can be tracked with less than 10 per cent intermodulation. If the level of this band is above the highest velocity reached on the equivalent music record, the pickup is said to track satisfactorily.

Of course, a pickup that tracks most of the record with low distortion (2-4 per cent) is superior to one which reads about 7 to 9 per cent over the same part of the record, although both are below the 10-per cent mark.

Therefore, the relative degree of tracking capability can be determined by this test. Figure 7 shows intermodulation curves for two well known modern pickups. Pickup A is one that is perfectly satisfactory and is found to track at the highest velocity reached on an



ordinary music record. Pickup B presents high intermodulation distortion at all velocities above the average. This is characterized in listening tests by noticeable fuzziness of the high frequencies and generally irritating reproduction.

It will be noticed from the curves that the intermodulation rises sharply once it begins. This is evidently a characteristic of all pickups, so it is necessary to choose one that tracks well at all velocities up to the highest recorded on modern records.

#### Calibration

The accuracy of the instrument was checked by applying simulated intermodulation products, comprised of three high-frequency signals, to the analyzer. The amplitude of the frequency representing the carrier was made larger compared with the two representing intermodulation products, thus approaching actual operating condition. The amount of intermodulation was read on the dial of the analyzer, and the amplitude of these distortion products was also measured on a wave analyzer. The intermodulation percentage was calculated by adding the two low-amplitude signals arithmetically and dividing by the amplitude of the simulated carrier. The calculated intermodulation was compared with that read on the analyzer and the accuracy of the equipment evaluated. It was found that the average difference between calculated and measured intermodulation on this analyzer is below 1 per cent. and the maximum difference is 1.4 per cent.

#### Conclusions

It has been found that intermodulation testing equipment is coming into increasing use in evaluating the quality of amplifiers and phonograph pickups. The analyzer described in this paper is believed to be entirely satisfactory equipment for performing the necessary tests. The circuits employed have been carefully worked out to give accurate as well as critical results, and the instrument is especially valuable in determining the tracking capabilities of pickups. At the present time it appears to be that there is complete correlation between the application of this test and listening tests.

#### BIBLIOGRAPHY

1. J. G. Frayne and R. R. Scoville, "Analysis and measurements of distortion in variable-density recording," *J. Soc. Mot. Pic. Eng.*, vol. 32, pp. 648-674; June 1939.
2. J. K. Hilliard, "Distortion tests by the intermodulation method," *Proc. I.R.E.*, vol. 29, pp. 614-620; Dec. 1941.
3. B. F. Meissner and J. K. Hilliard, "Discussion on distortion tests by the intermodulation method," *Proc. I.R.E.*, vol. 30, No. 9, p. 249; Sept. 1942.
4. H. H. Scott, "Audible audio distortion," *Electronics*, vol. 18, pp. 126-132; Jan. 1945.

5. Altec Lansing Corporation, "Intermodulation test unit measures distortion," *Elec. Equipment*, vol. 6, p. 22; May 1946.
6. H. E. Roys, "Intermodulation distortion analysis as applied to disc recording and reproducing equipment," *Proc. I.R.E.*, vol. 35, No. 10, pp. 1149-1152; Oct. 1947.
7. G. W. Read and R. R. Scoville, "An improved intermodulation measuring system," *J. Soc. Mot. Pic. Eng.*, vol. 50, pp. 162-172; Feb. 1948.
8. W. J. Warren and W. R. Hewlett, "An analysis of the intermodulation method of distortion measurement," *Proc. I.R.E.*, vol. 36, pp. 457-466; April 1948.
9. H. E. Roys, "Analysis by the two-frequency intermodulation method of tracing distortion encountered in phonograph reproduction," *RCA Review*, vol. 10, No. 2, pp. 254-269; June 1949.

## THE AUDIO FAIR

- 1950 -

October 26-27-28, 1950

Hotel New Yorker

New York City

# Lincoln

The Lincoln turns the record over



Record is placed on turntable . . .



First side is played . . .

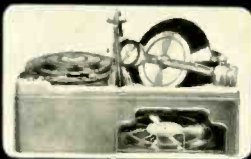

Turntable inverts . . .



Second side is played

After second side has been played record is released to Receiver, and cycle automatically repeats. (When Changer is set for "Single Side" operation, it releases the record without playing the second side.)

THE WORLD'S  
MOST VERSATILE  
RECORD  
CHANGER



FOR CUSTOM  
INSTALLATION

PLAYS BOTH SIDES OF RECORDS . . .  
ALL SIZES . . . ALL SPEEDS . . . ON A  
CUSHION OF AIR

The Lincoln Record Changer not only plays both sides, or one side of records, as desired, but plays 33 1/3 r.p.m., 45 r.p.m., and 78 r.p.m. speeds; any size, 7", 10" and 12" intermixed. Changer can provide up to 21 hours of continuous music, and shuts off automatically.

Only one record is on the turntable at any one time, eliminating slippage which may damage records. Records with rough or chipped edges and warped records may be played as easily as records in perfect condition. Soft rubber suction cups handle the records. No metal (except needle) ever touches the records.

THE LINCOLN . . . can be easily installed in Capehart console model cabinets if desired . . . Write for Brochure and Complete Information.

LINCOLN ENGINEERING CO.

5702 Natural Bridge Avenue • St. Louis, Missouri

**AN IMPORTANT NEW  
PHOTOFACT BOOK!**  
for **SOUND TECHNICIANS  
AUDIO ENGINEERS  
CUSTOM BUILDERS**  
**VOLUME TWO**  
**Howard W. Sams' Post-War  
"AUDIO AMPLIFIERS"**



**Full Analysis of  
104 Important  
Audio Amplifiers,  
12 Popular Tuners  
and Associated  
Equipment**  
**Based on Actual  
Study of the  
Equipment**

**COMPLETE, AUTHORITATIVE DATA**  
This new volume continues to fill the large sustained demand for data on Audio Amplifiers and associated equipment. Invaluable to public address and sound technicians, audio engineers, custom installers, BC engineers, and students. Provides a complete, clear, uniform analysis of 104 well-known audio amplifiers and 12 important tuners. Includes detailed circuit and design data based on original laboratory examination of the equipment. All new material, continuing audio equipment coverage begun in Volume 1 (see below). Profusely illustrated with hundreds of photos and diagrams. 368 pages; 8½ x 11"; sturdily bound.  
**ORDER AA-2. Only. \$395**



**VOLUME ONE**  
**Howard W. Sams' Post-War  
"Audio Amplifiers"**  
This is the initial volume covering audio equipment produced after the war, through 1948. Covers 102 audio amplifiers and FM tuners, plus data on important wire and tape recorders. Includes the products of 29 well-known manufacturers. 352 pages; fully illustrated; in sturdy binding,  
**8½ x 11". ORDER AA-1. Only. \$395**

**ORDER BOTH VOLUMES AND OWN  
A COMPLETE, AUTHORITATIVE SOUND LIBRARY**

**HOWARD W. SAMs & CO., INC.**

Order from your Parts Jabber today, or write direct to HOWARD W. SAMs & CO., INC., 2201 East 46th Street, Indianapolis 5, Ind.

My (check) (money order) for \$..... enclosed. Send the following books:

AA-2. "Audio Amplifiers." Vol. 2. \$3.95  
 AA-1. "Audio Amplifiers." Vol. 1. \$3.95

Name.....  
Address.....  
City.....Zone.....State.....

**RECORD REVUE**

[from page 30]

been sounding off with about 10 per cent intermodulation—relatively very good. That set, modified, sold, and is probably still selling, for about \$200, nothing like four or six hundred. With an over-all intermodulation distortion down to such levels, in the 2 per cent region, surely the set should already be famous among engineers as the example of what intelligent audio design can do in the strictly commercial field! And moreover, here was the set that ought to prove to the customers that good audio can and will be produced, when demand warrants it. . . .

**Good Audio—Poor Sales**

The only trouble is that this particular set and the original good one showed not the slightest signs of selling well to critical customers who might be ready to hear the difference. They sold about average, or perhaps even under average. There is no evidence at all to show that these two *measurably* superior sets—greatly superior—could "sell themselves" to the customers in direct competition with inferior (and more expensive) machines, on the usual radio show room floor. Not only that, the dealers are said to have disliked them. Reason? Because *they won't play loud enough.*

But they *are* loud, just as loud as those which produce the fancy 25 per cent distortion! And there we have the crux of this particular listening factor—and a typical case of dealer-consumer misunderstanding that, to my mind, ought to be the subject of a bristling inside campaign on the part of these manufacturers. The customers complain that these sets aren't loud enough, sound weak in comparison to their neighbors on the show floor. But those customers who have finally bought the good machines are—as we might guess—delighted. Virtue will come forth triumphant, if given half a chance.

Perhaps this sounds a bit too simple, but it is easy enough to prove the vital relation between apparent loudness and distortion content with a little close observation. It is simple.

**Apparent Loudness**

Apparent loudness and actual loudness are two quite different things. We know this from plenty of easily observable phenomena. The Fletcher-Munson curves show that loudness perception is not flat, by any means, and the loudness control now widely used in audio work helps match that unevenness in the ear. We have also the tricky phenomenon of the announcer's voice, on the air, versus broadcast symphonic music; though the VU meter may read the same, we often get startlingly different *apparent* loudnesses—and a good slice of the difference may even be associative, not physical; that is, we expect a louder sound from a symphony than from a single speaking voice and that affects our perception of the loudness—how loud we *think* things are. A small amount of reasonable reflection will convince you that apparent loudness is a very subtle thing.

The particular element we are dealing with here is that of distortion. Apparent loudness—and that's what the customer talks about—is radically affected by distortion content. The more distorted sound *seems louder*, the cleaner sound appears to be less loud. Much less loud. The difference is quite astonishing when you begin to investigate, and it is not hard for you to experience it yourself, once the idea we are getting at is clear, for there are very easy

**AMPERITE**  
Studio Microphones  
at P.A. Prices

Ideal for  
**BROADCASTING  
RECORDING  
PUBLIC ADDRESS**



"The ultimate in microphone quality," says Evan Rushing, sound engineer of the Hotel New Yorker.  
• Shout right into the new Amperite Microphone—or stand 2 feet away—reproduction is always perfect.  
• Not affected by any climatic conditions.  
• Guaranteed to withstand severe "knocking around."

Models  
RBLG—200 ohms  
RBHG—Hi-imp.  
List \$42.00



"Kontak" Mikes  
Model SKH, list \$12.00  
Model KKH, list \$18.00

**Special Offer:** Write for Special Introductory Offer, and 4-page illustrated folder.

**AMPERITE Company, Inc.**  
561 BROADWAY • NEW YORK 12, N. Y.  
Canada: Atlas Radio Corp., Ltd., 560 King St. W., Toronto

**A  
TIME-TESTED  
DEPENDABLE  
SOURCE  
FOR**

**HIGH-PRECISION FRACTIONAL H.P. INSTRUMENT-TYPE MOTORS & GENERATORS**  
PRODUCED TO ORDER

- GOVERNOR-CONTROLLED
- SELF-SYNCHRONOUS
- SWAG CUP
- VELOCITY & ACCELERATION
- DC & AC TACHOMETER
- SHUNT
- SERIES
- COMPOUND
- PERMANENT MAGNET
- SPLIT-FIELD
- SEPARATELY EXCITED
- UNIVERSAL
- INDUCTION
- RELUCTANCE
- HYSTERESIS
- ONE, TWO & THREE PHASE
- DC & AC SERVO
- TOTALLY ENCLOSED
- AC DYNAMICALLY BRAKED
- REL MOTORS
- ONE, TWO, THREE & FIVE-PHASE SYNCHRONOUS MOTORS

Experienced for years in meeting customer's exacting requirements for high-precision instruments designed by engineers of ability and versatility, and manufactured with extreme care and skill. Over 500 different basic types may be varied to meet your own unique requirements of use, either electrically or physically.

**ELECTRIC INDICATOR Co.**  
PARKER AVENUE  
STAMFORD, CONNECTICUT



ways of getting an absolute bearing on real loudness, without the necessity of a fancy test set up.

**Conversation**

My friend suggested that conversation is a fine clue to real loudness, and since he tipped me off I have been listening right along. Try this. Set an ordinary cheap radio or phonograph, that you know is fine for producing distortion, at a room volume level which seems to be fairly loud—as loud, say, as the wife will let you get away with in the front room. Perhaps even a bit louder, so that people say, "Couldn't you turn it down just a bit." Then notice what happens when there is conversation. Speaking voices will be understood fairly easily, with only slight raising of the accustomed speech level. It won't be necessary to shout, though you may have to speak a little loudly.

Now take a really good hi-fi system in a similar situation. Set the volume level so that it seems comfortably to fill the room with an easy sound—not loud; definitely less than loud. (Those of you who insist on 50 watts or nothing can keep out of this experiment.) Set it for an easy, relaxed listening, just this side of background. Now try conversation. You will be slightly surprised to find that you must really shout to be heard. Perhaps you won't be understood at all. Funny—because you would swear that the volume was turned down to a very moderate level.

It won't do, of course, to try this experiment on an AB basis, since, after all, there is a difference in actual loudness and we are looking for the ultimate effect of apparent loudness without comparison. A strident little table radio and a smoothly expensive hi-fi speaker are so far apart that the AB test would override the ear's natural tendency to determine loudness on a distortion basis. Best is just to observe radio and recorded music in the various situations you run into in average daily life. Listen always to the conversation-audibility, and compare it with the apparent loudness. I am quite certain that you will find, as I have, that this distortion factor is potent.

I know that in my own small room, with a reasonably good separate-speaker system and excellent pickup and amplifier equipment, my average choice of loudness makes conversation utterly impossible—and I do not as a rule like extra-loud sounds. Nor do my friends complain of the loudness—it isn't uncomfortable in the least. But conversation is out of the question.

**On the Sales Floor**

And so, back to the two superior commercial combinations and their poor sales records. On the shop floor, these sets are compared for a few seconds or a minute or so with others having similar power and tonal range but very much more distortion. The distortion is unrecognized—at least on such short contact. So is the lack of distortion. The average untrained ear does not immediately hear the difference between a distorted sound and an undistorted one, not having had the experience that is naturally a prerequisite. And so your customer walks off with the set that sounds loudest, biggest, most powerful, the one with the big distortion! *This is actually happening, day in and day out.*

The really good audio, in this situation, is at a very heavy disadvantage—unless, of course, the customer can be made to understand. And that means that the dealer must be made to understand and to explain. A fine job!

**—And in The Home**

The positive fact is that when the customer does get the good set home, the situa-

# Air-Tone HEADQUARTERS FOR Magnecord.

**AIR-TONE HEADQUARTERS FOR MAGNECORD**

Air-Tone offers Magnecord recording equipment for all those who desire the ultimate in Magnetic recording. Easy operating, Magnecord provides unusually high fidelity, great flexibility in use, outstanding realism in tone.



**PT6-JA Recorder & Amplifier**

Portable rig for professional, superb reproduction of all types of program material. 10-Watts output. Highest Quality. Greatest Value. **\$499.50**

**McIntosh Amplifiers**

Highest quality, efficiency. Full dynamic range. Frequency range—20 to 20,000 plus or minus 2db; 10 to 200,000 plus or minus 2db. Lowest phase shift distortion, lowest noise level.

- 50 W-1 for less than 1% distortion
  - Continuous single frequency rating
  - 50 watts RMS—Peak 100 . . . . . **\$249.50 net**
- 20 W-2 for less than 1% distortion
  - Continuous single frequency rating
  - 20 watts RMS—Peak 40 . . . . . **\$149.50 net**

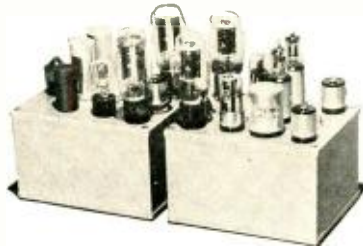

# Air-Tone

**SOUND & RECORDING COMPANY**

1527 CHESTNUT ST., PHILA. 2, PA. — RI. 6-8388

## NEW MUSIC LOVERS AMPLIFIER

### the GROMMES CUSTOM

... undisputed best "Ears" or Instruments!



**MODEL 50 PG**  
Dealer's Net **\$45.00**

**MODEL 200 PG**  
Dealer's Net **\$150.00**

Exclusive feedback circuits result in effective speaker damping. Equalized inputs for magnetic or crystal pickup, microphone and radio. Extremely flexible tone control with calibrated boost and droop in DB's.

Amplifiers pass all square wave tests — no phase shift or transient oscillations of any kind. Model 200 PG offers frequency response of ± 0.1 DB, 10 to 50,000 CPE. Distortion at 20 watts is 0.2%. Write today for free technical bulletin.

## PRECISION ELECTRONICS, INC.

641-43 MILWAUKEE AVENUE • CHICAGO 22, ILLINOIS

# Concertone

MAGNETIC TAPE  
RECORDER



Model  
#401

"just like  
being there"

Monitoring from tape while recording • Less than 0.1% flutter • 50 to 12,500 cycles  $\pm$  2 db • Full 50 db signal to noise ratio • High speed forward and reverse — 2500 feet in 60 secs • Instantaneous choice of 7.5" or 15" tape speeds • Handles 5", 7" and 10½" reels (66 minutes) • All controls interlocked to prevent spilling or tearing tape • Write for Bulletin #101.

MODEL #401 — Mechanism and electrical chassis ready for console installation.

\$295.00

Manufactured by

USER'S NET COST



**berlant associates**

4917 W. Jefferson Boulevard,  
Los Angeles 16, California

## Ready NOW ULTRASONIC FUNDAMENTALS

By S. YOUNG WHITE

The rapid increase in the use of ultrasonics during the last few years makes it natural that the well-informed sound engineer should want to learn something of the applications and potentialities of this amazing new field. But interest in ultrasonics is not confined to the sound engineer—it is of still greater importance to the industrial engineer for he is the one who will visualize its uses in his own processes.

Elementary in character, ULTRASONIC FUNDAMENTALS was written originally as a series of magazine articles just for the purpose of acquainting the novice in this field with the enormous possibilities of a new tool for industry. It serves the double purpose of introducing ultrasonics to both sound and industrial engineers. The list of chapter headings will indicate how it can help you.

### CHAPTER HEADLINES

Too Much Audio. Opportunities In Ultrasonics. Elements of Ultrasonics. Experimental Ultrasonics. Coupling Ultrasonic Energy to a Load. Ultrasonics in Liquids. Ultrasonics in Solids. Testing by Ultrasonics. High-Power Ultrasonics. Notes on Using High-Power Ultrasonics. Applications of Ultrasonics to Biology. Economies of Industrial Ultrasonics.

The applications of ultrasonics have already extended to many industries, and as its possibilities are explored they will increase a hundredfold. To keep abreast of its growth, engineers in all fields must know what they may expect from ultrasonics, how it is used, how the energy is generated, and the techniques of applying ultrasonic treatment to many processes.

ULTRASONIC FUNDAMENTALS is not a big book—it does not cover the entire field of ultrasonics with hundreds of pages of dull reading. But in the three hours it will take you to read it, you will get a down-to-earth glimpse into the far-reaching possibilities of a new art.

### ULTRASONIC FUNDAMENTALS

By S. YOUNG WHITE

36 pages, 40 ill., 8½ x 11, paper cover \$1.75

Book Division, Dept. A  
RADIO MAGAZINES, INC.  
342 Madison Avenue New York 17, N. Y.

tion is enormously different. At home, the real advantages of better audio, that are eclipsed in the split-second floor demonstration, have a chance to show themselves, and most assuredly do.

The customer who buys the distorted set will perhaps never complain—because he has no set of comparative values on which to base a complaint. He is not surprised, usually, at the results he gets, since they are what he expected. (But wait a few paragraphs for one exception to this.)

The customer who gets the good set, with the 2 per cent intermodulation, will find, when he gets home, that his machine—now that it is by itself and away from those others—has plenty of power for his needs. (At full rated output, the distortion naturally is somewhat increased, and so if he runs his machine at top volume he will tend to get the same effect of extra loudness, due to the increasing distortion—enough, in any case, so that he feels there is a reserve of "power.") In average listening, this customer will find that he can take an astonishing amount of music, for a very long time, without ear fatigue. The music at all times sounds modest, smooth, unobtrusive, and pleasingly un-loud. By degrees Mr. Customer will learn to run the set at what seems to be a lower volume level than he formerly used. Actually, if he will try the conversation test, it will turn out to be a higher level, most likely.

But more benefits accrue, as my friend points out and as I can readily affirm. Both receivers (that is, the two described above, with intermodulation distortion in the 2 per cent region), he says, will reproduce music that will outshine music from other sets by two simple tests. First, with a good pickup of the reluctance type, the amount of record scratch at a given measured acoustic output is noticeably less than that from the same records, same pickup, fed into the audio of another machine of the fancy \$600 25 per cent distortion type. Second, music via radio, again at a given measured acoustic output, sounds less scratchy.

Those are my informant's words more or less; I won't argue about the "given measured acoustic output. But, taking the other side of the picture, we have here the explanation of one of the most frequent beefs I receive via mail—excessive record scratch upon installation of a wider-range pickup. Most people tend to say that it's merely a matter of getting used to a little scratch—but it is not, as can now be readily understood. Without the slightest doubt, given the same tonal "range", increased distortion in the over-all system makes for increased scratch. At 25 per cent intermodulation distortion, even a heavily rolled-off upper range will give dreadful scratch—whether via radio or phonograph. Only an absolute cut-off will control this sort of thing! The new wide-range pickups have inadvertently made for a lot of trouble and confusion in this area. So has wide-range FM—in cheezy, distorted little table FM sets. (And the unbalance between the extended—distorted—highs and the utter lack of bass only makes things worse; for as we know, another hearing principle is that lack of bass makes the highs seem louder, and vice versa.)

### Truth can Prevail

What shall we do, then, about better commercial audio? Is it, then, impossible to sell better audio in competition with poor audio? Perhaps, if we persist in present ways of selling. It's pretty hard to "sell" the traditionally conservative radio dealer, who doesn't care about audio or anything else, so long as his customers are "satisfied"—that is, give with the dough.

But the job could be done, because, as we

## PROFESSIONAL DIRECTORY

### C. J. LeBEL

AUDIO CONSULTANT

Sound Recording • Instrumentation

370 RIVERSIDE DRIVE  
NEW YORK 25, N. Y.

Custom-Built Equipment

### U. S. Recording Co.

1121 Vermont Ave., Washington 5, D. C.

STerling 3626

Consultation • Design • Fabrication

Audio Facilities Corporation

133 West 14th Street,

New York 11, N. Y.

### HERMAN LEWIS GORDON

Registered Patent Attorney

Patent Investigations and Opinions

Warner Building 100 Normandy Drive  
Washington 4, D. C. Silver Spring, Md.  
National 2497 Shephard 2433

### Albert E. Hayes, Jr.

CONSULTING PHYSICIST

Audio • R.F. • Video

8 East Sampson St. Bay Park, L.I., N.Y.

RATES FOR  
PROFESSIONAL CARDS  
IN THIS DIRECTORY

•

\$10 Per Month.  
Orders Are Accepted  
for 12 Insertions Only



## HIGH "Q" DECADE-INDUCTORS

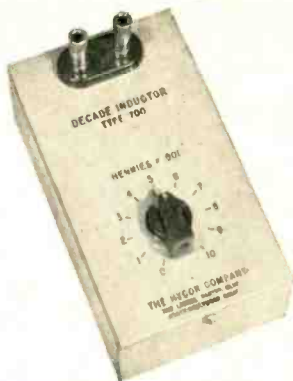

**HYCOR DECADE**—Inductor units are indispensable for design and experimental work on audio filters.

The units are available in four ranges up to 10 henries. Units may be used individually or all four may be connected in series to obtain 11.11 henries in 1 millihenry steps.

Toroid coils are used to obtain high "Q", stability and low pickup from external fields. Inductance accuracy is 2%.

The units are economically priced to bring them within the reach of all audio experimenters. Send for Bulletin D.

**THE HYCOR COMPANY**  
11423 VANOWEN ST.  
NORTH HOLLYWOOD, CALIF.

## NOTHING ELSE LIKE IT

**ELEMENTS of SINGLE and DUAL TRACK TAPE RECORDING and 1001 APPLICATIONS**



**\$1.00** ONLY *by A.C. Shoney*  
POSTPAID

96 pages crammed with facts. Contains circuit diagrams, parts lists, construction hints, as well as elementary and advanced theory and design. Send dollar bill. No C.O.D.'s.

**AMPLIFIER CORP. of AMERICA**  
398-94 Broadway New York 13, N. Y.

## AUDIO ENGINEERING SCHOOL

Practical engineering training in Audio fundamentals, Disc, Film, Magnetic Recordings, and Audio frequency measurements.

Studio training simulates Broadcast, Motion Pictures, Television, and Commercial Recording work.

Approved for Veterans

Hollywood Sound Institute, Inc.  
1040-A North Kenmore, Hollywood 27, Calif.

Specify if Veteran or Non-Veteran

## ADDRESS CHANGES—

Subscribers to **AUDIO ENGINEERING** should notify our Circulation Dept. at least 5 weeks in advance regarding any change in address. The Post Office Dept. does not forward magazines sent to a wrong destination unless you pay additional postage. We can NOT duplicate copies sent to your old residence. Old and new addresses **MUST** be given.

**AUDIO ENGINEERING RADIO MAGAZINES, INC.**  
342 Madison Ave.  
New York 17, N. Y.

often hear, truth will prevail. To sell good audio we must face the existing facts—the facts about performance, but more important, the facts about human hearing, the way people listen, the results of good and poor audio. Prejudice is important—but don't think that good audio will sell merely by getting around people's prejudices. A lot of those prejudices are in reality accurate, correct observations, given the listening conditions that people run into. Not prejudices at all, in the usual sense. The people who don't like the 2 per cent set in the radio shop because it sounds weak are 100 per cent right. In one minute's test they cannot be expected to hear the concrete benefits that good audio can give. Sales people must, then, be prepared with facts on what the customer is hearing, what he could hear, and why. Given an intelligent sales campaign, there is every reason to suppose that radically improved audio can sell as it ought to sell. And remember—one of the two sets we've been talking about achieved its improved performance at the cost of 18 cents' worth of parts per set. Good audio is not necessarily expensive.

If and when the manufacturers of the two remarkable radio-phonographs described here give me their permission, I will name names. Readers no doubt will be avidly curious as to which of the standard machines they are. Please, therefore, do not ask me or this magazine to reveal the secret!

(Mr. Canby will resume his record reviews in the August issue.)

## NEW LITERATURE

● **Radio Tube Division**, Sylvania Electric Products, Inc., 500 Fifth Ave., New York 18, N. Y. is now supplying through authorized Sylvania distributors a 128-page loose-leaf book titled "Servicing TV Receivers." Devoted to the servicing and maintenance of home TV equipment, the new book is wire-bound permitting it to lie flat when in use. Extensive illustration includes 53 screen patterns, 17 wave-form patterns, and seven schematic diagrams.

● **Electrical Timing Devices**. A new 8-page catalog is currently available from Haydon Manufacturing Co., Torrington, Conn. describing a complete line of electrical units for time delay, interval, repeat cycle, and elapsed time functions. The booklet is complete, and indicates data necessary for special designs. Copies may be had without charge by writing E. B. Hamlin, Adv. Mgr., requesting Catalog 323.

● **Racon Electric Company, Inc.**, 52 E. 19th St., New York 3, N. Y. is now distributing a new 12-page sound-equipment catalog in which is illustrated and described the company's complete line of sound products. In addition, the catalog contains reference data of distinct value to sound technicians. A copy will be mailed free upon request.

● **University Loudspeakers, Inc.**, 80 S. Kensico Ave., White Plains, N. Y. features high-fidelity speakers and accessories in a new illustrated catalog now available on request. In addition to describing and illustrating equipment, the catalog presents a considerable amount of technical information of general interest.

● **Gray Research and Development Co., Inc.**, 16 Arbor St., Hartford 1, Conn. is currently supplying on request its new catalog of television broadcasting equipment. Handsomely illustrated, the catalog describes the Gray Telop, camera turrets, multiplexer, and other basic equipment items for station application.

# One Pickup

**PLAYS ALL DISKS**

New Fairchild Turret-Head 3-Way Transcription Arm Plays Standard Laterals, Microgrooves, and Verticals Without Plug-ins . . .

## WHAT IT IS:

A revolutionary new pickup with provision for 3 separate cartridges—All in ONE arm



## WHAT IT DOES:

Obsoletes plug-in cartridges. Eliminates extra pickups on turntable. Performs functions of 3 separate pickups.

## RESULTS:

- Lateral, Vertical, Microgroove in 1 Arm
- Any combination of cartridges in 1 Arm
- Simply turn knob to select cartridge
- Pressure changes automatically
- Optimum performance — separate cartridge for each function
- No arm resonance — new viscous damping
- Fits all transcription turntables.

Write for  
Illustrated Details

**Fairchild**  
**RECORDING EQUIPMENT CORPORATION**

154TH STREET AND 7TH AVENUE  
WHITESTONE, N. Y.

FR-113

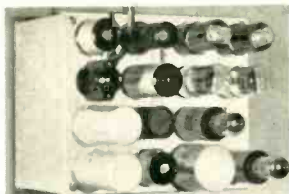

20 W-2 Amplifier \$149.50



AE-2 Equalizer PreAmplifier \$74.50

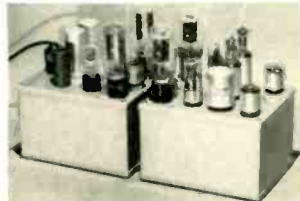

50 W-2 Amplifier \$249.50

# McIntosh

Engineering Laboratory, Inc.  
910 King St. Silver Spring, Md.  
Prices Subject to Change Without Notice.

## HARTLEY-TURNER REPRODUCTION AT LOW FIDELITY COST

Our new amplifier and pre-amplifier recently announced are going to cost you very little considering their superlative performance. At the time of writing this copy we think we shall be able to supply the pre-amplifier with independent non-distorting bass and treble control, and which can be used remote from the main amplifier, for about \$23.00 and the 20 watt high-fidelity amplifier, with overall feedback and flat response from 30 to 30,000 cps, for about \$102.00.

Added to this it seems likely that our new lightweight pickup for both standard and micro-groove records will work out at about \$10.00 including sapphires.

These items used with the 215 speaker at \$40.00 will give you record reproduction quite exceptionally outstanding, and if you have a motor you can now reckon that the very last word in photographs can be yours for a total cost of around \$175.00, and less if you are a member of a Speakeasy.

Send a dollar bill today for "New Notes in Radio", a regular mailing of data sheets and details of the Speakeasy marketing scheme. All names on our mailing list will receive full details and data sheets on the new products without the need for writing to us.

**H. A. HARTLEY Co. Ltd.,**  
152 Hammersmith Road,  
London W.6, England.

## ADVERTISING INDEX

|                                     |         |
|-------------------------------------|---------|
| Air-Tone Sound & Recording Co.      | 45      |
| Amperite Co., Inc.                  | 44      |
| Ampex Electric Corp.                | 48      |
| Amplifier Corp. of America          | 47, 48  |
| Astatic Corporation, The            | 6       |
| Audak Company                       | 31      |
| Audio Devices, Inc.                 | Cover 2 |
| Audio Facilities Corp.              | 46      |
| Belden Manufacturing Co.            | 2       |
| Bell Telephone Laboratories         | 10      |
| Berlant Associates                  | 46      |
| British Industries Corp.            | 36      |
| Camera Equipment Company            | V8      |
| Cinema Engineering Company          | 42      |
| Electric Indicator Co.              | 44      |
| Electro-Voice, Inc.                 | V2      |
| Fairchild Recording Equipment Corp. | 3, 47   |
| Gordon, Herman Lewis                | 46      |
| Gray Research & Dev. Co.            | 41      |
| Hartley, H. A. Co., Ltd.            | 48      |
| Harvey Radio Company, Inc.          | 39      |
| Hayes, Albert E., Jr.               | 46      |
| Heath Company                       | 37      |
| Hollywood Sound Institute           | 47      |
| Hycor Company, The                  | 47      |
| Jensen Manufacturing Company        | 1       |
| Leak, H. J. & Co., Ltd.             | 36      |
| LeBel, C. J.                        | 46      |
| Lincoln Engineering Company         | 43      |
| Magnecord, Inc.                     | 9       |
| McIntosh Engineering Lab, Inc.      | 48      |
| Newcomb Audio Products              | 8       |
| Partridge Transformers, Ltd.        | 48      |
| Pickering & Co., Inc.               | 5       |
| Precision Electronics, Inc.         | 45      |
| Professional Directory              | 46      |
| Racon Electric Company, Inc.        | 35      |
| Radio Corp. of America              | Cover 4 |
| Reeves Soundcraft Corp.             | 33      |
| Rek-O-Kut Co., Inc.                 | 38      |
| Sams, Howard W. & Co., Inc.         | 44      |
| Televex                             | 42      |
| Terminal Radio Corp.                | 7       |
| United Transformer Corp.            | Cover 3 |
| U. S. Recording Co.                 | 46      |



## TWIN-TRAX TAPE RECORDER

Available to you direct from the factory at savings that make TWIN-TRAX the only professional-type recorder in the popular-price field. More than a dozen model variations for portability, long-play, continuous operation, etc. For a better tape recorder that combines professional quality with operating ease and trouble-free construction, it's TWIN-TRAX. Write today for complete literature. \*Trade Mark Registered

**AMPLIFIER CORP. OF AMERICA**  
398-4 Broadway • New York 13, N. Y.



## Partridge News

*Individually tested*  
**AUDIO TRANSFORMERS**  
to the 'WILLIAMSON' Specification

This range of 20 watt push-pull output transformers is intended for use in equipment reproducing the full audio frequency range with the lowest distortion. The design and measured performance is exactly as specified by Williamson in the "Wireless World" August 1949 (see also Audio Engineering November 1949). The transformer is available in a varied range (separate models suitable for KT66, 807 tubes, etc.) Performance assured by comprehensive testing procedure applied to each unit. Close limits set on shunt reactance at 50 cps., series reactance at 5 Kc/sec., d.c. resistances and interwinding insulation resistances at 2 K.V. This is the best possible transformer of its type (weight 14 lbs.) Our new technical data sheet is available and will be rushed to you by airmail upon application. The price of the potted model is **\$19.50** post free to your door. Immediate from our stocks.



## PARTRIDGE TRANSFORMERS LTD

Reubek Road, Tolworth, Surrey, England

FOR **Critical** TAPE RECORDING  
to 40,000 cycles

Tape recording is superior to all other reproduction methods and "AMPEXED TAPE" has the greatest fidelity and range now possible. Simplified operation plus sure results, make AMPEX unexcelled for all critical recording uses. Dual tape speeds with automatic speed and equalization change is but one of many exclusive AMPEX features. *Unequaled for*

TELEMETERING • BROADCASTING • RESEARCH

## AMPEX STANDARD OF THE GREAT RADIO SHOWS

Simultaneous

- ERASE
- RECORD
- PLAY BACK

MODEL 300

Price \$1575

(f.o.b. San Carlos)

Meter Control

Panel \$114 Extra

AMPEX ELECTRIC CORP., San Carlos, California

Without obligation please send 10-page illustrated booklet containing technical specifications of AmpeX Magnetic Tape Recorders.

NAME \_\_\_\_\_  
ADDRESS \_\_\_\_\_  
CITY \_\_\_\_\_ STATE \_\_\_\_\_

Our need is for:

- |  |  |
|--|--|
| <input type="checkbox"/> Laboratory Research     | <input type="checkbox"/> Telemetering          |
| <input type="checkbox"/> Multi-Channel Recording | <input type="checkbox"/> Industrial Recording  |
| <input type="checkbox"/> Recording-Broadcasting  | <input type="checkbox"/> Aerophysical Research |

**AMPEX ELECTRIC CORPORATION**  
SAN CARLOS, CALIFORNIA  
DEALERS IN PRINCIPAL CITIES





## PERMALLOY DUST TOROIDS FOR MAXIMUM STABILITY...

The UTC type HQ permalloy dust toroids are ideal for all audio, carrier and supersonic applications. HQA coils have Q over 100 at 5,000 cycles... HQB coils, Q over 200 at 4,000 cycles... HQC coils, Q over 200 at 30 KC... HQD coils, Q over 200 at 60 KC... HQE (miniature) coils, Q over 120 at 10 KC. The toroid dust core provides very low hum pickup... excellent stability with voltage change... negligible inductance change with temperature, etc. Precision adjusted to 1% tolerance. Hermetically sealed.



**HQA, HQC, HQD CASE**  
1 13/16" Dia. x 1 3/16" High



**HQB CASE**  
1 5/8" x 2 5/8" x 2 1/2" High



**HQE CASE**  
1/2" x 1 5/16" x 1 3/16" High

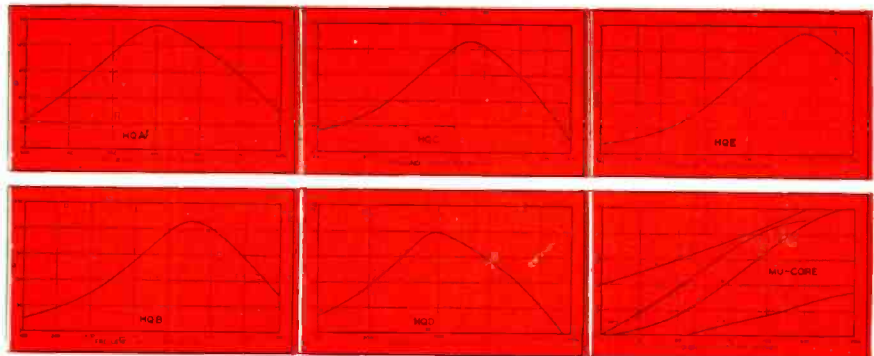

| Type No. | Inductance Value | Net Price | Type No. | Inductance Value | Net Price | Type No. | Inductance Value | Net Price |
|----------|------------------|-----------|----------|------------------|-----------|----------|------------------|-----------|
| HQA-1    | 5 mhy.           | \$7.00    | HQA-16   | 7.5 hy.          | \$15.00   | HQC-1    | 1 mhy.           | \$13.00   |
| HQA-2    | 12.5 mhy.        | 7.00      | HQA-17   | 10. hy.          | 16.00     | HQC-2    | 2.5 mhy.         | 13.00     |
| HQA-3    | 20 mhy.          | 7.50      | HQA-18   | 15. hy.          | 17.00     | HQC-3    | 5 mhy.           | 13.00     |
| HQA-4    | 30 mhy.          | 7.50      | HQB-1    | 10 mhy.          | 16.00     | HQC-4    | 10 mhy.          | 13.00     |
| HQA-5    | 50 mhy.          | 8.00      | HQB-2    | 30 mhy.          | 16.00     | HQC-5    | 20 mhy.          | 13.00     |
| HQA-6    | 80 mhy.          | 8.00      | HQB-3    | 70 mhy.          | 16.00     | HQD-1    | .4 mhy.          | 15.00     |
| HQA-7    | 125 mhy.         | 9.00      | HQB-4    | 120 mhy.         | 17.00     | HQD-2    | 1 mhy.           | 15.00     |
| HQA-8    | 200 mhy.         | 9.00      | HQB-5    | .5 hy.           | 17.00     | HQD-3    | 2.5 mhy.         | 15.00     |
| HQA-9    | 300 mhy.         | 10.00     | HQB-6    | 1. hy.           | 18.00     | HQD-4    | 5 mhy.           | 15.00     |
| HQA-10   | .5 hy.           | 10.00     | HQB-7    | 2. hy.           | 19.00     | HQD-5    | 15 mhy.          | 15.00     |
| HQA-11   | .75 hy.          | 10.00     | HQB-8    | 3.5 hy.          | 20.00     | HQE-1    | 5 mhy.           | 6.00      |
| HQA-12   | 1.25 hy.         | 11.00     | HQB-9    | 7.5 hy.          | 21.00     | HQE-2    | 10 mhy.          | 6.00      |
| HQA-13   | 2. hy.           | 11.00     | HQB-10   | 12. hy.          | 22.00     | HQE-3    | 50 mhy.          | 7.00      |
| HQA-14   | 3. hy.           | 13.00     | HQB-11   | 18. hy.          | 23.00     | HQE-4    | 100 mhy.         | 7.50      |
| HQA-15   | 5. hy.           | 14.00     | HQB-12   | 25. hy.          | 24.00     | HQE-5    | 200 mhy.         | 8.00      |

## UTC INTERSTAGE AND LINE FILTERS



**FILTER CASE M**  
1 3/16" x 1 11/16"  
1 5/8" - 2 1/2" High

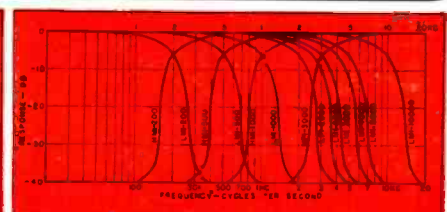
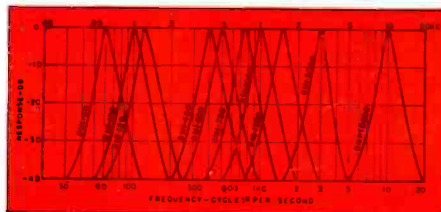

These U.T.C. stock units take care of most common filter applications. The interstage filters, BMI (band pass), HMI (high pass), and LMI (low pass), have a nominal impedance at 10,000 ohms. The line filters, BML (band pass), HML (high pass), and LML (low pass), are intended for use in 500/600 ohm circuits. All units are shielded for low pickup (150 mv/gauss) and are hermetically sealed.

**STOCK FREQUENCIES**  
(Number after letters is frequency)  
Net Price \$25.00

|          |           |           |           |
|----------|-----------|-----------|-----------|
| BMI-60   | BMI-1500  | LMI-200   | BML-400   |
| BMI-100  | BMI-3000  | LMI-500   | BML-1000  |
| BMI-120  | BMI-10000 | LMI-1000  | HML-200   |
| BMI-400  | HMI-200   | LMI-2000  | HML-500   |
| BMI-500  | HMI-500   | LMI-3000  | LML-1000  |
| BMI-750  | HMI-1000  | LMI-5000  | LML-2500  |
| BMI-1000 | HMI-3000  | LMI-10000 | LML-4000  |
|          |           |           | LML-12000 |

*United Transformer Co.*

150 VARICK STREET NEW YORK 13, N. Y.  
EXPORT DIVISION: 13 EAST 40th STREET, NEW YORK 16, N. Y., CABLES: "ARLAB"



**NEW CONVERSION KITS**

- MI-11882 for fine-groove cutting.
- MI-11860 and MI-11861 for 45 RPM operation.

The standard high-fidelity recorder for TV and Broadcast Stations, Professional Studios, and Advertising Agencies.

**For economical recordings . . .**  
**. . . nothing beats a high-fidelity 73-B**

**IN PRICE** . . . lowest in RCA history\* . . . the 73-B compares with any recorder of similar quality!

**IN CUTTING COSTS** per hour (where the records are permanently retained), the 73-B saves up to 92 per cent—compared with all other recording mediums!

**IN RECORD STORAGE** space, the 73-B saves up to 83 per cent—compared with all other recording mediums!

33 1/3 RPM, and MI-11861 for 45 and 73 RPM.)

Easy to operate, this professional recorder offers technical and economical advantages matched by no other recorder in its class. For details ask your RCA Broadcast Sales Engineer. Or write Dept. 7 G, RCA Engineering Products, Camden, N. J.

\*Ask your RCA Broadcast Sales Engineer for the special package price!

**New Fine-Groove and 45 RPM Kits**

Kit MI-11882 makes it easy to convert your 73-B recorder to cut fine-groove recordings—and reduce your recording costs one half!

New motor drive pulleys make it practicable to operate your 73-B at 45 RPM—and utilize this speed, plus either 33 1/3 or 78 RPM. (MI-11860 for 45 and

**Look at these low operating costs!**

| Specifications   | Records       |             |        |
|--|---------------|-------------|--------|
|  | Normal Groove | Fine-Groove |        |
|  |               | 15"         | 12"    |
| Record Cost per Hour (Records only)                        | \$4.00        | \$2.00      | \$2.20 |
| Cu. in. storage space needed per hour of recorded material | 36            | 18          | 20     |



**AUDIO BROADCAST EQUIPMENT**  
**RADIO CORPORATION of AMERICA**  
**ENGINEERING PRODUCTS DEPARTMENT, CAMDEN, N. J.**

In Canada: RCA VICTOR Company Limited, Montreal