

AUDIO ENGINEERING

JANUARY

1950

Coslon
35c

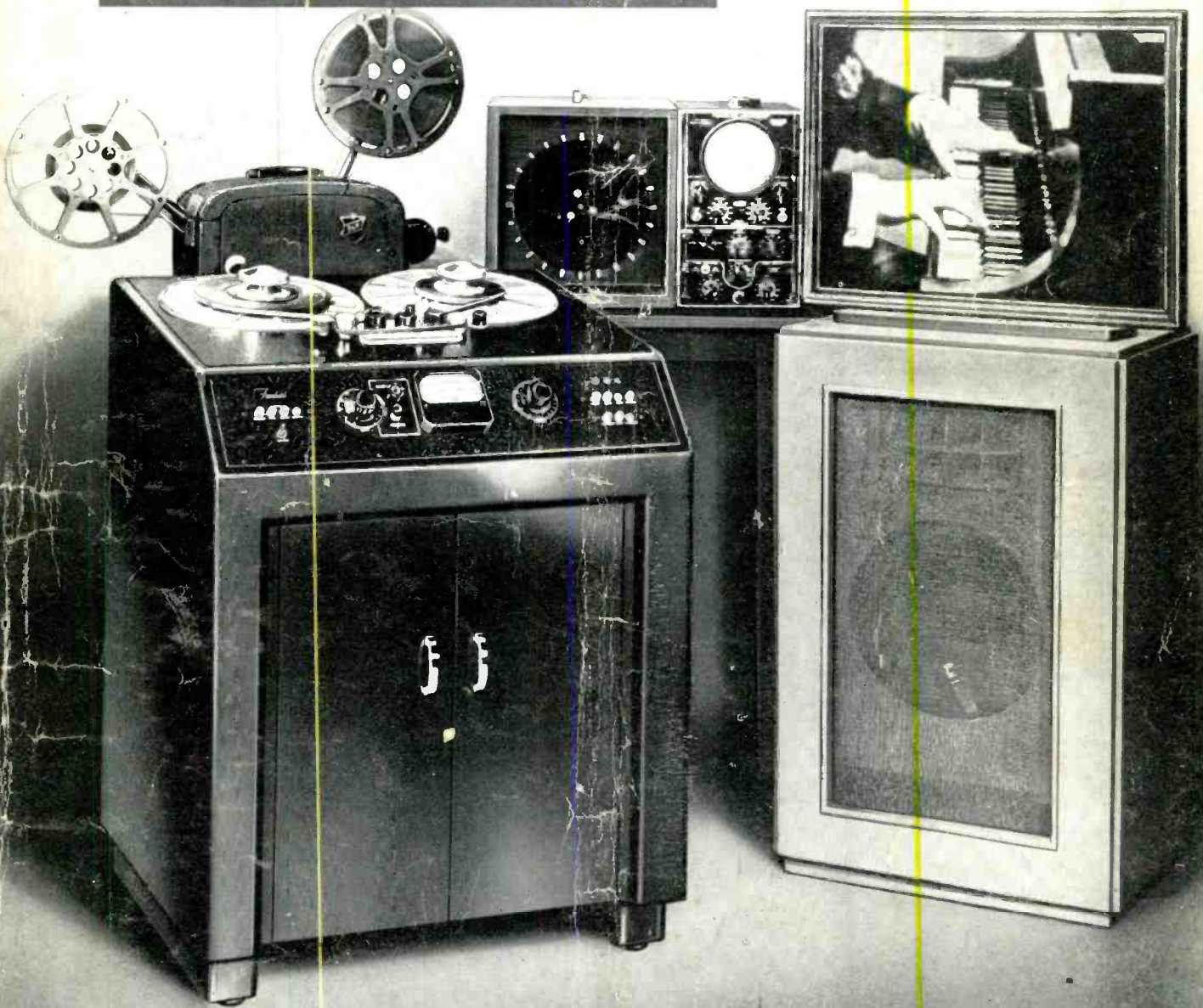

Published by RADIO MAGAZINES, INC.

12 Reasons Why **audiotape** can help you get the most out of your tape recorder!

1. AUDIOTAPE is wound on precision, all-aluminum reels.

2. AUDIOTAPE is cut by a superior straight-line slitting process which makes it track and wind absolutely flat.

3. AUDIOTAPE has no curl — lies flat on the magnetic head without increased tension, giving better frequency response and more uniform motion.

4. AUDIOTAPE has exceptionally low surface friction—reduces wear on heads.

5. AUDIOTAPE has definitely superior dispersion of oxide particles—no lumps, no bumps. This can be checked with any good microscope.

6. AUDIOTAPE is completely free from any tendency to stick, layer to layer.

7. AUDIOTAPE coating is specially formulated to give strong adherence of the oxide to the base.

8. AUDIOTAPE is designed to give maximum signal to noise ratio.

9. AUDIOTAPE has a wider bias range for optimum results—less sensitive to bias changes.

10. AUDIOTAPE has excellent high frequency response.

11. AUDIOTAPE has low distortion.

12. AUDIOTAPE has unequalled uniformity—within the reel, and from reel to reel. No magnetic weak spots that can cause fluctuations in output.

We know that every reel of AUDIOTAPE offers you all of these plus values — because all AUDIOTAPE is made in our own plant, under our own supervision and control, on machines designed by our own engineers. AUDIOTAPE is backed by over ten years of experience in producing professional quality recording discs. What's more, every foot of AUDIOTAPE is monitored for output, distortion and uniformity — your assurance of

the same consistent, uniform quality that has characterized AUDIODISCS for the past decade.

But why not try out a reel and let AUDIOTAPE speak for itself? Your AUDIODISC and AUDIOTAPE distributor will be glad to fill your requirements. And you're sure to be pleased with the professional discounts available. Or — we will be pleased to send you a 200 ft. sample reel of plastic or paper base AUDIOTAPE.

*Reg. U. S. Pat. Off.



AUDIO DEVICES, INC.

444 Madison Ave., New York 22, N. Y.

Export Dept. — Rocke International, 13 East 40th St., New York 16, N. Y.

Listen for the words "Transcribed by AMPEX" after the great shows in radio

Read what MARTIN BLOCK

(CREATOR OF "MAKE BELIEVE BALLROOM")

thinks about the

AMPEX series 300

magnetic tape recorder



Price approximately \$1,500.00
for Console, Portable or
Rack-Mounted Models*

*meter panel extra

wnew 565 fifth avenue new york 17, n. y.

Mr. Henry McMicking
Amplex Corporation
1155 Howard Avenue
San Carlos, California

August 5, 1949

My dear Mr. McMicking:

In the fifteen years that the Make Believe Ballroom has been on the air in New York, I have always striven for the finest quality on audio reproduction; consequently, much equipment has been tested and many companies have been dealt with.

The purpose of this little note is to let you know how much I appreciate the superb engineering and design of your Ampex 300. You and I know that the public is not "quality conscious", but there was an immediate reaction to a vastly superior reproduction of recording on the air, on the first day we started using your equipment.

May I at this time, also, compliment you on your New York staff. Mr. Hudson and your engineers have done everything to make the purchase painless and the operation a pleasure. Believing the listening public is entitled to the best in sound reproduction, I hope you will feel free to use this letter in any way, that it may serve as an added incentive to other radio stations to get on the Ampex band wagon.

Cordially,

Martin Block
Martin Block

1150 on your dial
24 hours a day

THE UNITED STATES DEPARTMENT OF
STATE IS NOW USING AMPEX
on the "VOICE OF AMERICA"
broadcasts at six beaming points throughout
the world.

Manufactured by Ampex Electric Corporation, San Carlos, Calif.

DISTRIBUTED BY

Bing Crosby Enterprises

9028 Sunset Blvd., Hollywood 46, Calif.

Graybar Electric Co., Inc.

420 Lexington Ave., New York 17, New York

Audio & Video Products Corporation

1650 Broadway, New York, New York

Designed by
engineers who had
your broadcast
results in mind.



16 COMPLETELY NEW MODELS

Three 15-inch Coaxials, One 12-inch Coaxial, Eleven 5-inch to 15-inch Single-Radiator Models

With these new models, Jensen offers the most complete line of high quality loudspeakers in the history of sound reproduction. There is a Genuine JENSEN Wide-Range Loudspeaker available for every application.

Write now for Data Sheet No. 152 describing all the new loudspeakers in the new Genuine JENSEN Wide-Range Series, and booklet, "Let Music Come to Life!"

GENUINE
Jensen
WIDE RANGE

JENSEN MANUFACTURING COMPANY *Division of the Muter Company*

6633 South Laramie Avenue, Chicago 38, Illinois

In Canada: Copper Wire Products, Ltd., 351 Carlaw Avenue, Toronto

AUDIO ENGINEERING

Successor to **RADIO**

Established 1917



C. G. McProud, Editor
Luci Turner, Edit. Prod. Mgr.
David Saltman, Production Manager
E. E. Newman, Circulation Manager

D. S. Potts, Publisher
S. L. Cahn, General Manager
H. N. Reizes, Adv. Mgr.
Harold J. Weisner, Assf. Circ. Mgr.

Editorial Advisory Board

Howard A. Chinn
John D. Colvin
C. J. LeBel
J. P. Maxfield
George M. Nixon

Representatives

Sanford R. Cowan, Mid-West Sales
342 Madison Ave., New York 17, N. Y.
James C. Galloway, Pacific Coast Sales
816 W. 5th St., Los Angeles 13, Calif.
Technical Book & Magazine Co.
297 Swanston St., Melbourne, C. I.
Victoria, Australia

CONTENTS JANUARY, 1950 Vol. 34, No. 1

Editor's Report	4
Letters	6
For the Discriminating Listener: An Audio Input System —Wayne B. Denny	9
The Bantam Velocity Microphone—L. J. Anderson and L. M. Wigington	13
Stereophonic Reproduction—Tenny Lode	15
A Loudspeaker for the Range from 5 to 20 kc —W. T. Selsted and B. H. Smith	16
Aircraft P. A. System—George H. Warfel	19
Audiana—Recording Characteristics II	20
Audio Engineering Society Section Longitudinal Noise in Audio Circuits—H. W. Augustadt and W. F. Kannenberg	22
Record Review—Edward Tatnall Canby	26
Pops—Rudo S. Globus	26
New Products	28
New Literature	29
Book Review	30
Employment Register	32
Advertising Index	48

COVER

The Fairchild Pic Sync Magnetic Tape Recorder set up for playback demonstration. The sound track for television or motion picture film is recorded on the tape and played back in synchronism with the picture-on-film. The recorder automatically compensates for any stretch or shrinkage of the tape. Synchronism is maintained by the camera, projector, and tape recorder without interconnections.

AUDIO ENGINEERING (title registered U. S. Pat. Off.) is published monthly at New York, N. Y., by Radio Magazines, Inc., D. S. Potts, President; Henry A. Schober, Vice-President, Executive and Editorial Offices at 342 Madison Avenue, New York 17, N. Y. Subscription rates—United States, U. S. Possessions and Canada, \$3.00 for 1 year, \$5.00 for 2 years; elsewhere \$4.00 per year. Single copies 35c. Printed in U. S. A. All rights reserved. Entire contents copyright 1949 by Radio Magazines, Inc. Entered as Second Class Matter July 29, 1948 at the Post Office, New York, N. Y. under the Act of March 3, 1879.

AUDIO ENGINEERING ● JANUARY, 1950

when you use
the **Audax**
POLYPHASE...
ONE single unit
plays **ALL**
your records
SUPERBLY...
and at less
than the cost
of ordinary
magnetic pick-ups



Microgroove,
78 r.p.m., etc.

Only \$11.70
net cost to you—
believe it or not!

"The Standard by which Others

Are Judged and Valued"

Enjoyment of today's discs demands a single pick-up unit that yields such quality performance as you'd expect from two or more high grade magnetic units, each made expressly for a given type of recording.

Not only does Audax POLYPHASE accomplish just that—exciting admiration when you hear it, and performing vital functions that no other pick-up does—but it refutes the traditional idea that because Audax is so GOOD it costs more.

Wide range performance with any disc and only one point pressure for all (6 to 8 grams); sapphire styli (or diamond) each replaceable independently of the other by the user himself; output about 30 mv.; needle talk very low; ear quality, par excellence.

—See it at your local dealer—

Models also available for radio stations

**Write for Editorial
Reprint on
POLYPHASE Principles**

to Dept. 44

AUDAX COMPANY

500 5th Ave., New York 18

Fine Electro-Acoustical Units Since 1915

EDITOR'S REPORT

AND NOW -- VIDEO ENGINEERING

WITH THOSE WORDS, the Editor's Report of January 1948 greeted the readers of *AUDIO ENGINEERING*. Their response was so overwhelming—against the idea—that it was quickly shelved. However, it is no longer possible to overlook television, and we again say these words, and without any intention of backing down.

Readers of *AUDIO ENGINEERING* need not worry about the contents of their magazine, however, for the new venture will not affect the editorial policy of *AE*. Starting with the March issue, the new *VIDEO ENGINEERING* will appear as a quarterly supplement, separately paged and entirely distinct from the present magazine, although bound with it. Those who are not interested in television may just pretend that the addition is simply not there. Video articles will not encroach on the space now devoted to audio—there will be just as many audio articles as there are now.

VIDEO ENGINEERING is an addition—there will be no increase in price. It is designed along the same lines as *AUDIO ENGINEERING*, using the editorial staff principle which has kept the quality of articles at the present standard. The new staff will have some of the same members and some new ones, and the first issue of *Video Engineering* is sure to be interesting to those involved in the new art.

78 vs 45 vs 33

Many radio stations are apparently overlooking a good thing by not taking advantage of the quieter surfaces and the higher fidelity obtainable from the new 45-rpm records, which are becoming increasingly popular every day. While we have hesitated a long time in taking sides in the 33-45 controversy—believing that both sides had advantages—there should no longer be any excuse for remaining on the fence. The 78 is rapidly becoming obsolete, and record buyers might just as well recognize the 33 and the 45 as the ultimate in recorded music. Both are here to stay—LP the favorite for selections longer than five minutes, and the 45 in the lead for shorter numbers. Further additions to record libraries might best be made with these superior records.

The cost of adding 33 and 45 facilities to home systems is not excessive, since several types of changers for "all three" are now available at reasonable prices. The hyper-critical record enthusiast may not be willing to use a changer, or may already have a satisfactory 78 model. Turntables are available with only two speeds—33 and 45—and these will solve his problem easily.

Broadcast stations and other professional users are generally equipped with two-speed turntables, with the conventional 78 and 33. These units are ordinarily used at the lower speed with transcriptions, and therefore have .0025 styli, or thereabouts. Since both of the new types of records use .001 styli, it is obvious that a change in the arm and pickup is required to provide complete versatility. Most manufacturers of turntables are prepared to furnish conversions to 45, and information about such conversions can be obtained easily by writing the manufacturer direct, furnishing him with the type number of the turntable in use. Two-speed—33 and 45—turntables of broadcast quality are now on the market from at least one manufacturer, and with a single microgroove pickup will provide facilities for both of the new record types.

Aside from the need for playing all kinds of records and transcriptions, broadcast stations would have the added advantage of offering their listeners higher musical quality and reduced surface noise. This is important to "disc jockeys" with their unquestionably large listening audiences, and it seems that they would be the first to demand the 45's because of both quality and surface. Classical record programs are handled more easily with the new LP's with fewer undesirable breaks in the longer selections.

Thus we have definitely gotten off the fence, and are in favor of both 33 and 45, with the 78 taking the back seat. They will be played still by record collectors and those with large libraries, but for additions or replacements, we vote for better quality and less noise.

UNWITTING DISTORTION

Distortion is commonly measured by two different methods—harmonic and intermodulation—but the resulting numerical values are both indicated in per cent. These two forms of measurement result in percentages which differ by a factor of approximately four—equipment with 2 per cent harmonic distortion usually measures about 8 per cent intermodulation distortion. Engineers accustomed to only one type of measurement are inclined to forget that the method must be specified to prevent misunderstandings.

The December advertisement of J. A. Maurer, Inc., carried just such an ambiguity. It is possible that many readers are unaware that IM measurements are the usual practice in film recording work, and they may have been led to believe that 5 per cent *harmonic* distortion is good in film sound equipment. All of the distortion figures mentioned in this advertisement referred to *intermodulation* distortion, and this note may help to clarify the statements in the minds of our readers.

AUDIO FAIR AUDIENCE ACCLAIMS NEW PICKERING PRODUCTS

... declared to be significant achievements in the audio art

Thousands of engineers, musicians, audio enthusiasts and music lovers were unanimous in their enthusiastic approval of the new Pickering loudspeaker, preamplifier, record compensator and pickup arm, all of which were shown to the public for the first time at the recent Audio Fair. The extraordinary acceptance by this critical audience confirms the soundness of the basic design of these new products. All of these audio components were developed for the exacting listener; the psychological factors associated with listening were given as much weight as the measurable quantities, such as frequency response, intermodulation distortion and transient response. It is comparatively easy to design equipment which measures good. It is not at all easy to produce audio equipment which sounds good. The successful realization of this fact is largely responsible for the absence of "listener fatigue" in Pickering products.

Pickering High Fidelity Components — speaker, preamplifier, record compensator, pickup arm and pickup cartridges are available through leading jobbers and distributors everywhere . . . detailed literature will be sent upon request.

**Pickering
& Company, Inc.**

Oceanside, Long Island, N. Y.

AUDIO ENGINEERING ● JANUARY, 1950



NEW LOUDSPEAKER MODEL 180L

designed to satisfy the musical ear. A low-cost high quality loudspeaker with smooth wide-range response (within 5 db, 45 to 12000 cycles) and low distortion . . . the only loudspeaker with acoustically adjustable bass response . . . occupies less floor space than any other high quality loud speaker — less than one square foot.

NEW PREAMPLIFIER MODEL 130H

This preamplifier represents the most advanced design ever achieved in phonograph preamplifiers . . . it equalizes the bass response of records and transcriptions and provides the necessary gain for high quality magnetic pickups . . . its intermodulation and harmonic distortion is exceptionally low — better than most professional equipment.



NEW RECORD COMPENSATOR MODEL 132E

This compensator, with 6 positions of equalization, provides the flexibility required to properly equalize for the different recording characteristics used by various record manufacturers . . . it is a most important addition to any record playing system using magnetic pickups.



NEW PICKUP ARM — MODEL 190

The only arm specifically designed for optimum performance on both micro-groove and standard records.

- Statically balanced to eliminate tendency to skip when jarred.
- Minimum vertical mass to track any record without imposing extra vertical load on grooves.
- Sensitive tracking force adjustment.

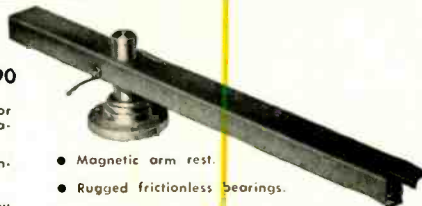

- Magnetic arm rest.
- Rugged frictionless bearings.
- Plug-in cartridge holder.
- One-hole mounting — self-contained levelling screws.

Cartridges used with this arm require 50% less vertical tracking force than, when used in conventional arms.

PICKERING CARTRIDGES SERIES 120, 140 AND 150

For broadcasting, transcription and laboratory use, and for home playing. Series 120 and 150 for standard records . . . Series 140 for micro-groove records . . . the optimum in record response for discerning music lovers who want all of the realism and brilliance originally recorded. They track with phenomenally low record wear and virtually eliminate harmonic and intermodulation distortion as well as frequency discrimination . . . available with either sapphire or diamond stylus.

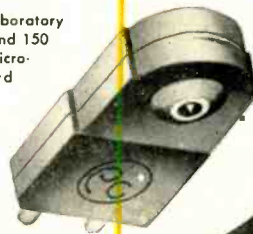

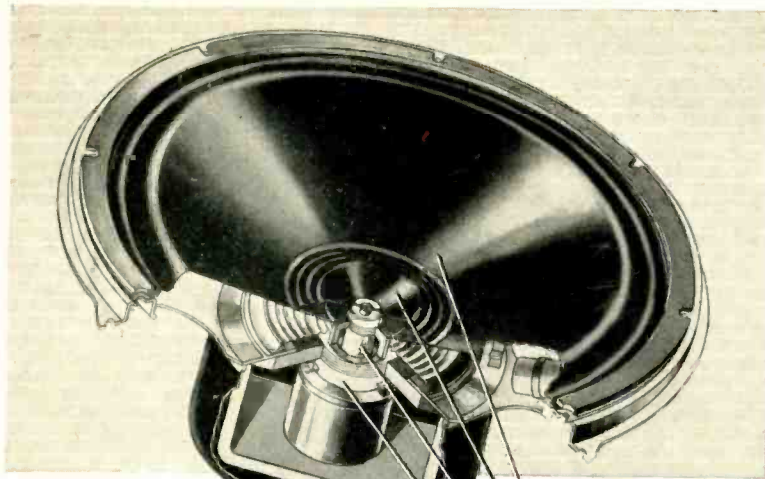

Now...

the RCA 15-inch Duo-Cone High-Fidelity Speaker . . .
a distinguished addition to RCA's line of quality speakers

Check these features—

- ✓ Frequency response—40 cps to 12,000 cps.
- ✓ Minimum cross-over interference.
- ✓ Uniform directivity pattern.
- ✓ Wide angle of radiation.
- ✓ Low non-linear distortion.
- ✓ Designed for either rim or flange mounting.

Now . . . through the economies of mass production . . . RCA offers a low-priced 25-watt speaker of outstanding acoustical performance, employing the famous duo-cone principle originated by Dr. H. F. Olson, world-renowned authority on acoustics, of RCA's famed Princeton Laboratories.

The RCA-515S1 is designed for broadcast station monitors, public address systems, and high-quality radios and phonographs. It consists of coaxially mounted high- and low-frequency cone sections and voice coils so arranged that sound pressure originates from the same conical surface, thus minimizing distortion of the output waveshapes at the cross-over frequency of 2000 cycles. A unique magnetic structure contains a bridge network which supplies equal flux density to the air gap for each voice coil, with the total flux provided by a 2-pound Alnico V magnet. The directivity pattern covers an angle of 60 degrees and is approximately uniform over the entire frequency range of 40 to 12,000 cps.

The RCA-515S1 provides for RMA standard rim mounting . . . but may be mounted with the cone edge flush with the front of the baffle to obtain a uniform response characteristic.

RCA has a complete line of quality speakers

designed to RMA standards. A variety of standard PM types is available ranging from the miniature 2" x 3" to the large 12" and having power-handling capabilities from 1/8 watt to 25 watts. There's a type and size for every requirement.

For full data on the RCA-515S1 duo-cone speaker, see your RCA Distributor or write RCA Commercial Engineering, Section A64S, Harrison, New Jersey.

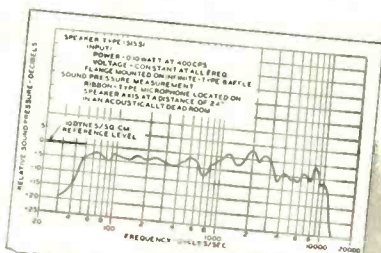

RADIO CORPORATION of AMERICA
ELECTRONIC COMPONENTS **HARRISON, N. J.**

Letters

Reprint Book

Sir:

Some months ago you intimated that you would publish a book containing reprints of many of the "hobby-type" articles which have run in the magazine in the past, but which are now out of print. This book would presumably cover all of the early issues of **AUDIO ENGINEERING**, and would give many of us later readers some valuable reference material. Do you still plan to publish such a book, and if so, when?

Thomas Abellera,
 4707 South 30th St.,
 Arlington, Va.

(A plan to publish such a book under the title "Audio Anthology" has been under consideration for a long time, but the demand does not appear to warrant the effort. If enough readers express their desire for this book and care to indicate some of the articles they would like to have included, we will proceed with the preparation. Preliminary estimates have shown that a book of about 120 pages will have to be sold for \$2.00. A postcard will help us make this decision. Ed.)

Permanent (?) Styli

Sir:

I have a pet peeve that should be aired in your "letters" column. It concerns the misleading advertising claims of styli manufacturers. We all know how many records can be played with precious metal, sapphire, and ruby points. There should be a law against anyone claiming 12,000 plays from a ruby or 8,000 from a sapphire when they must know that if we played that many records—shellac, plastic, or anything else—the needle would cease to be a point, and the records would be junk. Phooey!

H. L. Traylor, Jr.,
 132 N. Saratoga St.,
 Suffolk, Virginia

"Fuzzy LP's"

Sir:

In regard to Mr. Canby's request for accounts of experiences with pickups, I believe I may provide a definite nod of agreement to his findings, and add that he has jumped into an argument "up to his ears."

Over the past two years I have built and discarded many so-called equalizing circuits for magnetic cartridges. Although my present amplifier incorporates equalizer inputs for these cartridges, I have obtained excellent results from the QT3-J cartridge.

All due respect to the advantage of the LP record, even the crystal cartridge does not eliminate buzziness and distortion, although it does help in some instances. This buzziness seems to vary not only from record to record, but also on similar passages in the same recording.

F. C. Slemmer,
 Manhattan Beach,
 California



"Top Fidelity...the most dependable
Tape Recorder yet!" says WOR's STAN LOMAX

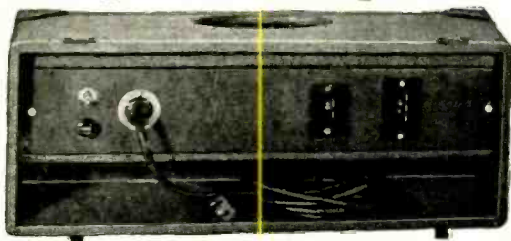
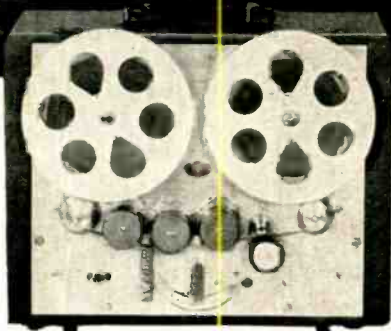

NEW PRESTO PORTABLE TAPE RECORDER

PRESTO'S PT-900 is the answer for delayed sports broadcasts - field recording - wherever there is a need for a portable recorder of complete broadcast quality. Look at these outstanding engineering features:

- Three separate heads for superior performance (and for monitoring direct from tape). One head each to erase, record and play back.
- 3 microphone channels with master gain control in recording amplifier.
- Large V.U. meter with illuminated dial to indicate recording level, playback output level, bias current and erase current, and level for telephone line.
- 2-speed, single motor drive system. Toggle switch to change tape speeds from 7½" to 15" per second.

Don't choose your tape recorder until you see the *new* Presto Portable Tape Recorder. Write for complete details today.



RECORDING CORPORATION
Paramus, New Jersey

Mailing Address: P. O. Box 500, Hackensack, N. J.
In Canada: WALTER P. DOWNS, Ltd., Dominion Sq. Bldg., Montreal

WORLD'S GREATEST MANUFACTURER OF INSTANTANEOUS SOUND RECORDING EQUIPMENT AND DISCS
AUDIO ENGINEERING ● JANUARY, 1950



Your telephone uses ***ceramics, too!***

Five thousand years ago, potters were making household vessels of clay. As skill grew, grace of shape and ornament were added. The beauty of fine china has been recognized by every civilization, while the availability, ease of manufacture and durability of other ceramics have given them wide use.

Your telephone, too, uses ceramics. Behind its dial is a metal plate, glazed as carefully and in much the same manner as this fine piece of pottery. It carries the letters and numbers you dial, so it must resist both fading and abrasion. You will find other ceramics as insulators, supporting wires on pole lines; in eighty thousand miles of underground conduit, where fired clays defy decay and corrosion.

Today at Bell Telephone Laboratories scientists utilize ceramics in ways undreamed of in ancient times. Thermistors, made of a ceramic, provide automatic controls for electric current, to offset fluctuations in temperature and voltage. One kind of ceramic makes low-loss insulation at high frequencies, while another supplies controlled attenuation for microwaves traveling in waveguides.

Each use demands a special composition, scientifically controlled and processed. Basic studies in the chemistry and physics of ceramics have shown how to utilize their versatile properties in electrical communication. And research continues on ceramic materials as well as on every other material which promises better and cheaper telephone service.

BELL TELEPHONE LABORATORIES



EXPLORING AND INVENTING, DEVISING AND PERFECTING, FOR CONTINUED IMPROVEMENTS AND ECONOMIES IN TELEPHONE SERVICE.

For The Discriminating Listener: An Audio Input System

WAYNE B. DENNY*

Preamplifier with flexible control provides facilities for practically any type of input, and is designed to feed a wide variety of equipment.

MANY EXCELLENT AUDIO AMPLIFIERS are currently available, together with improved accessories for the high-quality reproduction of recorded and radio programs. Much of this equipment is ideally suited to custom installations, but there are many situations where reasonably priced commercially built apparatus does not provide sufficient flexibility to permit proper matching of units and sufficient control of both the frequency and dynamic ranges of the signal. The system to be described was engineered in response to requests from serious listeners who desired something better than the usual commercial reproducer but who could not afford so-called "professional" equipment. Nor would these listeners, many of them musicians, tolerate equipment whose operation requires considerable technical skill. As finally evolved, the audio control system to be described meets this need by providing equalized high gain for variable reluctance pickups; controllable low-frequency attenuation or boost; controllable high-frequency attenuation or boost; volume expansion; extremely low noise level; and an output impedance sufficiently low to permit almost any number of power amplifiers to be bridged across the output without loss of gain or frequency response. This is achieved with only six manual controls,

making the operation simple enough for the most inexperienced personnel. Moreover, the cost is moderate.

The diagrams of *Figs. 1 and 2* show the circuits of the audio unit and power supplies. One of the power supplies provides filtered d.c. heater power for the first six tubes in the low-level section of the audio unit. Using one of the bias supply transformers now available on the surplus market, this unit provides about 72 volts at 150 ma for the heaters connected in series. In order to keep heater-cathode potentials at a minimum, the heater string is grounded at its electrical center, i.e., between V_2 and V_1 . This places essentially zero heater-cathode bias on the two tubes operating at the lowest signal levels. There is no reason why all tubes could not be tied into the heater string, pro-

vided the 6.3 volt types are replaced by suitable 150 ma equivalents and sufficient additional voltage is available. The other power supply—entirely conventional—provides 250 volts for the plate circuits and 6.3 volts a.c. for the remaining four heaters. Both power supplies occupy the same chassis.

Audio Circuits

Turning next to the signal circuits it will be seen that the phonograph preamplifier is conventional in every respect, providing fixed bass boost of 3 to 4 decibels per octave. By shorting out C_3 this boost can be eliminated, making the pre-amplifier suitable for use with microphones.

The input selector switch, Sw_2 , permits selection of any of five inputs. The additional complication of a mixer sys-

External view of amplifier, showing part of chassis space occupied by a tuner. Design was based on the provision for such additional equipment.

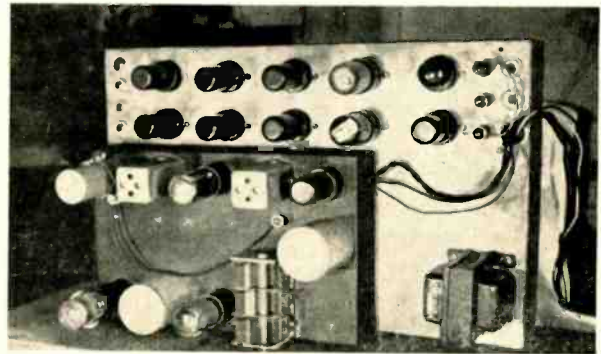

*Grinnell College, Grinnell, Iowa

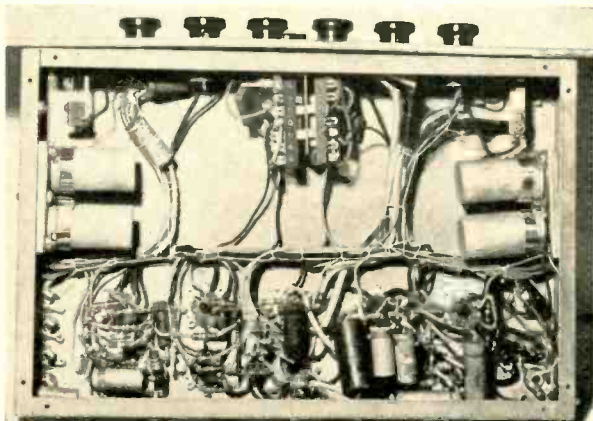

Controls, from left to right, are: input selector, input level, h-f equalizer, l-f equalizer, volume, and expander. Signal circuits are wired point-to-point to reduce stray capacitance; power circuits are cable.

tem appears to be unnecessary, considering the purpose for which this device was designed. R_9 is used primarily to provide the correct input level for the grid of V_2 . The plate of V_2 feeds the high-frequency control circuit consisting of C_{11} , C_{12} , R_{13} , R_{14} , and R_{15} . V_3 compensates for equalizer loss and isolates the high-frequency and low-frequency control circuits. The latter comprises R_{19} , R_{20} , R_{21} , C_{15} , and C_{16} . Both equalizing circuits are adapted from an equalizer developed by Logemann.¹ Each frequency control cir-

¹ Logemann, H., Simple RC Equalizing Circuits. *The Review of Scientific Instruments*, March 1948.

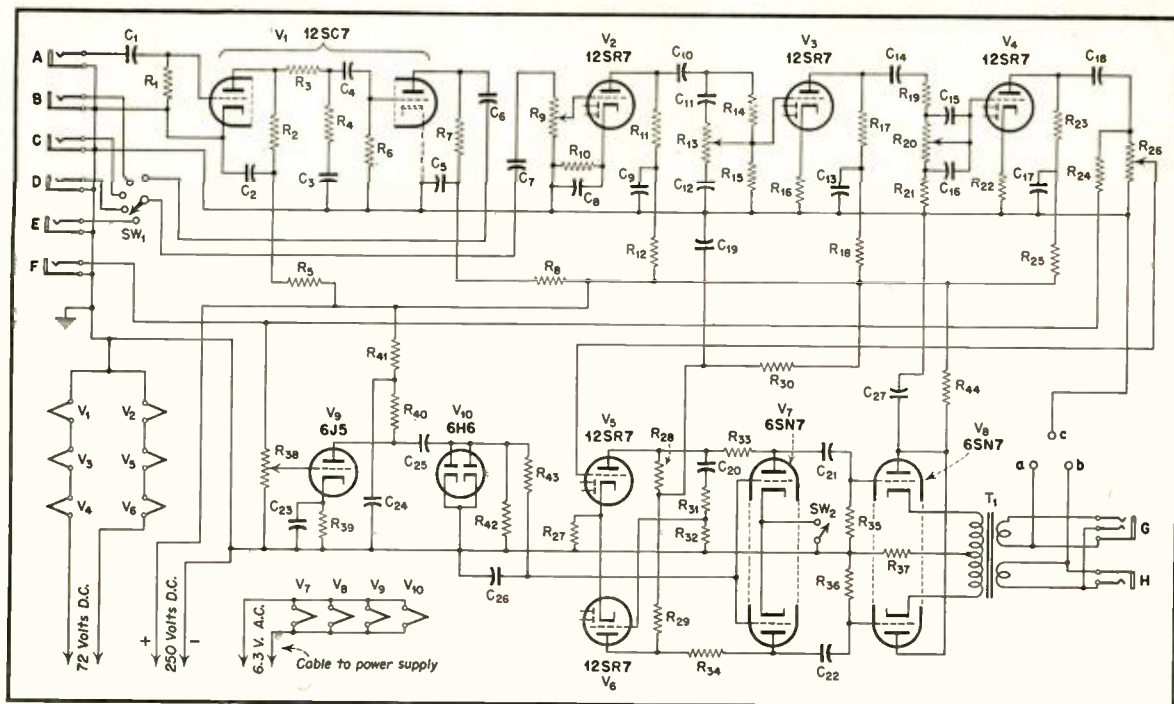

Fig. 1. Schematic of preamplifier unit. Note flexibility of control and provision for expansion if desired.

circuit provides approximately 15 db of boost or attenuation, the frequencies of maximum effect being 50 and 10,000 cps.

The main volume control is R_{26} . This is used in preference to R_9 because manipulation of R_9 disturbs the operation of the volume expansion circuit. V_5 and V_6 comprise a voltage amplifier and phase inverter. Expansion occurs in the plate circuits of these tubes. Push-pull operation of the expander is essential if extraneous control voltages are to be eliminated from the output signal. The expander circuit is a push-pull version of one originally developed fifteen years ago by the late McMurdo

Silver. The operation of the expander can be understood as follows: In the plate circuit of V_5 , the resistor R_{33} and the plate resistance of the top section of V_7 comprise a voltage divider. The variable arm of this divider, the plate resistance of V_7 , is controlled by the potential at its grid. Similarly, R_{34} and the plate resistance of the other half of the push-pull circuit. The side amplifier and rectifier for developing the variable control voltage for the expander are entirely conventional, using a 6J5 and a 6H6. The expansion control, R_{38} , has a self-contained switch, SW_2 , which permits V_7 to be effectively removed from the circuit when desired. With SW_2 open, the gain is the same as with maximum expansion during the loudest signals.

Time Constants

The attack time of the expander is determined by the values of R_{43} and C_{26} . Their product (megohms times microfarads) gives the time constant in seconds. The release time is determined by the product of C_{26} times the sum of R_{42} plus R_{43} . This permits the release time to be longer than the attack time. Since the signal circuits of the expander are entirely push-pull, the attack time can be made quite low, even though the release time is half a second or longer. Proper attack and release times are a matter of opinion, but in general depend somewhat on the

acoustics of the listening room and the damping constants of the loudspeakers. After careful listening, R_{43} was made 0.15 meg, C_{26} was made 0.5 μ f, and R_{42} was made 1.0 meg. These values provide a fast attack, together with a decay of slightly over one-half second. However, other values may prove more suitable in other situations or these elements might be made variable.

When properly used, expanders add much to the enjoyment of program material which has previously been compressed. It should not be supposed, however, that all such material requires expansion. Improperly used, expanders can detract considerably from the quality of the signal. The tendency seems to be to use entirely too much expansion. Although the circuit just described is capable of providing about 20 db of expansion, it will be found that a lower value is preferable. From 3 to 10 db is normally sufficient.

Output Circuits

After passing through the expander, the signal is impressed on the grids of V_8 , acting as a push-pull cathode follower. This circuit is unusual. First, the cathode follower serves to isolate the varying impedances of the expander from the output transformer. Second, since the gain of the cathode follower is less than unity, it is practically impossible for extraneous control voltages to drive the grids beyond the linear portions of their characteristics. Thus,



Complete input system installed in a typical operating cabinet.

the changing control potentials at the plates of V_7 cannot cause distortion. Third, the output of the cathode follower presents a low impedance to its load, and this is reflected to the secondary of T_1 . Fourth, the inclusion of T_1 causes any control voltages to cancel in the primary without being passed on to the secondary. Fifth, T_1 isolates the output connections from chassis ground, thus eliminating the ground loop and the accompanying hum which so often occur when various amplifiers are connected in cascade without isolating transformers. The output circuit permits either a balanced or an unbalanced connection. For balanced output, terminals *a* and *b* are strapped together. Both terminals, together with the ground terminal, *c*, are located near the output jacks. Connection is made to jack *G* for balanced output. An undistorted signal of approximately 10 volts rms is available from each half of the transformer secondary. Jack *H* provides unbalanced output.

Mechanical Construction

The entire amplifier unit was built on a steel chassis 11 x 17 x 3 in. with bottom plate. The ten tubes are mounted near the rear edge, permitting additional equipment to be stacked above deck with controls accessible from the front. All low-level signal circuits are completely shielded. An a.c. switch was *not* included on either audio or power chassis; an external master switch is more convenient besides isolating the audio circuits from a possible source of hum. One of the input jacks is located on the front panel, permitting temporary connection of input devices without removal of the amplifier from its cabinet. Similar considerations resulted in placing the low-level output jack *F* on the panel. Experience has shown that locating one input jack and one output jack on the panel is most useful when making comparison tests between tuners, pickups, and power amplifiers. This feature is highly recommended.

The two power supplies are mounted together on another steel chassis 8 x 17 x 2 in. with bottom plate. Aside from considerations of space, separation of signal circuits from the power supply is essential for quiet operation. The amplifier has a connecting cable terminating in an octal plug, the corresponding socket being placed on the power supply chassis. The cable may be any convenient length if sufficiently heavy wire is used, permitting the power supply to be placed out of sight at a remote point.

Wiring follows customary practice for audio units. In no case is any part of the chassis used as part of the grid return circuits, grounding occurring

only at one point. This precaution results in low noise and inaudible hum.

Operation

After several months' trial, the input system described has proved itself in every respect. While twelve tubes may appear excessive, each tube has a definite function. Heavy filtering eliminates hum and instability. The hum level of the unit (including the pre-amplifier) was measured at 65 db below one volt with all gain controls wide open and bass boost at maximum. In use, the signal-to-noise level is considerably better, since the maximum amplification is far greater than necessary. The unit has been used with a variety of power amplifiers and loudspeakers. A power amplifier was designed especially for use with the unit, consisting of two 6J5's in push-pull, transformer coupled to triode-connected 6L6's. The latter, operated as cathode followers, develop over 4 watts at the voice coil with a plate potential of 290 volts and a plate-to-plate load of 3500 ohms. This power is more than sufficient to drive a highly efficient corner-type loudspeaker using a single eight-inch cone coupled to two horns. The first horn is driven from the back of the cone and has a cut-off frequency of 40 cps. The second horn operates from the front of the cone and has a cut-off frequency of 300 cps. The horns increase the loading, raise the efficiency, and reduce intermodulation by restricting the excursions of the cone.

Noise Suppression

In the course of designing this unit, it was found that a simple modification of the expander circuit permits its use as an effective automatic scratch suppressor. As shown in Fig. 3, the plates of V_7 were connected to $B+$ through 0.25-meg resistors. Small capacitors

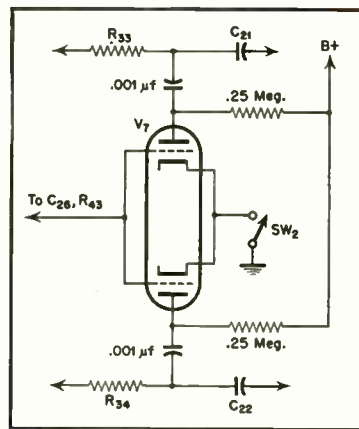

Fig. 3. Modification of V_7 circuit to make the expander function as a noise suppressor.

were then inserted between the plates of V_7 and resistors R_{33} and R_{34} as shown. The expander then became frequency selective, operating only at the higher frequencies, the lower registers receiving maximum amplification at all times. If desired, a switching arrangement could be incorporated to permit either expansion or noise suppression. It is suggested that a high-pass filter be placed ahead of R_{33} so that the "gate" operates only at high frequencies. This additional complication, plus the fact that with the new low noise recordings the scratch problem is not so important, caused the writer to decide against incorporating the noise suppressor in the final version.

An audio control unit of the type described is not something which should be built by the novice. However, those who are often called upon to provide

[Continued on page 31]

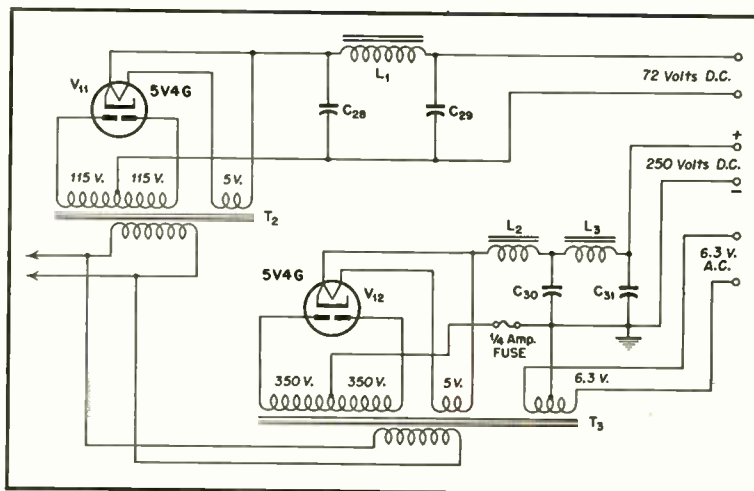

Fig. 2. Schematic of power supply used with preamplifier of Fig. 1.



Fig. 1. The KB-2C Bantam microphone compared in size and appearance to the familiar 44-BX.

The Bantam Velocity Microphone

L. J. ANDERSON*

and

L. M. WINGTON*

Design details for a miniature velocity microphone are discussed by the engineers who developed the KB-2C.

THE INTRODUCTION of the Type KB-2C Microphone has provided the broadcast industry with a valuable tool. This new microphone, about the size of a package of cigarettes, in many respects approximates the performance of the popular Type 44-BX Velocity Microphone and offers some further operational advantages. It is so small that the artist's or speaker's face is not hidden, a feature which is valuable on remote programs and on television pickups where the microphone must be in the picture. It is also very light and requires no special amplifiers or cables, thereby simplifying transport, in addition to making possible the use of light supporting means.

Small size, as shown in Fig. 1, and weight have been obtained without sacrifice in output level. Compactness has actually resulted in directional characteristics which more nearly approach the ideal for a velocity microphone over the entire frequency range (see Figs. 2 and 3). The frequency range is fully adequate for all operations. Aside from its small size, the microphone contains many interesting mechanical features. It incorporates a sponge rubber mounting between the head and the shank assembly, and additional cushioning should be necessary only when the microphone is used on a boom where the location of the microphone is changed frequently and rapidly. The usual unsightly cable and plug connection is "built-in" to the shank portion of the microphone, which in addition to serving as a mounting may also be used as a handle when one is required. Access to the connecting plug is obtained by means of a hinged cover forming the rear portion of the shank.

*Radio Corp of America, Engineering Products Dept., Camden, N. J.

The Cannon Type XL Connector was chosen for the application because its small size and quality are in keeping with the purpose of the design.

The microphone also contains electrical features which are equally as useful as the mechanical features previously described. The low-frequency response is readily adjustable for either voice or music operation by means of a switch that may be operated from the outside of the microphone by use of a small screw driver. The characteristic for the voice position has been selected so that response is approximately flat when the sound source is located about nine inches from the microphone (see Fig. 4). The design of the coupling transformer has resulted in a sensitivity to stray 60-cps magnetic fields low enough for any normal application. Since the sensitivity of the microphone to stray fields is a function of the direction of the field, it is possible in many applications where high intensity fields are encountered to minimize the pick up by rotating the microphone. Sensitivity to high-frequency fields is kept low by proper grounding and complete enclosure of the microphone parts in the external metal screen and case.

Design Features

The question naturally arises as to how all of these things can be accomplished in a microphone of such small size without any apparent sacrifice. The answer lies in painstaking design—the careful selection and use of materials in the most advantageous places. Involved in the design, and all inter-related, are acoustical, electrical, magnetic, and mechanical problems.

In a velocity microphone, the response-frequency characteristic will be flat over the frequency range in which the moving system is mass controlled, and the pressure gradient applied is

directly proportional to frequency.¹ In the case of a plane-wave sound field this means that the response will be constant for any frequency well above the resonance of the ribbon and below the frequency at which the gradient is no longer proportional to frequency due to the physical dimensions of the parts surrounding the ribbon.

Because of its relationship to the low-frequency response, the resonant frequency of the ribbon was the first characteristic considered in the design of the microphone. The ribbon is clamped at the ends, and the system is a combination of a stretched string and a bar clamped at the two ends.² The lowest resonance frequency will be obtained when the tension is zero, and this resonance will largely determine the absolute limit of the low-frequency response. The resonant frequency for the condition of zero tension is

$$f = \frac{3.56}{l^2} \sqrt{\frac{QK^2}{\rho}} \quad \text{cps}$$

For an aluminum ribbon 0.0001 in. thick,

$K = 7.3 \times 10^{-5}$ Radius of gyration

$Q = 5 \times 10^{11}$ Modulus of elasticity, dynes/cm².

$\rho = 2.7$ Density, grams/cm³.

$l =$ length of ribbon, cm.

In most of the microphone structures, the air load will approximately equal the ribbon density for a ribbon 0.0001 in. thick. The effective value of ρ will therefore be about 4. Substituting in the above

$$f = \frac{93}{l^2} \quad \text{cps}$$

¹ Dr. H. F. Olson, Elements of Acoustical Engineering, 2nd Edition, Chapter VIII, pp. 237-252.

² Dr. H. F. Olson, Unpublished Technical Report.

Since it is impracticable to install the ribbons without tension, and because of the stiffness coupled into the mechanical system from the electrical load, the following expression is more realistic

$$f_s = \frac{4.5 \times 93}{l^2}$$

cycles per second.

The low-frequency limit, f_s was set at 60 cps on the basis of satisfying most requirements. Substituting this value into the formula, the minimum ribbon length is found to be approximately one inch. Thus it was possible to use a ribbon only one-half the length of that in the Type 44-BX Velocity Microphone, providing the same sensitivity could be obtained.

The generated voltage in the ribbon is

$$e = B l v \times 10^{-8} \text{ volts}$$

where B = Flux density in gap, gauss

v = Velocity amplitude of ribbon, cm/sec.

l = Length of ribbon, cm

A measure of the efficiency of the microphone will then be

$$\text{Eff.} = \frac{e^2}{R_R} = \frac{(B l v)^2}{R_R}$$

where R_R is the electrical resistance of the ribbon in ohms. The loss in generated voltage, because of the reduced ribbon length, must therefore be made up either by increasing the flux density in the air gap, by some change in the physical structure, or a combination which will increase B , the net increase of 1.4 being required.

The ribbon width was chosen so as to maintain approximately the same lateral stability as in the 44-BX microphone. Since the new ribbon is one-half the length of the ribbon in the

Fig. 4. (upper) Response-frequency characteristic for a plane wave, and for a source 9 in. from the microphone. (lower) Impedance-frequency characteristic.

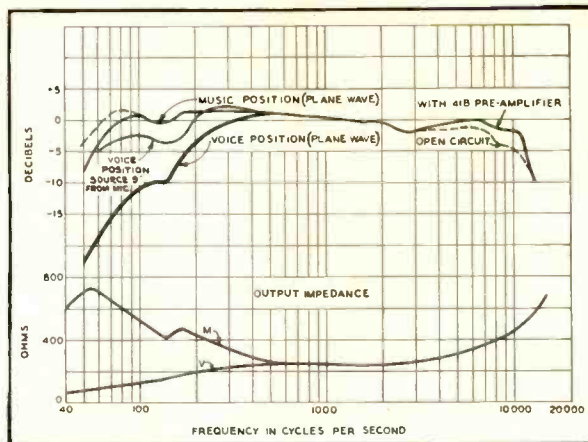

44-BX, as might be expected, a ribbon of approximately half the width was found to give the same stability. This reduction necessitates an additional increase of 1.4 in the factor $B l v$.

The extent of the high-frequency range was tentatively established at 10,000 cps. The limit of the high-frequency response of the microphone is determined largely by the baffle area surrounding the ribbon, and good response will be obtained up to the point where

$$d = 0.5 \lambda$$

d = the distance from the ribbon to the edge of the structure.

λ = the wavelength of the highest frequency at which good response is desired.

With 10,000 cps established as an upper frequency limit, d will be about 0.66 inch. In the actual structure it can be somewhat larger, because the path at the ends of the ribbon is less than this value, thus serving to lower the average.

Magnetic Circuit Design

The problem then remained to de-

sign a magnetic circuit which, within the established ribbon and baffle dimensions, would provide the desired output level. As mentioned, this level was tentatively set at being equal to that of the 44-BX microphone. The desired result was accomplished with a magnetic circuit of novel design in which the permanent magnet material forms the pole pieces and the return path is a part of the external microphone structure. Such an arrangement is efficient, both with regard to the amount of magnet material required and the amount of iron in the return path. The amount of magnet material required is reduced by virtue of the fact that the leakage flux can be decreased by placing the magnetic material as close to the air gap as possible; and since only a portion of the leakage flux returns through the iron path, the section of the magnetic return path is also small. The properties of Alnico V were ideal for the permanent magnet material.

As mentioned previously, the resonant frequency of the ribbon occurs

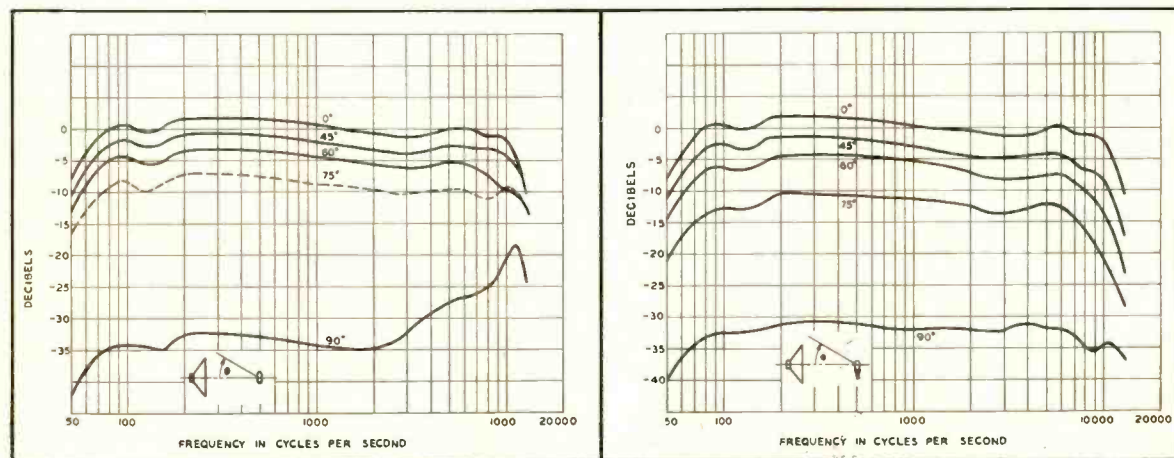

Fig. 2 (left). Directional characteristic of the KB-2C microphone when rotated about the vertical axis. Fig. 3 (right). Directional characteristic of the microphone when rotated about its horizontal axis.



Fig. 5. Miniature compensating reactor and impedance matching transformer employed in the KB-2C microphone.

at about 60 cps, well within the audio range, and must be critically damped through the use of a suitable acoustic resistance material. This arrangement materially reduces the sensitivity of the microphone to mechanical excitation by low-frequency building rumble, but does necessitate care in making ribbon replacements to assure the use of a correct value of resonance and acoustic damping. Failure to do so may result in a microphone whose low-frequency response is unsatisfactory because of its being excessively high.

In order to complete the small microphone, it was necessary to design an extremely small impedance matching transformer and compensating reactor, as shown in Fig. 5, as well as a switch, all of which are housed in the die casting immediately below the ribbon and magnet assembly.

Performance

These microphones have now been in service for a period of time, and an appraisal of some of the unforeseen

difficulties with this radically small microphone can be made and remedies discussed.

The small size has resulted indirectly, in many cases, in an exaggeration of the low-frequency response, such as is always experienced when the speaker is close to a velocity microphone, and, in addition, the ribbon is excited by the breath puffs to a greater extent than with larger microphones, such as the 44-BX. This condition results from a combination of two things. First, the smaller microphone apparently invites the user to get much closer because it is possible to do so without feeling restricted by the presence of the microphone. Second, the small size of the microphone screen enables the user to get much closer to the ribbon. As an example, the 44-BX microphone limits the closeness of the user to a minimum of about 1½ inches, whereas the limit on the KB-2C averages no more than ¾ inch. (The effect of source proximity on response is shown in Fig. 6.) In addition, the excitation by breath puffs is increased beyond the normal expectancy because the effectiveness of the windscreen is reduced by its closeness to the ribbon.

Considerable effort has been expended in trying to improve the windscreening without seriously affecting the response-frequency characteristic or increasing the microphone size, and apparently no good solution exists.

Out of this work, however, came one interesting and useful result. Where the microphone is always used for close talking applications, or where some attenuation of the low-frequency response is permissible, it is possible to improve the windscreening considerably by the addition of cotton, superfine fiber-glass, or similar acoustic materials

between the inner and outer screens. In addition, other operational advantages result. Figure 7 shows the response of the modified KB-2C microphone to a plane wave and also the response when the microphone is used for close talking applications. As can be seen, the response-frequency characteristic obtained for close talking is substantially flat from 50 to 9000 cps.

Above 1000 cps, the discrimination against random unwanted sound is about 19 db better than that obtained with a conventional pressure microphone used at a distance of 6 inches. Below 1000 cps the discrimination increases gradually to a value of 44 db at 100 cps. The net result, for the first time, is a high-fidelity anti-noise microphone.

Numerous applications will no doubt suggest themselves, in addition to the following two. (1) In programming, where the announcer can work close to the microphone, background noise can be eliminated. (2) On programs where audience participation necessitates the use of a public address system in combination with a microphone which is circulated among the audience, feedback can be completely eliminated while maintaining a reasonably high level on the P.A. system.

The excellent frequency response, high output level, absence of excitation due to breath, and anti-feedback characteristics are decidedly advantageous. A temporary means of accomplishing approximately the same thing would be to enclose the screen portion of the microphone with a handkerchief which has been folded several times.

Using the standard stock microphone, satisfactory performance can be assured if the microphone is used at distances of 18 inches or more for the

[Continued on page 31]

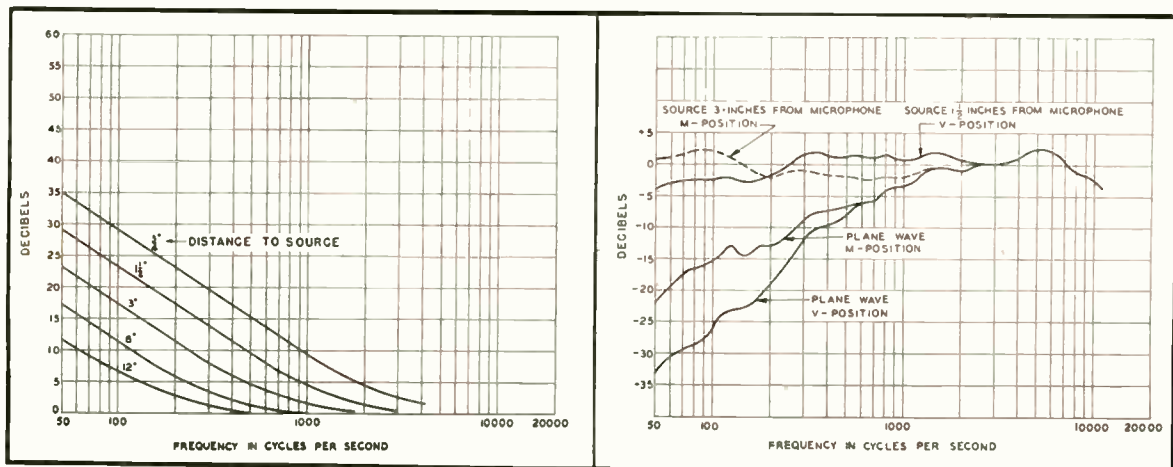

Fig. 6 (left). Curves showing increase in low-frequency response due to proximity of sound source. Fig. 7 (right). Response-frequency characteristics of KB-2C with special packing for plane wave and for close talking. Curves show how modification results in anti-noise characteristic.

Stereophonic Reproduction

TENNY LODE*

Simple method for simulating stereophonic effect with a single-channel radio or phonograph system.

A SOMEWHAT SERIOUS LIMITATION of most audio reproduction systems lies in the fact that the sound rather obviously emanates from a restricted source area. This is in direct contrast with the widely dispersed multiple-source effect usually associated with direct program presentation. Numerous attempts have been made to rectify this situation through the use of multichannel stereophonic systems. While these methods have met with varying degrees of success, they suffer collectively from the disadvantage that they cannot be used in conjunction with the commercially available programs. However, the procedure described herein, while not a true three-dimensional sound system, does create a reasonably acceptable illusion and may be used with standard commercial programs.

In a typical multichannel system, two or more slightly separated microphones are used. Variations in the position of the sound source will then cause corresponding variations in the relative output amplitudes and phases of the individual microphones. An arbitrary distinction is sometimes made as to whether the primary dependence of the system is upon phase or amplitude shifts between the various channels. This corresponds to whether the microphones are in close proximity to each other or comparatively separated in space.

If the microphone outputs are then

*1323 Sherburn Ave., St. Paul 4, Minn.

amplified separately and fed to individual properly positioned speakers, the initial directional qualities of the original tones will, to a certain extent, be preserved. In this type of system, the information pertaining to the directional distribution of the various tones is contained in the relative phase and amplitude relationships existing between the multiple transmission channels. Since, however, in a standard commercial program, no information concerning the spatial distribution of the sources is presented, any method of assigning directional characteristics to the individual tones must therefore follow a completely arbitrary pattern.

Network Design

A network may be constructed which will cause relative phase and amplitude shifts to arise between its various outputs according to a predetermined pattern. If the outputs of this network are then fed through the necessary amplifiers to two or more loudspeakers, a stereophonic effect will be created. This method is contrasted with the more conventional in Fig. 1. Admittedly, any relationship between the apparent spatial distribution of the reproduced program and that of the original will be entirely coincidental. However, as the listener seldom has an accurate knowledge of the conditions under which the program is originated, this defect is of comparatively minor importance.

The most satisfactory method of constructing the network is to make the

phase and amplitude shifts produced (and thus the apparent direction of a tone) a pure function of the frequency. This not only produces the most realistic effects, but is also by far the easiest to accomplish in practice.

The basic circuit which was used for the entire series of experiments is shown in Fig. 2. The values given are appropriate for operation with a triode

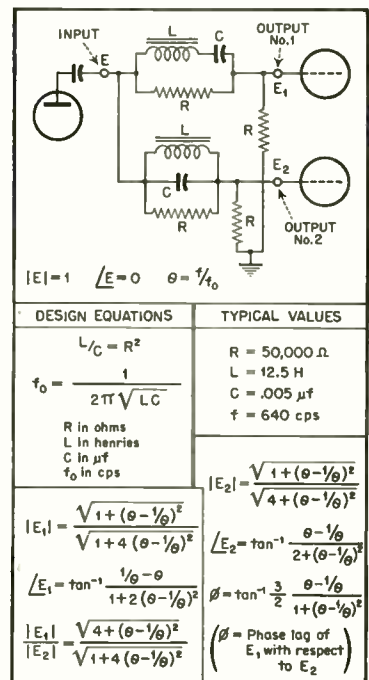

Fig. 2. Phase- and frequency-selective network employed within an amplifier to create spatial illusion.

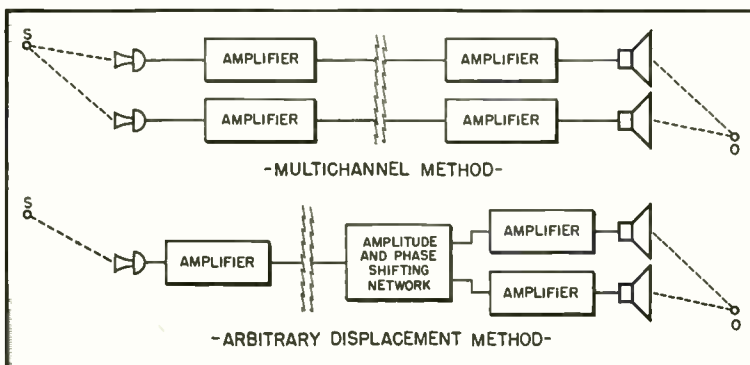

Fig. 1. Comparison between conventional and suggested methods of obtaining greater spatial realism.

driving stage, as the input impedance of the network is then of the order of 30,000 ohms. The outputs as shown should be fed through separate amplifiers to the individual speakers. The optimum placement of the speakers, both as to their location and orientation, is best determined by trial and error. It should be noted, however, that the most pleasing effects do not necessarily arise as a result of having the speakers pointed directly at the listener. Generally, a satisfactory effect may be at-

[Continued on page 46]

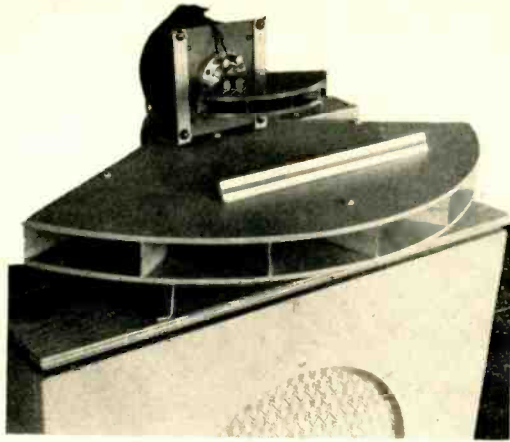

Fig. 1. The Smith-Selsted tweeter unit in combination with a more conventional h-f speaker and a woofer cabinet.

A Loudspeaker for the Range from 5 to 20 kc

B. H. SMITH* and
W. T. SELSTED**

In response to many requests for a description of the unit mentioned in the August issue, the authors provide full design information on this remarkable speaker.

IN ATTEMPTING TO DESIGN a single horn type loudspeaker to cover the range from 1,000 to 15,000 cps, one arrives at impractical constants. The moving system turns out to be so light that it would not stand the high powers and large excursions which occur towards the lower frequency limit. The air chamber thickness is found to be too small to be practical and the diaphragm loading too high. As a result, the designer is forced to choose a high frequency cut-off (half power point) between 4,000 and 7,000 cps.

The loudspeaker described here is intended to supplement a good quality two-way system. The experimental model tested has a frequency response within ± 2.5 db from 5,000 to 20,000 cps and an average efficiency of about 28 per cent. (See Figs. 1 and 2)

The angular distribution to half pressure points is 120 deg. in the horizontal plane and 90 deg. in the vertical plane. It will handle a peak power of 5 watts, but one can quickly see that since the peak power in a normal complex musical signal in the range above 5,000 cps is 10 db less than the peak in the range below 5,000 cps, such a tweeter can be used with a 50-watt system.

The frequency response of the speaker was measured by the motional impedance method. This method was chosen since it gives the total power radiated and is unaffected by changing directivity characteristics. It may be noted that although the response of the speaker is satisfactory down to 1,000 cps, it can not be used below about 3,000 cps because below this frequency the excursion of the diaphragm becomes

too great. The large excursions would cause greater air chamber distortion and possible damage to the moving system.

In order to understand loudspeaker design problems one must be familiar with one of the two main electro-mechanical analogies. The force-current analogy, which is used here, was first introduced in this country in 1933 by F. A. Firestone. It seems best to devote the next four paragraphs to a brief derivation of this analogy.

The elements of a mechanical system are mass, compliance, and mechanical bar resistance. The elements of an electrical system are capacitance, inductance, and resistance. The fundamental equations of these elements are:

Mechanical System	Electrical System
$F = m \frac{dv}{dt}$	$i = C \frac{de}{dt}$
$F = \frac{1}{C_m} \int v dt$	$i = \frac{1}{L} \int e dt$
$F = \frac{1}{R_m} v$	$i = \frac{1}{R} e$

Where:

F force is analogous to i current
 v velocity is analogous to e voltage
 m mass is analogous to C capacitance
 C_m compliance is analogous to L inductance
 R_m bar resistance is analogous to R resistance
 and the MKS system of units is used.

It is apparent that the equations of the two systems are of the same form. Further, the rules for combining these relations are identical. For the electrical system, the rules are known as Kirchhoffs laws, which are:

1. The sum of the currents entering a junction is zero.
2. The sum of the voltages around any closed loop is zero.

For the mechanical system the combining rules are:

1. The sum of the forces entering a junction is zero.

2. The sum of the velocities around any closed loop is zero.

Since the fundamental equations and the combining rules of the two systems are identical, it follows that the solutions of these equations may be obtained by identical means. A schematic diagram for the mechanical circuit may be drawn, and a solution may be obtained just as it is done for electrical circuits. For example, consider the mechanical circuit of (A) in Fig. 3. The schematic diagram and solution are shown at (B).

The quantity Z_m is the mechanical quantity analogous to electrical impedance. Firestone calls this the bar-impedance. Before Firestone introduced this force-current analogy, mechanical impedance had already been defined as the ratio of force to velocity. Thus, the bar-impedance is the reciprocal of the conventional mechanical impedance.

Equivalent Circuit for Horn

We shall now proceed to develop the equivalent circuit of a horn type loudspeaker. As current flows through the

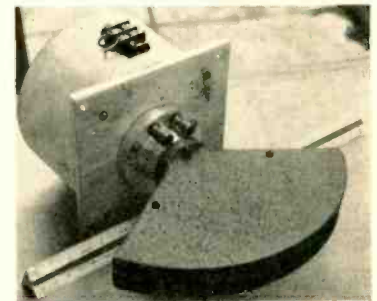

Fig. 2. The tweeter resembles an ordinary high-frequency speaker except for the relatively large field coil housing.

*2028 Delaware St., Berkely, Calif.

**363 Oakview Drive, San Carlos, Calif.

voice coil, a force is exerted according to the relation:

$$F = Bl i \quad (1)$$

where B = flux density,

l = length of wire on voice coil.

Also, as the voice coil moves in the magnetic field, a voltage is generated in it according to the relation:

$$E_{mot} = Bl v \quad (2)$$

where v = velocity.

Combining (1) and (2), the motional impedance of the loudspeaker,

$$Z_{mot} = \frac{Bl^2 v}{F} = (Bl)^2 Z_{mech} \quad (3)$$

Equation (3) indicates that the electro-mechanical coupling system may be represented by a transformer having a turns ratio of $Bl:1$. In addition to the motional impedance, there is, of course, the impedance of the voice coil itself. The equivalent circuit of the loudspeaker through the electromechanical coupling system is shown in Fig. 5.

The mechanical system of the loudspeaker consists of the mass of the diaphragm and voice coil and the compliance of the suspension system. Since the moving system absorbs force, it must be represented as a shunt element.

The next thing to consider is the mechanical-acoustical coupling system. The pressure of the air at the surface of the diaphragm is:

$$p = \frac{F}{A_d} \quad (4)$$

where A_d is the area of the diaphragm.

The analysis is simplified by using the volume velocity, rather than particle velocity, in the acoustical system. The volume velocity at the surface of the diaphragm is:

$$V = A_d v \quad (5)$$

Combining equations (4) and (5) the bar impedance,

$$Z_{mech} = \frac{p}{V} = \frac{F}{\rho A_d v^2} = \frac{1}{A_d^2} Z_{acoust} \quad (6)$$

It is apparent from equation (6) that the mechanical-acoustical coupling system may be represented by a transformer having a turns ratio of $1/A_d:1$. The equivalent circuit of the loudspeaker up to the air at the surface of the diaphragm is shown in Fig. 6.

We now consider the passage of the wave through the air chamber and into the horn. Air is an elastic medium, and therefore a drop in volume velocity occurs between the air at the surface of the diaphragm and the air at the point where the horn throat enters the air chamber. Hence, the volume of air in the air chamber has compliance. The value of this compliance is:

$$C_s = \frac{A_d t}{\rho c^2} \quad (7)$$

where ρ = density of air

c = velocity of sound in air

t = thickness of air chamber

An exponential horn is used to match the air chamber to the comparatively

free space of the listening room. Such a horn is one in which the cross-sectional area increases exponentially with distance from the throat according to the equation:

$$A_x = A_t e^{mx} \quad (8)$$

where A_x = area at point x

A_t = area at the throat

x = dist. from throat to A_x

When $f \gg f_c$ (where $f_c = mc/4\pi$), the bar-impedance of an infinite exponential horn can be shown to be approximately equal to $A_t/\rho c$.

It is assumed that the exponential horn will be designed with a cut-off frequency well below the lowest frequency that the loudspeaker is intended to pass, so that the throat impedance is almost a pure resistance for the frequencies of interest. If we now add the

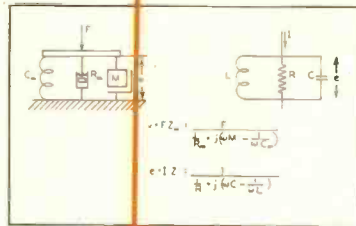

Fig. 3. A mechanical system and the equivalent electrical circuits for a speaker mechanism.

compliance of the air chamber and the resistance of the horn throat to Fig. 6, we have the equivalent circuit of the whole loudspeaker, Fig. 7. This can be reduced to the circuit of Fig. 8, which is a standard band-pass filter, and from the design equations of this filter one finds that for optimum performance the following relations should exist:

$$L = \frac{Z_o}{2\pi f_b}$$

$$M = \frac{f_s (Bl)^2}{\pi (f_s^2 - f_c^2) Z_o} \approx \frac{(Bl)^2}{\pi f_s Z_o} \text{ if } f_s \gg f_c$$

$$t = \frac{LA_s \rho c^2}{(Bl)^2}$$

$$A = \frac{\rho c A_s^2 Z_o^2}{(Bl)^2}$$

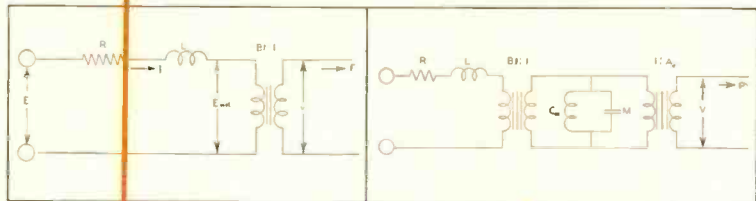

Fig. 5 (left). Equivalent circuit of voice coil—resistance, inductance, and electro-mechanical converting transformer. Fig. 6 (right). Equivalent circuit of the tweeter from input to air.

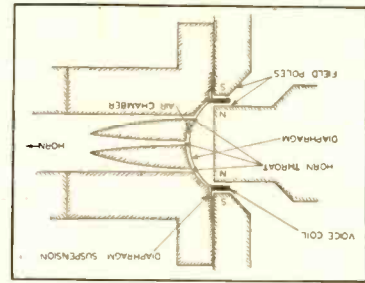

Fig. 4. Cross section of the high-frequency loudspeaker.

$$C_m = \frac{l}{M 4\pi^2 f_c^2}$$

Where $\rho = 1.21 \text{ km/m}^3$

$c = 344 \text{ m/sec}$

$f_c = \text{low-frequency cutoff}$

$f_b = \text{high-frequency cutoff}$

$Z_o = \text{characteristic impedance}$

$t = \text{air chamber thickness}$

These are the design equations for a horn type loudspeaker and were applied to the design of the high frequency unit. These equations determine the mass of the moving system, the dimensions of the air chamber, and the areas of the diaphragm and horn throat, once the low and high cut-off frequencies, the characteristic impedance, and the flux density are chosen.

Construction

After determination of the mechanical constants, the next problem was that of actual construction. Such items as air chamber, voice coil, support for voice coil, field structure, and so on, became something more than numbers on paper.

In order to produce a flux density of 20,000 gauss across the voice coil, a field structure of considerable size is necessary. The permanent-magnet type was not used in the speaker, for it is difficult to assemble and disassemble as is necessary in experimental work. Therefore, an electromagnetic field was used. The body of the field is cast iron, which has a rather low saturation flux density, so it was necessary to use steel at the air gap. From calculations of the magnetic reluctance of the field circuit, it was found that six pounds

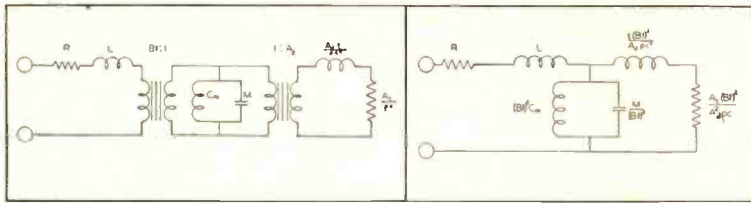

Fig. 7 (left). Equivalent circuit of the entire loudspeaker. Fig. 8 (right). Typical band-pass filter configuration.

of wire were needed to supply sufficient ampere-turns. The size of wire was chosen to give a current of 167 ma at 120 volts. This is very conveniently supplied by a half wave selenium rectifier on the a.c. line. The physical shape of the field may be seen in Fig. 9.

With a suitable field for the voice coil, the next project was to make the diaphragm assembly. It was found that the diaphragm had to be .001 inch thick in order to have sufficiently low mass, but this thin material is very hard to form without tearing. The problem was this: to form a spherical dome one inch in diameter and 3/16 inches high in the center of a two-inch diameter disc of .001-in. aluminum foil. Several processes were tried, including hydraulic forming, hot forming, and spinning. Spinning proved to be the only method which gave a reasonable percentage of successful diaphragms. The aluminum foil was clamped in a die in such a manner that the center one inch diameter was exposed to the operator, and the metal was worked into the carefully shaped die with a soft tool, thus forming the dome.

In order to keep the resistance of the voice coil at a minimum for a given moving system mass, it was found desirable to wind the coil without any coil form. The aluminum wire was wound into a coil of two layers so that the leads would come out at the same end. One layer was wound first on a cellophane mandrel and coated with a thin layer of cellulose cement. This cement bound the wire together and permitted the winding of the second layer almost immediately. The finished coil was then easily removed, since the cellulose cement did not adhere to the cellophane. The voice coil was then fastened to the aluminum diaphragm with the same cement after preparing the surface of the diaphragm by roughening.

The design equations revealed that the air chamber thickness should be .005 in. This meant that the accuracy of manufacture would have to be carefully maintained. This was accomplished by using the same cutter to shape the air chamber surface as was used to produce the die for making diaphragms. The shape and position of the

openings in the air chamber are quite important. Standing waves set up in the chamber can put dips and peaks of large magnitude in the final response. The position of the outer annular opening was selected so that the dip in response, occurring when the distance between this opening and the outer diameter of the air chamber becomes a quarter wavelength, is filled in by signal coming out of the center hole in the phase plug. The reverse is true when the quarter wave condition exists within the diameter of the annular opening.

Coupling to Air

The sound energy entering the throat must be coupled to the air. The analysis assumed that this would be accomplished by means of an infinite exponential horn. Of course, the actual horn had to be finite, but a finite horn approximates an infinite one, providing the mouth area is greater than the square of one-third the wavelength.

If the open end of the horn were made circular, its directivity would be

very great at high frequencies. The problem, then, is to make the area of the opening large, yet non-directional. This can be accomplished by the horn design shown in Fig. 9. The horn is not directional in the vertical plane, since here the dimensions are small compared to wavelength up to 15,000 cps. It would not be possible to make the horizontal dimensions small also, for this would result in insufficient horn area. The solution to this is to make the emitted wave appear to come from a point source back at the throat of the horn. This is done by dividing the horn into four equal exponential cells arranged so that the emitted wave is essentially a section of a sphere. This combination of vertical and horizontal directivities gives a uniform energy distribution over the audio spectrum above 5,000 cps.

The energy spread at half pressure points is approximately 120 deg. in the horizontal plane and 90 deg. in the vertical, at 10,000 cps.

This type of horn has an interesting performance characteristic. When listening to it one can not tell precisely from where the sound is coming. This is due to the fact that the focus of the sound source is not the same in the vertical and horizontal planes. The source of sound in the horizontal plane appears to be at the throat of the horn, while in the vertical plane it appears to be at the mouth. This effect is startling in a similarly designed horn for the 500 to 5000 cps range.

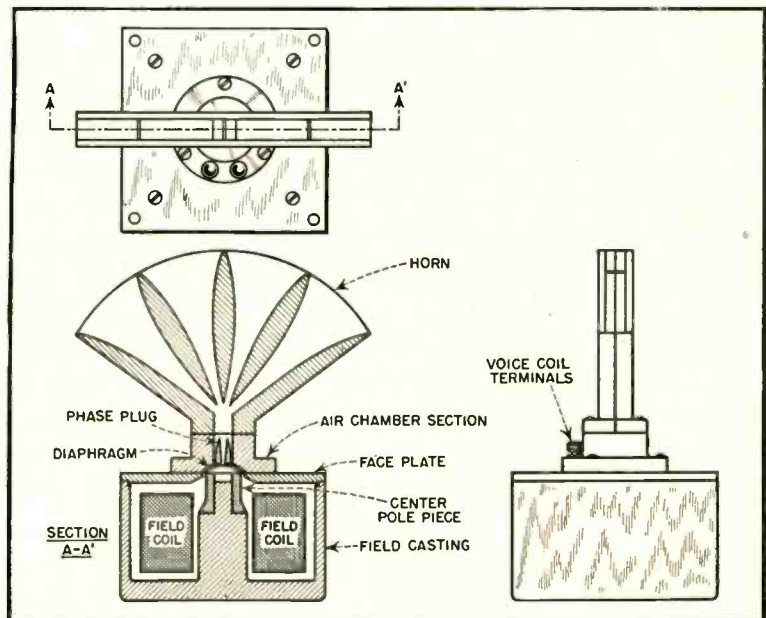

Fig. 9. Front, side, and cross-sectional views of the high-frequency loudspeaker.

Aircraft P. A. System

GEORGE H. WARFEL*

Design of a specialized system is shown to progress orderly as the various problems are encountered.

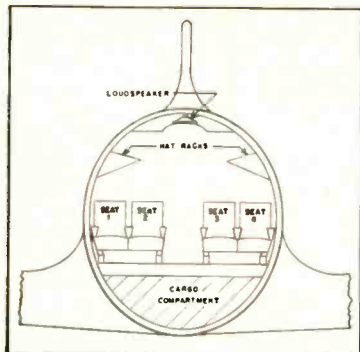

Fig. 1 (left). Cross-sectional view of Mainliner 300 showing ceiling location of loudspeaker. Eight of these speakers in the passenger cabin assure adequate acoustical coverage.

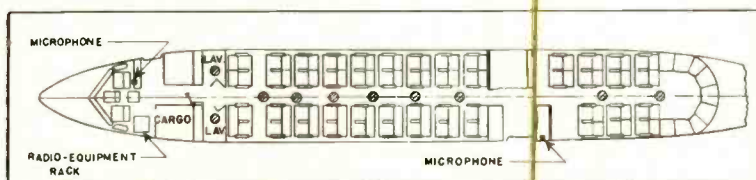

Fig. 2. Plan view of plane showing locations of speakers throughout the passenger compartments.

WITH THE INCREASE in cabin size of today's airliners, a public address system has become essential. It is an aid in paging a passenger for a telegram, announcing the service of meals, and in calling attention to scenic points of interest on the land below. The use and design of the system are considerably different from those of the recital hall or public lobby systems. It must function to alert and address all passengers for paging or instructional announcements, yet for entertainment type announcements it must reach only those passengers who are awake and interested and not disturb those who are napping. To serve this dual purpose, a well distributed, low-level output is necessary.

In addition to the dual-use feature, the acoustical properties of the cabin present an unusual problem. The DC-6 Airliner, for which this system was designed, has a long narrow cabin with only 2700 cubic feet of space and seats 50 passengers. The entire lining, except for windows and a narrow strip down the ceiling, is cloth backed with fiberglass. This makes an extremely dead enclosure.

The design of the system was attacked from the trial and error or "objective" angle, rather than from the theoretical standpoint. Once the loudspeaker location and power had thus been determined, the system design had to be correlated with the compromises common to all aircraft electrical designs. The space and weight had to be held to a minimum, all low-level circuits had to be shielded, the operational controls kept to a minimum, and all com-

ponents rugged enough to withstand continual vibration.

A cross sectional view of the cabin is shown in Fig. 1. Here it can be seen that no matter where on the periphery of the cabin a speaker was located, it would be no more than five feet from the nearest passenger. This indicated that many speakers would be necessary, each one operating at low volume, in order to provide a uniform level throughout the area and to prevent any individual from being subjected to a high-level direct blast. A further study of the cross sectional view shows that the point farthest from the passengers is the center ceiling. This is the only part of the cabin lining that is not cloth, and was therefore chosen as an ideal location for the speakers, both acoustically and mechanically.

Speaker Coverage

To determine the number of passengers that could be satisfactorily covered with one speaker, a single speaker was suspended from the center ceiling. This speaker was operated at a volume comfortable for the passengers sitting in the aisle seats directly under the speaker. While the speaker was operating, the observers took seats progressively farther from the speaker until they noticed a definite decrease in

[Continued on page 40]

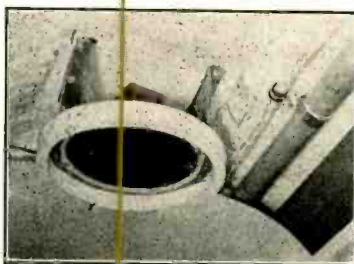

Fig. 3. Details of loudspeaker installation. The speaker may be dropped down for maintenance.

Courtesy United Air Lines

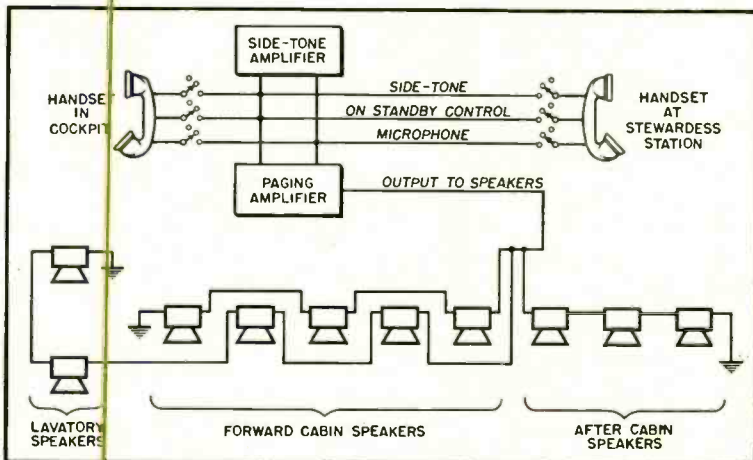

Fig. 4. Block schematic of P. A. system showing means for switching handsets to various circuits as required.

*1047 Berkeley Ave., Menlo Park, Calif.

Recording Characteristics – 2

Frequency content of a normal musical or speech program permits the use of pre-emphasis to increase signal-to-noise ratio.

PART I OF THIS SERIES attempted to describe as clearly as possible the reason for low-frequency equalization in phonograph recording. Reviewing, the swing of the stylus must be restricted to a certain maximum to avoid encroaching on the space allotted to the adjacent groove.

In recording for 78-rpm records, it is common practice to use a groove approximately 6 mils in width, and with 98 to 104 lines per inch. At 96 lines per inch, the centers of the grooves would therefore be 10.4 mils apart, and the lands—the spaces between the grooves—would be 4.4 mils in width. Referring to Fig. 1, the allowable swing for the stylus would be 2.2 mils each way, or slightly less, to provide for some solid material between peaks of the signal, as at point X. If the groove were exactly tangent at such points, the walls would be likely to break through on repeated playing. Naturally, the peaks of two adjacent grooves might not coincide as shown in the drawing, but it must be assumed that such a coincidence is possible, and allowance made for that possibility. Thus the allowable swing at the lower frequencies is of the order of ± 2 mils.

If all frequencies were recorded with the amplitude of swing at this maximum, it would be a "constant ampli-

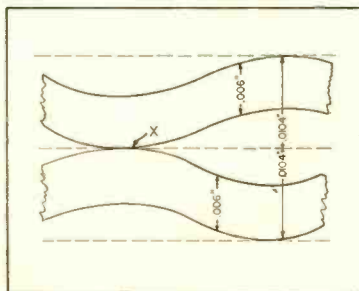

Fig. 1. Typical dimensions for a recording groove modulated slightly more than 100% at a low frequency.

ture" type of recording. At high frequencies, however, the stylus would have to make very sharp reversals, as shown at (A) in Fig. 2, with a resultant high velocity. As a matter of fact, it is doubtful if any stylus could follow such a groove at 10,000 cps. At constant velocity of stylus-tip movement, the groove would be more like (B) of Fig. 2. Practically, therefore, the groove is most usually cut with constant amplitude up to some intermediate frequency—generally somewhere between 250 and 800 cps—and at decreasing amplitude but at constant velocity above this frequency, which is known either as the transition frequency or the turnover frequency.

Equalization Methods

Methods of equalization for crystal

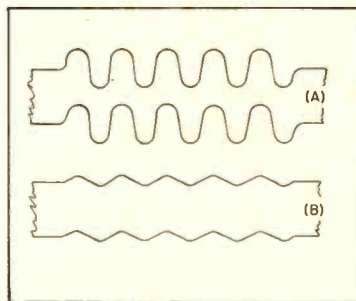

Fig. 2. (A) High-frequency signal recorded at 100% modulation on constant-amplitude basis. (B) Same signal recorded on constant-velocity basis.

pickups were discussed last month. For magnetic pickups, another type of circuit is required because of the difference in the output signal characteristics. Since magnetic pickups have a flat response from a constant-velocity recording, their output decreases at a fixed rate for a constant-amplitude recording, this rate being 6 db/octave. Therefore, the output for a magnetic pickup drops below turnover at this same rate, and must be compensated for.

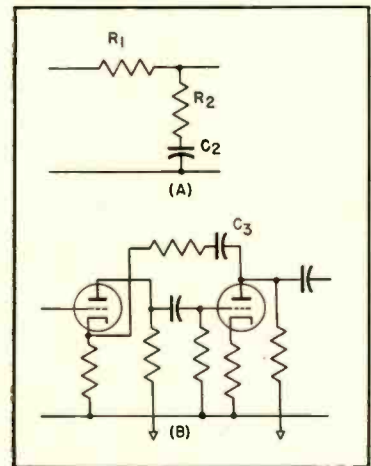

Fig. 3. (A) Losser circuit to provide low-frequency boost. This circuit is usually placed between two high- μ triode stages. (B) Feedback circuit commonly used in preamplifiers to provide required low-frequency boost.

Figure 3 shows two usual ways of providing the required low-end boost to compensate for this characteristic. (A) consists of a losser circuit placed between two high-gain triode stages. This type introduces a loss which increases gradually from zero at zero frequency up to a maximum at the frequency where the reactance of the capacitor becomes a small portion of the total impedance of the shunt circuit across the line. Above this frequency the loss is practically constant. The output voltage for zero frequency is essentially equal to the input voltage; at high frequencies it is approximately equal to $R_2/(R_1 + R_2)$ times the input voltage.

With one such equalizing circuit, consisting of the series resistor R_1 , and the shunt resistor R_2 and capacitor C_1 , the bend in the response curve at the turnover frequency is relatively rounded. Some equalizing amplifiers employ two such circuits, with an in-

crease in the sharpness of the bend at the turnover frequency.

At (B) is shown a circuit which provides the required boost by varying the gain of the amplifier by means of a frequency-selective feedback circuit. In this circuit, the voltage fed back decreases as the frequency is lowered, with the result that the gain at low frequencies is greater than at high frequencies. Thus, the amplifier is suitable to compensate for the low-end droop employed in recording. The relative values of the capacitor and resistor in the feedback circuit determine the turnover frequency.

In professional equipment, such as is used in broadcast stations, it is more common to employ a low-impedance equalizing circuit, such as that of Fig. 4. With this arrangement, it is possible to adjust the response for turnover at any desired frequency by suitable values for L_1 , C_1 , and R_1 , and to adjust the slope below turnover by selection of suitable values for R_2 and C_2 . This circuit is designed to work into a circuit with a nominal impedance of 250 to 600 ohms, and is thus suitable for connecting between the pickup and a standard microphone preamplifier. The output of this network is usually in the vicinity of 26 db below the input for frequencies above turnover, which is about the same degree of magnitude as that of a high-quality microphone as used in broadcast work. A network of this type may well be employed between a magnetic pickup and a low-impedance input of a P.A. system amplifier. Such an equalizer was discussed by the writer in an earlier issue¹, with a description of the method used to determine the component values.

Most P.A. amplifiers have only high-impedance inputs, so it is sometimes more convenient to connect an RC network of the type shown in Fig. 5 be-

tween a magnetic pickup and one of the high-gain microphone inputs of such an amplifier. The input resistor, R_4 is that normally employed for the termination for the pickup being used. The turnover frequency can be varied by changing the values of the two capacitors.

High-Frequency Equalization

Digressing for a moment, let us consider the power distribution in music

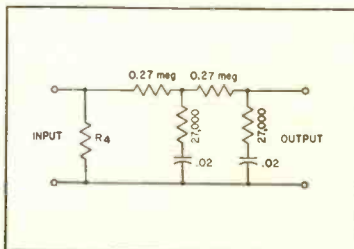

Fig. 4. Losser circuit suitable for use between magnetic pickup and high-gain, high-impedance input of P.A. system amplifier, such as normally used for crystal microphones.

with respect to frequency. A voluminous study of this problem has been reported by Sivian, Dunn, and White², and considerable work on speech has been reported by Fletcher^{3,4}.

These results are shown in the curves of Fig. 6, where (A) is the maximum power in $\frac{1}{8}$ -second intervals for male speech, and (B) represents maximum peak power in the same intervals for a 75-piece orchestra. While there is some reason to believe that higher efficiency in more modern microphones may modify these curves somewhat in the direc-

² "Absolute amplitudes and spectra of musical instruments and orchestras," *J. Acous. Soc. Am.*, Jan. 1931.

³ *Speech and Hearing*. New York: D. Van Nostrand Co., 1929.

⁴ "Physical Characteristics of Speech and Music," *Bell System Tech. J.*, July 1931.

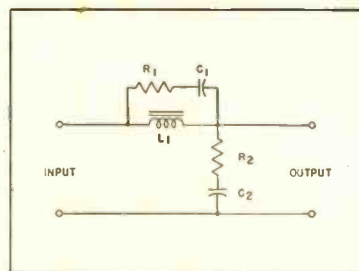

Fig. 5. Equalizer arrangement used between magnetic pickup and low-impedance input of microphone preamplifier.

tion of more highs, they may still be used to show why it is possible to pre-emphasize the highs to some extent.

Assuming, for example, that the maximum probable power in a 10,000-cps tone occurring in orchestra music is 15 db below that for a 1000-cps tone, it is possible to record with a 15-db boost at 10,000 cps without exceeding the 1000-cps stylus velocity, since a constant velocity is assumed for flat frequency response. With such pre-emphasis, it is necessary that an equivalent deemphasis be employed in the playback equipment, with a consequent reduction in surface-noise output, since noise is random and largely proportional to frequency.

Some pre-emphasis is employed in practically all commercial recordings made today. Typical curves are shown in Fig. 7, where (A) represents the NAB curve which is generally used with transcriptions and is standard for LP records. The curve used by RCA-Victor is believed to approximate that of (B), while the London (English Decca) curve is shown at (C). Undoubtedly there are some other curves in use, but these shown are commonly employed. If a phonograph amplifier is equipped with means to provide "rolloff" curves which are complementary to these re-

[Continued on page 45]

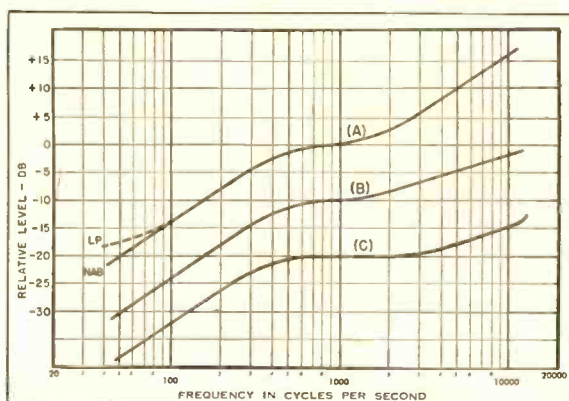
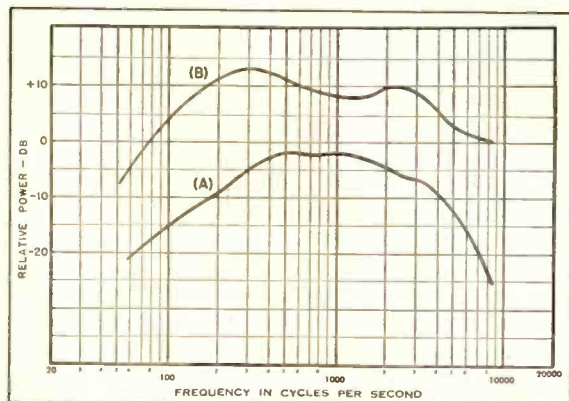

Fig. 6 (left). Curves showing maximum probable power in $\frac{1}{8}$ -second intervals in male speech (A), and in a 75-piece orchestra (B). Fig. 7 (right). Typical pre-emphasis curves: (A) NAB and LP; (B) presumed curve for RCA Victor; and (C) London ffr.



AUDIO engineering society

Containing the Activities and Papers of the Society, and published monthly as a part of AUDIO ENGINEERING Magazine

OFFICERS

Theodore Lindenberg, President

J. D. Colvin.....Executive Vice-Pres. John G. Frayne.....Western Vice-Pres.
Norman C. Pickering.....Secretary Ralph A. Schlegel.....Treasurer

Audio Engineering Society,
Box F, Oceanside, N. Y.

Longitudinal Noise in Audio Circuits—Part 1

H. W. AUGUSTADT* and W. F. KANNENBERG*

A discussion of the general effect of the presence of longitudinal noise on a transmission circuit, with a description of the differences between metallic circuit noise and longitudinal noise. Test circuits and representative conditions are illustrated and discussed.

LONGITUDINALS" is a term often used to explain the origin of unknown noise in audio circuits with little actual regard to the source of the noise. In this respect, the usage of these words is similar to the popular usage of the word "gremlins." We attribute to gremlins troubles whose causes are unknown without much attempt to delve deeper into the matter. Similarly, in the audio facilities field, many noise troubles are attributed to "longitudinals," "line noise," or even simply "hum," without a clear understanding of the nature of the trouble or the actual meaning of the terms. However, the noise trouble still persists, irrespective of the name applied to it, until its causes are thoroughly understood and the correct remedial action is applied. This paper describes and illustrates, with representative examples, various types of common noise and in particular those resulting from longitudinal induction, in order to lead to an understanding of their nature. The paper includes, in addition, a discussion of simple remedies which may be employed for representative cases of noise troubles due to longitudinal induction.

The examples used for illustration purposes are shown in terms of amplifier input circuits. This has been done because the article is directed primarily towards people whose interests are

*Bell Telephone Laboratories
Murray Hill, N. J.

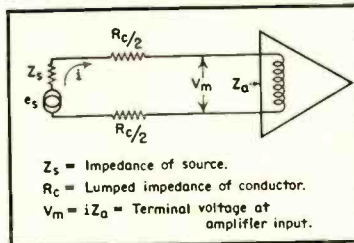

Fig. 1. Example of a metallic circuit voltage.

mainly in the design and application of audio facilities for broadcasting systems, sound reinforcement systems, and similar applications. The principles are general, however, and apply to the general field of communication circuits.

In order to achieve the objectives of this paper, it is necessary to make clear the meanings of the terms employed in describing various types of noise. It is, therefore, desirable to distinguish clearly between metallic-circuit noise and longitudinal noise. The first step is to distinguish between a metallic-circuit voltage and a longitudinal circuit voltage. The schematic representation of a metallic-circuit voltage is shown in Fig. 1 in which a source of constant voltage e_s with internal impedance Z_s impresses, through a conductor resistance R_c , a potential difference V_m across the input terminals of the receiving equipment. Note that the metallic-circuit voltage causes equal and oppositely directed currents to flow in the

two conductors connected to the input circuit of the equipment.

The source of the voltage in Fig. 1 might equally well have been depicted as a constant-current generator. This generator in the circuit of Fig. 1 would likewise have caused currents of equal magnitude and opposite direction to flow in the two conductors of the input of the equipment and thus impress the metallic-circuit voltage V_m on the input terminals of the receiving equipment.

Bearing in mind the conditions represented in Fig. 1, a metallic-circuit voltage is a voltage that exists at any point between the two conductors of a pair. It is the metallic-circuit voltage V_m which is amplified by the receiving equipment and affects the performance of the circuit.

Longitudinal Circuit Voltages

In contrast to the condition represented in Fig. 1, consider the circuit of Fig. 2. In this case, the impressed voltage e_s , of internal impedance Z_s , causes equal and like directed currents to flow down the two conductors, out through the centerpoint of the input transformer primary, and through some coupling impedance—represented here as Z_c —to a third conductor, and return via the third conductor, which is usually ground. Their flow in the input transformer of the receiving equipment is in such a direction that they mutually oppose one another, and hence, on the assumption that the transformer is perfectly balanced to the midpoint

ground, they produce no potential difference across the input terminals of the receiving equipment. The flow of this longitudinal current through the coupling impedance Z_{1a} causes a potential difference V_{1a} to exist between the input circuit of the amplifier and the third conductor, but no metallic-circuit voltage is produced by this current, and hence the voltage V_m across the input terminals of the receiving equipment is zero.

Note that as in the case of the metallic-circuit voltage condition of Fig. 1, the source of the longitudinal voltage may be either a constant-voltage generator as depicted or a constant-current generator. This latter generator may be thought of as a generator which introduces a current $i_l/2$ on each conductor of the input circuit. The longitudinal currents flow to the third conductor via the two impedances Z_{1a} and Z_{1a} .

In keeping with the conditions depicted in Fig. 2, a longitudinal voltage is a voltage that exists equally on the two conductors of a pair with reference to some third conductor to which it is conductively coupled, generally taken as ground.

When the generators of Figs. 1 and 2 are produced by unwanted sources they are designated as *noise generators*. The noise generators in the circuit of Fig. 1 may be either of the constant-voltage or constant-current type and produce *metallic-circuit noise voltages* and *metallic-circuit noise currents* respectively. In the longitudinal case of Fig. 2, the noise generators produce *longitudinal noise voltages* and *longitudinal noise currents*, depending on whether they are respectively of the constant-voltage or constant-current type. In addition, it should be noted that the generators may be lumped generators as depicted in the figures for ease of illustration, or they

may be distributed sources. Likewise, the conductor resistances and the impedances to ground, Z_{1a} and Z_{1a} , of Fig. 2 may be lumped or distributed.

Source of Longitudinal Noise

The illustrations employed to clarify the definitions of metallic circuit and longitudinal circuit voltages represent conditions which may be set up in the laboratory but do not reflect the conditions likely to be encountered in the normal use of the equipment. Hence, it is of interest to investigate the means by which longitudinal noise is introduced into the input circuits of audio equipment. Figure 3 represents one method by which longitudinal induced voltages of electromagnetic origin are introduced on a circuit. In this case, it is assumed that the conductors of the input pair are situated near a power conductor carrying substantial amounts of current. The resulting electromagnetic field from the power conductor cuts the conductors of the amplifier input circuit, and hence introduces distributed e.m.f.'s of approximately equal magnitude and the same sign on the two conductors of the pair. These e.m.f.'s cause approximately equal and like directed currents to flow on the conductors of the input pair and return via some third conductor with which they are coupled, indicated in the figure as ground.

Note that the condition represented in Fig. 3 may also be one by means of which a metallic-circuit noise voltage is introduced into the circuit. This happens whenever the two conductors of the pair are not linked by the same field. Assuming that changes cannot be made to eliminate the source of the disturbance, the magnitude of the metallic-circuit noise voltage induced in the circuit is reduced by employing

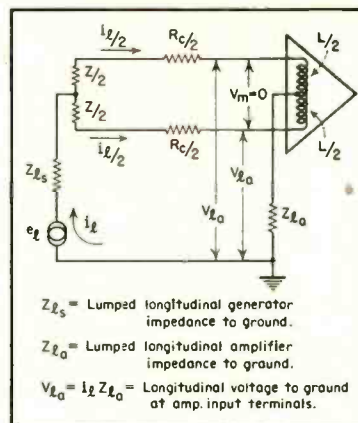

Fig. 2. Example of a longitudinal circuit voltage.

twisted or transposed pair conductors for the input circuit and also by making the distance between the audio pair conductors small compared with the distance of the audio pair from the power circuit. These precautions do not necessarily alter the magnitude of the voltage induced, but rather minimize the magnitude of the metallic-circuit voltage by arranging the circuit in such a way that equal e.m.f.'s of like polarity, are induced on both conductors. The sum of these e.m.f.'s around the input circuit itself is zero, and hence the metallic-circuit voltage at all points of the circuit is zero. Thus, in an exposure of the character represented, protection against metallic-circuit noise voltages is obtained by so arranging the circuit that substantially only longitudinal voltages are induced on the circuit.

For the case depicted in Fig. 3, it is quite obvious that in the usual installation the coupling impedance between the power circuit and the audio input

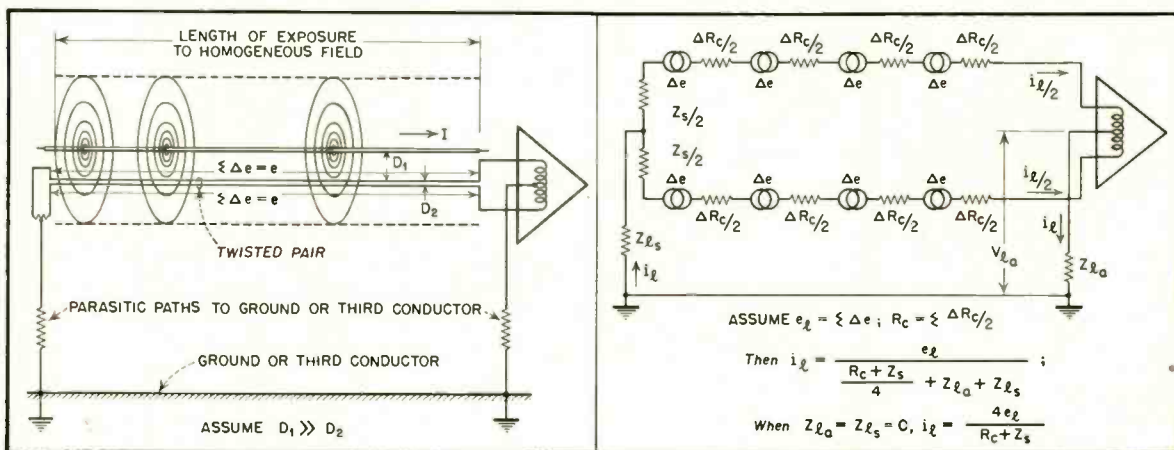

Fig. 3 (left). Example of longitudinal voltage caused by inductive coupling between power circuit and pair connecting source to amplifier. Fig. 4 (right). Schematic representation of longitudinal voltage resulting from magnetic induction.

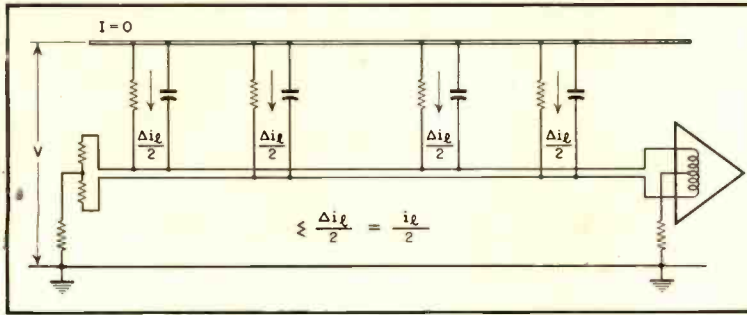

Fig. 5. Example of longitudinal current caused by electrostatic and leakage coupling between power circuit and pair connecting source to amplifier.

circuit is negligible with respect to the magnitude of the longitudinal and metallic-circuit impedances of the amplifier input circuit. This condition may be regarded as one in which the noise is introduced into the circuit by means of a zero-impedance generator. Noise of this type is known in this paper as noise due to a longitudinal noise voltage.

The schematic representation of the longitudinal induced voltage resulting from the conditions of exposure depicted in Fig. 3 is shown in Fig. 4. The equal incremental distributed voltages of like sign induced on the two conductors of the pair cause equal currents to flow down the conductors to some third conductor via the coupling impedances Z_{1s} and Z_{1a} .

The magnitude of the longitudinal current $i_i/2$ on the conductors in Fig. 4 is determined by the metallic-circuit impedances and the longitudinal impedances of the circuit to ground. On the assumption that the source and receiving equipments have their center points strapped to ground and that the input transformer of the receiving equipment is an ideal one, the magnitude of the longitudinal current is limited only by the metallic-circuit impedances and becomes $i_i = 4e_i/R_o + Z_s$. This expression for longitudinal current indicates that the effect of a longitudinal induced voltage on a circuit is that of a zero impedance generator.

Longitudinal Currents

The manner in which longitudinal induced currents are introduced in a circuit under representative field conditions is shown schematically in Fig. 5. In the case depicted it is assumed that the power-circuit conductor is at a voltage V with respect to ground but that the current flowing on the power circuit is negligible, and, therefore, the associated electromagnetic field is negligible. Parasitic leakages and capacitances are, however, assumed to exist between the power circuit and the input circuit of the amplifier. Under these conditions, incremental longitudinal in-

duced currents flow from the power conductor to ground via the input circuit of the amplifier. In general, for cases of induction of this type, the coupling impedance between the power circuit and the conductors of the input circuit is extremely large with respect to the longitudinal impedances of the input circuit to ground. Hence, the magnitude of the longitudinal induced current is determined by the coupling impedance. Noise of the type depicted in Fig. 5 may be regarded as resulting from a constant-current generator and is known in this paper as a longitudinal noise current.

The schematic representation of noise resulting from a longitudinal noise current is shown in Fig. 6. The longitudinal impedances of the input circuit to ground are assumed to be negligible in comparison with the magnitude of the coupling impedance Z_c , between the power circuit and the input circuit of the amplifier. Consider the case in which the metallic-circuit impedances are negligible compared with the magnitude of the longitudinal impedances to ground of the input circuit. The longitudinal noise current entering the circuit is then $i_i = 2V/V_c$. Under these conditions, the longitudinal voltage to ground of the input circuit of the amplifier is

$$V_{1a} = \frac{Z_{1a} Z_{1s}}{Z_{1a} + Z_{1s}} i_i$$

In the case of a longitudinal noise current, the magnitude of the longitudinal voltage, V_{1a} , is determined by the longitudinal impedance to ground of the input circuit of the amplifier.

Recapitulating, the noise introduced in a circuit by electromagnetic coupling is known as a longitudinal noise voltage because the noise generator has substantially zero internal impedance. The noise introduced in a circuit by leakage, or by electrostatic coupling, is known as a longitudinal noise current because it is due to a substantially constant-current generator.

Method for Identification

The above differentiation in the types

of longitudinal noise has been stressed because it will be shown later that the circuit modification required to mitigate the effects of longitudinal induction depends on which type of induction is predominant. Accordingly, it is valuable to be able to identify the type of longitudinal induction to which the circuit is subjected. A test circuit for identification purposes is shown in Fig. 7. As shown in this figure, the two conductors of the pair are strapped together and connected to one input terminal of the amplifier; the other input terminal of the amplifier is connected together and connected to one contact of a single-pole single-throw switch. The other contact of the switch is connected to ground.

Identification of the type of induction is established by using this circuit to demonstrate its predominant characteristics. Assume, for example, that the noise results from electromagnetic induction. Of the two sending end conditions, open-circuit or short-circuit-to-ground, the short-circuit-to-ground condition enables the longitudinal noise voltage to produce the larger current flow, and hence causes most of the induced voltage to appear across the amplifier input terminals. When the sending end is open-circuit-to-ground, the longitudinal current flow is a minimum because of the high impedance to ground at the sending end, and most of the induced voltage appears across the open circuit at the sending end. The voltage across the amplifier input terminals is small because the longitudinal current flow is a minimum.

In the presence of a longitudinal

[Continued on page 45]

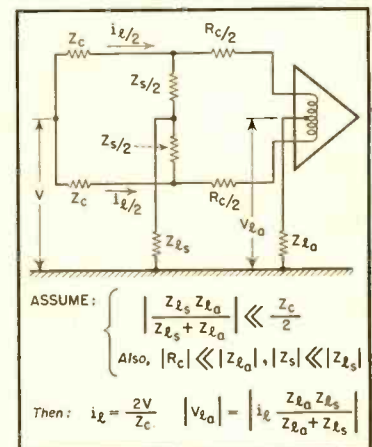

Fig. 6. Schematic representation of a longitudinal current resulting from parasitic coupling to a power circuit.

WORKS LIKE NEW!... after 9 months of daily use
ON 30,000 MILE TREK
THROUGH AFRICAN JUNGLE

with *Arch Oboler* Famous Radio Playwright.

E-V CARDYNE Cardioid Dynamic Microphone
takes everything... from the heat and humidity
of the Congo to the rain-swept slopes of the
Mountains of the Moon, to the snow and ice of
16,000 foot Mt. Kenya's glacier fields!

*"...trip was made by boat, pack horse, jeep and foot
under most difficult conditions...apparatus had to
endure penetrating dust and great variations in
humidity...used the Cardyne almost entirely...never
failed, during months of use and abuse...made
recordings of experiences on African safari for a
series of transcribed radio broadcasts...after return
to U.S., found the Cardyne to be in thoroughly
operative condition from every standpoint...
built-in ruggedness of E-V microphones means a
longer, more useful life at any time, anywhere."*

Arch Oboler...Author-Director.
Winner of Radio's Top
Awards, including the
Peabody Award
(Radio's Pulitzer).

Shown using E-V Cardyne
Cardioid Microphone in
recording the Ituri pygmies
in the Belgian Congo.

Write for Cardyne Bulletin No. 139

ELECTRO-VOICE, INC., BUCHANAN, MICH.

Export: 13 East 40th St., New York 16, U.S.A.

Cables: Arlab

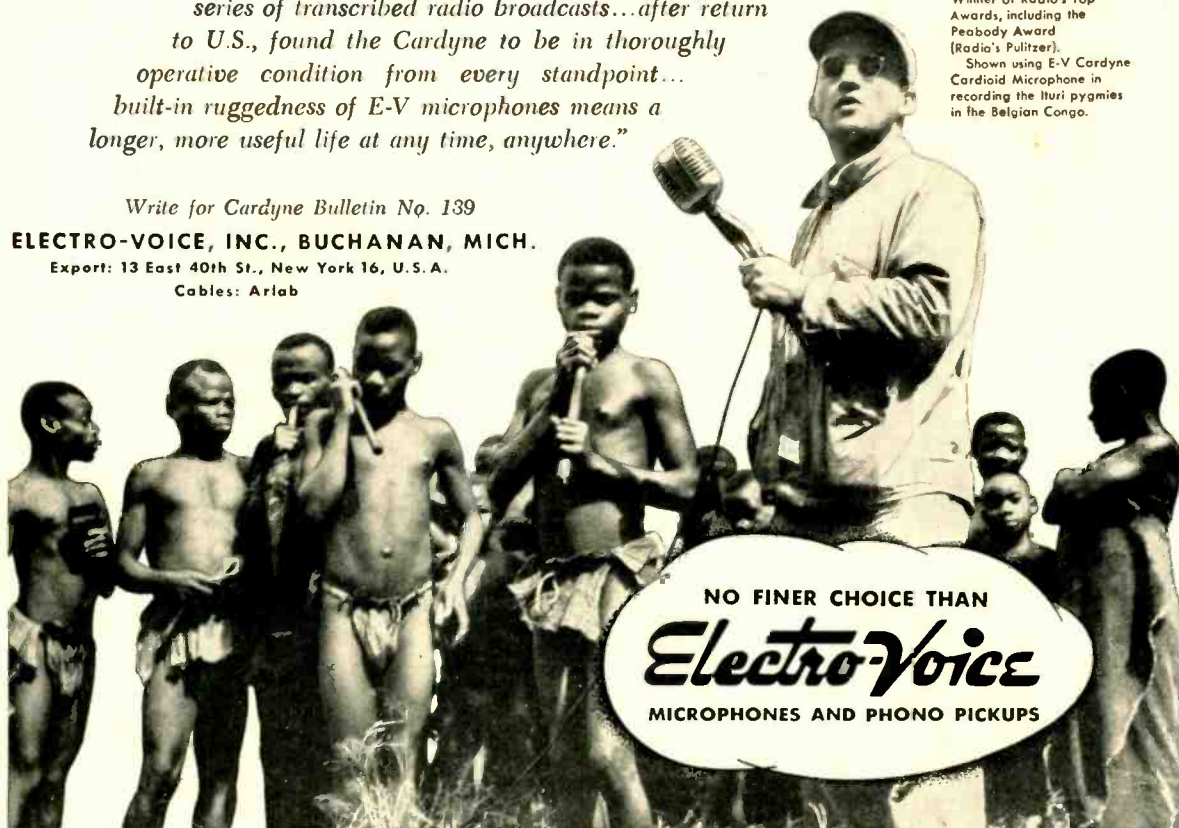

NO FINER CHOICE THAN

Electro-Voice

MICROPHONES AND PHONO PICKUPS

REVUE

Binaural and Monaural Equivalents 1

EDWARD TATNALL CANBY*

SMELLING RATS seems to be one of the more practical occupations of this department. That rat-sniffing agent fuzzy (?) LP records, back in November, produced the most astonishing volume and range of suggestions from our readers that this somewhat dazed individual has yet run into, covering virtually every conceivable phase of the entire audio process. The most amazing thing was that very few actually mentioned the possibility of stylus trouble and the mechanical-electrical problems involved in compliance. The discovery of the difference in performance between various GE styli did offer a clear and convincing proof of the actual difference the stylus factor can make. Other things being equal, I think there is no question at all that the major difficulty in fuzziness with LP's is to be found right there. However, it should be clear that there are plenty of other problems, plenty of other kinds of distortion or mal-reproduction; the numerous suggestions I received come under this category. None of them, as I see it, are of such major and vital importance as the complex troubles directly involving the mechanical properties of the stylus assembly. And so much for that.

And now for a family of rats of a different color, and not as easy to sniff down. Ever since the bit of binaural fantasy I perpetrated last summer suggesting a double-channel hearing aid and outlining the very great differences in perception that should show up between it and the usual monaural one, I've had the contrast between binaural and monaural hearing very much in mind. I am increasingly aware that most of us ignore that difference as too theoretical, in spite of the fact that we make decisions that take it into account every time we so much as set up a microphone. I think we grossly underestimate the apparent difference and the quality of difference between the monaural perception that we deal with in audio and the binaural perception which is, supposedly, our model and our ideal. (I have had letters suggesting that a binaural hearing aid would scarcely make any important difference in hearing as compared with the usual monaural machine. That is patently untrue, quite aside from practical inconveniences and technical difficulties that would occur in actually making the binaural model.) I am not too sure that our right hand knows what our left hand is up to. (Perhaps I should say our right ear.)

Hunch and Guesswork

I maintain that, thanks to this indifference to a difference, we are constantly "putting our feet into it" in our monaural work, leading with our chins, painting ourselves into corners, cutting our noses off to spite our faces, and what have you. I believe that, even for monaural audio work, we need a far better general understanding of the differences in sensation between monaural and

binaural hearing. I think we need to get rid of some off-center ideas about their relationship, and we need to cultivate some others which might be more accurate.

This understanding will be enormously helped by experiments designed to pin down these mind-differences, these perception-differences, to approximate numerical scales, units, formulas, and graphs, in the manner of Maxfield and Fletcher-Munson. (These two well-known sets of investigations succeeded in reducing to working mathematical formulas a set of factors in each case not measurable by instruments but *solely by the human ear itself*. Because in the end all audio is measured and judged by the ear, the Fletcher-Munson loudness curves and the Maxfield formula for monaural mike set-up are of tremendous importance in systematizing what otherwise would be a matter for pure hunch and guesswork.) The faulty conclusions that are commonly reached, the false relationship (like the idea of "concert hall realism on your records—just what you hear when you are actually at a concert"), which achieve easy and misleading usage, the inaccurate conception of what "realism" is or should be, what high fidelity means—all these things are component members of the rat family I am sniffing at. But I'll make a beginning and continue intermittently in future issues. Maybe some of you readers with know-how will do something about my rats.

Toward a Liveness Factor

I've already stated on various occasions the general principle that the apparent liveness of a given acoustic situation (the quality of sound which the mind "hears") is greatly increased when hearing of the "bi-" sort becomes "mon-". These is nothing new about the idea, since obviously the whole development of the sound-deadened studio depends upon it: if we are to broadcast monaurally, then we must deaden in order to come out with a normally live sound in the reproduction. The degree of that deadening—it is, if you will think twice, a very large amount of deadening—is a measure of the importance of this difference. Looking at it the other way around, you may re-read my binaural hearing aid article and the account there of the extreme excess of liveness one experiences when a normally live room is "listened to" monaurally via a mike-amplifier-earphone arrangement. The same is true, as countless amateur recording enthusiasts have learned to their dismay, when monaural recording is done in an ordinary home situation. The results are invariably terrible.

It would seem to me that the difference could be reduced to a useful mathematical factor, and I'll go no further this month than to take a look at that possibility. The present existing loudness scale, in terms of phons (as contrasted with decibels), is

[Continued on page 35]

Pops

RUDO S. GLOBUS**

A new column, designed to fulfill the demand of those who wonder which popular records are good, both musically and technically. Your comments and criticisms will be welcomed.

A few months ago we exchanged words with Benny Goodman on the jazz or popular versus classical problem. Reginald Kell, the distinguished English clarinetist (best known in this country through his recordings of the Mozart clarinet concerto and clarinet quintet), was present, and, in conjunction with Goodman, pointed out the lesson of the day. Boiled down to the simplest possible formula, it amounts to just this . . . the technical problems of any and all kinds of music are pretty much the same. Some pop arrangements require as much technical ability as some of the most difficult classical scores. Classical (we prefer the term serious) music requires considerably more discipline than the general run of pop arrangements.

But, the heart of the matter is the problem of imagination. A different kind of imagination is required for each and every different type of music, whether it be chamber, large orchestra, solo, romantic, modern, baroque, dixieland, Chicago, Kansas City, swing, pop, Latin American, and so on, ad infinitum. Some musicians are particularly gifted . . . and their range is fantastic, sic Goodman himself. Most musicians aren't. A good jazz man may not even be able to play a regular commercial arrangement of the more lush, intricate type anymore adequately than Roy Acuff could be expected to solo in the Tchaikovsky violin concerto. You can fill in the other examples from your own experience.

What interests us is the fact that, given the similarity in technical problems as well as the recognition of the part imagination plays in non-serious as well as in serious music, why demand less from jazz or pop recordings than from classical?

Some of the reasons are obvious. A vast majority of the standard popular releases do not belong in the categories mentioned above. These recordings, which are really one-dimensional, are not meant to be "listened to": they are meant to be heard, or overheard. As long as the lyric is adequately distinct, the beat evident enough for dancing or table thumping purposes, and, if necessary, the melody whistleable, everything is okay. And that is as it should be with these background music recordings, (a phrase to be used from now on to classify the hummable, whistleable, danceable, thumpable . . . but non-thinkable pop releases).

But what about the others, the "serious" jazz recordings; the clever, well-arranged

*270 W. 4th St., New York 14, N. Y.

**960 Park Ave., New York 28, N. Y.

and pre-eminently worthwhile "ensemble" records (ensemble referring to pop releases, which though not jazz or swing, require and get from the listener more than a thump or a wheeze). It is one of the great tragedies (or if you will, one of the lesser tragedies) of our point in the history of music that the "golden age" of jazz is represented on records by phone-booth recording studios, pick-axe cutting styli, engineering delicacy worthy of Jack the Ripper, and general recording equipment which just doesn't make the pioneers proud. Listening to some of the early Louis Armstrong recordings produces a vivid recollection of the Marx Brothers plus ten thousand compatriots emerging out of a two-by-four closet . . . nobody knows how they all got in, but a good prop man took care of that. So with the early and (may we say with delight) some of the more recent jazz recordings.

Early swing (a term requiring emendation) also suffered from inadequate facilities. The situation as far as ensemble music is concerned is not as serious. Since all that is necessary for a re-recording is the arrangement (who plays doesn't matter; whatever solos there are exist on paper and are, to say the least, impersonal), any group can re-record them under modern conditions. And that is exactly what is happening. London ffr has been releasing a number of re-recordings of old standbys utilizing wide-range technique, and the results are interesting. Pleasant to hear the music for a change.

At any rate, we intend to list a number of the great "non-serious" recordings along with the up-to-date reviews. What can we say about the technical features of these gems? Cut-out highs, sterilized lows, fuzzy, distorted excommunicated middles, sand-paper surfaces. We are humbly grateful for the weird sounds that issue from these souvenirs of a great time. True, the major three did release some "jazz" recordings which are occasionally tremendous. True, some of the little independents occasionally pressed a batch of worthwhile performances, which, with a little help from an expander, sound good. But on the whole, the golden age is buried under acres of lack of technical know-how. Do we care? Yes!

As soon as some enterprising somebody decides to resuscitate jazz (the facilities are available for recordings which will make possible an accurate knowledge of the genius of the non-serious instrumentalist. There are nuances, problems in phrasing and dynamics, in jazz too. Without them, a performance is flat. The great men of jazz not only thought melodically, but they also thought harmonically (meaning we would like to hear the harmonic line derivable from bass, guitar, piano, etc.), as well as in terms of the subtleties of forte and pianissimo . . . and believe it or not, tone. We may catch a glimpse of the genius of a Baby Dodds from a 1926 recording, but only a glimpse. More about this some other time.

To start the inevitable flow of saliva, we are listing a few choice items this time which dramatize our story somewhat. They are all collectors items (the jazz collector has the same problems as the classical collector), difficult to get, and expensive when found. To those of you who insist on a realistic jazz atmosphere, not even the best and most intricate of Hi-Fi instruments will help. The closest approximation to the real thing can be derived by buying two cats and one dog, loading your guests and yourself already loaded into a closet approximately ten feet away from the speakers, closing the closet door after sickening the cats and dogs after

[Continued on page 33]

THE ONLY ONE OF ITS KIND

FOR PERFORMANCE!

IN VALUE!

FOR CONVENIENCE!

Another great UNIVERSITY FIRST!

- HANDLES 30W CONTINUOUS INTEGRATED PROGRAM MATERIAL
- EASILY ACCESSIBLE, ALWAYS VISIBLE TERMINAL BLOCK
- TAPS MARKED IN BOTH IMPEDANCE AND WATTS
- SHATTERPROOF BAKELITE BODY, ENDURINGLY BEAUTIFUL
- SUPER-EFFICIENT "W" SHAPED ALNICO 5 MAGNET



University
MODEL PA-30
DRIVER UNIT



— plus **BUILT-IN, MULTI-TAP LINE MATCHING TRANSFORMER**

These rugged drivers represent the first high power continuous duty, completely waterproof units available with built-in line matching transformers. New type W-shaped Alnico 5 magnets result in the elimination of stray fields and a greater concentration of magnetic energy in the voice coil gap. Exclusive UNIVERSITY "rim centering" assures perfect alignment and concentricity — always. Units may be used with equal facility on constant voltage and constant impedance output systems. Transformer and voice coil terminals are brought out at the bottom of the unit to a terminal block which is an integral part of the molded housing. A translucent cover plate provides ready access to the 16, 165, 250, 500, 1000, 2000 ohm terminals and their equivalent wattages based on 70 volt line.

WRITE DEPT. B FOR ILLUSTRATED CATALOG



University
LOUDSPEAKERS, INC
80 SO. KENSICO AVE., WHITE PLAINS, N. Y.

Famous World-Wide for LOUDSPEAKERS • DRIVER UNITS • TWEETERS • PORTABLE POWRMIKES

NEW PRODUCTS

- **Gates Studioette**, Model 52CS, is a new, medium-size studio control console that may be used for AM, FM, or TV in main or sub-studio service, as well as a part of a master control installation. Electrically, the Studioette is a complete self-contained speech input system with provisions for four microphones, two transcription turntables, and network and remote lines. The microphone preamplifiers are built in, as are line and monitoring amplifiers for the high-level circuits. The usual facilities for loudspeaker muting, cueing, and other circuit switching have been elaborated on to a large extent in the new Studioette. Gates Radio Co., Quincy, Ill.
- **Ekotape Magnetic Recorders** are now available in two new professional models, according to an announcement by Webster Electric Co., Racine, Wis. The unit shown is the Model 105, which includes both recorder and amplifier in one compact case, and provides for a half-hour program at a tape speed of 7½ in. per second.

Model 107 consists of two compact units, one of which contains the recording mechanism, the other containing the amplifier chassis. For permanent rack mounting, these units may be obtained without cases. A two-speed synchronous motor provides tape speeds of 15 and 7½ in. per second, and fast forward and fast rewind speeds permit rapid selection and replay of any part of the recording.

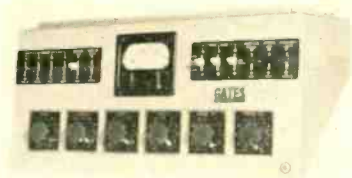

Gates Radio Co.



Webster Electric Co.

Both of these models are designed to meet the exacting requirements of broadcasting, and provide portable units for remote work.

- **The tweeter problem**—primarily that of finding some way of mounting the device easily and efficiently without performing a complicated rebuilding operation—is solved by the new Masco HFT-100 high-frequency speaker which utilizes a unique method of distributing the highs. The tweeter consists of a small speaker unit and a diffusing system, and the entire device is mounted on a protective metal grille placed in front of the conventional 12-in. cone. Also unique is the method of connecting the tweeter—it is simply placed in series with the existing speaker, using a single resistor

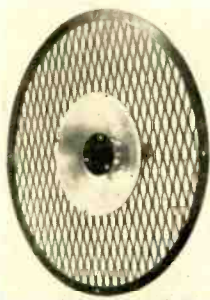

Mark Simpson Mfg. Co.

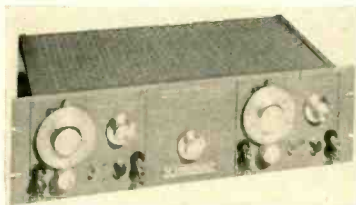

Spencer-Kennedy Laboratories, Inc.

to adjust for the impedance of the cone. Further information may be obtained from Mark Simpson Mfg. Co., Inc., 32-28 49th St., Long Island City 3, N. Y.

- **Electronic filters** are new in the audio field, but one new model has been introduced by Spencer-Kennedy Laboratories, Inc., 186 Massachusetts Ave., Cambridge 39, Mass. This filter employs a patented circuit, and has a continuously variable cutoff from 20 cps to 200 kc. Each of the two sections has a range switch which permits the selection of type of section to be used—that is, high-pass or low-pass—as well as four decade frequency ranges. Each section has an attenuation of 18 db per octave with a maximum of 70 db. When the two sections of the Model 302 filter are cascaded, the device becomes a variable band-pass

filter. Complete details will be furnished by the manufacturer.

- A **precision turntable** is now available for the first time as a complete unit with dual-type pickup assembled in a portable case. This unit, model P-43C transcription player, plays up to 16-in. records, and at all three speeds, and may be plugged into an amplifier, radio or central sound system, and comes in fabricoid covered carrying case. Prices and



Sola Electric Co.

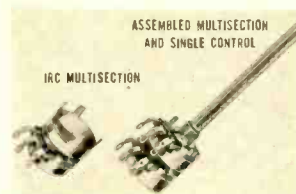

International Resistance Co.

specifications are available from Dept. AE, Rek-O-Kut Co., 38-01 Queens Blvd., Long Island City 1, N. Y.

- **Constant voltage transformers** have a number of unique applications where line voltage may be expected to vary greatly during the daily load cycle. A radio modification of the well-known Sola CV units, the new CVE models furnish both plate and filament current with a regulation of ± 3 per cent. Three stock models are now available which provide a range of sizes suitable for most electronic power problems.

The constant voltage feature is particularly desirable for users of electronic equipment who must, by necessity, obtain electric power over lines which are not sufficiently well regulated. This condition is common in rural districts where the gradual increase in power consumption has advanced beyond the capacity of the lines. Bulletin P-8, CVE-138 describes these three stock transformers, giving full technical and dimensional data, and may be obtained from Sola Electric Co., 4633 W. 16th St., Chicago 50, Ill.

- **Dual potentiometers**, often useful in experimental work, are seldom obtainable in jobber stock in the exact combinations of resistance values needed for a particular application. The new Mul-

tisection units, just announced by International Resistance Co., 401 N. Broad St., Philadelphia 8, Pa., may be attached to a standard single control in the same manner as are the usual a.c. switches, and permit the assembly of dual, triple, or even quadruple controls for specific uses. Catalog DC-4 describes these units, and may be obtained from the manufacturer.

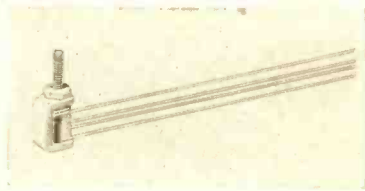

Bradley Laboratories, Inc.

• **Copper oxide rectifiers** have many instrument applications, and as the result of ten years of continuous improvement, a new model—CX14 series—is just announced by Bradley Laboratories, Inc., New Haven, Conn. The internal circuit arrangement consists of vacuum-processed plates with gold contacts, specially treated gold terminals, and copper alloy brackets. The design insures minimum aging and high efficiency, and the contact pressure remains constant under wide temperature variations. Complete specifications will be furnished by the manufacturer upon request.

NEW LITERATURE

• **Audio Development Company** has issued a new catalog showing their expanded line of transformers, including the Yeoman Series, and describing their special products which include amplifiers, plugs, patch cords, jacks, and jack strips. 2833 Thirteenth Avenue South, Minneapolis 7, Minn.

• **Laboratory instruments**, potentiometers, decade resistance boxes, gain sets, and other products in the audio line are shown in a new 40-page catalog, No. 11-A, available from Cinema Engineering Co., 1510 W. Verdugo Ave., Burbank, Calif. The catalog includes graphs and tables for computing attenuators and branching networks, as well as tables and diagrams for use with mixer circuits.

• **"Geofomers,"** a specialized line of units for geophysical work, are described fully in catalog GP-49, just published by Triad Transformer Mfg. Co., 2254 Sepulveda Blvd., Los Angeles 64, Calif. Also available are catalogs TR-49 on a complete line of audio transformers; and TO-49 on toroidal coils for wave filters.

• **Crossover networks** are discussed in a new 4-page pamphlet just released by Racon Electric Co., 52 E. 19th St., New York 3, N. Y. The information contained covers practical instructions and wiring diagrams for the construction of a 1000-cps crossover network, arranged for speaker impedances from 4 to 16 ohms.

PROBLEM:

*How To Meet Varying
Recording Channel Needs*

SOLUTION:

*Select from 14 Basic Units of
the FAIRCHILD
Unitized Audio System*

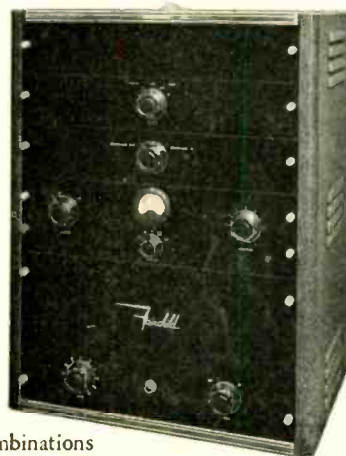

You can assemble numerous combinations of complete recording channels with the Fairchild Unitized Amplifier System, which includes 14 basic units.

Related units are simply plugged in, or cabled together. It's that easy . . . that quick. Units can be combined to meet the special requirements of a given installation. If requirements change later, the units can be rearranged and the system expanded with no loss of initial investment. With this versatile Fairchild System, you get custom construction at production prices.

Consult us
about your
specific needs.

Write for series of helpful articles, "Design of Recording Systems and Actual Installations." Ask for Series M.

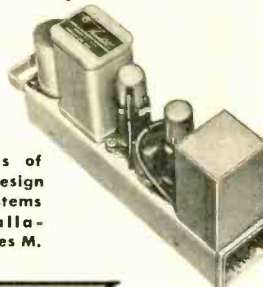

14 BASIC UNITS

- Power Amplifier
- Preamplifier
- Pickup Preamplifier-Equalizer
- Line Amplifier
- Output Switch Panel
- Input Switch Panel
- NAB Equalizer
- Variable Equalizer
- Diameter Equalizer
- Mixer Panel
- VU Meter Panel
- Bridging Device
- Auxiliary Power Supply
- Cuing Amplifier

 *Fairchild*

RECORDING EQUIPMENT CORPORATION

154TH ST. AND 7TH AVE.

WHITESTONE, L. I., N. Y.

Floating Action!

for all TV Cameras

"BALANCED" TV TRIPOD

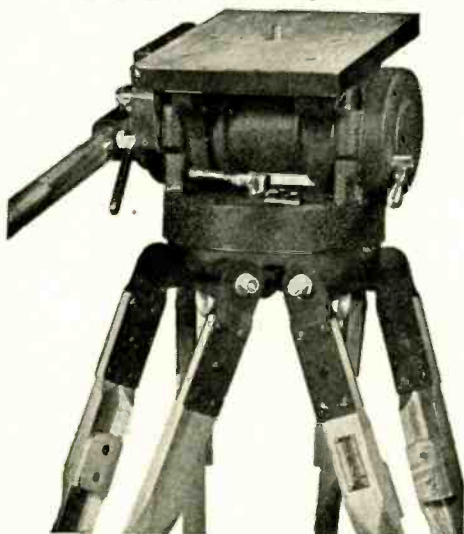

Pat. Pending

This tripod was engineered and designed expressly to meet all video camera requirements.

Previous concepts of gyro and friction type design have been discarded to achieve absolute balance, effortless operation, super-smooth tilt and pan action, dependability, ruggedness & efficiency.

Below:

3 wheel portable dolly with balanced TV Tripod mounted.

Complete 360° pan without ragged or jerky movement is accomplished with effortless control. It is impossible to get anything but perfectly smooth pan and tilt action with the "BALANCED" TV Tripod.

Quick-release pan handle adjustment locks into position desired by operator with no "play" between pan handle and tripod head. Tripod head mechanism is rustproof, completely enclosed, never requires adjustments, cleaning or lubrication. Built-in spirit level. Telescoping extension pan handle.

Write for further particulars

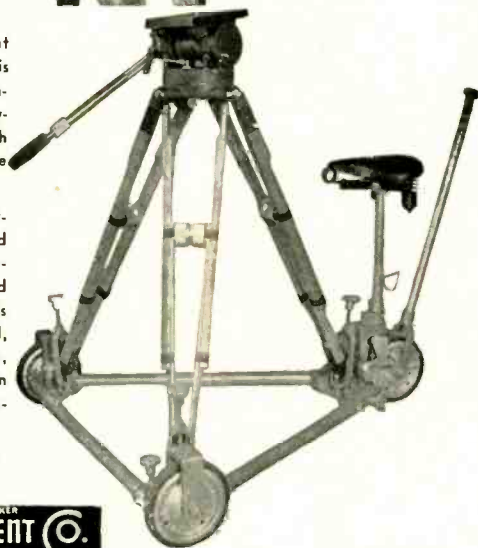

FRANK C. ZUCKER
CAMERA EQUIPMENT CO.
1600 BROADWAY NEW YORK CITY

NEED BACK ISSUES?

Only a few are available and
the supply is limited

<input type="checkbox"/> August 1948	<input type="checkbox"/> March 1949	1948 issues
<input type="checkbox"/> September 1948	<input type="checkbox"/> May 1949	50c
<input type="checkbox"/> November 1948	<input type="checkbox"/> June 1949	1949 issues
<input type="checkbox"/> December 1948	<input type="checkbox"/> August 1949	35c

Payment should accompany order.

Circulation Dept., Audio Engineering, 342 Madison Ave., New York 17, N. Y.

Book Review

Ultrasonics, by Benson Carlin, Hillyer Instrument Company, Inc., formerly with Sperry Products, 670 pages. New York: McGraw-Hill Book Co. Inc. \$5.00.

Mr. Carlin has written an interesting and practical book on a well-known but little documented subject. Earlier works on this topic have included lengthy derivations on specific phases of ultrasonics. From these, Mr. Carlin has taken the important information, and added to it a large amount of practical data, circuitry, mechanical drawings, and much information from his own experiences.

Among the information presented are the design criteria for ultrasonic crystals and crystal holders. Historical and patent references are given, in addition to the shapes and dimensions of crystals and holders used on existing ultrasonic equipment. Great stress is placed on application of ultrasonics to materials testing, underwater signaling, and sonar devices. Among the devices described are the Reflectoscope and underwater magnetostriction echo-ranging transmitter. He also includes the general theory of continuous wave testing, pulse testing, optical diffraction by ultrasonic signals in liquids, and ultrasonic agitation. Each topic, in addition to being thoroughly discussed, is accompanied by illustrations, block diagrams, and circuits enabling researchers in the field to make use of the valuable practical experience of others.

In addition to the text material there are a number of useful tables giving data such as velocity, density and specific acoustic impedance of common materials, and the wavelength in various materials at a number of ultrasonic frequencies. There are also tables giving the boundary reflection figures in per cent for the boundaries between two dissimilar materials, and the range of penetration of ultrasonic waves into various materials at different frequencies. All of these are useful in the design of equipment and checking the actual testing of specimens by ultrasonics.

This book should be of particular value to audio engineers who from time to time are called upon to work in the field of ultrasonics. It can be well recommended to the researcher, designer, or student. —L.S.G.

Giant Brains, or Machines that Think, by Edmund C. Berkeley, consultant on computing machinery. New York: John Wiley & Sons, Inc. \$4.00.

While this book is definitely outside the field of audio engineering, it offers some of the most fascinating reading encountered by this reviewer in months. Many articles have appeared in the literature about specific details of circuits used in the numerous types of electronic and electromechanical computing machines, but few have treated the entire subject in a way which would clarify the workings of these fantastic devices so that anyone completely unfamiliar with them could gain a basic understanding of how they function.

The average electronic engineer has a healthy curiosity about practically anything in his field, but in this age of specialization only a relatively small number have a broad understanding of electronic computers. The author describes a number of existing large-scale machines, not in great detail, but in a manner which will show how the actual computation is effected, and thus he eliminates much of the mystery which surrounds such equipment.

BANTAM MICROPHONE

[from page 14]

"M" position, and not less than 9 inches for the "V" position.

The use of high flux density and a screen so close to the ribbon, as required in a miniature design, increases the likelihood of magnetic dirt particles entering the gap between the ribbon and the pole piece. Such particles, if in contact with the ribbon, inhibit its motion and result in loss of low-frequency response. The collection of particles in a more remote part of the gap might cause the microphone to become noisy when it is subjected to any motion which results in relatively large low-frequency movements of the ribbon.

Fortunately, a simple and effective method—a magnetic screen—eliminates this possibility, and KB-2C microphones thus equipped are practically impervious to the entry of magnetic dirt particles. The magnetic screen is simply a small piece of wire mesh of magnetic material, slightly bowed, and placed over each side of the ribbon inside the outer screen. The ends are lightly plugged with cotton to prevent entry of dirt. The presence of the screen wire in the magnetic leakage field serves to concentrate the flux at the points where the wires are located. This produces magnetic poles which prevent the magnetic particles that penetrate the outer screen from being drawn into the air gap of the microphone. All KB-2C microphones now being manufactured are equipped with magnetic screens.

The design of the Bantam microphone is providing broadcasters with a miniature unit which offers both excellent performance and reliability. Because of its light weight and small size, the KB-2C is ideal for remote applications, as well as for banquets, night club shows, or other occasions where it is important that the artist's face be in full view. In addition, the KB-2C is fast becoming a favorite for standard use in TV, AM, and FM studios and control rooms.

AUDIO INPUT SYSTEM

[from page 11]

audio facilities for special purposes, particularly where several input devices are involved, may find this unit the answer to many of their problems. To date, several versions of the unit have been built, and all have operated extremely well. This, and the fact that no "trick" circuits are involved, makes

2 Reasons Why

MORE RADIO STATIONS USE

Magnecorders

THAN ANY OTHER PROFESSIONAL TAPE RECORDER

- 1 **BROAD BAND REPRODUCTION** — Users are really enthusiastic about the amazing tone quality and low distortion of Magnecordings. Magnecord frequency response extends from below 40 cps to 15 kc \pm 2 db with less than 2% rms harmonic distortion at all frequencies. Magne-recorded programs from remote pickups or studio lines meet the most critical broadcast standards.
- 2 **UNIT CONSTRUCTION** — Only Magnecord offers you the greater flexibility in use and greater economy of Unit Construction. Magnecord recorders, amplifiers, and other equipment are available as individual units. Buy only those you need. Combine or carry only those you need where you need them.

PT6-AH RECORDER is the heart of all Magnecord combinations. Weighs only 29 lbs. in carrying case, easily removable for rack mount. Quick-change capstans for recording at 7 1/2 or 15 in./sec. High speed rewind and high forward cueing speed, \$294.00



PT6-JA RECORDER AND AMPLIFIER is the only combination on the market today that offers such high professional quality at such a low price. Includes PT6-A Recorder plus amplifier with low impedance microphone and bridging inputs. 10-watt audio amplifier with monitor, speaker and jack for external speaker, zero level output terminal, only \$499.50

PT6-P PORTABLE AMPLIFIER is a highly versatile, light weight, self-contained unit including a record-playback-remote amplifier and power supply for use with PT6-A Recorder. Amplifier has 3 low level, independently mixed mike inputs plus bridging input for use with line level input. Power supply section has monitor amplifier and speaker.



PT6-R RACK-MOUNT AMPLIFIER is a high fidelity, single channel amplifier that quickly combines with the PT6-A Recorder in only 14 inches of rack space. Excellent with existing audio amplifiers.

See, Hear, Operate a Magnecord Today. Write for complete specifications and name of nearest dealer.

Magnecord, INC., CHICAGO 1, ILL.

360 NORTH MICHIGAN AVENUE

World's Largest and Oldest Manufacturers of Professional Magnetic Recorders.

you can
do it better

with the
revolutionary

ALTEC 21B MINIATURE MICROPHONE

It achieves uniformity of response... provides greater tonal fidelity... it is omnidirectional... it is blastproof, shockproof... there is no false bass build-up... more net acoustic gain before encountering feedback... tiny size contributes to remarkable versatility of positioning... extends the fidelity of sound transmission.

*talent deserves
to be Seen
as well as Heard*

ALTEC
LANSING CORPORATION

161 Sixth Avenue
New York 13, N. Y.

1161 North Vine St.
Hollywood 38, Cal.

ACTUAL
SIZE

it possible to recommend it to the serious audio enthusiast.

PARTS LIST

- C₁, C₄, C₆, C₁₀, C₁₄, C₁₈, C₂₀, C₂₁, C₂₂,
C₂₅—0.1 μf., 400-volt paper
C₂, C₅, C₉, C₁₃, C₁₇, C₁₉, C₂₄, C₂₇, C₃₀,
C₃₁—30 μf., 450-volt electrolytic
C₃, C₇—0.1 μf., 400-volt paper
C₈, C₂₅—20 μf., 20-volt electrolytic
C₁₁ 50 μf. mica
C₁₂ 500 μf. mica or paper
C₁₅ .002 μf., 200 volt paper
C₁₆ .02 μf., 200 volt paper
C₂₆ See text
C₂₈ 4 μf., 200 volt electrolytic
C₂₉ 200 μf., 200 volt electrolytic
R₁, R₆—3 meg
R₂, R₅, R₇, R₈—0.1 meg
R₃, R₃₃, R₃₄—25 meg
R₄—25,000 ohms
R₉, R₂₆—1-meg potentiometer
R₁₀, R₁₆, R₂₂, R₃₀—2000 ohms
R₁₁, R₁₇, R₂₃, R₂₈, R₂₉, R₃₂, R₄₀—
50,000 ohms
R₁₂, R₁₈, R₂₁, R₂₅, R₄₁—20,000 ohms
R₁₃, R₂₀—2-meg potentiometer
R₁₄—2 meg
R₂₄, R₃₁, R₃₅, R₃₆—0.5 meg
R₂₇, R₃₇—1000 ohms
R₃₀ 10,000 ohms
R₃₈ 1-meg potentiometer with switch (Sw₂)
R₄₂, R₄₃ See text
(All fixed resistors—1watt)
L₁ 8H, 175 ma
L₂, L₃ 8H, 100 ma
T₁ PP plates to PP grids, 1:1 ratio, with split secondary
T₂ 115-0-115 volts at 175 ma, 5 volts at 3 amperes
T₃ 350-0-350 volts at 75 ma, 5 volts at 3 amperes
V₁ 12SC7
V₂, V₃, V₄, V₅, V₆ 12SR7
V₇, V₈ 6SN7
V₉ 6J5
V₁₀ 6H6
V₁₁, V₁₂ 5V4G
(Note: 12J5GT's can be substituted if correct socket changes are made.)

Employment Register

- **WANTED:** E. E., electronics major, with an extensive bknd in magnetic and audio cct design and acoustical theory and practice. Must have at least 5 yrs. exp. in product design on products now being sold nationally. Must be capable of following product from experimental through production, and be responsible for specifications, quality control, field tests, operation and service manuals on product developed. Must be creative and have an exceptionally high degree of mechanical aptitude. State age, education and qualifications when answering. Location: Minnesota. Box 102.
- **Recording Engineer.** Experienced mixer; superior knowledge of classical music. Knows motion picture and radio mixing techniques. 30, married, presently employed. Graduate of Hollywood Sound Institute. Box 121.
- **Audio Engineer.** Graduate Hollywood Sound Institute, 25, married. Now attending television production school. Desire position with broadcast or recording studio, evenings, N.Y.C. Free to travel after January, 1950. Box 122.
- **Graduate** of Advanced Technology course at RCA Institutes, 26, married, with knowledge of music, desires position audio field. Salary secondary. Box 101.

a vital source of electronic
research from 1925
to the present
at your fingertips!

THE ELECTRONIC ENGINEERING MASTER INDEX

- complete bibliographical listings of subjects on electronics, optics, physics and allied fields.

Now available . . .

Combined 1947-1948 edition with cross referenced cumulative subject index of previously published 1925-1945 and 1946 Electronic Master Index editions.

Over 13,000 listings of articles published in 234 international scientific magazines, journals and proceedings. 399 different subject headings. All the finest engineering text books published are listed in a special reference section.

SPECIAL FEATURE

Listings of declassified documents available from U.S., Canadian and British Governments.

EXTRA FEATURE

Listings of 5,500 patent references giving number, title and claims of electronic patents granted in the U.S. during the years of 1947-1948.

THE ELECTRONIC ENGINEERING PATENT INDEX

All electronic and related patents, granted by the U.S. Patent Office since 1946 in three volumes. 1946 volume includes over 2,000 patents with circuit designs, components, manufacturing methods, etc. 1947-1948 combined issue covers 5,500 electronic patents. The 1949 issue covers approximately 3,000 electronic patents.

Books are heavy cloth
bound 7½ x 10½ inches
Write for complete particulars

Electronics Research
Publishing Co., Inc

JOHN F. RIDER, President

480 Canal St., Dept. AE-1, New York 13, N.Y.

POPS

[from page 27]

each other, filling the blacked out closet with smoke and high-ball fumes, starting an argument about the relative values of glass mouthpieces, and occasionally listening through the key holes for the documentarily real sounds of the jazz dive. To those of you who have forgotten the notorious Shady Jack's of speakeasy days, fond memories will shortly return. For those of you who don't care about atmosphere, beg, borrow, steal . . . try to listen to the discs listed below. Remember, you're not listening to the real thing, just a faint and very blurred memory of something that was in the past.

JAZZ Gems...Recording Tragedies:

Hotter than That O.K. 8535
(circa 1927)

Louis Armstrong, trumpet; Johnny Dodds, clarinet; Kid Ory, Trombone; Lil Armstrong (the great man's first wife) piano; Babe Dodds, drums; Johnny St. Cyr, banjo.

The above recording was made by as fine a group of jazz men to be found at any time. You'd never know it from the recording. The only tribute that can be paid to the recording wizards who turned this trick is that it takes skill to make a piano sound like a mixture of a Greek wedding and fifty congo drums on an hysterical jag. Other than this, the record is a classic.

Mahogany Hall Stomp O.K. 8535
(circa 1929)

J. C. Higgenbotham, trombone; Charlie Holmes, alto sax; Albert Nichols, alto sax; Eddie Condon, banjo; Lonnie Johnson, piano; Pop Foster, bass; Paul Barbarin, drums.

There are many recordings of the famous stomp, some by the same group listed above. This is our idea of the best, but not for technical reasons. Made during the year of the great slump, it has many aspects to recommend its classification in the same category. Surface is better than most, however, and unlike another disc below, the guitar is recognizable as such. Musically, a really great recording.

China Boy and The Eel Bluebird 10386
(circa 1940)

Bud Freeman, tenor sax; Max Kaminsky, trumpet; Brad Gowans, valve trombone; Dave Bowman, piano; Eddie Condon, guitar; Clyde Newcomb, bass; Danny Alvin, drums; Pee Wee Russell, clarinet.

The year this was recorded should indicate improvement, and it does. Surfaces are relatively good and range considerably broader. Still unsatisfactory in terms of available techniques, but with a marked improvement.

The recording itself is a gem, notably because of the combined efforts of Bud Freeman and Max Kaminsky, the kazotsky boy. The drive on both sides is tremendous despite omnipresent deadness still characteristic of the jazz recording.

Comin' On with the Come On (parts 1 and 2) Bluebird 10085 (circa 1938)

Tommy Ladnier and Sidney de Paris, trumpets; Mez Mezzrow, clarinet; James P. Johnson, piano; Teddy Bunny, guitar; Elmer James, bass; Zutty Singleton, drums.

This group, listed as Mez Mezzrow and Orchestra, is involved in one of the rare cases of a really excellent recording. Surfaces are fine and the echo is sufficient to



you get these **PLUS** values in
VITROHM RESISTORS

check each **PLUS**

PLUS...Ceramic Materials and Cores—of high density, low porosity and high dielectric, with correct thermal co-efficient of expansion—developed and produced by Ward Leonard!

PLUS...Exclusive WL Vitreous Enamel—tough, crazeless, moisture-proof, and acid-proof!

PLUS...Specially Drawn Resistance Wire—and Uniform High Precision Winding!

PLUS...Consistent Accuracy and Stability—even under extremes of temperature, humidity, corrosive atmospheres, shock, vibration, altitude!

PLUS...All Connections *Silver-Soldered*—with special silver solder developed in the WL laboratories!

PLUS...Terminals of special alloy, designed to provide the strongest anchorage!

PLUS...Careful adherence to resistance tolerance!

PLUS...Direct, Complete Control over physical, chemical and electrical qualities—to assure properly matched component characteristics and constant uniformity!

PLUS...Wide Range of Stock Types—as well as Vast Variety of Special Units!

PLUS...Proved Over Half a Century of Resistor Experience in all types of applications!

Electronic Distributor Division

WARD LEONARD ELECTRIC CO.

53-R West Jackson Blvd., Chicago 4, U.S.A.



SEND FOR STOCK-UNIT CATALOG D-130 Gives helpful data on Resistors and Rheostats available from stock... lists Radio Amateur Relays.

WARD LEONARD
RESISTORS • RHEOSTATS • RELAYS

WHERE BASIC DESIGNS ARE RESULT ENGINEERED FOR YOU

CLARKSTAN *NEW LOW PRICES*



ARM WITH SLIDE-IN CARTRIDGE HOLDER

Fits all types cartridges. No soldering required. Spring loaded plungers maintain positive contact. Weight adjustment quickly gives proper balance and needle force, meeting requirements for LP and standard records. Two sizes up to 12" and 17". See your jobber or write for bulletin 172-E.

Prices: 17" was \$22.50 **NOW \$19.90 net**
12" was \$22.50 **NOW \$18.90 net**



CLARKSTAN EQUALIZER

A low cost equalizer designed for use with all makes of high impedance variable reluctance cartridges. This equalizer includes the four most useful curves for broadcasters and owners of fine high quality equipment. Offers playback equalization for all modern records, including LP microgroove. Has four position selector switch for standard and N.A.B. curves. Mounts on panel with 1/2" hole. See jobber or write for bulletin 165-E.

Now **\$12.80 net**

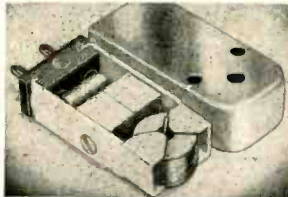

CLARKSTAN CARTRIDGE WITH DIAMOND STYLUS

This wide range variable reluctance pickup meets requirements of discerning users. Now available with removable and interchangeable diamond stylus in various tip radii, .0010", .0020", .0025", .0030" for all type records. Now at new low price. See your jobber or write for bulletin 141-E.

Prices: #201 Cartridge with one diamond stylus (any above radius) **\$30.60 net**
#201 Cartridge with sapphire stylus **\$15.00 net**

Will Your Amplifier --- Stand a 200% change in load --- and still deliver 85% of its undistorted power?

NOTE:
WHEN THE NORMAL LOAD OF 10 OHMS IS REMOVED THE OUTPUT VOLTAGE WILL ONLY RISE 1/2 DB.
ASK FOR BULLETIN 17.

AMPLIFIER PERFORMANCE AT 30 CYCLES audio pacific models 2 and 3

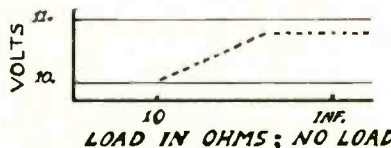
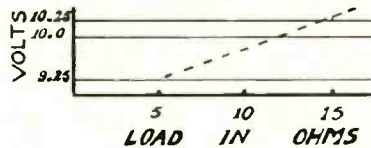
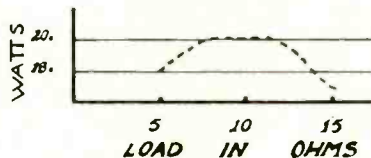

audio pacific co

30 w. colorado st.

pasadena 1, calif.

brighten up what might be under older conditions another case of slow death. Despite the lateness of the date, this is a collector's item in the unavailable class. Belonging in any well-rounded collection, it may cost you a fabulous pile of green stuff if you should ever run across it.

Everybody Loves My Baby O.K. 8787
(circa 1925-1926)

Clarence Williams, piano; Louis Armstrong, trumpet; Sidney Bechet, soprano sax; Buddy Christian, banjo or guitar. Known as the Clarence Williams Blue Five, the group has recorded a number of salivary specials. This is choice (why, I don't know. The reason the alternate listing for Buddy Christian above is that tender ears can't tell whether he's playing a string bass across his lap, or one of the early 12th century lutes.) A tragedy of the first water, since there is sufficient evidence to demonstrate the potential greatness of this recording if it had been made on anything other than cardboard. Bechet and Armstrong outdo themselves (we guess).

Royal Garden Blues O.K. 8544
(circa 1926-1927)

Bix Beiderbecke, cornet; Bill Rank, trombone; Don Murray, clarinet; Adrian Rollini, bass sax; Frank Signorelli, piano; Howdy Quicksell, banjo; Clarence Moorehouse, drums.

We don't happen to be a Beiderbecke zealot, but this recording of an old standby is one of the best . . . musically. Technically, it is one of the worst jazz recordings we know. We name the instruments only by virtue of inside information. Who can tell what who's playing simply by listening? An interesting case of how recording engineers can make a drum soggy without the use of water, or any other infernal liquid. Simply a wave of the magic pickup . . . and soggy it is.

Rosetta and The World Is Waiting for the Sunrise (Bluebird 10176) (circa 1939)
Frankie Newton, trumpet; Mezz Mezzow, clarinet; Pete Brown, alto; James P. Johnson, piano; Albert Casey, guitar; John Kirby, bass; Cozy Cole, drums.

A charming disc which will all but drive the jazz fanatics stark, driving mad. Beautiful work on all instruments, tremendous drive . . . all we can say about it technically is . . . not bad!

Need we continue? As contrast we could pick a more recent recording released by one of the major companies. The "Jazz Concert at Eddie Condon's" album (Decca A-490) would be a good case in point. The "Way You Look Tonight" side has Max Kaminsky on trumpet; Joe Dixon on clarinet; Fred Ohms on trombone; Condon on guitar; Gene Schroeder on piano; Jack Lesberg on bass; and the late Dave Tough on drums. A cute, interesting, driving record with no particular greatness or distinction. Technically it is a few million percent better than anything listed above. But any comparison would be merely relative. In this great day of the mystic Hi Fi, the recording is nothing to get excited about. It could have been if available facilities had been utilized. But nobody thinks it's worth the effort. Do you?

New Releases

Latin Rhythms: Stanley Black and his Concert Orchestra London L.P. LPB-60
Rhythm on Reeds: Phil Green and Group London L.P. LPS-17

The above two LP discs are hard to classify. I am tempted to put them in the "Pot Luck" category, but they're technically too good to be so easily disposed of. The Latin Rhythms is a good case in point of the benefits derived by the lower parts of the anatomy through the availability of the ffr

technique. Even the power supply wiggles when this baby goes on. Especially commendable are the bands marked Adios and Rustic Samba. Well-played, live performances, interesting percussion effects, this unfortunately will not make a good test record. It sounds fine when played with fingernail.

Rhythm on Reeds has an interesting history. During the last war, the B.B.C. scheduled an early morning show featuring England's three great woodwind men: Reginald Kell, clarinetist, Arthur Gleghorn, flute, and Leon Goosens, oboe. Playing clever arrangements of popular and semi-popular tunes, they established a tradition. Under the aegis of the guy who dreamt the whole thing up, London has released an LP disc of the arrangements played by unknown personnel. Recording quality excellent. Pure woodwind sounds are especially hard to reproduce. When reproduction is good, a poor instrumentalist sticks out like a sore thumb. The wind men here are only so so, although the arrangements don't demand high virtuosity. Recommended use of the discs? Good background music for breakfast, lunch, dinner, idle chatter. Two bands are especially good for fond farewells and tragic proposals.

RECORD REVUE

[from page 26]

one quite successful example of such an inquiry.

Suppose—thinking on paper—we postulate a Liveness Factor, in numerical terms, combining the numerous ingredients that go into the ear's determination of liveness. This sort of thing has already been conceived, and the groundwork is well prepared. In Federal Telephone's "Reference Data for Radio Engineers" (3rd ed.) I've been shown a nice collection of graphs indicating optimum reverberation time in seconds, at various frequencies, and for various sizes of room. Though it is quite obvious that an "optimum value for 512-cps frequency" is utterly meaningless for music, since a pure tone of 512-cps could scarcely be considered as music, nevertheless there is much to build on here. But I note at once that there is no indication whatsoever in this discussion as to whether the "optimum" factors given refer to monaural hearing—i.e. mike pickup—or binaural hearing. Evidently the difference was not even considered. Every radio technician knows that either he or someone else will have to figure that one out before any such information is of the slightest use to him. A Liveness Factor, whatever else it is, must be specifically explained as for monaural hearing or binaural hearing. Which?

But perhaps that gives us the clue to a more comprehensive approach. Take the usual radio and recording problem. What is the practical approach? In general terms, one attempts in the monaural system to approximate a natural sound as referred to the binaural situation—often called "the original." That is what we intend by "natural" reproduction, or so we say.

Suppose, then, we arrive at a scale of liveness which shall give approximate equivalents in monaural and binaural situations. A factor of 3, in the monaural set-up, would sound more or less like a factor of 3 in the binaural one. If it held reasonably true, such a working relationship put into a formula could be enormously useful.

The question is, how to determine the relationship between corresponding unities,

HOW TO PATENT YOUR IDEAS REGISTER YOUR TRADE-MARKS AND COPYRIGHTS

Get Complete Protection Within 48 Hours!
NO PATENT LAWYERS EXPENSIVE FEES TO PAY!
RECORD OF INVENTION NO LONGER NECESSARY!
SAVES MONTHS, EVEN YEARS OF TIME!

● **Eliminate Red Tape!** ●

"HOW TO PATENT YOUR IDEAS"

"HOW TO REGISTER YOUR TRADE-MARKS & COPYRIGHTS"

The only books of their kind ever published—tell you in simple, direct, understandable language how you can *safely* and *quickly* patent your ideas and register your trade-marks and copyrights with the United States Patent Office, Washington, D. C., in all States and foreign countries the world over.

NO PATENT LAWYER REQUIRED

WHY lose valuable time through unnecessary delays? WHY go to the expense and trouble of retaining a patent lawyer when you can get complete protection for your ideas, trade-marks and copyrights inside of 48 hours? *And all it will cost you to get this protection of your application is a United States Patent Office registration filing fee of \$30 for a patent; \$25 for a trade-mark; and \$2 for a copyright. That's all you pay. No charge for amendments.* "How to Patent Your Ideas," "Register Your Trade-Marks & Copyrights" describe the entire process in complete detail—information that is not available in any other book! Actual specimens of the application and amendments, etc., from start to finish, are shown.

"How to Patent Your Ideas," and "How to Register Your Trade-Marks & Copyrights", written by a recognized patent, trade-mark and copyright authority, are highly recommended by nationally known inventors, firms and business men who have followed these books' thorough, easy-to-understand system of filing and registering patents, trade-marks and copyrights.

ONLY \$5.00 FOR EACH BOOK

"How to Patent Your Ideas" and "How to Register Your Trade-Marks & Copyrights" are published by

**American Patent & Trade-Mark Bureau
OF WASHINGTON, D. C.**

New York Office — 62 WILLIAM ST., New York 5, N. Y.

Mail cash or money order to American Patent & Trade-Mark Bureau of Washington, D.C., New York Office, Dept. AE, 62 William St., New York 5, N. Y.

Send me (check box opposite book you want)

- "How to Patent Your Ideas"\$5.00
 "How to Register Your Trade-Marks and Copyrights"\$5.00

Please print your name, address, city, zone and state.

NAME

ADDRESS

CITY ZONE STATE

NOW

High Quality Reproduction at LOW COST



\$84.50

Net F. O. B. Union City

A new 10 watt 6V6 push-pull amplifier with 16 db of feedback that has the famous SOMERSET DYNAMIC NOISE SUPPRESSOR built in, with a separate power supply.

Substantially all scratch noises are eliminated by feeding the high frequency components into the first stage out of phase with the input signal so that they cancel themselves out to an extent depending upon the volume of the middle and high frequency notes. This action is dynamic—continuous—automatic—avoiding sharp cut-off and giving natural "scratch-proofed" reproduction without loss of tone color.

Four Inputs—three inputs for various pickups and one for radio

Wide Response. Low Distortion.

Controls—Volume, Treble, Bass, Input Selector and Suppression

Amplifier Chassis 7 x 9 x 2

Power Supply 7 x 7 x 2

Combined Weight 16 lbs.

Frequency Response 1 db 50 to 15,000 cycles Baked Dimenso finish in Brown or Silver Blue

Somerset

LABORATORIES, INC.
1701 PALISADE AVENUE, UNION CITY, N. J.

Sound Values at Terminal Radio

TERMINAL'S OWN BRAND RECORDING WIRE

First quality, stainless steel wire for use with all standard wire recorders. On regular die-cast metal spools, attractively packaged. Specify plastic or nylon thread leaders when ordering.

1 Hour Spools, each.....	\$2.58
lots of 10, each.....	2.35
3/4 Hour Spools, each.....	2.00
lots of 10, each.....	1.82
1/2 Hour, Spools, each.....	1.67
lots of 10, each.....	1.52
1/4 Hour Spools, each.....	1.12
lots of 10, each.....	.92

TERMINAL'S OWN BRAND RECORDING TAPE

Best quality paper base 1200 ft. spools on standard metal reels for all tape recorders. Records 1/2 hour in one direction at 7 1/2" per second, full hour with dual-track recorders. Specify inside or outside magnetic coating when ordering (or tell us your model recorder). Price per reel..... \$2.40
Empty metal reels, 1200 ft. capacity, each..... .39

Visit our Sound Department, the best in New York! All items are on demonstration—you can see, hear and compare before you buy!

TERMINAL RADIO CORP.

85 CORTLANDT STREET

NEW YORK 7, N.Y.

Phone: WORTH 4-3311

THREE-SPEED RECORD CHANGERS

with Cartridges for LP and Standard Records

Webster-Chicago 356-27 GE, G.E. cartridges, sapphire styli..... \$38.95

Webster-Chicago 356-27 PS, Pickering cartridges, sapphire styli..... 52.21

Webster-Chicago 356-27 PD, Pickering cartridges, diamond styli..... 88.21

V-M 406 GE, inter-mix changer, G.E. cartridges, sapphire styli..... 37.14

FEATURE ITEMS FOR AUDIO SPECIALISTS

Racon CHU-2 Tweeter Speaker \$22.03

Racon CON-20 Inductive Crossover

Network 13.13

RCA-Olsen 15-inch loudspeaker .. 32.34

MB Loudness Control (replaces volume control)..... 9.95

Approved 4-tube AM Superhet Tuner, new AC model..... 19.50

V-M #100 3-Speed manual record player 22.72

how to set up scales which would have a useful equivalency? A series of values for one, x_m , must be formulated in terms of the other, x_b ("x" since obviously these values are now undetermined.) In spite of complexities to be mentioned shortly, I should think it would not be too difficult to work out a practical relationship. What the mathematical relationship will be, I do not know. Whether the liveness scales will turn out to be logarithmic or arithmetic, I could not say. Might be that one would work out arithmetically, the other logarithmically: for it is quite clear that the mind is far more sensitive to monaural liveness changes than to binaural—by a huge factor. That is the biggest headache in monaural audio. We would have to deal here with a matter of liveness tolerance, and that tolerance is enormously wider in the two-eared situation than in the one-eared.

Optimum Reverberation Time

Whether monaural or binaural, a liveness factor, in terms of "dead," "fairly live," "very live," would be a one-directional scale which actually would be, of necessity, a simplification of a number of complex sub-factors. Here again, the way has been pointed out. The major factor in any liveness situation is the reverberation time of the room involved—the decay period. How quickly is the reflected sound damped out when the sound source suddenly ceases? That is a reasonably good indication of liveness as the ear hears it. (But remember, we will be working with two utterly different sorts of liveness, not just one.) It has also been shown clearly enough—and here is an arithmetical factor to include in calculations—that the "optimum" reverberation time (Note—this is a psychological factor, a measurement of sensation) increases with the size of the space involved. A large hall sounds just right with a greater reverberation time or decay period than a small one. The relationship is fairly simple and can be included in our hypothetical liveness factors without much trouble—but does the same relationship hold true for both the binaural and monaural situations? Or must we determine a quite different set of values for changing hall size for each? I suggest that this point would have to be thoroughly clarified before we could safely go on to something else. There's a year's work for somebody.

The optimum reverberation time (translate: "optimum liveness") also varies in the same room for different tonal frequencies. Obviously, in this case we must accept an over-all average that shall apply to all music. If this is too much of a generalization, we can take a specific range of values for our factor, covering, say, high, thin music at one end; low, bass music at the other; with "average" music in the middle. (Let us put aside the question of speech for the moment. Speech requirements are, as is well known, very different from those of music.)

Related to this last is a factor included in a graph quoted from "Architectural Forum." This graph gives optimum reverberation time in various hall sizes for a number of classes of sound—chamber music, speech only, drama, symphony and opera, and so on. Though my impression is that these categories are a bit oversimplified for use in recording and broadcasting of music, the idea is solid. Involved here is not only the average frequency of the sound—chamber music having more higher tones, less bass than, say, an organ—but also the peculiar quality of "rightness" for various kinds of music. It is obviously impossible to get at the bottom of this—for Mozart should have different acoustics than Brahms, Stravinsky a quite different third, and so on. But don't

be discouraged! All that is needed in such cases, as in the last paragraph, is a limited included range covered by the factor, rather than a point. That range could be achieved, no doubt, as part of the final over-all liveness factor, rather than at this special juncture. In other words, variations due to type of sound (type of music) and/or due to differing frequency balance can be accommodated by giving our Liveness Factors limited flexibility. A very similar situation has been nicely met in the readings given on photographic light meters such as the Weston, which has a central arrow with supplementary points on each side for reading the final result. That kind of flexibility should suffice to cover variables such as the above. Reminder: we are still talking of two separate and distinct liveness measurements for every given situation: all of the above factors must be worked out independently for monaural and binaural situations and the relationship between the two sets of figures then determined before we can come out with a useful result.

So far so good, but numerous objections will be forming at this point. Nobody said this was a simple matter. I'm only claiming that out of a welter of factors a reasonably useful scale can be evolved—simplified, generalized, but still workable.

Color and Flavor

I've assumed so far that liveness (in either situation) is more or less a function of reverberation time, taking into account the differences in room size and so on already described. But most musicians will object that the quality of liveness is far more subtle than any such linear scale would indicate. Even if we dismiss the problem of standing waves (they are at best an unwanted distortion that we try to avoid), there are subtleties of nuance in the acoustics which no doubt go far beyond what we've so far discussed. A musician might say that the sound of various halls differs in "color," or in "flavor." A given hall is so much itself that it almost has a personality in terms of acoustics. Surely this is more subtle than the mere rate of decay of sound! What of the reflection pattern, usually of enormous complexity? (What of those stone buildings in which the reverberation is actually flat in pitch — the frequency drops as it is reflected? Quite common.) What of the frequency discrimination — wood, plaster, glass, a thousand materials? And what of a thousand subtle sound traps that delay, change, distort, to give individuality and character to a hall's sound—good or bad? What of the differing sound in different parts of the hall, the dead spots, the directional beams of tone, the focussed reflections?

What, most important of all, of the enormous difference in room sound, in each such situation, as heard on the spot, binaurally or via the mike, monaurally? A very large percentage of heard sound in a reverberant hall arrives via reflection, not direct from the source. Reflected sound makes the essence of difference between monaural and binaural liveness.

Monaural and Monocular

I can only say that though all of this and more be the truth, still, we can do some gross simplifying and yet come out with useful results in our final arbitrary figure. A Liveness Factor would not pretend to indicate the "color" and "flavor" of sound in a hall. It would make no pretence of taking into account all the subtleties of music history and the vagaries of musical performance! But it would be useful in the same generalized way that the Maxfield formula for mike placement is useful in a variety of acoustic situations. I think (since space is

SOUND BUYS FROM BECK'S

San Francisco's Audio Specialists

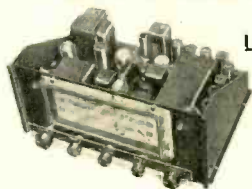

Left: AM-FM TUNER. Sargent-Raymont. Bandpass trf input and one stage of i-f at 455 kc, terminated in tuned infinite-impedance detector, for standard broadcast. Tuned r-f stage, stable drift-free triode oscillator, two stages of permeability-tuned i-f at 10.7 mc, and fully-balanced static-free ratio de-

detector for superior f-m performance. Input jacks for phono pickups—crystal or variable reluctance—and for tv. Smooth electro-acoustical control of bass and treble emphasis permits presetting amplifier controls . . . \$124.50 net

Right: 15-WATT 6L6 AMPLIFIER, Sargent-Raymont. Flat from 20 to 20,000 cps ± 2 db with 1.5 per cent distortion at rated output. Reflected load impedance of 3 ohms on 16-ohm tap . . . \$49.50 net

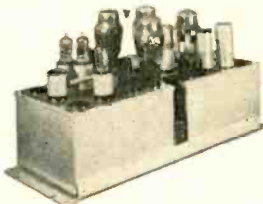

Left: SUPER-FIDELITY AMPLIFIERS, McIntosh. 40 to 100 db gain; universal input and output; plug-in components. 15-watt unit flat from 20 to 75,000 cps; harmonic distortion less than 0.5 per cent; efficiency 50 per cent; two 6V6's in take-turn circuit . . . \$199.50 net

50-watt unit flat from 20 to 40,000 cps; harmonic distortion less than 0.5 per cent, efficiency 60 per cent; two 6L6's in take-turn circuit . . . \$299.50 net

25% cash with COD orders—2% discount for cash with order

YOUR AUDIO NEEDS are filled at Beck's with complete lines of sound equipment either by nationwide mail-order; from the Beck Soundmobile traveling the Pacific Coast; or direct from San Francisco Headquarters for sound. Beck's, at 90 Ninth St., has a well-equipped listening and demonstration studio.

BECK'S CARRIES THESE AND MANY OTHER LINES:

Magnecord	Newcomb	Meissner
V-M Corp.	Altec-Lansing	Browning
Webster Ekkotape	Stephens	Rek-o-cut
Webster-Chicago	Jim Lansing	Pickering
Brook	University	Lear
Thordarson	Racon	Electro-voice
Bell	Peerless	Cannon

R. M. BECK Co.

Everything in Sound

90 Ninth Street • San Francisco 3, California
 Market 1-3330 Underhill 1-2025

RACON TWEETER

Here's how you can bring the concert hall right into your own living room! Simply add this Racon tweeter to your present 12 or 15" cone speaker and enjoy to the full the luxurious, life-like brilliance of FM and wide range recordings.

Response is clean and uniform to 12,000 cycles, with excellent usable output to 15,000 cycles. High frequency horn logarithmically expanded as two horns for wide, uniform distribution pattern. When used with crossover network, will handle amplifiers rated to 25-30 watts. Input impedance 4-15 ohms. Dimensions 10 $\frac{1}{4}$ " wide, 7" high, 8 $\frac{1}{4}$ " deep.

Cast aluminum throughout. Cutout template provided for easy flush mounting. Free wiring diagram and instructions to build an economical professional type 1,000-cycle crossover network.

Listen to the Racon tweeter at your nearest distributor or write for free Catalog A

Highest Music Quality
At Low Cost!



MODEL
CHU-2
\$37.50
List Price

Clean
Output to
15,000 Cycles!
Wide Distribution Pattern!

ACOUSTICAL  EXCELLENCE

Racon Electric Co. Inc.
52 East 19th Street, New York 3, N. Y.

ALL RACON PRODUCTS ARE GUARANTEED FOR 18 MONTHS

BROADCASTERS!

Announcing REK-O-KUT'S T 43-H 12" Turntable
for 33 $\frac{1}{3}$ and 45 rpm



PRICE - \$109.50

The only 12" turntable that is equipped with a hysteresis synchronous motor. Performance actually exceeds the NAB network standards for speed regulation. Designed specifically for the playing back of your new 45 and 33-1/3 rpm records.

Optional T-104 78 rpm idler. Interchangeable with 45.....\$5.00

SPECIFICATIONS

Starting: 0 to 33 $\frac{1}{3}$ rpm — $\frac{1}{4}$ revolution
0 to 45 rpm — $\frac{1}{4}$ revolution
0 to 78 rpm — $\frac{1}{2}$ revolution

Noise Level: —50 DB minimum.

Construction: Cast aluminum chassis and table. Built-in starting switch. Heavy duty neoprene idlers.

Mail Coupon for Complete Details
REK-O-KUT CO., Inc., Box A-1
38-01 Queens Blvd., Long Island City 1, N. Y.
Please send full information about the new T 43-H:

NAME
ADDRESS
CITY STATE

Save up to 30% on Long Playing Records — All Labels

(Liberal trade-in allowance on 78 R.P.M. pressings.)

- Lowest Prices Anywhere on All Domestic and Foreign Recordings
- Discounts ranging up to 50% off list on all 78 RPM Records.
- Specialists in High Fidelity Recordings, Telefunken, HMV, English Columbia, London FFRR, etc.
- Enormous Collection of Out-of-Print and Collectors Items
- Classical Collections Bought.

Send for Monthly Bulletin, containing latest recording news and monthly specials. Records shipped anywhere in the world.

MUSIC MASTERS 7 West 46th St., New York City 19, N. Y. Circle 5-5170

running out) that the analogy with vision is good to illuminate this simplification.

The photograph is no reproduction, but a grossly simplified mon-ocular approximation of the original in black and white. Even so, a photograph can be natural, and it can be related to the original bin-ocular scene in color without much trouble. We can go much further. A line drawing is far more artificial. It is a strikingly unrealistic representation of actual sighted space. Indeed, our understanding of, say, a newspaper cartoon, is so far removed from the actual physical sight being represented as to be almost entirely intellectual. The line drawing simply is not a "reproduction" at all. But it does the job.

Monaural sound reproduction may be thought of in these terms. It is never literal, never a "reproduction." It is, definitely, an artificial, *ersatz* illusion. It gives an illusion of naturalness which is as artificial as the line drawing. Maxfield takes this fact directly in hand with his formula. It seems that the most "natural" monaural reproduction can be had when we mix together sound picked up, say three feet from the source and simultaneously sixty feet away—a trick no human ear will ever manage as long as the Lord makes us in one single piece! Paradox—the illusion of monaural naturalness is actually worlds away from true natural hearing, the binaural, and indeed is quite unrelated to it. *Except* that the sensation of naturalness is there in both and can be heard and accepted by all.

Let us not, therefore, worry too much about complexities in the producing of a natural sound. Let's take the end result and learn to approximate that result with a fairly simple combination of vital ingredients, whatever they may be, according to circumstances. If monaural optimum naturalness is going to be related to Maxfield's principle (which is almost universally used with multimike techniques now), then include it. If a single-mike monaural technique also produces under right conditions an optimum result, then we may have to relate two kinds of monaural liveness—the optimum for single-mike use and the optimum with multimike set-ups. Studio designers will surely know more of this than I do. Even so, our purpose will be achieved if we end up with a monaural Liveness Factor which in each of these situations will give roughly a similar sense of liveness "degree," with flexibility towards greater or lesser liveness to cope with musical differences, as above.

Let us consider later the specific situations that would be involved in determining a binaural Liveness Factor which would ures. I think it's clear at this point that the ingredients are likely to be utterly and completely different. And that therefore the whole science of binaural mike pickup—when and if—may turn out to be utterly unlike our present monaural "illusion" techniques.

C. Dopfer, Gothic Chaconne;

Amsterdam Concertgehouw, Mengelberg.

Hans Pfitzner, Three Preludes, from

"Palestrina."

German Philharmonic of Prague, Keilberth

Capitol LP: P-8037 (12")

Bach, A German Organ Mass (Klavierbung,

Part 3).

Fritz Heitmann, organist, Charlottenburg

Palace Organ, Berlin. (1706)

Capitol LP: P-8029 (12")

• A strange mixture of names, these, but they are united in one vital way—excellence of reproduction on records. These are two outstanding discs from the large batch of Capitol 33 $\frac{1}{3}$ recordings now available, and I find them pretty stunning. We must assume

that the recording is not brand new (remember "German" Prague, 1938?) but, even so, this is good stuff. Not only the wide tonal range, but the superbly right mike placement, the resulting sense of depth, presence, perspective. We over here have learned, in part via the Maxfield formula, that there is in effect an almost resonant-like "right" mike set-up that somehow matches a given recording situation; we know that when this right combination is hit, we get what seems a decided increase in apparent loudness and fullness for a given electrical level, as well as enhanced realism. In Europe such things have been known or felt for a long time, and these are merely continuing examples of that "hunch" put into practice.

You may gently overlook Pfitzner as of not too great interest musically or tonally. The Doppler Chaconne, on the other hand, has some sensational hi-fi sound in it. Musically, the fairly rigid frame of the variation-like Chaconne form (with a repeated short series of harmonies) adds tension that would doubtless otherwise be lost in the shuffle. Doppler was a neo-Romantic, a sort of Dutch Respighi, composing in the midst of the "modern" period. He wrote this Nineteenth century style music in 1920—some years after Stravinsky's "Sacre de Printemps," not to mention plenty of even more "modern" works.

The Bach record is part of a tremendous collection of keyboard works that Bach published in three parts over a number of years. In this slice of it are a balanced series of preludes, fugues and chorale preludes (i.e. pieces based on then well-known hymn tunes), some of them among the most famous of all of the Bach works for organ. This astonishing recording is of an authentic, original "Baroque" organ, rather than a modern reconstruction set up in some closet-like studio. The sound is incomparably grand, and again—the mikes hit the exact spot of aural "resonance," between too-dead and too-live. Here are the rich, nasal, ultra-clear color contrasts of Bach's own time, and if you think you don't like Bach on the organ because it sounds like one grand blur—it does on most modern organs—just try this. The perspective effects between different stops, actually located in different parts of this chapel, are amazing, as is the naturalness of the breathy, almost hoarse tone of some of the pipes. Surfaces not too good. (May be noise in originals or vinylite pressings used for copying.)

Ravel, Mother Goose Suite. (Ma Mere L'Oye).

Andre Kostelanetz and His Orchestra.

Columbia 78: MX 320 (2)

• There is an English Decca version of this which will probably please the hi-fi enthusiasts more, but if you wish to stick to the cheaper domestic product, this new Mother Goose competes mainly with the recent Boston Symphony version. Neither matches, to my mind, an old Columbia recording by Howard Barlow and the Columbia Broadcasting Symphony, one of the best in that ancient series. Kostelanetz benefits from a superb orchestra, smooth strings; but the interpretation, while accurate and in no way grossly at fault, is less cogent, less aware of the music's possibilities than either the BSO version or the Barlow. Don't get me wrong—Kostelanetz may not be a great conductor, but his orchestral forces are tops, and they could play this piece well with no conductor whatsoever. One should not sneer too quickly at today's semi-popular orchestras, for nine times out of ten their personnel is comparable to the best of the major symphony orchestras in pure technical ability. (Plenty often these radio and commercial orchestras are made up largely of "symphony men," picking up a decidedly legitimate living where the fat lies.)

Mozart, Symphony #40 in G minor.

London Philharmonic, Kleiber.

London LP: LPS 89 (10")

• Here's more of the same: this familiar work also tends after too many performances to take on a certain nervous, over-tense, even harsh quality, and I've often heard it thus. It is supposed to be tragic, serious music; a tired conductor and tired orchestra, hereabouts at least, can give to it a sort of irritable tangover feeling. This version is, again, one with a difference, though not especially better than average. It treats the music quite casually for a change, lightly and with great smoothness, as contrasted with the bumpy quality we often hear in it. The finely wrought details of a Beecham job and the intensity of a Toscanini are both absent. But the music is fresh and pleasing none the less. The last movement is the best; I'd call it outstanding, notably for the impeccable phrasing of fast scale passages which, in far too many performances

are lost in the shuffle or forced into unnatural and inaccurate accentings and slurrings. Technically this is another top-quality LP. Inevitably, the early lemons which London perpetrated are now being replaced with first-line material. (No doubt, incidentally, the early and faulty masters have been re-made, too; you'd better make a re-check on some of them when a chance comes along.)

Mozart, Sleigh Ride. Tchaikowsky, Dance of Sugar Plum Fairy.
Leopold Stokowski and His Symphony Orchestra.

RCA Victor 45: 49-0553 (1)

• Whoops! Mozart too, and with sleigh bells. This is one of the numerous little German Dances, chains of simple minuets, with the bells as a special attraction. These are really something—they play tunes in harmony! Obverse is the familiar Nutcracker music, also with bells, of a sort. Nicely recorded.

Enjoy High-fidelity
RADIO RECEPTION WITH THE
Browning FM or AM Tuner

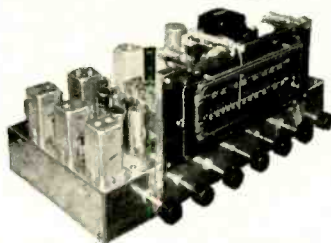

This is the new Model RJ-20 FM-AM Tuner . . . designed for high-fidelity reception on both FM and AM, and built to meet your highest performance requirements. Its features include:

- Armstrong FM circuit for maximum noise reduction and full frequency response to 15,000 cycles.
- Separate RF and IF systems for FM and AM . . . no coil switching.
- Variable bandwidth IF gives AM bandwidths from 9 kc. to 4 kc.
- Two-stage audio system allows 20 db. boost in bass or treble range.
- New 6AL7 tuning eye for precise tuning on strong or weak FM stations.
- Self-contained power supply.

See, hear, and handle this new Browning Tuner . . . and enjoy new satisfaction in your radio and music reproduction.

Write today for
Data Sheet A-912

HERE'S PERFORMANCE
to satisfy the man who knows
radio . . . provable by both
instrument and listening tests.

CHECK THESE CURVES
and you'll see why Browning
Tuners are chosen by those
who insist upon the best.

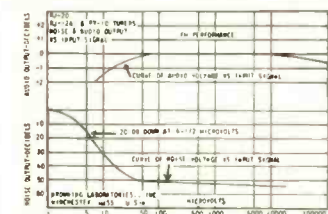
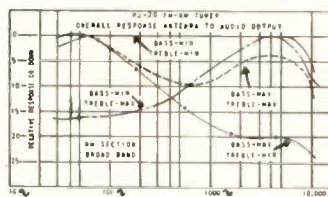
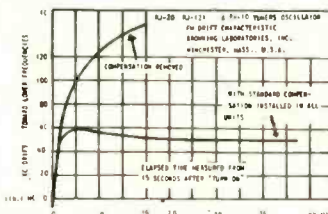

To feed a separate high-fidelity audio system, use the Browning RJ-12A for FM/AM or the Browning RV-10 for straight FM. They're all "tops" in the high-fidelity field.



BROWNING
LABORATORIES, INC.
WINCHESTER, MASS.

ENGINEERED FOR ENGINEERS

PROCTOR SOUNDEX

"FLOATING DISC DRIVE"

ANY RECORD - SPEED CARTRIDGE - PRESSURE INSTANTLY



Floating Disc Drive Multi-Speed Turntable

New SounDEX Pickup Arm

- Uses interchangeable Cartridge Carriers
 - Permits instant substitution of cartridges
 - Adapts any regular standard or micro-groove
 - Self-contained stylus pressure Scale
 - Precise adjustment of pressure in grams
Mounting radius — 13"
- Scale — 0 to 25 grams, Zero set indicator,
Self Leveling Base

- Instantly shifts to 33 1/3 - 45 - 78 r.p.m.
- Obsoletes rim, gear, belt drives
- Eliminates wow, flutter, speed variations
- Uses faster starting light-weight components
- 12" or 16" turntable is optional, same price
Dimensions: 17" x 21" x 7 3/4" deep,
12" or 16" turntable, 25 lbs.

Write for Bulletin



133 NORTH SIXTH AVENUE MOUNT VERNON, N. Y.

AIRCRAFT P. A. SYSTEM

[from page 19]

volume. These last seats were considered beyond the satisfactory range of the speaker. From these purely objective tests, it was concluded that eight passengers could be covered satisfactorily by one speaker. In the sleeper type airplanes, though, complete coverage of the fourteen seats in the aftercabin was attained with one speaker. This was possible due to the increased reflecting surfaces and the lower noise level in this area.

On the basis of one speaker for every eight seats, seven speakers would be required to cover the entire cabin. Due to the layout of the plane, however, a total of ten speakers was installed. Figure 2 shows, for example, one in each lavatory, six in the forward cabin, and two in the after cabin of the Mainliner 300 dayplane arrangement. The frame structure of the plane necessitated some slight deviation from exact equal spacing, but this deviation is not noticeable either to the eye when looking at the grilles or to the ear during an announcement.

Having determined the location and volume requirement of the speakers, the next task was to select the components. In choosing the proper loud-speaker and amplifier, space and weight were of extreme importance. The space between the cabin ceiling and the outer skin of the plane was the determining factor. This was only 3 3/4 inches in some locations. The Jensen 8-inch PM "extended range" speaker was chosen. It fit the space and combined rugged construction with a weight of only two pounds. A typical speaker installation is shown in Fig. 3. The ceiling material was .020 aluminum sheet and not capable of supporting any weight. Hence, the speaker was hung from the frame of the airplane, and a thick ring of foam rubber was used to match the speaker to the ceiling panel contour.

The amplifier chosen was the Bendix MI-36A. This unit was designed specifically as an aircraft paging amplifier and readily fit the standard mounts in the plane's radio equipment rack. The amplifier is a high-fidelity, three-stage model utilizing two 6J5's, one as the first audio tube and one as a phase inverter, and two 6L6's in push-pull for the output stage. These deliver 20 watts with less than 4 per cent distortion between 100 and 5000 cps. Filament power and relay actuating power are from the airplane's 28-volt d.c. radio bus, and the high voltage is from the plane's 400-cps 110-volt a.c. supply through a conventional power unit.

World-Wide Popularity

Since the inception of AUDIO ENGINEERING in May 1947, engineers and audio hobbyists have subscribed in ever-increasing numbers, not only in the 48 states and in all of the major foreign countries but in such places as Tasmania, Transvaal and Trinidad.

Each month AUDIO ENGINEERING covers the latest developments and practices in recording, reproduction and instrumentation for the entire audio field.

Subscribe Now—Don't Miss an Issue! Back numbers are hard to get!

AUDIO ENGINEERING
342 Madison Avenue, New York 17, N. Y.

Sirs: Here is my check (or money order) for \$..... Enter my subscription order to AUDIO ENGINEERING for the next..... issues. Subscription Price: In U.S.A., Canada and Pan American Union—12 issues \$3—24 issues \$5. All others \$4.00 per year. Please check one: New Subscription Renewal

Name (please print).....

Address..... City..... Zone..... State.....

Occupation (give title and department).....

Firm Name.....

Since the plane has circuits such as fluorescent lights and on-off relays that are possible sources of noise, it was necessary to shield the input circuit to the amplifier to prevent pick up. Conduit was used wherever possible, and all input lines were routed clear of the 400-cps lighting lines.

The circuit is shown in the block diagram of Fig. 4. Here it will be noticed that the input circuit is from existing telephone type handset microphones. This was done more in the interest of simplicity than economy. The mike is the same handset mike that is used for the stewardess-to-pilot interphone. Unfortunately, these microphones were intended as communications telephones, and do not have the fidelity that the rest of the system possesses. To make an announcement, the pilot or stewardess has merely to throw a three-position key switch to ANNOUNCE and speak into the mike. At the cockpit position, the switch automatically returns to the interphone circuit when the handset is hung up.

Operation

When the pilot announced, he was unable to hear any of the speakers, since they were in the passenger cabin. This left him with the feeling of speaking into a dead microphone. To remove this sensation and also to warn him in case the stewardess was making an announcement, both microphones were also fed into an auxiliary amplifier which furnishes "side tone" to the receiver of each handset. By thus hearing his own speech, the pilot is able to judge his diction and level. The level of this side tone in such a handset is very critical. It must be loud enough to be heard in a noisy cockpit, yet not loud enough to feed back into the microphone. In order to provide this critical level without adding another control, the amplifier which is normally used for the stewardess-to-pilot interphone is switched over to serve as a side tone amplifier during an announcement. Thus, when this amplifier is adjusted for the correct interphone level, it is also at the correct side tone level, and the paging amplifier volume is unaffected by this adjustment.

The output circuit was designed as a conventional series-parallel circuit of two lines of three speakers each and one line of four speakers. In order that a speaker failure would not blank out any one section of the plane, the speakers of each were staggered in location, as shown by Fig. 4.

At present, the entire fleet of United Air Lines Mainliner 300 planes is equipped with this system. It does much to add to the enjoyment of air travel and make the trip one to be remembered with pleasure.

HARVEY has the leaders...

LEAK

"Point One" AMPLIFIERS



Britain's best, using U. S. tubes. 12-watt power amplifier with remote control pre-amp. Freq. response ± 0.1 db, 20 to 20,000 cy. PP 6L6's triode connected in output. Switch for mike, radio, PU with automatic equal-

ization. Feedback tone control. Pre-amp can be mounted on mctor board or an power amplifier for portable use.

Shpg. Wt. 30 lbs.

Complete with tubes, \$168

LANSING "Signature" SPEAKERS



Model D-130. 15-inch general purpose PM speaker. Every excellent feature you expect in a Jim Lansing unit. We have the complete Lansing line of speakers and cabinets. Shpg. Wt. 25 lbs. Model D-130... \$46.50

RADIO CRAFTSMEN TUNER

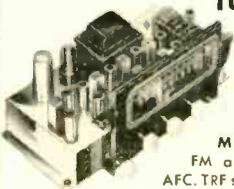

Model RC-8. FM and AM with AFC. TRF stage on both FM and AM. Nine fully shielded tubes, permeability-tuned IF, self-contained power supply. Mounting template, screws, instructions, etc. supplied. Also available for rack mounting. Shpg. Wt. 20 lbs. \$110.00
Model RC-2. Hi-Fi audio amplifier for the RC-8. Shpg. Wt. 30 lbs. \$39.00



GE FM TUNER

Only a few left of this unusual buy. Covers 88-108 mc range. Uses guillotine tuning. Designed for export and tropicalized, has power inputs for 110-220 volts, 60 cy. Shpg. Wt. 30 lbs.

HARVEY SPECIAL PRICE... \$49.50

All in stock for immediate delivery.

NOTE: All prices are Net, F.O.B. N.Y.C. and are subject to change without notice.

Telephone: 7hrc Luxembourg 2-1500

HARVEY RADIO COMPANY INC.

103 West 43rd St., New York 18, N. Y.

CONSOLES FOR TELEVISION-AUDIO!

BUILT TO SPECIFICATION



CINEMA ENGINEERING CO.
1510 WEST VERDUGO AVE.
BURBANK, CALIFORNIA

CONSOLE AT
CAPITOL RECORDS
HOLLYWOOD

Audio in England

A report on the way things are done on the other side.



...HAS NO APPRECIATION OF TONE...

It is possible to produce amplifiers that measure up to the most rigid requirements and tolerances of a "mechanical ear"... amplifiers that show perfect laboratory measurements, BUT may, despite their mechanical and technical perfection fall short of providing enjoyable "listening-quality."

When you buy a phonograph amplifier you buy one thing... listening quality. That elusive characteristic which, after all, is any amplifier's prime reason for being.

Newcomb amplifiers must not only measure up to the highest standards electrically... but in addition are subjected to critical "listening quality" tests by trained experts. That is why Newcomb amplifiers provide more real listening pleasure.



Insist upon hearing a Newcomb. Compare the listening quality of Model KXLP30 from the standpoint of enjoyment with that of any other amplifier. Your ear will readily hear the pure natural quality and true character of each deep bass note. Now, listen to the clear, undistorted, brilliant, high tones with their remarkable freedom from surface noise made possible by Newcomb's exclusive MAGIC RED KNOB. A comparison will convince you that Newcomb Sound is without question the closest you can get to "Live Music" quality.

Newcomb Phonograph Amplifiers from \$59.50



Write Dept. T

AUDIO PRODUCTS CO.
6824 Lexington Avenue, Hollywood 38, Calif.

THE TITLE OF THIS SYMPOSIUM of current British practice and thinking in the field must not be taken as a sly dig at the Scots or Welsh. A Scot myself, I am fully aware of the contributions made by Scotland to this curious civilisation of ours, and the impact of Welsh politicians is always felt, but the plain truth is that almost all activity in audio is concentrated in a small part of England—London and one or two other centers. So "Audio in England" it is going to be.

Your editor has suggested that I might treat of what we do in all the departments of audio research and development, more particularly detailing that which differs from American practice. There is without doubt a sharp cleavage of opinion on certain aspects of design, but leaving out the commercial bally-hoo and advertising overstatement, I have found from my bulky American mail that on both sides we who are vitally interested in *real* high-fidelity have got a common standard of assessment of really good equipment. That assessment spills over from the engineering department and involves aesthetic appreciation as well. This is dangerous ground for a technician, but in high-class audio work the technician has not got all the answers. I shall, therefore, try to convey to you some indication of the true worth of developments, as well as giving the technical low-down, and where I have positive knowledge of American achievements, I shall try to give a fair and factual comparison. And at the outset let me state quite unequivocally that we have as much to learn from you as you have from us. Fair enough?

We have no equivalent of your Audio Fair, and I doubt if we ever shall have. In October

we had our radio exhibition, which passes under the name of "Radiolympia" because it was held in Olympia exhibition hall. The previous effort was in 1947, and one wasn't held last year because the trade couldn't afford it. The radio industry has had a hard time of it over here since the war finished (as have other industries, of course), first by not being able to get supplies of raw materials and components, and secondly because the war years prohibited research and development of civilian equipment. As a result, when the new radios came out, the public soon spotted that they weren't even as good as in 1938 and cost considerably more.

Radiolympia had nothing very much to offer those of us who are interested in audio. Leaving recording gear for a future treatment, such interest as could be raised was centered on speakers, amplifiers, and pick-ups. In all these three "components" a sense of proportion and discrimination is needed. There has been a radio slump in this country for two years (hence present excitement in TV), and some people, having noticed that interest in high-fidelity audio had not fallen off to the same extent, thought this a market to exploit. Now the high-fidelity fan is always looking around for something new and better, and certain designs have appeared which, on performance, simply do not live up to the claims made or expected by the published specifications. In many cases this is not due to any inherent dishonesty on the part of the manufacturers concerned, but simply to an apparent lack of appreciation of what is involved. "New and better" speakers are always appearing, and yet the genuine progress is not discernible in terms of natural musical reproduction.

NEW LO - DISTORTION SPEAKER SYSTEM

SPECIFICATIONS

20 watts, 800 cps, 12 db/octave cross over.
H. F. Horn — 15" P.M. woofer.
40-cps fundamentals to 15,000 cps.

A new process of mechanically damping cone compliance improves edge damping and reduces distortion caused by cone break-up. The new line of Holl Lo-Distortion loud speakers permits free air resonance at 40-45 cps. Bass response is exceptionally clean. Full power 40-cps fundamentals are reproduced without bass boost. For something new in lo-distortion speaker quality at exceptionally low prices, send for data on the new line of Holl Lo-Distortion Loudspeaker Systems.



Cabinet hand rubbed mahogany finish: ¾" through-out: 37½" high, 25½" wide and 16" deep.



Hollywood Station Box 1230
Hollywood, California

Some little time ago, speaker makers over here went co-axial crazy after having struggled through the morass of ordinary duplex speakers. This was obviously inspired by American practice, and I am really anxious to find out how the better American multiple speakers perform. Over here fastidious listeners speak of the "disembodied top" effect when two sound sources are used, even when they are coaxial, and they don't like it. Do American manufacturers, with their greater experience, avoid this defect? We cannot tell, and what could be heard at Radiolympia threw no light on the matter at all. The celebrated Klipsch speaker system is now being made over here under license, and was being demonstrated. The results, which were certainly not the fault of the Klipsch design, were extremely poor, mainly through bad demonstration and inept musical approach.

The high's were there all right, but so was a lot of other stuff that wasn't music. Yet the proprietors wore that maddening smile of ignorant complacency, oblivious of the absurdity of a £200 speaker having, for some reason or other, a high non-musical content in its sound output. We still haven't heard a Klipsch properly driven, but what keeps nagging at me is a basis of assessment, for I have listened to many outfits which, their owners say, give "marvellous" results, and which to me sound beastly, because I assess them by what I hear in the concert hall. But then I haven't got tin ears. I haven't even got a radio set of my own. As my business welfare depends on my being able to form snap judgments on the musical quality of sound reproduction, I simply dare not allow my ears to become accustomed to canned cacophony. My wife has resented my point of view very much, but now that we have a larger flat she has her own music room, and I don't go in when she wants to listen.

Talking of tin ears brings me to Mr. Canby's deeply interesting Record Revue in the November 1949 issue. We have the same troubles here. Recording technique in England has improved enormously during the last few years, but that doesn't prevent our record-producing companies turning out duds now and then, and more than one of their engineers has told me that the reason for the dud can never be truly unearthed. But much more blame is applied to the recording people than they have ever justly earned—it is so easy for a high-fidelity demonstrator to say "We give you everything on the disc, good or bad, and we can't help it if it is sometimes bad." And how can the listener prove him wrong? I have supplied equipment to people who express great delight at what it does but complain bitterly that such and such a disc cannot be reproduced on my equipment. The disc may be wrong, so they send their own copy to me to try out. I do so and find it without flaw. Therefore, it must be the equipment. But it isn't the equipment; it is the way it is used.

I think Mr. Canby hits the nail squarely on the head when he says: "I begin to suspect that most engineers have been listening to hi-fi equipment for so long that the stuff has crept up on them. Equalise correctly and it sounds dull, so quick boost up those highs and get some real hi-fi!" You only have to think of what we are all trying to do, which I hope is recreation of the original performance as well as possible. The original performance has a level response, if one can

LOGGER

MODEL
121

A vacuum-tube voltmeter with extremely wide db range combined with an accurate linear-to-logarithmic converter to allow recording in db with inexpensive, high-speed, linear scale, direct writing oscillographs. The logarithmic effect is obtained by the use of a stable new material, and the cathode-follower output may be used to feed an oscillograph, either directly or through a suitable intervening amplifier for recording in db. This instrument is especially useful for acoustical reverberation measurements.



and the BRIDGER

MODEL 100

Using a cathode follower of advanced design, the Bridger makes it possible to measure the characteristics of high-Z electronic circuits without affecting performance, and without introducing hum into the circuits being measured.

Input Z: Approx. 100 megs in parallel with 6 μ f at end of 3' cable.
Output Z: 200 ohms, unbalanced.
Voltage Ratio: 0.98, or -0.2 db up to limit of undistorted output.
Undistorted Output: 40 volts, when feeding a low-C cable and typical high-Z load.
Output Noise: Equivalent to 60 μ v input when fed by high-Z circuit.

SPECIFICATIONS

Meter Scale: 50 db. On special order, scale of the internal meter may be made 20, 30, or 40 db without loss of linearity.
Input: 0.1 volts minimum for full-scale deflection.
Input Impedance: 100,000 ohms, grounded on one side.
Output: 0.8 volts, average, at full meter deflection.
Output Waveform: Approximately square; varies with input level.
Output Circuit: Internal output impedance = 1000 ohms. Load impedance must be high.
Log Circuit Speed: Virtually instantaneous.
Frequency Response at Output Circuit: Down 0.5 db at 40 and 10,000 cps; down 1 db at 25 and 20,000 cps; down 2 db at 40,000 cps; all measured with respect to 1000-cps indication.

Write on your letterhead for complete catalog, prices and further information

AUDIO INSTRUMENT CO.
1947 Broadway New York 23. N. Y.

AMPERITE

Studio Microphones at P.A. Prices

Ideal for BROADCASTING
• RECORDING
• PUBLIC ADDRESS

"The ultimate in microphone quality," says Evan Rushing, sound engineer of the Hotel New Yorker.

- Shout right into the new Amperite Microphone—or stand 2 feet away—reproduction is always perfect.
- The only type microphone that is not affected by any climatic conditions.
- Guaranteed to withstand more "knocking around" than any other type mike.

Special Offer: Write for Special Introductory Offer, and 4-page illustrated folder.

AMPERITE Company, Inc.

561 BROADWAY • NEW YORK 12, N. Y.

Canada: Atlas Radio Corp., Ltd., 560 King St. W., Toronto

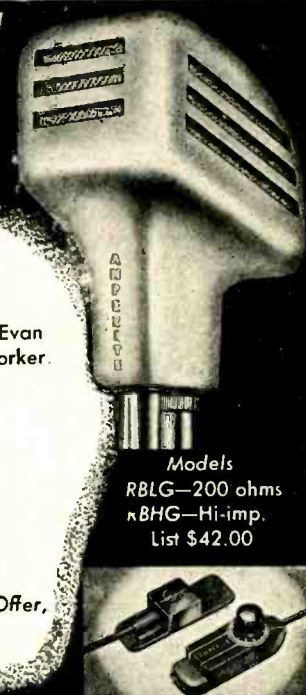

Models
RBLG—200 ohms
RBLG—Hi-imp.
List \$42.00

"Kontak" Mikes
Model SKH, list \$12.00
Model KKH, list \$18.00



Cannon Plugs

**FOR THE
ELECTRIC CIRCUITS
OF INDUSTRY**

COPIES of this deluxe, 76-page book on the "Quick Disconnect" are still available at no cost to you. It is a digest of ideas on quicker and better assembly, easier servicing, maintenance and greater portability of electric equipment through the use of Cannon Plugs. The book covers such divisions as Communications, Power, Controls, Railroads, Aviation, Textiles, Television, Welding, Mining, Motion Pictures, Technical Institutions, Sound, Public Utilities, Process Industries, Automotive, Commercial Radio, Electro-Motive Power, Petroleum, and Marine.

Cannon Electric also manufactures signal equipment for hospitals, industrial plants, schools, institutions and many other electrical specialties such as conduit fittings, D. C. Solenoids, fire alarm relays, cable terminals, indicator and pilot lights, etc., etc.

Address Cannon Electric Development Co., Division of Cannon Manufacturing Corporation, 3209 Humboldt Street, Los Angeles 31, Calif. Canadian offices and plant: Toronto, Ontario. World export: Frazar & Hansen, San Francisco.

SINCE 1915
CANNON ELECTRIC

use the term in that sense. In recording, the bass is attenuated to a prescribed formula; in LP the whole response is attenuated except for the extreme highs, but again in a predetermined manner. In reproducing these records, any compensation which is over-compensation is bound to produce distortion. If you fancy extra lift on the high's, you will amplify the high overtones to a greater extent than the low ones and the fundamental. The result may be music or it may not, but it isn't the original sound, and if it isn't, then distortion is present.

Now, generally speaking, American records are not much admired in Britain. I have been told that the lack of bass and shrill over-emphasized middle top is the result of an attempt by the recording companies to make the sound emerging from the average mass produced radiophonograph sound bearable. If so, the idea is all right in theory but fails on two counts in practice—because the scale distortion is not truly compensatory for the scale distortion in the reproducing equipment, and the outcome is painful with high-fidelity equipment. English records have not, generally speaking, had this faking applied to them so that when a good recording comes along it sounds so much better than an American. Decca frr have a wide flat response, but with a rising characteristic at 13 to 14 kc. Over and over again I have found them behaving fuzzily, just like Mr. Canby's LP. To the average tin ear the top was wonderful, but there was something else besides. But not all Decca are like this, and in the absence of authoritative data on the recording characteristic of each disc, it is unwise to be dogmatic.

On the other hand, I have got one LP—the Schelerezade disc—and playing this with a good magnetic pick-up and the standard compensation prescribed by the makers, the results are so astoundingly wonderful as to have sickened me at my own record library. I am told this is an outstanding disc. It may be, but the fact remains that an American recording company has produced a disc with stated characteristics so that the correct compensation can be applied, and the frequency response, transient reproduction and general "attack" are a revelation. We have nothing over here to touch it. And all this without any fuzziness or buzzing.

I might mention one common cause of fuzzy top even when over-correction is not attempted—the slack stylus. Our first lightweight pick-ups with miniature needles appeared way back in 1938. At the time they were a revelation, but on wide-range equipment there was top fuzziness even on ordinary recordings that stopped at 8,000. I traced this to loose needles (the lightweight armature had no tightening screw, and the needle was supposed to sit tightly in a V-groove). At that time we hadn't got as far as jewels, so I used to stop the looseness by jamming the needle tight with a shaving of matchwood. This was a nuisance because a chrome needle has to be replaced after five 12-inch discs with wide-range equipment, but it was borne uncomplainingly in the cause of clean top. Nowadays we cement our needles into place, using sapphires when we haven't got the money, and diamonds when things are good, and we don't get buzzes any more—except when we over-correct.

—H. A. HARTLEY

Laboratory Standards

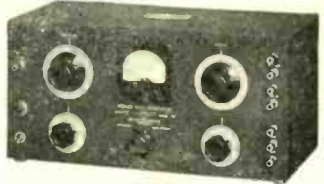

SQUARE WAVE GENERATOR

Model 71. Frequency Range: Continuously variable from 5 to 100,000 cycles. Wave Shape: Rise time less than 0.2 microseconds. Output Voltage: 75, 50, 25, 15, 10, 5 peak volts fixed; 0-2.5 volts continuously variable.

MEASUREMENTS CORPORATION
BOONTON NEW JERSEY



IRE National Convention
GRAND CENTRAL PALACE
and
HOTEL COMMODORE
New York

RADIO ENGINEERING SHOW
March 6-9 1950

230 Exhibitors



**Come Again -
Audio Men!**

15,710 qualified engineers and technically minded people visited the 1949 Radio Engineering Show. 46% were interested in audio equipment—and found it well represented in the exhibits and technical papers. Spotlight the New March 6-9, again. Non-member registration is \$3.00.

The
Institute of Radio
Engineers

1 East 79th St., New York 21, N. Y.

Stop listening to DISTORTED MUSIC



The connoisseur of music listening wants to recognize the clear brilliance of symphonic sound and

BROOK All Triode High Quality AUDIO AMPLIFIER

Gives It To Him



(Plus Model 10C3-30 watts)
Also available Model 12A3-10 watts

with

- Distortion and intermodulation at a new low.
- Reduction of listening fatigue.
- Brilliant, clear tone.
- Separate controls-stepped for Bass and Treble.
- Extremely low volume without any loss of quality.

Write TODAY for FREE Technical Bulletin
and Detailed Distortion Analysis

BROOK ELECTRONICS, Inc.
Sales Agent
Dept. AL-9, 34 De Hart Place, Elizabeth, N.J.

BRITAIN'S FINEST LOUDSPEAKER COMES TO YOU

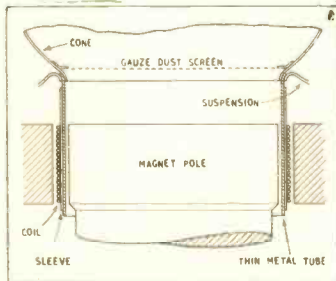

Here is the heart of the famous Barker loudspeaker. Unique, patented, exclusive to Barker. Fine aluminum wire wound over long life latex skin on wafer aluminum tube all drive graded cone together at middles and lows. Latex compliance allows tube to drive alone at highs by induction, extending smooth output to over 15,000 cps. Tube is also closed feedback circuit giving dead-beat control of transients. Crystal clear cut detail and wide-range warm naturalness result.

Two models, 14,000 or 17,500 lines/sq. cm., both 12 in. frame. Prices \$45 and \$60 by insured post home.

Write today to

Barker Natural Sound Reproducers
BCM/AADU, London, W.C.I, England.

AUDIANA

[from page 21]

ording curves, satisfactory results may be expected.

All of these rolloffs may be obtained by the use of RC networks, and many have been described in these pages^{5, 6}. The reader is referred to these articles for details of the circuit arrangements. With correct rolloff curves, it is thought that little trouble should be encountered from surface noise, except in the case of badly worn records.

Methods of designing these circuits will be discussed in next month's article, along with a discussion of low-pass filters as a means of reducing noise and distortion effects.

⁵ St. George and Drisko, "Versatile Phonograph Preamplifier," *AUDIO ENGINEERING*, March, 1949.

⁶ Sterling, "Simplified Preamplifier Design," *AUDIO ENGINEERING*, Nov. 1949.

LONGITUDINAL NOISE IN AUDIO CIRCUITS

[from page 24]

noise current, the effects observed with the test circuit are just the reverse from those described above. In this case, the voltage across the amplifier terminals is greater with the switch at the sending end open, because the noise current flows to ground mainly via the input transformer of the amplifier. Closing the switch to ground drains off the longitudinal noise current to ground through a short circuit and causes minimum voltage to appear across the input terminals of the amplifier. As previously explained, the longitudinal voltage to ground of the input circuit depends, in this type of noise induction, mainly on the impedance to ground of the input circuit.

Identification of the type of noise induction is possible by observing the magnitude of the amplifier output. If the output is greater when the switch at the sending end is closed, the noise is of the longitudinal-noise-voltage type. On the other hand, if the output is greater with the sending end switch open, the noise is of the longitudinal-noise-current type. If the output is approximately the same for either switch condition, both forms of induction are present in comparable amounts.

(To be concluded)

BIG Performance

in a . . .
small package



- TRIALLOY CASE AND TRIALLOY SHIELDS, NICKEL-PLATED FOR APPEARANCE AND DURABILITY
- HI CONDUCTIVITY INNER SHIELDS, COPPER.
- COIL INSULATION 2500 VOLTS.
- SPECIAL PUNCHED TRIALLOY LAMINATION.
- HUM-BUCKING CONSTRUCTION TWO IDENTICAL COILS.
- SOLDERED CONNECTION CORE TO CASE.
- ALL LEADS INSULATED FOR 2500 VOLTS.
- THREE TRIALLOY SHIELD LIDS CLOSE FITTING.
- MOUNTING STUDS WELDED TO LID. 6-32 BOLTS.
- STURDY LOW-LOSS TRIAD HERMETICALLY-SEALED TERMINAL HEADER SOLDERED TO LID. 3 TO 12 TURRET PINS.

...with TRIAD'S exclusive construction

This exploded view of a Triad Geoformer (Geophysical Transformer) illustrates the construction which makes Triad Geoformers and "HS" High Fidelity Transformers so outstanding in performance. Although of extreme small size, these units deliver a range of performance usually found only in much larger transformers—a feature of primary importance in the construction of high quality equipment for geophysical and general electronic applications.

Triad builds high performance into these units through advanced design, exact tooling, specialized engineering and the use of finest available materials. Built to meet JAN specifications, incorporating Triad's improved method of hermetic sealing, and vacuum impregnated by the exclusive "Climotile" process, Triad Transformers are more than meeting today's exacting performance requirements. Yet their cost is little more than that of ordinary cased types. For information and prices on **Triad Electronic Transformers** write for **Catalog TR-49**.

For information and prices on **Triad Geoformers (Geophysical Transformers)** write for **Catalog GP-49**.



2254 Sepulveda Blvd.
Los Angeles 64, Calif.

MAKE a 3-way system

from your Dual Speaker,

or a full 2-way Speaker

from your conventional

driver—with the Stephens

HY-SON—Model 107



Price
\$50.00
list, complete
with network

**A super high frequency
reproducer system for the
3500-20,000 cps. range**

The Hy-Son System, in combination with 2-way speaker systems or conventional single voice coil speakers, gives an added clean extension of high frequency reproduction. Due to the small mass of the moving system, together with a carefully designed throat configuration, very low distortion is assured. This unit finds itself a fitting complement to high quality source materials now available, such as tape and wide range disc recordings, FM Broadcasts, and live reproduction installations.

Specifications: Power input above 3500 cps, 20 watts from program material, 5 watts steady tone. Reproducing range 3500-20,000 cps., flat ± 3 db to 15,000 cps. Impedance, 16 ohms. Voice coil diameter 1", motor mass 350 milligrams. Weight, unit and crossover combined, 5 1/2 lbs. Size, driver only, 3 1/2" diameter by 2 1/2" deep, with 2 x 4 40° x 80° high frequency horn attached. 7" deep overall. Hy-Son System Model 107 is sold only with Model 3500X, one-half section high pass filter network, to insure proper operation of driver and attenuation of low frequencies. Price complete with network, \$50.00, list.

Any STEPHENS TRU-SONIC loud-speaker may now be ordered with the HY-SONIC at an additional charge of \$50.00 list.

STEPHENS

MANUFACTURING CORPORATION



8538 Warner Dr., Culver City, Calif.

STEREOPHONIC

[from page 15]

tained by placing the speakers in or near two adjacent corners of a rectangular room and rotating them to determine the proper orientation.¹

The characteristics of the network are illustrated graphically in Figs. 3 and 4.

As may be seen, it is quite effective

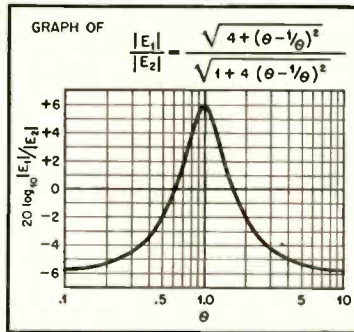

Fig. 3. Curve showing relative voltage at output #1 of Fig. 2. This curve also applies to output #2 if signs are interchanged.

in breaking up the relative phase and amplitude relationships between the two channels without seriously affecting the composite output amplitude. The approximate distribution produced by this network is one in which the low, middle, and high tones appear to emanate from a central region, the medium low tones from one side, and the me-

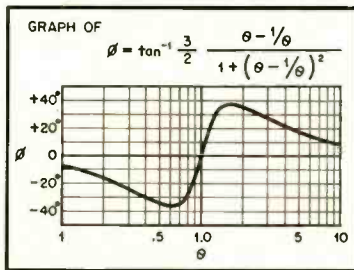

Fig. 4. Phase-shift curve for circuit of Fig. 2.

dium high tones from the opposite side. The apparent spatial "spread" thus obtained adds a great deal to the realism of the reproduced program. The effect is indeed sufficiently pronounced to render a program carried over a conventional system flat and lifeless by contrast.

¹ Marvin Camras, "Stereophonic Magnetic Recorder," *Proc. I. R. E.* April, 1949.

CABINETS • CHASSIS • PANELS • RACKS

**BUILDING Electronic
Equipment? SAVE
MONEY and TIME with
PAR-METAL HOUSINGS!**
They're Standardized!



- **READY-TO-USE**
- **LOW IN COST**

There's a Par-Metal Housing for every purpose, from a small receiver to a deluxe transmitter.

You may order Par-Metal units practically from stock, thus eliminating the need for special made-to-order equipment on many jobs. Remember, Par-Metal equipment is made by electronic specialists, not just a sheet metal shop.

We offer an extensive selection of units for Manufacturers, Service Men, P. A. Men, Amateurs, etc.

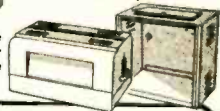

PAR-METAL
PRODUCTS CORPORATION

32-62 — 49th ST., LONG ISLAND CITY 3, N. Y.
Export Dept.: Rocke International Corp
13 East 40 Street, New York 16

WRITE
FOR
CATALOG

**DID
YOU
KNOW...**

that **AMPLIFIER
CORP. OF AMERICA
MANUFACTURES
THE LOWEST
PRICED PROFESSIONAL
TAPE RECORDERS** in the
WORLD?

We have more than 30 exciting models, 2-speed recorders, 24-hr. recorders, conference recorders and many others. Get the facts in our new 16-page catalog. Complete specifications given. Write today for your copy.

AMPLIFIER CORP. OF AMERICA

398-4 Broadway • New York 13, N. Y.

AUDIO ENGINEERING SCHOOL

Practical engineering training in Audio fundamentals, Disc, Film, Magnetic Recording, and Audio frequency measurements.

Studio training simulates Broadcast, Motion Picture, Television, and Commercial Recording work.

Approved for Veterans

Hollywood Sound Institute, Inc.

1040-A North Kenmore, Hollywood 27, Calif.

Correspondence Course Available

Specify if Veteran or Non-Veteran

**1949 Bound Volumes
of AUDIO ENGINEERING**
\$8.95

Order Now — Limited Supply
U. S. A. & Canada only

PROFESSIONAL DIRECTORY

C. J. LEBEL
AUDIO CONSULTANT

Sound Recording • Instrumentation

370 RIVERSIDE DRIVE
NEW YORK 25, N. Y.

Winston Wells

Designer and Consultant
Acoustical, Electronic and Nuclear
Research

307 East 44th St. MU 4-3487
New York 17, N. Y.

Custom-Built Equipment

U. S. Recording Co.

1121 Vermont Ave., Washington 5, D. C.
Sterling 3626

Consultation • Design • Fabrication

Audio Facilities Corporation

608 Fifth Avenue
New York 20, N. Y.

RATES FOR
PROFESSIONAL CARDS
IN THIS DIRECTORY

\$10 Per Month.
Orders Are Accepted
for 12 Insertions Only

HERMAN LEWIS GORDON

Registered Patent Attorney

Patent Investigations and Opinions

Warner Building Washington 4, D. C. National 2497
100 Normandy Drive Silver Spring, Md. Shepherd 2453

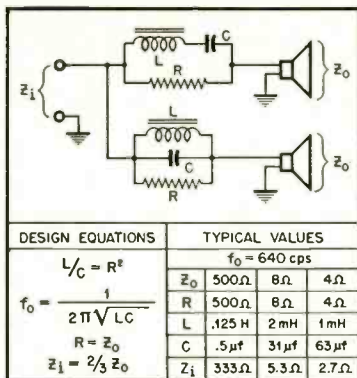

Fig. 5. Schematic of suggested circuit to be used between output of amplifier and two separate speakers.

Circuit for Speaker Line

The system described above, while capable of admirable results under the proper conditions, is still a decidedly inconvenient one for incorporating into existing equipment. For this reason, the following modification is offered as a compromise. The circuit, as shown in Fig. 5, is essentially the same. It does not, however, lend itself as readily to a detailed mathematical analysis because of the reactive nature of the load. The basic difference, as may be seen from the drawing, is that the two loudspeakers themselves now serve as the terminating impedances for the phase and amplitude shifting network, which is in turn driven directly by the output of the power amplifier. The general design equations are still valid and, as such, they are restated together with a few typical values for different impedances. In a low-impedance circuit, it is especially important to use reactances with low effective series resistances, and it will probably be necessary to wind the inductances, using heavy wire.

If the proper attention is paid to the location and orientation of the speakers, either of the systems described above is capable of adding a distinctly noticeable degree of realism to a program.

While, as mentioned earlier, there will be essentially no relationship between the *apparent* directional qualities of the reproduced program and the *original* spatial distribution at the source, this will not be greatly detrimental to the operation of the system, as seldom, if ever, will there be a chance for a comparison of the two.

In closing, it should be stressed that with this system, as with all such similar systems, the fullest benefits of the stereophonic effect may be realized only if the rest of the apparatus is also of a relatively high degree of excellence. If this is true, the system outlined above will offer a great deal to the enjoyment of the interested listener.

The Phenomenal Sun FM Tuner

Model
AFC-10

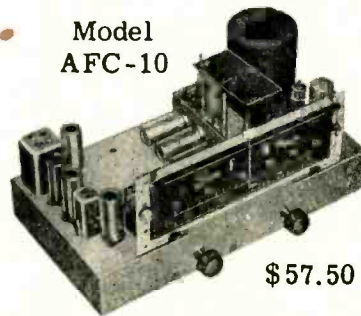

\$57.50

Has 2-Microvolt Sensitivity!

Plus Automatic Frequency Control and Much More...

Here's FM at its best and at mighty low cost, too. Highly compact, newly designed, the Sun FM Tuner is built to our own specifications and has a combination of features never before available at any price:

Full Armstrong circuit, 2-microvolt guaranteed sensitivity, AFC, no drift after two-minute warmup period, IF bandwidth 200 KC at 6 db down, patented permeability tuning head for high Q selective RF circuits, 13 1/8" long x 7 1/8" wide x 5 7/8" height overall, 10 high gain miniature tubes: 6AK5 RF, 6BE6 converter, 3-6AK5 IF's, 2-9001 cascade limiters, 6AL5 Foster-Seeley discriminator, 6X4 rectifier, 6J6 AFC. Complete, ready to use, not a kit. All for only \$57.50, FOB.

Order today by mail direct from Sun. Send check or money order for full amount or 25% with COD's.

Complete specifications for this tuner (model AFC-10) are available on request. But please don't ask for the circuit--we guard it rather jealously. Can you blame us?

AM-FM Tuner

AM-FM Tuner, Model AFC-20, also available. Specifications for FM section identical with those for AFC-10. AM section of similar high quality.

Sun Radio
AND ELECTRONICS COMPANY, INC.

122-124 DUANE STREET
New York 7, N. Y. BRtley 7-1840
2 BLOCKS NORTH OF CHAMBERS ST.

STORE HOURS: 9-6 Daily, 9-4 Saturday.

THE McINTOSH

Pre-Amplifier Equalizer Model AE-2

will be at home in the record library. It was designed inside and out for The Music Lover. A fixed two position filter provides 6db per octave rise below 300 or 500 cycles. A variable equalizer with two non-interfering controls gives:

- up to 15db bass boost
- or up to 20db bass attenuation
- up to 15db treble boost
- or up to 20db treble attenuation

Five Input circuits can be selected from:

1. Low level Microphone
2. G.E. Pickup (automatically equalized)
3. Pickering Pickup (automatically equalized)
4. Crystal Pickup
5. Tuner



Model AE-2 Pre-Amplifier Equalizer

1. Adjustable input levels.
2. Non-interfering equalizing controls.
3. Independent bass boost and attenuation control.
4. Independent treble boost and attenuation control.
5. Flat response settings.
6. Self-contained power supply.
7. Remote control of power amplifier.
8. All tubes shock mounted.
9. 300 and 500 cycle turnover.
10. Low impedance output.
11. Harmonic distortion less than 1% 20 to 20,000 cycles at 4 Volts out.
12. Gain from microphone input 50db.
13. Maximum gain from tuner input 27db.
14. Output level
 - Normal, 2 Volts
 - Maximum 6 Volts

For complete details ask your dealer or write to:
McIntosh Engineering Lab., Inc.
 910 King Street Silver Spring, Maryland
 Telephone: Juniper 7-9200

A NEW YEAR RESOLUTION.

Just a year ago the first of our monthly advertisements appeared in this place. We knew nothing about our prospects and the whole venture was an act of faith based on some confidence in ourselves and the things we make.

One year later it gives us the utmost pleasure to report that we have made a host of new friends. Some of you have bought the Hartley-Turner speaker and some other things too. A very large number of you sent for "New Notes in Radio".

But we did not expect to find the enormous amount of goodwill shown to us by the readers of Audio Engineering. Your letters have been a constant pleasure to us. The number of times you have wished us "Good Luck" encourages us always to give of our best.

We have had four complaints in the course of the year that our speaker is disappointing, yet the letters of complaint have been so nicely worded that it makes us all the more determined to root out the trouble in each one of those four cases.

On the other hand we have had a great many letters which speak very highly indeed of the 215 speaker and of the way we run our business. That encourages us to even greater efforts, for nothing is so good for morale as encouragement.

But the prime function of this advertisement is to thank all of you who have written to us for your kindness and interest and to state publicly our New Year Resolution—that whatever we have done in the past was not good enough and it is our resolve to do very much better in the future.

All who have written to us will be kept fully informed of what we are doing. Those who have not should write today.

H. A. HARTLEY CO., Ltd.

152, HAMMERSMITH ROAD
 LONDON W. 6, ENGLAND

ADVERTISING INDEX

Altec Lansing Corp.	32
American Patent & Trade Mark Bureau	35
Amperite Co., Inc.	43
Ampex Electric Corp.	1
Amplifier Corp. of America	46
Audak Company	3
Audio Devices, Inc.	Cover 2
Audio Facilities Corp.	47
Audio Instrument Co.	43
Audio Pacific Co.	34
Barker Natural Sound Reproducers	45
Beck, R. M. Company	37
Bell Telephone Laboratories, Inc.	8
Brook Electronics, Inc.	45
Browning Laboratories, Inc.	39
Camera Equipment Company	30
Cannon Electric Dev. Co.	44
Cinema Engineering Company	41
Clarkstan Corp.	34
Daven Co., The	Cover 3
Electro-Voice, Inc.	25
Electronics Research Pub. Co., Inc.	32
Fairchild Recording Equip. Corp.	29
Gordon, Herman Lewis	47
Hartley, H. A. Co., Ltd.	48
Harvey Radio Company, Inc.	41
Holl Audio Industries	42
Hollywood Sound Institute	46
Institute of Radio Engineers	44
Jensen Manufacturing Co.	2
LeBel, C. J.	47
Magnecord, Inc.	31
McIntosh Engineering Lab., Inc.	48
Measurements Corporation	44
Murray Hill Books, Inc.	48
Music Masters	38
Newcomb Audio Products	42
Par-Metal Products Corp.	46
Partridge Transformers, Ltd.	48
Pickering & Co., Inc.	5
Presto Recording Corp.	7
Proctor Soundex Corp.	40
Professional Directory	47
Racon Electric Co., Inc.	38
Radio Corp. of America	6
Electronic Components	6
Rek-O-Kut Company, Inc.	38
Somerset Laboratories, Inc.	36
Stephens Manufacturing Corp.	46
Sun Radio & Electronics Co., Inc.	47
Terminal Radio Corp.	36
Triad Transformer Mfg. Co.	45
United Transformer Corp.	Cover 4
U. S. Recording Co.	47
University Loudspeakers, Inc.	27
Ward Leonard Electric Co.	33
Wells, Winston	47

PARTRIDGE

PRECISION

AUDIO-TRANSFORMERS

"To Specification"

Nearly two decades of specialized research is behind every Partridge Transformer. That specialization is at your service to fulfill your own specific requirements. Here are two typical "to measure" Partridge products.

Push-Pull Output Transformers

Provide full A.F. range with minimum distortion. Rating 12 W. for 0.5% harmonic distortion at 50 cycles. Six models available for accurate anode/anode load matching between 4,000 and 12,000 ohms. Please specify the tubes and speaker when ordering.

Unpotted (Style DN/404B) \$10.50
 Potted (Style DN/404B) \$11.50
 (including postage, packing and insurance).

Williamson Output Transformer

A "quality" 20 W. output transformer built in accordance with the Williamson design (see "Wireless World" August 1949) and regarded as the finest possible transformer of its type. Weight 12 lbs.

Unpotted (Style VDN/436B) \$18.50
 Potted (Style VDN/436B) \$19.50
 (including postage, packing and insurance)

The above transformers are available for IMMEDIATE DELIVERY. Technical literature free on application to —

PARTRIDGE TRANSFORMERS LTD.

Roebuck Road • Tolworth • Surrey
 England

MAGNETIC RECORDING

All about the theory, types and makes of recorders and performance measurements



by S. J. BEGUN

Chief Engineer, The Brush Development Co. 300 pages, 6x9, 130 illustrations, \$5

Here is the "low-down" on this rapidly expanding development in all of its design, engineering, and experimental phases. MAGNETIC RECORDING acquaints you with every detail of modern equipment, brings you latest data on applications ranging from home entertainment to movies, broadcasting, professional and amateur radio, and many special uses including military speech scrambling.

COMPLETE TECHNICAL DETAILS—

Explains acoustic and magnetic factors. Describes in detail A-C and D-C biasing methods, distortion factors, reproducing heads, drive mechanisms, recording media and methods, reproducing and erasing, instruments for checking performance. Discusses magnetic recording versus other methods. Many other topics. Send coupon today.

10 DAY MONEY-BACK GUARANTEE

Dept. AE-10, MURRAY HILL BOOKS, INC.

232 Madison Ave., New York 15, N. Y.

Send me a copy of MAGNETIC RECORDING for which I enclose \$5 (\$5.50 outside U.S.A.) or

Send book C.O.D. (in U.S.A.) for \$5 plus postage. I will pay postage.

If book is not satisfactory, I will return it in 10 days and you guarantee to refund my \$5.

Name

Address

City, Zone, State



30 step "T" networks, T-30 series, 2 1/4" diameter

30 step ladder, LA-130 series, 1 3/4" diameter (also available as potentiometer)



45 step "T" networks, T-345 series, 2 3/4" diameter

**THEY'RE
NEW!**

**THEY'RE
SMALL!**

3

**ADDITIONS to the most
complete line of Attenuators
in the WORLD!**

Daven offers a new group of Attenuators which are designed for compactness and light weight. This has been done as an aid to Design Engineers—in line with the growing trend to miniaturization of components.

By combining all the other well-known Daven features, these units are ideal where space and weight are at a premium.

Let Daven fill your needs from over 5,000 types of standard attenuators. Our Engineering Department will be glad to work with you in selecting a unit for your specific requirements.

Write to Dept. A-5 for additional information

*"The best equipment deserves
the finest attenuators—
... Always Specify Daven!"*

- Multiple Input & Output Networks
- Potentiometers
- "T" networks
- Balanced "H"
- Ladder Networks
- R. F. Attenuators
- Fixed Pads

- Impedance matching networks
- Reostats
- Balanced Ladder Networks
- Video Attenuators
- Dual Potentiometers
- Power Attenuators
- Decade Attenuators

THE DAVEN CO.

191 CENTRAL AVENUE
NEWARK 4, NEW JERSEY



Linear Standard Units...

THE ULTIMATE IN QUALITY...

UTC Linear Standard Audio Transformers represent the closest approach to the ideal component from the standpoint of uniform frequency response, low wave form distortion, high efficiency, thorough shielding and utmost dependability.

UTC Linear Standard Transformers feature...

- **True Hum Balancing Coil Structure**... maximum neutralization of stray fields.
- **Balanced Variable Impedance Line**... permits highest fidelity on every tap of a universal unit... no line reflections or transverse coupling.
- **Reversible Mounting**... permits above chassis or sub-chassis wiring.
- **Alloy Shields**... maximum shielding from inductive pickup.
- **Miperm-Alloy**... a stable, high permeability nickel-iron core material.
- **Semi-Toroidal Multiple Coil Structure**... minimum distributed capacity and leakage reactance.
- **Precision Winding**... accuracy of winding .1%, perfect balance of inductance and capacity; exact impedance reflection.
- **High Fidelity**... UTC Linear Standard Transformers are the only audio units with a guaranteed uniform response of ± 1 DB from 20-20,000 cycles.



TYPICAL LS LOW LEVEL TRANSFORMERS

Type No.	Application	Primary Impedance	Secondary Impedance	± 1 db from	Max. Level	Relative Hum-pickup reduction in prim'y	Max. Unbal-anced DC in prim'y	List Price
LS-10	Low Impedance mike. pickup, or multiple line to grid	50, 125, 200, 250, 333, 500/600 ohms	60,000 ohms in two sections	20-20,000	+15 DB	-74 DB	5 MA	\$25.00
LS-10X	As Above	As above	50,000 ohms	20-20,000	+4 DB	-92 DB	5 MA	32.00
LS-12	Low Impedance mike. pickup, or multiple line to push pull grids	50, 125, 200, 250, 333, 500/600 ohms	120,000 ohms overall, in two sections	20-20,000	+15 DB	-74 DB	5 MA	28.00
LS-12X	As above	As above	80,000 ohms overall, in two sections	20-20,000	+14 DB	-92 DB	5 MA	35.00
LS-26	Bridging line to single or push pull grids	5,000 ohms	60,000 ohms in two sections	15-20,000	+20 DB	-74 DB	0 MA	25.00
LS-19	Single plate to push pull grids like 2A3, 6L6, 300A, split secondary	15,000 ohms	95,000 ohms; 1.25:1 each side	20-20,000	+17 DB	-50 DB	0 MA	24.00
LS-21	Single plate to push pull grids. Split primary and secondary	15,000 ohms	135,000 ohms; turn ratio 3:1 overall	20-20,000	+14 DB	-74 DB	0 MA	24.00
LS-22	Push pull plates to push pull grids. Split primary and secondary	30,000 ohms plate to plate	80,000 ohms; turn ratio 1.6:1 overall	20-20,000	+26 DB	-50 DB	.25 MA	31.00
LS-30	Mixing, low impedance mike, pickup, or multiple line to multiple line	50, 125, 200, 250, 333, 500/600 ohms	50, 125, 200, 250, 333, 500/600 ohms	20-20,000	+17 DB	-74 DB	5 MA	25.00
LS-30X	As above	As above	As above	20-20,000	+15 DB	-92 DB	3 MA	32.00
LS-27	Single plate to multiple line	15,000 ohms	50, 125, 200, 250, 333, 500/600 ohms	30-12,000	+20 DB	-74 DB	8 MA	24.00
LS-50	Single plate to multiple line	15,000 ohms	50, 125, 200, 250, 333, 500/600 ohms	20-20,000	+17 DB	-74 DB	0 MA	24.00
LS-51	Push Pull low level plates to multiple line	30,000 ohms plate to plate	50, 125, 200, 250, 333, 500/600 ohms	20-20,000	+20 DB	-74 DB	1 MA	24.00
LS-141	Three sets of balanced windings for hybrid service, center-tapped	500/600 ohms	500/600 ohms	30-12,000	+10 DB	-74 DB	0 MA	28.00

TYPICAL LS OUTPUT TRANSFORMERS

Type No.	Primary will match following typical tubes	Primary Impedance	Secondary Impedance	± 1 db from	Max. Level	List Price
LS-52	Push pull 2A5, 250, 6AV6, 32 or 2A5 A prime	8,000 ohms	500, 333, 250, 200, 125, 50, 30, 20, 15, 10, 7.5, 5, 2.5, 1.2	25-20,000	15 watts	\$28.00
LS-55	Push pull 3A3's, 6A5G's, 300A's, 275A's, 6A3's, 6L6's	5,000 ohms plate to plate and 3,000 ohms plate to plate	500, 333, 250, 200, 125, 50, 30, 20, 15, 10, 7.5, 5, 2.5, 1.2	25-20,000	20 watts	28.00
LS-57	Same as above	5,000 ohms plate to plate and 3,000 ohms plate to plate	30, 20, 15, 10, 7.5, 5, 2.5, 1.2	25-20,000	20 watts	20.00
LS-58	Push pull parallel 2A3's, 6A5G's, 300A's, 6A3's	2,500 ohms plate to plate and 1,500 ohms plate to plate	500, 333, 250, 200, 125, 50, 30, 20, 15, 10, 7.5, 5, 2.5, 1.2	25-20,000	40 watts	50.00
LS-6L1	Push pull 6L6's self bias	9,000 ohms plate to plate	500, 333, 250, 200, 125, 50, 30, 20, 15, 10, 7.5, 5, 2.5, 1.2	25-20,000	38 watts	42.00

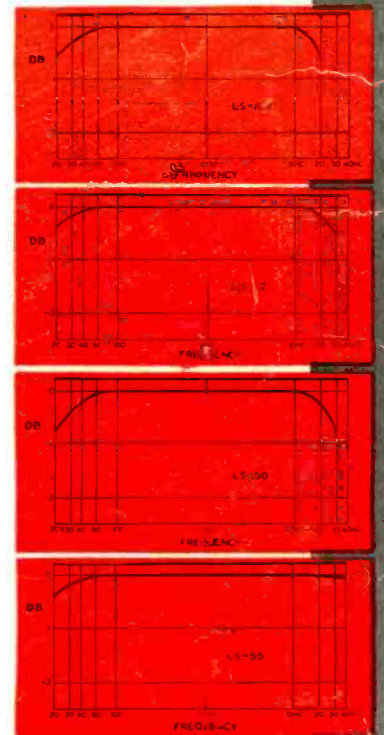

Write for our Catalog ES-409

United Transformer Co.

150 VARICK STREET NEW YORK 13, N. Y.
EXPORT DIVISION: 13 EAST 40th STREET, NEW YORK 16, N. Y., CABLES: "ARLAB"

DON'T LET THE SUMMER'S HUMIDITY HAUNT YOU THIS FALL!



Left-over moisture is no problem when you record on humidity-resistant

audiocdiscs*

The worst of the summer months have passed—but the humidity lingers on. And its after-effects may actually be felt far into the fall and winter. For an ordinary lacquer recording disc absorbs moisture much more readily than it will give it up. And “left-over moisture,” absorbed during the summer, can spoil many a recording months after the humidity has fallen below the danger point. So why risk “grey rings” and high noise level, when you can be sure of faultless recording with *humidity-resistant Audiocdiscs*?

In Audiocdiscs, the moisture problem has been solved *permanently* by the addition of a special moisture resisting agent—without any change in the basic lacquer formulation. As this development was perfected in 1947, we have had plenty of field experience to back up our own laboratory tests. During the summers of 1948 and 1949, for example, none of our customers has reported any humidity trouble.

So—for truly fine recording and reproduction all year around—be sure to ask your dealer for Audiocdiscs!

TAPE RECORDISTS—Send for your Free Samples of the NEW audiotape*



Now, after 2½ years of research and development, Audio Devices offers you a complete line of highest quality magnetic recording tape—designed for *matched performance* in any tape recorder.

Two different types of paper-base Audiotape are now available—one with a high coercive-force black oxide, and the other with a medium coercive-force red oxide. This choice of charac-

teristics enables you to select the tape that best matches the bias of your machine—for maximum quality of recording and reproduction.

Plastic-base Audiotape, with the same choice of oxides, will be available shortly.

We'd like you to test this new Audiotape, in your own machine. The coupon at the left, or a request on your company letterhead, will bring you a 200-foot sample of each type without cost or obligation.

AUDIO DEVICES, INC.

444 Madison Ave., New York 22, N. Y.

Gentlemen:

Please send me, free of charge, two, 200-foot samples of paper-base Audiotape—one with high coercive-force oxide, and the other with medium coercive-force oxide.

NAME _____

COMPANY _____

ADDRESS _____

CITY _____ STATE _____



*Trade Mark

AUDIO DEVICES, INC.

444 MADISON AVE., NEW YORK 22, N. Y.

Export Dept.: ROCKE INTERNATIONAL, 13 East 40th St., New York 16, N. Y.

Audiocdiscs are manufactured in the U. S. A. under exclusive license from PYRAL, S. A. R. L., Paris