

# AUDIO ENGINEERING

JUNE  
1949

THE JOURNAL FOR SOUND ENGINEERS

Whatever the

# SPEED

Whatever the

# PITCH

**audiodiscs\***

*are your best assurance  
of truly fine recording  
and reproduction*



**78 rpm**

**96 grooves per inch**



**45 rpm**

**264 grooves per inch**



**33 $\frac{1}{3}$  rpm**

**224 grooves per inch**



Un-retouched shadowgraphs, showing Audiocassette recorded at 78, 45, and 33 $\frac{1}{3}$  rpm. Magnified 125 times.

Today, with the trend toward higher and higher fidelity, the *quality* of a recording disc is more important than ever before. The new recording and reproducing techniques — slower speeds, finer grooves, and feather-weight pick-ups — demand a lacquer coating of truly flawless perfection.

Professional recordists everywhere are finding that Audiocassette meet the most exacting requirements for every type of conventional or microgroove recording. The automatic machine-coating process, the selection and blending of lacquer ingredients, the tireless testing — from raw materials to finished Audiocassette — are your assurance of matchless quality. *And for the finest results, it pays to cut Audiocassette with precision-matched Audiopoints — now available for microgroove as well as conventional recording and playback applications.*

\*Reg. U.S. Pat. Off.

Audiocassette are manufactured in the U.S.A. under exclusive license from PYRAL, S.A.R.L., Paris

**Audio Devices, Inc., 444 Madison Ave., N. Y. C.**

Export Dept: Rocke International, 13 East 40th Street, New York 16, N. Y.

*they speak for themselves* **audiocassette**



## SYLVANIA RADIO TUBES IN *Motorola* RADIOS SPEED THE CAB-DIRECTING MESSAGES!

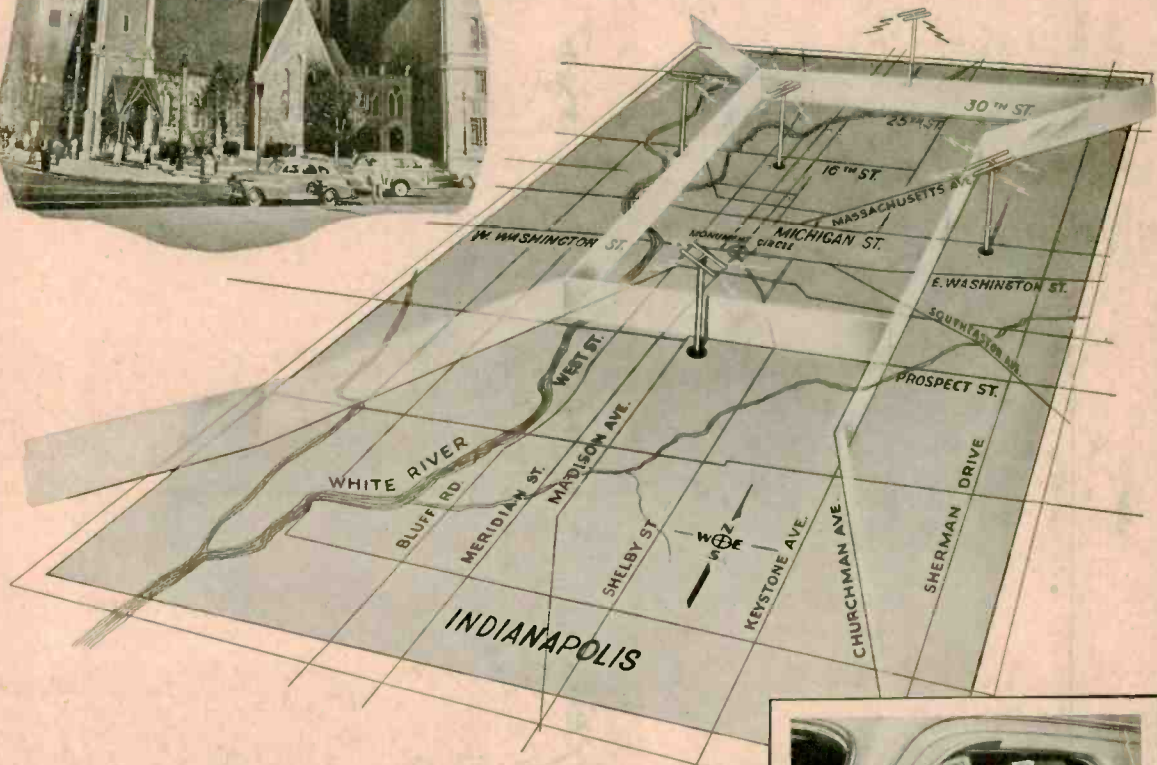

### Red Cab of Indianapolis conducts 5 times more business with "Satellite" 2-way FM system!

THIS advanced system of taxicab dispatching used by Red Cab, Inc., of Indianapolis, Indiana, was especially developed by Red Cab, Inc., with the assistance and technical advice of Motorola Radio Engineers to answer the problem of congestion of the single radio frequency allowed to taxicab operators. Replacing the single central station and its single dispatcher with five independent stations, the system makes it possible for a large cab company to conduct many more times the business and radio dispatching without jamming the air. The five stations are

controlled by a set of toggle switches under the various dispatchers' fingertips so that any number of dispatchers from one to five may be used and so that each dispatcher may select one station at a time or any combination.

And in every set in the 111 radio-equipped cabs, Sylvania's rugged Lock-In Tubes are firmly seated in their sockets, performing admirably day in and day out, under all kinds of jarring road conditions! For information on Sylvania Tubes see Sylvania Distributors, or write Radio Division, Emporium, Pennsylvania.



Red Cab driver receiving radioed instructions for picking up a fare in his district, in city of Indianapolis.

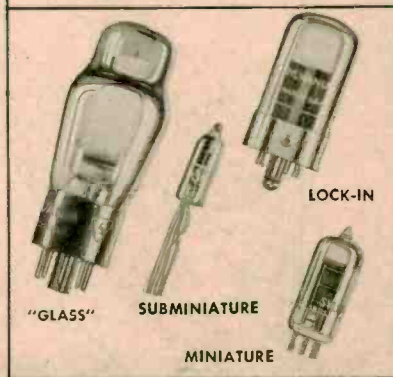

# SYLVANIA ELECTRIC

RADIO TUBES; CATHODE RAY TUBES; ELECTRONIC DEVICES; FLUORESCENT LAMPS, FIXTURES, WIRING DEVICES; ELECTRIC LIGHT BULBS; PHOTOLAMPS  
 AUDIO ENGINEERING • JUNE, 1949

# DELTAMAX *-now available!*

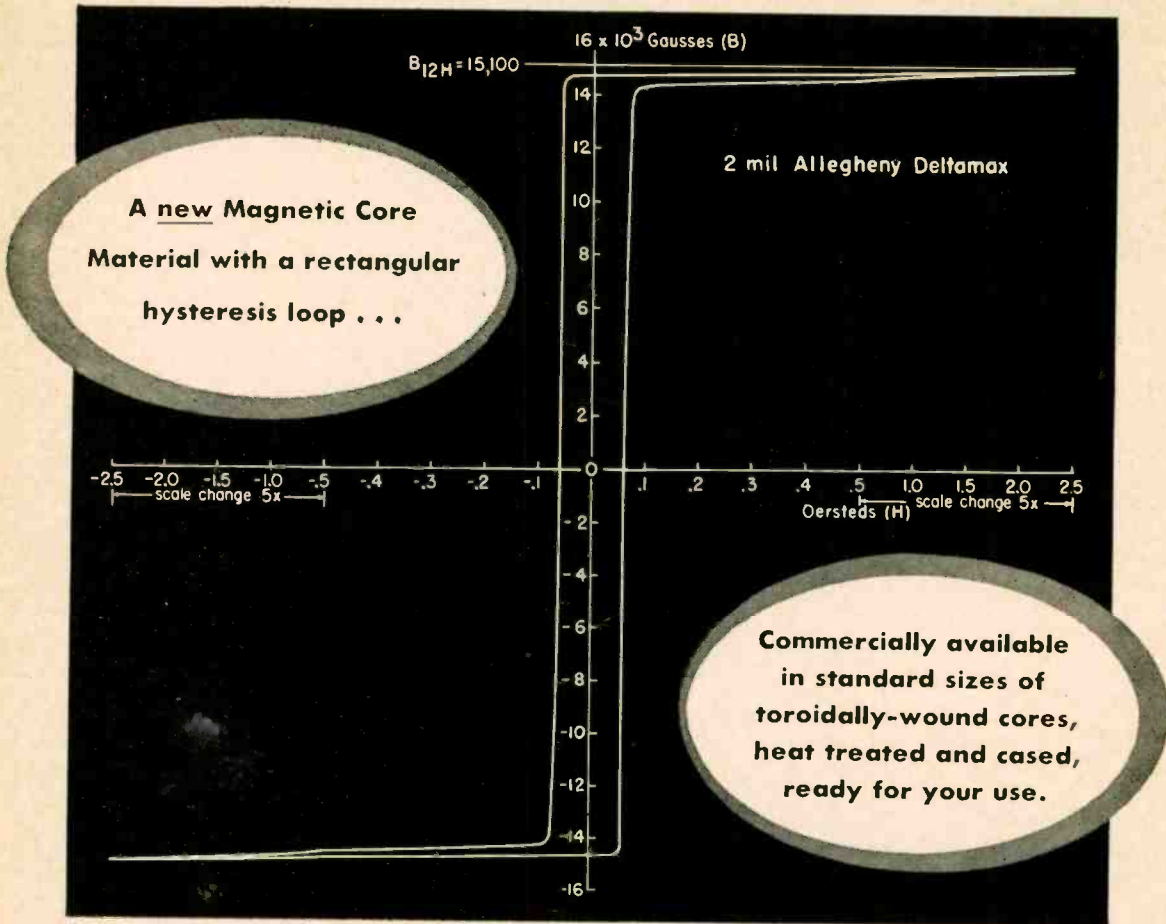

## Where can YOU use a Magnetic Material with these specialized, dependable characteristics?

The properties of Deltamax are invaluable for many electronic applications, such as new and improved types of mechanical rectifiers, magnetic amplifiers, saturable reactors, peaking transformers, etc. This new magnetic material is available now as "packaged" units (cased cores ready for winding and final assembly) distributed by the Arnold organization. Every step in manufacture has been fully developed; designers can rely on

complete consistency in each standard size of core.

Deltamax is the most recent extension of the family of special, high-quality electrical materials produced by Allegheny Ludlum, steel-makers to the electrical industry. It is an orientated 50% nickel-iron alloy, characterized by a rectangular hysteresis loop with sharply defined knees, combining high saturation with low coercivity.

● Call on us for technical data.



## THE ARNOLD ENGINEERING COMPANY

SUBSIDIARY OF ALLEGHENY LUDLUM STEEL CORPORATION  
147 EAST ONTARIO STREET, CHICAGO 11, ILLINOIS

W40 2379

# AUDIO ENGINEERING



Successor to **RADIO**

**D. S. Potts, Publisher**                      **C. G. McProud, Editor**  
 Lawrence LeKashman, Asst. Editor      S. L. Cahn, Adv. Director  
 Louisa B. DeSoto, Edit. Prod. Mgr.      H. N. Reizes, Adv. Mgr.  
 David Saltman, Production Manager      L. B. Devine, Circ. Mgr.

Editorial Advisory Board	Representatives
Howard A. Chinn	Sanford R. Cowan, Mid-West Sales 342 Madison Ave., New York 17, N. Y.
John D. Colvin	
C. J. LeBel	James C. Galloway, Pacific Coast Sales 816 W. 5th St., Los Angeles 13, Calif.
J. P. Maxfield	Dale International Publications, Ltd. 105 Bolsover St., London W. 1, England
George M. Nixon	Harris & Floyd, 297 Swanston St. Melbourne C. I, Victoria, Australia
Winston Wells	
S. Young White	

Established 1917

CONTENTS JUNE, 1949

Vol. 33, No. 6

Editor's Report .....	4
Letters .....	0
New Developments in Preamplifiers— <i>C. J. LeBel</i> .....	9
New Polyphase Reproducer System— <i>Maximilian Weil</i> .....	13
Problems in Audio Engineering, Part II— <i>Lewis S. Goodfriend</i> .....	15
Crossover Filter for Disc Recording Heads— <i>H. E. Roys</i> .....	18
Magnetic Tape and Head Alignment Nomenclature— <i>N. M. Haynes</i> .....	22
Record Review— <i>Edward Tatnall Canby</i> .....	24
New Products .....	26
Techni-Brjefs .....	30
Book Review .....	32
Advertising Index .....	40

**COVER**

Joint Senate and House Recording Facilities in the Congressional Office Building,  
 Washington, D.C.

AUDIO ENGINEERING (title registered U. S. Pat. Off.) is published monthly at New York, N. Y., by Radio Magazines, Inc., D. S. Potts, President; Lawrence LeKashman, Vice Pres. Executive and Editorial Offices at 342 Madison Avenue, New York 17, N. Y. Subscription rates—United States, U. S. Possessions and Canada, \$3.00 for 1 year, \$5.00 for 2 years; elsewhere \$4.00 per year. Single copies 35c. Printed in U. S. A. All rights reserved. Entire contents copyright 1949 by Radio Magazines, Inc. Entered as Second Class Matter July 29, 1948 at the Post Office, New York, N. Y., under the Act of March 3, 1879.

# EDITOR'S REPORT

## TRANSFORMER IMPEDANCE STANDARDIZATION

During the course of an average month, many interesting letters are received, with ideas, suggestions, and questions vying with one another for first place in quantity and quality. Some are abstracted for the Letters column, others answered in due course. A few, however, are simply digested and served here in another form, for a wider dissemination of the ideas contained therein. One such letter, from F. A. Morris of Rochester, questions the present "standards" of transformer impedances, and in so doing actually calls attention to a condition which is tantamount to no standardization at all.

Omitting for the moment the output-impedance taps on power amplifiers, it still appears that there are nine different source impedances in common use from 600 ohms down, namely 600, 500, 250, 200, 150, 135, 125, 50, and 30. Some are designed to work directly from a line of the nominal impedance, yet do not offer a termination to the line. This is a satisfactory condition for a microphone preamplifier, since most microphones are designed to work into an unloaded transformer, and it is doubtful if there is much difference in the performance of a 30-ohm microphone whether followed by a 30- or a 50-ohm transformer, except as to voltage step-up in the transformer itself.

There is much less justification for the 125-135-150 range, however, and these three values might possibly be related to a single nominal value, preferably 150 ohms since this is the impedance of half of a 600-ohm winding. The 200-ohm value seems to be the orphan of the group, but 250 is firmly established as a medium value.

But now, ten years after the "standardization" to 600 ohms and 1 milliwatt, much equipment is still rated on the 500-ohm basis, and even the 6-mw reference level has not been completely superseded. Not that 600 is any better than 500 as a number, but would certainly make for greater simplicity if the standard were to be followed more closely. Then too, there is the condition where an input transformer may not look like 600 ohms, yet must see a 600-ohm source. If the source is terminated by a 600-ohm resistor, the transformer then sees 300 ohms.

Thus it appears that further study is needed in this matter of standardization of transformer impedances and working methods. As a starter, the following might be considered as a suitable array of impedances:

1. Primary to work from 30-50 ohm microphones, unterminated.
2. Primary to work from 250-ohm source, unterminated; or across 500-600 ohm lines terminated with a resistor; or from a 250-ohm source with the termination supplied on the secondary.
3. Primary to work from 600-ohm source with a termination supplied on the secondary; this winding center-tapped to work from 150-ohm sources.

There will always be special cases where a specific design of transformer is required for certain purposes, but for a general line of transformers which would serve most satisfactorily in the average condition, it would seem that standardization on these three proposed values would suffice as a starting point.

## WHAT PRICE CONSULTANTS?

In every type of business or industry a problem often arises to which a solution is possible, but which involves the expenditure of considerable time and effort to obtain that solution. This should not be construed as a reflection upon the abilities of those working on the problem, for no one can know everything about *any* subject. How often does it occur to those in authority that the quickest and most practical answer can be obtained from the consulting specialist—and often at a saving in both dollars and time?

The consultant is actually a type of merchant—he sells experience in units of hours or days. While his fees may be in excess of salaries normally paid to the regular employee who does the spade work from day to day, they usually represent a real economy in the long run. Plain arithmetic will show this advantage quite readily—if it takes the regular technician or engineer a week to work out a problem that can be solved by the specialist in a single day of consultation, the specialist should be entitled to a fee which is at least half of the regular salary which would be paid to obtain the same results.

Chances are that the specialist was once one of the "regular employees" and the accumulation of experience in the same field is worth a reasonable remuneration. Yet, in spite of these advantages, the fees charged by the consultant are rarely exorbitant—in most instances they are of the same order as the salary of the executive empowered to call on him.

## LOOKING FORWARD

Some years ago, an electronic engineer was described as one who developed apparatus which employed vacuum tubes, but who used as few tubes as possible. In this age of multitube equipment, it is refreshing to see a new design for a high-quality AM tuner which uses an absolute minimum of vacuum tubes—in fact, none. Consisting of three coils, a two-gang tuning capacitor, a germanium diode for the detector, a resistor, and three fixed capacitors, this new circuit serves as an excellent tuner for locations where the signal strength is sufficient. Even in the heart of Manhattan, it has sufficient selectivity to receive all the more important stations without interference, and needs only a good audio amplifier and speaker to provide truly high-quality reproduction. A description of this circuit will be a feature of the July issue. Also in preparation is a complete listing of frequency and test records. Beginning shortly is a series on the methods of handling audio circuits efficiently in the production of television programs.

The book division, pulling one out of the hat, announces the July 5 publication date for a compilation of S. Young White's articles on ultrasonics which have appeared over the past two years. Demand for back issues has exhausted the supply completely, so a separate printing is necessary. All of the previously published articles are included under one cover in the new 32-page booklet.

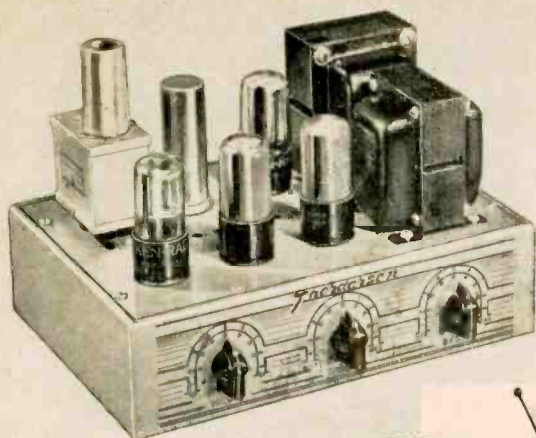

New THORDARSON T-32W10 AUDIO AMPLIFIER. Less T-32W00 Pre-Amplifier—but complete for use with high impedance pickup or tuner.  
List Price **\$55.00**

New THORDARSON T-32W00 Plug-in Pre-Amplifier. Necessary when Audio Amplifier is to be used with any of the popular reluctance phono pickups or high impedance microphones.  
List Price **\$9.90**

## Features

- Frequency responses from 20 to 20,000 cycles.
- -70 Db hum level below rated output.
- Adequate gain to obtain full output from the ordinary high impedance pickup or tuner.
- A treble boost and treble attenuation tone control feature.
- A bass boost or flat response control.
- Both tone controls continuously variable.
- Output for 3 to 4 ohms, 6 to 8 ohms, or 15 to 16 ohms which covers all popular high fidelity speakers.
- The unit will be supplied in a gray Hammer-tone finish which will give it an appearance that will blend into surrounding equipment and furniture.
- The units will be supplied with felt mounting feet and a separate bracket for permanent installations.
- A pre-wired socket will allow the use of a T-32W00 plug-in pre-amp which will accommodate any of the popular magnetic reluctance phono pickups or a high impedance microphone.
- A frequency compensated pre-amplifier, T-32W00 can be supplied with 15 DB of bass compensation for use with magnetic phono pickups. The bass compensation can be removed for flat response when microphone operation is desired.
- Output impedances are terminated to a four-screw terminal board.
- Tubes: One 6SL7-GT, two 6V6-GT, one 5Y3-GT.
- Complete with self-contained power supply, 115 volts A. C., and tubes.
- Output — 10 clean watts at less than 2% distortion.



America's  
Greatest  
Value in  
QUALITY

- Available with or without pre-amplifier
- Has pre-wired socket for pre-amplifier
- Low harmonic distortion
- Low inter-modulation distortion
- Extended frequency response
- 10 watt output
- High quality — low cost

Now you can have both! Yes, you can now enjoy highest fidelity audio amplification and yet pay only a modest price.

These twin advantages are yours to enjoy with the new outstanding T-32W10 THORDARSON AUDIO AMPLIFIER.

THORDARSON was able to keep costs down because THORDARSON manufactures most of the components that go into this fine instrument. Highest fidelity performance has been achieved through careful, thoughtful engineering by THORDARSON engineers — transformer specialists for more than half a century.

You'll thrill to the T-32W10's pure, natural tones — the unexcelled listening pleasure it affords.

### VERSATILE—buy only what you need, add pre-amplifier if needed later

Versatility is another important reason the new THORDARSON T-32W10 Audio Amplifier is in a class by itself.

With it one need not buy unnecessary extras. Although it is complete for use with the ordinary high impedance pick-up or tuner, it can be instantly converted when operation with reluctance pickups or high impedance microphones is contemplated. Simply plug in the new Thordarson T-32W10 Pre-Amplifier. A pre-wired socket is provided. It's as easy as changing a tube! By adding the pre-amplifier you can use any crystal or dynamic microphone or low output pickup!

Once you've heard the Thordarson T-32W10 Audio Amplifier you'll be satisfied with nothing else. Clear — undistorted — brilliant tones and elimination of surface noise place the T-32W10 entirely in a class by itself.

Here, truly, is America's Greatest Value in Audio Amplifiers!

# THORDARSON

Manufacturing Quality Electrical Equipment Since 1895

500 WEST HURON

CHICAGO 10, ILLINOIS

A Division of Maguire Industries

# DISK RECORDER

## For Lip Synchronous

### STANDARD AND MICROGROOVE RECORDING



#### FAIRCHILD STUDIO RECORDER, UNIT 523

- ★ Continuous variation of pitch from 80 to over 500 lines per inch.
- ★ Instant variation of pitch with only one feed screw and the Fairchild precision selector.
- ★ Ability to change pitch while in operation increases dynamic range.
- ★ Velvet smooth direct to center turntable gear drive—eliminates slippage, musical pitch change and insures positive timing of program material.
- ★ Precision recording — simplified operation.
- ★ Absolute synchronism for use with sound on film dubbing.
- ★ Visible armature in the Fairchild cutterhead permits easy and accurate alignment for high recording level—without distortion.
- ★ Laboratory quality microscope with adjustable light for visual examination of the groove side walls.
- ★ Vernier control of depth and angle of cut—adjustable during recording.

Above are some of the features that are responsible for the professional performance of the Fairchild Studio Recorder. Designed for continuous duty, the Fairchild Unit 523 offers the utmost in equipment flexibility for recording Standard NAB or MICRO-GROOVE pitch instantaneous transcriptions and masters. One lathe, one feed screw, one drive, one unit — FAIRCHILD.

The Fairchild Recording Equipment Corporation also manufactures a complete line of audio equipment for recording installations. Write to us about your specific requirements and for complete details about UNIT 523.

SOUND  
EQUIPMENT



154TH STREET AND 7TH AVENUE, WHITESTONE, L. I., N. Y.

## — Letters —

### Aural Acuity Absent?

Sir:

The results of the survey conducted some time ago as to fidelity preferences interested me greatly. It seems amazing that people should prefer imperfect reproduction, and thus miss much of the true quality of music. However, I have arrived at a possible answer to this paradox.

Since its inception more than 25 years ago, radio broadcasting has played an ever-increasing role in American entertainment. It has in fact come to such a point that—due to convenience—many people do their musical listening almost entirely through it. Thus they learn music not as it really is, but as an essentially imperfect instrument reproduces it. No popular-priced sets have fidelity much better than 100-8000 cps, and very few are better than 200-5000. Thus when people are confronted with a system with a range of 50-10,000 cps or better, they are not familiar with the new sensation, and prefer the reproduction to which their ears have become accustomed.

The influence of this factor could be determined quite easily on a survey. The subjects could be asked how much they listen to the radio, how much music listening is by radio and how much "live," and finally whether most of their radio listening is done on a five-tube table model or on a supposedly better console model. Such a survey should prove conclusively that the preference for poorer fidelity is due to an environmental condition, and not to any aspect of the natural hearing process.

I feel that this situation has implications more far-reaching than the mere accuracy of a survey. It may mean that aural discrimination is becoming less acute, perhaps with respect to such factors as harmonic distortion as well as fidelity. Consider also that the people tested were adults who had begun to feel the influence of the radio only relatively late in life. What about those of the present generation who have received practically all of their aural entertainment from radios and phonographs of decidedly doubtful quality, turned up far beyond the distortion point? What about television which is bringing people even more in contact with the dubious quality of electronic sound? Is the radio ruining our ears?

Charles Erwin Cohn  
7720 Marquette Ave.  
Chicago 49, Ill.

### "Phase Bandwidth"

Sir:

Recently, Prof. Richardson of Britain exploded a long-standing myth in the acoustics and audio fields when he demonstrated that it is the attack and decay times of sounds that largely determine their tone quality, not so much their harmonic overtones. This lends a much greater significance to transient distortion in audio networks and points to a weakness in the conventional sine-wave test methods and the harmonic and intermodulation ratings of reproducing systems.

A couple of months ago, DiToro of the Federal Telecommunications Laboratory in—  
[Continued on page 32]



# How to CUT YOUR DISC DOLLAR



SOUNDCRAFT discs are made in 25 types and sizes. You don't wear your Sunday go-to-meeting clothes to work in the garden. Why use unnecessarily expensive disc grades for everything?

Unlike some brands, Soundcraft discs are all coated with the same high-fidelity lacquer. The grading differences are based on the nearness to microscopic physical perfection.

Three grades in five sizes plus single or double face, and oversize masters, are tailored to every budget.

## STANDARD NET PRICES TO RADIO STATIONS AND RECORDING STUDIOS (In Standard Packages)

### THE 'BROADCASTER'

A MASTER selection in instantaneous sizes for vitally important recordings.

10" Double Face	\$.84
12" "	1.32
16" "	2.37
10" Single Face	.54
12" "	.98
16" "	1.65



### THE 'PLAYBACK'

A standard broadcasting-quality blank record for all professional uses in radio stations, recording and motion picture studios.

10" Double Face	\$.69
12" "	1.14
16" "	2.07
10" Single Face	.48
12" "	.84
16" "	1.44



### THE 'AUDITION'

A selection from the runs of "BROADCASTERS" and "PLAYBACKS" having minor physical defects outside of the recording areas.

6 1/2" Double Face	\$.27
8" "	.42
10" "	.60
12" "	.93
16" "	1.59



Standard Soundcraft economy packages of only 20 discs permit stocking wide variety of grades and sizes while simultaneously holding inventory value down.

### ELECTRONIC ELECTRONICS CO.



301 252 foremost radio parts distributors in principal cities and towns deliver Soundcraft discs from local stocks.

REEVES **Soundcraft** CORP.  
10 EAST 52ND STREET • NEW YORK 22, N. Y.

## MARGIN CONTROL RECORDING BOOSTS MICROGROOVE RANGE

By A. C. Travis, Jr.\*

For some time now Mercury Records have carried a little notation on their record envelopes explaining that the recording was done by a special process called, "Margin Control." That many recordists are not familiar with the meaning of these words is evidenced by the fact that we have so many times been asked for an explanation. Credit for the technique goes, according to all indications, to Bob Fine of Reeves Sound Studios. An interpretation of "Margin Control" follows in the form of a quotation from the external house organ of a famous manufacturer of blank records for both master and instantaneous recording.

"It seems that one of the major tactical problems in the ten inch versus seven inch microgroove war is the problem of the crescendo (evidently an old Mexican word meaning a noise that grows so loud it wakes up the customers). Now, when one of these crescendo passages comes along in microgroove recording, naturally the cutting stylus starts beating from side to side with such ferocity, that, while it cuts, it also displaces land material sufficiently to distort the adjoining groove. The resulting echo, even with the best discs, has relegated many master recordings to the reject pile. The obvious remedy of reducing volume cuts dynamic range, but, of course, when an irresistible force meets an immovable object, something has to give. Bob Fine gave—with an idea. He runs through the original recording or live number and "scores" it by plotting VU meter readings against time. Then, using new Fairchild equipment wherein lines-per-inch are infinitely variable from approximately ninety to five hundred, he makes the master fine-line recording by monitoring the lines-per-inch so that spacing is finest on lowest passages, coarsest on loudest ones. Appearancewise this procedure makes, from a light pattern standpoint, a funny looking record. For our money a disc recording, however, was always something to be more listened to than looked at. So, Mercury Records seem downright pleased with the resulting 62 db dynamic range."

"Margin Control", according to Mr. Fine, because of the inherent low noise level of the material is particularly effective with Soundcraft 'Maestro' discs. Soundcraft's triple-filtering to remove foreign matter, and Soundcraft's uniform consistency establish wide-dynamic-range microgroove recording on a predictable basis. Incidentally, Soundcraft ads, like Soundcraft discs, are equally effective either way up.

Advertisement

\*Vice. Pres., Reeves Soundcraft Corp.

REEVES **Soundcraft** CORP.  
10 EAST 52ND STREET • NEW YORK 22, N. Y.

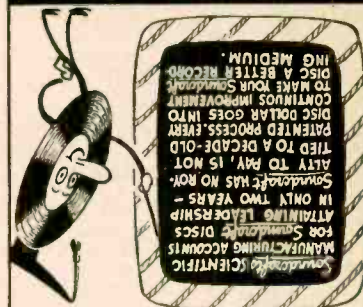

PROF. SOUNDY SAYS...



### THE ANALYSIS:

PROPERLY COMPOUNDED RECORDING LACQUER  
MINUS } FOREIGN MATTER IN LACQUER  
MICROSCOPIC DUST IN DRYING  
AIR }  
EQUALS NEW IMPROVED QUIETNESS  
IN CUTTING

### THE FORMULA:



# Two BIG reasons why you'll want...

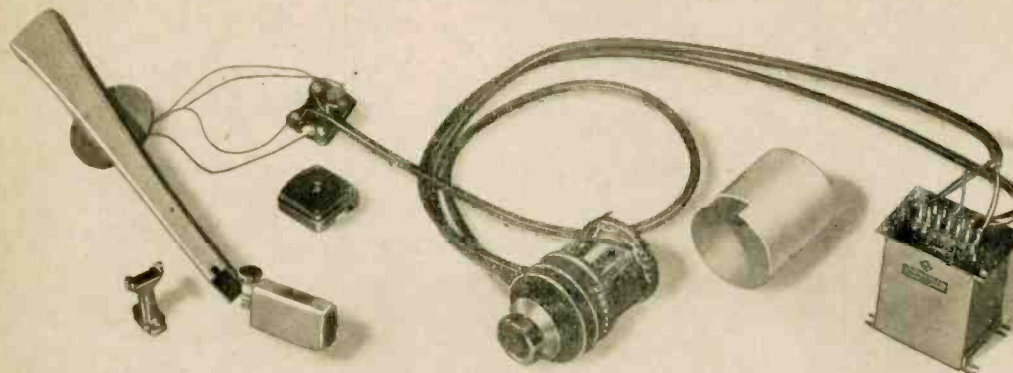

## ...the 109 Type Reproducer Group!

### 1. Low intermodulation distortion

Naturally, the Western Electric 109 Type Reproducer Group gives you extremely low harmonic distortion. But here's a still more important point—its advanced design practically eliminates *intermodulation* distortion.

Intermodulation distortion is one of the important factors that cause the "fuzziness" so often heard in the reproduction of the higher frequencies. Tests *prove* that the moving coil principle of reproduction, used in the 9 Type Reproducer, introduces far less intermodulation distortion than other currently used methods. That's *one* reason why the 109 gives exceptionally "clean" reproduction!

### 2. Wide, uniform frequency response

The combination of the 9 Type Reproducer and the equalizer used in the 109 Group is carefully designed for uniform frequency response—and this 7-position equalizer permits correction for any of the more commonly used recording characteristics. With the 109 Group, you can match within close tolerances all vertical and most lateral transcriptions and 90% of phonograph records.

The 109 Type Reproducer Group is *available from stock*—place your order with your local Graybar Representative, or write Graybar Electric Company, 420 Lexington Avenue, New York 17, N. Y.

## — QUALITY COUNTS —

### Immediate replacements on 9 Type Reproducers

If your 9 Type Reproducer needs repairs, send it to your Graybar District Warehouse — you can get a *factory-rebuilt* replacement immediately from stock.



# Western Electric

DISTRIBUTORS: IN THE U. S. A. —  
Graybar Electric Co. IN CANADA  
—Northern Electric Co., Ltd.

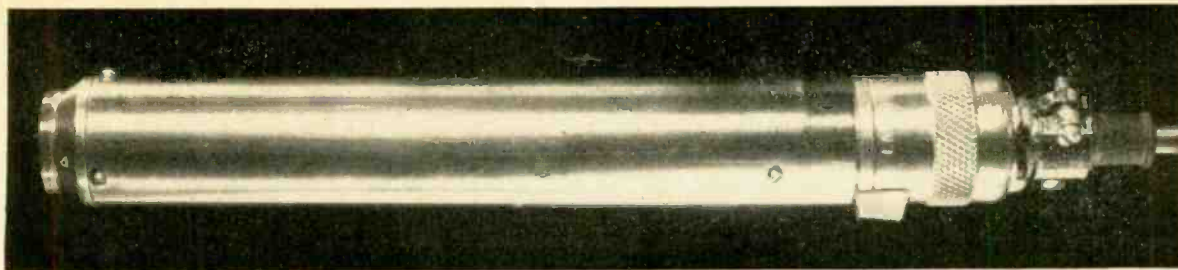

Compact two-stage preamplifier for WE-640AA condenser microphone. Circuit is essentially similar to that of Fig. 5.

# New Developments in Preamplifiers

C. J. LeBEL\*

A comprehensive discussion of the advantages of subminiature design techniques.

**T**HE LAST SEVERAL YEARS have seen growing interest in the condenser microphone among recording and broadcast engineers. This is not the old three-inch 5000-cps design, but one less than an inch in diameter, with essentially uniform response to 10,000 cps. We refer to the Western Electric type 640AA.

Attractive as the microphone is, its use has been badly hampered by the lack of a modern preamplifier to go with it—one of small size and low power consumption—and we wish to advance means of remedying the situation.

## Why be Interested in the 640AA?

Before describing new developments in preamplifiers, it might be well to present some information on the microphone with which they are used.

This form of miniature microphone has been in use for over ten years, and about a thousand have been made. Many of them are in use in precision laboratory applications. The change to a stainless steel diaphragm (from dural) was made six or seven years ago to improve the high degree of stabilization still more, and the second "A" in the type number marks the change.

The output is high—only about 50 db below 1 volt per dyne per square centimeter—and this makes possible attainment of excellent signal-to-noise ratio in a preamplifier in spite of the high input impedance which is necessary.

The high output is attained by a careful reduction in parasitic capacitance, so that as much as possible of the effective capacitance is working. The diameter is larger than mechanical consideration alone would dictate, again for the purpose of increasing the out-

put. The high sensitivity is not achieved at the expense of fragility—microphone overload occurs at about 150 db sound pressure, which is unbearably painful to the human ear. Most preamplifiers will overload before the microphone does. Because the human ear overloads before the 640AA does, it has become the standard microphone for hearing aid testing, where receiver output sound pressures may reach 135 db.

Since the diaphragm is tightly stretched, wind has no effect, and close talking has no tendency to blast. The tight stretching places the diaphragm resonance at the top of the working frequency range and makes it easy to damp it out by air viscosity. There are no resonances in the working range, and this makes for a smoother output.

The finite size of the microphone produces a variation of response with angle of incidence of sound, a rise in pressure due to its acting as a baffle. This can be and has been widely used to make one part of an orchestra stand out from the rest, i.e., to improve presence.

The effect can best be shown by a series of typical curves. At (A) Fig. 1 is shown the response curve of the microphone with constant sound pressure at the diaphragm. The response in a free field, with the sound passing across the diaphragm is shown at (B). Note that the response has been extended and is very uniform. If, however, the microphone is pointed directly at the sound, there is a hump in the response curve, as is shown at (C).

The first practice in using the micro-

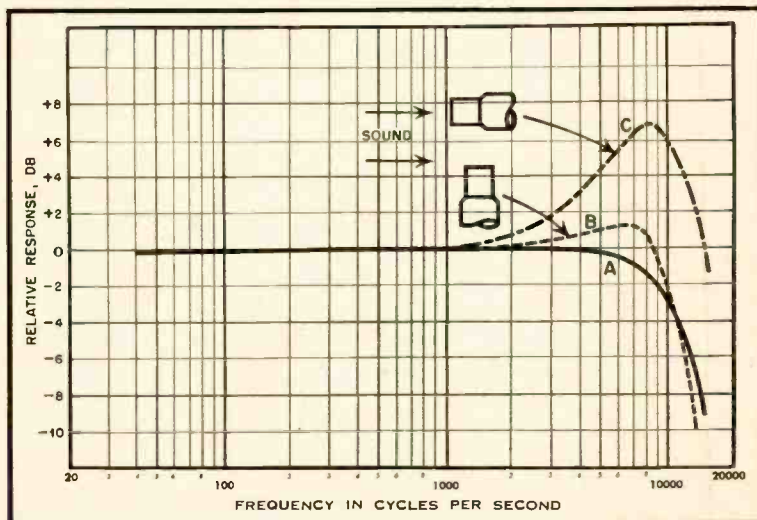

Fig. 1. Response of typical 640AA condenser microphone under various conditions: (A), with constant sound pressure at the diaphragm; (B), in free field with sound passing across the diaphragm; (C), in free field when pointed directly at sound.

\* Audio Instrument Co., 1947 Broadway, New York 23, N.Y.

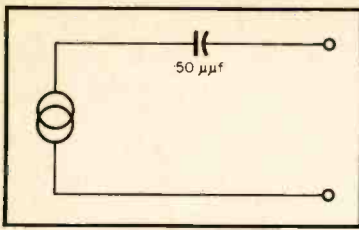

Fig. 2. Equivalent circuit of 640AA condenser microphone.

phone was to point the *side* at the source of sound. This is very satisfactory in an anechoic room where there is no reflected sound. In a studio, however, the direct sound is reproduced with uniform response, but the reflected sound is reproduced with a hump in the high-frequency range. Such an effect is definitely harmful to presence—it tends to give an unnatural sound.

More recent practice is to point the microphone directly at the sound source, and use an equalizer to remove the response peak. Then the direct sound is reproduced with uniform response, but the reflected sound is reproduced with mild attenuation of the higher frequencies. This corresponds to our normal mode of hearing, and presence is enhanced. The average broadcast studio has excessive reverberation at the higher frequencies and this method serves to alleviate the effect.

Such a method of enhancing presence does not turn the 640 into a highly directional device. It is still fundamentally non-directional (with a directional accent) and should not be misused. It is very suitable for single microphone orchestral pickup. When handling a soloist it may not be directional enough to keep the orchestra down without using a screen, in many studios. It has been used as a cast microphone, where the ability to handle six or more actors

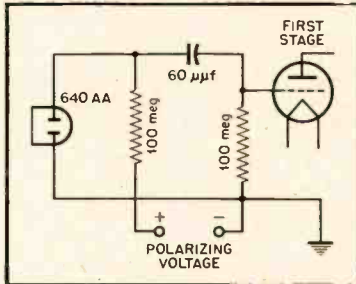

Fig. 3. Input circuit of preamplifier.

non-directionally is very useful. Its smoothness and naturalness contrast well with the sound of many microphones currently used, though a comparative listening test is often necessary for one who has become accustomed to the raw rough sound of the average speech microphone.

### Subminiature Construction

From the foregoing it is evident that interest in the 640AA microphone is well justified, and that a suitable preamplifier for it would warrant the design effort.

In the equipment to be described it was decided that use of subminiature techniques would be worthwhile, to reduce size. A great deal of audio equipment can be reduced 50 to 90 per cent in size—without impairing performance—by the use of subminiature techniques, but these methods have not been used on precision equipment heretofore. This has resulted from the fact that subminiature specialists have generally had little interest in or acquaintance with the high quality field. It does take knowledge of both fields to produce a satisfactory design.

Before we start our discussions, it might be well to correct some common misconceptions by emphasizing that miniature tubes plug into sockets (no soldering is necessary), and that high fidelity and an excellent degree of stability can be achieved if the circuit is properly designed.

The design of the input circuit can best be understood if we remember that a condenser microphone requires polarizing voltage to operate, and that it is equivalent to a generator with capacitive internal impedance. The 640AA for design purposes is equivalent to the typical circuit of Fig. 2.

At very low frequencies the impedance of the microphone rises to a high value: 50  $\mu$ f has a reactance of over 50 megohms at 50 cps. It is therefore necessary to keep the shunt resistance of the input circuit insulation above 5000 megohms, and the circuit itself at 50 megohms. A good arrangement is given in Fig. 3.

The use of 100-megohm resistors poses a problem with the coupling capacitor. If we have 200 volts across the capacitor, and use a 100-megohm grid leak, then the leakage resistance of the capacitor must be very high. For example, a leakage resistance of 100,000 megohms will place two-tenths of a volt, d.c., at the grid circuit, with adverse effect on performance. Essentially the same requirements apply to insulation supporting these terminals. This means that the circuit insulation should be polystyrene or Teflon, and the coupling capacitor should be molded ceramic. For best results the insulation surface should be cleaned with pure alcohol just before assembly, and protected by a dust cap when the microphone is not in place.

The output circuit offers no choice if the preamplifier is to be used in a broadcast or recording system. It is highly undesirable to run unbalanced circuits (one side grounded) of any real length, for noise pickup becomes a real problem

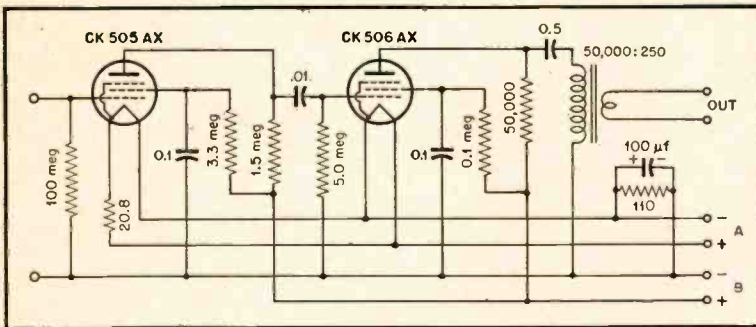

Fig. 4. Basic two-stage preamplifier.

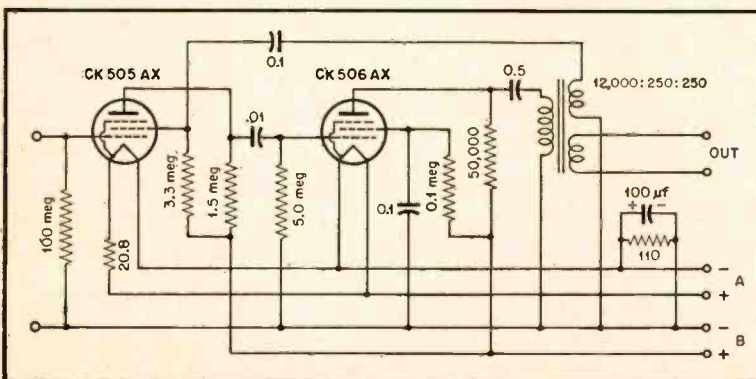

Fig. 5. Two-stage preamplifier with over-all feedback.

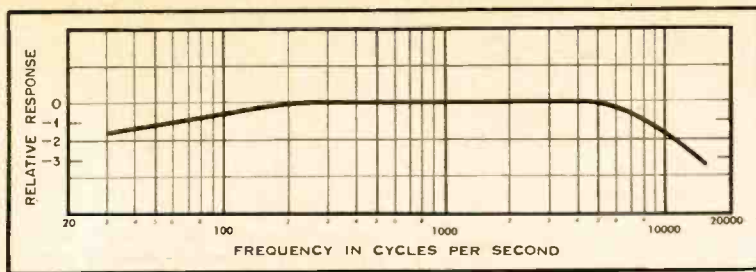

Fig. 6. Frequency response of a two-stage preamplifier with over-all feedback.

in spite of any reasonable amount of shielding on the cable. An output transformer must be used to feed the cable, and the output circuit must be balanced to ground.

Of course, in the laboratory, cables a few feet in length are possible, and an unbalanced output is permissible. This allows us to dispense with the output transformer. Sometimes there is a great deal of electrical equipment about a laboratory, and switching clicks get into the output cable. Fortunately, most laboratory work involves meter reading rather than listening, and clicks that would be annoying to the ear become occasional meter kicks that are annoying but not too harmful. Hum will also not affect meter readings if it is far enough below the working tone in level, yet still far stronger than the ear would tolerate.

#### Possible Designs

Three types of circuits are possible, and each has its own proper place in the audio field.

The first is a two-stage design of such high gain that it can work directly into the mixer of a speech input system. It may be convenient to gain an extra microphone position or two by feeding such a preamplifier into a medium-gain mixer position usually used for phonograph pickups. The same design can be used successfully in the laboratory, for it has enough gain to work directly into a standard vacuum tube voltmeter even with low level sounds.

The second is a single-stage circuit which should be fed into the low-level input of a system. In some cases it can work into the medium-level input, but too often there will not be enough gain available. In the laboratory it will work directly into a standard vacuum tube voltmeter with sounds of conversational level and above. Of all three designs, the single stage comes nearest to being a good general purpose job, for it has both the high stability of laboratory equipment and the medium-gain balanced output required by the broadcaster and recordist.

The third is a cathode follower, designed by applying subminiature techniques to the circuit popularized by

Cruft Laboratory for sound measurements during the war. This circuit has great stability, but the lack of gain and the unbalanced output make it more a laboratory device than one suited to

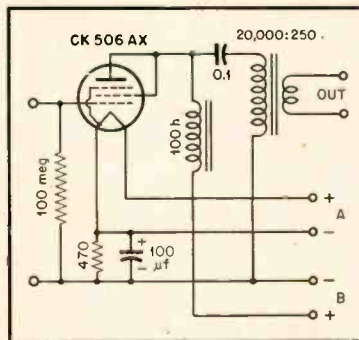

Fig. 7. Single-stage preamplifier schematic.

every application. It is particularly useful for measurements of hearing aid output, where the input is at high level, and other circuits might approach overload. It also lends itself to a wearable design, and to an easily hidden ultra compact model for television applications.

For high gain we chose a two-stage circuit, shown basically in Fig. 4.

If we wish to modify the performance of the circuit, we have two alternatives: Change the output stage to triode form, or add two-stage inverse feedback. The latter way is rather interesting, and we have shown it in Fig. 5.

It is not convenient to use the usual form of two-stage feedback, from the second plate to the first cathode, when using filament tubes. Using a separate filament battery for the first stage would place the cable capacitance between filament circuit and ground across the feedback resistor. This would give a rather undesirable rising high frequency response.

Instead we have used a tertiary winding on the output transformer, as in Fig. 6. The amount of feedback, and therefore the over-all gain, is easily set by adjusting the number of turns on this winding. Excessive feedback leads to instability, and insufficient feedback to less than optimum performance, but the balance between the two is only moderately critical with a well designed transformer. Frequency response of a design of this sort can be very satisfactory.

The light drain of a subminiature design encourages battery operation. With an *A* drain of 80 ma at 1½ volts and a *B* drain of 2 ma at 135 volts, battery life is long even with compact hearing-aid batteries.

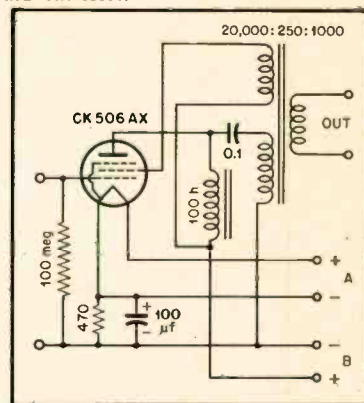

Fig. 8. Single-stage preamplifier with feedback.

#### Medium Gain Circuit

A single-stage circuit, Fig. 7, presents fewer design problems and a more compact layout. Its reduced gain is an ad-

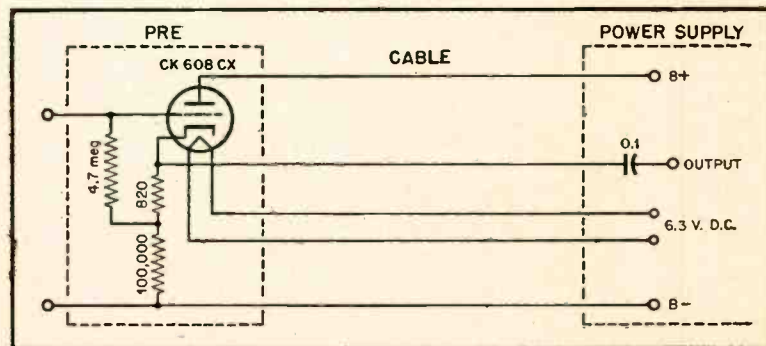

Fig. 9. Cathode-follower preamplifier schematic.

vantage in most broadcast systems, for then less padding is needed to work into the microphone input position, as is usually preferred.

As will be discussed further in a later section, the circuit has ample stability. If it is desired to add feedback, this can be done very readily by the method shown in Fig. 5. The following circuit, Fig. 8, which dispenses with the blocking capacitor at the expense of more feedback energy from the transformer, is also possible.

It is not possible to use feedback from plate to control grid because of the frequency discrimination which would result from having the microphone capacitance shunted across the feedback path. Feedback from plate to screen grid by direct resistance path is not satisfactory; the low amplification factor of the screen grid gives too low a value of gain in the feedback loop, and the feedback can exert little benefit. Feedback, if any, should be derived from a transformer tertiary winding.

#### Ultra Compact Design

The circuit shown in Fig. 9 is fundamentally a precision laboratory circuit of approximately unity gain. Because it has fewer components, and because many of these can be placed at

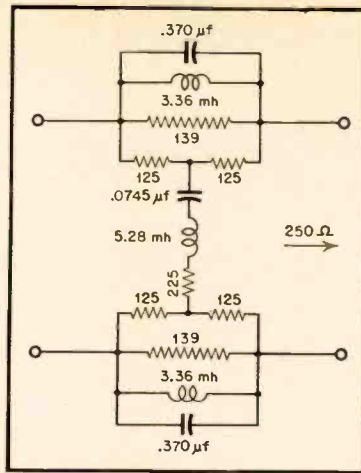

Fig. 10. Schematic of balanced equalizer for removing microphone peak.

the power supply, it also lends itself to ultra compactness. The output is grounded on one side, which makes a long cable run undesirable from the noise point of view. It is possible to place an isolating transformer in the audio output line at the power supply box if it is properly shielded, and there-

by reduce the length of unbalanced line to an absolute minimum.

In most laboratories the output cable is not over ten or fifteen feet long, and these remarks on noise pickup do not hold. The invariability of ratio is a big attraction to the laboratory user, for it gives him a sound level meter of higher inherent stability than that of the average sound level meter, with the high accuracy of calibration which is possible with the 640AA by use of the reciprocity method.

In the design of the circuit two relations must be borne in mind. The output impedance of the tube itself is determined by the relation

$$R_{out} = 1/G_m$$

Under the conditions holding in the usual design, this gives a close approximation to the true value. It should be remembered that  $G_m$  is not the tube data-book transconductance, but the value under the voltage conditions imposed by the circuit, and generally a great deal lower than the book value. To get a reasonably low output impedance, therefore, a tube with high data-book  $G_m$  is necessary.

The voltage ratio of the follower is reasonably closely determined by the following relations:

$$\frac{E_{out}}{E_{in}} = \frac{\mu'}{\mu' + 1}$$

This relation holds only when the external circuit does not load the tube appreciably. It should be remembered that  $\mu'$  is not the data-book amplification factor of the tube; it is the equivalent gain of the circuit if operated as a plate-loaded amplifier.

The formula would seem to suggest the use of a pentode. However, a pentode is somewhat sensitive to external loading at high levels, and a triode is often preferable. The loss in gain is only of the order of 0.5 db. The use of a heater type tube of high transconductance raises the power consumption and a-c operation becomes highly desirable.

At the beginning of this paper it was indicated that an equalizer to remove the microphone response peak would be highly desirable. It is best to use an equalizer which will not disturb the balance of the circuit, so the balanced network of Fig 10 has been designed.

#### Stability

Whenever we propose battery operation, we have to design for high stability, so that the shape of the response curve will not change appreciably with battery voltages. The gain should also be constant right up to the end of useful battery life. It is possible to secure such stability without the use of feedback, as the curves of Figs. 11 and 12 will show, taken on the circuit of Fig. 7.

Longer tube life and greater freedom

[Continued on page 35]

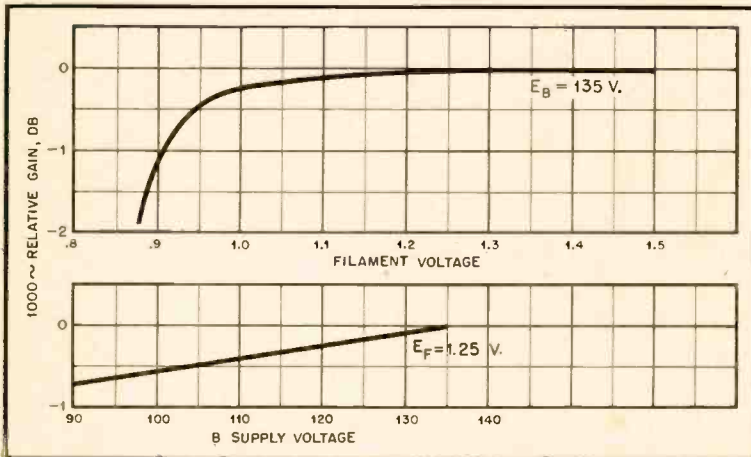

Fig. 11. Effect of A and B battery voltages upon 1000-cps gain.

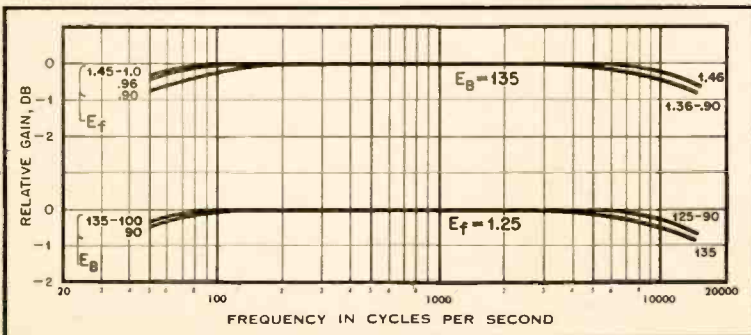

Fig. 12. Effect of A and B battery voltages upon frequency response.

# New Polyphase Reproducer System

MAXIMILIAN WEIL\*

A new phonograph pickup design incorporating established operating principles which provides a simple and logical solution to the problem of reproducing different types of records and transcriptions.

**C**ONVENIENCE DICTATES that a satisfactory phonograph pickup must be able to play different types of recordings with a minimum of effort on the part of the user. To produce a system wherein one and the same instrument may be capable of doing this at will—with equal efficiency and without cross-modulation and other forms of distortion—was the object of considerable development which has reached a successful conclusion. Many attempts in that direction have been made since the advent of the lateral disc—more than fifty years ago—but, until now, without success.

To the average person, the need of more than one reproducer to play the present commercial discs properly is something new. Actually, that problem has been with us for many years. In the acoustic days, prior to 1925, the buying public had to contend with at least three different types of discs. There were the lateral disc, the Edison hill and dale, and the Pathe. Although the Pathe was a hill and dale type of disc, it required a spherical stylus point—believe it or not—of 16.0 mils radius.

To meet that problem in those days, there were the double tone-arm on one base, two reproducers back to back, two needles joined together on the same stylus-bar, etc. This latter arrangement is shown in *Fig. 1*. Note the stylus-mass further loaded by the weight of the additional needle. Counterparts of such

\*Chief Engineer, Audax Company.

devices will be recognized readily in today's picture.

The problem of a universal reproducer exists not only in the home. Radio stations have had to and do contend with different types of discs, apart from the recently introduced microgroove types. There are the vertically-cut discs, the

*Fig. 1. Early form of acoustic reproducer employing two needles for reproduction of both lateral and vertical (hill and dale) discs.*

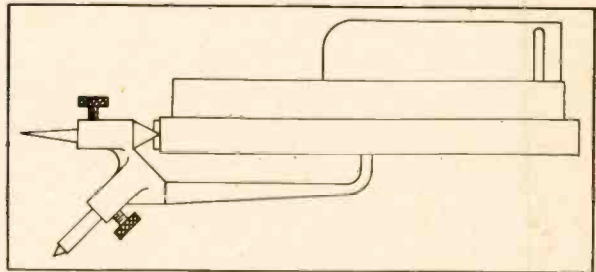

lateral transcriptions and the commercial phonograph records. It will be seen then, that the problem of a universal reproducer is still with us. Indeed, with the appearance of the microgroove type of discs, the problem is greatly magnified for the home as well as for studios.

This development was nearing completion when the microgroove discs made their appearance. The commercial success of microgroove discs depends entirely on the availability of the proper playback equipment—special turntables and pickups. Thanks to the development of the "rim drive," satisfactory turntables are now available which, by the mere flip of a switch, will run at the desired speed.

## Reproducer Requirements

Microgroove discs call for a reproducer affording a new order of delicacy in responsiveness and fine-groove-riding qualities. This presented a problem with a new and more difficult order of dimensions.

Reduction of the vibrating mass as

nearly as possible to the theoretical zero ideal is the primary essential to any reproducer system where high quality or facsimile performance is the objective. The term "facsimile" rather than "high fidelity" is used here because, through loose usage, "high fidelity" conveys a variety of meanings. To the electronic field, "high fidelity" denotes merely a wider frequency range, whereas a good deal more than wide frequency range is required to obtain facsimile performance. Obviously then, any attempt to provide a single reproducer unit for all types of discs by grafting two needles to the same vibrating element, thereby greatly increasing the moving-mass, is in a direction away

New Audax Polyphase Reproducer which provides two styli of differing radii to permit playing on both standard and microgroove records simply by rotation to pickup head. Head may be mounted on any conventional arm.

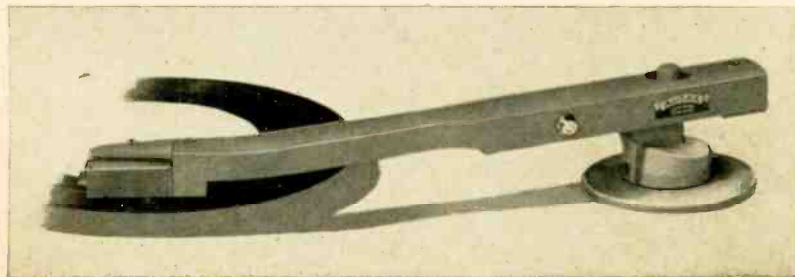

from quality performance. Loading of the vibrating mass brings with it a bad form of distortion which not only impairs the added quality in the new discs but accelerates the destruction of the grooves as well.

For commercial practicability the different types of today's discs require a single pickup unit capable of delivering a high quality performance, the same as would be delivered by two (or more) separate reproducers each designed expressly for a given type of recording. The radically new reproducer system developed by the writer and here to be described will do just that.

#### Relayed-Flux Principle

To achieve near-zero vibrating mass, the writer's "relayed-flux" principle was decided upon for use in this system. This principle is well-known by now and needs no detailed description here other than to state that the conventional vibrating armature-mass is made stationary—that is, it is fixed in the coil—and a tiny bit of magnetic alloy is used to *relay* the modulated flux to the stationary armature.

The problem was approached in reverse. Instead of first designing the generating system and letting the stylus fall where it might, the problem of styli was first disposed of, and a single generating unit was then built to serve the disposition of the styli.

The foundation was laid with two styli, 17 and 18, in Fig. 2, although this system may be built for three or even four styli. Each stylus-bar is a highly tempered cantilever spring of non-magnetic material. The extreme end of the

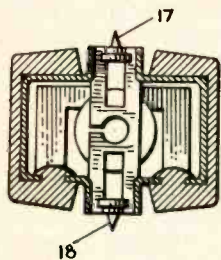

Fig. 2. Drawing of end view of new Polyphase reproducer with two separate styli, single magnet and voice-coil.

stylus-bar carries a jewel-point in a tiny piece of mu metal—the "relay"—whose function is to relay the oscillating flux from the pole shoes to the stationary armature.

The crux of the design is a magnetic circuit built to coact with a plurality of styli. It is in the form of a bridge, as shown in Fig. 3.

In Fig. 2, the two styli are *replacably* anchored, as shown. It will be noted that the styli are mechanically independent of each other. Each stylus is capable of being vibrated without af-

fecting the other in any way. The voice-coil is wound in solenoid fashion and, instead of the usual location in front, it is unconventionally placed to the rear of the structure, with its stationary armature longitudinal and parallel to the pole-shoes. One end of the stationary armature is split up into as many branches as the number of styli desired. These branches extend radially from the center of the voice-coil and are disposed in proper magnetic relation to each "relay." The reluctances (air-gaps) of the magnetic circuit are disposed as shown in Fig. 2. It will be seen that when the styli are idle, there is no flux through the armature. However, when a stylus is vibrating, an alternating magnetic-flux surges through the armature, inducing an e.m.f. in the voice coil. *F* is the source of magnetic flux, and is provided by a permanent magnet.

Disposition of the styli in a simple series arrangement would be the first to come to mind. However, in a series

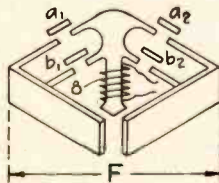

Fig. 3. Equivalent magnetic circuit corresponding to a balanced bridge.

circuit, there would be interaction between the styli which would introduce a form of phase-distortion. This is something to be avoided if *ear quality* performance is to be had. The bridge arrangement of the reluctances, shown in Fig. 3, prevents such phase-distortion very effectively.

In a unit designed for two types of discs, the styli are preferably mounted 180 deg. apart. Therefore, to bring into action either one of the styli, the unit is rotated through 180 deg., where it snaps into the proper position for the selected stylus. The arm is built with a special bearing to receive the neck of the reproducer, which may be rotated manually. The arm extension, shown in the photo, has the function of protecting the idle stylus against any mechanical injury.

#### Stylus-Bar Design

The material used in the stylus-bar is one of the important points that was given special attention from the very first conception of the system. If the magnetic circuit were so designed as to embrace the stylus-bar as part of it, then the stylus-bar would have to be of soft iron. Mechanically, the structure of the unit is such that the acting stylus supports the reproducer and arm—to the extent of the point-pressure on the disc.

Each time the reproducer is placed on a disc, the tendency is to press the stylus upward. Therefore, if the stylus-bar were of soft iron, it would gradually become set. To prevent this, the stylus-bar must have high reactive properties that will not fatigue.

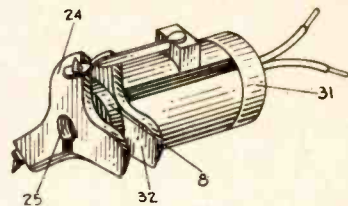

Fig. 4. Polyphase reproducer arranged for mounting of three styli. As shown, upper stylus is for lateral records, one at lower left is for vertical transcriptions.

On the other hand, if the stylus-bar were made of spring steel, it would instantly become polarized and introduce serious distortion. That is why the magnetic circuit evolved for use in this system specifically excludes the stylus-bar from being a part of it.

Figure 4 shows one of these new units designed for three different styli. It will be observed that the styli operate in parallel and each is capable of being vibrated independently of the others. The inner tube 25, the voice-coil 8, and the outer tube 32 are telescoped over one another, with the voice-coil 8 sandwiched between the two tubes. The two tubes are of high quality magnetic alloy. To prevent eddy currents, both the inside and outside tubes are split longitudinally as shown. The magnet 31 is disposed in proper magnetic relation to the two tubes. It is magnetized radially, that is, from the center outward to the periphery. The outer tube provides excellent shielding, as it entirely encloses the voice-coil.

Each of the stylus-bars may have such point-radius as may be required for any given purpose. It will be observed in Fig. 4 that the stylus-bar at the top is for lateral recordings, and the stylus at the lower left is for vertical recordings. Easy visibility of the stylus point is highly desirable for obvious reasons. Note that all stylus points are at the front and are easily visible. To bring any of the styli into action, the unit is rotated through 120 deg. Vibration of any stylus will cause modulated flux to surge through the stationary armature. This structure makes a compact and presentable unit.

In reproducing lateral recordings, the stylus-point traces a vertical component whose frequency may be shown to be equal to twice that of the impressed

[Continued on page 33]



# Problems in Audio Engineering

LEWIS S. GOODFRIEND\*

Part II. Continuing the discussion of the effect of sound upon the human ear, with particular attention to intensity and frequency—a subject known as psycho-acoustics.

IN ORDER TO finish the study of hearing we shall examine the units of sound power and the experimentally determined behavior of the ear together with certain psychological facts. From them we shall be able to understand many rule-of-thumb methods used in audio work.

Engineers in audio and radio for many years used units of power that bore a logarithmic relationship to the actual power. These units of power made it possible to use small numbers to refer to great changes in magnitude. For example, a radio receiving system may absorb  $10^{-9}$  watts from the antenna and have an audio output of 10 watts. This is a power ratio of  $10^{10}$ . Moreover the power ratio usually involves three or four significant figures, which must be written out in computation or description. The use of logarithmic ratios obviates much of this bookkeeping annoyance. Although several common logarithmic units have been used, the most common today is the decibel (db) which fundamentally is defined by the expression

$$n \text{ db} = 10 \log_{10} W_2/W_1$$

where  $W_2$  and  $W_1$  are the two powers

\*Stevens Institute of Technology, Hoboken, N. J.

being considered. The expression may be modified to use voltage, pressure, current, or velocity ratios. However, only when the impedances and power factors associated with these parameters are the same may the pressure ratio, for example, be expressed as

$$n \text{ db} = 20 \log_{10} p_2/p_1$$

The case of varying sound pressures in air is one where the impedance and power factor are essentially the same and we may use either the power or pressure ratio. Also for convenience, since db always refers to a ratio between two powers, we may choose some reference value for one of them. Then we can say that one power is  $n$  db above or below the reference power, thus signifying that it is a certain multiple or fraction of the reference power. The db as a unit of power is extremely useful when we consider the range of audible sound powers and it has been applied universally in audio work. Usage has established several accepted standard reference levels. The two most-used references today are  $10^{-16}$  watts/sq. cm. ( $10^{-16}$  watts per square centimeter) for acoustical intensity, and 1 milliwatt (0.775 volts across 600 ohms) for the audio facilities reference.

In this series of articles db will be

used wherever applicable. It is interesting to note that this unit, proposed originally for engineering facility, is closely related to the Weber-Fechner Law, one of the fundamental laws of psychology concerning sensation. The Weber-Fechner Law states that for a certain intensity of a given sensation (light, heat, pressure) equals the logarithm of the intensity of the stimulus producing the sensation multiplied by a constant. This may be expressed algebraically in two ways

$$\text{Sensation} = K \log \text{pressure}$$

$$\text{Change in sensation} = K \frac{\text{change in pressure}}{\text{pressure}}$$

Here we have an expression that looks similar to that for the decibel, and the db is close enough to the manner of sensation of sound so we now have a rule of thumb, fairly accurate and very practical. Two db is the smallest average discernible step in the sound intensity of speech and music at normal intensity levels. This value does not agree exactly with the published curves for pure tone tests of this minimum perceptible difference. The variation is caused by the fact that the tests were pure tone tests, and were minimum values obtained under laboratory conditions. Furthermore, the methods used cannot be applied outside of the laboratory.

Nevertheless it is still important to consider the curves of Fletcher, Fig. 1, which show the pure tone "differential sensitivity" of the ear to intensity changes at various levels above the threshold of hearing (sensation levels). The curves do show that the ear is most sensitive to changes in intensity at high sensation levels and in the mid-frequency range.

The threshold of hearing at certain points has already been discussed, and it is now necessary to examine the threshold of the entire spectrum. Many observers have made extensive surveys of the threshold and their result is shown in Fig. 2. The threshold of feeling is also shown on the figure and is from the data of R. L. Wegel. Two important audio facts can be seen on these curves; it takes more sound energy to reach threshold at the low and high frequencies than it does at the mid-frequencies. Moreover, the threshold of feeling is approached more rapidly at the extremes

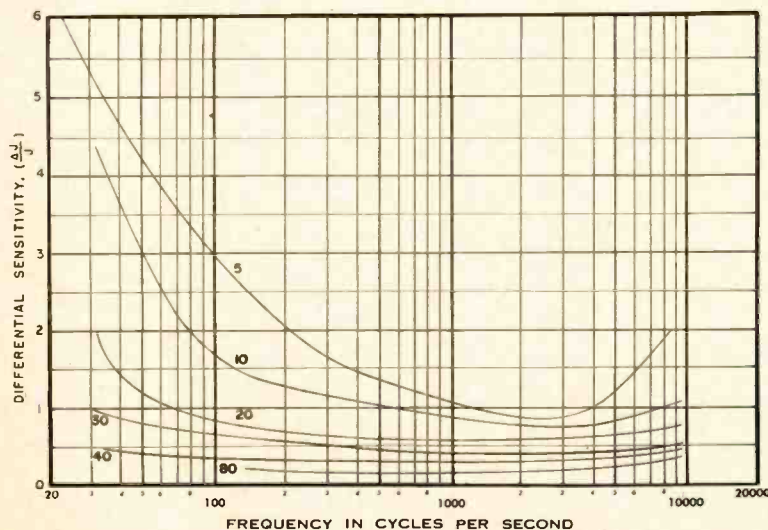

Fig. 1. Differential sensitivity of the ear for pure tones.  $J$  is the sensation level and  $\Delta J$  the change in level. The sensation level in db is marked on each curve. (H. Fletcher, *Speech and Hearing*, D. Van Nostrand Co., Inc.)

of the spectrum. In modern living these characteristics provide a comfortable cushion for the constant hum and rumble of radios, large aircraft, subways, and trains, all of which make up the ambient noise of a city. It is a pleasing thought that we are not able to hear the rumble as readily as speech and music which have their energies concentrated in the mid-frequency range. It is also well to realize that *feeling* sound when it reaches high intensity is a safety system. It is a signal to the hearer that he is exposing himself to sound intensities that may damage his ears. Most people having the sensation described by "feeling" would call it annoying or painful and would probably stop the source, or leave the vicinity.

It is now necessary to study the response of the ear to frequency and its sensitivity to frequency change. The subjective response to a tone of a given frequency that relates it to tones of other frequencies is known as *pitch*. When someone strikes a note on a piano most of us associate that note with some pitch. The tone need not have any particular waveform, to be tagged by the ear as having a given pitch. Nor is the numerical relationship of the frequency associated with a given pitch constant, but is dependent on intensity and waveform. Thus we note two basic sensations in hearing: loudness related to intensity, and pitch associated with frequency.

In defining the pitch of a tone as its position on a subjective frequency scale we are saying in effect: low frequencies produce low-pitch sensation and high frequencies produce high-pitch sensation, but pitch and frequency are not identical. The frequency of a tone is the number of cycles per second of the sound pressure in the transmitting medium. The pitch, on the other hand, is the *sensation* of these vibrations and is related to frequency by the ear in a manner following the Weber-Fechner Law. That is, the sensation (pitch) increases logarithmically with an increase in the stimulus (frequency). A series of experiments were made by Stevens, Volkman, and Newman to determine which frequencies sounded half the pitch of other frequencies. The results of this series of tests were plotted and a sensation unit determined. The sensation units have been given the name *mel*, with the reference point at 1000 cps equal to 1000 mels.

Concerning the sensation of change in pitch, W. B. Snow has shown that the pitch of a pure tone changes with loudness level and that at low frequencies changes in pitch on the order of ten per cent can occur for changes in loudness of sixty db. Here again the audio man should stop and think about the application of this fact to his every-

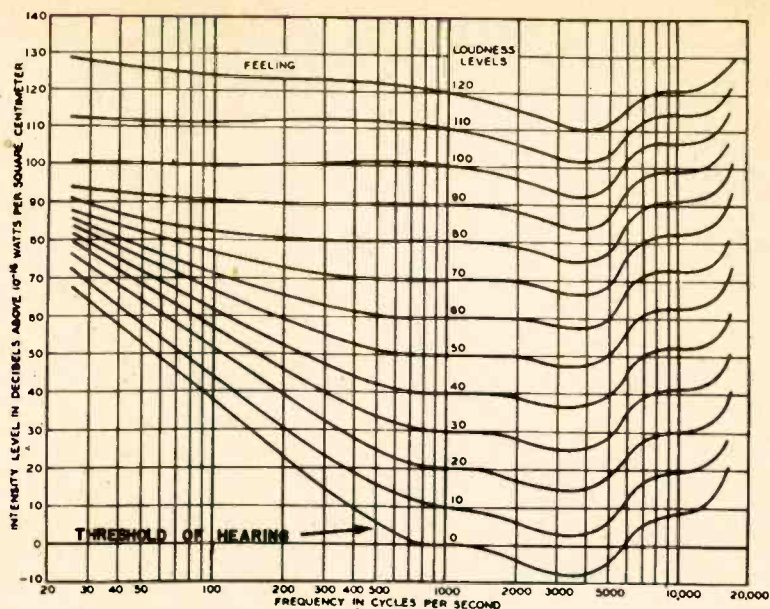

Fig. 2. Equal loudness contours with the thresholds of feeling and hearing. (After Wegel, and Fletcher and Munson, *J. Acous. Soc. Am.*)

day work. A change in loudness can change the pitch of low-frequency tones. The relation of pitch to loudness is shown in Fig. 3. Another factor in the sensation of pitch is the ability to differentiate between the pitches of two different tones. Figure 4 shows the minimum perceptible differences, plotted against frequency for pure tones. The curves show that the ear is a critical comparator for pitch. It will be seen later that the ear is not as good as an absolute measuring device for either pitch or loudness.

The Fletcher-Munson curves have been mentioned and used by numerous authors as the basis for many strange statements and devices and a few practical and useful ones. The curves, in a

modified form, shown in Fig. 2, lie in the area between the thresholds of hearing and pain. To obtain the data, a number of test tones were compared to a 1000 cps tone at various intensity levels by a large sample of young people with good hearing. The curves show the number of db above threshold required for a given tone to sound as loud as the 1000-cps tone at the intensity level marked on each curve. At other frequencies this value is the sensation level of the tone. The curves show the response of the ears with the listener in a free field. For tones introduced into the ear by earphones as in the original tests, the little dip occurring between one and five thousand cycles is absent. There has been much speculation as to

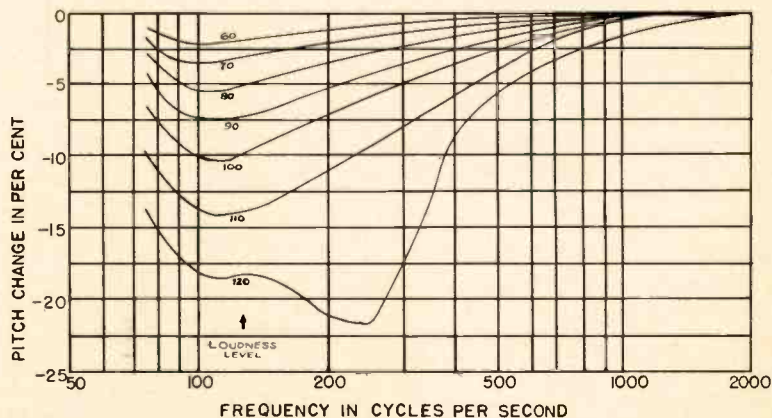

Fig. 3. The variation of pitch with loudness at low frequencies. The pitch decreases with loudness. (Snow, W. B. *J. Acous. Soc. Am.*)

the cause for this difference in the results of free field minimum audible sound intensity, and the minimum audible pressure in the ear canal.

The part played by the ossicles in introducing distortion in the ear at high sound levels has already been discussed, and the curves of Fig. 5, show the sensation levels at which the harmonics are just perceptible when the ear is stimulated by pure tones. Here again we see a fact often neglected. The ear produces appreciable distortion of low-frequency tones at normal sound intensity levels. When the high fidelity enthusiasts realize the importance of these curves and begin to study the comparative effects of level vs aural harmonics and amplifier power output vs harmonic distortion they may find that it is the reproduction intensity level and not the amplifier distortion that is causing their troubles.

It is also interesting to note the effects of two loud pure tones introduced in the ear simultaneously. This case too can exist in practical sound work, and gives rise to numerous *sum and difference tones*. These by-product tones are the result of the *beating* of two tones and their harmonics, and to the non-linear characteristic of the ear. Wegel and Lane have shown that when two tones of 1200 and 700 cps are introduced in the ear at an 80 db sensation level, seventeen subjective tones and the two original tones were heard. Other experimenters using animals' ears and electrical measuring systems have confirmed this work.

Having examined intensity, loudness, frequency, and pitch and their relationships, we may now examine masking. When listening to a loud sound the ear tends to suppress a second sound impressed on it. In other words the first, loud, sound masks the new sound. This statement is not absolutely true for all frequencies, and tests have been performed to discover the nature of masking. The results of some of these tests are shown in Fig. 6. It can be seen that in general the loudest sound masks sounds of lower loudness, and that low-frequency tones mask high frequency ones. There are no other generalizations that can be made concerning masking. Early studies indicated many results which were later shown to be incorrect. However, there are certain points of interest on most of the curves. Note that the tones near the masking tone may not actually be heard but only indicated to the ear as being present by beating with the masking tone. Beats may also indicate the presence of a masked tone at the harmonics of the masking tone. Figure 7 shows the masking effect of low-frequency noise.

One of the few places where the ear  
[Continued on page 34]

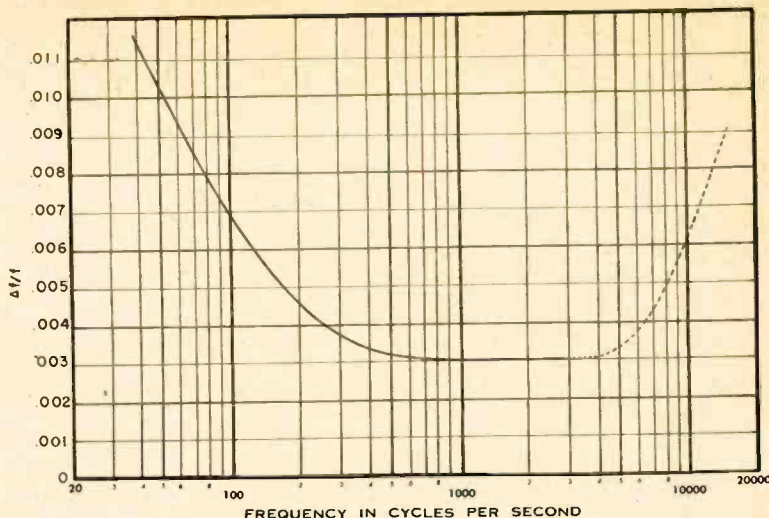

Fig. 4. Minimum perceptible difference in frequency for pure tones plotted as the ratio of the change in frequency  $\Delta f$  to the frequency  $f$  at a sensation level of 40 db.

(H. Fletcher, *Speech and Hearing*, D. Van Nostrand Co., Inc.)

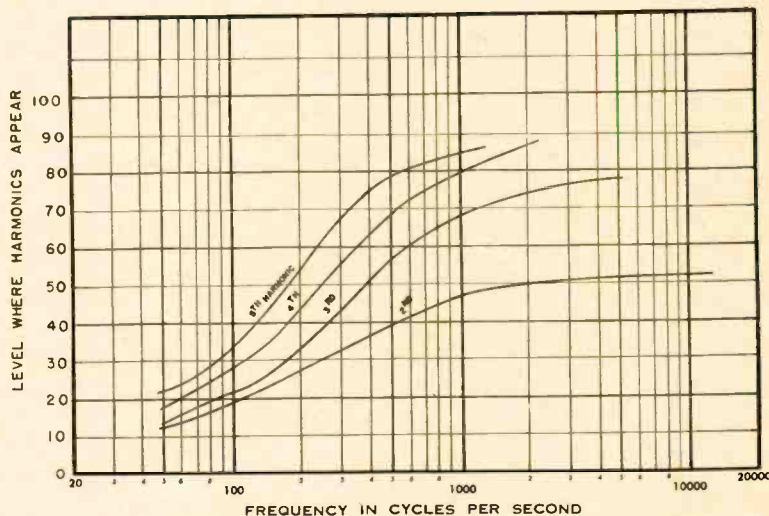

Fig. 5. The sensation levels at which harmonics are just perceptible.

(H. Fletcher, *Speech and Hearing*, D. Van Nostrand Co., Inc.)

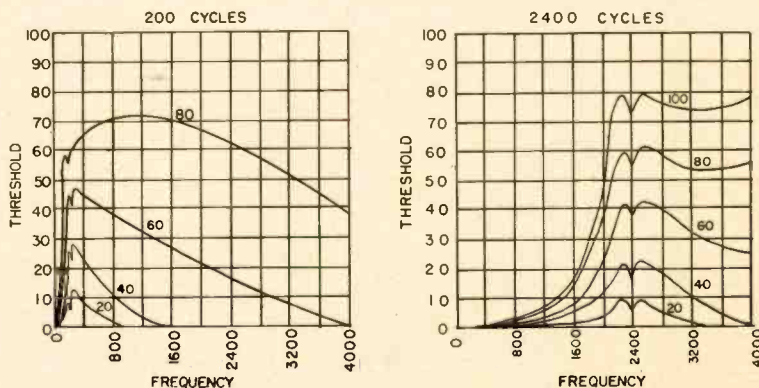
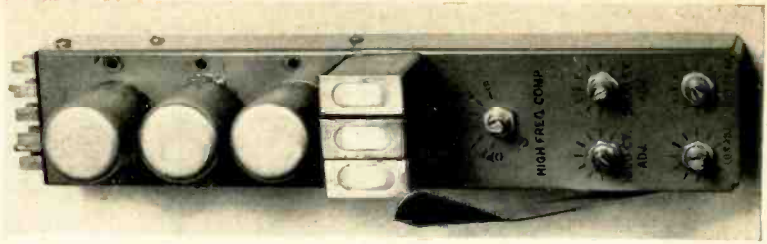

Fig. 6. Masking of 200 and 2400-cps tones. The masking is expressed by the number of db that the threshold is raised.

Crossover filter showing adjustments. Note the unit is of the "plug-in" type.



# Crossover Filter for Disc Recording Heads

H. E. ROYS\*

Description of a practical device designed to compensate for variations in cutter characteristics, both at the transition frequency and at the high-frequency end of the spectrum.

**T**HE FREQUENCY-RESPONSE characteristic standardized upon by the National Association of Broadcasters for lateral disc recording is based upon a cutter characteristic having a transition frequency of 500 cps. The NAB standard curve, *Fig. 1*, includes high-frequency tip-up having the characteristic shape of a resistance capacitance network of such proportions that the time constant  $T = RC$  is equal to 100 microseconds ( $R$  expressed in ohms;  $C$ , in farads). Some additional low-frequency boost, below 100 cps, is also included, as illustrated by the flatness of the curve between 100 and 50 cps. If

\*Advanced Development Engineer, RCA Victor Division, Radio Corporation of America.

we subtract the 100- $\mu$  sec tip-up curve from the standard and extend the low-frequency response on a 6 db per octave slope, we then have the characteristic of the ideal cutter, *Fig. 1*. Extensions of the constant-velocity and constant-amplitude portions of the curves intersect at 500 cps, which is designated as the crossover point.

### Cutter Design

The ideal curve shows some rounding off at the crossover frequency. This is desirable from the cutter-design standpoint and also for design of the playback filter, since an abrupt change in response characteristic is difficult to obtain—both mechanically and electrically. The crossover frequency of the cutter is determined by the resonant fre-

quency of the mechanical system comprising the effective mass of the moving system and the effective stiffness of the centering means. Below resonance the mechanical system acts like a spring—constant applied force results in constant armature deflection—and hence the lower frequencies are recorded at equal amplitude. Above resonance the system is mass controlled and constant applied force results in decrease in amplitude of deflection inversely proportional to frequency, or the motion becomes constant in velocity. Mechanical damping is used to control the height of the resonance peak, and usually enough damping is included to obtain a smooth characteristic which is rounded off at the transition point between constant-amplitude and constant-velocity portions. With the moving iron-vane type of cutter, it may be difficult to obtain as low a crossover frequency as wanted by decreasing the resonant frequency—either by increasing the armature mass or decreasing the centering stiffness, or both—without encountering instability. The effect of the steady magnetic field provided by the permanent magnet is to act in opposition to the centering spring and attract the armature to the nearest pole piece. If the attraction is too great, centering of the armature becomes uncertain, and hence it becomes undesirable to carry this means of lowering the crossover frequency too far. Increasing the armature mass is not a desirable solution either where wide-range and maximum sensitivity (minimum driving current) is wanted, since both of these requirements call for low mass.

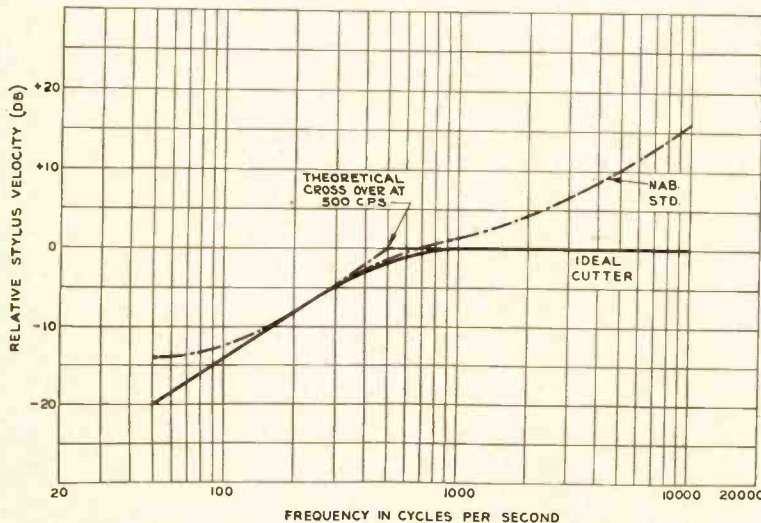

Fig. 1. NAB standard lateral recording characteristic and ideal cutter having a crossover point at 500 cps.

### Crossover Filter Design

An electrical network is a practical means of obtaining the crossover at the

desired frequency and has the advantage that additional controls can be included easily for adjusting other portions of the range. A typical response characteristic of the RCA MI-11850-C recorder while cutting lacquer is shown in Fig. 2, and if we take the difference between this and the ideal curve, we have the desired filter characteristic, Fig. 2c. Analysis of this curve shows that a tuned circuit resonated at about 500 cps will be needed and that the drop-off above resonance must occur at a faster rate than it does below resonance. For one octave above 500 cps, the required response has dropped 3 db, whereas for an octave below, 250 cps, the required reduction is only about 0.3 db. This indicates that a circuit which will put a dip into the curve at about 1000 cps is necessary. In order to equalize the response above 1000 cps, a network which will put a rather broad hole in at about 4500 cps is also needed. Response curves for a number of different cutters show that the same type of filter characteristic is necessary, although the degree of compensation is different in each case. The filter circuit finally arrived at is shown in Fig. 3. It is designed for operation ahead of the amplifier driving the cutter and the input and output impedance is rated as 600 ohms. Input and output impedance characteristics are shown in Fig. 4 for a typical filter setting. The variation of the input impedance is slight, so that a number of filters can be bridged across a program line, using bridging transformers or bridging pads without greatly altering the line impedance. A greater variation in output impedance can be tolerated since the outputs go to individual amplifiers and are not connected together.

In many cases it is found desirable to provide some high-frequency boost, and this is accomplished by connecting capacitors across the two 300-ohm series line resistors. It is also found advantageous to have adjustable resistors in series with the capacitor and the inductance of the 500-cps parallel tuned circuit. By having individual resistors, control of the response at the extreme low frequencies is possible without greatly affecting the amount of boost at 500 cps or the characteristic at the higher frequencies. Likewise, the variable resistance in series with the capacitance permits independent control at the higher frequencies. Variable resistors in the series circuits, which are tuned to 1000 and 5000 cps, provide the necessary adjustments required at these frequencies. The filter may appear somewhat complicated with so many circuits and controls, but this is necessary where ease of adjustment, close tolerances, and adaptability are wanted.

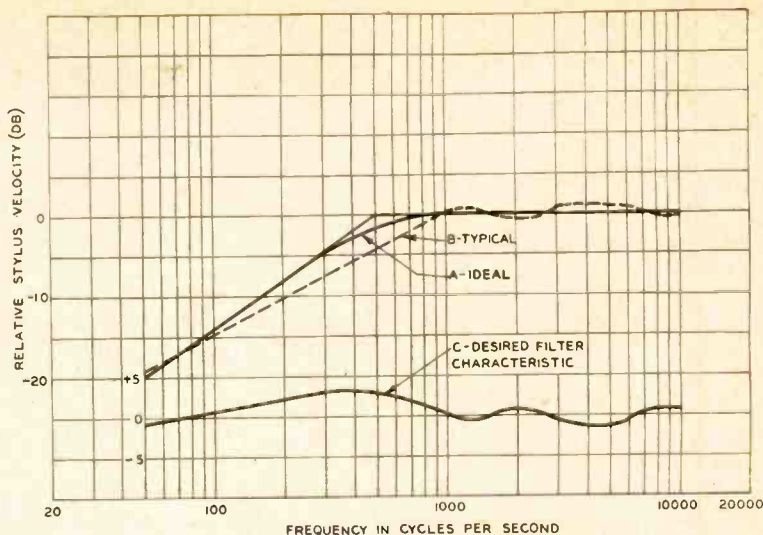

Fig. 2. (A) ideal cutter characteristic; (B) typical response of MI-11850-C recording head; (C) difference between A and B gives the desired filter characteristic.

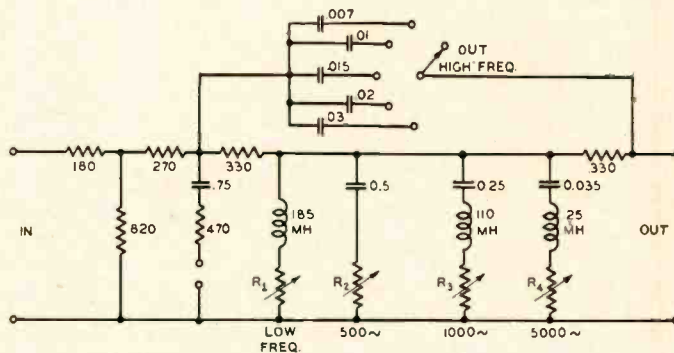

Fig. 3. Circuit of crossover filter.

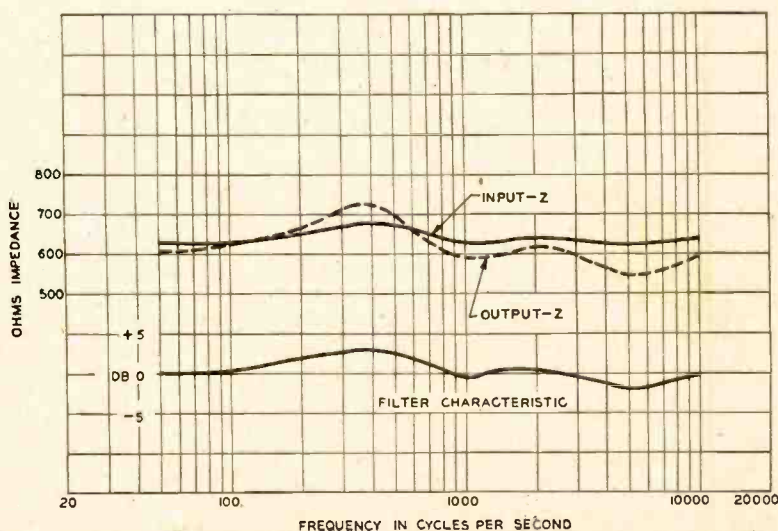

Fig. 4. Input and output impedance of crossover filter for typical filter adjustments.

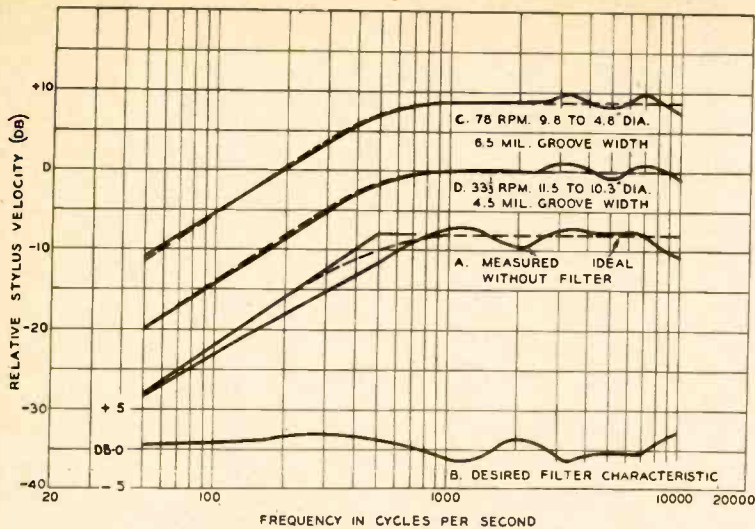

Fig. 5. (A) cutter response without filter; (B) desired filter characteristic; (C) cutting characteristic with filter at 78 rpm; (D) cutting characteristic at 33-1/3 rpm.

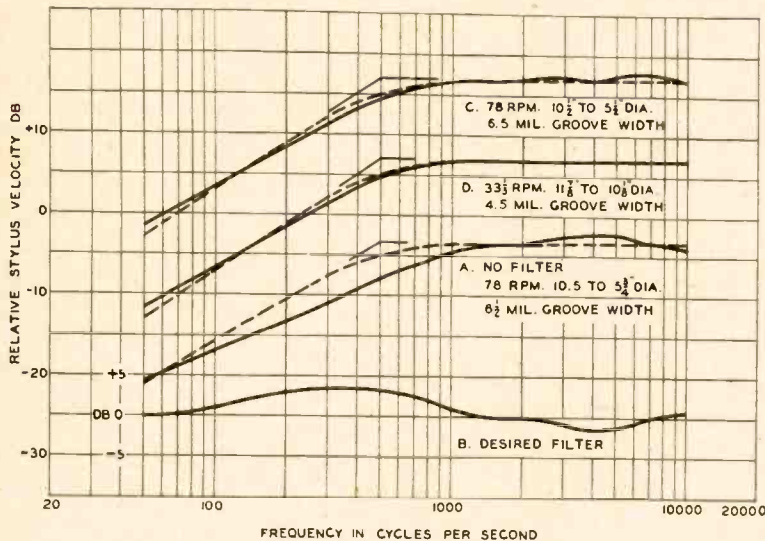

Fig. 6. Characteristics of another cutter without and with filter adjusted for proper crossover and smooth response.

#### Typical Operating Characteristics

A number of cutters were selected and tried, several of which had not received final factory adjustments so that their characteristics were outside of normal limits. This was done in order to check the adequacy of the filter characteristic and range of the adjustments.

The results obtained with one of the cutters which had not received final adjustments is shown in Fig. 5. The cutting characteristic, Fig. 5a, was first measured, with the aid of the FM calibrator while cutting a lacquer, and the desired filter response, Fig. 5b, then determined. Adjustments to the filter were made, using an oscillator, and response measurements with the filter in

place obtained while cutting lacquers at both 78 and 33-1/3 rpm, with the resulting curves shown in Fig. 5c and 5d. Since, as stated before, this cutter had not received final adjustment and the characteristic was not normal, it was found impossible to obtain a smooth, flat response throughout the high-frequency range, but it is believed that the characteristic shown would be acceptable in most cases.

The same tests were repeated with another cutter which had more nearly normal characteristics, and a much smoother response characteristic was obtained, as shown in Fig. 6.

It is interesting to note that the characteristics measured at 78 are al-

most identical with those obtained at 33-1/3 rpm. A groove width of 6.5 mils was used for 78 rpm, since a larger playback stylus having tip radius of 3 mils is normally used for such records, whereas for 33-1/3 rpm recordings, the groove width is narrower—about 4.5 mils—which is wide enough to accommodate a 2.3-mil tip normally used for transcription service. These tests indicate that the filter need not be adjusted for different turntable speeds under normal operating conditions.

Another cutter was set up, and after suitable filter adjustments, a series of response measurements was made throughout the area normally used for the 16-inch discs at 33 1/3 rpm. These results are shown in Fig. 7, and it will again be noted that very little variation in cutting stylus motion was obtained from 15 to 7 1/2 inches diameter. The reflected light pattern, however, showed considerable loss at the higher frequencies, which is attributed to springback and cold flow of the lacquer medium after cutting, and possibly to some bending of the stylus shank, although the FM plates were mounted low and close to the sapphire tip in order to minimize this error. The lacquer recording stylus does not have sharp cutting edges like the stylus used for recording in wax. Instead, the edges are polished at a slight back angle in order to form a smooth surface for pushing the material aside in order to burnish and polish the sidewalls of the grooves. Such burnishing produces grooves which are very quiet in playback. This method of shaping the stylus has become an accepted practice for lacquer recording. The burnishing surface puts some lateral load on the recording head while cutting, which has been investigated.<sup>1</sup> The high frequency loss due to burnishing is difficult to separate from the loss due to springback or cold flow of the recording medium. Investigation<sup>2</sup> shows that this loss becomes smaller as the width of the burnishing edge is decreased.

Since the loss is variable depending upon the recording stylus as well as the medium, it is thought unwise to attempt to correct for it in the recording head. The only justifiable requirement that can be imposed upon the recording head is that for the same input level the stylus must move the same amplitude at the inside of the disc as it does at the outside. A cutter of the true feedback type, where the feedback voltage is derived from the motion of the stylus, could do no better than this. Since the curves in Fig. 7 show no appreciable change in stylus motion when cutting at different diameters, it appears that another means of controlling the high-frequency loss encountered during the cutting of lacquers must be observed. Stylus and lacquer selections are possible means,

and recording with increased high-frequency tip-up at small recording diameters is a practice that has been in use for many years. In fact, most lacquer recording machines constructed today provide for an attachment such as the RCA MI-11101, which will progressively raise the level of the high frequencies as the recording diameter is decreased.

#### Calibrating the Cutter

If an FM calibrator, or a similar device for measuring the amplitude of stylus motion, is available, adjustment of the crossover filter is not difficult. A recording characteristic is first obtained without the filter, the desired filter characteristic is derived, and the filter adjustments made with the aid of an oscillator. Cutting measurements are then taken and minor adjustments made if necessary.

If an FM calibrator is not available, the cutting characteristic should be obtained while recording at 78 rpm, so that a suitable light pattern can be obtained. As is well known, the width of the reflected light pattern is constant for constant velocity of recording<sup>3,4</sup> so that this method may be applied for all frequencies above 1000 cps. For frequencies below 1000 cps, the recorded lacquer should be played back and the output readings compared with those obtained from a calibrated frequency record.

When making light-pattern measurements with the MI-11850-C recording head, it is recommended that 5000 cps be used as the reference frequency. Measurements have shown that the variation at this frequency due to stylus loading when cutting at different diameters is a minimum. This is due to the fact that 5000 cps lies between the two resonant frequencies which are 1000 and 10,000 cps, so that the mechanical impedance is high at this frequency, and the stylus motion is affected very little by cutting losses. Some loss due to loading in the order of one or two db will occur at other frequencies, such as 1000 and 10,000 cps, and this must be remembered when cutting at different diameters. After recording a short band at 5000 cps, some other frequency as 1000 cps, for example, should be recorded for a few grooves adjacent to the 5000-cps band. If the width of the two patterns is not the same, level adjustments at 1000 cps should be made, and a few more grooves recorded for observation. As a check, a new 5000 cps band should be recorded frequently so that finally the correct level is found for 1000 cps as judged by equal width of the two patterns which are adjacent, or nearly so. Such procedure should be followed for each test frequency from 1000 to 10,000 cps. Precautions should be taken to have the cutter at normal

operating temperature before starting, and for accuracy it is well to apply program signal during warm-up and occasionally during calibration, if much time is consumed in this process.

#### Crossover at Lower Frequencies

Crossover at a lower frequency can be obtained by connecting a series capacitor and resistor across the line. By properly proportioning  $R$  and  $C$ , additional boost at the low-frequency end can be obtained effectively, and adjustments can then be made which will result in a crossover at a lower frequency. The curves of Fig. 8 show the results obtained with adjustments for 300-cps and also 500-cps crossover frequencies.

#### REFERENCES

- 1H. E. Roys: "Experience with an FM Calibrator for Disc Recording Heads," *J. Soc. Mot. Pict. Engrs.*, Vol. 44, No. 6 (June 1945), pp. 461-471. Also *Broadcast News* Vol. 43 (June 1946), pp. 42-47.
- 2C. J. LeBel: "Properties of the Dulled Lacquer Cutting Stylus," *J. Acous. Soc. Am.*, Vol. 13, No. 3 (Jan. 1942) pp. 265-273.
- 3G. Buchman and E. Meyer: "A New Optical Method of Measurements for Phonograph Records," *Elektrische Nachrichtentechn.*, Vol. 7, pp. 147-157, April 1930, translated by J. M. Cowan, *J. Acous. Soc. Am.*, Vol. 12, pp. 303-306, October 1940.
- 4B. B. Bauer: "Measurement of Recording Characteristics by Means of Light Patterns," *J. Acous. Soc. Am.*, Vol. 18, No. 2, pp. 387-395, October 1946.

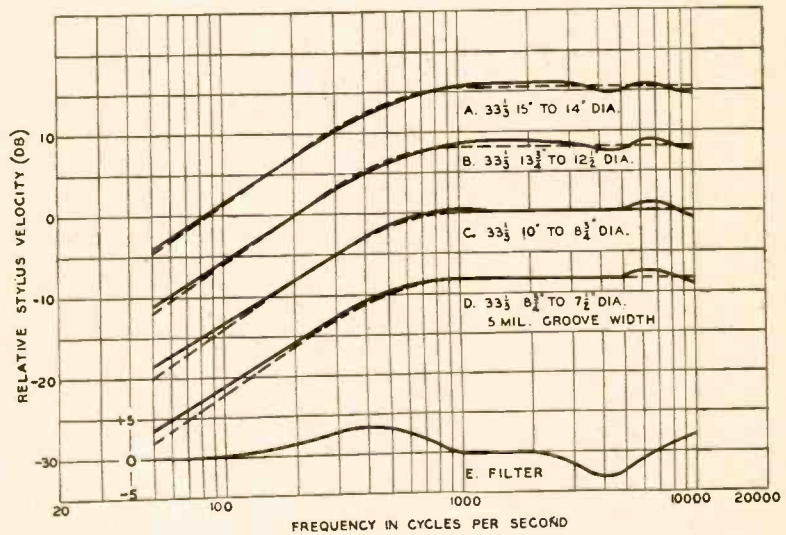

Fig. 7. Response characteristics at different recording diameters and 33-1/3 rpm. Note how little change occurs between outside and inside of the disc.

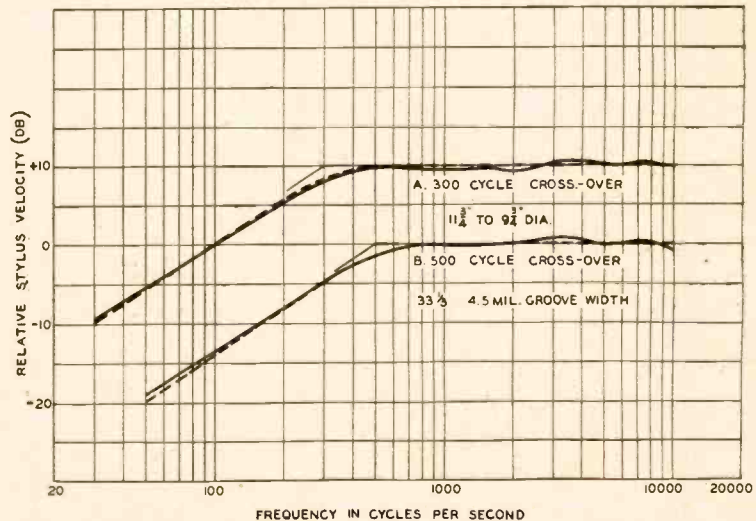

Fig. 8. Filter with additional network for 300-cps crossover and comparison with the 500-cps crossover adjustment.

# Magnetic Tape and Head Alignment Nomenclature

N. M. HAYNES\*

Suggested terminology for expressing causes of malfunctioning of experimental and commercial tape recorders.

**S**OMEBODY ONCE SAID that an art drops its swaddling clothes when it loses its ambiguous expressions, and becomes a science when its terminology acquires both conciseness and accuracy.

The development of some phases of the art of magnetic tape recording has

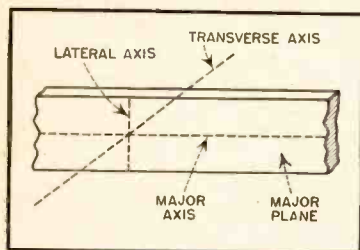

Fig. 1. Tape axis nomenclature.

been handicapped by inadequate terminology. This handicap has somewhat hindered the free exchange of ideas between experimenters and technicians.

Although some work has been done to compile a glossary for magnetic tape recording all efforts have been focused on definitions instead of derivations of much needed terms.

The inadequacy of our present terminology was humorously exemplified when a designer of recording heads found it extremely difficult to transmit precautionary instructions to a subcontractor without using his hands. Subsequently, two project engineers (both college graduates) were found discussing head alignment problems in the sign language. (The left hand, with fingers extended represented the tape, the fingers pointing in direction of tape travel and the palm representing the coated side. The right hand, similarly held but at right angles to the left hand, represented the head gap. Tilting, skewing and rotating the right hand effectively portrayed common types of gap misalignments.)

Early efforts attempted to tie mis-

\*Engineering Vice President, Amplifier Corp. of America, 396 Broadway, New York 13, N. Y.

alignment to astronomical and gun control terms. For a short while azimuth, elevation, and meridional deviations became meaningful. When the tape transport mechanisms were redesigned for vertical (rack mount) operation, junior engineers were literally standing on their ears to reorientate their terminology. Subsequently geographical terms were applied. Longitudinal, lateral, polar, and transverse deflections took on some meaning. Difficulties, however, became evident when attempts were made to correlate the working head gap with the tape.

For example, the actual gap length determined the magnetic track width. The gap width was used to determine the effective resolution of recorded wave lengths. It was finally decided that inasmuch as the tape was the most determinative characteristic element of the pro-

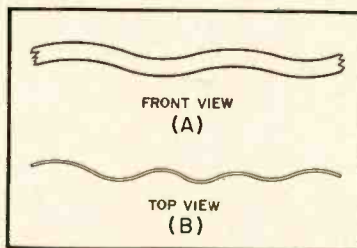

Fig. 2. Tape motion nomenclature: (A) Lateral weave; (B) transverse weave.

cess, all terminology was to be in terms of the dimensions of the tape, the orientation of the tracks on the tape and the direction of tape travel.

## Tape Nomenclature

**Major Plane:** The major plane of the tape is its largest surface. Its boundaries are determined by its length and width.

**Major Axis:** The longest axis on its major plane.

## Directional Nomenclature

**Longitudinal:** Along the longest dimension of the tape (length).

**Lateral:** Across the width of the tape (second largest dimension).

**Transverse:** Through the thickness of the tape (third tape dimension).

**Longitudinal Axis:** An imaginary line coinciding with the major axis.

**Lateral Axis:** An imaginary line on the major plane perpendicular to the major axis.

**Transverse Axis:** An imaginary line perpendicular to the major plane and major axis. (See Fig. 1)

## Tape Motion Nomenclature

**Lateral Weave:** Movement of the tape in the direction of its lateral axis. This kind of movement is usually caused by inadequate tape guides and, if excessive, will result in improper tracking between the record and playback heads and the production of amplitude variations. When improper tracking between the erase head and pickup head occurs, incomplete erasure is sometimes evident because the erase track does not consistently "blanket" the pickup track.

**Transverse Weave:** Movement of the tape in the direction of its transverse axis. This type of tape travel is usually caused by improper pressure pads, wrinkled tape, or obstructions in the normal tape path and results in amplitude variations particularly pronounced in the high frequencies. (See Fig. 2)

**Longitudinal Weave:** An irregular movement in the direction of the tape travel caused by eccentric rotary elements, uneven rotary torque in the drive system, or variations in tape drag or tape takeup. Produces frequency modulation (flutter, "wow" and "drift").

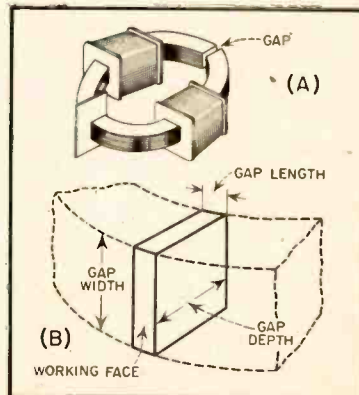

Fig. 3. Recording-playback head terminology: (A) Gap placement in recording head; (B) gap dimensional terminology.



## Recording-Playback Head Gap

### Terminology

For sake of simplicity the dimensions of the gap in the record or playback head are correlated to their respective effect on and in relation to the tape.

**Gap Length:** Dimension of the gap along the longitudinal axis of the tape. This dimension determines the scanning resolution of the head. (The shorter the gap, the lower the pickup level and the higher the frequency it resolves.)

**Gap Width:** The dimension of the gap along the lateral axis of the tape. This dimension determines the magnetic track width. The wider the gap the higher the signal level and the greater the dynamic range. (Doubling the track width increases dynamic range by 3 db.)

**Gap Depth:** The dimension of the gap along the transverse axis of the tape. Short depths provide less leakage and enable full magnetic tape modulation with lower recording levels. (See Fig. 3).

### Gap Alignment Terminology

The working face of the gap can be misaligned in three different planes in relation to the tape. These misalignments are known as angular deviations expressed in degrees and arc of the most serious type for they prevent tape interchangeability between machines.

**Longitudinal Deviation** (also known as tangential, azimuth, and polar deviations): Angular displacement of the working face of the gap in an arc tangential to the longitudinal axis and major plane of the tape. Perfect tangential contact of both gap edges cannot be maintained easily when longitudinal deviation exists. This type of deviation results in loss of both amplitude and high frequencies. In a two-way drive system frequency response characteristics vary according to the direction of tape travel and the head tends to clog up much sooner.

**Lateral Deviation:** Angular displacement of the working face of the gap in the major plane and about the transverse axis of the tape. The type of misalignment is the most serious for it contributes largely to loss of high frequencies and is most deleterious to tape interchangeability between different machines.

**Transverse Deviation:** An angular displacement of the working face of the gap in the transverse plane of the tape about the longitudinal axis. This misalignment prevents the full width of the magnetic track from coming in contact with the working face of the gap and results in lowered recording and pickup levels. It has the same effect as reducing track width. (See Fig. 4)

In terms of the magnetic track on the tape, the gap in the recording or playback head may be set improperly. The maladjustments are known as displacements.

**Longitudinal Displacement:** (Longitudinally stepped) An irregular and discontinuous gap caused by misalignment of each gap formed by the individual laminations in the core structure of the head. Misalignment takes place along the longitudinal axis of the tape and also prevents inter-

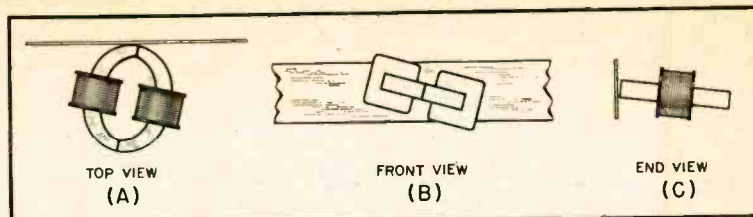

Fig. 4. Gap alignment terminology: (A) Longitudinal deviation; (B) lateral deviation; (C) transverse deviation.

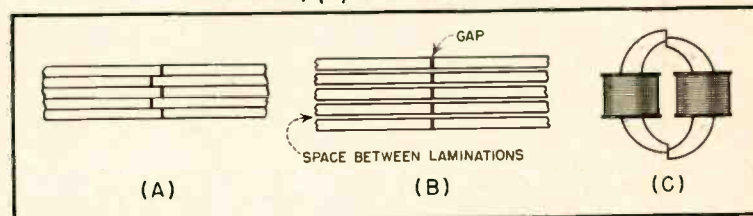

Fig. 5. Gap displacement terminology: (A) Longitudinal displacement; (B) lateral displacement; (C) transverse displacement.

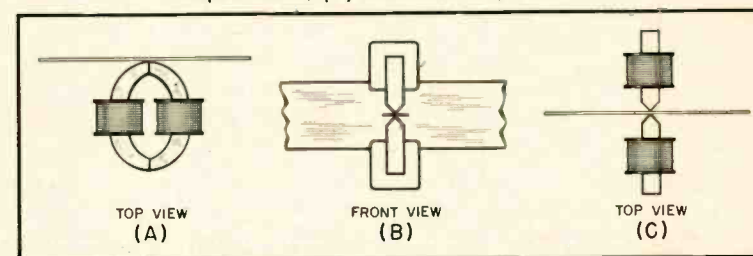

Fig. 6. Direction of magnetization terminology: (A) Longitudinal; (B) lateral; (C) transverse.

changeability between machines. (See Fig. 5A)

**Lateral Displacement:** A discontinuous gap caused by actual separation of the laminations along the lateral axis of the tape. (See Fig. 5B)

**Transverse Displacement:** (Transversely stepped) An uneven alignment of the edges of the gap along the transverse axis of the tape. Results in poor high frequency response. (See Fig. 5C)

Gap maladjustments may exhibit any combination of two or more deficiencies which are usually easily detected by examination through a low power microscope.

### Direction of Magnetization Terminology

It is unfortunate that, in the early stages of the art, all possible variations and directions of magnetizations on tape had not been considered carefully before usage popularized the terms "longitudinal" and "perpendicular." Both these terms are well suited and self-explanatory for two-dimensional wire recording but confusing for tape. Although subsequently carried over to tape, an additional term was needed for the third-dimensional type of recording (across the width). Transverse was inappropriately chosen to form a rather conglomerate trio of longitudinal, perpendicular and transverse expressions. The term "perpendicular" is both ambiguous and unrelated to longitudinal or transverse.

If "longitudinal" be reserved for lengthwise magnetization and "lateral" for width-

wise magnetization, then transverse is a natural term for magnetization through the medium. (The length of the magnet would be exposed in a transverse cross section of the medium). With these expressions a correlated family of terms results which nicely ties in with the suggested magnetic tape and head alignment nomenclature.

**Longitudinal Magnetization:** Magnetization of a recording media in its major plane along its longitudinal axis. (See Fig. 6A)

**Lateral Magnetization:** Magnetization of a recording media in its major plane along its lateral axis. (See Fig. 6B)

**Transverse Magnetization:** Magnetization of a recording media perpendicular to its major plane along its transverse axis. (See Fig. 6C)

Any combination of two or more types of magnetizations can be described easily with this nomenclature. For example, oblique magnetization indicating a lateral deviation in degrees concisely defines a specific mode of magnetization of a recording media. Oblique transverse with lateral deviation expressed in degrees similarly describes a combination of all three types.

It is the writer's hope that these or similar terms will soon become standard so that technicians working in the field of magnetic tape recording can more easily effect an exchange of ideas and more readily express results of their investigations.

# RECORD REVUE

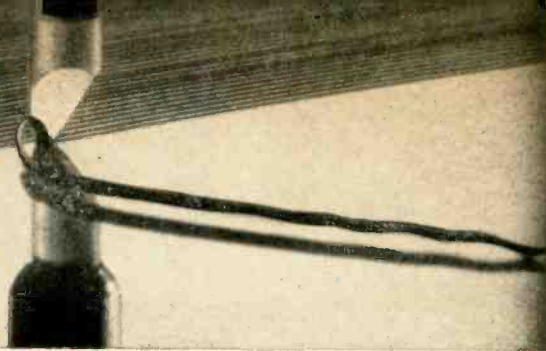

**R**EVIEWED below is a Mozart piano Concerto that goes under the triple-threat title of *Piano Concerto in E flat number 9, K. 271*. Engineer readers are by this time quite used to brushing aside such horrendous handles. I trust, but few of us ever get at the explanation. A lot of people are simply annoyed. It occurs to me that this column might do well to go into some of the terminological complexities of music occasionally, with the idea of making just sense can be made of them (only too often they don't make much sense anyway).

"K." stands for nothing more alarming than a gentleman named Ludwig Ritter von Koeschel. He was born nine years after Mozart died and lived to the pleasant age of 77, dying in 1877. (That dates Mozart for you.) He was a musical clean-up-man—there have been many like him. Mozart himself never managed to keep up a decent catalogue of the stuff he wrote in spite of sporadic attempts and no one else got around to the backbreaking task of digging up all the Mozart available, scattered all over Europe and elsewhere, and reducing it to a reasonable system with numbers until the redoubtable K. stepped forth to do it. It was the least we could do to use his initial ever afterwards in pinpointing Mozart's huge mass of works via his numbering system. The proper title of the "K." catalogue (reason for abbreviation) is *Chronologisch-thematisches Verzeichniss* (chronological-thematic catalogue) and on this listing, complete with themes to identify each piece, the "complete" edition of Mozart's work was based. Recently Dr. Alfred Einstein (not Albert) has done the whole thing over, inserting a batch of odds and ends of Mozart that have since appeared and generally straightening out a lot of inevitable mistakes and omissions. You may have seen the cryptic "K. Anh." attached to some Mozart piece—it refers to Herr Koeschel's "anhang," which as you may guess means the inevitable extras that were "hung on" to the original catalogue after the numbers were all fixed. Dr. Einstein, using considerable common sense, has now re-numbered these *anhangs*, giving them numbers that put them chronologically in the right place, as far as can be determined; he avoids imposing decimals upon us (say, K. 271.5) by using "a"—K. 330a. Simple.

Since Mozart turned out considerably more than 600 items in his life, you can understand that the "K." system is indispensable. But how about the two other pieces of handle, "number 9" and "in E flat"? Well, people aren't systematic and logical enough to depend on the uninteresting K. 271. Keys are important, in the hearing and the playing; so we use the key too, even though obviously there must be hundreds of works in each of the few available keys. As for the numbers

EDWARD TATNALL CANBY\*

—that too is a matter of (supposed) convenience. If there are ten violin sonatas, then we are bound to give them their own numbers, Koeschel or no. But worse, there have always been publishers who, with self interest in mind as is quite natural, have put forth an edition of, say, piano sonatas arranged in whatever sequence happened to work out nicely for them—and then have assigned their own numbers accordingly. "Number 1" in one edition may turn up as "number 5" in another. And who, pray tell, is going to arbitrate as to which system is final?

We could go on indefinitely on the subject of Mozart and Mr. Koeschel; there are, for instance, the spurious works, by someone else, listed as Mozart. Some of them via the kindness of Mrs. Mozart, who (when she found out how valuable her dead husband's works were) patched up a number of "sonatas" by combining some real Mozart with appropriate movements by someone else to fill out. Very clever, especially since for a long time no one knew the difference! Needless to say, in the case of every composer who has suddenly become great there is bound to be a fine batch of works panned off as the Master's, knowingly or via some high-powered wishful thinking. Most publishers, when profits loom, are apt to look hastily in the opposite direction when someone suggests a doubt as to authenticity. After all it *sounds* like Mozart (and will sell as Mozart) why investigate further?

Other notable jobs of cataloguing have been done that compare with Koeschel's and other names are similarly used. Thus, quite recently, the five or six hundred priceless little keyboard sonatas written by Domenico Scarlatti in the 18th century were untangled by an Italian named Longo and now, properly, every Scarlatti sonata should carry its own Longo dog-tag number. Occasionally the job of putting things in order is so monumental that a society is formed to undertake it—hence the famous Bach Gesellschaft (Bach Society), founded in 1850, just a century after Bach's death. Robert Schumann was the leading force in that case. In 1850, believe it or not, practically nothing of Bach's had been published. Only a handful of keyboard works were well known. You may appreciate the clean-up job that followed when you find that it took this group and the co-operating publishers, Breitkopf and Haertel 50 years of hard work to put all of the available Bach music into authentic printed form (and even then, as has since been shown,

plenty of mistakes were made and some black sheep crept in—music not even composed by Bach). There are 59 huge, fat volumes in the basic set and you'd need more than a five-foot shelf, heavily reinforced, to hold them. You can find the Bach Gesellschaft set in various spots all over the U.S. today, and that's where we go if we want to know what the Grand Old Man really wrote.

*Opus?* Mozart used a few "opus" designations for his music but they haven't stuck. He was one of the first, but Beethoven's were about the first to remain as real handles. An opus is a "work," technically speaking. The plural of opus, it seems, is *opera* and no one has yet figured out just how to manage these two words in an intelligible musical sentence! Most of us resort to a kind of pig-Latin and call two of them *opi* or *opuses*. The scholars do the same thing but they make it look good—"Opp." is the official term. Many operas have opus numbers—but let us go no further; "operas" is already a double-plural. An opus is not necessarily, alas, a chronological indication nor is it a single work always. Opus is properly a publisher's term, for a work or group of works published together. In the case of a hugely successful composer each of his works is instantly published hot off the griddle and his *opi* follow one another very nicely in chronological order of composition. But few composers are that famous or that systematic. Most have numerous works on the fire at once. And even Beethoven wasn't able to sell his stuff on sight. Poor Schubert, relatively unknown during his life, was largely published after his death. His earliest works, hundreds of songs, were published last and hence have the higher opus numbers. Usually three or four songs, sometimes many more (and similarly two or three sonatas, etc.) are conveniently issued together in a volume and hence we find "Opus 29, number 3" and so on.

But the worst opus confusion comes from the misguided efforts of the composers themselves. Dvorak is a fine case of misdirected zeal. He carefully opused (?) his earlier works, even through middle age; then, after an access of conscience or something, he went in for an overhauling of the then existing Dvorak system, throwing out a great deal of stuff and—sad mistake—re-numbering what was left. Naturally, people being people, the old numbers refused to disappear and two systems were therefore in circulation. Whereupon his publishers, thinking to untangle the affair, tried to work out a compromise third system. You guessed it; all three sets of numbers became current, though by today things are reasonably well straightened out. Symphony numbers—the symphony being so important that composers take more than usual pains with it—are another source of utter confusion. Beethoven's 6th came be-

[Continued from page 35]

\*279 W. 4th St., New York 14, N.Y.

**FONO-FITTED**  **CARTRIDGES**

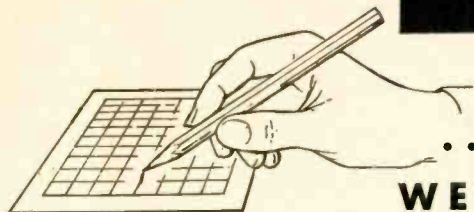

*... you draw the curve*  
**WE'LL BUILD THE CARTRIDGE**

*Your specifications . . . your special requirements in phono pickup cartridges . . . are ideally "custom-solved" through E-V creative engineering . . . unusual manufacturing facilities . . . and inherent advantages of exclusive TORQUE DRIVE.\**

**CUSTOM RESPONSE**

Smooth upper response with roll off frequency to your specifications or wide range, peak-free response to 10 kc. You draw the curve, we'll build the cartridge.

**VOLTAGE**

E-V TORQUE DRIVE cartridges provide the highest compliance per volt output. For example, the E-V 14 cartridge tracks at 5 grams with excellent wave form down through 50 c.p.s. on the RCA 12-5-31V record at 1 volt at 1,000 c.p.s.

**TRACKING FORCE**

With the high compliance and low mass of the driving system, needle forces at 5 grams for both one and three mil records are used in everyday production by leading manufacturers. Cartridges with even lower needle force with slight reduction in voltage are thoroughly practical. 3 gram tracking pressures are definitely in sight.

**COMBINATION**  
*One and Three Mil*

E-V TORQUE DRIVE again leads in twin needle cartridge design. Tracking force of 5 grams on both one and three mil records precludes weight changing. Straight line needle position assures accurate set down when used with changers. Approximately the same output is obtained on both styli. The E-V Twin-Tilt cartridge mounts in any arm with 1/2" mounting holes with no modification except adjustment for correct needle force.

**MOISTURE PROOFING**

The cartridge is *entirely filled* with DC4 Silicone jelly—the material that is used for inhibiting moisture on aircraft wiring. Tests indicate that it increases the life of an ordinary crystal *some 20 times*. This is a *plus* feature, found in all E-V crystal cartridges.

*Our engineering staff and full facilities are at your service. Contact us today.*



**Modern One-Acre Plant with Complete Internal Facilities for Quality-Controlled Volume Production**

From original conception to final product, you get full benefit of the unusual E-V processes. Here are E-V laboratories, where constant research keeps making new contributions to the Art. Here we make tools and dies . . . die cast, plate, screw machine, stamp, mold plastics, and assemble. Here we use specially designed test equipment for quality control. With all these facilities, we produce high standard acoustical products in quantity, with utmost economy. Come—see this plant in action.

NO FINER CHOICE THAN

**Electro-Voice**

\*E-V Pat. Pending  
 Licensed under Brush patents

Export: 13 East 40th St., New York 16, U.S.A.  
 Cables: Arlab

**ELECTRO-VOICE, INC. • BUCHANAN, MICHIGAN**

# NEW PRODUCTS

• **General Electric Type DA-6-A** portable audio amplifier, designed for remote pickup applications, incorporates a number of valuable features. The built-in a-c power supply provides for normal operation, but a self-contained battery system can be switched on in case of power failure. The small batteries used are not intended as a normal supply, but purely as an emergency protection.

A built-in tone generator simplifies level setting, removes need for "woofs." The vu meter also checks battery condition—a normal practice—and a switch permits use of one, two, three, or four preamplifiers as required, saving battery current.

• **Camera Equipment Co.**, 1600 Broadway, New York 19, N. Y. has a recent addition to their line which fills the need television technicians have encountered for a pan and tilt head which is safe and easy to use. The unit is so constructed that the camera cannot fall forward or backward even if left unlocked. Each head is adjusted



General Electric

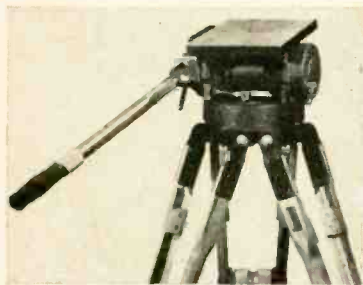

Camera Equipment Co.



McIntosh Engineering Laboratory

for a specific type and weight of camera, fitting the head exactly to the application.

• **The McIntosh Engineering Laboratory**, 910 King Street, Silver Spring, Md. has recently announced an amplifier of unusual capabilities, incorporating a completely new design concept. It has an output of over fifty watts at less than one per cent distortion, using a single pair of 6L6's in the output stage. All components except transformers and filter chokes are in plug-in units, and the chassis consists simply of a number of interconnected sockets wired to the transformers and chokes which are potted in the base. The basic amplifier has a gain of 45 db, but this may be increased to either 69 or 100 db by adding one or two plug-in preamplifier units. Response is flat within 1 db from 10 to over 100,000 cps; phase shift is less than 10 deg. from 20 to 30,000 cps. Under normal ratings—5 per cent distortion—this amplifier would be called an 80-watt unit.

• **Gray Research & Development Co.**, Inc. of 16 Arbor St., Hartford 1, Conn. announces a stylus force gauge which gives an accurate measure of this important quantity. Used simply by resting the point of a phonograph pickup stylus on the extended arm and adjusting the knob for balance, it does not depend on spring deflection which may vary with age.

• **Square holes in chassis**—long a bugaboo to home constructors—may be cut easily by the new Pioneer Square Hole Punch, in either  $\frac{3}{8}$  or  $\frac{1}{4}$  in. sizes. Also available is the new Keyed Chassis Punch which cuts holes with the key necessary to keep certain types of sockets from rotating in the chassis. The Pioneer punches are made with square shanks so that alignment is maintained throughout the entire cutting operation. Full information about these cutters may be obtained from Pioneer Broach Co., Dept. AA, 1424 South Main St., Los Angeles 15, California.

• **Audio Instrument Co.** solves one problem by the introduction of the Model 100 Bridger. Many circuits react unfavorably when loaded by even 0.5 meg in the input circuit of a v. t. v. m. With the Bridger, the input impedance is 100 megs in parallel with  $6 \mu\text{f}$  at the end of a three-foot cable, permitting the use of the probe in practically any circuit encountered. The output impedance of the bridger is 200 ohms, with one side grounded, and the ratio of output to input voltage is 0.98, corresponding to a loss of 0.2 db. Circuit incorporates advanced cathode follower and a new development in double-shielded cable. Configuration practically balances out cable capacitance.

• **Mounting power-type resistors** on top of a chassis is often unhandy, but the new Standee is ideal for ranges in the 10, 15, 20, and 25-watt ratings. This new Clarostat product consists of a wire winding on a fibre-glass core, bent into hairpin form and sealed in a ceramic tube with inorganic cement. Both terminals come out one end, and a clamp bracket supports the entire unit. Heat dissipation is thus outside of the chassis, resulting in lower operating temperature of the equipment. Until jobber stocks are complete, Standees may be obtained from Clarostat Mfg. Co., Inc., Dover, N. H.

• **Users of Selenium Rectifiers** will be interested in the new catalog, VC-3000, offer-



Gray Research & Development Co.



Pioneer Broach Co.

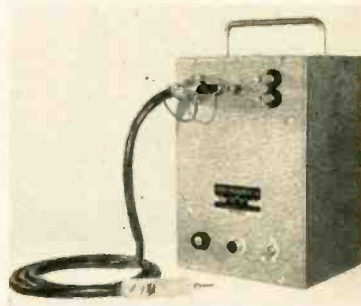

Audio Instrument Co.



Clarostat Mfg. Co.

ed by Vickers Electric Division, 1815 Locust Street, St. Louis 3, Mo. This is a 24-page catalog illustrating selenium rectifier characteristics, applications, design factors, and other important data. This information is practically indispensable to designers of d-c relay and filament supplies.

• **Kalbfell Laboratories, Inc.**, 1076 Morena Boulevard, San Diego 10, Calif. has introduced a number of useful devices which aid in measurement work. The newest, the Logaten, is an attenuator which gives an output voltage proportional to the logarithm of the input voltage without need for any

power supply. With the Logaten, an ordinary tube voltmeter or recorder becomes a linear db meter.

Another item is the Bridged-T Filter, which may be used to eliminate hum from signals being observed on a 'scope, with the attenuation at the critical frequency being at least 50 db. Using two such filters in series, with rejection frequencies of 60 and 120 cps, practically all hum voltages are eliminated from the desired signal.



• A Flutter Meter has recently been announced by Amplifier Corp. of America, 398-4 Broadway, N. Y. 13, N. Y. Some means of measuring "wow" and flutter is essential in any work on turntables and tape transporting mechanisms, since the percentage of variation from true speed must be extremely low, beyond the ability of the ear to detect it. This instrument has three ranges, with maximum values of 0.3, 1.0, and 3.0 per cent. The instrument operates by measuring the ratio of the rms deviation in frequency of a 3000-cps signal to the average value, which complies with the tentative standards for flutter and wow measurements as set up by the SMPE Sound Committee. It responds uniformly to all flutter, wow, and drift rates from 0 to 200 cps. Limiters in the circuit cancel the effect of amplitude variation of the measured signal, thus removing one of the more difficult problems in flutter measurement.

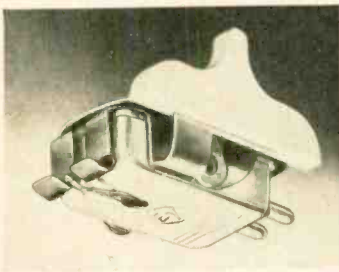

• The New Electro-Voice "Twilt" has a single mechanism which is actuated by a twin-tip replaceable stylus for use on 78, 45, and 33 1/2 rpm records. Design provides for operation on any type of record with only 6 grams stylus force. The Twilt mounts in most standard arms, only change needed being a reduction of stylus pressure. Cartridge is tilted to put desired needle into playing position, and may be had with crystal or magnetic unit. For details, write for Twilt bulletin 153, addressing Electro-Voice, Inc., Buchanan, Michigan.

• Noise Suppressors are still in the news. The Minnesota Electronics Corp., has added two new models, one being designed for use with high-quality magnetic cartridges for installation between the pickup and the input to the preamplifier. This model, NSF-2, incorporates a five-position selector switch giving ranges from flat to a relatively low cutoff for elimination of needle scratch. The dual control model, NSF-1, incorporates a

## THE McPROUD SPEAKER CHAMBER

Proud, eminent audio authority, as described in January, 1949, Audio Engineering. With a good 15-inch speaker, effortless response to 37 cycles is easily achieved with unsurpassed purity of tone. The McProud corner cabinet provides the realism of reproduction so long sought after and now a fact.

As offered by Terminal, the McProud Chamber is supplied in knocked-down form, easily assembled with a screw-driver the only required tool. Finely grained selected hardwood veneers are used so that you may finish all surfaces to match your furniture or room decoration. It will take high gloss or waxed finishes beautifully.

Supplied for 2-way speaker systems or for 15" coaxial speakers. Complete with all hardware and instructions for easy assembly, less speaker components **\$99.50**

Here is a new design for fine loud-speaker performance by C. G. Mc-



## FULL-RANGE LOUDNESS CONTROL

This is the scientific loudness control based on the well-known Fletcher-Munson curves. These curves chart the frequency response of the human ear at various volume levels.

23-step control gives fine shading of volume. Easily connected in place of regular grid circuit volume control. Single hole mount, 3" long, 2 1/4" diameter, 1 1/2" shaft length. Conventional 3-terminal connection. Net price... **\$9.95**



See article by John Winslow in February, 1949, Audio Engineering for interesting discussion on this loudness control.

## CLARKSTAN 12" VINYLITE SWEEP FREQUENCY RECORDS

For use with oscilloscope, instantaneously shows the entire audio spectrum from needle point to output terminals of amplifier. Illustrates visually the effects of equalizing and tone control circuits. Indispensable for precision audio engineering.

102-M—33-1/3 rpm LP micro-groove frequency sweep from 70 to 10,000 cps ± 1 db, with pips at 1, 3, 5, 7 and 10 Kc.

1000-A—78 rpm, 70 to 10,000 cps recorded flat within ± 1 db. Frequency marker pips, high level output.

1000-D—78 rpm, 5,000 to 15,000 cps, recorded flat within ± 1 db. Distinct frequency markers at 5, 7, 9, 11, 13 and 15 Kc. High level output. Your cost, each **\$6.60**

All records supplied with instructions and calibration charts for 3" and 5" oscilloscopes.

## IN STOCK FOR IMMEDIATE DELIVERY!

Barker & Williamson Instruments for Audio Measurements  
Distortion Meter, model 400 **\$140.00** Audio Oscillator, model 200 **\$115.00**  
Frequency Meter, model 300 **105.00** Sine Wave Clipper, model 250 **10.00**

## NEW THORDARSON WIDE RANGE AMPLIFIER

Model 32W10—Has frequency response of 20 to 20,000 cps, push-pull 10 watts audio power output with less than 2% distortion. Hum level is so low (70 db. below maximum output), that you'll find this amplifier one of the quietest and cleanest you've had the pleasure of listening to. Has input for tuner and crystal phono cartridge, with provision for plug-in preamplifier needed for new wide-range magnetic cartridges. A dual tone control provides separate bass and treble boost and attenuation, each control continuously variable for best response. Output impedances are 4, 8 and 16 ohms. Finish is attractive hammertone. Net price, **\$32.34** complete with tubes.

32W00—A preamplifier for plug-in to 32W10 amplifier. Provides proper frequency compensation for all popular magnetic wide-range cartridges, such as G.E., Pickering, Clarkstan, etc. Complete with tube, only. **\$5.82**

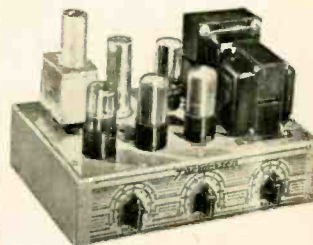

**FREE!**

WRITE FOR YOUR COPY OF OUR NEW 1949 CATALOG OF HIGH QUALITY SOUND EQUIPMENT

# TERMINAL

RADIO CORPORATION

Distributors of Radio & Electronic Equipment

85 Cortlandt St.-New York 7, N.Y. • Phone-WORth 4-3311 • Cable-Terradio

# Floating Action!

## for all TV Cameras

### "BALANCED" TV TRIPOD

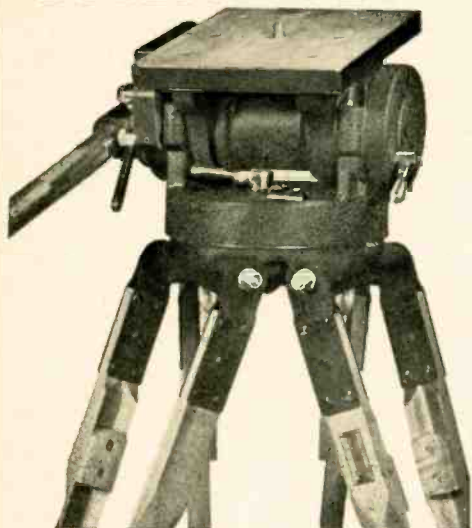

Pat. Pending

This tripod was engineered and designed expressly to meet all video camera requirements.

Previous concepts of gyro and friction type design have been discarded to achieve absolute balance, effortless operation, super-smooth tilt and pan action, dependability, ruggedness & efficiency.

Below:

3 wheel portable dolly with balanced TV Tripod mounted.

Complete 360° pan without ragged or jerky movement is accomplished with effortless control. It is impossible to get anything but perfectly smooth pan and tilt action with the "BALANCED" TV Tripod.

Quick-release pan handle adjustment locks into position desired by operator with no "play" between pan handle and tripod head. Tripod head mechanism is rustproof, completely enclosed, never requires adjustments, cleaning or lubrication. Built-in spirit level. Telescoping extension pan handle.

Write for further particulars



**CAMERA EQUIPMENT CO.**  
FRANK F. BECKER  
1600 BROADWAY NEW YORK CITY

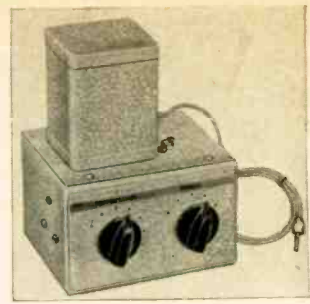

circuit basically similar to the dynamic noise suppressors, but without the dynamic action. Thus, it provides the same type of sharp cutoff as is obtained with a conventional dynamic noise suppressor with the threshold control set at zero. Further information may be obtained from The Minnesota Electronics Corp., 97 E. Fifth St., St. Paul 1, Minn.



● **Rauland-Borg Corporation** has recently introduced the Model 1825 high-fidelity amplifier in a form which makes it especially desirable for custom installations. The power supply and output stages are mounted in a conventional chassis with a protective cover, while the remote control preamplifier has a chassis size of 2 3/4 in. square by 11 in. in length, permitting a convenient mounting where the controls may be accessible. Controls include high-cut, treble and bass boost, and volume control, with a selector switch designed for connecting the amplifier input to either phono or radio. Compensation for phono pickup is contained in a plug-in equalizer, several types being available for different pickup characteristics. Details may be obtained from Rauland-Borg Corporation, 3523 Addison St., Chicago, Ill.



● **Tape Recorders** must fill a variety of requirements, but the first to be completely self-contained in a 6 x 7 x 13 in. case weighing but 10 pounds is exhibited by Stancil-Hoffman Corp., 1016 N. Highland Ave., Hollywood, California. This instrument makes

## NEED BACK ISSUES?

Only a few are available and the supply is limited

- |   |  |             |
|---|--|-------------|
| <input type="checkbox"/> December 1947  | <input type="checkbox"/> December 1948 | 1948 issues |
| <input type="checkbox"/> August 1948    | <input type="checkbox"/> January 1949  | 50c         |
| <input type="checkbox"/> September 1948 | <input type="checkbox"/> March 1949    | 1949 issues |
| <input type="checkbox"/> November 1948  |  | 35c         |

Payment should accompany order.

Circulation Dept., Audio Engineering, 342 Madison Ave., New York 17, N. Y.

it possible for the "man on the street" broadcaster to carry his equipment without the aid of a truck or wheelbarrow—yet record a 15-minute program with a frequency range extending to 5000 cps, using a tape speed of 7½-in. per sec. At 15-in. per sec, a 7½-min. program may be recorded. Self-contained batteries operate both motor and amplifier, and both are switched on simultaneously by the action of a switch on the outside of the case.



• **45-RPM Record Changers** are now available in chassis form for building into existing cabinets. Supplied by Crescent Industries, Inc., the unit is available for 117 and 220 volts, either 50 or 60 cps, and provides the center-drop mechanism needed for optimum handling of the new discs.



• **Freed Decade Inductors**, available in four types, cover the ranges from 0.1 to 100 mh for high frequencies from 10,000 to 30,000 cps; from 1 mh to 1 h for frequencies from 2000 to 50,000 cps; from 10 mh to 10 h for frequencies from 500 to 15,000 cps; and from 0.1 h to 100 h for frequencies from 50 to 1000 cps. Experimenters working in the audio ranges will find these units of considerable value in development work, since the decade feature gives a large selection of values with maximum convenience. Further information may be obtained from Freed Transformer Co., 1718 Weirfield St., Brooklyn 27, N. Y.

## Diamonds cost less . . .



**P**ICK-UP cartridges equipped with diamond styli may cost more than sapphire or metal stylus cartridges, initially, but the useful life of a diamond stylus cartridge is so much greater than the difference in cost that, from the viewpoint of length of service, listening pleasure and record life, diamond styli cartridges are cheapest by any comparison.

For those who want and demand the highest quality record reproduction and who don't want their records chewed up by being played with worn styli, the values of a Pickering Diamond Cartridge will prove most significant.

Pickering Diamond Cartridges are unique—their supremacy is unchallenged. They meet the exacting requirements of the most critical listener who wants to hear the realism and brilliance originally recorded and which makes record playing such a pleasure. The design and manufacture of Pickering Diamond Cartridges include all known factors which minimize record wear and eliminate unpleasant, annoying sounds while recreating the quality, brilliance and realism of the original recording.

The diamonds used for the stylus of Pickering cartridges are whole diamonds and not splints. They are more resistant to damage than any other stylus gem material (sapphire, ruby or diamond splints). They are well cut, gem-polished to high accuracy and precisely mounted to ride smoothly in the groove walls, reproducing all the fine modulations which can be pressed into modern recordings.

Pickering Diamond Cartridges are good for thousands of playings . . . compared with hundreds for sapphire and less for metal styli. An authority writing on wear resistance of stylus materials, states— ". . . the ratio of wear resistance between diamonds and sapphires is 90 to 1 in favor of diamonds."

Pickering Diamond Pick-up Cartridges are true gems for record playing . . . and cost less.

**Model D-120** for transcriptions and lacquer discs

**Model R-150** for phonograph records

**Model C-140** for microgroove records

Order your Pickering Pick-up Cartridges from your favorite jobber.

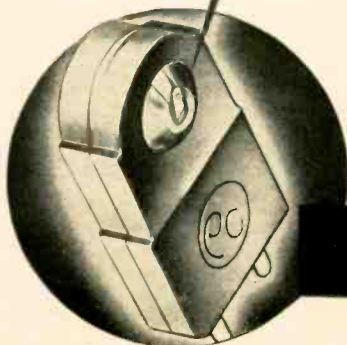

# PICKERING

& COMPANY, INCORPORATED  
OCEANSIDE, NEW YORK

# Techni - Briefs

## Low - Power Cathode - Coupled Amplifier

**T**HE amplifier described below is the result of an arduous two year search for an inexpensive, low power, good quality audio amplifier for home use with an FM and AM tuner and a phonograph reproducer.

The circuit illustrated below represents the results of experimentation with many conventional circuits that have been published in the available magazines. All were discarded one by one until the author, in desperation, tried the cathode-follower output shown. The results were completely satisfactory.

According to the limited literature available in various publications, a cathode-follower output stage, in comparison with a conventional output stage, will provide.

1. Improved low frequency response.
2. Improved high frequency response.
3. Damping out of peaks in both the output transformer and speaker.
4. Less distortion at the same rated power output.
5. 100% degenerative feedback with all its benefits.

The circuit is simple and straightforward with no special tricks to reduce hum, although the amplifier constructed by the author has no audible hum at full gain.

The primary of the output transformer,  $T_2$ , was selected so that its d-c resistance was approximately equal to the normal cathode bias resistor, or approximately 250 ohms. The primary impedance should be 5,000 ohms, with the secondary impedance selected to match the speaker to be used. The plate and screen of the 6V6 are tied together,

and to the B supply. The power transformer,  $T_1$ , has a secondary voltage of 250-300 v. each side of center tap, and the choke  $L_1$  is a ten-henry, 70-ma unit.

When used with the new RCA 45-rpm record attachment or a good FM tuner, together with a Jensen extended-range twelve-inch speaker in a bass reflex enclosure, the results are astonishing, and the power output more than meets the requirements for small living room use. It will be noted that the gain is not adequate for use with low-level magnetic pickups, but the simplicity of the amplifier makes it well suited for small, high-quality installations.

Raymond H. Bates  
Lt. Col., CAC.

### Cartridge Adaptation

A simple operation with a suitable Swiss file will permit the use of Astatic's new clip-in LP-33 crystal cartridge in the Philco or Columbia Micro-groove record-playing attachments. The new Astatic cartridges are equipped with sapphire styli and display a smooth frequency response well beyond that observed with the crystal cartridges originally supplied with these players.

The only significant physical difference between the cartridges is the absence of a pair of guide grooves on the sides of the Astatic unit. These two guide grooves can be cut readily on each side of the cartridge with the edge of a Swiss file which is approximately one millimeter (0.0394 in.) thick. The cuts should be approximately square, that is 0.0394 in. deep, and should be parallel to the long edge bounding the surface from which the contacts pro-

50  
to  
18,000  
C. P. S. !



### THE NEW NC-108 RACK FM TUNER-RECEIVER

Now... National offers an 88-108 Mc. band FM tuner-receiver designed to meet the most exacting demands. Flat from 50 to 18,000 cps,  $\pm 2$  db, when connected to external amplifier or line.

Built-in speaker, audio output stage, standard de-emphasis switch, and tone control also permit use as ideal monitoring receiver. Built to National's famous standards of quality, the NC-108 is worthy of the finest in amplifiers and speakers. Nine tubes plus rectifier and tuning meter.

Write for complete specifications.

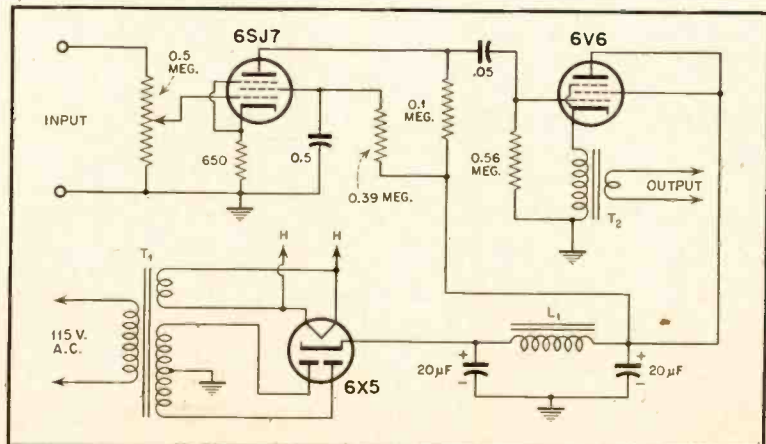



trude. The distance from the rear edges should be nine millimeters (0.354 in.). The exact orientation of the grooves and dimensions may be obtained from the original cartridge supplied with the players. Care should be exercised with regard to the depth of the cuts as one side wall of the Astatic cartridge is slightly thinner than the other. It may be found desirable to cut a pair of horizontal "finger-nail" grooves along the lower edge of the opposite sides of the Astatic cartridge to facilitate removal from the Philco or Columbia arms.

William J. Kessler,  
Engineering & Industrial  
Experiment Station,  
University of Florida,  
Gainesville, Florida

### Low-Loss Tone Control

For some years the writer has been using the tone control system described in the February issue<sup>1</sup>, but with a modification which may be of interest because of a reduced loss. Both high-

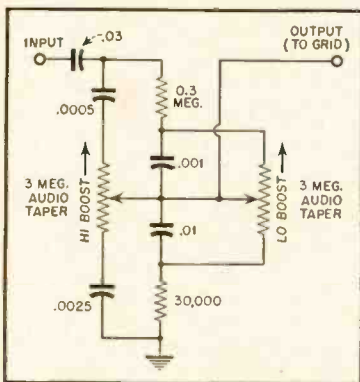

and low-frequency control circuits can be combined into one network with a mid-frequency loss of only 20 db, instead of the total loss of 40 db when the networks are used separately as described in the article. As a result, only one triode amplifier is needed to compensate for the loss introduced by the tone control.

The network is shown above and the values shown give substantially the same response curves as shown in the article. The input should be connected to a source impedance not higher than about 20,000 ohms, to prevent loss at high frequencies when in the high boost position, and the output should work directly into a grid, as pointed out in the editorial note.

James J. Faran, Jr.,  
Acoustics Research Lab.,  
Harvard University.

<sup>1</sup>"Flexible Dual Control System," Sterling, Feb. 1949.

# HARVEY

takes great pleasure in presenting the NEW

## MAGNECORDER PT6-JA

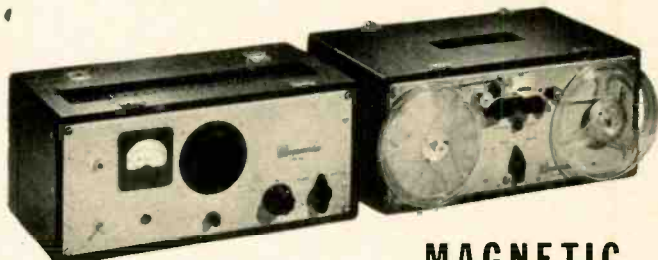

PT6-JA recording mechanism and amplifier

## MAGNETIC TAPE RECORDER

### BROADCAST QUALITY REPRODUCTION

The two-case portable Magnecorder PT6-JA is designed for the professional user and features low distortion and wide band reproduction. It conforms to all N.A.B. specifications. The entire equipment has a frequency response of 50 to 15,000 cps  $\pm$  2db, and less than 2% harmonic distortion at full modulation. The mechanical unit has high speed rewind (time: 45 seconds); operation and control are simple. Two tape speeds are obtained by easily interchangeable capstans — 7 1/2" per second and 15" per second.

### HIGH FIDELITY • GREAT VERSATILITY

Single low impedance microphone input with gain control, high level terminal for tuner or amplifier input, a 5" P.M. monitor speaker, zero-level output terminal for external amplifier, and a 10-watt audio amplifier with associated jack for an external speaker are included in amplifier. VU meter is provided for continuous volume level indications. Three-position switch selects erase/record/playback/or public address. Can be used with existing Magnecord equipment.

**\$499.50**

Same as above but with high speed forward.....

**\$515.50**

All prices Net, F.O.B., N.Y.C.

Telephone: **7-1000** LUxemburg 2-1500

**HARVEY**  
RADIO COMPANY INC.

103 West 43rd St., New York 18, N. Y.

WRITE FOR LITERATURE  
OR  
COME IN FOR  
DEMONSTRATION

IN STOCK FOR  
IMMEDIATE DELIVERY

## FLASH! Western Electric SPEAKERS REDUCED!

**728B**—12-inch speaker, uniform frequency response 60 to 8,000 cycles, 10 db down at 10,000 cycles. 30 watts power, level at 30 feet 93.5 db at 30 watts. **\$52.00**

**755A**—8-inch speaker, smaller version of 728B. 8 watts, 81.5 db, 70 to 13,000 cycles. **\$29.15**

**757A**—Two-unit woofer and tweeter, built-in crossover network, 30 watts power, 60 to 15,000 cycles. The combination is built into an enclosure. **\$364.00**

All prices Net, F.O.B., N.Y.C., and subject to change without notice.

**HARVEY RADIO CO. Inc., 103 West 43rd St., New York 18, N. Y.**

**GRAY**

**BETTER REPRODUCTION FOR BROADCASTING —**



**GRAY TRANSCRIPTION TURNTABLE 304T with exclusive RECORD LIFT**

The Gray Transcription Turntable 304T assures you virtually perfect reproduction with 78 rpm or 33-1/3 rpm transcriptions. It features . . .

- Absolute synchronism at 78 and 33-1/3 r.p.m.
- Instant speed change
- Single control for starting and speed change
- Filters building vibrations
- Record Lift lever-operated
- No record slipping, flutter, wow
- Record Lift guarantees exact timing
- Maximum simplicity and SPEED of operation

Mounted in all metal cabinet 27" square. Price \$450 f.o.b. Hartford (Pickup, Equalizer, casters extra)



**GRAY STYLUS FORCE GAUGE 901**

Preserve your record library. Check stylus force with this new gauge. Accurate to *grams*. As simple as it is important to use! Each \$14.75

Please ask for descriptive bulletins.

**THE GRAY RESEARCH & DEVELOPMENT COMPANY, Inc.**  
16 ARBOR STREET • HARTFORD, CONN.

**PROCTOR SOUNDEX**

**PLAYBACK UNIT**

**ANY**

RECORD  
SPEED  
CARTRIDGE\*  
PRESSURE

**INSTANTLY**



**MULTI-SPEED TURNTABLE:**

Employs new "Floating Disc Drive"  
Eliminates rim, gear, belt drives  
Eliminates wow and flutter  
Instantly shifts to 33 1/3 - 45 - 78  
No exchanging of idlers  
All speeds instantly available  
Light-weight, faster starting  
Available in 12" or 16" diameter

**SOUNDEX PICKUP ARM:**

Uses new exchange Cartridge Carriers  
\*Adapts any 1/2" mounting cartridge  
Extra Carrier-mounted cartridges  
Permits instant substitution  
For both standard and microgroove  
Self contained Stylus Pressure Scale  
Precise pressure adjustment in grams  
Unique reduction of vertical inertia

Turntable and Arm each available alone or in unit as shown

SEND FOR BULLETIN

**PROCTOR SOUNDEX CORP.**

133 North 6th Ave.

Mount Vernon, New York

**BOOK REVIEW**

**The Motion Picture Theater.**

Society of Motion Picture Engineers, 342 Madison Ave., New York 17, N.Y. \$5.00 postage prepaid.

While slightly foreign to the usual field of the audio engineer, this book should be in the library of anyone serving the theater trade because of the general overall treatment of the problems of the engineer or architect concerned with the planning, construction, or modernization of a movie palace.

Little of the text material is devoted directly to sound projection and the necessary equipment, although the problems of theater acoustics are considered carefully. In particular, the idea is stressed that acoustic performance should be considered during the design stages rather than afterward when the defects must be remedied. The engineer involved in theater design must also be familiar with lighting, since the problems are related with those of the other electrical equipment. With the trend toward television, even in theaters, a thorough background of knowledge of the historical progress of the new art is a desirable addition to the storehouse of information necessary to the practicing engineer.

The book is well written, and serves to familiarize the reader with the whole picture of motion picture theater design, starting with the physical construction of the building itself up through seating arrangement, ventilating and air conditioning, acoustics, lighting, floor coverings, and ending with a series of tentative conclusions regarding equipment and programming possibilities for television. One type of American theater television system is explained in detail, as is equipment for photographing televised images.

**— Letters —**

[from page 6]

roduced the concept of "phase bandwidth" in the study of pulse amplifiers and has pointed out the interesting fact that merely to produce a wide frequency bandwidth will not necessarily result in an amplifier capable of passing steep wave fronts without transient overshoot or "ringing" distortion. A small and linear phase shift over the given frequency bandwidth is also necessary. The more non-linear and the greater the amount of phase shift, the greater the tendency toward transient distortion. Of course, the steeper the wave front, the wider the frequency and phase bandwidth that is required.

Hence phase distortion is quite significant in audio work, and the "phase bandwidth" concept throws a new light on audio circuit and component design. It also explains why many bass and treble boost circuits produce such irritatingly harsh highs and mushy, boomy lows. . . It also explains why many inverse feedback circuits that look good on sine-wave tests sound so poor on complex and percussive signals, especially with the high gain, high plate impedance, high-order odd harmonics of the beam power tube. This concept may also explain why the British are cutting their phonograph discs out to 20 kc.

Ted Powell  
5719 69th Lane  
Maspeh, N. Y.

## NEW POLYPHASE REPRODUCER SYSTEM

[from page 14]

signal. If ear quality is to prevail, reproduction of this component must be prevented. Accurate machining of the core extremities into parallel arms effectively accomplishes that.

Those skilled in the art know that the stylus must be prevented from oscillating to and fro in the direction of disc rotation. The drag on the stylus-point varies with the amplitudes recorded. This drag also becomes greater as the point travels nearer the center of the disc. If the stylus is permitted to follow the drag to and fro, a delayed-phase distortion will be introduced. It will be observed that the construction and mounting of the styli in this unit do not permit frontal oscillations.

### Performance Characteristics

It would serve no practical purpose to state that the compliance of this wide-utility instrument is, say "6 x 10<sup>-6</sup> cm per," or any other figure, since the reader has no standard for comparison. However, an excellent measure of its compliance will be gained when it is stated that the 78 rpm stylus also tracks with the exceedingly low point-pressure of six to seven grams. It will be noted that one and the same unit functions for all styli. Independently, each stylus-point modulates the flux through the one stationary armature. The electrical connections of the voice-coil to the amplifier remain undisturbed no matter which stylus is performing. This, then, maintains identical operating characteristics with the amplifier.

Any stylus, be it sapphire or diamond, will play only a limited number of discs, after which it will erode the grooves. Obviously, then, a periodic change of the stylus is imperative. Accordingly, one of the requirements adhered to from the very first conception of this system was that whatever the ultimate design, it must have provision for easy replaceability of the stylus by the user himself.

By the simple process of selecting the desired styli, any of the following combinations may be had with the two-stylus instrument:—

1. Microgroove and 78 rpm
2. Microgroove and lateral transcriptions
3. Microgroove and vertical transcriptions
4. Microgroove and microgroove
5. 78 rpm and lateral transcriptions
6. 78 rpm and vertical transcriptions
7. 78 rpm and 78 rpm
8. Lateral and vertical transcriptions
9. Vertical and vertical
10. Lateral and lateral

SUN RADIO  
AMPLIFIER  
Model CR-10



only  
**\$42.50**

BRILLIANT HIGH-FIDELITY - -

## SUN RADIO ALL-TRIODE AMPLIFIER KIT!

FROM THE DESIGN PUBLISHED BY  
CONSUMERS RESEARCH, INC., OF  
WASHINGTON, N. J.

Treat yourself to superb audio quality found only in amplifiers costing many times more. Exclusive at Sun Radio!

- All-Triode, Self-Biased, 10 Watt, High-Fidelity Amplifier.
- Frequency Response: 20-15,000 c.p.s. ± 1 db.
- Distortion: less than 2.5% at 10 Watts; 2.5% at mid-frequencies at 11.8 Watts.
- Hum Level: 60-70 db. below rated output at radio input.
- Gain: radio, 75 db; phono, 97 db; magnetic pickup, 117 db at 50 c.p.s.
- Built-in pre-amplifier and equalizer.
- Complete with all 7 tubes, components, punched chassis, hardware, etc., and simplified instructions.

CR-10 Amplifier, laboratory-wired and tested ..... \$69.50

Order directly from SUN RADIO  
25% deposit on C.O.D. orders



### SOUND-MAN'S PARADISE

Visit Sun Radio's famous Sound Demonstration Studio, where you may hear and instantly compare thousands of different High-Fidelity Sound Systems. Friendly, expert assistance. Open daily, 9 A.M. to 6 P.M.

**SUN RADIO**  
AND ELECTRONICS COMPANY, INC.  
122-124 DUANE STREET  
New York 7, N. Y.      Barclay 7-1840  
2 BLOCKS NORTH OF CHAMBERS ST.

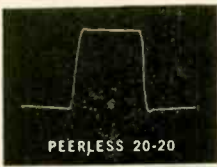

## ENGINEERS AT I. R. E. CONVENTION AND JOBBERS AT RADIO PARTS SHOW SEE PEERLESS 20-20 TRANSFORMERS PROVEN BEST BY SQUARE WAVE TEST

Photos show square wave response with 11,000 cycle fundamental frequency

Square waves provide the most rigorous test of an audio system and give indisputable evidence on transformer performance. These square wave tests were made under conditions simulating actual transformer operation, that is, square waves were fed from a balanced generator through resistors equivalent to the plate load of the tubes. A non-inductive resistance load was used on the secondary. All transformers were demonstrated under identical conditions. No compensation of any kind was used. A switching mechanism was arranged to give an A-B comparison between any of the transformers. All competitive transformers (as well as the Peerless transformer used) were selected from jobber stock items of leading transformer manufacturers. Only the highest priced "high quality" transformer of each manufacturer was chosen. Equally decisive comparative results were obtained at all other frequencies from 20,000 down to 20 cycles. Let Peerless figure on all of YOUR transformer requirements.

### PEERLESS ELECTRICAL PRODUCTS DIVISION

1161 N. Vine St., Hollywood 38, Cal.  
161 Sixth Avenue, New York 13, N. Y.

Fruzar & Hansen Ltd., 301 Clay St., San Francisco 11, Cal.  
Exclusive Export Agent

**ALTEC**  
LANSING CORPORATION

# Ready July 5th

## ULTRASONIC FUNDAMENTALS

By S. Young White

32 pp, 8 1/2 x 11, 34 illus. Paper Cover,  
\$1.75 Postpaid.

A compilation of articles appearing in Audio Engineering over the past two years on this fascinating new branch of the audio field.

Covers: Elements, generation, coupling to load, testing, and applications in biology; effects in liquids and solids, economic considerations, and opportunities.

An important subject which is rapidly coming into prominence in a myriad of industries, and one in which big opportunities are open to anyone familiar with the methods used in working with "silent sound."

Book Division, Dept. A

RADIO MAGAZINES, Inc.

342 Madison Ave., New York 17, N.Y.

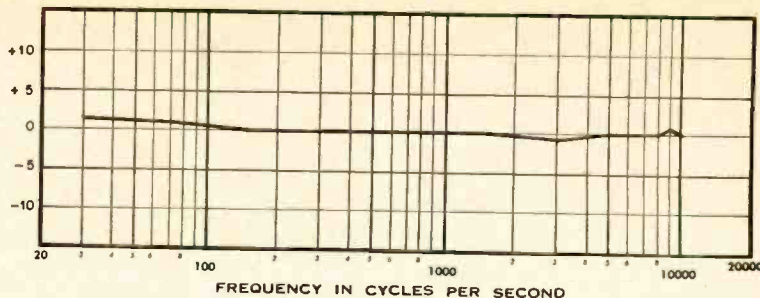

Fig. 5. Response of high-impedance polyphase reproducer, based on constant velocity of stylus.

Such versatility is highly desirable in any use, whether for use in the home or studio, especially so as the additional utility is possible at little extra cost. In the home when anything goes wrong with a steel needle, it is quickly replaced with another one. Such is not the case with jewel points, as spares are seldom on hand.

Utility for studios is obvious. For example, at present, radio stations generally use the same reproducer for transcriptions and for commercial discs. A jewel point, either diamond or sapphire, will score badly the grooves of lacquer and vinyl discs when used also on shellac records. This is a common complaint of studios, but one which is corrected effectively by this single instrument.

The curve of Fig. 5 shows the response of this instrument on a constant-velocity basis. However, as has been frequently pointed out, wide-range by itself does not mean high quality performance. For example, of two singers each capable of reaching high "C",—one may be pleasing, the other shrill. Actually, wide-range can be quite unpleasant unless all the essential factors are satisfied.

The special magnetic circuit used gives a high output, which ranges between 25 and 50 mv. Since the armature is stationary and fixed in the voice-coil, the unit permits any impedance desired, low or high.

Months of tedious effort were spent in scores of changes in the layout and assembly in an effort to keep costs down to a point where the unit could be sold in a competitive market. All indications are that this has been achieved.

## World-Wide Popularity

Since the inception of AUDIO ENGINEERING in May 1947, engineers and audio hobbyists have subscribed in ever-increasing numbers, not only in the 48 states and in all of the major foreign countries but in such places as Tasmania, Transvaal and Trinidad.

Each month AUDIO ENGINEERING covers the latest developments and practices in recording, reproduction and instrumentation for the entire audio field.

**Subscribe Now—Don't Miss an Issue! Back numbers are hard to get!**

AUDIO ENGINEERING  
342 Madison Avenue, New York 17, N. Y.

Sirs: Here is my  check (or  money order) for \$..... Enter my subscription order to AUDIO ENGINEERING for the next..... issues. Subscription Price: In U.S.A., Canada and Pan American Union—12 issues \$3—24 issues \$5. All others \$4.00 per year. Please check one:  New Subscription  Renewal

Name (please print).....

Address..... City..... Zone..... State.....

Occupation (give title and department).....

Firm Name.....

## PROBLEMS IN AUDIO

[from page 17]

behaves well on an absolute basis is in the perception of the qualities which are almost undefinable — timbre, tremolo, vibrato, duration, rise time, and decay. It is these factors that distinguish one musical instrument, one voice, or one sound from another when sounded at the same frequency and intensity. Timbre is the subjective response to harmonic structure, and vibrato or tremolo is a slow variation of either pitch or

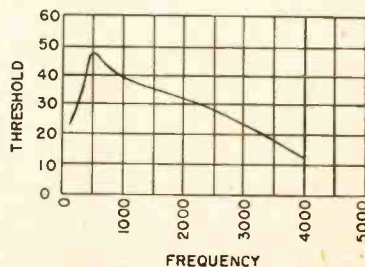

Fig. 7. Masking due to low frequency noise.

H. Fletcher, Speech and Hearing,  
D. Van Nostrand Co., Inc.

loudness of a tone. Studies have indicated that the most pleasing frequency or rate of a tremolo or vibrato lies in the range from six to thirteen cps. The other terms have their usual physical significance, but their actual subjective effect is still the subject of much speculation.

This article has covered the subject of psychological acoustics in general, and the next installment will include material on deafness, articulation, and intelligibility. The author acknowledges the cooperation of Bell Telephone Laboratories in securing permission to use the illustrations for this article.

#### READING LIST

- Acoustics, pp. 460-484:  
Wood, Alexander; Interscience Publishers, Inc. 1941
- Psychophysiological Acoustics: Pitch and Loudness  
Stevens, S. S. and Davis, H.  
*J. Acous. Soc. Am.* 8, 1, 1-13
- Change of Pitch with Loudness at Low Frequencies:  
Snow, William B.  
*J. Acous. Soc. Am.* 8, 1, 14-19
- Certain Subjective Phenomena Accompanying a Frequency Vibrato  
Kock, Winston E.  
*J. Acous. Soc. Am.* 8, 1, 23-25
- Relation Between Loudness and Masking  
Fletcher, H. and Munson, W. A.  
*J. Acous. Soc. Am.* 9, 1, 1-19

## PREAMPLIFIERS

[from page 12]

from early failure will be realized if the voltage of the A battery supplying subminiature filaments is not excessively high when the battery is new. Batteries made for hearing aid use have a special mix which gives about 1.45 v under load when fresh, and which is well suited to operation at low drain for several hours a day. It is not too easy to get such batteries without visiting your hearing aid dealer; the average parts jobber does not stock them. A few jobbers are beginning to stock them, and with a little pressure they should become generally available.

Hearing aid mix makes a cell which is especially suited to electronic applications. Its shelf life is as long as the more common cell, and its only fault is poorer performance in a flashlight.

## RECORD REVUE

[from page 24]

fore the 5th. Schumann's 4th was actually the 2nd, but he withdrew it, rewrote it, and issued it again after the 3rd, as number 4. Dvorak, the conscientious, wrote nine symphonies of which the famous number 5, the "New World," is the last. The last symphony Schubert wrote didn't appear until years after his death, and then as number 7. But the "Unfinished" was out of circulation even longer, though written earlier; it appeared 37 years after Schubert's death, as number

# ALTEC LANSING

*has the correct answers to your sound problems*

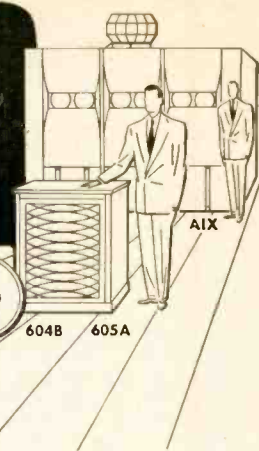

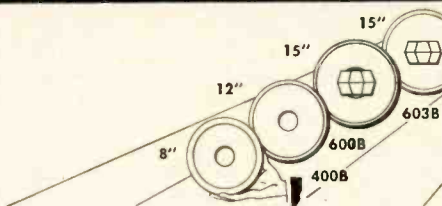

Regardless of your problem of high quality sound reproduction and distribution, you will find the solution with one or a combination of the highest quality units in the Altec Lansing line. From a small, efficient, 8-inch speaker to a huge industry approved theatre loudspeaker system, Altec Lansing manufactures over 25 different types and sizes of speakers and speaker systems. Each unit has been especially designed to adequately solve a specific sound problem. Thousands of Altec Lansing speakers are now in use in the motion picture, public address and radio in-

dustries. If your problems are sound, consult Altec Lansing. You will find the right answer to your sound problems.

Write for descriptive brochure



161 N. Vine St., Hollywood 38, Cal.  
161 Sixth Ave., New York 13, N. Y.

## New AUDIO INSTRUMENT Developments

Specialists in the audio field have had to develop and build much of their apparatus for themselves, at high cost, because it could be secured in no other way. Thus the audio specialist has generally been far ahead of the ordinary instrument designer. This organization was formed to make available new and original developments in audio apparatus. Developed by audio specialists, our products are designed to fill this gap in instrumentation.

### PREAMPLIFIERS FOR USE WITH 640AA CONDENSER MICROPHONES

Model No.	Output for 1 dyne/cm <sup>2</sup>	Output Z. ohms	Power Requirements			
			Plate E	Plate I	Fil. E	Fil. I
12	-40 dbm	250, balanced	135 v	2.2 ma	1.25 v	70 ma
14	-55 dbm	250, balanced	135 v	2.2 ma	1.25 v	50 ma
16	1.6 mv, open cct	500, unbalanced	300 v	3.0 ma	6.3 v	200 ma

#### MODEL 100 BRIDGER

For bridging measuring instruments across any part of audio circuit through shielded cable without appreciable loading. Cable capacitance almost completely balanced out by use of improved cathode follower and special double-shielded cable. Input impedance—100 megohms in parallel with 6 mmf at end of 3-foot shielded cable.

#### MODEL 104 VOLTAGE DIVIDER

10:1 ratio; input impedance—100 megohms in parallel with 5 mmf. Extends input-voltage range of Bridger to 250 v. Slips on tip of cable probe.

Our work is concentrated in fields involving new methods or unusual techniques. These have been used to give improved performance at reduced cost.

#### MODEL 121 LOGGER

Logarithmic voltmeter with 50 db linear scale; output may be used to feed direct writing recorder (via a suitable amplifier) for acoustical reverberation tests. Input impedance—50,000 ohms; output impedance—1000 ohms.

#### MODEL 140 DISC-NOISE METER

Overload-proof amplifier voltmeter for quality control of lacquers, phonograph records, transcriptions. New stable logarithmic element. 20-db linear scale. Minimum reading 75 db below 7 cm/sec. velocity with pickup cartridge supplied.

## AUDIO INSTRUMENT COMPANY

1947 Broadway

New York 23, N. Y.

## PROFESSIONAL DIRECTORY

**C. J. LeBEL**  
AUDIO CONSULTANT

Sound Recording • Instrumentation

370 RIVERSIDE DRIVE  
NEW YORK 25, N. Y.

### Winston Wells

Designer and Consultant  
Acoustical, Electronic and Nuclear  
Research  
307 East 44th St. MU 4-3487  
New York 17, N. Y.

### Custom-Built Equipment

## U. S. Recording Co.

1121 Vermont Ave., Washington 5, D. C.  
Sterling 3626

Consultation • Design • Fabrication

### Audio Research Associates

608 Fifth Avenue  
New York 20, N. Y.

## HERMAN LEWIS GORDON

Registered Patent Attorney

Patent Investigations and Opinions

Warner Building Washington 4, D. C. National 2497  
100 Normandy Drive Silver Spring, Md. Sitepherd 2433

### RATES FOR PROFESSIONAL CARDS IN THIS DIRECTORY

\$10 Per Month.  
Orders Are Accepted  
for 12 Insertions Only

8. To cap it all, someone decided that another 'unfinished symphony should be included too, as the correct "number 7"—thus (at least this is the way I figured it) the last symphony became number 9, and is now usually known as the 9th (7th). You'll find it exactly that way on some record labels. Its key is C major, but then so is number 6's. How do we get around that one? We usually speak of the "Great C Major Symphony". Gotta call it something.

Erna Sack, the European Nightingale.  
Orch. and Chorus the German Opera House, Berlin, etc.

Capitol ECL 2500 (3)  
Franz L  har—Operettas from Vienna. (Merry Widow, Count of Luxembourg, Paganini). Duets by assorted tenors and sopranos). Chorus and Orchestra State Opera House, Berlin, etc.

Capitol ECL 2501 (3)  
Beethoven, Symphony #3 ("Eroica"). Amsterdam Concertgebouw Orch., Mengelberg.

Capitol EFL 2502 (6)  
Verdi, Sicilian Vespers Overture.  
La Scala Orch. Milan, Marinuzzi

Capitol 82000 (1)  
Gluck, Overture to Alceste.  
Berlin Philharmonic, Furtwangler.

Capitol 81001 (1)

• Here is a cross section of the first batch of re-pressings from the famed German Telefunken catalogue, now represented in this country by Capitol. This German company for many years put out recordings that were technically extraordinary, and regularly in advance of their time. The proof is right here—for these records are all apparently pre-war (though there is a certain vagueness as to the date of recording which Capitol has not cleared up; some of these may, for all I can figure, have been made after the war began and thus perhaps on the wrong side of some important former iron curtains). This first batch is, understandably, not from the more elderly sections of the Telefunken catalogue. Capitol, of course, wants to show the very best technical material that Telefunken offers. But the older Telefunken's will be comparably good for their time and none will be technically below minimum acceptability among today's newest offerings.

Two things will be outstanding as you listen to these on a hi-fi outfit. First, you will note a remarkably wide tonal range for pre-war recording. In the three instrumental works (Beethoven, Verdi, Gluck) the sharper high sounds are beautifully represented and, perhaps more important, they are present with an unusually clean sound.

Thus the second remarkable factor appears—a surprisingly low distortion. The highs in these recordings are relatively weak as compared to those in recent wide-range recording which often has a rising characteristic, but they can take an astonishing amount of boost without showing unpleasant distortion, particularly in the case of the single Verdi record. Turn the average (continuously-variable) treble control on a good amplifier up to near maximum boost; the triangles and cymbals jump out at you and with excellent clarity. (Behavior of a record under "boost" conditions is, I would say, an excellent indication of the audible distortion, given, of course, a good amplifier in the first place.) But most impressive of all, at least in the all-instrumental samples of the Telefunken recording technique, is the low dis-

## The ONE-STOP STORE for FILM PRODUCTION EQUIPMENT

Since 1926 S.O.S. has supplied leading film producers with Studio, Cutting Room and Lab equipment. COMPLETE ASSORTMENT IN STOCK — Cameras, Lenses, Booms, Blimps, Dollies, Moviolas, Recorders, Printers, T.V. Background Projectors, Processors, etc.—UNDER ONE ROOF.

### SPECIAL VALUES for this month!

2000W Fresnel spots with heavy yoke	\$ 57.50
Neumade 16/35MM automatic film cleaner	194.50
B. & H. automatic 16/35MM hot splicer	795.00
35MM Cinephone Recorder	495.00
B. & H. Eyemo Q with lens	895.00
M. H. Viewfinders (plus tax)	135.00
New Auricon Pro Silent Camera	644.50
Bardwell Quadlites on stands	29.50
New Auricon 16MM Recorders	664.50
New Micro 16MM Sound Readers	147.50
Arri 16MM Step Printer	97.50

### FREE! CATALOG "STURELAB"

—Listing over a thousand "Best Buys" in new and rebuilt apparatus, is ready. Well-named "The Bible of the Industry". It's worth having. Write for your FREE copy—edition 45 limited.

### S. O. S. CINEMA SUPPLY CORP.

Dept. G, 602 W. 52nd St., N. Y. 19, N. Y.

A New, but Proud, Name

## LIVINGSTON

Runs its first advertisement



The Universal, by Livingston

We are growing up! Your enthusiastic response to the Livingston Arms did it! Your orders "snowed" us for a year. Our product was our only ad. NOW — We announce an addition to our audio equipment line. The MB LOUDNESS CONTROL — designed to fill the need created by similar units often described in Audio Engineering



Here it is — and you know by now that it's enough to say "It's by LIVINGSTON"

Livingston Electronic Corp.  
Livingston, New Jersey

tortion in the heavily recorded passages. Noisy, buzzy, distorted loud passages were the greatest bugbear of recording in the pre-war era; the clean rendering of fortissimo music is about the greatest contribution to recording of the post-war era. These pre-war Telefunkens can match the upper 50 per cent of today's records in this respect and that is probably the highest tribute that can be paid them. (Alas, the vocal recording in the Lehar and Sack albums is not quite as good; there, you will find, notably in the male voice recording, the kind of buzzy distortion that for so long plagued all high-volume voice recording. In this respect post-war techniques seem much improved, at best.)

Not much room left for musical comment—the Sack and Lehar albums are full of what inevitably is called "schmaltz" in this country; nice, juicy, sentimental stuff, heavy and sweet! La Sack is at her best here, singing as always in a very musical manner. If over-sweet, ending up almost every record with some incredibly high passage, up in the piccolo range, but doing it in the most casual and unsensational manner. The Beethoven Eroica is a somewhat eccentric but most interesting and musical interpretation, very different from the more familiar versions. It is notably lighter in quality—less bombastic—and the instrumental details are stunningly clear; many newcomers to Beethoven may find this lighter treatment much to their taste. The Verdi is a splendidly Italian performance of juicy melody and noisy, triumphant fanfare. The Gluck is a serious, rather heavy job, orchestra too big for the original intentions of the serious, personal Gluck music; one of the finest bits of recording acoustics I've heard, with a very live sound but great depth and presence.

Ravel, Scheherazade (Song Cycle with Orchestra). Susanne Danco; Paris Conservatory Orch., Ansermet

Decca frr EDA 100 (2)  
Debussy, Trois Ballades de Villon; Ravel, Don Quichotte à Dulcinée. Martial Singher, baritone; CBS Symphony, Abravanel.

Columbia MM 820 (3 10")

• Two remarkable song-with-orchestra albums. The Scheherazade songs (not to be confused with the familiar Rimsky-Korsakov music) are very early Ravel, 1903, when that composer was still in the midst of the then full-blown school of Impressionism—the kind of atmospheric, happy never-never-land music that you find in Debussy's earlier work, notably the three Nocturnes (Nuages, Fêtes and Sirènes) and the familiar Afternoon of a Faun. The songs are, in this stunning performance, an experience to hear. The singing of Danco is out of this world, in several senses; the backing of the famed Paris Orchestra under Ansermet adds to the spell—plus incredibly beautiful recording via the frr process, which in this case is acoustically ideal. The orchestra surrounds and enfolds the voice—yet somehow the voice is close, with sharp, clear diction.

The Martial Singher album is a bit more advanced and will suit those who are already up on the general style of the French song. He is an impeccable singer (no pun) in the French nasal manner. In this case the recording favors the voice at the expense of the orchestra, which has plenty to say on its own. The Debussy songs are late works, concentrated, not overly easy to get without numerous hearings. Ravel, on the other

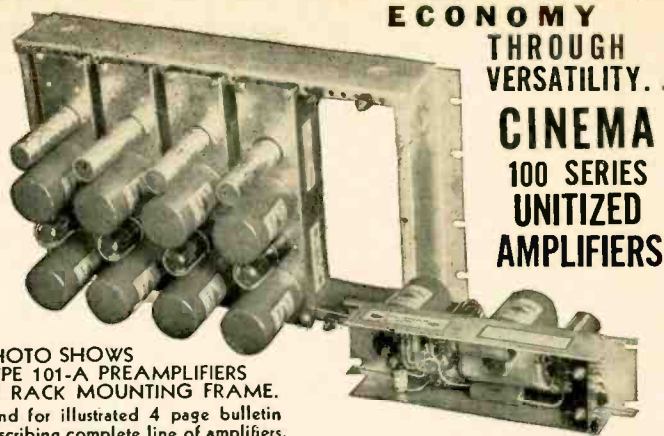

**ECONOMY  
THROUGH  
VERSATILITY.  
CINEMA  
100 SERIES  
UNITIZED  
AMPLIFIERS**

PHOTO SHOWS  
TYPE 101-A PREAMPLIFIERS  
IN RACK MOUNTING FRAME.  
Send for illustrated 4 page bulletin  
describing complete line of amplifiers.

The 100 Series consists of a complete range of units from preamplifiers to 40 watt recording amplifier and associated power supplies. The series is designed to furnish high-fidelity, moderately-priced audio channels for broadcast and recording studios.

The standardized method of mounting the chassis permits extreme flexibility and facilitates future expansion and modification of rack layouts.

You may obtain any type of channel required by selecting the proper chassis "units" and mounting them on the rack-mounting frames provided. (see photo)

All input and output circuits are suitable for both balanced and unbalanced lines. Reliable circuits and careful choice of high-grade components make this amplifier series especially suitable for services which demand consistent performance and reliability.



**CINEMA  
ENGINEERING COMPANY**  
1510 W. Verdugo Ave. Burbank, Calif.  
Cable Address: CINENG BURBANK



**FOR THE ULTIMATE**

*... in Listening Pleasure*

**MODEL B-201 LOUDSPEAKER**

**A two-way direct radiator system**

THE ONE ABOVE

ALL OTHERS IN—

- Full and Natural Bass
- Freedom from Resonances
- Clarity of Reproduction
- Naturalness of Highs

**SPECIFICATIONS—**

- Response 40-13,000 cycles
- Input Power 12 watts
- Impedance 8 Ohms
- Enclosure—32" diam. Hemisphere



**R. T. BOZAK, 90 Montrose Ave., Buffalo 14, N. Y.**

**Just Published!...**

the only book that covers  
the entire field of recording

## ELEMENTS OF SOUND RECORDING

By John G. Frayne, Supervisor of Development Engineering; and Halley Wolfe, Development Engineer, both of Electrical Research Products Division, Western Electric Company.

Here is a comprehensive, practical reference volume on basic sound problems for the designer, operating engineer or technician.

The authors discuss in detail those subjects that belong to the restricted field of sound recording and reproduction, and which are not discussed in books devoted to the allied fields of electronics, radio engineering, etc. However, since those interested in studying sound recording have widely different kinds of training and experience, some closely related subjects such as electromechanical analogies, acoustics, vacuum tubes, and audio amplifiers are discussed.

The book includes . . .

A large number of numerical examples to make the design procedure perfectly clear to the reader.

More than 480 diagrams and photographs illustrating every step of the text material.

Contents: Nature of Sound, Sound Waves and their Perception. Electrical, Acoustical, and Mechanical Circuits. Microphones and Their Uses. Vacuum Tubes, Audio Amplifiers, Network Theory. Attenuators. Filters. Equalizers. Compression and Limiting. Recording Systems. Electrical Measurements. Principles of Disk Recording. Disk Records and Their Processing. Fundamental Principles of Variable-Density Recording. The Light Valve. Variable-Intensity Modulators. Principles of Variable-Area Recording. Variable-Area Modulators. Noise-Reduction Methods. Intermodulation Test Methods. Flutter and Its Measurement. Film and Disk Drive Mechanisms. Motor Drive Systems. Film Laboratory Processes. Recording. 35-mm Motion-Picture Recording Systems. 16-mm Sound Film Systems. Magnetic Recording. Loudspeaker Systems. Acoustics of Stages and Theatres. Stereophonic Recording.

May 1949

486 pages

483 illus.

\$8.50

10-DAY

EXAMINATION

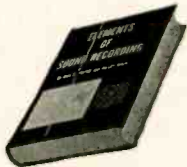

### ON APPROVAL COUPON

JOHN WILEY & SONS, INC.  
440 Fourth Ave., New York 16, N. Y.  
Please send me, on 10 days' approval, a copy of Frayne and Wolfe's ELEMENTS OF SOUND RECORDING. If I decide to keep the book, I will remit \$8.50 plus postage; otherwise I will return the book postpaid.

Name.....

Address.....

City.....

Zone.....

State.....

Employed by.....

(Offer not valid outside U.S.) AE-6-49

hand, though his very last work, from 1932, is an easy and not very profound set of Spanish style songs, with typical Spanish dance rhythms in the accompaniment. This album will be available as one side of a Singher LP record.

Debussy, *Petite Suite* (arr. Busser).

Paris Conservatory Orch., Ansermet.

Decca frr EDA 99 (2)

Ravel, *Ma Mere L'Oye* (Mother Goose Suite).

Boston Symphony, Koussevitsky

RCA Victor DM 1268 (2)

• While we're on the subject, here are two more additions to the French music category. The *Petite Suite* of Debussy is a piano work, much played by piano students; the orchestral arrangement gives it to another type of audience. Knowing both, I prefer the original piano—but for those who like orchestral music this will bring some very nice short pieces into that category, and for hi-fi enthusiasts there are some fine “demonstration” passages. The triangle is always busy, and on side 4 there's a triangle *solo!* Extraordinarily fine surfaces make the low-level music on sides 1 and 3 most listenable; faint instrumental solos come through sharp as needles.

Ravel's familiar “Mother Goose” is still often heard in the notable old Columbia recording with the CBS Symphony under Howard Barlow (X 151). This new version I find not musically as effective, though in part it is a difference in the recording itself. The old set, lacking highs, still has a closeness and presence and a definition that made it outstanding, whereas the new one, with the advantage of better tonal range, is recorded at a distance—too great a distance in the sound. It is largely at a very low level too, and there is not enough sharpness of definition to make it effective as in the frr Debussy above. Incidentally, just as Decca moves its 2-record sets into the fancy box-type album (as here) Victor dispenses with the album entirely and ships the records in a paper folder, including printed annotations. Whether the albums are worth the money is hard to know; the paper folders are inconvenient for any kind of permanent storage. The two-record work always was a problem and still is.

Dvorak, *The Golden Spinning Wheel* (Symphonic poem). Royal Philharmonic Orchestra, Beecham.

RCA Victor DM 1291 (3)

Smetana, *Excerpts from The Bartered Bride*. Royal Philharmonic Orchestra. Beecham.

RCA Victor DM 1294 (2)

• Two Czech-Bohemian items, from the long list of recent Beecham recordings. Musically both of these are interesting. The Dvorak, practically never heard, turns out to be a most melodious and pleasant work, full of those fresh, sunlit tunes that seem to grow in Bohemia, and played with great care and attention by Beecham's orchestra. The much more familiar *Bartered Bride* music (Overture, Polka, Dance of the Comedians) is given a special Beecham treatment reserved for music that has much microscopic detail work, usually more or less snowed under by the general orchestral sound; Beecham delights in bringing out all such details with meticulous accuracy, even at the expense of the more prominent surface themes. The Smetana music is particularly subject to blurring in the detail and it is most interesting to hear the tiniest scurrings of the strings and

STILL THE  
**LEADER!**

The famous ACA-100 Amplifier — a self-balancing, drift-correcting, direct-coupled amplifier — the most satisfying musical amplifier ever designed. Based on early LoTfin-White circuits, perfected by A. C. Shaney in 1934, and now brought to a standard of quality far above that of any corresponding amplifier. Exclusive features include:

- Push-Pull Triode Expander.
- Non frequency-discriminating noise suppressor.
- Push-pull hi and lo freq. variable equalizers.

If you are satisfied with nothing less than the best, write today for free technical literature.

Special models for all magnetic cartridges.



**AMPLIFIER CORP. OF AMERICA**

398-4 Broadway • New York 13, N. Y.

### AUDIO ENGINEERING SCHOOL

A Practical Audio Engineering course in Sound Fundamentals; FILM, MAGNETIC and DISC Recording; Transmission Measurements; Monitoring and Mixing. Laboratories contain: Transmission Sets, Oscillators, Distortion Sets; Harmonic Analyzer; Intermodulation Analyzer and other eqpt. Recording Studio assimilating Broadcast, Motion Picture and Commercial Sound Recording. H. M. TREMAINE, Pres.-Dir.

Approved for Veterans and Foreign Visas  
**HOLLYWOOD SOUND INSTITUTE INC**  
1040-A No. Kenmore Hollywood 27, Calif.

### 8 WIRE SHIELDED CABLE

Two No. 16, Six No. 20 tinned, stranded, copper, rubber insulated, coded leads. Waterproof rubber jacket. Tinned copper armor shield overall. New material—No. AEB. Lengths to 400 ft. Price 10¢/ft., \$30/Mft., \$700/10Mft. FOB Chicago warehouse.

**Trans-World Radio-Television Corp.**  
6689 Aberdeen St. Chicago 21, Ill.  
Phone: AUstin 7-4538 ENglewood 4-4484

### VERTICAL LATERAL

#### REPRODUCERS RECONDITIONED

Types 9-A, 9-B, D-93306, MI-4856, MI-4875-G  
Complete Stock of New Replacement Parts for All Types

This service is being used by leading radio stations and wired music companies from coast to coast. Factory prices prevail.

**VIBRATION SYSTEMS, INC.**  
1040 W. Fort St. Detroit 26, Michigan

### WANTED FOR SAFARI

Experienced sound man, capable operating, repairing and maintaining Hallen and Macnecord recorders to be used for sound-moving pictures of bird and animal life in Kenya, Congo and Sudan, January through March 1950. In application state education, full personal history, experience, references, salary required, and enclose photograph. Box 152, Audio Engineering.

### WANTED

Issue No. 9, Volume 2 (1946) of “Audio Record”, published by Audio Devices Inc., New York City. We will pay \$5.00 for a copy of this issue in good condition, to complete our file. Box 140 Audio Engineering, 342 Madison Ave., New York 17.



woodwind brought out neatly and precisely.

A significant contrast in recording however. Perhaps these were made at the same place with the same equipment—if so they do not show it. Beecham's offerings must go through mysterious metamorphoses somewhere between the playing and the RCA Victor pressing, for they display the most astonishing variation in quality. The Dvorak here is first rate, with clean, adequate highs, loud passages absolutely clear, a sparkling quality. On the other hand the Smetana is not only less clean in its general sound but the loud passages, at least on my copy, are buzzy and seemingly distorted. Play the endings of the two sets for yourself and see the difference! Other Beecham sets seem to lack most of the higher highs though the originals are supposed to be super-wide range. This Dvorak is the best one I've heard yet and a match for almost anything you can suggest. Fauré, Ballade for Piano and Orch.

Gaby Casadesus; Lamoureux Orch., Rosenthal.

Vox 645 (2)

Mozart, Piano Concerto #9, in E flat, K. 271. Gaby Casadesus; Lamoureux Orch., Paray.

Vox 650 (4)

• Gaby Casadesus is the wife of the pianist Robert Casadesus and no mean pianist herself. In these two Polydor imports, recent recordings made in France, she plays with an orchestra that has a distinguished name but isn't any too accurate in its string section. Gaby is at her best in the French music of Fauré; I find her Mozart somehow cold—hard to say exactly why but it's mostly a matter of phrasing and touch, plus simply a "feeling" for Mozart, which it doesn't seem to me she has. The Fauré piece is a quiet, lush little work, not far from the quieter music of César Franck. It doesn't say much, but its design is beautiful, tasteful, and most pleasing to hear. The Mozart—utterly different—is one of the bigger concertos, though no less bright and gay for that, in its outside movements. The center movement is serious, of great lyric beauty, and here Mme. Casadesus is good, as is the orchestra. The album is worth having for the middle movement alone. Acoustics: rather close and studio-ish. But not bad for the Mozart; too much Mozart is played with over-large orchestras in huge halls. The Fauré could stand a bigger, more live sound.

Barnby, Sweet and Low; Gounod, Sing, Smile, Slumber. Swiss Music Box.

Bornand S 501, 2 (10")

Brahms, Cradle Song; Williams, Rockaby Baby. Swiss Music Box.

Bornand S 503, 4 (10")

• The cycle is complete! Before there was such a thing as reproduced sound the music box gave at least an approximation of man-made music and it pleased no end. Now, with hi-fi reproduction of any sound easily possible, here we are back to the music box once more, but this time not only because of its quaint, old fashioned sound but because its music, while no reproduction of the original, turns out to have had its own charm and still does. And so—we reproduce the sound that once was the nearest thing there was to phonograph music! The Bornand Music Box company (Pelham, N.Y.) is a family business dealing in the music boxes themselves; the records were an ingenious afterthought. (Each side plays one cylinder three times.) Excellent job of recording, pressed on plastic.

## 3 SPEED TURNTABLE Using *Instantaneous* Speed Selector



LOOK! ONLY

**\$49<sup>95</sup>**  
NET

HOW IT WORKS!

3 SIMPLE OPERATIONS!

1. **78 r. p. m.**  
slide shift-lever to left
2. **45 r. p. m.**  
slide shift-lever to right
3. **33<sup>1</sup>/<sub>3</sub> r. p. m.**  
press selector button down,  
slide shift-lever to right

### MODEL LP-743

Noise Level — 30 db  
Motor — 4 pole, induction  
Turntable — Cast aluminum  
Dimensions — L. 15"; W. 12"



**REK-O-KUT COMPANY, INC.**

38-01 QUEENS BOULEVARD, LONG ISLAND CITY 1, N. Y.

## The First CERAMIC CARTRIDGE

with  
CHANGEABLE NEEDLE  
LIGHT WEIGHT  
LOW PRESSURE

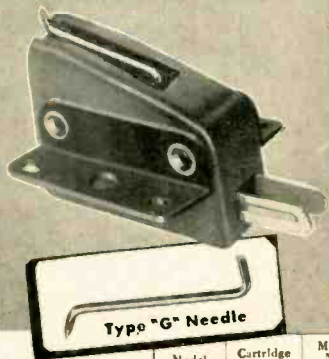

Write for  
Additional  
Information

*Here's the First* major engineering stride in phonograph pickup cartridges employing ceramic elements since Astatic first pioneered in this type unit last year. It's Astatic's tiny new gem—the "GC"—the first cartridge of its kind with replaceable needle. Takes the special new Astatic "Type G" needle—with either one or three-mil tip radius, precious metal or sapphire—which slips from its rubber chuck with a quarter turn sideways. Resistance of the ceramic element to high temperatures and humidity is not the only additional advantage of this new development. Output has been increased over that of any ceramic cartridge previously available. Its light weight and low minimum needle pressure make it ideal for a great variety of modern applications. Details of performance appear in the accompanying table.



Model	Cartridge Type	Minimum Needle Pressure	Output Voltage	Frequency Range (c.p.s.)	Needle Type	Application
GC	Ceramic	6 gr.	0.55*	50-10,000	G (1 mil tip radius)	33-1/3 and 45 RPM Records
GC-1**	Ceramic	6 gr.	0.55*	50-10,000	G (1 mil tip radius)	33-1/3 and 45 RPM Records
GC-78	Ceramic	12 gr.	0.7†	50-10,000	G-78 (3 mil tip radius)	Standard 78 RPM Records

\*Columbia #281 Test Record †Audio-tone Test Record  
\*\*Has mounting bracket to fit top mounting 453-inch center

# Laboratory Standards



## SQUARE WAVE GENERATOR

Model 71, Frequency Range: Continuously variable from 5 to 100,000 cycles. Wave Shape: Rise time less than 0.2 microseconds. Output Voltage: 75, 50, 25, 15, 10, 5 peak volts fixed; 0-2.5 volts continuously variable.

**MEASUREMENTS CORPORATION**  
BOONTON NEW JERSEY



## HARTLEY - TURNER Highest Fidelity Service

The reports on Hartley-Turner 215 Speakers recently sent to the U.S.A. are now beginning to come in. Typical of these is one from an engineer who deprecates the normally wretched performance of educational sound equipment.

"The speaker has been put into operation. Its comparative performance is truly remarkable and fully justifies your statements. It carries us a long step forward towards that elusive goal of realistic reproduction and makes the building of a neatly packaged high fidelity system practical."

W.G.K. St. Louis, Mo.

We were convinced of the musical quality of Hartley-Turner reproduction, but although we and our British customers knew we had got something, we did wonder if our ideas filled the needs of the American music-lover. We needn't have worried. Science, engineering skill and musical appreciation have no national frontiers, and our wish to do business with you is not that we are British but that we are Hartley-Turner.

Our speaker sets an entirely new standard in realism and three-dimensional sound propagation, and its absurdly low price of \$39.50 is due entirely to our unorthodox methods of reaching the desired goal. We ask you to compare it with any speaker you admire, no matter what its price, and we will confidently await the outcome of your tests.

Send \$1 bill today for a copy of "New Notes in Radio", THE pocket guide to high-fidelity, and we will also send you technical data sheets from time to time to keep you abreast of our research work. Descriptive literature is free for the asking.

**H. A. HARTLEY Co., Ltd.**  
152, HAMMERSMITH ROAD,  
LONDON, W. 6, ENGLAND

## ADVERTISING INDEX

Altec Lansing Corp.....	35
Amplifier Corp. of America 38, 40	
Arnold Engineering Co.....	2
Astatic Corporation, The.....	39
Audio Devices, Inc.....	Cover 2
Audio Instrument Company.....	35
Audio Research Associates.....	36
Bozak, R. T.....	37
Camera Equipment Company.....	28
Cinema Engineering Co.....	37
Electro Motive Mfg. Co., Inc. 40	
Electro-Voice, Inc. ....	25
Fairchild Recording Equip. Corp. 6	
Gordon, Herman Lewis.....	36
Gray Research & Dev. Co.....	32
Hartley, H. A. Co., Ltd.....	40
Harvey Radio Co., Inc.....	31
Hollywood Sound Institute.....	38
LeBel, C. J.....	36
Livingston Electronic Corp.....	36
Measurements Corp. ....	40
National Company, Inc.....	30
Peerless Elec. Products.....	33
Pickering & Co., Inc.....	29
Presto Recording Corp. Cover 3	
Proctor Soundex Corp.....	32
Professional Directory.....	36
Reeves Soundcraft Corp.....	7
Rek-O-Kut Company, Inc.....	39
S. O. S. Cinema Supply Corp. 36	
Sun Radio & Electronics Co., Inc.....	33
Sylvania Electric Products Inc.....	1
Terminal Radio Corp.....	27
Thordarson Elec. Mfg.....	5
Trans-World Radio-Television Corp. ....	38
United Transformer Corp. Cover 4	
U. S. Recording Co.....	36
Vibration Systems, Inc.....	38
Wells, Winston.....	36
Western Electric Company.....	8
Wiley, John & Sons, Inc.....	38

## ERRATUM

The photograph illustrating the new Daven 11A Transmission Measuring Set in the advertisement appearing on the third cover of the May issue erroneously showed a unit with two indicating meters. The instrument described has only one meter, as shown on page 19 of the May issue along with a complete description of its construction features.

## BETTER COMPONENTS BUILD BETTER REPUTATIONS



# El-Menco

## SPECIFY

No product is better than its weakest component. That's why more and more manufacturers specify El-Menco — the mica capacitor that always gives customer satisfaction and builds better reputations.

- CM 15** ( $\frac{3}{32}$ " x  $\frac{1}{2}$ " x  $\frac{3}{16}$ ")  
For Radio, Television, Other Electronic Applications  
2 to 420 mmf. capacity at 500 VDCw  
2 to 525 mmf. capacity at 300 VDCw  
Temp. Co-efficient  $\pm 30$  parts per million per degree C for most capacity values.  
6-dot standard color coded.
- CM 20** Available in "A", "B", "C" and "D" characteristics  
2 to 1500 mmf. intolerances down to  $\pm 1\%$ \* or .5 mmf. at 500 D.C. working voltage  
6-dot color coded \*Whichever is greater
- CM 35** Available in "A", "B", "C", "D" and "E" characteristics  
Minimum tolerance 1%  
500 D.C. working voltage  
6-dot color coded

### ARCO ELECTRONICS

Sole agent for jobbers and distributors in U. S. and Canada.

135 Liberty St., New York, N. Y.

Write, on firm letterhead, for samples and catalog.

**THE ELECTRO MOTIVE MFG. CO., INC.**  
Willimantic Connecticut

Some  
Prefer a  
Portable



Others  
Prefer a  
Standard

But ALL Prefer  
**TWIN-TRAX**  
"The Tape Recorder  
the Engineers are Buying"

When it comes to high fidelity sound equipment, it's the specifications that count with engineers. And that's why they're buying Twin-Trax — the popular-priced tape recorder with professional specifications. Extended frequency response, wide dynamic range, low hum level, easy operation, trouble-free performance! And two tracks means twice the playing time on standard tape reels, with tape costs cut in half — a saving you don't have to be an engineer to appreciate.

Write today for technical literature and professional factory discounts.

\*Trademark

**AMPLIFIER CORP. OF AMERICA**  
398-4 Broadway • New York 13, N. Y.



# Comparisons

indicate this is the world's finest recorder of its type

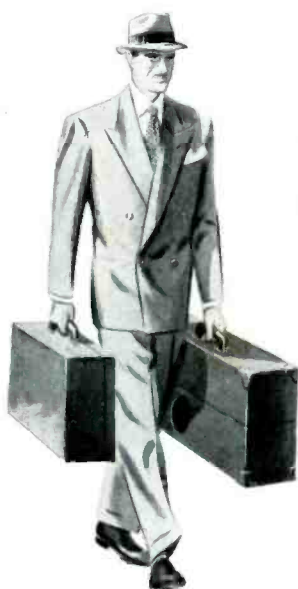

## NEW PRESTO Portable Tape Recorder 900-P

Complete in two easily portable cases—  
one containing the recorder, the other  
the amplifying equipment.

**PRESTO**

RECORDING CORPORATION  
Paramus, New Jersey

### MANY OUTSTANDING FEATURES:

- Three separate heads for superior performance (and for monitoring direct from tape). One head each to erase, record and play back.
- 3 microphone channels with master gain control in recording amplifier.
- Weston type 30 V. U. meter with illuminated dial to indicate recording level, playback output level, bias current and erase current.
- 2-speed, single motor drive system. Toggle switch to change tape speeds from  $7\frac{1}{2}$ " to 15" per second.

Production on this exciting new equipment is being rushed to meet the great demand for truly fine portable equipment. Write for complete details.

Write today to be put on our mailing list for "The Presto Recorder," new house organ of practical ideas for anyone in the recording and broadcasting field.

Mailing Address: P. O. Box 500, Hackensack, N. J.  
In Canada: WALTER P. DOWNS, Ltd., Dominion Square Building, Montreal

WORLD'S LARGEST MANUFACTURER OF INSTANTANEOUS SOUND RECORDING EQUIPMENT AND DISCS



# COMPONENTS FOR EVERY APPLICATION



**LINEAR STANDARD**  
High Fidelity Ideal



**HIPER-A ALLOY**  
High Fidelity . . . Compact



**ULTRA COMPACT**  
Portable . . . High Fidelity



**OUNCER**  
Wide Range . . . 1 ounce

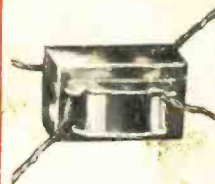

**SUB OUNCER**  
Weight 1/2 ounce



**COMMERCIAL GRADE**  
Industrial Dependability



**SPECIAL SERIES**  
Quality for "the Ham"



**POWER COMPONENTS**  
Rugged . . . Dependable

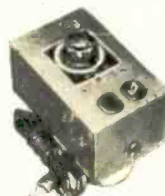

**VARITRAN**  
Voltage Adjustors



**MODULATION UNITS**  
One watt to 100KW



**VARIABLE INDUCTOR**  
Adjust like a Trimmer



**TOROID HIGH Q COILS**  
Accuracy . . . Stability

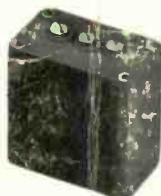

**TOROID FILTERS**  
Any type to 300KC

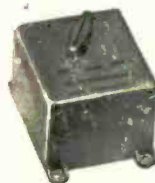

**MU-CORE FILTERS**  
Any type 1/2 - 10,000 cyc.



**EQUALIZERS**  
Broadcast & Sound



**PULSE TRANSFORMERS**  
For all Services



**HERMETIC COMPONENTS**  
Ceramic Terminals



**PLUG IN ADAPTER**  
Impedance Matching



**FOSTERITE**  
Grade 3 JAN Components



**CABLE TYPE**  
For mike cable line



**VERTICAL SHELLS**  
Husky . . . Inexpensive



**REPLACEMENT**  
Universal Mounting



**STEP-DOWN**  
Up to 2500W . . . Stock



**LINE ADJUSTORS**  
Match any line voltage



**CHANNEL FRAME**  
Simple . . . Low cost

*United Transformer Co.*

150 VARICK STREET

NEW YORK 13, N. Y.

EXPORT DIVISION: 13 EAST 40th STREET,

NEW YORK 16, N. Y.,

CABLES: "ARLAB"