

AUDIO ENGINEERING

JUNE
1948

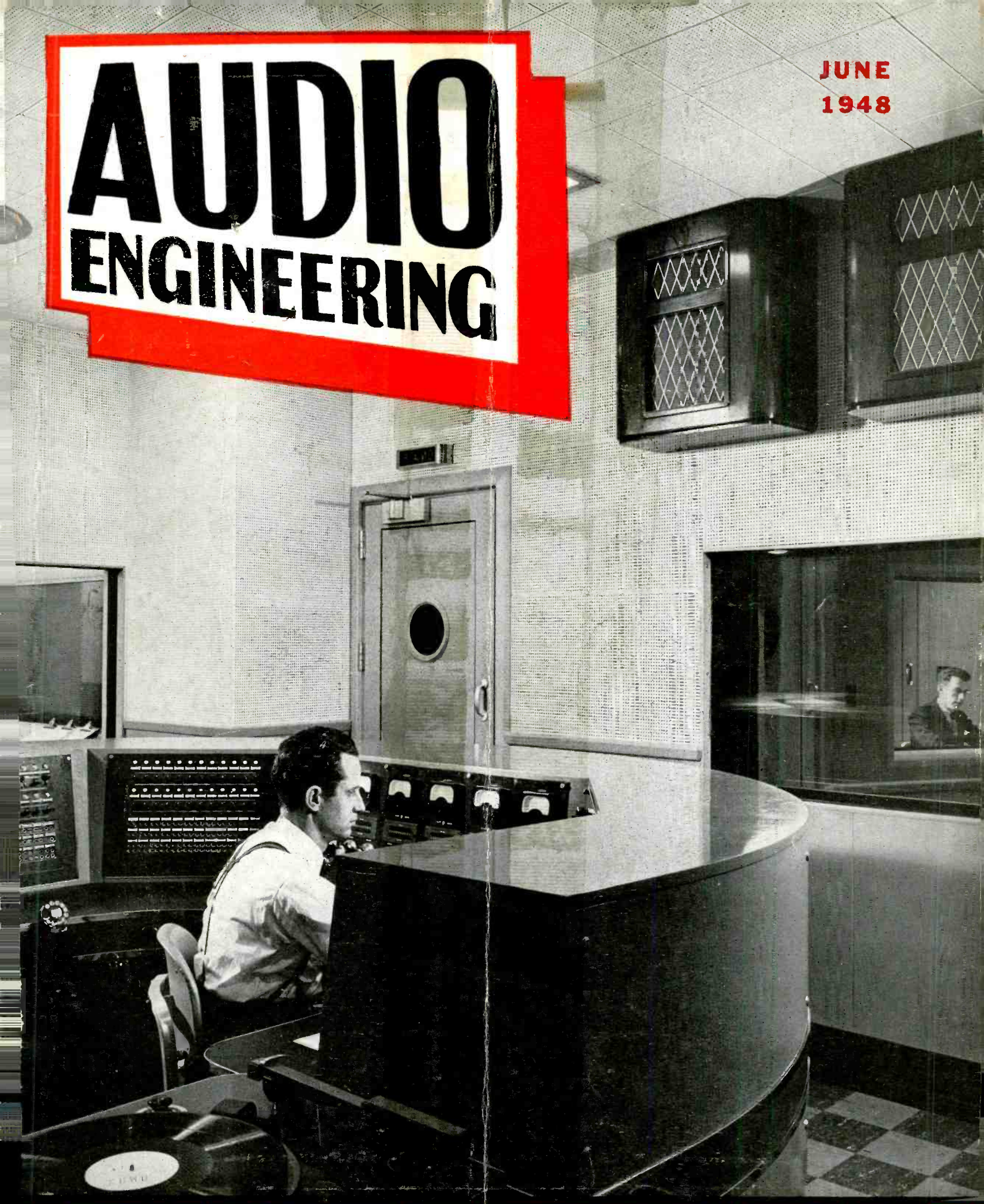

THE JOURNAL FOR SOUND ENGINEERS



TEN YEARS OF LEADERSHIP

Ten years ago the first AUDIODISC was manufactured . . . manufactured by a patented precision-machine process, which produced the finest recording disc known.

During this decade AUDIODISCS have been rated first in every field of sound recording . . . radio broadcasting, commercial recording studios, the phonograph record industry, motion picture studios, educational institutions, home recording, research laboratories and governmental agencies. In every country throughout the world, AUDIODISCS are regarded as the true standard of recording quality.

At first the output of AUDIODISCS was measured in tens of thousands, then in hundreds of thousands and later in millions per year. Today this highest rate of production is being maintained and the quality is the finest yet achieved.

AUDIO DEVICES, INC., 444 Madison Avenue, New York 22, N.Y.

Export Department: Roche International Corp., 13 E. 40th Street, New York 16, N. Y.

Audi discs are manufactured in the U.S.A. under exclusive license from PYRAL, S.A.R.L., Paris



they speak for themselves **audi discs**

AS NEW AS THE FUTURE!

... the only transformer
line of its kind

*Advanced, practical
engineering
gives you*

THESE OUTSTANDING FEATURES



CHICAGO TRANSFORMERS

Sealed in Steel

Have Complete Details On Hand For Your New Equipment Planning

WRITE TODAY FOR CATALOG

CHICAGO TRANSFORMER Division, Essex Wire Corporation

3501 ADDISON STREET, CHICAGO 18, ILLINOIS

1 SEALED IN STEEL CONSTRUCTION

Chicago Transformer's drawn steel cases provide convenient, compact mountings; seamless steel-wall protection against atmospheric moisture and corrosion; unsurpassed strength and rigidity to withstand shock and vibration; clean, streamlined appearance that adds eye-appeal to any equipment.

2 CHOICE OF CONNECTORS

Solder lugs or wire leads. Most units are available with identical ratings in two base styles to fit your price and/or wiring preference.

3 CHARACTERISTICS KEYED TO MODERN TUBES

Voltage, current, and output ratings have been designed for one purpose only—to fill the requirements of the receiving, transmitting, and industrial electronic tubes currently most in demand. No listings wasted on obsolete circuit needs. Result—a condensed, yet comprehensive, line that's right in step with today's new circuit designs.

4 EXACT MATCHING OF REACTORS

with power transformers. Current ratings of plate and filament supply transformers and of the high voltage plate transformers are matched by choke capacities specially designed for the purpose. Mountings match, as well, for uniform, "tailored" good looks.

5 TRUE HIGH FIDELITY THROUGHOUT 3 RANGES

Frequency response within $\pm 1/2$ db; distortion exceedingly low, even at low frequencies. These are the characteristics of the input and output transformers. Driver and modulation transformers provide response within ± 1 db. All audio units are designed for frequency ranges that fit three classes of up-to-date audio application. Full Frequency Range: 30-15,000 cycles (good up to 20,000 cycles, where required). Public Address Range: 50-10,000 cycles. Communications Range (voice): 200-3,500 cycles.

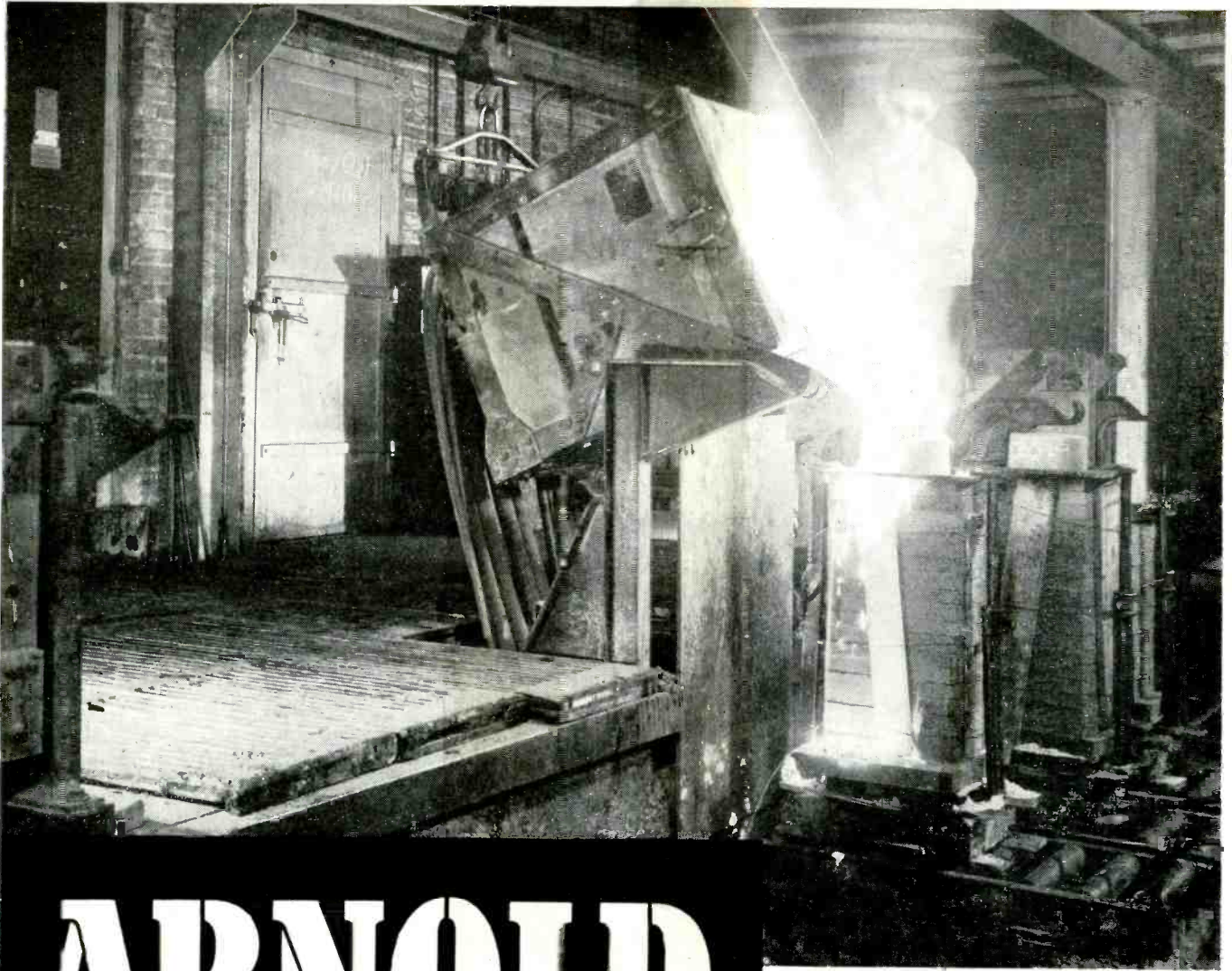

ARNOLD

PERMANENT MAGNETS

*100% quality-controlled
at every step from
the design board
to final assembly*

The increased efficiency and economy you'll realize in the use of Arnold Permanent Magnets are *constant* factors. The thousandth unit is exactly like the first—because they're produced under controlled conditions at every step of manufacture, to bring you complete uniformity in every magnetic and physical characteristic. Count on Arnold Products to do your magnet job *best*—and they're available in any grade of material, size, shape, or degree of finish you require. Write us direct, or check with any Allegheny Ludlum field representative.

THE ARNOLD ENGINEERING CO.
 Subsidiary of
ALLEGHENY LUDLUM STEEL CORPORATION
 147 East Ontario Street, Chicago 11, Illinois
Specialists and Leaders in the Design, Engineering and Manufacture of
PERMANENT MAGNETS



W&D 1297

Member of Audit Bureau of Circulation



Successor to RADIO

John H. Potts, Editor
C. G. McProud, Managing Editor
Lawrence LeKashman, Asst. Editor
Louisa B. Dresser, Edit. Prod. Mgr.

Sanford R. Cowan, Publisher
S. L. Cahn, Adv. Director
H. N. Reizes, Adv. Mgr.
Jerome S. Harris, Circ. Mgr.

Editorial Advisory Board

Howard A. Chinn
John D. Colvin
Paul A. de Mars
C. J. LeBel
J. P. Maxfield
George M. Nixon
S. Young White

Representatives

James C. Galloway
816 W. 5th St., Los Angeles 13, Calif.
Dale International Publications, Ltd.
105 Bolsover St.
London W. 1, England
Harris & Floyd
297 Swanston St., Melbourne
C. 1, Victoria, Australia

Established 1917

CONTENTS JUNE, 1948

Vol. 32, No. 6

Letters 5
Editor's Report 6
Misconceptions About Record Wear—Norman Pickering 11
Sapphire Group Second Anniversary Meeting 14
Three-Way Speaker System—George Douglas 15
RC Circuits as Equalizers—Holger Marcus Dahl 16
The Problem of Sound Distribution, Part I—O. L. Angevine, and R. S. Anderson 18
General Purpose 6AS7G Amplifier—C. G. McProud 24
Audio Engineering Society News 29
Applications of Ultrasonics to Biology—S. Young White 30
Record Revue—Edward Tatnall Canby 32
New Products 34
Professional Directory 34
Advertising Index 48

COVER

The ingenious arrangement of control facilities and studios of the broadcasting station recently completed for KOMO by The Austin Company is shown in this view of the master control room. The engineer can see into two 2-way control booths which serve three small studios on the left. He can control broadcasts from the console and his constant visual contact with the operations control center through window on the right. Photo courtesy of The Austin Co.

AUDIO ENGINEERING (title registered U. S. Pat. Off.) is published monthly at 28 Renne Ave., Pittsfield, Massachusetts, by Radio Magazines, Inc., J. H. Potts, President; S. R. Cowan, Sec'y-Treas. Executive and Editorial Offices at 342 Madison Avenue, New York 17, N. Y. Subscription rates—United States, U. S. Possessions and Canada, \$3.00 for 1 year, \$5.00 for 2 years; elsewhere \$4.00 per year. Single copies 35c. Printed in U. S. A. All rights reserved, entire contents Copyright 1948 by Radio Magazines, Inc. Entered as Second Class Matter at the Post Office, Pittsfield, Massachusetts, under the Act of March 3, 1879.

ASTATIC BRINGS YOU A TRULY REVOLUTIONARY DEVELOPMENT



Here are the **OUTSTANDING FEATURES . . .**

1. No "Air Gaps."
2. Necessity for delicate handling eliminated.
3. No troublesome, costly armature balancing problems.
4. Longer-lived, troublefree performance without distortion or changes in characteristics.
5. Transcription quality reproduction.
6. Velocity response flat to 12,000 cycles.
7. Output is 100 millivolts. This is approximately 20 db. greater than most previously available, light-weight magnetic pickups.
8. Needle pressure, 1 oz.
9. Impedance, 7,500 ohms at 1,000 c.p.s.—110,000 ohms at 10,000 c.p.s.
10. Interchangeability: Physical dimensions of this cartridge are such that it can be employed with a majority of present day standard pickup and transcription arms.

Now Available

THE MAGNETO-INDUCTION PICKUP

Yes, this is it! An entirely new concept in record-reproduction engineering. A radically new pickup cartridge that opens broad new vistas of listening pleasure . . . offers unchanging faithfulness and quality of reproduction that is stable and trouble-free.

The Astatic Magneto-Induction Pickup represents the first clean break with traditional principles, employed in the manufacture of magnetic type reproducers, since the introduction of such devices in early phonographs. Discarded now by this amazing development is the need for delicately spaced "air gaps," which collect lint and dust, and thereby become a prime source of trouble in other type magnetic pickups. Their elimination in the Magneto-Induction cartridge is all the more revolutionary . . . a newly opened door to greater record enjoyment . . . to a peak fidelity of reproduction that LASTS, even under the most consistent service or adverse climatic conditions.

MODEL MI-1, Code ASAKA MODEL MI-2, Code: ASALZ
Standard Housing Mumetal Housing*

**Provides increased shielding effect for maximum reduction of hum*

Two Equalizer-Amplifier models available:

Model EA-1, compact unit designed for installation in radio sets and audio amplifiers having insufficient gain for operation of Astatic Magneto-Induction Pickup Cartridges. Provides "bass boost."

Model EA-2, self-powered, provides adjustable "bass boost," adjustable treble "roll-off," and selection of "turnover frequency."

THE
Astatic
CORPORATION
CONNEAUT, OHIO
IN CANADA CANADIAN ASTATIC LTD. TORONTO, ONTARIO

Manufactured under Massa Laboratories License

Copyright, THE ASTATIC CORP. 1948

"Toward a New Audio"

Sir:

About Mr. S. J. White's letter and his "most unlinear" system in the world, I will say that his ideas have a certain wild charm about them. Mr. White is one of those fortunate men of sanguine temperament and decisive opinions and tastes—a latter-day rugged individualist and free-enterpriser of the music room. Not one of your timid, deferential souls who think that maybe Mozart, et al., could be relied on to have known what was good for their music when they indicated certain tempi or other instructions for instrumentalists. Well, Mr. White has every constitutional right to twiddle all those dials on his unflat, unlinear system in the sacred precincts of his own castle. However, I have a sneaking suspicion that many of us would need a good supply of 100 proof Old Overholt handy in order to really get in the mood of the thing were we ever in the interesting situation of standing by while he twiddled the dials.

Maybe the core of the matter is that Mr. White is a thwarted conductor. But a rebellious, *avante garde* conductor. I can see him in swallow tails before his most unlinear system conducting Chopin or Beethoven through his finger tips and dials—utterly disdainful of the composer's modest instructions as to tempo, dynamics and mood. "After all, this is my sound system," he might say, if you lifted an eyebrow or wiggled an ear. (Or maybe Mr. White has, in melancholy contrast to his sound system, a most flat and linear ear. In that case, we've really got to be understanding.)

Anyway, I sure wish I knew as much as Mr. White does about how to make reproducing systems respond to the modest requests of one's ear and soul. You see, I'm not an engineer, but one of those baffled creatures still browsing and shopping around for a nice amplifier in this world of understandarized audio. And with each issue of *Audio Engineering*, what with all the blurbs and fancy specifications, I become more and more baffled.

Mr. White has a point in what he says about variation with individuals of the "neuro-response to frequencies" and the "subjective pleasure" of twiddling dials in accordance with "emotional preferences." But like any privilege, it can be abused. There are some of us who are pleased if an oboe or a hot trumpet through a loud-speaker sounds like an oboe or hot trumpet. And who like to sit quietly without too much twiddling around the dials and let the composer and instrumentalist speak their minds like they want to. After all, I've got my rights—and so has the composer.

It's true that very often the marriage of composer and instrumentalist is not a happy one. But when you throw into the domestic picture an engineer-interpretor of an interpreter—wow!

Please don't get me wrong about Mr. White's letter. I enjoyed it fine—as much, I hope, as he did in writing it. Especially

[Continued on page 8]

For Unusual and Difficult Requirements

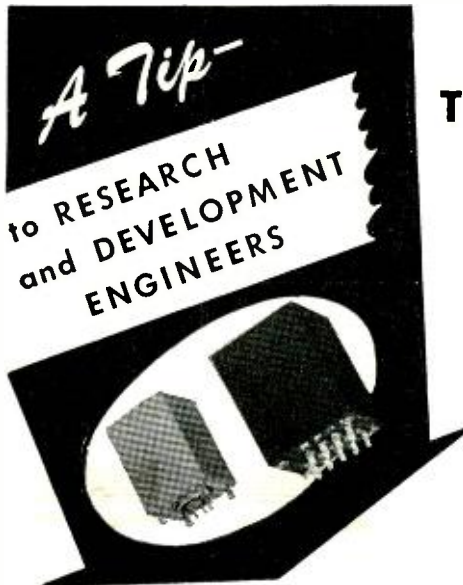

USE **ADC**

TRANSFORMERS

- Research
- Models
- Testing

STEEL When a steel company engineer was presented with a problem of testing steel with an application of variable frequency, an oscillator output impedance as low as 0.01 ohms was required over a wide Frequency range.

Through the aid of **ADC** engineers and the use of special **ADC** designed transformers a regular oscillator was equipped to perform the test satisfactorily with great savings in time and money to the steel company. Remember **ADC** as a transformer source for unusual and difficult assignments as well as for high quality and dependable production transformers.

Research



Models



Development



COMMUNICATIONS Today a large utility company has a satisfactory communication system between its central location and its mobile units because **ADC** engineers worked out technical transformer applications for the maker of a power line carrier telephone. From model stage to production this company depended upon the skill of **ADC** transformer design and production. You, too, will find **ADC** helpful in all unusual model work as well as production.

ENGINEERING The development of a computer to check the muzzle velocity of a cannon with greater accuracy required many special transformer applications. This job is typical of scores of development tasks presented to **ADC** engineers from university laboratories, communication developments, guided missile programs and developmental engineers everywhere. **ADC** supplies transformer "know how" with excellent transformer production to assure you a reliable source of dependable transformers.

Have an **ADC** catalog in your file for ready reference. Write us about your special problems.

Foreign Inquiries Solicited. Cable address: **AUDEVCO MINNEAPOLIS**



ADC *Audio DEVELOPMENT CO.*
 "Audio Develops the Finest!"
 2833 13th AVE. SOUTH • MINNEAPOLIS 7, MINN.

EDITOR'S REPORT

AUDIO HOBBYISTS

● ALTHOUGH this magazine is published by and for audio engineers, we find that our policy of presenting practical articles, rather than highly mathematical, abstruse material, is attracting an ever-increasing number of readers for whom high-quality audio reproduction is solely a hobby. While most radio engineers automatically fall into this category, there are quite a number of other professional men, such as lawyers, doctors, etc., whose enthusiasm for better audio has encouraged them to make an intensive study of our field. As a result, many who are not engineers have been able to make useful contributions to the art.

Typical of these is George Douglas, an expert photographer, who contributes the interesting article on a three-way speaker system in this issue. Mr. Douglas' work conforms to sound engineering practice and the cross-over networks are carefully and accurately worked out. Although the speaker housing obviously represents a compromise between the requirements of best performance and best appearance, it serves exceptionally well in both respects. And we believe that this three-way system is the first to be described in detail in any technical magazine.

In our "Letters" column this month, there appears a comment by another audio hobbyist, Samuel Weissman, on the letter from S. J. White (*Toward a New Audio*) in our April issue. For the information of those who did not get this issue, Mr. White wrote brilliantly, but in general terms, regarding the facilities for bass and treble control which he had incorporated in his receiver. Mr. Weissman's equally interesting comments are based in part on the common fallacy that exact reproduction of all transmitted audio frequencies, *per se*, represents perfect reproduction. What so many forget, and which Mr. White meant to convey, is that reproduction at a different loudness level from that which would be experienced in, for example, a concert hall, calls for a greater emphasis of some frequencies than of others, to make reproduced music sound, in a room, like a "live" program does in a concert hall. A loudness control which does this automatically was described by David C. Bomberger, of Bell

Labs., in our May issue. In addition, we must remember that the reproduced music is coming from a point source, the loudspeaker, and not from a distributed source, such as an orchestra. Binaural reproduction, with modified transmission technique, is a further refinement which is necessary for better reproduction. We shall soon make an interesting announcement regarding experiments along these lines.

WITH OUR AUTHORS

● SCHEDULED for our July issue is another interesting article on telephone recording by E. W. Savage, in collaboration with S. Young White. This one deals with the design of audio automatic gain control circuits, in which the requirements for this purpose differ greatly from those in the conventional p.a. system. A unique method of amplification for greater intelligibility is also outlined.

The article on the manufacture of record matrices by Harris, which was too long to be included in our last issue, will appear next month. C. G. McProud has another outstanding article, this time on the design and construction of a simple impedance bridge. Bertram Stanleigh is back with his review of popular records, and we expect that Winston Wells will have another instalment ready on electronic organs.

For broadcast engineers, there is an interesting article especially directed to those who may wish to construct a small studio, by an engineer who designed and operates one. There will be more for the professional recorder, as well as for the audio equipment designer.

We need articles concerning the audio end of professional sound-on-film recording to round out our coverage of the recording field. Engineers who feel that they have something new and useful to contribute on this topic are invited to write to us immediately.

The controversy over the inclusion of TV data in this magazine continues, but the majority prefer that we stick exclusively to audio, because much of the audio data is equally useful to the TV men. So be it.

—J. H. P.

WHAT
MAKES A GOOD
RECORDING-BLANK*
GOOD?
?

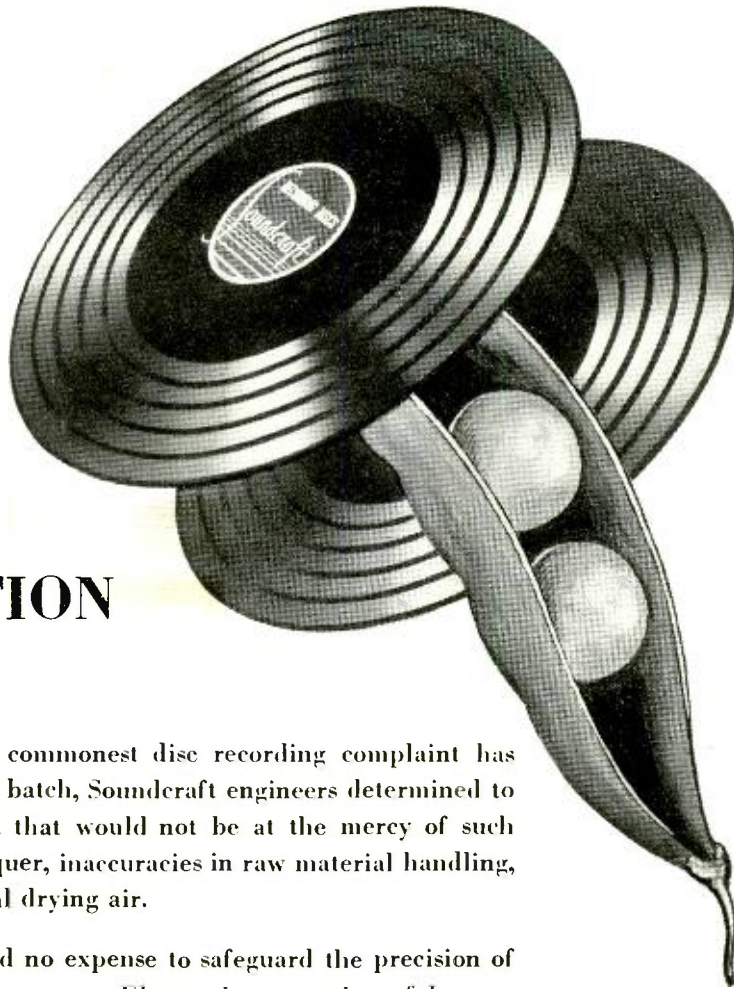

STANDARDIZATION CONTROLS

Aware from the outset that the commonest disc recording complaint has always been variations from batch to batch, Soundcraft engineers determined to build disc manufacturing equipment that would not be at the mercy of such conventional ills as impurities in lacquer, inaccuracies in raw material handling, and inadequate control of the critical drying air.

To this end Soundcraft has spared no expense to safeguard the precision of each step of its disc manufacturing processes. Electronic pre-testing of lacquer batches . . . mechanical re-working of new aluminum bases . . . viscosimeter control of lacquer consistency . . . synchronous motor-control of conveyor speed . . . micrometer adjustment of coating thickness . . . automatic removal of even microscopic foreign matter in lacquer . . . electrostatic elimination of minute dust in drying air . . . automatic humidistat and thermostat control of weather-making equipment to assure constant fume absorption of drying air . . . continuous velometer test of air flow . . . all these and dozens of other double checks and inspections have made possible Soundcraft's widespread reputation as "the most consistent disc".

**Watch this space for succeeding ads in this informative series on how Soundcraft discs are made.*

No. 6 of a series

REEVES **Soundcraft** CORP.
10 EAST 52nd STREET • NEW YORK 22, N. Y.

When the utmost in recording quality is needed, ask for the 'Broadcaster', a master-disc selection in instantaneous sizes at an "extra-fare" price.

For work-a-day broadcast-quality recordings, the Soundcraft 'Playback' offers superior cutting properties in competition with other "best-grade" blanks.

Soundcraft discs are sold by over 250 radio parts distributors in principle U. S. cities. Foreign sales by Reeves International, Inc., 10 East 52nd St., New York 22, N. Y. Cable REEVINTER.

The 'Broadcaster' The 'Playback' The 'Audition' The 'Maestro'

PICKERING REPRODUCERS



THE PICKERING MODEL 161M PICKUP incorporates all of the requirements for the finest possible reproduction of lateral records and transcriptions. It is extremely rugged and absolutely stable, ensuring long trouble-free service with minimum record wear. **TECHNICAL SPECIFICATIONS** include: Perfectly polished diamond stylus with .0025" radius; other radii available on special order at no extra cost ★ Correctly offset head gives negligible tracking error ★ ★ Extremely rugged, may be scraped across records or dropped from full height without damage to pickup ★ ★ Tracking pressure adjusted at factory to 14-18 grams ★ ★ No measurable effect of temperature, humidity or age ★ ★ Equalized output level—60 dbm ★ ★ Frequency response flat within 1 db from 30 to 15,000 cycles per second ★ ★ Back-tracking will not affect either pickup or record ★ ★ Convenient finger grip permits rapid accurate cueing ★ ★ Optimum combination of counterweight and spring permits excellent performance on warped records ★ ★ Convenient to mount, occupies least space of any transcription reproducer ★ ★ No measurable intermodulation or harmonic distortion ★ ★ Adaptable for turntables from 1" to 2½" high ★ ★ UNCONDITIONALLY GUARANTEED.

THE PICKERING Model 163A EQUALIZER

- positions
1. Flat high frequency response to over 15,000 cycles per second. Low frequency rise to give full compensation from 500 to 40 cycles.
 2. Flat high frequency response. Low frequency response approximately 5 db below position 1.
 3. For NAB or Orthacoustic transcriptions.
 4. Low frequencies same as position 2. High frequencies sharply attenuated to reduce surface noise. Attenuation starts at 4000 cycles.
 5. Low frequencies same as position 1. High frequencies same as position 4.



MADE to a tolerance of ± 1 db, provides five different lateral characteristics to equalize properly all types of records and transcriptions. It is designed for use with 250 to 600 ohm input circuits at a level of -60 dbm. Hum pickup is less than -120 dbm. The model 161M PICKERING PICKUP with a 163A EQUALIZER is so free from distortion of all kinds that it may be used as a standard for measurement.

THE PICKERING Model 125H EQUALIZER-AMPLIFIER for use with model 120M PICKERING CARTRIDGE REPRODUCER—it compensates for average recording characteristic, raises output voltage to as high as obtainable from crystal pickups, operates from the power supply of amplifier or radio set, saving cost of separate power supply, very simple to install.



**Pickering
& Company, Inc.**

Oceanside, Long Island, N. Y.

THE PICKERING Model 120M CARTRIDGE REPRODUCER

A compact version of the PICKERING PICKUP for high quality reproduction, it fits into any arm which will accommodate a standard cartridge and affords the cleanest and smoothest response ever achieved. Its Frequency Response is ± 2 db, 40-10,000 cps ... its Waveform Distortion is 1 percent maximum ... its Output Level is 70 millivolts ± 2 db ... its Tracking Pressure is 15 grams maximum at 40 and 10,000 cps. NO OTHER PICKUP CAN MATCH THE PERFORMANCE OF THE PICKERING MODEL 120M



[from page 5]

the part about the voluptuous relish of being able to let the highs slither at will through either ear canal.

Samuel Weissman
90-60 179th Place
Jamaica 3, New York

Re: "TV or No TV"

Sirs:

Please, NO video in *Audio Engineering*. What about some FM tuners, with a practical AFC, for instance? That would do a lot for good audio.

John L. van Heijenoort
116 West 11th Street
New York 11, N. Y.

FM Tuner is Coming—Ed.

Sirs:

No TV, please. Keep up the good work.

Harry J. Reed, Jr.
Manville Lane
Pleasantville, N. Y.

Sirs:

Just saw the April issue, and want to cast one vote against the inclusion of TV material in your magazine. TV ought to have its own book soon enough. It already has a share of several others.

I enjoy *Audio Engineering* to the last word, and wish you continued success.

Robert Noll
2907 Hatzell St.
Evanston, Ill.

Sirs:

* * * * Incidentally, we would like to see some articles on video engineering so you may add our vote to the list. Your magazine is very refreshing and we note you have managed several "firsts" in presentation.

Arthur R. O'Neil
WBST Engineering
Department
South Bend 26, Ind.

RE: MUSICAL ACOUSTICS

Sir:

Mr. Benjamin F. Tillson's series of articles on Musical Acoustics have proved most informative, and will take their place in the reference literature.

I believe therefore that Mr. Tillson may wish to correct a not immediately obvious error in the fifth article in the October issue.

I refer to the paragraph on the calculation of reverberation time. Dealing with the number of reflections to decay a sound 60 db with an absorption coefficient of 0.97, it is implied that the log of 10^{-6} is (6.00000-10). Surely this should be (4.00000-10). The statement that the log of n equals the log (6.00000-10—log (9.013228-10)) is equal to 2.65667 is therefore not true, and requires re-writing in the form—

log of n equals the log (4.00000-10)—log (0.013223) which does equal 2.65667, and n becomes 453.57

L. F. Odell
Sonic Laboratory
Philips Electrical Limited



SETS A NEW PERFORMANCE STANDARD!

YOU GET ALL THESE FEATURES
IN THIS NEW HIGH FIDELITY
SIGNAL GENERATOR



-hp- 206A Audio Signal Generator

Voltage accurate within 0.2 db
Distortion less than 0.1 %
Continuously variable a-f voltage
Frequency range 20 cps to 20 kc
High stability of frequency

For the first time all the features listed above are combined in one precision instrument, to give you signals of utmost purity and accuracy for high fidelity measuring work.

In addition, the new -hp- 206A Generator includes low-temperature coefficient frequency determining ele-

quality audio circuits, the -hp- 206A is ideal for FM transmitter maintenance, studio amplifier and console testing, a source for bridge measurements, a-f voltage or transmission measurements; and for other applications requiring a very low distortion signal of known amplitude.

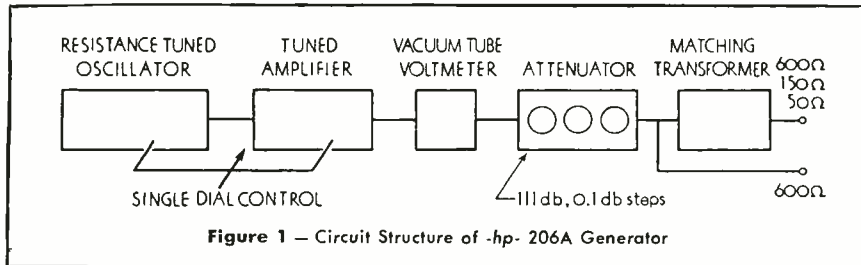

ments for high stability and unvarying accuracy over long periods of time. A precision attenuator varies output signal level in 0.1 decibel steps throughout 111 decibels.

Resistance-tuned Oscillator

The resistance-tuned oscillator is followed by an automatically tracked amplifier whose high selectivity reduces oscillator harmonics. Following the 111 db attenuator is a transformer which can be matched to loads of 50, 150 and 600 ohms. A 600 ohm single-ended output is also provided (Fig. 1).

Specially designed for testing high

Full details available on request

HEWLETT-PACKARD CO.

1640D Page Mill Road, Palo Alto, Ca:ifornia
Export Agents: Frazar & Hansen, Ltd.
301 Clay Street • San Francisco, Calif., U. S. A.

SPECIFICATIONS

FREQUENCY RANGE: 20 cps to 20 kc, 3 bands.

CALIBRATION: Direct in cps on lowest band.

STABILITY: Better than 2%. Low temperature coefficient frequency network.

OUTPUT: +15 dbm into 50, 150, 600 ohms. Approx. 10 v into open circuit.

OUTPUT IMPEDANCE: 50, 150, 600 ohms balanced. 600 ohms single ended. Matched internal impedances.

FREQUENCY RESPONSE: Within 0.2 db, 30 cps to 15 kc, beyond meter, at all levels.

DISTORTION: Less than 0.1% above 50 cps. Less than 0.25% below 50 cps.

HUM LEVEL: 70 db below output signal, or 100 db below zero level.

OUTPUT METER: Reads in dbm or volts.

ATTENUATORS: 111 db in 0.1 db steps. Accuracy approximately 0.1 db.



Power Supplies Frequency Standards Amplifiers Electronic Tachometers Frequency Meters
UHF Signal Generators Square Wave Generators Audio Frequency Oscillators Attenuators
Audio Signal Generators Noise and Distortion Analyzers Wave Analyzers Vacuum Tube Voltmeters

WHERE can you get all these features in one loudspeaker?

Amazingly high quality

Surprisingly low cost

Small size (8³/₈" diam., 3¹/₈" depth)

ONLY in the Western Electric **755A**

Immediate shipment from stock

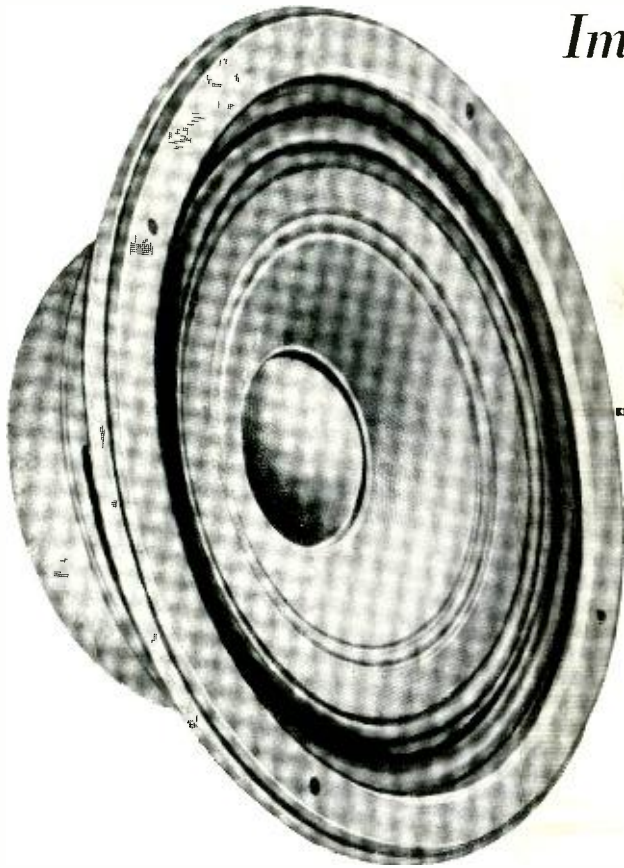

Compare for yourself the quality of music reproduction that you get from the 755A with that of other speakers on the market. We think you'll agree that it's tops.

Combining outstanding quality with small space requirements, the 755A is a leading choice for broadcast stations, wired music, program distribution and sound systems. Ideal for home radios and record players, too. In fact, name *any* spot where you want the finest quality at low cost—it's a job for the 755A.

Details? 8 watts continuous capacity. Frequency range 70 to 13,000 cycles. Coverage angle 70 degrees. Weight only 4³/₄ pounds. Size: 8³/₈" diameter, depth 3¹/₈". Only 2 cubic feet of enclosure space needed.

Don't forget—this amazing speaker is ready *right now* for immediate shipment from stock—in quantity! Call your nearest Graybar Representative—or write to Graybar Electric Company, 420 Lexington Ave., New York 17, N. Y.

—QUALITY COUNTS—



DISTRIBUTORS: IN THE U. S. A.—Graybar Electric Company. IN CANADA AND NEWFOUNDLAND—Northern Electric Company, Ltd.

Western Electric

Misconceptions About Record Wear

NORMAN C. PICKERING*

A thorough analysis of the causes of record wear.

THE LIFE expectancy of phonograph records is a subject which is under constant discussion; to the person who has invested a considerable sum in a record library much of which is irreplaceable, record wear is a topic of more than academic interest.

It is regrettable that so much inaccurate information has been disseminated about record and stylus wear. Much of it has been offered in all sincerity, but too often sweeping conclusions have been drawn from experiments which failed to include some of the most important factors involved. A great deal of the published "data" on record wear and stylus life, unfortunately, has originated in the optimistic imagination of some uninformed copy-writer. This situation gives rise to some of the following commonly-held beliefs:

1. That a hard reproducer stylus wears records faster than a soft one.
2. That a soft reproducer stylus wears records faster than a hard one.
3. That shellac records wear faster than vinylite.
4. That vinylite records wear faster than shellac.
5. That tracking pressure is the only important factor in record wear.
6. That tracking angle is the most important factor in record wear.
7. That lateral compliance of the pickup is the determining factor in record wear.
8. That vertical compliance is the determining factor in record wear.
9. That a large stylus radius imposes less wear on records.
10. That a small stylus radius imposes less wear on records.

Factors Affecting Record Wear

The above statements all represent an attempt to reduce the problem of record wear to a simple one-dimensional affair. As a matter of fact, the actual problem is so complex and the factors involved so numerous that it is not possible to predict record life without specifically evaluating all of the following:

1. Record material.
2. Spectral distribution of recorded energy.
3. Velocity angles of the record grooves.
4. Shape of the groove cross-section.
5. Relation of groove cross-section to shape and polish of reproducer stylus.
6. Lateral and vertical mechanical impedance at stylus tip at all frequencies.

*Pickering & Co., Inc., 309 Woods Ave., Oceanside, N. Y.

7. Tracking pressure of reproducer.
8. Lateral and vertical warpage of the record.
9. Lateral and vertical pivot friction in reproducer arm.
10. Tracking error and head offset of pickup arm.
11. Lateral and vertical turntable vibration.

An attempt has been made to arrange the parameters in the approximate order of their importance to record wear. They are not all independent variables, so it is impossible to discuss each one without constant reference to the others.

Actual Process of Record Wear

Record wear is a change in the character of the record groove resulting in one or all of the following:

1. A change in appearance of the record surface, visible to the unaided eye.
2. An increase in background noise.
3. An increase in distortion.

It seems to be fairly certain that the

perfectly "quiet" groove. Fig. 1a shows a cross-section of a stylus in a groove, and Fig. 1b shows the plan view of the same record and reproducer.

F_T is the tracking pressure normal to record surface

F_Y is the force normal to groove wall supporting stylus

B is the tracking error angle only in the case of a straight arm

α is one-half the included angle between groove walls

k is the coefficient of friction between the stylus and groove

F_R is a radial force which will be derived.

Each F_Y , from the force triangle, is seen to equal $\frac{F_T}{2 \sin \alpha}$

There is also a resultant frictional force tangent to the record groove at the point of contact equal to $\frac{F_T k}{\sin \alpha}$

Fig. 1A. Cross-section of stylus in groove. Fig. 1B. Plan view of same record and reproducer.

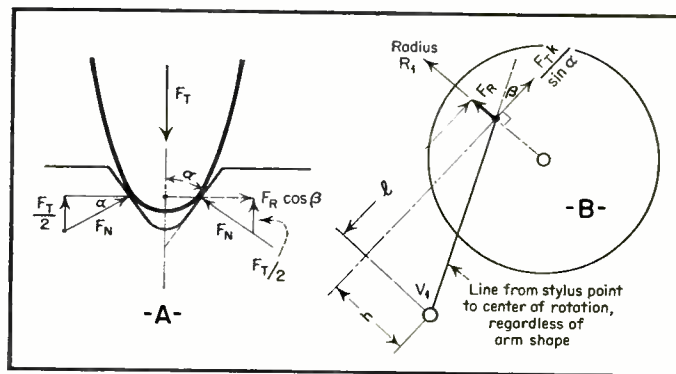

actual process of record wear is accomplished by one or all of the following:

1. Frictional erosion of the groove walls by a rubbing action between the stylus and the groove.
2. Deformation or crumbling of modulation cusps by dynamic forces between the stylus and the groove.
3. Shearing of modulation cusps by sharp edges on the reproducing stylus.
4. "Rolling in" of surface dirt between the stylus and groove walls.

Forces on an Unmodulated Groove

In all the following discussion a "standard" groove shape of 90° included angle .002 bottom radius and .006 top width is assumed. There are various steady forces which act on a stylus in blank grooves, assuming for the sake of argument that there is such a thing as a

Since this force is applied as a moment about the vertical axis of the reproducer arm, there must be a stabilizing force applied radially to the stylus:

From Fig. 1b it will be seen that:

$$\frac{F_T k}{\sin \alpha} (h) = v_R (l)$$

$$\therefore F_R = \frac{h F_T k}{l \sin \alpha} \quad \text{but } \frac{h}{l} = \tan \beta$$

$$\therefore F_R = \frac{F_T k \tan \beta}{\sin \beta}$$

Since k depends largely on the stylus polish and the finish of the record ma-

terial this force will be small on good records played with a good well-polished stylus, provided that the tracking pressure is not great. A metal tip cannot be made to keep a high polish for more than one or two revolutions of the average shellac record. To minimize this force, therefore, a highly polished jewel stylus is indicated.

Two other forces can add to F_R . A frictional moment about the vertical axis V will usually add a force to F_R .

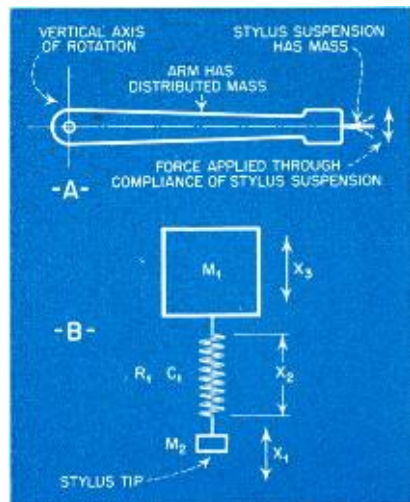

Fig. 2. In (A) Pickup arm and stylus and (B), equivalent mechanical circuit diagram. Mechanical forces are designated as listed below. M_1 = Moment of inertia of pickup arm
 M_2 = Moment of inertia of stylus suspension
 C_1 = Compliance between stylus suspension and arm

R_1 = Damping of system
 X_1 = Displacement of stylus
 X_2 = Displacement of compliance
 X_3 = Displacement of mass
 $X_1 = X_2 + X_3$
 X_2 is the useful motion in the reproducer.

Note: This diagram applies equally well to vertical or lateral motion at the stylus point, except for a change in values of the parameters. For vertical motion, M_1 and C_1 will usually be lower and M_2 higher than for lateral motion.

Any gravitational component along radius R_1 caused by poor leveling of the turntable may also add to F_R . If F_R did not vary as the tracking angle β changes, a slight intentional mis-leveling might help matters, but unfortunately things are not so simple.

In addition to the steady forces described above, there are also numerous alternating forces in the unmodulated groove which exist under actual conditions. An eccentric record causes forces equivalent to extreme low-frequency lateral signals. This causes an acceleration force against the groove walls once per revolution on each side. In addition, friction about V_1 will reverse direction once per revolution with an eccentric record. These effects add to the lateral forces on the stylus.

Warpage of the disc causes periodic positive and negative accelerations of

the vertical moment of inertia of the pickup arm. These forces are modified by friction in the horizontal arm pivots.

Lateral and vertical vibration will add to the forces already described. Under certain conditions, vibration can be a very significant factor in record wear. Lateral vibration will, of course, appear in the electrical signal output from the pickup as rumble or hum. Vertical vibration will not be reproduced as sound in a good pickup, but the forces on the record and stylus exist, just the same.

Forces on a Modulated Groove

In order to appreciate the complex nature of the motion at a reproducer stylus point, it is good to review the basic mechanics of the vibrating system of a record reproducer.

The forces set up at the stylus tip in Fig. 2b are determined by the constants of the elements in the system and the nature of the motion imposed on the stylus tip. Referring to the diagram, the useful motion of the reproducer is the deflection of the compliance C_1 , denoted by X_2 . This deflection is equal to the sum of the forces at both ends of the spring times the compliance of the spring. Imagine the point marked "stylus tip" being vibrated rapidly in the direction X_1 . At high frequencies the principal force is that required to accelerate the mass M_2 . This force equals M_2a where a is the acceleration which the record groove imposes on the stylus. As the frequency is lowered, we approach the point where M_2 is resonant with C_1 . At this frequency the mass M_2 moves quite easily, and the force applied by the record groove is determined only by the damping R_1 . This damping force is equal to R_1V where V is the velocity of the motion applied to the stylus point. As we go lower in frequency, we find that the stiffness of spring C_1 is the controlling factor. This force is C_1X_2 . As we approach the frequency where

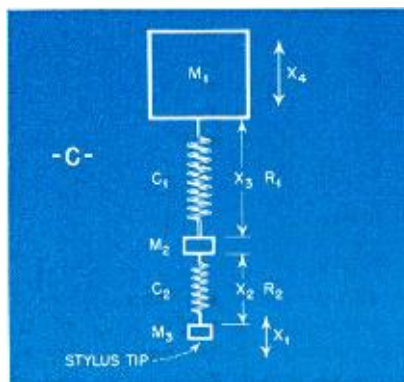

Fig. 2C. Equivalent mechanical circuit for magnetic reproducer.

M_1 , M_2 , C_1 , and R_1 are the same as in Fig. 2B. C_2 is the compliance between the stylus and the moving system. M_3 is the moment of inertia of the stylus suspension. R_2 is the damping of the stylus support. In this case X_3 is the useful motion of the system.

M_1 and C_1 are in resonance we find that the amplitude X_2 builds up rapidly to a maximum value limited only by the damping R_1 and limit stops on the stylus supports. Below resonance M_1 and M_2 move together and there is no deflection of X_2 to produce useful output from the reproducer.

The point of this rather crude discussion of the dynamics of pickup action is to assist the reader to visualize the reaction forces on the record groove. At high frequencies even a groove with very small displacement can have a high acceleration, because the displacement is multiplied by frequency squared to obtain acceleration. In this era of straining for 15 kc reproduction it is well not to lose sight of some of the things we are asking the record to do. If we use considerable pre-emphasis while recording, we will produce some records which cannot support the force developed by the unmounted jewel alone, without a reproducer fastened to it! Recently suggested modifications of the NAB recording characteristic are based on this realization.

At low frequencies (above arm resonance) the stiffness of the stylus suspension is the most important consideration. The ability to track bass passages well is directly related to this characteristic. As the frequency is lowered toward arm resonance, the output from the reproducer increases, but so do the forces on the record groove. These forces reach a maximum at resonance, where they may become extremely high. If the amplitude of oscillation is high enough to cause hammering against the stops of the stylus support, the record walls will quickly be broken down. Of course, the actual value of the force depends on the mass of the arm, so a light arm has some advantage in this respect. On the other hand, resonance will be reached at a much higher frequency with a light arm, so excitation will be provided by frequencies within the desired range of reproduction. This will give rise to a situation where the groove forces reach a peak on some particular bass note, which condition may cause groove breakdown at that frequency.

Frictional Erosion

It now becomes possible to discuss in some detail what actually goes on as the groove wears. Wear in a blank groove when no vibrational forces exist can only occur by breakdown due to static load, or by actual abrasion from a rough stylus point.

The forces mentioned in earlier sections are applied to the groove wall by a spherical stylus in the ideal condition. The unit load, therefore, is dependent on the actual area of contact. This area is largest for a worn stylus, so we find

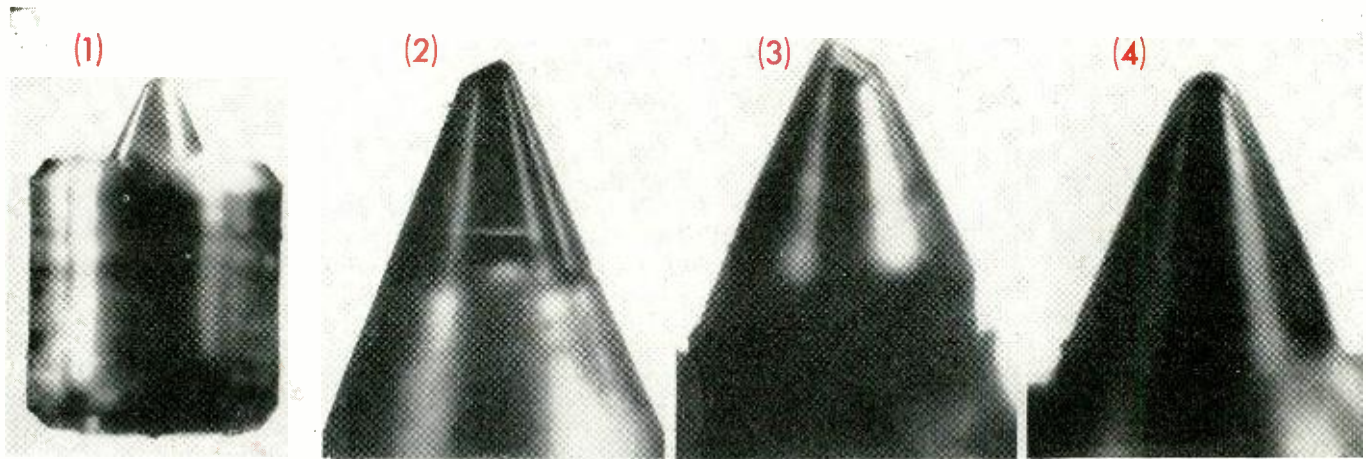

(1) Diamond stylus mounted for use in the Pickering cartridge (before insertion in tube). (2), (3), (4) Wear tests. All were for 400 plays (200 plays per side) on RCA Victor record "Begin the Beguine," Tony Martin, using Garrard changer No. RC60/L16, 1¼ oz. pick-up, Astatic cartridge L75. Photomicrographs 100X (approx.). (2) Sapphire bent shank, (3) Osmium tip, (4) Tetrad diamond (bent shank).

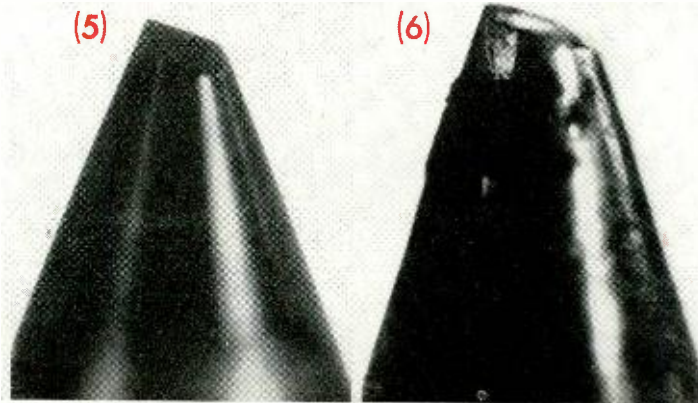

(5) Ruby tip, removed from a juke box by operator who decided that the reproduction was poor. The excessive record wear which accompanied this stylus wear was blamed on the "fact" that record manufacturers no longer use "good hard rubber."

(6) "Precious metal" playback stylus, removed from a juke box by operator who decided it was time for a change. Photomicrographs 100X (approx.).

Photos courtesy Tetrad Corp.

that the unit stress on the record material is least when the blank groove is played with a worn stylus! This is by no means intended to indicate that stylus wear is advantageous, although in the early phonograph days it was the wear on the steel needle which made the phonograph feasible at all because of the enormous tracking pressure of the reproducers. The only thing which made possible repeated playings of a disc was the fact that both the recorded amplitude and the high-frequency content were low. A modern high-level record played on an old acoustic phonograph will not survive the ordeal.

With pickup pressures of one ounce or less, even a perfectly spherical stylus will not subject a shellac record groove to more stress than it can withstand, due to static forces alone. Some elastic deformation will occur in vinylite, however, and even more in instantaneous lacquer. These latter materials have good plastic memory, and the grooves do not seem to be any the worse for wear after being played with a highly polished stylus even with considerable pressure. Materials like lacquer and vinylite are easily scratched, and the least roughness on the stylus will act like a file in the grooves. Shellac is not nearly so easily abraded, although a chipped jewel stylus will ruin any groove.

Lacquer and vinylite are particularly susceptible to having surface dirt imbedded in the grooves. This dirt is rolled in under the pressure of the stylus,

and evidences itself as an increase in background noise, particularly "clicks and pops."

Tests made indicate that black grooves on shellac records will wear indefinitely with a smooth spherical stylus which does not exceed one ounce pressure. Turntable vibration can alter the conditions sufficiently that wear will show in regular patches, indicating that the peak forces at such places have greatly exceeded the tracking pressure. Certain low-priced record changers show considerable vertical vibration which produces wear of this description.

Vinylite and lacquer, on the other hand, do not show these wear patches under the same conditions. This would indicate that the compliance of the record material prevents the high peak accelerations which exist with the hard shellac. The softer records do show a general increase in noise because of dirt, however.

Dynamic Wear

By far the most significant cause of wear is the dynamic action of the stylus in the grooves. The mechanism of wear is the same as for static forces, but it occurs only at certain parts of the record, depending on the shape of the groove. What happens on shellac is fairly certain. It can be seen through the microscope in progressive stages.

A spherical stylus in the groove produces dynamic forces which were discussed in an earlier section. If the

resultant force exceeds momentarily the elastic limit of the record material, the material deforms. Since shellac is brittle, it crumbles away completely. The breaking away of the piece which was under stress permits the stylus to drop down into the groove a little deeper, eventually increasing the bearing area of the stylus by contact with the groove bottom. At this point with a low-mass reproducer the wear apparently stops, because the peak unit stress no longer exceeds the elastic limit of the shellac.

An interesting fact about this type of wear is that it does not produce any apparent change in quality of the reproduced sound, although it can be seen as a light streak on the surface of the record. This type of wear occurs more readily with the larger stylus radii (.003" or larger) than with a radius of .0023" to .0025". Of course, it can be seen that too small a radius, beside causing "skating" in the bottom of the groove, will concentrate the stress on the groove bottom with a worse effect on the quality.

It must be made clear that the foregoing discussion refers to high-frequency effects where the force required to accelerate the mass of the stylus mounting is predominant. It also applies both to vertical and lateral forces, and both must be considered at all times. Fig. 2c shows a mechanical schematic diagram of a type of reproducer which is arranged to decouple the mass of the stylus from the moving system at very high fre-

quencies. The "bent shank" type of stylus acts in a similar fashion. Although this reduces the forces on the groove walls, it also eliminates electrical response to very high frequencies.

Since the metal and sapphire stylus tips acquire worn flats much more readily than does the diamond, this is probably the reason for the belief held by some people that diamonds wear records more rapidly than sapphires or metal tips. Although it is possible that visible wear might occur sooner with the diamond, audible wear, caused by actual widening of the groove at corners, will occur far more rapidly with a worn stylus. The flats on the sides act as scrapers in attempting to negotiate sharp bends in the record track. When the record groove is widened the pickup will rattle at these spots. Another effect of a worn stylus, even in a perfect groove, is the distortion, which rapidly becomes unbearable at high frequencies.

At low frequencies the amplitude of the groove swing determines the force applied to the stylus. If this force exceeds the instantaneous tracking pressure, the reproducer is said not to "track," and the stylus slips over the land adjacent to the groove. If this happens often enough the groove wall is broken

down, and the result is a "rattle" on such bass passages. With most modern reproducers this is not a serious problem, however. A similar effect results from too light a tracking pressure at high frequencies. Because of the slope of the groove wall the stylus may be forced upward under acceleration, which will cause rattling and hammering of the groove walls. This may actually cause more damage than if the tracking pressure had been slightly higher.

These dynamic forces mentioned in connection with shellac records do not reach such high values with vinylite or lacquer discs. The material itself is elastic enough to reduce the force applied to the stylus, although continual application of excessive force to the same points in the groove wall will eventually widen the groove and produce distortion and rattles.

Deformation of the groove walls indicates that the reproducer stylus does not follow the path cut by the cutting stylus. It is obvious, therefore, that the resultant signal is not a true reproduction of the original cut. This is the reason high-level passages never sound as "clean" on lacquer or vinylite as they do on good shellac.

Lacquer and vinylite are much more

easily cut by a worn playback stylus, which is another reason why only a highly polished diamond should be used in a reproducer which must play all three types of material.

Summary

For minimum record wear a low moving-mass highly compliant pickup with a highly polished diamond stylus produces the best results. The pickup arm must be free from friction and the turntable level and free from vibration. Tracking pressure should be as low as possible, but is not the principal factor in dynamic wear. Some improvement can be effected at the expense of very high frequencies by introducing compliance between the stylus and the moving system.

Shellac records may show visible signs of wear with no deleterious effect on the output signal from the pickup, provided that the above conditions prevail. Vinylite and lacquer discs do not show wear as readily, but are much more susceptible to surface dirt.

Whereas a slightly worn stylus may have no particularly harmful effect on a shellac record, lacquer and vinylite are easily damaged under these con-

[Continued on page 47]

Sapphire Group Second Anniversary Meeting, March 10, 1948

Front row sitting, left to right: Gordon Edwards, Motion Picture Research Council; John Hilliard, Altec-Lansing Co.; Bob Morris, Universal Recorders; J. L. Pettis, R. C. A.-Victor; Russ Hanson, Samuel Goldwyn Studios; Art Davis, Cinema Engineering Co.; Earl Grant, KHJ; L. W. Sepmeyer, U. S. Navy Laboratory.

Second row sitting, left to right: C. V. Olson, Master Craft Laboratory; Victor Quan, C. P. MacGregor Studio; Vern Carson, Orto-Vox Mfg. Co.; Art Felthousen, C. P. MacGregor Studio; Dick Burgess, Recorders Laboratory; Bill Elliot, Cinema Engineering; Frank Gilbert, Orto-Vox Mfg. Co.; Bill Miller, Capitol Records.

Third row sitting, left to right: Eddy Delapina, KHJ Recording; Jean Marks, Electro Vox Recording Studios; Bill Stancil, Stancil Tape Recording Co.; Olin Dupy, MGM Pictures; Wayne Johnson, KFI; Dick Hull, Consolidated Engineering Co.; L. S. Doubt, Caltec Sound Laboratory.

Fourth row sitting, left to right: Sil Caranchini, National Broadcasting Co.; Bill Lambeth, KHJ Recording Division; Chief Warrant Officer Price, U.S.N., Armed Forces Radio Service; Howard Talbot, Armed Forces Radio Service; Captain Robert DeVilbiss, Armed Forces Radio Service; Robert B. Walders, Symmetric Research Co.; Glen Glenn, Glen Glenn Sound Studios; Mort O. Smith, National Broadcasting Co.; Ernie Knight, Diacoustic Laboratory; Alan Bodge, Audio Devices Co.; Bob Callen, Standard Recorders; Dr. John G. Frayne, W. E. Co.; H. P. Stark, S. & S. Engineering.

Back row standing, left to right: Nick Slavich, Owner of Nickodell Restaurant; Ken Lambert, MGM Pictures; Walter Carruthers, Don Lee Broadcasting—KHJ; Jack Mullen, Palmer Co.; "Shang" Winter, Radio Recorders; Harry Bryant, Radio Recorders; Cliff MacDonald, Arcturus Manufacturing Co.; Howard Tremaine, School of Radio Arts; Charlie Douglas, Columbia Broadcasting Studios; Garry Harris, Samuel Goldwyn Studios; Jim Bayless, RCA Victor; Lester Culley, National Broadcasting Co.; J. P. Maxfield, Western Electric Co.



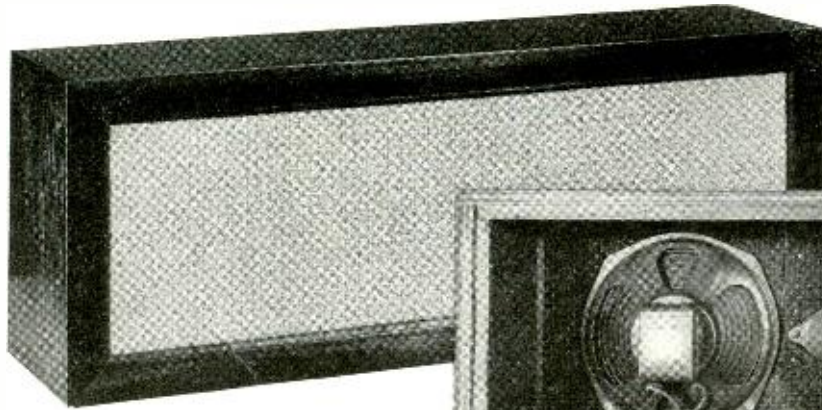

(Above.) Front view of three-way speaker system cabinet.

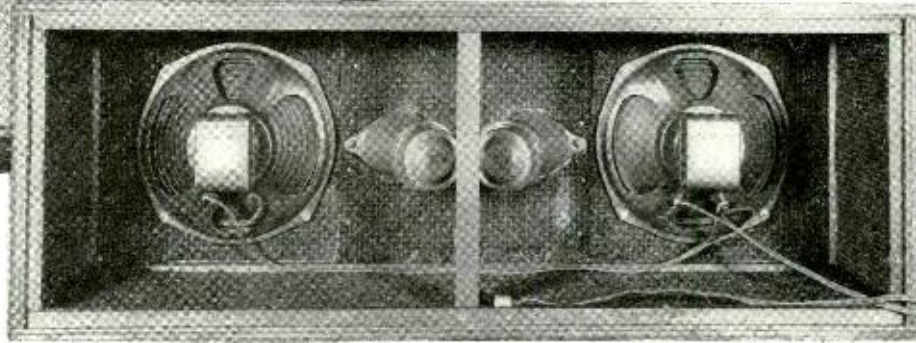

(Below.) Arrangement of the three speakers on the baffle.

Three-Way Speaker System

GEORGE A. DOUGLAS*

THE wide acceptance of some form of multiple speaker arrangement as a requisite of high-quality reproduction is responsible for a renewal of interest in three-way systems. The extraordinary strides made by dual speaker systems in the last few years has tended to a state of complacency and has resulted in obscuring somewhat the need for further experiment along these lines. The writer has been unable to find any published data on the three-way system, and has worked at the problem according to his own ideas—which may or may not be consistent with good engineering practice. However, the results attained with the system to be described should warrant serious consideration of the three-way system as a factor in tracking down the elusive will o' the wisp of realism in sound reproduction.

Theoretical discussion is not within the scope of this article other than to point up the desirability of limiting the coverage of single speakers to bandwidths within their capabilities, and utilizing as many as are deemed necessary to overcome as much as possible the shortcomings of each unit as regards mass, cone breakup, and other inherent deficiencies of design contributing to distortion. In a three-way system, these deficiencies are minimized in that each unit is called upon to deliver only within a range of about three octaves, a band well within the ability of any speaker of reasonably good quality. Besides permitting the use of a small unit in the upper band and thereby reducing the effects of mass, a separate middle frequency speaker allows the choice of a very low cross-over without the excessive cost of a comparative dual system, and

restricts the low frequency speaker to operation within optimum limits.

Components

A three-way system was constructed along the same lines as the conventional two-way system, design data being merely extended to include an additional speaker. The existing reproducer, a 15" cone in a large cabinet, became the low frequency unit without modification. Eight inch cones serve in the mid section, two being used to provide sufficient power-handling capacity. In this connection, a horn type speaker was considered, and might have been used if a suitable one had been available. However, the cones were convenient and have proven satisfactory. The upper range is adequately taken care of by the dual horn unit shown in the photograph. It has excellent horizontal and vertical distribution with a manufacturer's rating of 12 watts and response to 15,000 cycles.

Figure 1 shows the manner in which the filters are arranged to provide the cross-overs. Two series type dividing networks are cascaded to form the low-pass, band-pass, and high-pass transmission characteristic of Fig. 2. Economy

and the limitations of the speakers were factors in the choice of cross-over points at 500 and 3000 cycles.

The cabinet shown in the photograph was constructed to house the upper and middle frequency speakers. No difficulty due to relative positioning was experienced. At 3000 cycles the distance involved is so small that the units could all be mounted flush and phasing accomplished by observing polarity. The small cabinet, on top of the large baffle, may be placed to advantage with reference to the low frequency speaker.

Constructional Data

In the design of the dividing networks, the configuration and accompanying data described by McProud in the June, 1947, issue of this magazine, were followed. Flanges for the coil forms were made by cutting discs of one-eighth inch masonite with a circle cutter, the edge of the tool being reversed so that the bevel does not appear on disc. One and one-quarter inch dowel stock in lengths of three quarters and one and one quarter inches served as cores. The flanges are glued to the core, being held in place with a small

[Continued on page 46]

Fig. 1. Schematic showing circuit of the cross-over networks.

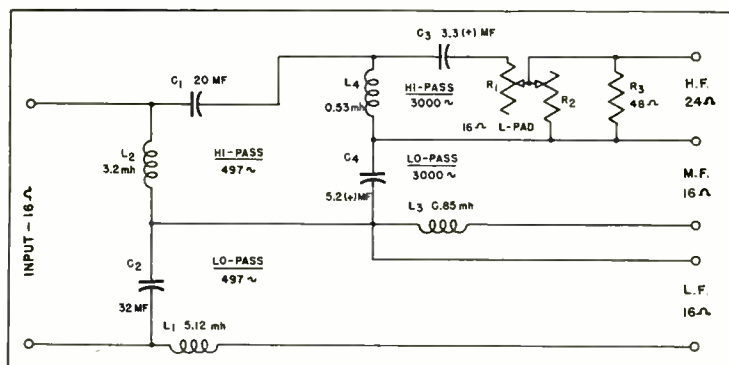

*51 E. 42 St., N. Y., N. Y.

RC Circuits as Equalizers

HOLGER MARCUS DAHL*

A simplified method of computing the elements of RC circuits

FOR AUDIO frequency equalizing purposes, RC-circuits of two types are common in interstage coupling (Figs. 1 and 2). These circuits give a rounded step upward or downward in the frequency response curve. These curves are usually plotted on graph paper with logarithmic scales. The logarithm for the frequency is plotted on the x -axis ($x = a \cdot \log \frac{f}{f_0}$) and the logarithm for the output voltage is plotted in decibels on the y -axis ($y = 20 \cdot \log \frac{V_2}{V_0}$).

The Equations

The equations for these circuits are rather laborious (Figs. 1 and 2) but they can be much simplified by choosing suitable parameters.

*Sjorwagen 10, Lidöngö 1, Sweden.

The first frequency parameter is the reference frequency ω_0 . At this frequency the reactance of the capacitor is equal to the combined resistance in the RC-branch

$$\frac{1}{\omega_0 C} = R; \omega_0 = \frac{1}{RC} \quad (1)$$

The equations for step-up and step-down are

$$\begin{array}{l} \text{For step-up} \\ R = R_1 + r \end{array} \quad \begin{array}{l} \text{for step-down} \\ R = \frac{r R_1}{r + R_1} \end{array} \quad (2a, 2b)$$

The second frequency parameter μ is the frequency in relation to the aforementioned reference frequency.

$$\eta = \frac{\omega}{\omega_0} \quad (3)$$

The third parameter is the step ratio S between the maximum transmission and the minimum transmission.

$$S = \frac{T_{\max}}{T_{\min}} \quad (4a)$$

This ratio can be easily calculated by taking the transmission with the capacitor shortcircuited and disconnected, respectively.

When used for the response curve the step ratio may be expressed in decibels

$$h = 20 \log \frac{T_{\max}}{T_{\min}} \quad (4b)$$

With these parameters the equations for the step type response curves are much simpler and become for the step-up type

$$\frac{V_2}{V_0} = T_{\min} \frac{1 + j\eta}{1 + \frac{j\eta}{S}} = T_{\max} \frac{1 + j\eta}{S + j\eta} \quad (5)$$

and for the step-down type

$$\frac{V_2}{V_0} = T_{\min} \frac{1 + j\eta}{\frac{1}{S} + j\eta} = T_{\max} \frac{1 + j\eta}{1 + jS\eta} \quad (6)$$

It can be shown that the response curves in the aforementioned logarithmic coordinates are antisymmetrical with an inflexion at the midfrequency

$$\omega_i; \eta_i.$$

The second frequency parameter for the inflexion point can be easily calculated, and is for the step-up response curve

$$\eta_i = \sqrt{S}; \omega_i = \omega_0 \sqrt{S} \quad (7a)$$

Further it can be shown that the slope α_i at the inflexion point is

$$\left(\frac{dy}{dx}\right)_i = \gamma_i = \frac{S-1}{S+1} \quad (8a)$$

For the step-down response one gets the following equations

$$\eta_i = \frac{1}{\sqrt{S}}; \omega_i = \frac{\omega_0}{\sqrt{S}}; \gamma_i = \frac{S-1}{S+1} \quad (7b)$$

With the three characteristic tangents, the two steps and the inflexion tangent, an approximation of the response curve is obtained, which will satisfy most of the practical cases. (Fig. 3.)

The fundamental equations and the tangent approximations are brought together in Fig. 4. It should be noted that

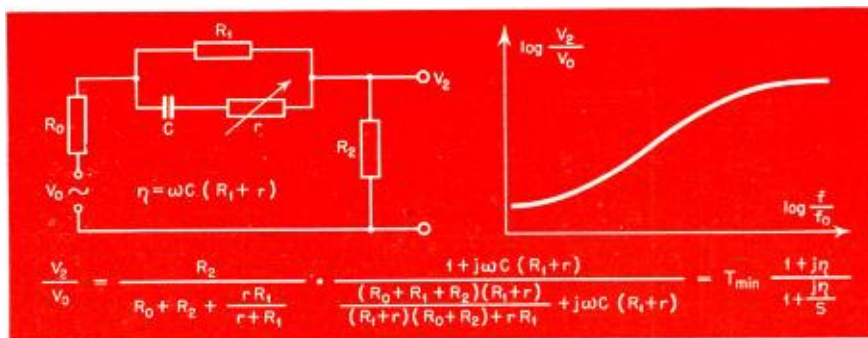
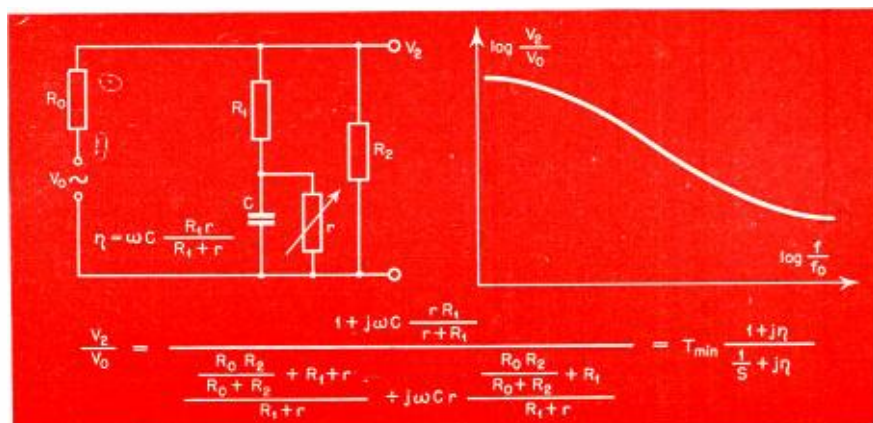

Fig. 1. Typical RC equalizer circuit used in interstage coupling.

Fig. 2. Same as above, but designed to attenuate the higher frequencies.



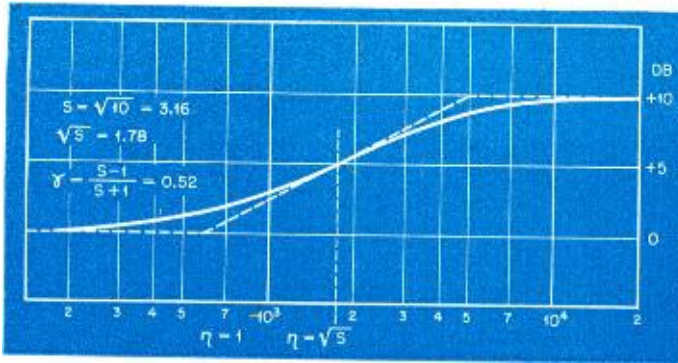

Fig. 3. (left). Tangents show a close approximation of the resulting frequency response curve.



Fig. 4. (below). Fundamental equations and tangent approximations

the step up has its reference knee to the left, and the step down has its reference knee to the right.

Application

The first problem is to compute the elements of a circuit, which shall give the desired frequency response curve. This problem may be solved as follows:

1. Choose the step ratio S .
2. Choose the inflexion frequency f_i or the reference frequency f_0 for the curve. (Keep in mind that the rounded step has an interval of at least three octaves.)
3. Using these values and equation (7a) or (7b) one can find the reference frequency.
4. Compute the resistances (R_1 ; r) using the given value of S and the actual source and load resistances. This is preferably done by calculating transmission with the capacitor shorted and disconnected.
5. Compute the capacity value using the resistances from (4) and equations (2a) or (2b) and (1).

The second problem is to draw the response curve of a circuit, whose elements are known.

1. Find the step ratio by comparing transmission with the capacitor shorted and disconnected.
2. The step ratio is expressed in decibels, equation (4b).
3. Calculate the reference frequency, equation (1).
4. Using (1) and (3) one gets the inflexion frequency, equation (7a) or equation (7b).
5. Using (1) and equation (8a) or equation (8b), one gets the slope of the inflexion tangent.
6. Plot the step levels and the inflexion point on the curve paper noting that the transmission level at the inflexion frequency is half-way between the two step levels. Draw the inflexion tangent through the inflexion point with the slope found in (5).

These simplified formulas are of great help, if one becomes familiar with them by using them once. After that only a copy of Fig. 4 and an ordinary reactance chart are needed to make very quick calculations for these RC-circuits.

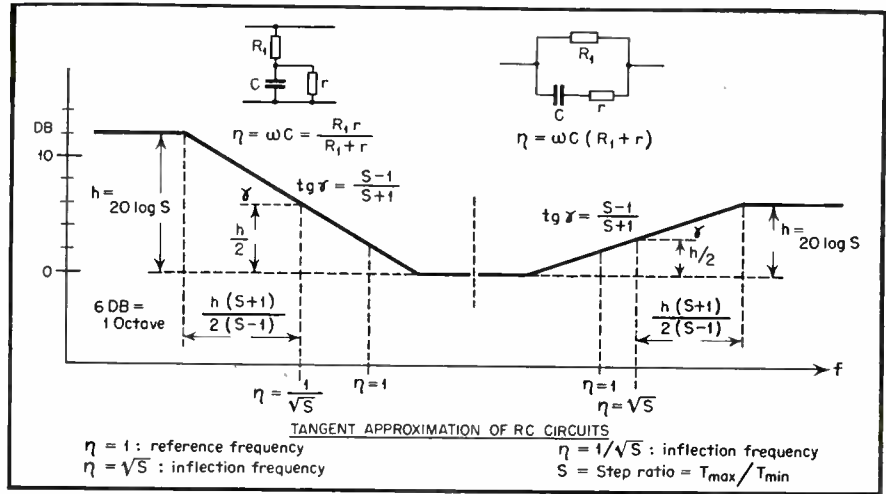
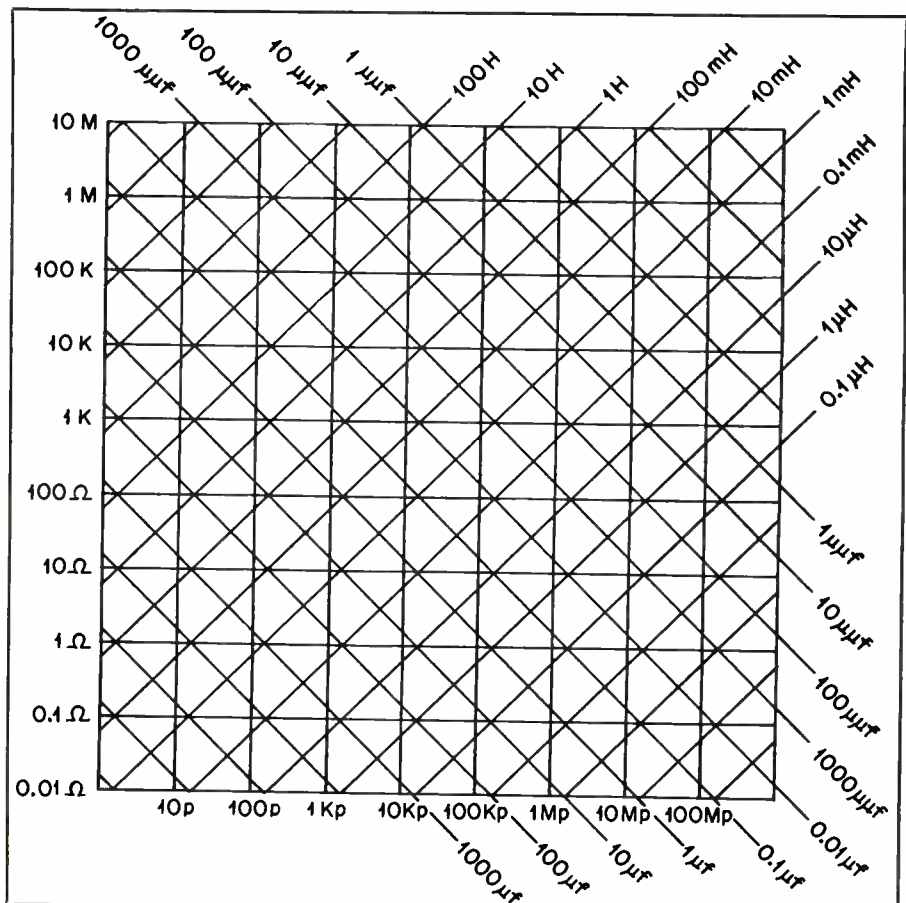

Fig. 5. (below). Reactance chart suitable for use with these formulas.



The Problem of Sound Distribution

O. L. ANGEVINE, JR.,* and R. S. ANDERSON**

PART I

Valuable Data on Planning Sound Installations.

THE person who is facing his first sound distribution problem usually is over-awed by the apparent complexity of a job involving the choice of speakers, their location, and the determination of the audio power requirements. Will everyone be able to hear? Will the reproduction be natural? And the novice wonders at the casual ease with which an experienced sound man finds the answers by what seems to be sheer intuition.

Actually, the old-timer has developed a "feel" for the problem by installing systems and profiting by his mistakes. Since applied acoustics is an art and not an exact science dealing with readily determined values, the only two methods of learning are either to be an apprentice or to install a few systems and learn by doing. If the novice has the courage to use the latter approach, he will not get into as much trouble as he might expect because he can correct errors by moving speakers and adjusting levels as each system is tested. The more serious dangers, because they are not readily

*Chief Sound Equipment Engineer, Stromberg-Carlson Co.

**Acoustical Engineer, Stromberg-Carlson Co., Rochester, N. Y.

corrected, are either to underrate the fidelity and power requirements for fear of high cost, or to overrate these factors and thereby cause unnecessary expense.

Although planning and installing a sound system requires experience, there is a wealth of published data that will permit more accurate planning, even by the experienced man. Unfortunately, much of this information is scattered throughout the technical literature. In this article the authors have attempted to present the more valuable data in a useful form.

Planning a System

The first step in planning a sound system is to determine what it is supposed to accomplish. The four most common types of systems are:

- Paging and Announcing.
- Voice and Music Reinforcement.
- Theater and Auditorium.
- Music Distribution.

All these types present different problems. Indoor and outdoor requirements vary. Frequency response and level requirements needed for background music differ from those needed where the program itself is the major interest. Some systems require naturalness, as in voice and music reinforcement, and others only

good articulation, as in paging and announcing. The way in which these factors influence the choice of equipment will be discussed in detail later.

Speaker Selection

The second step is to select the speakers to be used. Here it may be well to summarize the performance of various types of speakers as discussed in the two previous articles on loud speakers.

The two types of speakers in common use are the direct-radiator or cone-type and the "projector" or horn-type. The cone-type usually has a wider and smoother frequency response than does the horn-type, which is subject to large variations in response with frequency and has a low-frequency cut-off severely limiting the range except in the largest speakers. Likewise, cone speakers usually generate less distortion than do horn speakers. For these reasons, cones are generally used to reproduce music unless large, high-quality theatre-type horns can be employed.

On the other hand, for voice paging and announcing systems, the high efficiency and directional properties of horns may make them more desirable, especially outdoors or in noisy locations where high power is required. For wide-band reproduction and exceptionally low distortion, a two-speaker system may be used. In theater installations, where speaker size is of little importance, horns may be used on cone woofer speakers to improve their efficiency.

Power Requirements Indoors

Once the speakers have been selected, the audio power required must be calculated precisely enough to determine the amplifiers to be used. Figs. 1, 2 and 3 show the electrical power required to produce various sound pressure levels in a given room volume for speaker efficiencies of 2, 5 and 15%.[†] Where the efficiency of a speaker is not known,^{††}

[†]The authors are indebted to the Western Electric Company (see Bibliography reference No. 1) and Messrs. W. L. Black and W. J. Brown of the Bell Telephone Laboratories for the basic ideas involved in this method.

^{††}An R.M.A. committee is preparing standard proposals for the rating of speakers by the manufacturer. Hopkins and Stryker (see Bibliography reference No. 2) also have suggested a novel method or rating.

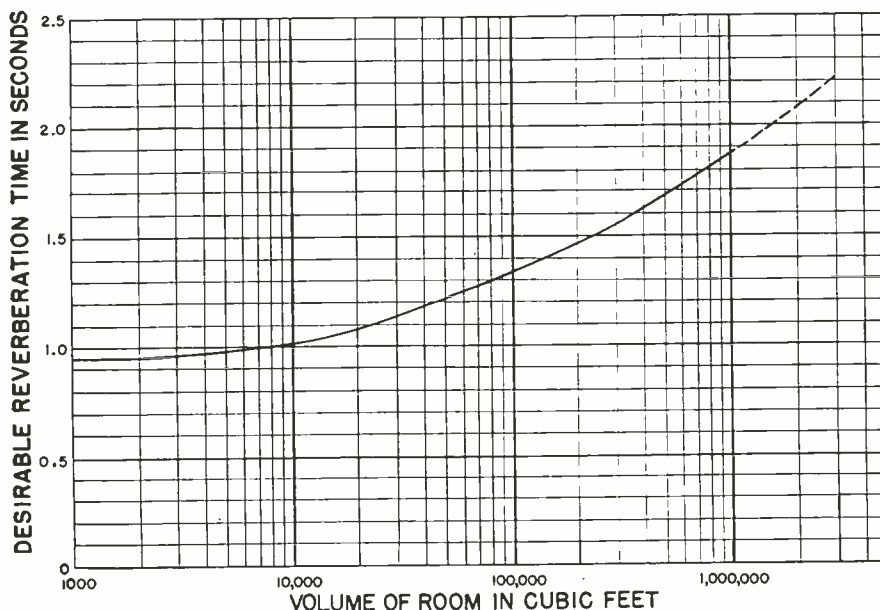

Fig. 4—Desirable reverberation time vs. volume of room (for 512 cycles).

a safe assumption is that the average cone speaker is 2%, theater-type speakers are 5% and horn-type speakers are 15%.

Three assumptions are implicit in these curves:

1. That the reverberation time of the room is optimum for its volume (Fig. 4).
2. That the speaker layout insures a reasonably uniform sound distribution.
3. That the shape of the room is not

too peculiar, such as long narrow hallways or "L" shaped rooms.

The reverberation time of a room is defined as the length of time required for a sound in that room to decrease 60 db after the originating source is turned off. It is an indication of the amount of sound reflected from the walls, floors, and ceiling, which adds to the sound being emitted by the sound source to

determine the sound-pressure level in the room at a given instant. A long reverberation time represents a reverberant, "live" room. Few rooms will have a reverberation time much below the optimum although many will be well above. In the latter case, the curves will indicate only slightly more power than is necessary; and if the power requirement is determined using an

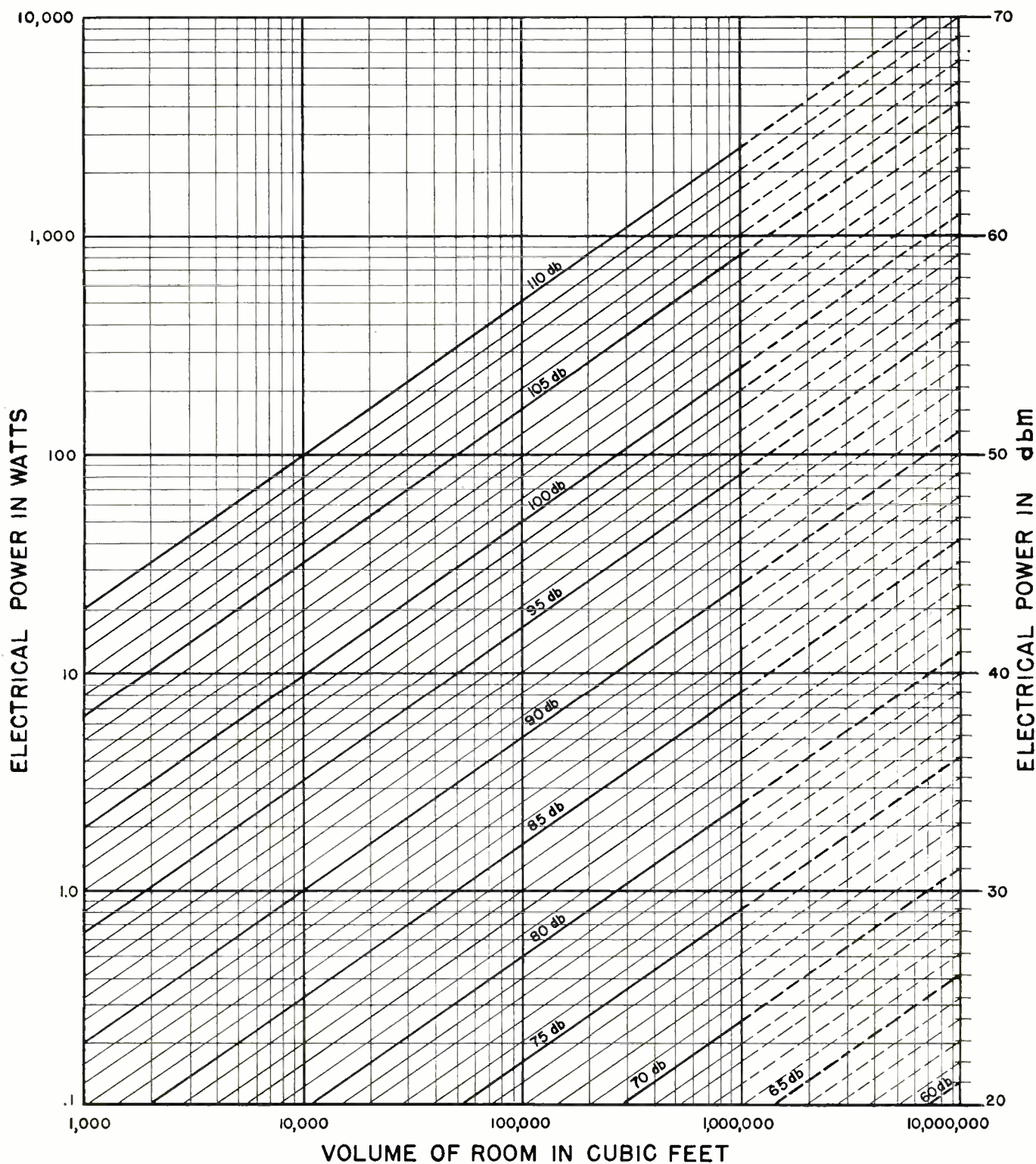

Fig. 1—Sound pressure level produced by loudspeakers of 2% efficiency indoors.

optimum reverberation time, acoustic treatment may be added at any time without changing this requirement.

Among the deviations from uniform sound distribution is the usual railroad station where the high ceiling provides a volume several times larger than the actually occupied volume near the floor. A practical solution with a precise enough result is to use a slice of con-

venient height from the floor to determine speaker location and power requirements. Another deviation is the auditorium where all speakers are placed near the stage to localize the source of sound. With good acoustics, and proper placement of speakers, this usually results in a sound-pressure level at the back of the auditorium about one db less than the average level.

In the case of the hallway or "L" shaped room, the error may be on the side of less than optimum reverberation, but again, the difference will not be more than one or two db.

The most important factor in determining power is the choice of the proper sound-pressure level for the intended use. The RMA committee concerned with this has pretty well agreed on the follow-

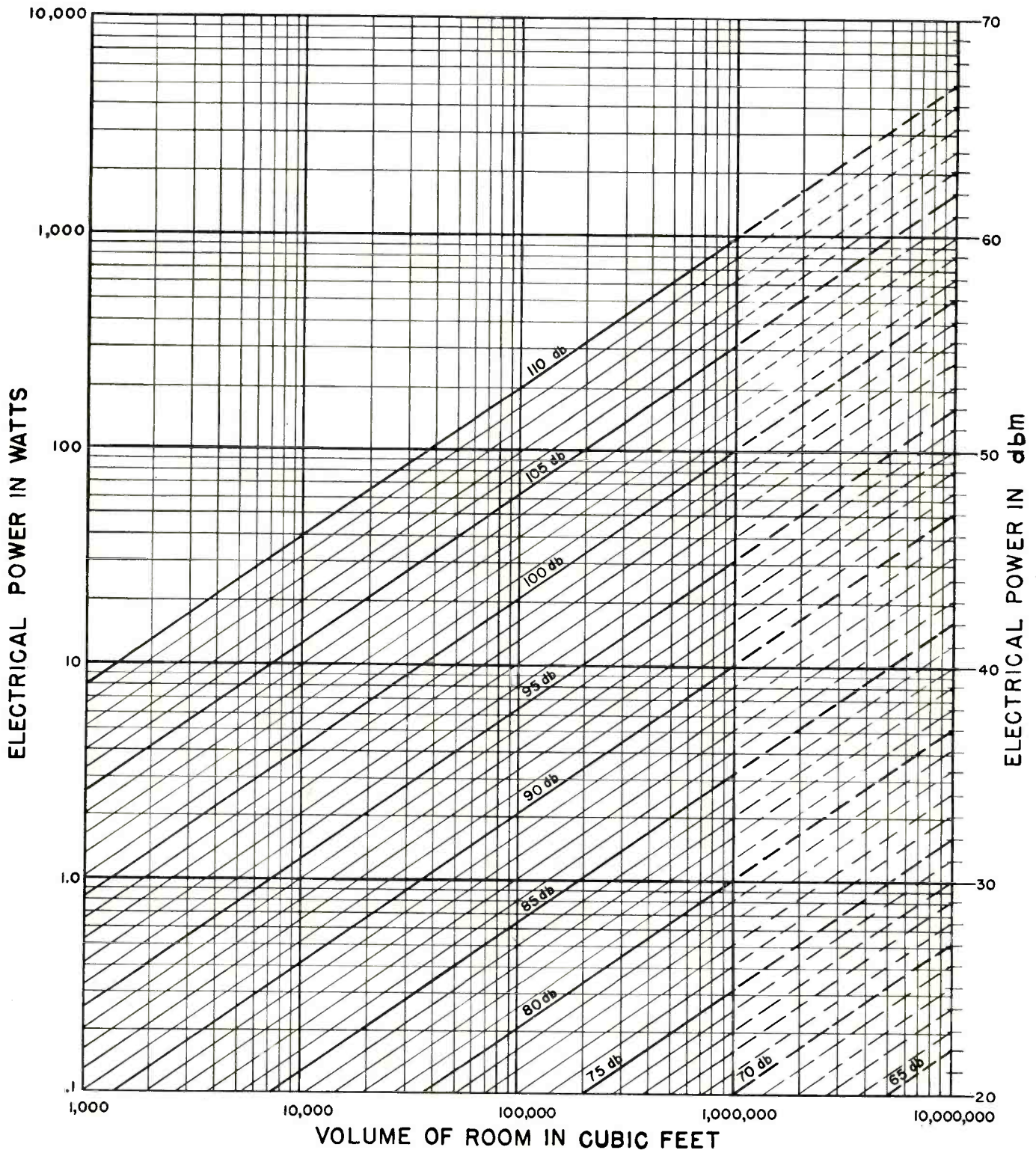

Fig. 2—Sound pressure level produced by loudspeakers of 5% efficiency indoors.

ing values:

Large Symphony Orchestra	...-105 db‡
Small Orchestra- 95 db
Speech- 80 db

These levels provide some margin over the maximum levels measured for speech at three feet³ and music at thirty

‡Levels referred to 0.0002 dynes-per-square-centimeter—approximately the threshold of hearing at 1,000 cps.

feet⁴ for 1/8-second intervals. Only rarely will short program peaks exceed these values, so their use in computing amplifier power requirements will insure that the equipment will be able to produce a normal listening level without exceeding its rating. Note that if a VU meter is used to read the signal level, the meter will read 10 db below the actual program peaks.⁵ Since more than

normal listening level may be required to override noise, the RMA committee is recommending that the program level be 10 db above the noise. For example, if the noise level is 78 db, the sound-pressure level for speech should be 88 db rather than the 80 db value given above. (A noise meter will also read 10 db below actual peak levels, but in this case the values of occasional peaks are of less

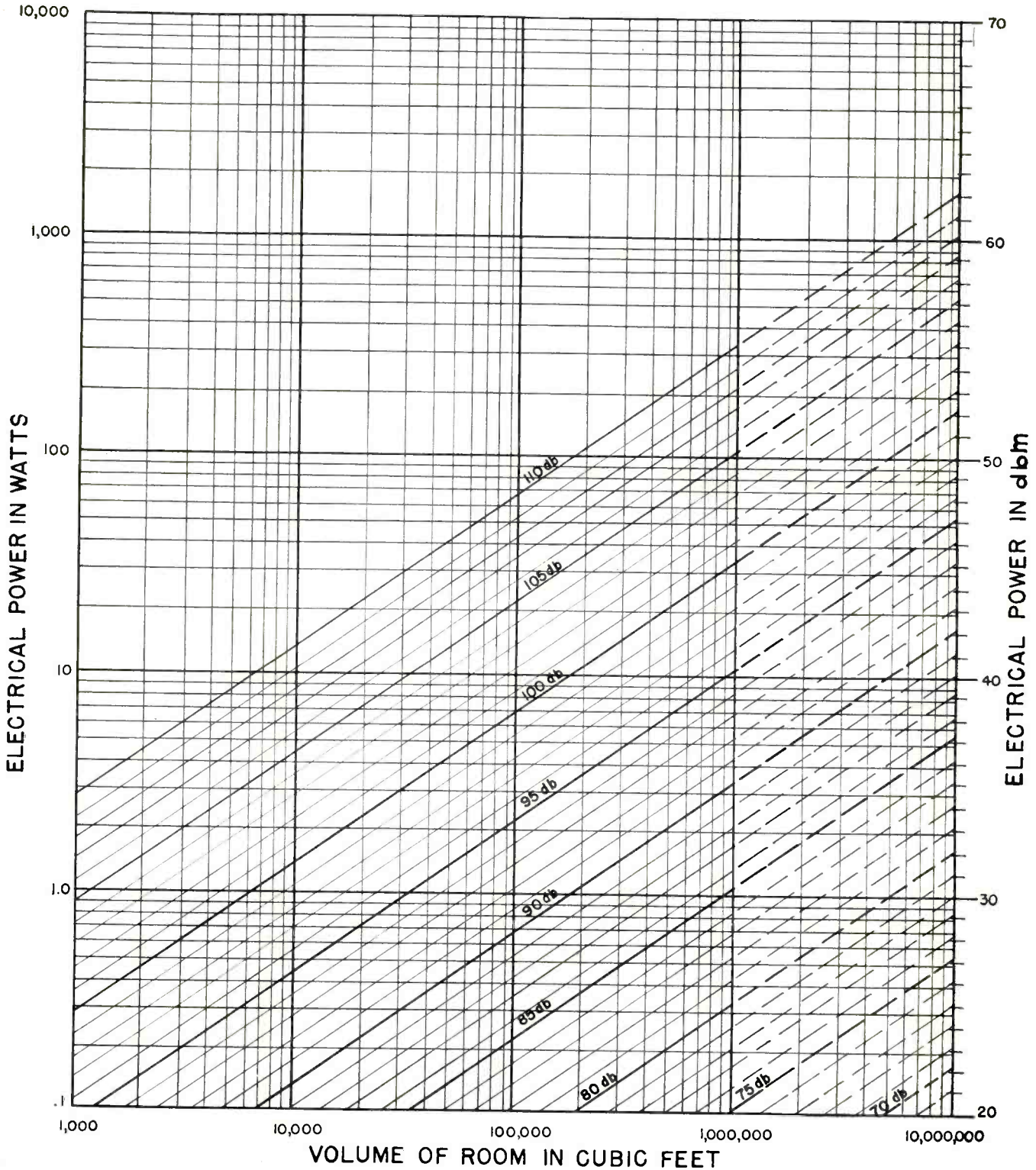

Fig. 3—Sound pressure level produced by loudspeakers of 15% efficiency indoors.

interest than the steady background noise which the noise meter reads correctly.) Table I shows typical noise levels for various sources.

In some applications, the noise level may be so high that the additional 10 db recommended will be approaching the threshold of pain. Program levels of this loudness are extremely irritating. Fortunately, people who are exposed to

high ambient noise levels of a continuous type, such as screw machines or weaving looms, become conditioned so that they can hear music or speech even though its level is not much above the noise or, in some cases, below. This accounts for the fact that people conditioned in this manner are able to converse under conditions where the occasional visitor may not be able to hear a word. Thus, it is

not always desirable to provide a 10 db margin over the noise. Conditioning does not take place in the case of intermittent noises such as punch presses, wood planers, bowling alleys, and small children beating drums.

One of the dangers in determining the proper level is misinterpreting the use. For example, a system to be used for reinforcing solo voice or instruments,

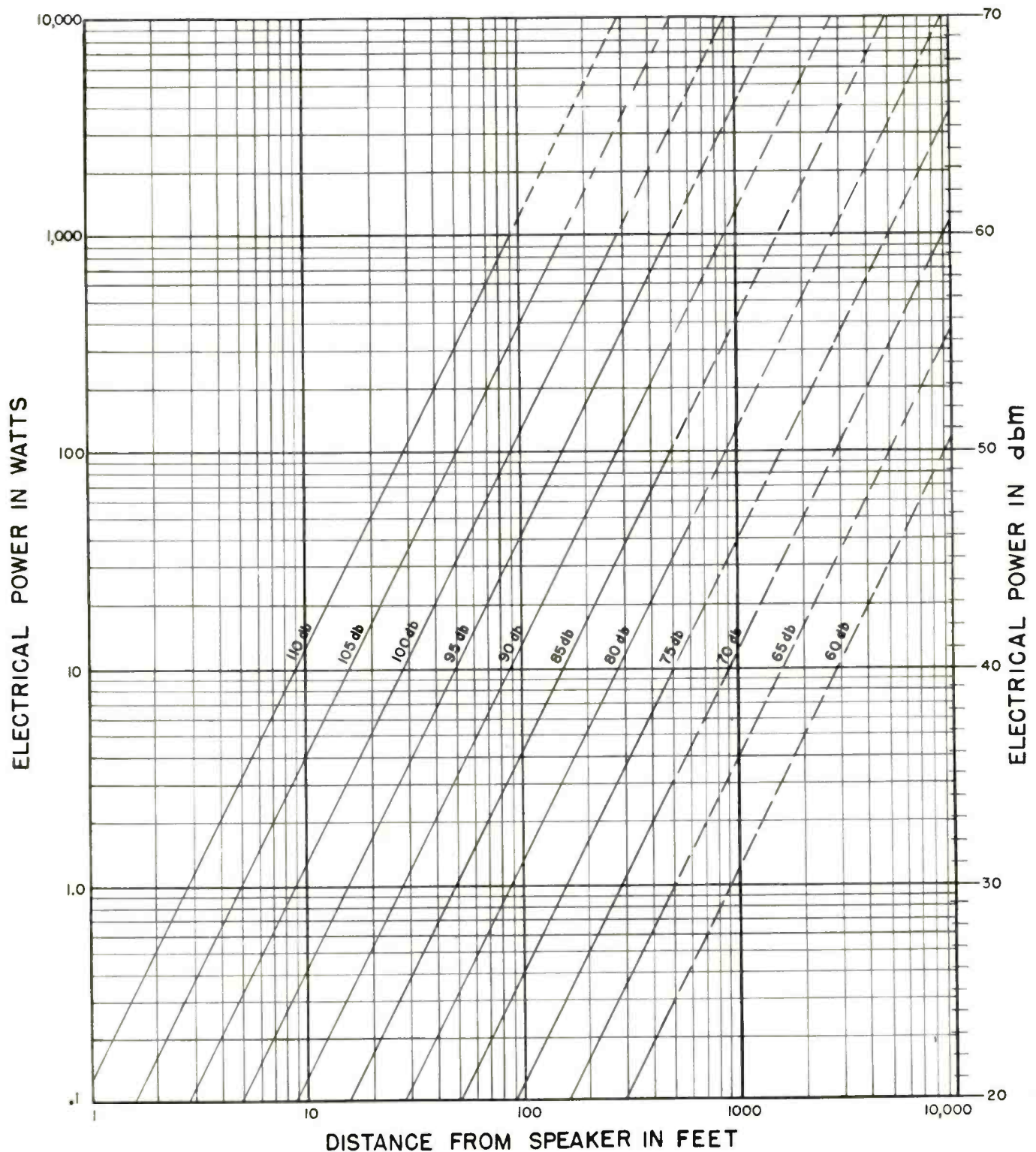

Fig. 5—Sound pressure level produced by loudspeakers of 15% efficiency outdoors.

accompanied by a symphony orchestra, is only required to produce the levels of that voice or instrument and need not produce the peak levels of a symphony orchestra, since the orchestra does not play at maximum volume for accompaniment. Conversely, this system cannot reproduce the levels of a symphony orchestra when used for playing recordings or remote pickup. A mistake in choosing level in a large auditorium may make the difference between a power requirement of 50 watts or 500 watts.

One common misconception is that less power is required for reinforcement than for remote pickup. This is obviously untrue when one considers the fact that, if the reinforcing system adds an acoustical power equal to that produced by the live program, the level has been increased only 3 db. As most reinforcing systems are justified by the need to increase the level at least 10 db, the contribution of the live program is only 10% or less of the total power required and thus may be neglected in computing power requirements.

While the recommended levels are correct for those cases where the program is of primary interest, somewhat lower levels are used if the program is only a background, as is commonly the case with wired music. Here, even in quiet locations, the ambient noise is the deciding factor and may result in a very low program level.

Power Requirements Outdoors

Outdoors, since there is no "room volume," level is plotted against distance from the speaker† (Fig. 5). Horn speakers are practically always used because of their high efficiency and because their sharp directional pattern allows the sound to be concentrated where desired, rather than allowing it to be dissipated all over the landscape. As most outdoor installations are primarily for voice, the low-frequency cut-off of horns is not objectionable.

All that has been said about choice of level and overcoming noise indoors applies equally well outdoors. In addition, since Fig. 5 is for 30° coverage speakers—a conservative figure for horns—it will be necessary to multiply the power indicated by the curve by the ratio of the actual coverage angle to 30°.

Watts, Dollars and Decibels

When the required power has been computed, it is good engineering practice to provide some surplus to allow adjustment of levels at the time of installation. A reserve should be allowed for future expansion to permit the addition of a few speakers without requiring additional amplifiers. It is also desirable to work amplifiers somewhat below their rated maximum output so

Fig. 6—Cost of audio power per watt.

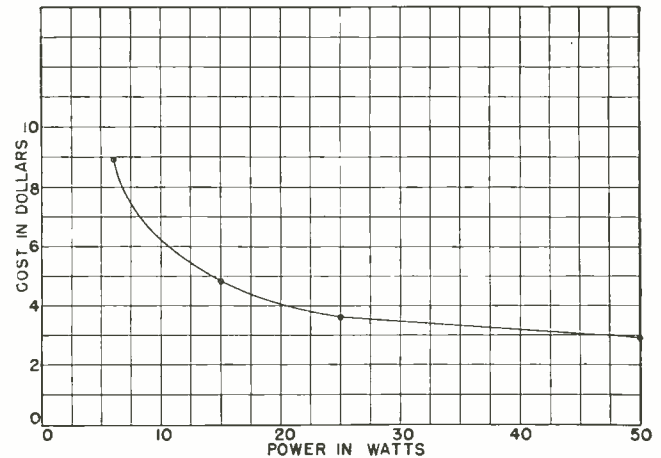

COST OF AUDIO POWER PER WATT

Amplifier	Power Watts	List Price	Dollars per Watt
AU-29	6	\$ 53.50	8.92
AU-42	15	72.50	4.83
AU-34	25	90.00	3.60
AU-36	50	144.00	2.88

The above figures are based on four Stromberg-Carlson amplifiers having similar features so that the price reflects only the output power.

that they can handle occasional abnormally high peaks in the program level without distortion. Doubling the com-

TABLE I

Noise	Level in Decibels
Threshold of Pain	130
Hammer Blows on Steel Plate... 2 ft.	114
Airplane Engine	110
Elevated Train... 15 ft.	90
Typical Factory	78
Busy Street Traffic	68
Ordinary Conversation... 3 ft.	65
Store	62
Restaurant	60
Garage	55
Quiet Office	47
Suburban House	32
Average Whisper... 4 ft.	20
Quiet Whisper... 5 ft.	10
Threshold of Hearing	0

puted power will provide margin for all of these possibilities.

One factor in favor of providing more power is the fact that with higher-power amplifiers, the cost per watt is less—see Fig. 6. It is obvious from this figure that, if more than 15 watts may be required eventually, it will be cheaper to buy a 25-watt amplifier in the first place. Another factor is that in large distribution systems, so many speakers will be used that their cost will be the major part of the total, thus making an increased amplifier cost to provide more power less important.

One of the difficulties in determining audio power requirements is that, while the customer pays for power in watts, the ear hears the result in decibels.

One db is a rough average of the minimum audible difference in level for single frequencies. If speech or music are used rather than a single frequency, a 3-db increase in level is necessary before the change becomes noticeable and is about the smallest step worth taking. An increase of only 3 db represents a doubling of power and may be costly in the case of a high-powered system. As power increases, the cost of every additional decibel of level increases rapidly, proving again the necessity of careful choice of the sound-pressure level required by the system.

The next article in this series will deal with the placement of speakers, the shaping of the frequency response of a system to suit room acoustics and background noise, and will give examples of sound systems planned according to these data.

REFERENCES

1. Manual of Sound Systems, Western Electric Company, Kearney, New Jersey, 1941.
2. H. F. Hopkins and N. R. Stryker, "Loudness-Efficiency Ratings for Loudspeakers," *Proceedings of the I.R.E.*, Vol. 36, No. 3, p. 315, March, 1948.
3. N. R. French and J. C. Steinberg, "Factors Governing the Intelligibility of Speech Sounds," *Journal of the Acoustical Society of America*, Vol. 19, p. 90, January, 1947.
4. L. J. Sivian, H. K. Dunn, and S. D. White, "Absolute Amplitudes and Spectra of Certain Musical Instruments and Orchestras," *Journal of the Acoustical Society of America*, Vol. 2, p. 330, January, 1931.
5. H. A. Chinn, "Dbm vs Vu," *AUDIO ENGINEERING*, Vol. 32, No. 3, p. 28, March, 1948.

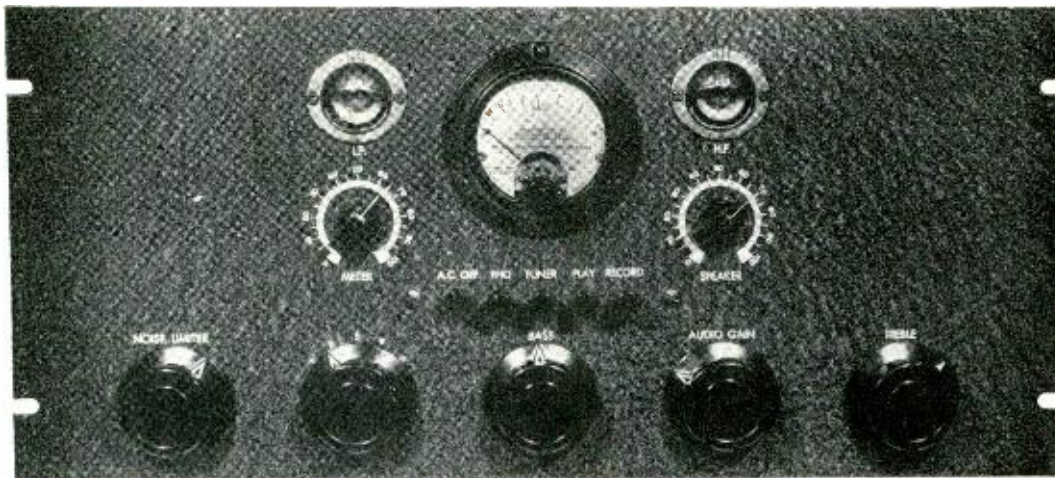

Panel view of amplifier described in this article.

General Purpose 6AS7G Amplifier

C. G. McPROUD*

Modifications of the 6AS7G high-fidelity amplifier to provide bass and treble tone controls, a dynamic noise-suppressor, high-gain input stage, and recorder feeds—sectionalized for flexibility.

ALTHOUGH the three-stage high-quality amplifier described in the March issue left little to be desired in the way of performance, it has elicited many requests for information as to the best method of adding some form of tone control in the circuit. The gain of the amplifier is sufficient to accommodate certain types of tone controls, but others require still more amplification in order to perform correctly. The feedback placed around the first two stages eliminates the interstage coupling circuit as a location for tone controls, and in general, the amplifier is not suitable for this modification.

Added to this difficulty, some interest has been shown in the possibility of adapting the basic circuit to accommodate a dynamic noise-suppressor amplifier, and as a further incentive, one re-

quest was received for circuit data to permit the connection to a crystal cutter for use as a recording amplifier. In order to make the unit still more complete, it was decided to incorporate a low-level stage for use with a magnetic pickup of the Pickering or GE Variable Reluctance type.

The amplifier described in this article was accordingly designed and built as an answer to all these requirements. It is relatively complicated in construction—but only because it has a large number of components. The layout is straightforward, and the adjustments necessary to put the noise-suppressor section into operation are not difficult, *provided* an audio-frequency oscillator is available. One feature of this design is that it is sectionalized so that the basic amplifier may be constructed either with or without the noise suppressor, or it may be constructed without the preamplifier

stage if it is to be used with an external preamplifier or with a crystal pickup. By so sectionalizing the design, it can be adapted readily for any specific requirement to which the user may wish to put it.

Circuit Arrangement

The basic arrangement of the amplifier, reduced to its simplest form, is shown in the block diagram, *Fig. 1*. The power supply is omitted for the sake of simplicity. The first section includes the two-stage preamplifier, equalized by feedback to compensate for the low-end recording characteristic of commercial records. A three-position switch permits the selection of the desired input source—either phonograph, radio, or a recorder.

The second section is the dynamic noise-suppressor amplifier, which follows the H. H. Scott circuit (with some modifications lifted from the Goodell version of the original Scott amplifier). This section incorporates an input stage, providing a source impedance of the proper value, and enough gain to actuate the side amplifier which furnishes the control voltages. The input stage is followed by a two-tube high-frequency gate circuit and a single low-frequency gate circuit, together with the necessary control amplifier and rectifiers. The output of this section may then be fed directly into the output amplifier. This consists of three stages, essentially identical with the original 6AS7G amplifier. It employs a tapped volume control to provide an increase in low-frequencies which may be reduced at will by the low-frequency tone control, and a treble control which in-

Fig. 1. Block diagram of sectionalized amplifier suitable for wide variety of uses.

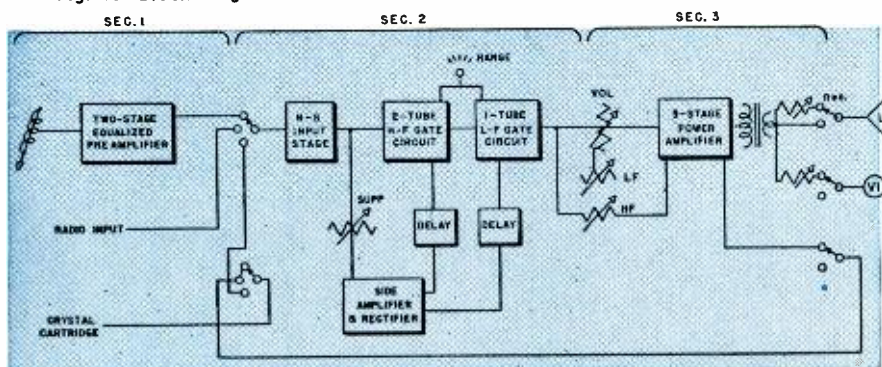

creases or decreases the high-frequency response as desired.

The output circuit contains switching arrangements which connect the speaker directly to the secondary of the output transformer for normal use, or through a variable resistor for monitoring, and which also connect a volume indicator and the recorder to the output stage during recording. Although the switching appears to be complicated in that it requires a number of operations to change from record to playback, such is not the case because of the use of a push-button switch which performs all of the switching operations quite simply.

The type of recorder used will control the switching circuits to a great extent. For the Wagner-Nichols unit used in this particular job, it is necessary to connect the crystal cartridge to either the input or the output of the amplifier. Most recorders employ a separate unit for playback, which simplifies this switching. It is desirable to connect the cutter of the Wagner-Nichols unit to the plates of the output tube through capacitors, giving a constant-amplitude characteristic over the entire range. With other crystal cutters, some series resistance should be employed to provide a characteristic which is similar to standard phonograph records. Low-impedance magnetic cutters will naturally be connected to a source of the correct impedance. Various arrangements for these connections are shown in Fig. 7.

The power supply section is conventional, with the exception of the d-c filament supply which is simply a connection between ground and the center tap of the high-voltage secondary through the heaters of the first two tubes, V_1 and V_2 . Both of these tubes have 12-volt heaters, and they are connected in series. After the amplifier is completed, a value of bleeder resistor is selected which will make the total current drain equal 140 ma. It will be noted that this is slightly below the normal value, but the low-level stages operate perfectly with the lower current, and are somewhat less susceptible to the slight a-c component remaining in this supply. The amplifier is quite low in hum, but because of the large number of stages it is desirable to take all possible precautions.

Tone Control Methods

The methods of adding high- and low-frequency tone controls to the circuit are relatively simple. For general use in home reproduction systems, it is usually considered desirable to employ a tapped volume control so that when the output level is lowered, the frequency is altered somewhat in accordance with the Fletcher-Munson curve. A control with a single tap will not give complete compensation, but it is some improvement over an untapped control. The circuit used for this compensation consists of a

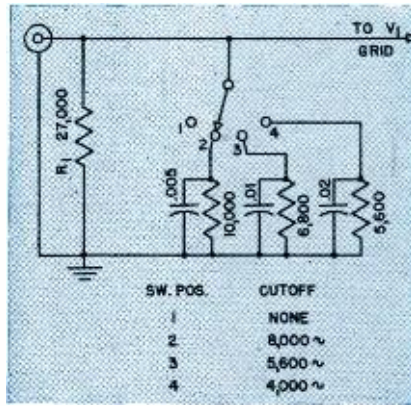

Fig. 2. Input circuit for use with low-level magnetic pickups when noise-suppressor section is not employed.

resistor and capacitor connected in series between the tap on the control and the low end of the control, usually ground. If a potentiometer is connected across the capacitor, the amount of compensation is reduced as the shunting resistance is decreased. This serves quite adequately for the low-frequency control. For smoothest operation, the shunting potentiometer should have an audio taper, and should be connected so that clockwise rotation of the control increases the resistance across the capacitor, thus increasing the bass response. With a 1.0-meg volume control, the recommended resistor and capacitor values are 27,000 ohms and 0.01 μf . A 0.25-meg shunting potentiometer provides a smooth control of bass response.

In most amplifier designs, it is not considered desirable to utilize the feedback circuit for tone control purposes, since it reduces the amount of feedback available, and hence negates the beneficial effect of the feedback. This is particularly important in the case of a pentode amplifier, with feedback over the output and driver stages. However, with this amplifier the feedback is employed over only the driver and input stages, and its primary advantage is obtained over the low- and middle-frequency ranges because that is where the highest signal voltages are encountered. Therefore, with at least 20 db of feedback in use normally, it is felt that it will not affect the performance ad-

versely if 10 db of this feedback is used up in the high-frequency tone control circuit. The signal voltage at high frequencies is comparatively low, and the driver stage will not be required to furnish as much signal voltage as at the middle and low frequencies.

Therefore, if a capacitor is shunted across the cathode resistor to which the feedback circuit returns, it will reduce the feedback at high frequencies, and thus increase the output. A potentiometer in series will permit variation of the amount of treble boost. If another capacitor in series with a potentiometer is connected across the entire volume control, the high frequencies may be reduced at will. Since highs will not be boosted and cut simultaneously, the two potentiometers can be combined so that clockwise rotation will increase highs and counterclockwise rotation will decrease highs. To make this circuit perform smoothly, the taper on the control must be the reverse of the standard audio taper. With these two potentiometers, a resistor, and the three capacitors, quite satisfactory tone controls for both bass and treble are provided.

While some high-frequency cutoff is an advantage when reproducing phonograph records, no separate control is provided for this purpose since the dynamic noise suppressor section performs this function. It may be used simply as a controllable low-pass filter, with no dynamic action, or the suppressor control may be advanced so that the signals themselves control the opening of the gates. However, if the suppressor section is not included, it is suggested that a four-position switch be added, with the necessary resistors and capacitors, giving various cutoff frequencies. This is shown in Fig. 2, and was described in an earlier issue.¹ This control is not necessary if the noise suppressor section is included.

Construction Features

Since individual constructors will rarely choose the same components, a complete

¹High-Frequency Equalization for Magnetic Pickups, *Audio Engineering*, September 1947.

Fig. 3. Wiring of push-button switch for selecting the use to which the amplifier is to be put.

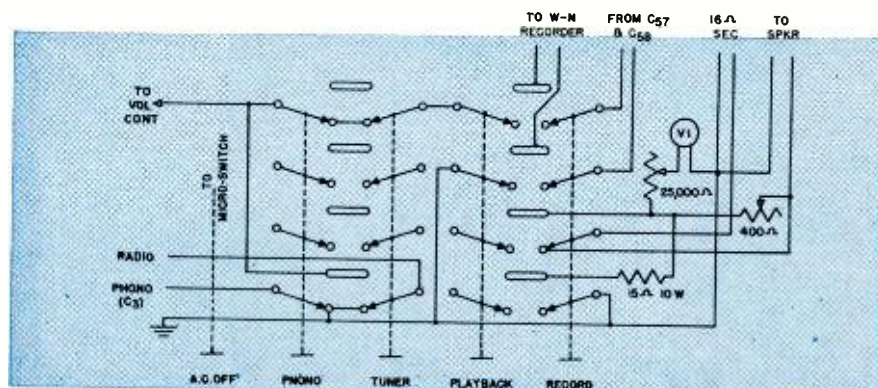

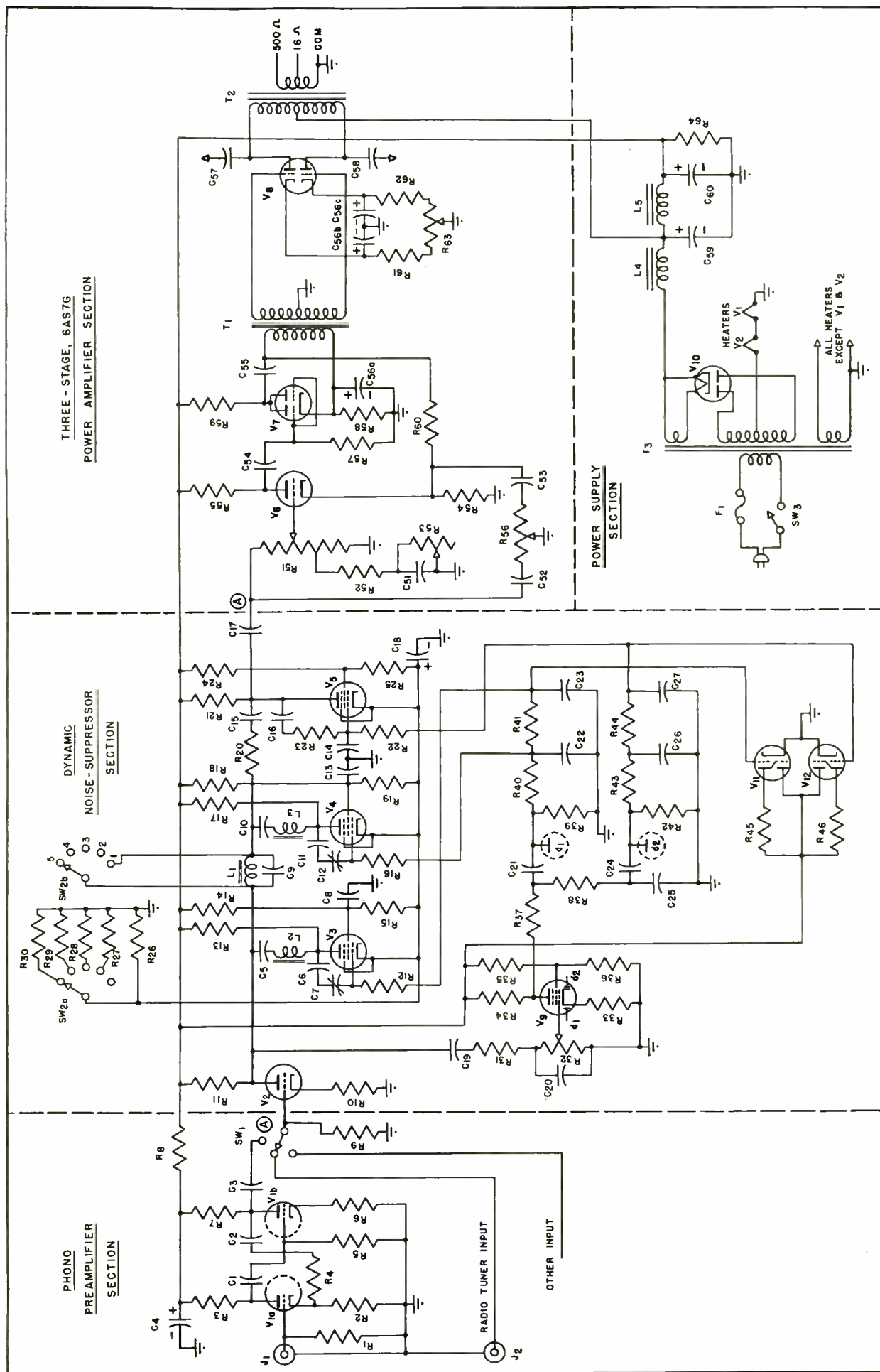

Fig. 5. Complete schematic for the sectionalized amplifier. By combining desired sections, practically any requirements may be met. V₁—12SL7GT, V₂—12J5GT, V₃, V₄, V₅—6AB7, V₆—7A4 (6J5), V₇—6N7, V₈—6AS7G, V₉—7E7 (6J8), V₁₀—5V4G, V₁₁, V₁₂—6E5.

- C₁, C₂₂, C₂₃, C₂₆, C₂₇, C₅₁, C₆₅—.01 μ f, 600 v., paper.
 C₂, C₂₄—.003 μ f, mica.
 C₃—.04 μ f, 600 v., paper.
 C₄, C₅₉, C₆₀—40 μ f, 450 v., electrolytic.
 C₅, C₆, C₁₀, C₁₁, C₁₄, C₁₆—.006 μ f, mica.
 C₇, C₁₂—7-45 μ f adjustable, in parallel with 33 μ f fixed mica.
 C₈, C₁₃—.03 μ f, 600 v., paper.
 C₉—80 μ f (select to resonate L₁ to 15,000 cps. approx).
 C₁₅—.035 μ f, 600 v., paper
 C₁₇, C₃₄—0.1 μ f, 600 v., paper.
 C₁₈—100 μ f, 50 v., electrolytic.
 C₁₉—.002 μ f, mica.
 C₂₀, C₂₁—100 μ f, mica.
 C₅₂—.001 μ f, mica.
 C₅₅—2.0 μ f, 600 v., oil filled.
 C₅₆—40-40-20/150-150-25 electrolytic.
 C₅₇, C₅₈—0.5 μ f, 600 v., oil filled (omit if not for recording).

F₁—3 amp fuse in Littelfuse holder.

J₁—Phono pickup input.

J₂—Radio tuner input.

L₁—1.5 h, (Mid-America Co. No. MA-1220' terminals 1-3).

L₂, L₃—0.375 h, (Mid-America Co. No. MA-1220, terminals 1-2).

L₄, L₅—10 h, 200-ma power supply choke.

R₁, R₅₂—27,000 ohms, 1/2 w.

R₂, R₆—2,200 ohms, 1/2 w.

R₃, R₄, R₇—0.12 meg, 1 w.

R₅, R₉, R₂₃, R₄₀, R₄₁, R₄₂, R₄₃, R₄₄—1.0 meg, 1/2 w.

R₈—56,000 ohms, 1 w.

R₁₀, R₅₄—2,700 ohms, 1 w.

R₁₁—27,000 ohms, 1 w.

R₁₂, R₁₆—0.1 meg, 1/2 w.

R₁₃, R₁₇, R₆₀—0.22 meg, 1 w.

R₁₄, R₁₈, R₂₄, R₃₃, R₅₅, R₅₆, R₅₉—0.1 meg, 1 w.

R₁₅, R₁₉—22,000 ohms, 1 w.

R₂₀—18,000 ohms, 1 w.

R₂₁—0.47 meg, 1 w.

R₂₂—0.33 meg, 1/2 w.

R₂₅—10,000 ohms, 1 w.

R₂₆, R₅₈—2,200 ohms, 1 w.

R₂₇—470 ohms, 1/2 w.

R₂₈—330 ohms, 1/2 w.

R₂₉—220 ohms, 1/2 w.

R₃₀—68 ohms, 1/2 w.

R₃₁—0.27 ohms, 1/2 w.

R₃₂—1.0 meg, IRC D13-137, suppressor control.

R₃₇—560 ohms, 1/2 w.

R₃₈—0.33 meg, 1 w.

R₃₉—33,000 ohms, 1 w.

R₄₅, R₅₃—0.22 meg, 1/2 w.

R₄₆—3.9 meg, 1/2 w.

R₄₇, R₄₈—1.0 meg, 1/2 w. (in Amphenol MEA-6 socket)

R₅₁—1.0 meg, tapped for tone compensation, IRC DI3-137X

R₅₂—27,000 ohms, 1/2 w.

R₅₃—0.25 meg, bass tone control, IRC D13-130.

R₅₆—1.0 meg, treble tone control, IRC D14-137.

R₅₇—0.56 meg, 1 w.

R₆₁, R₆₂—1,570 ohms, 10 watts, Ohmite Brown Devil.

R₆₃—500 ohms, 4 watts, wire-wound control.

R₆₄—30,000 ohms, 20 watts, Ohmite Brown Devil.

SW₁—1 cct, 4 position, rotary switch, Centralab 1402 (or use push-button switch; see text).

SW₂—2 cct, 5 position, rotary switch, Centralab 1404).

SW₃—SPST toggle switch (or use push-button with Micro-Switch).

T₁—ADC 215C interstage transformer, turns ratio 1:3.

T₂—ADC 315F output transformer, 3,000/-500, 16, 8, 4, etc.

T₃—400-0-400, 200 ma 5 v. 3 a; 6.3 v. 6 a.

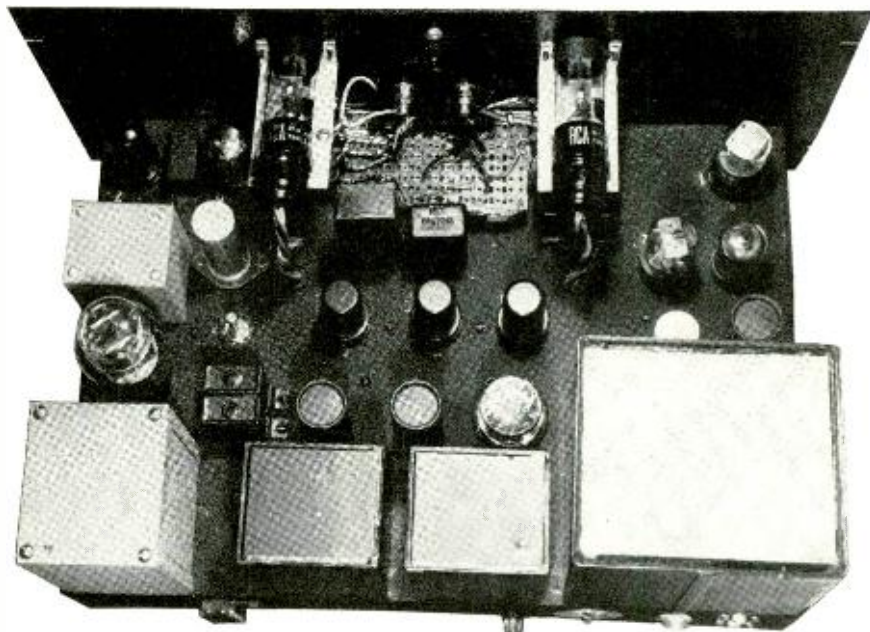

Top view of amplifier chassis.

layout of the chassis is not shown. The unit as built occupied a 12 x 17 x 3 chassis quite completely, and an 8-3/4-in. rack panel was used for the front. The power transformer and filter chokes were surplus items, but the table at the end of this article lists a number of possible transformer and choke selections which should be obtainable from regular stocks. While the first 6AS7G amplifier was constructed with broadcast quality ADC transformers, this one uses the industrial line which is somewhat less costly. Excellent results were obtained, however, and unless the highest possible quality of all components is desired, it is suggested that these are quite satisfactory. All other transformers shown in the table were selected from specifications, but it is expected that the results obtained would be about in proportion to the cost of the components.

In the interests of simplicity of operation, a push-button switch was chosen for the selector switch. Again resorting to surplus stocks, a switch was located which consists essentially of four separate 4pdt switches, with a fifth push button bar which actuated no switches, only releasing all other buttons. This switch was mounted just above the chassis with the buttons extending through the panel. A normally-closed micro-switch was mounted under the chassis, with a spring actuator extending upward through a slot and so positioned that the push-button bar causes the switch to operate when the button is depressed. Thus one position of the switch is marked "A.C. OFF," and the amplifier is turned off whenever this button is depressed. When any other button is pressed, the "off" button is released, and the power is turned on. The other four push buttons are wired for radio tuner, phono,

playback, and recording. The wiring of the switch is shown in Fig. 3. One advantage of the push-button switch is that it permits connection to either radio or phonograph pickup as a source for recording simply by depressing two buttons simultaneously.

In order to maintain a proper recording level, it is desirable to incorporate a volume indicator in the amplifier. When used with the Wagner-Nichols embossing unit, the output transformer should be terminated with a resistive load and the cutter connected to the plates of the output tube through 0.5- μ f capacitors. However, the recording level required—of the order of 30 volts—furnishes too high a level to the monitor speaker, so the switching is arranged to connect a 16-ohm terminating resistor across the secondary of the output transformer, and insert a 400-ohm rheostat in series with the voice coil. Thus it is possible to adjust the speaker volume to a de-

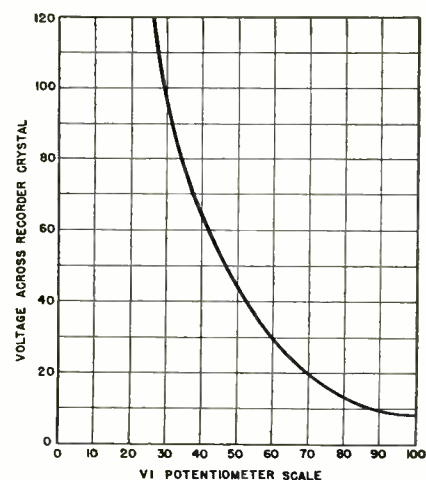
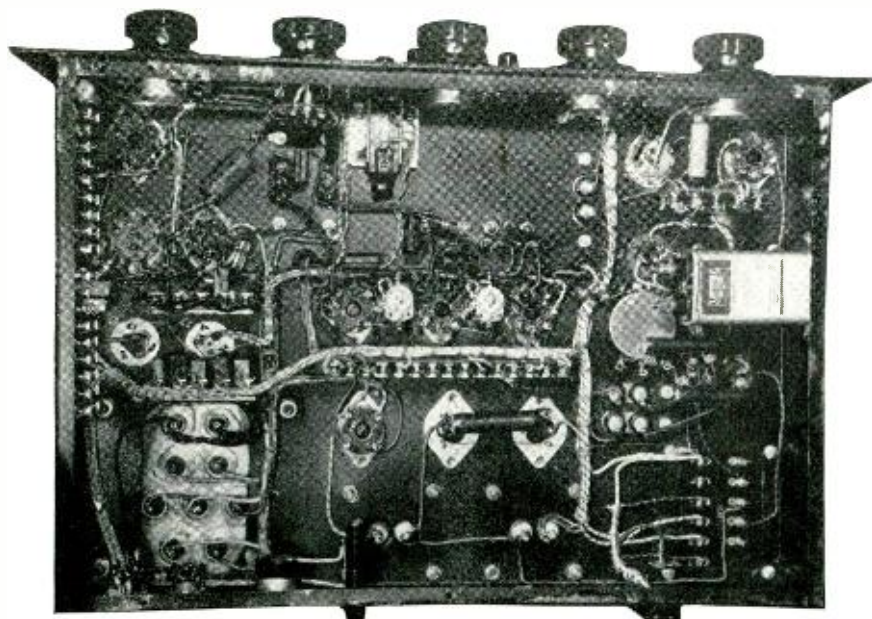

Fig. 4. Calibration of VI potentiometer for voltage across recorder head at zero indication



Bottom view of the chassis of the 6AS7G amplifier.

sirable level while maintaining the correct recording level to the cutter.

The volume indicator is a standard db meter, calibrated at 1.73 volts for zero indication. A 25,000-ohm potentiometer in series with the VI provides a control over the output level, with the calibration of the scale for this resistor being plotted on a curve, *Fig. 4*, so the desired output level may be obtained. The potentiometer used for this circuit is a grid-bias control, and while the curve is apparently reversed, it seems correct in use because the meter deflection is increased as the knob is turned clockwise.

From the photo of the amplifier, it will be noted that the panel is labeled quite profusely, giving a professional appearance. This is made possible by the new Tekni-Cals, which provide a wide range of identifying names. They are easy to apply, inexpensive, and of excellent appearance.

Adjustment of Suppressor

The circuit of the dynamic noise-suppressor amplifier is shown in the complete schematic, *Fig. 5*, and since the operation of this circuit has been described many times in the literature, no further mention of the principles underlying this section will be made here. It will be noted that it is practically identical to the Goodell amplifier, even to the physical layout of the schematic. In any discussion of this circuit, the coils have been described as rather critical, and of high Q . These will undoubtedly be difficult to obtain—one source of supply of 2.4 and 0.8 henry chokes used in one model of the suppressor being ADC, which supplies them under part numbers 414D and 414E respectively. One of the former and two of the latter would be required. Another source of suitable coils would be

the UTC adjustable types, VI-C10 and CI-C12—again requiring two of the former and one of the latter. All of these types are very satisfactory for this unit. Another suitable coil is available from Mid-America,² under the number MA-1220. This coil has a total inductance of approximately 1.5 H, and is center tapped, providing 0.375 H across either half. The half between terminals 1 and 2 has the higher Q , and should be employed for the inductances L_2 and L_3 , while the entire coil is used for L_1 . These are the coils used in the amplifier shown, and they work satisfactorily.

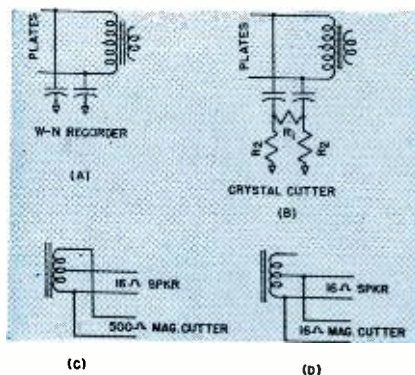

Fig. 7. Change in output wiring for feeding different types of recorders.

Once the complete amplifier is constructed, the alignment of the noise-suppressor section is not particularly difficult, but an a-f oscillator is essential. The value of the capacitor C_7 is specified, and is determined so as to resonate L_1 and C_7 at 15,000 cps. Some noise-suppressor amplifiers employ a variable or adjustable capacitor for this circuit, but the adjustment is not critical, and a

²Mid-America Company, Inc., 2412 So. Michigan Ave., Chicago 16, Ill.

calculated value is adequate if the value may be obtained with fair accuracy. With the switch SW_2 on position 2, capacitors C_7 and C_{12} are adjusted for minimum signal at 9,000 cps, R_{32} —the suppressor control—being at the minimum position so there is no opening of the gates by the signal itself. Then, turning SW_2 to position 5, check the frequency of minimum output, which should be around 4,000 cps. Minor adjustments in the values of R_{16} and R_{19} may be employed to cause the circuits to “track” at 9,000 and 4,000 cps. Any change in the resistor values will necessitate returning of C_7 and C_{12} , so the work is of the nature of a “cut and try” process, but no trouble was experienced in adjusting the first model, so it is assumed that the work may be duplicated by a careful constructor with the assurance that the final unit will work as it should.

The time constants for the rectifier circuits are quite satisfactory as shown. Longer release times may be obtained by an increase in the values of R_{41} or C_{23} for the high-frequency gates, or of R_{44} or C_{27} for the low-frequency gate. The value of R_{31} may have to be adjusted for the individual amplifier. This should be such that with about three-quarters rotation of R_{32} the gates open and close with the applied signal. The average signal at the arm of SW_1 will normally be around 1.5 volts, whether from a tuner or from a phonograph pickup. This will give adequate signal level to cause the side amplifier to operate with the resistor value given in the parts list. It may be stated safely that if the circuit values are followed accurately, the amplifier should perform in the normal manner for a noise suppressor.

Construction Hints

As with any high-gain amplifier, it is necessary to exercise normal care in shielding grid and plate circuits, especially where there are any long runs. This does affect the frequency response if carried to extremes, and minor compensation may be effected by the addition of a small capacitor across R_{44} . It is at this point that the high-frequency losses may be corrected if found necessary. However, with the parts layout shown in the photo, such compensation will probably not be necessary.

Because of the large number of wires in a circuit of this type, it is desirable to cable the wiring. This necessitates either of two procedures—a complete full-size wiring diagram may be made first and the individual wires laid in place using a forming board with finishing nails driven in at points where the cable makes a bend or where wires branch off. After all the wires are in place, the cable may be laced up. The other method appears to be simpler in that it does not require the full-size wiring diagram, but

once the wiring is in place it is often difficult to form it into cables smoothly. In the long run it is easier to cable the wires outside of the chassis. After the lacing is completed, the form is put into place and the wires cut off at suitable lengths for connection to the sockets and other components. The form is then removed, the insulation stripped back, and the wires tinned. Then the form is replaced and connections made and soldered, a very rapid process after the initial cable forming is completed.

Performance

Measurements made on the complete amplifier indicate an output of 5 watts at 7 per cent intermodulation distortion, with frequency response curves as shown in Fig. 6. The upper curves show the effect of the high- and low-frequency tone controls with the volume control at one-third rotation and the suppressor range switch, SW_2 , on position 1. The lower curves show the response for positions, 2, 3, 4, and 5 of the range switch and the suppressor control, R_{32} , off. Note that the amount of suppression increases as the range is narrowed, which is a desirable condition since the worst records necessitate a narrower trans-

Fig. 6. Frequency response curves (upper) effect of tone controls; (lower) effect of noise suppressor in various positions of range switch.

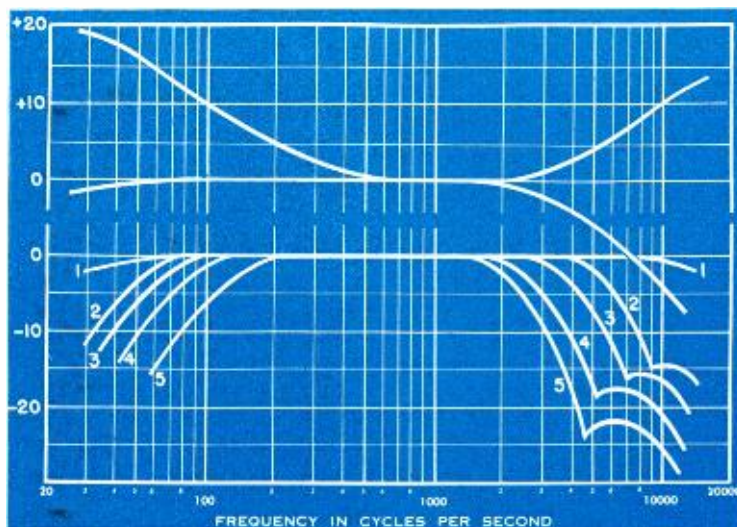

mission band as well as greater suppression outside the band.

Conclusion

Although the parts list specifies the transformers and chokes employed in the amplifier as built, some substitutions may be desirable, depending upon avail-

ability of parts. Therefore, the table shows a number of components which should perform similarly.

Assuming the use of good components throughout, this amplifier should give completely satisfactory performance for the record enthusiast or for the home recorder. The output power is not sufficient for use with professional disc cutters, but reasonably satisfactory results may be obtained with the better quality of either magnetic or crystal cutters, assuming that the correct coupling circuits are used between the transformer and the magnetic types of cutters. For ordinary reproduction of records or of radio programs, this amplifier will be found to answer most of the requirements of critical listeners.

POSSIBLE TRANSFORMER AND CHOKE SUBSTITUTIONS

Part	ADC	Stancor	Thordarson	UTC	Part	ADC	Stancor	Thordarson	UTC
T ₁	215C†	A-103C	T-2A40	LS-21	T ₂	515D	P-6165	T-22R34	LS 70
	214H*		T-20A23	CG-132					CG-428
T ₂	315F†	A-3301	T 3822	LS 55	L ₁ , L ₂	415D	C-1646	T-20C55	LS-92
	314C*		T 22S72	CG 16					CG-40

†original specification for 6AS7G amplifier *as employed

Adaptation of Sections

Since this amplifier is laid out so as to be flexible in construction, it may be well to indicate the various arrangements possible. The simplest arrangement consists of the preamplifier and the output section, which simply omits the center portion of the circuit, connection being made between points "A." This provides sufficient amplification for use with a low-level magnetic pickup and furnished the tone controls desired by most users. The high-frequency cutoff for the pickup should be added in the form of the circuit of Fig. 2 across R_1 .

When desired for use with an ordinary crystal cutter, the wiring of the output circuit and the feed for the recorder should be modified as shown at (B) of Fig. 7. (C) and (D) show connections for 500-ohm and 16-ohm magnetic cutters respectively. The wiring of the complete output circuit for feeding the recorder is shown in Fig. 3, complete with VI and speaker circuit wiring.

If the previous 6AS7G amplifier has already been built, the first two sections

Audio Engineering Society News

TO AUDIO engineers of Denver, Colorado, goes the credit for organizing the first local section of the Audio Engineering Society on May 4. No technical program was presented at this first meeting, but the entire time was given over to the organization activities. Three technical meetings are already scheduled for the newly formed section, the first to be held on June 8.

Heading the group responsible for the new section are R. W. Cross, of Electronic Network, Denver Muzak licensee; W. R. Bliss of Decimeter, Inc.; and W. H. Eichelberger, assistant chief engineer of Hathaway Instrument Co. and formerly with RCA at Indianapolis. Mr. Eichelberger is Acting Secretary and engineers in the Denver area who are interested in taking a part in Society activities may contact him at 1315 So. Clarkson St., Denver 10, Colo.

New York Meeting

The May meeting of the New York group was held in Studio 6A, Radio City, on May 11, with over 250 in attendance. A well-prepared and informative paper on

"A New Audio Sweep-Frequency Generator" was presented by Hershel Toomin of Instrument Electronics. This generator embodies many unique features which are of importance to the audio engineer.

Mr. Toomin, who is responsible for the design of the new generator, pointed out in his paper that instruments designed for use by engineers are of greatest value if they relieve the user of the necessity of making improvisations in the measurements, or if they provide definite and labor-saving features. As is well known, the usual procedure in making a frequency-response measurement on a piece of equipment is to apply a fixed tone to the input and to measure the output. This must be done at a number of selected frequencies so spaced that they are capable of indicating accurately the trends at important points of the curves, particularly in the case of filters and equalizers. This is a time-consuming operation, for after twenty to thirty measurements are made, they must then be plotted before the whole picture is made visible to the engineer.

(Continued on page 39)

Applications of Ultrasonics to Biology

S. YOUNG WHITE*

How ultrasonics can be used in medical research and sterilizing liquids.

A GREAT number of papers have been written on ultrasonics in biology. We have received quite a few letters of inquiry that indicate considerable interest in the subject. We shall briefly review the known art and then point out a few experiments that can be done with rather simple apparatus which can be constructed by a skilled experimenter with some familiarity with electronics and mechanics.

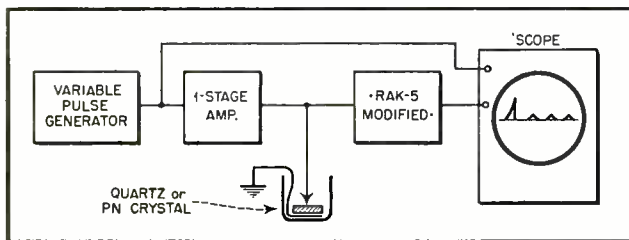

Fig. 1. Setup for using pulse techniques in ultrasonics.

A university in Pennsylvania has published much data on experimenting with bacteria, and of course Loomis in 1928 described the tearing apart of rod bacilli and the like. It is obvious that these offer great promise of sterilization in the sense of working on fluids or gas outside the body. With some modification we may apply some of these effects to an animal or human being for the control of pathological conditions.

One promising field that has apparently been overlooked is the control of inhabitants of the blood stream. The desired ones that interest us at the moment are in the size range from the large protein molecule to the largest inhabitant met with in many cases, the spirochete, almost large enough to be visible. The main mass of solid particles are of course the red and white blood corpuscles, which we need badly.

As we discussed in connection with aerosols, any small particle in a gas has a certain "natural period." If the frequency is below this, the particle will wash back and forth with the gas, with almost no relative motion. If the frequency is well above this, the gas will wash back and forth past the particle, which will be anchored in space by its mass. The critical frequency will cause the particle to have large random motions, and a considerable amount of work will go into this motion.

*Consulting Engineer, 52-12 Van Horn St., Elmhurst, L. I., N. Y.

This effect is also true if the particle is in a liquid. By choosing the proper frequency, we can put work into a particle of any size, and at the same time put very much less work into a particle either larger or smaller than the one we have chosen. This selective energy absorption is effective over a range of mass of about eight to one.

If we have a spirochete in the blood stream, we would choose a very low

eliminate them, but many times we have bacteria in the blood that are much smaller than the red corpuscles, so our frequency for them would be quite high. Since we are severely limited as to the power density which can be applied to the body because of the resonating and rupturing effect in the capillaries, as described in previous articles, this attack would allow working at comparatively low amplitudes that are quite practical to reach with quartz crystals.

The large molecules that are normal to the blood might be either activated or de-activated with this treatment, since the relative motion to the blood stream would change the boundary layer conditions to some extent. The writer has no thoughts as to the possible benefit here.

Sterilizing with Ultrasonics

We have already covered sterilizing beer and food in cans. An obvious application we did not mention is sterilizing milk at the point of use. It would be quite practical to design a milk sterilizer that would apply the energy to the milk as it was poured into the glass for serving to the user, particularly in

frequency because its mass is considerable, and the larger the mass the lower the frequency. Spirochetes are quite sensitive to temperature, so we would heat them selectively, a number of degrees, with perhaps a tenth degree rise in temperature of a white blood cell. It is possible to imagine applying the ultra-

Fig. 2. Method of applying test probe to skull.

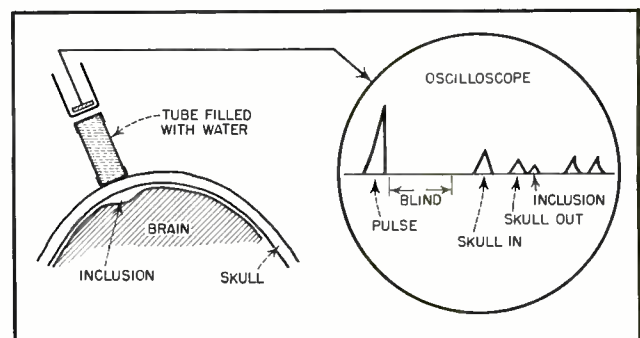

sonic energy at the pulse on the wrist, or in the large mass of blood near the heart. While these things seldom work as expected, it is theoretically possible to overheat the spirochete in one passage of the blood past a given point, so blood-borne syphilis would be cured in three minutes. Do not take this as a definite statement of fact—the human body is too complicated to be regarded as merely a laboratory experimental piece of apparatus, but fundamentally, the theory should be correct.

At times we have too many white blood corpuscles, so we might want to

restaurants. This would allow considerably cheaper handling of milk to keep the bacteria count down at the moment of drinking, as in general we have little interest in the number of dead bacteria in the milk, and we should kill all of them in any case.

There is some possibility of sterilizing operating instruments and the like by dipping them into a liquid having sufficient energy level to be at the cavitation point. It would certainly be true if mercury were used, as the impedance match would be almost perfect. Of

[Continued on page 42]

IMPROVED!

... to Provide a New Standard of Performance!



CARDYNE

Cardioid Dynamic Microphone

● It's better than ever . . . with new impedance selector . . . new external shock-mount . . . improved response . . . increased output! All this, plus Mechanophase* principle, Acoustalloy diaphragm and other great features, combines to make E-V Broadcast Cardyne today's leader!

True cardioid performance cuts reverberation and random noise pick-up . . . stops feedback . . . nearly doubles conventional pick-up range . . . provides clear, natural close-up response. Excellent for broadcasting, recording or high quality public address. Try the improved Cardyne now! *It's your best buy!*

E-V Model 731. Broadcast Cardyne II. Frequency response substantially flat 30-12,000 c.p.s. Output -50 db. Includes external shock mount. Cannon XL-3 connector. List Price \$80.00
(Also available without "On-Off" switch or with 50-250 low impedance selector.)

E-V Model 726. Cardyne I. Frequency response substantially flat 40-10,000 c.p.s. Output -53 db. Without external shock mount. MC-3 connector. List Price \$59.50

Send for Bulletin No. 139

NEW EXTERNAL SHOCK MOUNT

Model 345. Newly developed vibration isolation unit with double shock absorber action. Utilizes dual Lord shear-type mountings—eliminates undesirable vibrations transmitted from stand—reduces side sway of microphone without reducing efficiency of isolation unit. Furnished with Model 731 Cardyne. Also available separately for Model 726.

NEW IMPEDANCE SELECTOR

Recessed switch at rear of microphone case gives instant selection of high impedance (25,000 ohms) or low impedance (150 ohms). Switch easily actuated by pencil point or small screw driver. Included in both Models 731 and 726.

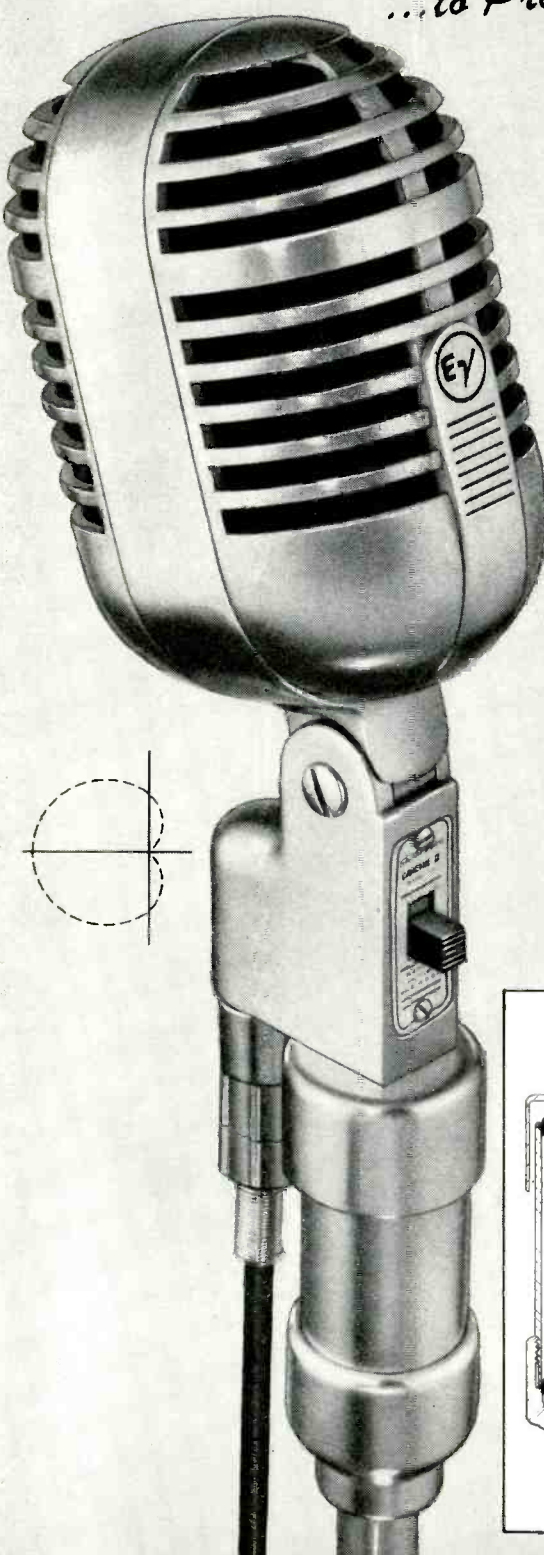
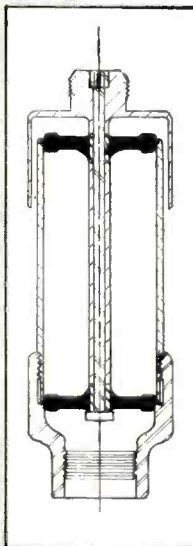

NO FINER CHOICE THAN

Electro-Voice

ELECTRO-VOICE, INC., BUCHANAN, MICHIGAN—Export Division: 13 East 40th St., New York 16, U.S.A., Cables: Arlab



In this department the author, who is a very well-known record critic, will review monthly record releases of outstanding technical, as well as musical, quality.

EDWARD TATNALL CANBY*

WHAT'S an amplifier without a good speaker—and what *is* a “good” speaker? That seems to be a debatable question among engineers right now, and an even more vital one than the eternal triode-vs.-beam power argument (this last being the kind of argument that has long since been “settled”—in both directions—by those who line up on each side of the fence!).

Now this is a field into which the record reviewer had better keep his nose out of, to use some fine grammar. Except in one respect—that being the fact that the speaker is the ultra-crucial point at which the engineer's electronic signal—so beautifully “flat,” so nicely measurable and controllable, becomes finally, actual sound. And paradoxically, once turned into the audible McCoy, this signal is no longer so easily measurable, in objective, scientific terms. There's only one final instrument for testing real sound—especially when it purports to be a facsimile of some other sound and is to be judged, not for itself, but as a reproduction—the ear, and no other. And the ear's measuring circuit, tied into the mind, is horribly complex, and subject to about nine million irrelevant or irrational factors to botch things up. And, anyway, no two people can prove they are hearing alike . . .

All of which is merely to say that judging a speaker, professionally or amateurishly, is oh-so-different from judging even the final signal that reaches its voice coil. I gather that some standards for rating speakers have been set up and accepted. Whether they constitute a reliable objective, mechanical guide for engineers, for all listeners, is

*279 W. 4th St., New York 14, N. Y.

another question. A glance at the dreadful saw-toothed “curves” published for the performance of some expensive speakers make me wonder! Can *this* be what we hear? Do speakers really make such hash of the beautiful curves they receive? In any case, it's clear enough that there can never be any such objectivity in the judging of speakers as there is in judging amplifiers, et al.

How to pin down a speaker's performance? Don't ask me, but it obviously can't be simple, I suppose one begins with a pressure measurement of the accuracy of the actual sound issuing forth, at some median point in the range (which point must be arbitrarily and therefor dangerously determined); and this accuracy would have to include transient responses. But this is hardly a start. A speaker throws out a three-dimensional blast and we must know its coverage, its response at various angles, for various frequencies. I would guess that the shape of a speaker's beam is one of the biggest factors in our actual hearing of it, our judging it as good sounding or bad. If the speaker has more than a single element things get really complicated, and we have additional factors of interference . . . but then, these things are not my business again; the best and most satisfying way to judge a speaker's over-all value is, for most of us, engineers included, just plain listening.

And in the listening I find things to wonder about. I can't account for what seems to be uncalled for differences or likenesses between speakers. How come my cheap (\$10) 12" PM speaker sounds so well as compared to its neighbor, a fancy 15" type costing seven or eight

times as much? There's no such great difference in the actual sound—not to my ear. The 12" job just shouldn't sound as well as it does. I can't account either for the fact that a friend, to make a recording monitor, souped up an ancient radio, about 1928 (cost: \$3.50) using the original amplifier *and speaker*; and that speaker gives markedly better sound than a brand new 15" tweeter-woofer combination using the same signal. (And I mean *better*—wide-range, smooth, un-peaky, easy on the ear, natural sounding.) True, a tiny tweeter was added for top highs, but even without it that old speaker is too good to be true. Doesn't make sense. My question is, would objective, scientific measurements back me up in these cases, or is it just my ear against the next man's?

Enough of speakers themselves. I would like to quarrel briefly, speaking of speakers, with the way most engineers place their speakers in a room. The engineer's rule is, always listen in the direct beam, so that no highs shall be lost. My own rule is a bit different: *never* sit in the direct beam! Long before I graduated from the cactus needle and tone control stage I discovered I much preferred my music indirectly. I liked to have something between me and the source—even to have the phonograph in another room. Now, after a lot of experience, I still feel the same way, highs or no.

Granted that, using objective measurements, the best place to get all the music is in the center of the speaker beam. But remember, your speaker sound is always the monaural reproduction of another sound, a sound which was in-

[Continued on page 39]

EFFICIENCY More APPLICATIONS VALUE

by using these NEW RACON SPEAKERS and HORN UNITS

NEW SPECIAL PM HORN UNIT, having Alnico V magnet ring, completely watertight, housed in a heavy aluminum spinning. Provides extremely high efficiency reproduction with minimum input. Handling capacity 35 watts continuous, 60 w. peak.

NEW SMALL RE-ENTRANT HORNS, extremely efficient for factory inter-com and paging systems; for sound trucks, R.R. yards and all other industrial installations where high noise levels are prevalent. Watertight, corrosion-proof easily installed. Two new models—type RE-1½, complete with Baby Unit, handles 25 watts, covers 300-6000 cps.; type RE-12, complete with Dwarf Unit, handles 10 watts, freq. response of 400-8000 cps.

NEW RADIAL RE-ENTRANT SPEAKER, excellent for all types of industrial sound installations. Provides superlative and complete 360° speech intelligibility by efficiently over-riding factory high noise levels. Frequency response 300-6000 cps. Handling capacity 25 watts continuous 35 w. peak. Has mounting bracket. Size 12" wide by 12½" high.

Other RACON products now available:

PM Horn Driving Units, 10 types.	Straight Trumpets, 21 types.
Reentrant Trumpets, 7 types.	Re-entrant Cone Speakers, 7 types.
Tweeter & High Freq. Speakers, 3 types.	Flat bell straight trumpets, 2 types.
Radial Horns and Speakers, 3 types.	Armored Cone Projectors, 7 types.

Also—cellular and auditorium horns, inter-com, paging, monitor, and dwarf speakers, cone speaker housings, etc., besides all basic accessories such as swivel brackets, mounting units, cone housings, multiple horn throat combinations, etc.

To the more than 60 different type and size speakers and horn units that already comprise the RACON line — these new models have been added. There is a RACON speaker and horn unit ideal for every conceivable sound system application.

RACON has not only the most complete line, but also the most preferred line. For over 20 years leading Soundmen have recognized and specified them because of dependability, efficiency and low-cost, and because the reproducers are trouble proof.

ASK YOUR JOBBER, OR—Write today for full details

RACON ELEC. CO., INC., 52 E. 19th ST., N. Y. 3, N. Y.

RACON

AUDIO ENGINEERING JUNE, 1948

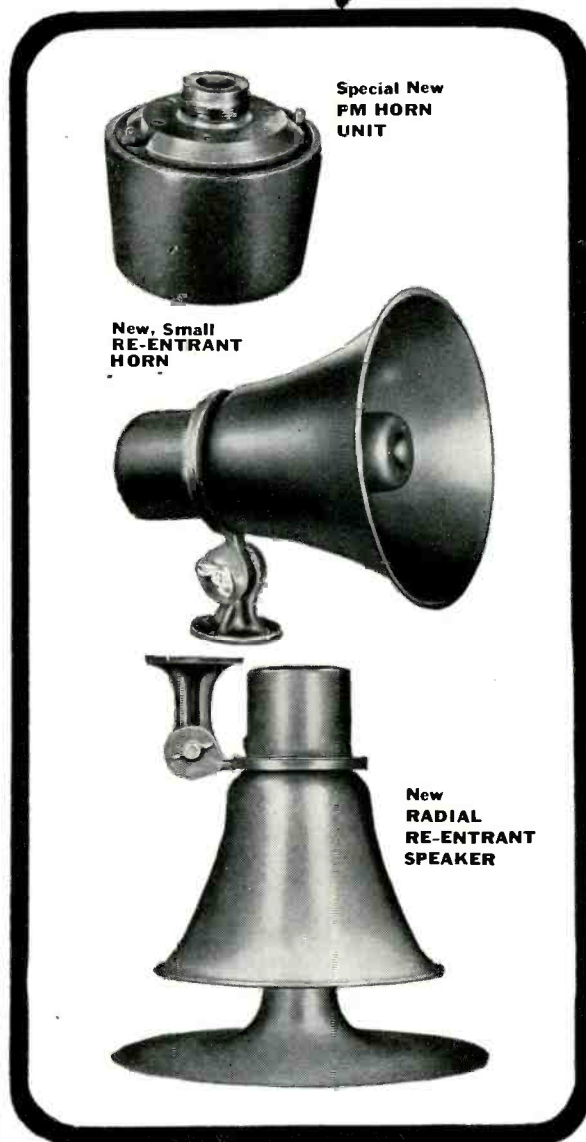

Special New
PM HORN
UNIT

New, Small
RE-ENTRANT
HORN

New
RADIAL
RE-ENTRANT
SPEAKER

NEW PRODUCTS

CRYSTAL CARTRIDGE

• In an exclusive modern type "LY" Crystal Phono Cartridge, The Astatic Corporation, of Conneaut, Ohio, has just introduced a new, low needle talk reproducer in the low price field. Output voltage, 1.00 volt, avg.



at 1,000 c.p.s.; minimum needle pressure, 3/4 ounce; cutoff frequency, 4,000 c.p.s.; and replaceable Type "T" Needle with "Electro Formed" precious metal playing tip. In the reproduction of high frequencies, the Astatic Corp. reports, the "LY" Cartridge is noticeably free from disagreeable surface noise or needle talk for greater clarity and beauty of tone reproduction.

CUEING ATTENUATOR

• A new line of improved cueing attenuators has just been announced by the Shallcross Manufacturing Co., Collingsdale, Pa.

These new Shallcross units, which feature a special switching mechanism to transfer attenuator input to a pair of separate output terminals for cueing purposes, facilitate program switching and fading in "on cue" without any increase in the diameter of the attenuator.

Any standard Shallcross ladder, bridged T, straight T, or potentiometer may be equipped for cueing action, including units as small as 1 3/4" in diameter. All controls are available with mounting by means of a single-hole 3/8"-32 thread bushing or two 6-32 or 8-32 screws on 1-1/4" or 1-1/2" (except 1-3/4" diameter units) centers.

In addition to its value as a space saver, the cueing attenuator contributes to improved program handling. With it the operator can listen for cue and can transfer

a program from cueing amplifier to the transmitter preamplifier smoothly and efficiently by merely turning up the volume in the usual manner for proper gain control, instead of using a separate switching arrangement.

The cueing position is at the extreme counter-clockwise position, following the attenuator "off" position. The unit may be equipped with detent action for the "off" position, the cueing position, or both, if desired.

Specification sheets for simplified quotation requests on any attenuator requirement are available from the manufacturer.

WIRE RECORDER

• Electronic Sound Engineering Co., 4344 W. Armitage Ave., Chicago, Ill., has introduced a new high-fidelity wire recorder which is expected to open up new fields for the use of wire recording, particularly where quality of sound is important. Built around the Company's patented amplifier circuit, the new unit is being sold under the trade-name "Polyphonic Sound."

The built-in six-inch speaker, with a range up to 10,000 cycles, has a special diaphragm to insure smooth reproduction of high frequencies. For those who want the very ultimate in sound performance there is available a fifteen-inch, dual channel auxiliary speaker. This speaker connects with a jack on the front panel and carries the lower range down to fifty cycles.

Input facilities consist of a low-level input for a microphone and a front-panel input arrangement for high level sound via direct connection with a radio or record player. The microphone has a response of 60 to 10,000 cycles. Standard equipment includes a fifteen-minute spool.

CONSOLE RECORDER

• Fairchild Camera and Instrument Corporation has announced it is now producing a new console model recorder, in the moderately-priced field, for professional use.

Called the Unit 539, the new machine's performance compares favorably with Fairchild's larger Unit 523 console recorder, now widely used in radio stations, recording studios and sound laboratories.

The 539's synchronous drive meets all requirements for direct lateral recording on discs up to 17 1/4" in size at 33.3 and 78 rpm, and the instrument is suitable for a-m and f-m broadcasting uses, professional recording, synchronizing of sound-on-disk with film, recording of facsimile on disk, instruction in speech, language and music, or wherever else high-fidelity and split-second time are essential.

Additional details about these recorders are available from C. V. Kettering, sales manager, sound equipment division, Fairchild Camera and Instrument Corporation, 86-06 Van Wyck Blvd., Jamaica 1, N. Y.

FISHER AMPLIFIER

• The new Fisher Dynamic Noise Suppressor-Wide Range Amplifier features 20-watt output with less than 1% distortion. Response is rated uniform within 1 db from 20 to 20,000 cycles. The phono circuit is compensated for use with the new magnetic pickups, made by G. E. and Pickering. Equipped with bass and treble controls, as well as means for regulating band width, and noise suppression.

This amplifier uses the following tubes: 2-12AT7, 1-6C4, 3-6BA6, 1-6AL5, 1-6AQ6, 2-6E5. Licensed under Hermon Hosmer Scott patents pending.

[Continued on page 37]

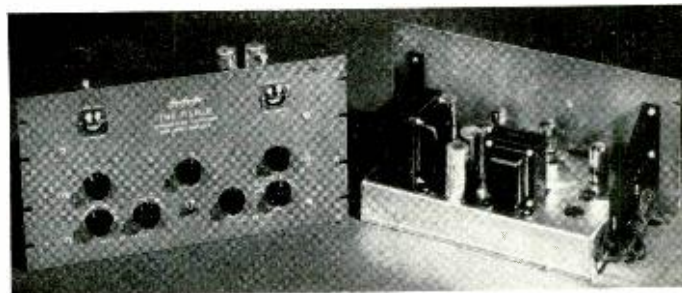

PROFESSIONAL DIRECTORY

C. J. LeBEL
AUDIO CONSULTANT

370 RIVERSIDE DRIVE
NEW YORK 25, N. Y.

PRODUCT DESIGN • INSTRUMENTATION
PSYCHO ACOUSTICS • SOUND RECORDING
ELECTROMEDICAL • SUBMINIATURE AUDIO

Custom-Built Equipment

U. S. Recording Co.

1121 Vermont Ave., Washington 5, D. C.

District 1640

Winston Wells

Designer and Consultant
Acoustical and Electronic Research

307 East 44th St. MU 4-3487

New York 17, N. Y.

Always room for something **NEW** and **BETTER**

NEW ▶ ▶ ▶
Presto
8D-G
Recorder

Extreme accuracy . . . designed for the finest instantaneous and master recordings. A special feature is the direct gear drive with separate motors for $33\frac{1}{2}$ and for 78.26 rpm. Overhead driven independently of the turntable and has a choice of seven different feed pitches in each direction.

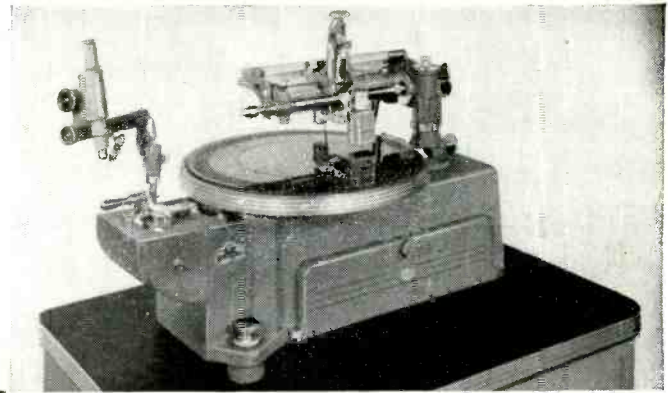

NEW ▶ ▶ ▶
Presto 92-A
Recording
Amplifier

Sixty-watt amplifier especially designed for high-fidelity recording. Vertically mounted chassis. Removal of front panel gives access to all circuits. Output stage has four 807's in push-pull parallel. Selector switch and meter provide both output level indicator and plate current readings for all tubes. Response: 20-17,000 cps.

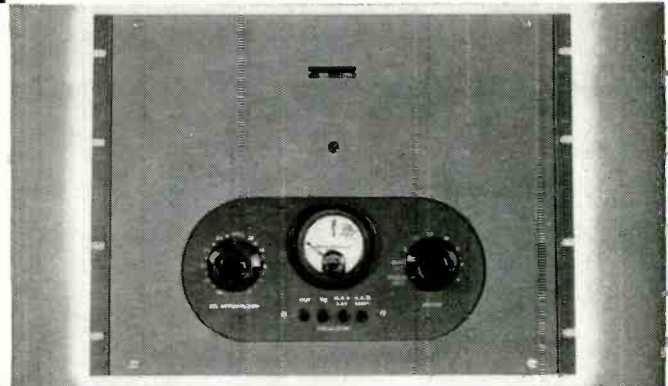

NEW ▶ ▶ ▶
Presto 64-A
Transcription
Unit

Directly gear-driven at both $33\frac{1}{2}$ and 78.26 rpm, with two separate motors, one for each speed. Instantaneous speed selection by turning mercury switch, without damage to mechanism. Speed: Total speed error is zero. Noise: At least 50 db below program. Starting: Table on speed in less than $\frac{1}{2}$ revolution at $33\frac{1}{2}$ rpm.



NEW ▶ ▶ ▶
Presto
90-A

Complete portable recording console. Three low-level input channels with mixers, master gain control and variable high and low frequency equalizers. Four fixed characteristics: Flat between 30 and 15,000 cps, NAB recording, 78 rpm recording, and playback complementing NAB recording.

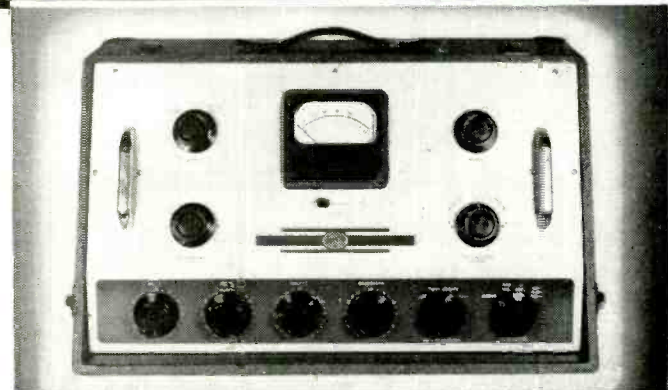

For further information about any of this new equipment, write or wire



RECORDING CORPORATION, Paramus, New Jersey
 Mailing Address: P. O. Box 500, Hackensack, New Jersey

WORLD'S LARGEST MANUFACTURER OF INSTANTANEOUS SOUND RECORDING EQUIPMENT & DISCS
 AUDIO ENGINEERING JUNE, 1948

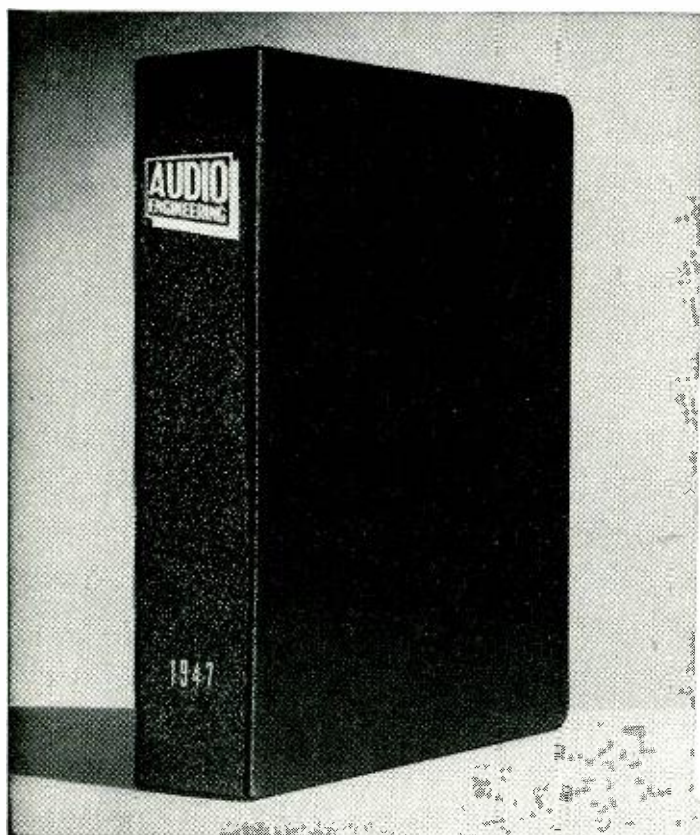

**AUDIO
ENGINEERING**

BINDERS
\$2⁵⁰

« « « « Here at last is a binder using modern postwar materials at prewar prices. Designed to provide instantaneous reference to your monthly copies of Audio Engineering. An unusually fine library finish that will stand up under constant use.

- Rich blue Dupont Fabricord—stainproof and washable.
- Rigid backbone with bound-in metal support.
- Light weight tarnishproof aluminum ends.
- Coil springs built in at each end to securely position spring steel wire holders.
- Backbone gold stamped with Audio Engineering and year.
- Center channel to keep magazines fastened in position.
- Round corners, hinges and backbone fully reinforced.
- \$2.50 postpaid. Foreign orders add 50c.



RADIO MAGAZINES, INC.

342 MADISON AVE.
NEW YORK 17, N. Y.

**AUDIO ENGINEERING
BINDERS**

1947 1948

Enclosed find \$..... for..... Binders

Name.....

Address.....

City..... State.....

AUDIO ENGINEERING JUNE, 1948

For further information, write Fisher Radio Corp., 41 E. 47th St., N. Y. City.

PORTABLE DISC RECORDER

Audar, Inc., of Argos Indiana, is proud to announce the Model RE-8 portable disc recorder. It is a compact portable acetate disc recorder and playback having the following features:

- 1—78 and 33 $\frac{1}{3}$ RPM recording and playback.
- 2—6 $\frac{1}{2}$ " heavy duty PM dynamic speaker.



3—High output amplifier for higher fidelity recordings with minimum distortion—115 volt, 60 cycle A.C.

4—Recording level indicators.

5—All switching from recording to playback with one control which also switches the proper tone compensation adjustments for recording or playback.

6—All this including a hand microphone with 7 feet of mike cable installed in a two-toned leatherette carrying case.

For further data, please write the manufacturer.



ELECTRONIC VOLT-OHMMETER

EICO announces another addition to their line of test equipment, the Model 221 Vacuum Tube Voltmeter

A completely new and modern approach

in designing vacuum tube voltmeters makes this exceptionally high quality utility instrument at an unusually low price. Its amazing performance sets standards of accuracy, linearity, and stability, with a coverage of wide ranges and applications heretofore not usually available in this type of instruments.

1. Completely electronic on all functions and ranges.

2. Electronic AC range is more linear and accurate than was ever possible with a copper oxide rectifier. More accurate measurements can now be made over a wider frequency range.

3. *The meter can not be burned out.* This automatic overload protection is only

possible because of its all electronic circuit.

4. Special type electronic bridge circuit practically eliminates all zero drift short warm up period.

5. Accuracy is 2% on all ranges.

6. Each instrument is individually calibrated.

7. Twenty-six (26) megohms input resistance.

8. Electronic AC & DC ranges 0-5, 10, 100, 500, 1,000 volts.

9. Electronic ohmmeter measures from .2 ohms to 1,000 megohms on 5 convenient ranges.

10. Wide range db scale.

11. Stable on all ranges, due to care-

**Proved in Millions
of Applications!**



RELAYS
RESISTORS
RHEOSTATS

Vast Variety of Stock Units

ANSWERS EVERYDAY NEEDS ECONOMICALLY

Relays are available from stock in general-purpose, industrial, and radio amateur types for continuous or intermittent duty.

Vitrohm wire-wound Fixed Resistors are available in 8 stock sizes from 5 to 200 watts. Adjustohms in 7 stock sizes from 10 to 200 watts. Plaque Resistors in 3 sizes from 20 to 125 watts. Discohms in 18 watts. Strip-ohm in 5 stock sizes from 30 watts to 75 watts. Ring-type close control Rheostats in 4 stock sizes from 25 to 150 watts. (Plate Type Rheostats recommended for larger sizes.) Wide variety of Resistance Values.

AUTHORIZED DISTRIBUTORS EVERYWHERE

WARD LEONARD ELECTRIC COMPANY

Radio & Electronic Distributor Division

53-R West Jackson Blvd., Chicago 4, U. S. A.

SEND FOR HELPFUL CATALOGS

Catalog D-30 gives complete data and listings on stock units available in Resistors, Rheostats and Radio Amateur Relays. Catalog D-20 lists Industrial and General-Purpose Relays. Write for them today!

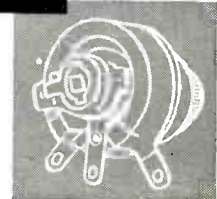
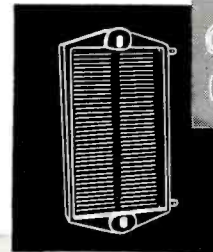
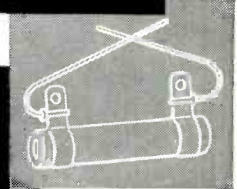
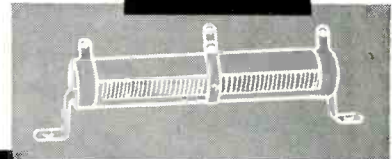
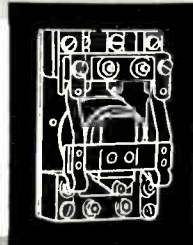

WARD LEONARD

Basic 3R's in Current Control

FOR PRECISE AUDIO MEASUREMENTS

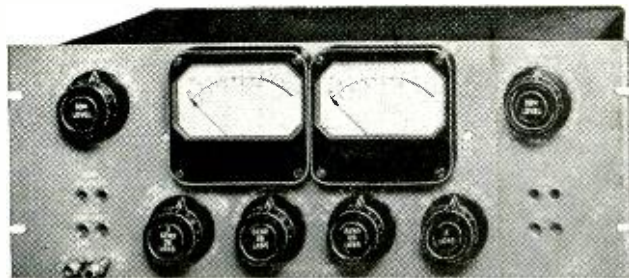

CINEMA TYPE 4983 TRANSMISSION MEASURING INSTRUMENT

This unit was designed to make precise measurements of circuit gain, loss and power level. Special attenuator design and circuit layout minimizes leakage at the higher frequencies and makes possible a guarantee of 0.2% accuracy over the range between 30 and 17,000 cycles.

An important feature is the use of *Balanced H* type attenuators and matching networks to obtain absolute circuit balance to ground.

The oscillator input transformer is placed directly ahead of the transmission attenuators. The transformer response is within 0.1 db. from 20 to 20,000 cycles and the distortion is less than 0.1% over the entire range of the instrument.

SPECIFICATIONS

Attenuation Range:—

Transmission: -106 to plus 26 db. in steps of 1 db.

Load Network: Plus 4 to plus 42 db. in steps of 2 db.

Accuracy: Component resistors within plus or minus 0.5%.

Frequency Characteristic: Plus or minus 0.2 db. between 30 and 17,000 cycles.

Impedance Ranges: 30, 150, 250, 500 and 600 ohms. (balanced)

15, 150, 250, 500 and 600 ohms. (unbalanced)

Meters: Weston Model 802, Reference level 1 mw, 600 ohms.

Mounting: Rack panel, 7 inches high.

CINEMA
ENGINEERING COMPANY
1510 W. Verdugo Ave. Burbank, Calif.
Cable Address: CINENG BURBANK

FOR ENGINEERS ONLY!



Specifications that speak for themselves

1. Push-pull direct-coupled driver stage
2. Self-balancing, drift-correcting circuit
3. Automatic dynamic balancer
4. Push-Pull triode expanders (introduce less than 1½% distortion at full 20 db. expansion.)
5. No interstage transformers
6. Exclusive non-frequency discriminating scratch suppression circuit
7. Overall gain 94 db. (High gain model 117 db)
8. Guaranteed ± 1 db. at 20 to 20,000 cycles
9. Independent push-pull high and low frequency equalizers
10. Enlarged, 83 db., dynamic range (less expansion)
11. DC on heaters assures exceptionally low noise and hum (-48 dbm)
12. Input stages employ anti-microphonic construction
13. Regulated fixed bias
14. Automatically delayed plate voltage
15. Balanced output transformer
16. Automatic hum balancer continuously cancels hum
17. Balanced power feedback increases dynamic stability
18. High condenser safety factor
19. No shielded wire in input circuit assures extended high frequency response
20. Models available with built-in pre-equalized pre-amplification for GE and other low level pickups.

Send for Technical Literature

AMPLIFIER CORP. of AMERICA

398-4 BROADWAY

NEW YORK 13, N. Y.

fully designed compensating circuit.

12. Complete instructions included with every instrument.

13. Large 4½" meter with 2% accuracy.

14. One single linear scale for both AC and DC measurements.

More information on this instrument can be obtained from the manufacturer, Electronic Instrument Company, Inc., 926 Clarkson Avenue, Brooklyn 3, N. Y.

HOME RECORDER

• The Speak-O-Phone Recording & Equipment Co., 23 W. 60th St., New York, N. Y., announce their newest model dual speed home recorder. The HR-48, known as the 20th Anniversary model, commemorates twenty years of instantaneous recording in which Speak-O-Phone was one of the pioneers.

The features of this combination recorder, playback and public address unit include a dual speed motor, a visual volume indicator, compensating tone control, radio input and head phone monitoring jack. The amplifier contains 2-7C7's, 1-7C5 and 1-7Y4 tubes.

MAGNESONIC TAPE RECORDER

• Instrument panel of the new Magnesonic magnetic tape recorder displayed at the National Retail Dry Goods Association Convention, at the Hotel Pennsylvania, New York, by Sound Recorder and Reproducer

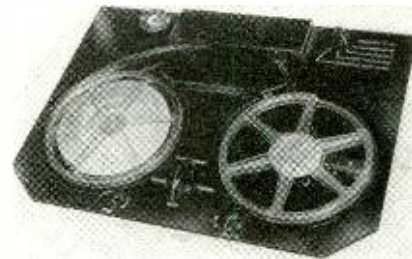

Corporation of Philadelphia. Magnesonic, through finger tip control, will record, playback, select programs, rewind or select tone with equal speed and facility.

WRCA ACQUIRES ST. GEORGE

• Announcement has been made of the incorporation of Wire Recording Corporation of America who have taken over the assets and manufacturing facilities of St. George Recording Equipment Company of New York City. The latter company were pioneers in the manufacture of electronic recording equipment and during their existence made and sold more wire recording instruments than any other manufacturer. Mr. J. J. Sullivan, President of the newly formed corporation has revealed plans to consolidate the various manufacturing facilities of this pioneer organization as well as sales offices in extensive quarters at the company's new plant at 1331 Halsey Street, Brooklyn, N. Y.

Wire Recording Corporation of America have completed plans to manufacture and distribute the Wireway Wire Recorder in both a portable and cabinet model whose

design will incorporate many new features developed by Mr. Robert J. Marshall, Chief Engineer.

GRAHAM JETEC CHAIRMAN

Virgil M. Graham, director of technical relations for Sylvania Electric Products Inc., Flushing, N. Y., has been elected chairman of the Joint Electron Tube En-



Virgil M. Graham

gineering Council which is sponsored by the Radio Manufacturers Association and the National Electrical Manufacturers Association. The Council was established in 1944 to standardize data and engineering practice for electron tubes.

Audio Society News

[from page 29]

To provide a rapid method of making these curves and of presenting them in a form which is correlated to conventional curves as drawn on semi-log graph paper was the aim of the instrument. Primarily, it consists of a beat-frequency oscillator which is swept over the entire audio-frequency spectrum, or over any desired part of it, at a rate which is continuously variable from two sweeps per second to 15 per second, or at a long sweep of once in 25 seconds.

The problems of making the sweep of such a character that the low frequencies are shown in the same detail as those in the higher ranges are rather complicated, but with a considerable amount of straightforward engineering and clear thinking, this sweep was achieved. Since sufficient time must be allowed for the response of the measured circuit to reach a maximum for each frequency applied, the sweep is so arranged that 90 per cent of the sweep cycle is devoted to frequencies below 200 cps. In addition to providing the frequency-swept audio voltage, a signal is furnished to the horizontal circuits of an

oscilloscope to move the beam at a logarithmic rate.

Considering the generator as one problem, there was still another to be solved—that of making the output voltage appear on the 'scope screen in a form which is most familiar to engineers. Normal deflection of the 'scope beam is proportional to voltage, but the curves should be presented in db, which necessitates another form of logarithmic amplifier. This is incorporated into the instrument, and provides a linear db scale on the vertical deflection of the 'scope, the range covered being 40 db. Thus, with the single instrument it is possible to present normally recognizable frequency response curves on any cathode-ray oscilloscope.

* * *

The Society is continuing to grow, with over 600 members now on the rolls, and from 21 states and three foreign countries. Further information and application blanks may be obtained from the Secretary, N. C. Pickering, Box F, Oceanside, N. Y.

Classical Recordings

[from page 32]

tended to be binaural, a sound that *under no circumstances could ever have come from a single point* (except perhaps in a totally dead studio, which would guarantee unnaturalness!). Aside from the actual width of the primary sound source

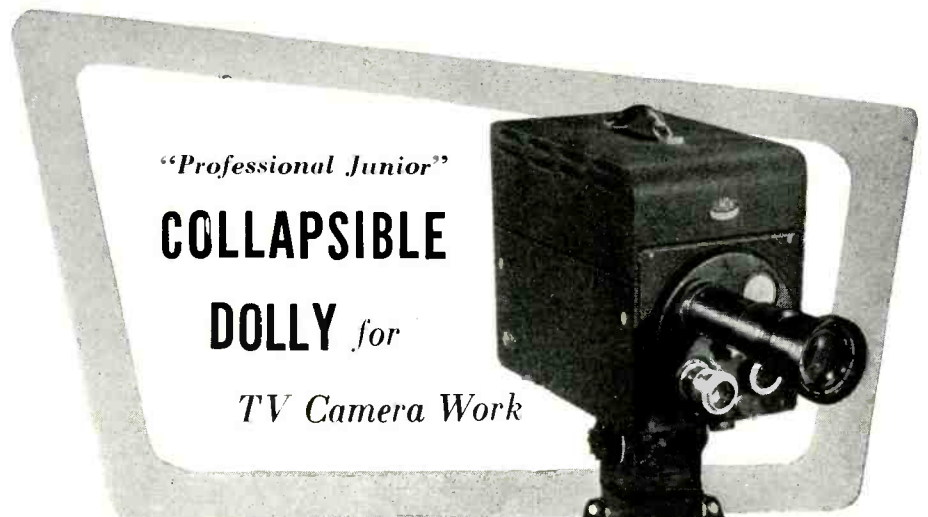

**Now being used by RCA--NBC
CBS & DuMont Video Stations**

Sturdily supports TV camera on tripod, also cameraman. Assembles quickly without tools. Collapses into carrying case 1' sq. by 6' long. Ideal for Studio & Location TV work.

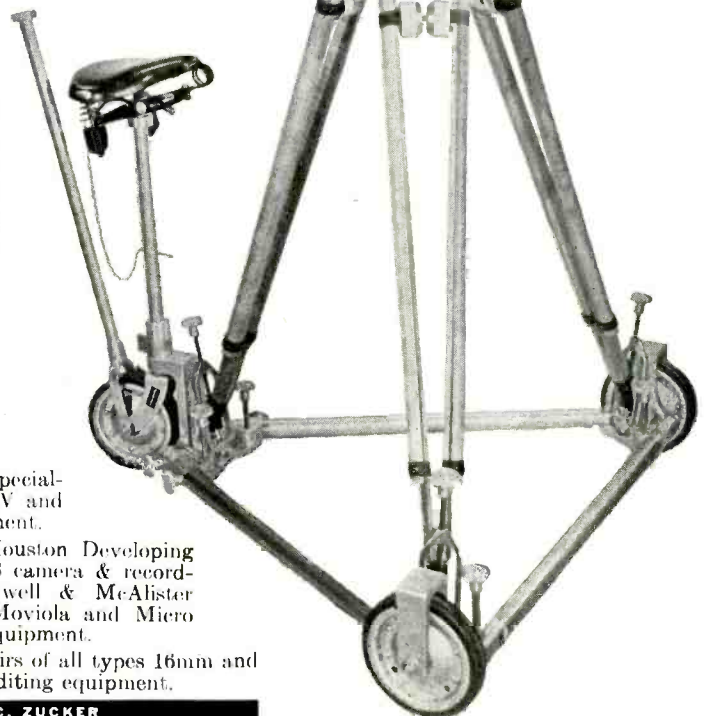

This Dolly made by specialists in custom-built TV and motion picture equipment.

Representatives for Houston Developing Machines; Auricon SS camera & recording equipment; Bardwell & McAlister lighting equipment; Moviola and Micro Engineering editing equipment.

Rentals, Sales & Repairs of all types 16mm and 35mm cameras, and editing equipment.



Complete staff of trained technicians available for consultation.

ONE STANDARD
OF QUALITY
ONLY...THE
HIGHEST



DEDICATED TO
THE CONSTANT
BETTERMENT
OF SOUND

1161 N. VINE ST., HOLLYWOOD 38 • 250 W. 57th ST., NEW YORK 19

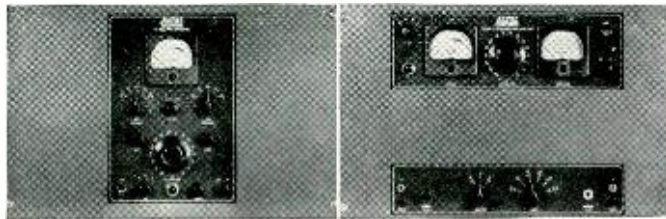

LEFT—Altec Lansing TI-401 Signal Generator contains 2 independent resistance-capacity sine wave oscillators. Weight: 34 lbs. Dimensions: 12¼H x 19W x 8½D.

RIGHT—Altec Lansing TI-402 Intermodulation Analyzer. Weight: 45 lbs. Dimensions: 12¼H x 19W x 9½D.

ALTEC LANSING INTERMODULATION ANALYZER A VALUABLE MULTI-PURPOSE INSTRUMENT

Letters received by Altec Lansing demonstrate impressively that the Altec Lansing TI 402 Intermodulation Analyzer, used with the Altec Lansing TI 401 Signal Generator, has become an indispensable tool to:

- (1) broadcasting station engineers, for the measurement and correction of intermodulation distortion in radio transmitters; for analyzing distortion in speech input equipment; for routine checking of speech input equipment; for building special equipment for broadcast purposes, such as echo devices, filters, line equalizers, system equalizers, sound effects, etc.;
- (2) recording studio engineers,

for checking cutter head performance and playback heads, amplifiers, compression devices, equalizers, etc.;

- (3) film recording engineers, for optimum film recording, processing, and reproducing; and
- (4) sound research laboratory engineers, for making progressive checks in the design and development of new electronic apparatus.

The many-sided usefulness of Altec Lansing Intermodulation test equipment is evidenced by the fact that over 200 firms, in all branches of the electronic industry, have purchased this equipment. Among users are: U. S. Department of State, International Broadcasting Di-

vision, and other government departments; WOR Recording Studios; and other major recording companies; Rudolph Wurlitzer Company; radio stations throughout the U. S.; motion picture producing companies; leading manufacturers of radios, radio-phonographs, electrical instruments, sound reproducing equipment and motion picture theatre sound systems; and many others.

Complete engineering data on Altec Lansing Intermodulation Test Equipment are available, and will be sent on request. Use address nearest you: 250 West 57th St., New York 19, or 1161 N. Vine St., Hollywood 38. Write to Dept. IT 4.

Built Like a Fine Camera

With the Type 210-A Amplifier, you have complete control over all factors in the reproduction of recorded music. Regardless of turn-over point, amount of pre-emphasis or surface noise conditions, you get the most out of each record with the original H. H. Scott Type 210-A Amplifier with *Dynamic Noise Suppressor.

This is a precision instrument providing all of the electronic equipment for *distortionless, low-noise-level* record reproduction in a *single compact* unit.

In addition to playing records, the Type 210-A may also be used with FM and AM tuners or other signal sources. Its effective frequency range exceeds 20 cycles to 20 kc., with *Dynamic Noise Suppressor to 16 kc.

This advanced amplifier is made by the makers of the famous H. H. Scott *Dynamic Noise Suppressor, Type 910-C, the only instrument of its kind suitable for commercial FM and AM broadcasting of recorded music. Once you have heard the Type 210-A, you'll agree that nothing else will do for those who want the very best.

Available through leading distributors or direct from the manufacturer. Complete technical specifications upon request.

Price: \$460.00 list; \$276.00 net, tax included. Order today for early delivery.



Engineering Representatives
CHICAGO:

1024 Superior Street Oak Park, Ill.,
Phone: Village 9245

HOLLYWOOD:

623 Guaranty Building; Hollywood 28, Calif.,
Phone: HOLlywood 5111

*Licensed under patents pending



HERMON
HOSMER **SCOTT, INC.**

"PACKAGED ENGINEERING"

DEPT. AE-2

385 PUTNAM AVE. • CAMBRIDGE 39, MASS.

—often plenty wide—sound heard binaurally is very largely reflection; the liveness is what gives it life. And this reverberation must necessarily have come from all directions and never from a single point. To me, then, there is nothing that so quickly kills the naturalness of musical reproduction as a single point source—no matter how high fidelity. (And this applies as well to several single point sources—multiple speakers, all pointing directly at you.) I find reflection absolutely necessary for realistic reproduction, and I think my reasoning is sound. My speaker of the moment (in a celotex infinite baffle) stands behind a grand piano in a corner. The sound must bounce off numerous shiny obstacles—pedals, chair legs, seats, the piano itself. Some of it goes upwards, some comes under the piano. The effect is one of considerable diffusion, and thanks to the shiny surfaces involved, not much loss of highs; after

RECORD LIBRARY

In this spot a continuing list of records of interest will be presented. The list specifically does not suggest "the" best recordings or versions. It will draw predominantly but not entirely from postwar releases. All records are theoretically available, directly or on order; if trouble is experienced in finding them *Audio Engineering* will be glad to cooperate. Records are recommended on a composite of musical values, performance, engineering; sometimes one, sometimes another predominates but records unusually lacking in any of the three will not be considered. Number of records in album is in parenthesis.

Out-of-the-way orchestral items, by the familiar composers

Dvorak, Symphony in D major, op. 60. Cleveland Symph., Leinsdorf.
Columbia MM 687 (5)

Dvorak, 'Cello Concerto in B minor. Philadelphia Orch., Ormandy; Piatigorsky.
Columbia MM 658 (5)

Franck, Psyche; Le Chasseur Maudit (tone poems). Chicago Symphony, Defauw
RCA Victor DM 1122 (4)

Beethoven, "Battle" Symphony, King Stephan Ov., Janssen Symphony of L. A. Janssen. Artist JS 14 (3 pl)
"Salzburg Serenade" (Mozart, Concertante and Rondo, K. 320; Serenata Notturna, K. 239) Vox Chamber Orch., Fendler.
Vox 161 (4 10")

Respighi, Roman Festivals. Philadelphia Orch., Ormandy. . . Columbia MM 707 (3)

Tchaikowsky, Symphony No. 1, "Winter Reveries"). . . Indianapolis Symphony Orch., Sevitsky. . . RCA Victor DM 1189 (5)

Tchaikowsky, Symphony No. 2 ("Little Russian"). . . Minneapolis Symphony Orch., Mitropoulos. Columbia MM 573 (5)

Prokofieff, Romeo and Juliet, Suite No. 2 Boston Symphony, Koussevitsky.
RCA Victor DM 1129 (2)

Stravinsky, The Fairy's Kiss (Baiser de la Fée) ballet music (1928).
RCA Victor DM 1202 (3)

repeated experiment with direct beam listening I am convinced that this style is highly preferable. Reflection and diffusion, off shiny, non-absorbent surfaces, is the trick. Conceivably a scientific diffusion board could be built, but I think the furniture principle does a more natural job; its very random quality adds to the effect. Mounting the speaker in the corner of a room of course is of great help since it allows the side walls to reflect a maximum of sound at an infinite number of points, and in this respect I'd suggest the Klipsch type system is an improvement because the bass tones, at least, come from a relatively wide area to begin with.

I have had to give many phonograph "concerts" and lectures. I have listened to many given by others, invariably using the direct beam principle. I can't emphasize too much the difference in listening ease that the indirect approach gives. If furniture, etc., is not available, then the speaker must be aimed either to one side, anglewise, or upwards-and-anglewise, to get maximum reflection from the ceiling and walls, avoiding the direct beam. I strongly suspect that many people's objections to "high fidelity" music is in part a reaction, not understood, to the unnatural effect of the direct beam—unrealistic quite aside from questions of fidelity to the signal.

I am gratified when I turn on my present machine, to see people look startled, glance around the room trying to find where the music is coming from! Yes, somewhere over there, behind the piano... hard to tell exactly where. That's as it should be. Speakers should be heard but not seen.

RECENT RECORDINGS

Beethoven. Symphony No. 9 ("Choral"). Koussevitsky, Boston Symphony Orchestra, Berkshire Festival Chorus (Shaw), soloists.

RCA Victor DM 1190 (8)

The Ninth Symphony, written at the end of Beethoven's life when, long deaf, he had become increasingly out of touch with everyday requirements of musical performance, is a problem to perform and even more to record. This newest attempt is perhaps the least successful of all except the old Stokowsky version. Done, apparently, in the empty semi-open-air "music shed" at Tanglewood, the acoustics blur and confuse without giving real liveness. The whole performance seems at a distance; there is little roundness and perspective. Without Victor's accustomed fine acoustics, the lack of real high highs becomes important in adding more confusion. Musically, the performance is good, but heavy-handed in the Koussevitsky manner. Some surfaces reported extremely poor; mine were so-so. (Partly due to very low level in many passages.) The Columbia Ormandy version is somewhat preferable: somewhat more in the highs, acoustics deadish instead of too live, performing less heavy but not super-inspired. By far the best version on all counts is still the beautifully recorded and

performed Weingartner-Vienna Philharmonic album, many years old. (C MM 227). It shows what could be done, minus real highs, but with marvelous acoustics, some (?) pre-emphasis of low highs to add brilliance, excellent mike placement. Only the chorus suffers, in loud parts. This recording is now quite worn in the new pressings. It is still best of all.

Brahms, Violin Sonata No. 3, opus 108. Isaac Stern, Alexander Zakin.

Columbia MM 730 (3)

Brahms, Cello Sonata No. 2, opus 99. Gregor Piatigorsky, Ralph Berkowitz.

Columbia MM 590 (4)

These two sonatas illustrate both an excellent musical directorship on the part of this company and, as well, the progress in chamber music recording that

has been made, notably in respect to wider range reproduction, but also in the matter of acoustics and balance. This type of record makes music for small group of instruments more nearly what it was intended to be—*big music*, to be heard close-to, not at a distance. It so sounds here. Excellent "presence" on the part of the soloists, fine "edge" and sharpness to both cello and violin tone. The Cello Sonata is not as well balanced as the violin—possibly because of the low pitch of the cello and the consequent difficulty in making it stand out clearly. Also possibly—just possibly—because of the soloist's big name... Berkowitz' piano is outstanding and makes the Cello album musically an exciting one; the Stern-Zakin team is known for perfect coordination and fine ensemble playing.

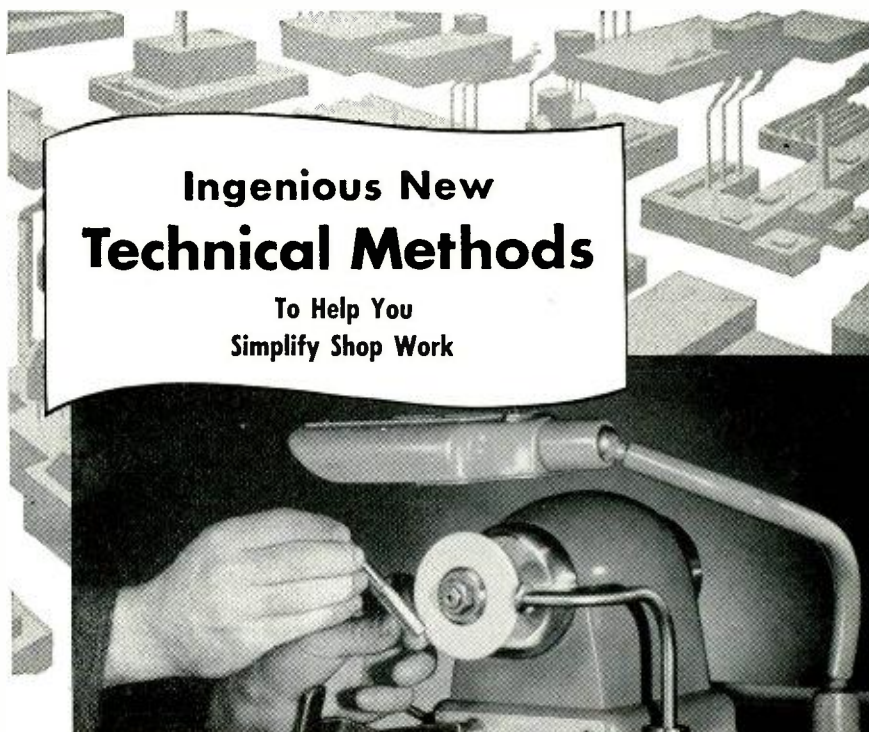

Ingenious New Technical Methods

To Help You Simplify Shop Work

Versatile New Grinder Saves Time — Improves Grinding Efficiency

A new grinder, the Corlett-Turner G-3, permits changing of grinding wheels in a matter of seconds and assures a true running wheel at all times. Each wheel is individually mounted on a ground, tapered arbor.

Easy wheel changing is accomplished by a slight wrist motion on the end bells of the grinder head. A twist to the left releases the wheel arbor; the reverse action instantly secures it in place. It's all done in a matter of seconds. No costly time is lost in repeated wheel dressing.

In addition to its primary function, the G-3 grinder has innumerable uses for burring, buffing, polishing, and production applications requiring a high speed spindle. Powered by a 1/3 horsepower motor, a three-step pulley arrangement provides speeds of 5600, 8000, and 12,000 r.p.m.

Efficiency in precision work is also increased when tension is relieved by the act of chewing. And chewing Wrigley's Spearmint is a pleasant, easy way to help relieve workers' nervous tension. For these reasons Wrigley's Spearmint Chewing Gum is being made available more and more by plant owners everywhere.

Complete details may be obtained from
Corlett-Turner Co., 1001 S. Kostner Avenue
Chicago 24, Illinois

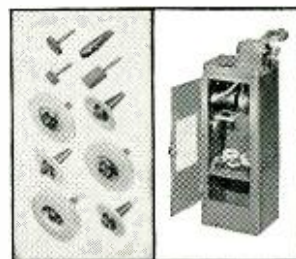

Grinding Wheels

Corlett-Turner Grinder



AC-65

Tchaikowsky, The Sleeping Beauty (ballet music). Stokowski and his Orchestra.

RCA Victor DM 1205 (6)

Rimsky-Korsakoff, "Antar" Symphony. Monteux, San Francisco Symphony.

RCA Victor DM 1203 (3)

Two outstanding orchestral recordings from Victor, with interestingly different recording techniques. Stokowski's was

done with orchestra split up, each group a separate pickup, plus very considerable over-all liveness. Monteux presumably kept his men in more or less usual formation. Both give excellent results. Though I've heard the Stokowski highly praised, I prefer the Monteux recording as the more natural, the more realistic. Too much long-period liveness in the Stokowski for my taste—but this is strictly a matter of opinion. There is

such a strong impression of increased highs here that I'm almost ready to say they are present in the pressing, instead of in the acoustics and perhaps pre-emphasis of lower highs! Try them and see.

The Tchaikowsky is series of short ballet pieces, many of them surprisingly light and humorous—for him. Antar is dull as a symphony, but gorgeous orchestration makes it good listening.

Mahler, Symphony No. 5. Bruno Walter, New York Philharmonic.

Columbia MM 718 (8)

This tremendous tone is one of the finest recordings ever made. Wide range, with only moderate liveness (some would prefer more), it brings out the complexities of this music in a wonderful way. Brass—and there's plenty of it—is particularly good; loud passages get every "ounce" of volume, with remarkably little distortion, tracking trouble, etc. (Compare this technique with the quite different Victor technique above. Much to be said for both). Bruno Walter makes this a tremendous performance, probably not to be matched by any other conductor. Its 16 sides reel off remarkably quickly.

Americana (American works for violin and piano). Louis Kaufman, violin, Annette Kaufman, piano.

Vox 627 (3)

This is a far-from-forbidding collection of fairly innocuous bits of today's music, mostly stressing folk-jazz background, mostly humorous. Interesting recording technique: violin sound huge—tremendous liveness, might even be artificially doctored. Brilliance through liveness, apparent pre-emphasis of low highs, rather than through wide range—but it'll fool plenty of people. Some distortion in violin tone (compare with Columbia, above). Excellent piano, noticeably better than Columbia's, also balance is on whole better (counting acoustics too) than Columbia's.

Brahms, Variations on a Theme by Paganini, op. 35. Jakob Gimpel, pianist.

Vox 209 (2)

Here's the Vox piano by itself, and, no question about it, this company has found out how to pick up the piano well, even if subsequent processing is not yet perfection. These brilliant variations are on same familiar theme as the Rachmaninoff Rhapsody on a Paganini theme.

Exactingly Engineered Response Curves

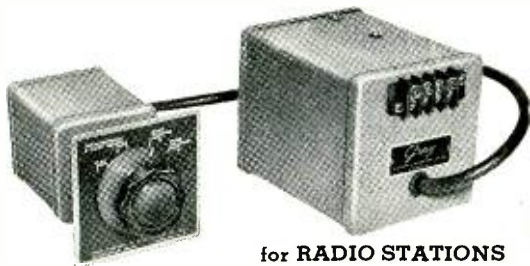

GRAY #601 EQUALIZER for GE CARTRIDGE

for RADIO STATIONS

Four control positions (flat, NAB, etc., etc.) complement current record and transcription frequency characteristics. Adopted by radio networks mentioned below. Matches pickup to microphone channel. Complete, \$42.50.

DIAMOND STYLUS GE CARTRIDGES

We are now supplying GE cartridges selected for uniform characteristics with finest quality diamond styli mounted and wired in the Gray Transcription Arm at \$29.63 additional. The long life of a diamond stylus makes this an exceptionally economical investment.

Reduce Intermodulation Distortion



with the GRAY TRANSCRIPTION ARM

Reduction of the distortion content of "lows" results from minimum vertical inertia and maximum stiffness. Other characteristics include frictionless motion, adjustable stylus pressure, self-leveling base and features resulting in the finest lateral reproduction. Accommodates all modern cartridges—GE, etc.—and has been adopted for all transcription tables by national radio networks—Columbia Broadcasting System, American Broadcasting Company—and numerous independent stations. Arm, less cartridge, \$35.00.

GRAY RESEARCH & DEVELOPMENT COMPANY, Inc.

Factory: Hartford, Conn.

Sales: 565 FIFTH AVENUE, NEW YORK 17

CAPACITORS

can be both

Mighty

and SMALL

EL-MENCO'S NEW CM15 for Television, Radio and other Electronic Applications . . . possesses the might of powerful performance, endurance, and accuracy, yet it measures only $\frac{9}{32}$ " x $\frac{1}{2}$ " x $\frac{3}{16}$ ".

We're now ready to fill your CM15 orders promptly . . . in any quantity.

Foreign Radio and Electronic Manufacturers communicate direct with our Export Department at Willimantic, Conn., for information.

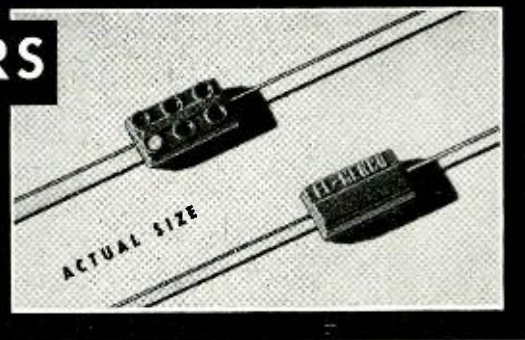

500 D.C. working voltage.
2 to 500 mmf. capacity.
Temperature Coefficient 0 ± 100 Parts per million per degree C.
 $\pm 20\%$ to 1% tolerance.
6-dot color coded to Joint Army-Navy Standard Specifications JAN-C-5.

ARCO ELECTRONICS

Sole Distributor for Jobbers and Retailers in United States and Canada
135 Liberty St., New York, N. Y.

**THE ELECTRO MOTIVE
MFG. CO., INC.
WILLIMANTIC, CONNECTICUT**

Ultrasonics in Biology

[from page 30]

course, many materials are affected adversely by the mercury.

Sterilizing tumors by ultrasonics offers some difficulty, but is at least at the edge of being practical. The energy tends to set up standing waves, and the null point of the waves has no effect. We might frequency modulate the source, however, sufficiently to displace the waves a quarter wavelength, or physically oscillate the diaphragm assembly at some very low frequency, such as 5 cycles, and over a distance of a quarter wavelength, sufficient to give a traveling pattern over the area we are interested in. Again we face the difficulty of setting up enough energy to rupture the capillaries.

Pulse Techniques

Pulse measurements have been little employed, though they offer considerable promise in work on the human body. While they seem complicated, there is little difficulty for a person skilled in radar or television in handling of pulses. The main use is in measurements of several kinds, and these can be done with such low power that we should be running little risk of injuring tissue. By their nature, the average power of a pulse is very low, and if we use very small duty cycles it is quite impossible to build up resonance effects in the capillaries, which is real danger with continuous wave energy. On the other hand, common sense tells us not to try it on the eye, for instance, where some obscure effect might cause damage that we cannot foresee.

If we build up an assembly as in *Fig. 1*, we can use a variable pulse generator such as we may buy for \$100 and which many already have. It is hardly worth while to build one. They will usually give pulses of 3 to 100 microseconds, and repetition rates of from 20 cycles to several thousand per second. This is adequate for our work. We may add a stage to the output to put about 250 volts across a quartz crystal, or 500 volts or more across a PN cubical X cut. The quartz crystal may be X-cut about 3/8ths inch, square or round, and about 20 to 40 thousandths thick—about 3 to 6 mc.

The receiver can be an RAK-5 with the grid circuits rebuilt to a time constant of less than 5 microseconds, to allow quick recovery from the pulse. A series resistor of 1 meg in the first grid will reduce grid currents.

Have the quartz metallized on both faces, and mount as in *Fig. 2*, with a thin rubber diaphragm—about 1½ mils thick. The PN must be mounted with and by means of a similar diaphragm.

Since the receiver will be out of action for a few microseconds, during and after the pulse, the device will be "blind" for an inch or so. This can be corrected by a tube full of water or carbon tetrachloride, with a thin rubber diaphragm at both ends. Make this tube of brass or any metal or plastic, with thin walls, and about one-half inch I. D. and two or three inches long.

Feed the assembly into a 'scope, using preferably a 5-inch or larger tube, and with a trigger sweep, although we don't really need the trigger.

Apply this to your leg, and obtain a reflection from the bone, you will not be bothered by a blind spot due to recovery time. Then try the water-filled tube in series to eliminate the blind spot, and you will have a nice tool for work on the body.

It will locate bullets, which are an ideal type of load. Some tumors should give reflections which will appear on the

Studio Quality AMPLIFIERS

WITH CUSTOM - BUILT FEATURES

Designers and Manufacturers
of Broadcast Speech Equip-
ment, School Sound Systems
and Recording Equipment.

Designed and Fabricated by
the Manufacturers of High
Quality Sound and Recording
Equipment for the Motion
Picture Industry.



Bardwell & McAlister's new line of Commercial Amplifiers answers the great demand of sound engineers for commercial amplifiers embodying the principles used in "custom-built" units which have been successful in the sound equipment of the motion picture industry. These principles result in high fidelity reproduction at any setting of volume controls up to full rated output with less than 4% distortion, versatility of application, ease of operation and the longer life found only in Bardwell & McAlister Studio Quality Amplification Systems. Manufactured by Union Craftsmen and fully licensed.

Write for our sound equipment catalog and
technical bulletins. Dealer inquiries invited.



13

ELECTRONIC DIVISION
BARDWELL & McALISTER, INC.
BOX 1310, HOLLYWOOD 28, CALIFORNIA

STATION WHKC ...Selects TECH LABS VERTICAL ATTENUATORS

for new CONSOLE INSTALLATION

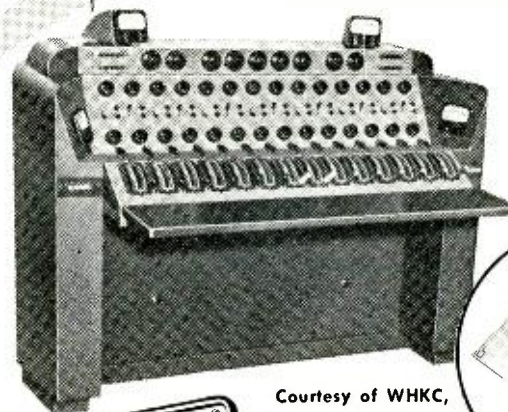

The flick of a finger operates the patented "Gove" Vertical Attenuator. Representing the very latest in broadcast components, these units are suitable for every type of sound equipment from elaborate broadcast stations to the simplest P.A. system. Unit gives smooth easy operation and can be cleaned from front of panel by removing escutcheon. Completely shielded and dust proof.



Write
for
Descriptive
Bulletin

Courtesy of WHKC,
United Broadcasting Co.



Manufacturers of Precision Electrical Resistance Instruments
337 CENTRAL AVE. • JERSEY CITY 7, N. J.

FREE



NEW! COMPLETE! Concord Radio Catalog

160 Value-Packed Pages of
the LATEST and BEST in
**RADIO • TELEVISION and
ELECTRONIC EQUIPMENT**
Write for FREE copy. Address Dept. 256

CONCORD RADIO CORP.

CHICAGO 7 901 W. Jackson Boulevard
ATLANTA 3 265 Peachtree Street
Downtown Chicago Branch: 229 W. Madison Street
LAFAYETTE RADIO CORP.

screen. If pus or other matter forms between the skull and the brain, it should also show up as a reflecting layer. Reflections from objects as small in cross-section as a needle can be detected.

Noise in the Body

If you use a PN crystal for a pickup microphone, there are very many sounds generated inside the body that you can hear by ultrasonics that are impossible to distinguish by ordinary stethoscope. If you apply a high-fidelity microphone

one point to watch. If you mount it in a probe and use a six-foot shielded lead for convenience, the capacity of the lead gives twenty to forty db loss in signal.

So, for serious work, mount a high-gm miniature pentode, such as a 6BA6, in the probe, and use a cathode output. A 100-ohm cathode resistor will match nicely into a 72-ohm line. The receiver can be adapted to take that line impedance very well, and you will have a very sensitive device. See Fig. 3.

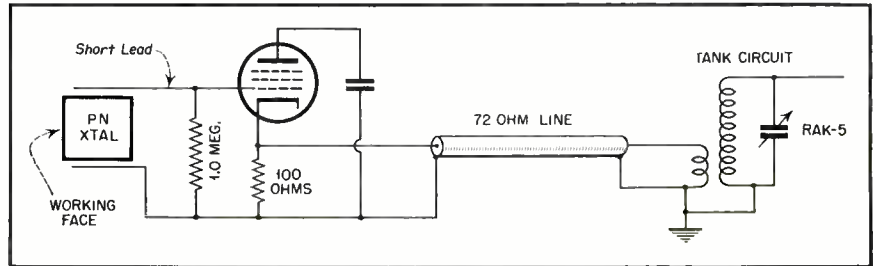

Fig. 3. Application of cathode follower to test probe.

to the chest cavity you will hear a horrible bedlam of confused sounds that are almost impossible of analysis. But by listening at a chosen ultrasonic frequency through the pass band of the RAK-5 you can isolate various components by the choice of frequency and directional properties inherent in ultrasonics.

The PN crystal operated off resonance is the best for general work, but there is

One interesting sound in the body cavity is that emitted by the sphincter muscle. We all know that the stomach is sealed off while digestion takes place, and then it builds up to a high pressure. The sphincter muscle is a round assembly that acts as a relief valve, and the stomach discharges every several seconds or so, usually about a half hour after a meal. This squirting sound can be heard above

It's Tops!

Surveys show that **AUDIO ENGINEERING** is preferred over all other technical magazines read by the best informed in the sound field—the broadcast engineers. Each issue brings you outstanding articles on five or more of the following subjects:

- Broadcasting
- Sound on Film
- Recording
- Phono Reproduction
- Public Address
- Industrial Sound equipment and applications.
- Acoustic treatment of studios, rooms, auditoriums etc.

In addition, each month **Audio Engineering** presents latest improvements in sound reproducing equipment design, test methods, and technical news from here and abroad. The editorial staff includes top authorities in the sound field.

Subscribe NOW! Don't miss an issue!

Sorry, back numbers of practically all issues are unobtainable because of the terrific demand.

AUDIO ENGINEERING
RADIO MAGAZINES, INC.
342 Madison Avenue, New York 17, N. Y.

Sirs: Here is my check (or money order) for \$..... Enter my subscription order to **AUDIO ENGINEERING** for the next.....issues.

Subscription Price: In U. S. A. and Canada—12 issues \$3—24 issues \$5. Foreign subscriptions are \$4 annually.

Please check one: New subscription Renewal

Name (please print).....

Address..... City..... State.....

Occupation (give title and department).....

Firm Name.....

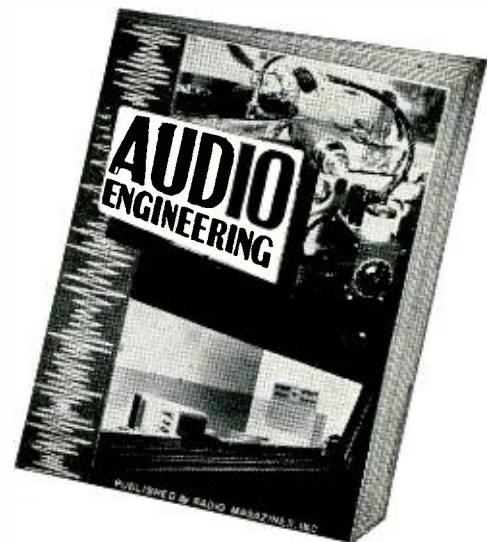

100 kc with very good directional properties. By listening at several points around the chest you can obtain a beautiful triangulation fix on the location of the muscle.

While everyone knows where his stomach outlet is, there are other similar sounds that could guide the surgeon in his diagnosis. For instance, a fold in the intestine will often be revealed by the squirting sound as food is forced through it. Since the device will often detect the sound of blood running through veins, it might trace an obstruction.

The lungs are often very interesting to listen to. Breathing rates are fairly easy to locate. If you place the crystal against the throat as close as possible to the vocal cords, and tune in the speech at 50 kc, the effect is very amusing. It could be used as a sound effect in radio.

Sonar For The Blind

A very interesting and practical application of ultrasonics is to use the echo to show a blind person the obstructions in his path. A small parabolic reflector can be mounted on his cane, and point ahead over the path he is interested in passing over. An echo will warn him of obstructions, and the characteristics of the echo will tell some story about the size of the object and its distance. At 50 kc, quite respectable echoes can be obtained from a string suspended ten feet in front of the beam. Too bad that bats discovered this a million years ago.

Most official work on this project was done with a magnetostriction unit, but a PN crystal should give good range. It is not as effective in transmitting, but its receiving efficiency is much higher. This is a project that many people have the skill to do, and would prove quite interesting as a problem in physics.

By modulating such a unit with a key or voice, "secret" transmission could be had over fair ranges.

This article has been written for the man with some equipment and skill to not only try out his hand on US, but to arouse his interest to employ his skill on the many things that should be done for the general good. If you can cooperate with the medical people in your vicinity, many of these simple things and the obvious modifications they suggest have a chance of really helping the medical researcher, who has almost an infinity of problems to contend with.

It is possible that by concentrating on one line of work you would be able to solve some general problems and give medicine a tool it really needs, and have all the fun of discovery at the same time. It is the earnest wish of the author to interest the experimenter in this field, not only as a toy, but to do some solid work on it that takes limited equipment, but great ingenuity, which the young American has in great abundance.

The MOST PERFECT AMPLIFIER



for
Reproducing
Fine Music

New! Model 10C3—Remote control unit with both high- and low-gain inputs for all types of tuners and pickups.

amplifier flat within 0.2 DB from 20 to 20,000 cycles—with intermodulation and harmonic distortion reduced to negligibility.

Although its "paper performance" surpasses that of any other amplifier, the Brook must really be heard to be fully appreciated. When you hear the Brook alongside other amplifiers—any amplifiers—you are in for an experience that is both surprising and enlightening.

Write today for copy of distortion analysis and Descriptive Bulletin BF-8!

The Brook All-Triode Amplifier is built with only one objective . . . to provide the cleanest possible reproduction of fine music.

It makes use of low-mu triodes throughout—specially-designed transformers—and the Brook-patented Automatic-Bias-Control circuit which more than doubles efficiency of the output system and at the same time reduces harmonic distortion. *The result is an*

The BROOK High Quality Amplifier

— Designed by LINCOLN WALSH



BROOK ELECTRONICS, Inc.,
34 DeHart Place, Elizabeth 2, N. J.

AMPERITE MICROPHONES

The ultimate in microphone quality, the new **Amperite Velocity** has proven in actual practice to give the highest type of reproduction in Broadcasting, Recording, and Public Address.

The major disadvantage of pre-war velocities has been eliminated—namely "boominess" on close talking

- *Shout right into the new Amperite Velocity—or stand 2 feet away—the quality of reproduction is always excellent.*
- *Harmonic distortion is less than 1% (Note: best studio diaphragm mike is 500% higher).*
- *Practically no angle discrimination . . . 120° front and back. (Best studio diaphragm microphones—discrimination 800% higher).*
- *One Amperite Velocity Microphone will pick up an entire symphony orchestra.*

STUDIO VELOCITY, finest in quality; ideal for Broadcasting and Recording.

Models R80H, R80L . . . List \$80.00

There is an Amperite Microphone for every requirement.

WRITE FOR ILLUSTRATED 4-PAGE FOLDER giving full information and prices.



P. G. Dynamic
Models PGI, PGL
List \$32.00

Address inquiry
attention Dept. AE



AMPERITE
Velocity Microphones
for Public Address
Models RBHG, RBLG
List \$42.00



"Kontakt" Mikes
Model SKH, list \$12.00
Model KKH, list \$18.00

In Canada:
Atlas Radio Corp.
560 King St. W. Toronto, Ont.

AMPERITE Company, Inc.
561 BROADWAY NEW YORK 12, N. Y.

New ATLAS SOUND ALNICO-V-PLUS

A great step forward . . . Atlas Alnico-V-Plus Super-efficient magnetic assembly. Energy per unit volume over three times as great as any used before. Traditional Atlas Quality and Fidelity to Precision are incorporated in all these new developments. Keep step with Sound Advancement with Atlas Sound.



PD-8V New Atlas streamlined Hi-Fidelity Alnico-V-Plus Driver Units.



TP15V New Atlas Alnico-V-Plus Dual Projector. Also in larger model TP24V.



HU-24V All Atlas Speakers have new unbreakable Alnico-V-Plus Driver Units.

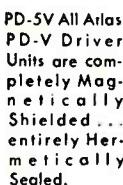

PD-5V All Atlas PD-V Driver Units are completely Magnetically Shielded . . . entirely Hermetically Sealed.



PD-3V All Atlas PD-V Driver Units have full phenolic unbreakable diaphragms.

Write for New Illustrated Catalog.

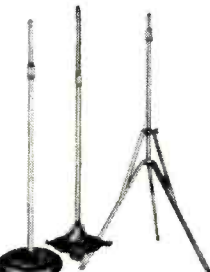

MICROPHONE STANDS—Atlas is outstanding in Quality, completeness and variety of models produced.

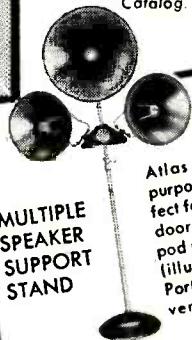

MULTIPLE SPEAKER SUPPORT STAND

Atlas Sound's dual purpose value. Perfect for powerful outdoor (collapsible tripod model) or indoor (illustrated) array. Portable. Quick, convenient, practical.

ATLAS SOUND CORP.

1445-39th STREET
BROOKLYN 18, N. Y.

Three-Way Speaker

[from page 15]

wood screw until the glue is dry, after which the screw is taken out.

Using No. 17 DCE wire, coil specifications are approximately as follows:

Inductance MH	Winding Space	Turns
5.12	1.25	375
3.2	1.25	315
.85	.75	140
.53	.75	115

Capacitors were assumed to be reasonably accurate and were used to check the

coils with the aid of an audio oscillator. It will be noted in the circuit diagram that each pair of inverse reactances are resonant at the cross-over frequency. Connected in series across the output of the oscillator, it was only necessary to alter the inductance until the point of greatest attenuation coincided with the cross-over frequency. Thus the pairs L_1 and C_1 , and L_2 and C_2 , are resonant at 500 cycles; L_3 and C_3 , and L_4 and C_4 resonate at 3000 cycles. Components were calculated for an R_o of 16 ohms, and in the case of the lower network, the cross-over point was fixed at 497 cycles to arrive at standard capacitor values.

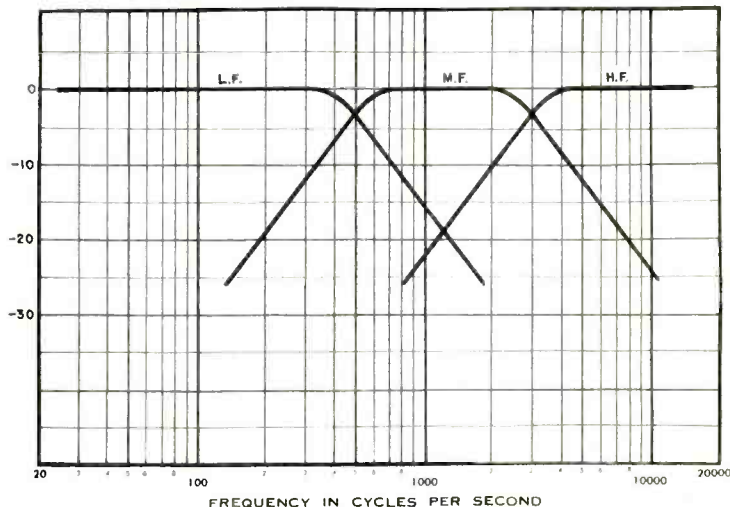

Fig. 2. Transmission characteristic of the dividing networks shown in Fig. 1.

SUPERIOR POWERSTATS

For precise Voltage Control—the "Superior" line of variable transformers stands at the top of the list. It is "Superior" in performance — "Superior" in mechanical construction — "Superior" in design and durability.



VARIABLE TRANSFORMERS

TYPE 20: 115V. input, 0-135 V. output @ 3.0 amps. 0.4 KVA	\$12.50
TYPE 116: Mounted; 115V input, 0-135 V. output @ 7.5 amps. 1.0 KVA	23.00
TYPE 116U: Unmounted; 115V. input, 0-135 V. output @ 7.5 amps. 1.0 KVA	19.00
TYPE 1126: 115V. input, 0-135 V. output @ 15.0 amps. 2.0 KVA	46.00
TYPE 1226: 230V. input, tapped at 115 V., 0-270 V. output @ 9.0 amps. 2.4 KVA	46.00
TYPE 1156: 115V. input, 0-135 V. output @ 45.0 amps. 6.1 KVA	118.00

If not rated 25% with order, balance C.O.D. All prices F.O.B. our warehouse New York. We ship to any part of the globe. Write Dept. RE

LEEDS
The Home of RADIO

75 VESEY STREET
COrtlandt 7-2612 N. Y. C. 7

Address Changes

Subscribers to **AUDIO ENGINEERING** should notify our Circulation Dept. at least 3 weeks in advance regarding any change in address. The Post Office Dept. does not forward magazines sent to a wrong address unless you pay additional postage. We cannot duplicate copies of **AUDIO ENGINEERING** sent to your old residence. Old and new addresses **MUST** be given.

Circulation Dept.

AUDIO ENGINEERING Radio Magazines, Inc.

342 Madison Ave.
New York 17, N. Y.

AUDIO ENGINEERING SCHOOL

A practical 9 months' course in Sound Fundamentals, Recording, and Sound Transmission measurements; in a laboratory containing transmission sets, oscillators, square wave generator and intermodulation analyzer, and other equipment. Complete recording studios assimilating broadcast, motion picture and commercial sound recording.

For information write

H. M. Tremaine, Director
HOLLYWOOD SOUND INSTITUTE, Inc.
1040-E. No. Kenmore, Hollywood 27, Calif.



D61B CONSTANT VELOCITY FREQUENCY RECORD

Here's an indispensable guide for fast, accurate direct checking of phono pick-ups and indirect checking of recording heads, loud speakers, p. a. equipment, etc. 12" double-faced Vinylite record. 78 RPM—recorded in 3 sections, 50-10,000 cps, 400 cps, 1,000 cps. Lists \$3.50 ea.—see your distributor or write—

UNIVERSAL MICROPHONE CO.
INGLEWOOD CALIFORNIA

VERTICAL LATERAL
REPRODUCERS RECONDITIONED
Types 9-A, 9-B, D-93306, MI-4856, MI-4875-G
Complete Stock of New Replacement Parts for
All Types

This service is being used by leading radio stations and wired music companies from coast to coast. Factory prices prevail.
VIBRATION SYSTEMS, INC.
1040 W. Fort St. Detroit 26, Michigan

WAR SURPLUS

Below Wholesale Cost!!!
WESTERN ELECTRIC
BRAND NEW

A sensational buy in quality reflex speakers. Blasting and blaring completely eliminated by a heavy gauge metal main trumpet section. The Western Electric Driver Unit, rated at 35 watts will handle 55 watts safely without blasting. A new plastic diaphragm replaces the standard metal type and is unconditionally impervious to climatic changes and free from atmospheric corrosion. Minimum power—Maximum coverage. reduces cost of installation.

- Full frequency response driver unit complete with project-a.
- Excellent for concessions, ball parks, mobile, P. A. work.

20% deposit with order, Bal. C.O.D.
MANUEL KLEIN, 74 Cortlandt St.
New York 7, N. Y.

This slight shift can be ignored and is only mentioned as a point of information. An eight-ohm L pad is connected as shown in the h-f output, the resistor, *R1* changing the pad impedance to 16 ohms and at the same time reducing the maximum attenuation possible to 6 db.

The small cabinet is of plywood and was constructed with no particular attention to acoustical considerations other than to build it solidly and of ample proportions, and to partially line it with felt. Open mesh grill cloth covers the entire front panel, enhancing the appearance by concealing the speaker openings. On the rear panel is the h-f level control and two jacks for convenient access to speaker leads.

Phasing

The pairs of speakers in the upper and mid sections were each connected in series and phased separately before connection to the outputs of the dividing network. Then, with all speakers in the circuit and the entire system connected to the amplifier, 3000 cycle response was measured with a microphone and VU meter. Maintaining a constant level, the h-f leads were reversed and the two meter readings compared. Maximum indication occurred when the high and mid frequency speakers were correctly phased. As mentioned before, the relative position of the upper and middle speakers was found to be approximately correct when both are mounted on the front panel in the usual manner.

Using a 500-cycle signal, the same procedure was followed with the low and mid frequency speakers. In addition it was necessary to locate the small cabinet by sliding it backward and forward for maximum response.

Bibliography

"Applied Acoustics"—Olson
"Motion Picture Sound Engineering;"
Series and parallel operation of low-pass and high-pass filters—p 322.
Dividing networks for loud speaker systems—Chap. 20.
Loudspeakers—Chap. 7.
"Design and Construction of Practical Dividing Networks,"—McProud, *Audio Engineering*, June, 1947.
"Two Way Speaker System,"—McProud, *Audio Engineering*—Nov. 1947; Dec., 1947; Feb., 1948.

Record Wear

[from page 14]

ditions. A slightly worn stylus will produce high-frequency distortion even from an undamaged groove. A badly worn stylus will cut the grooves in places where the angles are sharp, producing serious rattling.

Tests indicate that with standard commercial records a stylus radius of .003" or larger produces more rapid indications of wear than a radius of .0032" to .0025".

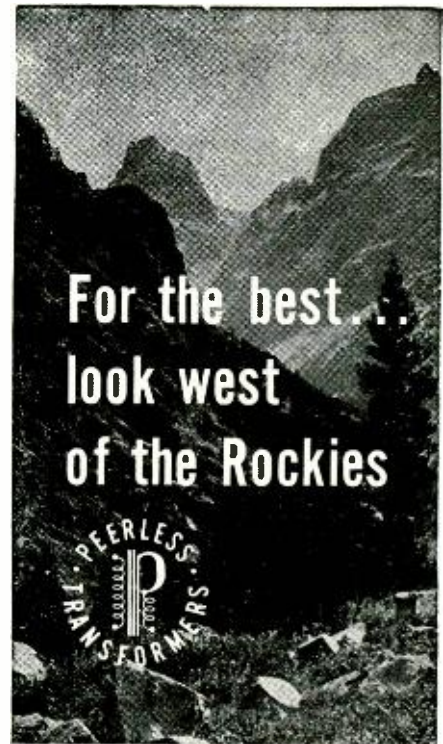

For the best...
look west
of the Rockies

**FLAT
WITHIN 1DB
from 20 cycles
to 20,000 cycles**

Altec Lansing presents the new Peerless "20-20 Line" to meet today's need for audio transformers incorporating the admittedly superior principles of Altec Lansing design and engineering know-how, at prices attractive to present day manufacturing and replacement markets. Transportation prepaid anywhere in the U. S. on orders totaling 100 lbs. or more.



**The NEW
PEERLESS
"20-20 LINE"**

A new Peerless catalogue, presenting the complete line of Peerless audio, power, and special purpose transformers, will be sent on request. Write to Dept. P

**PEERLESS
ELECTRICAL PRODUCTS
DIVISION**



6920 McKinley Avenue • Los Angeles 1, Calif.
Frazar & Hansen, Ltd., 301 Clay St.,
San Francisco 11, exclusive export agent

SPECIAL PROBLEMS

demand

SPECIAL TREATMENT

Engineering judgment is often the most important ingredient in the design and construction of apparatus for your specific needs. We specialize in —

- one-of-a-kind instruments for electronic or electro-acoustic measurements
- recording or reproducing systems with special characteristics
- subminiature audio for

Laboratory, Production Testing, Broadcast Station, Recording Studio, or Discriminating Home

Audio Instrument Company
420 Lexington Ave., New York 17, N. Y.

for the *FINEST*
**Wide Range,
Hi-Fidelity**

insist on

RACON'S
Hi-Frequency
TWEETER



● Simply connect this tweeter in parallel with your present speaker, using a cross-over network, and you will obtain perfect sound reproduction throughout the entire audible frequency range.

● RACON'S tweeter is designed so that only one unit is needed to assure optimum performance.

● Level response 250 to 12,000 cps with actual cutoff beyond 14,000 cps. Uses 17 oz. Alnico V magnet. Continuous power handling capacity 8 watts enabling its use with multi-cellular horns if desired.

Write for free catalog

RACON ELECTRIC CO., INC.
52 E. 19th St. N. Y. 3, N. Y.

ADVERTISING INDEX

Altec Lansing Corp.	40
Amperite Co., Inc.	45
Amplifier Corp. of America	38
Arnold Engineering Co.	2
Astatic Corporation, The	4
Atlas Sound Corp.	46
Audio Development Co.	5
Audio Devices, Inc.	Cover 2
Audio Instrument Co.	48
Bardwell & McAlister, Inc.	43
Brook Electronics, Inc.	45
Camera Equipment Co.	39
Chicago Transformer Corp.	1
Cinema Engineering Co.	38
Concord Radio Corp.	44
Daven, Company, The	Cover 3
Electro Motive Mfg. Co., Inc.	42
Electro-Voice, Inc.	31
Gray Research & Dev. Co.	42
Hewlett-Packard Company	9
Hollywood Sound Institute	47
Klein, Manuel	47
LeBel, C. J.	34
Leeds Radio Company	46
Peerless Transformer	47
Pickering & Co., Inc.	8
Presto Recording Corp.	35
Professional Directory	34
Racon Electric Co., Inc.	33, 48
Reeves Soundcraft Corp.	7
Robinson Recording Labs.	48
Scott, Hermon Hosmer, Inc.	40
S. O. S. Cinema Supply Corp.	48
Tech Laboratories	43
United Transformer Corp.	Cover 4
Universal Microphone Co.	47
U. S. Recording Co.	34
Vibration Systems, Inc.	47
Ward Leonard Electric Co.	37
Wells, Winston	34
Western Electric Co.	10
Wrigley, William Jr., Co.	41

ROBINSON

BELT DRIVE

Professional

RECORDER



Precision Built—Wowless and Vibrationless. 88-96-112-128-136 lines per inch. Mounts any cutter.

Micrometer Speed Adjustment. Quick Feed Spiraling. Cuts Eccentrics. Suction Pipe. Lifetime adjustable bearings.

ROBINSON

Recording Laboratories

2022 Sansom Street, Phila. 3, Pa.

S. O. S. SPECIALS of the Month

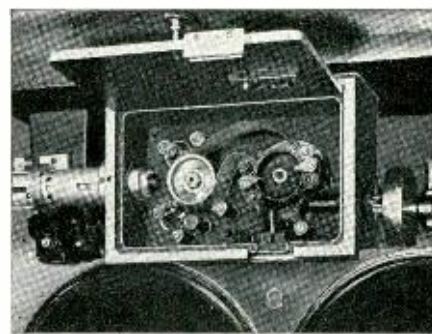

35mm Studio Recorder - \$1995

ART REEVES TYPE 35 MM SOUND ON FILM RECORDER with oil damped rotary stabilizer; footage counter; 220 volt 3 phase 60 cycle synchronous motor; new RCA licensed Modulate dual lateral variable area galvanometer and extra recording lamps. Frequency range 50 to 10,000 cycles. Rebuilt like new.

Off-the-Tube Television Recording Camera, includes: noise reduction amplifier, operates from audio output of television receiver at 30 fps with 180° shutter opening. Less lens. \$1300.00

ADDED SPECIALS!

Kodak Cine Special Blimp	\$295.00
Wall 35mm Studio Sound Camera, 4 lenses	1295.00
Arriflex 35mm Camera, 4 lenses, complete	895.00
W.E. 35mm Sound Moviola 3 way	795.00

EVERYTHING FOR STUDIO, CUTTING ROOM & LABORATORY—Lights, Mikes, Rooms, Dollies, Lenses, Background Process, Noviolas, etc. Send for Catalog Stu-7, thousands of good buys

S. O. S. CINEMA SUPPLY CORP.

Note New Address, occupying entire building
Dept. AE 602 West 52nd St., New York 19

VERSATILE *New* TRANSMISSION MEASURING SET*

Frequency Range 30 CY to 17 KC

This gain set has been designed for the accurate and rapid measurement of the transmission characteristics of audio systems and their components. It is a direct reading instrument, entirely eliminating laborious calculations and complex set-ups. This unit is arranged so that the meters and their associated range controls can be independently used as VU meters in program monitoring.

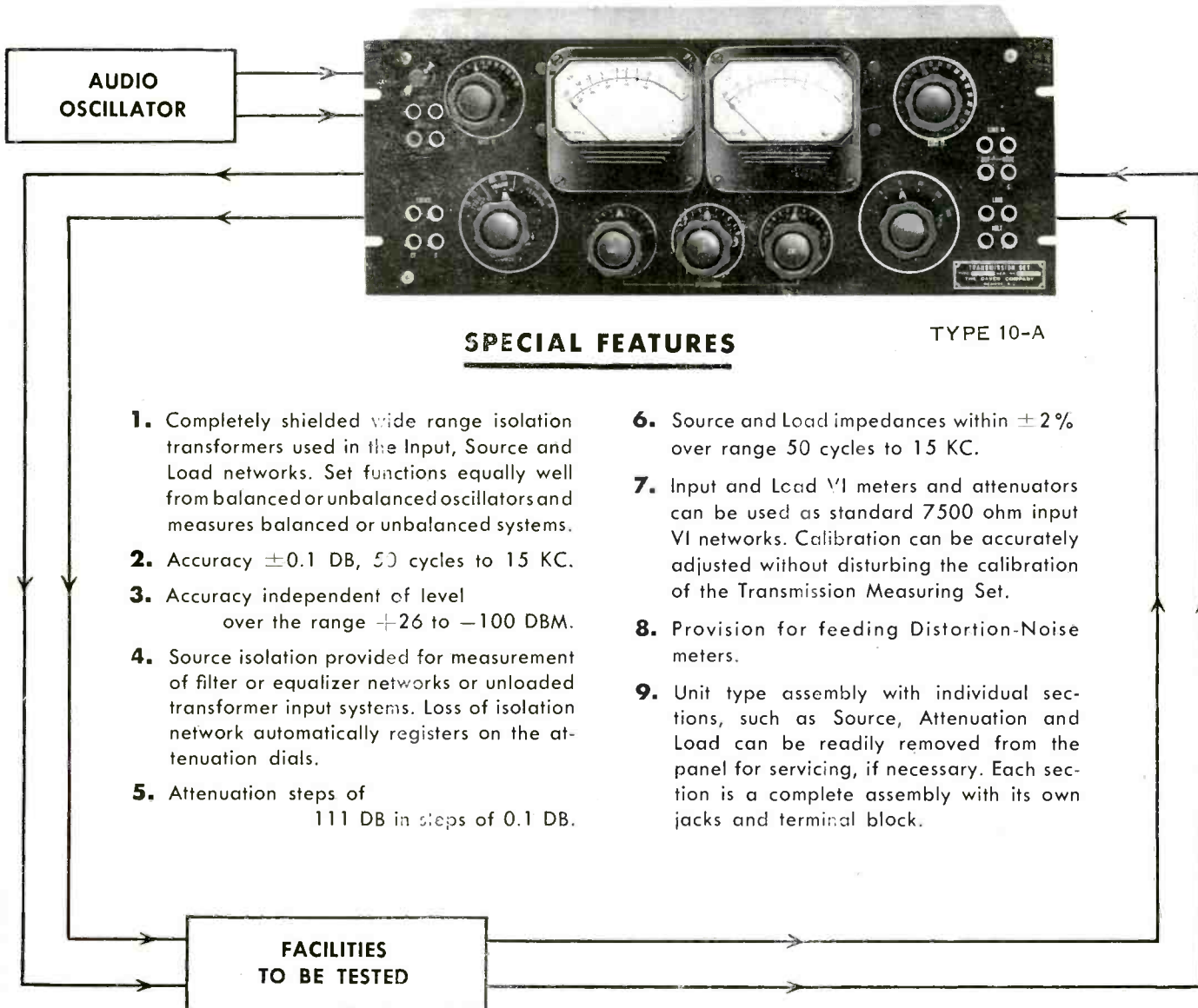

SPECIAL FEATURES

TYPE 10-A

1. Completely shielded wide range isolation transformers used in the Input, Source and Load networks. Set functions equally well from balanced or unbalanced oscillators and measures balanced or unbalanced systems.
2. Accuracy ± 0.1 DB, 50 cycles to 15 KC.
3. Accuracy independent of level over the range $+26$ to -100 DBM.
4. Source isolation provided for measurement of filter or equalizer networks or unloaded transformer input systems. Loss of isolation network automatically registers on the attenuation dials.
5. Attenuation steps of 111 DB in steps of 0.1 DB.
6. Source and Load impedances within $\pm 2\%$ over range 50 cycles to 15 KC.
7. Input and Load VI meters and attenuators can be used as standard 7500 ohm input VI networks. Calibration can be accurately adjusted without disturbing the calibration of the Transmission Measuring Set.
8. Provision for feeding Distortion-Noise meters.
9. Unit type assembly with individual sections, such as Source, Attenuation and Load can be readily removed from the panel for servicing, if necessary. Each section is a complete assembly with its own jacks and terminal block.

APPLICATIONS

1. Audio Gain Measurements.
2. Audio Loss Measurements.
3. Complex Circuit Measurements.
4. Measurements of matching and bridging devices.
5. Measuring Mismatch Loss.
6. Frequency Response Measurements.
7. May be used as two Volume Level Indicators.
8. Provision for feeding Distortion-Noise meters.

Always Specify Daven For Precision Equipment

*Patent Pending

THE **DAVEN** CO.
191 CENTRAL AVENUE
NEWARK 4, NEW JERSEY

This unit was developed in cooperation with the General Engineering Department of the Columbia Broadcasting System



COMPONENTS FOR EVERY APPLICATION



LINEAR STANDARD
High Fidelity Ideal



HIPERM ALLOY
High Fidelity . . . Compact



ULTRA COMPACT
Portable . . . High Fidelity



OUNCER
Wide Range . . . 1 ounce

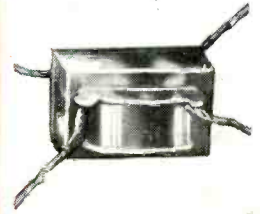

SUB OUNCER
Weight 1/3 ounce



COMMERCIAL GRADE
Industrial Dependability



SPECIAL SERIES
Quality for the "Ham"

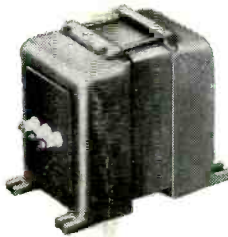

POWER COMPONENTS
Rugged . . . Dependable

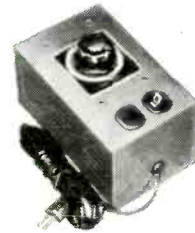

VARITRAN
Voltage Adjustors



MODULATION UNITS
One watt to 100KW



VARIABLE INDUCTOR
Adjust like a Trimmer



TOROID HIGH Q COILS
Accuracy . . . Stability



TOROID FILTERS
Any type to 300KC



MU-CORE FILTERS
Any type 1/2 - 10,000 cyc.



EQUALIZERS
Broadcast & Sound



PULSE TRANSFORMERS
For all Services



SATURABLE REACTORS
Power or Phase Control



LARGE UNITS
To 100KW Broadcast



PLUG-IN TYPE
Quick change service

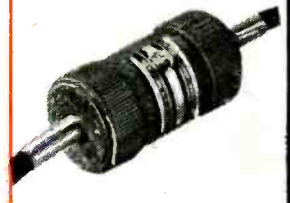

CABLE TYPE
For mike cable line

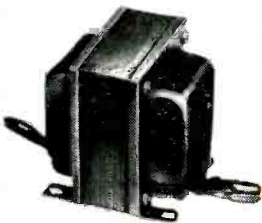

VERTICAL SHELLS
Husky . . . Inexpensive

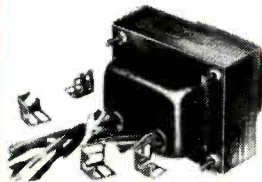

REPLACEMENT
Universal Mounting

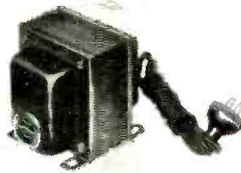

STEP DOWN
Up to 2500W . . . Stock



LINE ADJUSTORS
Match any line voltage

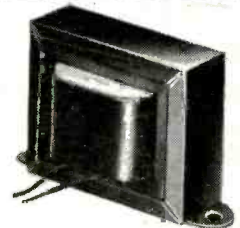

CHANNEL FRAME
Simple . . . Low cost

United Transformer Co.

150 VARICK STREET

NEW YORK 13, N. Y.

EXPORT DIVISION: 13 EAST 40TH STREET, NEW YORK 16, N. Y.

CABLES: "ARLAB"