

AUDIO ENGINEERING

JANUARY
1948

JAN 27 1948

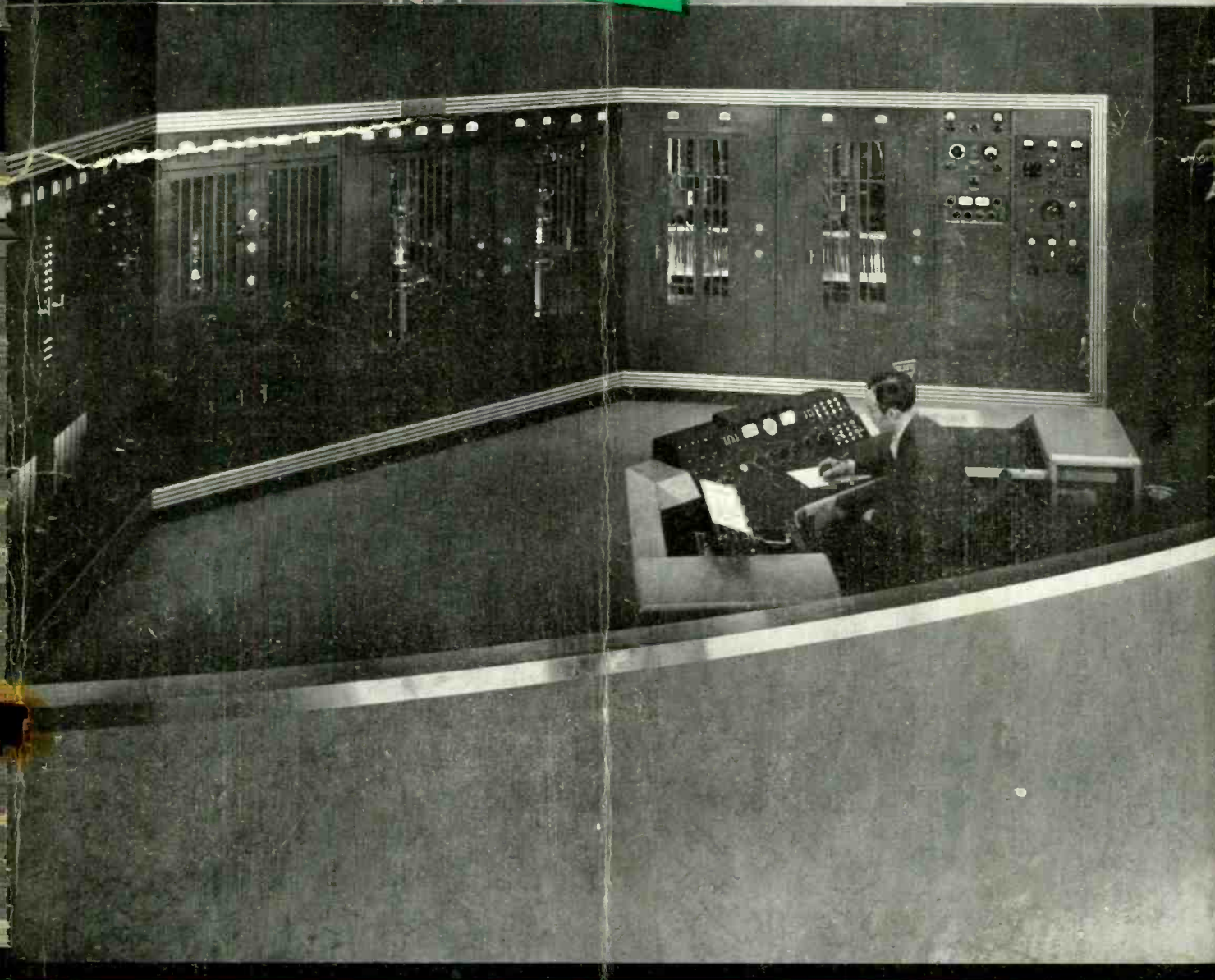

THE JOURNAL FOR SOUND ENGINEERS

For Truly Fine Recording and Reproduction



Professional Recordists Use—
Professional Recordists Recommend—

audiopoints*

THE NEWLY EXPANDED LINE of Audiopoints now covers the full range of recording and playback needs. There are Audiopoints that fully meet the requirements of the most exacting professional recordists. There are also Audiopoints which these engineers unhesitatingly recommend to the non-professional and the general public.

RECORDING AUDIPOINTS

Sapphire #14. Long recognized by recording engineers as the best recording stylus obtainable. Manufactured to rigid specifications. Disc tested on a recording machine just before packaging. List price \$7.25.

Sapphire #202. A fine quality brass shank stylus, ideally suited for those recordists not requiring the super quality of Sapphire Audiopoint #14. List price \$5.25.

Stellite #34. Favorite with many professional and non-professional recordists. Though moderately priced, it is the very best stellite stylus produced. List price \$1.75.

Diamond-Lapped Steel #50. Most practical stylus for home recordists when "first cost" is important. Being diamond-lapped, it cuts a quiet, shiny groove. List price 3 for \$1.00.

PLAYBACK AUDIPOINTS

Sapphire #113. Materials, workmanship and design make this playback point the finest made for original recordings and vinyl transcriptions. For years the outstanding choice of professional recordists. List price \$6.50.

"Red Circle" Sapphire #103. With straight dural shank and fine polished jewel point. Excellent for original recordings, vinyl pressings and phonograph records. List price \$2.00.

"Red Circle" Sapphire #303. Bent dural shank sapphire needle that is tops for phonograph records. For the first time a phonograph needle with a resharpening feature. List price \$2.00.

Steel Transcription Needle #151. The ideal all-purpose transcription needle for original recordings, vinyl pressings and phonograph records. Quality performance is assured since each point undergoes a shadow-graph test. *Reg. U. S. Pat. Off.

Write for new dealer discounts and our folder "Audiopoints."

RESHARPENING SERVICE

Established years ago, our resharpening service gives real economy in the use of Audiopoints #14, #202, #34, #113, #103 and #303.

Audiopoints are a product of the manufacturers of Audiodiscs.

AUDIO DEVICES, INC., 444 Madison Ave., New York 22, N. Y.



**MODEL 260
VOLT-OHM-MILLIAMMETER**

20,000 Ohms per Volt D.C.
1,000 Ohms per Volt A.C.

Volts, A.C. and D.C.: 2.5, 10, 50,
250, 1000, 5000.

Milliamperes, D.C.: 10, 100, 500.

Microamperes, D.C.: 100.

Amperes, D.C.: 10.

Decibels (5 ranges): -10 to 52 D.B.

Ohms: 0-2000 (12 ohms center).

0-200,000 (1200 ohms center).

0-20 megohms (120,000 ohms
center).

Model 260—Size 5¼" x 7" x 3½"
\$38.95

Model 260 in Roll Top Safety Case
—Size 5¾" x 9" x 4¾". \$43.75

Both complete with test leads and
32-page Operator's Manual*

ASK YOUR JOBBER

**WORTH MORE...
...COSTS NO MORE!**

For what it buys in sensitivity, precision, and useful ranges, the price of Model 260 has always purchased value far beyond that of even remotely similar test instruments. Today this famous volt-ohm-milliammeter is a finer instrument than ever, with added ranges and with a new sub-assembly construction unmatched anywhere in strength and functional design.

The price is the same. That means, of course, that your investment today buys even more in utility and the *staying* accuracy that distinguish this most popular high-sensitivity set tester in the world.

*No other maker of test instruments provides anything to approach the completeness of the pocket-size 32-page Operator's Manual that accompanies Simpson Model 260. Illustrated with 12 circuit and schematic diagrams. Printed on tough map paper to withstand constant usage.

Simpson
INSTRUMENTS THAT STAY ACCURATE

SIMPSON ELECTRIC COMPANY • 5200-5218 W. Kinzie Street, Chicago 44, Ill.
In Canada, Bch-Simpson Ltd., London, Ont.

AUDIO ENGINEERING JANUARY, 1948

Member of Audit Bureau of Circulation

AUDIO ENGINEERING

Successor to **RADIO**

John H. Potts, Editor
C. G. McProud, Managing Editor
Lawrence LeKashman, Asst. Editor
Louisa B. Dresser, Edit. Prod. Mgr.
Edgar E. Newman, Circ. Mgr.

Sanford R. Cowan, Publisher
S. L. Cahn, Adv. Director
H. N. Reizes, Adv. Mgr.
David Saltman, Adv. Prod. Mgr.
Jerome S. Harris, Asst. Circ. Mgr.

Editorial Advisory Board

Howard A. Chinn
John D. Colvin
Paul A. de Mars
C. J. LeBel
J. P. Maxfield
George M. Nixon
S. Young White

Representatives

James C. Galloway
816 W. 5th St., Los Angeles 13, Calif.
Dale International Publications, Ltd.
105 Bolsover St.
London W. 1, England
Harris & Floyd
297 Swanston St., Melbourne
C. 1, Victoria, Australia

Established 1917

CONTENTS JANUARY, 1948

Vol. 32, No. 1

Editor's Report	4
Letters	5
Experimental Noise Suppressor— <i>Charles D. Cole</i>	9
A Flexible Decade Amplifier— <i>Donald L. Clark</i>	13
Hollywood Sapphire Group— <i>Robert J. Callen</i>	17
Design of A New Lacquer Recording Stylus— <i>Isabel L. Capps</i>	18
Audio Frequency-Response Measurements in Broadcasting— <i>A. E. Richmond</i>	21
Record Revue:	
Classical Recordings— <i>Edward Tatnall Canby</i>	25
Popular Recordings— <i>Bertram Stanleigh</i>	25
Review of the Present Status of Magnetic Recording Theory, Part III— <i>W. W. Wetzel</i> ..	26
Economic Considerations in Industrial Ultrasonics— <i>S. Young White</i>	31
Technicana: 807 Amplifiers, Parmlly Anechoic Chamber, New Unit of Resistance	34
Professional Directory	34
New Products	36
Advertising Index	48

COVER ILLUSTRATION

The control room at Columbia Broadcasting System Station WJSV, Wheaton, Md. Douglas fir plywood was bent on a long arc to make the railing and linoleum was applied over the plywood.

AUDIO ENGINEERING (title registered U.S. Pat. Off.) is published monthly at 28 Renne Ave., Pittsfield, Massachusetts, by Radio Magazines, Inc., J. H. Potts, President; S. R. Cowan, Sec'y-Treas. Executive and Editorial Offices at 342 Madison Avenue, New York 17, N. Y. Subscription rates—United States, U. S. Possessions and Canada, \$3.00 for 1 year, \$5.00 for 2 years; elsewhere \$4.00 per year. Single copies 35c. Printed in U. S. A. All rights reserved, entire contents Copyright 1947 by Radio Magazines, Inc. Entered as Second Class Matter at the Post Office, Pittsfield, Massachusetts, under the Act of March 3, 1879.

EDITOR'S REPORT

AND NOW—VIDEO ENGINEERING

● THE big push is on. Television has clicked at last. Throughout the country, broadcast engineers are rushing to get TV on the air. The speed with which the demand for video equipment has built up has not only created shortages of apparatus but also of engineers with the know-how to install and operate the equipment. And it is gratifying to learn that the major networks, from their experience, have found audio engineers best able to handle the problems which arise in video engineering.

Early last fall we had detected this trend, and in the intervening months we have discussed the need for video engineering articles with members of our advisory board and other prominent audio engineers. The consensus was that AUDIO ENGINEERING could render a most welcome service to its readers by including authoritative, practical articles on video engineering as a portion of its text. To this end, we have arranged for contributions of this nature from some of the outstanding men in the video engineering field. As soon as these articles are ready, they will be promptly scheduled for publication in a department of this magazine.

Others of our readers who feel they have ideas which will be of interest and assistance to those confronted with video engineering problems are invited to write to us immediately.

ULTRASONIC MAGIC

● AT THE regular meeting of the New York chapter of the Institute of Radio Engineers on January 7th, S. Young White presented a most interesting talk on "Industrial Applications of High-Power Ultrasonics." The data for the lecture and the drawings for the illustrations used were taken from articles by Mr. White which have been appearing regularly in AUDIO ENGINEERING. We are happy that ours was the first magazine to publish any articles whatsoever on this new science. Our first article, in the May, 1947, issue of this magazine, attracted the attention of the editors

of *Time* magazine, and a very interesting article, dubbed "silent sound," followed, with full credit to our magazine. It was gratifying to learn that this story created more comment from readers of *Time* than any other article ever before published in their science section, so much, in fact, that the publisher of *Time* devoted his page in a subsequent issue to a discussion of the interest which the story had aroused.

More recently, *Life* magazine also featured a story on ultrasonics, showing many tricks, as well as industrial applications, which can be performed with this scientific tool. While so-called magic, as such, is inappropriate for detailed discussion in an engineering publication, it is amusing and interesting. At his lecture before the IRE, S. Young White described one such demonstration which was largely instrumental in kindling his interest in the new science. A small piece of carbon was placed in a glass of clear water, which was then subjected to an ultrasonic frequency of approximately 20,000 cycles. The ultrasonic energy caused the carbon to disintegrate almost instantly, changing the clear water to ink. Then, by simply increasing the ultrasonic frequency to approximately 200,000 cycles, the carbon was precipitated and again formed in a small piece, restoring the water to its former clarity.

What engineer worthy of the name wouldn't be fascinated by such a demonstration?

NEWS

● THE series of articles on sound engineering fundamentals by O. L. Angevine, Jr., Chief Sound Equipment Engineer for Stromberg-Carlson, which started in our December issue, will be continued in the February issue, and should appear regularly thereafter. We have moved up our publication date so that you will receive your magazine earlier in the month, and in the process, some articles intended for the January issue had to be held over because all work on them had not been completed when the new deadline arrived.—J. H. P.

Letters

Audio Engineering Society

Sir:

In the last issue Mr. Frank E. Sherry, Jr., suggested that audio engineering had grown to the point where it needed a professional society of its own.

A group of us, long active in broadcasting and recording, feel the same way he does. Audio engineering will be unhampered only when it has a society devoted exclusively to its needs—controlled by, and run only to benefit, the audio engineer.

We have been discussing this matter for several months, and are preparing to hold an organization meeting.

Will those interested in such a society please write the undersigned, giving the following information:

Name
Mailing Address
Company
Title or nature of work

We will notify you of the meeting date.

C. J. LeBel
307 Riverside Drive
New York 25, N. Y.

Re "Two-Way Speaker System"

Dear Mr. McProud:

I should like to take this opportunity to thank you for your characterization, in your article, "Two Way Speaker System" of the Klipsch low-frequency horn as ideal.

At the same time, I am anxious to correct what I strongly believe to be a wrong impression resulting from the remark, "... since the walls of the room become a part of the horn, its use in apartments if frowned upon—usually quite vigorously—by one's neighbors."

As you truly state, the corner walls form a part of the horn. One of the main requirements of a horn is that its walls must not vibrate, and this requirement is well fulfilled by the massive and rigid walls of a room. There is no reason to believe that the sound transmitted through the walls of a room in which a Klipsch speaker is located is greater than that from a speaker mounting of any other kind that permits reproduction of fundamentals below, say, 150 cycles. As a matter of fact, the boomy, resonant bass produced in the 50-100 cycle range by many speaker enclosures, particularly open back cabinets, is far more objectionable and much more likely to be heard in adjacent rooms, since the loudness efficiency in the neighborhood of resonance is high, and the sensitivity of the ear much greater than at lower frequencies. If one *must* listen to a neighbor's radio, anyone would prefer music or intelligible speech to a succession of irregularly spaced, resonant, "booms."

It might be well to point out, too, that the user of a Klipsch Speaker System is able to

[Continued on page 7]

Here's Something **NEW** in Wire Recording . . .

the "MAGNETONE" offers 3 hours of high quality recording

● The "MAGNETONE" uses plated brass wire and makes permanent magnetic recordings of unsurpassed quality. Recordings may be "erased" and the wire reused any desired number of times. "Erasure" is automatic as a new recording is made. Life of the magnetic wire is unlimited. Reels of wire in ½, 1, 2 and 3 hour time periods are available. The "MAGNETONE" is portable, durable, in attractive metal or black leatherette case.

Broadcasting stations will find this magnetic recorder ideal for remote pickup and delayed broadcast work. Especially suited for conference recording, case history study, educational training, opera recording, dispatchers' monitoring, police radio monitoring and many other long period recording usages.

Outstanding characteristics of the MODEL BK-303 "MAGNETONE" are its fast rewind, fast forward speed, and constant recording speed which permits any section of a recorded program to be spliced into any other section without impairing the faithful reproduction.

See and hear the "MAGNETONE" . . . compare it with any magnetic recorder in America. Write today . . .



SPECIFICATIONS INCLUDE:

Frequency Response	55-7,000 cps
Signal-to-noise ratio	35 db
Wire linear speed (constant)	24 inches per second
Recording or play-back time (maximum)	3 hours
Rewind ratio	Approximately 15 to 1
Forward ratio (fast nonplay)	Approximately 15 to 1
Input line	High and low level, high impedance
Output line	500 ohms
Equipped with footage indicator for program cataloging.	
Monitor speaker	5 inches permanent magnet
Metal carrying case	
BA-106 Crystal Microphone—8 feet of cord	
Approximate over-all weight	50 pounds

THE **Brush**
DEVELOPMENT CO.

3405 Perkins Avenue • Cleveland 14, Ohio, U. S. A.

MAGNETIC RECORDING DIV. • ACOUSTIC PRODUCTS DIV.

INDUSTRIAL INSTRUMENTS DIV. • CRYSTAL DIVISION

ARNOLD

Specialists and
Leaders in the
Design,
Engineering
and
Manufacture
of
PERMANENT
MAGNETS



Arnold's business is permanent magnets, *exclusively*—a field to which we have contributed much of the pioneering and development, and in which we have set peak standards for quality and uniformity of product.

Our service to users of permanent magnets starts at the design level and carries on to finish-ground and tested units, ready for your installation. It embraces all Alnico grades and other types of permanent magnet materials—any size or shape—and any magnetic or mechanical requirement, no matter how exacting.

Let us show you the latest developments in permanent magnets, and how Arnold products can step up efficiency and reduce costs in your magnet applications. Call for an Arnold engineer, or check with any Allegheny Ludlum representative.

THE ARNOLD ENGINEERING CO.

Subsidiary of

ALLEGHENY LUDLUM STEEL CORPORATION

147 East Ontario Street, Chicago 11, Illinois



Specialists and Leaders in the Design
Engineering and Manufacture of PERMANENT MAGNETS

W40 1100

Letters

[from page 5]

derive satisfaction from listening at low volume because the extreme bass is well reproduced, and will be less inclined to play his set at ear-shattering levels in an attempt to make up for the usual absence of true bass response.

In addition to these theoretical reasons, a fair number of these speakers have been in operation in apartments for a sufficient length of time to have called themselves to the attention of neighbors. Despite this, no reports have been received of complaints or the rather more drastic action implied in the article. It is precisely those rare souls who are considerate of their neighbors who deserve the best, and should certainly not be frightened away from the Klipsch reproducer.

Victor Brociner
Brociner Electronics Laboratory
 1546 Second Ave.
 New York City

CORRECTION

We have been advised that a mathematical error was present in Professor Morrical's article, "Design and Use of Mixing Networks," which appeared in the November issue of this magazine. Although the math was checked by two of Professor Morrical's assistants, as well as by the chief engineer of a manufacturing company, it unfortunately got into print.

Equations 10, 11, and 12 should read as follows:

$$R_1 = \frac{(2n-1)}{(n^2)} R \quad (10)$$

$$\epsilon_{56} = \frac{R-P}{R} \epsilon_{12} = \frac{\epsilon_0}{2n}$$

$$P_c = \frac{\epsilon_{56}^2}{R_1} = \frac{\epsilon_0^2}{4n^2 R_1} = \frac{\epsilon_0^2}{4R(2n-1)} \quad (11)$$

$$\begin{aligned} \text{M.L.} &= 10 \log \frac{P_b}{P_c} \\ &= 10 \log \frac{\epsilon_0^2 / 4R}{\epsilon_0^2 / 4R(2n-1)} \\ &= 10 \log (2n-1) \end{aligned} \quad (12)$$

With these changes, the new values for the tables become:

n	Table II	Table III
1	0 db	0 db
2	4.77	1.25
3	6.99	2.55
4	8.45	3.59

Because the particular type of network referred to in these equations is very little used, the errors, while regrettable, do not seriously affect the excellence of the article.

2 New Firsts by

TRU SONIC

FOR THAT

FINE FM SIGNAL

P-63HF
 SEPARATE 2-WAY
 SYSTEM

Specially designed for reproduction of the very highest quality source material; ideal for theaters and auditoriums up to 1750 seats. Oversize components make possible low level operation with negligible distortion for the deluxe FM station monitor room.

Conservatively rated at 30 watts to permit full dynamic impact at high levels of operation, it employs a 600 cycle crossover to relieve the two model P-52L, 15", 20 watt low frequency drivers of high frequencies and consequent intermodulation and cone break-up. Radical design permits horn loading down to 60 cycles. Special chamber behind drivers reinforces bass to 30 cycles. 2 x 5, 10 cell, 100° x 40° HF dispersing horn. Model P-30, 30 watt HF driver extends range beyond 15000 cycles with efficiency over 50%. Total Alnico V magnet over 11 pounds. Equipped with HF attenuator to perfectly balance room acoustics. Size, 25" deep by 36" wide by 45" high, allows this unit to be employed under practically any space limitation. Input: 16 ohms. Price: \$630.00 list, complete. Components available shortly in exquisite furniture of period design.



An Economical Conversion to High Fidelity for the Broadcast Listener

A high fidelity unit to be used with existing components; response provides a cut-off below 70 cycles to subdue record changer rumble. Emphasizes "presence"! Brilliance effected through extended HF response to 6700 cycles, where gradual attenuation is introduced to minimize source material disturbances. HF dispersion over 90 degrees. 15" diameter, 8 ohm input, Alnico V magnet. Price: \$80.00 list. Available with 12" cone at \$70.00 list.

Normal trade discounts prevail on all Tru-Sonic products. See your local distributor or write for 16-page bulletin describing the complete line.

STEPHENS

MANUFACTURING COMPANY

10416 NATIONAL BLVD.

LOS ANGELES 34, CALIFORNIA

Speaker Systems For



Theater and Home

BUILD YOUR QUALITY SOUND SYSTEM

A new three-stage amplifier designed to operate from microphone and other low level sources and to raise them to line levels. Provided with gain adjustment and sufficient power output capacity to make it ideal for booster and line amplifier applications.



with these
“BUILDING BLOCK”
 Amplifiers



Self-contained power or cabinet mounting building sound systems of wide variety of input levels capable of accommodating impedance without employing negative feedback. Internal impedance is exceptionally low value. Audio power output is 75 watts. Each has an amplifier directly on which mounting space



available for rack or flexibility in combinations and wide range of load power output. Maintaining the exceptionally low value. Audio power output is 75 watts, of 143 is mounting a 141 and each can be bridging coil for d.



HERE'S an interesting series of Western Electric amplifiers that was designed by Bell Laboratories from the simplest into systems of any complexity. A single channel setting or the most complex multiple channel system can thus be increased to any complexity by easy and economical additions. They provide program distribution with the utmost flexibility in use, performance, and reliability through a policy of trouble-free service.

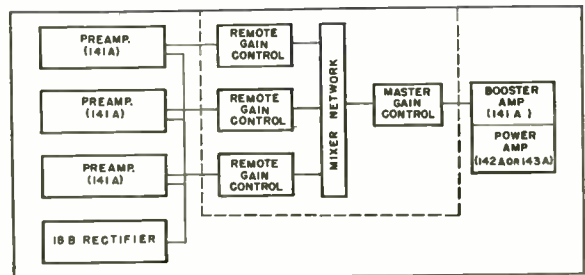

This schematic diagram illustrates the adaptation of these “building block” amplifiers to a representative sound system.

Bulletin T-2361 is available to help you with your sound system planning. Ask your local Graybar representative for it, or write Graybar Electric Co., 420 Lexington Ave., New York 17, N. Y.

Western Electric

— QUALITY COUNTS —



DISTRIBUTORS: In the U. S. A. — Graybar Electric Company. In Canada and Newfoundland — Northern Electric Company, Ltd.

AUDIO ENGINEERING JANUARY, 1948

Front panel of the experimental noise suppressor.



Experimental Noise Suppressor

CHARLES D. COLE*

Complete data on a noise suppressor developed by the General Engineering Department, American Broadcasting Company.

A CHALLENGE, long outstanding in both the broadcasting and home radio industry, is the needle noise or hiss generated in the playback of recordings. Although the ordinary shellac pressing is the worst offender in this respect, the high grade electrical transcription often contains noise components which may prove objectionable, especially on low level musical passages. Electronic noise-suppressing devices have been designed to overcome this difficulty, but for the most part have proved to be somewhat expensive, especially for the home record player. Below is presented a system for noise suppression which needs little or no maintenance and whose initial expense is quite moderate.

Operation

The operation of this suppressor is based, first of all, on the nature of playback noise and its relationship to the recorded program material. It has been found that the amplitude of the noise is approximately constant throughout a recording, irrespective of the amplitude of the recorded program. For high level passages the noise is masked, but for moderate to low level passages, which constitute a greater portion of an average recording the noise may become quite objectionable. Secondly, investigation reveals that the greater part of the noise energy lies in the middle and upper ranges of the audio spectrum. Very little noise is found below 1500 cycles. The third factor which enters into the design of this equipment is the relationship between the peak amplitude of the recorded program to the average amplitude of the noise. The program peaks are approximately 40 db above the noise, and this figure was used for design purposes. With these facts concerning the nature

and behavior of playback noise, an instrument was designed whose fundamental basis for operation was first set forth by Dr. H. F. Olson of the Radio Corp. of America's Princeton Laboratories. Dr. Olson's proposal and the final instrument evolved from it centered around the characteristics of the germanium diode, and the principle of selective octave filtering.

In a conventional representation of input vs. output voltages for the germanium diode, (see Fig. 1) little attention is given to the load line as it approaches very closely to the origin. The load line for most practical purposes is linear. However, if the portion near the origin is investigated more closely, it will be found that the load line does not remain linear, but curves tangentially to meet the ordinate axis. The point of tangency (approximately 1 millivolt input) deter-

mines the practical minimum level at which conduction can occur in the forward direction. Therefore, an effort to adjust the noise level of the recording so that it would fall in this rejection range was made. For reasons of design it was found more desirable to connect two diodes in series, doubling the rejection level and operating the networks at higher voltages. Two sets of series diodes are connected to give full wave conduction essentially linear except for very small voltages. (See Fig. 2). With the noise level adjusted to fill the dead zone, the program material has a linear excursion some 40 db higher in level.

Although noise is rejected below the point of conduction, program material of a corresponding level is also rejected. This is not especially noticeable to the ear due to the wide dynamic range of most speech and music, except for some elimi-

Chassis layout of the experimental noise suppressor.

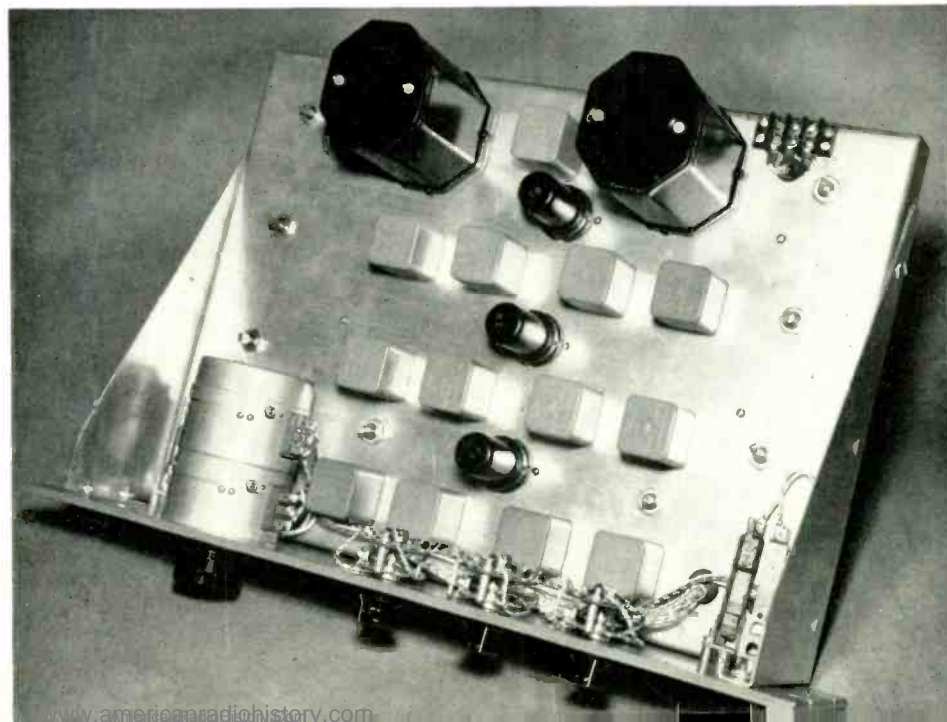

*General Engineering Dept., American Broadcasting Co., N.Y.C.

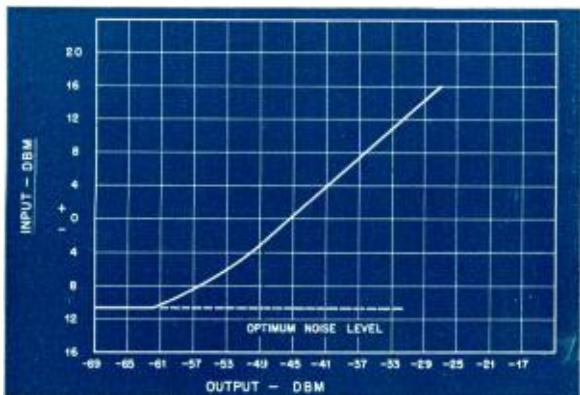

Fig. 1 (left). Suppression characteristic for 1.5 kc to 3 kc channel at 2500 cycles.

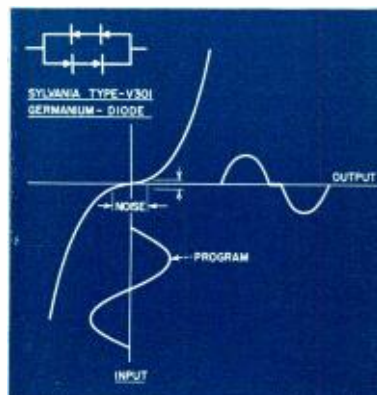

Fig. 2. Conduction characteristic of germanium diodes used in the suppressor.

nation of reverberation, or attenuation of sounds inherently low in amplitude such as the spoken letter "S."

Distortion

For signals whose amplitudes are 6 to 12 db above the noise level, serious distortion occurs due to clipping and bending of the load line. It is this distortion that necessitates the use of electric wave filters. Identical filters are used both before and after the diodes. The input filter admits a band of frequencies one octave wide and the output filter passes only this octave and rejects all other frequencies by at least 30 db. The term "all other frequencies" includes not only the program material frequencies, but even more important, the harmonic frequencies or distortion generated by the action of the diodes. The frequency range has been arbitrarily divided into four channels: 0-1500 cycles low pass, 1500 to 3000 cycles band-pass, 3000 to 6000 cycles band-pass, and 6000 to 12000 cycles band-pass. The fact that very little noise occurs below 1500 cycles accounts for this division and subsequent octave relationship. In general, the filters were designed to include the least number of reactors and yet give satisfactory performance. For the low pass filter "m" derived section was chosen. A value of .6 for "m" was selected since both input and output terminate in resistive networks. With the low pass

section adjusted for satisfactory operation, rejection at the notch is 38 db, least rejection 21 db and rejection at three octaves is 28 db.

The three band-pass filters are constant K networks whose surge impedance is equal to six thousand ohms as is the impedance of the low pass "m" derived filter. All three band-pass filters behave similarly so far as attenuation is concerned. (See Fig. 3.) A frequency response curve through both input and output filters shows approximately 30 db attenuation one octave either side of the roll off frequency. The surge impedance of 6000 ohms was chosen to represent the best relationship between the high signal and low signal bridging resistance of the diodes whose resistance varied from several hundred to over 40000, ohms.

The input and output mixing busses are identical. (See Fig. 4.) All four channels are fed by "L" pads with proper building out resistors which are fed in turn from a matching transformer. A variable "T" pad isolates the transformer from the mixing bus. The output transformer is identical with the input and is also isolated from the output mixing bus by a variable "T" pad. The input and output "T" pads are ganged on the same shaft and are reverse connected so that as the input is raised the output is lowered by the same amount, thus

achieving uniform level out while correcting for proper noise level into the diodes. A variation of 15 db input results from this arrangement which has proved adequate for correction of differences in individual recordings. A fixed loss of 15 db results from this arrangement. The input bus, which is composed of potentiometers "L" connected and building out resistors, has a fixed loss of 8.4 db. In general, individual adjustment for each frequency range is made with the corresponding input potentiometer to achieve best signal to noise ratio in that band of frequencies. The output potentiometers are adjusted for uniform response through out the entire band and since some adjustment is required at both input and output bus, a mixing loss somewhat greater than 8.4 db is incurred. Therefore, the total loss in the suppressor is on the order of 35 db. With the constants shown in the diagram, (Fig. 5), the optimum input level was found to be plus 20 dbm and the resultant output, approximately minus 15.

Crystals

The crystals selected for this equipment are the standard four-element balanced diode modulators mounted in a metal shell provided with an octal base. They are known as the Sylvania type 1X40 Germanium-Diode varistor. In the construction of the filters, UTC

Fig. 3 (left). Individual filter response curves for experimental noise suppressor.

Fig. 4 (right). Block diagram of noise suppressor.

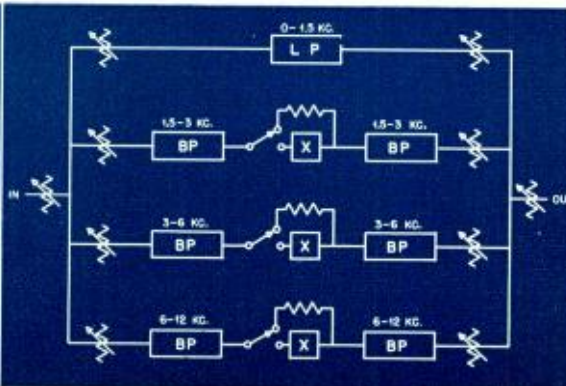
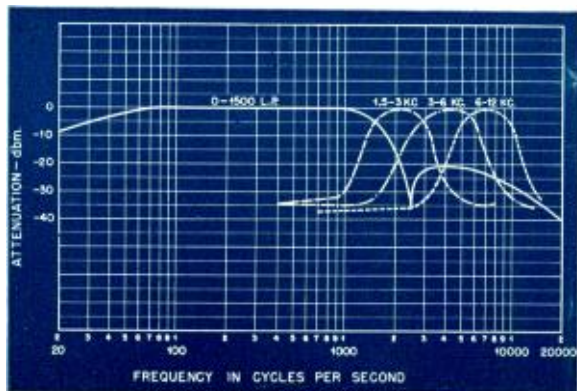

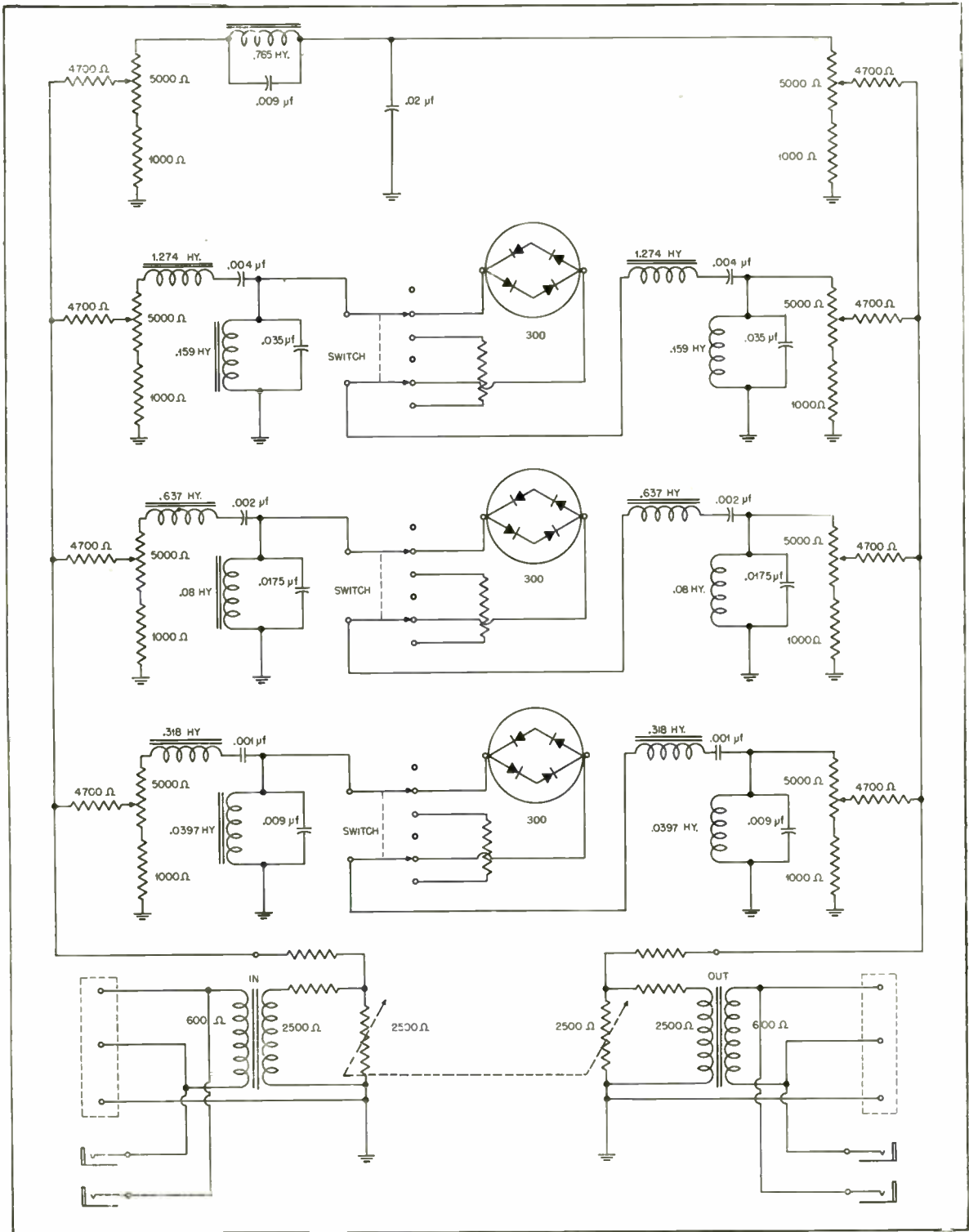

Fig. 5. Complete schematic of the experimental noise suppressor.

variable inductors were selected for the reactive elements. These reactors have an adequate range of inductance, satisfactory Q and permit trimming of the

final filter to compensate for stray capacities. The capacities encountered in the filter elements are for the most part odd values and parallel connection of two or

more standard capacities is required in many instances to achieve correct values. Small postage stamp mica capacitors are used because they lend themselves well

Decade amplifier and pre-amplifier. These units are designed to provide a wide range of accurately known voltage amplification with low distortion and noise level.

A Flexible Decade Amplifier

DONALD L. CLARK*

Describing an audio amplifier having exceptionally fine characteristics for exacting laboratory test purposes.

THE AMPLIFIER to be described was developed primarily for use in measurements of noise, frequency response, distortion, etc., on experimental magnetic recording systems. Although this use appears to be somewhat specialized, there is no feature of the amplifier which limits it

*Research Department, Stromberg-Carlson Company. This paper is based in part on work done for Evans Signal Laboratory under Contract No. W-36-039 SC-32278 with the Stromberg-Carlson Company.

to this particular application. Its flexibility and performance are such as to recommend it for a wide variety of work at audio frequencies. However, since it was developed for use in conjunction with magnetic recording systems, it will be described in terms of the requirements imposed by this application.

The design objective was an amplifier having highly stable gain adjustable over a wide range of known values. Exceptionally low distortion and noise, and uniform-

ity of gain over a wide frequency range were also required. In addition, it was desired to make the unit flexible, convenient to use and to service, and to use standard components wherever possible.

General Description

The design which has finally evolved consists of two units; a pre-amplifier in a small box which can be placed within a short distance of the reproducing head of a magnetic recording system, and the main amplifier and power unit. The pre-amplifier gives a nominal voltage gain of 100 with a one-step attenuator at the input, which reduces the gain to 10. The main amplifier gives an additional voltage gain of 100 with a similar attenuator at its input. In addition, there is an accurately calibrated potentiometer-type attenuator in the main amplifier so that intermediate values of gain are readily available. Both input and output leads of each unit are brought out to terminals so that the two units can be used separately, in cascade, or with an equalizer or filter between the pre-amplifier and the main amplifier. The input impedance of each unit is of the order of 500,000 ohms. The output impedances are comparatively low, for voltage amplifiers, and a wide range of load impedances can be used. Either unit can be used with such loads as a Ballantine voltmeter, oscilloscope, headphones, the usual recording head circuits, or the input to a power amplifier stage.

●
Rear view of chassis of main unit of decade amplifier. Power supply components are at the back of the chassis and the amplifier stages at the front. The potentiometer on the front panel is an accurately calibrated gain control.

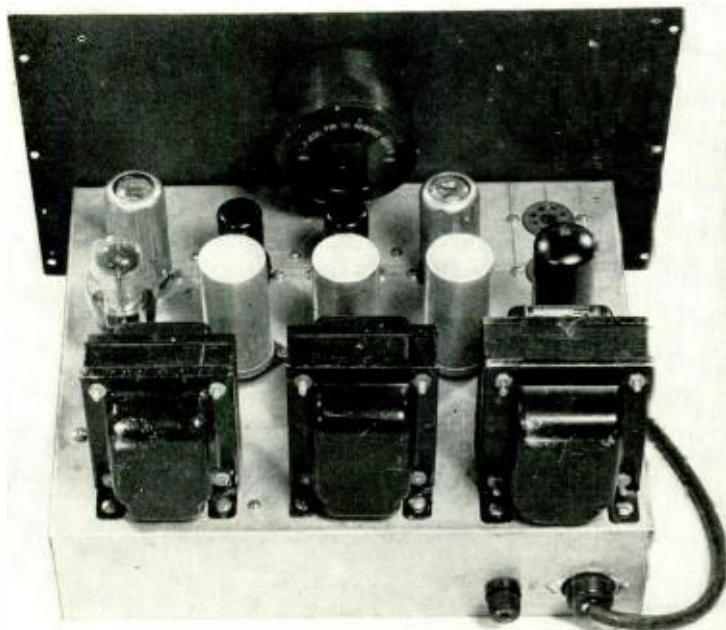
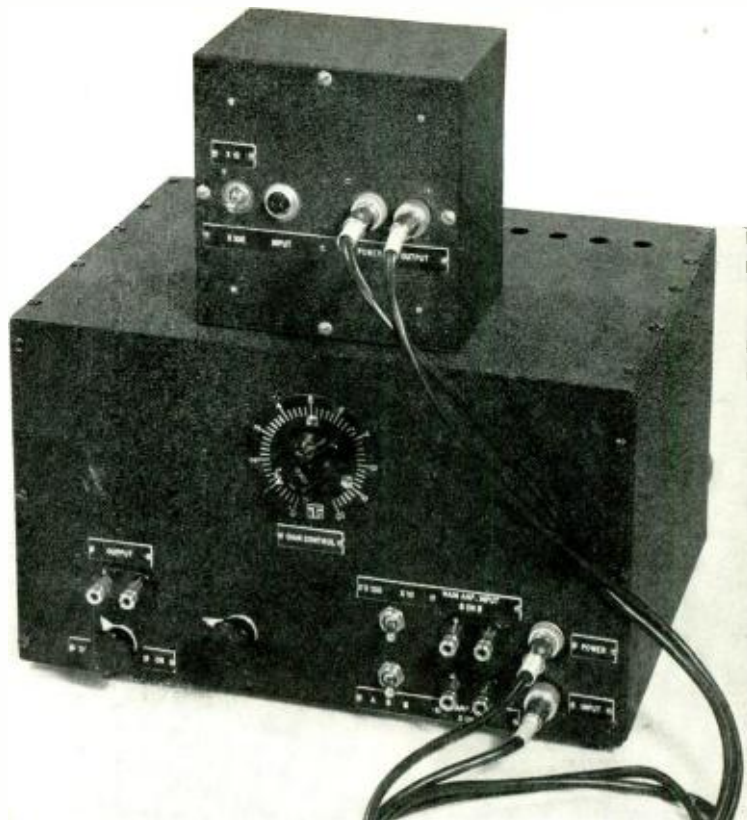

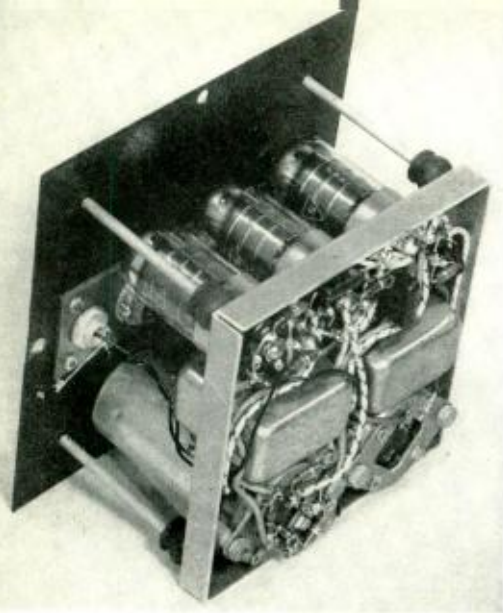

View of pre-amplifier chassis showing manner of supporting entire unit from front panel.

Mechanical Construction

The pre-amplifier is housed in a sheet metal box 6" x 6" x 4". It consists of three type 1280 tubes with their associated circuit components mounted on a small chassis bent up from a sheet of 1/16" aluminum. The chassis is supported at each corner by a rubber shock-mount. The chassis is supported entirely from one panel of the box and all external connections and the attenuator switch are mounted on the same panel. Thus the pre-amplifier can readily be removed from its box for inspection or testing. The leads from the chassis to the panel are made with flexible wire to minimize transmission vibration to the chassis. External connections are made through standard microphone connectors and shielded leads, thus making possible complete electrostatic shielding of the pre-amplifier and all leads to it.

The main amplifier is built on a standard 10" x 12" x 3" chassis and is housed in a sheet metal box 10 1/2" x 14" x 8".

The power supply is built across the rear of the chassis and the amplifier stages across the front. A sheet metal partition underneath the chassis provides electrostatic shielding between the power supply and the amplifier stages. The controls provided are an on-off switch, a 10 to 1 attenuator switch, a calibrated gain control, and a switch to connect the two amplifiers in cascade or to bring the output of the pre-amplifier and the input of the main amplifier to the front-panel terminals.

Space was provided in the main amplifier unit for the addition of a flexible low-frequency equalizer and two additional stages of amplification should these become desirable at some later date.

Electrical Design

The pre-amplifier consists of two resistance-coupled pentode stages and a cathode follower as shown in the circuit diagram, Fig. 1. Feedback is taken from the output of the cathode follower to the cathode of the input stage through an adjustable resistance. This resistance permits presetting the gain to a value of 100. A pentode is used for the input stage in order to keep the input capacitance low. A cathode follower is used for the output stage in order to provide low output impedance.

The main amplifier consists of a cathode follower, two resistance-coupled pentode stages, and another cathode follower, as shown in the circuit diagram, Fig. 2. The first cathode follower is used as an impedance transformer between the high-impedance input and the relatively low-impedance calibrated gain control. The output from the pre-amplifier is normally connected to the input terminals by means of a shielded cable. The double-pole, double-throw switch S is normally in the down position. However, if it becomes desirable to insert a filter, an equalizer, or any other similar device between the pre-amplifier and main amplifier, the switch S can be placed in the up position and the

auxiliary terminals A and B will then be available for the insertion of such a device. The remainder of the circuit is similar to that of the pre-amplifier.

The power supply is unconventional in that all tubes except the rectifier and voltage regulator are heated by well-filtered direct current. In order to keep the power supply from being too massive and unwieldy, tubes having 150 ma heaters were used. Since high voltage was not required for a power stage, a standard power transformer designed for high current output at a relatively low voltage was used. The output from the rectifier is heavily filtered to insure a wide margin of safety from troubles due to power supply ripple. Heater current is taken from the output of the filter through an adjustable resistance. Plate voltage for all stages is also taken from the output of the filter, and is regulated by a VR150 tube.

PERFORMANCE DATA

Intermodulation Distortion—In making measurements of non-linear distortion on magnetic recording systems, it was anticipated that measurements would be made of distortion components having amplitudes well below one per cent of the amplitude of the applied signal. If an amplifier is to be used between the reproducing head and a wave analyzer, this imposes the requirement that the amplifier shall deliver a few volts output with harmonic distortion of the order of 0.1 per cent or less. In terms of intermodulation as measured on an Altec-Lansing intermodulation analyzer, this would be about 0.4 per cent intermodulation, or less.

Fig. 3 shows curves of per cent intermodulation versus output voltage (as read on a Ballantine voltmeter) for the pre-amplifier unit and for the main amplifier unit, output being expressed in decibels above one volt. The frequencies used in these measurements were 60 and 7000 cycles per second. The load was a 10,000

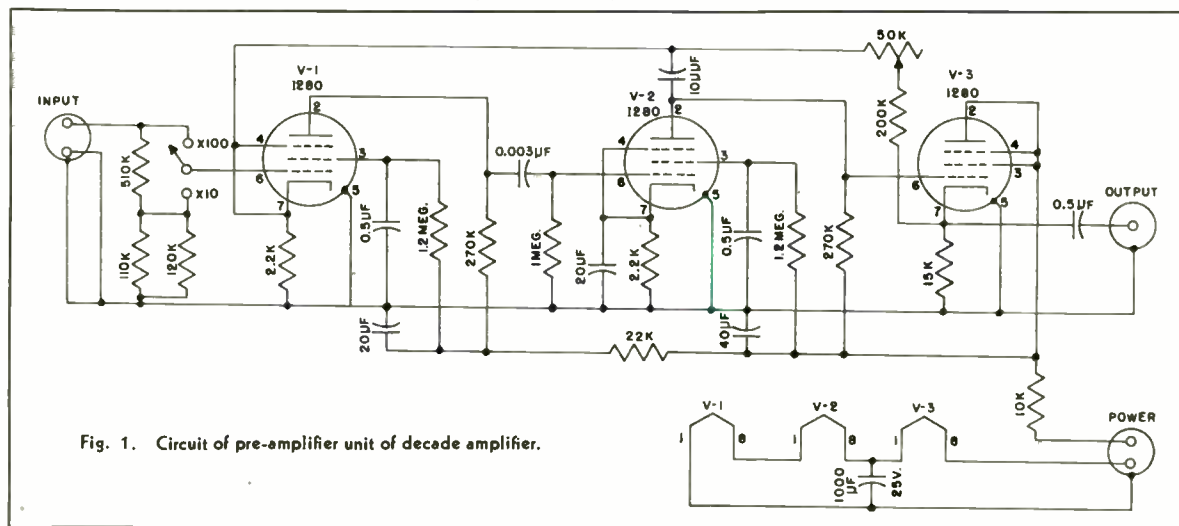

Fig. 1. Circuit of pre-amplifier unit of decade amplifier.

a coupling condenser between the two stages in order to obtain independent control of the grid bias voltages. The distortion of the pre-amplifier was initially low and no attempt was made to improve it further by adjustment of voltages.

Gain and Frequency Range—It was anticipated that there would be occasion for making measurements at frequencies from about 20 to about 20,000 cycles per second. It is obviously desirable to have the gain of the amplifier as uniform as is practically possible within this range at any setting of the attenuators. It is also desirable to have the gain independent of signal-source impedance and of load impedance over a wide range.

Fig. 4 shows the gain of each of the two units versus frequency, with the attenuators set for maximum gain. These measurements were made using two Ballantine voltmeters, one reading the input voltage and the other the output voltage of the unit under test. Variation of gain over the frequency range of interest is less than one decibel for either unit, most of the variation occurring between 20 and 30 cycles per second. Measurements of gain were also made with other attenuator settings, with only slight variation in the shape of the curves. For instance, with the attenuator switch of the pre-amplifier set for a gain of 10, the gain at 100,000 cycles per second was down five db from that at 1000 cycles per second, while, with the switch set for a gain of 100, the corresponding figure was 4 db. The difference in shape below 20,000 cycles per second for the same conditions was negligible.

Uniformity of gain over the desired fre-

quency range was attained by several means. Using adequate coupling and bypass capacitors and avoiding the use of transformers tends to reduce variation of gain with frequency. Inclusion of as much as possible of each amplifier circuit in a feedback loop further reduces variation of gain in the frequency range of interest. In addition to these obvious methods of securing uniform gain, several other expedients were used. For one, the input capacitance of the pre-amplifier was made low by using a pentode input stage, and by using mechanical construction such that the unit can be located near the reproducing head of a magnetic recording system, thereby keeping the connecting cable short and its capacitance small. It had been found in previous experimental setups that the capacitance of the cable and of the amplifier input were large enough to resonate with the inductance of a high-impedance reproducing head, thereby introducing an error into frequency response measurements. Keeping the input capacitance of the pre-amplifier low was an attempt to reduce this error.

Another expedient is the use of a cathode follower as an impedance transformer at the input of the main amplifier. This permits a high-impedance input and the use of a relatively low-impedance gain control. The gain control is a 10,000-ohm potentiometer calibrated with an accuracy of plus or minus one per cent plus or minus one-half dial division, with a total of 50 dial divisions. Use of the low-impedance gain control reduces the effect of shunting capacitances to a negligible value, and insures uniform gain over the desired fre-

quency range at any setting of the gain control.

Still another expedient is the use of a cathode follower as the output stage of each unit. This, together with the large amount of inverse feedback, makes the impedance looking back into either unit very low. Thus, the capacitance of the cable connecting the two units does not appreciably affect the gain at high frequencies. Furthermore, the variation of gain with load impedance is undetectable for any load above 10,000 ohms, thus eliminating variations of gain when using reactive loads.

Above 20,000 cycles the gain is deliberately made to fall off by use of a 10 μ f capacitor from the plate of the second 12SJ7 to the cathode of the first, and similarly in the pre-amplifier. This eliminates regeneration at about 200 or 300 kc which tends to produce a large increase in gain in that region, or even oscillation.

Noise The lowest noise measurements that we have made up to the present time on magnetic recording systems show minimum values of noise of about 5 or 6 microvolts from a system using a high impedance reproducing head having good frequency response, a nda recording speed of 24 inches per second. In order to be able to make accurate measurements and to provide for possible lower noise levels it is obviously necessary to have the noise generated in the amplifier as much lower than this as it is practicable to make it.

The noise level finally achieved is equivalent to about 1.5 to 2 microvolts at the input to the pre-amplifier, with the input shortcircuited and with a pass band equivalent to a 10,000 cycle rectangular band. This is not quite the ultimate that can be achieved, but any substantial improvement would have required the use of a high-mutual-conductance triode as the input stage, the sacrifice of the low input capacitance attainable with a pentode, the use of batteries or a much bulkier power supply, and the provision for more elaborate shock mounting of the pre-amplifier.

[Continued on page 38]

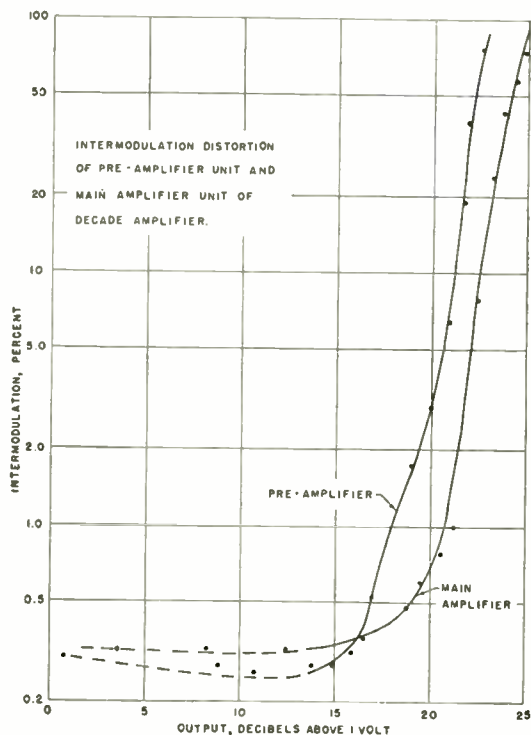
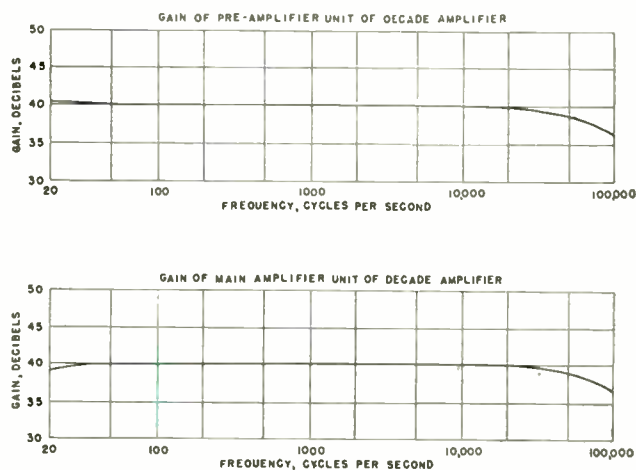

Fig. 3. Per cent intermodulation versus output voltage for pre-amplifier and main amplifier unit.

Fig. 4 (below). Gain vs. frequency curves.



Hollywood Sapphire Group

ROBERT J. CALLEN*

ONE OF THE outstanding advancements of sound-on-disc recording is not, as one might suspect, another electronic gadget but is, in the opinion of the writer, the formation of the "Sapphire Group," a social organization comprised of one hundred members in New York and fifty in Hollywood, all associated with sound recording. These two groups meet and dine together monthly and in this friendly, congenial environment discuss the technical problems common to all sound recordists.

The early producers of disc and cylinder phonograph records were extremely keen competitors in this new and unique art. This may help to account for the fact that these men were usually personal enemies. I don't know whether Emile Berliner and Tom Edison were as well acquainted with each other as they were with the man who read the gas meter in their studios. It was, however, a common ruse for a recordist to assume the disguise of a meter reader and thus gain admittance to his competitors studio to learn of his advancement in the recording art. In such an environment, a social organization such as our Sapphire Group obviously would have been inconceivable.

However, since the advent of radio broadcasting, the electrical recording and reproduction of sound has continued to improve so that today information

about this art is generally considered common knowledge. It seemed inevitable, therefore, that a group of men engaged in various phases of the sound recording should assemble to discuss their common problems.

New York City Group

As early as 1942, the Sapphire Group became a reality in New York City with regularly scheduled meetings, a group pin, and a printed membership list. Prior to that time, it had been customary for W. H. Rose of Frank L. Capps and Co., Inc., to have lunch occasionally with G. E. Stewart of N.B.C. Recording Division and V. Liebler of Columbia Recording Corporation. As the size of this group increased and their discussion became more prolonged, there was no alternative but then to meet regularly for dinner when the discussion need not be curtailed by the necessity of returning to the office. The New York Sapphire Group continues to meet on the third Wednesday of each month in one of the dining rooms of the New York Athletic Club. As the group expanded, it became necessary to limit the membership to one hundred men all engaged in one of the many phases of sound recording.

By the end of 1945, the New York Sapphire Group membership included at least eight members from Hollywood. Some effort was made at that time to organize a Hollywood Sapphire Group,

chiefly by Chester Boggs of Columbia Recording Corporation and the writer. However, it was not until Chuck Phillips of OWI in New York visited Hollywood in February, 1946, that the first meeting was held at Brittingham's Restaurant in Columbia Square on February 13, 1946. Seventeen of the 30 sound recordists invited attended the initial dinner and meeting. (See photo). Chester Boggs served as chairman. The eighteenth and vacant chair in the foreground of the picture was intended for Roy La Violette, CBS, who was called to cover a program before dinner was served.

After the dinner was served, a talk by each member present was recorded and the 16-inch disc forwarded to the parent group in New York City. The Hollywood Group has continued to meet regularly on the second Wednesday of each month except July. The membership increased so rapidly that it soon became necessary to decide either to limit the membership of the group or to transfer the meeting place to a larger dining room. As a result, a membership committee was elected to decide this and several other problems. The membership committee comprised six charter members: Chester Boggs, Harry Bryant, Bob Callen, Les Culey, Art Felthausen and Ernie Knight. At its first meeting, the committee decided that the group should be restricted to fifty active members, all

[Continued on page 39]

*1101 S. Edinburg Ave., Los Angeles, Calif.

Initial Meeting of Hollywood Sapphire Group, February 13, 1947

Seated at table from left to right are: Harry Bryant, Radio Recorders; Russ Hansen, Sam Goldwyn Studios; Bert Gottschalk, Electro-Vox; Ernie Knight, Diacoustic Lab.; Charlie Douglas, CBS; Chuck Phillips, OWI; Jay Eiseman, CRC; Ludwig Sepmeyer, USN; Chester Boggs, CRC; Gary Harris, RCAV; Bob Callen, NBC; Burton Boatright, Langevin Co.; F. H. (Shang) Winter, Radio Recorders; Les Culey, NBC; Victor Quan, C. P. MacGregor; Darrell Minkler, Radio Recorders; Art Felthausen, C. P. MacGregor.



The Design of A New Lacquer Recording Stylus

ISABEL L. CAPPS*

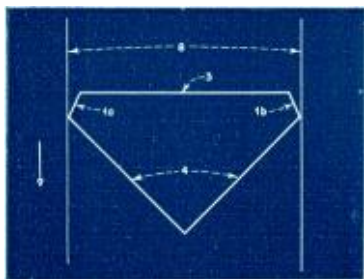

Fig. 1. Cross-section of standard lacquer recording stylus in unmodulated groove. Burnishing facets (1a and 1b) form 25° angles with groove walls (8). Arrow shows direction of record travel. Other facets: Cutting face (3) and clearance faces (4).

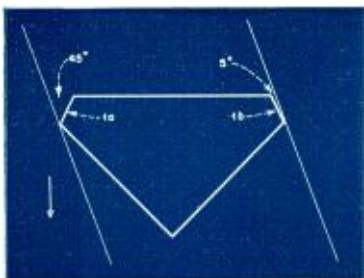

Fig. 2. Cross-section of same stylus in groove with 20° slope. Change in angular relationship between burnishing facets and groove is shown. Facet 1a forms angle of 45° with adjacent groove wall. Facet 1b on opposite side of stylus forms angle of 5° with its adjacent wall. In this and subsequent illustrations groove slopes in the opposite direction will merely reverse the effects described.



Fig. 3a. Same stylus cross-section in groove whose slope is 30°. Burnishing facet 1a forms angle of 55° with adjacent wall. Facet 1b cannot burnish with groove slope in excess of its basic angle. In fact, the edge formed by the meeting of cutting face and burnishing facet (A) will tear the adjacent groove wall.

Fig. 3b. (right) Diagram of a highly modulated groove showing areas (arrows) which will be rough where the burnishing facets (1a and 1b) cannot function properly.

A LACQUER recording stylus of modified design is now available which offers several advantages in the recording of high quality discs, particularly originals from which pressings are to be obtained. This modification relates to the burnishing facet which is an important part of the standard lacquer recording stylus.¹

Burnishing Facet Angle

The single burnishing facet of the standard stylus is usually polished at an angle of 25° to the side walls of an unmodulated groove (Fig. 1). In a dead groove this angle remains constant and burnishing action is steadily effective. When the groove is modulated, however, the stylus is carried on excursions of varying direction and slope from the axis of an unmodulated groove, causing radical changes in the angular relationship between the burnishing facet and its adjacent groove wall.

A study of the cross-section of such a stylus in grooves of varying slope is essential to an understanding of the effect

modulation has upon the ability of the burnishing facet to polish the groove. By this means it is readily seen that the burnishing angle is reduced on one side of the groove and increased on the other according to the direction of the stylus excursion (see Fig. 2). For example, a groove slope of 20° finds one facet now forming a 5° angle to the adjacent groove wall while the other forms an angle of 45° with its adjacent groove wall. Under these conditions both walls are effectively polished.

When groove slope exceeds the angle of the burnishing facet, however, the facet on the side where the angle is diminished will not be able to burnish at all since it presents only a sharp point to the adjacent groove wall (see Fig. 3). The unpolished wall of such portions of a modulated groove will result in noise patches upon subsequent playback. This noise modulation will be particularly noticeable in the record because it occurs on the side of the groove which more positively drives the playback stylus (Fig. 3b).

The above condition could be remedied easily enough merely by increasing the angle at which the burnishing facet is

President, Frank L. Capps & Co., Inc. 244 W. 49th St., New York City.
¹Capps U. S. Patent No. 2187512.

Fig. 4a. Lower portion of a stylus having two burnishing facets along the cutting edge. The figures represent parts as follows: 1-shank; 3-cutting face; 4 clearance face; 5-back edge formed by meeting of clearance faces; 6-burnishing facets.

Fig. 4b. Cross-section of stylus shown in Fig. 4a. in an unmodulated groove. The trailing facets 1a and 1b form burnishing angles of 15° with adjacent groove walls.

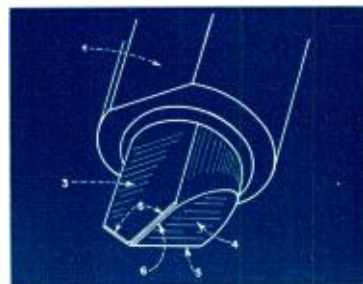
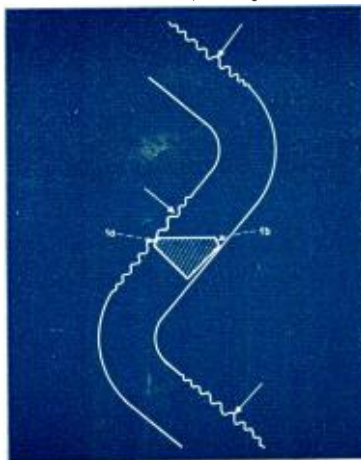
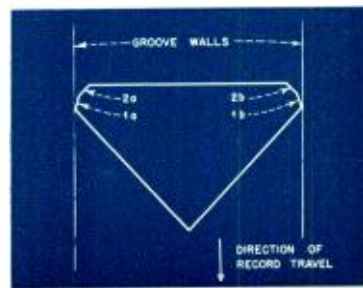

Fig. 4(a) above. Fig. 4(b) below.



originally ground. To do so, however, would be to increase the angle between facet and wall on the opposite side of the groove to a dangerous degree. Shearing action takes place at an angle of 90° , the relationship of the cutting face to the record material. It follows that any burnishing facet increased by groove slope to 60° or more will tend to become a cutting face and will tear rather than polish the groove wall.

Moreover, mastering levels frequently produce a groove slope of 40° or more. It would be necessary to grind the single facet at an angle of 45° in order to burnish such a groove on the side where the angle is diminished. This same groove slope would then increase the burnishing angle on the opposite side of the groove to 85° . It is clearly impossible, therefore, to grind a single burnishing facet at any angle which will guarantee effective polishing of both groove walls at the same time regardless of the direction or slope of the groove.

A modified stylus design² which provides multiple burnishing facets rather than one along the cutting edge offers a positive solution to the problem of burnishing angle at mastering levels. The facets of this stylus are polished at different angles so that groove slope naturally selects the facet which has an effective burnishing relationship to the adjacent groove wall. In the case where two facets are provided, for example (see *Figs. 4a & 4b*) the leading facet may be polished at an angle of 45° , the trailing facet at an angle of 15° in relation to the walls of an unmodulated groove. A groove slope of 40° would therefore find the leading facet operating at an angle of 5° on one side and the trailing facet at 55° on the opposite side (see *Fig. 5*). These angles may be changed to 50 and 10 degrees respectively so that even a groove slope of 45° will result in the same effective relationship between burnishing facets and groove walls.

That noise patches are effectively eliminated by styli of this modified design is illustrated in *Fig. 6*. Here actual photographs reveal the rough area left in a highly modulated groove cut with a single-faceted stylus and the absence of such rough areas in a similar groove cut with a multi-faceted stylus.

Other Features

The new stylus is called an Anti-Noise Modulation Stylus but its geometry provides additional benefits which largely overcome other limitations imposed upon the single burnishing facet². Each of the two facets illustrated in *Fig. 4* may be so small that their aggregate dimension is less than the width of the standard single facet (see *Fig. 7*). And due to the wide

²Capps and Cook, Patent applied for.

¹Isabel Capps "Recording Styli" *Electronic Industries*, November 1946.

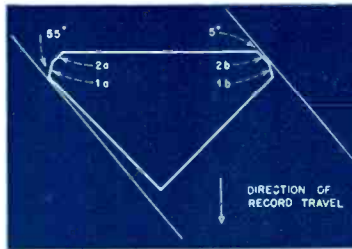

Fig. 5. Cross-section of same Anti-Noise Modulation Stylus in a groove whose slope is 40° . Leading facet 2b functions at an angle of 5° on the side where groove slope diminishes the burnishing angle. Facet 1a burnishes the opposite wall at 55° .

Fig. 6a. (below) Noise modulation in sidewall is not hard to see with a low-power microscope when properly lighted.

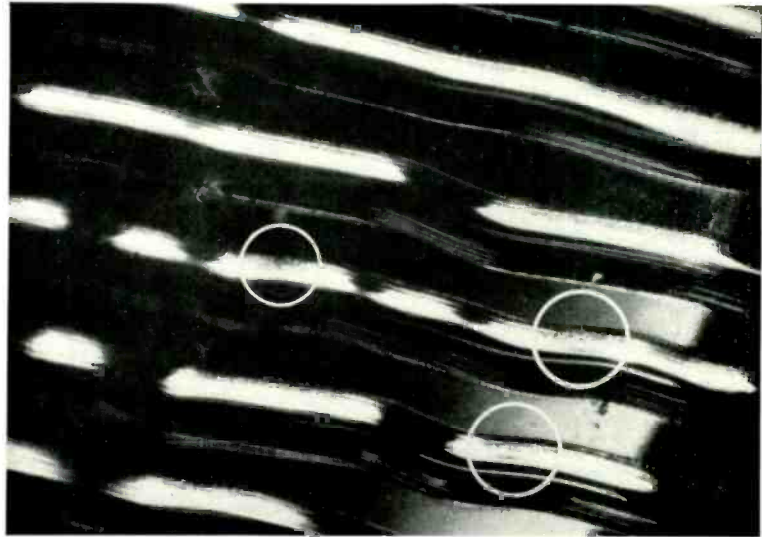

Fig. 6b. A record made with an anti-noise-modulation stylus shows no egregious sidewall speckling even with 40° excursions. Special microscope lighting must be arranged to produce sidewall illumination because the anti-noise-modulation stylus produces such a high polish. Although halation occurs in some spots, due to lack of retouching, direct viewing with the microscope eyepiece coupled with movement of the light sources discloses no unburnished sidewall areas. (Below)

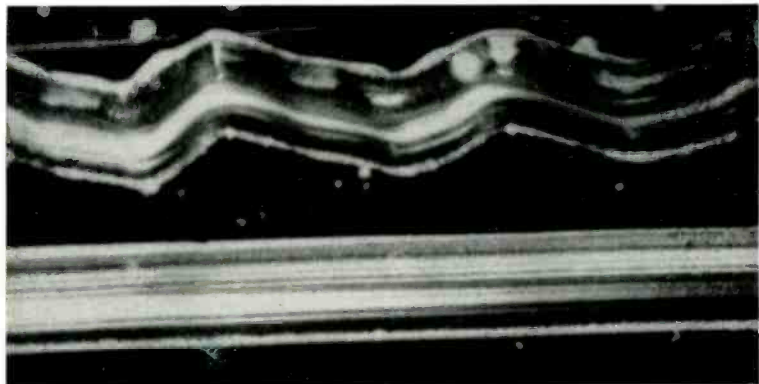

Fig. 7. (right) Enlarged view showing comparatively large width of a standard (0.0005) single facet (S1) in contrast with the small aggregate widths of the double facets (1a and 1b), each of which is 0.0001". Cross-hatched section shows amount of groove material that will be displaced by double-faceted stylus. This area plus shaded portion of the above stylus constitutes mass that will be displaced by single-faceted stylus.

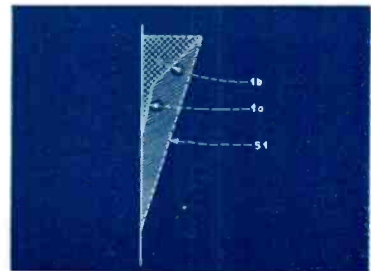



Fig. 8. Cross-section of an Anti-Noise Modulation Stylus having the leading facet 1a and 1b 0.0002" in width; and trailing facet 2a and 2b 0.0001" wide.

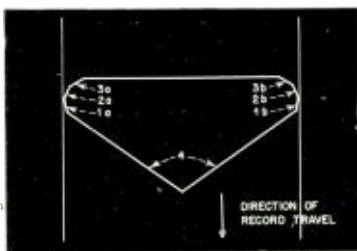

Fig. 9. Cross-section of an Anti-Noise Modulation Stylus provided with three burnishing facets, each 0.0001" wide. The leading facet (3a-3b) is polished at an angle of 60°; the middle facet (2a-2b) at 25°; the trailing facet (1a-1b) at minus 10°. The clearance faces (4) are polished at 35° to provide additional clearance in 45° groove slopes.

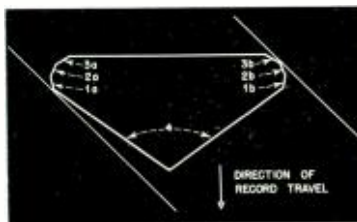
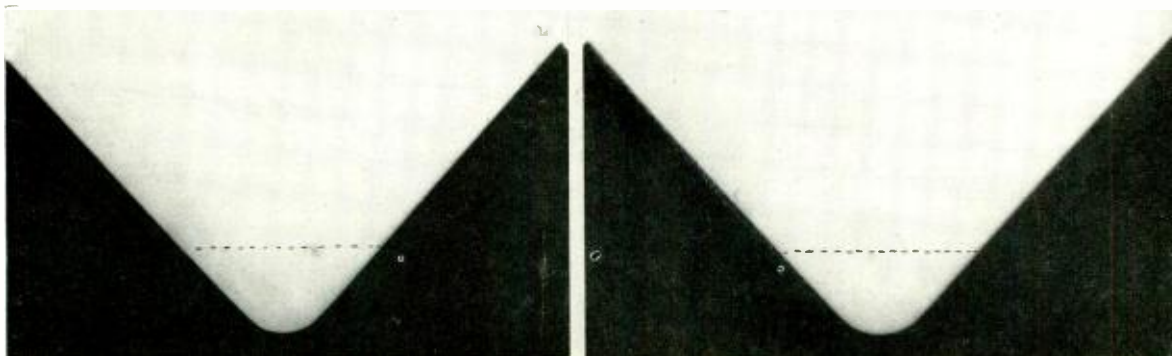

Fig. 10. Stylus cross-section of Fig. 9 in a groove slope of 45°. Here facet 1a (polished at minus 10°) burnishes the adjacent groove wall at 35°. On the opposite side leading facet 3b (polished at 60°) burnishes its adjacent groove wall at 15°.

Fig. 11 (left) & 12 (right). Contact prints of shadowgraphed two-faceted styli. The dotted line indicates the functional portion for 100 lines per inch and consequently the portion below this line will be the resultant groove shape. Deviation from "ideal" shape lies in the fact that in Fig. 11 the radius does not blend perfectly with the angle on one side.



COMPARATIVE READINGS OF TYPICAL STYLI

Stylus Type	Diameter	R P M	Normal Position	Offset 30°	Offset 40°
Regular stylus (single facet)	16"	78	-55	-25	off scale
	16"	33½	-60	-20	off scale
	7"	78	-60	-20	off scale
	7"	33½	-55	-20	off scale
Anti-Noise Modulation Styli (two facets)	16"	78	-50	-40	-25
	16"	33½	-52	-40	-25
	7"	78	-50	-35	-20
	7"	33½	-48	-35	-20

difference in the angle provided, each facet may work independently of the other so that its own width is the only structural impedance offered to the registration of high frequencies. Distortion caused by wider single facets is also reduced since the smaller facet displaces less material in its polishing action with less subsequent restoration of the groove wall.

Variations Possible

Three types of styli embodying the principles of this modified design have been used with highly satisfactory results. The first two provide double facets of 50 and 10 degrees respectively as illustrated in Fig. 4. However, in one the facets are equal in width, each being 0.1 mils wide. The other enlarges the leading facet to 0.2 mils (Fig. 8) thereby enabling it to give a higher degree of polish to the groove wall which drives the playback stylus.

The third variation provides three burnishing facets along the cutting edge as follows:

A leading facet polished at 60°, a middle facet at 25°, and a trailing facet at minus 10°, all angles given in relation to the side wall of an unmodulated groove (see Fig. 9). The advantage here lies in the fact that even a groove slope of 45° increases the burnishing angle between the rear facet and its adjacent groove wall only to 35° (see Fig. 10), a more effective burnishing angle than the 55° resulting from the first two types.

New Method of Rating Noise Factor

To the stylus itself, an excursion of any slope is the equivalent of being twisted to that degree in the cutting head while making an unmodulated groove. This method has been temporarily adopted therefore to measure the factor of merit⁴, (noise below a signal of 10 e/s) in styli having multiple facets. Comparative readings in round figures of typical styli of both the single and multi-facet type are given in the chart above.

The readings given reveal the advantage enjoyed by the Anti-Noise Modulation Stylus when degrees of groove slope common at mastering levels are reached. As stated, the figures are given in round terms but accurately represent the average of many styli of both types tested.

Full appreciation of the improved quality obtainable with the Anti-Noise Modulation Stylus must come with its use. There are probably almost as many ways of determining what constitutes a "good stylus" as there are recording technicians. Some judge the stylus entirely by its shadowgraphed outline. Some make test cuts, unmodulated, on the outside diameter of the disc at 78 rpm. If the groove is "quiet" (virtually inaudible at full gain) and the flash lines parallel to the groove axis are shiny and unbroken, the stylus is considered good.

[Continued on page 41]

⁴Emory Cook, AUDIO ENGINEERING, Dec., 1947.

Audio Frequency-Response Measurements In Broadcasting

A. E. RICHMOND*

Describing the proper technique of testing broadcast audio apparatus.

AMONG the important characteristics by which performance of broadcast equipment is judged is the frequency response of the equipment. This characteristic is important to the broadcast engineer and to the designer of broadcast equipment for two reasons—first, prudent operation demands the best possible fidelity, consistent with other considerations, and second, the Federal Communications Commission has established, in its Standards of Good Engineering Practice, minimum frequency-response requirements^{1,2,3} with which the equipment must comply. While there exists some controversy as to the desirability of a "wide-range" system, we choose to take no part in these discussions. Rather, some considerations bearing directly upon the engineer's job of determining the frequency-response characteristics of the electronic portions of his equipment will be presented.

Frequency Response

A question might arise as to the necessity for accuracy in such measurements. While the FCC standards allow for a reasonable variation in response with frequency over the required ranges, there are nevertheless the response characteristics of many individual pieces of equipment included in the over-all composite curve of a station, from microphone to transmitter output. To comply with present requirements, measurements must be carefully made in determining the performance of each unit. These tests become somewhat critical at the

*Chief Engineer, KALE/KALE-FM, Portland, Ore.

¹Federal Communications Commission, "Standards of Good Engineering Practice Concerning Standard Broadcast Stations," Effective August 1, 1939, Revised to June 1, 1944, U. S. Government Printing Office, Washington 25, D. C., 65¢; pages 52 and 61.

²Federal Communications Commission, "Standards of Good Engineering Practice Concerning FM Broadcast Stations," effective September 20, 1945, Revised to January 20, 1946, U. S. Government Printing Office, Washington 25, D. C., 10¢; pages 14 and 21-22.

³Federal Communications Commission, "Standards of Good Engineering Practice Concerning Television Broadcast Stations," December 19, 1945, U. S. Government Printing Office, Washington 25, D. C., 10¢; page 14.

high-frequency extreme (i. e., 15 kc) of the required range of audio response for FM stations and for the sound channels of television stations.

It is well that there should be agreement upon what is meant by the term "frequency-response characteristic." This is the "response" (gain, amplification or transmission) of a system or unit, versus frequency. We may indicate a loss or attenuation as a negative gain, with obvious correctness. There are a number of ways in which gain can be defined.⁴ In this article, we shall take the "response" as the *transmission insertion*

The characteristic is generally obtained by point measurements, although curve-tracing devices have been developed for such purposes. In U. S. broadcasting practice, the response curve shows the response in decibels as ordinates, versus frequency in cycles as abscissae. The response obtained at 1000 cycles is often used as a reference point. Linear decibel and logarithmic frequency scales are used. See Fig. 1.

Transmission Measuring Sets.

In obtaining the frequency-response characteristic of a piece of equipment,

Fig. 1. Sample frequency-response curve, showing method of plotting curve.

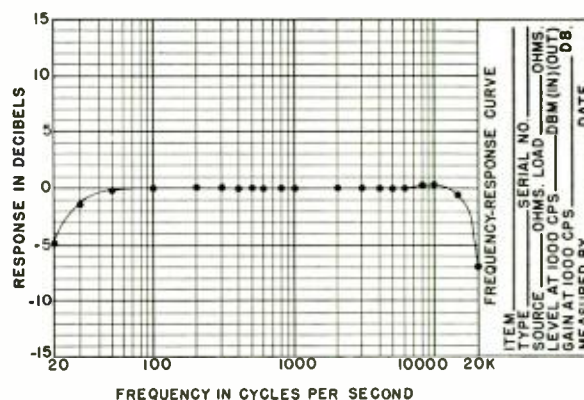

gain^{5,6} (or amplification, etc.) which is defined as

$$\text{gain (db)} = 10 \log_{10} \frac{P_o}{P_o'}$$

Here, P_o is the output power of the equipment under test, when driven by the specified generator and when connected to its specified load (generally a resistive load, in broadcast audio facilities). Likewise, P_o' is the power assumed to be delivered to the same load by the same generator when it is connected to the load through a hypothetical ideal transformer of the most favorable ratio.

⁵S. J. Haefner, "Amplifier-Gain Formulas and Measurements," *Proc. I. R. E.*, Vol. 34, No. 7, pages 500-505; July, 1946.

⁶Research Council of Academy of Motion Picture Arts and Sciences, "Motion Picture Sound Engineering," D. Van Nostrand Co., New York, N. Y., 1938, pages 226-227.

⁴See Reference 4, page 505.

a transmission measuring set (variously known as a transmission set, gain set or measuring set) is often used. The set is a convenient assembly of the components required for the purpose. It replaces the random arrangements sometimes laid out on the test bench for measurement purposes. Besides convenience, the advantages of the set normally include adequate shielding and repeatability of results. Many engineers have made use of the circuits about to be described without applying the name "transmission measuring set" to their equipment.

The set is divided into two sections, the transmission (or input or sending) section, and the load (or output or receiving) section. These sections may be assembled as one unit, or, for program-line measurements, constructed separately. The purposes of the transmission

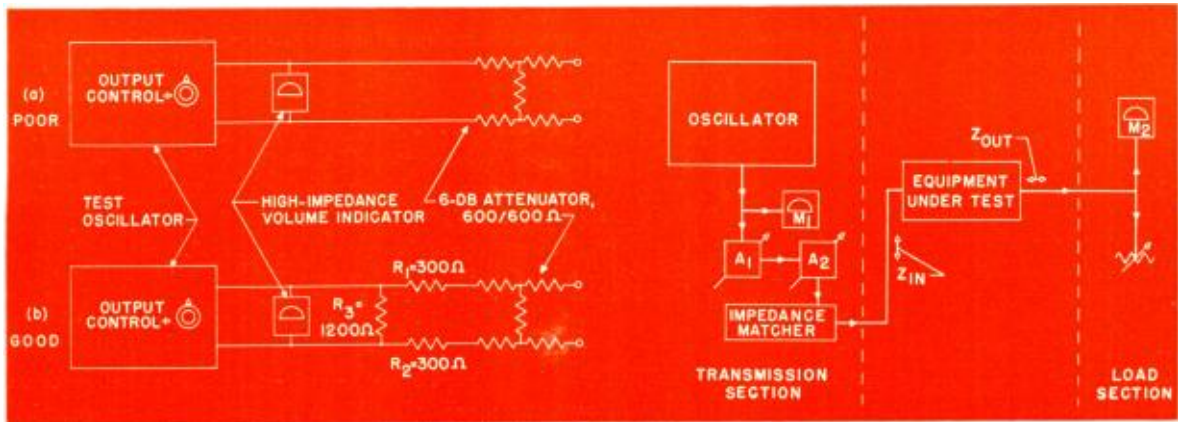

Fig. 2 (left). (a) Isolating volume indicator from tested equipment by use of a pad, and (b), with addition of series resistors. Fig. 3 (right). Basic transmission measuring set.

section of the set are (1) to provide audio-frequency signal voltages of known and adjustable frequency, (2) to adjust the amplitude of these signals to accurately-determined values, and (3) to provide the desired internal source impedance.

The load section is intended to provide the desired load impedance for the equipment being tested. A volume indicator or other suitable instrument for determining levels, is provided. Its frequency characteristic over the audio range should conform to that of the indicator of the transmission section.

Transmission Section

If we should attempt to excite the input circuit of a device under test directly from the output of the usual audio-frequency oscillator, we encounter some difficulties. First, many broadcast devices operate at very low input levels. For testing under operating conditions, the oscillator output control would be a very crude means of setting levels accurately when in a nearly "off" position. Also, a sensitive instrument would be

needed to indicate these levels directly. At low levels, the noise in the oscillator output stages might mask the signal if the output control were situated at a low-level point in the oscillator amplifier, as is often the case.

Finally, the input impedance of many devices to be tested varies greatly over the audio spectrum. Because of the internal impedance of the oscillator, this variation would cause the voltage applied to the input of the tested equipment to vary. Hence, difficulty is encountered in maintaining a constant reference reading on the input volume indicator. Of course, we could always reset the oscillator output control, thus maintaining a constant reference level at all frequencies. This adjustment of oscillator output is an artificial condition, however, because the source which normally feeds the equipment being tested will, in practice, not adjust its amplitude at different frequencies to compensate for the variation in input impedance. This continual adjustment of oscillator output would give the oscillator the equivalent a source

having zero output impedance (a constant-voltage generator). Obviously, we should not provide a source whose internal impedance is zero, but one whose impedance is in accordance with that specified for the equipment being tested.

As the first approach to the source-impedance problem, as applied to measurements, assume a device to be tested requiring a fairly high input level at a resistive, balanced impedance of 600 ohms. The test oscillator is intended to work into a 600-ohm load.

If we first insert a 6-db isolating attenuator between the volume indicator M and the tested equipment (see Fig. 2a), we will effect some improvement over the direct connection to the oscillator. But the impedance variation of the tested device will still reflect somewhat upon the instrument reading. The result is a resistive source impedance, having a magnitude in the neighborhood of 350 ohms, which, while representing an improvement over the zero-impedance source, is yet hardly satisfactory.

Going now to Fig. 2b, resistors R_1 and R_2 , each of 300 ohms, are inserted in series with the input of the pad. These introduce an additional 6 db loss, but since the oscillator remains an effective short-circuit when looking back to its terminals (as long as the volume-indicator reading is kept constant) the pad is now matched on its input side by R_1 and R_2 . Likewise, we have our desired 600-ohm resistive source. The 1200-ohm resistor across the oscillator terminals completes the 600-ohm oscillator loading system, in conjunction with the added resistors in the circuit to the pad. The desired circuit constants are now realized.

If the isolating pad is increased to 20 db or more, the effective impedance seen by the input circuit of the device being tested will vary by only a comparatively few per cent. Since attenuation of 20 db or more will often be required to reduce the oscillator signal to the operating input level, the additional series resistors

Fig. 4. Hewlett-Packard 206-A Audio Signal Generator, equipped with volume indicator and attenuators. This instrument can replace the input section of the transmission set for 50, 150 and 600 ohm circuits. A resistor and vacuum-tube voltmeter can serve as the output section.

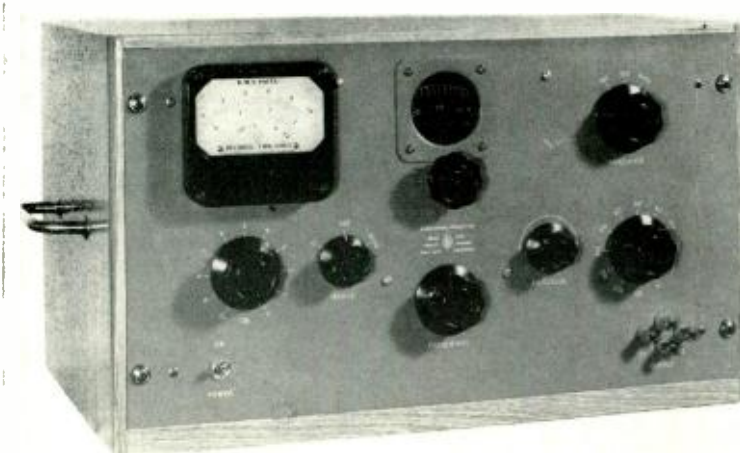

R_1 and R_2 may not be required. The foregoing example, however, illustrates the importance of adequate isolation between the input circuit of the tested device and the volume indicator. The circuits, as shown, apply only to the balanced-to-ground case. Other arrangements are required if one side of the circuit is to be grounded.

Practical Transmission Set

Fig. 3 shows the "block" diagram of a basic transmission measuring set suitable for measuring the loss, gain, or frequency response of most broadcast equipment. The actual components will vary with the particular model. The variable a-f oscillator may be included as a part of the set, or may be connected externally. In some cases, an isolating pad may be inserted between the oscillator output and the point at which the volume indicator M_1 is connected.

Attenuators A_1 and A_2 constitute a decade arrangement, calibrated in decibels. The oscillator noise as well as the signal is attenuated by the decade pads, and a convenient level may be applied to M_1 for measurement. The impedance matcher may be a wide-range matching transformer with tapped windings, in which case an additional fixed isolating attenuator of suitable characteristics and about 20 db loss should be connected between the transformer secondary and the input of any device under test having an appreciable reactance (such as an amplifier with an input transformer). This pad assists in avoiding error at extreme audio frequencies. On the other hand, for measurements on amplifiers, the impedance matcher may be an attenuator, having adjustable output impedance and at least 20 decibels of loss.

The available output impedances of the transmission section should include those commonly encountered at the input of present-day broadcast equipment. Despite the proposed RMA standard of 150- and 600-ohm impedances in broadcast circuits, much equipment in use at the present time has other impedance values. The following values will be recognized: 30, 50, 125, 150, 200, 250, 500 and 600 ohms.

The load section of the transmission measuring set consists of a resistor, and, in parallel with it, an output power-indicating instrument. The resistor is adjustable to values found as loads for broadcast equipment. Besides those input impedances mentioned above, 8 and 15 ohms are encountered as output impedances. The indicator may be coupled to the load by a bridging transformer having a high primary impedance and adjustable turns ratio, in order to maintain a true power indication with different load resistances. Such a transformer may introduce some load errors at the extreme audio frequencies, so the load section may be isolated from the output



Fig. 5. Daven 6C Transmission Measuring Set.

of the tested equipment by a pad of at least 6 db loss. As previously stated, the indicator should have a frequency characteristic closely similar to that of the instrument in the transmission section.

Certain transmission sets use a single indicating instrument which is switched between the two meter positions shown in Fig. 3. A vacuum-tube instrument of very high input impedance may be used, or a suitable resistor may be substituted for the instrument when it is disconnected from either circuit. Typical commercial transmission measuring sets are shown in Figs. 4 to 6, inclusive.

Resistive Sources

Except for isolating pads and other resistive networks, most broadcast audio facilities are intended to operate into resistive loads and from resistive sources. Such resistive sources and loads are often provided by isolating or control attenuators or by "differential" networks.⁷

Transmission measuring sets similar to that diagrammed in Fig. 3 can be used directly for measuring the frequency response of equipment such as:

(1) Amplifiers, in those cases where the source impedance will be an attenuator or other resistive network.

⁷H. A. Chinn, "CBS Control-Console and Control-Room Design," *Proc. I. R. E.*, Vol. 34, No. 5, page 294; May, 1946.

(2) Program lines, with their equalizers and repeating coils, which usually operate into terminating attenuators. At the sending end, the line amplifier is, in actual operation, isolated from the line by a pad of from 6 to 12 db loss; hence, it is proper to test the line from a resistive source.

(3) Filters, when intended to be used with resistive terminations.

(4) Attenuators.

One may ask: "Why should it be necessary to measure the frequency response of a resistive attenuating pad?" In explanation, both fixed and variable attenuators may have a capacitive "leakage" effect, or, in the case of power-dissipating attenuators using wire-wound resistors, an inductive effect, upon frequency response. This effect will be, of course, most noticeable at the highest audio frequencies. The capacitive leakage effect will often increase transmission. Since many attenuators may be installed in the over-all system, it is well to be able to predict their combined effects. Indeed, errors introduced by possible frequency discrimination of pads in the transmission measuring set itself must be guarded against.

Measurement Technique

Here is the actual procedure to obtain the frequency-response curve of a piece of apparatus whose response can be measured accurately with a resistive

Fig. 6. Cinema 1901 Transmission Measuring Set.



source and a resistive load. Referring to Fig. 3, the load is first connected to the output terminals of the equipment being tested, and adjusted so as to provide the desired loading. The multiplier on the output indicator M_2 is set to the maximum range. Attenuators A_1 and A_2 are set to maximum loss. The audio-frequency oscillator is adjusted to a frequency of 1000 cycles, and the output level is set at a convenient value which is noted on indicator M_1 . The impedance matcher is adjusted to simulate the output impedance of the source to be used with the equipment being tested. The attenuators A_1 and A_2 are now adjusted so that their loss (combined with any loss in the impedance matcher) will bring the volume indicated by M_1 down to that normally fed to the tested equipment during operation. (It is well to use a reasonably high level from the oscillator, and thus use sufficient attenuation in A_1 and A_2 to assure adequate isolation of the equipment being investigated from the constant-voltage generator simulated by the oscillator output.)

The transmission section is connected to the input of the equipment being tested, and the multiplier of M_2 is reduced in setting so that a convenient reading is obtained on the scale of M_2 . The gain of the equipment at 1000 cycles can now be computed. The gain in decibels of the equipment tested will be equal⁸ to its output in dbm minus its input in dbm. The amplitude of the signal fed into the tested unit is, of course, equal to

$$\text{Input} = DM_1 + S - A_1 - A_2 - C,$$

where DM_1 = reading of M_1 in dbm.

S = setting in decibels of multiplier attenuator associated with M_1 ,

A_1 and A_2 are losses in decibels of attenuators A_1 and A_2 respectively, and

C = loss in decibels of impedance matcher.

The output level of the tested equipment is obtained by reading the output meter M_2 and its multiplier. (In some sets, a correction factor may be required for various output impedances.)

In testing most audio facilities, the "dbm" is the single frequency power level in decibels with respect to a reference level of 1 milliwatt.

procedure consists in repeating the response measurements at suitable frequencies, keeping the reading of the input indicator M_1 constant. The resulting deviations of the output indicator M_2 from its 1000-cycle indication are plotted as shown in Fig. 1.

Sources of Error

Numerous possible causes of error exist in response measurements, some of which have to do principally with particular equipments and applications. In general, some of the precautions which must be taken in order to avoid misleading frequency-response measurements are:

(1) The measurements should be made with the tested equipment installed and operating as nearly as possible in the manner in which it will be used. This provision applies to power-supply voltages, length and type of input and output leads, and source and load impedances. The same points and sides of circuits should be grounded in the tests as will be grounded in use. The transmission set must be adequately shielded and grounded, not only at the case, but at the output, if the source it simulates will be grounded.

(2) The equipment should be tested at the same approximate power level at which it will be used. This precaution relates especially to low-frequency response. The rise in permeability accompanying an increase in magnetizing force in the cores of transformers operating at low signal levels can result in misleading high values of low-frequency response, if the equipment is tested at an abnormally high power level.⁹

(3) Sufficient attenuation must be used in the input section of the transmission measuring set to assure adequate isolation of the input volume indicator from the input of the tested equipment.

(4) Circuits carrying a-f energy should be well isolated from each other. Thus, the oscillator leads should be isolated by all possible factors, including space, from the input circuit to an amplifier under test, which, in turn, should be similarly well-isolated from the amplifier output circuit. This precaution is worth while in all cases, including those where the leads are twisted and shielded. It is especially important when the circuits concerned carry radically different power levels. It is difficult to duplicate a response curve with different physical equipment set-ups, and the "dress" of the circuits will be found to have an important bearing on this difficulty. The cross-talk between circuits can cause difficulty when the oscillator output is set exceedingly high in order to accommodate excessive attenuation adjustments in the

⁹See Reference 5, pages 207-208.

transmission set. Caution should be exercised in the use of long, unshielded patch cords in frequency-response measurements.

(5) Effects of the capacitances of cables and twisted pairs are important. For instance, insertion of unbalanced testing components in rather long shielded pair circuits under certain conditions, may cause an abnormally high response at high frequencies. (This same effect can occur in audio facilities in use.) This effect is shown in Fig. 7, where a "Tee" attenuator is connected in a circuit which is floating with respect to ground. The capacitances C to shield, ordinarily expected to cause high-frequency losses, may by-pass the higher frequencies around the attenuator to a noticeable extent, thus increasing the relative high-frequency response.

Complex Sources

In measuring the frequency response of equipment which is to operate from a source having a reactive component in its internal impedance, the resistive-source measurements described above are not conclusive. For example, if an amplifier output transformer works directly into a reactive filter section, the significant response of the amplifier-filter combination can best be obtained by measurement of the combination rather than by separate measurements with resistive terminations on the amplifier and filter.

Another example is found in measuring the frequency response of a certain microphone preamplifier, when operating from a particular type of microphone. The microphone is very likely to be designed to approach a flat response in output e.m.f. when on open circuit. Its internal impedance may vary with frequency. The preamplifier is designed to have a very high input impedance⁷ at most audio frequencies (although its rated source impedance may be low). The input impedance may, however, vary appreciably with frequency. The response of the amplifier-microphone combination to the open-circuit e.m.f. developed by the microphone may be of interest.

A well-known method of simulating the internal impedance of source of this type is shown in Fig. 8. Here, the microphone itself is used to present its own internal impedance to the circuit. The arrangement shown is intended for use where one side of the microphone cir-

[Continued on page 45]

Fig. 7 (left). Effect of line-shield capacitances when unbalanced components are used. Fig. 8 (right). Connections for testing the electrical response of a microphone-amplifier combination.

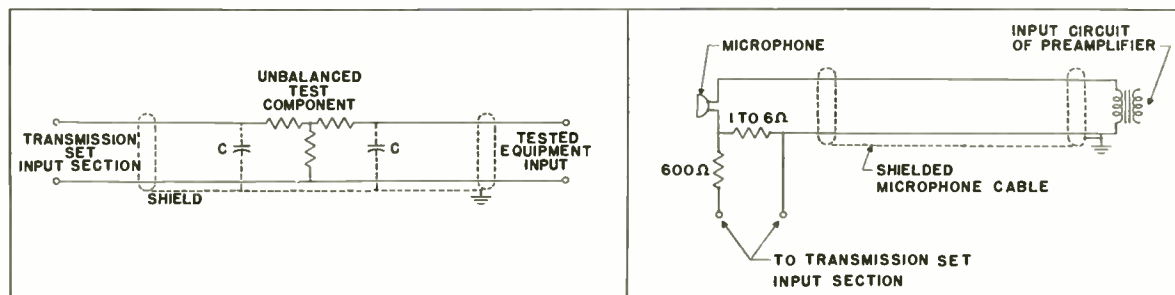



RECORD

REVUE

Classical Records

EDWARD TATNALL CANBY*

THIS department apologizes for its total absence in the last issue of *Audio Engineering*—the difficulty was entirely a too flexible deadline that flexed a bit too far.

In the November issue I suggested that the term “faithful reproduction” as used in speaking of fidelity, was not adequate. To be more accurate one would have to say, “faithful to the *imagined* original,” since that original is in fact virtually never actually heard by the listener. The implications of that idea have some important bearings on the question of “high fidelity” and what people like and don’t like about it, which it seems worth summing up at this point.

Come to think of it, it is surprising that those who operate the sound business—radio and recording, at least—assume so easily that a listener can distinguish between “faithful” and “unfaithful” reproduction! It must be remembered in the first place that our memory for sounds is not unlike that for colors: we can make extraordinarily accurate distinctions of color shades in direct comparison, when we have two adjacent points of reference. So, in sound, we can distinguish between very similar pitches with really enormous accuracy, and similarly between tone colors, rhythms, speeds, and other aspects of sound—when we have the possibility of direct comparison. But sound memory, like color memory, is short, even when trained. We are notoriously unable to match colors by memory, and we are (as I have plenty of reason to know) just about as inaccurate when it comes to comparing, say, an actual performance of music with another that is in the memory. (A good part of the interest in a radio record review I perpetrate is the *immediate* comparison of the same musical passage as heard in various recordings.

*279 W. 4th St., New York 14, N. Y.

To Mr. Canby’s widely read column, we add Bertram Stanleigh’s interesting evaluation of recent popular music records.

The difference in sound is always startlingly greater than one might have expected, using memory as a reference point.)

Thus, even in the case of a highly educated concert-going listener, who may be thoroughly familiar with a given piece of music as heard in concert, who may even have an “average,” composite idea of what it should sound like, thanks to many concert hearings—even this man, judging “fidelity” of reproduction, must make memory (trained and well-tended, but still memory) one of his points of reference. It is physically impossible for him to be objectively accurate, in such a lopsided comparison.

Add to this that in nine cases out of ten even the intelligent listener who is asked to judge “fidelity” is quite unaware of the complications of monaural sound. This single factor may account for a great deal more confusion than most experts are ready to admit. I quote a letter from an amateur engineer: “. . . As to *bin-versus monaural listening* . . . I doubt that our hearing has reached the equivalent of stereoscopic vision. Perhaps what ‘roundness’ we get may be gotten as well from a phonograph or radio output as in the concert hall.”—A typical reaction from one who has not personally faced the extraordinary problems of microphone pickup and acoustics that must be solved before this blithely simple assumption can be made! The gentleman pays a fine compliment to the engineers, but he misses the point entirely. It’s not *directional* perception that worries us in monaural hearing. We’re pretty well satisfied by even a rough pretense of polydirectional sound output, as with several speakers, but our perception of liveness—for on this our whole idea of natural reproduction is based. If monaural repro-

[Continued on page 42]

Popular Records

BÉRTRAM STANLEIGH**

ONE month ago we announced that a new series of British recordings would soon be available in this country. Bearing the name *London* (British Decca does not own rights to the Decca name here), these discs are now widely distributed throughout the United States. Although they do not have the range of 30 to 14,000 cps which their manufacturer claims, they are a definite technical improvement over American popular recordings. The bass drum is no longer a muffled thud and the tone of the brass section is full and resonant. Like their classical cousins, the frr recordings, they are unmonitored and more closely approximate the sound of a whole instrumental unit than domestic waxes do. The surfaces of these *London* records are also quieter and longer wearing.

Only the music on these discs is inferior to the American product. English popular music is primarily an imitation of our own, and most often it is a meaningless imitation in which the effect is reproduced but the basic idea is omitted. *London* had hoped to overcome this defect by importing “Toots” Camarata, one of the top American arrangers. Camarata’s arrangements for *London*, however, differ widely from his earlier ones for the Benny Goodman band. His present output consists of an album of Kostelanetz-like orchestrations.

There is good music in the British Decca files, including some stunning full frequency recordings of French songstress, Edith Piaf. A great deal of talent is available to this company; its roster includes Beryl Davis, Anne Shelton, Stephanie Grappelly, Gracie Fields, and many others. While their first releases have been poorly chosen for the American market, future releases of a

[Continued on page 45]

**41 East 59th St., New York 22, N. Y.

Review of the Present Status of Magnetic Recording Theory

W. W. WETZEL*

PART III

In this series of three articles, Dr. Wetzel presents the first complete discussion of magnetic tape recording theory for engineers.

IN THE two foregoing parts we have examined some of the properties of magnetic materials and the forces to which the materials are subjected during recording. In Part III we shall summarize the effects and illustrate the results with data taken from actual measurements. We shall then examine noise and distortion phenomena from the experimental point of view since theories of the cause of noise and distortion are far from complete.

Summary

In order to compare the over-all response of a tape as a function of frequency it appears fair to examine the outputs at different frequencies on the basis of some form of constant input. The basis usually selected is that the

maximum exciting field in the recording gap be made the same for each frequency, i. e., the total maximum flux be made equal before demagnetization. This is done by keeping the exciting current in the playing head the same for each recorded frequency. The output curves so obtained are known as constant current frequency-response curves and have been generally adopted as demonstrating one characteristic of a magnetic medium.

Forgetting for the moment demagnetization and the gap effect of the reproducing head, let us see what might be expected of constant current recording. If the field of the gap induced the same maximum remanent flux Φ regardless of frequency, we should have as an expression of the flux:

$$\Phi = ai \sin \omega t$$

On playback where the derivative of

the induction is proportional to the response, we have for the output voltage "V" of the reproducing head

$$V = b \frac{d\Phi}{dt} = abi \omega \cos \omega t$$

Since the maximum output voltage "V" is directly proportional to $\omega = 2\pi f$, we see that the output may be expected to vary linearly with the frequency. This represents an output which increases 6 db per octave and is illustrated by the straight *Curve 1*, *Fig. 1*.

If to the above considerations we add the effects of demagnetization on the induction remaining in the tape, we obtain *Curve 2*, which indicates that a large drop in remanent induction accompanies increased frequency.

Superimposing on the above effect the gap effect of the reproducing head, we

*Minnesota Mining and Manufacturing Co., 900 Fauquier Ave., St. Paul, Minn.

Fig. 2. Equipment assembly for testing loops of magnetic recording tape.

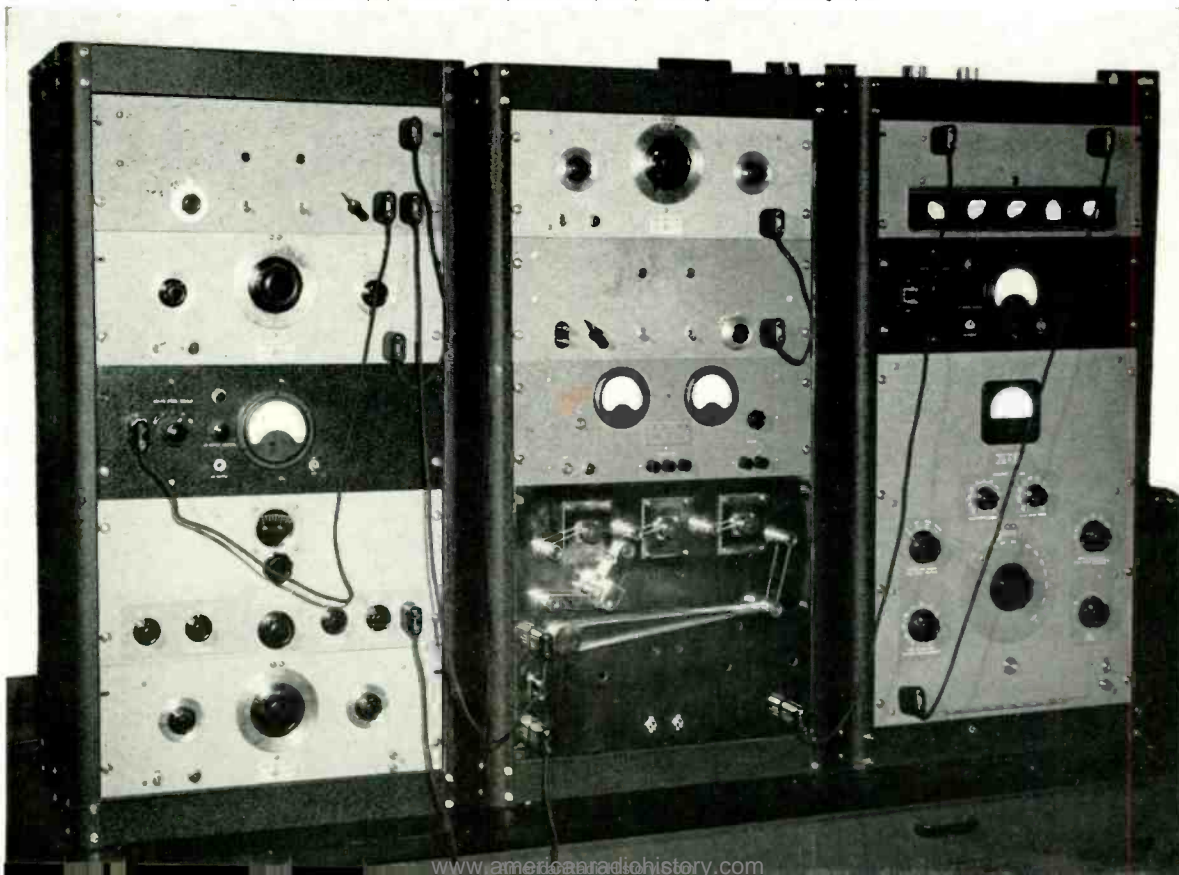

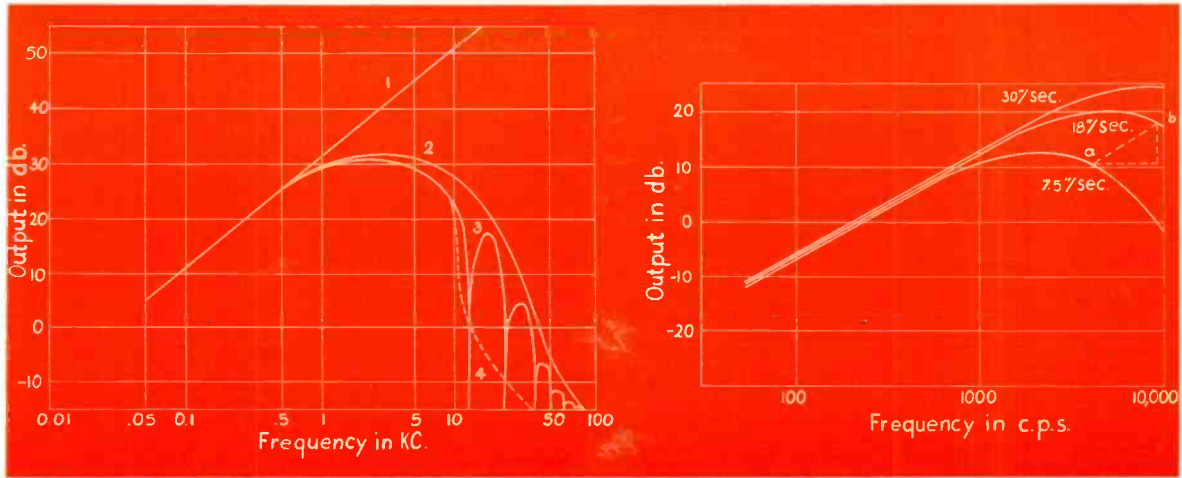

Fig. 1 (left). Showing Curve 1, the 6 db/octave increase inherent in constant current recording; Curve 2, the effect on Curve 1 of the demagnetizing forces; and Curve 3, the addition of the characteristics of the reproducing head. Curve 4 is added to illustrate the desirability of an amplifier cut-off at high frequencies. Fig. 3 (right). Showing the effect on the frequency response characteristic obtained by changing the speed of the tape drive. American tape.

obtain Curve 3 which shows the over-all frequency response of the magnetic recording system dissociated from amplifier characteristics.¹

The chief contributors to Curve 3 are the remanent flux pattern on the tape and the geometry and permeability of the reproducing head. For purposes of illustration it has been tacitly assumed that the tape and its flux pattern were driven at some constant velocity across the reproducing head. This permits the

¹It is advantageous from two considerations that the amplifiers cut off as abruptly as possible at frequencies above those which we intend to record. This sharp upper cut-off is illustrated by the dashed Curve 4, Fig. 1. This cut-off has these beneficial effects: a) it reduces the background noise to the extent of reducing the contributions in the upper frequency range, and b) it represses harmonic distortion to the extent that harmonics above cut-off frequency will be suppressed.

plotting of the output against frequency " f " although the wavelength " λ " is the basic constant upon which the flux pattern depends.²

We are now in a position to predict the effect on the frequency response curve of using the same recording and reproducing system at a different velocity of tape drive. For constant current recording the flux on the tape will be identical, wavelength for wavelength, independent of the velocity.

Because the output of the reproducing head is proportional to the rate of change flux, if the velocity is halved the output is reduced 6 db. If the velocity is halved, any given wavelength corresponds to half the frequency. The effect of a velocity change would be that of moving Curves 2 and 3 along Curve 1 until any

²The equation for the velocity " v " is obviously $v = f\lambda$.

reference point on the curves corresponding to a given wavelength for the initial velocity reaches the frequency corresponding to the new velocity.

The effect of changing the gap width of the reproducing head is more complex and will not be discussed here beyond the mention that the effective gap is not equal to the physical gap width.

The Loop Tester

Because it offers the convenience of being able to study a small sample of wire or tape for any given length of time, most laboratories engaged in the study of recording materials employ loop testers. On this device a loop of tape or wire is driven continuously and repeatedly over erase, record and playback heads. An example of a loop tester with the associated instruments is shown in Fig. 2. Separate variable oscillators and amplifiers are provided for the bias

Fig. 4 (left). The frequency response is shown to vary with the coercive force of the coating material in a manner similar to that obtained by a velocity change. Experimental tapes. Fig. 5 (right). Illustrating the law of diminishing returns applied to coating thickness on a tape. Experimental tapes.

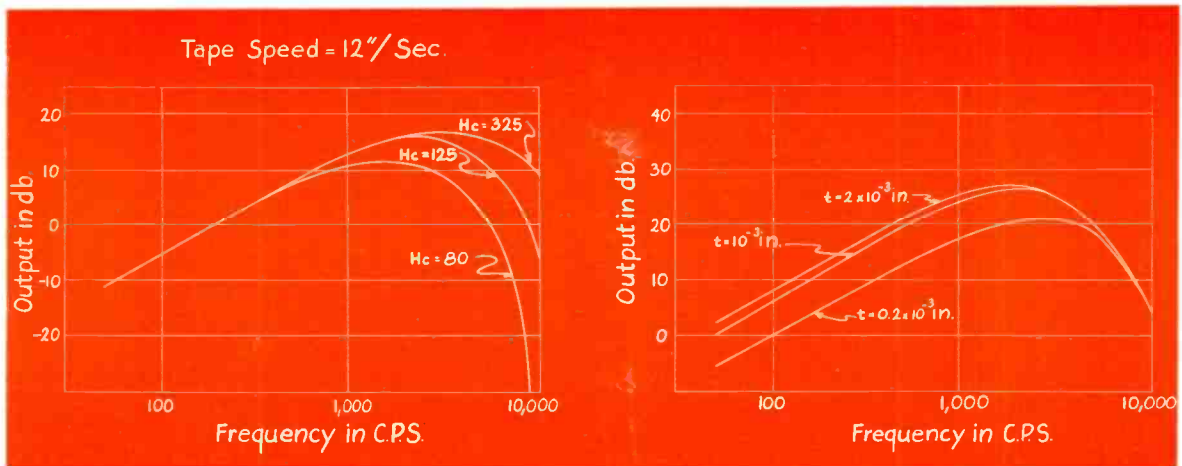

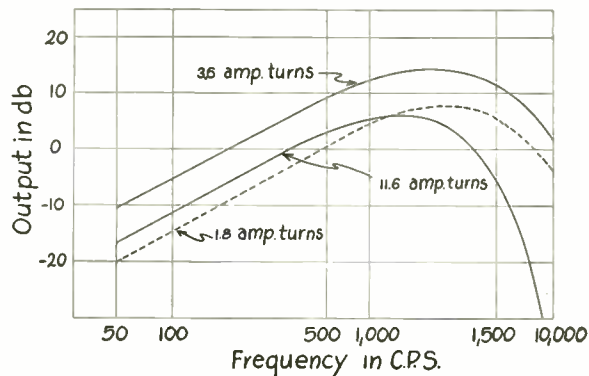
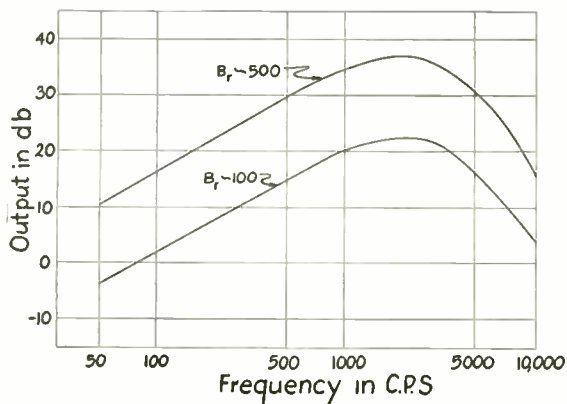

Fig. 6 (left). Showing the effect of varying the remanence of a coating material. Experimental tapes. Fig. 7 (right). Showing the influence on output of varying the bias current. Note the decrease in output at high frequencies obtained from an excessively high bias. American tape.

and erase supplies. The audio signal or signals are obtained from audio frequency oscillators which have sufficient output to supply the recording current without additional amplification.

The output of the playback head is amplified and examined in an oscilloscope, on a Ballantine voltmeter or the wave analyzer. A low pass filter cutting off at 16 kc is incorporated in the output amplifier to eliminate the pick-up of bias and wipe frequencies. Similarly, high pass filters suppress the power line frequencies in the bias and wipe amplifiers.

This combination of instruments permits one to make many of the determinations required to evaluate tapes. The graphs illustrating the remaining portion of this article were assembled from measurements taken on this equipment. The plots are generalized and occasionally represent smoothed readings. The omission of reference voltages and specifications of the heads is intended to indicate the generalization.

Miscellaneous Observations

In the discussion of the general theory we have made certain predictions concerning the effects of variables on the output characteristics. We shall illustrate a number of these effects by considering the results obtained on the loop tester.

The effect of increasing the velocity of the tape drive was shown to be the shifting of each point on the frequency response curves along a 6 db octave line. The curves shown in Fig. 3 give the results obtained on an American tape by varying the speed holding all other factors constant. The triangle illustrates the construction proposed by Holmes³ for calculating the response for any velocity if it is known for one velocity. Point *a* on the 7.5"/sec. curve transferred to point *b* on the 18"/sec. curve along the hypotenuse of a triangle

sloping at 6 db/octave whose base is the $\log \frac{I_2}{I_1}$ or $\log \frac{v_2}{v_1}$.

Fig. 4 shows the frequency response as a function of H_c alone. Since it is difficult to obtain materials of the same remanence but widely different values of the coercive force, the curves were "normalized" by shifting them vertically until the response at the lower frequencies coincided. It will be observed that the increase in velocity has essentially the same effect as an increase in H_c . Other factors being equal, the high coercive force tapes may be used at lower, more economical speeds.

Fig. 5 shows the effect of varying the thickness of a tape and consequently the total flux Φ which would be observed in the hysteresis loop tester. Increasing the flux Φ by a factor of five increases the output of the lower frequencies by only 6 db or a factor of two. There is no change at the high frequency end of the spectrum. This tendency of the curves to approach one another at high frequencies was first mentioned by Kornei⁴. It may be attributed to the lack of penetration of remanent induction into the tape for short wavelengths after demagnetization forces have come into play. At a tape speed of 7.5"/sec. a 7.5 kc tone will record with a wavelength of .001". The spacing along the tape from center to center of the pole pattern is therefore .0005". In a thick tape after demagnetization very little contribution to the remanent flux from depths greater than .0005" would be expected. It is therefore immaterial for short wavelengths after the demagnetization equilibrium has been established whether the original flux distribution penetrated the tape to a depth of one mil or one inch. Similarly, it should be immaterial from the standpoint of output at high frequencies whether a tape be one or two

mils thick. There is no reason to assume that bias frequency flux in the recording gap does not penetrate as deeply into the coating as the audio frequencies. The penetration effect observed is the result of the geometry of the flux after demagnetization.

Fig. 6 illustrates results obtained from conditions which were identical in all respects except that the value of the remanence differed by a factor of five. The predicted increase of 14 db at low frequencies is found. In this case, the high frequency determinations are questionable. Although the curves approach one another at 10 kc, because of the inaccuracy of the measurement it cannot be concluded that they prove the prediction that a change in remanence has a smaller effect on the output at high frequencies. What may certainly be concluded is that Figs. 5 and 6 show B_r rather than Φ to be more nearly the determining factor in the output of tape.

Fig. 7 shows the effect on frequency response of bias current variations. As will be seen later the output curve as a function of bias current develops a sharper peak at high than at low frequencies. As a result a high value of bias current causes a drooping characteristic at the higher frequencies. The bias of 11.6 ampere turns was chosen deliberately to be very high to illustrate the point.

Noise

One of the more interesting studies made on a loop tester is that of the spectral distribution of noise. Since some aspects of the distribution serve to illustrate the behavior of modulation or under-signal noise, it may be well to consider such curves. Fig. 8 shows data taken with a Brush KB919 reproducing head on a good sample of German Type C tape driven at a speed of 21"/sec. Curves *a* and *c* have been smoothed off peaks attributed to power frequencies in the output amplifier and to pick-up from the

³ Lynn C. Holmes, "Some Factors Influencing the Choice of a Medium for Magnetic Recording," *J. Acoustical Soc.*, 19, 395, 1947.

⁴ Otto Kornei, "Frequency Response of Magnetic Recording," *Electronics* 20, 124-28, August 1947.

motor drive. All measurements were made on the 30-cycle half band width setting of a Hewlett Packard Harmonic Wave Analyzer. The noise distribution after an a-c erase is shown by Curve *a*. Curve *b* shows the distribution after a saturating d-c wipe. The effect of the d-c wipe has been that of increasing the noise level at all frequencies. Curve "c" shows the distribution of noise after applying an a-c wipe and recording a moderately strong 400-cycle note on the tape. It will be seen that, in addition to the presence of the fundamental and the third and fifth harmonics, a broad distribution of noise has been recorded. For frequencies well above 400 cycles the effect of recording has been the equivalent of wiping with a d-c field somewhat less than that required for saturation. At frequencies below 400 cycles the noise drops off to approach the a-c erased level.

Two rather striking features of the modulation noise are: the small peak located at 800 cycles or the second harmonic point, and the very substantial noise contributions in the neighborhood of the 400 cycle peak. The curve has not been corrected for the pass band of the analyzer, but it may be stated that the contributions near the peak greatly exceed the filter correction. As Holmes¹ has shown, the amplitude of the under-signal noise as a function of a recorded d-c field increases with the field up to a saturation value. Any portion of the 400 cycle wave may be considered to be the application of an instantaneous d-c field accompanied by a corresponding value of the under-signal noise. The greatest value of the noise will occur at the peaks of the recorded induction, falling to zero as the induction goes to zero. The modulation envelope for this noise distribution has therefore twice the frequency of the recorded note, and the small peak at 800 cycles is believed to represent this modulation frequency.

Chapin⁵ has offered an explanation of the noise in the neighborhood of the parent frequency. Unfortunately, the abstract of the paper does not present his theory completely, however, the author understands it to be based on sum and difference frequencies between noise at lower frequencies and the parent 400 cycle frequency.

The noise developed during recording has come to be known as under-signal or modulation noise. The scale of Fig. 8 was chosen to illustrate the noise, and the reader should note that the peak of the fundamental lies about 50 db above the d-c wipe level. The maximum 700 cycle signal at 2.5% distortion to over-all noise for the tape was 68 db while the signal to total d-c wipe noise was 46 db.

When a new tape is examined, the noise level is found to be quite low. It is frequently stated that wiping such a tape increases the noise background. While this may actually be observed, it usually may be traced to one or more of three difficulties. The erase fields are not sufficiently strong to saturate the tape or the erase head design does not allow for the many decreasing alternations in the field required for a good wipe. The wipe may have a d-c component which will result in recording the d.c. as "idealized" magnetization. This will result in under-signal or modulation noise. The d-c component of the wipe may be caused by a non-symmetrical wave form in the oscillator, the unbalanced plate current of a push-pull amplifier coupled directly to the head or by permanent magnetization or the erase head core. If these wipe difficulties are avoided, it is possible to reduce the noise background to a point lower than that of new or virgin tape.

⁵ D. M. Chapin, "Measurement and Calculation of Under-Signal Noise in Magnetic Recording," Program 33rd Meeting Acoustical Soc. Am.

Similarly, noise contributions may arise as the result of passing the tape over the recording head. Permanent magnetization of the recording head, a d-c component in the bias current or asymmetry of the wave form give rise to modulation noise through reordering of the d-c component.

Permanent magnetization of the playback head gives rise to noise by two processes. First, after passing the head, the tape will have been magnetized and modulation noise developed for the next playing. Second, during play the flux in the magnetized head varies with the reluctance of the gap. Thus, in addition to magnetization, any variations in the coating material cause a variation in gap reluctance which will show up as noise.

There are conflicting opinions regarding the possibility of generating noise on a neutral tape by passing it over a recording head which carries bias but not audio excitation. Some observers find the noise level to have increased under these conditions. Equally careful observers find that by removing any trace of a d-c field component from the recording head the noise level remains unchanged over that of the erased tape.

The noise, if present and not due to a d-c component of the recording field, must be attributed to modulation noise caused by the bias frequency. While the data of Fig. 8 may be considered to be reliable for region of frequencies above 200 cycles, the readings below are not sufficiently accurate to draw positive conclusions. The modulation noise curve is shown approaching the a-c wipe curve at low frequencies. The fact is that it is certainly well below the d-c wipe curve, but we cannot be certain it falls off as rapidly as shown. Unfortunately, this prevents our drawing conclusions from

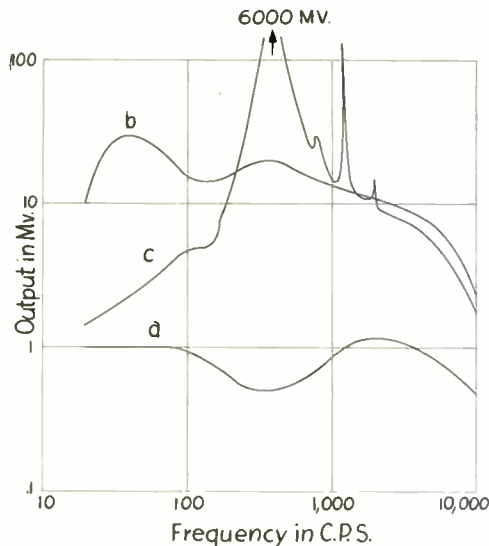
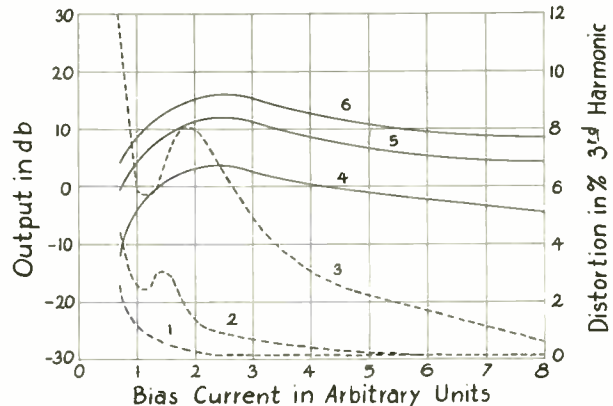

Fig. 8 (left). Noise analysis on a German tape showing the distribution for a) an a-c erase, b) d-c wipe, and c) the noise developed upon recording a 400 cycle signal. Note that the values below 200 cycles on Curve "c" are not dependable in detail but indicate the trend.

Fig. 9 (below). The third harmonic distortion and the output at 1000 cycles, 9.2" sec is shown to vary with the bias current. Distortion at 1) 5 db, 2) 10 db and 3) 20 db input levels. Output at 4) 5 db, 5) 10 db and 6) 20 db input levels. American tape.



this curve as to the possibility of a super-sonic bias generating lower frequency audible noise.

Distortion

Intermodulation distortion measurements have been made on recording media by at least three laboratories, but for one reason or another this method of evaluation has not been generally adopted. When distortion is considered in tapes or wires, it is usually harmonic or amplitude distortion which is meant.

If a magnetic medium is saturated by a d-c wipe and the recording is made with either a-c or d-c bias, the operation is performed on an asymmetric transfer characteristic. This permits both even and odd harmonics to develop. In addition to the lower noise levels generated, the use of a-c bias on a tape erased to a neutral condition provides for operation on a symmetrical transfer characteristic curve which eliminates the even harmonics. Thus we see in *Fig. 8* with the exception of a small contribution to the second harmonic attributed to the modulation frequency of the under-signal noise, the harmonics observed are the third and fifth.

It is interesting to note at this point that one form of distortion which may be recorded is the beat frequency of this fifth harmonic with the bias frequency. If a 30 kc bias is used and we record say a 6,050-cycle audible tone, a 250-cycle beat note appears as distortion. This gives rise to the very practical rule that the bias frequency be at least five times that of the highest frequency one expects to record.

Returning to the subject of harmonic distortion we find two methods in general use for its evaluation. The first employs the conventional 400-cycle distortion meter which has a flat rejection filter on the band from 350 to 400 cycles. A 400-cycle note is recorded and the output through the filter measured as total distortion. Because of the peculiarities of modulation noise, this practice may be

questioned, since from *Fig. 8* we may deduce that appreciable contributions to the modulation occurring near 400 cycles but outside the rejection band of the noise meter, will be counted as harmonic distortion. To this will be added the modulation noise contribution generated at all higher frequencies. The second method, which has tentatively been adopted in this laboratory, is the measurement of the third harmonic component on a wave analyzer. The fifth harmonic is usually negligibly small.

Fig. 9 shows the per cent third harmonic distortion as a function of a-c bias for recording on a demagnetized American tape. Output curves are also plotted in accordance with the practice introduced by Holmes¹. It will be seen that maximum output is found in a region of bias for which distortion is high and lower distortion must be obtained by sacrifice of output. At first glance the regions of low distortion at low bias values may appear attractive. For two reasons they should not be used; first, they represent sharp minima which occur at different bias values for different recording levels, and second, they correspond to very low output levels. These minima correspond to recording on the toe developed in a transfer characteristic for the under-biased condition. It is the situation which causes disappointing results when high coercive force American tapes are used on machines whose bias is set for good results on low coercive force German tape. The proper condition for bias is a compromise between distortion and output on the portion of the curve beyond maximum output. Here the bias value is not critical, i. e., small shifts in bias will not cause large changes in distortion.

Recording on a machine designed with a sharp high frequency cut-off develops its distortion only at low frequencies. Suppose we expect to record up to 10 kc and provide a sharp cut-off in the output amplifier at this point. Fifth harmonics

of 2000 cycles and third harmonics at 3333 cycles and above are eliminated. At high frequencies distortion may be neglected and output alone considered in choosing the bias.

Fig. 10 shows the output of a tape as a function of bias current for a number of frequencies. It will be seen that at the higher frequencies the fall from maximum output is steeper than at low frequencies. These observations will be found to correlate with the curves of *Fig. 7*.

One form of distortion inherent in wire recording does not occur in tape. This is the effect of rotation of a wire on high frequency response. In the "U" shaped recording gap through which wire travels, only the portion of the wire in contact with the head is magnetized at high frequencies. This corresponds to the penetration effect in tape (*Fig. 5*) as a function of wavelength. If on playback the wire is rotated 180°, the weakly magnetized portion contacts the reproducing head resulting in serious deterioration of high frequencies. If wire is used carefully, unless a break occurs and splicing is required, there are only accidental forces which tend to rotate the wire. There is some probability that upon repeated playback the orientation remains essentially the same.

Fig. 11 shows a second effect in wire recording which causes non-uniform increase in response with increasing frequency at the lower end of the spectrum. The non-linearity of the frequency response at low frequencies is attributed to poles arriving at and leaving the reproduce head simultaneously. Some flux from these poles which is by-passed through the pick-up coil may aid or oppose the flux pick-up in the gap. That the effect should occur in wire and not tape is attributed to the surface area of wire being small compared with tape. This allows for precision contact of wire entering and leaving the head. The

[Continued on page 46]

Fig. 10 (left). An American tape used to illustrate the effect on output caused by bias variations at different frequencies at the same level (10db) of recording. **Fig. 11 (right).** Showing the irregularities in the response curve of a wire recording. These variations from linearity are not observed for tape.

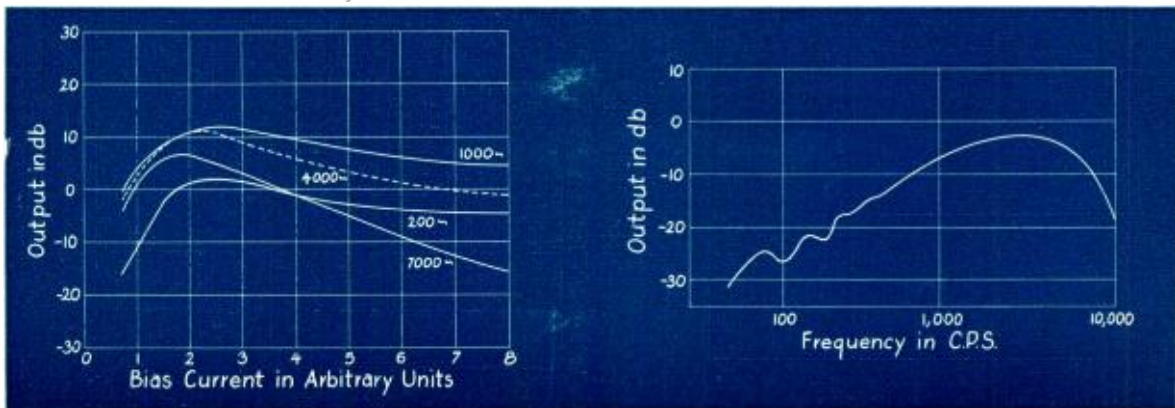

Economic Considerations in Industrial Ultrasonics

S. YOUNG WHITE

Factors of importance in commercializing industrial ultrasonics.

SINCE the purpose of this series of articles is to present some rather simple theory of the action of ultrasonic energy, but with the main emphasis on the economic side, let us review what has been presented commercially so far.

It seems obvious that the key to exploitation of the art lies primarily in the generator. Impedance matching, transmission over a distance, and boundary layer problems are vital, but if there are no generators of a few hundred watts up to perhaps a thousand kilowatts, with long life and trouble-free operation over a period of months or years, the future is limited. Replacement of a simple part, such as a nozzle, can be considered practical if called for every few weeks or months.

Efficiency

Efficiency is also of great importance in many applications. This is not universal, because if we have a "jewelry" type load, such as a high-speed tool bit to make more dense, tough and uniform, we could afford to spend a kilowatt hour of power on it. We see this taking place in radio-frequency heating of metal parts, where due to the size and shape of the piece worked on, only a few per cent of the energy drawn from the line is actually effective in the piece itself.

In loads that run to high tonnage per day and possibly require a thousand kw or so, efficiencies of energy transfer into the load cannot be considered if they average only a few per cent, unless the product is extremely high-priced. The development cost of huge equipment is enormous, and if we must handle twenty kw to put one in the load, few industries will be able to consider using it.

In the higher power range, steam is a cheap source of energy, often running a half cent kw hour or less, and is often available in huge supply in existing plants. An oil refinery, for instance, has a great surplus of steam power available, which they obtain from the unusable lighter fractions that they would "flare off" (burn up) anyway. A steel mill usually has a few hundred

hp excess capacity steam. And if steam is attractive due to its thermodynamical characteristics we need not be reminded an electrically fired steam boiler is 98% efficient.

If you decide on compressed air operation for large loads, a centrifugal turbine driven compressor is pretty efficient up to 40 pounds pressure. Since these are high rpm jobs, they go well with a turbo-jet ultrasonic generator that could be mounted on the same shaft, and it could operate up to 500 kw per rotor, if desired.

a device such as the turbojet generator already described, it needs some superheat. Wet steam has great erosive properties due to the velocity of the water particles in it traveling at considerable speed and impinging on a surface. In the rotor of the turbojet unit the velocities involved would cause the wet steam droplets to hit the moving parts with forces of the order of 40 tons to the square inch or higher, causing considerable rotor wear in a short time. So a hundred degrees of superheat would be necessary.

Fig. 1. A simple method of designing a self-modulated jet. See text.

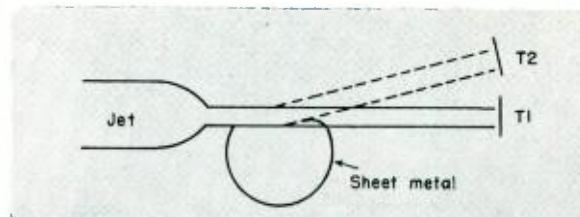

There is one range of powers that we have considered only briefly—from perhaps 50 watts to a kilowatt. It seems reasonable that if ultrasonics is ever in general use in large numbers of units, it must enter the home or shop in small units of this power requirement. A shining example is the home laundry application, etc.

Power Source

We must keep in mind that even though our ultrasonic device were 100% efficient, and cost nothing to produce, it must still have a source of power suitable to it. If we need a few kw of compressed air, and there is no air supply on the premises, a compressor is noisy, expensive, and not too efficient. A small steam boiler can also be quite a nuisance, especially the boiler feed water and safety angles. A water pump is cheap and efficient and fairly quiet if the proper type is chosen. If we consider something in the way of an electro-acoustical transducer, such as magnetostriction or quartz, we have the expense of a high-power electronic oscillator.

Steam is also subject to another difficulty. If you intend to use it in

The sources of power readily available in most locations are 110 or 220 volts, 60 cycles. We often have a water tap available that will deliver 10 to 20 cubic inches a second at a pressure of 40 pounds or so, representing a power of 50 to 100 watts. Many places also have gas for heating.

For widespread use of a few hundred watts of ultrasonic energy, then, we must work with these limitations. The ideal generator would be a crystal transducer of a few ohms impedance which we could hook directly across the 110-volt line and have the 60 cycles shock excite it into continuous oscillations at say 25 kc or so. Unfortunately, mother nature has not provided us with such a device, and there seems little likelihood of it ever being discovered.

Use of the water supply seems distinctly hopeful. It already contains say 50 watts of energy as it comes from the tap in most places. The main problem then is to modulate it into discrete bullets or slugs separated by twice their length, as shown previously.¹

Any self-resonant oscillator using a fluid medium, such as an organ pipe of whistle, seems to have an inherent efficiency of about 3 or 4 per cent.

Expressed another way, the percentage modulation seems to be limited to that figure. Even the Hartmann generator, which operates with what might be termed "solid air"—that is, air moving at sonic velocity and consequently obeying a different set of rules than the normal ones—has the same limitation.

This problem must be overcome. We cannot build a useful art on 4% efficiency, and the jet or whistle principle is too simple and obvious to be overlooked in our search for the ideal small generator. If we reach high efficiencies with water in the jet, we shall probably have terrific impact values from our deliberate high values of what is almost equivalent to turbulence. This we can hope to overcome two ways—first by using erosion-resisting materials such as carbonyl and, second, when we understand the laws of fluid flow better in the special case of small jets of this nature, we can arrange to have the water impact fall on a fluid instead of on the solid material forming the jet.

This last thought needs a little elaboration. Observation teaches us the ocean can wear away the shore, but the shore cannot wear away the

Self-Modulated Jet

In our search for a 100% self-modulated jet, the arrangement shown in Fig. 1 is of interest. It is well known that a well formed jet of water from a well designed nozzle at proper pressure will maintain its uniform cross-section for some distance—at least for an inch or so. So we arrange to have the jet impinge on target No. 1 directly in its path, to which it will give a steady d-c push, which does not interest us. If we take a thin strip of metal and form a deflector as shown and insert it partly into the stream, it will pick up a portion of the water, bring it around in a smooth curve, and strike the stream near the nozzle. This should give a right angle component that will deflect the main stream to target No. 2. The deflection must be sufficient so that the stream no longer hits the deflector, thus stopping the stream around the deflector and removing the right angle component so the stream returns to its original position, and the process is repeated. Since the stream alternates between the two targets, a.c. is produced.

The writer has not tried this out, giving it as an example of the kind of

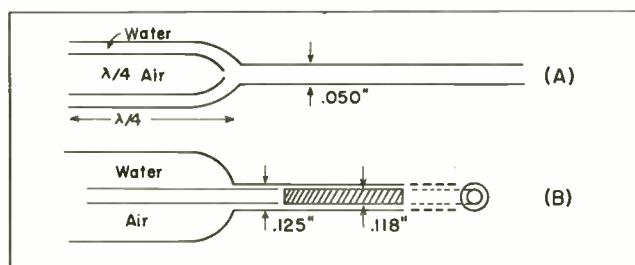

Fig. 2. Interrupter jet. The position of the air injection point in (a) is critical. In (b), the insertion point is not so critical.

ocean. A fluid at high velocity can erode almost any solid in time, but remains unaffected itself. On the other hand, a fluid impacting on a fluid may develop any value of shock impact pressure up to infinity and not "wear out." Of course, it may turn into steam, or suffer chemical changes which may be highly desirable or the reverse, but it is certainly not subject to erosion.

This thought allows us to hope that intelligent design will provide a fluid cushion to absorb high power density without harm, and also act as a power distributor to take the high unit powers and spread them over a larger area, so that we have the same power, but at lower unit values.

In this discussion we shall use the term "air" for any highly compressible fluid, and "water" for a relatively incompressible fluid. In general, the compressible fluid has much less density than the incompressible one—in round numbers, about one-thousandth as much, for instance, so its mass can be neglected. We could also work with hydrogen and mercury, for an extreme case.

thinking that must be done on jets in general. There is a nice phasing and amplitude problem in this arrangement, but we have the mechanical stepup of the angle of deflection of the jet, which can be theoretically very large. It has the great advantage of simplicity, but we should be able to try it out with water pressure from the faucet and obtain medium audio frequencies out of it. A proper nozzle will give you nearly 50 feet a second velocity from the kitchen faucet. This should also be tried with compressed air.

A more important type of interrupter jet is shown in several forms in Fig. 2. Here we arrange to introduce air in disciplined bubble form in a stream of water. We always start with a water jet of more or less conventional design, which performs the usual function of converting the static head pressure of the water to velocity head, having kinetic energy.

Concentrically mounted inside the water jet (WJ) we have a critically adjustable air jet (AJ). At this point it begins vaguely to resemble our old

friend, the aspirator. If operated this way, with no detail to give an a-c component to our air or water pressure or velocity, it would simply mix the two in the usual aspirator fashion. To remind you of your high school physics, the water jet so completely changes the static head to kinetic or velocity, that there is no pressure at all left, so the pressure in the throat of a venturi is practically zero absolute. The air outside is still at 14.7 pounds absolute, so it is forced into the aspirator and mixed in random manner with the water. Again to remind you, you can easily obtain 26 inches of vacuum this way.

Jet Size

What diameter shall we make the jet? Since our object is to generate a.c. by "pushing" in one direction only when our water slugs hit a target, we can effectively push only one third of a cycle, allowing the elasticity of the load to carry on for the complete cycle. Therefore our water slugs must be separated by twice their length.

If we set up a trial case of one inch diameter and with cylindrical slugs one inch long, each complete cycle is represented by one slug with two air slugs for spacers. The assembly would be three inches long, and if we wanted 24,000 per second, our velocity would be 72,000 inches/sec, or 6,000 feet a second, which is pretty high, although possibly attainable.

If we go to one-tenth inch diameter our necessary velocity comes down to 600 ft/second, and so on. So we calculate about .050 inches (50 mils) is a nice size for experiment, with 300 ft/sec and a power of about 67 watts or so. We must start with an initial velocity of the water of about 100 ft/sec, which requires about 125 pounds pressure through a good orifice.

For initial experiment, though, we could design for say 5,000-cycle operation, and then the initial water pressure can be usually obtained from a faucet. Also the air compressor requirement can be met by the usual small compressor we often have in a shop.

The theory of such small jets and pipes is not very well understood. You are operating at such high Reynolds's numbers that you are off the tables completely. It is necessary that internal parts be well contoured and smooth to minimize turbulence.

In Fig. 2A the position of the air injection is bound to be very critical as in the length of the water jet proper there is a complete conversion from pressure to velocity. In Fig. 2B however, this is obviously not so serious, as it is pure velocity at the insertion point.

[Continued on page 47]

PRESENTING NEW **E-V 635**

HIGH FIDELITY DYNAMIC MICROPHONE

For Studio and Remote
BROADCASTING



Chuck Acree, well-known radio personality, shown using E-V 635 on network audience participation programs.



Substantially flat out to 13 kc.
Individually Laboratory Approved... Quality Certified
Now in Use by Prominent Broadcast Stations

Engineered for the exacting requirements of broadcast service . . . this new E-V 635 is proving its *quality* and *versatility* on important radio network programs. Substantially flat, wide range response (60 cycles to 13 kc, plus or minus 2.5 db) conforms to modern FM as well as AM standards . . . assures faithful reproduction of speech and music. *Omni-directional* below 2000 c.p.s., becoming directional at higher frequencies . . . effective for group or individual pick-up. Output -53 db.

The 635 is *excellent, dependable* for announcing, audience participation, applause pick-up, roving reporter, sports, special events, recording . . . and for high quality sound amplification systems. *Can be used on a stand or in the hand*—indoors and outdoors. Recessed switch in microphone stud gives ready selection of 50 or 250 ohms impedance. Fully guaranteed. *Try it . . . test it . . . see and hear it for yourself!*
Model 635 Broadcast Microphone. List Price..\$60

Send now for Bulletin No. 135

AUTHORIZED DISTRIBUTORS EVERYWHERE



No Finer
Choice Than

Electro-Voice

ELECTRO-VOICE, INC., BUCHANAN, MICHIGAN

Export Division: 13 East 40th Street, New York 16, N.Y., U.S.A. • Cables: Arlab

TECHNICANA

807 AMPLIFIERS

• Two types of 807 amplifiers are described in the March-April 1947 issue of *Radiotronics* by R. H. Aston, one of which supplies thirty watts of output power with a plate voltage of 450, while the other is capable of supplying forty-five watts with a plate supply voltage of 670. Both amplifiers are similar in arrangement, employing a 6SJ7 as a

pentode first stage, a 6SJ7 as a triode for the second stage in a cathodyne circuit, and the 807's in the final stage. Resistance coupling is used throughout.

The output transformer has extremely close coupling between primary and secondary windings, and care must be exercised to keep phase shift to a minimum throughout the feedback loop. The values shown in the schematic are for the 30-watt condition. For 45 watts output, R_1 is 2950 ohms,

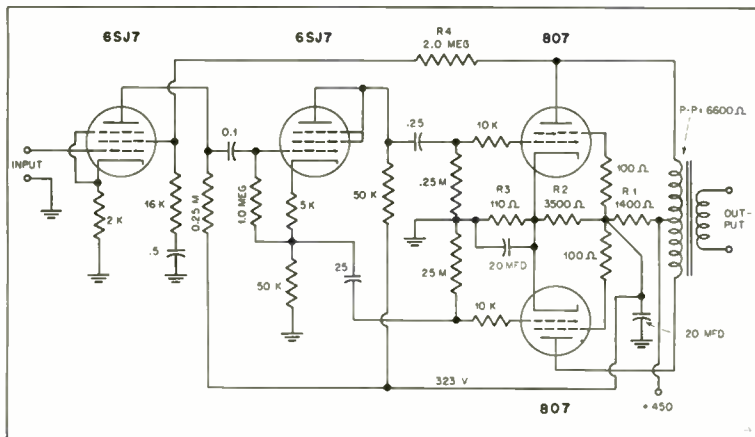

pentode first stage, a 6SJ7 as a triode for the second stage in a cathodyne circuit, and the 807's in the final stage. Resistance coupling is used throughout.

The basic schematic is shown above with the essential features being incorporated in the circuit. The feedback arrangement is rather unusual, since a direct connection is made from one 807 plate to the screen of the first tube, with a dropping resistor in series, and a series resistor and capacitor for partial by-passing. It will also be noted that each 807 screen is isolated from a-f ground by-passing by means of a 100-ohm series resistor, and the two control

R_2 is 2750 ohms, and R_3 is 134 ohms, and the plate voltage is raised to 670 volts. The feedback resistor R_4 becomes 3.0 megohms, and the plate-to-plate load offered by the transformer is increased to 10,000 ohms.

PARMLY ANECHOIC CHAMBER

• The recently completed Anechoic Chamber, constructed by the Parmly Foundation at Technology Center, Chicago, is the subject of a complete constructional description in the November 1947 issue of *J. Acous. Soc. Am.* under the authorship of Peter J. Mills. The same issue contains an analysis of the performance of this chamber, by H. C. Hardy, F. G. Tyzzer, and H. H.

Hall. The anechoic chamber is a section of a complete sound laboratory.

The chamber itself is a 40-ton structure of concrete steel, wood, and sheet-rock, fully suspended on Neoprene pads to have a natural frequency well below the audible spectrum—at four and a half cycles per second. Ventilation is furnished through ducts having sound insulation of 90 db at 128 cps, and the inside of the chamber has an absorption of 99 per cent at frequencies of 115 cps and above.

The interior of the chamber is lined with Fiberglas wedges having an eight-inch square base and a height of 29 inches, and a total of 2,320 wedges was used. The constructional data even provides information on the time required to cut and install the wedges—a total of 235 man hours being required to fabricate them and 144 man hours to install them. An additional 52 man hours were required to make the plugs and the door, also covered with wedges. The plugs are used to cover the ventilating ports when complete closure is necessary.

The chamber has been thoroughly measured over a band of frequencies from 60 to 24,000 cps, and the sound absorption follows the inverse square law very closely. Sound transmission through the walls from the outside is approximately 70 db below 150 cps, and increases to 140 db at 2,000 cps.

NEW UNIT OF RESISTANCE

• The International Committee of Weights and Measures which met in Paris in October, 1946, adopted what is known as the absolute ohm as a unit of resistance. The present International Ohm (U. S.) is equal to 1.000495 absolute ohms. This makes the absolute ohm about 1/200% smaller than the present unit of resistance (International Ohm) now used.

Since most leading manufacturers of precision electrical measuring equipment have adopted this new unit, it will be necessary to manufacture precision resistors of 0.1% accuracy or better to this new standard.

IRC, in keeping with this new standard, will manufacture all precision resistors of 0.1% tolerance to the new absolute ohm standard. These units will be identified by "abs" stamped on the label. This conversion will take place by January, 1948, at which time all the precision instrument manufacturers plan to convert.

PROFESSIONAL DIRECTORY

C. J. LeBEL
AUDIO CONSULTANT

370 RIVERSIDE DRIVE
NEW YORK 25, N. Y.



Custom-Built Equipment

U. S. Recording Co.

1121 Vermont Ave., Washington 5, D. C.

District 1640

Winston Wells

Designer and Consultant

Acoustical and Electronic Research

307 East 44th St.

MU 4-3487

New York 17, N. Y.

Now Available...

New, important additions to the most complete line of Speakers and Driving Units made

To the more than 60 different type and size speakers and horn units that already comprise the RACON line—these new models have been added. There is a RACON speaker and horn unit ideal for every conceivable sound system application.

RACON has not only the most complete line, but also the most preferred line. For over 20 years leading Soundmen have recognized and specified them because of dependability, efficiency and low-cost, and because the reproducers are trouble proof.

Here is a partial list of the various types of RACON products now available:

PM Horn Driving Units, 10 types	Straight Trumpets, 21 types
Re-entrant Trumpets, 7 types	Re-entrant Fone Speakers, 7 types
Tweeter & High Frequency Speakers, 3 types	Flat bell straight trumpets, 2 types
Radial Horns and Speakers, 3 types	Armored Cone Projectors, 7 types

In addition there are cellular and auditorium horns, inter-com, paging, monitor, and dwarf speakers, cone speaker housings, etc., besides all basic accessories such as swivel brackets, mounting units, cone housings, multiple horn throat combinations, etc.

Write for free catalog

RACON ELECTRIC CO., INC.

52 East 19th St.

New York 3, N. Y.

RACON



NEW SPÉCIAL PM HORN UNIT having Alnico V magnet ring, completely watertight, housed in a heavy aluminum spinning. Provides extremely high efficiency reproduction with minimum input. Handling capacity 35 watts continuous, 60 w. peak.



NEW SMALL RE-ENTRANT HORNS, extremely efficient for factory inter-com and paging systems; for sound trucks, R.R. yards and all other industrial installations where high noise levels are prevalent. Watertight, corrosion-proof, easily installed. Two new models — type RE-1½, complete with Baby Unit, handles 25 watts, covers 300-6000 cps; type RE-12, complete with Dwarf Unit, handles 10 watts, freq. response of 400-8000 cps.



NEW RADIAL RE-ENTRANT SPEAKER, excellent for all types of industrial sound installations. Provides superlative and complete speech intelligibility by efficiently over-riding factory high noise levels. Frequency response 300-6000 cps. Handling capacity 25 watts continuous, 35 w. peak. Has mounting bracket. Size 12" wide by 12½" high.

NEW PRODUCTS

BROOK AMPLIFIER

Newest addition to the complete line of Brook high quality audio amplifiers is the Model 10-D, a 30-watt rack-mounting unit with 75 db gain and equipped with volume control and on-off switch on front panel. As in all other Brook Amplifiers, Model 10-D uses triodes throughout.



Designed essentially for broadcasting stations, recording studios and high-quality public address installations, Model 10-D provides frequency response 20 to 20,000 cycles within *two-tenths* of one db. At five watts harmonic distortion is only 0.6% and intermodulation distortion only 0.2%. Total distortion is under 2% at full 30-watt output. Power supply is self-contained. Noise level is 70 db below full output. Power available for external tuner or pre-amplifiers—250 volts at 90 ma and 6.6 volts at 5 amperes.

Full information and technical sheet may be obtained by writing Brook Electronics, Inc., 34 DeHart Place, Elizabeth, New Jersey.

MULTI-PURPOSE TESTER

Just announced for delivery by Simpson Electric Company, Chicago, is their new Model 1005 Electrical Laboratory, a new multiple purpose test instrument. Designated by its makers as a complete test unit for use by radio, electronic and electrical technicians in laboratories, shops or service departments, the Laboratory is said to combine the functions of over sixty separate instruments. It consists of six individual 4½" rectangular instruments, each with a complete set of ranges.

In addition to the wide variety of a-c and d-c voltage and current ranges, a multi-range ohmmeter and a single phase wattmeter have been incorporated. Also, to meet the need for extreme sensitivity required in testing circuits where only a small amount of current is available, an instrument is provided with a sensitivity of 50 microamperes, providing 20,000 ohms per volt on all d-c voltage ranges. The Electrical Laboratory incorporates a rectifier type instrument for measuring a-c voltage with a resistance of 1,000 ohms per volt on all

ranges. This latter instrument also has in combination a complete coverage of db ranges from minus 10 to plus 55 for volume indications.

CONTACT MICROPHONE

An interesting bulletin on the E-V Model 805 contact pick-up microphone for stringed instruments has been issued by Electro-Voice, Inc. Bulletin No. 136 fully describes this new product which is designed to provide smooth natural sound reinforcement of instrumental music: guitar, banjo, mandolin, violin, viola, cello, harp, drum, and piano. A copy will gladly be sent on request. Write to Electro-Voice, Inc., Buchanan, Mich.

MAGNETAPE RECORDERS

Among the more popular models in the new series of Magnetape Recorders now being produced by the Magnephone Division of the Amplifier Corp. of America are the portable series.

The user is offered a selection of 4 different models in the portable series, depending on the frequency response desired. One model, TP-800-C, will record and playback frequencies up to and beyond 12,500 cycles,



with less than 3% distortion. Model TP-800-D contains, in addition to this extended frequency range, an instantaneous start-stop clutch mechanism for dictation, conference recording and transcribing, or for any automatic or intermittent application.

A simple inverter easily adapts these portable recorders for 6 volt automobile operation. They will operate in any position, even upside down. External vibrations have no effect upon the recording and reproduction process. All models can be supplied with provision for playback with external playback equipment.

For additional technical information, including complete specifications and performance ratings, write to Magnephone Division, Amplifier Corp. of America, 3984 Broadway, New York 13, N. Y.

PROGRAM EQUALIZER

The 4031-B Program Equalizer is designed to fill a wide range of equalization requirements for broadcast and recording studios.

12 db equalization is effected at 100 cycles and 3, 5 and 10 kc. in calibrated and detented two db steps.

High and low frequency attenuation up to 16 db in two db steps is accomplished by merely turning the same controls in a counter clockwise rotation past the center point.

A constant-K circuit maintains the level and eliminates wave distortion over the entire range.

Over 1465 curve combinations may be obtained. The unit has only 14 db insertion loss in a 500/600 ohm circuit.

For further data, write Cinema Engineering Co., 1510 W. Verdugo Ave., Burbank, Calif.

NEW RECORDING DISC

A new professional instantaneous recording disc, said to offer more consistent quality as a result of a new lacquer formulation and controlled coating technique used in its manufacture, is announced by Sonic Recording Products, Inc., 50 Mill Road, Freeport, L. I., New York.

The new blanks are made in three grades, both single- and double-faced. The Super-Sonic disc is intended for critical reproduction, Ultra-Sonic for general use, and Trans-Sonic for reference purposes.

CENTURY MIKES

A complete bulletin on the new series of "Century" microphones for low-cost public address, paging, recording, and communications has been issued by Electro-Voice, Inc.

Bulletin No. 137 fully describes and colorfully illustrates the complete adaptability of the Century which can be used in any position—stands by itself on a table or desk, rests on its back, mounts on the new E-V Model 415 reclining desk stand, hand held, mounts on conventional floor or desk stand, overhead suspension, fitted with hook for dash mounting in mobile communication.

Detailed specifications are given for the three types: crystal, dynamic, carbon. A copy of Century Bulletin No. 137 will be gladly sent on request. Write to Electro-Voice, Inc., Buchanan, Mich.

CONSOLE RECORDER

Fairchild Camera and Instrument Corporation has announced it is now producing a new console model recorder, in the moderately-priced field, for professional use.

[Continued on page 48]

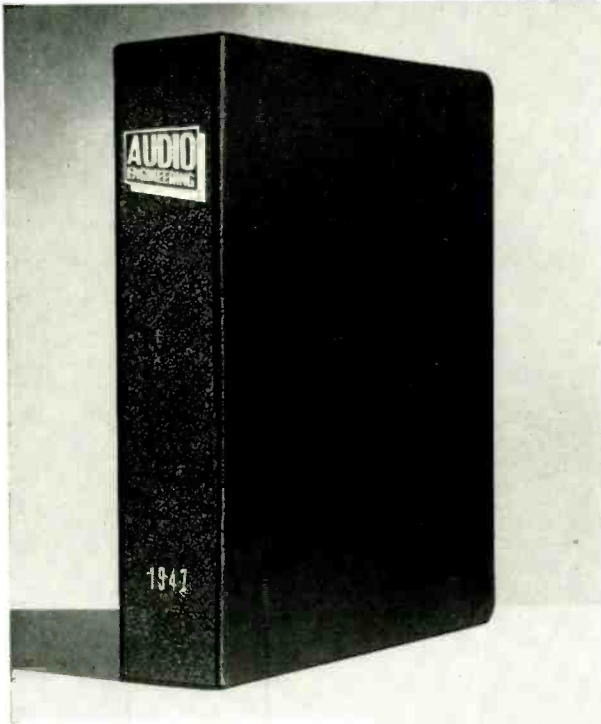

**AUDIO
ENGINEERING**

BINDERS
\$2⁵⁰

« « « Here at last is a binder using modern postwar materials at prewar prices. Designed to provide instantaneous reference to your monthly copies of Audio Engineering. An unusually fine library finish that will stand up under constant use.

- Rich blue Dupont Fabricord—stainproof and washable
- Rigid backbone with bound-in metal support
- Light weight tarnishproof aluminum ends
- Coil springs built in at each end to securely position spring steel wire holders

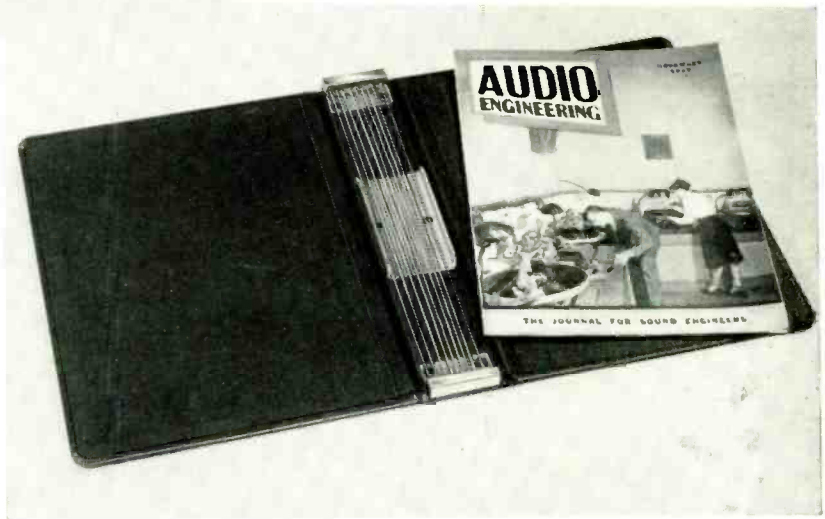

- Backbone gold stamped with Audio Engineering and year
- Center channel to keep magazines fastened in position
- Round corners, hinges and backbone fully reinforced
- \$2.50 postpaid. Foreign orders add 50c

RADIO MAGAZINES, INC.
342 MADISON AVE.
NEW YORK 17, N. Y.

AUDIO ENGINEERING
BINDERS

Enclosed find \$..... for..... Binders

Name.....

Address.....

City..... State.....

**ECONOMY
THROUGH
VERSATILITY.**

**CINEMA
100 SERIES
UNITIZED
AMPLIFIERS**

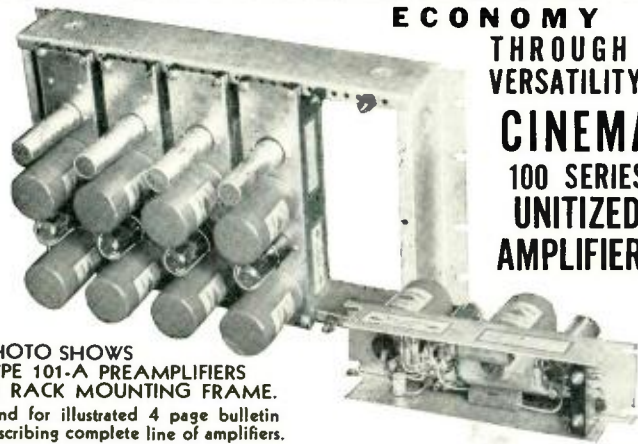

**PHOTO SHOWS
TYPE 101-A PREAMPLIFIERS
IN RACK MOUNTING FRAME.**
Send for illustrated 4 page bulletin
describing complete line of amplifiers.

The 100 Series consists of a complete range of units from preamplifiers to 40 watt recording amplifier and associated power supplies. The series is designed to furnish high-fidelity, moderately-priced audio channels for broadcast and recording studios.

The standardized method of mounting the chassis permits extreme flexibility and facilitates future expansion and modification of rack layouts.

You may obtain any type of channel required by selecting the proper chassis "units" and mounting them on the rack-mounting frames provided. (see photo)

All input and output circuits are suitable for both balanced and unbalanced lines. Reliable circuits and careful choice of high-grade components make this amplifier series especially suitable for services which demand consistent performance and reliability.

CINEMA
ENGINEERING COMPANY
1510 W. Verdugo Ave. Burbank, Calif.
Cable Address: CINENG BURBANK

**For the finest lateral reproduction
the GRAY TRANSCRIPTION ARM**



Exhaustive study proves the impossibility of combining ideal lateral and vertical mechanical requirements into one arm. The Gray Transcription Arm, designed for finest lateral reproduction, accommodates all modern cartridges — General Electric, Pickering, etc., has been adopted as standard equipment by national radio networks including CBS, ABC and numerous independent radio stations.

ARM, LESS CARTRIDGE, \$35.00

Gray Equalizer for G.E. Cartridge



DIAMOND G.E. CARTRIDGES!

At last a permanent solution to the quality pick-up problem. We can now supply a Selected G.E. Cartridge with finest quality Diamond Stylus for mounting in the Gray Transcription Arm. The practically unlimited life of the Diamond Stylus makes it an exceptionally economical investment at \$25.45 net to radio stations.

FOR RADIO STATION USE, No. 601, 4-position Equalizer (Flat, N.A.B., etc., etc.) expertly engineered for use with the G.E. Variable Reluctance Cartridge. Matches pick-up to microphone channel. Adopted by radio networks. COMPLETE \$42.50.

GRAY RESEARCH & DEVELOPMENT CO.
ELMSFORD 4, WESTCHESTER COUNTY • NEW YORK

Decade Amplifier

[from page 16]

The noise level of the main amplifier is somewhat higher than that of the pre-amplifier but is not a limitation for any ordinary use. The noise voltage read at the output of the main amplifier with the gain control at zero is at times barely detectable on the 0.01 volt scale of a Ballantine voltmeter, which reads down to 0.001 volt.

Rather elaborate means were employed to obtain this low noise level. One obvious source of trouble was effectively abolished by heating all tubes except the rectifier and voltage regulator with well-filtered direct current. This made it unnecessary to carry any a-c power into either amplifier compartment. The result is that the hum component in the noise is not detectable when observed on an oscilloscope.

The noise was minimized in other ways by using selected "non-microphonic" tubes in the pre-amplifier, shock mounting the pre-amplifier, restricting the frequency range, and using complete electrostatic shielding of the pre-amplifier and associated wiring. Of the several types of "non-microphonic" tubes available, the 1280 was chosen because it apparently is the only type with a 150 milliamper heater. This feature is desirable for the sake of economy and minimum power supply bulk when using direct current from a rectifier and filter for heating the tubes. The tube for use in the first stage of the pre-amplifier was selected from six available for lowest noise. Three of the six were found to be suitable for use in the first stage.

Restricting the frequency range is useful in reducing noise because thermal-agitation noise voltage varies as the square root of the bandwidth. Further restriction of any desired degree can be employed by inserting a simple resistance-capacitance filter between the pre-amplifier and the main amplifier.

Stability—In order for an instrument of this type to be most useful in everyday laboratory work, it is necessary that there be a minimum of critical adjustments, and that its characteristics be essentially independent of aging, changing tubes, or varying line voltage.

The only critical adjustments are the potentiometers in the feedback circuits which vary the gain over a small range. These potentiometers are set to make the voltage gain of each unit equal to 100, and should not require frequent adjustment. The one-step attenuators were made up to accurate attenuation values from selected five-percent resistors.

Use of a large amount of inverse feedback makes the characteristics of the amplifier essentially independent of small changes in circuit component values, in tube characteristics, or in supply voltage. Changing

tubes results in a variation of gain of one or two per cent, or less, and negligible variation of distortion. Variation of the a-c supply voltage from 130 volts to 110 volts results in a change of gain of about plus or minus two per cent from that at 120 volts.

One form of instability usually encountered in a new design of a high gain amplifier is a tendency toward oscillation. This one was no exception, each unit originally oscillating by itself and, after this was overcome, oscillating when the two were used together. Oscillation in the pre-amplifier was due to phase shift at high frequencies which caused the feedback to become positive in the neighborhood of 200 or 300 kc. The phase shift was due to the shunting effect of stray and tube capacitances. The 10- $\mu\mu$ f capacitor from the plate of the second 1280 to the cathode of the first completely eliminated any tendency to oscillate in this region. A similar capacitor was included in the main amplifier because it was regenerative in this region, although it did not actually oscillate there.

Oscillation in the main amplifier was due to phase shift at low frequencies in by-pass and decoupling networks. Use of voltage dividers of fairly low impedance rather than series resistors to supply screen voltages completely eliminated any tendency toward oscillation in this region.

Oscillation when the two were used together was due to coupling through the B + lead to the pre-amplifier at frequencies of 20 or 30 kc. This was effectively eliminated by by-passing the voltage regulator tube with a small capacitor.

Acknowledgement

The author wished to acknowledge his indebtedness to William H. Ridley of the Stromberg-Carlson Instrument Laboratory for his help in the design and construction of this decade amplifier and in the measurement of its performance characteristics. He also wishes to express his appreciation to Lynn C. Holmes of the Stromberg-Carlson Research Department for assistance in the preparation of this paper.

Sapphire Group

[from page 17]

engaged in the engineering or executive phases of sound recording. No one organization would be allowed a preponderance of membership, but instead attempts would be made to offer all recording organizations representation.

The writer believes that the Hollywood Sapphire Group is a most unique and democratic organization. It has no regular permanent officers. The chairman of the current meeting chooses his successor who then serves as treasurer at that meeting and chairman at the next meeting. In this way, each member as both

New Shure Wire Recording Heads



WR 16



WR 14

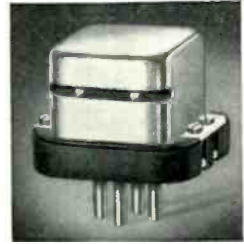

WR 12

*... offer unusual versatility of
mechanical and electrical adaptation*

✓ CHECK THESE FEATURES FOR EXCEPTIONAL PERFORMANCE

- 1** Versatility of playback and recording circuits.
- 2** Variety of Impedances for individual needs.
- 3** Closely controlled Air-Gaps for uniform performance and excellent wear characteristics.
- 4** Reduction of hum pickup.
- 5** Controlled groove contour for maximum effective position of recording wire.

Shure Patents Issued and Pending

MORE COMPLETE INFORMATION IS AVAILABLE TO FIRMS INTERESTED IN THE MANUFACTURING OF WIRE RECORDING EQUIPMENT. WRITE ON COMPANY LETTERHEAD.



SHURE BROTHERS, INC.

Microphones & Acoustic Devices

225 W. HURON ST., CHICAGO 10, ILL. • CABLE ADDRESS: SHUREMICRO

chairman and treasurer has an opportunity to arrange a program he feels will be of interest to the majority of the group. In this way, he also becomes better acquainted with his fellow members and is more tolerant of other members when they serve as chairman.

During the early meetings some discussion arose among the members regarding the scope of the groups activities. Should the meetings be technical or social or combine both activities? Meetings of the New York Sapphire Group have so far been only social gatherings. Informal technical talks combined with a social dinner appears to be the most popular meeting for the Hollywood group.

This fact was more than confirmed when Wallace V. (Wally) Wolfe, recently elected director of the Motion Picture Research Council, Inc., gave a talk at RCA-Victor illustrated with motion pictures describing the early use of sound-on-disc in sound pictures. As a contrast, present film re-recording techniques were demonstrated by actually scoring a reel from a current motion picture. This demonstration attracted sixty-two members and guests who more than filled the RCA-Victor review theater.

After its first year, the Hollywood Sapphire Group began considering the problem of standardizing recording techniques. In pursuance of that goal, Mr.

John Hilliard, Chief Engineer of the Altec-Lansing Corporation, was elected chairman of the Recording Standards Committee. He, in turn, appointed three Standards Sub-Committees: 1) Stylus Committee with four members, 2) Mechanical Committee with five members, and 3) Committee on Response with five members. These committees have met with the Motion Picture Research Council, supplied NAB's Washington, D.C. engineering offices information on proposed standards, and discussed the problem of standardization with members of IRE, ASA, and RMA.

Mr. Jim Bayless of RCA-Victor as chairman of the Mechanical Standards Sub-Committee has compiled a glossary of standard recording terms. The glossary seeks to avoid the ambiguity in the use of names of components used in sound-on-disc recording and processing. At present, each studio and factory has unique names for one or more of the components used in the production of disc records. The confusion resulting from this practice is readily understandable, particularly by a customer who uses the facilities of more than one factory.

Mr. Kenneth Lambert of MGM, a member of both the Hollywood Sapphire Group and the Motion Picture Research Council is chiefly responsible for arranging two joint meetings of the two groups which resulted in the acceptance of the names and definitions of eighteen specific recording terms.

The terms named and defined are included below. It is believed that by printing this glossary in *AUDIO ENGINEERING* its readers will circulate the list and in this way help to alleviate the confusion which now exists in the vocabulary of the sound-on-disc recording profession.

PROPOSED LIST OF PREFERRED TERMS FOR DISC RECORDING

The following definitions were originally formulated by the Sapphire Club and later approved in this form at a joint meeting of the Sapphire Club Standards Committees and the Research Council Disc Recording Subcommittee:

Original

A recording made by direct amplification and connection of the sound source microphone to the recording equipment.

Duplicate

A disc recording made when the sound source is from an "Original" or any other recording, regardless of media.

Instantaneous Original or Instantaneous Duplicate

When an "Original" or "Duplicate" is intended to be used for direct sound reproduction.

Process Original or Process Duplicate

When an "Original" or "Duplicate" is intended for process to record pressing matrices.

Master

A metal matrix derived by electroforming from the recorded face of a "Process Original" or "Process Duplicate."

[Continued on page 41]

QUALITY SHORT CUT TO MASS PRODUCTION OF TV RECEIVERS...



COMPACT, CUSTOM-WIRED

DUODECAL AND DIHEPTAL

AMPHENOL

CATHODE RAY TUBE SOCKET ASSEMBLIES

• Amphenol custom-wired cathode ray tube socket assemblies are unusually compact. Leads are grouped within the housing in unit cable form and brought through the side of the socket in any of six positions. This effects a further saving of space. High voltage lead may be segregated from main trunk wires. Safety socket cap enclosing all wiring connections is easy to remove. Recessed socket front shields operator or serviceman from high voltages; serves also as a guide for tube insertion. Creepage barriers between contacts provide long leakage paths and positive lead wire separation. For manufacturer's applications, sockets are furnished in wired assemblies.

Duodecal Tube Sockets: For most popular television viewing tubes with a maximum of twelve pins on a pin circle diameter of 1.063 inches.

Diheptal Tube Sockets: Made in two sizes, for small (2.050 inch) diameter tube bases, also for medium (2.250 inch) diameter bases. Both provide for a maximum of fourteen pins on a 1.750 inch diameter pin circle.

Complete technical data, and prices, are available.
Write for them today!

AMERICAN PHENOLIC CORPORATION

1830 SOUTH 54TH AVENUE • CHICAGO 50, ILLINOIS

COAXIAL CABLES AND CONNECTORS—INDUSTRIAL CONNECTORS, FITTINGS AND CONDUIT—ANTENNAS—
RADIO COMPONENTS—PLASTICS FOR ELECTRONICS



Metal Positive

Metal matrices derived by electroforming from the "Master."

Stamper

A metal matrix derived by electroforming from a "Metal Positive" and further plated and machined for use as a molding die for record pressing.

Duplicate Master

A metal matrix derived by electroforming from the "Metal Positive" and intended to be used for the further electroforming of "Metal Positives."

Duplicate Metal Positive

Metal matrices derived by electroforming from the "Duplicate Master."

Converted Master Stamper

When a "Master" is further machined and prepared for use as a molding die for pressing records.

Master Test Record

A record pressed using a "Master" (not converted) as a molding die and intended for proof of processing.

Pressed Records

When records are pressed using "Stampers" or "Converted Master Stampers" as molding dies.

The following four terms are applied to records to indicate extent of licensing:

Broadcast Transcription Pressed Records

Slide Film Pressed Records

Special Purpose Pressed Records (Not Licensed)

Phonograph Pressed Records

Recording Stylus

[from page 20]

Others apply the same criterion but make the test cuts at 33½ rpm at diameters of from 5 to 6 inches. Still others inspect a groove under the microscope and, unless it is jet black in color, the stylus is rejected. A few ask for the best possible conditions in the aforementioned respects with burnishing facet dimensions which allow higher frequency registration and low distortion.

The latter few along with the majority of critical listeners will find that the modified design of the new stylus gives them that last speck of recorded quality they have previously been missing. Judged by the other methods described however, this stylus might be rejected.

As shown by the above chart, readings on unmodulated grooves show the new stylus type to be 5 VU noisier than the old stylus type. It is the modulated noise which is most important to the record, however, and here a multi-faceted stylus produces readings at least 15 to 20 VU better than those obtained with the single-faceted stylus.

Again, the groove will not necessarily be jet black. It will have a high luster, however, and provided the record material is free from foreign particles, the flash lines will be shiny and uninterrupted, even when modulation is at mastering level.

Finally, the shape will not necessarily

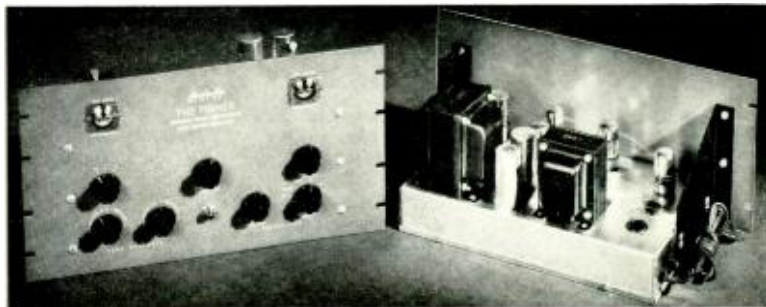

TWO-CHASSIS CONSTRUCTION OFFERS HIGHEST QUALITY, MAXIMUM FLEXIBILITY

It's by FISHER! It's the BEST!

The Fisher

DYNAMIC NOISE SUPPRESSOR WIDE RANGE AMPLIFIER

If you seek the finest in dynamic noise suppression, coupled with an amplifier that is precision built to exceptional, laboratory standards, there can only be one choice—THE FISHER Dynamic Noise Suppressor-Wide Range Amplifier,* custom constructed on two chassis. Here is its pedigree:

THE FISHER Wide Range Amplifier

1. A man's size amplifier with only 1% distortion at twenty watts!
2. Intermodulation distortion less than ½% at 5 watts output.
3. Uniform response from 20 to 20,000 cycles, plus or minus 1 db.
4. Hum level warranted less than 0.5 microwatts for one watt output.
5. Internal impedance less than 1.25 ohms, 6.18 db of negative feedback.
7. Phono preamplifier and first audio operated entirely on DC to reduce hum.
8. Phono preamplifier comprises two triode stages operated in cascade, to minimize tube noise.
9. Phono circuit compensated for G. E. and Pickering pickups.
10. Exclusive, two-position pickup compensation for pre-emphasized recordings as well as recordings without rising characteristic at high end.
11. Two, medium gain auxiliary inputs for radio, etc., with selector switch on front panel, for convenience of use.
12. Output impedances 8 and 16 ohms. Professional quality line matching transformer for 125 and 300 ohms available at additional cost. (NOTE: Our experience has shown that it is not practical to design a high quality output transformer including both voice coil and line matching windings.)
13. Push-pull parallel output tubes, for conservative operation and superior output transformer design.

THE FISHER Dynamic Noise Suppressor

1. Incorporates six tubes, for optimum flexibility and effectiveness.
2. Two high frequency gates, dynamically controlled.
3. One switch position (see below) provides fixed filter tuned to 18 Kc. (Readily tuned to 10 Kc. by simple screw adjustment.)
4. Independent control voltage amplifier for operation of gates.
5. Double diode tube to provide DC control voltage for gate circuits.
6. Two cathode ray indicators to show

- individually the dynamic operation of high and low frequency gate circuits.
7. Muting circuit and connecting plug for complete silencing of needle swish in run-off groove and "blip" when the pickup lands on the next record.

GENERAL FEATURES

1. TWO-chassis construction, for optimum electrical performance and ease of installation in limited space—without undesirable long leads. Chassis constructed of 16-gauge steel.
2. Power available for external microphone preamplifier, etc., 250 volts at 50 ma. DC and 6.3 volts at 3 amperes AC.
3. SEVEN CONTROLS, (a) Volume Control, (b) Three-position switch for phono and two auxiliary inputs, (c) Six-position, On Off and Range Switch (20-20,000 cycles, 20-10,000 cycles, 70-100 cycles*, 90-3200 cycles*, 120-2700 cycles*) *Frequency response with gates in fully closed position. With gates fully open, response is that in position 2, except that in position 3 response is limited to 6000 cycles. (d) Treble Control, continuously variable with maximum boost 16 db at 10,000 cycles, maximum cut 20 db at 10,000 cycles. (e) Bass Control, continuously variable with maximum boost 16 db at 100 cycles, maximum cut 32 db at 20 cycles. (f) Gate Sensitivity Control on front panel. Varies dynamic range of suppression for positions 3 to 5 of Range Switch and permits optimum adjustment for various input levels and background noise characteristics, instantly and easily. (g) Phono Equalization Switch, two-position.
4. Tube Complement, Suppressor-Voltage Amplifier Chassis: 2-12AT7, 1-6C1, 3-6X6, 1-6AL5, 1-6AQ5, 2-6E5. Panel: 10½" x 19", height 8¾", width 13", depth 8". Power Chassis: 1-7C5, 1-7A1, 2-5Y3. Panel: 8¾" x 19", height 7¾", width 11½", depth 8¾".
5. Auxiliary AC Outlets, Two available, for tuner, turntable, etc., controlled by master On Off Switch.
6. Jewel pilot light on front panel.

*Licensed under Herman Hoxmer Scott patents pending for use only in phonograph and phonograph distribution systems.

PRICE \$254.50 • LIMITED QUANTITY AVAILABLE FOR IMMEDIATE DELIVERY

FISHER RADIO CORPORATION • 41A EAST 47TH ST., NEW YORK

AMPERITE MICROPHONES

The ultimate in microphone quality, the new *Amperite Velocity* has proven in actual practice to give the highest type of reproduction in Broadcasting, Recording, and Public Address.

The major disadvantage of pre-war velocities has been eliminated—namely “boominess” on close talking.

- Shout right into the new *Amperite Velocity*—or stand 2 feet away—the quality of reproduction is always excellent.
- Harmonic distortion is less than 1% (Note: best studio diaphragm mike is 500% higher).
- Practically no angle discrimination . . . 120° front and back. (Best studio diaphragm microphones—discrimination 800% higher).

- One *Amperite Velocity* Microphone will pick up an entire symphony orchestra.



P. G. Dynamic Models PGH, PGI. List \$32.00

Address inquiry attention Dept. A

STUDIO VELOCITY, finest in quality; ideal for Broadcasting and Recording. Models R80H, R80L . . . List \$80.00

There is an *Amperite* Microphone for every requirement.

WRITE FOR ILLUSTRATED 4-PAGE FOLDER giving full information and prices.

AMPERITE Company
561 BROADWAY NEW YORK



AMPERITE Velocity Microphones for Public Address Models RBHG, RBLG List \$42.00



“Kontak” Mikes Model SKH, list \$12.00 Model KKH, list \$18.00

In Canada: Atlas Radio Corp. 560 King St. W. Toronto Ont.

be as perfect as in the case of the Master stylus. The size and angle of the bur-nishing facets are of utmost importance to the recording and manufacturing tolerance must favor these factors above ideal shape. Figs. 11 and 12 are photographs of such styli. No processing difficulties or poor playback fit will result from grooves having the contour of either one of these styli.

Conclusion

Widespread conversion of the recording industry from wax to lacquer materials in the cutting of originals has emphasized the need for lacquer recording styli particularly adapted to this critical purpose. The Master Stylus was the first development towards this end and because of the controls possible in its specifications has contributed largely to improved recordings. This latest stylus development assures still further improvements. In fact, records of extremely high fidelity have already been obtained by its use.

Classical Recordings

[from page 25]

duction increases the apparent liveness by a factor of at least 2—I'd bet on 3 or 4—as compared with binaural hearing at the same point, then how can the average listener, not knowing this—even a highly intelligent one and perhaps a trained musician to boot—how can he be expected to judge fidelity to the original when he is attempting the impossible, to relate the monaural sound he is hearing to the binaural remembered sound of the concert hall?

But these are mere physical responses. Just as important in this business of judging fidelity are the associated psychological reactions of the listener.

It's only natural for engineers to feel that a thing as indefinable in mathematical exactitudes as a psychological reaction has no place in an objective scientific inquiry. Nevertheless, it's healthy to keep in mind, as alas, many sound men do not, that the be-all and end-all of sound reproduction is to affect (and to please) the mind. Whatever they may be, the processes that work upon the engineer's sound signal once it has entered the ear and the nerve channels are more important than all the rest of the chain of reproduction together.

Let us mention two general aspects of this, which cannot be ignored though I have recently touched upon them in another journal. First is the simple, elemental preference in all human beings for the familiar. “Be it ever so humble . . . etc.”—To jump far afield, the process of slum clearance is greatly impeded by the fact that many people in so-called slums have not the slightest desire to move out,

Studio Quality AMPLIFIERS

WITH CUSTOM-BUILT FEATURES

Designers and Manufacturers of Broadcast Speech Equipment, School Sound Systems and Recording Equipment.

Designed and Fabricated by the Manufacturers of High Quality Sound and Recording Equipment for the Motion Picture Industry.



Bardwell & McAlister's new line of Commercial Amplifiers answers the great demand of sound engineers for commercial amplifiers embodying the principles used in “custom-built” units which have been successful in the sound equipment of the motion picture industry. These principles result in high fidelity reproduction at any setting of volume controls up to full rated output with less than 4% distortion, versatility of application, ease of operation and the longer life found only in Bardwell & McAlister Studio Quality Amplification Systems. Manufactured by Union Craftsmen and fully licensed.

Write for our sound equipment catalog and technical bulletins. Dealer inquiries invited.



ELECTRONIC DIVISION
BARDWELL & McALISTER, INC.

BOX 1310, HOLLYWOOD 28, CALIFORNIA



13

to some new and unfamiliar environment—improved or not. Everything new must run the gauntlet of the unfamiliar. Conversely, no matter how unsuitable, painful, unsatisfactory, the familiar thing sooner or later becomes desirable. For twenty years the radio and record buyers of this country have been accustomed to (a) the extremely limited range, top and bottom, (b) the distortions, and (c) the static, surface noise, interference, of existing sound reproduction. People not only tolerate these things but they have become extraordinarily expert in ignoring them, tuning them out mentally, and even more, in mentally supplying that which is missing, for example the “s” sibilant sounds in broadcast speech, which as heard on many AM receivers are 100% missing. True, it takes great mental effort and even strain to do all this. (Hence the unwritten radio rule against more than 45 seconds or so of unadorned talking in most situations, the necessity for overdramatizing and “punching” in the announcer’s technique, all of which is on its way out, or should be, with FM.) But, effort or no, the average person likes things that way. It’s the familiar way.

He will quickly object to something new and different, even if it be “high fidelity.” He will tune out the sibilants in f-m speech to make it sound “right” (familiar). And he will be just as quick to make up nice, plausible, intellectual reasons to cover up the hurt of the unfamiliar. The mind works that way. If engineers swallow these fine, natural rationalizations as so much fact, it’s just too bad.

Power of Association

The other and related aspect of listening psychology is the power of association. We all know that during past years by far the most unpleasant noises to come from a loudspeaker have been those in high registers. Distortion is mostly there; record scratch is there, static is there. The tone control has been the great remedy-at-hand and the association between tone control and absence of plain, physical pain is too strong for most of us to ignore. Recent misguided “high fidelity” reproduction without safeguards against distortion has only made things worse. The “I told you so” school of thought is, in a way, quite right; anything is preferable to distorted, “wide-open” high range sound.

The fact is that most listeners have a long-time, deeply conditioned reaction against any high frequency sound coming from a loudspeaker. It has hurt too often. Even such a minor matter as the high frequency distortion caused by worn phonograph needles may have a tremendous psychological effect; I say so with authority, for it was this that kept me away from true wide range reproduction for a long, long time—until I learned to

Now Ready

**JACK STRIPS
PATCH CORDS
PLUGS-JACKS**

Jacks are used in audio facilities for interconnecting various circuits and equipment units, using patch cards with suitable plugs. These patch cards permit connection to or around any component or circuit, and thus provide flexibility in operating and test procedures.

Through the use of closed circuit jacks, regularly used circuits are “normalised” and no patch cards are necessary for normal system operation. Inserting a plug into the jack opens the circuit through an additional pair of contacts, and the speech circuit is then completed through the patch card.

Jack strips are designed to mount a number of jacks in a convenient arrangement on a rack, and to provide a means of identifying each circuit terminated on the jacks.

AUDIO EQUIPMENT SALES
933 EIGHTEEN AVENUE — NEW YORK 19, N. Y.

CIRCULAR No. 21
WRITE FOR YOUR COPY

PICKERING UNIFORMITY

EVERY Pickering Cartridge which leaves our laboratory has been carefully tested for the following characteristics, the allowable limits for which are shown:

FREQUENCY RESPONSE • ± 2 db, 40-10,000 cps
WAVEFORM DISTORTION • 1 per cent maximum
OUTPUT LEVEL • 70 millivolts, ± 2 db
TRACKING PRESSURE • 15 grams max. at 40 and 10,000 cps

IN ADDITION, optical inspection of the stylus polish and shape, mechanical inspection of the moving parts, and electrical inspection of the pickup coil has been made on each unit.

REGULAR sampling tests reveal absolute stability, amazing ruggedness, and complete insensitivity to the effects of temperature and humidity.

NO OTHER PICKUP CAN QUITE MATCH THIS PERFORMANCE

Available with diamond or sapphire stylus from all principal distributors

Pickering & Company, Inc.
29 West 57th Street — New York 19, N. Y.

HARVEY

has

TRANSCRIPTION EQUIPMENT



**GRAY
TRANSCRIPTION ARM**

For your favorite cartridge, such as the new GE Variable Reluctance. Assures optimum performance; gives smoothest possible frequency response; reduces surface noise ratio; provides adjustable scale to conveniently regulate for ideal performance of the particular pickup in use. Net \$35.00

VIBROMASTER TYPE K PROFESSIONAL ARM



for General Electric Variable
Reluctance Pick-ups Or the New
Pickering 120M Cartridge

Resonance characteristic flat plus or minus 1/2 Db 40 to 10000 cycles (measured in 10-cycle steps throughout resonant range).
Price, net less cartridge \$34.50
General Electric Cartridge \$ 4.77



The Pickering Cartridge gives professional quality to your home phonograph. It mounts in practically any arm, operates perfectly even at 30 cps, with but 15 grams pressure; linear response to over 10,000

cps. Available with sapphire (S120M) at \$15.00 net, or with diamond (D120M) at \$39.75.

The Pickering Equalizer-Amplifier works with the Model 120M Pickering Cartridge, providing a full 20 db of bass boost for record compensation. Complete with built-in low-pass filter switch to minimize needle scratch on noisy records. Model 125H. \$19.50 net.



NOTE: All prices are Net, F.O.B. N.Y.C. and are subject to change without notice.

Telephone: **hr** LONGacre 3-1800

HARVEY
RADIO COMPANY INC.
103 West 43rd St., New York 18, N. Y.

separate true high tones from false. (Cactus needles had been my own pain-killing device!)

Here is the significant point: (And note well, givers of listeners' tests on fidelity preference.) Our response to painful high tones has become a conditioned reaction, to the point where most of us (experienced sound engineers excepted) react with pain where there is no pain. The very suggestion of a high-pitched sound, monaurally reproduced from a loudspeaker, instantly arouses the conditioned reaction, even though that sound may in fact be accurate, distortionless, and in no way actually painful. Most people's first reaction to high volume in a big speaker is similar, thanks again to years of nasty noises associated with overloaded pill-box radios.

Let's add hastily that of course this initial false reaction may be overcome in most people, given a reasonable time, given an exposure to the facts, and a chance to "see for yourself." Even the objection on grounds of unfamiliarity goes by the board, if the unfamiliar has time to become familiar. But how may listeners' tests—both those given in the laboratory under formal conditions and the countless casual "tests" given in a thousand radio dealer's showrooms—are more than single-shot, immediate-reaction affairs? How often is the "testee" given half a chance to accustom himself to the new before he has to give his supposedly well considered answer? Put all the reactions here discussed together, make them instantaneously and unthinking, as they are bound to be in any normal human being, than face your prospect with his first real "high fidelity" reproduction. It's a sure thing he won't like it. Look at the tests—isn't that what they've been proving, right along?

Toch, The Chinese Flute (1923).
Pacific Symphonetta, Manuel Compinsky.
Alice Mock, soprano.
Alco AC 203

Bach, Concerto in D Minor; Violin, Oboe and Orch.
Pacific Symphonetta, M. Compinsky, violin,
G. Schoenberg, Oboe.
Alco A 202

Two representative albums from a West coast company now distributing nationally. "The Chinese Flute" is a remarkable recording of small ensemble and soprano voice. Exotic, unusual tone-color effects. Outstanding technically for the extremely low-level, wide-range recording featured in certain parts of this. Engineers take advantage of very quiet plastic and of wide range, keep level low. Try side 1. But (to get maximum dynamic range?) the loud passages are steadily over-recorded, with blasting. Too bad.

"... An oboe or similar instrument at two or three feet or even a dozen (from the mike) is strident and mechanical"—this department in the August 1947 issue, speaking of hi-fi recording and FM broadcasting. A beautiful example is this Bach concerto. The oboe is, apparently, far too close to the mike for the wide range recording being made. It makes a nasty,

nasal, fowl-like sound. (The sound, in fact, that an oboe makes when you must stand only a few feet away from it, as you never should.) Interestingly enough, the volume balance is OK; the oboe isn't too loud. Just too close.

Special note: The Alco records are alternatively available—the first time in the industry to my knowledge—on 16" records, 33 rpm. The price I believe, is slightly lower, note for note. Have not yet had an opportunity to compare the two versions adequately. Comparisons will be made here in a later issue. Given good quality, these records should be of great interest to engineers, who presumably have the equipment to play them. Dances (Violin and Piano). Bronislaw Gimpel, violin; Artur Balsam, piano. (Collection of semi-pop dances, each a single 10" side)

Vox 616

This album is a remarkable improvement technically over other Vox albums recently issued. Velvety smooth surfaces, if not noiseless; the mike pickup is absolutely first rate, the tonal range has apparently been extended considerably. Very similar to the Francescatti album of Columbia ("Violin Recital," C M 660) and just as well done.

Beethoven, Symphony No. 3 ("Eroica").
Boston Symphony Orchestra, Serge Koussevitsky.

Victor DV 8 (plastic)

Victor continues its policy of relying on good acoustics, well-played music to give the illusion of realism, without extended tonal range. These plastics have about the same range as the shellacs; the sound is better, thanks to better surface. No high highs. There seems to be some distortion in the very loud portions. The plastic is good, not as quiet as some used recently by smaller companies. Pickup is very live, but agreeably so. (Compare with Victor's Toscanini "Eroica," M 765, made in NBC studio 811 at its absolute deadiest!) Musical listeners will find little to complain of in this type of recording, highs or no highs.

Tschaikowsky, Nutcracker Suite.

Andre Kostelanetz and his orchestra.
Columbia MM 714

The Nutcracker to end all nut cracking! Wide range. (Triangles—the ultimate test—are nicely audible in places you haven't noticed them before.) Excellent liveness adds to the impression of range. Strings steady, but not overly so. Surfaces superb; almost identical in sound by direct test with above plastics. Recordings seem to have low turnover, European-style(?).

Franck, Symphony in D Minor.

Paris Conservatory Orchestra, Munch.
English Decca EDA 36

One of outstanding series done with this orchestra. Makes interesting technical comparison with same music, U. S.-recorded, on Columbia. (MM 608; Ormandy & Phila. Orch.). Both are tops in their style of recording. Columbia's uses (apparently) some accentuation, solo instruments are close, sharp, clear, though over-all liveness is good. Considerable gain-riding—very soft passages (as at opening) are brought up; climaxes are weakened, but in long run a good idea. Decca uses very live, over-all technique; solos are distant, blended with whole orchestra. Minimum gain riding makes soft passages almost inaudible in the scratch, climaxes superb.

Popular Recordings

[from page 25]

higher quality should have a marked effect on American popular recording techniques.

Some of the more important *London* records are listed below:

Music by Camarata London album LA 11, Kingsway Symphony Orchestra conducted by Camarata.

The Kingsway Orchestra is composed of members of the London Symphony and their performance closely approximates those of Kostelanetz and Alfred Newman. The album contains such popular classics as Grieg's *Ich Liebe Dich*, *Come Back to Sorrento*, Gershwin's *Prelude No. 2*, and Camarata's more or less original *Rumbalero*.

Don't You Know I Care—No One Else Will Do London 101. Beryl Davis with Stephane Grappelly Quartet.

Beryl sounds better on this disc than on her recent Victor waxings, but this singer has displayed more style and intelligence on other *London* masters. The instrumental backing is too thin, and this inferior ensemble should not be confused with the Quintet of the Hot Club of France with which Grappelly was featured violinist.

The Lord's Prayer—Bless This House London 115, Graeic Fields with Phil Green Orchestra.

Familiar melodies sung in Graeic Field's familiar manner. Phil Green's Orchestras is one of the best on this label, but it is hampered by a sticky arrangement with organ solo.

Swing Low, Sweet Clarinet, London 108. Reginald Kell, clarinet, Ambrose and his Orchestra.

Reginald Kell is probably the finest classical clarinet player extant. Just as Benny Goodman tends to be a trifle stiff and formal in his approach to the classics, so Mr. Kell reacts to swing. I have never cared for the sweet, mannered playing of Ambrose, and this disc only intensifies my distaste.

Audio Measurements

[from page 24]

cuit is grounded in practice. It will be noted that the signal is inserted directly at the microphone, to prevent error caused by the by-passing of the higher frequencies around the microphone impedance by the capacitance of the cable.

Filters and Equalizers

Frequency-response measurements on filters and equalizers, and on "pre-emphasized" equipment, involve possible steep slopes on response curves. This is perhaps the single class of frequency-response measurements wherein reasonably low harmonic distortion in the test oscillator output may become important. Even here, however, if the oscillator is a modern one having a fraction of one per cent distortion, the error will be negligible. For large values of oscillator distortion, strong harmonics may occur at

New . . . Improved ATTENUATORS by TECH LABS



Type 800



Type 900

TYPE
800
and
900

"New Times—New Modes", says old proverb. These new attenuators were born to meet new wa-created demands. They represent a new medium frame size. Type 800 (2 1/4" dia.) and a larger size: Type 900 (3" dia.). The Type 800 is supplied as potentiometer, rheostat, ladder and T-pad up to 20 steps. The larger size Type 900 is similarly furnished with up to 45 steps. Write for new bulletin.

TECH
LABORATORIES, INC.

Manufacturers of Precision Electrical Resistance Instruments
337 CENTRAL AVE. • JERSEY CITY 7, N. J.

An Amplifier Which Reproduces Sound Indistinguishable From The Original

The superiority of a triode amplifier is most apparent in the final test...listening



The Brook High Quality Amplifier brings to its users a fidelity of reproduction never before achieved except under controlled laboratory conditions.

The Brook is alone in this ability—due largely to the use of specially designed transformers available in no other amplifier, and to the use of triodes throughout.

There is no way in which additional expense could improve the performance of the Brook Amplifier. Technical Bulletin AK-7 and list prices will be mailed on request, without obligation.

CHARACTERISTICS

- ★ Within two-tenths DB 20 to 20,000 cycles.
- ★ Both intermodulation and harmonic distortion reduced to negligibility.
- ★ Rated output 30 watts.
- ★ Automatic Bias Control—a patented circuit feature available only in the Brook Amplifier.
- ★ Precisely calibrated Bass and Treble compensation—two-stage tapped R-C network.
- ★ Gain—55 to 120 DB in various models.

The BROOK HIGH QUALITY AUDIO AMPLIFIER



Designed by LINCOLN WALSH

BROOK ELECTRONICS, Inc., 34 DeHart Plaxe, Elizabeth 2, N. J.

Now Available! 8 HOURS OF CONTINUOUS PLAY WITH THE MAGNETAPE* RECORDER!



Now — record and play back on this amazing instrument any sound that can be heard, and many that cannot — from a concert hall symphony to the beat of your heart. Simple interchangeable capstans provide a choice of three tape speeds for high fidelity, medium fidelity, or up to 8 hour voice recording. The ideal recorder and playback unit for home, office, industry, and broadcast station.

Other standard and portable models of shorter playing duration also available. Write today for our free illustrated catalog featuring our complete series of Magnetape Recorders and accessory equipment.

Send 25c. in stamps or coin for A.C. Shaney's new booklet, "Elements of Magnetic Tape Recording — and 999 Applications." Trademark

AMPLIFIER CORP. of AMERICA
398-4 Broadway New York 13, N. Y.

FREE



NEW! COMPLETE!
Concord
Radio Catalog

160 Value-Packed Pages of
the LATEST and BEST in
RADIO • TELEVISION and
ELECTRONIC EQUIPMENT

Write for FREE copy. Address Dept. F-18

CONCORD RADIO CORP.

CHICAGO 7 391 W. Jackson Boulevard
ATLANTA 3 265 Peachtree Street
Downtown Chicago Branch: 229 W. Madison Street
LAFAYETTE RADIO CORP.

frequencies where the response is much greater than at the fundamental, and under these conditions, spuriously high response readings may conceivably occur.

As previously noted, resistive-termination measurements on filters are not precisely indicative of the filter performance when the filter is actually used with complex terminations.

Transmitters

Transmitter audio frequency-response characteristics can be obtained by observing modulation percentage, by means of either an oscilloscope, or the station modulation monitor if the monitor response is sufficiently flat.^{10, 11}

The Institute of Radio Engineers has defined¹² the "frequency discrimination" of a transmitter as the comparison of the percentage of modulation of various audio frequencies for constant audio-frequency input. Overloading and overmodulation must be considered as possibilities in this method, in special cases. If overloading or overmodulation occurs as a result of exceeding the modulation legitimately to be expected of the transmitter, a compromise may be made at these points by reducing the input signal and correcting the modulation observations accordingly.

The language of the FCC standards concerning measurements for type approval of manufactured transmitters may be construed to mean that tests are to be made at the specified modulation percentages. In this case, the audio input level variations would be observed at different frequencies while maintaining a constant percentage of modulation. It is probable that results will be found substantially similar, whether measurements are made on a constant-input or on a constant percentage modulation basis, as long as the transmitter response is reasonably flat and no overloading occurs.

RMA Standards

Radio Manufacturers Association (RMA) has recently adopted standards for audio facilities for broadcasting systems. These standards specify, among other interesting items: (1) use of standard impedance values of 150 and 600 ohms in the design of future audio facilities, (2) a standard input signal (for testing) of 2.45 millivolts, r.m.s., in series with 150 ohms, which for system gain calculations corresponds to an input level of -50 dbm, (3) a standard output level of +18 dbm for feeding telephone lines, or of +12 dbm for feeding transmitters, and (4) figures for maximum audio-frequency response deviations permissible for com-

¹⁰See Reference 1, page 66.

¹¹See Reference 2, page 25.

¹²Institute of Radio Engineers, "Standards on Transmitters and Antennas—Methods of Testing," Institute of Radio Engineers, Inc., New York 21, N. Y., 1938, reprinted 1942, page 4.

pliance with RMA standards. Additional proposed standards, now under consideration, include (1) gain control settings for tests such that the standard input signal results in the standard output signal, and the attenuation as nearly as possible equally divided among all the gain controls in the main transmission path of the tested facility, (2) test oscillator spurious components should not exceed 10% r.m.s., of the output voltage for frequency-response measurements, and (3) two frequency-response tests are to be made, one at the standard input signal and the second at a level 20 db lower.

Standard measurement methods are, of course, to be recommended because of standard test conditions and the decreased ambiguity in interpretation of results. Emphasis will be placed by the station engineer upon interpretation of, and compliance with, FCC standards and methods of measurement. Future experience will assist the station engineer in formulating the exact methods to be used in assuring compliance with FCC requirements as to frequency response and other equipment characteristics. It is believed that methods and principles which have been presented herein will prove helpful, both for general station measurements, and as a basis for comparing station performance with FCC requirements.

Magnetic Recording

[from page 30]

greater width of the tape allows an uneven approach and departure contact which averages out the flux return. If this explanation is correct, the same irregularities should be observed in tape if a very narrow recording track is used. This experiment has not been reported.

Printing or signal transfer from a recorded turn to an adjacent turn of the medium on the storage roll exists in both wire and tape. Because of the separation of the active layers of a coated tape by the magnetically inert backing some reduction, about 6 db, is obtained in signal transfer in tape as it is used over the situation in which active layers of tape come in contact. The much greater reduction which might be expected due to the physical separation of active layers is partially lost because of pole geometry. The relatively long line of poles formed across the tape during recording, which results in greater output than in a 4 mil wire of comparable magnetic properties, also results in somewhat stronger fields available for printing. In either medium the effect falls off exponentially with the level of the original recording. It may be shown that the resulting transfer is not appreciable in wire if the recording level is

kept below the overload point. Tape may be expected to exhibit 6 db less in transfer than a wire of comparable magnetic properties.

Conclusion

The author announced his intentions of including in this review a discussion of equalization. The complexity of the subject together with a rapidly approaching dead-line rules out its consideration at this time. For information on equalization, the reader may see two excellent papers partially devoted to the subject.^{6,7}

Finally, the author wishes to express his indebtedness for many of the ideas presented in these articles to the friends with whom he has had the opportunity to discuss magnetic recording. These are R. Herr of Minnesota Mining and Manufacturing Company, Lynn C. Holmes of Stromberg-Carlson Company, S. M. Rubens of Engineering Research Associates and R. B. Vaile, Jr. and R. E. Zenner of Armour Research Foundation.

⁶ L. C. Holmes and D. L. Clark, "Super-sonic Bias for Magnetic Recording," *Electronics*, p. 126, July 1945.

⁷ A. E. Barrett and C. J. F. Twesed, "Some Aspects of Magnetic Recording and Its Application to Broadcasting," *Jour. I. E. E.*, p. 265, March 1938.

Industrial Ultrasonics

[from page 32]

The air must be inserted in a pulse manner, so that the water slugs will have as well defined length limits as possible. This can possibly be accomplished by having both columns of fluid resonate as shown.

If we feed the inner concentric air jet with the turbojet unit, as shown previously,¹ then we have ideal conditions, as the slug of air can be adjusted to have more than sonic velocity, with an extremely sharp leading edge, and very large peak pressures.

¹S. Young, "Ultrasonics in Solids," Oct., 194.

WAA SURPLUS SALES END

War Assets Administration has notified distributors of surplus electronic equipment that sales through them will be terminated March 1, 1948.

Should any inventory remain in the hands of distributors after that date, WAA said, it will be disposed of by donations to educational institutions in line with the program now applying to electronic inventories still in possession of WAA.

WAA said distributors now have a large inventory of electronic equipment comprising a variety of end equipment, radio components and vacuum tubes. However, disposal progress has indicated that present distributor inventories will be largely depleted by March 1.

RMC TRANSCRIPTION PLAYER Model TP-16C

Two-Speed . . . 16-inch . . . Low Price . . . Portable . . . Compact Lightweight . . . Easy to Carry
**FOR HIGH FIDELITY REPRODUCTION IN RADIO AUDI-
TIONING AND PROGRAMMING ROOMS**

Distinctive in design and quality. Finest tone reproduction for superior recorded entertainment.

Precision-built, expertly engineered, and sturdily constructed for trouble-free performance.

Switch output impedance: 30,250, and 500,600 ohms.

Free of wow and rumble.

2 speeds: 78 and 33 $\frac{1}{3}$ R. P. M.

Fully portable: in carrying position 23" w., 17 $\frac{1}{2}$ " h., 8" d.

Constant speed heavy duty motor; silent, smooth operation.

Bulletin TP4, upon request.

Export: Roche International Corporation, 13 East 40th Street, New York 16, N. Y.



Turntable Chassis only, \$78.80 Net
F. O. B. Port Chester, N. Y.

Supplied with or without professional broadcast station Para-Flux Reproducers. Write for prices.

Available Through Authorized Jobbers.

RADIO-MUSIC CORPORATION
PORT CHESTER • NEW YORK

**KEEP POSTED ON
ELECTRON TUBES**

Use this convenient coupon for obtaining the RCA tube reference data you need.

RCA, Commercial Engineering,
Section AW 65 Harrison, N. J.

Send me the RCA publications checked below. I am enclosing \$..... to cover cost of the books for which there is a charge.

Name _____
Address _____
City _____ Zone _____ State _____

- Quick-Reference Chart, Miniature Tubes (Free). [A]
- HB-3 Tube Handbook (\$10.00)*. [B]
- RC-15 Receiving Tube Manual (35 cents). [C]
- Receiving Tubes for AM, FM, and Television Broadcast (10 cents). [D]
- Radiotron Designers Handbook (\$1.25). [E]
- Quick Selection Guide, Non-Receiving Types (Free). [F]
- Power and Gas Tubes for Radio and Industry (10 cents). [G]
- Phototubes, Cathode-Ray and Special Types (10 cents). [H]
- RCA Preferred Types List (Free). [I]
- Headliners for Hams (Free). [J]

*Price applies to U. S. and possessions only.

TUBE DEPARTMENT

RADIO CORPORATION of AMERICA
HARRISON, N. J.



New Products

[from page 36]

Called the Unit 539, the new machine's performance compares favorably with Fairchild's larger Unit 523 console recorder, now widely used in radio stations, recording studios and sound laboratories.

The 539's synchronous drive meets all requirements for direct lateral recording on discs up to 17 $\frac{1}{4}$ " in size at 33.3 and 78 rpm, and the instrument is suitable for a-m and f-m broadcasting uses, professional recording, synchronizing of sound-on-disk with film, recording of facsimile on disk, instruction in speech, language and music, or wherever else high-fidelity and split-second timing are essential.

Additional details about these recorders are available from C. V. Kettering, sales manager, sound equipment division, Fairchild Camera and Instrument Corporation, 86-06 Van Wyck Blvd., Jamaica 1, N. Y.

FOR SALE

Recorder and playback, Amertype "Commando," Model A Recordgraph, carrying case, 110 W. AC 60 Cycles, eight hour recording on vinylite tape. Original purchase price \$850. Make reasonable offer.

PILOT MARINE CORP.

29 Broadway New York City

VERTICAL LATERAL
9A, 9B, D-93306, MI-4856

Reproducers Reconditioned

Only new parts used—includes repainting and replating;
Response checked with advanced Laboratory equipment
FAST SERVICE

VIBRATION SYSTEMS, INC.

1040 W. Fort Detroit 26, Mich.

AUDIO ENGINEERING SCHOOL

A practical 9 months' course in Sound Fundamentals, Recording, and Sound Transmission measurements; in a laboratory containing transmission sets, oscillators, square wave generator and intermodulation analyzer, and other equipment.

Complete recording studios assimilating broadcast, motion picture and commercial sound recording.

For information write

H. M. Tremaine, Director
SCHOOL OF SOUND RECORDING AND TRANSMISSION ENGINEERING
1655-A Cherokee Hollywood 28, Calif.



CRYSTAL CARTRIDGE

In an exclusive modern type "LT" Crystal Phono Cartridge, The Astatic Corporation, of Conneaut, Ohio, has just introduced a new, low needle talk reproducer in the low price field. Output voltage, 1.00 volt, avg. at 1,000 c.p.s.; minimum needle pressure, $\frac{3}{4}$ ounce; cutoff frequency, 4,000 c.p.s.; and replaceable Type "T" Needle with "Electro Formed" precious metal playing tip. In the reproduction of high frequencies, the Astatic Corp. reports, the "LT" Cartridge is noticeably free from disagreeable surface noise or needle talk for greater clarity and beauty of tone reproduction.

CUEING ATTENUATOR

A new line of improved cueing attenuators has just been announced by the Shallcross Manufacturing Co., Collingsdale, Pa.

These new Shallcross units, which feature a special switching mechanism to transfer attenuator input to a pair of separate output terminals for cueing purposes, facilitate program switching and fading in "on cue" without any increase in the diameter of the attenuator.

Any standard Shallcross ladder, bridged T, straight T, or potentiometer may be equipped for cueing action, including units as small as 1- $\frac{3}{4}$ " in diameter. All controls are available with mounting by means of a single-hole $\frac{3}{8}$ "-32 thread bushing or two 6-32 or 8-32 screws on 1- $\frac{1}{4}$ " or 1- $\frac{1}{2}$ " (except 1- $\frac{3}{4}$ " diameter units) centers.

In addition to its value as a space saver, the cueing attenuator contributes to improved program handling. With it the operator can listen for cue and can transfer a program from cueing amplifier to the transmitter preamplifier smoothly and efficiently by merely turning up the volume in the usual manner for proper gain control, instead of using a separate switching arrangement.

The cueing position is at the extreme counter-clockwise position, following the attenuator "off" position. The unit may be equipped with detent action for the "off" position, the cueing position, or both, if desired.

Specification sheets for simplified quotation requests on any attenuator requirement are available from the manufacturer.

WIRE RECORDER

Electronic Sound Engineering Co., 4344 W. Armitage Ave., Chicago, Ill., has introduced a new high-fidelity wire recorder which is expected to open up new fields for the use of wire recording, particularly where quality of sound is important. Built around the Company's patented amplifier circuit, the new unit is being sold under the trade-name "Polyphonic Sound."

The built-in six-inch speaker, with a range up to 10,000 cycles, has a special diaphragm to insure smooth reproduction of high frequencies. For those who want the very ultimate in sound performance there is available a fifteen-inch, dual channel auxiliary speaker. This speaker connects with a jack on the front panel and carries the lower range down to fifty cycles.

Input facilities consist of a low-level input for a microphone and a front-panel input arrangement for high level sound via direct connection with a radio or record player. The microphone has a response of 60 to 10,000 cycles. Standard equipment includes a fifteen-minute spool.

HOME RECORDER

The Speak-O-Phone Recording & Equipment Co., 23 W. 60th St., New York, N. Y. announce their newest model dual speed home recorder. The HR-48, known as the 20th Anniversary model, commemorates twenty years of instantaneous recording in which Speak-O-Phone was a pioneer.

The features of this combination recorder, playback and public address unit include a dual speed motor, a visual volume indicator, compensating tone control, radio input and head phone monitoring jack. The amplifier contains 2-7C7's, 1-7C5 and 1-7Y4 tubes.

REPS ELECT STONE

The Los Angeles chapter of the Representatives of Radio Parts Manufacturers, Inc., held its annual election in the Mayfair Hotel, Nov. 21st.

Carl A. Stone, veteran manufacturers' representative on the West Coast, was elected President for the ensuing year. Gerald G. Miller was elected Vice-President and M. D. Ealy was re-elected to continue as Secretary-Treasurer.

ADVERTISING INDEX

American Phenolic Corp.	40
Amperite Company	42
Amplifier Corp. of America	46
Arnold Engineering Co.	6
Audio Devices, Inc.	Cover 2
Audio Engineering School	48
Audio Equipment Sales	43
Bardwell & McAlister, Inc.	42
Brook Electronics, Inc.	45
Brush Development Company	5
Cinema Engineering Co.	38
Concord Radio Corp.	46
Electro Motive Mfg. Co., Inc.	Cover 3
Electro-Voice, Inc.	33
Fisher Radio Corp.	41
Gray Research & Development Company	38
Harvey Radio Co., Inc.	44
LeBel, C. J.	34
Pickering Company, Inc.	43
Pilot Marine Corp.	48
Presto Recording Corp.	Cover 4
Racon Electric Co., Inc.	35
RCA (Tube Div.)	47
Radio Music Corp.	47
Shure Brothers, Inc.	39
Simpson Electric Company	2
Stephens Manufacturing Co.	7
Tech. Laboratories	45
Thordarson	1
U. S. Recording Co.	34
Vibration Systems, Inc.	48
Wells, Winston	34
Western Electric Co.	8

this is the house . . .

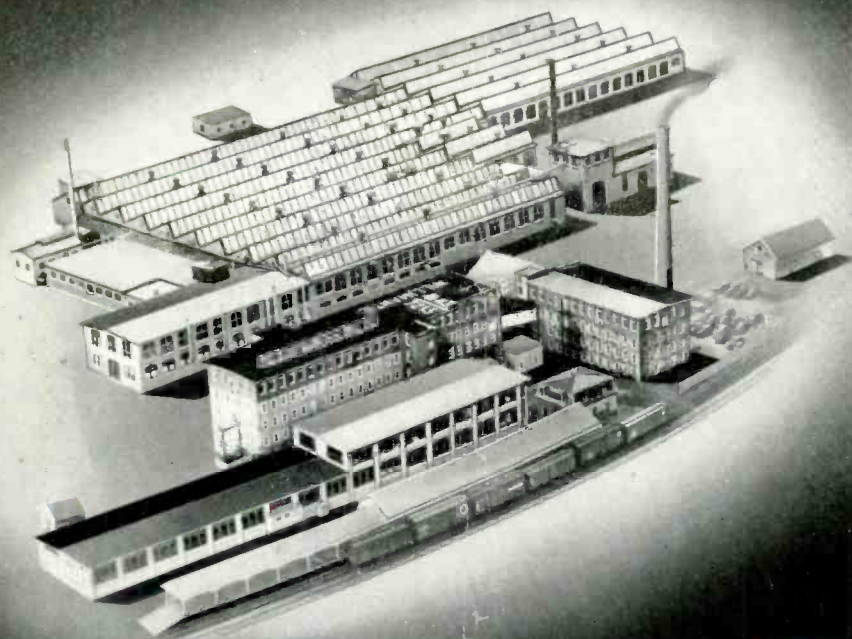

. . . that El-Menco built!

Size is not necessarily a sign of greatness. But when size is the result of consistently steady growth, based on an ever-widening demand for a product, then it is truly indicative of outstanding quality.

Year after year, in more and more instances, El-Menco Capacitors become first choice with manufacturers who are proud of their products.

Send for samples and complete specifications.

Foreign Radio and Electronic Manufacturers communicate direct with our Export Department at Willimantic, Conn., for information.

THE ELECTRO MOTIVE MFG. CO., Inc., Willimantic, Conn.



Write on firm letterhead
for samples and
catalog.



MOLDED MICA

El-Menco
CAPACITORS

MICA TRIMMER

From this package
come the finest recordings
in the world

Presto

GREEN LABEL DISCS

ALSO AVAILABLE—

Presto Brown Label discs. They're one-side perfect . . . with a flaw on the other side you probably couldn't find. Perfect for one-side recordings, reference recordings and tests, and at greatly reduced cost.

FREE! Presto will send you free of charge a complete bibliography of all technical and engineering articles on disc recording published since 1921. Send us a post card.

ALUMINUM
HANDLE WITH CARE
PRESTO RECORDING CORP.
NEW YORK, N. Y., U. S. A.



PRESTO

RECORDING CORPORATION
242 WEST 55TH STREET
NEW YORK 19, N. Y.