

# AUDIO ENGINEERING

FEBRUARY  
1948



THE JOURNAL FOR SOUND ENGINEERS

# For Truly Fine Recording and Reproduction



Professional Recordists Use—  
Professional Recordists Recommend—

## audiopoints\*

THE NEWLY EXPANDED LINE of Audiopoints now covers the full range of recording and playback needs. There are Audiopoints that fully meet the requirements of the most exacting professional recordists. There are also Audiopoints which these engineers unhesitatingly recommend to the non-professional and the general public.

### RECORDING AUDIPOINTS

**Sapphire # 14.** Long recognized by recording engineers as the best recording stylus obtainable. Manufactured to rigid specifications. Discussed on a recording machine just before packaging. List price \$7.25.

**Sapphire # 202.** A fine quality brass shank stylus, ideally suited for those recordists not requiring the super quality of Sapphire Audiopoint # 14. List price \$5.25.

**Stellite # 34.** Favorite with many professional and non-professional recordists. Though moderately priced, it is the very best stellite stylus produced. List price \$1.75.

**Diamond-Lapped Steel # 50.** Most practical stylus for home recordists when "first cost" is important. Being diamond-lapped, it cuts a quiet, shiny groove. List price 3 for \$1.00.

### PLAYBACK AUDIPOINTS

**Sapphire # 113.** Materials, workmanship and design make this playback point the finest made for original recordings and vinyl transcriptions. For years the outstanding choice of professional recordists. List price \$6.50.

**"Red Circle" Sapphire # 103.** With straight dural shank and fine polished jewel point. Excellent for original recordings, vinyl pressings and phonograph records. List price \$2.00.

**"Red Circle" Sapphire # 303.** Bent dural shank sapphire needle that is tops for phonograph records. For the first time a phonograph needle with a resharpening feature. List price \$2.00.

**Steel Transcription Needle # 151.** The ideal all-purpose transcription needle for original recordings, vinyl pressings and phonograph records. Quality performance is assured since each point undergoes a shadow-graph test. List price 20 for 25¢.

<sup>4</sup>Reg. U. S. Pat. Off.

### RESHARPENING SERVICE

Established years ago, our resharpening service gives real economy in the use of Audiopoints # 14, # 202, # 34, # 113, # 103 and # 303.

Write for new dealer discounts and our folder "Audiopoints."

Audiopoints are a product of the manufacturers of Audiodiscs.

**AUDIO DEVICES, INC., 444 Madison Ave., New York 22, N. Y.**

# More EFFICIENCY APPLICATIONS VALUE

## by using these NEW RACON SPEAKERS and HORN UNITS

**NEW SPECIAL PM HORN UNIT**, having Alnico V magnet ring, completely watertight, housed in a heavy aluminum spinning. Provides extremely high efficiency reproduction with minimum input. Handling capacity 35 watts continuous, 60 w. peak.

**NEW SMALL RE-ENTRANT HORNS**, extremely efficient for factory inter-com and paging systems, for sound trucks, R. I. yards and all other industrial installations where high noise levels are prevalent. Watertight, corrosion-proof easily installed. Two new models—type RE-12, complete with Baby Unit, handles 25 watts, covers 300-6000 cps; type RE-12, complete with Dwarf Unit, handles 10 watts, freq. response of 400-8000 cps.

**NEW RADIAL RE-ENTRANT SPEAKER**, excellent for all types of industrial sound installations. Provides superlative and complete 360° speech intelligibility by efficiently over-riding factory high noise levels. Frequency response 300-6000 cps. Handling capacity 25 watts continuous 35 w. peak. Has mounting bracket. Size 12" wide by 12 3/4" high.

### Other RACON products now available:

PM Horn Driving Units, 10 types. Straight Trumpets, 21 types.  
 Reentrant Trumpets, 7 types. Re-entrant Cone Speakers, 7 types.  
 Tweeter & High Freq. Speakers, 3 types. Flat bell straight trumpets, 2 types.  
 Radial Horns and Speakers, 3 types. Armored Cone Projectors, 7 types.

Also—cellular and auditorium horns, inter-com, paging, monitor, and dwarf speakers, cone speaker housings, etc., besides all basic accessories such as swivel brackets, mounting units, cone housings, multiple horn throat combinations, etc.

To the more than 60 different type and size speakers and horn units that already comprise the RACON line — these new models have been added. There is a RACON speaker and horn unit ideal for every conceivable sound system application.

RACON has not only the most complete line, but also the most preferred line. For over 20 years leading Soundmen have recognized and specified them because of dependability, efficiency and low-cost, and because the reproducers are trouble proof.

ASK YOUR JOBBER, OR—Write today for full details

RACON ELEC. CO., INC., 52 E. 19th ST., N. Y. 3, N. Y.

# RACON



# ARNOLD

## PERMANENT MAGNETS

*Depend on them  
for Uniformly  
High Quality  
in every  
PHYSICAL, MAGNETIC  
and METALLURGICAL  
Characteristic*

You would find it hard to set a requirement on Arnold magnets that is not already exceeded in our regular production procedure.

All Arnold products are made on a basis of 100% quality-control at every step of manufacture. These rigidly maintained standards cover all physical, magnetic and metallurgical characteristics. . . you can place complete confidence in the uniformity and dependability of Arnold Permanent Magnets, and their resultant performance in your assemblies.

Remember, too, that Arnold's service covers all types of permanent magnet materials, any size or shape of unit, and any field of application. Our engineers are at your command—write us direct or ask any Allegheny Ludlum representative.

W&D 1098



### THE ARNOLD ENGINEERING COMPANY

Subsidiary of

ALLEGHENY LUDLUM STEEL CORPORATION

147 East Ontario Street, Chicago 11, Illinois

Specialists and Leaders in the Design, Engineering and Manufacture of **PERMANENT MAGNETS**

Member of Audit Bureau of Circulation



Successor to **RADIO**

John H. Potts, Editor  
C. G. McProud, Managing Editor  
Lawrence LeKashman, Asst. Editor  
Louise B. Dresser, Edit. Prod. Mgr.  
Edgar E. Newman, Circ. Mgr.

Sanford R. Cowan, Publisher  
S. L. Cahn, Adv. Director  
H. N. Reizes, Adv. Mgr.  
David Saltman, Adv. Prod. Mgr.  
Jerome S. Harris, Asst. Circ. Mgr.

Editorial Advisory Board

Howard A. Chinn  
John D. Colvin  
Paul A. de Mars  
C. J. LeBel  
J. P. Maxfield  
George M. Nixon  
S. Young White

Representatives

James C. Galloway  
816 W. 5th St., Los Angeles 13, Calif.  
Dale International Publications, Ltd.  
105 Bolsover St.  
London W. 1, England  
Harris & Floyd  
297 Swanston St., Melbourne  
C. 1, Victoria, Australia

Established 1917

CONTENTS FEBRUARY, 1948

Vol. 32, No. 2

Editor's Report 4
Letters 6
Broadcasting Studio Pickup Technique—H. M. Gurin 9
Sound Reinforcement in the Hollywood Bowl—M. Rettinger, and Sterling M. Stevens 15
Analyzing Intermodulation 17
Feedback Preamplifier for Magnetic Pickups—Richard S. Burwen 18
Two-Way Speaker System, Part III—C. G. McProud 21
Facts About Loudspeakers, Part I—O. L. Angevine, Jr., and R. S. Anderson 24
Cavity Pressure Determination of Hearing Aid Gain 27
Elements of Ultrasonics—S. Young White 28
I.R.E. 1948 National Convention, Tentative Technical Program 30
Record Revue:
Classical Recordings—Edward Tatnall Canby 32
Popular Recordings—Bertram Stanleigh 32
New Products 34
Technicana: High-Quality Amplifier, Synchrodyne Receiver, Changes in Standard Frequency Broadcast 36
Professional Directory 36
Advertising Index 48

COVER ILLUSTRATION

Control room of Studio 1, KSL, Salt Lake City, Utah.

AUDIO ENGINEERING (title registered U. S. Pat. Off.) is published monthly at 28 Renne Ave., Pittsfield, Massachusetts, by Radio Magazines, Inc., J. H. Potts, President; S. R. Cowan, Sec'y-Treas. Executive and Editorial Offices at 342 Madison Avenue, New York 17, N. Y. Subscription rates—United States, U. S. Possessions and Canada, \$3.00 for 1 year, \$5.00 for 2 years; elsewhere \$4.00 per year. Single copies 35c. Printed in U. S. A. All rights reserved, entire contents Copyright 1947 by Radio Magazines, Inc. Entered as Second Class Matter at the Post Office, Pittsfield, Massachusetts, under the Act of March 3, 1879.

# EDITOR'S REPORT

---

## NUMBER ONE BOOK

● A FEW months ago one of the largest advertising agencies conducted a survey to determine which of the eight trade publications serving the broadcasting field were preferred by broadcast station technical personnel. When the returns were tabulated, three magazines ran neck and neck, with the others trailing badly. *Audio Engineering*, although in existence but six months, was rated among the top three.

More recently, a manufacturer made a similar survey. This time, with two more excellent issues under our belt and with our increased circulation, *Audio Engineering* was rated best in the field.

## MORE ON HI-FI

● IN THE same mail we received two letters which point up the wide gulf between the two schools of thought on high fidelity. From England, a British engineer writes that we shouldn't call an amplifier "high-fidelity" unless the harmonic distortion is kept down to around one-tenth of one per cent and the frequency response flat to within one db from 20 to 20,000 cycles. The other writer maintained that his amplifier had to be designed to boost both lows and highs far above the middle register to give him satisfactory reception. Canby has written in his column that what we really want is pleasing reception, whether or not it is high fidelity, and cites the fact that even a pleasant voice might sound awful if the speaker got too close to the mike, especially if exactly reproduced.

All this has its parallel, of course, in other fields. A couple of decades ago, the same controversy arose in photography. Portrait photographers didn't like high grade anastigmat lenses because they brought out every pore and blemish in the skin, details which were not normally noticed when directly viewed by the eye. A fad arose for partially corrected lenses, cliffon diffusers, and other means of softening the details. In some cases, these expedients did give more pleasing pictures, but these devices have largely disappeared with the advent of better photographic materials and improved techniques in lighting and finishing processes.

Because a reduction in sound power causes a far greater decrease in the loudness of the lower fre-

quencies (and, to a lesser degree, the higher frequencies) than those in the middle register, due to the characteristics of the human ear, it has been argued that some compensation is necessary when reproducing sounds at a lower power level. This is not necessarily true. The sound power developed by a large orchestra, for example, is far greater than that produced by the average radio. But the orchestra would normally be spreading this acoustic power over a much greater area than that covered by a home radio when operated in a living room. Thus the radio could reproduce in the home orchestra music with much less sound power, yet give the same degree of loudness as would be experienced by the listener to the orchestra at some point in a large auditorium. Therefore no bass boost is necessary unless the listener operates the reproducing equipment so that the music is not as loud as it would be if he were listening to the orchestra directly in an auditorium.

Engineers who test loudspeakers are often somewhat amused at the efforts of designers of amplifiers to make the electrical response flat to within a fraction of a db over a wide frequency range, because the speakers to which the amplifiers connect have such jagged response curves. Actually, if uniform frequency response were the only consideration, the care would not be worth the trouble. But in making the frequency response flat, distortion is also reduced, so that a fine amplifier does enable better reproduction from the same speaker than could be secured from a mediocre design.

## WITH OUR AUTHORS

● WINSTON WELLS has recovered from his illness and his next article on the design of electronic organs will appear in our March issue. C. J. LeBel and Norman Pickering dropped in to tell how well they are progressing in organizing an audio engineering society. Had lunch with Howard Chinn and Bob Monroe of CBS. Howard has in preparation an excellent series of books on audio engineering which we hope to start publishing in the near future. From KSL comes word of a new noise suppressor with many outstanding features. An article on it will appear in an early issue.

—J. H. P.

*now being used by*  
**DUMONT - RCA**  
**NBC - CBS**  
*for studio and*  
*location productions*

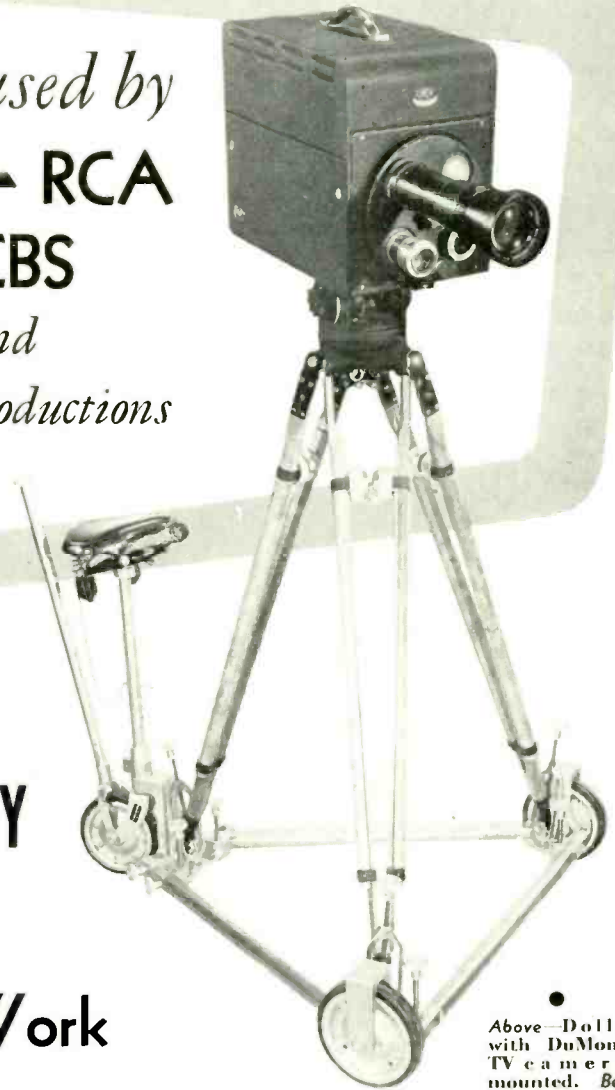

*"The Professional Junior"*

## COLLAPSIBLE DOLLY

*for all types of*

## Television Camera Work

IMMEDIATE DELIVERY

• Above—Dolly with DuMont TV camera mounted. Below—Dolly collapsed. •

This Dolly designed by specialists of custom-built television and motion picture equipment, and lens mounts. Representatives for Houston Developing Machines, Auricon single system camera and recording equipment, Hardwell McAlister lighting equipment, Moviola and Micro Engineering editing equipment. Rentals, Sales and Repairs of all types of 16mm and 35mm cameras, lighting and editing equipment. Complete staff of trained technicians available for consultation.

Write for Literature

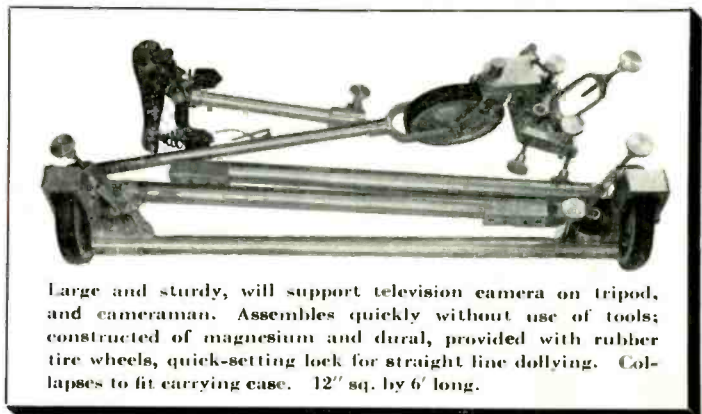

Large and sturdy, will support television camera on tripod, and cameraman. Assembles quickly without use of tools; constructed of magnesium and dural, provided with rubber tire wheels, quick-setting lock for straight line dollying. Collapses to fit carrying case. 12" sq. by 6' long.



## GROOMING an **ADC TRANSFORMER** for FAULTLESS PERFORMANCE

### 3 Complete Tests to Meet Rigid ADC Specifications

Strict electrical tests are given to **ADC** Transformers at three different stages of production. In order to give you faultless performance on the job, each and every transformer must come within **ADC** catalog specifications on every test. (Customer specifications on special transformers.)

**1st TEST.** After assembly of coil and laminations, each component is given complete performance tests for compliance with specifications. *Any* unit failing to meet *all* requirements is rejected.

**2nd TEST.** After impregnation, baking and casing, each transformer is re-checked for continuity, breakdown and other requirements of the particular unit. This guarantees correct wiring, perfect insulation—no "shorts" or "opens."

**3rd TEST.** After cleaning, labeling, etc., a final continuity, breakdown and thorough visual check is made. This quality control test—plus the finest materials and workmanship available—assures you of faultless performance on the job.

### ADC Quality

**ELIMINATES** necessity for large over-runs to allow for rejects. (Customer returns consistently less than 1/2 of 1%.)

**AVOIDS** expense and delays due to rejects which must be sent back.

**GUARANTEES** performance as specified in **ADC** catalog. (Custom-built transformers guaranteed to meet *your* specifications.)

### Other ADC Quality Components

**JACKS • JACK PANELS • PLUGS • PATCH CORDS**

*"Audio Develops the Finest"*



*Audio Development Co.*

2833-13th Avenue So., Minneapolis, Minn.

## Letters

### AUDIO SOCIETY ACTIVITIES

Sir:

A letter from C. J. LeBel (published in the January issue of this magazine) explained that a group of audio engineers were giving serious consideration to the formation of a professional organization for the advancement of the science and art of audio engineering. Your readers will be interested to know that this proposed Audio Engineering Society is organized. Discussions among a group of well-known audio engineers have already been held, and this group has appointed C. J. LeBel to be acting chairman and Norman C. Pickering to be acting secretary to bring the aims of this new organization to interested engineers and technicians. Those who have not been reached directly are invited to write the Acting Secretary for further information.

The formal organization meeting will be held on Tuesday, February 17th, at 8:00 p. m., at the RCA Victor studios at 155 E. 24th St., New York City, at which organizational details will be settled and temporary officers elected. The society has been fortunate in obtaining Dr. Harry F. Olson of RCA as the speaker at the first technical meeting of the Society, to be held Thursday, March 11th, at 8:00 p. m., at 155 E. 24th St., New York City. Dr. Olson will discuss some specific problems associated with high quality sound reproduction and present an interesting demonstration.

The need for an Audio Engineering Society has long been felt. It is certain to succeed in its aims if firmly supported by audio engineers and technicians. It will furnish a medium for presentation of new ideas in audio, discussion of which will unify thinking along these lines.

Norman C. Pickering,  
Oceanside, N. Y.

### FROM PROF. JONES

Dear Mr. Wells:

I have just seen the August number of *Audio Engineering*, and have read with much interest the first of your series of articles on the design of electronic organs. I hope to see the rest of the articles in this series, and I congratulate you on the clear presentation of the material in this first article.

I notice several points at which the statements you have made cause me some surprise, and in case you care to know what they are I am mentioning them in the following comments.

(1) You state that "the pedal contacts are usually designed to "make" when the pedal has been depressed about one inch." On the manuals you say that "the electrical contacts "make" when a key is depressed about one-half inch." These values seem so large that I have checked them on one organ. I had no measuring device with me, but I should say that on this particular organ the pedals were depressed not more than half an inch before the pipes spoke, and the manual keys not more than three sixteenths of an inch.

(2) You say that combination pistons are usually actuated "by means of the knuckles." Last evening I asked two different organists about this. Neither



of them had ever heard of using the knuckles for this purpose. They said that the knuckles might, of course, be used, and that there might be some occasions when this would be convenient. However, I doubt it being a practice that is at all common. If you were playing, let us say, on the great manual, and wished to change the combination for that manual, you would certainly not make use of your knuckle.

(3) Your treatment of the tremolo on an organ seems to suggest that it is a frequency vibrato. In such a stop as a celeste my impression is that your statement is correct, but is it not the case that the tremolo on an organ is usually closer to a fluctuation in amplitude?

(4) You seem to restrict the term "voicing" to a balance in loudness throughout a given rank of pipes. Is it not true that this balance is only one of several things that the voicer must do? Does he not have the job of making a pipe speak with sufficient promptness, of seeing that the speech is good, and of securing a nice adjustment to the musical quality that is desired?

I am not an organist, and perhaps my remarks will be of no value to you, but if they interest you, you are welcome to them.

**A. T. Jones**  
Professor of Physics  
Emeritus,  
Smith College,  
Northampton, Mass.

Dear Professor Jones:

I have just returned to my activities after a long illness; otherwise, I should have answered your letter long before this.

To say that your letter and comments were welcomed would be an understatement, for your book, entitled "*Sound*," has occupied a place within arm's reach of my desk since it was first published.

Furthermore, I always enjoy receiving a letter from a professor of physics since, during my college days, most of my mail was from the dean's office . . . I never thought I'd live to see the day when things would be different.

But, to answer your questions in the order in which you asked them:

**(1) Values of Pedal and Manual Movement**

There is, as yet, no set of standards for the distance of travel of the keys. Organists and designers disagree widely on the ideal distances.

The values which you give are typical of certain instruments. Those which appeared in my article are mean values, taken from a representative group of existing instruments. The trend seems to be toward shorter distances, and it has been my experience that an instrument so designed is less fatiguing to play for long periods.

**(2) Actuating the Combination Pistons by Means of the Knuckles**

I'll admit that this is a technique more common to theatrical and radio organists than to those of the church and concert fields. Practically all of my professional work as an organist was in the entertainment field and, along with many of my brethren, I used my knuckles to change combinations.

You are correct in assuming that it would be difficult to use this method on the manual upon which you were playing; that is, with the same hand you were playing with.

[Continued on page 48]



When 1948 brings important events . . .

## Get long-period coverage with a "MAGNETONE" Magnetic Recorder

To cover the news-making events of '48, or to develop special programs for rebroadcast, the "MAGNETONE" is unequalled. This highly professional magnetic recorder has been especially designed for quick, accurate and controlled recording and playback.

The "MAGNETONE" uses plated brass wire and makes permanent magnetic recordings of unsurpassed quality. Recordings may be "erased" and the wire re-used any desired number of times. "Erasure" is automatic as a new recording is made. Life of the magnetic wire is unlimited. Reels of wire in 1/2, 1, 2 and 3 hour time periods are available. The "MAGNETONE" is portable, durable, in attractive metal or black leatherette case.

Outstanding characteristics of the Model BK-303 "MAGNETONE" are its fast rewind, fast forward speed, and constant recording speed which permits any section of a recorded program to be spliced into any other section without impairing the faithful reproduction. See and hear the "MAGNETONE" . . . compare it with any magnetic recorder in America.

Write today for complete specifications

THE *Brush*  
DEVELOPMENT COMPANY

3405 Perkins Avenue - Cleveland 14, Ohio, U.S.A.

MAGNETIC RECORDING DIV. - ACOUSTIC PRODUCTS DIV.

INDUSTRIAL INSTRUMENTS DIV. - CRYSTAL DIVISION



# Magnetone

**Try it!** —and you'll  
**come back for more!**

**It's just  
this size!**



THE NEW WESTERN ELECTRIC  
**755A**  
8-INCH LOUDSPEAKER

**Available immediately  
—in quantity!**

Here's more quality than you ever thought possible in an 8-inch speaker!

This new Western Electric 755-A gives you wide frequency response—exceptionally brilliant tonal quality—ample output—all at surprisingly modest cost.

The relatively small space required to obtain such high quality with this 8-inch speaker makes it ideal for broadcast station use, wired music, program distribution and sound systems, home radios and record players—in fact *everywhere* for top quality reproduction!

Brilliant performance is possible with an 8-inch speaker. Prove it to yourself by putting the 755-A through its paces. We'll bet you'll be so pleased you'll come back for more!

**Call Graybar today!**

Get your 755-A's quickly—call your nearest Graybar representative right now—or write to Graybar Electric Co., 420 Lexington Ave., New York 17, N.Y.

**Specifications of the 755-A**

<b>Power Handling Capacity</b> 8 watts continuous	<b>Coverage Angle</b> 70 degrees
<b>Frequency Response</b> 70 to 13,000 cycles	<b>Weight</b> 4¾ pounds
<b>Input Impedance</b> 4 ohms	<b>Dimensions</b> Diameter: 8¾" Depth: 3⅝" Baffle Hole Diameter 7"
<b>Efficiency</b> Sound level at 30 feet on axis is 81.5db above 10-16 watts per square centimeter at 8 watts input	<b>Enclosure Required</b> 2 cubic feet



**DISTRIBUTORS:** IN THE U. S. A. — Graybar Electric Company. IN CANADA AND NEW-FOUNDLAND—Northern Electric Company, Ltd.

**Western Electric**  
**—QUALITY COUNTS—**

AUDIO ENGINEERING FEBRUARY, 1948

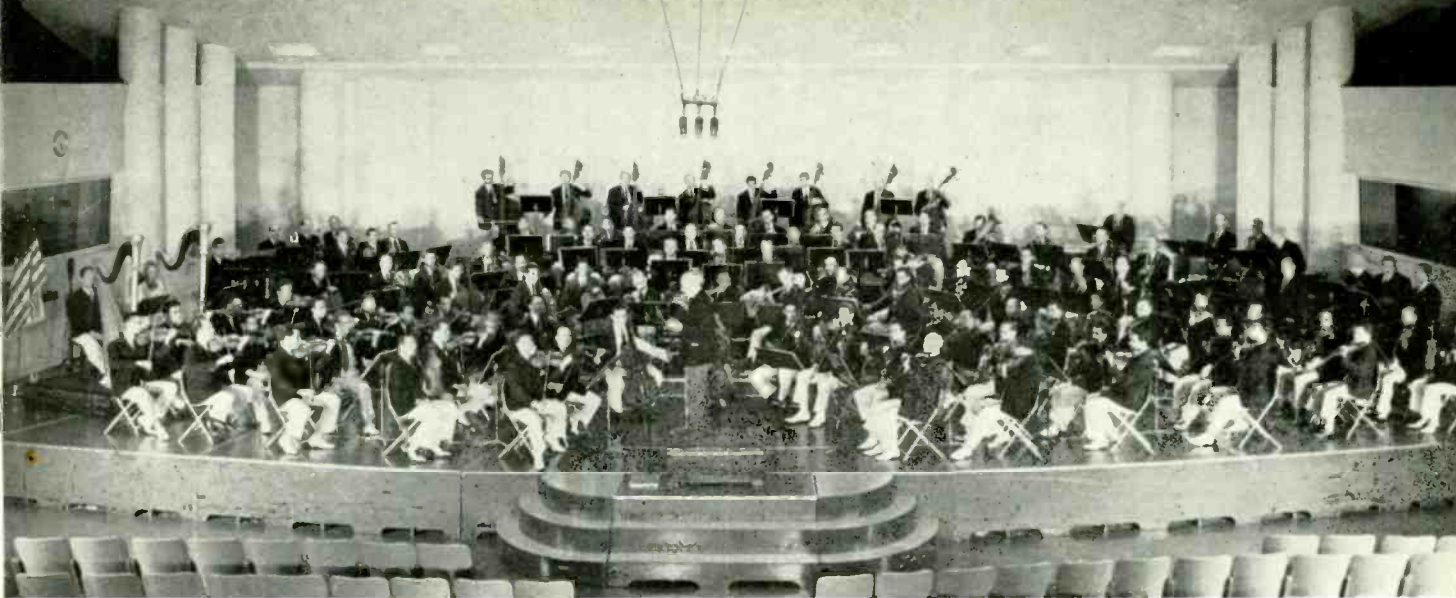

Toscanini conducting the NBC Symphony Orchestra.

# Broadcasting Studio Pickup Technique

H. M. GURIN\*

## Factors influencing placement of microphones and performers in broadcast studios

**P**ROGRESS in the engineering development of broadcasting equipment and studios has been greatly accelerated in the last decade, and noteworthy contributions have been made in this field.<sup>1</sup> As a result, the expectations of higher standards of technical perfection and performance may be justified. The usefulness of any improvement is premised on the skill with which this information can be applied so that the quality of the performance<sup>2</sup> can keep pace with technical advances placed at one's command.

In broadcasting, whether it is AM or FM, the primary purpose is to bring to the listener, in the most pleasing and intelligible manner, whatever information may be transmitted. For speech, one would normally look for intelligibility and naturalness of the reproduced sound so that a mental picture of the person and his surroundings may be formed as well as the message being clearly understood. In music, faithful reproduction without distortion and the enhancement of musical programs to heighten the listeners' personal pleasure are the major objectives.

The transmission of sound from a

\*Engineering Dept., National Broadcasting Co.

<sup>1</sup> Nygren, A.—*FM & Television*, May '46, Vol. 6, No. 5, p. 25; Volkmann, J. E.—*Journal of Acoustical Society of America* XII 234 ('42); Olson, H. F.—*RCA Review*, Vol. 1, No. 4, p. 68 (1937); Olson & Massa, "Applied Acoustics" P. Blakiston Sons, Philadelphia.

broadcasting studio, to achieve the results mentioned above, involves a number of technical factors among which are:

- a. The acoustics of the studio.
- b. The electrical system characteristics, (amplifiers, filters, microphones, etc.).
- c. The studio pickup and microphone technique.

It is with the last mentioned item that this article is primarily concerned, and only some comments will be made of the first two factors. Since the program is to originate in a broadcasting studio of conventional design, it is assumed that:

(1) the frequency reverberation time

characteristic of the space is acceptable (2) that the volume is adequate for the intended programs and audiences, if any, (3) that the diffusion of the sound field obtained by proper acoustic treatment and geometrical configuration is satisfactory and that no unusual grouping of resonant frequencies exists.<sup>2</sup> It is further assumed that in the electrical system<sup>3</sup>

<sup>2</sup> Morse, P. M. & Bott, R. H.—*Rev. Mod. Phys.* XVI, 69, 1944.

<sup>3</sup> NBC Engineering Department Bulletin—"Down to Earth on High Fidelity"—O. B. Hanson, C. A. Rackey, G. M. Nixon.

TABLE I

General Properties and Characteristics of Microphones

Model	Type	Frequency Response**	Output Impedance	Output Level*	Directional Characteristics
RCA 44-BX	Ribbon Velocity	30—15,000 ±6 db	30/250	-55 vu	Bi-directional
RCA 633-A	Combination Ribbon Velocity and Pressure	30—15,000 ±5 db	50/250/600	-54.3 vu -57.3 vu	Bi-directional Uni-directional
RCA 77-1D	Pressure (moving coil)	60—10,000 +5 db	50/250	-55 vu	Non-directional
RCA 88-A	Pressure (moving coil)	50—9,000 +3 db	20	-59 vu	Non-directional
WE 639-A	Combination Ribbon Velocity and Pressure	40—10,000 ±4 db	35	-55 vu -61 vu	Uni-directional Bi-directional
WE 639-A	Condenser (with assoc. amplifier)	50—15,000 ±6 db	(Amp. Out.) 30—50/200 250	(Amp. Out) -45 vu	Uni-directional Bi-directional Non-directional

\*Input level of 10 dynes/cm<sup>2</sup>  
\*\*Manufacturer's specifications

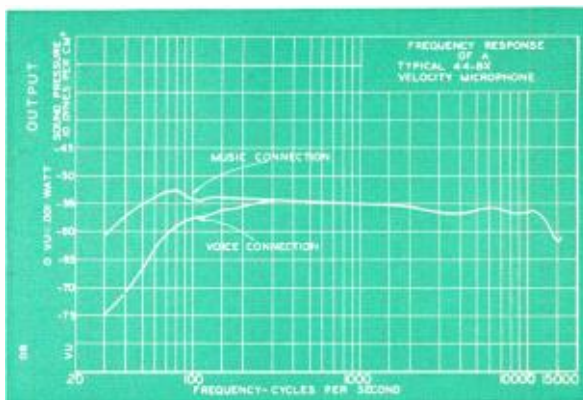
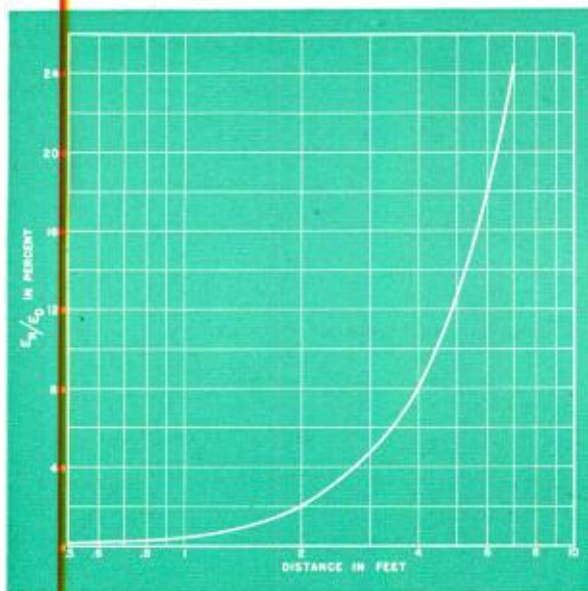

Fig. 1 (left). Ratio of reflected to direct sound energy with respect to distance from a ribbon velocity microphone.

Fig. 3 (above). Frequency response of the RCA Type 44-BX microphone.

(1) there is no discrimination in any of the component parts against any frequency within the range under consideration unless specifically desired for special effects, (2) there is a minimum of phase distortion, (3) there is a minimum of harmonic distortion, (4) there is a minimum of extraneous noise.

#### Studio Pickup Technique

Of the factors listed, probably the most controversial is that relating to studio pickup technique, which includes the applications and placement of microphones and performers. It is important to remember that the system we are dealing with is monaural and lacks the ability to discriminate as to the location of a sound, although it can differentiate as to apparent distance of the source of sound to the microphone.

When sound is generated in a space, the collecting system, via the microphones, is generally so oriented that the first sounds come from the source directly and are followed by the sound reflected from the surrounding surfaces. When the absorption between boundaries equals the output of the source, the steady state condition is reached. The ratio of reflected to direct sound is considered the

effective reverberation of the collected sound. It is obvious that an increase in the total number of reflections reduces the energy density of each reflection and permits a more uniform and diffusive sound field to exist.

The proportion of reflected to direct sound in a pickup is determined only partly by the acoustical characteristics of the studio. The directional character of the sound source and the receptive angle of the microphone used as well as its distance from the source are also important.

Fig. 1 illustrates the relationship of reflected to direct sound energy,  $E_r/E_d$ , with respect to distance of the sound source from a ribbon velocity microphone in a suitably treated studio for frequencies between 200 and 1000 cycles. It is readily apparent that any enhancement of the tonal quality of a singer or instrumentalist by the acoustical properties of the studio is negligible when the performer is too close to the microphone. Fig. 2 shows the energy response for various microphones in a typical studio.

Since most musical sounds and human voices produce sound waves of a complicated series of harmonics, each with a different wavelength, frequency and

amplitude, two or more microphones placed at unequal distances from the source of the waves will receive them successively, rather than simultaneously. The time interval will cause the composite wave to present a different arrangement of its harmonics to each microphone at a given instant. If the outputs of these microphones are then blended and reproduced by a single loudspeaker, the results manifest themselves as raspiness and raucous tones, particularly at the higher frequencies. It is for this reason that single mike pickups are recommended, particularly for musical programs. However, if multiple microphones are required to obtain full coverage, considerable care must be exercised to avoid distortion caused by wave interference and phasing.

A general understanding of the characteristics of the microphones commonly used in broadcasting is of material assistance in selecting the proper type for a specific task to obtain optimum results. The tabulation, Table 1, shows the general properties and characteristics of several such microphones.

Figs. 3-4 graphically show the directional and frequency response characteristics of the RCA-44-BX ribbon velocity microphone. Fig. 5 illustrates the RCA-77-D combination velocity and pressure microphone characteristics.

The acceptability of the final outcome depends in a large measure on the subjective reaction of the individual responsible for the performance as well as on the listener, and for this reason no hard and fast rules can be established. Instead, some illustrations will be given in which various acoustical problems have been met and from which general principles may be derived as a guide to acceptable practice.

Fig. 2. Energy response curves for direct and reflected sounds in a typical studio

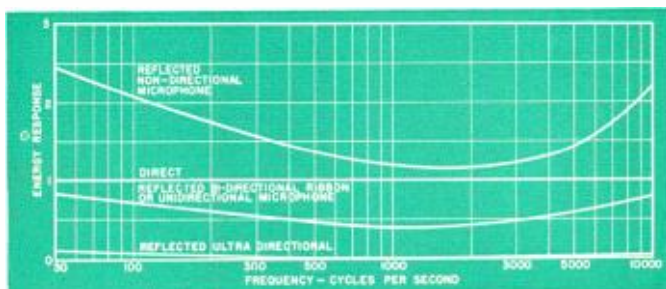

When an interview for an individual is conducted or a brief address is being delivered from a small speaker's studio, a bi-directional microphone can be used, from both sides if necessary. The receptive sides of the microphone should be located at least 8 feet from the nearest reflecting wall so that no distortion due to wave interference results. Since the

major portion of the sound is direct, as it should be, when articulation is important, the reverberation time should be low. This condition may be carried too far, and sometimes sounds artificial and unrealistic. Under practical application, the apparent reverberation may be increased by increasing the microphone distance from the speaker, thereby increasing the

ratio of reflected to direct sound at the pickup point. The bi-directional microphone is particularly suitable for a speaker in a "dead" studio, because the microphone responds to sounds originating both in front and behind it, thereby increasing the apparent reverberation. Of course, where the background noise is excessive or the studio reverberation time

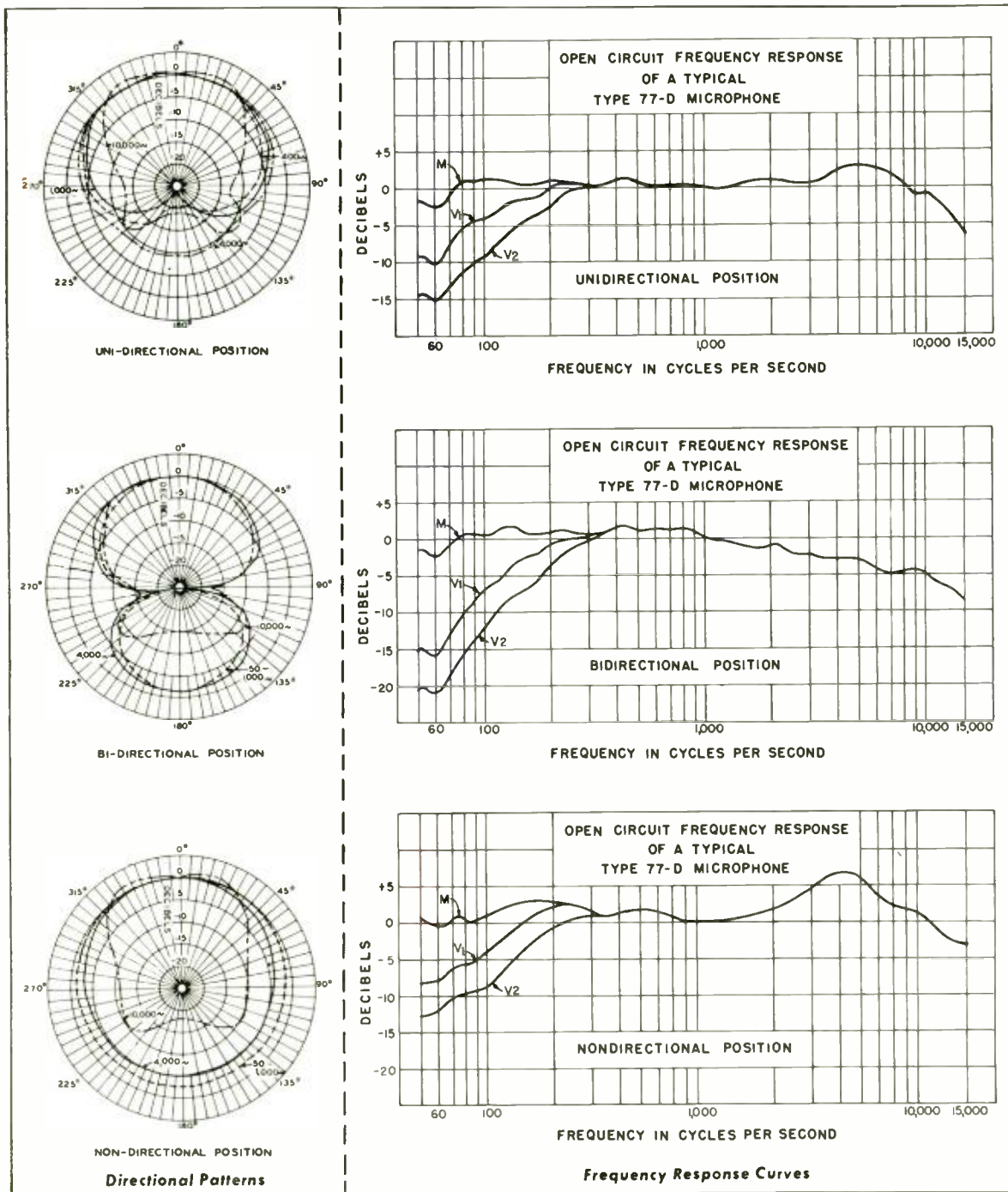

Fig. 5. Directional patterns and frequency response curves for the RCA Type 77-D microphone.

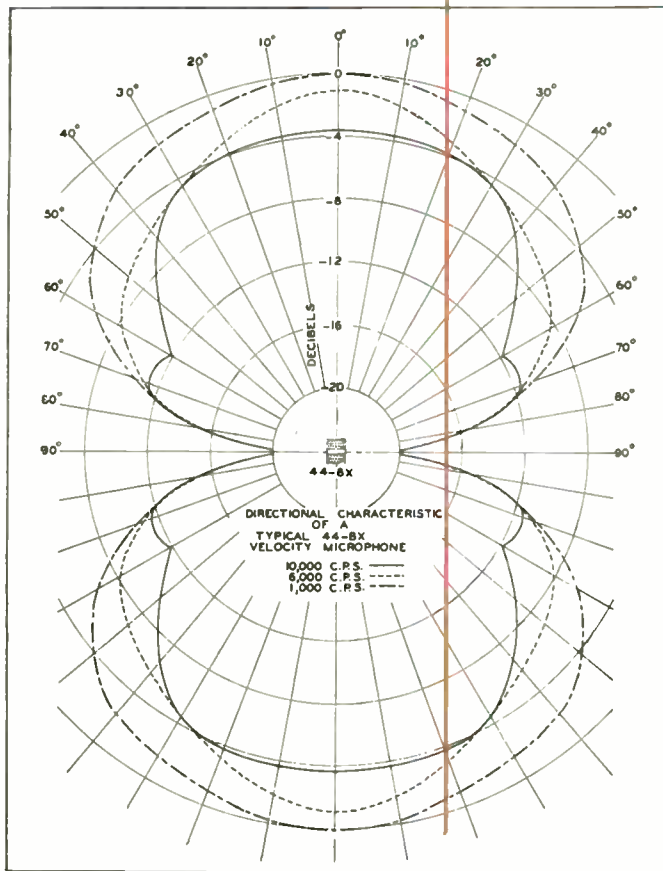

Fig. 4. Directional characteristics of the RCA Type 44-BX microphone.

is high, uni-directional microphone which discriminates against all frequencies equally, other than those in front of it, is preferable.

**Special Effects**

Very often, during dramatic sequences, special speech effects are desired or

simulated, as for example, during a telephone conversation or when voices in a cavern or supernatural voices are being reproduced in a fantasy or mystery story. The customary means involve the use of electrical filters and equalizers inserted in the microphone circuit. Fig. 6 is a block diagram of such a device with its corre-

Fig. 6 (left). Typical telephone filter characteristics. Fig. 7 (right.) Echo chamber line-up.

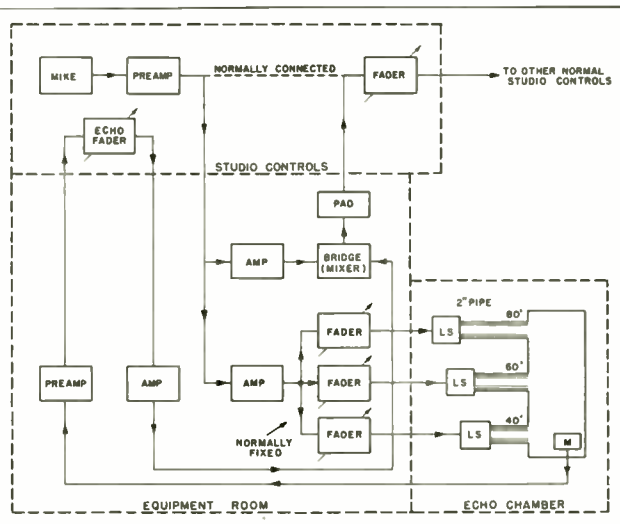
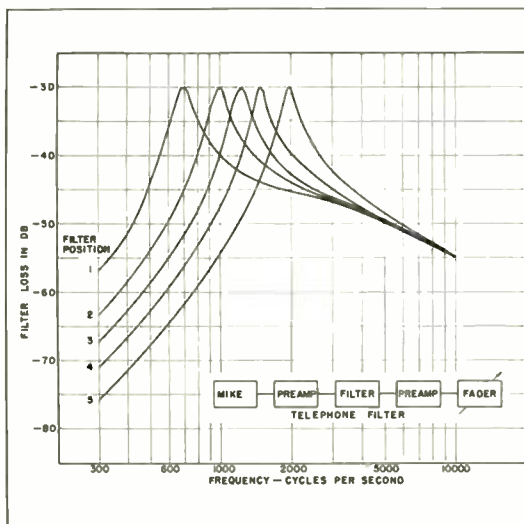

sponding characteristic curves. By means of this unit, a large variety of effects may be obtained as required by the script.

A very useful adjunct along the same line is an echo chamber, within which an additional microphone, either non-directional or bi-directional, and loudspeaker are located and connected in the transmission system so that an artificial delay, together with multiple reflections, are introduced. The echo chamber is sometimes used for musical programs, particularly with small or medium sized groups where an aural effect of spaciousness similar to a concert hall is to be envisioned. Fig. 7 is a block diagram showing an echo chamber line-up. Fig. 8 illustrates a typical arrangement for a dramatic presentation using an orchestra for musical bridges, sound effects, voice effects, together with the usual cast and announcer's microphone.

**Groups**

In setting up musical groups, the technique for microphone placement in relation to the performers depends on the type of program, the number of participants, and the effect desired. The pickup for a solo instrument or vocalist is generally a simple matter. Care must be taken, however, not to place the microphone close enough to pick up the mechanical noise of an instrument such as a piano hammer, the plucked strings of a guitar, or the surface noise of bowing, as in the case of a violin. In the case of a vocalist, it is important to remember that the low frequency response of the velocity or ribbon microphone is accentuated when the distance between the source and the microphone is less than a wavelength. Consequently, singers should stay at least 3 feet away or more, depending on their volume range. Typical arrangements for voice with piano accompaniment are shown below in Figs. 9A and 9B.

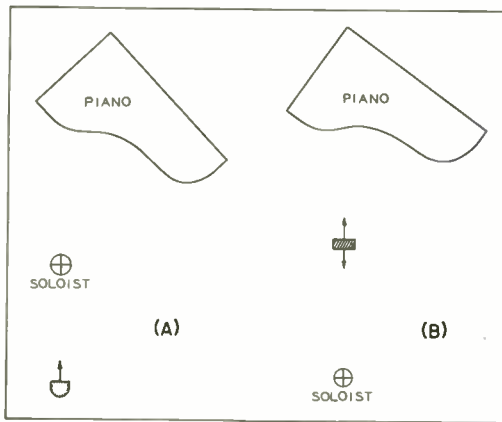

Small musical groups, such as quartets or trios, may be treated similarly to a soloist with piano accompaniment, with some slight modifications. In this case, it would be preferable to keep all the instruments on the same side of the microphone, as shown in the Fig. 10.

If the microphone is located too close to an instrumental group, high differentiation of the individual instruments would result. If the microphone is further away, the sounds will blend together, as they do when heard in an auditorium or music room, and result in a more realistic and normal reproduction. Care must be exercised, however, in not going too far since "definition" may be lost entirely.

For the concert orchestra, the sensitive and comparatively noise-free ribbon velocity microphone has been highly useful. Because of its uniform receptivity at all frequencies, it permits greater control of the low pitched instruments by proper angular orientation to the axis of a microphone.

It is possible to bring the entire group within an effective angle of 90° by placing a single microphone sufficiently far enough in front of the orchestra. Under

Fig. 8 (right). Setup for dramatic program with musical bridges.

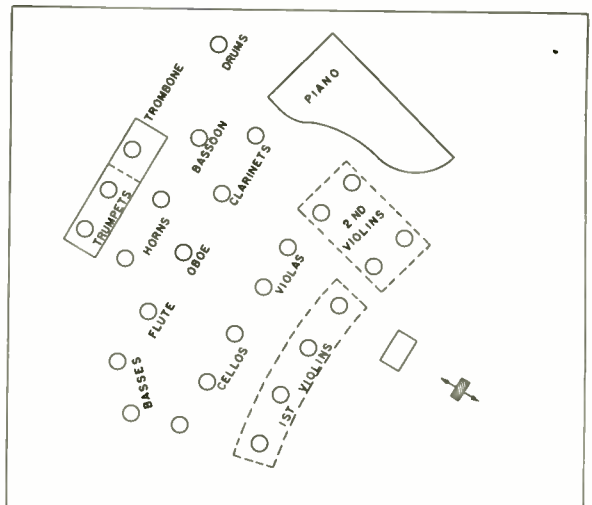
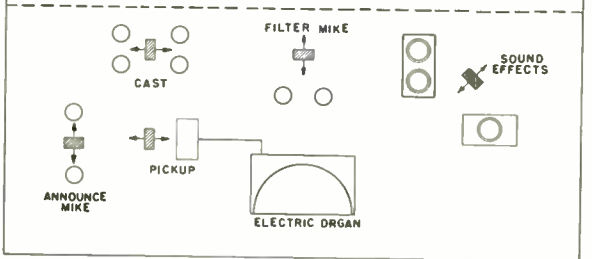

Fig. 9 (above). A—Microphone placement for solo with piano accompaniment. B—Alternate microphone placement for solo with piano accompaniment.



such conditions, the arrangement of the instruments needs little, if any, changing from the regular concert seating plan for satisfactory results in broadcasting. Illustrated, in Figs. 11 and 12, are the seating plan and microphone position for the NBC Symphony Orchestra.

The optimum distance and height of the microphone in any pick-up can be determined when all the factors, such as acoustical conditions, random noise, size and character of performing group, type of microphone selected, etc., are known.

Laudable efforts<sup>4</sup> have been made in setting up some mathematical basis for determining the position but the elements of personal judgment plus the individual acoustical character of the space from which the program originates are too important to be neglected.

The varying directional characteristics of the orchestral instruments themselves must be considered; for example, strings, woodwinds and percussion are practically

<sup>4</sup>J. P. Maxfield—"Liveness in Broadcasting"—*W. E. Oscillator*, Jan. 1947.

Fig. 10 (left). Arrangement and microphone placement for small musical groups. Fig. 11 (right). Arrangement and microphone placement for symphony orchestra and soloist.

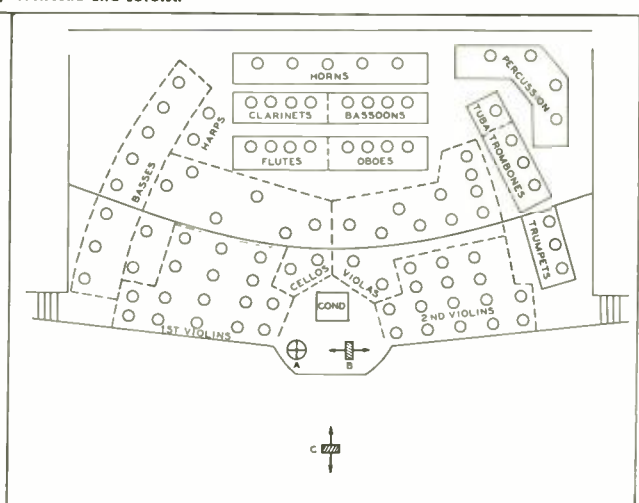
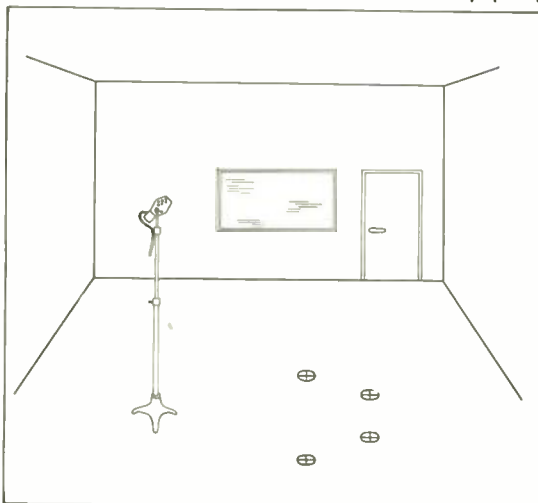

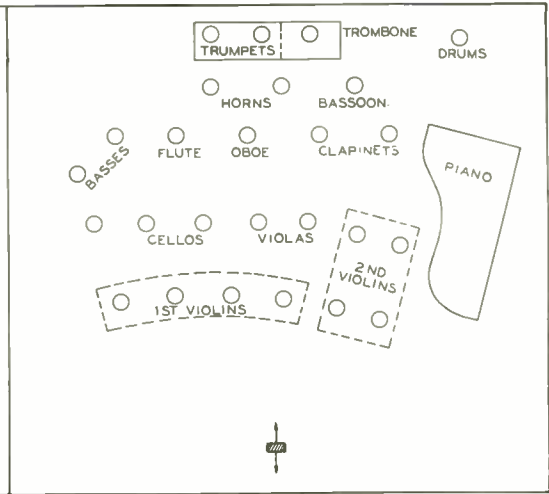
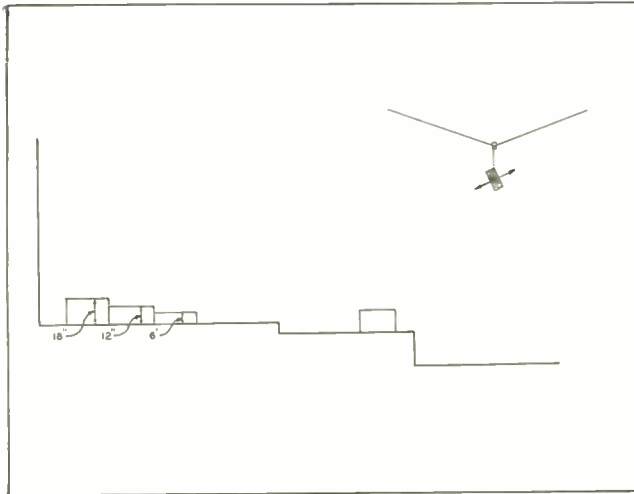

Fig. 12 (left). Microphone elevation and platforms for orchestra for the NBC Symphony. Fig. 13 (right). Microphone pickup for small concert orchestra.

non-directional, while brasses project strongly in the direction of their bells. Since the microphone is essentially monaural, it is strongly affected by the directivity of the instruments and since the apparent volume of sound at a given angle is inversely proportional to the distance of the source from the microphone, the strings should be placed nearest and well within the effective response angle of the microphone in use. On the other hand, the percussions are not only non-directional, but capable of almost unlimited volume. Consequently, they should be located at the maximum distance and anywhere within the limits of the response angle. It will be noted that this arrangement is quite similar to the usual concert seating plan.

When a soloist is accompanied by an orchestra, the pick-up for the orchestra remains the same as described above, but the soloist may have a separate microphone, and placed so that its position toward the orchestra is at its minimum response angle as shown in Fig. 11. Frequently, in the case of instrumentalists

or vocalists with strong, well-projected voices, additional microphones are not required, and the orchestra mike serves as the sole pick-up.

#### Smaller Groups

For smaller groups, such as a salon orchestra or 20 to 30 piece orchestra, the fundamental treatment is the same as previously described. The principles of directivity and volume of the instruments must be kept in mind, and the weaker, non-directional strings, woodwinds, etc., placed in a correspondingly more favorable location, as illustrated in Fig. 18.

A departure from the single microphone pickup for a musical group is frequently justified when a popular dance band is being broadcast. The use of multiple microphones in many cases is absolutely necessary. When the program originates in night-clubs, hotels, ballrooms, etc., considerable random noise exists. As a result, it is necessary to place the mike as close to the source as possible to exclude the unwanted noise. Because of the proximity of the microphone to the band,

all the instruments cannot be included within its effective response angle, and additional microphones are necessary to obtain full coverage.

Another equally important reason for the use of multiple microphones with a dance band is the prominent use of low volume sounds such as a muted trumpet or trombone, and other special effects, which are an inherent part of the musical content itself. Frequently a rhythm section, consisting of piano, drums, bass viol, and guitar are grouped together and separated from the brass and strings. Because of these special effects, a popular singer almost always requires his own microphone. Two illustrations below, Figs. 14 and 15, show the setup for popular dance bands with and without a vocalist. In most cases, the special effects achieved by use of multiple mikes are considered more important than any detrimental effects due to wave interference.

The foregoing principles as to methods and applications constitute only an out-

[Continued on page 48]

Fig. 14 (left). Typical arrangement for dance orchestra. Fig. 15 (right). Microphone pickup for dance orchestra with strings and a vocalist. A—Principal microphone. P—Vocalists microphone. Other microphones for group accentuation.

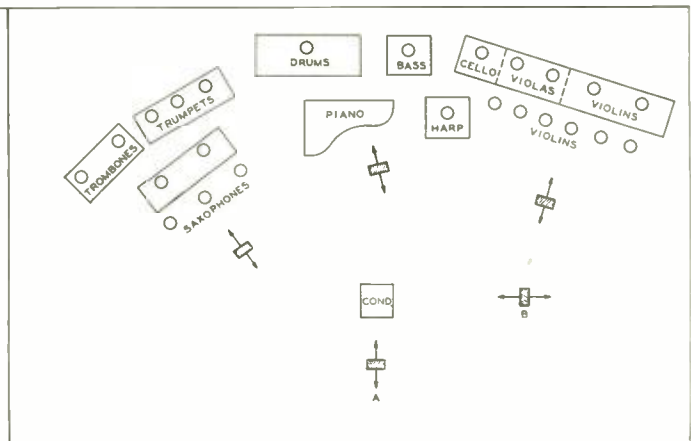
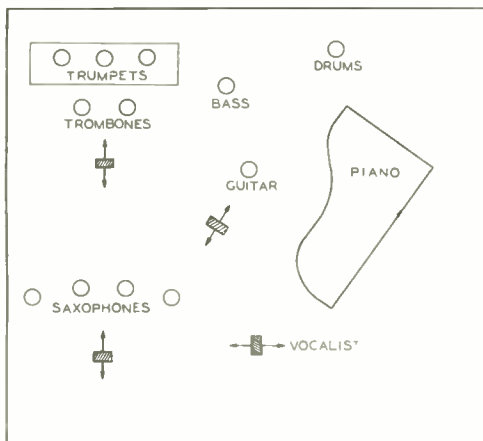



# Sound Reinforcement in the Hollywood Bowl

M. RETTINGER\* and STERLING M. STEVENS\*\*

**T**HE PURPOSE of this article is twofold: (1) To give a resume of the public address systems employed in the Hollywood Bowl during the past nineteen years; (2) To describe in detail the present installation.

Open-air concerts have long been popular with the American people. When the music played in the bandshell of such an outdoor theater is suitably reproduced over loudspeakers, it can be enjoyed by several times the number of persons who ordinarily could listen to it if it were not amplified. This fact, plus the concomitant condition that a larger audience makes, usually, for more popular admission fees, has brought first-class entertainment to untold millions. The electric ear and the electric mouth are unsurpassed as disseminators of culture.

The "Symphony Under the Stars" program in the Hollywood Bowl in California is undoubtedly one of the best known and most popular open-air con-

\* RCA Victor Division, RCA, Hollywood, California.

\*\* Otto K. Olesen Company, Hollywood, California.

•  
**Describing one of the best known outdoor orchestral p-a installations.**  
•

cert series in the world. The number of famous maestros who have appeared there outranks that of any other outdoor concert stage. Celebrated patrons—motion picture stars, music critics, radio performers, etc.—add a glamour of their own at these occasions. The Bowl is also the largest "natural" amphitheater in the world.

The land on which the Bowl is situated belongs to the county of Los Angeles, and was leased for 99 years by the Hollywood Bowl Association 26 years ago. The Bowl itself is ideally located in the wind-protected hollow of some hills dividing Hollywood and the San Fernando Valley. It may be remarked that, contrary to popular opinion, the absence of wind contributes markedly to the hearing

quality of outdoor locales. Hearing in the open is curtailed regardless of the direction of the wind: articulation tests conducted outdoors have shown that a wind with a velocity of 20 miles an hour generally reduces the percentage articulation by as much as 40%, while even gentle winds having velocities from 5 to 10 miles an hour, can reduce it as much as 20%.

Figure 1 shows plan and elevation of the Bowl, and it is seen that its width is greater than the length of a football field and that its total length is nearly 1/10th mile. It has a seating capacity close to 20,000—with the spectators in the last row 120 feet above the boxes in front.

Much of the credit for the development of this cultural center goes to Dr. Karl Wecker, able manager of the Bowl and first-class musician.

## First Installation

In 1928, seven years after the inaugural program, the first public address system was installed in the Bowl. In the light of modern equipment, the installation was rather primitive. It consisted of several dynamic speakers coupled to

The Hollywood Bowl at night during an orchestral program.



six-foot long horns, and a power amplifier containing two UX-250 tubes. A few years later the reproducers were replaced by twenty-five  $3\frac{1}{2}$ " horns disposed about the lawn in front of the stage. The microphones—as in many installations of this type at the time—were condenser units, which, of course, exhibited many of the defects usually found in the early kind. Still, the system was able, at the sacrifice of a somewhat restricted frequency range, to deliver the programs to many untold thousands who otherwise would have received it not at all, or else at the cost of a greatly reduced volume.

When Leopold Stokowski was engaged to conduct a program in the Bowl, he was able to promote, through the good will of the Paramount Studios and the Western Electric Company, an elaborate "stereophonic" public address installation. Three complete two-way speaker systems were placed on top of a 60-foot steel structure erected over the music shell, each system being driven by a separate amplifier. The positions of the reproducers on top of the shell corresponded with the sections of the band below that were picked up by the microphones in front of the sections. The amplifier installation, for its day, was tremendous, consisting of ten 6-foot racks. The total effect, however, left much to be desired. Because the width of the Bowl is 400 feet, auditors in the extreme side sections heard chiefly the loudspeaker system closest to them, thus receiving an "unbalanced" reproduction of the music. At a distance of 200 feet in front of the shell, the "stereophonic" character was lost since the subtended angle at the

auditor was too small to permit ready localization of the sources. At the boxes, the auditors had a tendency to look at the speakers on top of the shell from where the too powerfully reproduced sound originated.

(Of course, given time and money, it might have been possible to develop the installation into a very satisfactory system. After two programs, however, it had to be returned to its owners, and the Bowl was again without equipment for the amplification of its music.)

But, once more, Leopold Stokowski came to the Bowl as a guest conductor, and again he insisted on a reproducer system. This time—in 1942—no Paramount Studio and no Western Electric Company were able to lend equipment.

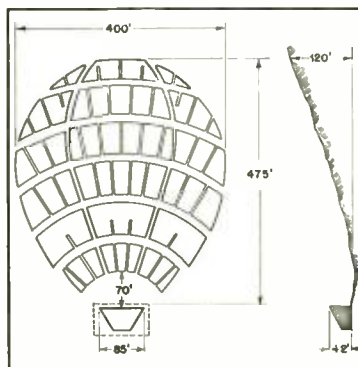
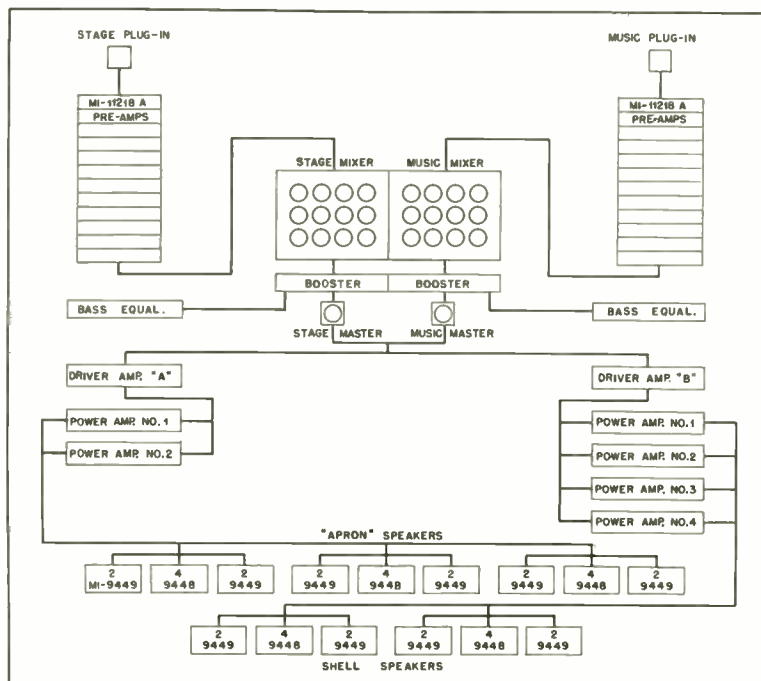

Fig. 1. Layout of the Hollywood Bowl. The stage for the orchestra is at the lower end of the drawing.

Fig. 2. Block diagram showing arrangement of sound equipment.



With what limited funds were available, a system was installed which consisted of a number of high and low frequency speakers in their respective horns. These were placed on the ground in front of the shell, and the sound from them was kept to a sufficiently low level to achieve a realistic representation. While, obviously, it was not a superior system, it was better than none.

In 1945, Leopold Stokowski signed up as permanent conductor, and purchases were made of an elaborate RCA installation comprising several two-way speaker systems, pre-amplifiers, uni-directional microphones, etc. A forty-foot tower was built at a distance of 30 feet on each side of the shell, and a complete two-way speaker system was installed on top of each tower. The purpose of this construction was to allow delivery of sound to the rear sections of the Bowl without flooding the boxes with sound.

This construction also produced a misdirection of sound. This time the extreme side-sections were conscious of sound emanating, not directly from the shell, but somewhat to the side of it. The central audience area and the boxes were unaffected. But sound *did* arrive at the "gallery!" It was an improvement, a vast one, and much credit should go to the maestro who so clearly recognized the need for amplification. For that matter, Leopold Stokowski is known to many as the sound man's friend—a musician who appreciates and understands the technician's problems, and who is sufficiently acquainted with technical procedures and terminology to convey to the engineer an idea of the desired results.

### Final Installation

Finally, in 1947, when more funds became available, a permanent steel structure was built on around the shell so as to maintain its contour. Near the top of this structure were mounted two complete RCA two-way systems consisting of four low-frequency horns and 2 high-frequency horns each equipped with p-m. units. The horns were so oriented as to cover with sound the area from approximately 200 feet in front of the shell to the "gallery." Since localization of sound was not critical at a distance, these raised systems fulfilled their purpose very well, and could indeed be operated at a rather high level. The sound definitely came from the shell—it certainly gave the impression of coming from there—and the problem of providing the upper side sections with sufficiently centralized sound was solved. The area from the shell to a distance of approximately 200 feet in front of it was covered with sound by 3 two-way speaker systems installed below a curved "apron" in front of the shell. Of course, neither the systems above the shell nor those below the apron were exposed to view, but were covered with a grill work.

There is a slight impairment of illusion for the auditors in the boxes inasmuch as the frontal speakers are some fifty feet ahead of the band, but it is not serious. It is hoped that next year funds will become available for placement of speakers below the steps in front of the band shell, so that even this small shortcoming will be remedied.

### Features

It may now be of interest to explain briefly some mechanical and acoustical features of the two-way speaker system used. The cross-over frequency was chosen as 300 cycles, rather than some higher frequency, so as to allow a larger portion of the energy to be issued by the rather directional high-frequency horns. This means, of course, that feed-back problems are considerably minimized, and that sound is sent to where it can be heard and not where it is idly expended.

But what about the feed-back effect produced by the sound coming from the non-directional low-frequency horns? This effect is reduced considerably by a low-frequency variable band-suppression filter, having an insertion loss of approximately 10 db over a band 20 cycles wide. When this variable band-suppression filter is adjusted for minimum feed-back, it will be found that the sound from the horns can be maintained at a level 10 db higher

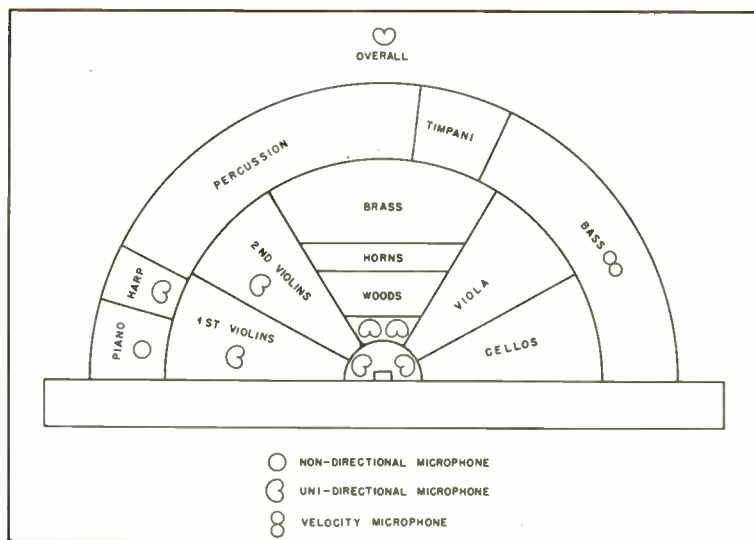

Fig. 3. Types of microphones used and their placement.

than would be the case without the equalizer in the circuit.

The system contains also a number of equalizers which permit the raising and the lowering of the response above as well as below 1000 cycles to provide, if necessary, any desired correction, particularly for voice. Normally the channel characteristic is kept flat, but on occasions—

always at the direction of the conductor, the artist, or his manager—compensation is introduced to achieve the most desirable results.

Figure 2 shows a block diagram of the amplifier and horn equipment. The two twelve-position mixers are required due to the necessity of having to use the

[Continued on page 38]

## Measuring Intermodulation

**A** NEW SYSTEM for the measurement of distortion caused by intermodulation has been announced by the Electrical Research Products Division of the Western Electric Company. Although designed to determine optimum processing conditions in variable density sound-on-film recording, the system is expected to prove valuable in many fields where audio frequencies are used. This meter replaces the earlier RA-1107 system which has been in wide use for several years.

The new system consists of the RA-1258 signal generator unit and the RA-1257 intermodulation analyzer. In operation, a signal of two frequencies, the low between 40 and 150 cycles and the high either 2000 cycles or between 7000 and 12,000 cycles, are added by the signal generator with a minimum of amplitude modulation of one frequency by the other. The high frequency is attenuated to a desired ratio, which may be 1:1, 1:2, 1:4, or 1:10, and the two frequencies combined in a hybrid coil. Output levels range between +23 and -44 dbm at 600 ohms output impedance, sufficient for tests of most equipment without the use of additional amplifiers which might in themselves introduce distortion. The

summed voltage is passed through the device under test.

The output from the equipment being tested is fed to the analyzer where the percentage of intermodulation, or the percentage of amplitude modulation of the high frequency signal by the low frequency signal, may be closely measured. A distortion phase meter is provided for determining, when measuring variable density recordings, whether compression is occurring on the positive or negative half of the low frequency signal.

The analyzer itself functions by first amplifying the input signal from the device under test, then eliminating the low frequency component by means of band-pass filters. The resulting high frequency component is amplified and rectified, producing an envelope which is a replica of the intermodulation in the input signal. The average output of the rectifier is attenuated to a reference value, amplified, rectified, and applied to a vacuum tube voltmeter which is adjusted to read the per cent intermodulation directly.

The inclusion of a phase meter in the Testing with the Western Electric RA-1257 Intermodulation analyzer and RA-1258 Signal Generator.

analyzer, the high sensitivity of that unit, and the high power output of the signal generator are among the factors which will make this new system a valuable tool in the motion picture field as well as other fields where audio frequencies are employed.



# Feedback Preamplifier for Magnetic Pickups

RICHARD S. BURWEN\*

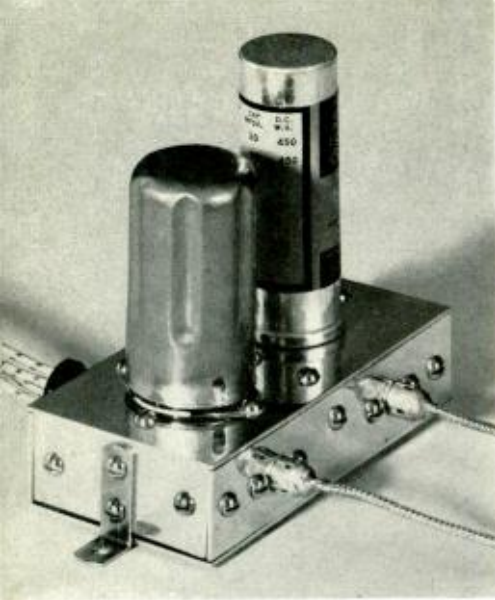

Complete preamplifier with associated cables.

By using negative feedback for response equalization, this preamplifier design presents many advantages over previous types.

THE PHONOGRAPH preamplifier described herein shows how a feedback circuit can surpass conventional design in four ways and actually cost less to build. These points of superiority are:

1. Very low output impedance enables use of shielded coupling cable without causing severe attenuation of high frequencies.
2. Negative feedback reduces harmonic distortion.
3. Noise and hum originating in the preamplifier are also attenuated.
4. Simpler to build.

Proper reproduction from transcriptions and commercial records with magnetic pickups such as the General Electric and the Pickering requires that the low frequencies be boosted with respect to the middles and, in most cases, that the high frequencies be attenuated to offset the attenuation of lows and emphasis of highs put into the record in the

\*17 Sheffield Rd., Melrose 17, Mass.

process of recording. Since the output voltage of these pickups is small, especially at low frequencies, and as it is a good idea to isolate such low level circuits from the power amplifier and a-c supply components, a separate preamplifier unit has been designed which includes this equalization and thereby adapts the pickup to the medium level input of any flat amplifier. Selective feedback accomplishes the equalization.

Designed around the G. E. variable reluctance pickup, the circuit produces the response characteristic shown as the smooth curve in Fig. 1. However, it is readily adaptable to other pickups and different degrees of high and low frequency compensation with the aid of formulas developed later on.

The curve in Fig. 1 has been chosen as suitable for both transcriptions recorded with the N. A. B. characteristic and commercial records. Variations from the complement of this curve in the record-

ing characteristics of individual records can be easily taken care of with the usual bass and treble controls elsewhere in the system. By continuing on straight instead of leveling off at 50 c.p.s. it provides 3 db more output at that point than the N. A. B. playback curve; this helps compensate for the deficiencies in many records.

## Design Considerations

The conventional method of accomplishing the job of this preamplifier might consist in using two high- $\mu$  triode stages with a resistance-capacitance equalizer between them. Although this arrangement may be fairly satisfactory provided all the stray capacities are kept to an absolute minimum, we immediately run into difficulty when we try to feed the output voltage through a shielded cable to the main equipment, since shunt capacity in the cable attenuates the high frequencies. We could compensate for

Fig. 1 (left). Play-back curve and its asymptotes for a cross-over frequency of 500 cycles. Fig. 6 (right). Curve showing equalization required to bring magnetic pickup (G. E.) up to flat response on a constant velocity basis.

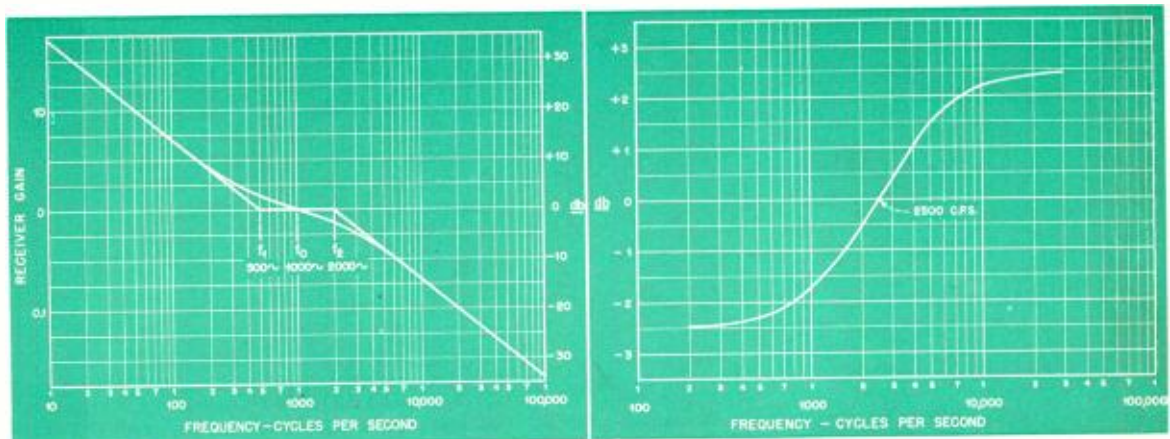

this loss within the amplifier, but then we would always have to connect the amplifier to the same cable or use a suitable coupling transformer, which would increase the cost.

Another disadvantage with conventional circuits, when the high frequency roll-off part of the equalizer is inserted between stages, is that while tube hiss generated in the first stage is reduced, that generated in the second stage is not. A simple way of alleviating both these disadvantages would be to roll off the high frequencies at the plate of the second stage by means of a capacitance to ground instead of between stages; but new troubles arise from this expedient because this reactance, effectively across the plate load resistor, will seriously limit the signal voltage handling capability of the tube and greater distortion will result. If the high frequency roll-off capacitor were connected between grid and ground, we have left a new point where stray capacities and Miller effect can cause unwanted attenuation of the highs.

### Circuit

All these disadvantages are overcome in the feedback preamplifier circuit of Fig. 3. It uses the same number of parts, but capacitors in the equalizing circuit are smaller; several more advantages are incorporated in the design and construction. Feedback from the plate  $P_2$  of the second triode  $V_2$  to its own grid through the network consisting of  $R_5$ ,  $C_3$ , and  $C_4$  provides the proper frequency compensation. As a result of this feedback, the effective output impedance at high frequencies is of the order of a thousand ohms and the outgoing signal can be fed through a shielded cable or to certain types of tone control circuits that ordinarily require a cathode follower driver without fear of losing the high frequencies. Noise originating in the plate circuit of the last stage is fed back out of phase to its grid and noise and harmonic distortion originating elsewhere are reduced by virtue of the frequency discrimination. Harmonic distortion generated within the second stage is lowered by a factor of 6 at 30 c.p.s. and considerably more at higher frequencies. Only one point remains where stray capacities can cause appreciable unwanted attenuation of the high frequencies (the plate  $P_1$  of the first stage) instead of two, and the feedback eliminates the possibility of high frequency oscillations due to stray capacitive coupling from plate  $P_2$  to the grid  $G_1$ , rendering the mechanical layout less critical.

### Construction

The author's preamplifier was built on a 4 x 2 x 1 inch aluminum chassis with a bottom cover. The tube and the 1 x 3-

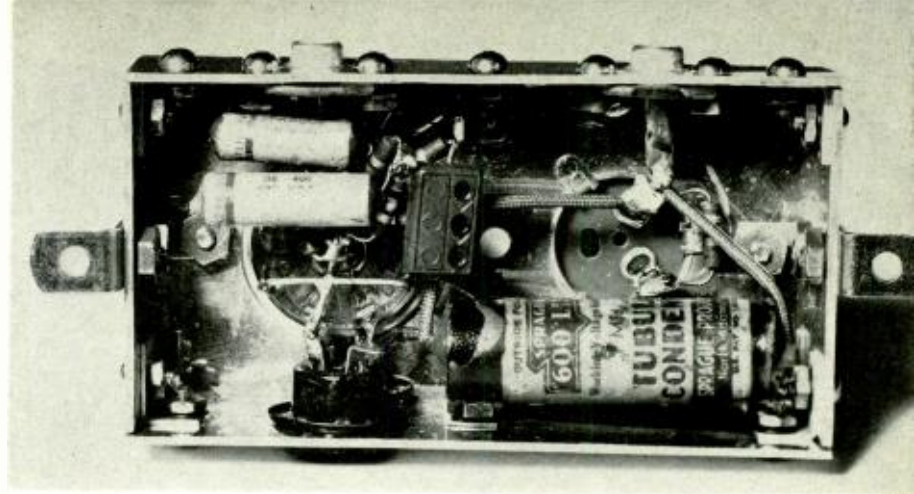

Under-chassis view of preamplifier.

inch aluminum can filter capacitor were mounted on top and the rest of the parts inside. Filament hum was minimized by completely eliminating filament wires, accomplished by feeding the power in through a miniature four-prong socket on the side of the chassis that had two of its lugs soldered directly to the filament contacts of the tube socket on the top of the chassis, the types 7F7 and 6SC7 tubes being conveniently designed with the filament prongs adjacent to each other. All the signal-carrying wires were kept down to less than a half inch in length and midget coupling capacitors were used so as to offer as little surface area as possible to the electrostatic field of the filament circuit and to prevent loss of high frequencies through capacity to ground. Hum is thus reduced to a low value provided that the center-tap and not one side of the filament supply be

grounded, and this preferably by means of a potentiometer.

### Hum

It must be pointed out that no amount of care in construction can completely eliminate hum that originates within the tube itself and that where the utmost of fidelity is required the six-volt tube should be replaced by the twelve-volt heater types to reduce current consumption, so the filaments may be heated by a 150 ma direct current supply.

Of the tubes indicated the 7F7 is the one around which this circuit was designed. It was chosen on account of its high gain and low harmonic distortion,\* the total r-m-s distortion for the preamplifier is estimated to be around 0.1 or 0.2 per cent on peaks. The gain is such that with the G. E. pickup, instantaneous peaks seen on an oscilloscope reach five volts on loud records. However, the amplification with the type 6SC7 was found to be nearly the same and the measured plate voltages turned out to be a little closer to the desired values. The 6SC7 is also cheaper and, in the cases of the particular pairs of tubes compared, less microphonic than the 7F7.

### Equalization

Equalization to flat response from the majority of lateral records and transcriptions requires that the gain rise at a rate

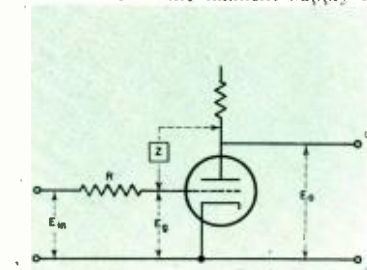
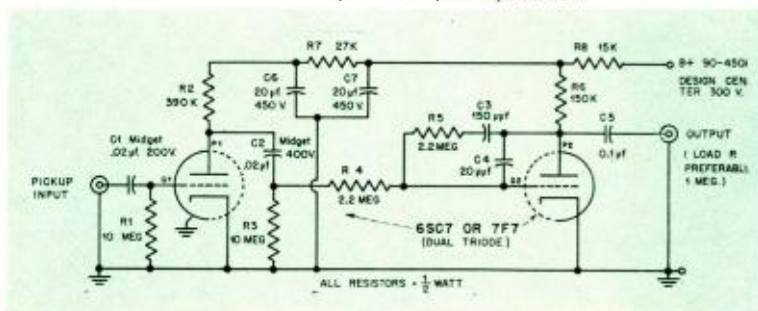
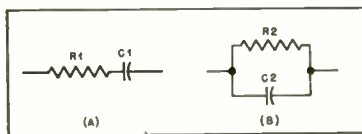

Fig. 2. Detail of feedback stage. Z represents the network  $R_5$ ,  $C_3$  and  $C_4$  of Fig. 3.  $R$  is approximately equal to  $R_4$ .

Fig. 3. Complete schematic of the magnetic pickup preamplifier, using negative feedback over the second stage to accomplish equalization.



of 6 db per octave below some frequency which we shall call  $f_1$  and that the gain fall off at a rate of 6 db per octave above some frequency which we shall call  $f_2$ . In addition, there may be a frequency at the low end where the gain begins to level off again which we will consider later. Actually, the bends in the curve at these frequencies are very gradual so that they can be made with simple resistance-capacitance networks and the slope only approaches 6 db per octave at a considerable distance from the bend. The two frequencies  $f_1$  and  $f_2$  vary with different manufacturers, and if we were to construct a network for every combination of  $f_1$  and  $f_2$  in present-day records we would indeed have a large number of networks. The simple way out is to build a single network having  $f_1$  and  $f_2$  representative of a large number of records and leave the rest to be taken care of by ordinary bass and treble balancing controls elsewhere in the equipment. The smooth curve in *Fig. 3* has therefore been chosen with  $f_1 = 500$  c.p.s. and  $f_2 = 2000$  c.p.s. It corresponds closely to the present N. A. B. characteristic.



**Fig. 4.** In (A), network for bass boost only.  $X_{C1} = R_1$  at  $f_1$  (Fig. 1). In (B), network for high frequency attenuation only.  $X_{C2} = R_2$  at  $f_2$ .

Mathematically, the simplest way to attain this curve is in two steps, first by boosting the lows and then by attenuating the highs in two separate consecutive amplifier stages. By replacing our  $Z$  in *Fig. 2* with the network  $A$  or *Fig. 4* we can attain the 6 db per octave slope at the low end. The turnover frequency  $f_1$  is the point at which the reactance  $X_{C1} = R_1$ . A 3 db rise occurs at this point to effect the gradual bend, and the slope approaches nearer and nearer to 6 db per octave as the frequency goes down because the impedance becomes very nearly that of the reactance  $X_{C1}$ , which doubles in every octave. Above  $f_1$  the reactance is small compared to  $R_1$  and so the impedance approaches  $R_1$ , resulting in constant output.

#### High-Frequency Attenuation

The high frequencies can be attenuated at a rate approaching 6 db per octave above  $f_2$  by replacing  $Z$  with the network  $B$  of *Fig. 4* where  $X_{C2} = R_2$  at  $f_2$ . Below  $f_2$ ,  $X_{C2}$  becomes large and the impedance approaches  $R_2$ ; above  $f_2$ , where the effect of  $R_2$  becomes small, it approaches  $X_{C2}$ . By passing the signal through a stage containing network  $A$  and then through a stage containing network  $B$  we get the combination of these two curves, the same one as in *Fig. 1*. The

straight lines, called asymptotes, show the limiting value of the slope.

If the phonograph turntable produces an excessive amount of rumble, common to the cheap types, it may be necessary to choose a gain reduction factor of about 10 for a leveling off point of 50 c.p.s. and in addition lower the values of all three coupling capacitors  $C_1$ ,  $C_2$ , and  $C_3$ . The N. A. B. playback curve has a leveling off point at 50 c.p.s., but this is usually taken care of by the deficiencies in the recordings and the associated equipment, particularly the loudspeaker.

#### Pickup Response

So far the actual response of the phonograph pickup has not been taken into account. The author tested two G. E. cartridges on the Columbia 10004-M frequency record and on H. M. V. constant tone frequency record numbers D. B. 4034 and D. B. 4035 which according to the label are accurate to within 0.2 db and whose light patterns tend to confirm their accuracy. Agreement was close between the cartridges and fairly good between the Columbia and the British records. The general trend of the curves was that of a roll-off 3 db down at 3600 c.p.s. reaching a maximum dip of 5 to 6 db and then rising again at 10,000 c.p.s. On the Columbia record 10,000 c.p.s. was only 3 db down. Discontinuities in the curve of the British records, which take four sides to change from 8560 c.p.s. down to 500 c.p.s., prevented determination of an exact curve for equalization to flat response, probably on account of the inability of the large point

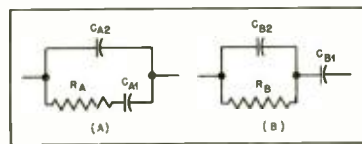

**Fig. 5.** Network (A) to boost bass and attenuate highs; and (B) equivalent circuit of (A).

radius to reproduce high frequencies as efficiently at the center of the record as at the outside grooves.

So far as the author has been able to determine the resistance-capacitance equalizer curve which comes closest to bringing the output up to flat response is the one shown in *Fig. 6*. In ordinary amplifiers it is achieved by means of the simple 5 db equalizer in *Fig. 7* having a half-loss frequency of 2500 c.p.s. This curve seems to be a happy medium since 10,000 c.p.s. will be up about 2 db at the outside of a record and will be down slightly at the inside.

A word of caution might here be mentioned in connection with the use of long shielded cables between the pickup and amplifier. On account of the 100 mh inductance of the magnetic pickup and the capacitance of the cable, a ten-foot

shielded cable will add another 2.5 db to the output at 10,000 c.p.s.

Fortunately, we can compensate for the pickup characteristic without adding anything to the preamplifier. It happens that if we design the equalizing network for a high-frequency turnover point  $f_2 = 3560$  c.p.s. instead of 2000 c.p.s., the curve of the pickup will subtract from that of the equalizer and produce almost exactly the curve we originally intended in *Fig. 1*. For the two equalizer networks of *Fig. 5* we have.

$$R_A C_{A1} = 318 \text{ microseconds}$$

$$R_A C_{A2} = 52.0 \text{ microseconds}$$

and

$$R_B C_{B1} = 274 \text{ microseconds}$$

$$R_B C_{B2} = 44.7 \text{ microseconds}$$

$$\text{The gain } A_o = \frac{Z_o}{R}$$

at  $f_o$ , now 1336 c.p.s., was chosen to be slightly less than unity to permit a gain reduction of at least 50 times and a departure from the asymptote of not more than 0.5 db at 30 c.p.s. for the entire preamplifier. Network  $A$  was more easily fitted by standard values of resistors and capacitors, making allowance in  $C_{A2}$  for the plate to grid capacitance of the tube and socket.

For use with other magnetic pickups having a higher output than the G. E., it is suggested that the first stage be eliminated and the pickup connected directly from ground to the  $P1$  side of coupling capacitor  $C_2$  in *Fig. 1*. The output can be brought up sufficiently by selecting a higher value of  $\frac{Z_o}{R}$  provided a higher leveling off point can be tolerated. Another pickup will of course require different equalization at the high end. A worthwhile addition to the circuit that will make for more pleasing reproduction from worn records would be a switch that would shunt a resistor and capacitor in parallel across the pickup or several pairs so as to cut off the high frequencies fairly sharply at selected points in the manner described in the September 1947 issue of *Audio Engineering*. The pre-

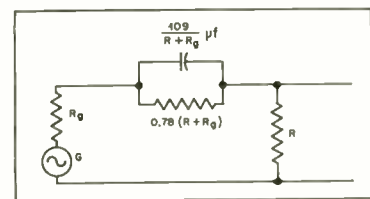

**Fig. 7.** Interstage equalizer for flat response from G. E. or similar magnetic pickups.  $R_0$  represents the internal resistance of the driving amplifier.

amplifier can be powered with plate supply voltages other than 300 volts; in fact, there is little difference between operation at 90 volts and that at 450 volts. But, in general, the higher the voltage, the less the distortion.

# Two-Way Speaker System

C. G. McPROUD\*

## PART III

The third of three articles describing the design and construction of an excellent two-way speaker system.

THE FIRST article of this series covered the construction of an eight-cell multicellular horn for use with an efficient high-frequency speaker unit, providing the constructor with information heretofore not commonly available, and reducing the assembly of a set of horns to a relatively simple operation.

In the second article, the low-frequency speaker baffle was discussed, together with a number of empirical methods for determining reasonable approximations for the size of a reflexed cabinet, and the necessary port opening, for loudspeakers of various sizes. In the absence of suitable measuring equipment, it is essential that approximations be made, primarily because of the difference in the characteristics of the speakers themselves, but also to the variation in preferences of the individual constructor and the space available for the finished speaker system.

This article covers the construction of the auxiliary components required, together with the final assembly of the system to provide better than average reproduction from a high-quality sound source. It will be remembered from the first article that a complete system consists of a low-frequency speaker, suitably enclosed, a high-frequency unit and the multicellular horn, and the dividing network. In addition, there are a few other features which make the system more flexible, and provide sufficient controls for the critical listener.

### Dividing Network

The dividing network consists of two coils and two capacitors, and serves to feed the low frequencies to the cone speaker and the high frequencies to the horn speaker. There are several reasons for this—the most important being to prevent the high-frequency unit from being damaged by the high amplitude of the low-frequency excursions which would be set up in the small diaphragm, inadequately loaded for those frequencies. A second reason is to prevent the high frequencies from reaching the cone and causing the inevitable breakup which occurs in that type of speaker unless it is especially designed for the purpose.

The dividing network used with this

system is the series filter type, with the circuit shown in Fig. 1. Since both the specified high-frequency unit and the low-frequency cone type suggested for this system were eight-ohm units, the dividing network is calculated for an eight-ohm circuit, and the input to the network should be connected to an eight-ohm winding of the output transformer.

The choice of network circuit was discussed in an earlier article,<sup>1</sup> and will not be repeated here. From that article, however, the formulas for the four com-

ponents of the dividing network are as follows:  $L_1 = 1.413$  mh;  $L_2 = 0.883$  mh;  $C_1 = 22.1$   $\mu$ f;  $C_2 = 35.3$   $\mu$ f. Taking refuge again in empirical values, it may be stated that the two inductances may be made by winding on forms 1-3/4" in diameter and 3/4" in width, using wood flanges to keep the windings in place. This size of form, when used with No. 17 DCE wire—as used in the field coil of Western Electric 555W units—will wind about 13 turns per layer. Referring to the charts of the earlier article, it is determined that  $L_1$  requires 185 turns and  $L_2$  requires 146 turns. For optimum results, these should be adjusted with the aid of an accurate bridge, but with reasonable care in the winding the coils to these specifications, the results should be acceptable.

The accumulation of sufficient capacitance was considerable of a problem until surplus material became available. The writer had an arrangement with a capacitor manufacturer long before the war to provide the values required for dividing networks at eleven cents per microfarad, furnished to exact required values. However, since 10- and 15- $\mu$ f capacitors are now readily obtainable at six to eight cents per microfarad, it is much easier to use these units. Two 10- $\mu$ f units and one 2- $\mu$ f unit should suffice for the 22.1  $\mu$ f capacitor, while two 15- $\mu$ f units and 5- $\mu$ f unit approach the 35.3- $\mu$ f capacitor. The final values can be built up by the use of smaller units to the correct values, using a bridge for the measurement. In the absence of a bridge, a capacity meter will suffice.

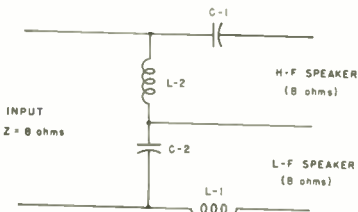

Fig. 1. Basic dividing network circuit used for this speaker system. This is the series filter type.

ponents of the dividing network are as follows:

$$L_1 = \frac{159 R_o}{f_c} \text{ mh}$$

$$L_2 = 0.625 L_1 \text{ mh}$$

$$C_1 = \frac{159,000}{f_c R_o} \mu\text{f}$$

$$C_2 = 1.6 C_1 \mu\text{f}$$

With a crossover frequency of 900 cps and

<sup>1</sup>"Design and Construction of Practical Dividing Networks," C. G. McProud, *AUDIO ENGINEERING*, June 1947.

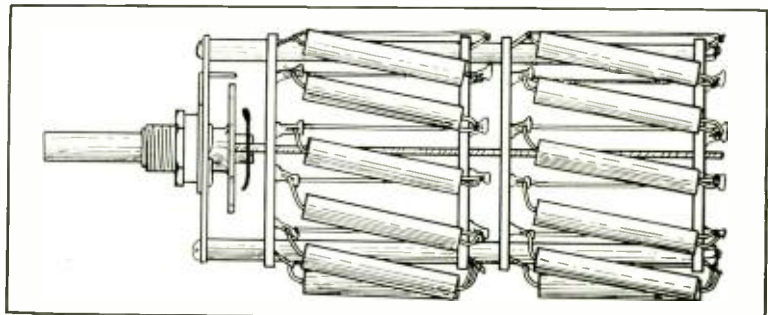

Fig. 2. Method of arranging switch sections to support the resistors for the 1 db/step attenuator in the h-f speaker circuit.

\*Managing Editor, *AUDIO ENGINEERING*.

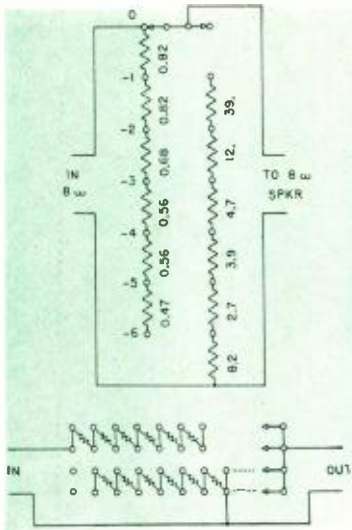

Fig. 3. Circuit arrangement for h-f attenuator, showing resistor values for an 8-ohm circuit.

### High-Frequency Attenuator

Since the high-frequency speaker unit is more efficient than the low-frequency cone, an attenuator will be required in the h-f output of the network in order to balance the sound output from the two speakers at crossover frequency. The simplest arrangement is to use a 10-watt adjustable resistor, with a value of 10 ohms, connecting the speaker unit to the tap. However, this does not give an easily variable adjustment, and in general, those who experiment in audio equipment prefer rather more flexibility than is afforded by a semi-permanent adjustment.

The recommended high-frequency attenuator is a step potentiometer, with attenuation values of zero to 6 db in 1-db steps. Such a device is not readily available on the market, but may be constructed on a standard switch. The switch required is a Centralab K-123 index assembly with two "A" decks and two "B" decks. The switch should be assembled with the two "A" decks spaced about 1-1/2" apart, followed by the two "B" decks also spaced 1-1/2" apart, and with a 1/4" spacing between the two pairs. This construction, shown in Fig. 2, permits the mounting of 1-watt resistors directly on the switch, and parallels two decks for each circuit, thus increasing the current carrying capacity. The circuit of the attenuator is shown in Fig. 3, the resistors being IRC Type BW-1 in the values shown. Fig. 3 also shows the connection of the various switch sections.

A simpler arrangement for the high-frequency attenuator is to employ a 6-ohm L-pad in the circuit shown in Fig. 4. The regular L-pads provide attenuation from zero to infinity in their total rotation, which is more than is desirable for this application. When

connected as shown, the total loss is approximately 12 db—still more than necessary, but an improvement over the usual connection.

### 10-kc Suppressor

When the speaker system is to be used for reproduction of radio programs from a high-fidelity receiver, some trouble may be experienced from the 10-kc inter-channel squeal. A simple suppressor can therefore be installed in the high-frequency horn circuit, and if properly adjusted, it will suppress 10 kc quite effectively without appreciably affecting the remainder of the frequency band.

This suppressor takes the form of a null circuit, shown in Fig. 5. The coil is a 0.5 mh unit, composed of 110 turns of No. 17 DCE wire wound on the same type of form as used for the dividing network coils. The two capacitors resonate with the coil, forming a low-impedance shunt across the h-f speaker circuit. The

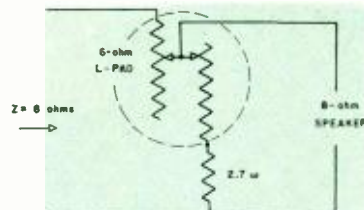

Fig. 4. Alternate arrangement showing the use of a 6-ohm L-pad in an 8-ohm circuit to provide a maximum loss of 12 db.

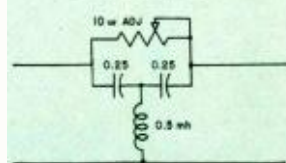

Fig. 5. Circuit of 10-kc suppressor useful for eliminating interstation squeal from wide-range radio receivers.

resistor, 10-ohms, 10-watt adjustable, provides resistance neutralization for the coil, and makes the attenuation curve of the equalizer extremely sharp, as shown by the curve of Fig. 9. This suppressor should be arranged for switching in or out of the circuit by means of a switch, Mallory 2006-L push-button type which

locks in either position. Since the suppressor causes a loss of approximately 3.5 db throughout the transmission band, an additional fixed pad of this value should be connected across the switch terminals in the filter-out position, to equalize the levels. This pad is shown in Fig. 6, and consists of two resistors, each being a BW-1, 1-watt type.

### The Complete Circuit

The combined circuit of the dividing network, the attenuator, the 10-kc suppressor, and the other connections are shown in Fig. 6. Note that four jacks are inserted between the output of the switching circuit and the speakers, two in each circuit. This permits the insertion of a plug into either circuit for measurement purposes, or permits feeding a signal to either speaker without using the dividing network. This provides sufficient flexibility for the most enthusiastic experimenter.

After the completion of the entire switching circuit, it is advisable to make frequency-response measurements of both legs of the dividing network and the 10-kc suppressor. The resulting curves should resemble those of Fig. 9, with the voltage across the two sections being equal at points removed from the crossover frequency, and with both outputs being down 3 db at crossover. The 10-kc suppressor should be adjusted for frequency by adding or removing turns from the coil, assuming that the capacitor values are reasonably close to the specified 0.25  $\mu$ f in each section. After arriving at the correct attenuation peak, the maximum attenuation may be obtained by an adjustment of the 10-ohm shunting resistor. When correctly adjusted, the attenuation at 10 kc should be approximately 40 db, with the response flat at about 9,000 and 11,000 and down 6 db in the vicinity of 9,600 and 10,600 cps.

### Final Assembly

The dividing network, attenuator, and 10-kc suppressor—if used—should be mounted suitably on or in the low-frequency baffle cabinet. If the entire speaker is to be hidden from view, it is possible to mount these parts on top of the cabinet at the sides of the high-fre-

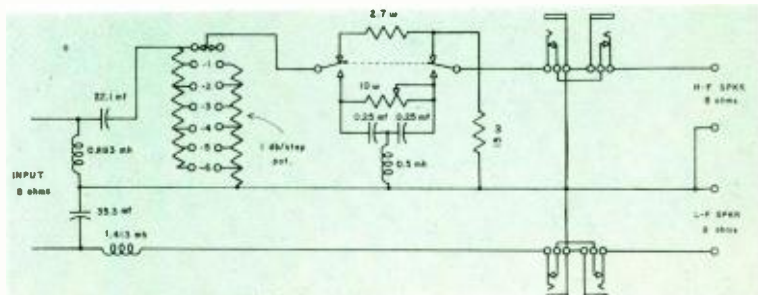

Fig. 6. Complete circuit of dividing network, h-f attenuator, 10-kc suppressor, and jacks to permit access to the various circuits.



quency unit. In any case, the controls should be accessible, but the special requirements of the physical design may dictate the actual placement of the parts and the controls. It should be remembered that the currents involved in a low-impedance speaker circuit are relatively large—at one watt, for example, the current in an 8-ohm circuit is approximately 0.35 amps. On account of this, the wire used for the connections should be relatively heavy, particularly when higher powers are involved. The choice of switches for such circuits is important—ordinary toggle switches are not satisfactory for speech circuits at these low impedances.

The high-frequency horn and unit should not be permanently mounted until the exact location is determined. To make this determination, it is desirable to have a microphone and an amplifier, together with an output indicator, for best results.

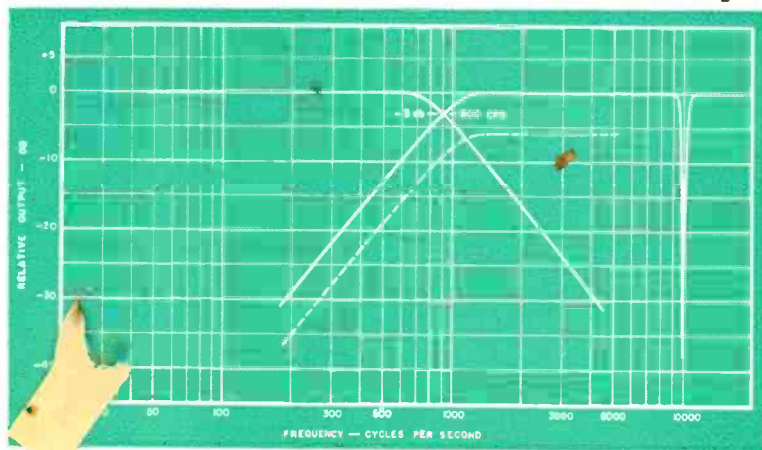

Fig. 6. Curves of typical response from dividing network, and attenuation to be expected from 10-kc suppressor. Dotted curve shows range of adjustment furnished by 1 db/step attenuator.

With the h-f horn and unit connected to the circuit, and placed on top of the low-frequency cabinet, the two should be energized by a signal at crossover frequency. Then, with the microphone about six feet in front of the combined speakers, move the high-frequency horn and unit back and forth until the maximum output is obtained, as indicated by the output meter on the amplifier connected to the microphone. If the position of the horn is too far forward or too far back of the front of the cabinet, the two leads to the high-frequency unit should be reversed and the procedure repeated. This will give a new position to the horn approximately 7.45 in. from the first position.

The correct position for the h-f unit can be determined roughly by calculation. The dividing network used causes a phase shift of  $221^\circ$  at crossover, which corresponds to 9.2 in. at 900 cps. Thus the two diaphragms must be displaced by that amount, or the phase of the h-f

unit may be reversed, requiring a displacement of 9.2—7.45 in. or 1.75 in. However, the diaphragm of the low-frequency cone is not a plane surface, and the exact point of measurement may not be definite, although there is some evidence to support the choice of the voice-coil position as the measuring point. The best method of adjusting the two speakers is by using the microphone, as previously described.

Actually, a trained ear will suffice to select the correct location of the two speakers, although it may require more time and experimenting. It is necessary to play the same selection from a record through the speaker over and over, moving the high-frequency horn slightly each time. The best quality will be heard when the adjustment is correct, and after all, the ear is the best judge of the performance anyhow.

After the correct position of the high-

frequency horn is determined to the user's satisfaction, the horn should be permanently mounted. Typical speaker systems of two-unit construction are assembled as shown in Figs. 7 and 8, the latter showing a model which may be used for monitoring purposes, or in locations where the appearance is not objectionable. The furniture cabinet of Fig. 7 includes the same apparatus, but it is all enclosed and suitable for use in the home. These are commercially available two-way speaker systems.

#### Operational Readjustments

One of the bad features of many two-way speaker systems is that the new experimenter is apt to run the system with the high-frequency speaker operating at levels considerably above the correct balance, on the theory—probably—that "now I have a tweeter and you're going to hear the high frequencies, or else." This is a natural fault, and is generally overcome after using the speaker for some time. The best test for any speaker

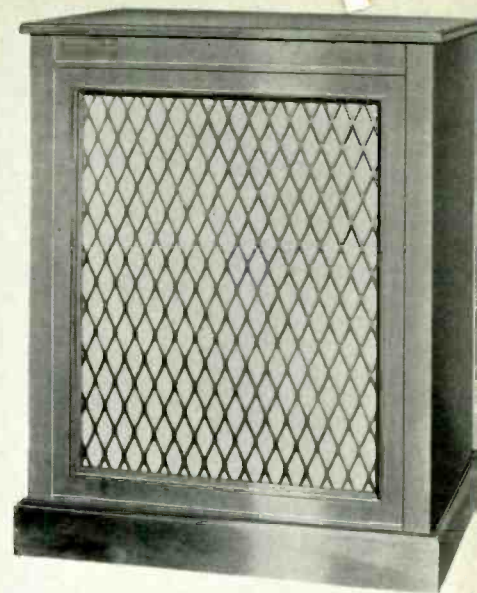
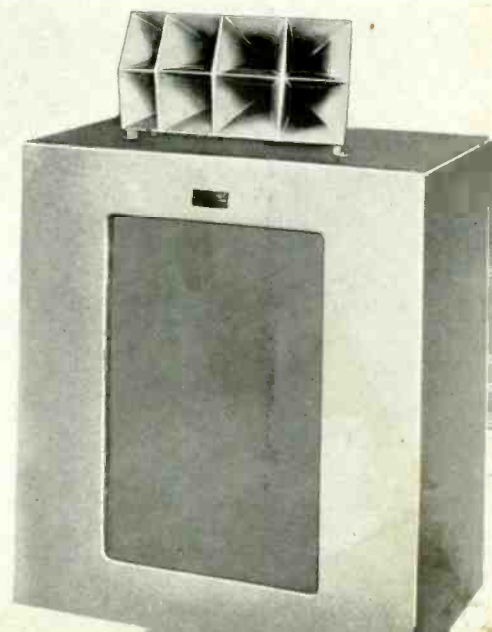

Fig. 7. Furniture cabinet, enclosing same components as used in speaker of Fig. 8. Courtesy Stephens Manufacturing Co. Inc.

is how well it "wears" although many authorities advise us that the ear can become accustomed to any speaker, and when it does, any other reproduction sounds wrong. However, if the user makes a point of attending a live concert occasionally in order to keep his perspective on a reasonable balance, he should be able to adjust the operation of a two-way speaker system so that it is capable of giving increased realism over any single-unit speaker available. The "presence" afforded by the reproduction of the frequencies above 900 cps on a small, well-loaded diaphragm makes listening a pleasure, and the time and effort spent in constructing a speaker of this type will be well repaid.

The use of the attenuator in the high-frequency speaker circuit permits a  
(Continued on page 38)

Fig. 8. Typical mounting of two-way speaker system, commercially available. Courtesy Stephens Manufacturing Co. Inc.



# Facts About Loudspeakers

O. L. ANGEVINE, JR.,\* and R. S. ANDERSON\*\*

## PART I

Second in a series for beginners in sound engineering.

**A** PERSON interested in sound distribution systems had better be concerned with loudspeakers as he is going to buy a lot of them. In fact, the cost of the loudspeakers can be a large part of the total cost of the sound system. At the same time, the quality of reproduction of the system can be no better than its speakers and good results may be sacrificed to low prices.

Speakers are less well understood than are electronic devices, such as amplifiers, because they require a familiarity with acoustics and mechanics as well as electricity. The use of speakers also involves the psychology of hearing and architectural acoustics, which are not part of the speaker. The fact that the above-men-

\*Chief Sound Equipment Engineer, Stromberg-Carlson Co.

\*\*Acoustical Engineer, Stromberg-Carlson Co., Rochester, N. Y.

Fig. 1. Outdoor measuring set-up. Two layers of parachute cloth one inch apart serve as a windscreen transparent to sound. The speaker is mounted on a baffle flush with the wall and the microphone supported on an adjustable boom in front of the speaker.

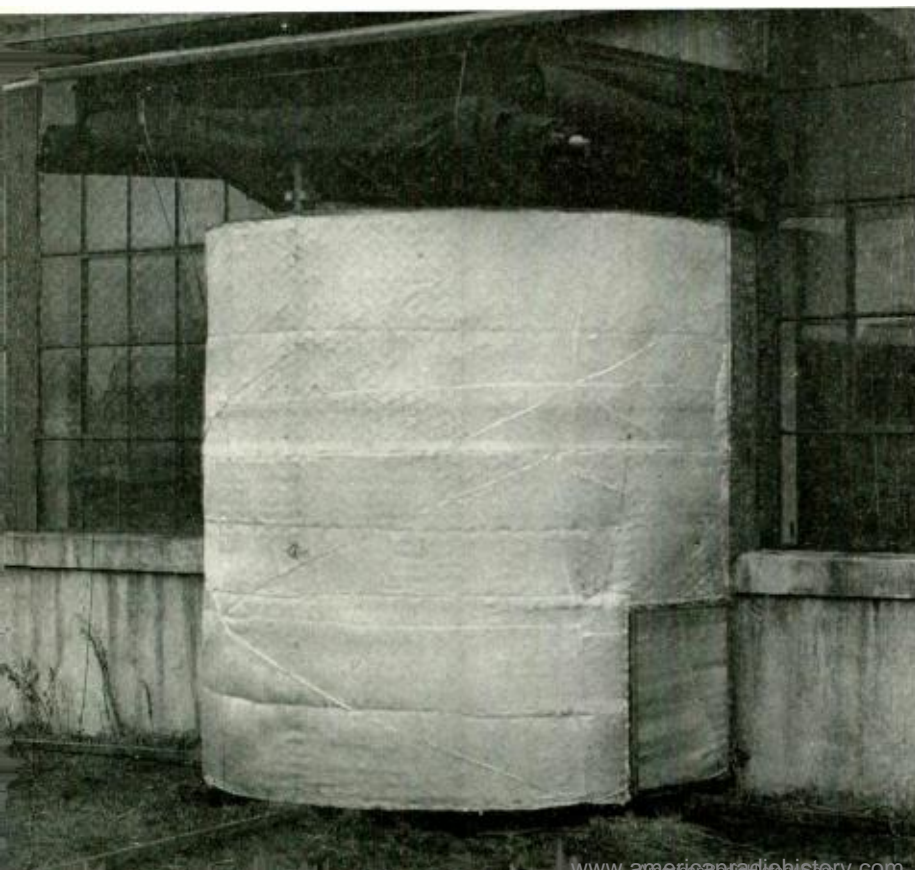

tioned intangible factors are involved allows anyone to think himself an expert on acoustics. It also provides the acoustical engineer with an alibi in the face of apparent contradictions, as most acoustical measurements can be made in some manner that will permit the desired interpretation.

### Loudspeaker Measurements

Before discussing loudspeakers, it is important to be familiar with the complexity of their measurements.

The average purchaser of loudspeakers is not an engineer and, naturally, is not familiar with many technicalities of acoustical measurements as they are made in the laboratory of the speaker manufacturer and recorded as "response curves." Measurements of the frequency characteristic of an amplifier or an electrical network are comparatively simple and can be specified in a manner that is

universally acceptable. In other words, a frequency response measurement of an amplifier, tested in New York, will look the same as the same amplifier measured in San Francisco. Unfortunately, there is no such happy solution for loudspeaker measurements as there are large variations in observed performance due to the different methods of measurement and the differences in the acoustics of the surrounding space. Therefore, it is difficult for the user to evaluate frequency characteristics from a response curve unless he is thoroughly familiar with the methods used to obtain it.

Measurements are preferably made indoors to eliminate dependence on weather and interference by extraneous noises. But, in a room, the sound from the speaker under test reaches the measuring microphone not only directly but also reflected from the walls, the ceiling, the floor, and from anything else that may be in the room. The microphone measures the resultant sounds from many sources, each different in frequency response, amplitude, and phase—depending upon the type of reflecting surface and the length of the reflecting path. Acoustically, a room is a hall or mirrors. A listener, because he has binaural\* hearing, is able to discriminate to some degree in favor of the direct sound over the reflected sound; but a microphone used for measuring the response of a speaker does not distinguish between them. A speaker response curve represents, as a function of frequency, the total *sound pressure* arriving at the measuring point from all sources and is not an indication of the *impressions of the listener*.

To minimize reflections, the speaker is measured outdoors (*Fig. 1*) or in an anechoic (echo-free or "dead") room in which reflections have been reduced to a minimum by the use of sound-absorbing material. The response curve of a speaker depends both upon these acoustic surroundings and the method of measurement—choice of baffle, distance of measuring microphone to speaker, etc.

\**Binaural*—Webster—"Having two ears." A person with two ears is able to determine the direction of a sound source. Binaural is frequently used incorrectly to mean *stereophonic* or "three dimensional" reproduction. Any person listening with two ears is obviously listening binaurally whether or not the reproduction is stereophonic.

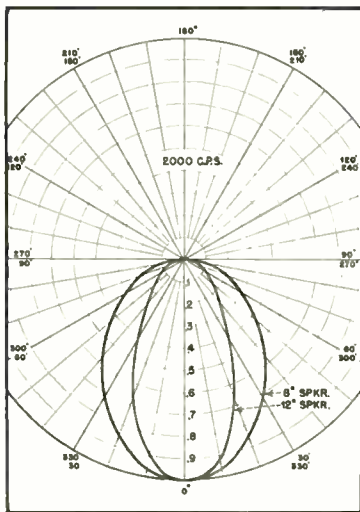
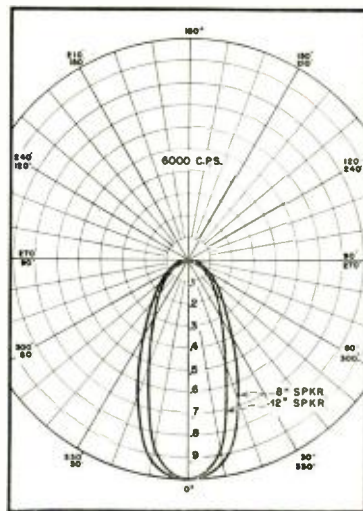

Fig. 2A. Directional characteristics of typical 8'' and 12'' speakers at 2000 cycles.  
Fig. 2B. Directional characteristics of typical 8'' and 12'' speakers at 6000 cycles.



To obtain the response curves shown in Fig. 4, a speaker was sent to three well-known laboratories. Each was asked to measure the speaker by its normal methods. As can be seen, the curves are quite different and might lead to different interpretations. The differences in response are due entirely to the methods of measurement, each of which is equally satisfactory when interpreted by an experienced engineer familiar with the methods and acoustics of that test laboratory, but dangerous in the hands of people not familiar with the measuring technique. To offset this danger to some extent, manufacturers, when they do publish response curves, correct for known peculiarities in the measuring set-up.

Point-by-point measurements being tedious, more response curves per lifetime can be made on a response recorder such as the one shown in Fig. 3. This recorder is sponsored by the authors and does not necessarily represent the opinions of other acoustical engineers.

#### Other Factors

Frequency response is only one of several characteristics to be considered when choosing a speaker for a particular application. Other factors are directional characteristics, transient response, intermodulation distortion, harmonic distortion, and efficiency. For many of these characteristics, there are, again, no standard invariable methods of measurement.

Directional characteristics are usually measured outdoors to eliminate reflection difficulties to which this type of measurement is particularly susceptible. Typical results are plotted as shown in Fig. 2A. Note that the 12'' speaker is more directional than the 8'' speaker. Fig. 2B shows that both speakers become more directional as the frequency is increased. The reason for both of these facts is that, for any

radiating device to be directional, it must be large with respect to the wavelength of the energy it is radiating. Thus, speakers are non-directional at low frequencies where the wavelength is many feet and are quite directional at high frequencies when the wavelength is only one or two inches. Likewise, a large speaker becomes directional at a lower frequency than does a small speaker.

But this measurement does not predict what will actually happen when a speaker is installed in its normal surroundings. If a speaker is used indoors, reflections will vary the response from point to point in the room and the total sound arriving at the listener may be several db greater than the direct sound from the speaker. In this case, it is not the on-axis sound pressure that is important, but the total radiated sound. With speakers large enough to be quite directional, if the on-axis frequency response curve is flat, the off-axis, sound pressure is falling off at the high frequencies. Thus, the total radiation is not uniform with frequency as might be thought from seeing only an on-axis frequency response curve, but is reduced at the high frequencies.

One solution might be to increase the on-axis response with frequency. This might help if one never listened near the axis, but in the average room, absorption and reflection make both the on-axis response and the total radiation important. A better solution is to use less directional speakers. As usual, the best answer may be expensive. Another less expensive solution involves the use of a well-known illusion. If the response is peaked in the 1000 to 4000 c.p.s. region, the listener gets an impression of brilliance similar to that due to a more extended range of high frequencies. This has become an accepted compromise when the

more expensive speaker cannot be justified.

The absolute efficiency of a speaker is the total sound power radiated in all directions divided by the total electrical power available to the voice coil. To secure the total radiation, it is necessary to integrate measurements made over the entire surface of a sphere with the speaker at its center. This is a laborious process and is seldom done. An R.M.A. committee is now working on a simpler method to give an approximate measure of efficiency.

To determine the power handling capacity of a speaker, it is necessary to measure the level and frequency at which mechanical damage occurs. It is also necessary to determine the level at which distortion becomes excessive. It is beyond the scope of this article to discuss the measurement and interpretational problems involved, but let it suffice that there is no generally accepted measurement,

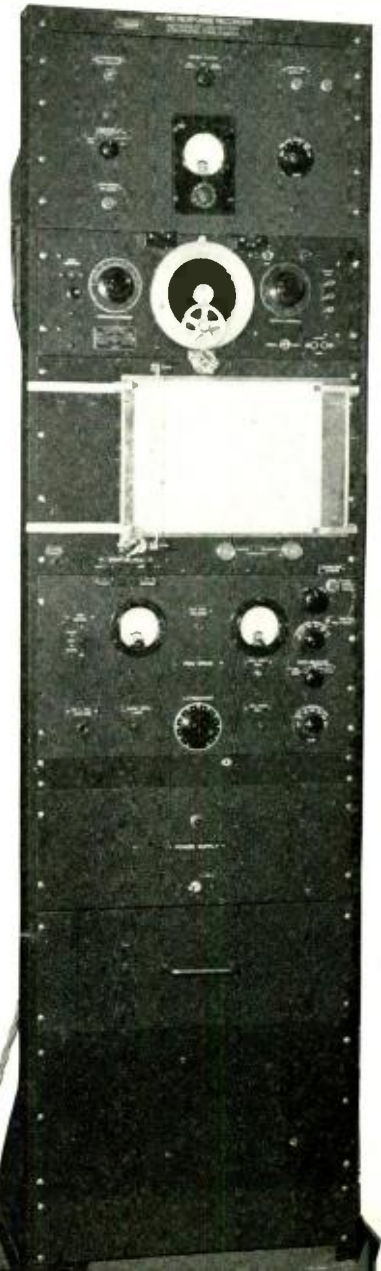

Fig. 3. Automatic audio response recorder.

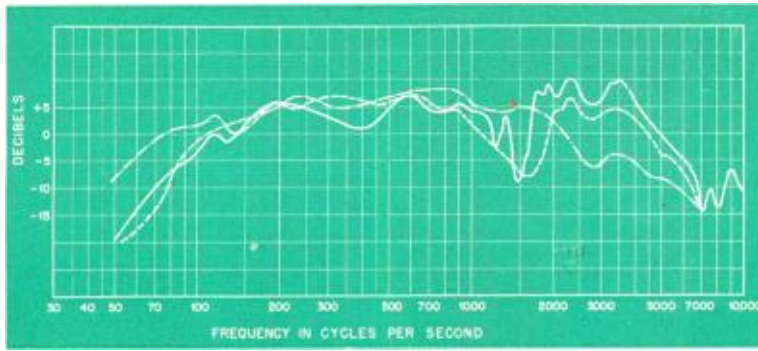
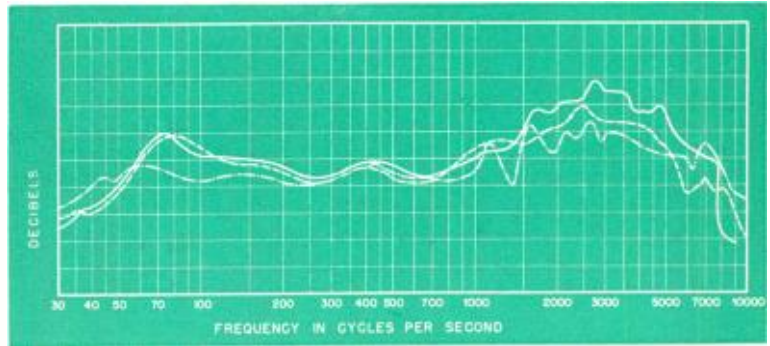

Fig. 4. Response curves from the same speaker with different measuring methods. (Courtesy Jensen Radio Mfg. Co.)



Fig. 6. On-axis response of typical 12" speakers. (Below).



and the common practice is to use a listening test.

Most of the tests described so far are objective in nature and there is always difficulty in interpreting objective tests in terms of subjective results. For this reason, a listening test of over all speaker performance should be made in comparison to a known reference speaker. When making a test of this sort, care must be taken to select program material that covers the frequency range involved. Broadcast transcriptions may be used that have been selected for the particular characteristics of interest. South American orchestras with maracas or popular dance bands with trap drums allow comparison of the high-frequency response and spatial distribution. Selections with string bass and timpani aid in disclosing cavity resonance and hangover. The test must be done by skilled listeners and should not be a snap first-impression test.

#### Modern Speakers

Modern speakers can be divided into two types—horns and cones (as well as combinations of them). Horn type speakers have an efficiency of about 15% compared to about 5% for cone type speakers. Both types usually have a moving-coil dynamic system, but the

cone speaker radiates the sound directly from the face of the cone, whereas the horn speaker couples the diaphragm to the air through a horn. The cone speaker is usually used for reproducing speech and music at relatively low power. The horn speaker is used to reproduce speech at high power and to give it directivity.

#### Construction of Cone Speakers

Loudspeaker cones are felted from a short-fibered material. Details are shown in Fig. 5. A short-fibered material of the mixture desired is in suspension in water. Into this bath, a perforated die, the shape of the cone desired, is lowered. A vacuum at the back of the die draws the water

through it, depositing the fibers on the surface of the die. The number and spacing of the perforations and the length of time the die is submerged control the thickness and weight of the cone. The next operation dries the cone. At this point, it is weighed so that not more than two cones are made before a weight deviation is caught and corrected. A 12" cone weighs about 12 grams and requires a tolerance of plus or minus 10%, so the process must be controlled accurately. From this step, the cones go on to be trimmed to size, lacquer-dipped or treated in any of the number of ways that may be required.

A spider which holds the cone and voice

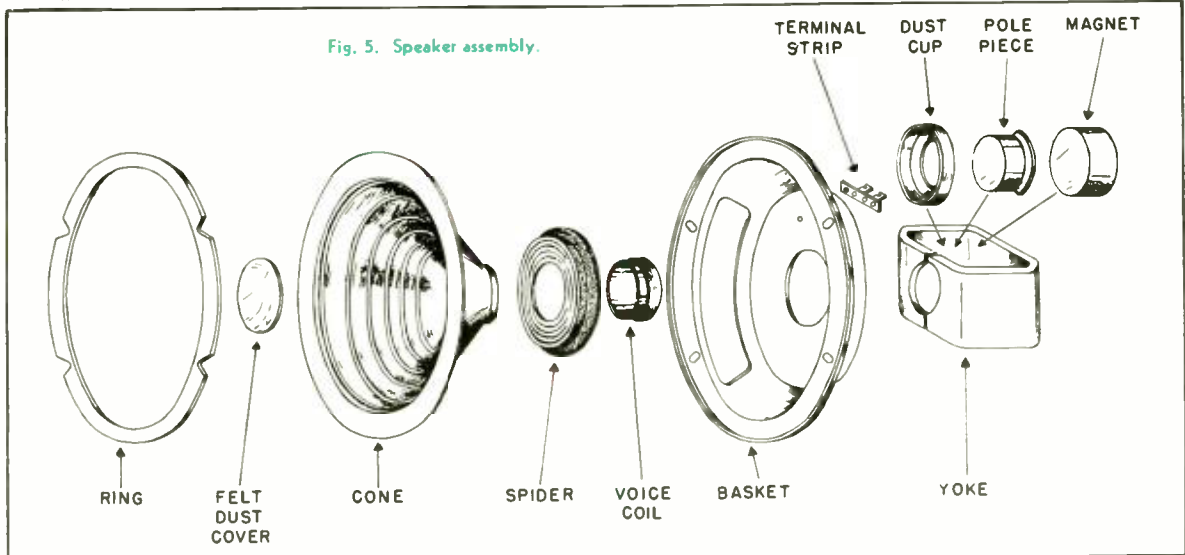

Fig. 5. Speaker assembly.

coil in alignment with the air gap is made of a plastic impregnated cloth whose warp and woof are so spaced that air may pass through but dust and dirt will be filtered out. A porous spider of this type relieves the back pressure built up by its motion so that the trapped air can then escape without being forced around the voice coil where it may introduce spurious hisses and noises. Another advantage of the outside spider over the old center mounting style, is that it has a high radial stiffness with great axial mobility. This means a lower natural resonance and closer gap clearances. This, with a dust cap in the center of the cone, makes a dust and dirt-proof speaker.

The recent introduction of Alnico V as a magnet material for use in loudspeakers has served to muddy the waters of an already confusing subject. There is nothing mysterious about this new magnet material and it contributes nothing to the quality of the speaker that cannot be acquired in some other manner. All that the magnetic structure does is to provide flux in the air gap for the voice coil to

operate on. Eight thousand gauss in the gap is still 8,000 gauss whether it is supplied by Alnico III, Alnico V, or an electro-magnet field. Of primary importance is the cost of the structure to supply the required flux density.

Chemically, Alnico V is different from III in that it contains cobalt and copper as well as the usual aluminum and nickel. In addition, it is heat-treated in a manner that results in a material having about three times the "energy product" of Alnico III. The reduced magnet size, using Alnico V, permits some design improvements. For a direct comparison, consider the 20-ounce Alnico III structure. In current loudspeakers, the R.M.A. standard 4.64-ounce Alnico V magnet produces an equivalent flux density. Not all of this difference can be assigned to the greater energy of Alnico V. The small size permits a slug-shaped magnet which appreciably reduces the leakage flux.

In addition to being more efficient, the slug-type magnetic structure is less effected by surrounding metal. With a

ring-type magnet, short-circuiting the magnet has a demagnetizing effect that may permanently reduce the efficiency of the speaker. With a slug-type magnet, shorting bars or mounting boxes only act as return paths for the flux. This is an important advantage when speakers are placed in metal housings.

#### Rating of Cone Speakers

Rating the frequency response of a speaker is difficult because there is no standard. *Figure 6* shows the measured on-axis response of several competitive speakers. Some of the variations in response in this figure are due to measuring conditions as discussed previously. Manufacturers claim different ratings for speakers of this type. One speaker, no better than these, is rated to give 14,000 c.p.s. response, although a reasonable rating would be 50 to 8000 c.p.s. Conservative manufacturers are reluctant to publish ratings until there is a standard, because the curves on equivalent speakers will give some justification even to an

[Continued on page 48]

## Cavity Pressure Determination of Hearing Aid Gain

**A** PROCEDURE for measuring the gain of hearing aids, recently developed by the sound laboratory of the National Bureau of Standards, offers to manufacturers and commercial laboratories a useful and economical method for maintaining adequate quality control of hearing aids. The apparatus, utilizing a cavity pressure method,<sup>1</sup> permits a compact test set-up and therefore is much simpler than that required by the free-field procedure now in general use. Because the equipment may be constructed at extremely low cost as compared to an expensive sound-insulated, echoless room, closer control of the gain performance of hearing aids should now be readily available even to the small manufacturers.

#### Definition

The gain of a hearing aid, probably the most important single factor in its performance, may be defined as the ratio of the sound level transmitted to the ear of the user by the receiver to the level of the sound impinging on the microphone of the hearing aid. The ear of a hard-of-hearing person is less responsive to sound stimuli than a normal ear, and the gain is a measure of the magnification of sound

stimuli available to the user of a hearing aid. Hence the magnitude of the gain is directly related to the maximum severity of hearing loss which a hard-of-hearing person may suffer and still derive benefit from use of the instrument.

Though the definition of gain is forthright, its measurement is complex and indirect. It involves measuring the sound

pressure actually impinging on the microphone of the hearing aid, and the sound pressure produced in the ear of the user by the hearing-aid receiver.

A major difficulty in testing a hearing aid and the chief expense for testing equipment are encountered in the quantitative determination of the sound level

[Continued on page 47]

**Fig. 1.** Laboratory assembly of apparatus used for determining hearing aid gain by a cavity pressure method. Essential items include (left to right) driver oscillator, the source cavity and preamplifier source tube, loudspeaker element, electronic amplifier-voltmeter, and in right foreground, the "artificial ear" and its preamplifier, on which the hearing aid receiver is mounted. The power level recorder (right) is used here for automatic recording of data. The sound pressure level in either the source cavity or "artificial ear" can be recorded by switching the output of one or the other of the preamplifiers into the amplifier and recorder input.



<sup>1</sup> For complete technical details see "A Cavity Pressure Method for Determining Gain of Hearing Aids," by E. L. R. Corliss and G. S. Cook, *J. Research, NBS* Vol. 40, No. 1 (Jan. 1948) RP 1857.

# Elements of Ultrasonics

S. YOUNG WHITE\*

A discussion of first principles and methods of making simple ultrasonic generators.

**M**ANY inquiries have come in from readers of this series of articles and from potential users of ultrasonic energy. There seems to be considerable confusion in the minds of some as to the nature of ultrasonics, especially among those who are not sound engineers. We have defined ultrasonics in several ways in this series, but let us re-define it in terms that will have meaning to, say, a process engineer who may have only a dim recollection of his college physics course.

Ultrasonic energy used in processing materials is distinguished from ordinary sound waves as used for communications by two marked differences: first, the frequency is much higher and secondly, the energy density is considerably greater.

must be thousands of times greater than this loud sound. In fact, any power density less than about 10 watts/in.<sup>2</sup> will generally produce no effect at all.

Because acceleration increases only as the square root of the power density, to increase it by a factor of ten, we must increase our power density a hundred times. So we must think in terms of tens of watts or even of thousands of watts per square inch if we wish to tear material apart, or seriously change the nature of some material composed of very fine particles.

While high acceleration is our chief aim, there are also doubtless some effects produced by the large values of sound pressure we develop in liquids and solids. For instance, a kilowatt/in.<sup>2</sup> in steel

The second is the energy loss in the load. Nature has made many materials which are almost perfectly elastic—you compress them and they spring back to almost original dimensions, less a very small amount indeed. In radio terms, their "Q" is very high, and the resistive component resulting in heat loss is very low. One standard way to express the loss in the load is to state how far the wave will travel until it is weakened or attenuated to half value.

Water is rather astonishing in that at 24,000 cycles the wave will travel about 40 miles before it is weakened to half power. Most metals have a "Q" of several thousand. On the other end of the scale, a 50% solution of cornstarch in water, stirred for one minute, will reduce an ultrasonic wave to half power in about six inches. This brings us to what we might designate as the cubical nature of the load, and we can see that it varies over very wide limits.

The figures on high power density are rather discouraging when first encountered, as in many cases we think of a load say ten feet square, containing 100 square feet, or 14,400 square inches. At one kw/in.<sup>2</sup> this would mean about 15,000 kw applied to the load, which sounds quite impractical. But the "Q" of the load lowers this figure by a very large amount. Let us take water as an example:

If we establish 1 kw over one square inch, we can have a 1 inch square column of water behind this square inch, and it can theoretically be 40 miles long if we are willing to have the far end working at  $\frac{1}{2}$  kw per square inch. This gives us 2.4 million cubic inches, or 43 tons of water being treated at one time, and since many of the effects we desire are accomplished in a tenth of a second, we can change this water ten times a second and treat 430 tons a second. Since in a practical case we must have boundary layer losses and wave interferences that seriously lessen this possible result, we shall actually treat very much less, but the figure is so large that even so it is very encouraging.

Now let us return to the effect of frequency on acceleration. At ten times the frequency, or 240 kc, we would have ten times the acceleration. Unfortunately, we would also have ten times the loss per cycle, and ten times the number of

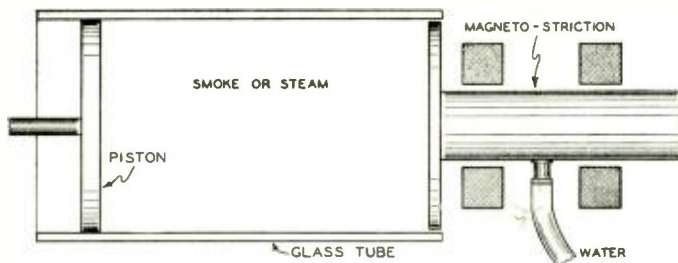

Fig. 1. Using a magnetostriction ultrasonic generator to coagulate steam or smoke.

This combination produces very high values of acceleration in the load.

Since all known useful processing effects stem from acceleration, we aim to secure the maximum acceleration possible from a given power. Because acceleration increases directly with the frequency, the higher the frequency the greater the acceleration. For example, the acceleration is increased 24 times by simply increasing the frequency from 1000 to 24,000 cycles.

As for power, an 8-inch loudspeaker dissipating one watt of electrical power in its voice coil delivers only about 50 milliwatts of sound energy spread over approximately 50 square inches, so the energy density is about 1/1000th watt per sq. in., or one milliwatt/in.<sup>2</sup> The ear is a sensitive device, so if we listen only a few inches from the cone, the sound will be very loud indeed.

## Power Density

If we wish to produce any noticeable effect upon any material, the power density

gives us a compression wave of plus 4,000 lb./in.<sup>2</sup>, immediately followed by a negative pressure or rarefaction wave of minus 4,000 lb./in.<sup>2</sup>, stressing the steel 8,000/in.<sup>2</sup> in a rapidly reversing manner. This effect is independent of frequency. Some generators we have described have power densities of over a hundred kw/in.<sup>2</sup>, so these values can probably be exceeded in practice. In fact, there is reason to believe we can disintegrate almost any material in time, as we become able to develop more power.

Since acceleration equals frequency times the square root of the power density, to economize on power we must use the highest possible frequency. But in practice, there are two modifications that must be made.

## Modifications

The first is that many desirable effects occur at specific frequencies; for instance, dust coagulation of one micron particles requires 24 kc for most efficient results, and at 100 kc the effect would be very small.

\*Consulting Engineer, 52-12 Van Horn St., Elmhurst, L. I., N. Y.

cycles, so the attenuation would be 100. The wave falls to half value in 0.4 mile, and we are only treating 0.43 tons of material. If we lowered the power to ten watts/in.<sup>2</sup> we would have the same acceleration, and treat the material ten times as fast, so if we could move the material fast enough past the generator, we would again have 430 tons a second. So frequency cancels out if the desired effect occurs in a thousand cycles and if the material can be made to flow fast enough. In general, the advantage of using the lower frequency and higher power is that at the present state of the art it is easier to generate high power at low frequency than moderate power at very high frequency.

Since ultrasonic energy is usually useless unless sufficient power is employed to produce some marked effect on the material under treatment, and the minimum power level must usually be determined by trial, let us try to define ultrasonics from a practical point of view.

Ultrasonic energy consists of alternate compression and rarefaction waves of sufficiently high power level to produce some marked effect in the material, usually by affecting the particles of which it is composed.

This definition can be polished up in time to come, but it indicates there is no magic in merely increasing the frequency of a sonic wave—the power must be enormously increased over that usually thought of in connection with sound.

Table I emphasizes the values that can be obtained in practice with high power. It is similar to one given previously, but increased in power and given in British units throughout.

There is a very good book of its kind, "Ultrasonics" by Bergmann, published by John Wiley and Sons in the U. S. This book is by all means the most complete on the subject, and gives 605 references, the latest being 1938. It is by a physicist for physicists, and does not lean very far toward the practical. Many papers are appearing in the *Journal of the Acoustical Society*, mostly on underwater sound work done during the war.

#### Power Level

It must be emphasized that the work done to date has been accomplished with power densities not exceeding 10 watts/cm<sup>2</sup> or 65 watts/in.<sup>2</sup>. Since many effects have critical minimum amplitudes that must be exceeded before any noticeable effects occur, we can appreciate that the development of much higher power-density generators will allow many materials to be worked on successfully that at present show no effects from the treatment by the 65 watts/in.<sup>2</sup>.

There has been some interest from readers asking what ultrasonic apparatus is available on the American market. Some simple devices such as the Hart-

**TABLE I**  
**Ultrasonic Values**  
Power Density—1 kw/sq. inch, Frequency—100,000 cycles.

Medium	Pressure lb./inch	Motion micro-inches	Acceleration "G" miles/sec.	"G" miles/sec.
Air	10	3,000	2,700,000	16,800
Water	310	95	84,000	520
Steel	1600	20	18,000	110

mann whistle can be easily made at home in a small shop with a lathe. Considerable work can also be done on water jets interrupted by compressed air bubbles, as described in the last issue. For commercial equipment we have the following:

Eimer and Amend, 633 Greenwich St., New York City, has two quartz crystal units—a table model, 200 watts, and a floor model 500 watts, for about \$1,075 and \$2,250 respectively. They are produced by Crystal Research Labs. These are well made units, and the danger of the crystals breaking has been almost completely removed by good workmanship on the crystal. The oil bath unit containing the crystal could well be redesigned for special applications. The range of crystal frequencies is from about 250 kc to over a megacycle, with opti-

mum performance for many uses at 400 kc.

The Brush Development Company has a line of Primary Ammonium Tartrate (PN) crystal units that will stand temperatures up to 200 degrees F, and put out from a watt or two up to several hundred watts, some c.w. and some pulse rating. The larger units have a 7½-inch housing, and due to their small capacity the voltage is pretty high.

The International Nickel Company has a bibliography on magnetostriction which they will supply to anyone interested. So far as the writer is aware, only Raytheon produces magnetostriction units commercially, but they are easy enough for a radio man to construct. Better have at least 500 watts in the oscillator to drive them. It is a considerable nuisance to make up the 500-watt, 20-ke coils for the job.

A high-power siren good up to about 8 ke, as written up in a recent article in *Life* magazine, may be inquired about from the Ultrasonic Corp., 883 Boylston St., Boston, Mass. My jet turbine unit is not yet in production for general use.

Anyone who wishes to investigate ultrasonic phenomena in a small way can

[Continued on page 40]

Crystal ultrasonic generator providing 600 watts into final stage. Four frequencies, from 400 kc to 1200 kc, are provided. (Courtesy Eimer and Amend)

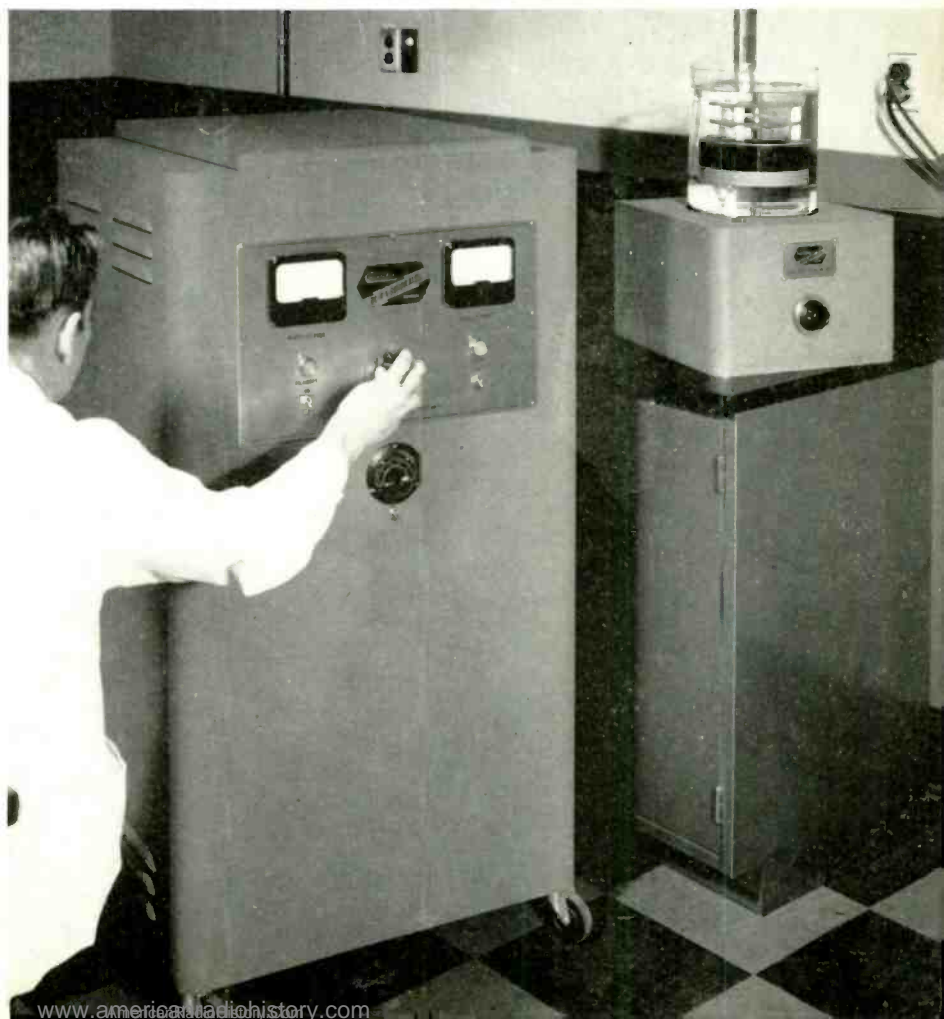

# 1948 I.R.E. National Convention

March 22-25, 1948

**T**HE Institute of Radio Engineers will hold its 1948 Annual Convention and Radio Engineering Show at the Hotel Commodore and Grand Central Palace on March 22-25.

Theme of the convention and show is "Radio-Electronic Frontiers," and both the program and the exhibits are being planned to fulfill this theme.

A diversified technical program consisting of 130 papers in 26 sessions has been arranged plus two special symposia with outstanding invited speakers on "Nucleonics" and "Advances Significant to Electronics."

The annual banquet of the Institute will be held the evening of Wednesday, March 24, and the President's Luncheon on Tuesday noon, March 23. Both will feature national figures as principal speakers. A cocktail party is scheduled for Monday, March 22, at 6 P.M.

On the opening morning, March 22, the Annual Meeting of the Institute will be held. At this meeting, an innovation at I.R.E. conventions, Dr. H. B. Richmond will address the membership on "An Engineer in the Electronics Industry—Prospect, Preparation, Pay."

The largest Radio Engineering Show in history, occupying two and one-half floors of Grand Central Palace featuring the products of approximately 170 exhibitors will be held in conjunction with the convention. Attendance is expected to equal or exceed the figure of over 12,000 who attended the 1947 convention and show.

## Tentative Technical Program

**MONDAY AFTERNOON  
MARCH 22, 1948**

### FREQUENCY MODULATION

"F.M. Detector Tube with Instantaneous Limiting and Single-Circuit Discriminator," Robert Adler, Zenith Radio Corporation, Chicago, Ill.

"A Proposed Combined F.M. and A.M. Communication System," John C. O'Brien. "Ratio of Frequency Swing to Phase Shift in Phase—and Frequency-Modulation Systems," D. K. Gannett and W. R. Young, Bell Telephone Laboratories, New York, N. Y.

"A New Magnetron Frequency-Modulation Method," Philip H. Peters, Jr., General Electric Company, Schenectady, N. Y.

"I.F. Design for F.M. Receivers," K. E. Farr, Hazeltine Electronic Corporation, Little Neck, N. Y.

### SYSTEMS I

"Technical Aspects of Experimental Public Telephone Service on Railroad Trains," N. Monk and S. B. Wright, Bell Telephone Laboratories, New York, N. Y.

"Reflected-Power Communication," Harry Stockman, Watson Laboratories, Cambridge, Massachusetts.

"Static-Free Systems of Detection," D. L. Hings, International Electronic Corporation, Indianapolis, Indiana.

"Selective-Sideband Transmission and Reception," Donald E. Norgaard, General Electric Company, Schenectady, N. Y.

"Statistical Methods in the Design and Development of Electronic Systems," Leonard S. Schwartz, Hazeltine Electronics Corporation, Little Neck, N. Y.

"The Fundamental Principles of Doppler Radar," Edward Barlow, Sperry Gyroscope Company, Great Neck, N. Y.

### NAVIGATION AIDS

"The Radiovisor Landing System for Aircraft," Douglas Shearer and William W. Brockway.

"Considerations in the Design of a Universal Beacon System," L. B. Hallman, Jr., Communication and Navigation Laboratory, Wright Field, Ohio.

"Surveillance-Radar Deficiencies and How They Can Be Overcome," J. Wesley Leas, Air Transport Association of America, Washington, D. C.

"The Course-Line Computer," F. J. Gross, C. A. A., Department of Commerce, Indianapolis, Indiana.

"Aircraft Instrumentation and Control," Francis L. Mosely, John A. Biggs, Earl T. Heald, and John C. McElroy, Collings Radio Company, Cedar Rapids, Iowa.

### ANTENNAS I

#### Antennas For Circular Polarization

"An Omnidirectional High-Gain Antenna for Circularly Polarized Radiation," A. G. Kandoian, Federal Telecommunication Laboratories, Inc., Nutley, N. J.

"Analysis of the Effect of Circulating Currents on the Radiation Efficiency in Broadcast Directive Antenna Design," Glenn D. Gillett, Glenn D. Gillett and Associates Washington, D. C.

"A U.H.F. Model Study of Current Distributions Induced in Low-Frequency Broadcast Towers and a Discussion of Means for Reducing Undesired Radiation," Andrew Alford and Henry Jasik.

"Helical Beam Antennas for Wide-Band,

Applications," John D. Kraus, Ohio State University, Columbus, Ohio.

"Circular Polarization for F.M. Broadcasting," Carl E. Smith, United Broadcasting Company, Cleveland, Ohio, Robert A. Fouty, O.S.U. Research Foundation, Columbus, Ohio.

**TUESDAY MORNING  
MARCH 23, 1948**

### SYSTEMS II

"Theoretical Study of Pulse-Position Modulation Without Fixed Reference," Arnold E. Ross, Stromberg Carlson Company, Rochester, N. Y.

"High-Quality Radio Program Links," M. Silver and H. A. French, Federal Telecommunication Laboratories, Nutley, N. J.

"Signal-to-Noise Ratio Improvement in a Pulse-Code Modulation System," A. G. Clavier, P. F. Panter, and W. Dite, Federal Telecommunication Laboratories, Nutley, N. J.

"Radio-Wire Links for Multichannel Transmission," E. M. Ostlund and H. R. Hunkins, Federal Telecommunication Laboratories, Nutley, N. J.

"Bandwidth Reduction in Communication Systems," W. G. Tuller, Melpar Incorporated, Alexandria, Virginia.

### AMPLIFIERS

"Low-Noise Amplifier," Henry Wallman, A. B. Maenee, and C. P. Gadsden, Massachusetts Institute of Technology, Cambridge, Massachusetts.

"Phase Distortion in Audio Systems," L. A. de Rosa, Federal Telecommunication Laboratories, Nutley, N. J.

"Visual Analysis of Audio-Frequency Transient Phenomena," Donald E. Maxwell, Columbia Broadcasting System, Inc., New York, N. Y.

"Square-Wave Analysis of Compensated Amplifiers," Philip M. Seal, University of Maine, Orono, Maine.

"A New Figure of Merit for the Transient Response of Video Amplifiers," R. C. Palmer and Leonard Mautner, Allen B. Dumont Laboratories, Passaic, N. J.

### PASSIVE CIRCUITS

"Properties of some Wideband Phase-Splitting Networks," D. G. C. Luck, Radio Corporation of America, Princeton, N. J.

"Theory and Design of Constant-Current Networks," Carl S. Roys and P. T. Chin, Syracuse University, Syracuse, N. Y.

"New Parameter Adjustment for Television



Network Transients," M. J. DiToro, Federal Telecommunication Laboratories, Nutley, N. J. R. C. Wittenberg, Ford Instrument Company, Long Island City, N. Y.

"Application of Tehebysehef Polynomials to the Design of Bandpass Filters," M. Dihal, Federal Telecommunication Laboratories, Nutley, N. J.

"Matrix Treatment of Four-Terminal Vacuum-Tube Networks," F. D. Bennett, University of Illinois, Urbana, Ill. J. S. Brown, Argonne National Laboratories, Chicago, Ill.

## ELECTRONICS I

### Tube Design and Engineering

"Thermionic Emission from Grids in Vacuum Tubes," M. Arditi and V. J. De Santis, Federal Telecommunication Laboratories, Nutley, N. J.

"The Negative-Ion Blemish in a Cathode-Ray Tube and its Elimination," R. M. Bowie, Sylvania Electric Products, Flushing, N. Y.

"Wide - Tuning - Range Continuous - Wave High-Power Magnetrons," Paul W. Crapuchettes, Litton Industries, San Carlos, California.

"Wide-Range-Tuning Systems for Magnetrons," E. W. Kather, Raytheon Manufacturing Company, Waltham, Massachusetts.

"Design Characteristics of Hearing-Aid Tubes," George W. Baker, Chatham Electronics Corporation, Newark, N. J.

## ANTENNAS II

"Physical Limitations of Directive Radiating Systems," L. J. Chu, Massachusetts Institute of Technology, Cambridge, Massachusetts.

"The Radiation Resistance of an Antenna in an Infinite Array or Waveguide," H. A. Wheeler, Consulting Radio Physicist, Great Neck, N. Y.

"Reflectors for Wide-Angle Scanning at Microwave Frequencies," R. C. Spencer, Wade Ellis, and Ellen Fine, Watson Laboratories, Cambridge, Mass.

"Measured Impedance of Vertical Antennas over Finite Ground Planes," W. P. Summers and A. S. Meier, Ohio State University, Columbus, Ohio.

"Current Distributions on Aircraft Structures," J. V. N. Granger, Harvard University, Cambridge, Massachusetts.

### TUESDAY AFTERNOON MARCH 23, 1948

## SUPERREGENERATION

"Superregeneration as it Emerges from World War II," Harold A. Wheeler, Consulting Radio Physicist, Great Neck, N. Y.

"Theory of the Superregeneration Receiver," W. E. Bradley, Philco Corporation, Philadelphia, Pa.

"Superregeneration—An Analysis of the Linear Mode," Herbert A. Glucksmann, Watson Laboratories, Cambridge, Mass.

"External and Internal Characteristics of a Separately Quenched Superregenerative Circuit," Sze-Hou Chang, Watson Laboratories, Cambridge, Mass.

"The Hazeltine Fremodyne Circuit," B. D. Loughlin, Hazeltine Electronic Corporation, Little Neck, N. Y.

## TRANSMISSION

"Simplified Procedure for Computing the Behavior of Multiconductor Lossless Transmission Lines," S. Frankel, Federal Telecommunication Laboratories, Nutley, N. J.

"Optimum Geometry for Ridged Waveguides," W. E. Waller, S. Hopper, and M. Sucher, Polytechnic Research and Development Company, Brooklyn, N. Y.

"Fields in Nonmetallic Waveguides," Robert M. Whitmer, Rensselaer Polytechnic Institute, Troy, N. Y.

"A Wide-Band Waveguide-Filter Structure," Seymour B. Cohn, Harvard University, Cambridge, Mass.

"Transmission-Line Vector Diagram," W. C. Ballard, Jr., Cornell University, Ithaca, N. Y.

## NUCLEAR STUDIES

"Oscillator Design for the 130-inch Frequency-Modulated Cyclotron," E. M. Williams and H. E. De Bolt, Carnegie Institute of Technology, Pittsburgh, Pa.

"An Electronic Interval Selector for the Determination of the Deadtime and Recovery Characteristics of Geiger Counters," L. Costrell, National Bureau of Standards, Washington, D. C.

"Electronic Classifying, Cataloging, and Counting Devices," J. Howard Parsons, Monsanto Chemical Company, Oak Ridge, Tenn.

"Health Physics Problems in Atomic Energy," K. E. Morgan, Monsanto Chemical Company, Oak Ridge, Tenn.

"A Selective Detector for Heavy Charged Particles," Keith Boyer, Massachusetts Institute of Technology, Cambridge, Mass.

## ELECTRONICS II

### Industrial Applications and Electronic Circuits

"Experimental Study of the Effects of Transit Time in Class-C Power Amplifiers," Oliver Whitby, Harvard University, Cambridge, Massachusetts.

"New Receiving Tubes for Industrial Use," C. M. Morris and H. J. Prager, RCA, Harrison, N. J.

"Use of Diode Rectifiers with Adjustable Transformers for Motor Speed Control," W. N. Tuttle, General Radio Company, Cambridge, Massachusetts.

"Servo-System Performance Measurement," Charles F. White, Naval Research Laboratory, Washington, D. C.

"Spark Oscillators for Electric Welding of Glass," James P. Hooker, Corning Glass Works, Corning, N. Y.

## Components and Supersonics

"Phase-Corrected Delay Lines," M. J. DiToro, Federal Telecommunication Laboratories, Nutley, N. J.

"On the Theory of the Delay-Line-Coupled Amplifier," H. G. Rudenberg, Harvard University, Cambridge, Mass.

"Losses in Air-Cored Inductors," R. F. Field, General Radio Company, Cambridge, Mass.

"A Simplified Design Procedure for Iron-Core Toroids," H. E. Harris, Massachusetts Institute of Technology, Cambridge, Mass.

"Coupling Effects Between Infrared Radiation and a Supersonic Field," W. J. Fry and F. J. Fry, University of Illinois, Urbana, Illinois.

### TUESDAY EVENING MARCH 23, 1948

#### Symposium: Nuclear Studies

A panel of distinguished experts will discuss basic questions in the nuclear field.

### WEDNESDAY MORNING MARCH 24, 1948

#### Symposium: "Advances Significant to Electronics"

Five exceptional invited papers from outstanding authors will be presented.

### WEDNESDAY AFTERNOON MARCH 24, 1948

## TELEVISION

"A Unitary Tuner-Amplifier for Television Receivers," E. L. Crosby, Jr. and G. W. Clevenger, Bendix Radio, Baltimore, Md. H. Goldberg, National Bureau of Standards, Washington, D. C.

"A Picture-Modulated R. F. Generator for Television Receiver Measurements," Allan Easton, Hazeltine Electronics Corporation, Little Neck, N. Y.

"The Application of Projective Geometry to the Theory of Color Mixture," F. J. Bingley, Philco Corporation, Philadelphia, Pennsylvania.

"Reflection of Television Signals from Tall Buildings," Andrew Alford and G. J. Adams. "Field-Coverage Considerations of New York Television Stations," Thomas T. Goldsmith, Jr. and R. P. Wakeman, Allen B. Dumont Laboratories, Passaic, N. J.

## ELECTRONICS III

### Tube Manufacture

"ASTM Committee Work on Factory Tests on Cathode Nickel," J. T. Acker, Western Electric Company, New York, N. Y.

"A Standard Diode for Radio-Tube Cathode-Core-Material Approval Tests," R. L. McCormack, Raytheon Manufacturing Company, Waltham, Mass.

"European Practices in the Manufacture of Cathodes," T. H. Briggs, Superior Tube Company, Norristown, Pa.

"Processing Vacuum-Tube Components,"

[Continued on page 39]



## Classical Records

EDWARD TATNALL CANBY\*

SOME months ago this department made a point of the great gulf that separates the engineer's conception of quality audio equipment and the sort of material commonly used in home phonographs. (The observation was made that, perhaps unintentionally, some engineers by their very scorn of this lesser equipment are impeding progress towards better audio quality in the mass market phonograph and radio, playing into the hands of those who capitalize on the status quo.) I have been a constant plunger of better quality sound reproduction, in records and in ordinary home machines too. As a result I am constantly asked by friends and readers to recommend new equipment, to give them at least the benefit of some of the improvements I speak of—with their small budgets.

A few, of course want the best. Recommendations to them are in line with what engineers might expect, and in their own terms. But the large majority of requests—and I am convinced there are thousands and thousands of other like-minded souls—fall squarely in the middle of the Great Gulf. People who are sick of their old equipment, dissatisfied with anything in the stores within their budget (they say so, in so many words)—can I recommend *any* machine other than those they've tried—can they install one of the new pickups (but how does one attach a preamplifier . . .), would a new speaker do any good? Radio salesmen are uniformly vague and entirely uncooperative. On the other hand, too many engineers, consulted, are unwilling to compromise with their own sky-high standards. What to do, then, given perhaps \$75. to a maximum of \$250? Most people, frustrated, give up

\*279 W. 4th St., New York 14, N. Y.

To Mr. Canby's widely read column, we add Bertram Stanleigh's interesting evaluation of recent popular music records.

and angrily return to their old machines. The gulf widens.

There is much to be done, however, I've made suggestions right along, as to available equipment. I am ready to go farther and give, for what they are worth, a few ideas for equipment, yet to be manufactured. Equipment particularly designed to fit the needs of these earnest, intelligent non-engineer listeners who can find nothing to satisfy them for their money.

Many people insist on the all-in-one console, in spite of disadvantages, and this is significant for it must be considered. For them there is the mail order radio phonograph, at a saving. But this is no real answer. I have consistently recommended the separate-unit arrangement. It offers more for the money, very much greater flexibility, resistance to obsolescence and performance clearly superior according to engineers' standards, to that of standard consoles costing the same. For under a hundred dollars a man can have himself a good changer, a modest "high fidelity" amplifier or a P.A. amplifier, and a good 12 inch speaker; for a bit extra there is the GE or Pickering cartridge and pre-amplifier, or a nylon type crystal. A piece of wallboard baffling gives as good results as most confined radio cabinets. In fact here is surely the ideal basic equipment to suit in its capacity the real needs of the Great Gulf consumer.

Except that it has to be put together. Simple for some, but for the majority this is an impossible thing! Wires to hook up, soldering to be done. A large number of phonograph owners are ready and willing to operate more than the over-simple controls on an average machine and they appreciate the im-

(Continued on page 43)

## Popular Records

BERTRAM STANLEIGH\*\*

BY NOW we expect new advances in recording to originate in England, and it will come as no great surprise that HMV has announced TT (transient true) recordings which include frequencies up to 20,000 cps. The British market has been strongly affected in the last two years by the Decca frr recordings, and these new TT discs are the answer of the most important competitor.

That American record companies have not felt this pressure for wider range recording can be seen from the number of inferior old recordings which are finding their way back into the catalog. Gradually they are repressing a large portion of their prewar catalog of recordings which are musically interesting but which could easily be rerecorded under much finer conditions today. The popular interest in these inferior recordings coupled with the general lack of interest in the new *London* extended range discs seems to indicate that popular demand will not be sufficient to force our record companies to improve the quality of their products.

The inferiority musically of the first *London* recordings to be imported has created a resistance which will not easily be overcome despite the vastly improved quality of their more recent releases. It seems that only a prolonged record ban in this country will give these discs enough of a foothold to favorably influence American recording technique. One could hardly hope for so drastic a cure.

The following discs are among the more interesting in the current crop:

**Old Man Rebob** London 139. Jack Parnell and his Quartet.

(Continued on page 42)

\*\*41 East 59th St., New York 22, N. Y.

# The Complete **E-V** Line Assures the Right Microphone for Every Need

● Only **ELECTRO-VOICE** provides such a complete line of microphones. With outstanding developments in Unidirectional, Differential†, Bi-directional, and Non-directional types . . . in Dynamic, Crystal, Carbon and Velocity models . . . you can more easily obtain the microphones best suited to your needs.

● Proved in critical service, E-V Microphones are widely used today by leading manufacturers and sound engineers in all kinds of applications. They are produced from finest materials under E-V quality control. Consult our engineers.

**THE CARDYNE**—True cardioid unidirectional dynamic microphone, with exclusive E-V *Mechanophase\** principle, *Acoustalloy* diaphragm, smooth, wide range response, and high output.

**THE CARDAX**—The only high level cardioid crystal microphone with Dual Frequency response for high fidelity voice and music, or rising characteristic for extra crispness of speech.

†Patent No. 2,350,010 \*Electro-Voice Patents Pending



**THE  
CARDYNE**

**THE  
CARDAX**



Send for Catalog No. 101

This illustrated catalog gives complete data and information on E-V Microphones. Includes helpful selection guide. Write for it today.

V-3, V-2, V-1 Velocity	640 Dynamic	630 Dynamic	605 Dynamic 905 Crystal	610 Dynamic 910 Crystal	600-D Dynamic 210-S Carbon 602 Differential	205-S Differential
					606 Differential	Comet Crystal Comet-D Dynamic

A portion of the Complete E-V Line is shown here

NO FINER  
CHOICE THAN

## Electro-Voice

ELECTRO-VOICE, INC., BUCHANAN, MICHIGAN

Export Division: 13 East 40th Street, New York 16, N. Y., U. S. A. Cables: Arlab

Crystal Microphones  
licensed under Brush patents

# NEW PRODUCTS

## HOME RECORDER

A new home recording unit with professional features has just been announced by the Universal Microphone Company, Centinela at Warren Lane, Inglewood, Calif.

Called the Universal RC Recording Chassis, this new unit has been designed and built by commercial recording equipment engineers. According to Mr. Fouch of Universal Microphone Company, it is the only home recording unit with patented and exclusive advantages of:

- (1) Recording extremely close tangency.
- (2) Patented pantographic movement makes possible equally spaced cutting over the entire record.
- (3) Groove depth adjustment is visible and adjustment can be made in recording position.
- (4) Pantographic action keeps guide shoe at correct angle in lead screw thread—records inside to outside.
- (5) Lift lever at side of head allows the operator to locate the stylus in the exact groove location after the lead screw has been engaged.
- (6) RC Recording Chassis records music and voice at commercial levels and loudness.
- (7) Recording head is automatically lifted at the end of a 10" record.

Using a 10" turn table the heavy duty, 110 volt, 60 cycle, 78 RPM motor which can be easily converted to 50 cycle operations, is complete with crystal pick-up to play back 12" records.

Further information can be had from your distributor or by writing direct to the Universal Microphone Company, Centinela at Warren Lane, Inglewood, Calif.

## SCOTT AMPLIFIER

The dynamic-band-pass principle reaches new peaks of performance in the Type 210-A Laboratory Amplifier. This unit, supplied with a matched variable reluctance



pickup cartridge, provides a complete phonograph system except for turntable or record changer and loudspeaker. The amplifier provides 20 watts output with less than 2% distortion, and below 8 watts, the distortion is under 1/8%. The output transformer is arranged to match speaker impedances between 2 and 500 ohms.

The maximum frequency range of the amplifier exceeds 20,000 cycles—with the Dynamic Noise Suppressor the response is flat to 10,000 cycles and extends to 16,000 cycles. Independent tone controls allow boost or attenuation at either end of the frequency range. A whistle filter is provided for AM reception. In addition to reproducing phonograph records, the amplifier may be used with any standard tuner. This amplifier was designed to provide the best possible reproduction of phonograph records, FM or AM.

For further data, write Hermon Hosmer Scott, Inc., 385 Putnam Avenue, Cambridge, Mass., Dept. AE.

## PORTABLE PA AMPLIFIER

A new portable public address amplifier engineered to provide quality consonant with the highest price microphones and loudspeaker systems has been brought out by Altec Lansing Corporation, according to an announcement by A. A. Ward, vice-president. The new amplifier is catalogued as Model A-324.



The A-324 is conservatively rated at 15 watts with a guaranteed full power output within 1 db from 35 to 12,000 cycles. Its over-all frequency response is rated flat within 1 db from 20 to 20,000 cycles.

An unusual feature is a continuously variable bass control which at the low end is coupled to a switch which cuts in special equalization to correct for the boomy reproduction which often results from poor microphone technique. A continuously variable treble attenuator is also provided.

## SHURE WIRE RECORDING HEADS

These new recording heads have the following features:

- 1—Versatility of playback and recording circuits.
- 2—Variety of impedances for individual needs.
- 3—Closely controlled air-gaps for uniform

performance and excellent wear characteristics.

4—Reduction of hum pickup.

5—Controlled groove contour for maximum effective position of recording wire.



For further data, write Shure Bros., Inc., 225 W. Huron St., Chicago 10, Ill.

## HI-FI AMPLIFIER

Allied Radio Corporation, Chicago, announces a newly designed Knight 20-watt phono amplifier that is especially adapted to high-fidelity reproduction from phonograph records, or AM or FM tuners. Especially suitable for industrial plants broadcasting music programs, for laboratory testing, music hobbyists, and for all purposes requiring wide range response. Precise engineering has resulted in the production of an amplifier developing less than 2% harmonic and less than 8% intermodulation distortion at rated power of 20 watts. Individual bass and treble tone controls permit both boost and attenuation of bass and treble frequencies. With tone controls at normal, frequency response is plus or minus 1 db from 20 to 20,000 cps. Hum is better than minus 75 db from rated output. Gain is 78 db. Adjustable automatic volume expansion is incorporated. Its action is independent of volume control setting. Dual high impedance input selected by switch. Output impedances of 4, 6, 8 and 500 ohm are provided.

For additional details including complete specifications and response curves write to Allied Radio Corporation, 833 W. Jackson Boulevard, Chicago 7, Ill.

## VOCAL-AIRE SPEAKERS

The formation of a new company to take over production of air column loudspeakers under the Dilks patents has been announced.

William Petzold and Frank Holdenecker are principals of the new organization to be known as The Dilks Company and located at Seymour, Conn. Production has been started and deliveries are being made on complete sound systems utilizing the Dilks Vocal-Aire Speaker unit. The new com-

[Continued on page 47]

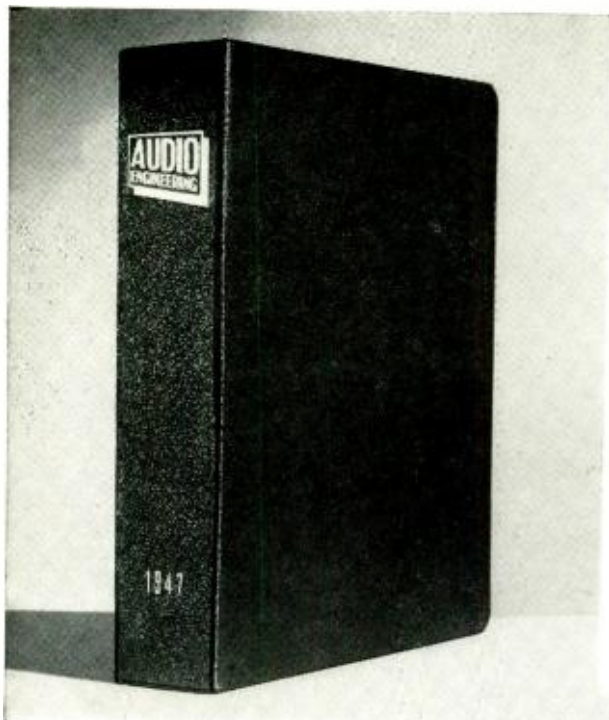

**AUDIO  
ENGINEERING**

**BINDERS**  
**\$2<sup>50</sup>**

« « « Here at last is a binder using modern postwar materials at prewar prices. Designed to provide instantaneous reference to your monthly copies of Audic Engineering. An unusually fine library finish that will stand up under constant use.

- Rich blue Dupont Fabricord—stainproof and washable
- Rigid backbone with bound-in metal support
- Light weight tarnishproof aluminum ends
- Coil springs built in at each end to securely position spring steel wire holders
- Backbone gold stamped with Audio Engineering and year
- Center channel to keep magazines fastened in position
- Round corners, hinges and backbone fully reinforced
- \$2.50 postpaid. Foreign orders add 50c



AUDIO ENGINEERING FEBRUARY, 1948

RADIO MAGAZINES, INC.

342 MADISON AVE.  
NEW YORK 17, N. Y.

AUDIO ENGINEERING  
BINDERS

1947     1948

Enclosed find \$ ..... for ..... Binders

Name .....

Address .....

City ..... State .....

# TECHNICANA

## HIGH-QUALITY AMPLIFIER

Continuing the discussion of the relative merits of tetrodes vs. triodes, but with the details of a high-quality tetrode amplifier to back up his arguments, P.

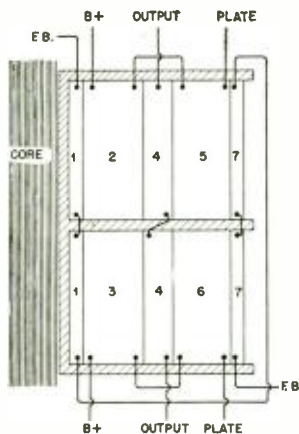

J. Baxandall of the Telecommunications Research Establishment presents the data for another design in the January issue of *Wireless World*.

The principal reason for the use of tetrodes is one of economy since the power efficiency is greater, the required grid swing is less, and the application of feedback which is almost a necessity with triodes also aids in the reduction of hum. The amplifier described provides 10 watts into a 15-ohm load from an input signal of 4 volts rms over a working frequency range from 30 to 16,000 cps. By working frequency range, the author implies the response is down 0.1 db at the indicated frequencies. The harmonic distortion is less than 0.1 per cent, at rated output, and hum is 80 db below 10 watts output.

The amplifier design is relatively conventional, using a pentode for the input stage, another for the phase inverter, and two 6L6G's for the output. The feedback loop includes the output transformer, the connection being made through a tertiary winding in series with the cathode of the first pentode. The solution to the problem of applying a large amount of feedback when the output transformer is included in the feedback loop lies in the design of the output transformer, which uses a specially positioned third winding for feedback. As designed, the amplifier performs without any trace of self-oscillation with the maximum obtainable feedback (using the special transformer) of 36 db, although the feedback is readily controllable.

The transformer construction is unique in the placement of the windings, which are arranged as shown in the figure. Sections 1 and 7 are the two halves of the feedback winding, each half containing 20 turns of No. 27 wire, wound 10 turns on each side of the separator *S*, and distributed over the entire winding area. Sections 2, 3, 4, and 5 each consist of 800 turns of No. 32 enameled wire, with ap-

proximately 70 turns per layer, and with the layers separated by 1 mil transformer paper. The 15-ohm output winding, section 4, consists of 128 turns of No. 20 wire, equally divided between the two halves of the bobbin. The start leads of sections 2 and 3 are connected together, and to the B supply; sections 2 and 5 in series comprise one half of the plate winding; sections 3 and 6 comprise the other half. The core is a 1½-in. stack of Radiometal laminations, 0.015 in. thick. Coil sections are insulated by three layers of Empire cloth. Final measurements give a primary resistance of 160 ohms total, and an inductance of 60 henrys. The leakage inductance across the whole primary with the output winding shorted is only 50 mh, approximately.

The results obtained with this amplifier give considerable credence to the belief that the output transformer's ability to work properly when included in the feedback loop determines the operating characteristics of the entire amplifier.

## SYNCHRODYNE RECEIVER

Considerable interest has been shown in England during the past few months in a new receiver circuit known as the Synchrodyne. The circuit was originally described in principle in *Electronic Engineering* early last year, and more recently D. G. Tucker and J. F. Ridgeway have given practical circuits for this receiver with constructional details in the August and September issues.

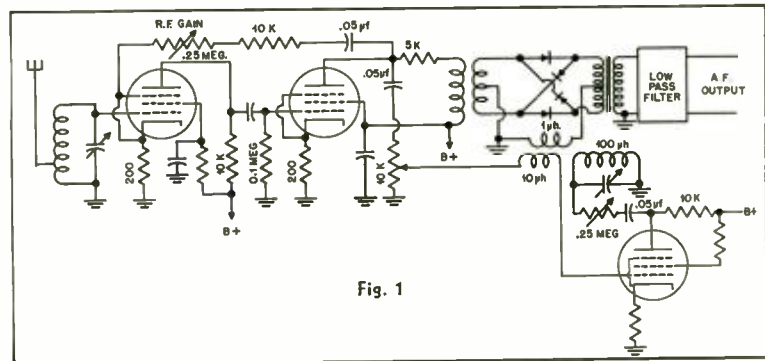

Fig. 1

## PROFESSIONAL DIRECTORY

**C. J. LeBEL**  
AUDIO CONSULTANT

370 RIVERSIDE DRIVE  
NEW YORK 25, N. Y.



Custom-Built Equipment

**U. S. Recording Co.**

1121 Vermont Ave., Washington 5 D C.

District 1640

**Winston Wells**

Designer and Consultant  
Acoustical and Electronic Research

307 East 44th St. MU 4-3487  
New York 17, N. Y.

The Synchrodyne circuit is not especially new in principle. It consists of an r-f amplifier and a heterodyne detector. The new portions of the circuit are the means used to mix the local signal and the received signal, and the method of synchronizing the local oscillator so that it works at exactly the same frequency as the incoming signal.

A simplified circuit of the Synchrodyne is shown in Fig. 1. One of the principal advantages of it lies in the divorcement of the tuning from the r-f amplifier, with a single tuned circuit being used in the input to restrict high-level signals from the grid of the first r-f amplifier tube, thus reducing the tendency toward cross-modulation. The oscillator is a conventional three-coil arrangement, with the grid return being connected to the arm of a potentiometer across which appears a portion of the incoming r-f signal. This provides a means for synchronizing the oscillator with the signal.

The detector is a ring modulator, and the output audio signal is fed through a low-pass filter to remove the unwanted components. The circuit as shown is said to give an audio output of 60 mv for an r-f input of 10 microvolts, and the circuit is capable of operating with increased r-f input up to an audio output of the order of 1 volt.

Suitable design should make it possible to gang the r-f tuning capacitor with the oscillator capacitor, since the former is not particularly critical. The volume control as shown is of the feedback type, and it is also necessary to make adjustments for both r-f sensitivity and oscillator synchronization voltage.

It would appear that while this circuit is relatively simple, a few refinements should simplify the actual tuning operation. If a limiter were to be inserted between the plate of the second r-f tube and the oscillator, the modulation would be effectively removed from the synchronizing voltage, with probably better performance. If a limiter similar to those employed in FM receivers were used, it would also provide an a-v-c voltage to avoid the necessity of manually changing the gain of the r-f amplifier.

A receiver of this type should provide a high-fidelity signal if the relative phase of the two r-f signals can be held at a reasonable constant value, since phase shift would cause a variation in a-f output level of 6 db when the relative phases differed over the range from zero to 180°.

#### CHANGES IN STANDARD FREQUENCY BROADCAST

● Effective January 30, 1948, the technical broadcast services from radio station WWV of the National Bureau of Standards will be somewhat modified and improved, according to an announcement



### A DYNAMO AMONG DYNAMIC MICROPHONES

Here is *the* microphone in its class—a high-output moving-coil dynamic that was designed to outperform . . . outsmart . . . outlast even higher priced microphones. The “Sonodyne” features a multi-impedance switch for low, medium, or high impedance—plus a high output of 52 db below 1 volt per dyne per sq. cm. It has a wide range frequency response (up to 10,000 c. p. s.) and semi-directional pickup. Mounted on swivel at rear, can be pointed 90° for non-directional pickup.

The “Sonodyne” is ideal for all general purpose use, including public address, communications, recording, and similar applications.



Multi-Impedance Switch for **LOW, MEDIUM, or HIGH** Impedance

**HIGH OUTPUT**  
(-52 db)

**WIDE RANGE  
FREQUENCY  
RESPONSE**  
(up to 10,000 c. p. s.)

Shure Patents Pending



**MODEL "51"**

**CODE: RUMON**

**LIST PRICE . . . \$37.50**

**SHURE BROTHERS, INC.**

Microphones & Acoustic Devices

225 W. HURON ST., CHICAGO 10, ILL. • CABLE ADDRESS: SHUREMICRO

by Dr. E. U. Condon, Director of the Bureau.

Each of the eight radio carrier frequencies 2.5, 5, 10, 15, 20, 25, 30, and 35 megacycles will be broadcast continuously day and night. Standard audio frequencies of 440 and 4000 cycles per second will be transmitted on the carriers 10, 15, 20, and 25. The 440 cycle frequency, which is the standard of musical pitch (A above middle C), will also be broadcast on 2.5 and 5 megacycles. The accuracy of each of the transmitted radio and audio frequencies is better than one part in 50 million.

The attention of all users of the National Bureau of Standards time an-

ouncements is particularly called to the following change: Time announcements in International Morse Code, accurately synchronized with basic U. S. Naval Observatory time, will be advanced one minute with respect to the old announcement scheme. With the new system the audio frequencies are interrupted at precisely one minute *before* each hour and at each succeeding five-minute period. They are resumed precisely on the hour and each five minutes thereafter.

Under the old system, the time signals were interrupted for a minute on the hour and on each succeeding five minutes, while under the new scheme interruptions will be for a minute precisely on the 59th

minute, on 4 minutes past the hour, 9 minutes past the hour, etc., and resumed precisely on the hour and each five minutes thereafter. The exact moment to which the time refers is the moment of interruption of the audio frequencies of 440 and 4000 cycles per second. The audio frequencies will continue to be interrupted for one minute to allow for the time announcement, for station identification by voice at the hour and half hour, and to afford an interval for checking radio frequency measurements free from the presence of audio transmissions.

Station WWV provides six important technical broadcast services to the nation and five to the world, 24 hours a day. These are: (1) standard radio frequencies, (2) time announcements, (3) standard time intervals, (4) standard audio frequencies, (5) standard musical pitch, (6) radio propagation disturbance warning notices. The national standard of frequency, of which the Bureau is the custodian, is fundamental to much of the work in radio, electronics, acoustics, and other fields where measurements require accurate frequencies. Accurate time-interval signals are important in seismology, geodesy, navigation, and research. The Bureau's broadcasts—the only such service being provided by any country—are being utilized by many organizations including schools and universities, the Department of National Defense, scientific laboratories, manufacturers, amateur radio operators, observatories, power companies, communication companies, musicians, and radio broadcast companies.

A detailed announcement of WWV broadcast services, LC886 will be provided upon request from the National Bureau of Standards, Washington 25, D. C.

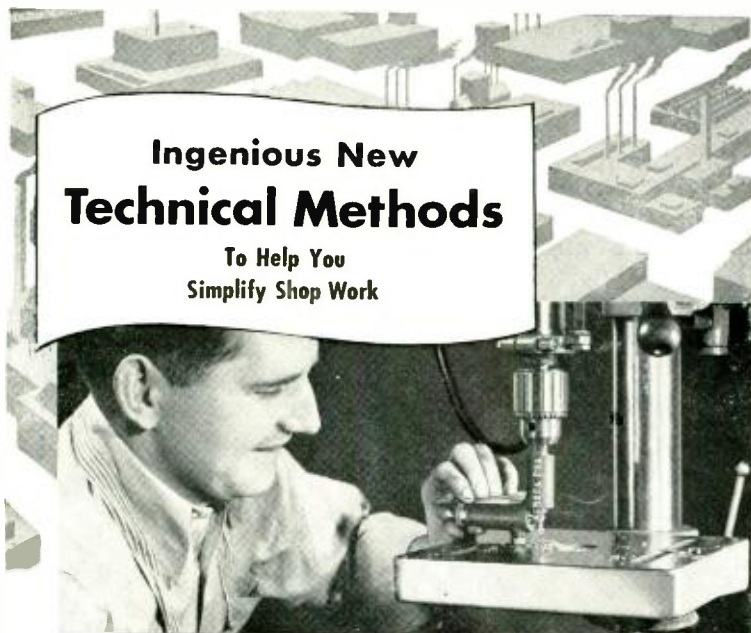

## Ingenious New Technical Methods To Help You Simplify Shop Work

### Metal Turning Made Easy with New Simplified Tool!

A new tool called "Tru-Turn" makes possible the conversion of drill presses, woodturning lathes, or grinder stands into tools that will turn and cut-off steel, bronze, copper and aluminum. The "Tru-Turn" tool shown above is mounted on a Buffalo Drill Press, Spindle Size.

The "Tru-Turn" tool is easy to operate and cuts and turns bar stock of steel, bronze, copper and aluminum measuring  $\frac{1}{8}$ ",  $\frac{3}{8}$ " and  $\frac{1}{2}$ ". Its built-in micrometer permits adjustments that give tool-room accuracy to 1/1000 inch.

Small tool shops as well as all types of repair shops and garages find the "Tru-Turn" ideal for cutting long pieces of bar stock into desired lengths. Also, home craftsmen are able to produce accurate, highly finished precision-machined parts from metal even without previous training.

Accurate, precision work is also easier to do when tension is relieved by chewing gum. The act of chewing gum seems to make the work go easier, faster—thus helping on-the-job efficiency. For these reasons Wrigley's Spearmint Chewing Gum is being made available more and more by plant owners everywhere.

You can get complete information from  
Millholland Screw Products Corp., 132 West 13th Street  
Indianapolis 2, Ind.



Tru-Turn Tool



### Two-Way Speaker

[from page 23]

small variation in the level of the frequencies above crossover, and this will be set at a point that appears to give the correct balance. The average difference between the two outputs is of the order of 4 to 8 db, and with the 3.5 db fixed pad to replace the 10-ke suppressor when it is out of the circuit, this indicates that from 0.5 to 4.5 db will be required in the variable pad. It may be desirable to remove the suppressor from the circuit when using the speaker for reproduction of phonograph records, but in general, the band suppressed is so narrow that it is difficult to detect, and little harm is done by leaving it in the circuit at all times. It does help on AM radio, however, when the output of the tuner contains any of the objectionable squeal which goes with the usual high-quality tuner.

The first and second instalments of this series appeared in the November and December, 1947, issues of AUDIO ENGINEERING.

AC-55



## 1948 I.R.E. Convention

[From page 31]

Paul D. Williams, Eitel-McCullough, Inc., San Bruno, Calif.

"Continuous Exhaust Machine for Electronic Tube Manufacture," L. Grant Hector, Sonotone Corporation, Elmsford, N. Y.

### MEASUREMENTS I

#### V.H.F., U.H.F., and S.H.F.

"Swept-Frequency 3-Cm. Impedance Indicator," H. J. Riblet, Submarine Signal Company, Boston, Mass.

"An Automatic V.H.F. Standing-Wave-Ratio Plotting Device," W. A. Fails, L. L. Mason, and K. S. Packard, Airborne Instrument Laboratory, Mineola, N. Y.

"Microwave Impedance Bridge," M. Chodorow, E. L. Ginzton, and J. F. Kane, Stanford University, California.

"Impedance Measurements by Means of Directional Couplers and a Supplementary Voltage Probe," B. Parzen, Federal Telecommunication Laboratories, Nutley, N. J.

"A Waveguide Bridge for Measuring Gain at 4000 Megacycles," A. L. Samuel and D. F. Crandell, University of Illinois, Urbana, Ill.

**THURSDAY MORNING  
MARCH 25, 1948**

### COMPUTERS I

#### Systems

"Large-Scale Computers," R. L. Snyder, University of Pennsylvania, Philadelphia, Pennsylvania.

"The Univac," J. L. Mauchly.

"Engineering Design of a Large Scale Digital Computer," James R. Weiner, Charles West, and John E. De Turk, Raytheon Manufacturing Company, Waltham, Mass.

"A Network Analyzer for Study of Electromagnetic Fields," Karl Spangenberg, Glenn Walters, and F. W. Schott, Stanford University, California.

#### Broadcasting and Recording

"Modern Design Features of CBS Studio Audio Facilities," R. B. Monroe and C. A. Palmquist, Columbia Broadcasting System, Inc., New York, N. Y.

"Methods of Calibrating Frequency Records," H. E. Roys, R. C. Moyer, and D. R. Andrews, RCA, Camden, N. J.

"Distortions in Magnetic Tape Recording Due to the Configuration of the Bias Field," S. J. Begun, The Brush Development Company, Cleveland, Ohio.

"Instantaneous Audience Measurement System," Peter Goldmark, Columbia Broadcasting System, New York, N. Y. John W. Christensen, Andrew Bark, John T. Wilmer.

#### Propagation

"Continuous Tropospheric Sounding by Radar," Albert W. Friend, RCA, Princeton, N. J.

"A Theory of Radar Reflections from the

## Variable LINE EQUALIZER

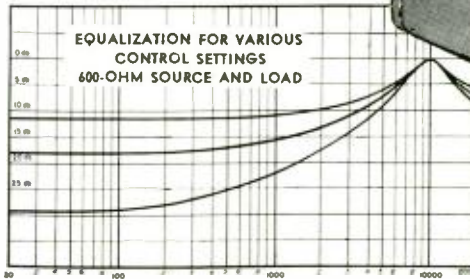
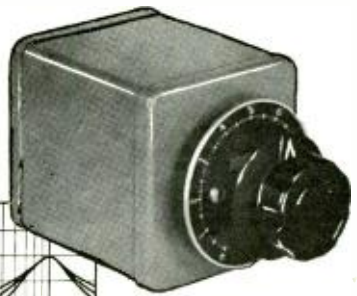

The new Type 402 Line Equalizer combines the lower cost of fixed units with the flexibility of variable control. Calibrated dial permits quick adjustment of resistance value when panel mounted for use on various lines, or as indication of setting when permanently connected to individual line. Resonant frequency may be set at either 8 or 10 kc by strap on terminal lugs to provide optimum adjustment for flat equalization over entire audio band.

### FEATURES

- Adjustable to equalize at either 8 or 10 kc
- Continuously variable equalization control
- Engraved scale for easy resetting
- Three-hole mounting
- Five units mount on a single 3 1/2" panel
- Works on lines from 150 to 600 ohms
- Low in price

Type  
402 ..... **\$15.00**

## AUDIO EQUIPMENT SALES

923 EIGHTH AVENUE — Circle 5-7798 — NEW YORK 19, N. Y.



## Radio Engineers! Hams!

If you are interested in amateur radio, you'll want "CQ" every month. Subscribe now. Use the handy coupon below. Attach your remittance and mail today.

-----CUT OUT-----MAIL TODAY-----

CQ-RADIO MAGAZINES, INC. Call.....  
342 MADISON AVE., NEW YORK 17, N. Y.

Sirs: Here is my  check (or  money order) for \$..... Send me..... issues of CQ. 12 issues \$2.50—24 issues \$4. (Foreign subscriptions are \$1.00 higher per year.)

Please indicate:  NEW  RENEWAL

Subscriber's Name (print carefully).....

Address.....

City..... Zone..... State.....

**A BASIC Improvement  
in Sound Reproduction**

# KLIPSCH SPEAKER SYSTEM

FREQUENCY RANGE  
**30** to 15,000 cycles

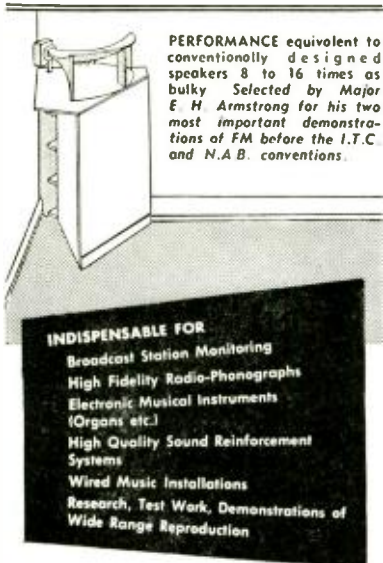

The KLIPSCH Speaker System design utilizes the corner of a room as an integral part of the acoustic system, the walls and floor being in effect an extension of the low frequency horn

- **FUNDAMENTAL TONES** down to 30 cycles per second.
- **CLEAN RESPONSE** throughout the range of hearing
- **LOW DISTORTION** and intermodulation at all frequencies.
- **PERFECT DISPERSION** of middle and high frequencies throughout the entire room.
- **HIGH EFFICIENCY:** Because of the horn loading, acoustic output for a given input power is several times that of conventional speakers.
- **NON-RESONANT: BASS TONES ARE REPRODUCED** — not generated by the speaker. Instruments of low pitch are clearly recognized; one hears the original tone — not one created by the loudspeaker.

**ASK FOR FULL PARTICULARS**  
Dept. A

**BROCINER** ELECTRONICS  
LABORATORY  
1546 SECOND AVENUE, NEW YORK 28, N. Y. • REGENT 7-5794

Lower Atmosphere," W. E. Gordon, University of Texas, Austin, Texas.

"New Techniques in Quantitative Radar Analysis in Rainstorms," David Atlas, Air Material Command, Wilmington, Ohio.

"The Propagation of Radio Waves Through the Ground," Knox Mellwain, Hazeltine Electronics Corporation, Little Neck, N. Y. Harold A. Wheeler, Consulting Radio Physicist, Great Neck, N. Y.

"Design and Application of a Multipath Transmission Simulator," Harold F. Meyer and Arthur H. Ross, Coles Signal Laboratory, Red Bank, N. J.

## ELECTRONICS IV

### New Forms of Tubes

"New Design for a Secondary-Emission Trigger Tube—NUTR-1032-J," C. F. Miller and W. McLean, National Union Radio Corporation, Orange, N. J.

"A Spiral-Beam Method for the Amplitude Modulation of Magnetrons," J. S. Donal, Jr. and R. R. Bush, RCA, Princeton, N. J. "The Dyotron—A New Microwave Oscillator," E. D. McArthur, General Electric Company, Schenectady, N. Y.

"Electrostatically Focused Radial-Beam Tube," A. M. Skellett, National Union Radio Corporation, Orange, N. J.

"A New Two-Terminal High-Voltage Rectifier Tube," George W. Baker, Chatham Electronics Corporation, Newark, N. J.

## MEASUREMENTS II

"Simplification of the Theory of Supersonic Interferometry," J. L. Hunter, John Carroll University, Cleveland, Ohio.

"Frequency Measurement by Sliding Harmonics," J. K. Clapp, General Radio Company, Cambridge, Massachusetts.

"A General-Purpose Oscillograph for Precision Time Measurements," R. P. Abbenhouse, Allen B. Dumont Laboratories, Clifton, N. J.

"Some Considerations in Extending the Frequency Range of Radio Noise Meters," W. J. Bartik and C. J. Fowler, University of Pennsylvania, Philadelphia, Pa.

"Some Considerations in the Design of Precision Telemetry Equipments," R. Whittle, Federal Telecommunication Laboratories, Nutley, N. J.

**THURSDAY AFTERNOON  
MARCH 25, 1948**

## COMPUTERS II

### Components

"Megacycle Stepping Counter," Charles B. Leslie, Naval Ordnance Laboratory, Washington, D. C.

"Rectifier Networks for Multichannel Switching," N. Rochester, Sylvania Electric Products, Inc., Boston, Massachusetts. D. R. Brown, Massachusetts Institute of Technology, Cambridge, Massachusetts.

"Mercury Delay-Line Memory Using a Pulse Rate of Several Megacycles," Isaac L. Auerback, J. Presper Eckert Jr., Robert F. Shaw, and C. Bradford Sheppard, Electronic Control Company, Philadelphia, Pa.

"Selective Alteration of Digital Data in a Magnetic Drum Computer Memory," A. A. Cohen, W. R. Keye, Engineering Research Associates, Inc., St. Paul, Minn.

"Methods for Visual Observation of Patterns Recorded on Magnetic Media," S. N. Alexander, L. Morton, I. L. Cooter, National Bureau of Standards, Washington, D. C.

## Microwaves

"Cavity Resonators for Half-Megavolt Operation," A. E. Harrison, Princeton University, Princeton, N. J.

"Analysis and Performance of Waveguide Hybrid Rings for Microwaves," H. T. Budenbom, Bell Telephone Laboratories, Whippany, N. J.

"Frequency Stabilization with Microwave Spectral Lines," W. D. Hersherberger and L. E. Norton, RCA, Princeton, N. J.

"Analysis of a Microwave Absolute Attenuation Standard," Anthony B. Giordano, Polytechnic Institute of Brooklyn.

"Synthesis of Dissipative Microwave Networks for Broad-Band Matching," Herbert J. Carlin, Polytechnic Institute of Brooklyn.

"10-Cm. Power-Measuring Equipment," Theodore Miller, Westinghouse Electric Corporation, East Pittsburgh, Pa.

## Receivers

"The Application of Noise Theory to the Design of Receivers," William A. Harris, RCA, Harrison, N. J.

"The Design of Input Circuits for Low Noise Figure," Matthew T. Lebenbaum, Airborne Instruments Laboratory, Mineola, N. Y.

"Frequency Converters," William H. Lewis, Pennsylvania State College, State College, Pa.

"Radio Set AN/CRD-1," William Todd, Evans Signal Laboratory, Belmar, N. J.

## Active Circuits

"Reactance-Tube Circuit Analysis," R. Carroll Maninger, U. S. Navy Electronics Laboratory, San Diego, Calif.

"Electronically Controlled Reactance," J. N. Van Soyoc and J. L. Murphy, Armour Research Foundation, Chicago, Ill.

"Stable Regulated Power Supplies," Robert R. Buss, Northwestern University, Evanston, Ill.

"The Photoformer," D. E. Sunstein, Philco Corporation, Philadelphia, Pa.

"Mode Separation in Oscillators with Two Coaxial-line Resonators," Herbert J. Reich, Yale University, New Haven, Conn.

## Ultrasonics

[from page 29]

do so with quite simple equipment. A pair of rubber microphones, a Hartmann whistle, a Rochelle salt crystal from an old phonograph pickup and a simple low powered nickel magnetostriction unit will allow considerable work to be done.

The Navy surplus RAK-5 receiver, or better yet the DZ-2, with a tuning range

of 14 to 1600 kc makes an excellent vacuum tube voltmeter, sensitive down to a microvolt, and being sharply tuned, can be used as a harmonic analyzer as well. The signal-to-noise ratio of these two receivers is very good.

Do not try to do much with the quartz crystals available from surplus. It is true that some of the larger transmitting crystals have good activity, but they are usually shear cut, and only X cut types give a disciplined piston action. The shear cuts have activity on the edges in a rather peculiar manner that makes their emitted pattern very complex and almost unusable.

The phonograph pickup types are usable even if broken if you clear away any tinfoil causing a short. The full size job will act as a microphone with many resonant spots up to well above 100 kc, and small pieces, say one-eighth inch square, may work above 250 kc. If used under water they may be rubber protected, or given a glyptal coat. If used in air, be sure they are lined up toward each other or the source, as their pattern is very sharp.

A word of warning if you go in for magnetostriction—be sure you have "A" or "Z" nickel and not monel, which is almost useless. If you have access to a little electric furnace, treat the rod or tube for several hours at 1475 degrees F., and then turn off the furnace and allow at least 12 hours for slow cooling. Be very careful not to shock the rod in handling. If you even chuck it in a lathe very carefully and lightly polish it with crocus cloth, you will lose most of the activity.

#### Smoke Coagulation

A magnetostrictive cooled tube makes a fairly satisfactory device for setting up resonant waves in air to observe coagulation of smoke. The trouble with using a whistle for this work is that the percentage of modulation of the air stream is only about 4%, so a large quantity of useless air appears as a blast that blows away the smoke you wish to study. We can use a parabolic reflector and bring the energy to a focus say 7 feet away, so most of the air blast will disappear and there will be high energy density at the focal point.

If you take the magnetostrictive rod, or better yet, use a tube and water-cool it, then you can sweat a 1½-inch plate on one end, say three-sixteenths inch thick. Take a precision glass tube that clears this diaphragm by a few thousandths all around, and mount it so the diaphragm is well into one end. Arrange a movable piston at the other end and adjust it to resonate the air inside the tube, thus we can build up quite high field strengths that will coagulate tobacco smoke and steam inside the tube. See Fig. 1.

[Continued on page 42]

## Studio Quality AMPLIFIERS

WITH CUSTOM-BUILT FEATURES

Design of Bardwell & McAlister's New Commercial Amplifiers embodies the principles which have been proven in custom-built units developed in the Motion Picture Industry, where quality is requisite. Fully licensed.

12w. models operate up to 8 indoor speakers, effectively cover outdoor audience of 2500.

25w. models operate up to 16 indoor speakers, effectively cover outdoor audience of 8000.

Designed & fabricated by manufacturers of high quality Sound & Recording Equipment for the Motion Picture Industry. Union made.

2 to 4 high gain input channels and 2 to 4 high or low gain radio or phonograph input channels.



With or without professional "T" type bass and treble equalizers.

High fidelity reproduction of any setting of volume controls up to full rated output with less than 4% distortion.

Frequency response flat within ½ db from 50 to 10,000 cycles.

Output impedances 500, 250, 16 & 8 ohms. Overall gain 105 db. Hum level 85 db below full output.

Write today for informative catalog & Technical data.

Dealer inquiries invited.

12



ELECTRONIC DIVISION  
**BARDWELL & McALISTER, INC.**

BOX 1310, HOLLYWOOD 28, CALIFORNIA

## NOW AVAILABLE AT TERMINAL THE NEW WIREMASTER high fidelity WIRE RECORDER!

MEETS PROFESSIONAL STANDARDS —  
SUITABLE FOR BROADCAST REQUIREMENTS

The WIREMASTER handles up to a full hour of wire recording and playback on a single spool, as well as standard phono playback of up to 12" records.

A specially designed 10 tube amplifier provides high fidelity wire reproduction (40 to 10,000 cycles per second), with dual-tone control for bass and treble equalization. Mixing and fader controls are provided for two microphone inputs, one phono input and built-in radio. Dual recording level indicators and separate volume control for monitoring add to ease of operation. Output jack for dubbing available at no extra cost.



See and hear the  
WIREMASTER in our  
modern Sound Studio!

The WIREMASTER is ruggedly constructed to withstand more than average use and is housed in a sturdy portable carrying case. Operates on 115 volts, 50/60 cycles A. C. Visit our Audio Exhibit at the I.R.E. Show, March 22-25, Grand Central Palace, Booth No. 222.

**295<sup>00</sup>**  
NET

# TERMINAL

RADIO CORPORATION

85 CORTLANDT STREET  
NEW YORK 7, N. Y. — Phone: WOrth 2-4415

# HARVEY

has

## TRANSCRIPTION EQUIPMENT



**GRAY  
TRANSCRIPTION ARM**

For your favorite cartridge, such as the new GE Variable Reluctance and Pickering 120M. Assures optimum performance; gives smoothest possible frequency response, reduces surface noise ratio, provides adjustable scale to conveniently regulate for ideal performance of the particular pickup in use. Net **\$35.00**

### VIBROMASTER TYPE K PROFESSIONAL ARM



for General Electric Variable Reluctance Or the New Pickering 120M Cartridge

Resonance characteristic flat plus or minus 1/2 Db 40 to 1000 cycles (measured in 10-cycle steps throughout resonant range). Price, net less cartridge **\$34.50**  
General Electric Cartridge **\$ 4.77**



The Pickering Cartridge gives professional quality to your home phonograph. It mounts in practically any arm, operates perfectly even at 30 cps, with but 15 grams pressure; linear response to over 10,000

cps. Available with sapphire (S120M) at \$15.00 net, or with diamond (D120M) at \$39.75.

The Pickering Equalizer-Amplifier works with the Model 120M Pickering Cartridge, providing a full 20 db of bass boost for record compensation. Complete with built-in low-pass filter switch to minimize needle scratch on noisy records. Model 125H, \$19.50 net.



NOTE: All prices are Net, F.O.B. N.Y.C. and are subject to change without notice.

Telephone: **7-1111** Longacre 3-1800

# HARVEY

RADIO COMPANY INC.

103 West 43rd St., New York 18, N. Y.

To digress for a moment, several friends of mine have made up little Hartmann whistles to call their dogs by ultrasonics. They all had some difficulty in adjusting the spacing to give oscillations, so they claimed. The real reason is that the air in the jet must reach sonic velocity in order to "pack" the air into the resonant cavity. This takes at least 13.6 lbs./in.<sup>2</sup> of air, and nobody except Superman can develop over 4 pounds pressure, so it is impossible to blow a Hartmann whistle by lungpower.

In order to make an intelligent effort to analyze a load from the commercial point of view, there are four things we must know. We shall call them *Z, G, Q* and *T*. These represent Impedance, Acceleration, Losses, and Time of Application of the power.

*Z* is the sonic impedance. If the load is a gas, we must use a gas-type generator. If liquid or solid, we can probably use either a liquid or solid generator and match the impedance to suit.

"*G*" is the acceleration required to produce some desired effect. In coagulation of aerosols or dispersoids we really work by the length of path of the excursion of the particles, so that many collisions take place in a short time. Most other effects stem from the acceleration itself. In most cases this must be determined from experiment, as we have insufficient knowledge to calculate in advance at what *G* value a long chain molecule will be broken up, or a crystal broken into several fractions. However, many such effects are in the literature, with approximate values of the power and frequency given.

*Q* is the ratio of elasticity to losses, or resonant rise in a closed chamber with perfect reflecting walls. This can be very high, as shown in connection with water.

*T* is the time of application. In many cases, this is less than a tenth of a second, allowing rapid flow of the material through the treating chamber.

Some values given in the literature are only approximate, as there is often great doubt about the actual power generated, and more doubt about how much actually appeared in the load. One example is coagulation of one micron dust of high concentration—about one watt per cubic foot per minute, at 24 kc. Another example is degassing metal and controlling grain size—about 2 to 5 kw per hundred pounds at 700 kc.

Now that ultrasonics is obtaining considerable publicity it would seem attractive for many engineers to at least obtain a nodding acquaintance with the phenomena involved by doing some work with the cheap and simple units described above. It is a rather peculiar form of energy, and well worth studying, especially now that we can visualize means of generating practically unlimited power and much higher power densities than ever before.

## Popular Recordings

[from page 32]

One of the finest discs yet imported by London. The Parnell Quartet has produced some palatable rebop which might even teach some of its American creators a thing or two. Technically this disc is an absolute dream. It is unmonitored and has a very wide frequency range.

**Dickory Dock** London 137. Ted Heath and his Music.

The Ted Heath band is the larger unit from which the Parnell Quartet stems. Like the quartet, they seem to have grasped the rhythmic quality of American popular music. The results are good, and this disc compares favorably with the best dance music currently produced here. Reproduction is up to the first standard.

**Old Time Religion** Victor 20-2614. Phil Harris and the Sportsmen.

The musical material on this disc is a cheap, condescending imitation of a negro spiritual, but the recording is one of Victor's most successful in the popular field. It is smoothly monitored, and although the range does not extend beyond 6,000 cps, there is excellent clarity and a pleasing acoustical effect.

## Hollywood Bowl

[from page 17]

multiple-microphone method of pick-up. Since the loudspeakers are in such close proximity to the microphones, and a symphony orchestra covers such a large area, it is necessary to use a much larger number of microphones than might otherwise be required. Figure 3 shows a typical orchestra and microphone arrangement. Sometimes eight, sometimes ten microphones are connected to the "Music Mixer." The second twelve-position mixer is employed for soloists, choirs, vocalists, or the control of any sound which must be balanced against the orchestra.

### Mixing Technique

The mixing technique for a multiple-microphone pick-up of a symphony orchestra for sound reinforcement is considerably different from that for broadcasting. Not only is there a loudspeaker feed-back problem to be considered, but there is also the requirement of having to match the amplified sound against the original sound. Any tendency toward over- or under-amplification is immediately noticeable when one has the "real thing" for comparison. Our method is to amplify each section sufficiently to secure a "pianissimo balance." When the orchestra conductor or his musical assistants agree that a satisfactory low-level balance has been achieved, the attenuator controls for the individual orchestral section microphones are set, and attention is turned to the "master gain." Various tests must then be made to establish just how much amplification is necessary to make this "smallest" sound readily audible in all parts of the Bowl. Once "pianissimo balance" is established, the

orchestra conductor controls the dynamics of the amplified sound as much as that of the original. There is a difference of some thirty VU between pianissimo and quad-forte, and this much undistorted power output must be available in the channel.

Levels for the vocalists and instrumentalists are established in the same manner, and care is always taken not to over-estimate the sound necessary satisfactorily to hear "pianissimo."

## Letters

[from page 7]

However, a motion study will show that a piston can be depressed much more quickly, and with considerably less movement of the hand, in this manner, when going from a lower manual to a higher one, or where the alternate hand is used.

There is, undoubtedly, a certain dignity attached to reaching under the manual with one's thumb and depressing a piston. But it takes time and, with the registration changes demanded by modern music, a few milliseconds mean a lot, when approaching the beginning of a new musical phrase.

### (3) Amplitude Versus Frequency Tremolo

I believe that you will find through actual experimentation, that the tremolo on an organ is a frequency vibrato, and that my treatment of it is correct.

The subject has been much debated since the days of Helmholtz . . . I believe it ranks only second to sea serpents. Many men, far more learned than I shall ever be, have stated flatly that no appreciable pitch variation occurs in an organ tremolo.

While I was staff organist at WILL, Urbana-Champaign (1932), the controversy arose among a group of my friends.

To settle the argument, I connected a microphone to a cathode ray oscillograph, using an external sweep generator, so that there could be no coupling between the signal and the sweep circuit. I later found this to be unnecessary.

The microphone was placed in front of the organ loft, and the sweep generator adjusted to hold the pattern stationary at middle "C," with the tremolo off.

Upon turning the tremolo on, the waveform shifted from side to side along the time axis with each beat, indicating a periodic rise and fall in frequency. We measured this deviation and found it to extend roughly to three per cent each side of the nominal frequency. There was little or no variation in height of the waveform; thus, no observable amplitude tremolo.

This was on a clarabella flute stop. The strings proved to be about the same, while the reeds showed very little pitch deviation with about a ten per cent amplitude variation.

During subsequent years, I have repeated the experiment with improved apparatus, and have taken many measurements on organs, string and woodwind instruments and the human voice. In all instances, the vibrato was shown to be largely due to a fluctuation in pitch.

### (4) Voicing

The term voicing is used in both senses—to denote the mere balancing of a rank of pipes in loudness, and to denote the entire artistic treatment of the rank. However, I believe the former meaning is the more frequent one.

Winston Wells

## Classical Recordings

[from page 32]

mense values in the unit system enough to forego the convenience of a simple console model—but to put things together is another and an insuperable

problem. We non-engineers are a bunch of incurable Milquetoasts in this respect! Most people have an unreasonable fear of radio innards. There is high voltage about, they know, and things suddenly go up in smoke, inside radios. On the other hand, they are unwilling to call in a

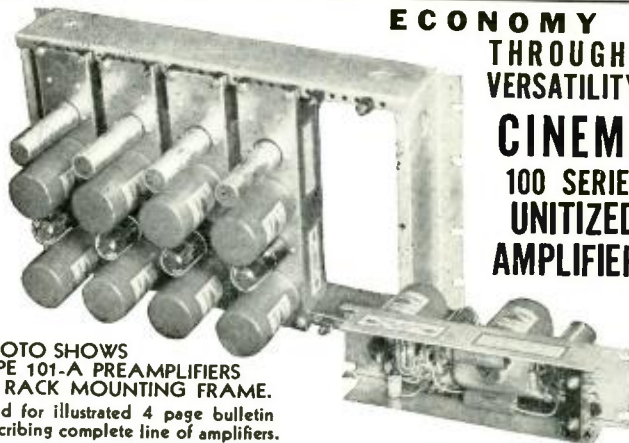

**ECONOMY  
THROUGH  
VERSATILITY...  
CINEMA  
100 SERIES  
UNITIZED  
AMPLIFIERS**

PHOTO SHOWS  
TYPE 101-A PREAMPLIFIERS  
IN RACK MOUNTING FRAME.

Send for illustrated 4 page bulletin  
describing complete line of amplifiers.

The 100 Series consists of a complete range of units from preamplifiers to 40 watt recording amplifier and associated power supplies. The series is designed to furnish high-fidelity, moderately-priced audio channels for broadcast and recording studios.

The standardized method of mounting the chassis permits extreme flexibility and facilitates future expansion and modification of rack layouts.

You may obtain any type of channel required by selecting the proper chassis "units" and mounting them on the rack-mounting frames provided. (see photo)

All input and output circuits are suitable for both balanced and unbalanced lines. Reliable circuits and careful choice of high-grade components make this amplifier series especially suitable for services which demand consistent performance and reliability.



**CINEMA**

**ENGINEERING COMPANY**

1510 W. Verdugo Ave. Burbank, Calif.

Cable Address: CINENG BURBANK



## FOR RELIABLE CAPACITORS

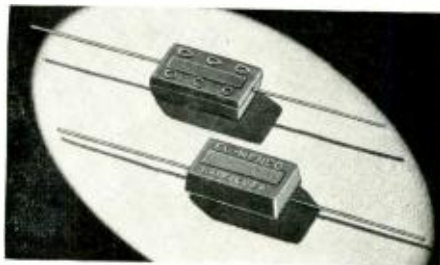

*Specify*  
**El-Menco**

Write—on firm letterhead—for new catalog.  
Foreign Radio and Electronic Manufacturers  
communicate direct with our Export Department  
at Willimantic, Conn., for information.



**THE ELECTRO  
MOTIVE Mfg. Co. Inc.**

Willimantic, Connecticut

## WHO'S WHO IN SOUND



HANDI-MIKE

## Trustworthy... a "First Class" Mike

Rated first class for hand work. Has passed all tests for dependability and true speaking. Choice of carbon or dynamic types. Just call upon

**UNIVERSAL  
HANDI-MIKE**



UNIVERSAL MICROPHONE CO.  
Inglewood, Calif.

# COME!



to the  
**I. R. E. National Convention**  
and  
**Radio Engineering Show**  
March 22-25, 1948  
Grand Central Palace  
New York City

**HEAR** - over 100 Technical Papers, many on audio topics

**SEE** - 167 Engineering Exhibits of Instruments, Components, Transmitter Equipment

4 Day Registration \$3.00  
to non-members of I. R. E.

**THE INSTITUTE OF  
RADIO ENGINEERS, INC.**

1 East 79th Street  
New York 21, N. Y.



serviceman to install equipment bought through other channels. The agony of assembly is usually turned over, with enormous trepidation and fear of electrocution, to a sympathetic friend (I have been that friend); but the fear of wiring failures, of something going wrong in the home-made connections never quite goes! So staunchly does the public trust the sturdy manufacturer! This, then, is a major disadvantage that keeps many of these people from even attempting the unit plan of construction.

Suppose then, to come to the point, I were asked for suggestions as to how an enterprising manufacturer might meet the needs of this growing number of record owners who are unsatisfied with conventional radios and phonographs? My approach would be something as follows:

What is needed, as always, is equipment that will give the advantages desired, while avoiding the disadvantages. A platitude, but a vital one. It seems to me that in this case the principle of the separate unit system is an enormous advantage. A contrary advantage of another sort is that of the simple console, both due to its lack of clutteriness and to the simplicity of its workings. We must meet squarely the disadvantage of the hooking-up process in the unit system. But we must at all costs avoid the insurmountable disadvantage in the usual machine of parts inextricably (for the amateur) intertwined, both electrically and mechanically. Finally we must meet the cost problem by remaining strictly in the Gulf area. Our simplest basic equipment should not cost much more than \$75, perhaps \$100. Top, with all the extras should be \$300-\$400; above that we reach the engineer's stage, already beautifully covered.

The problem can be met, it seems to me, in the way that the vacuum cleaner men, the makers of home movie equipment and medium priced still cameras have met a similar kind of problem. By facing the necessity for flexibility, for complications with fool-proof, mistake-proof instantaneous connections and couplings, interchangeable parts, ingeniously simplified design that accords with the modern home owners' idea of convenience and dependability, that builds confidence instead of fear. A vacuum cleaner is no simple instrument these days and a good camera even less so. But ingenious (not costly) design has removed the disadvantages to the point where just about anybody can and does use both.

More specifically? Let me say at once that what I have in mind would call for daring and even radical planning, not as to components, but as to their housing and the means of connecting and assembling them, which is the vital point. Take one aspect only, to begin

with, the housing or cabinet. I suggest a type of interchangeable-section cabinet, perhaps two or three basic, simple units, into which all components could be fitted, with simple one-twist lock-in mechanical connections instead of elaborate nuts and bolts (elaborate, for the user). Moreover, these units themselves should be arranged to couple easily together (in the manner of the multiple unit p.a. systems now available) to make one solid piece, when desired. In this way a separate-unit

## RECORD LIBRARY

In this spot a continuing list of records of interest will be presented. The list specifically does not suggest "the" best recordings or versions. It will draw predominantly but not entirely from postwar releases. All records are theoretically available, directly or on order: if trouble is experienced in finding them *Audio Engineering* will be glad to cooperate. Records are recommended on a composite of musical values, performance, engineering; sometimes one, sometimes another predominates but records unusually lacking in any of the three will not be considered. Number of records in album is in parenthesis. C: Columbia, V: Victor, other companies written out.

### A GROUP OF POSTWAR RECORDS—"B" COMPOSERS.

#### Beethoven, Symphony No. 6.

Walter, Phila. Orch. . . . .  
C MM 631 (4)

#### Beethoven, Violin Sonata, op. 30, No. 2.

Stern, Zakin. . . . .  
C MM 604 (4)

#### Beethoven, Quartet op. 59, No. 1 ("Rasoumovsky").

Paganini Quartet. . . . .  
V M 1151 (5)

#### Beethoven, Theme and Variations in F, op. 34.

Leonard Shure, pianist. . . . .  
Vox 602 (2)

#### Bernstein, "Facsimile". (Ballet music.)

RCA Victor Orchestra, Bernstein. . . . .  
V M 1142 (2)

#### Bartok, Violin Concerto. (1941).

Menuhin, Dallas Symph. Dorati. . . . .  
V M 1120 (5)

#### Berg, "Wozzeck" excerpts. (opera)

Janssen Symph. of Los Angeles; Charlotte Boerner. . . . .  
Artist JS 12 (2 pl.)

#### Britten, Serenade for Tenor, Horn and Strings.

Peter Pears, Dennis Brain. Boyd Neel String Orch. Britten. . . . .  
Eng. Decca EDA 7 (2)

#### Bach, Cantata, "God's Time is the Best" (No. 106).

Harvard Glee Club, Radcliffe Choral Society, instrs. from Boston Symphony  
Technichord T-6 (3 pl.)

#### Bach, Brandenburg Concerto No. 2.

Boston Symphony, Koussevitsky (Tanglewood). . . . .  
V M 1118 (4)

(Also includes No. 5).

system may have all the advantages of a console. In fact—beginning from the other end—we might better call this a console model with detachable parts, and make it available primarily in the form of a number of “console” models, all assembled from the basic ingredients . . . Thus nicely having our cake and eating it too.

It may be asked at this point why such a scheme should be of interest to engineer readers of this magazine? Because there can be no engineer who is not interested in the wider acceptance of the engineer's viewpoint towards good sound equipment. Good in quality, but also good in its ability to meet varying conditions. It is to his advantage that more and more people, intelligent, curious people, if untrained in engineering, see the phonograph not as a mere push-button box with mysterious dangerous insides but, realistically, for what it is, an assembled collection of units basically simple in their separate functions and, given a little leeway, highly flexible in their practical use in the home. Most people aren't dumb. Lots are intensely curious. Plenty—a big plenty—are ready for a more complex machine, *provided* it's safe, quick to assemble and adjust, absolutely foolproof and above all, with no menacing “live” wires to touch! Given this, they'll take almost anything. Look at the vacuum cleaner. (*More next month.*)

#### RECENT RECORDINGS

**Respighi**, Roman Festivals. (1929). Philadelphia Orchestra, Ormandy . . .

##### Columbia MM 707

This is relatively little known sequel to the brilliantly orchestrated Fountains of Rome (1916) and the Pines of Rome (1924). Its lush stuff, fine for hi-fi recording, but also considerably dissonant, showing the influence of the harsh 1920s. Recording is wider range, a bit pinched acoustically. This one seems to have low turnover point, in European style (300?). Try it.

**Schubert**, “Unfinished” Symphony, Philadelphia Orchestra, Bruno Walter. (*Comparison: The same, with Vienna Philharmonic, Bruno Walter.*)

##### Columbia MM 699 (Victor G-9)

The latest of dozens, this recording musically is first rate. Technically it is wide range, but in Schubert this counts for not much; the music isn't highly overtoned (as Respighi, above.) Here, the Columbia recording technique, without excessive liveness, is not particularly well suited to the music. The old Victor album G-9 (out of print) sounds better. It is very live, and the liveness suits Schubert. Its range is restricted but an apparent boost in low highs gives fine feeling of brilliance. Microphoning, for liveness and detail too, is absolutely first rate.

**Handel**, arr. Sir Hamilton Harty, Water Music Suite. London Philharmonic, Basil Cameron. (*Comparison: The same. London Philharmonic, Harty.*)

##### English Decca EDA 38 (Columbia X13)

The Old Columbia recording of this suite as arranged by Harty (the original has over 20 movements) has long been a recorded classic, and was one of the mile-

AN  
IMPORTANT  
TECH LAB  
DEVELOPMENT

New Type 1250  
R. F. SWITCH

TECH  
LABORATORIES, INC. ©

High r. f. current carrying capacity  
50 amps. max. intermittent load; 30  
amps. steady load. Low loss factor.  
Sturdy mechanical design . . .  
Mycalex insulation.  
Furnished in any  
number of  
decks.

Write for Bulletin No. 472

Manufacturers of Precision Electrical Resistance Instruments

337 CENTRAL AVE. • JERSEY CITY, N. J.

Report No. 1 from typical PARA-FLUX REPRODUCER USERS:

## BROADCASTING ENGINEER REPORTS: “Acetate Master Recording plays 295 times from a PARA-FLUX REPRODUCER without material wear”



Para-Flux Reproducer with interchangeable Heads:  
Universal . . .  
Lateral only . . .  
Vertical only

Protecting precious records today is vitally important. Recordings must last as long as possible. The above report is a typical result of the minimum wear on records when PARA-FLUX Reproducers are used. The new RMC lightweight Head permitting the pressure of only 20 grams on the record, as well as the low mechanical impedance of the stylus, means longer record life. All PARA-FLUX REPRODUCERS are tough and durable, yet afford the highest quality reproduction. Using PARA-FLUX is your best assurance of minimum record wear and maximum life with improved tone quality.

Sold through local jobber.

Write for Bulletin PR4.

Export: Roche International Corporation, 13 East 40th Street, New York 16, N. Y.

RADIO-MUSIC CORPORATION

PORT CHESTER • NEW YORK

stones in the recording art. It still sells. The new recording, same orchestra—Harty is dead—is the first since. (There are other arrangements of the music, however; none is as good as this one.) In spite of frr, I prefer the old set. No highs to it, but excellent, highly natural resonance, enough brilliance to carry the music. Musically the performance is superb. The new set is of course wider range, but the usual frr liveness is *not* good in this music. The performance is duller, less precise, more mannered. One more example of the fact that wider range, distortion-free recording is only the beginning of success in this business!

**"Listen to Our Story;" "Mountain Frolic."** American ballads, square dances, hoedowns. Various artists. (Records originally made in the later 1920s.)

**Brunswick 1024, 1025**

Two rather astonishing albums, edited by Alan Lomax, leading authority on American folk song. These records were all made before 1930, a number in 1927, and originally sold as singles. In these repressings they are as remarkable for quality as many of the oldest hot jazz records are. No highs, of course. But otherwise they are excellent, well balanced, with realistic and lively acoustics (no dead studio effects) seemingly very little distortion, except, as often happens, assorted blasting due to untrained performers with inadequate mike experience. The modern repressing gives smooth, if not silent surfaces. Music is "authentic," untouched by radio and commercial singing; it is nasal, out of tune, but often highly musical and sometimes extremely funny. Try "The Derby Ram!" This is priceless historical material, as well as important music—regardless of what you

call it. (Apologies to Stanleigh, if this rates as "popular!")

**Disc "Ethnic Series:"** (5 albums) Cuban Cult Music, Folk Music of The Central East, Haiti, Ethiopia, American Indian Songs and Dances. Recorded "on location" by Charles Hofmann. Harold Courlander, others. **Disc 131, 132, 141, 142, 161**

An astonishing series, representing an enormous amount of field work with portable equipment. When you hear the "music" you'll sympathize with the recording personnel! Some of these have remarkably good quality, though minus highs. Others are highly distorted, mainly due to unpredictable noises of people in violent motion, assorted drums with superabundance of low frequency DBs, etc. Try the Central East, Ethiopian albums for best listening, and to shock your friends and relatives. But this stuff is to be taken seriously too. Main trouble: excerpts are too many, far too short. They fade in, fade out just as things get going. Excellent booklets, well illustrated fine photos.

**Songs of Tchaikowsky.** Irra Petina, Orchestra conducted by Walter Hendl. **Columbia MM 712**

Technically a very beautiful album. Singer, singing in Russian, is close, but with very great "presence," aided by hi-fi sibilants, vocal-color overtones. Orchestra at slightly greater apparent distance—but by no means a mere background; its tone is live, warm, enveloping. In short, a perfect recording—for this type of music. These songs are mostly piano, originally. Arrangement for orchestra popularizes the album, but does no great harm, in this case, to Tchaikowsky. Petina has strange mannerisms (off pitch notes, slings, etc.) but is

heartfelt, honest singer of her native music.

**Saint-Saens, Violin Concerto #3.** Louis Kaufman, Santa Monica Symphony, Rachmilovitch. **Disc. 805**

Another of the film-music players' orchestra recordings. Kaufman has apparently made a long series of concertos, this being the 2nd released. Same old story: poor liveness, dead studio effect. Violin, beautifully recorded, is too close, balance is very poor; orchestra far off in the background. Let's hope that before the December 31 deadline the Santa M. engineers woke up to the facts (a) that music must have liveness, and (b) that a violin concerto is *not* a violin solo with faint orchestral background! Most recording companies left that stage behind ten years ago.

## New Products

[from page 34]

pany will also service Vocal-Aire units now in use.

A new application for the system has been found in laboratories where studies and analyses of vibration are conducted. The high power level of the modulated air stream in conjunction with the high frequency range makes it especially valuable for this purpose.

Inquiries relative to the Vocal-Aire system should be addressed to the new company at Seymour, Conn.

## It's Tops!

Surveys show that **AUDIO ENGINEERING** is preferred over all other technical magazines read by the best informed in the sound field—the broadcast engineers. Each issue brings you outstanding articles on five or more of the following subjects:

- Broadcasting
- Sound on Film
- Recording
- Phono Reproduction
- Public Address
- Industrial Sound equipment and applications.
- Acoustic treatment of studios, rooms, auditoriums etc.

In addition, each month Audio Engineering presents latest improvements in sound reproducing equipment design, test methods, and technical news from here and abroad. The editorial staff includes top authorities in the sound field.

**Subscribe NCW! Don't miss an issue!**

Sorry, back numbers of practically all issues are unobtainable because of the terrific demand.



**AUDIO ENGINEERING**  
**RADIO MAGAZINES, INC.**  
 342 Madison Avenue, New York 17, N. Y.

Sirs: Here is my  check (or  money order) for \$..... Enter my subscription order to **AUDIO ENGINEERING** for the next.....issues.  
 Subscription Price: In U. S. A. and Canada—12 issues \$3—24 issues \$5. Foreign subscriptions are \$4 annually.  
 Please check one:  New subscription  Renewal

Name (please print) .....

Address .....

City .....

State .....

Occupation (give title) .....

Firm Name .....



## Hearing Aid Gain

[from page 27]

applied to the microphone of the hearing aid. In the free-field procedure in common use, a pure-tone signal from an electronic oscillator drives a loudspeaker. The hearing aid is suspended facing the speaker so that it receives sound radiated from the speaker.

Because the distribution of sound radiation from a speaker is non-uniform, that is, it possesses a directional pattern which varies strongly with frequency, it is not feasible to compute the sound pressure incident on the hearing aid microphone. It is therefore necessary to measure the sound radiated by the speaker at the point in space occupied by the hearing aid microphone. For this purpose, a calibrated microphone is substituted at the position to be occupied by the hearing aid. The sound pressure indicated at each frequency by the measuring microphone is taken to be the sound pressure incident at the face of the hearing-aid microphone.

### Test Conditions

For these measurements to be valid, sound must come only from the speaker with no spurious effects introduced by reflection of sound from the walls, floor, or ceiling of the test room. The interior surfaces of the test chamber must therefore be built of material having a very low reflection coefficient for sound waves. Moreover, the volume of the room must be large to minimize reflection, and sounds originating outside the test chamber must be excluded. The construction of an "anechoic" chamber with highly absorbent walls and a sound-isolating structure is expensive. Acoustic materials exhibiting low reflection and high sound absorption are fragile and delicate and must be carefully protected. A good chamber can be constructed at an expenditure of the order of a hundred

thousand dollars, though measurements can be made over a limited frequency range with a less effective anechoic chamber built at a cost of perhaps twenty thousand dollars.

Although the Bureau has an anechoic chamber of adequate quality, it was necessary to devise some means for testing hearing aids which would release the test room for other work. The new procedure utilizes a system analogous to a piston and cylinder for applying the incident sound pressures to the hearing-aid microphone. The face of the hearing aid and a calibrated measuring microphone are made, in effect, part of the cylinder wall. They are mounted as flush closures on opposite sides of a small cavity cut into a heavy brass block. The driver unit of a loudspeaker serves as the piston generating the pressure alternations of a sound signal in the air volume enclosed by the source cavity. It is coupled to the source cavity via a brass tube. For sound frequencies low enough for the pressure alternations in the cavity to be instantaneously uniform throughout the cavity volume, the indications of the measuring microphone are a direct measure of the sound levels applied to the hearing-aid microphone. The frequency range is extended to higher frequencies, at which the sound pressure in the cavity is not altogether uniform, by mounting the measuring microphone and the hearing aid microphone symmetrically with respect to the speaker tube. (Figures 1 and 2.)

The output sound level produced in the ear of the user by the receiver of the hearing aid is measured by the same technique in both the old and the new procedures. Ears differ in size and shape, and so the load which they present to the receiver differs from one individual to the next. However, an "artificial ear" has been devised<sup>2</sup> which contains a measur-

<sup>2</sup> "Method for Measuring the Performance of Hearing Aids," by Frank F. Romanow, *Jour. Acous. Soc. Am.* Vol. 13, p. 294 (1942).

Fig. 2. Dimensional drawing of the cavity and schematic diagram of the equipment set up which utilizes a cavity pressure method for measuring the gain of hearing aids.

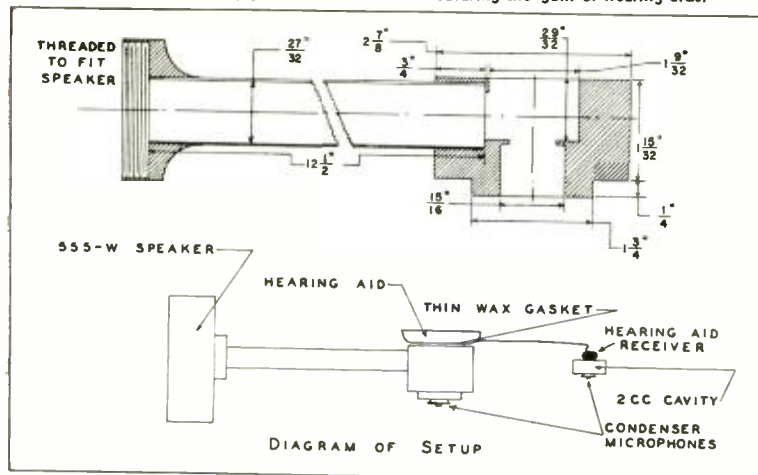

## TOP NOTCH FOR TOP FREQUENCIES —the new UNIVERSITY TWEETER



Use it with any  
Standard Cone  
Speaker

So you want high-fidelity? Then this tweeter is for you. A simple high-pass filter permits quick connection to your present cone speaker with only two wires. Extends the range of your existing cone speaker to 15,000 cycles. Available in several types unmounted or in cabinet. Prices from \$20.00. For details address UNIVERSITY LOUD-SPEAKERS, INC., 80 South Kenisco Avenue, White Plains, New York.

University Loudspeakers

# FREE

NEW! COMPLETE!  
*Concord*  
Radio Catalog

160 Value-Packed Pages of  
the LATEST and BEST in  
RADIO • TELEVISION and  
ELECTRONIC EQUIPMENT  
at LOWEST PRICES

Write for FREE copy. Address Dept. F-28

## CONCORD

901 W. Jackson Blvd.  
Downtown Chicago Branch - 239 West Madison St.

## RADIO CORP.

CHICAGO 7      ATLANTA 3  
255 Peachtree St.

LAFAYETTE RADIO CORP.

ing microphone in a position corresponding to the tympanum of the human ear, and which presents to the receiver of the hearing aid a load representative of a human ear fitted with an ear mold. Comparison with measurements on human subjects has shown that this "artificial ear" provides a valid though rather inexact means for measuring the output of the hearing aid receiver. The differences between the results obtained by using the artificial ear and those obtained with human subjects are sufficiently small so that they do not mar the significance of data obtained using objective method.

The equipment required in the cavity

pressure method for applying known sound levels to the microphone of a hearing aid may be simply constructed in a machine shop. The entire source cavity unit, including the calibrated standard microphone, its associated amplifier and output meter, the speaker unit, and signal oscillator can probably be assembled at an expenditure of a few hundred dollars. The cost of a complete "artificial ear" including the measuring microphone and its associated amplifier and output meter, and a small brass block of which the "ear canal" is constructed, is of the order of several hundred dollars.

The construction and maintenance of a specially-treated echoless room is expensive. The simpler test procedure developed at the Bureau provides a more economical means of testing hearing aids, and one that can easily be adopted by any manufacturer.

## Loud Speakers

[from page 27]

extravagant rating should a competitor care to use it.

Efficiency rating is usually avoided by the manufacturer and it has become common to judge the efficiency of a speaker by the size of its magnet. There is even a general impression that the larger the speaker, the more efficient it is. The output of a speaker is proportional to the flux density in the air gap, the length of wire in the voice coil and the current in the voice coil. The size of the speaker or magnet has nothing to do with efficiency except as it may help determine one of the three critical factors. The apparent loudness of two speakers is not an index of efficiency either, since loudness depends also on directional characteristics and frequency response.

Rating the power-handling capacity of a speaker is extremely dangerous as well as difficult. In the first place, what does it mean to specify that a speaker is a 25-watt speaker? It has been found<sup>1,2</sup> that the long time average power for speech is 20 db less than the instantaneous peak power. For music, this value is approximately 12 db. Thus, a speaker capable of handling 25-watt instantaneous peaks need only handle 1.6 watts of continuous power. For this reason, a speaker rated at 25 watts generally will not handle a continuous 25-watt sine wave at all frequencies in its range without danger of mechanical damage or burn-out. More often, however, a speaker's power handling capacity is limited by distortion.

<sup>1</sup> H. K. Dunn and S. D. White "Statistical Measurements on Conversational Speech," Jour. Acous. Soc. Am., Vol. 11, Pt. 278; Jan., 1940.

<sup>2</sup> L. J. Sivian, H. K. Dunn, and S. D. White "Absolute Amplitudes and Spectra of Certain Musical Instruments and Orchestras," Jour. Acous. Soc. Amer., Vol. 9, pp. 1-10; July, 1937.

## Pickup Technique

[from page 14]

line and indicate the results that might be expected using the various pick-ups, microphones, and acoustical conditions. They are intended as a guide rather than strictly formulated rules. There is no known substitute yet for individual judgment, taste, or listeners' reactions, which are the principal guides in achieving the optimum results. The success of every broadcast depends on sound fundamental principles intelligently applied with flexibility and originality, taking full advantage of every technical advance to meet the needs of a particular situation. In this way, only, can the skill in technique of broadcasting keep pace with the engineering developments so frequently being provided.

The author wishes to acknowledge the generous help of the NBC staff and is particularly indebted to Rinehart and Company for permission to reproduce Figs. 9 to 15 from their current book "Broadcasting Music" by E. La Prade (1947).

Ever hear  
re-recording **BETTER**  
than the original

### Q-C Recording ACTUALLY DOES IT

Cook Exclusive Q-C (Quality Control) recording does these things.

- 10 db Better Signal-Noise.
- All Masters Uniformly Distinguished in quality.
- Full Frequency Range—Perfectly Clean.
- Enormous Volume Level Capacity — Double the Dynamic Range without Increased Record Wear.

We are equipped to do your Re-Recording, or to supply complete Q-C Recording Systems.

Write for Detailed Information.

### COOK LABORATORIES

139 Gordon Blvd. Floral Park, N. Y.

### AUDIO ENGINEERING SCHOOL

A practical 9 months' course in Sound Fundamentals, Recording, and Sound Transmission measurements; in a laboratory containing transmission sets, oscillators, square wave generator and intermodulation analyser, and other equipment.

Complete recording studios assimilating broadcast, motion picture and commercial sound recording.

For information write

H. M. Tremaine, Director  
SCHOOL OF SOUND RECORDING AND  
TRANSMISSION ENGINEERING  
1655-A Cherokee Hollywood 28, Calif.

VERTICAL LATERAL  
9A, 9B, D-93306, MI-4856

### Reproducers Reconditioned

Only new parts used—includes repainting and replating:  
Response checked with advanced Laboratory equipment

FAST SERVICE

### VIBRATION SYSTEMS, INC.

1040 W. Fort Detroit 26, Mich.

### ADVERTISING INDEX

Arnold Engineering Co. . . . .	2
Audio Development Co. . . . .	6
Audio Devices, Inc. . . . .	Cover 2
Audio Engineering School . . . . .	48
Audio Equipment Sales . . . . .	39
Bardwell & McAlister, Inc. . . . .	41
Brociner Electronics Laboratory . . . . .	40
Brush Development Co. . . . .	7
Camera Equipment Co. . . . .	5
Chicago Transformer Corp. . . . .	Cover 4
Cinema Engineering Co. . . . .	43
Concord Radio Corp. . . . .	47
Cook Laboratories . . . . .	48
Electro Motive Mfg. Co., Inc. . . . .	43
Electro-Voice, Inc. . . . .	33
General Radio Co. . . . .	Cover 3
Harvey Radio Co., Inc. . . . .	42
Institute of Radio Engineers . . . . .	44
LeBel, C. J. . . . .	36
Professional Directory . . . . .	36
Racon Electric Co., Inc. . . . .	1
Radio Music Corp. . . . .	45
Shure Brothers, Inc. . . . .	37
Tech. Laboratories . . . . .	45
Terminal Radio Corp. . . . .	41
U. S. Recording Co. . . . .	36
Universal Microphone Co. . . . .	44
University Loudspeakers, Inc. . . . .	47
Vibration Systems, Inc. . . . .	48
Wells, Winston . . . . .	36
Western Electric Co. . . . .	8
Wrigley, Wm. Jr. Co. . . . .	38



## NEW AUDIO & SUPERSONIC OSCILLATOR

with **LOW DISTORTION** • **UNIFORM OUTPUT** • **HIGH STABILITY**

This new wide-range, continuously adjustable oscillator was designed to fill a need for an instrument for laboratory measurements of gain, distortion, impedance and frequency response at frequencies well above the audio range.

With a single dial and four push-button-controlled multipliers, the Type 1302-A Oscillator covers the range of 10 to 100,000 cycles. Because of its wide frequency range and flat output this oscillator is particularly suited to taking frequency response characteristics on amplifiers, telephone lines, filters and other such circuit elements.

### FEATURES

- **WIDE FREQUENCY RANGE**—10 to 100,000 cycles—180-degree rotation of dial covers the 10 to 100-cycle decade—panel push buttons add in decade steps
- **ACCURATE CALIBRATION**—adjusted with  $\pm(1\frac{1}{2}\% + 0.2 \text{ cycle})$
- **LOW DISTORTION**—less than 1% at any frequency
- **SMALL FREQUENCY DRIFT**—less than 1% in first 10 minutes; less than 0.2% per hour afterwards
- **FREQUENCY DRIFT CONSTANT PERCENTAGE OF OPERATING FREQUENCY**—particularly helpful with bridge measurements at low frequencies
- **CONSTANT OUTPUT VOLTAGE**—within  $\pm 1.0 \text{ db}$  over whole range; 20 volts open circuit on 5,000-ohm output, 10 volts on 600 ohm
- **STABILIZED SUPPLY**—compensated for transient line voltage surges and average line voltage variations between 105 and 125 (210 and 250) volts
- **VARIABLE CONDENSER FREQUENCY CONTROL**—avoiding contact difficulties often found in variable resistance control
- **TWO SEPARATE OUTPUT CIRCUITS**—balanced 600 ohm and unbalanced 5,000 ohm

TYPE 1302-A OSCILLATOR . . . . \$365.00



**GENERAL RADIO COMPANY** Cambridge 39,  
Massachusetts

90 West St., New York 6

520 S. Michigan Ave., Chicago 5

550 N. Highland Ave., Los Angeles 38

# AUDIO TRANSFORMERS for [ UNIFORM RESPONSE LOW DISTORTION

## IN 3 FREQUENCY RANGES

*Write for Catalog  
showing complete  
new stock line*

### Full Frequency Range

**30 to 15,000 Cycles**, provides uniform response over this entire band with  $\pm 1/2$  db up to 10 watts of audio power, within  $\pm 1$  db over 10 watts. Standard RMA impedances. Hum balancing coil structures and nickel alloy shielding. Included are Input, Output, Driver, and Modulation Transformers; Modulation Reactors. *Sealed in Steel* construction, stud mounting, with pin-type terminals.

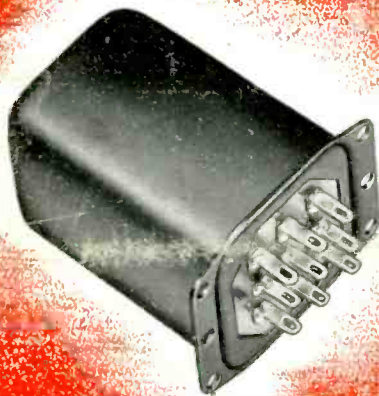
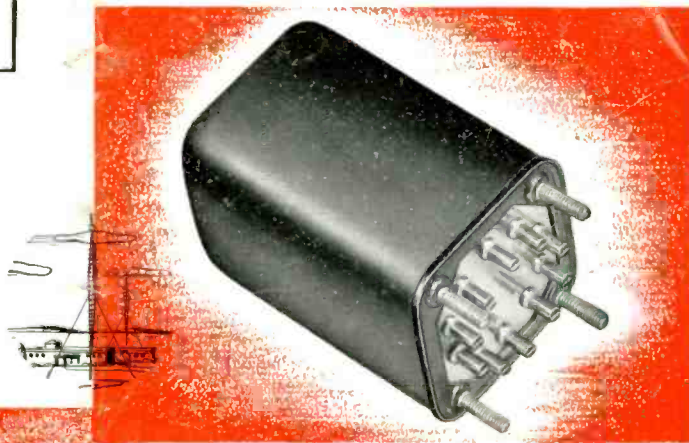

### Public Address Range

**50 to 10,000 Cycles**, frequency response within  $\pm 1/2$  db up to 10 watts of power, within  $\pm 1$  db over 10 watts, throughout this range. Secondary impedances match 600 and 150-ohm lines, 16, 8 and 4-ohm reproducing systems. Listed are Driver and Output Transformers. *Sealed in Steel* construction, flange mounting, with solder lugs or wire leads.



### Communications Range

**200 to 3,500 Cycles**, affords response with variations not exceeding  $\pm 1$  db over the range of voice frequencies. For use with 600 or 150-ohm lines. Input, Output, Driver and Modulation Transformers offered. *Sealed in Steel* construction, flange mounting, with wire leads or solder lugs.



# CHICAGO TRANSFORMER

DIVISION OF ESSEX WIRE CORPORATION

3501 ADDISON STREET • CHICAGO 18, ILLINOIS