

**POPULAR
MECHANICS**

75¢

THE **SOUND** OF HIGH FIDELITY

A HANDBOOK

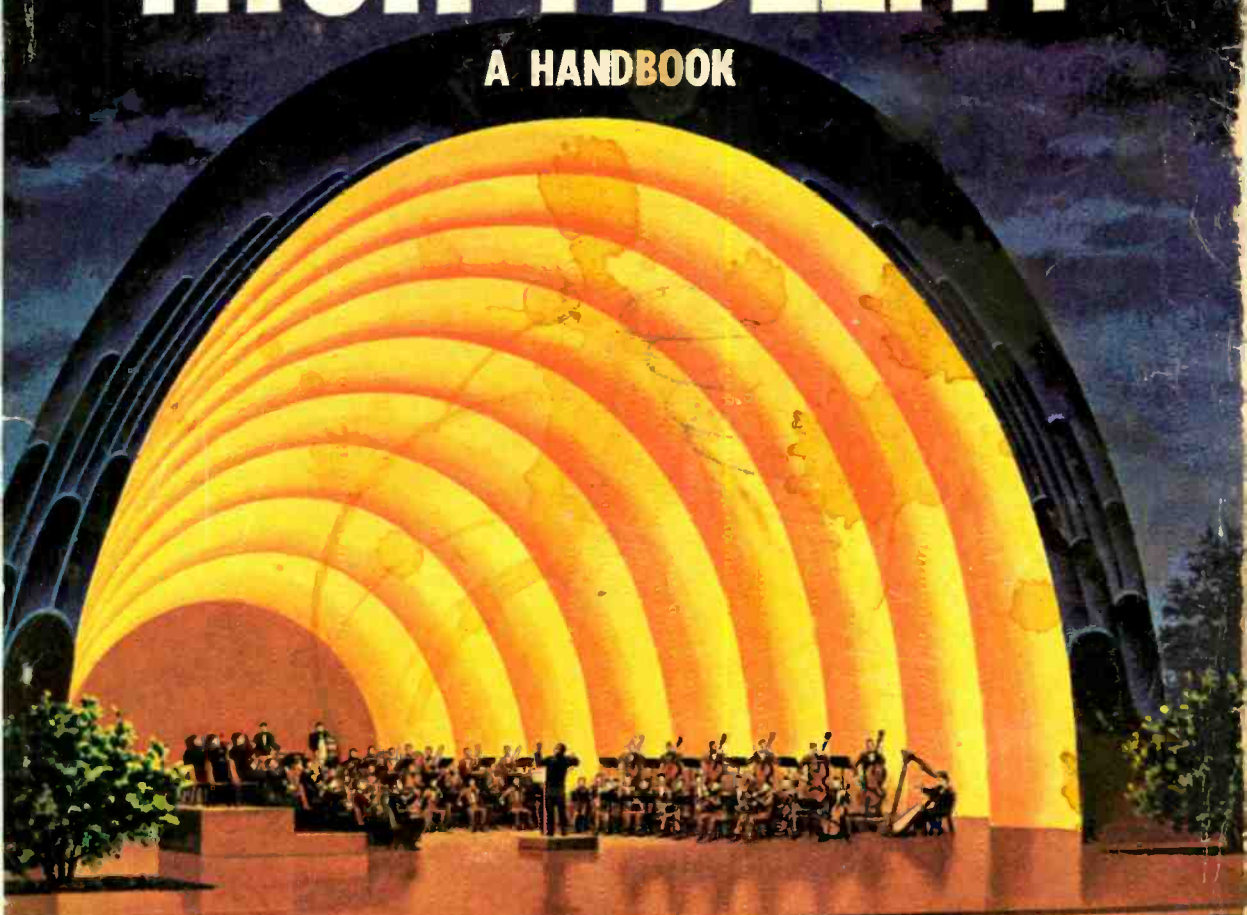

*By Robert Oakes Jordan
and James Cunningham*

**A Guide to Understanding Mechanical Reproduction
of Sound . . . A Complete Handbook for the Hi-Fi Enthusiast**



Your High Fidelity Equipment— Stereophonic or Monaural— These B.I.C. Products Will Make It Outstanding—

Your friends who own or sell fine high fidelity equipment will advise you to assemble your entire high fidelity system with B.I.C. quality endorsed components...each the finest, fully guaranteed, uniformly better, yet competitively priced with ordinary components. Your continuing satisfaction is assured by really complete parts and service facilities throughout the U. S.

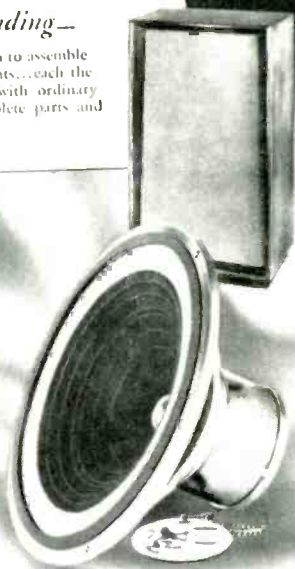

Garrard RECORD PLAYERS

Fully Wired for Both Stereo
and Monaural Records

35 years of experience producing record playing equipment, have resulted in a family of instruments known for time-proven features and enduring, superlative performance—the world's finest record playing equipment.

Auto-Manual Record Players



Model RC 98
4-speed super changer. ± Variable speed control \$67.50

Model RC 88
4-speed deluxe changer with pusher platform \$54.50

Model RC 121/D
4-speed Plays 12" and 10" records in any order \$42.50

Turntables and Tone Arm



Model 301
Transcription turntable. \$89.00

Model 4Hf
New turntable with tone arm \$59.50

Model T/D
4-speed manual Player. \$32.50

Model TPA-12 Stereo Transcription tone arm. Plays all records up to 16" \$19.50

LEAK AMPLIFIERS

Stereophonic and Monaural

Renowned Leak standards of craftsmanship are now available in stereo amplifiers and preamplifiers as well as monaural models. Leak amplifiers give the consumer the benefit of professional quality components and workmanship, at popular prices.

Stereo Amplifiers and Preamplifiers



Leak Stereo Amplifier, Dual channel amplifier on single chassis. "Stereo" 20 (12 w/ch) \$139.00 "Stereo" 50 (25 w/ch) \$179.00



Leak "Point One Stereo" Preamplifier, Matches Stereo amplifier or any pair of Leak single channel power amplifiers. All inputs, channel switch \$109.50

Single Channel Amplifiers & Preamplifiers



Leak Amplifiers, Remarkable low 0.1% harmonic distortion. TL/50 (50 watts) \$149.50 TL/25 (25 watts) \$109.50 TL/12 (12 watts) \$ 89.00



Leak Preamplifiers, Designed and built specifically for Leak amplifiers. All inputs and controls. "Point One Plus" \$55.00 "Variotape III" \$79.00

Wharfedale SPEAKERS

For Natural Reproduction—
Single or in Pairs

Designed and built under the direction of England's G. A. Briggs, Wharfedale Speakers, matching enclosures and speaker systems provide a unique quality of full-bodied, non-strident tone which has become associated only with this name.

Foam Suspension Speakers



Treble with wide angle basketed diffusion cone Super 3 \$22.50

Full Range Aluminum voice coils 8" 10" 12" \$22.50—\$78.50

Low Frequency Down to 25/35 cps 12" & 15" \$44 to \$78.50

Speaker Systems and Enclosures



SFB/3—3-way system, Sand filled baffle Custom \$199 Deluxe \$249 Wharfedale enclosures for 10" and 12" speakers are also available.

WAF/1—WAF/2 2-way systems acoustical filter \$144.50 and \$199

R-J SPEAKER ENCLOSURES

Ideal for Stereo

The original small space loudspeaker enclosures with patented* R-J design principles that assure full, smooth bass and unobstructed highs. Now available in these 5 newly styled models...

*U.S. Pat. Nos. 2694462, 2694463

RJ/8 shelf model for 8" speakers, 11" high, 23 1/2" wide, 10" deep Plain \$28.50 Finished \$37.50
RJ/12S 12" speaker shelf model, 20" high, 21" wide, 10" deep Plain \$38.50 Finished \$49.50
RJ/12F 12" speaker floor model, 20" high, 20" wide, 16" deep Plain \$45.00 Finished \$56.00
RJ/15 15" speaker floor model, 20" high, 20" wide, 16" deep Plain \$45.00 Finished \$56.00
RJ/Super 8 RJ/8 enclosure with Super 8/TS/AL speaker complete Plain \$50.50 Finished \$59.50
 Finished Mahogany, Walnut or Blond. Plain—Unfinished Birch.

River Edge Customized Cabinets and "Do-it-yourself" Kits
29 models, 10" finishes



Genalex... Finest Audio Tubes
 New! K188 Power Tetrolde \$4.95 net
 R156 Power Tetrolde Replaces 6L6 \$3.50 net
 2729 Low hum input tube \$2.95 net

the **SOUND** of **HIGH FIDELITY**

by
ROBERT OAKES JORDAN
and
JAMES CUNNINGHAM

COPYRIGHT 1958

Artists:

DAVID FOSTER
ROBERT BARKER
ARTHUR LUTZ

Cover Artist:

ROBERT C. KORTA
Photographs by:
ROGER KIRKGASSER

POPULAR MECHANICS PRESS
200 EAST ONTARIO STREET
CHICAGO 11, ILLINOIS

Printed in U.S.A.

ANY

of these superb

COLUMBIA and EPIC

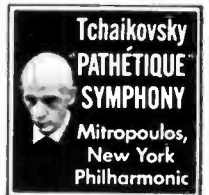
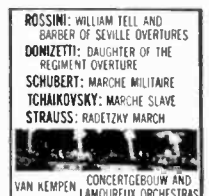
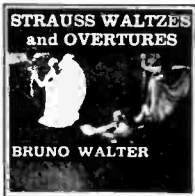

The finest selection of American and European classical records ever offered by the world's largest record club

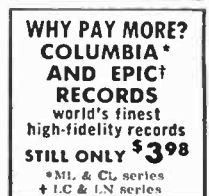
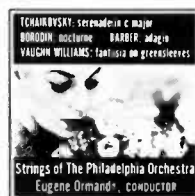
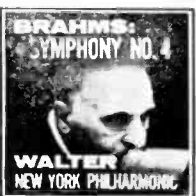
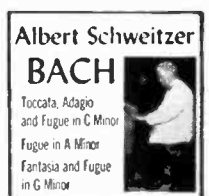
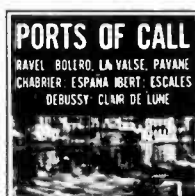

FIVE

Classical High-Fidelity

RECORDS FOR ONLY

\$3.98

if you join the Columbia (Lp) Record Club now — and agree to purchase 5 selections during the coming 12 months

... a convenient method of acquiring, systematically and with expert guidance, an outstanding record library of the world's finest music — at far less than usual cost

- ★ You receive, at once, ANY 5 of the Columbia and Epic records shown here for only \$3.98
- ★ Your only obligation as a member is to purchase five selections from the more than 100 high-fidelity Columbia and Epic records to be offered in the coming 12 months. Thus, you receive ten records for the price of six — a saving of more than one-third on your record purchases
- ★ After purchasing only five records, you receive a Columbia or Epic Bonus record of your choice free for every two additional selections you buy
- ★ Each month the Club's staff of musical experts selects a classical recording that will be a distinguished addition to your record library. In addition, at least seven other exceptionally fine recordings, both classical and popular, will be avail-

- able to you as alternate selections. All are fully described in the Club Magazine, which you receive free each month
- ★ You may accept or reject the regular Classical Selection, take any of the other records offered, or take NO record in any particular month
- ★ You may discontinue membership at any time after purchasing five records
- ★ The records you want are mailed and billed to you at the regular list price, now only \$3.98, plus a small mailing charge
- ★ You must be delighted with membership or you may cancel by returning the five records within 10 days

COLUMBIA (Lp) RECORD CLUB

Terre Haute, Indiana

Members regularly enjoy performances by great artists like these

- ★ Amsterdam Concertgebouw
- Sir Thomas Beecham, Bart.
- Eduard van Beinum
- Leonard Bernstein
- E. Power Biggs
- Budapest String Quartet
- Robert Casadesus
- Pablo Casals
- Cleveland Orchestra
- Zino Francescatti
- Glenn Gould
- Arthur Grumiaux
- Clara Haskil
- I Musici
- Paul van Kempen
- Dimitri Mitropoulos
- New York Philharmonic
- David Oistrakh
- Eugene Ormandy
- Philadelphia Orchestra
- Royal Philharmonic
- Albert Schweitzer
- Rudolf Serkin
- Isaac Stern
- George Szell
- Vienna Symphony
- Bruno Walter

SEND NO MONEY — MAIL COUPON TO RECEIVE 5 RECORDS FOR \$3.98

COLUMBIA (Lp) RECORD CLUB, Dept. 272-1
Terre Haute, Indiana

Please send me the 5 records whose numbers I have circled at the right, for which I am to be billed only \$3.98 plus small mailing charge — and enroll me in the Classical Division of the Club.

My only obligation is to purchase five selections from the more than 100 to be offered during the coming 12 months... at regular list price, plus small mailing charge. For every two additional selections I accept, I am to receive a 12" Columbia or Epic Bonus record of my choice FREE.

Name.....
(Please Print)

Address.....

City..... ZONE..... State.....

CANADA: Prices slightly higher, address 11-13 Soho St., Tor., 28
If you wish to have this membership credited to an established Columbia or Epic record dealer, authorized to accept subscriptions, please fill in the following:

Dealer's Name.....

Dealer's Address.....120

© Columbia Records Sales Corp., 1958

© "Columbia," (Lp), "Epic," (Lp) Marcas Reg.

CIRCLE 5 NUMBERS BELOW:

1. Levant Plays Gershwin
2. Beethoven: Emperor Concerto
3. Beethoven: Quartets 9 and 11
4. Mozart: Requiem
5. Finlandia, Swan of Tuonela, etc.
6. Beethoven: 3 piano sonatas
7. Beethoven: "Eroica" Symphony
8. Vivaldi: The Seasons
9. Tchaikovsky: "Pathetique" Symphony
10. Dvorak: "New World" Symphony
11. Bach: Goldberg Variations
12. Schweitzer Plays Bach, Vol. 1
13. Rossini: William Tell Overture, etc.
14. Strauss Waltzes and Overtures
15. Mendelssohn: Midsummer Night's Dream; Schubert: "Unfinished" Symphony
16. Firebird; Romeo and Juliet
17. Vivaldi and Bach: Violin Concertos
18. Haydn: "Surprise", "Drum-Roll" Sym.
19. Brahms: Symphony No. 4
20. Ports of Call
21. Debussy: La Mer; Ravel: La Valse, etc.
22. Bach: Brandenburg Conc. 1, 2, 3
23. Paganini and Saint-Saens Concertes
24. Strings of Philadelphia Orchestra M-22

CONTENTS

1	SOUND	5
2	HEARING	19
3	AMPLIFICATION	25
4	LOUDSPEAKERS	70
5	DISK RECORDS	124
6	TUNERS	148
7	TAPE RECORDING	162
	ABBREVIATIONS	24
	SCHEMATIC SYMBOLS	28

save on hi-fi

see the best values in the 1959

ALLIED CATALOG

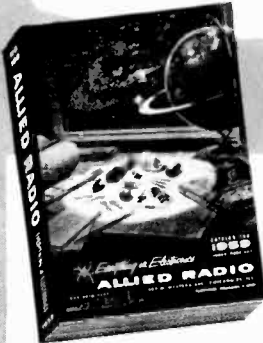

FREE!

Send for it!



world's largest choice of money-saving

HI-FI SYSTEMS and COMPONENTS

EVERYTHING
IN THRILLING
STEREO

Here's your complete, money-saving guide to *everything* in Hi-Fi! Choose from the world's largest selection of latest Hi-Fi systems, including new thrilling Stereo. See how you save on exclusive ALLIED-recommended complete systems! Choose everything from our complete stocks of components (amplifiers, tuners, changers, speakers, enclosures, recorders, accessories). You'll find *everything* you need in this money-saving ALLIED Catalog—you get the best in Hi-Fi for less!



KNIGHT SUPER-VALUE HI-FI: You'll save most with ALLIED's own KNIGHT Hi-Fi components and complete matched systems—equal to the very finest in quality, yet far lower in cost!

BUILD-YOUR-OWN HI-FI: It's easy, it's fun with ALLIED's own KNIGHT-KITS. You do the simple assembly and get professional appearance and performance at up to 50% savings! See our complete selection of KNIGHT-KIT build-your-own Hi-Fi!



EASY TERMS AVAILABLE

ALLIED RADIO

America's Hi-Fi Center

FREE
send for it

ALLIED RADIO, Dept. 126-9
100 N. Western Ave., Chicago 80, Ill.

Send FREE 452-Page 1959 ALLIED Catalog

Name _____

Address _____

City _____ Zone _____ State _____

The authors would like to extend their thanks to some of the people who helped make this book possible. Chief among these are:

Jory Nordland

Robert Nereim

Ruth Nereim

Charles Shipley

Edgar Vinyard

Mrs. Robert Oakes Jordan

Gee Reid

William Leonard

SOUND

THE NATURE OF SOUND

One man interested in the production of sound might describe it thusly: Sound is produced by a body vibrating in air. Another might say: Sound is a longitudinal vibration occurring as a mechanical disturbance of air particles. Yet another might say: Sound is a sensation received in the ear due to slight changes in atmospheric pressure, which results in hearing.

All these answers are partly correct; all serve to offer an idea of what really constitutes sound. However, an all-inclusive answer would involve a combination of these responses, with attention paid to the vibrating object producing the disturbance which is conveyed to the hearing mechanism, causing the sensation of hearing in the mind. Such a definition might sound something like this:

Sound is longitudinal vibrations set up in a surrounding medium (air, water, iron, etc.) by a vibrating object, which, when communicated to the brain by the ear, produce the sensation of hearing.

We are primarily concerned with sounds conveyed to us through air. The actual connecting link between the air in a recording studio or concert hall and that in our listening rooms may be a disc record or a recorded magnetic tape. The definition offered previously will still hold true in these circumstances.

Though it differs from individual to individual, the range of human hearing is now established as being from below 10 vibrations per second to above 18,000 vibrations per second. The rate of vibration of a sound is the *frequency* of the sound, which is usually expressed in terms of cycles per second.

Sound energy is conveyed through air at the rate of approximately 1,100 feet per second. Even though sound energy may be transmitted over large distances at this rate, no movement of the medium as a whole takes place. The air particles oscillate along the direction of propagation, but do not move very far from their original positions. Sound is a transfer of energy from molecule to molecule of a medium, from its source to a receptor.

FREQUENCY

When an object vibrates—a tuning fork or a piano string, for example—it actually moves to and fro in the air. The number of times the object vibrates each second is governed by several physical factors. A tuning fork made of

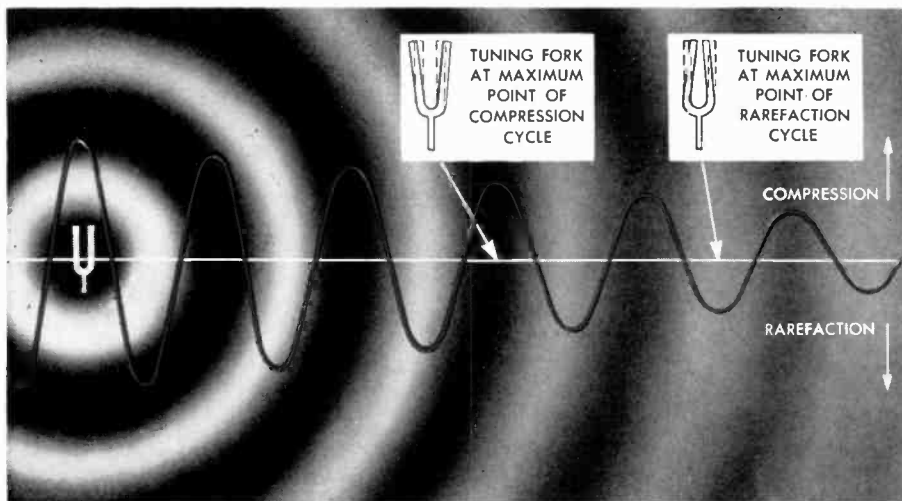

As the vibrating tines of a tuning fork move away from each other, they compress the air around them. As they move toward each other, the air is rarefied

lead would vibrate in a different way than an otherwise identical one made of steel. The difference is caused by the variation in density between lead and steel. The lead tuning fork, being denser, would have a much lower rate of vibration than the steel fork.

Another point of difference might be the actual comparative sizes of two vibrating objects. A small steel tuning fork would vibrate much more rapidly than a large fork made of the same material. The relationship of such physical factors to frequency of vibration is extremely important.

As an object vibrates, its motion is cyclical. Imagine an inverted tuning fork vibrating. The two tines of the fork move back and forth in cyclic oscillation from the resting, or middle, position. To follow just one of the tines through its path: if it were possible to see the tine move, the movement would appear exactly like that of a clock pendulum. Once the tuning fork was set in motion, the swing from side to side would always take the same amount of time. Starting from the rest position the tine would swing to one side, back through the middle, out to the other side, and finally back to the middle again, in position to start another cycle.

The frequency of vibration of a clock pendulum is usually about one cycle per second. The sound the clock makes comes from the *escapement*, a mechanism which restores the small amount of energy lost through friction in the swing of the pendulum. The pendulum strokes are thus made to cover the same distance each cycle, maintaining the accuracy of the clock. In a tuning fork or other vibrating object, friction will in time cause the vibrations to die away. Even though the *intensity* of the vibrations goes from maximum to dead still, however, the *frequency* of vibration will remain the same, due to those all-important physical factors of size and density.

WAVELENGTH

As a vibrating object moves from the rest position, from side to side, and back, it is considered to have completed *one cycle*. It is the length of time taken by the object to cover this distance which governs the wavelength of any particular frequency of sound. Hence, the wavelength of any sound is measured from two corresponding points in successive cycles of vibration. If a tuning fork vibrates at a rate of 1,100 times per second, then the frequency of the sound it produces in air is 1,100 cycles per second. As a further example:

the tuning fork has a frequency of 1,100 cycles per second; sound travels at a rate of 1,100 feet per second in air. It can easily be calculated, by dividing the speed, or velocity, of sound by the frequency, that the wavelength is 1 foot $\frac{V}{F}$ or $\frac{1100}{1100} = 1$

If the frequency under consideration were only half that of the preceding example, 550 cycles per second, the wavelength would be 2 feet. The simple formula given here will be most useful to the experimenter. It is easy to remember that the product of wavelength and frequency is equal to the speed of sound and that, in consequence, wavelength is inversely proportional to frequency.

Where the source of a particular wavelength is small, the sound can be considered to come from a point source. A large symphony orchestra is composed of many of these small point sources, all combined into large wave fronts of sound. A wave front may be visualized as a surface which passes through all the points of equal density in one wave of a vibrating medium; in sound, the points of initial disturbance of the medium. A wave front may have a complex shape, indicating a complex frequency range, when coming from an orchestra; it may have a very simple shape when coming from a single small source such as a tuning fork.

The ever-expanding series of wave fronts coming from a tuning fork might be conceived of as an infinite number of spheres of smoke particles being

A wave front of sound is an area in which all the air in one sound wave is of equal density. A series of regular wave fronts, as propagated by a tuning fork, is shown at right. As a wave front gets farther and farther from the source of initial propagation it tends more and more to resemble a straight line

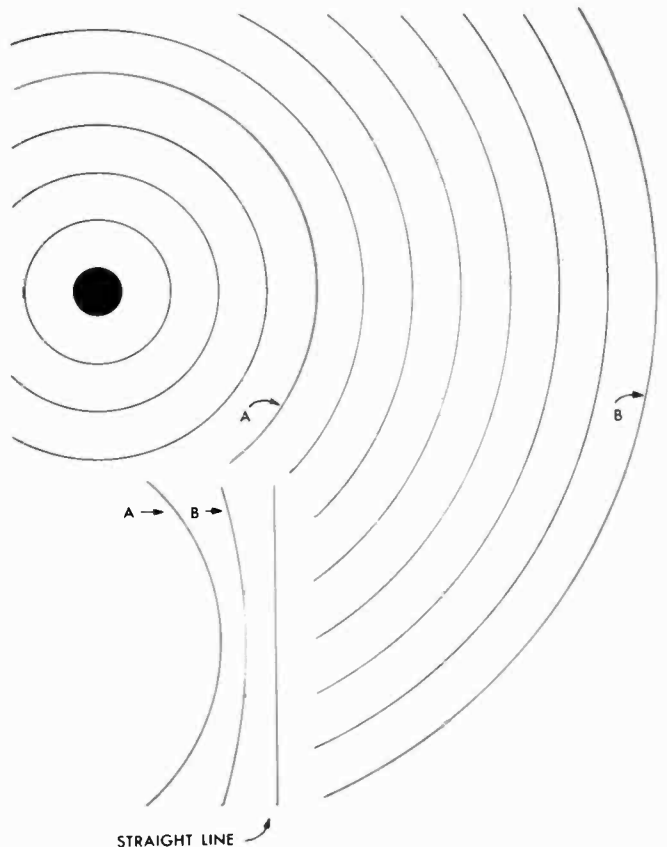

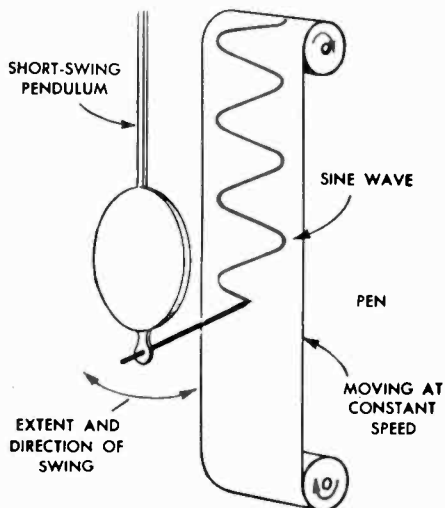

The simple harmonic motion of a swinging pendulum may be used to inscribe a sine wave pattern on a strip of paper moving at a constant speed. The pendulum arm must be very long and the arc swung must be very short or the shape of the sine wave will be distorted

generated inside each other, constantly expanding, each getting larger until it fades in the air. If the spheres were able to expand sufficiently, they might ultimately be observed as straight-line wave fronts.

The waves of sound emanating from a vibrating tuning fork are caused by compression of air as the tines of the fork move away from each other and a succeeding rarefaction of the air as the fork tines reach their maximum points of travel and come back to the center position. In other words, the vibrating sound generator changes its direction of travel during each cycle.

PITCH AND QUALITY

If an 1100-cycle note from a tuning fork were followed immediately by a note of the same frequency played on a piano, even the least musical of us would be able to tell that the sounds did not come from the same instrument. All the musicians in an orchestra may tune up on A, but a wide variety of sounds will come from the group in practice. The two elements which give each instrument its own characteristic sound are *pitch* and *quality* (timbre).

The pitch of a sound is determined by the fundamental frequency of vibration at the source of the sound. In musical scoring, the terms *treble* and *bass* are used to indicate high-pitched and low-pitched tones respectively. In the reproduction of sound by means of electronic instruments, bass and treble are used to indicate the degree of emphasis on low- or high-pitched tones desired by an operator at the controls.

Pitch can be described as the *subjective* effect of frequency of vibration; that is, the effect of the quality of frequency on the human hearing system. The intensity of any sound affects the pitch of the sound. In the case of low-frequency sounds, intensity varies directly with pitch; just the opposite is true at high frequencies, where pitch varies inversely with intensity. In plain language, two sounds with the same frequency characteristics would be different in pitch to a listener if the intensity levels were far enough apart.

If the character of a sound depended only upon pitch, two different instruments vibrating at the same frequency and intensity would produce identical sounds. Earlier in this text, the to and fro vibrations of a single tine of a tuning fork were compared with the movement of a clock pendulum. Both the fork and the pendulum exhibit what is called simple harmonic motion. If a pen were fixed to the bottom of the pendulum and the pendulum allowed to swing naturally, it would draw a straight line on a piece of paper placed under it. If,

however, the paper was moved at right angles to the swing of the pen, the picture on the paper would be quite different. Instead of a straight line, a perfectly symmetrical sinusoidal wave would be drawn on the paper. Using this curve as a basis for comparison, and employing a writing oscillograph to plot a two-dimensional picture of a wave of the sound from a piano string, it would be found that the latter curve was not nearly as smooth and symmetrical as the former. The piano-string vibration is composed of a fundamental frequency just like the one from a tuning fork, with the addition of certain other frequencies known as *harmonics*. These harmonic frequencies are multiples of the fundamental frequency of the piano note. These combinations of different harmonics at different intensities with the fundamental frequency of a note from any instrument are what gives the instrument its own particular quality, or timbre.

A sound from any musical instrument may contain four or five harmonic frequencies in addition to the fundamental frequency. Some instruments may exhibit strong audible harmonics of the 2nd, 3rd, 5th, 9th, etc., order, while others may be strong in only the 3rd, 5th, and 7th harmonics. It is the relationship of these harmonics in order, phase, and amplitude that is important in establishing the character of an instrument.

Even though some of the harmonics of the instruments in an orchestra may lie beyond the normal range of human hearing, they may combine to produce audible tones which are most important to the over-all quality of the piece of music being performed. In recording and reproducing sounds by means of electronic equipment, these harmonics must be handled in proper proportion to the fundamental tones, without change or distortion, or loss of fidelity will result.

INTENSITY AND LOUDNESS

When speaking of the physical properties of sound, people are often heard using the terms *intensity* and *loudness* interchangeably. This is incorrect usage. It is true that these characteristics of sound are closely related, but they are not the same. The intensity of a sound in air is directly proportional,

A sound wave from a piano may be recorded for visual inspection by means of an oscillograph

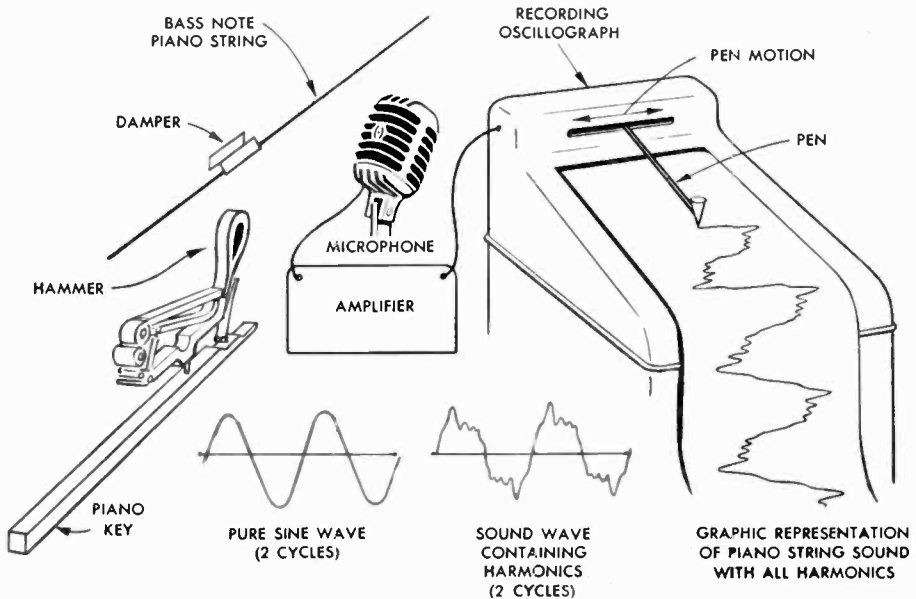



If the molecules of air were large enough to be viewed as black dots, sound frozen in time might appear as illustrated here. Above: a segmented sphere of frozen sound. The sound source is in the center. Below, left: a partial section of the sphere above. Below, right: a variable-density motion picture sound track. These illustrations are representations of sound in terms of density

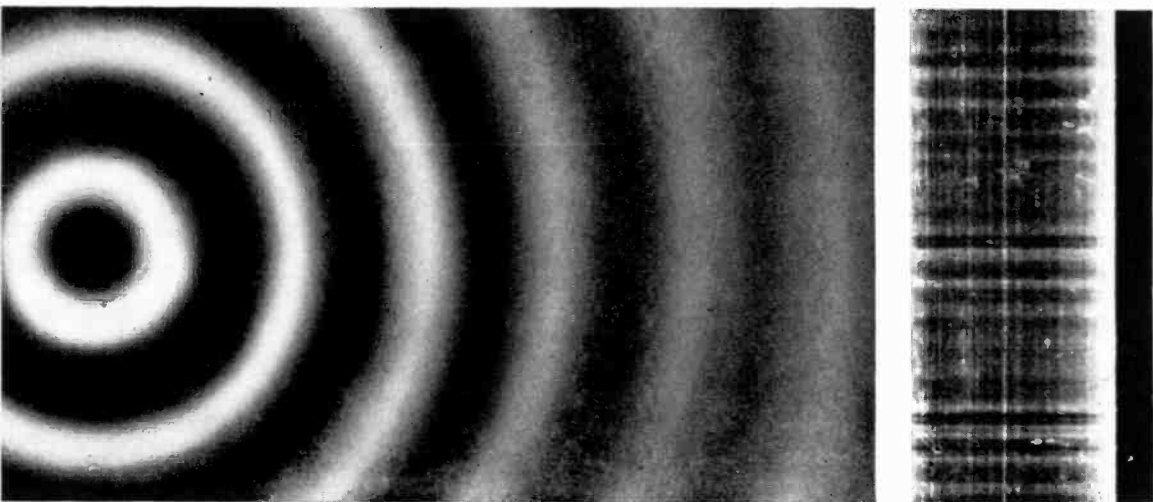

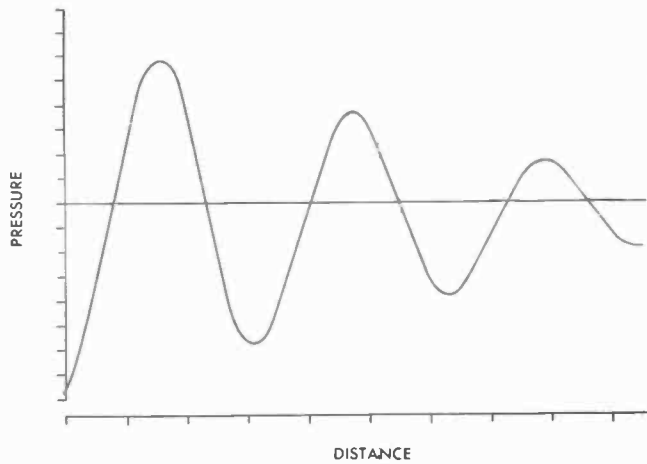

Left: a linear representation of sound in terms of air pressure and distance from the source. Right: 78-RPM phonograph record grooves



Different ways of visualizing sound

Right: a linear representation of sound in terms of air pressure and time, as measured from a fixed position

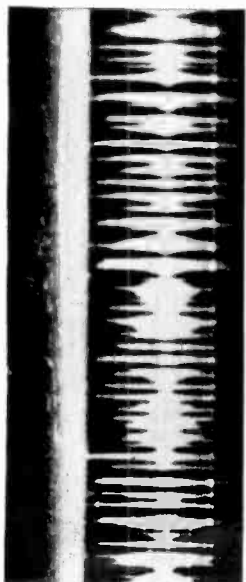
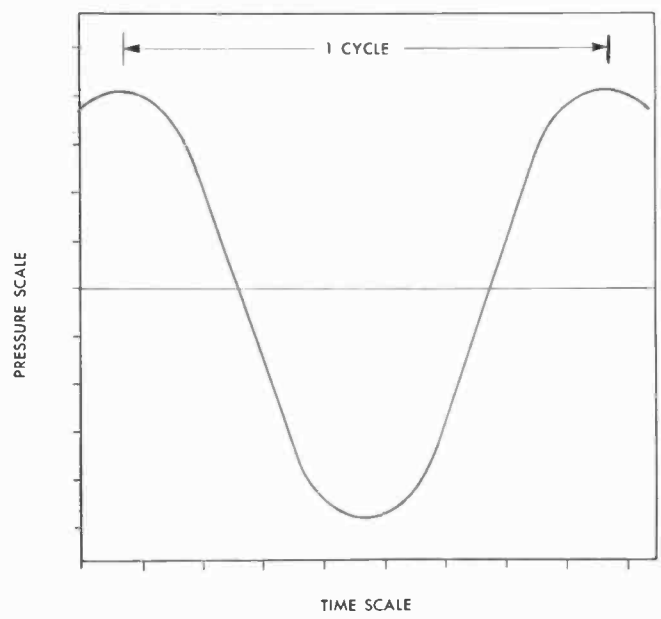

Left: a variable-area motion picture sound track

Below: sound represented as a series of wave fronts expanding from a central source



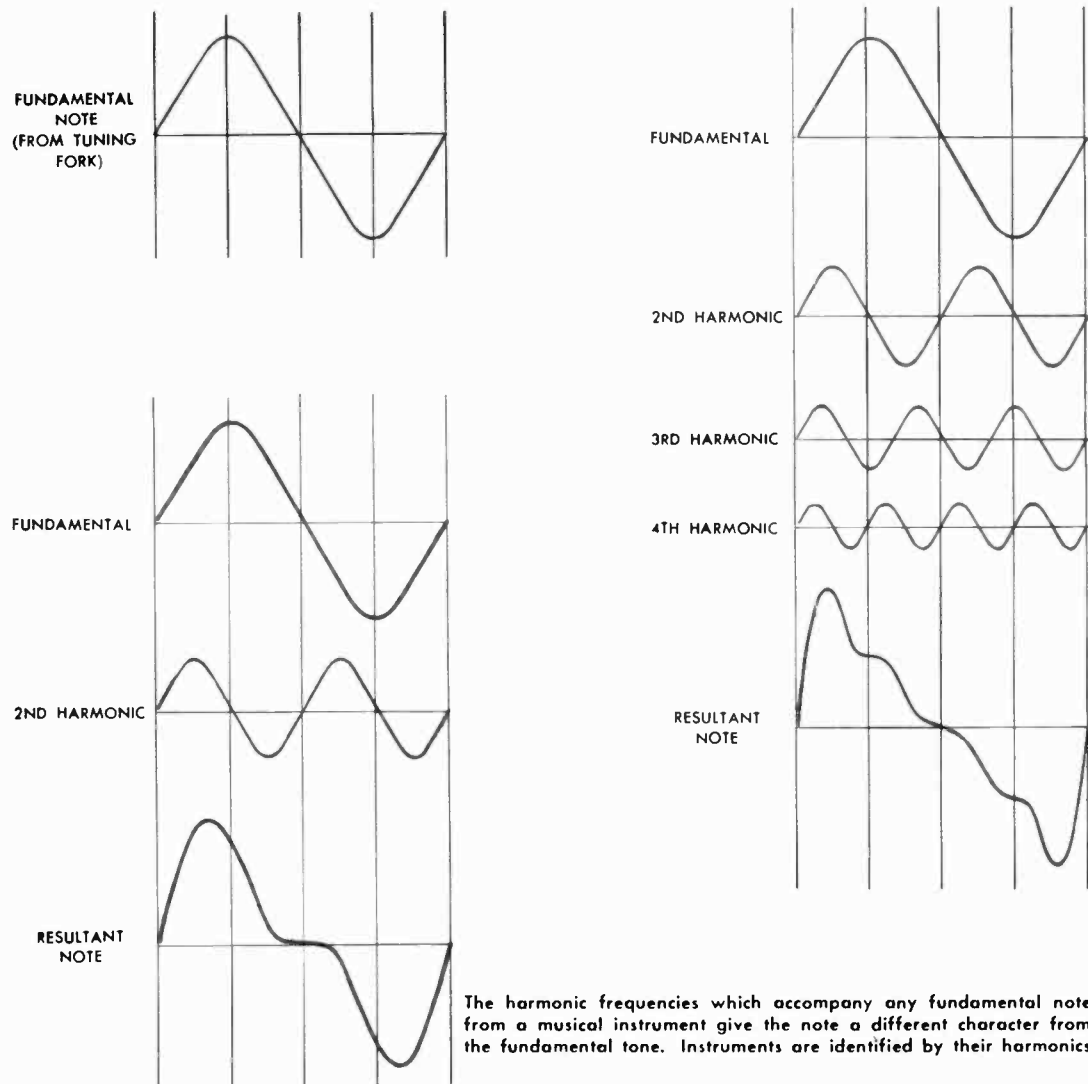

The harmonic frequencies which accompany any fundamental note from a musical instrument give the note a different character from the fundamental tone. Instruments are identified by their harmonics

in terms of actual air pressure, to the power radiated at the source of the sound. Intensity can be measured easily on laboratory instruments, and is a fixed quantity under equivalent circumstances. The measure of loudness, on the other hand, calls for the subjective analysis of a human being. Loudness concerns the ways in which changes in intensity at the source of a sound affect the sensation of hearing. Going back once again to the illustration of spheres of smoke representing the expanding wave fronts of sound radiating in all directions: it is obvious that equivalent portions of these spheres must contain less and less smoke as they move farther and farther from the source which generated them. In effect, the smoke becomes thinner and thinner with increasing distance. Just so, the condensations and rarefactions of air in a sound wave become less and less extreme with increasing distance. In the case of the smoke spheres, the amount of smoke in each sphere remains the same no matter how great the distance from the source. Just so, the amount of energy remains the same in each sound wave, no matter how great the

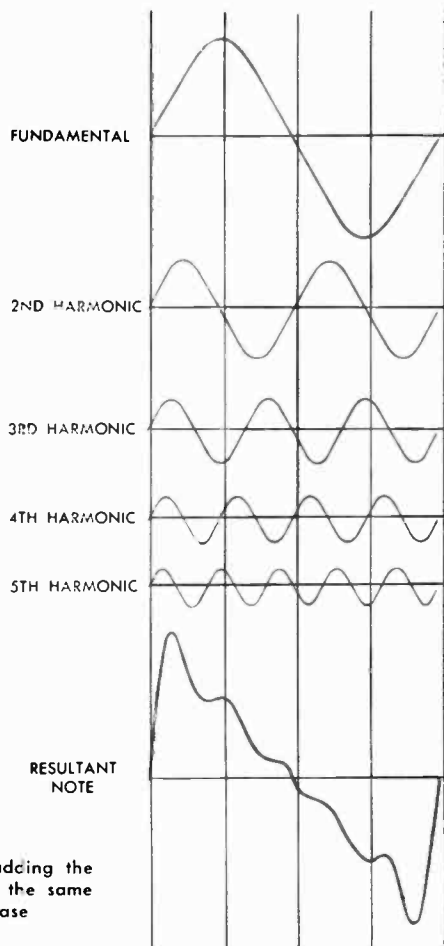
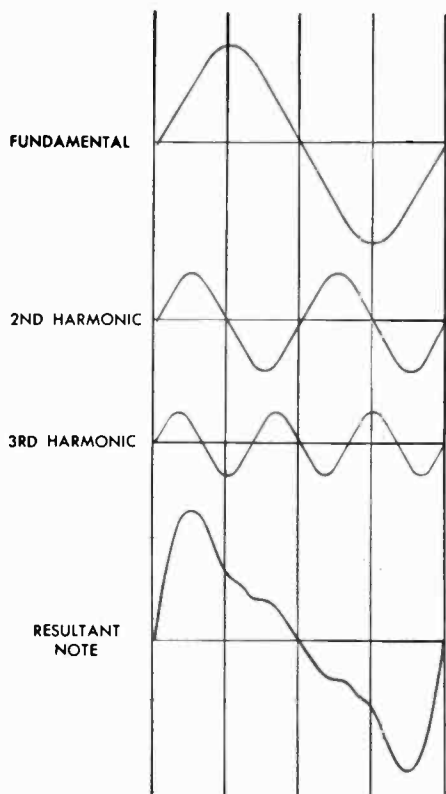

The bottom notes in the graphs above are obtained by adding the values of different accompanying harmonic frequencies to the same fundamental note. Pitch remains the same in each case

distance from the source. It is *intensity* which diminishes with increasing distance in each case, not *amount*.

A geometric law holds that the surface area of a sphere increases as the square of its radius. Relating this law to the spherical wave fronts of sound, it is apparent that the intensity of a sound decreases inversely with the square of the distance from the source of the sound. In other words, if a sound has an intensity of 1 at a two-foot distance from the source, the intensity will be $\frac{1}{4}$ at a four-foot distance, and $\frac{1}{16}$ at an eight-foot distance.

The effect of intensity on the human hearing system is the subjective value called *loudness*. The human hearing system responds to very wide ranges of intensity and frequency, and functions well under complex sound conditions that make the electric microphone inoperative and useless. It is possible to turn down the volume of a sound coming from an electronic instrument until it is at a point of intensity where the ear no longer responds to it. This lower limit is at the very threshold of hearing; it is called just that: the *threshold of hearing*. Conversely, as the intensity of a sound increases, its loudness—that is, the effect of the sound to the ear—can increase to the point where listening is painful. This upper limit is called the *threshold of pain*.

In dealing with loudness, it is well to remember that no two people hear with the same relative sensitivity. Present-day standards of measurement of loudness are derived from thousands and thousands of individual tests given

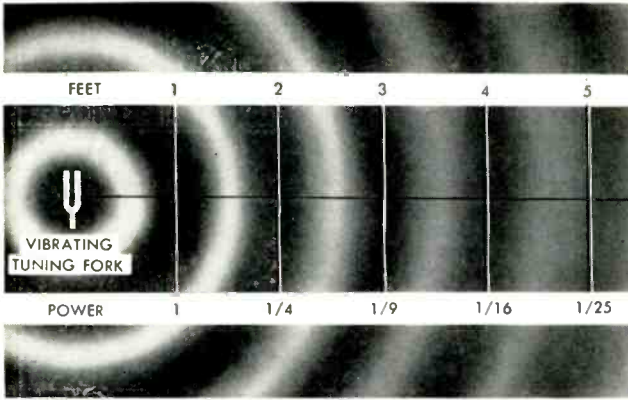

Relative energy distribution in an expanding sound wave. Power diminishes with the square of the distance the sound travels from its source

to humans under standard laboratory conditions. From these findings it is possible to make some general statements about the nature of the relationships between intensity and its subjective counterpart, loudness.

It has been found that although the intensity of sound may be increased by equal increments, the human ear will not necessarily register equal increases in loudness. Messrs. Fletcher, Munson, and Weigal, in their work at Bell Laboratories, have demonstrated that variations in the thresholds of hearing and pain exist; these are governed by the variations in the particular frequencies involved.

If the intensity of the sound of a single instrument in an orchestra were measured, the ratio of its intensity to that of the full orchestra might be found to be several million times. Imagine how painful it would be if, when the orchestral sound reached its peak intensity, the loudness registered at the human ear also increased by several million times. It is at this point that the importance of the relationship between intensity and loudness becomes apparent. As the source intensity of a sound increases in multiples of 10, starting at 10 and going from there to 100, then 1,000, then 10,000, 100,000,

Manmade noises encompass and exceed the total range of human hearing

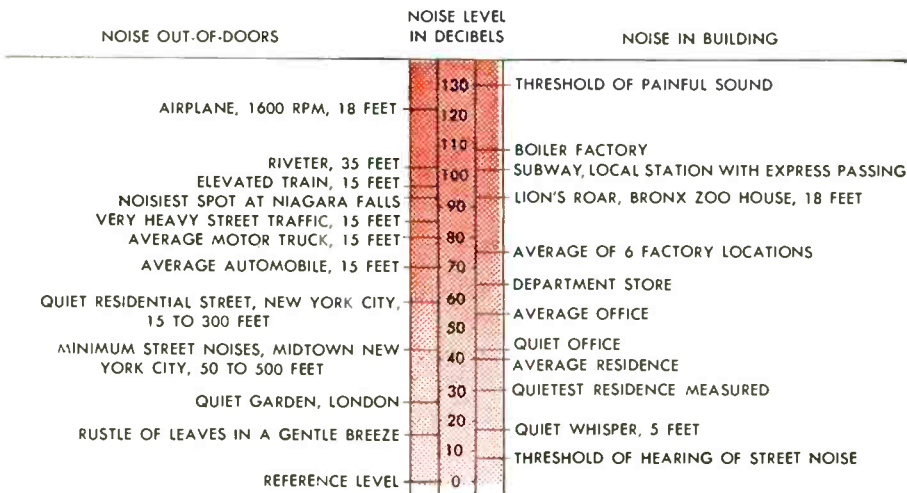

ZERO LEVEL = 10⁻¹⁶ WATTS PER SQUARE CENTIMETER

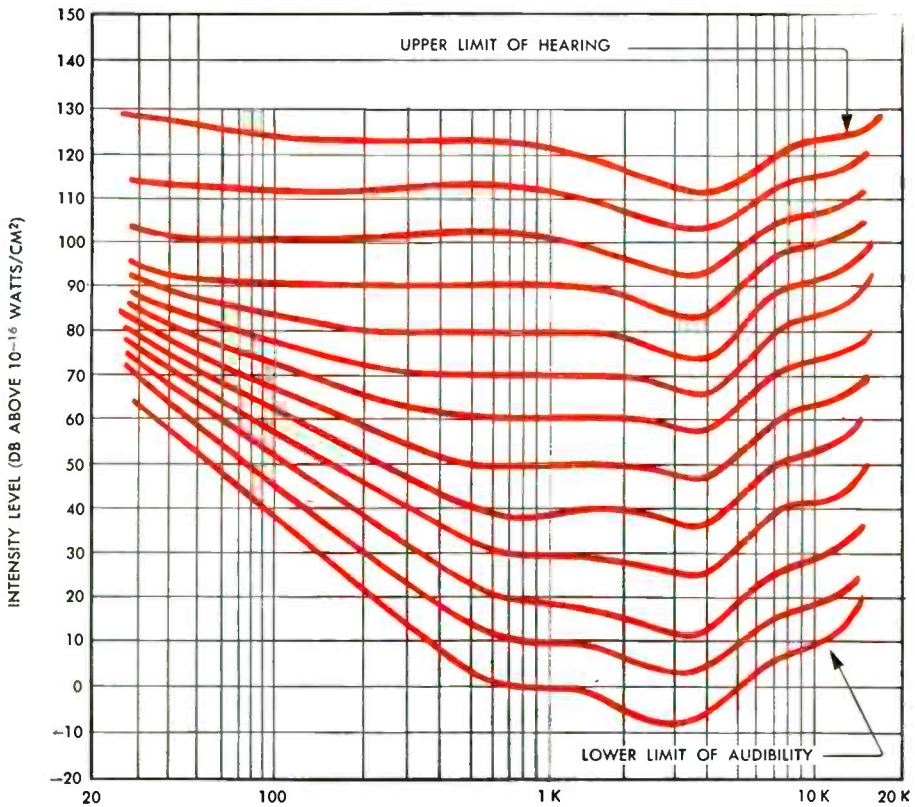

The chart above, based on the studies of Fletcher and Munson, indicates the response of the average human ear to sounds of different frequency at various loudness levels

and so on, the sensation of loudness increases in multiples corresponding to the logarithms (to the base ten) of the numbers given as examples, i. e., 1, 2, 3, 4, etc. Thus, an intensity increase of 1,000 to 100 corresponds to a loudness increase of only 2 to 1.

INTENSITY IN HIGH FIDELITY

The total range of human hearing, that is, the range between the threshold of audibility and the threshold of pain, is about 130 or 140 *decibels* (a decibel is a unit on a logarithmic intensity-measurement scale, as discussed previously). The loudest noise from an orchestra may be 15 to 20 million times as great as the noise from a single instrument. The range of hearing sensation in an orchestra may thus reach 75 decibels. In modern electronic-magnetic recording equipment, the maximum reproducible range may be somewhat lower than this full orchestral range of 75 decibels; methods of compressing this range onto the tape medium, and later expanding it, have consequently been developed.

In electronic equipment, inherent factors of noise, both mechanical and thermal, tend to reduce the maximum possible dynamic range by a background masking effect. *Masking* is a condition wherein a continuous, or *ambient* sound of low intensity, or any irrelevant sound, serves to limit the total loudness range out of all proportion to its own intensity. The surface scratch of a disc record is an example of such a masking noise. Later in the text these factors of dynamic range and signal-to-noise ratios will be mentioned where they apply to the equipment under consideration.

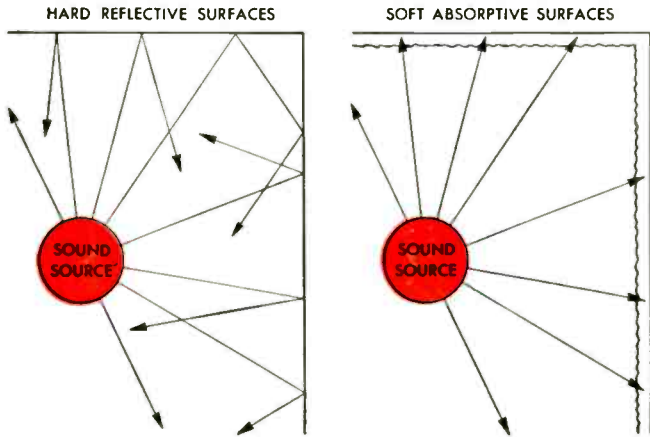

The sound reflection characteristics of different wall and surface areas have a great effect on a sound as heard by a listener

REVERBERATION AND EXCLUSION

Sound rebounds from solid objects. The familiar echoes in mountain areas, the echo of a public address system, the voices of a crowd in a football stadium; all are part of the phenomena of sound. Almost everyone has had the experience of entering a room with very hard floor, wall, and ceiling surfaces. A spoken word, or another sound, will bounce off such a surface in a complex fashion until it is hard to recognize the original, or direct, sound. And, of course, most of us can recall rooms with heavily draped walls, deep pile carpets, and acoustically treated ceilings, where most direct sound energy has been absorbed and little reflected.

Apart from the degree of sound energy absorption, a mountain echo differs only in time relationship from the reverberation in a "live" room. A point exists where the ear does not register a sensation of reverberation on the conscious mind; a short-time echo, or a sound reflection from a nearby surface, will fulfill this condition.

Imagine that you are seated in a small room with hard-surfaced walls. The time it would take for a sound to leave your lips, bounce off a wall, and return to your ears would be governed by your distance from the wall. In the small room under consideration, sound will not only bounce directly from adjacent wall areas but will bounce in angles, much like a tennis ball thrown obliquely at the wall. Let us expand this analogy and think of sound as a cluster of tennis balls. Uttering a sound in the small room would now be analogous to exploding a cluster of tennis balls in all directions. If the force of the explosion was sufficient, all the tennis balls would ultimately rebound to a basket at your feet; similarly, all the sound would ultimately rebound to your ears. As one first ball—representing direct sound—was catapulted directly into the basket, many others would go off in all different directions. Some would make many bounces, angling from surface to surface before landing in the basket. Each ball would take a different length of time to come to rest, depending on distance traveled. Some balls, rebounding only once and then from very near surfaces, would follow the first ball into the basket with only a few thousandths of a second delay. If you were to attempt to distinguish the first ball from the other early arrivals, you would find your choice very difficult.

So it is with sound in our everyday world of aural complexity. Nature has designed the human hearing system in such a way that it is able to exclude from recognition those reflected sounds which return quickly, on the heels of the direct sound from a source. Since the approximate speed of sound in air is 1,100 feet per second, it is easy to see that the average living room would

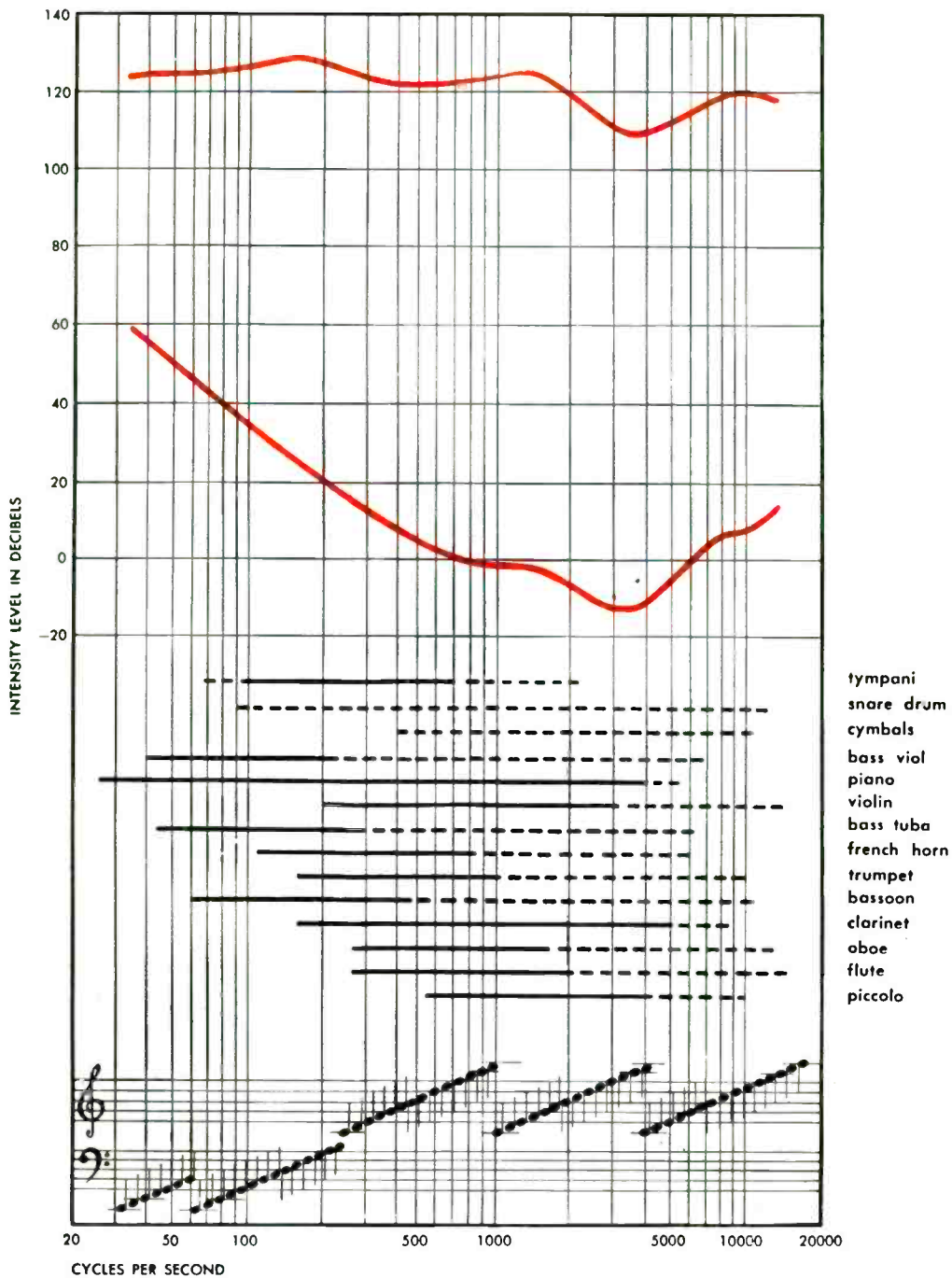

The intensity levels of music and the frequency ranges of different orchestra instruments

have many disturbing reverberations or short-time echoes. The important exclusion period, that is, the period of time a reflected sound may take to travel to the ear without interfering with the recognition of the direct sound from a source, has been established to be between $\frac{1}{1000}$ second and $\frac{6}{1000}$ second. Sound travels 1.1 feet in $\frac{1}{1000}$ second. Hence, in $\frac{1}{1000}$ second it will

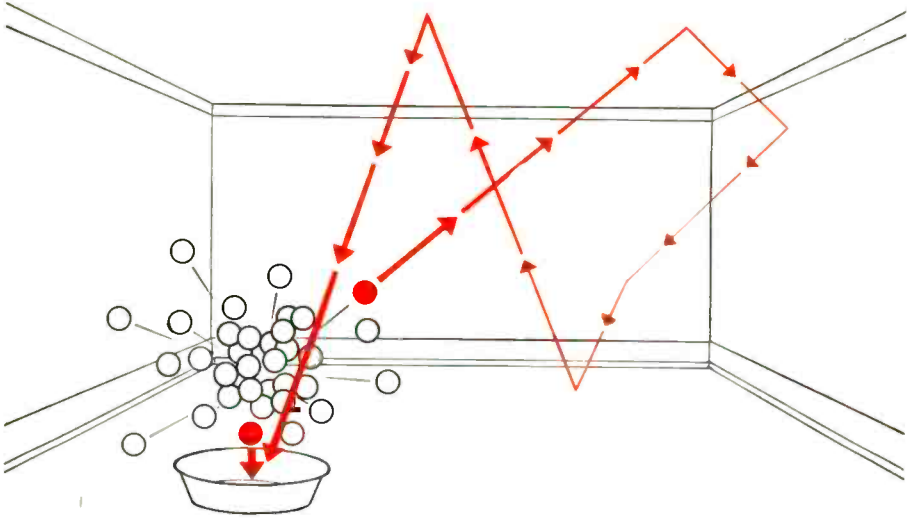

An explosion in a cluster of tennis balls. One ball is shot directly into the container. Another ball reaches the container later, after a series of rebounds, at considerably reduced velocity

travel 5.5 feet. The sound could thus travel to a surface 2.75 feet away and return without registering an impression on the mind. In the maximum case, the same could occur with a wall 27.5 feet away, in which case the sound would travel a distance of 55 feet in $\frac{5}{1000}$ second. If the human hearing system did not function in this manner, it would be most difficult to hear even ordinary conversation in the average room. In larger areas, most sound reflections will take even longer than $\frac{5}{1000}$ second, and will thus be heard as ordinary reverberation, adding to the "liveness" of the room.

One very useful characteristic of the human hearing system is its directional quality. We are able to concentrate our hearing mechanisms, both mentally and physically, on any desired sound, partially excluding those sounds deemed undesirable. The human hearing system is highly adaptable, being able to adjust itself to a tremendous range of audial frequencies and ambient noise levels.

One illustration of the ability of the human hearing system to exclude unimportant sounds from consideration is its responses during periods of sleep. We are jarred into wakefulness only by strange sounds; familiar sounds lose their ability to capture the attention of the sleeping human.

HEARING

If we are to believe sound has a history, we must go back in thought to a time when early man relied only on his senses to protect himself, many thousands of years before a mechanical means of recording and reproducing sound existed. In this period of time, the human hearing system probably evolved by adaptation to man's cultural and natural environment.

Man's sense of hearing at this time was, in effect, an acoustical radar system warning him against his natural enemies. The vision of primitive man was probably often obscured by disease and by the dense undergrowth and trees of his surroundings, which would have limited even perfect vision. His hearing system, however, protected by long hair and by the placement of his ears, would have been a protective warning device with a relatively long range.

Animals with two-channel, or *binaural*, hearing are able to locate the immediate source of a sound quickly, and with fair accuracy. Man must have combined his directional sense of hearing with his ability to reason in order to survive attacks by stronger, faster, hungrier animals.

Until comparatively recent times, there had probably always been a functional reason for the production of a particular sound; that is, sounds were in congruity with their surroundings. Jungle animal sounds were heard by man only in specific places. Thunder, and other sounds of nature, accompanied visible physical phenomena. Art forms such as dance and music would have been specific occurrences; the accompanying sounds were integral parts of those occurrences. Man's growing intellectual ability must have given him reasons to differentiate between the various sounds recurring in the small circles of his activity. New sounds once experienced, however fearful, could be instantly associated with their sources. Hence, the sound of a child at play would not cause alarm, as might the roar of a tiger.

Placement and localization of sound sources must have begun very early in man's development. The snarl of a wild animal or the footstep of another man could be positioned instantly in relationship to the listener. In those dangerous times, when a sound was heard the mind of man simply activated the muscles on the basis of recognition of friend or foe. Defensive acts or friendly recognition, depending on the circumstances, then took place.

A man can locate a source of sound in relation to his own position in several ways. A person with defective hearing in one ear, for example, can locate a sound by virtue of the differential directional sensitivity of his good

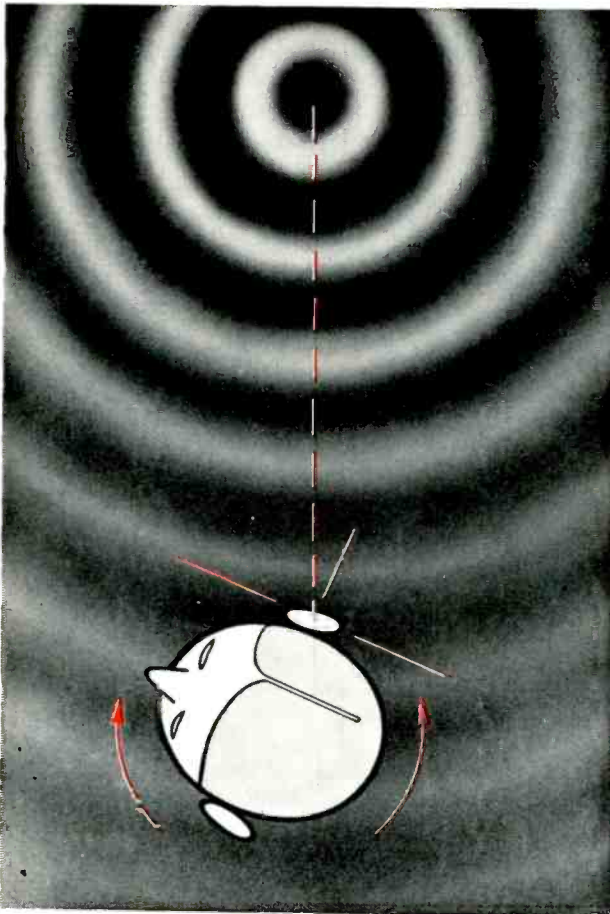
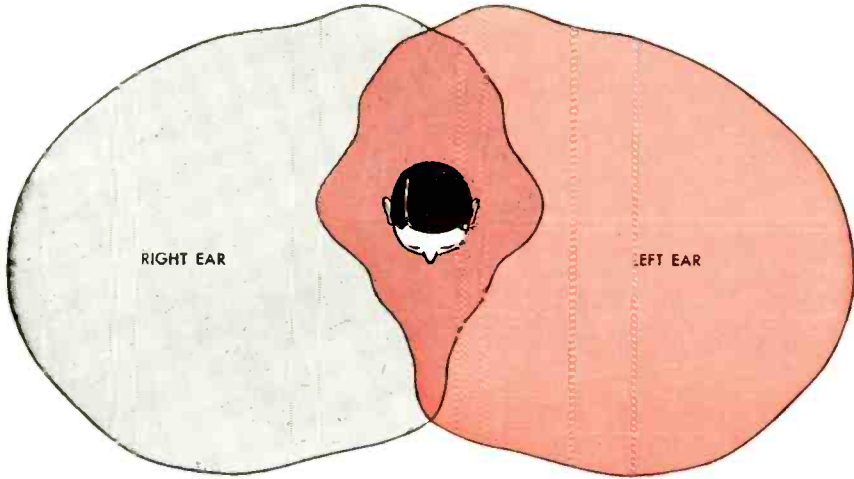

Above: loudness varies with direction. A "white," or mixed-frequency, sound of constant intensity will appear equally loud to the left ear at any point on the periphery of the colored area. Left: locating the direction of a sound source monaurally. The head is turned until the single ear receives the sound at maximum loudness. Since turning the head takes time, sounds of short duration cannot readily be located monaurally.

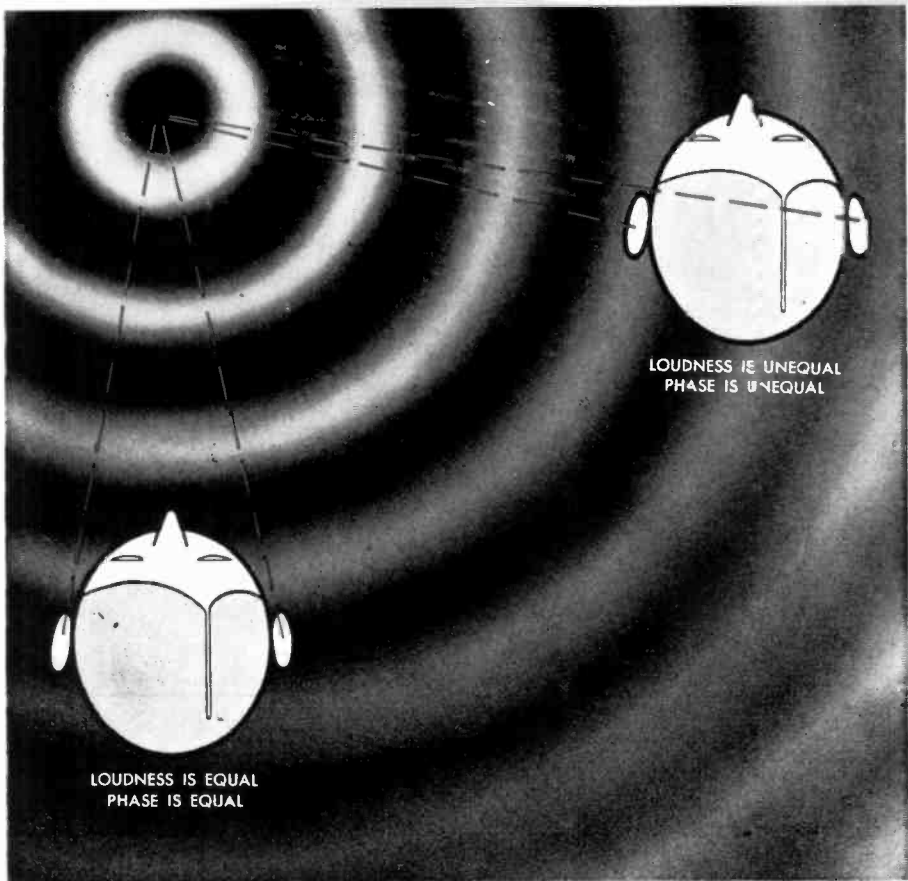

Locating the direction of a sound source binaurally. When a sound is at an angle to the head, right, loudness and phase are different at the two ears. Turning the head to make them equivalent, left, places the eyes in position to observe the source

ear. To the one-eared, or *monaural* listener, the loudness of a sound of constant intensity at a fixed distance varies with its direction in relation to the ear. The position of maximum loudness of a sound is usually about eighty degrees toward the ear from the center of the nose. Thus, by turning his head until loudness is at maximum, a one-eared man can judge the direction of a source of sound fairly accurately.

The chief objections to the one-eared method of locating a source of sound are, first, the sound must be fairly constant and of long duration, and second, a good deal of time must be spent in turning the head back and forth to bracket the position of maximum loudness. The monaural listener of primeval times could thus be attacked and half devoured while he was still trying to locate the source of impending danger.

The two-eared, or *binaural* listener is at a considerable advantage in this respect. Sounds generated at an angle to a line bisecting the head, between the two ears, will be of unequal loudness to the two ears and, because of the physical distance between the ears, will be out of phase as well; i. e., a time lag will exist between the responses of the two ears. Thus, sounds of very short duration may be located quickly by the two-eared listener through a practically instantaneous process of mentally comparing the differences in the sounds received by the two ears.

Binaural hearing must have been very important to primitive man in that many of the sounds of danger were probably of very short duration, preceding attack only by seconds. Man's rapid perception of audial direction may have provided him many narrow escapes.

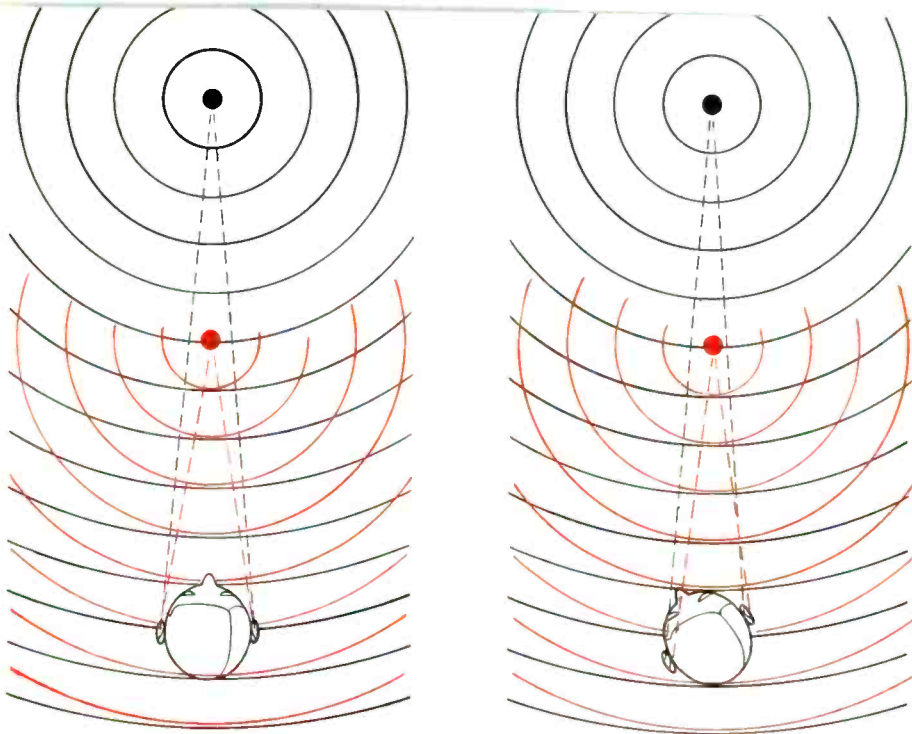

Locating the distance of a source of sound in an open, non-reverberant area is difficult unless the sound is a familiar one of known loudness or unless it is very near. Loudness and phase relationships remain nearly the same in both ears regardless of distance. Angling the head, right, alters the relationships slightly and may help

Since practically all the sounds of prehistoric times would have had a direct bearing on the people who heard them, it would have been natural for people to support the evidences of their senses of hearing with their vision. Thus, people probably turned to face each and every sound, bringing their eyes to bear on the sources. One reason for this assumption is this: while man's audial perception of *direction* is good, his audial perception of *distance* is rather poor, unlike that of some animals, at least in open spaces without reverberations. Thus, man may have relied on his ears for initial perception and for perception of direction, and then on his eyes for final recognition and for perception of distance.

As man's intelligence grew, mental sorting of the many sounds reaching his ears must have taken place. Surrounded by the harmless sounds of nature, domestic animals, family, and neighbors, man doubtless began to concentrate on his progressive endeavors without feeling the need for constant head motion. Man's adaptation to a world of dimensional sound began to take place, and it became natural for him to hear many sounds simultaneously.

In part, progress in religious ceremonies and various forms of entertainment would force man to develop a new manner of using his hearing. Whenever he was a spectator and heard many sounds at one time, or in quick sequence, he would have had to overcome his instinctive impulse to move his head, orienting himself to each sound. We can only speculate that this is what happened, but the facts at hand seem to lead to this conclusion. Man must have grown more and more accustomed to these multiple, complex sound situations as his role as spectator became increasingly important. It was then that his cultural conditioning must have overcome his instinctive listening habits.

As a modern example of a spectator situation, let us visualize a man attending a musical concert. In front of the man are the hundred members of a

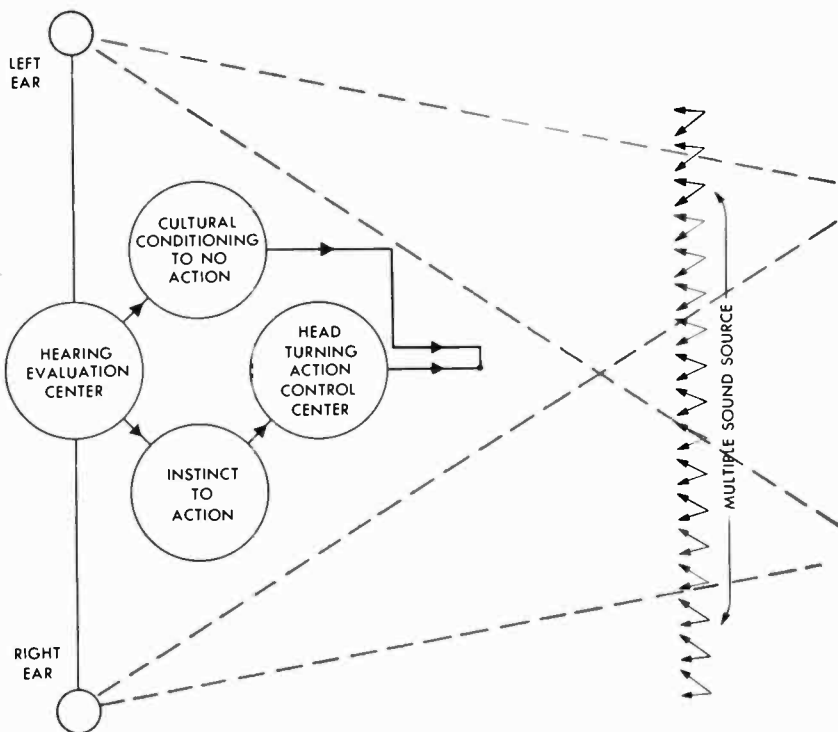

Cultural conditioning can overcome the normal instinct to move the head to face a source of sound. One path is followed when protective head movement is called for. The other path is followed when identification is unnecessary

symphony orchestra, each with an instrument capable of making noise. During the course of the concert, some of these instruments will function together, some singly, and some in quick sequence. Though by instinct the listening man may wish to locate each sound source, he realizes that it would be impossible for him to do so. As a passive spectator, the listener's cultural conditioning overcomes his instinct. His instinctive head movements, formerly catalyzed by signals from the part of his brain controlling his actions, are inhibited by his cultural conditioning, which interrupts these signals if no action is necessary. It is the inner tension caused by this series of action signals and reaction cues that gives a feeling of dimension and spatiality as we listen to music. It must be remembered that this discussion has not dealt with the acoustical reasons for the feeling of dimension caused by direct and reverberant sounds; the authors have merely conjectured about the psycho-acoustical development of human hearing as accurately as they can.

Abbreviations

Multipliers: For the most part, the following are used to denote numerical quantities less than 1; when capital letters are used, the reverse is true.

d = deci = 1/10

c = centi = 1/100

m = milli = 1/1,000

μ = micro = 1/1,000,000

$\mu\mu$ = micromicro = 1/1,000,000,000,000

K (k) = kilo = 1,000

M = meg = 1,000,000

Units of measure:

A (a) = ampere
 MA (ma) = milliampere
 μ A (μ a) = microampere

} measures of current flow

F (f) = farad
 μ F (μ f) = microfarad
 $\mu\mu$ F ($\mu\mu$ f) = micromicrofarad

} units of capacity

H (h) = henry
 mH (mh) = millihenry
 μ H (μ h) = microhenry

} units of inductance

Ω = ohm
 M Ω = megohm

} units of resistance

V = volt
 MV (mv) = millivolt
 KV (kv) = kilovolt

} units of electromotive force

W = watt
 MW (mw) = milliwatt

} units of power

m = meter

cm = centimeter

mm = millimeter

λ = wavelength

Z = impedance

a.c. = alternating current

d.c. = direct current

af = audio frequency

if = intermediate frequency

rf = radio frequency

vhf = very high frequency

uhf = ultra high frequency

r.m.s. = root mean square

db = decibel

dbm = decibels of power referred to 1 milliwatt

cps (c/s) = cycles per second

Kcs (Kc/s) (kcs) = kilocycles per second

Mcs (Mc/s) (mcs) = megacycles per second

A.V.C. = automatic volume control

A.F.C. = automatic frequency control

AM = amplitude modulation

FM = frequency modulation

ips = inches per second

AES = Audio Engineering Society

MRIA = Magnetic Recording Industry Association

NARTB (NAB) = National Association of Radio and Television Broadcasters

RIAA = Record Industry Association of America

AMPLIFICATION

The first time someone said to another person "What did you say?" the need for amplification was established. How many thousands of years ago this may have been is anybody's guess. Little indication exists that man ever had any desire to send the sounds of speech over extremely long land distances. He seems to have been content with cupping his hands, or, in later seafaring days, with using a speaking trumpet to communicate over a distance just greater than cannon range. When a man was beset with deafness, a hearing trumpet was his only recourse in collecting enough sound to hear. Strictly speaking, none of these expedients really amounted to what moderns would call amplification, although by different means they accomplished much the same thing. When the term *amplification* is applied to any of our physical sources of energy, the addition of an external source of energy is implied.

The difference between shouting and whispering is not amplification as we use the word. (In raising the intensity of his voice, a man simply moves more air than before.) As a man speaks into a modern microphone, the voice signal is fed into a transistor, or another electronic device which operates on some source of electrical power; this voice signal is then fed to a loudspeaker, which duplicates the words aloud with an intensity a thousand times greater than the original voice power. This has been accomplished through *amplification*; the increased power of the voice was not caused by shouting, but by the external electrical power applied to the transistor or other amplifier system.

It was not always so; until the early part of the 19th century no means of amplifying the human voice existed; man had to be content with raising his voice or using an ear trumpet. By the end of the 19th century men had found a method of amplifying sound by the use of externally introduced compressed air. It was the hope of these men that compressed-air amplifiers would provide a means of increasing voice and music volumes for large gatherings.

Thomas Edison and Dr. Chichester Bell, working independently, both devised systems of this type. Edison called his machine the *aerophone*. Later, Charles A. Parsons, English inventor of the compound steam turbine and of non-skid automobile chains, perfected a device he called the *auxetophone*, working on the same principle of sound amplification through the addition of compressed air. Robert L. Gibson and W. M. Dennison, both of the Victor company, adapted this amplification system to the disc phonograph. The French Pathé company tried to couple this device with a new medium, motion pictures, in order to turn out talking pictures in 1904.

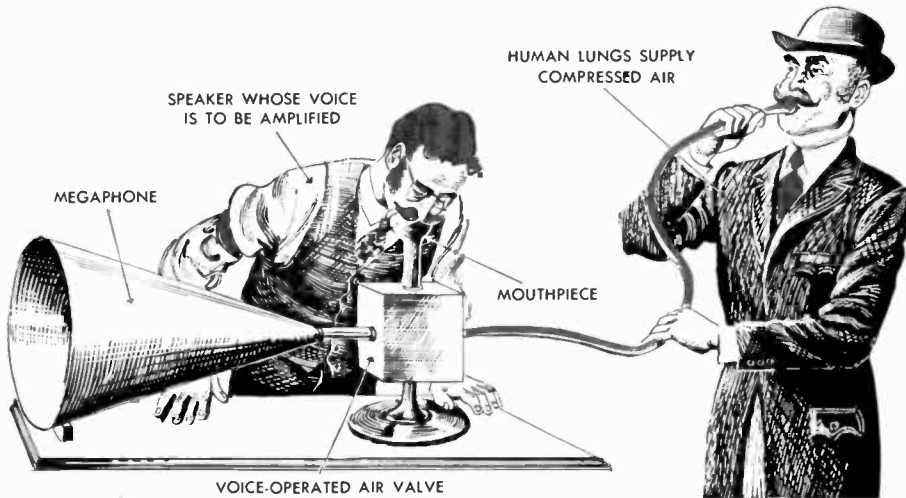

Above: the compressed air amplifier called the aerophone by its inventor, Thomas Edison. Right: a modern compressed air loudspeaker operating on the same principle, but with an electrically operated valve

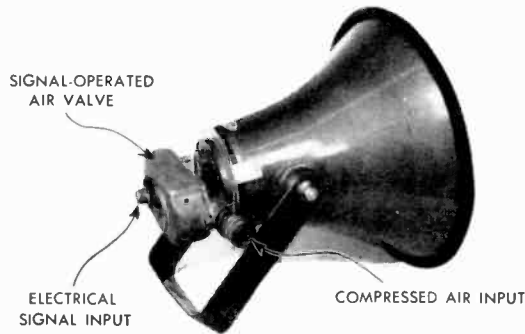

All these compressed air devices functioned along the same lines. A supply of compressed air was forced through a tube and against a small valve. This valve, which interfered with the passage of the air, was operated by the voice power of a speaker. As he talked into a mouthpiece, the valve opened and closed according to his voice modulations. The force of the compressed air was the power amplifying the sound. When such a compressed-air amplifier was connected to a phonograph, the vibrating stylus opened and closed the air valve, and the compressed air took the place of the air-pushing diaphragm. With a pressure of only 3 pounds per square inch in the sound box, the increase in volume was considerable. However, due to poorly conceived mechanisms, the compressed-air amplifier of the early 1900's was not commercially successful. The compressed-air amplifier is still used today in situations where a limited range of frequencies needs to be amplified with an extraordinary increase in power. The most effective air raid warning sirens in existence today are compressed-air amplifiers, rather than the conventional motor-driven rotary sirens.

The wonderful 20th century began, and man's technical knowledge was on the upsurge. It was the beginning of the air age and the electronics age; radio and television, though not yet practical, had at least been conceived. In 1904 Sir John Ambrose Fleming announced to the world the invention of the two-element vacuum tube, with its uncontrolled flow of electrons. Fleming found that if you could electrically heat a cathode element in an evacuated glass bottle, electrons would bubble off and be attracted by a plate element in the same bottle. He could control the current flow to a limited extent by varying the voltage relationship between the two. The major discovery in

this invention was that electrons could flow across the distance between the cathode (negative element) and the plate (positive element). In effect, this device of Fleming's was a valve for electrons, and current flow was either on or off, without much control in between. A few years later, Dr. Lee De Forest took advantage of Fleming's device by inserting a control element between the two basic elements. This third element De Forest called a grid; in physical configuration it was just that, a grid of fine wire mesh which could be electrically charged, and used to control the flow of electrons. He found that by negatively charging this grid in relation to the cathode element he could place a very small electric signal on the grid and cause it to be amplified into a much larger signal in the output of the tube. This first tube, called the De Forest Audion, marked the beginning of the electronics age.

The invention of the vacuum tube did not bring about startling changes in sound amplification techniques; in fact, it took almost another 20 years before amplified audio systems were recognized as an important part of radio broadcasting. Until this time the vacuum tube was considered only as a source of high frequency vibrations (radio waves), much as the tuning fork was its counterpart in sound vibrations. The tube provided an easy non-mechanical means for producing these electromagnetic wave motions and amplifying them to the great power necessary to broadcast. Later, their use was necessary for home radio reception; still, the audio amplifier was the least part of a radio of that day. Many who are working in the field of electronics at the time of publication of this text can review with ease the life span of the conventional vacuum tube. It came to life in the late 20's and 30's, enjoyed widespread use in World War II, and now we see its gradual decline in use, supplanted by the transistor, magnistor, and other devices designed to control the flow of electrons.

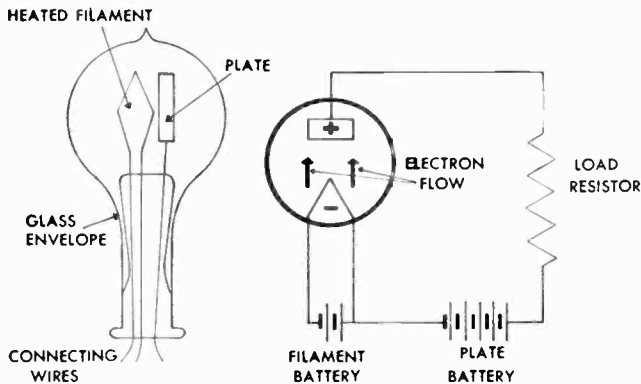



Left: sketch and schematic diagram of Fleming's electron valve

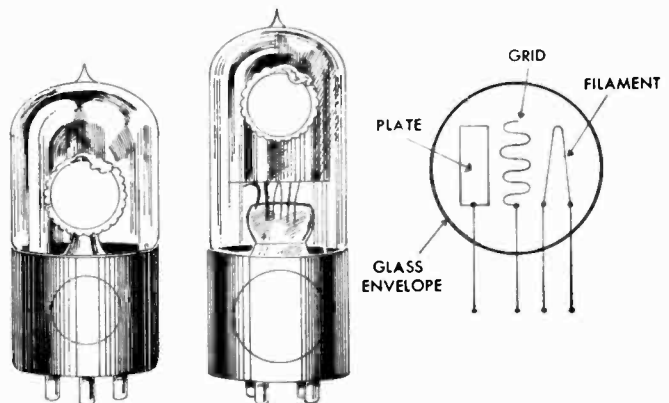

Right: the De Forest Audion tube, which employed a grid element in addition to the other two





Capacitors (condensers):

Fixed		1
Adjustable		2
Variable		3



Resistors:

Fixed		4
Variable		5
Tapped		6



Potentiometers:

Single		7
Dual		8



Batteries

Single cell		9
Multiple cell		10





Relays:

Single contact		11
Multiple contact		12



Rectifiers (non-vacuum tube):

Half wave		13
Full wave Bridge		14 15



Inductors (coils):

Fixed		16
Adjustable		
Shielded		
Magnetic core		17







Antennas:

Non-directional	
Directional	

Reproducers (phonograph pickup cartridges):

Ceramic or crystal	
Electromagnetic	

Transformers:

Fixed		23
Adjustable		
Variable core		21
Magnetic iron core shielded		20
Magnetic iron core shielding on one winding		
Magnetic iron core tapped winding		22
Magnetic iron core multiple winding		18

Microphones:



Ceramic or crystal	
Dynamic (moving coil)	
Velocity	

CHART OF ELECTRONIC SYMBOLS: some of the common electronic devices pictured in the photograph at right are illustrated here in schematic form. The key numbers refer to the photograph



Vacuum tubes:

Diode (2-element)	
Dual diode (rectifier)	
Triode (3-element)	
Dual triode	
Pentode (5-element)	
Multiple section	
Beam power amplifier	

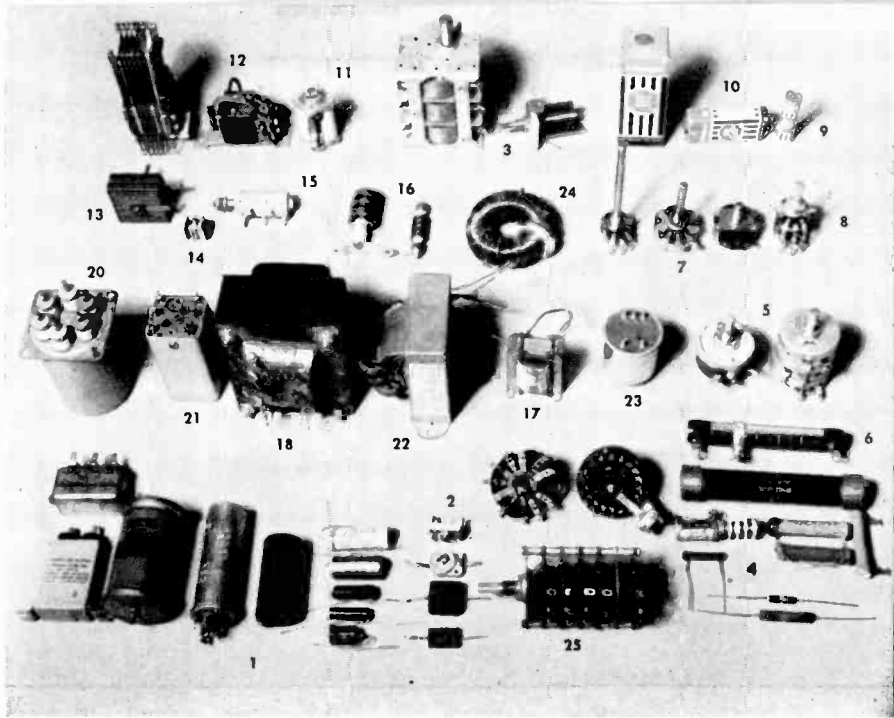
Semiconductors (transistors, etc.):

P-N-P transistor	
N-P-N transistor	
P-type unijunction transistor	
N-type unijunction transistor	
P-N-P tetrode transistor	
N-P-N tetrode transistor	
P-I-N triode transistor	
P-I-N diode transistor	

Toroidal coil:		24
Rotary selector switch:		25

Loudspeakers:

Permanent magnet	
Electromagnetic	

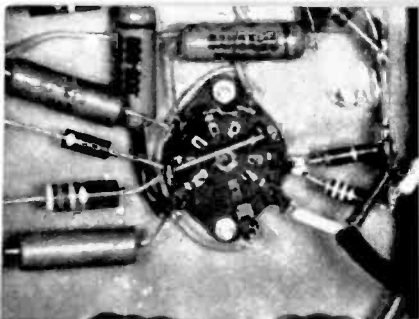

Above: actual placement of electronic parts around a tube socket in an amplifier. Right: conversion of mechanical stylus motion into electrical signal energy

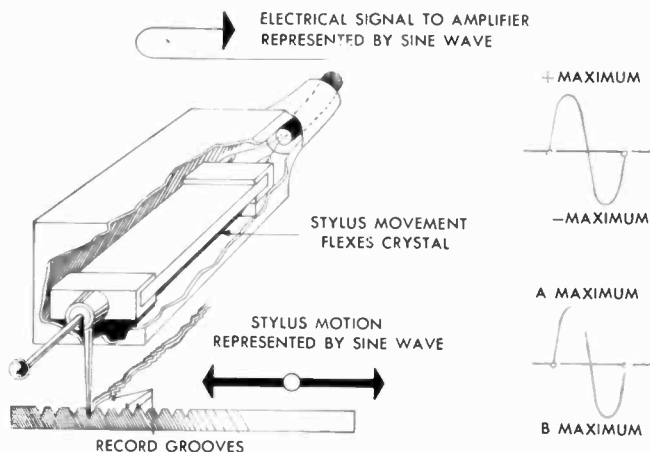

The new types of amplifiers which incorporate the use of transistors, magnistors, and nuclear- and solar-powered elements accomplish the same feats as the vacuum tube amplifiers, but eliminate the necessity for special filament heating supplies, unreliable construction, and over-all bulk.

HOW A VACUUM TUBE AMPLIFIER WORKS: The purpose of any amplifier is to increase the energy level of the signal applied to its input circuit. In high fidelity sound reproduction, we are concerned with several different input signals. These signals may come from a phonograph cartridge, an FM tuner, a microphone, a tape recorder, or a television set. If these signals could be fed directly to a loudspeaker there would be no need for audio amplifiers. Unfortunately, these signals are much too weak to power a loudspeaker. The only requirement of an audio amplifier is that it increase the signal level, without changing the character of the signal. If the amplifying circuit changes the wave form of the signal, and/or adds noise to the sound, then it fails to do its job.

Let's see what happens to the small signal from a phonograph cartridge as it is amplified to an audible volume. In tracing this signal from the input circuit of an amplifier we will see what undesirable things may happen if the circuit does not operate correctly. Let's begin with the operation of a simple audio amplifier using triode (3-element) tubes. Many of the tubes used in

The input vacuum tube circuit with its component parts in schematic form. The input-output signal relationship is indicated

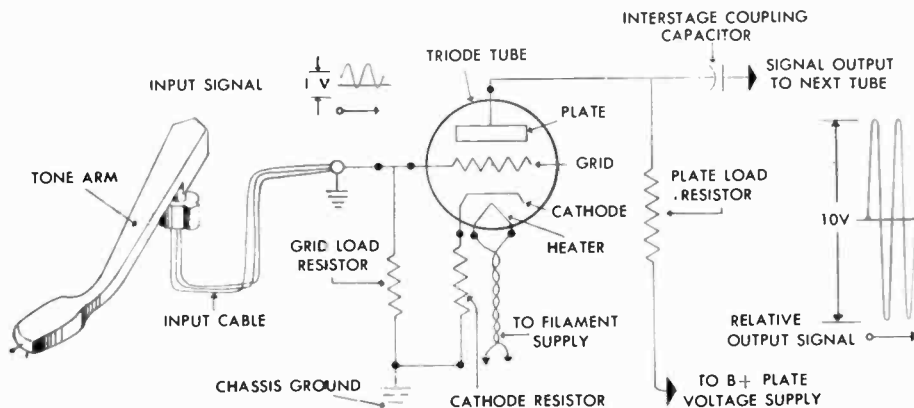

today's modern amplifiers have more than three elements for special purposes. For ease of understanding, the basic diagrams here represent the operation of all vacuum-tube circuits. Later in this chapter the operation of other types of amplifiers—those employing semi-conductors (transistors, etc.) and magnetic elements—will be covered briefly. In essence, these devices function much as do vacuum tubes.

The phonograph cartridge produces a minute electrical signal voltage which varies directly with the mechanical variation in the record grooves. The coupling device between the disc and the cartridge unit is the stylus. Just as a page of sheet music can represent, in a passive way, the music on the disc, so the music on the disc can be converted to a representative electric signal voltage. This voltage would be too small to be heard if it were directly connected to a loudspeaker. It is the job of the amplifier to increase this electrical signal level to a point where it will be able to "drive" the loudspeaker. Though it would seem logical simply to fit together any cartridge, amplifier, and loudspeaker units, it is not. Certain problems of electrical matching occur. Much as it is the job of a plumber to fit various sizes of water pipe together with an understanding of specific plumbing requirements, matching is one of the jobs of an electronics engineer. It is his responsibility to design and construct these audio units in such a way that they will fit together or match, so that they will accomplish their purpose most efficiently. This operation involves, primarily, a matter of matching the opposition to the flow of current, or *impedance*, of the various components of a high-fidelity system. One problem which often arises in matching is that impedance usually varies with frequency. The manufacturers of high-fidelity equipment, taking their cues from their engineers, label all their equipment in such a way that the interested novice can make his connections with as little technical knowledge as possible. While the various stages of amplification may be discussed here as though they involved individual tube units, such is not the case. These various circuits are combined into one or more chassis provided with accessible standard jacks and terminal strips for easy connection of the components.

In the sketches and diagrams given here you will find standard symbols used to designate specific electronic parts. Circuit diagrams for engineers are composed entirely of these symbols; while the circuits themselves may be complex, the symbols are not. A chart of most of the symbols designating electronic components found in the average high-fidelity system is given here. First comes the symbol, then a sketch of the part as it might be used in pictorial do-it-yourself kit diagrams, and in some cases a photograph of the part itself.

From our earlier discussions on sound we know that a sine wave can be used to designate an audio signal. As a turntable rotates with a stylus in the groove of a record, the physical variations in the groove cause the stylus to move back and forth laterally. It is this movement of the stylus in the phonograph cartridge that produces the audio signal voltage we have represented with a sine wave. Cartridges can be obtained in a wide variety of styles and types.

Output signals vary widely. The crystal or ceramic units have high output signal voltages, while the magnetic varieties have lower output voltages and often require additional amplification. Let's assume that the unit used in this explanation has an output signal voltage which varies from $\frac{1}{10}$ -volt in quiet musical passages to a maximum of $\frac{1}{2}$ -volt in the loud sections, and ignore the range of frequency response at this time. The signal is being fed to the grid of a triode vacuum tube. In operation this tube is supplied with a small a.c. filament voltage. This filament voltage is sufficient to heat up the negative element of the tube: the cathode. In many tubes the red glow of this heat is visible and during operation many tubes become hot enough to scorch paper. Along with the filament or heater supply, the plate or positive element of the

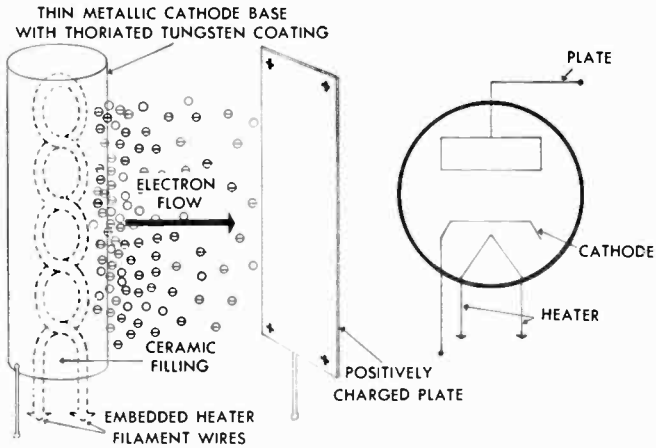

A stylized sketch of the internal operation of a diode tube. Electrons emitted from a hot cathode are attracted to a plate element across a partly evacuated space

tube is supplied with a high positive voltage; several hundred volts d.c. In the construction of the vacuum tube the manufacturer has coated the cathode with a material called thoriated tungsten which, when heated, gives off many electrons in a random manner, much as grease bubbling off a very hot frying pan. In their natural state the negative electrons are attracted to the highly positive plate in the same fashion as the grease from a frying pan might collect on a blotter held above it. This movement of electrons across the space between the cathode and the plate causes current to flow in the circuit connected to these two elements. Without a grid, this flow would go on at a steady rate, dependent upon the supply voltages and the configurations of the tube elements. The flow can be controlled simply by placing an electrical charge on the grid. Negatively charged objects repel each other. From this it is easy to see that if the grid were charged negatively, the negatively charged electrons coming off the cathode would be repelled right back to the cathode, leaving the vacuum tube in a condition of inactivity (called cutoff). By placing

The internal operation of a triode tube. Some of the electrons which would otherwise be attracted to the plate are repelled by the varying negative charge of the grid

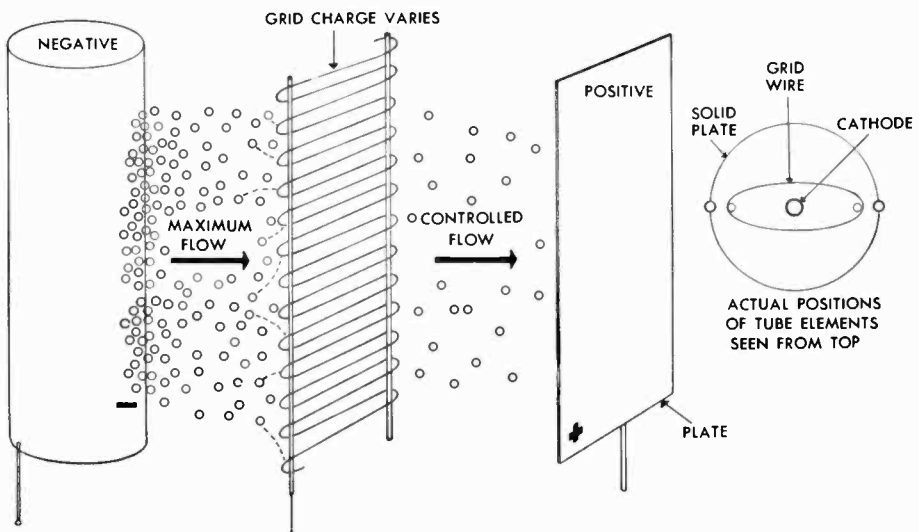

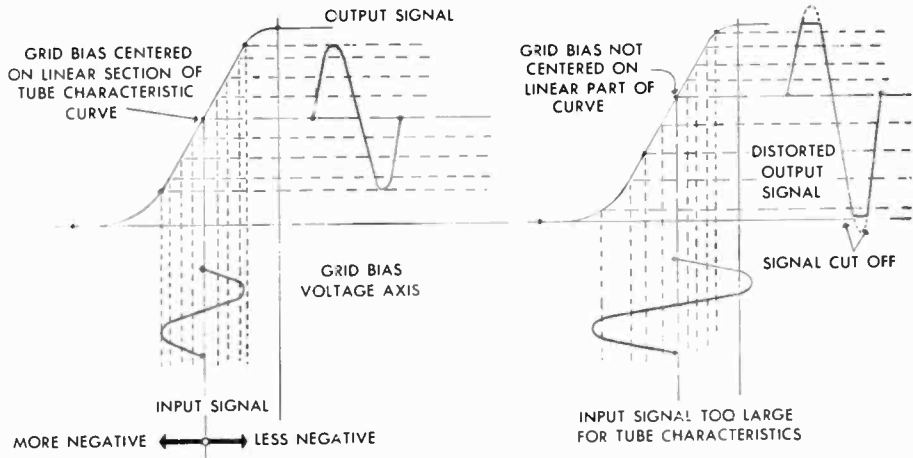

The operation of a linear amplifier vacuum tube. Left, proper operation. Right, improper usage

a fixed balancing voltage, called *bias*, between the cathode and the grid connections of the tube, the degree of this negative charge on the grid may be varied. It is necessary to keep the grid always at some degree of negative charge, since in swinging into a positive charge the grid would attract electrons, losing its purpose in the process. The grid of the tube is biased with a fixed negative voltage about half-way between zero voltage and the lowest negative grid voltage at which the tube would cease to conduct, that is, be at cutoff. As the signal voltage output from the phonograph cartridge is allied to the grid, the alternating-current nature of the signal causes a constant variation of the negative charge on the grid. As the signal voltage becomes positive, it decreases the negative charge on the grid; then, as the signal voltage swings into the negative portion of its cycle, it adds to the negative charge on the grid. As these changes take place, more or fewer electrons are allowed to flow between the cathode and the plate, in direct relationship to the variations caused by the very small signal voltage on the grid. In this manner, we are able to control a very large flow of electrons with a very small grid signal.

These amplified signals are passed on to the next stage of amplification through the resistor-capacitor circuits connecting the two stages. While it is possible to gain tremendous increases in signal level, it is sometimes necessary to add several tubes together to effect the maximum level needed for the operation of a loudspeaker system.

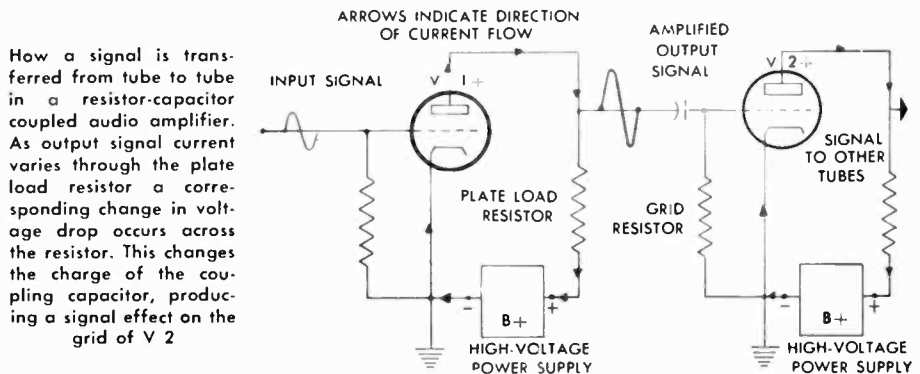

How a signal is transferred from tube to tube in a resistor-capacitor coupled audio amplifier. As output signal current varies through the plate load resistor a corresponding change in voltage drop occurs across the resistor. This changes the charge of the coupling capacitor, producing a signal effect on the grid of V 2

While many specific details have been left out of this simplified explanation of vacuum tube amplification it is sufficient to explain the operation of most vacuum tubes used in the reproduction of high-fidelity sound. The application and arrangement of tubes and circuit components for specific jobs in high-fidelity sound are grouped into several general amplifier classifications: control or preamplifiers, equalizer or tone-control amplifiers, power amplifiers, etc.

DISTORTION IN AMPLIFIERS: We have traced a signal through a single triode vacuum tube stage of amplification, finding that the output signal is identical to the input signal except for the increased magnitude. It would be very nice indeed if such high-fidelity amplification took place in every circuit, but this is not the case. Many disagreeable changes and additions to the signal take place in practice. Most listeners are familiar with a 60-cycle hum sound coming from their loudspeakers, especially noticeable during soft musical passages. Other noises are often audible; some are caused by faulty parts, loose connections, or by the tubes themselves. All these distractions, whether mechanical or electronic, cause small signal voltages of their own to be added to the desired signal. In the course of normal amplification these noises are amplified right along with the signal.

Every high-fidelity component can be plagued with unforeseen part failures, causing noise, but these noises are inherent in some systems due to poor design. While noise and hum add small disturbing signals of their own to the desired signal, distortion in its several forms changes the desired signal on its way through the amplifier. As distortion increases in an amplifier, it lessens fidelity in the output signal. Distortion can be classified as to type. The major types of distortion are: harmonic, intermodulation, frequency, transient, and phase.

HARMONIC DISTORTION: Earlier in the text, the nature of sound from musical instruments was mentioned. Even though two instruments may play the same note, the resulting sounds will be different. Each instrument has its own sound characteristics because of its harmonic content. Harmonic distortion exists to some degree in every high-fidelity amplifier. It is as if each amplifier had its own harmonic structure. Harmonic distortion occurs after a signal is put into an amplifier; it is the amount of harmonic energy formed as the signal passes through the various stages of the amplifier. This type of distortion takes place because of the difficulty of maintaining linearity of amplification in both the vacuum tubes and the circuit components connected between them. Going back to the diagram showing amplification in a simple triode tube, we can see how the sine wave signal applied to the input is amplified without change. However, in faulty circuits or in poorly designed ones, the input wave is distorted within the tube or its associated electronic components. Earlier, the balancing voltage called bias voltage was mentioned.

The addition of various harmonic energies will change the form of an amplified sine wave output signal. The resulting effect on recorded music is intolerable

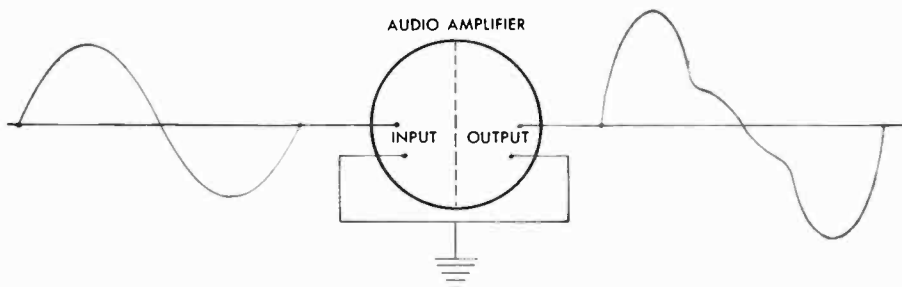

Intermodulation distortion is an effect of one signal on another. A high-frequency signal may be modulated, or "beat," by a low-frequency signal

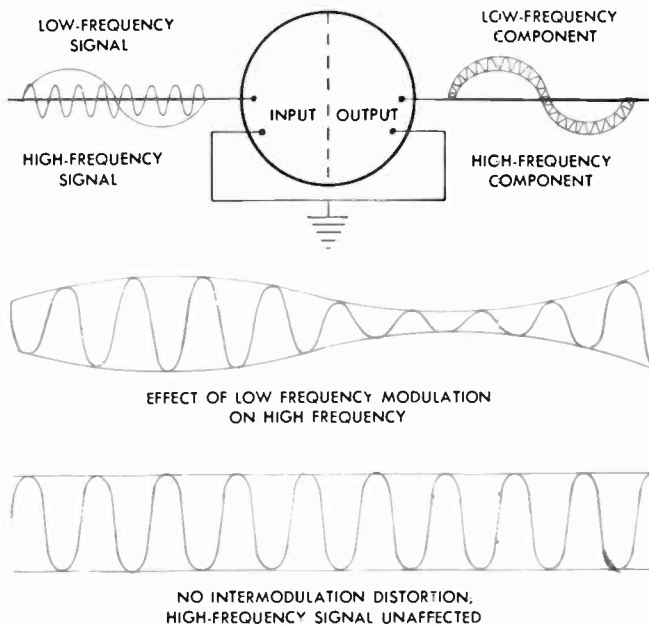

Should this bias voltage be the wrong value, too high or too low, the variations of the signal on the grid would not cause corresponding changes in electron flow. Should the wrong vacuum tube have been chosen by the designer of an amplifier, then this situation could have occurred in a different way. This is one of the reasons there are so many different types of vacuum tubes available; each has been designed for a specific job. Harmonic distortion can also take place in the circuits between the various tubes in an amplifier. Another frequent cause lies in the fact that for increased output power the signal on the input grid of a tube is sometimes swung too wide, exceeding the linear amplifying power of the tube. New types of high-power output tubes have been designed to meet the need for more audio output power in modern high-fidelity amplifiers.

INTERMODULATION DISTORTION: There would be very little trouble with intermodulation distortion if audio amplifiers were called upon to amplify only one note at a time. However, most of the signals impressed onto the input of an amplifier are of a complex nature: many notes at one time. As these complex frequencies and their harmonics are amplified in a system with even the slightest non-linearity, beats occur between them. In the ordinary performance of music, these sum-and-difference frequencies regularly occur, giving a pleasing character to the sound. In an amplifier having intermodulation distortion, these so-called beats produce non-musical sounds at the loudspeaker. Intermodulation distortion is one of the most difficult for the human ear to hear: it can occur in natural sound, in a record or tape, in an amplifier, or in a loudspeaker system.

Motion pictures were the first to employ a limited frequency range in audio equipment, but within that range there was as little harmonic and intermodulation distortion as was possible to obtain. As the frequency response of audio amplifiers was widened, the small amount of intermodulation distortion became more noticeable. The improvement of high-power output tubes and transformers has tended to limit the rise of intermodulation distortion as the power of amplifiers rises. Both manufacturers and consumers have found that intermodulation distortion rating of amplifiers is justifiable as a standard of quality, providing the method of testing is standard.

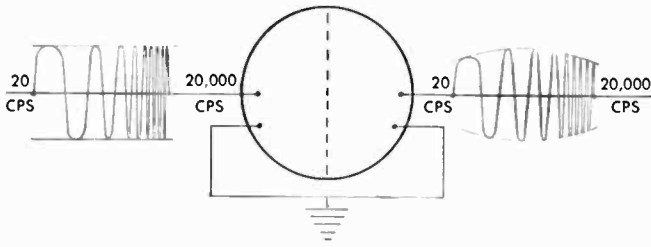

Frequency distortion is caused by amplifiers with frequency limitations at the ends of their response curves

FREQUENCY DISTORTION: While seldom referred to as frequency distortion, it is this factor that governs the frequency response of an amplifier. The frequency response range includes all signals between the very lowest note and the highest. In the perfect amplifier all these notes (frequencies) would be amplified the same amount. In most audio amplifiers without any tone compensation, both the low and high notes drop off in amplification. In the standard vacuum tube amplifier, the middle-range frequencies are most easily amplified. Frequency distortion occurs because of the effects of natural capacity existing between elements of a vacuum tube or elsewhere in the circuit components. Going back to the basic amplifier circuit, these points can be made clear.

In most resistor-capacitor coupling circuits, the plate of the preceding tube is connected to the grid of the next tube through a capacitor. At low frequencies, the capacitive reactance of this capacitor becomes large enough to limit the signal effect on the grid. The middle frequencies are not affected by this capacitor and are fully amplified. At high frequencies, the combination of inter-electrode capacitance, cathode by-pass capacity, and the capacity of the plate circuit of the tube tend to load down the output of the tube with their combined low impedance at high frequencies. Inter-electrode and plate capacity exist due to the physical construction of the tube elements and the fact that a capacitor is simply two metal conductors separated by a non-conductor. Tubes are not planned in this fashion; the capacity exists due to the proximity of the metallic elements in the tubes.

High-fidelity audio amplifiers can be designed to compensate for these failures. Careful choice of design features and components and special vacuum tubes go a long way to eliminate frequency distortion. The set owner is provided with bass and treble controls so that he can compensate for these limitations as he desires.

TRANSIENT DISTORTION: Transient distortion must be limited if an amplifier is to have good audio response. The complex sounds of speech, music, and noise change at a very rapid rate. This transient nature of sound raises a problem in amplification. Most amplifiers can easily pass the steady frequencies of sound, but in the case of transient portions of those sounds a series of

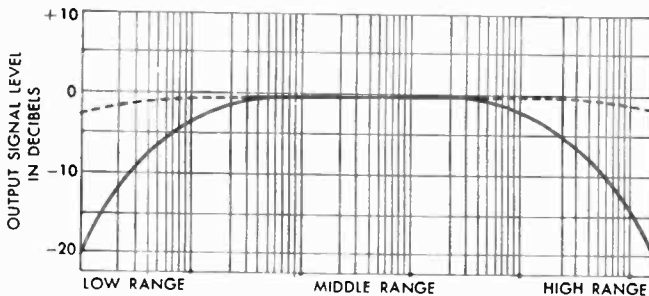

The frequency distortion effects caused by the limitations of circuit components are indicated by the curve

minute oscillations may be set up. These oscillations occurring in transformers or other circuit elements are called transient distortion. Its elimination is mainly a problem of correct amplifier design.

PHASE DISTORTION: Phase distortion, through discernible, is often obscured by other forms of distortion. It is caused by flaws in the design of an amplifier. It is a major cause of loss of articulation in recorded speech, and fuzzy or mushy sounds in percussive passages of music. If an amplifier has little or no phase distortion, all signals from the very low to the very high in frequency will take the same length of time to pass through the amplifier. Definition is lost when phase distortion, caused by an unequal transit time between the high and middle-range frequencies, exists. If the high-fidelity amplifier is designed to operate with an extended high-frequency range, it is likely that phase distortion will be at a minimum.

CONTROL AND PREAMPLIFIERS: Control or preamplifiers serve several purposes in modern high fidelity systems. Since the sources of high fidelity include not only radio and phonograph records, but perhaps a tape recorder and the audio from a television set as well, the preamplifier must have some means of switching in these various signals. A control or preamplifier is, in essence, an amplifying device which takes these input signals and increases their power sufficiently to drive the power amplifier. However, in this process of amplification, there must be a facility for changing the volume level of the sound and its frequency characteristics through either a record equalization switch or by the treble and bass controls. In some types of preamplifiers a loudness control is included which provides for differential volume changes according to frequency, to better suit the response of the human hearing system. The progress of sound signals through a conventional control or preamplifier is illustrated here. Though there are several input circuits, each input signal is sent through the same outlet into the power amplifier. The particular path

Block diagram of a preamplifier. The colored arrows indicate the direction of signal flow through the circuit

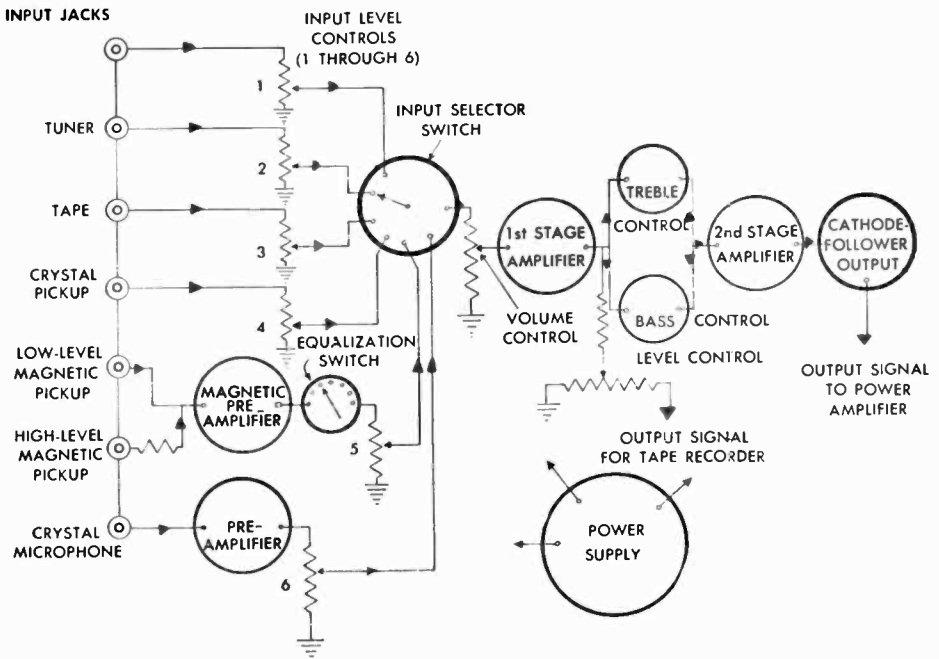

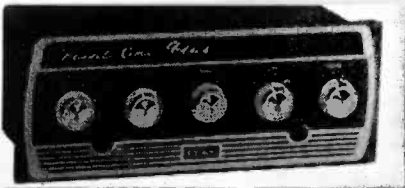

The English-made Leak preamplifier features extremely neat parts arrangement

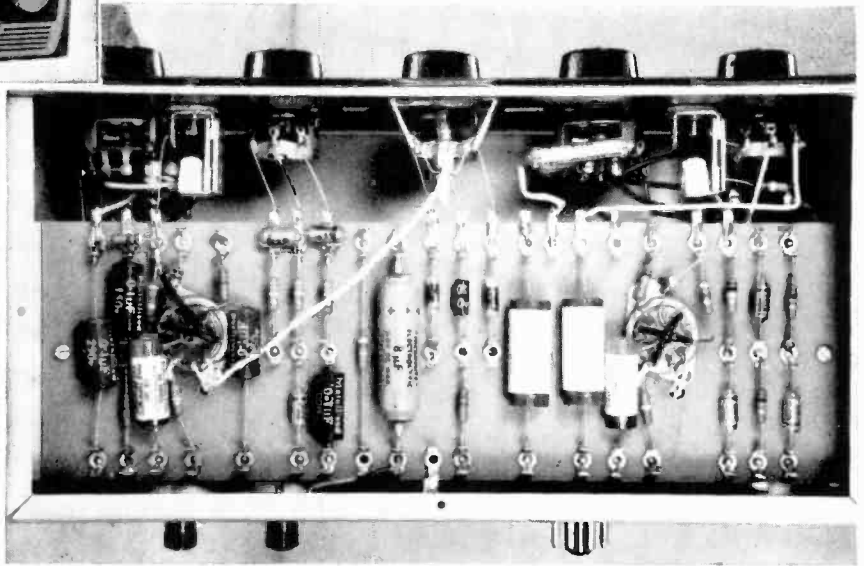

Equipment for evaluation furnished by British Industries, Inc.

chosen depends upon the position of the selector switch. A self-contained preamplifier which is on a chassis separate from the power amplifier is shown. This is not always the case; some preamplifiers are incorporated on the same chassis as the power amplifier. Some are separate, but still employ the voltage supply from the power amplifier, while others may be included in an FM tuner. However they are constructed, preamplifiers do the same job in each case. The lower-priced units are all-in-one and the higher-priced are on separate chassis. This explanation of the various inputs, and of the switching and control circuits, is greatly simplified.

MAGNETIC PHONOGRAPH INPUT: The signal from a magnetic phonograph cartridge is very weak in amplitude. In order to amplify this small signal voltage sufficiently, an additional vacuum tube amplifying stage must be employed. When the selector switch of the preamplifier is in the position marked *Magnetic Phono*, the signal from the cartridge is sent into an amplifying

An amplifier of compact design featuring both pre-amplifier and power amplifier on one chassis

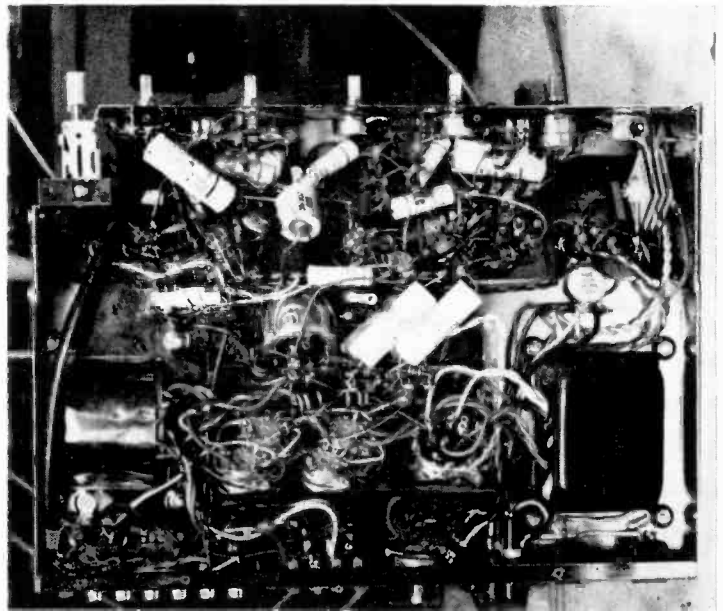

Equipment for evaluation furnished by Sherwood Electronics, Inc.



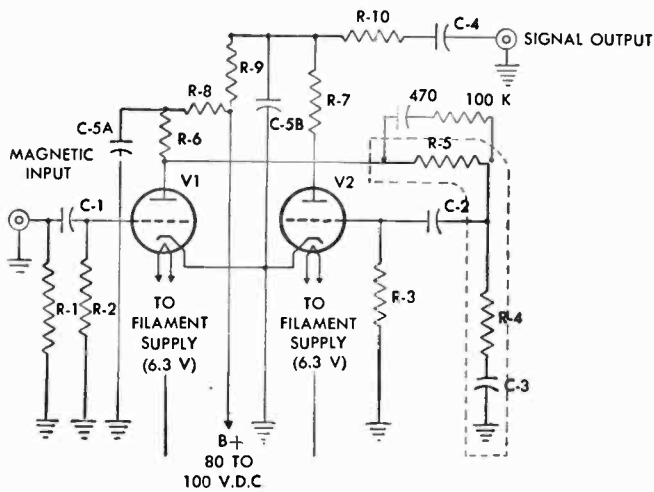

Left: a phonograph pickup preamplifier circuit diagram. The colored components indicate the high-frequency peaking circuit sometimes employed. The dashed lines enclose the low-frequency compensation circuit for magnetic cartridges

Right: block diagram of an input circuit for crystal or ceramic pickup cartridges

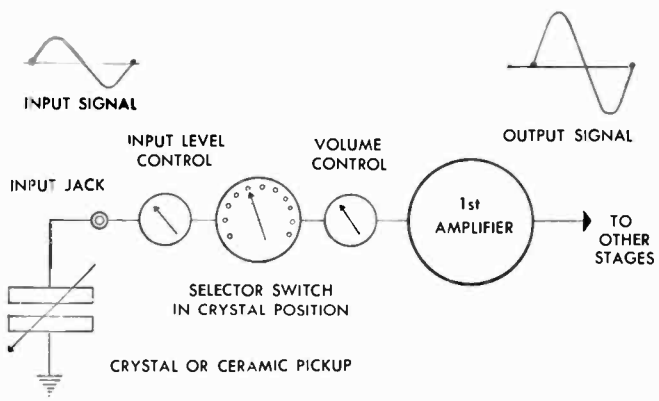

stage (represented by a block on the diagram), and then from there into the rest of the preamplifier. The relative amplitude of the various signals is shown by the height of the sine waves. As a signal progresses, you can see the relative voltage increase in each vacuum-tube stage. However, in some of the vacuum-tube stages there is no amplification, since these circuits are employed as equalizers (tone controls). In some of these circuits a signal loss is encountered which must be made up in later stages. In the amplifier stage for the magnetic cartridge, certain specific circuit arrangements of the component resistors and capacitors are made to compensate for the peculiarities of magnetic devices. In most cases, however, this circuit arrangement is standardized for the average magnetic cartridges.

In the recording and processing of modern phonograph records, each record manufacturer adopted one of several recording systems. These various systems are classified as industry recording curves. The curves relate to the amount of change in bass and treble frequencies that occur during the actual cutting of a disc master. Some of these changes are due to the inherent nature of the magnetic cutter and others are planned changes, designed to increase the frequency range recorded. Only recently has standardization in the recording industry to the RIAA curve come to pass, so high-fidelity equipment manufacturers must still equip their devices with other recent popular record equalization curves. The equalization control is usually a rotary switch with all



Left: an amplifier input selector switch showing various input positions. Right: an internal view of the selector switch

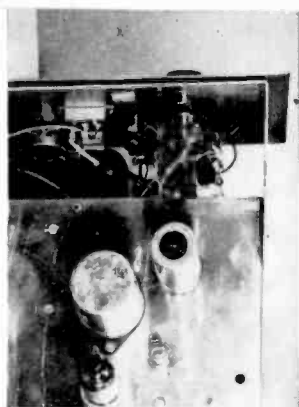

Equipment for evaluation furnished by H. H. Scott, Inc.

input channels clearly marked. As the switch is rotated through various positions, the channels are selected through connections made within the inner sections of the switch. On these selector switches may be four or five phono-graph positions, depending on the manufacturer's readiness to provide record equalization for whatever records might be in your collection. On the block diagram you will see how the output of the magnetic cartridge amplifier goes into this switching network. Since this particular preamplifier is equipped to use a crystal or ceramic phonograph cartridge, with its higher signal voltage, a choice switch is used to by-pass the unnecessary magnetic-cartridge amplifier tube.

THE CRYSTAL OR CERAMIC INPUT: The development of newer and better-quality crystal phonograph cartridges along with their counterparts, the ceramic cartridges, has made them the choice of many high-fidelity fans. No question of the relative merits of the two types exists, but actually just a question of choice. One of the features of the crystal or ceramic units is their increased signal voltage over the low signal of the magnetic units. With a higher output, the crystal-unit signal can be amplified with fewer stages of amplification, and hence with lower cost in the construction of the amplifier. While the output voltage of some magnetic units is as low as 2 millivolts (.002 volt), some of the crystal cartridges designed for inexpensive portable phono-graphs can produce up to 5 volts. The crystal and ceramic cartridges used in high-fidelity record playbacks produce from .5 volt to 1.0 volt of signal energy. Some manufacturers provide their crystal or ceramic cartridge with a small network of resistors and capacitors connected across the terminals of the unit so that it may be plugged into a magnetic cartridge input without over-loading the tubes with too much signal voltage.

The operation of a simple tone control system indicated in block diagram form

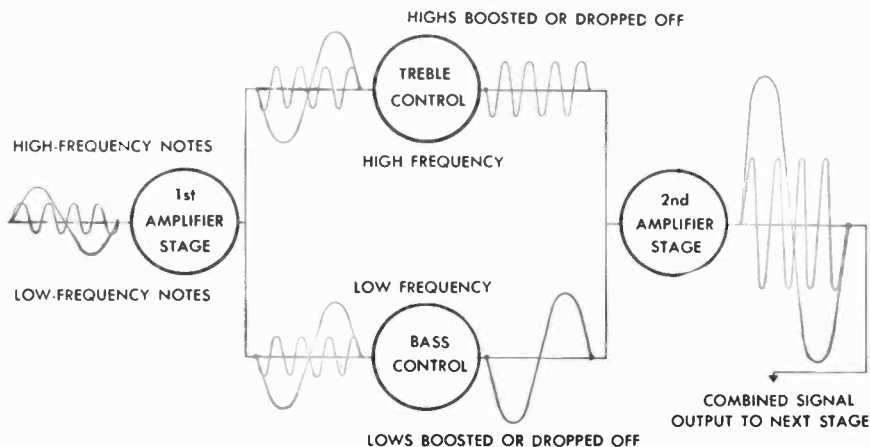

The versatility of an amplifier may depend upon its selective switching and the number of input and output jacks provided

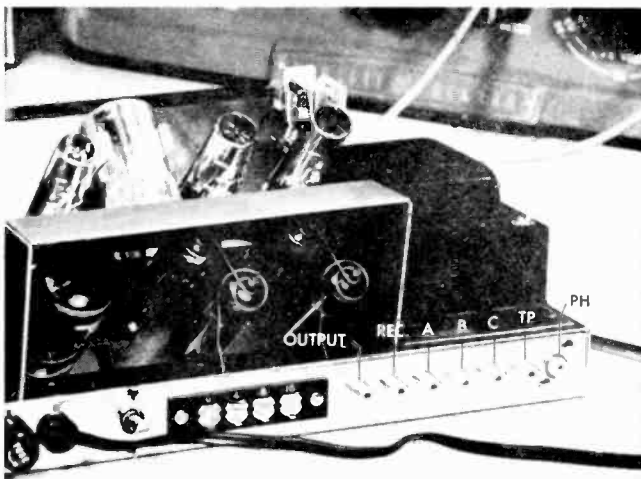

Equipment for evaluation furnished by Sherwood Electronics, Inc.

Even though the first stage of amplification has been bypassed, the signal from the crystal or ceramic cartridge must still go into the equalization stage, as can be seen on the block diagram. The choice of playback characteristics is made by the selector switch. It is necessary to follow the rest of the inputs up to this point, where the record signal voltage comes out of the output of the equalizer circuit.

FM-AM TUNER INPUT: The output signal voltage of the average radio tuner used in a high-fidelity system is high, like that of a crystal cartridge. However, the music or sound that is conveyed over the airwaves either is live, and requires no record equalization, or if it comes from a record being played at a studio, equalization is performed on the spot, before the signal goes to the transmitter. This signal does not require the first stage of amplification the magnetic cartridge did, nor does it call for the use of the equalizer circuit so, as seen on the block diagram, this radio audio signal is switched into the preamplifier at the same point as the output of the record equalizer. This point is the input of the bass and treble controls, which can be used to modify all the input signals to suit individual tastes. These controls and their functions will be discussed later.

The controls used to alter the character of an output signal in a high-fidelity amplifier



Equipment for evaluation furnished by Bell Sound Systems, Inc.

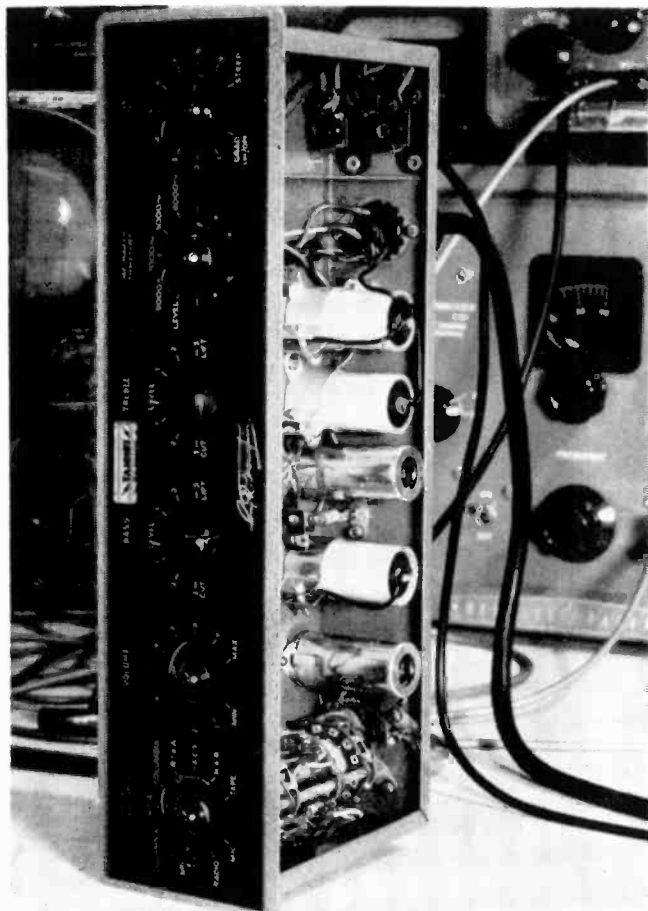

This special high-quality preamplifier by Tannoy of England features calibrated tone and loudness filters

Equipment for evaluation furnished by Tannoy Products, Ltd.

TAPE RECORDER INPUT: This signal is of the same nature as the radio tuner signal in the amplitude of its voltage output. Most high-fidelity tape recorders provide their own special preamplifiers, which boost the very weak signals from the magnetic tape heads. A head preamplifier is located either in the tape device or in a separate unit. Some of the more progressive amplifier manufacturers have incorporated a tape head preamplifier in the circuit arrangement, just as the preamplifier provides for a magnetic cartridge. The dotted line shows the position of this amplifier if it were to be employed. Notice that it also bypasses the record equalization circuit.

MICROPHONE INPUT: If a crystal microphone is to be used, it may be plugged into the crystal phonograph input if its output voltage is sufficient. However, in the case of most crystal microphones and especially in the case of dynamic microphones, additional amplification must be used. A crystal or ceramic microphone can be directly connected to the input circuit, since these are high-impedance devices. Magnetic microphones can be purchased with either high or low impedance. In the case of a low-impedance unit, an input transformer is needed to effect a good match to an amplifier. This transformer may be located on the preamplifier chassis or, more usually, on a microphone-cord attachment. The microphone circuit, however arranged, will bypass the record equalization circuit and go directly into the tone control circuit.

TELEVISION OR AUXILIARY INPUTS: The television and/or auxiliary inputs are connected into the circuit just before the tone control amplifiers

and, of course, bypass the preamplifiers and the record equalization circuits.

THE TONE CONTROL: The tone controls are provided so that a listener can make adjustments in the final sound coming from his high-fidelity system. The necessity for these changes is warranted by several facts. Individual hearing preference is the most obvious reason, coupled with the acoustical changes caused by the furnishings in different listening rooms. In the descriptive tone control block diagram, one block is used to show the treble circuit, and another to show the bass-frequency circuit. Regardless of the type of signal fed to the tone-control circuit, it may be desirable to change the degree of amplification at any one frequency. If, for instance, the high-fidelity system is to be used in a room that is highly absorptive at high frequencies, then these high notes would tend to be lost. An amplification boost in the treble circuit would solve the problem. The converse is true of a room where bass frequencies are lost or need to be attenuated. In an individual case, a person may have a hearing loss at any of these frequencies, either high or low, and the additional amplification of these frequencies would tend to restore normal hearing.

The signal has thus far been carried through the preamp stage and the phonograph equalizer selector network, and is now ready to be sent through the portion marked *Treble* and *Bass Controls* on the block diagram.

The tone controls used in many cases are non-resonant in character, employing either capacitive or feedback effects to do the job. In an actual amplifier circuit, the controls may employ the two halves of a dual triode vacuum tube. The increase or decrease of treble is almost always accomplished first, as the signal is passed through the circuit with the bass unaffected. Then, in the second part of the circuit, the bass is increased or decreased according to the listener's desire; the newly changed treble response is unaffected. It is

Silicon rectifiers are often used in modern amplifier power supplies, replacing vacuum tubes

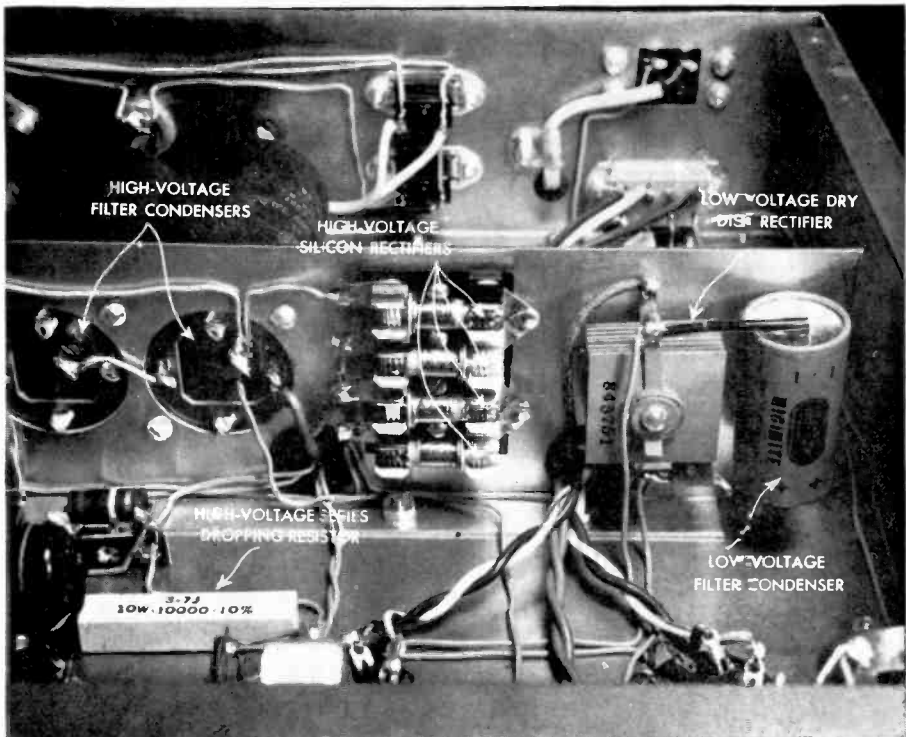

wise to remember that the job of the tone controls is to decrease amplitude as well as to increase amplitude in a particular range of frequencies. Control is effected by the rotation of the treble and bass knobs. When these knobs are left at the middle or "O" position, the tone-control circuit is inoperative, and the signal goes through the amplifier unaffected. There are many methods of gaining bass and treble control; an understanding of them would demand an extensive study of electronics. All these types of controls accomplish the same thing in that the user has an instantly variable set of controls to increase or decrease the amount of bass and treble amplification in his system.

LOUDNESS CONTROLS (TONE COMPENSATED VOLUME CONTROLS): The modern preamplifier often has, in addition to its tone controls, a control called the loudness control. This control is a combined volume and tone control. The human hearing system has the faculty of losing sensitivity to both bass and treble frequencies as the intensity level of the sound is reduced.

Earlier in the text it was mentioned that *loudness*, the response of the human hearing system to different sounds, varied with frequency and intensity. Since it is not always possible for a high-fidelity system to be operated at a volume level similar to that of a live performance, some sort of frequency adjustment should be made under conditions of reduced volume. One of the functions of the tone controls is to boost both bass and treble when the volume level is reduced. However, unless an operator keeps some sort of log of his settings it will be very difficult for him to reset the controls each time the volume is changed. In the design of loudness controls, automatic tone compensation was kept in mind. By the construction of this special control, with its own circuit of resistors and capacitors, volume of intensity of a sound is changed, and as it is, so is the bass and treble relationship. As the volume is decreased, the bass and treble range is increased and vice-versa, to conform with the sensitivity of the human ear.

In amplifiers using loudness controls, a switch may be provided to cut out the conventional tone-control circuits, but should there be none, the tone controls should be set at "O." In the diagram, the loudness control can be switched into or out of the circuit.

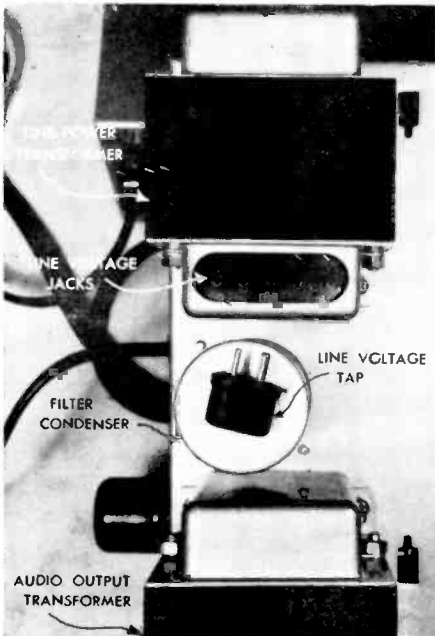

The English-made Leak amplifier. Left: top view, showing line voltage adjustment taps. Below: side view

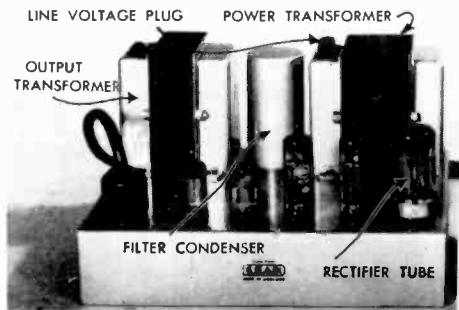

Equipment for evaluation furnished by British Industries, Inc.

The final vacuum tube stage in a preamplifier is constructed according to whether or not the preamplifier and the power amplifier are on the same chassis. If they are, the signal is fed directly into the first tube of the power amplifier, but in the case of separate units that may be some distance from each other, a special vacuum-tube circuit called a *cathode-follower* circuit is employed. The cathode-follower is a specially operated vacuum tube, which is not used as an amplifier, but rather as a low-impedance signal output source. A very long length of cable can be connected to this source without signal loss at the end of the cable; in this case at the input of the power amplifier. In this type of circuit, no line-matching transformers are necessary, as would be the case if the signal were taken off the plate circuit of an amplifying tube.

The signal has been traced through the control or preamplifier to show what needs this device must fill. Signal is ready now for power amplification.

POWER AMPLIFIERS: The primary function of a power amplifier is to receive the program signal voltage from a preamplifier circuit and to send it through various amplifying stages until it has sufficient power to drive a loudspeaker system. The power amplifier, sometimes called the basic amplifier, may be constructed on the same chassis as the preamplifier, or it may be on a separate chassis. The operating voltage supply, commonly known as the power supply, is usually on the same chassis as the power amplifier.

POWER SUPPLY: As we know it today, all electronic equipment employs external voltage or power sources. Whether these supplies are in the form of batteries, radiation-powered units, or generators, their energy is necessary for the operation of the circuit. Most electronic devices depend upon direct current (d.c.), and this current, if not supplied from battery units, must be converted from alternating current (a.c.). Vacuum-tube rectification is most commonly employed to obtain the higher d.c. voltages, and metallic disc rectifiers to obtain lower d.c. voltages. Since the performance of an amplifier depends directly upon the quality of its power supply, an explanation of the operation of this unit follows. The block diagram shows the parts of the power supply, as: power transformer, vacuum-tube rectifier, filter chokes, filter condensers, metallic disc rectifier (for the preamplifier filament supply), and high-wattage load resistor.

A power transformer is an alternating-current device made of two or more wire coils with laminated steel cores. The purpose of the transformer is to conduct 110-volt a.c. house current through its primary coil or winding, and, through the process of induction, produce in other coils or windings (called *secondary* windings), higher or lower voltages as needed. The transformer simply steps up or steps down the a.c. voltage in its primary winding. To step up 110 volts in the primary to 440 volts in the secondary winding, four times as much wire is wound in the secondary coil. For the filament voltages, 11 volts may be needed; $\frac{1}{10}$ as much wire is wound on another secondary coil. Transformers are seldom made by experimenters because of the complexity of their designs. Other considerations besides voltage are those of power-handling capabilities and efficiency. While a power transformer operates within a very narrow frequency range (usually 60 cycles), it must be designed to produce sufficient power for all the vacuum tubes and other circuit elements in the system. Heavy construction, with high-grade iron laminations, good insulation between windings, and the proper gauge of copper wire, are the marks of good transformer.

Several secondary a.c. voltages have been produced in the transformer; they must now be converted to direct current where necessary. A vacuum-tube rectifier is a device for the conversion of a.c. to d.c. It functions like the vacuum tube explained earlier in the text, with the exception of the control grid, which it lacks. The polarity of alternating current is constantly reversing, according to its frequency. In this case, that frequency is 60 cycles. The need for unchanging positive voltages on the plate elements of the various vacuum

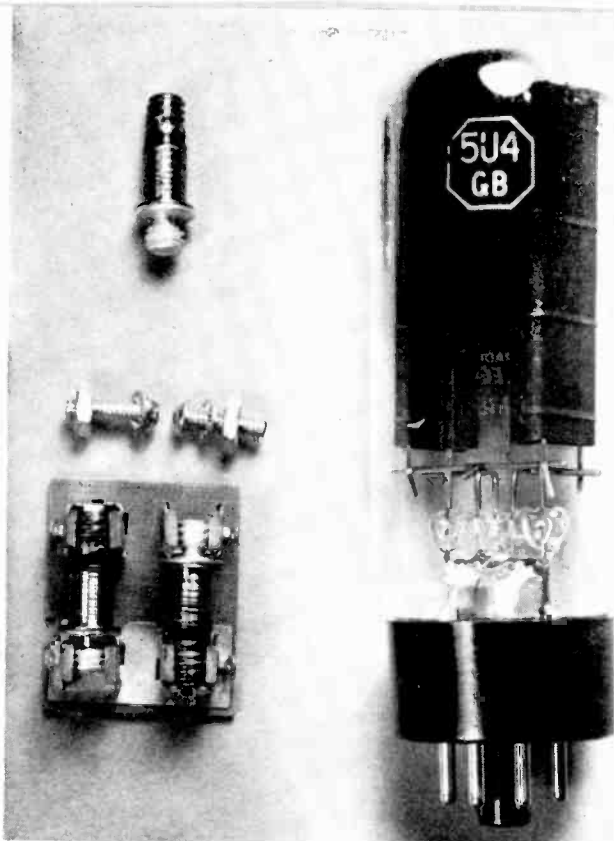

Left: modern silicon rectifiers and mount. Right: an old-style vacuum-tube rectifier

Equipment for evaluation furnished by Audio Devices, Inc.

tubes in any electronic device can be met by employing a vacuum-tube rectifier. Operating as a switch during the alternation of the current, the rectifier allows current to flow naturally from cathode to plate whenever the plate is positive. During the alternation of the voltage from the secondary winding of the transformer, the plate is positive half the time and negative the other half. During the negative cycle the electrons from the always-negative cathode are repelled, and hence the tube current flow is cut off. As the current again becomes positive, it is allowed to flow in the circuit. In this fashion only that half of the a.c. sine wave representing a pulsating direct current is used. By putting another set of elements, plate and cathode, in the same glass bulb, these elements can be made to work during the other half-cycle. Even then, after the rectifier has done its work, the resulting pulsating direct current is not smooth enough to be used in the circuits. If this pulsating voltage were used on the plates of the various vacuum tubes in an amplifier, the resulting sound from the loudspeaker would be characterized by the familiar 60-cycle hum heard in worn-out kitchen radios. When this happens we have all heard someone say, "I guess a condenser went bad." The filter circuits in a power supply are used to make absolutely pure direct current.

Filter choke coils and filter condensers are employed together to alternately store and discharge their current supply into the rectifier circuit. As the process of filtering goes on, the dips between the voltage peaks are filled in and a pure direct current results. Alternating current can be used to power the filament or heater elements in most of the vacuum tubes in amplifier circuits, but in the primary or early stages of the preamplifier it is wise to use direct current. In these sensitive stages the alternating current used on the heaters of filaments of the tube might cause 60-cycle hum interference. To provide this low-voltage d.c., metallic disc-type rectifiers are used. These operate much as vacuum tube rectifiers, but provide the extra current needed in these low-voltage supplies.

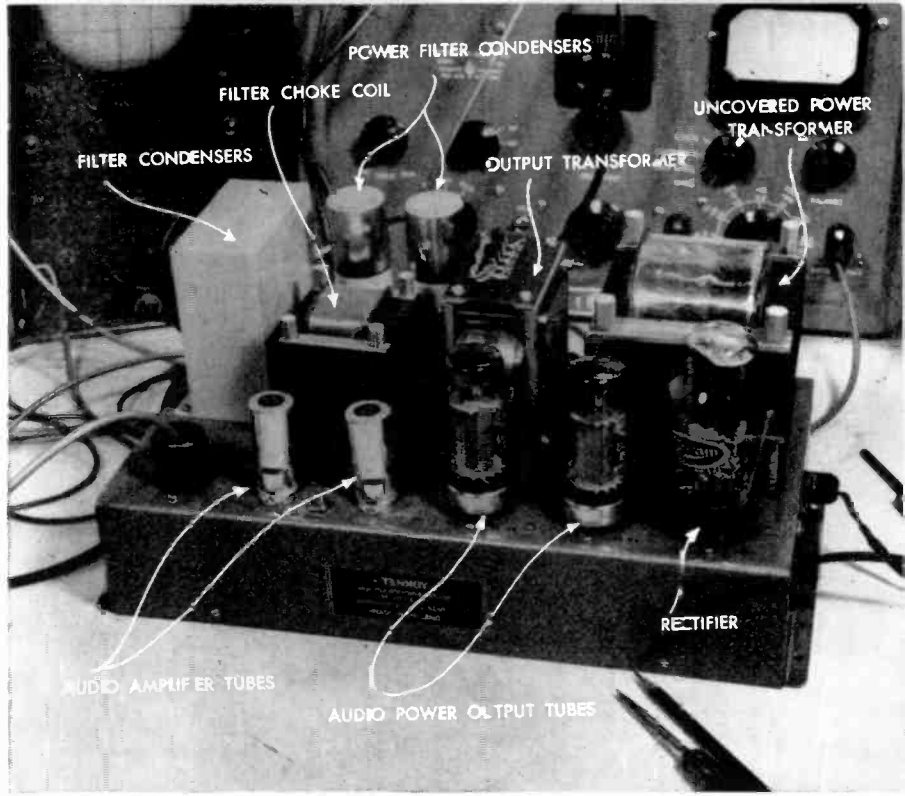

Equipment for evaluation furnished by Tannoy Ltd.

Above: the remarkable Tannoy H. F. 100/20L power amplifier with cover removed

The first power supply kit. This was sold in the 1920's to replace wet batteries

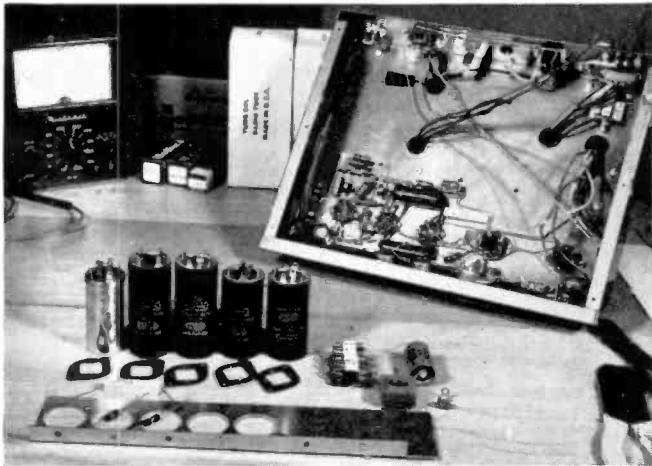

Equipment for evaluation furnished by Heath Co.

Rectifier and filter components for high and low direct current supplies designed to power the Heath 70-watt amplifier kit

Courtesy Sonic Arts, Inc., Chicago

The block diagram shows the progress of a high-fidelity signal through a preamplifier and its various controls, along with the power supply, which powers the complete device. The block diagram continues with the final part of the complete amplifier: the power amplifier.

Improvements in the design of the modern amplifier have increased its frequency range. Extending the bass end of the range has made the disturbing fact of greater intermodulation distortion more prevalent; extending the high range has made this distortion easier to detect. Fortunately for the high-fidelity enthusiast, this extension of frequency range has brought new circuit developments. Until about 1945, very little was done in the development of the final audio stages of amplifiers. Designers of radios up to the late 1930's gave little concern to anything but loudness as the function of the audio amplifier. Every set from the kitchen radio to the console for the living room had the simplest basic amplifier circuit. The antiquated systems of transformer coupling of vacuum tube stages gave way to less expensive resistor and capacitor coupling. Transformer interstage coupling in audio circuits was saved for professional systems.

The invention of what is called push-pull output was the major breakthrough into high-fidelity sound. This output system will be discussed later. The next major innovation in high fidelity was the design of the Williamson amplifier by D. T. N. Williamson of England in 1946. The success of this fine amplifier design lay in several areas; for one, it was an improvement electronically over other push-pull power amplifiers in that it employed an output transformer designed for the circuit; also, it used "beam power" tetrode tubes connected in the circuit much as triode tubes would be, but requiring less driving signal voltage than triodes. In accomplishing the desirable circuit action of the triode tube, the Williamson design employed negative feedback voltage, producing increased power efficiently with less over-all distortion. Another factor in the acceptance of this circuit was its relative simplicity of construction and operation, the major expense being in the output transformer, still the most important part of a power amplifier. Soon other circuits of great merit, like the ultra-linear, were designed, requiring even greater design care in the output transformer, with special windings and high-grade iron transformer laminations.

In the block diagram for the power amplifier are included these components: the input stage, the phase inversion stage, the push-pull output stage, and finally the output transformer. A brief explanation of these stages as the signal progresses through the amplifier follows.

INPUT VACUUM TUBE STAGE: Since the job of a power amplifier is to add power to a signal without otherwise changing it, the input stage—at the other end of the cable or connecting circuit from the preamplifier—is a simple amplifying circuit. The same action takes place in this stage as was explained previously concerning vacuum tube amplifiers. A small signal is impressed on the control grid of a tube, and is further amplified thereby. In some basic amplifiers a level control is placed in the circuit at this point for over-all maximum volume control of the amplifier. It would be unwise to connect and use the full power of a 30 watt amplifier on a speaker system designed for 15 or 20 watts. Severe damage to a speaker can result during maximum power overload, because a loudspeaker is designed for specific current and voltage ratings. When placed in conditions of excessive voltage, like an electric light bulb, it will burn out. Loudspeaker and amplifier manufacturers are now installing protective fusing devices in their components. The block diagram shows simply an increase in signal amplitude with circuit connections to the next stage, the phase inverter.

PHASE INVERTERS: Since the push-pull output tube arrangement with two tubes is being used, it is necessary to get the signal to the control grids of each tube in the proper sequence. The signal going to the output trans-

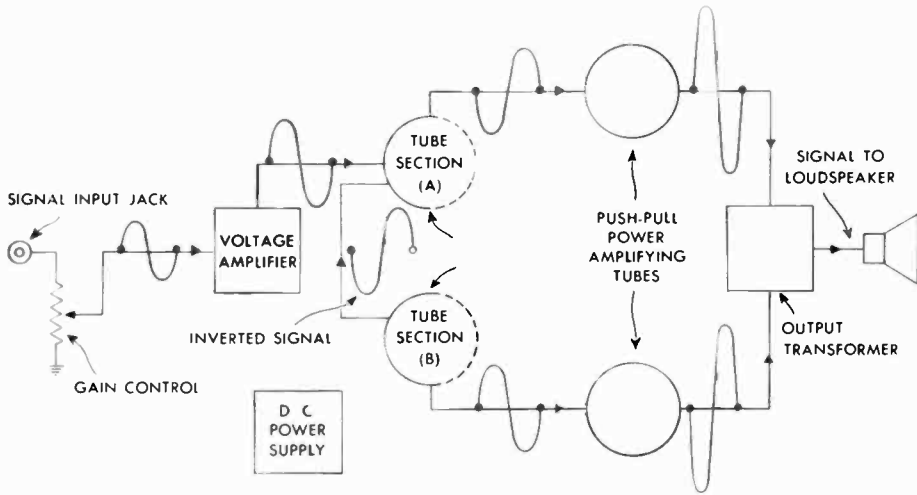

A block diagram of a push-pull power amplifier showing the relative amplitudes of a signal as it is amplified in different parts of the circuit

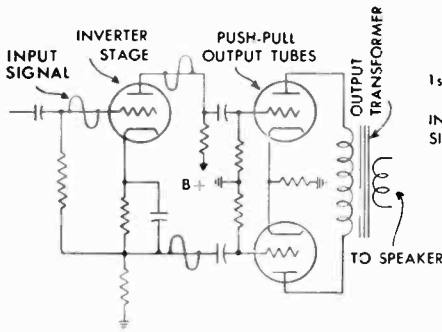

CATHODE-FOLLOWER SINGLE-TUBE PHASE INVERTER

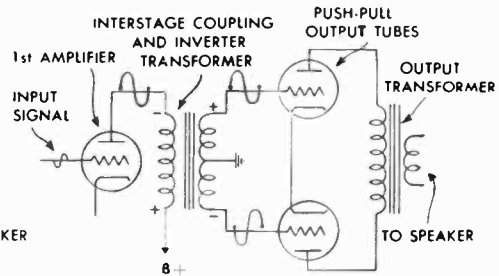

TRANSFORMER PHASE INVERTER

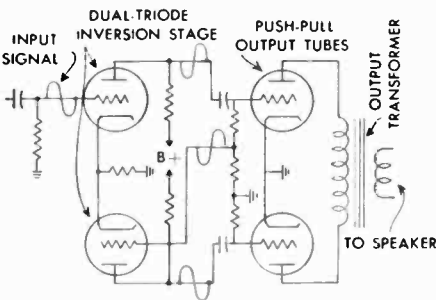

DUAL-TRIODE PHASE INVERTER

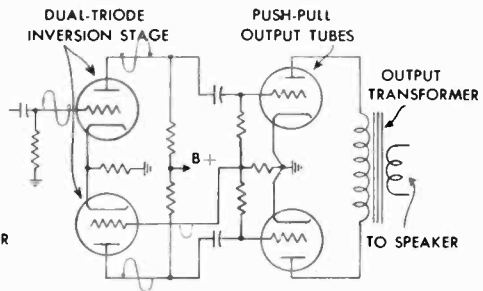

SELF-BALANCING DUAL-TRIODE PHASE INVERTER

Different types of phase-inverter stages

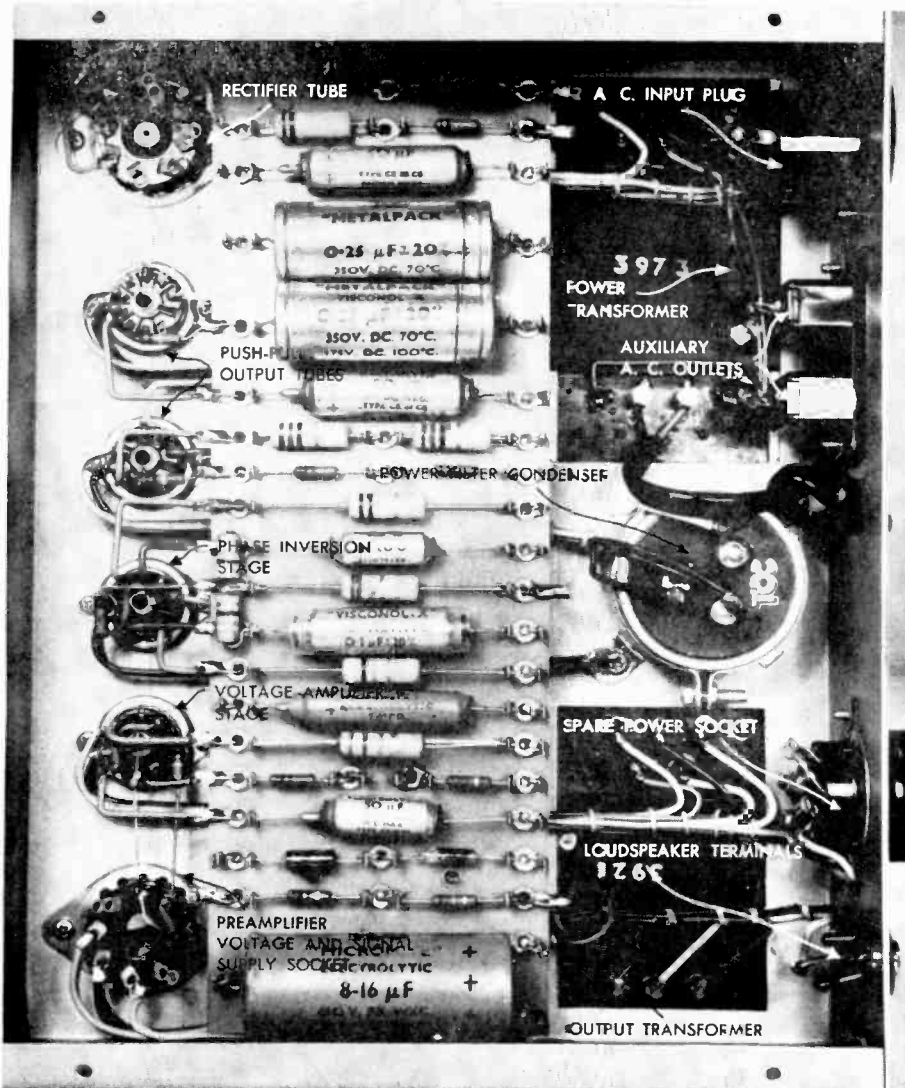

The underside of the Leak amplifier showing the various signal stages and components. Neat, easily serviced parts layout is a feature of this amplifier

Equipment for evaluation furnished by British Industries, Inc.

former from one output tube must be 180° out of phase with the signal from the second tube if a *null* condition, that is, cancellation of the signal, is to be avoided. There are several methods for accomplishing this phase inversion. One method is interstage transformer coupling. The plate circuit of the first amplification stage is connected to the primary of an interstage transformer; the secondary is electrically isolated but inductively coupled to the control grids of the output tubes in the push-pull circuit. Much like the action of a power transformer, the interstage transformer has a constantly changing but always opposite phase relationship at the connecting ends of the winding. In modern high-fidelity circuits the transformers required for this type of operation have to be of extremely high quality to compete with the resistance-capacitance type of inverter. Where feedback is used, other problems are inherent in transformer designs. However, there are several extremely high-quality amplifiers using transformer coupling and inversion which seems to dispute this concept.

Resistor and capacitor electronic inverters accomplish the same job, but with lower cost and greater stability. In some of these electronic inverters no amplification is gained, and in others the full gain of the tube circuit is provided. A small block diagram of a simple resistive-capacitive inverter

shows how the out-of-phase signal is gained. This circuit is one of the early phase inverters; it has been abandoned as unstable by all but the manufacturers of inexpensive amplifiers. Two blocks, representing the two inverter tubes, have been set up. The top tube is a straightforward amplifier stage with the signal applied to its grid. The signal goes through the vacuum tube and is passed on to the following stage (in this case one of the push-pull amplifiers). Now, as has been explained, the output signal in the plate circuit of any amplifying tube maintains a 180° phase reversal with the input signal. In normal amplifying, this has no relationship to the quality of amplification. However, in this case it fits our needs very well. It is plain that we need some sort of signal on the control grid of the bottom tube if it is to power the second push-pull amplifier. Yet, this signal must maintain this 180° phase reversal with the original signal. Here is such a signal at the grid of the first push-pull tube. Another requirement is that the two inverter tubes supply their two signals at the same amplitude. Both these needs may be gained if a variable resistor, or control, is inserted in the grid circuit of the push-pull stage to tap off the required signal, as shown in the block diagram. Once instituted in the circuit the two signals, 180° out of phase, will be supplied to the output stage grids. There are problems in this type of arrangement, since the balance of such a circuit is very difficult to maintain. Any change in adjustment or resistor/capacitor value will throw the whole circuit off, causing unbalance and eventual distortion of the sound.

The more common types of inverters use the cathode-follower type of circuit. An example of this circuit in block form is included here so that it may be more easily understood. It operates according to the basic laws of electrical currents flowing through resistive elements and their associated voltages (signals) across identical resistors. It is a fact that if a certain amount of current flows through a vacuum tube, this current is also present in each part of the plate and cathode circuits of this tube. The correlation is easy to see. If the normal plate load resistor is put in the circuit, split into identical halves but at different points in the circuit, as shown in the block diagram, the same current flows through each half. Now the voltage drop (signal) across the plate resistor is identical to that across the extra half put in the cathode circuit. The relationship of the phase of the input signal to the output signal still maintains in this circuit, with the plate signal going straight into the control grid of the push-pull output tube. The second control grid is supplied by the 180° out-of-phase signal from the other half of the split resistor in the cathode circuit. There are several variations of this circuit, but all accomplish the same job: to supply the control grids of push-pull output tubes. The

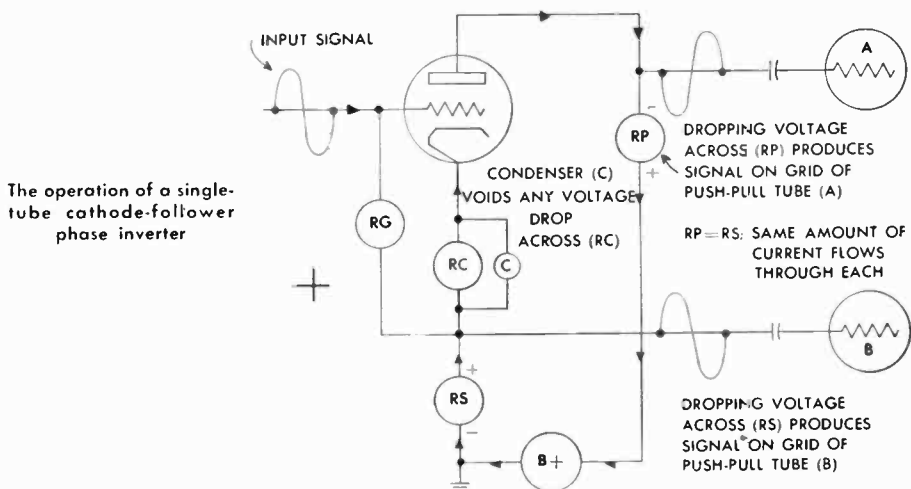

purchaser of an amplifier has little chance to choose his type of phase inverter, but at least this explanation will provide a measure of understanding of what takes place in the amplifier.

PUSH-PULL OUTPUT STAGE: In the course of explaining the progress of a signal through the phase inverter stage, the driving signal requirements have been explained for these two vacuum tubes, which work together in alternation to provide power amplification with a minimum of distortion.

The functioning of a push-pull circuit is as simple to understand as the operation of a vacuum-tube rectifier. In the block diagram each tube is represented by a block, these two blocks connected with the previous stage by resistor and capacitor elements. The output of this final stage in the power amplifier is connected directly to the output transformer.

For clarity, let's review the operation of a vacuum tube. Current flows from the negative cathode element to the positively charged (d.c. voltage from the power supply) plate element. In the path of this flow of electrons is a metallic wire grid which can be charged, more or less negatively in respect to the cathode, by the input signal we wish to amplify. When the signal forces the control grid to become more negative, then fewer electrons flow. There is a point or degree of negative charge where all electrons cease to flow, and the vacuum tube is at cutoff. When the signal in its positive swing allows the control grid to become less negative, then electrons will flow, to a point where the grid swings out of the negative portion of its operating mode, and *saturation*, or clipping, occurs. In this manner, small signal voltages are amplified.

In a push-pull circuit the control grids are energized 180° out of phase. The currents flowing through the two tubes are equal, reaching their maximum and minimum peaks alternately, 180° out of phase. As one tube's current is increasing from a zero value, the other's is decreasing from a maximum value. These currents, flowing in the output transformer's tapped primary, produce a signal in each half; the two are added together to induce the complete signal in the secondary (voice coil) winding. There are many other factors involved which do not bear discussion in a non-technical text, but one that does is the output transformer, its design and function.

OUTPUT TRANSFORMERS: Earlier in this section we discussed conventional transformers used in power supplies. Power transformers are designed to do the job of either voltage step-up or step-down, or both. Designers of such transformers need consider only one operating frequency. In most cases,

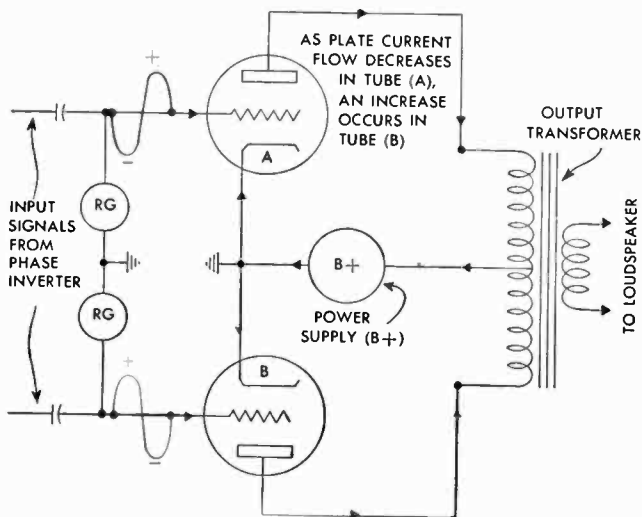

The operation of a simple push-pull output circuit. The black and colored arrows represent alternate tube operation, a result of the 180° -degree phase difference between input signals

Some major components of a Tannoy amplifier, illustrating the practical approach to high-quality transformer design practised by British manufacturers

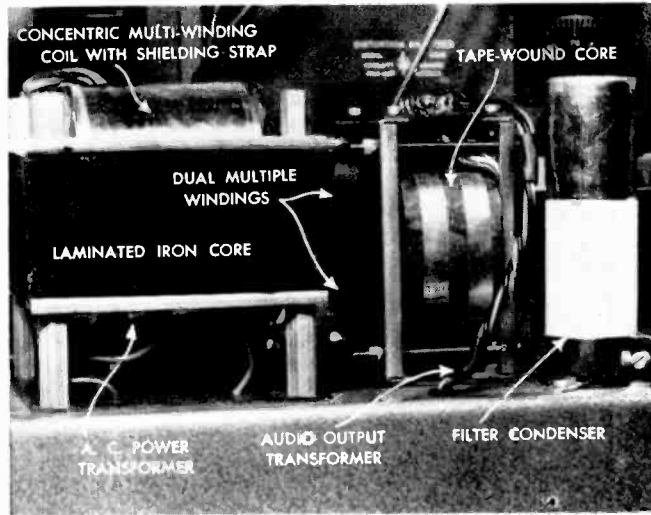

Equipment for evaluation furnished by Tannoy, Ltd.

power transformers are designed to operate on alternating frequency, 60-cycle power line supplies. In aircraft electronics, the frequency of operation may be from 400 up to 4000 cycles, though usually a transformer will be designed for one frequency range. A high-fidelity audio output transformer, on the other hand, must function over a range of perhaps 10 to 40,000 cycles. Special problems exist for designers of these devices. Mistakes in transformer design almost always show up in some form of distortion, which is often blamed on the preceding electronic circuits. Frequency distortion (limitation of frequency range) may be due to low winding inductance, reactance caused by leakage, or resonance. Intermodulation and harmonic distortion may be reflected into the output stage, caused by overloading the primary winding during low-frequency passages. Lightweight construction of a transformer causes low primary inductance in the bass frequency range; as this occurs, distortion is caused by a reduction of load impedance in the output plate circuit. Another feature of poorly designed output transformers, causing these same kinds of distortion, exists when a situation of saturation of the core by the flux density permits non-linear operation. These and other faults can be found in inexpensive output transformers though good design has tended to reduce many of them to unimportance.

Modern transformer design involves the use of balanced coils rather than the older single coils, and special methods of winding the coils on laminated iron cores of better design and construction. Once a transformer is finished it is placed in a metal container and sealed against moisture absorption. If your output transformer can handle its rated power load, providing a wide frequency response with good transient characteristics, your amplifier will perform its high-fidelity function.

NEGATIVE FEEDBACK: The use of negative feedback is universal in the design and manufacture of audio amplifiers. Its very universality has precluded it from becoming a sales argument at the time of purchase of high-fidelity equipment. Since one of the functions of negative feedback in an amplifier circuit is to partially correct for a poor output transformer, we have left this explanation until now. With its corrective capabilities, negative feedback can aid in bettering frequency response, reducing harmonic, intermodulation, and phase distortion, correct for a poor output transformer, and in general stabilize a whole amplifier circuit.

Negative feedback is a most complicated subject and this explanation will be limited to a surface treatment only. The accompanying block diagram

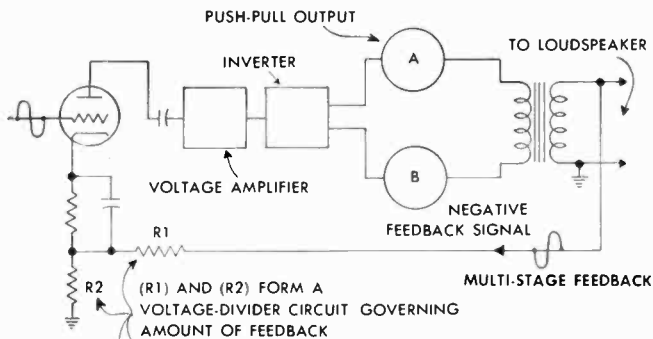

Two examples of applications of negative feedback in audio amplifiers

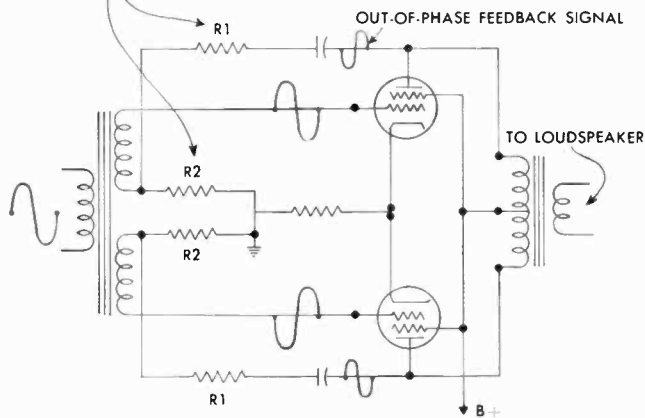

FEEDBACK CONTAINED WITHIN THE OUTPUT STAGE

illustrates, in reference to the block diagram of the complete amplifier, how negative feedback is applied in a circuit.

In operation, negative feedback occurs when a portion of the signal voltage output of an amplifier is taken off the secondary of the output transformer and fed back through a resistive-capacitive circuit into the control grid of an earlier vacuum-tube stage. In audio amplifiers, the feedback loop usually encompasses three stages. For purposes of simplicity let's assume that the signal being amplified is a note from a 1000-cycle tuning fork. As this note is amplified by each vacuum tube stage, it gets larger in amplitude and elements of distortion may creep into its otherwise smooth sine wave. Observe in the diagram the smooth input signal representing the 100-cycle note, and the 180° phase reversal between the sine wave on the control grid and the sine wave on the plate circuit. Depending on the number of vacuum-tube-stage reversals, the phase relationship from input to output may be in phase or out of phase (180°). Negative feedback gets its name from the fact that if two sine wave signals are put together *in phase*, the result of their signals is additive. If these two signals are put together 180° *out of phase*, their signals are subtractive, so to speak. The former would be positive feedback and the latter negative feedback. We are concerned with negative feedback. For the input of our feedback signal we pick some stage that is 180° out of phase with the ungrounded lead of the secondary winding of the power output transformer. Through a resistive-capacitive circuit, a portion of the output voltage or current (depending on the type of negative feedback desired) is fed back to this control grid, or input element. The signal, being out of phase, tends to modify the prime input signal in such a way that the resultant signal, though lower in amplitude, is smoother and more free from distortion.

SPECIAL AMPLIFIERS:

PRINTED CIRCUITS: Electronic devices are constructed of special parts and interconnecting wires and cables. Conventional wiring and construction are expensive because of the necessity for hand work and visual inspection. As the wiring is not fixed in place, insulation must be provided; more space is thus consumed. A maze of wires is not easily traced in production inspection, and very little can be done with conventional wiring in automation (optimum use of machinery).

Printed circuits get their descriptive name from their flat printed-page appearance. It is a popular misconception that they are all actually printed by a printer's press. Printed circuits (electronic, electrical) are manufactured by various processes of printing (conductive paints), etching, embossing, pressure laminating, and inlaying metal conductive patterns on a sheet of board-like insulating material. The purpose of any wire in an electronic circuit is to carry current from one part of the circuit to another. Printed circuitry does the same thing more compactly. In many cases the non-conductive board material can be used to mount other parts, making for much smaller size with less complexity.

Since metallic conductors can be applied to both sides of an insulating laminate, other circuit components, such as small capacitors and inductances, can be formed in place right on the board. Switch contacts, volume control surfaces, and mounting contact holes are readily formed in place. With transistors and other semi-conductive devices, electronic components can be made much smaller and manufactured almost entirely by automation.

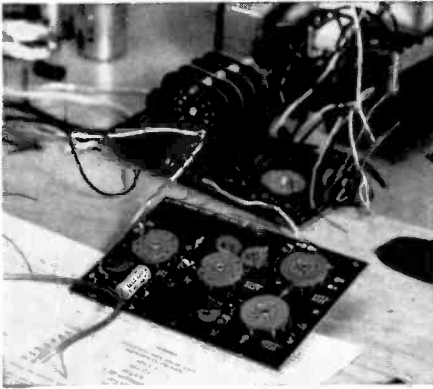

Printed circuit boards, which serve as mounts for audio components, make for easy soldering and compact chassis layout

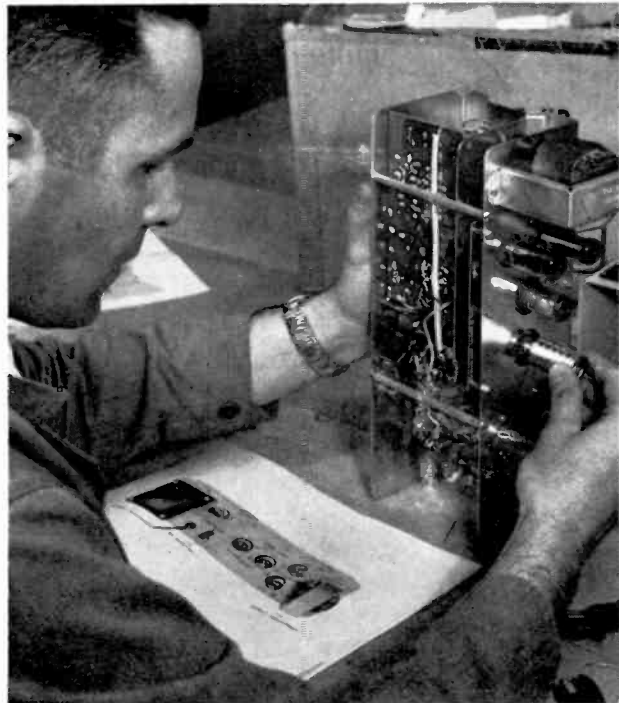

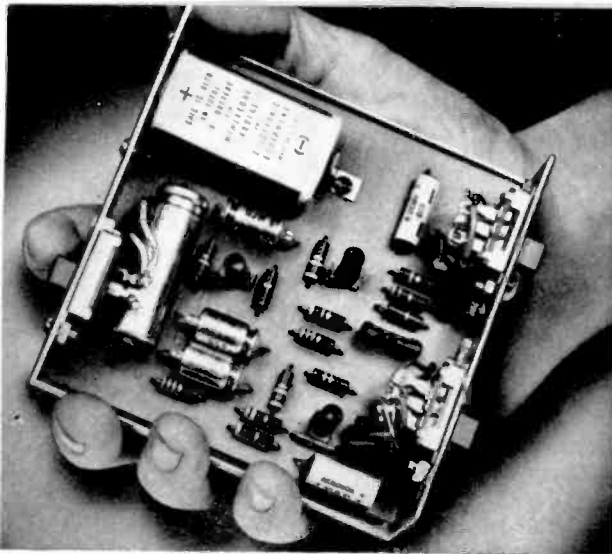

The hand-sized, battery-powered
Fisher transistorized preamplifier
with its schematic diagram
Diagram and equipment for evaluation
courtesy Fisher Radio

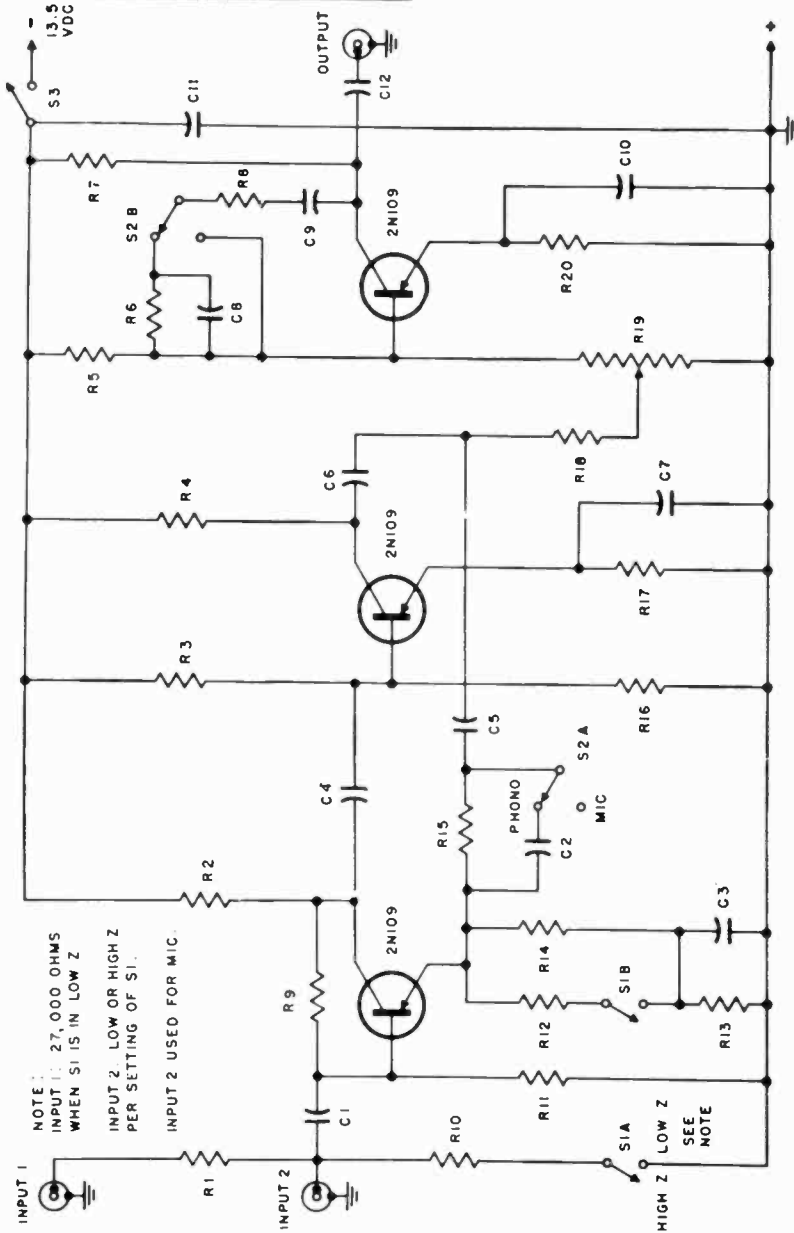

Advantages in high-fidelity equipment: The major value of printed circuits to the buyer of high-fidelity equipment lies mainly in reduction of size. The cost factor as yet is mainly in favor of the manufacturer. Little quality difference exists between a wired and a printed circuit, certainly not a difference that could be noticed by the human ear. We will see more and more use of printed-circuit elements in electronic equipment as automation comes into widespread use.

TRANSISTOR AMPLIFIERS: The advantages of transistors as used in audio work are obvious. They are small, give long-term trouble-free operation, require no heater or high-voltage supplies, operate for long periods of time from small batteries, and are current-operated devices rather than voltage-operated devices like vacuum tubes. Though not always quiet, because of design failures, the transistor is not *microphonic*, i.e., subject to hum fields or thermal noise, as is the vacuum tube. Transistors are low-impedance devices, unlike the high-impedance vacuum tubes, and have many direct applications in the audio field.

We have shown how electrons in vacuum tubes are freed through heat from a metallic cathode within a vacuum. Our problems have been concerned with the control of those electrons on their way to the positively charged metallic plate. The transistor might be termed a solid-state electronic device. There is no heater or cathode element as such, nor a plate within a vacuum. To the eye, the transistor is a solid metal object not much larger than an aspirin tablet.

The operation of transistors and other semi-conductors depends upon a flow of electric charge carriers within the solid of which the transistor is made. Rather than electron flow such as we have in the vacuum tube, we are concerned with the generation and control of these electric charge carriers within the solid.

The solid most used in transistors is germanium in a polycrystalline form, prepared in a very involved manufacturing process. The operation of transistors and other semi-conductors depends upon certain impurities in the germanium crystals. Ways have consequently had to be found to control these impurities, which provide the electric charge carriers and aid in the control of the flow of these carriers. These imperfections are of several kinds, such as radiation energy, imperfect atomic structure, and chemical impurities.

The early "point contact" transistor brought in a complete new set of terms with its invention. Where *grid*, *cathode*, and *plate* were common terms in vacuum tube work, there were now the *emitter*, *base*, and *collector* for the transistor. The point contact transistor consists of two closely spaced contact points on a small wafer of germanium much like the "cat's whisker" of an old crystal set detector. One of the contacts is known as the *emitter* and the other as the *collector*: the wafer of germanium with its holder is called the *base*. The signal input is usually between the emitter and the base; the output is between the collector and the base.

In later transistors, called *junction types*, two sections of germanium crystal of the same polarity of conductiveness are separated by a center section of another material of opposite polarity. Differing from the point contact transistor, where the action takes place at the points, the action in the junction transistor takes place in the union points between the various materials. The transistors employing a *grown junction*, called *N-P-N*, have an emitter with negative bias and a positive collector with respect to the base. With this flexibility, numerous circuits can be devised for the transistor. Newer, more complex transistors are suitable for many other vacuum tube replacements.

ADVANTAGES OF TRANSISTORS IN HIGH-FIDELITY EQUIPMENT: The transistor has made possible lighter and more easily portable equipment. There are no unique advantages in having transistorized circuits outside of the compactness and simplicity of the external power supplies. The transistor has

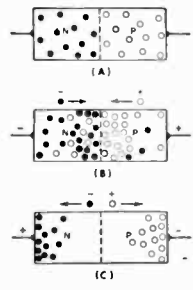
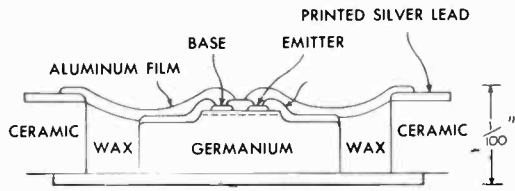
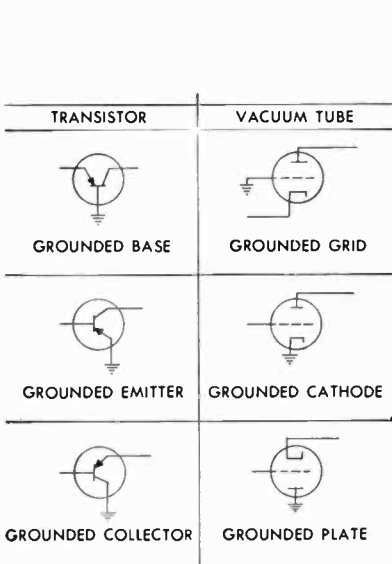

Above: the ultimate in compactness. A printed transistor developed by the U. S. Army. Left: junction-type transistors (A) without potential applied, (B) with forward polarity, (C) with backward polarity applied. Far left: transistor applications and their vacuum-tube counterparts. Below: (A) point contact, (B) grown junction, (C) alloyed junction transistors

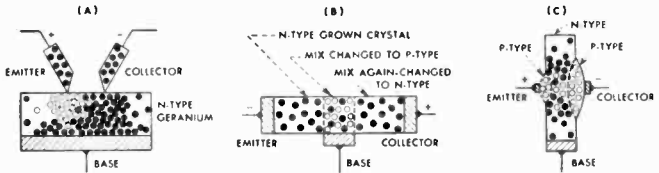

not given better or, at present, less expensive equipment. Preamplifiers in high-fidelity systems were the first to employ battery-driven transistors, which help to avoid hum signals and thermal noise. As yet the power transistor has not made its way into high-fidelity equipment, but when it does there will be a radical design change in all high-fidelity audio equipment; we will be able to expect smaller combined units.

MAGNETIC AMPLIFIERS: Permanence and reliability of electronic equipment has always been a problem where parts which wear out, like vacuum tubes, are employed. In recent years there has been much experimentation with types of amplifiers that can be put into service and left without care. Transistorized units have come as close to this ideal as anything in practical operation at this time. Other new developments in old fields of endeavor are producing promising results. In 1901 C. F. Burgess and B. Frankenfield started the basic work that produced what is called the magnetic amplifier. Their device was primarily used for industrial power distribution and control, but their investigations have produced the modern magnetic amplifier, so important to navigation, industrial controls and power devices, modern computers, rocket and aircraft guidance, and many other fields. The magnetic amplifier is not well known to many high-fidelity amateurs, but one day it will perhaps supplant the vacuum tube and the transistor amplifiers.

The magnetic amplifier, which uses only coils (reactors), unusual transformers, and disc rectifiers, is not subject to the characteristic changes or failures of vacuum tubes. Shock or vibration does not affect it, and it is in operation the moment it is turned on, without warmup. The magnetic amplifier has no moving parts, and so can be *potted*, that is, enclosed in a metal container and surrounded with resin, which on hardening protects the device from moisture and corrosion. Complete isolation between input circuits and output circuits can be accomplished. The versatility of control of the magnetic

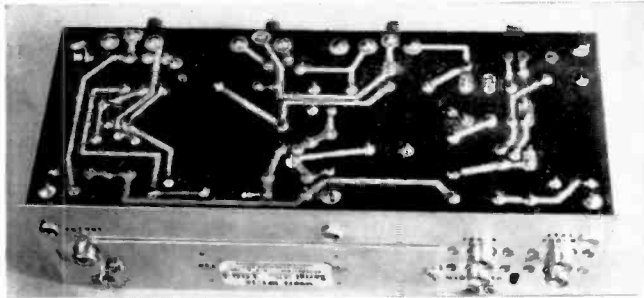

Equipment for evaluation furnished by Itegency

A single dip-soldering operation makes connections on the printed circuit wiring board of this compact preamplifier. Preamplifier has self-contained, battery-operated power supply

amplifier makes it the perfect amplifier within its operating frequencies, with capabilities of many times the power gain of a single vacuum-tube stage. The input and output circuits can be prepared to cover a wide range of impedances without extra cost problems. Successful work has been done to provide designs for audio frequency amplifiers operating up to 20,000 cycles. It is probable that combinations of magnetic and transistor amplifiers will appear before the magnetic amplifying device by itself.

CAPACITOR (DIELECTRIC) AMPLIFIERS: Rather new developments in an old idea have brought the dielectric amplifier into the range of possible use for amplification within high-fidelity audio ranges. Its qualifications are much the same as those of the magnetic amplifier, with the exception that it is capacitance-operated.

One of the basic electrical phenomena connected with certain types of electrolytic capacitors is that their capacity varies with the d.c. voltage applied to them in a circuit. This variation can be used for wide-range amplification. The use of capacitor (dielectric) amplifiers is limited to special instrumentation and computer circuits at this time, but further work is being conducted toward their use in audio work.

STEREOPHONIC (MULTIPLE CHANNEL) AMPLIFIERS: Stereophonic playback, employing two loudspeakers, has brought the need for two power

A simplified magnetic amplifier employing a magnistor. A large flow of current can be controlled by a relatively weak signal

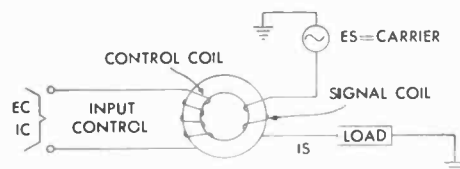

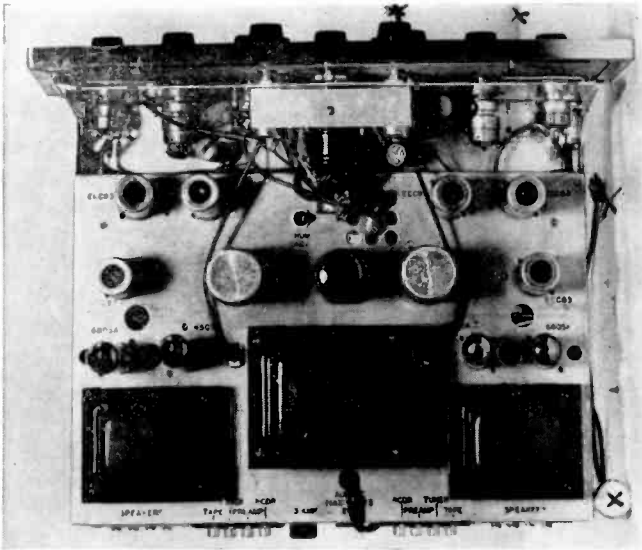

A dual-channel stereophonic amplifier with operational controls. Left: top view. Below: front view

Courtesy Madison-Fielding Corp.

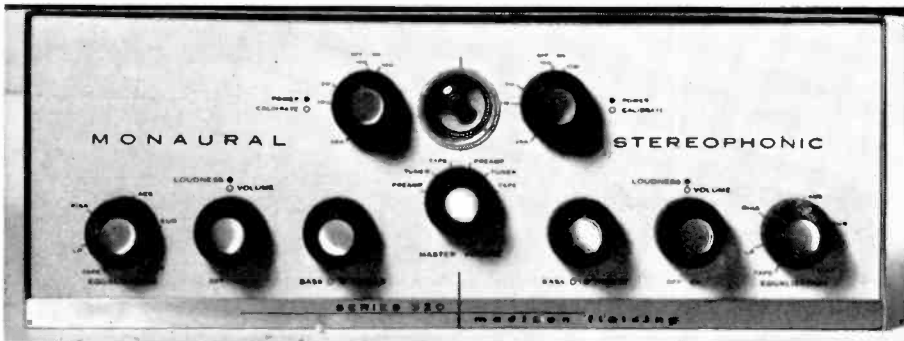

amplifiers in high-fidelity systems. Regardless of the number of channels used in the playback of stereophonic sound, each must use its own amplifier and speaker combination.

The power amplifiers used for each channel are no different than any other power amplifiers used in conventional high-fidelity systems. Whether the stereophonic sound is recorded on magnetic tape or on a single-groove disc, each channel will need power amplification. Since the principle of "stereo" lies in the fact that completely separate channels are used for recording and reproduction, the power amplifiers should be completely individual even though they are sometimes constructed on the same chassis by the manufacturer. It is not necessary that the power units be together; they may be separate conventional power amplifiers even of different makes, working in the same or in different locations.

AMPLIFIER INSTALLATION: The prime requirement in the installation of any electronic equipment is adequate ventilation, with considerations of decor, access, and ease of mounting following.

There are two reasons for stressing the importance of ventilation. The first is the safety factor, and the second the proper functioning of the equipment. All vacuum tubes operate at elevated temperatures. Some, as in portable radios, emit only a small amount of heat and others, like the latest type of power amplifier output tubes, operate at a temperature high enough to

ignite paper. In planning the installation of a power amplifier and power supply, you must give consideration to venting the confining area so that the heat can escape.

1. Try to mount your amplifier in a horizontal position with the tubes vertical so that the heat can be carried away by natural convection. If possible, raise the amplifier at least an inch from the mounting board. (Some amplifiers have perforations in both the chassis top and the bottom cover plate to aid natural ventilation around the component parts.)
2. If the amplifier must be mounted so that the vacuum tubes are horizontal, the amplifier should be turned so that the tubes are not shielded at the top by transformers or other component parts.
3. Try to place the equipment in an area with at least 4 inches of clearance on each side and 6 to 8 inches of clearance at the top. If possible, drill many 1-inch holes in the back or floor of the mounting area to facilitate ventilation. Wire mesh decorative panels in concealing doors will also aid in cooling the area.
4. When it is necessary to install two power amplifiers and power supplies in one area for stereophonic sound, extra care must be taken to provide more

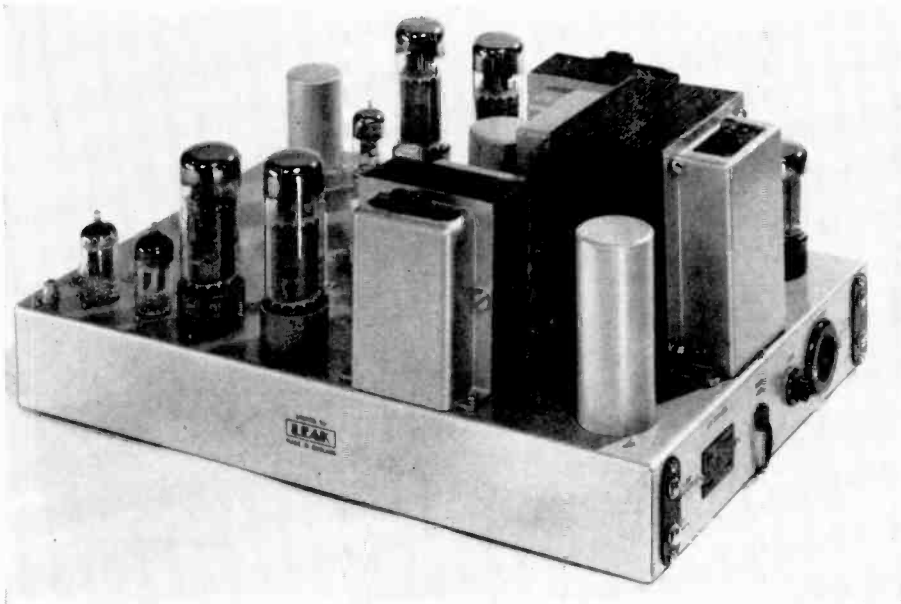

Above: a dual-channel stereophonic power amplifier. Right: a stereophonic preamplifier for use with the above power amplifier. Ganged controls are featured



Equipment for evaluation furnished by British Industries, Inc.



Left: front view of dual-channel stereophonic amplifier. Below: schematic diagram of same

Equipment for evaluation furnished by Bell Sound Systems.

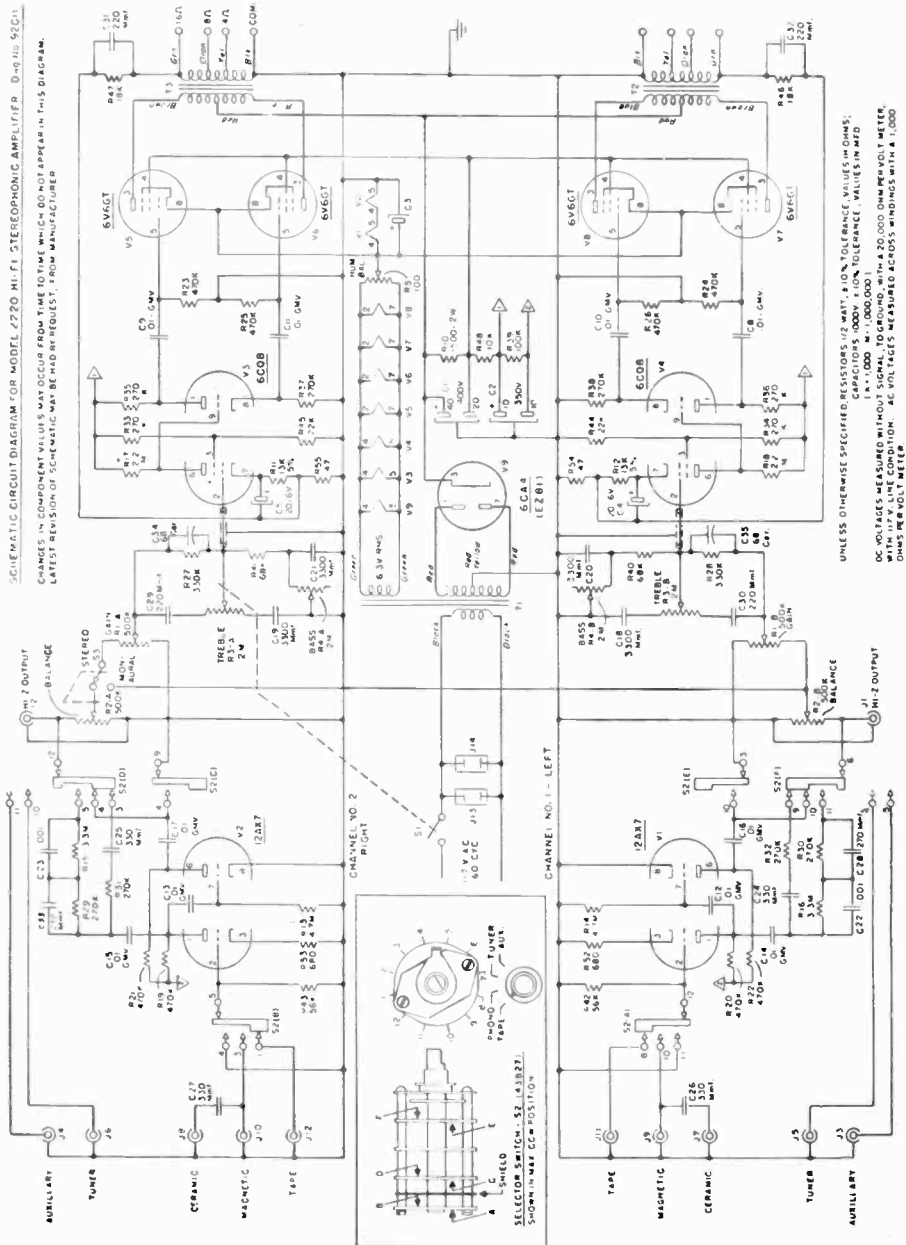

Two separate high-quality amplifiers are here used together for dual-channel stereophonic sound reproduction. This is a recommended practise.



Equipment for evaluation furnished by H. H. Scott, Inc.

than minimum air passage. Where the area is small, forced-air ventilation by electric fan is advisable.

5. Avoid close contact between vacuum tubes and flammable materials such as wood surfaces and grill cloth and paper.

6. Avoid storing plastic disc records close to the heat generated by power amplifier equipment.

7. Avoid storing magnetic tape in areas that may be heated above 75°, by either the household heating system or the heat from the amplifier equipment.

8. Avoid storing magnetic tape in areas near the large power transformers used in both power supplies and power amplifiers.

9. The placement of a separate control or preamplifier is less limited due to the fact that less heat is generated by these units unless they are self-powered. Even those that are self-powered do not generate as much heat as the power units.

If all the basic safety requirements for amplifier installation are met, the final requirements of access for maintenance and repair can be considered along with those of decor. Decor is a matter of aesthetic choice, and should be appropriate to the mechanical design. Access is simply a matter of mounting the unit so that it can be easily unbolted or unscrewed and removed.

Exterior decor should complement the existing fittings of the room. Interior decor of the installation is a matter of good judgment; no flammable painted surfaces, water-mixed casein or rubber base paint. A better surface is ¼ inch of asbestos board or similar fire-proof material. Heeding this advice will provide a safe, long-lasting system.

THE DO-IT-YOURSELF AMPLIFIER KIT: Apart from the fun derived from assembling a modern kit amplifier, you can have a better system per dollar spent. We do not imply that kits are better than factory-made units. There are "lemons" in both cases. However, if you are interested enough



Good soldering practise is one of the most important requirements for successful kit building

Equipment furnished by Heath Co.

in doing the mechanical work, you need not consider the fact that you may never have had a pair of pliers or a soldering iron in your hands before.

There are many kits available, some good, and some bad. The only advice we have is to buy your kit from a reputable manufacturer. The companies that sell kits at marginal prices must use cheaper and less reliable parts. You will find "off-brand" parts—resistors, condensers, capacitors, and transformers—of unstable and unreliable quality in these units.

You will have several important considerations before buying and starting any amplifier kit:

1. Are you willing to follow the directions? The manufacturers of these kits have gone to a great deal of trouble to provide just exactly the right parts,

Below: Check off kit parts on a check list before assembly. Right: good tools and a neat place to work are necessary. Below, right: finished kits can have professional appearance

Equipment furnished by Heath Co.

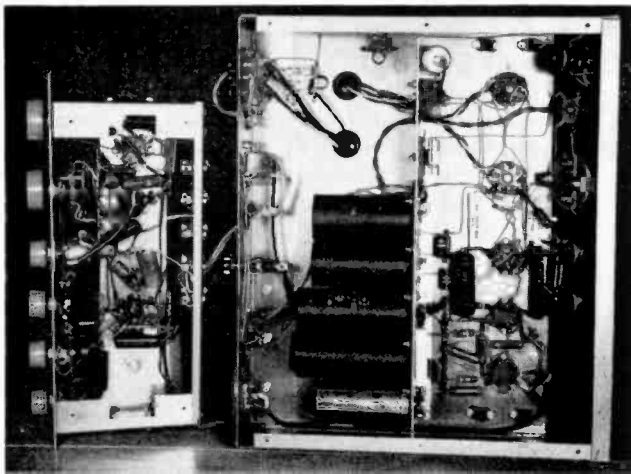
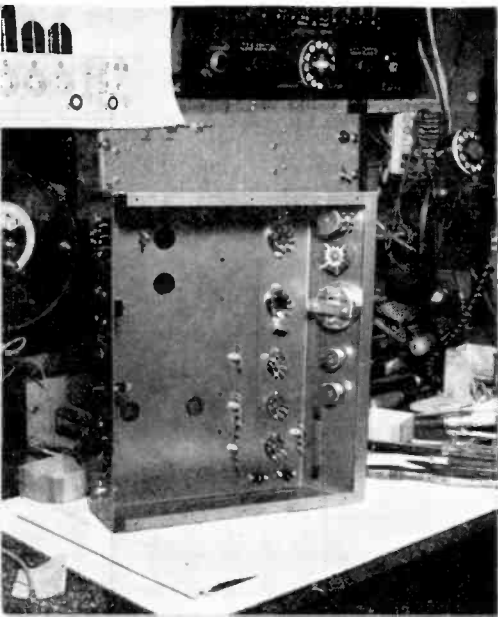
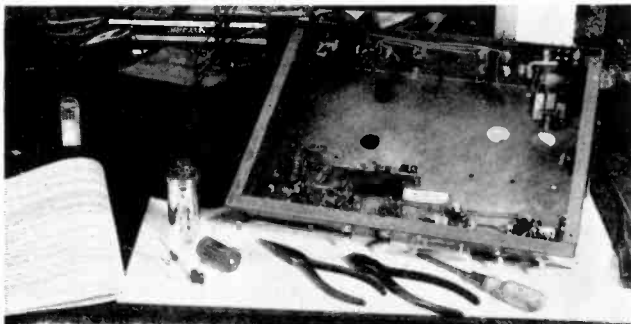

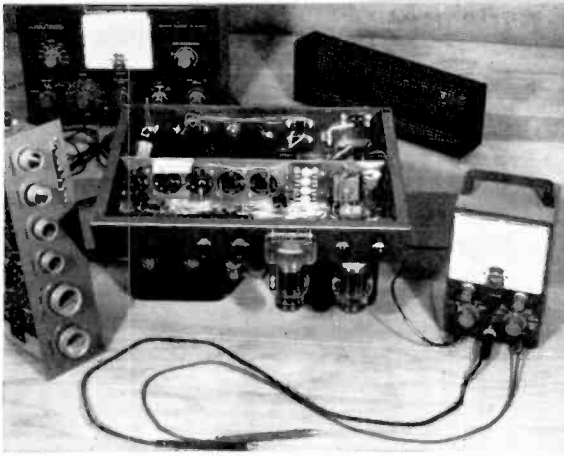

Test equipment may be constructed from kits. Above: kit-constructed audio analyzer, left, and vacuum-tube volt-ohmmeter, right. Right: Co-author Jordan at work



Equipment furnished by Heath Co.

the correct lengths of wire, and good design and layout. Even if you have had considerable experience in electronics, you will find that following directions will not only save you time but eliminate electronic troubles in the final unit.

2. You will have to be able to solder correctly, since poor soldering is an eventual source of trouble. Lead solder has only one function: that of making a good electrical connection. It is not intended as a support for parts. The only solder to be used is rosin core solder. **ACID CORE SOLDER MUST NEVER BE USED. ALMOST ALL SOLDERING PASTES ARE BAD FOR USE IN DELICATE ELECTRONIC EQUIPMENT.** The corrosive effects of acid on metal are well known. Acid core solder, when heated with a soldering iron, splatters small globules of acid on all surrounding parts. In the course of time corrosion takes place, with serious harm to the functioning of the circuit.

3. You will have to observe safety rules in connection with the high voltages used to operate amplifier circuits.

4. Again: Follow the directions provided by the manufacturer for placement of parts, layout of wiring, and correct soldering of the final connections. Instructions for balancing the modern high-fidelity amplifier are given by the manufacturer and should be done exactly as stated. Sometimes a voltmeter is required; it can be borrowed or built from another kit.

MAINTENANCE OF AMPLIFIERS: On the whole, serious maintenance problems in high-fidelity audio amplifiers are the responsibility of trained technicians. However, there are steps that can be taken to prevent minor problems from occurring.

1. Follow all requirements laid down for the ventilation of vacuum-tube equipment to avoid overheating of tubes and component parts, which would tend to shorten the operating life of the amplifier.
2. Keep all plugs and connectors free from loose connections.
3. Do not run plastic-covered wire or cables near or against hot vacuum tubes.
4. Check vacuum tubes at least every 6 months to a year, replacing any tubes showing short-circuited elements or low emission.
5. Be sure that all speaker terminal screws or connections are maintained tightly against the wires.

6. In making long runs from other units to amplifiers be sure to use the correct cable.

7. In making long runs between amplifiers and loudspeakers be sure to use wire of large enough diameter, and try to avoid running it long parallel distances against grounded waterpipes or metal air ducts.

8. Do not use conventional light plugs and sockets for connectors on loudspeaker lines, since there is always a chance that someone may plug or connect these elements to a 110-volt house receptacle.

CORRECTIVE MAINTENANCE: Should an amplifier fail to operate, there are certain things the owner can do to locate the trouble and, if it is not serious, correct it himself. The steps which follow are those to use when trouble occurs.

If the trouble is audible, such as hum or "static," it may be caused simply by a bad tube or loose connection. However, it may be internal trouble for which a trained serviceman will be necessary.

One of the cardinal rules of set maintenance is not to try to force a failing or faulty piece of electronic equipment into prolonged operation after trouble has set in. It is common for a simple trouble like a shorted tube or part to cause the burn-out of major transformers, producing an expensive repair situation. If in doubt call in an experienced repairman or technician.

Many of the failures of vacuum tubes can be averted by periodic checks and replacement of tubes that have become weak or shorted. It is wise to keep track of the time in service of all your vacuum tubes and the type and number of repairs necessary over the life of the equipment.

Proper testing, as on the Fisher 100 amplifier shown, calls for high-quality test equipment

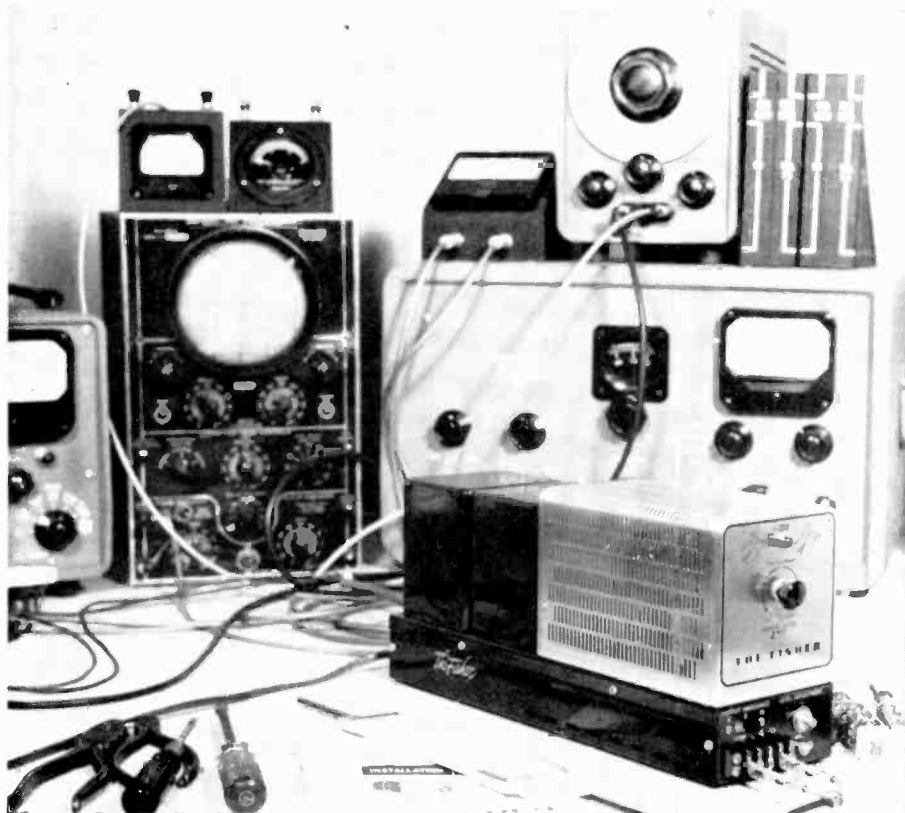

Amplifier furnished for evaluation by Fisher Radio Corp.

FAULT	CAUSE	CORRECTION
1. Hum (goes away as volume control is turned off)	Loose cable or lead to input of amplifier	Check leads and connectors for poor connection
2. Hum (same)	Bad tube or loose lead in preamp or early stages of amplifier	Check tubes and leads
3. No visible tube filaments or dial lights	Faulty fuse or short somewhere in circuit or tubes	Check fuse, replace once with same size fuse. If still bad, check tubes and replace fuse
4. Static (intermittent noise)	Loose connection in connecting cable	Check plugs, connectors, and cables for loose connections
5. Microphonic noise (ringing sound)	Microphonic tube	Test by tapping and replace
6. No sound	Blown fuse Burned out tube	Check fuse. Check for filament light, substitute
7. Fuzzy sound (increased distortion) on all selector positions	Disconnected cable Open speaker voice coil	Check cables and speaker by substitution
8. Fuzzy sound on phonograph position only	Bad tube or circuit troubles	Check tubes or call technician
9. Fuzzy sound on phonograph position only	Faulty phono cartridge or stylus. Bad preamp tube	Check stylus, cartridge or tube
9. Low volume (on all selector positions)	Bad amplifier tube or bad rectifier tube	Check tubes
10. Smoke, no sound	Shorted part or tube	Call technician

4

LOUDSPEAKERS

HISTORY: Man's efforts to be heard across long distances were described earlier in this text. The development of sound amplification started with the speaking trumpet, which was in use as far back as the pre-Christian era of ancient Greece.

The primary work in the modern concept of the loudspeaker, a device for changing electrical signal energy to acoustical signal energy, might be credited to Alexander Graham Bell and Thomas A. Watson, inventors of the telephone. However, the accidental invention of a voice reproducer came before the arrival of the disc phonograph in 1876. Bell and Watson found that two sets of wire coils and spring steel reeds could be hooked together by wires in a circuit with a battery; when one spring was set in motion mechanically, the other spring was made to vibrate by impulses sent along the wire from one coil to the other. It was in this fashion that the first conversion of electrical signal energy to acoustical energy took place. As distinguished from the signal of the already useful telegraph, the Bell and Watson discovery showed that all the subtle variations of speech might be converted into electrical signal energy at one end of a pair of wires, transmitted any distance, and then reconverted into acoustical energy that could be heard by the human ear.

The whole history of the telephone is closely linked with the necessity of accomplishing this electricity-sound conversion in the most practical and efficient manner. The earpiece (receiver) of the telephone was really the first loudspeaker, however softly it transmitted sound. The first loudspeaker might best be described by analogy to Bell's idea of a coil of wire and a piece of spring steel. In the case of the loudspeaker, the coil is wound around a magnetic iron core; the disc-shaped piece of spring steel (diaphragm) is placed over the pole pieces of the coil. As electrical signals are fed into the coil, the over-all magnetism of the iron core is changed in direct relationship to the signals; the suspended metal diaphragm is attracted to and repelled by the core accordingly, causing the air to pulsate and produce audible sound. What has been described is the principle by which most loudspeakers operate. There are some electrical and mechanical differences between units, but all accomplish fundamentally the same job. Design and production methods vary because of differences in approach to the problems of converting electrical signals to acoustical energy as efficiently and with as much fidelity as possible.

The radio loudspeaker was developed shortly before World War I by Peter

Alexander Graham Bell and Thomas Watson used this device in discovering that an alternating signal could be transmitted over wire

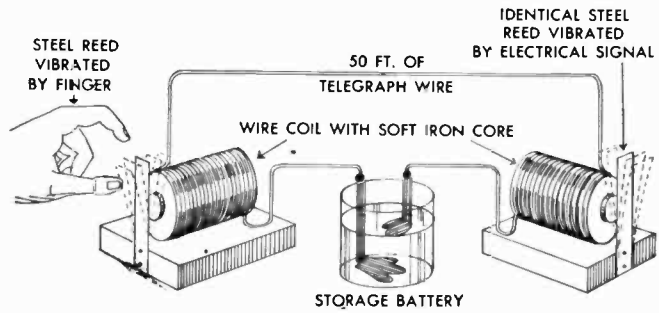

Jensen and Edwin Pridham, who discovered and patented the moving coil dynamic loudspeaker in January of 1913.

The personal history of Peter Jensen reads like a novel. It begins in Denmark, where Mr. Jensen was born in 1886. His first important job was with Valdemar Poulsen, the Danish Edison, at Poulsen's laboratory. It was Jensen's job, as an assistant engineer, to operate Poulsen's experimental radio station at Lyngby, Denmark. Jensen initiated and carried out the first successful experiment in transmitting music and voice by wireless (radio telephony) in 1907. In many broadcasts during the next two years he had what might be called the first "disc jockey" show, since his programs were made up of talk, news, and phonograph record music. Included in the text is a photograph of a letter, received by Peter Jensen in 1909, thanking him for the "wireless music."

In America by 1910, Jensen went to work in San Francisco and soon got together with Edwin Pridham and Richard O'Connor to form the Commercial Wireless and Development Company, which later became the Magnavox Company. Mr. Pridham remained an executive of The Magnavox Company until he retired in 1954.

Jensen and Pridham worked together until 1925, acquiring some thirty U.S. patents during their association. Among these patented devices were unique and successful loudspeakers, telephone transmitters and receivers, and radio microphones. They concealed the first public address system at the Panama-Pacific Exposition high on the Tower of Jewels in 1915 and tried out their yet-unpatented invention for a few days. It was reported in the local papers that sailors on the old battleship *Oregon*, at anchor out in San Francisco

Below: the operation of an iron diaphragm sound reproducer as used in telephone communications. Right: a moving-armature loudspeaker of the type used in the 1920's

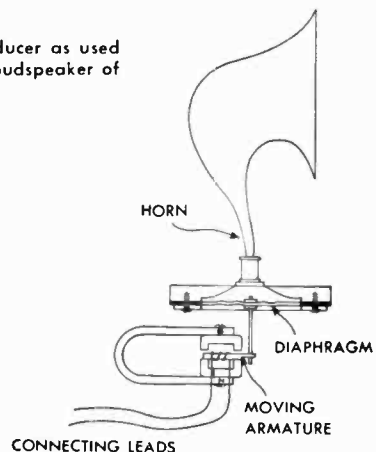
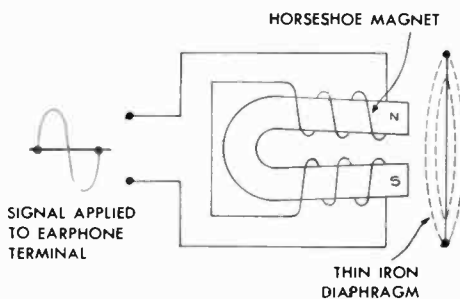

Bay, were dancing to mysterious music in the air. Later that year the P. A. system was used at a public Christmas Eve gathering in front of the San Francisco city hall.

Jensen and Pridham perfected and produced speech equipment used in World War I destroyers, and devised and patented the first lip microphone for aircraft use at the same time. In 1916 they applied for a patent, granted in 1920, on the first electrical sound-magnifying phonograph. They used a microphone and speaker arrangement with a volume control located on the front of the phonograph. In 1919, they provided the public address system for President Wilson's speech at the League of Nations in San Diego. A story, filed by Philip Kinsley of the *Chicago Tribune* on September 20, 1919, tells all about this remarkable feat.

In 1915 Jensen and Pridham provided the world with its first stereophonic demonstration. In a two-story roadhouse and restaurant called the *Hoo Hoo House* they installed, at the request of the management, an astonishing and intricate system. A live orchestra played upstairs, with microphones attached to each of the five instruments; the microphones were connected to individual amplifiers and run to speakers on the lower floor which were set up in the same positions as the live players upstairs. The stereophonic effect was so astounding that people forgot to dance. Unfortunately, nothing further was done with this unique and remarkable system.

Jensen and Pridham helped to change the course of cultural as well as scientific activity with their development of the public address system and the forerunner of the modern microphone. The first prize fight at which a Magnavox announcing system was used was the Dempsey-Carpentier fight in Jersey City in 1921. There ended the era of the "leather-lunged" fight announcer. Mr. Jensen founded and directed the Jensen Radio Manufacturing Company until 1940, when he resigned to form Jensen Industries, makers of phonograph needles under the trade name *Jensen*. His has been a remarkable career in a fabulous business.

Of all the types of loudspeakers invented and tested in the past, the moving coil dynamic system has provided the most efficient and highest quality unit.

Right: Edwin Pridham and Peter Jensen in their laboratories with one of the first dynamic horn-type loudspeakers, circa 1915. Below: The first dynamic loudspeaker. Designed and produced by Jensen and Pridham in 1911

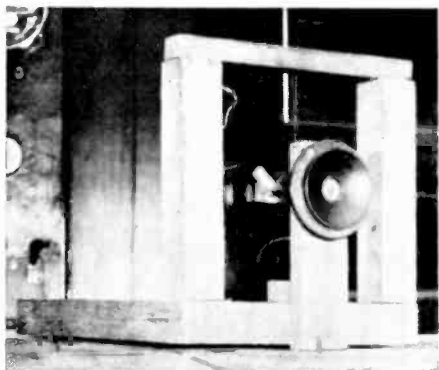

Courtesy of Peter Jensen, Jensen Industries, Forest Park, Ill.

Right: Wilson was the first president to use electronic voice amplification. This speech occurred on September 20, 1919. The microphones are at upper left. The horns were used to direct the sound to carbon microphone units



Courtesy of Peter Jensen, Jensen Industries, Forest Park, Ill.

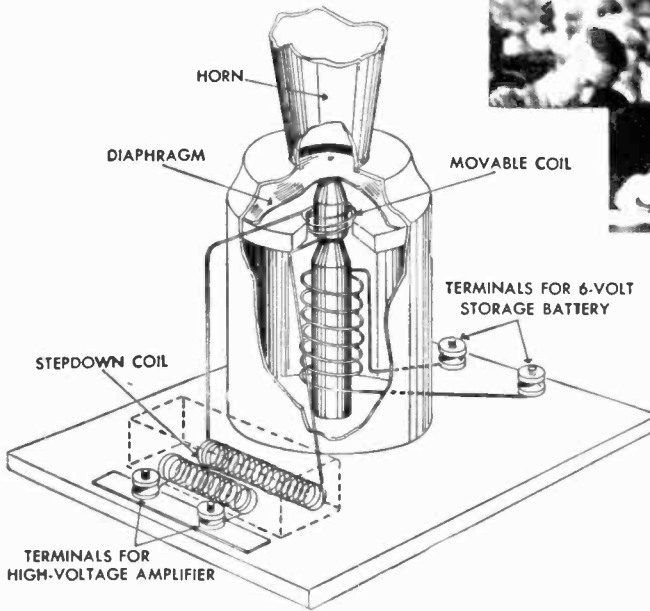

Left: internal cutaway of an early dynamic horn driver loudspeaker designed by Peter Jensen and Edwin Pridham

Courtesy of Peter Jensen, Jensen Industries, Forest Park, Ill.

Right: original Magnavox dynamic loudspeakers of 1919. The amplifier illustrated used the De Forest Audion three-element tube

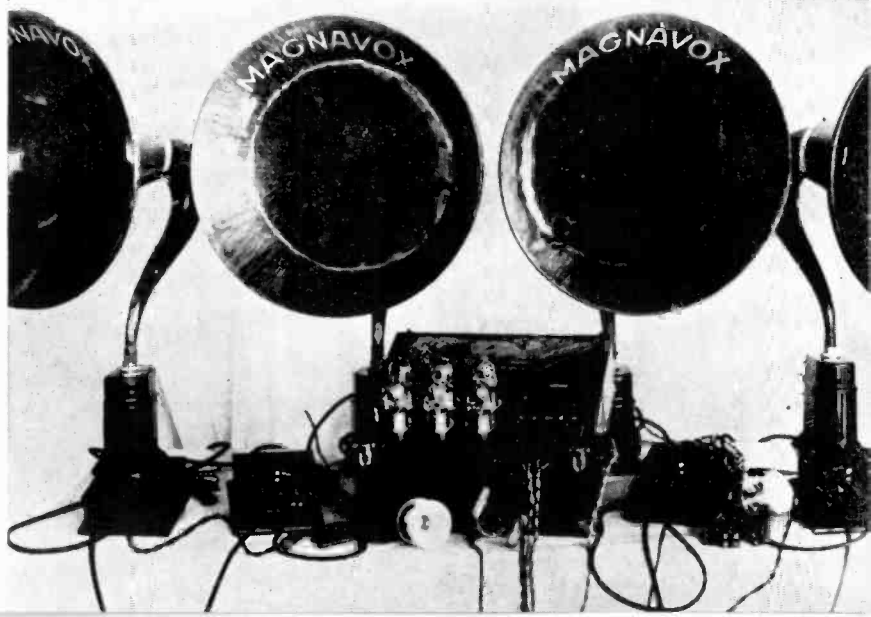

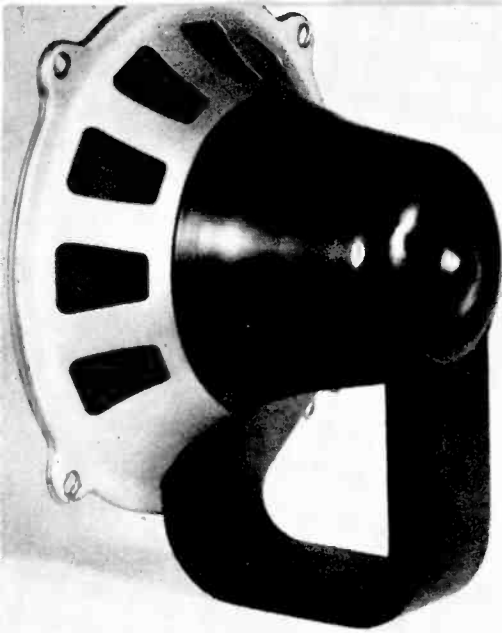

One of the first permanent-magnet dynamic loudspeakers ever put into production. This was manufactured by the Jensen Manufacturing Company

Courtesy Jensen Mfg. Co.

Other types, such as the flat metallic diaphragm, the moving armature magnetic, and condenser loudspeakers, have fallen by the wayside and are no longer used. The transition between the older types of moving-armature cone loudspeakers and the moving-coil cone loudspeakers took place about 1930, with the advent of the electrodynamic unit. Though many refinements have been made in recent years, there has been little change in the external appearance of the loudspeaker. The permanent magnet has taken the place of the large and heavy field coil that produced the necessary magnetic fields; the former have gotten smaller as new, stronger magnets have been developed. Speaker cones have changed somewhat in appearance, with special configurations and new types of pulp materials. The combining of several speakers of different ranges into one multi-axial unit has added bulk to some speakers.

THE LOUDSPEAKER: A loudspeaker is a device designed to move air in response to electrical signals supplied to it by an audio amplifier. Working back and forth very much like a piston in an air compressor, the speaker moves the air around it, causing compressions and rarefactions, which result in the sensation of sound in the human hearing system.

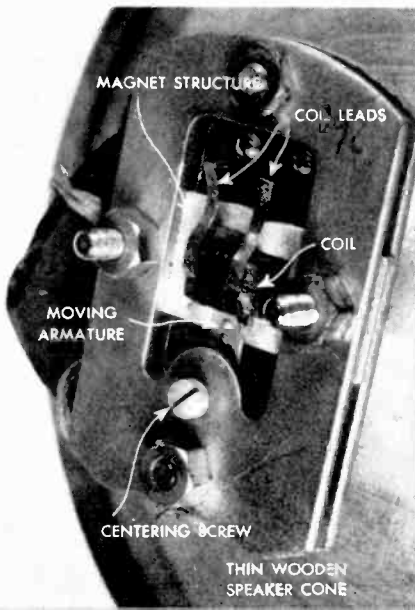

Early Atwater-Kent speaker with thin wood veneer cone. Left: driver structure. Below: soft chamois compliance ring

Laboratories of Robert Oakes Jordan, Highland Park, Ill.

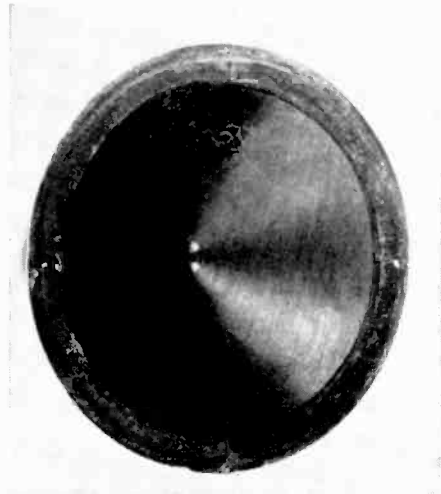

The modern loudspeaker, a magnetic motor device, consists essentially of a metal frame, a paper pulp cone, a voice coil ring form and wire coil, a cone suspension system, and a magnet frame with magnet and cylindrical pole piece. The basket-like frame and the magnetic system are welded together concentrically to provide a rigid holding and centering device for the moving cone and coil assembly.

In the manufacturing process the cone and coil assembly is slipped into place concentrically between the annular (ring-shaped) magnetic top plate the centered pole piece. The voice coil and its form move freely in this position, without touching either the pole piece inside or the magnetic top plate outside. After the cone has been accurately centered in this position, the suspension system, often called the "spider," and the cone rim are cemented in place permanently. The leads from the coil system are brought out to soldering terminals through very flexible wires.

There are many different types of designs in loudspeaker cone, frame, and magnet structures. In any working system such as a loudspeaker there are many mechanical and electrical drawbacks which can be circumvented only

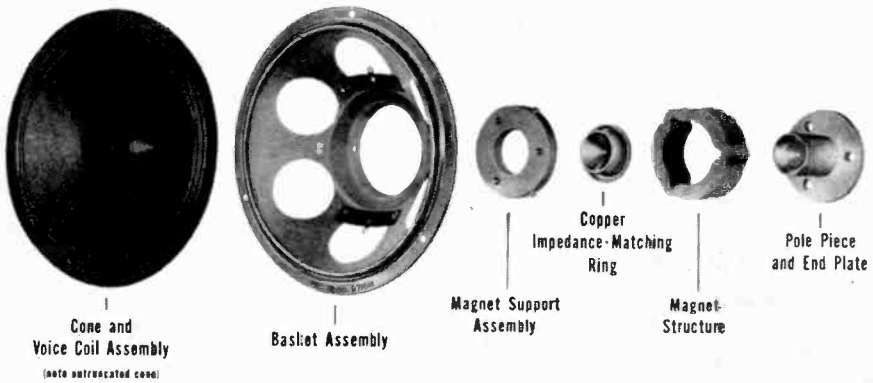

Photograph courtesy Norelco

Above: the components of a modern high-quality loudspeaker. Right: the assembled loudspeaker

Equipment for evaluation furnished by Norelco

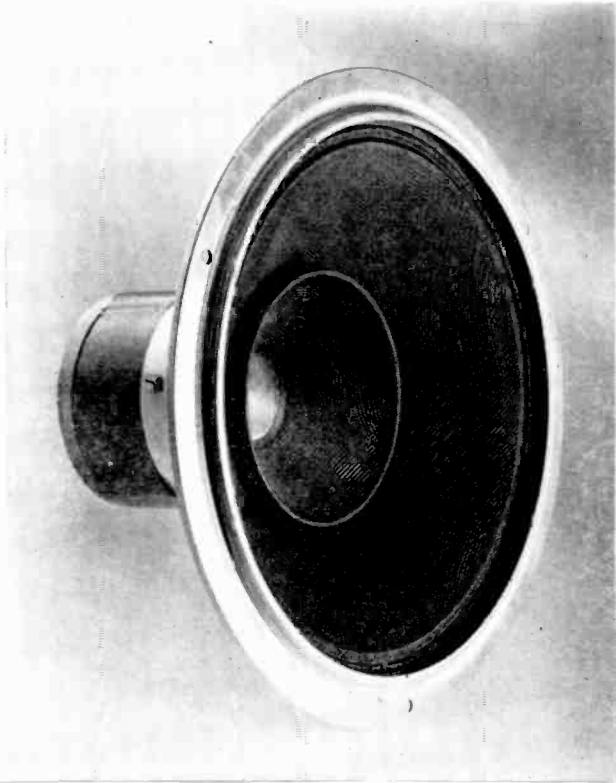

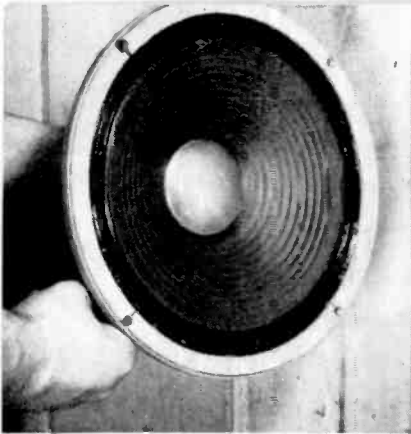

Equipment for evaluation furnished by James B. Lansing Sound, Inc.

Above: the James B. Lansing D-130 loudspeaker showing the 4" voice coil and the aluminum dome which aids in the dissemination of higher frequencies

Equipment for evaluation furnished by Jensen Mfg. Co.

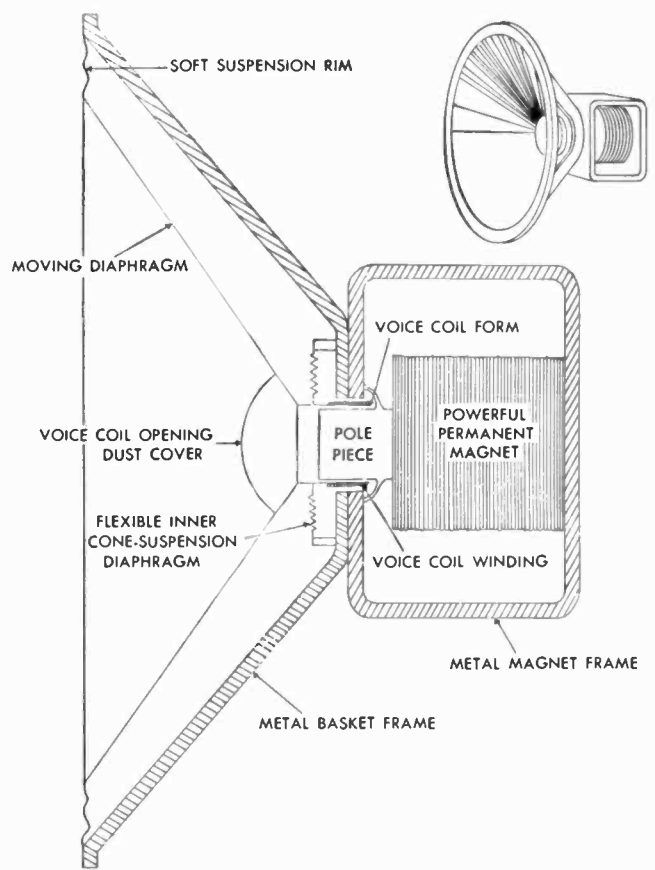

Above: the construction of an ordinary permanent-magnet loudspeaker. Left: a dual cone on a single base is used to provide wide-range sound reproduction

Equipment for evaluation furnished by British Industries, Inc.

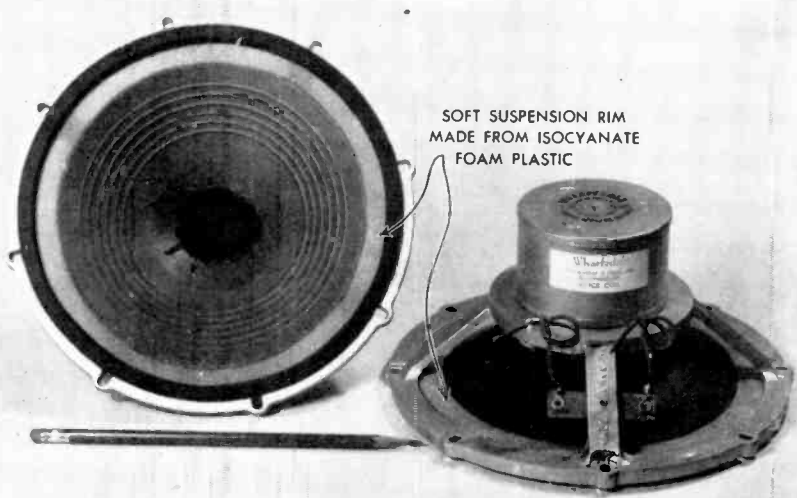

Extremely soft rim-suspension materials are sometimes used to raise the compliance of a loudspeaker cone

by special considerations in design. Each manufacturer has his own idea of what makes a good loudspeaker, and this accounts for the wide variation in a basically simple device. These variations in types of speaker units are partly the result of the jobs they are designed to do.

THE FULL RANGE ALL-PURPOSE LOUDSPEAKER: To understand the difficulty a single loudspeaker has in reproducing a full frequency range of sound, it is necessary to see what happens to the speaker and its cone as the range is widened. Since the function of a loudspeaker is to move air, the cone should be active at all frequencies in the audible range. If a theoretically perfect speaker cone were possible, it would be weightless, not subject to inertia (the resistance of an object in motion or at rest to any change of mode), and non-resonant; i.e., it would not move more easily or to a farther point at any one particular frequency.

If just one note at a time were played through a speaker, many so-called all-purpose loudspeakers would function very nicely. However, loudspeakers are expected to reproduce faithfully each of the many different sounds coming simultaneously from an orchestra. If the action of a loudspeaker cone were to be photographed with a slow-motion camera, it would be apparent that the rim of the cone was unable to keep pace with the rapid movement of the portion of the cone nearest the voice coil. This is due to the inertia of the cone. No cone material is entirely without inertia.

Large speaker cones reproduce low-frequency sounds best; small cones reproduce high-frequency sounds most efficiently. Designers of single-unit speakers usually try to compensate for the inertia-caused disadvantages of single speakers by utilizing the central portion of a cone for high frequencies and the peripheral portion for low frequencies. Thus, many single-unit speakers have hardened central areas or aluminum domes over their voice coils which radiate sound in the high-frequency range.

If a single-unit speaker is to be used, it should ideally be large, stiff, and light in weight, with an extremely soft suspension system. The resonant frequency of the cone, e.g., the frequency at which the cone tends to vibrate sympathetically, should be below the operational limit of the amplifier with which it is used.

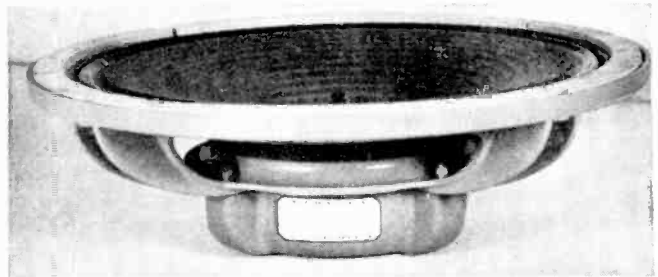

The James B. Lansing D-123 loudspeaker. The shallow frame and thin styling make this speaker suitable for use in cramped installations



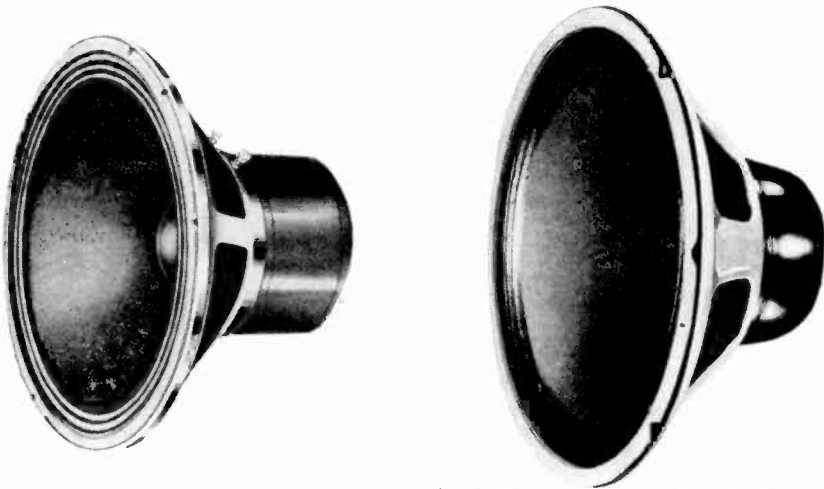

Equipment for evaluation furnished by Electro-Voice, Inc.
Left: an 18" Electro-Voice "woofer." Right: Jensen P15-LL low-frequency driver

Other cone design features can include annular embossed rim corrugations, which lower the mass of a diaphragm at high frequencies through greater compliance, and variations in the actual shape and depth of the cone itself. Two popular types of cones for full-range work include the plate type (shallow diaphragm with large-diameter, dome-covered voice coil) and the exponential (curvilinear) type with a large-diameter, dome-covered voice coil. Even with all the design features that can help a single speaker to operate over a wide range, there is still the possibility of intermodulation distortion caused by the two modes of diaphragm operation at either end of the frequency spectrum. However, in better speakers intermodulation distortion is at a very low point and not too noticeable.

LOW-RANGE LOUSPEAKERS (WOOFERS): The limitations of full-range, all-purpose single speakers have given rise to a popular loudspeaker system in which the audio frequency range is divided among two or three, or sometimes four, individual loudspeakers. Each of these individual loudspeakers is designed to operate over a narrow range of frequencies. With correct design, the narrow ranges of these units overlap in such a way that the complete audible range is smoothly covered. Some manufacturers advocate a separate speaker for each range to be reproduced; others advocate coaxial systems, where two or three speakers are constructed on the same frame. There are merits and drawbacks to each system. In considering a system using individual loudspeakers the low-frequency unit, often called the *woofer*, is the starting point.

The frequency range in which any loudspeaker operates best is determined by the peculiarities of its design and manufacture. In the woofer's driver unit the important thing is the lower range of frequencies in the audible scale. Here are the major points to look for in a woofer: good low frequency performance, insured by a moderately stiff, large-diameter cone backed by a large permanent magnet of high efficiency; a highly compliant suspension system allowing relatively unrestricted movement at high driving power; a deep cone diaphragm, desirable if the woofer is to be used in a direct-radiator enclosure (reflex or infinite baffle type); heavy frame and magnet construction to prevent distortion due to warping of the structure in mounting; low diaphragm resonant frequency (below the lowest response point of amplifier operation); and the proper crossover frequency in relation to other loudspeakers in the same system.

The crossover frequency between the loudspeakers in any system is the

point on the frequency response curve at which the operation of one speaker drops off and another begins to operate. The crossover point is not a point at which a speaker which has been going full blast suddenly stops operating. It is the point at which the action of the speaker begins to taper off. As an example, the woofer in a system may have a crossover point of 600 cycles per second. The woofer will reproduce all signals between about 35 and 600 cps in a realistic, linear fashion: above 600 cps the sound from the woofer will fade slowly. The speaker handling the next range will have realistic, linear reproduction characteristics from 600 cps on up. However, it will begin operating at about 400 cps, gliding into operation gradually. The response of the two speakers is controlled by a filtering system known as a frequency-dividing network. The same type of tapering action takes place between all successively operating speakers in the system, insuring smooth coverage of the entire frequency range.

In a three- or four-speaker system the woofer is designed to cover a frequency range of 35 to 600 cycles (or lower). In a two-speaker system, however, the low-range speaker may have a crossover frequency near 1200 cycles, starting from 35 to 50 cycles at the low end. How the speaker operates depends upon the manufacturer's concept and design. How well the speaker operates within its designed limits depends upon the quality of construction and the type of enclosure employed.

MIDDLE-RANGE LOUDSPEAKERS (MID-RANGE DRIVERS): An old theory suggests that a separate loudspeaker for each of the many thousands of note combinations played by an orchestra would make possible a perfect reproducing system for sound. It should be added that each of these speakers would have to be especially designed to operate at its own frequency. This type of high-fidelity system *might* be the best obtainable, but of course it would be large and expensive. As a practical compromise, manufacturers of speaker systems have provided high-fidelity enthusiasts with multiple speaker arrangements.

Cone-type speakers are often used as mid-range units. Such speakers are governed by the same design factors that apply to any other narrow-range units. Tweeter units, however, have attained many partisans because of their great efficiency and high fidelity in the middle and high-frequency ranges.

The average tweeter unit employs a relatively large diameter voice coil for the small area of its diaphragm. Of the general types of tweeter systems available, the annular (ring-shaped) style, the V-shaped limited-area style, and the dome-diaphragm style are most used. For situations where a tweeter must cover a fairly low range of frequencies, as in the case of a mid-range driver,

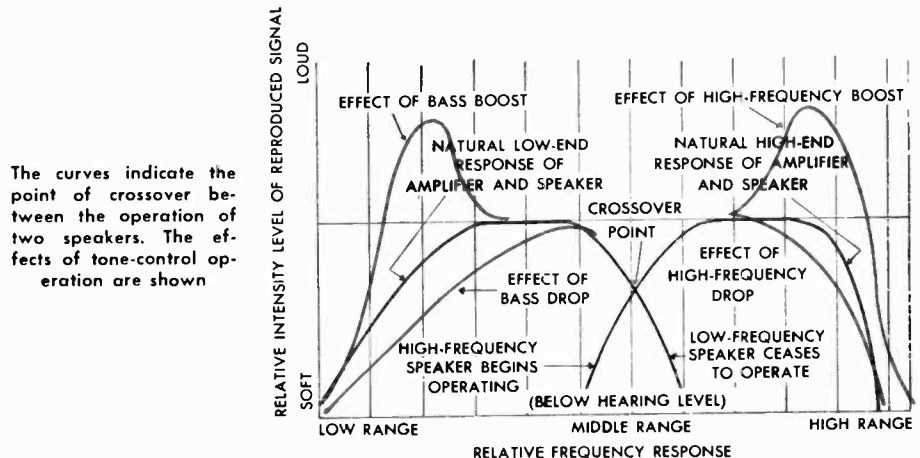

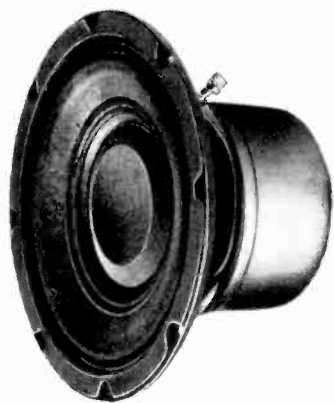

Speaker furnished for evaluation by Jensen Mfg. Co.

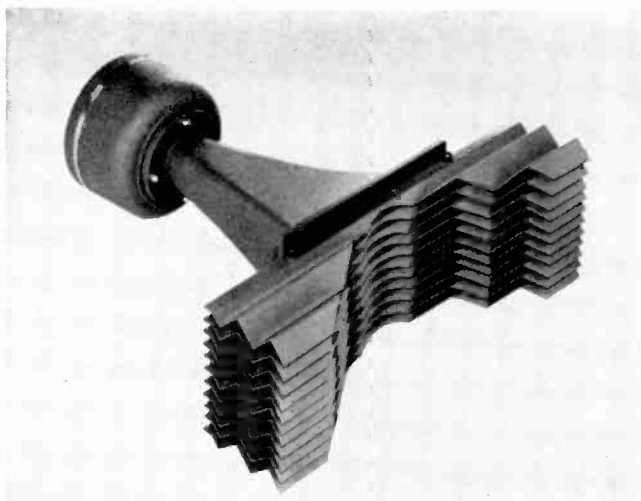

High-frequency unit furnished for evaluation by James B. Lansing Sound, Inc.

Left: unusual cone arrangements are sometimes used to increase the frequency range of a loudspeaker. Right: special dispersion elements are sometimes added to high-frequency horns

the V-shaped unit is preferable. Since the diaphragm is clamped in the structure by both its inner and outer edges, and the voice coil structure is attached to the apex of the V, it performs without the characteristic break-up which often occurs in a dome or cone-diaphragm speaker. The horn structure used to transform and couple the sound to air in a room is designed in such a way that the most efficient and widest possible radiation of the higher frequencies takes place. This feature eliminates the problem caused by the fact that the higher audible sounds go, the more directional they become. Dispersion over a wide angle becomes necessary if wide-range sound is to be heard everywhere in the listening room. With the horn-type driver the problem of a suitable enclosure is solved by the tweeter structure and its horn casing. Often a mid-

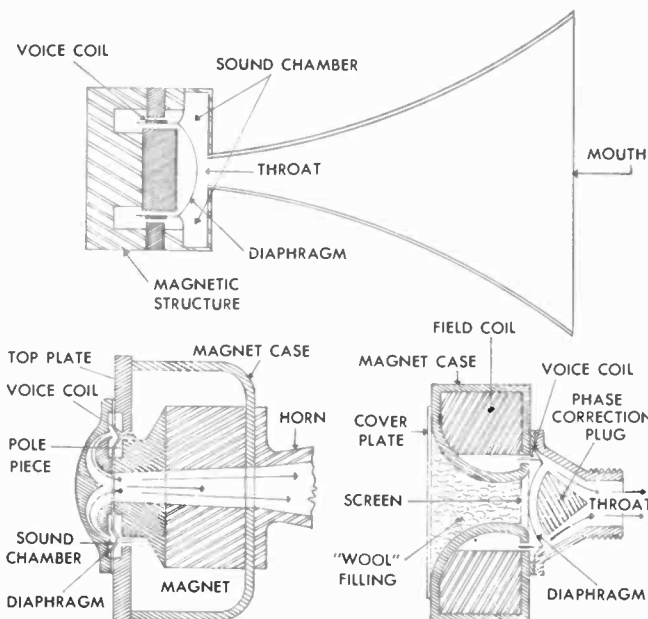

Different types of mid-range driver units

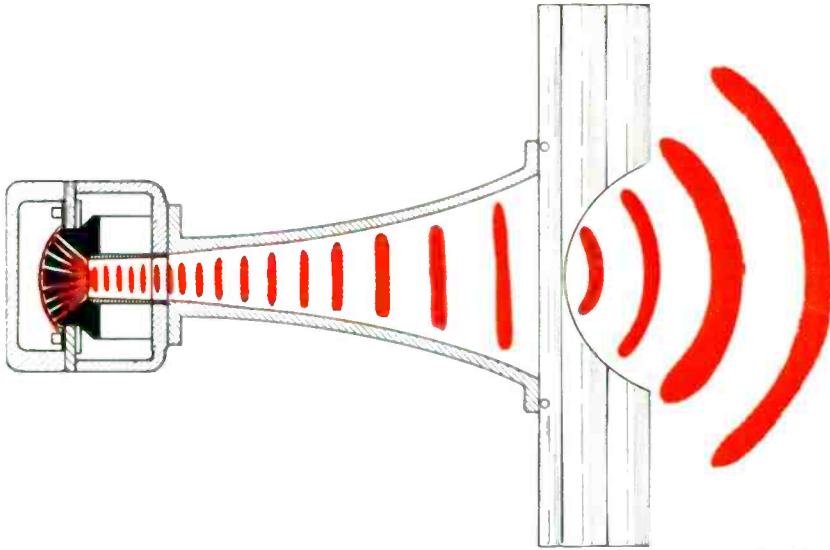

Courtesy of James B. Lansing Sound, Inc.

The effect of a horn and a diffusion element on the sound from a high-frequency driver

range driver unit and its multicellular flared horn are separate from the low-range speaker and its complex enclosure.

HIGH-RANGE LOUDSPEAKERS (HIGH-FREQUENCY TWEETERS):

The hard-cone, small-diameter diaphragm or the hard-shelled dome diaphragm, along with an annular ring driver unit, performs with great fidelity and efficiency in the extremely high audio frequency ranges. The hard cone and the dome types of driver units are, in reality, simply small loudspeakers that operate in piston fashion at the frequency ranges where the current is weakest. These diaphragm driver units (tweeter) have large-diameter voice coils in relationship to their small-diameter cones or domes.

Most horn units have small apertures or throat openings in comparison with the size of the plastic or metallic dome. This results in some difficulty as the

Different types of tweeter units. Below, right: a multicellular-horn unit. Below and above, right: cone-type units



Courtesy of Kingston Products Co.



Equipment for evaluation furnished by Jensen Mfg. Co.



Courtesy of Kingdom Products, Inc.

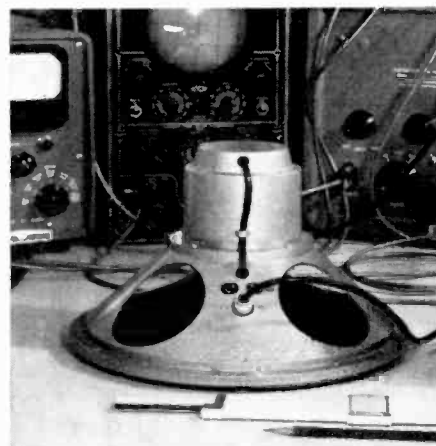
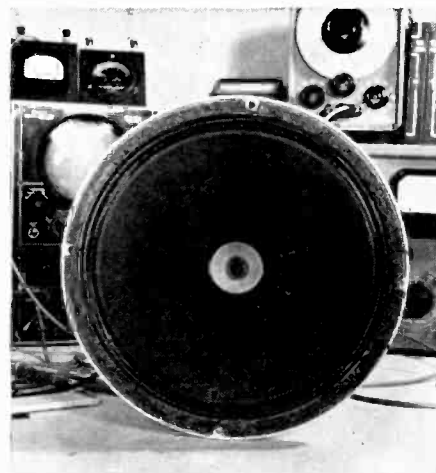

Equipment for evaluation furnished by Tannoy Co., Ltd.

Above: a two-unit coaxial loudspeaker. Right: the Tannoy dual-concentric loudspeaker. The high-frequency horn runs through the center of the voice coil of the low-frequency cone

dome and voice coil structure move in and out. The difficulty lies in the fact that points on the surface of the dome diaphragm are not at the same distance from the sides of the apex or throat of the horn. If this situation were allowed to exist, cancellation at certain frequencies would occur, destroying the fidelity of the higher sounds. A solid phasing core is consequently used in the throat area in such a way that only the outer areas of the diaphragm radiate effectively into the throat area. As in other horn-type drivers, the flared-horn throat and flange couples the moving part of the unit acoustically to the listening room.

The dispersion of high frequencies can be accomplished in a number of ways: the flared horn is most in use, acoustic lenses are the most efficient method, and in very high frequency tweeter units a dispersion plug at the mouth of the unit accomplishes the job. Regardless of the system used, a simple test involves only a selection of full-range music and your own ears. If you can hear the higher frequencies at some position off-center from the axis of the tweeter system, it is doing its job.

COMBINED (COAXIAL) LOUDSPEAKER SYSTEMS: It was only natural that designers began to conjecture that if more than one loudspeaker was desirable in high-fidelity systems a way might be found of putting them all together on one frame. This way of thinking led to the origin of the coaxial loudspeaker. Someone took a cone-diaphragm speaker large enough to receive a cone speaker of smaller diameter suspended from the front rim of the former.

The addition of a capacitor in the speaker leads feeding the small unit divided the high and low frequencies, and the first coaxial speaker was constructed. Many such combined units are manufactured and sold today.

It is easy to see some of the drawbacks to these early designs. One of the chief problems inherent in this type of system involves the fact that the low-frequency speaker is coupled by air to the small tweeter, causing the larger to drive the smaller. In effect, this type of interference causes a form of intermodulation distortion in the higher ranges. Added to this is the fact that the usual small cone speaker used as a tweeter is not as efficient as the larger unit; hence, the additional driving force adds even more distortion to the highs. If the small tweeter were increased in size for the sake of efficiency, it could cause additional trouble by blocking the output of energy from the large unit.

In recent years, speaker manufacturers have offset some of these basic flaws in coaxial speakers by combining the units into truly coaxial systems. Instead of placing the high-frequency driver at the front of the cone, they have employed the interior of the voice coil as a portion of the high frequency horn, with its own driving unit at the back of the magnetic structure of the bass speaker. Where a dispersion unit, such as a flared horn or a multicellular horn, is used, it is of solid construction and free from influence by the large driver. With such designs it has been possible to lower the crossover frequency of the large unit by virtue of the efficient self-powered mid-range driver with its own magnetic structure. Then, to provide an extra-high range, a small tweeter driver is sometimes placed on a bracket at the front of the large cone, without a chance of interference through obstruction. This third unit is usually as far off center as possible, so as not to obstruct the mid-range frequencies coming through the center of the woofer. The final considerations in loudspeaker selection will be space requirements, budget restrictions, and finally the effectiveness of the different systems as they sound to the listener. Space considerations will involve both the choice of enclosure and the room space that can be devoted to the speaker system.

Eight-inch coaxial loudspeaker. Capacitor is used as dividing network

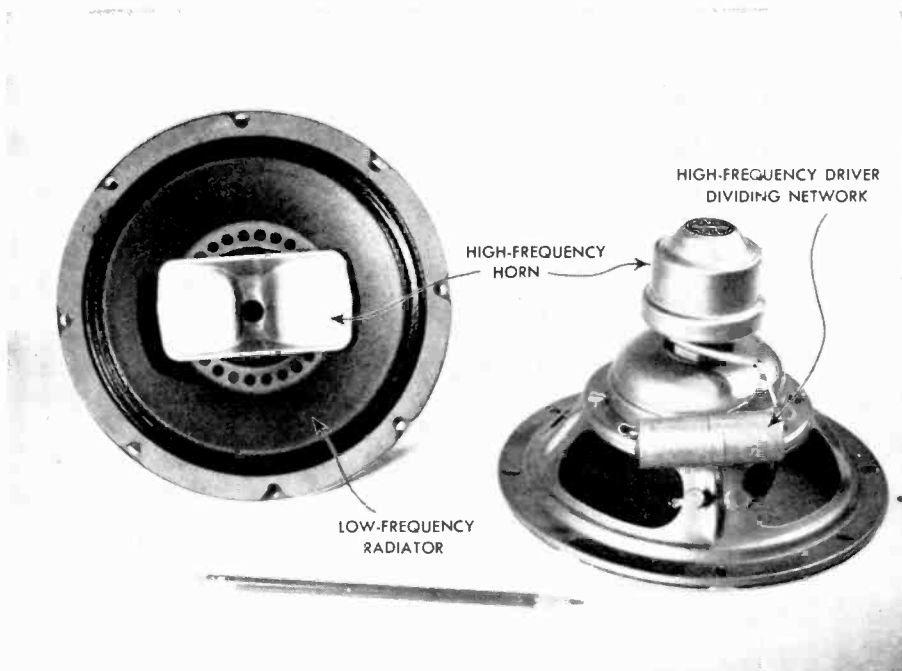

A single-unit coaxial loudspeaker system will fit into almost any enclosure designed for a single speaker. It can easily be adapted to in-the-wall mounting or to closet-door mounting, or to other situations where extensive alterations are not feasible. The over-all cost for achieving a desired degree of quality is lower with a single-unit coaxial system than with a multiple-speaker system.

SPECIAL LOUDSPEAKER TYPES AND APPLICATIONS: In the course of the development of loudspeakers, improvements have been made in conventional types, but at the same time new concepts have been produced and marketed. Some of these newer devices are simply refinements of earlier concepts; others are completely new. These progressive steps have been inspired by the need for more efficient and better means of reproducing audio material. A need continues for speakers that require less room area. In all, loudspeaker systems need meet but one basic requirement; they must reproduce sound with true fidelity. The search for mechanical and electrical improvements stems from the inherent weaknesses in any physical system. In overcoming these drawbacks the inventor-designer must use every means at his command. Knowledge of prior accomplishments in the field, coupled with technical and manufacturing skills, has brought new units and applications into being.

THE ELECTROSTATIC LOUDSPEAKER: In the early days of radio, when the electrostatic speaker was first proposed, it was then thought of as a condenser or capacity speaker. It was conceived of as a cone-type diaphragm with capacitive elements as the driving force. The inception of the moving-coil dynamic loudspeaker, however, forced such speakers out of use before further development could take place.

The modern electrostatic speaker was first brought into use as a high-frequency tweeter; it found its first widespread use in conventional factory-assembled phonographs. About all it accomplished was to make the listener more aware of the surface scratch in standard disc records. Later, with the addition of certain refinements, the range of operation of electrostatic units was broadened so that more advantageous crossover frequencies could be obtained between them and the conventional cone-diaphragm speakers in the same system.

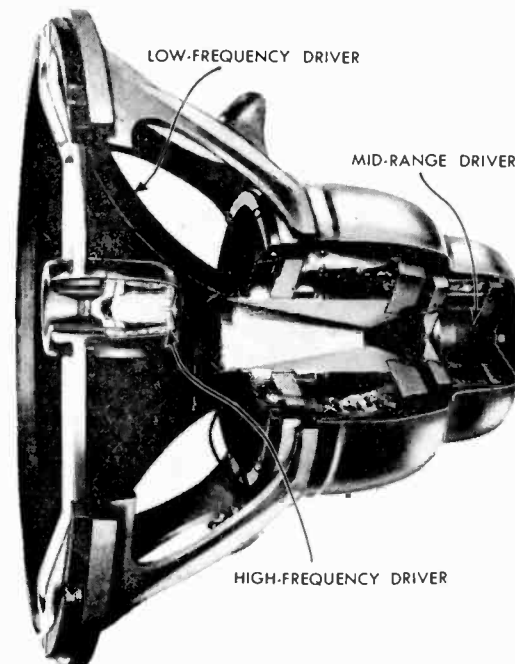

The drivers covering various frequency ranges in a triaxial speaker. The mid-range driver horn passes through the voice coil form of the low-frequency driver. The high-frequency driver is mounted off-center within the low-frequency cone.

Equipment for evaluation furnished by Jensen Mfg. Co.

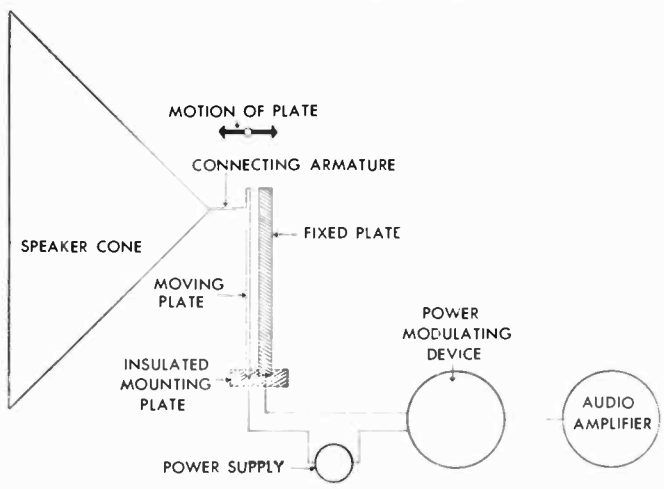

Left: A simplified block diagram of an early condenser loudspeaker

Below: The basic building block unit used in the Janszen electrostatic loudspeaker

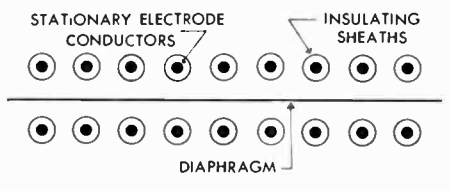
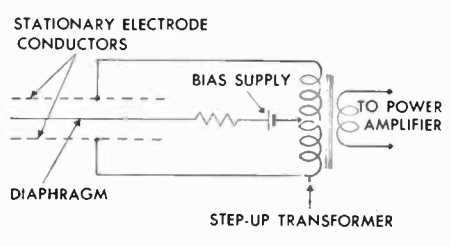

Above: A schematic diagram of the Janszen electrostatic loudspeaker. The actual placement of the elements is indicated below

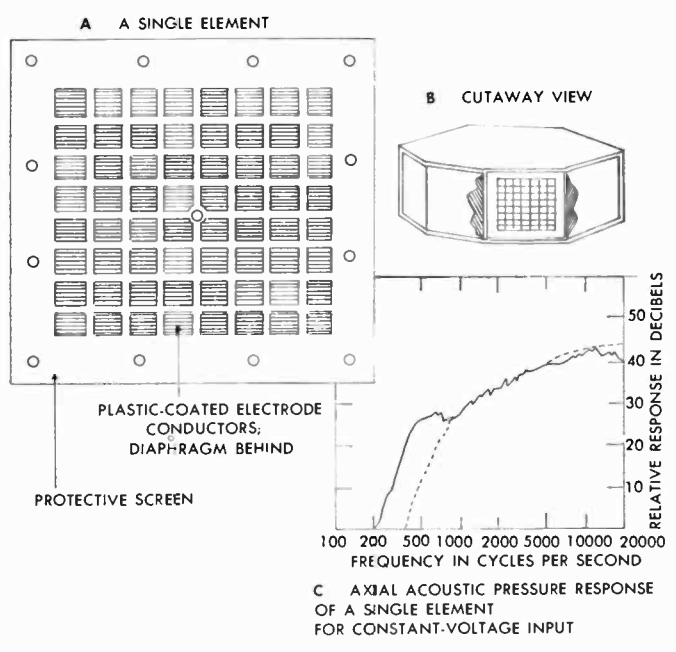

C AXIAL ACOUSTIC PRESSURE RESPONSE OF A SINGLE ELEMENT FOR CONSTANT-VOLTAGE INPUT

Electrostatic speakers employ straightforward electrical concepts in operation. Objects with opposite electrostatic charges attract each other in accordance with certain physical laws. First, the force of attraction is directly affected by the amount of static charge that exists between the two objects. Small charge, small attraction; large charge, strong attraction. Secondly, the distance between the two objects governs how much attraction there will be for any given static charge. Imagine two sheets of rigid clear plastic with different static charges, one positive and the other negative. If these are mounted $\frac{1}{4}$ in. apart in some sort of rack, a certain force of attraction will exist between the two, dependent upon the degree of the charge and the distance between them. This force is divided equally throughout the entire area of the two sheets of oppositely charged plastic. This is, essentially, the condition that exists in an electrostatic loudspeaker before any audio signal is fed into it. Suppose one of the rigid plastic sheets is fixed in the rack; the other is placed in a flexible frame so that it is free to move in or out. The flexible sheet will naturally move toward the rigid sheet according to the amount of static charge existing between them. If the static charge were to be varied in response to an electrical audio signal, the thin sheet would move back and forth, simulating mechanically the variations

JANSZEN MODEL 1-30 SCHEMATIC

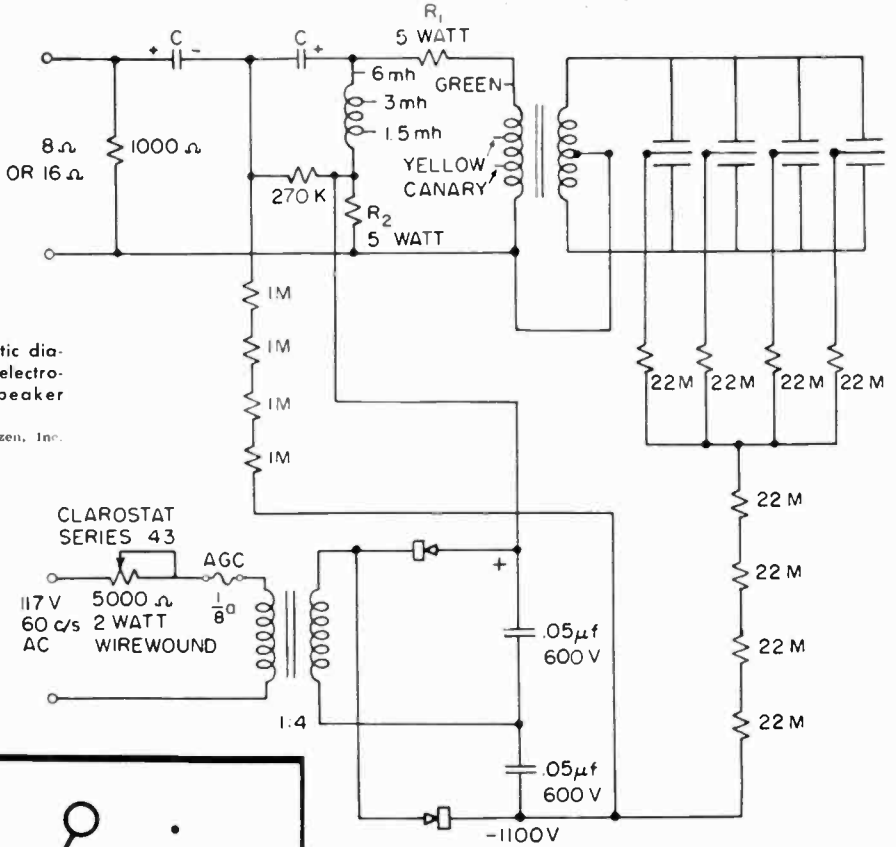

Right: Schematic diagram of an electrostatic loudspeaker circuit

Courtesy of Janszen, Inc.

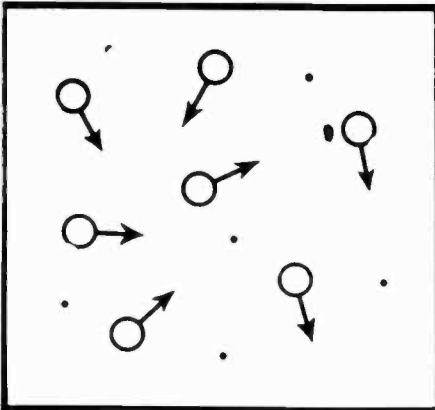

(A) NORMAL STATE

A through F: In sequence, the process of ionization in an electrostatic high-frequency loudspeaker in diagrammatic form

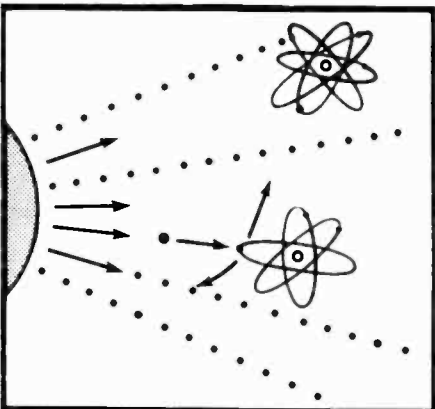

(B) STARTING

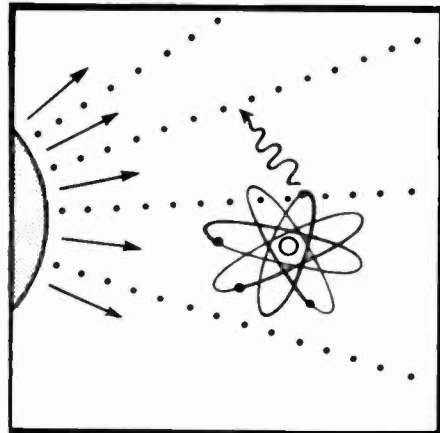

(C) IONIZATION AND EMISSION OF LIGHT

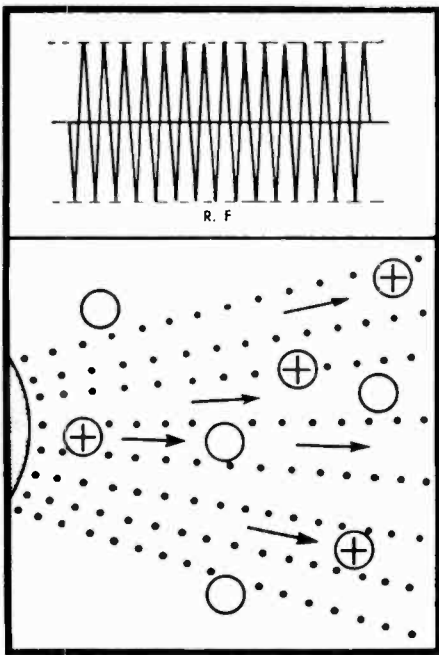

(D) POSITIVE IONS CONTROLLED BY ELECTRICAL LINES OF STRESS

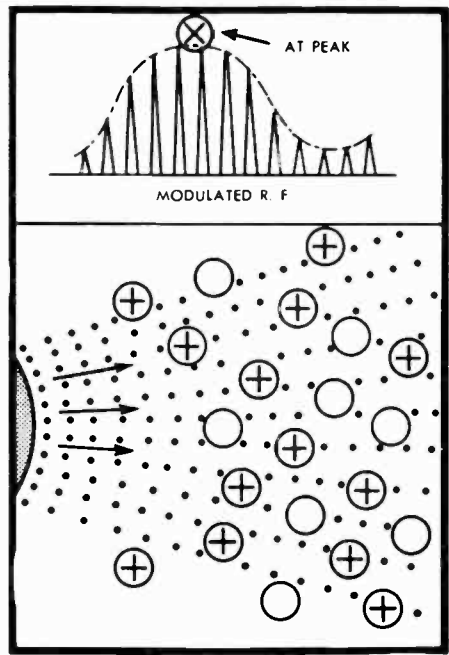

(E) INCREASED ELECTRICAL STRESS; INCREASED IONS; INCREASED AGITATION

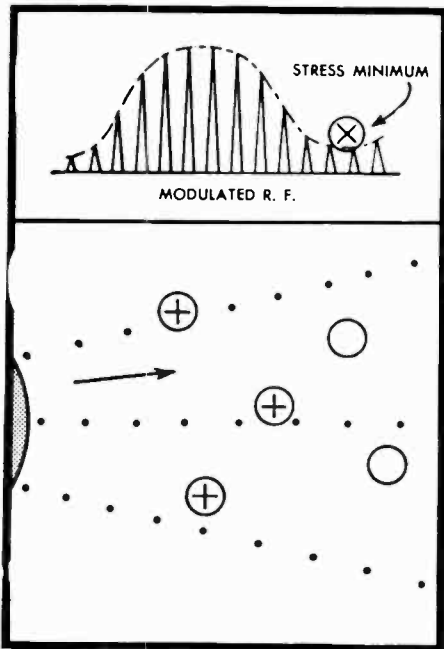

(F) DECREASED STRESS; DECREASED NUMBER OF IONS; LESS AGITATION

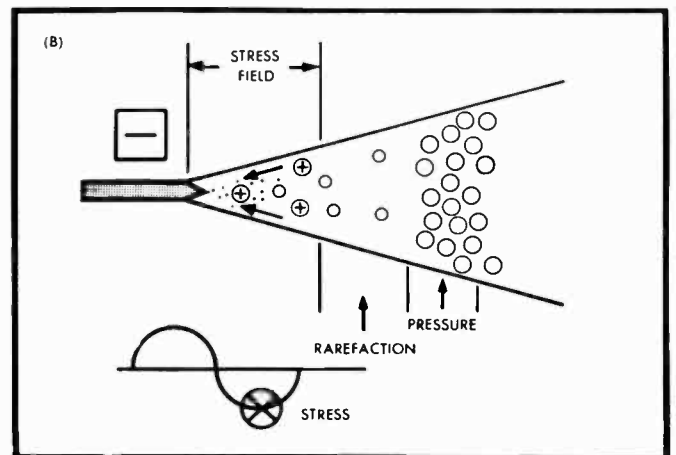
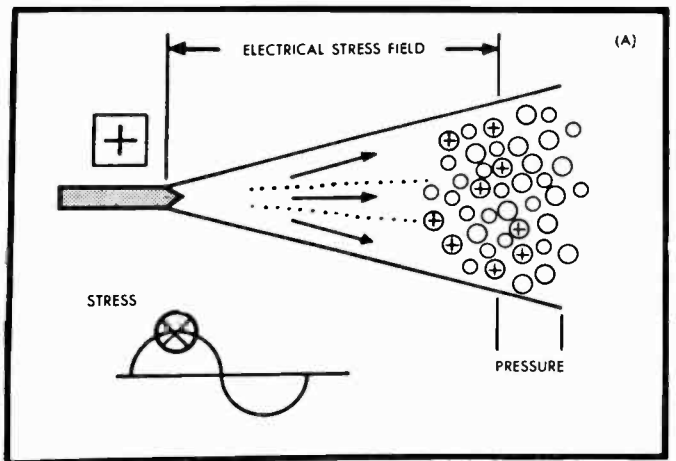

Right, above and below: Alternate pressure and rarefaction of air is a result of the changing electrical stress field in an electrostatic loudspeaker

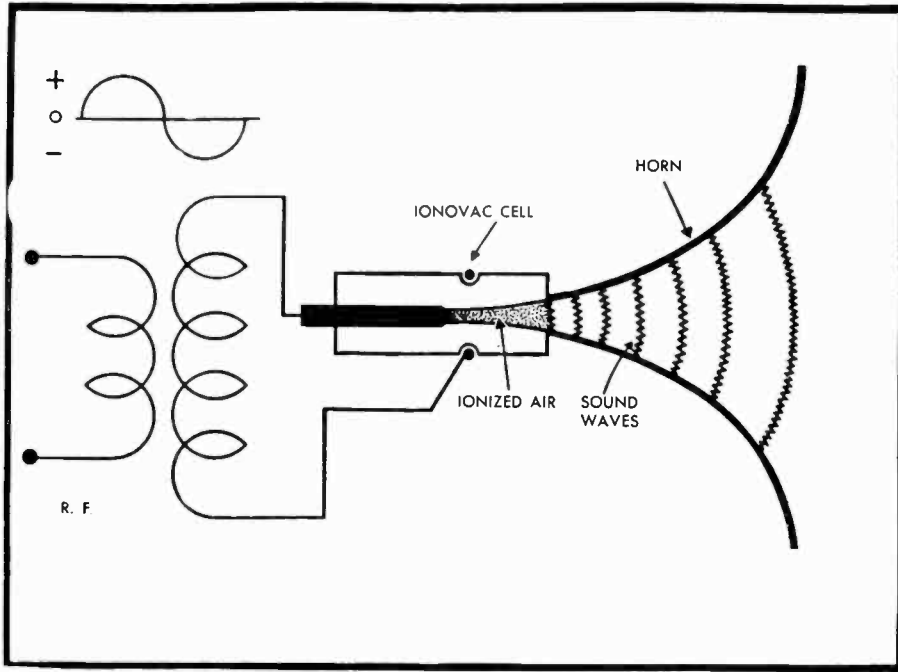

Left: Ionization occurs in the narrow throat of the Ionovac loudspeaker horn

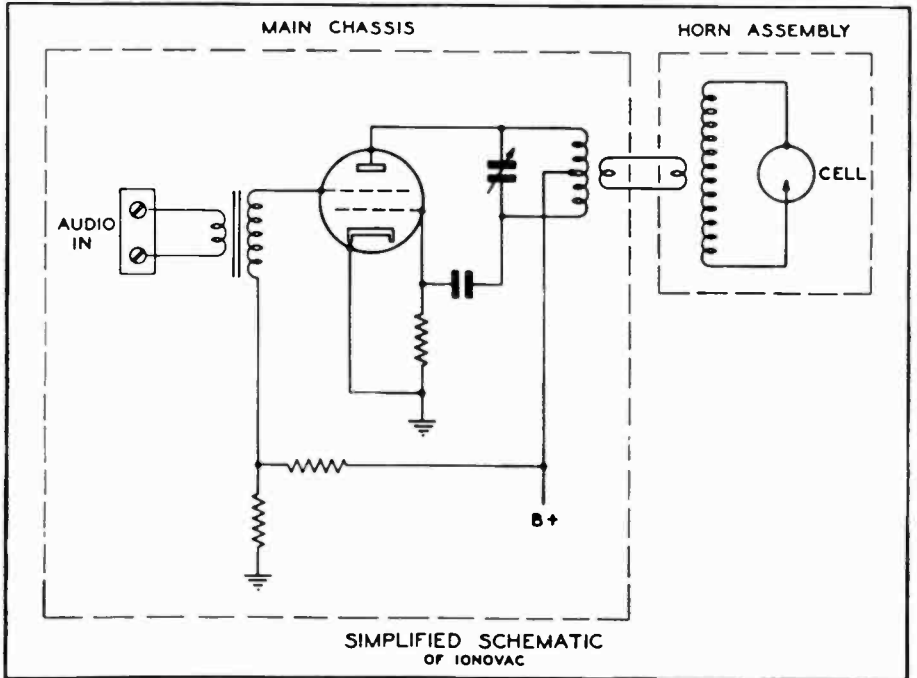

Right: Schematic circuit diagram of the Ionovac loudspeaker

in static charge. Referring to earlier discussions of conventional cone diaphragms, you can see that the moving plastic sheet, if properly constructed, could produce sound.

This is, of course, an oversimplified description of the electrostatic loudspeaker, but in essence it is true. In the actual case the statically charged sheets are metallic, and as they move a rather serious drawback occurs. The spacing of the two plates governs the force of attraction with any given charge on them. In motion, however, this force does not simply increase or decrease directly with distance; rather, as one sheet is moved away, the force decreases dis-

proportionately rapidly as the distance increases. The same thing occurs as the plates move toward each other; the force of attraction increases more and more rapidly as they move together. The increment of attraction varies inversely with the square of the distance; another case in which the law of inverse squares applies. The effectiveness of the electrostatic speaker thus decreases as the separating distance increases. To counteract this effect somewhat, designers have employed one fixed-charge plate in the center, and on either face of this sheet used two movable changing-charge plates. Thus, one plate is repelled as the opposite plate is attracted. In this push-pull movement the effectiveness of the unit is not impaired.

In constructing these push-pull electrostatic units in large sizes it is possible to bring down the low end of the response curve to a point where a crossover frequency of 600 cycles is possible. When a woofer and a divider network of high quality are used, sound reproduction can be accomplished smoothly over a very wide range of frequencies without the stridency and harshness found in the early tweeter-type electrostatic speakers. Coupled with the fact that the whole charged speaker plate area moves in and out at one time, there is no chance of break-up or of serious intermodulation distortion, as may occur in some conventional speaker units.

THE IONIZATION HIGH-FREQUENCY LOUDSPEAKER: It is strange how many devices have grown out of what was once considered simply an electrical phenomenon. The ionization speaker is just such a device. It operates on the principle that two oppositely charged objects will cause the air between them to ionize when conditions of electrical charge, relative position, configuration, and humidity are right. When ionization occurs in air or other gases (neon, fluorescent lights, etc.), it is visible through the light that is formed.

Ionization—or properly, corona discharge—was first noted and misunderstood by the mariners of ancient times. As the early ships plied their ways over the oceans they would sometimes build up a static charge, either positive or negative. Such a static charge is the same sort you can produce by scuffing your feet on a thick carpet. When the charge is sufficient and an oppositely charged object is near, such as a doorknob or another person, a spark can occur. On the sea such a static charge will build up enough so that it will dis-

Right: Operational sketch and circuit diagram of a new type of ionization high-frequency speaker. Below: A high-frequency speaker work on the ionization principle

Equipment for evaluation furnished by Electro-Voice

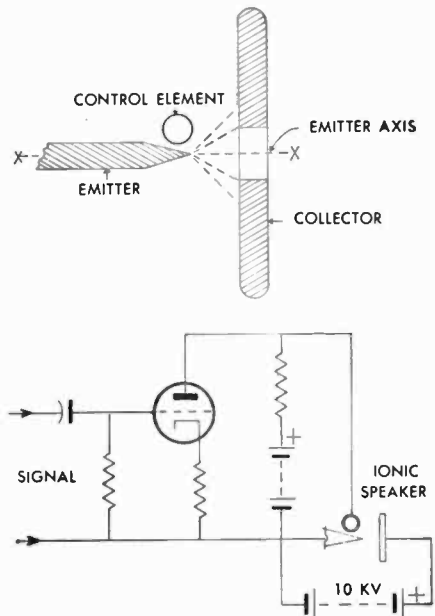
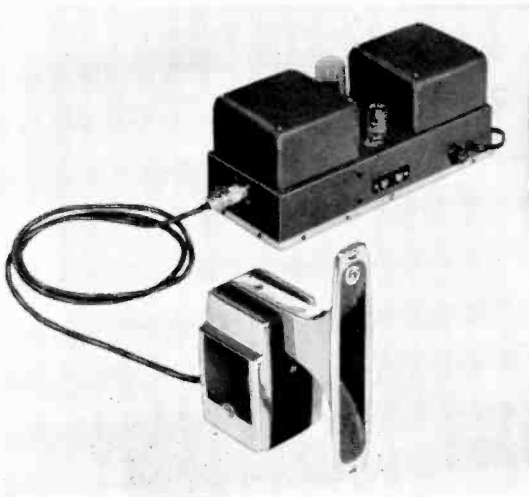

charge itself into the air from any high, sharp point such as a yardarm or masthead. The charge is large enough, and the rate of discharge slow enough, so that instead of a quick spark a long-lasting glow can be seen. The ancients called this phenomenon *Saint Elmo's fire*. It was believed to be the *corpus sancti*, the body of Saint Elmo, patron saint of the sailor, coming to watch over the ship and its contents. At times, when the sea was calm enough, a sound could be heard coming from the weird light. It is this part of ionization that is important to loudspeakers.

In a confined area, air at rest does not produce sound. In this new concept in loudspeakers, the confined area is the throat of an ionization chamber. The molecular distribution of the air at rest is undisturbed. As the static charge in the ionization chamber is built up, electrolysis takes place in the air and ionization occurs, represented by the emission of light. If the static charge is maintained by an electronic radio-frequency oscillator and a high voltage supply at a fixed level, no audible sound can be heard because of the disturbed air. The electrical stress field caused by the existing static charge remains constant when no audio signal is applied to the accompanying electronic circuit. When an audio signal is applied, 20-megacycle radio-frequency oscillations are modulated (varied) according to the signal voltage. There is then a variation in the electrical stress field in the chamber. This results in a compression of air. As the audio signal approaches its negative peak in the other portion of its cycle, a period of minimum ionization occurs, represented by a minimum electrical stress field. At this time a rarefaction occurs. These alternate compressions and rarefactions of air result in sound.

At this point in its development the ionization loudspeaker is limited in usefulness to the relatively high audio frequencies, within a range of 3,000 to 50,000 cycles. The ionization speaker system affords the engineer a unit that has virtually no critical mass, and hence is not subject to the ills of cone diaphragm and voice coil speakers.

Improvements in the two-element ionization speaker have been made through the use of an added control element. With this system, an ion stream

Charles Parsons' Auxetophone. The first practical compressed-air "loudspeaker"

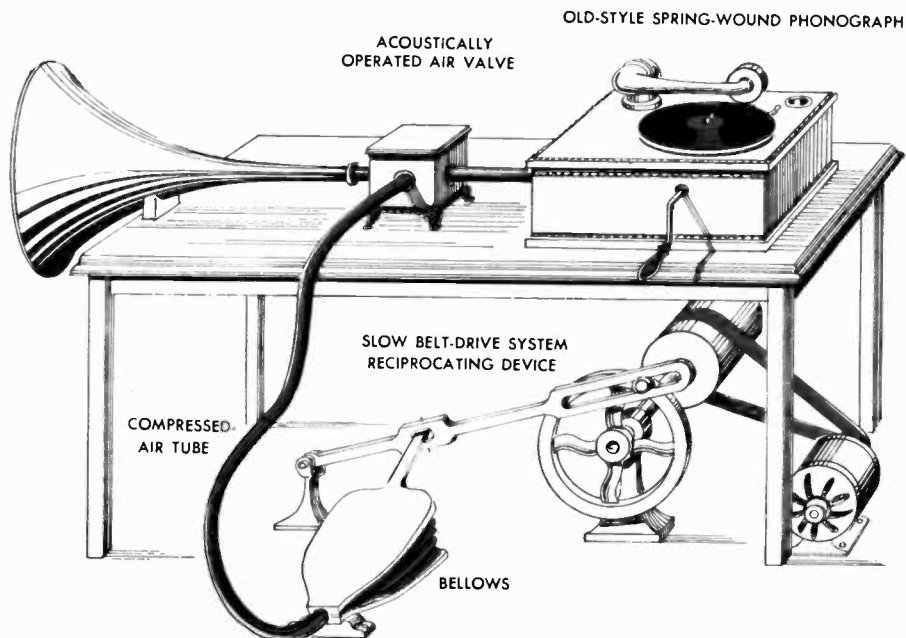

is produced between a highly positively charged collector ring and a negatively charged emitter. The corona discharge (ion stream) is maintained at a fixed level to prevent arcing. The control element, with its relatively positive charge varied by the signal voltage, is placed near the emitter and acts much as the grid in a conventional vacuum tube. The need for a complicated oscillator circuit is thus eliminated, making for a simpler and less expensive system.

THE COMPRESSED-AIR LOUDSPEAKER: The independent attempts of Thomas Edison, Chichester Bell, Charles Parsons, and others to produce a practical means of sound amplification through the use of compressed air were mentioned previously. Edison called his patented machine the *Aerophone* and Parsons, who produced the most practical device of this type, called his the *Auxetophone*.

In reality the compressed-air loudspeaker and the compressed-air amplifier are one and the same device. The *Auxetophone* operated on the principle that added outside energy was necessary to provide for the amplification of sound. By the use of a source of compressed air in conjunction with a sound-operated valve (in this case the valve-operating sound was a voice or vibrations from a mechanical phonograph pickup) amplification could be obtained.

Basic principles have changed very little, but refinements in electronic driving circuits and the modes of operation of modulating valves have brought compressed-air speakers and amplifiers into use in many specialized applications. The fact that tremendous energy gains can be accomplished with a

Right: A compressed-air loudspeaker. Below: An exploded view of the amplifying section of the compressed-air speaker



Courtesy Cook Research, Inc.

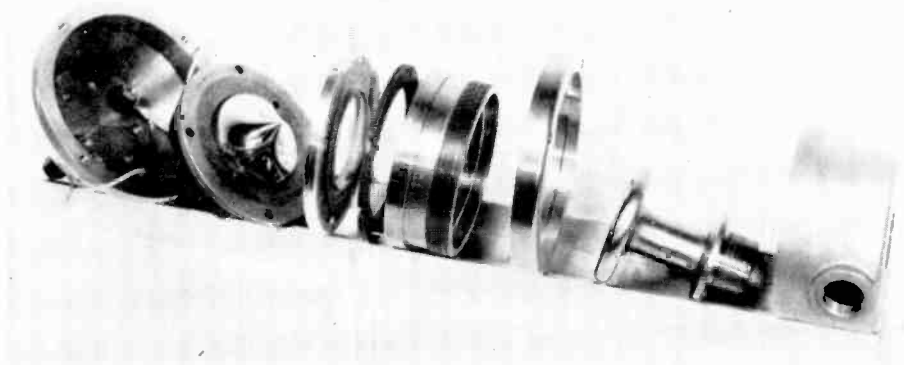

minimum of equipment gives this system widespread use in air-raid warning devices, replacing conventional rotary sirens. Through modern developments by Stanford University and Cook Research the audio range of compressed-air units has been increased to a point where large amounts of power can be distributed over wide response limits. Work is under way on a unit that will cover the entire audio range. The use of these compressed-air devices will most certainly be limited to industrial and military applications.

HIGH-POWER INDUSTRIAL AND MILITARY CONVENTIONAL LOUD-SPEAKERS: World War II saw the first wide-scale use of extremely high-power units. These devices came into use in areas where there were heavy ambient noise levels from machinery or battle. No problems existed in building an amplifier that would produce continuous power of 500 to 1,000 watts. However, certain problems arose in finding a conventional voice-coil-diaphragm speaker that could handle this power without breakdown or undesirable distortion. The problem was solved by employing as many high-power driver units as were needed in a single bank. These driver units looked very much like the conventional wide diameter voice coil, dome-type high-frequency driver units used today. In order to cover the limited range of audible communication frequencies, the dome-shaped diaphragms were constructed of heavy resin-impregnated materials. Large magnetic elements were used to give them the power reserve necessary under all conditions.

Where these units were used on submarines, the diaphragms were constructed in such a way that limited movement produced sufficient power, yet great pressure during submersion would not destroy the mechanisms.

Peacetime applications for high-powered systems exist in railroad marshalling yards, jet airstrips, and large industrial plants.

THE SERVO-COIL LOUDSPEAKER: A servo coil loudspeaker is an ordinary permanent magnet loudspeaker with an extra voice coil winding. The added voice coil serves to damp unwanted vibrations of the diaphragm. The desirability of a well-damped cone arises from the fact that if a momentary signal is fed to a loudspeaker the cone will continue to oscillate after the signal has ceased. These oscillations are analogous to the operation of a pendulum, which will continue to swing until friction finally brings it to a halt. The same situation applies in the case of loudspeakers. Unwanted loudspeaker vibrations are usually damped mechanically; lightweight cones and soft suspension systems help keep them to a minimum, as does the high flux density (magnetic field strength) brought about through larger, more powerful magnets.

Unwanted sympathetic cone vibrations cause distortion. When a loudspeaker diaphragm vibrates after a signal has ceased, the movement of the voice coil over the magnetic pole pieces generates current. The small voltages generated affect the general linearity of the output circuit, including the ampli-

Front and rear views of a 16-unit 500-watt military loudspeaker with wide dispersion

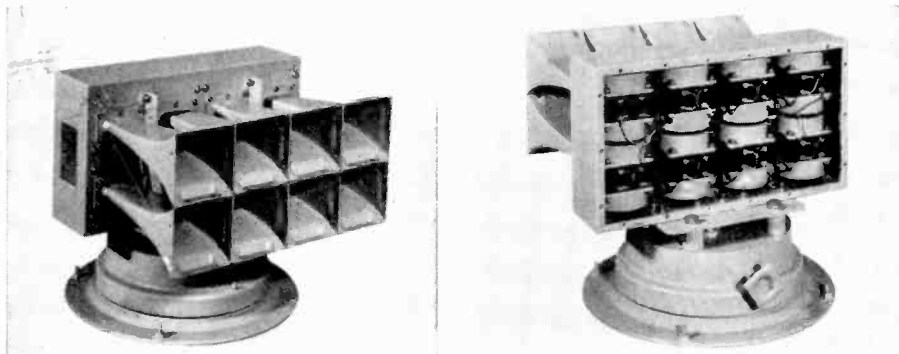

Cutaway view of a high-power, all-weather military horn loudspeaker

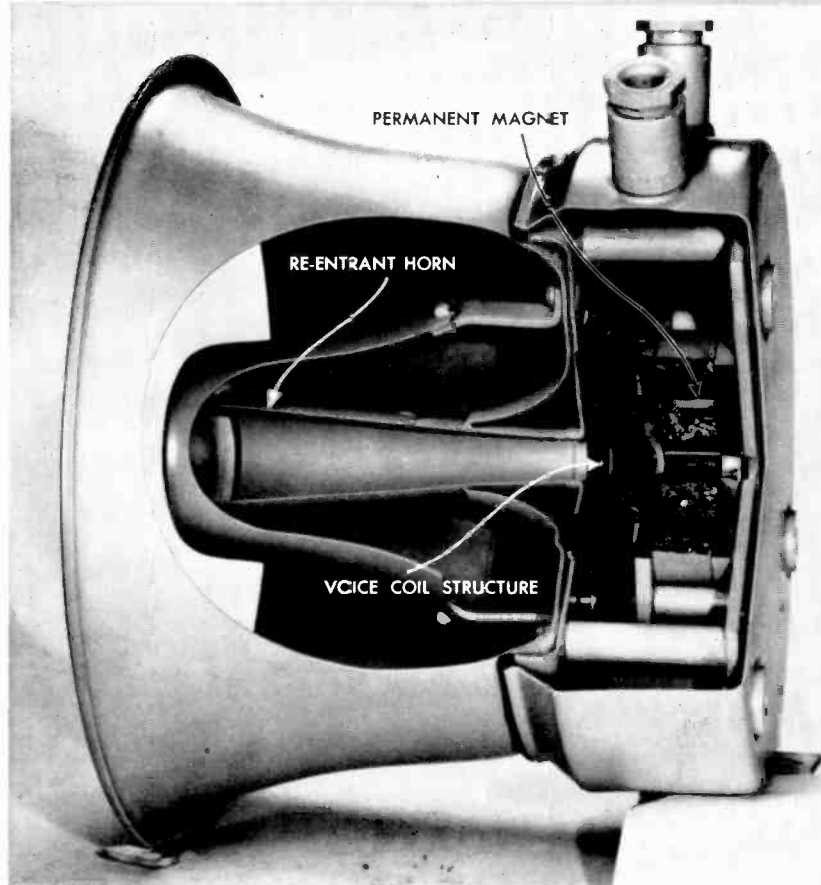

Courtesy Jensen Mfg. Co.

fier, the transformer, and the speaker, which may not be able to recover soon enough to reproduce succeeding signals with fidelity.

The damping occurring in any ordinary loudspeaker is a combination of acoustical, frictional, and electromagnetic factors. At this point we are more concerned with electro-mechanical damping as a function of the effective plate resistance of the amplifier circuit. In the over-all view damping, involving feedback and special electronic circuits, is far too complicated to explain in a few phrases. In loudspeaker design, desirable damping can be increased by increasing the size of the magnetic structure and its flux density. Beyond this measure and the application of feedback from the secondary of the output transformer to increase damping, the servo loudspeaker system has been developed as an answer to truly instantaneous electromagnetic damping. In previous unsuccessful attempts to accomplish the same feat the inventors have called the system by several names; "motional feedback" and "velocity feedback" are among them. With two coils wound in close proximity to each other on the same voice coil form, the second coil produces its feedback voltage by the motion of the coil over the magnetic pole piece. This voltage is a pure motional voltage at most frequencies and may be used to increase damping and reduce any distortion arising from non-linearity of the diaphragm and cone suspension system.

The only difficulty that may arise in this system may come into play at very high audio frequencies, where mutual inductance may occur between the feedback servo coil and the adjacent voice coil, causing a signal component which is dependent upon the induction between these two coils rather than upon their motion. Counter-inductance is added to correct this at a point outside the magnetic field.

Since a certain amount of damping is highly desirable, manufacturers

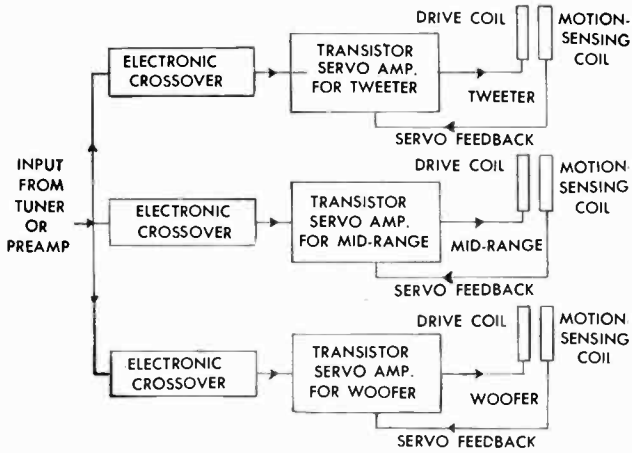

Above: A basic block diagram of the Integrand 3-way servo-speaker system. Right: The types of speaker units used in a servo system

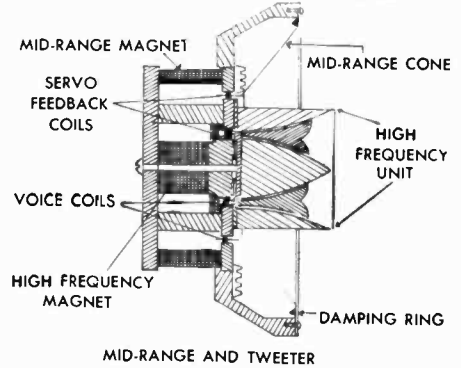
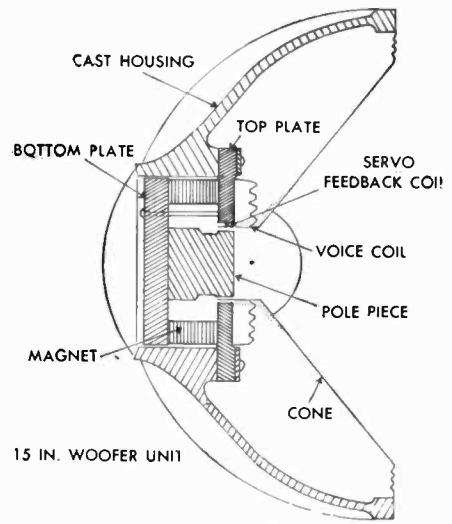

have employed one or all of the existing systems of obtaining critical damping. However, none of these systems ever provided the complete answer to successful damping until the development of the servo-speaker-amplifier system produced by Integrand. Taking a cue from industrial engineers and their servo systems, designers added the second coil; with accompanying circuits a continuous "auditing," or sampling, of the output signal condition in the voice coil winding could be taken. This sample, in the form of feedback voltage, can be sent back into the amplifier as instantaneous current factors, calling for corrective damping as needed.

THE OPERATION OF THE SERVO SPEAKER-AMPLIFIER SYSTEM:

The production of operational audio-power transistors is the major factor in making servo systems possible. These new amplifiers make it possible to provide any speaker with a direct-coupled, output transformerless driving source.

The Integrand Servo Speaker Amplifier System, made in Westbury, New York, is the only available example of this new working concept. It uses a three-speaker system, with an individual woofer, mid-range speaker, and tweeter. Each speaker has its own transistorized power amplifier and crossover/divider network. The loudspeakers are of special design, containing extra-heavy magnetic systems and dual coils on each voice coil form.

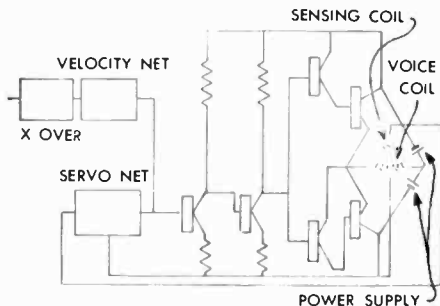

A diagram of a compact transistor amplifier, as used in a servo-speaker system

A special multiple-speaker installation utilizing the construction elements of a home. Builder Sherwin Janows used two-inch-thick solid wood baffle boards

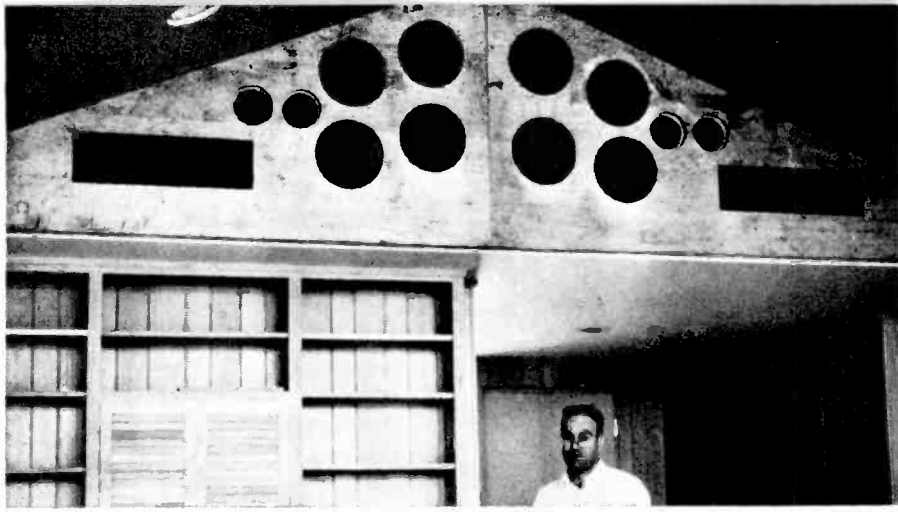

The servo coils act as sensing units, feeding back corrective "information" to each individual servo-amplifier network. The information data instantaneously and automatically corrects for the effects of listening room acoustics, cabinet or enclosure resonances, and distortion arising from inherent amplifier characteristics. Nonlinearities, which occur in most loudspeaker suspension and magnetic structures, are virtually eliminated through the feedback "cueing" from the sensing coils. These coils are wound over each driving coil in such a way as to be in the exact center of the magnetic field; the information voltage will thus be as nearly linear as is possible. Operating on a principle of velocity feedback voltage, a change to current feedback is necessary. This is accomplished through a conversion network, which produces a pressure control of the sound output rather than the initial velocity changes. The resultant output is remarkably free of the usual audio system distortions.

THE INSTALLATION OF LOUDSPEAKERS: No matter what the choice of enclosure may be, the installation of any loudspeaker must be guided by certain acoustical and mechanical principles. The acoustical rules mainly concern type of grille or covering, placement, and choice of unit. The mechanical rules mainly involve the mounting structure and the method of mounting the speaker.

Let us first go into detail on coverings for the speaker. A loosely woven fabric of almost any type can be used to cover a cone-diaphragm speaker used to radiate the lower frequencies. If the speaker is of the coaxial variety soft,

A Klipschorn enclosure properly located. The corners of the room are used as extensions of the horn

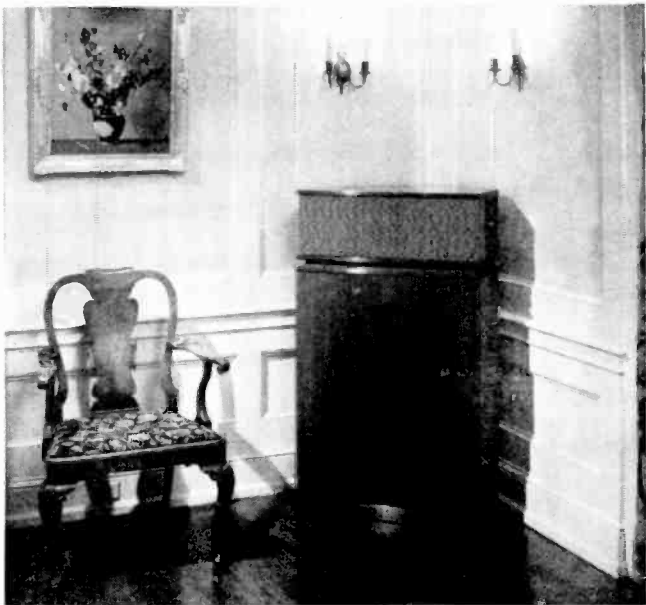



Equipment for evaluation furnished by Klipsch Associates



Above: Mounting a speaker on a baffle board. Screws should be tightened uniformly to avoid warping speaker frame. Left: Technicians Richard Hilton and Theodore Osborne reassemble an enclosure after testing it

loosely woven fabric can obstruct and absorb the radiation from the high-frequency tweeter. If any grille cloth is to be used at all in such a case it should be a tightly stretched, open-weave, hard cloth (nylon or commercial plastic grille cloth). In factory-finished enclosures special grille materials are used which fit the particular speaker system; additional coverings should not be used.

The covering that goes over the port below the speaker in a bass-reflex cabinet is as important as the material covering the speaker itself. The wrong cloth can change the characteristics of the enclosure. Again, open-weave, hard cloth, tightly stretched over both openings, is the best bet. Experiments can easily be made by the interested to determine just what effects various cloths can produce.

The placement of a loudspeaker system is governed first by the size and shape of the listening room. With the exception of stereophonic speaker placement, corner placement usually provides best operation. The corner should be chosen with regard to frontal obstructions, and, in the case of horn-type enclosures, adjacent wall areas should also be free of major obstructions. It is not always possible to have absolutely free wall space in the average living room, but a simple solution to the problem is to move the furniture just a few more inches away from the wall. In installing the base unit, try to get it as near the floor as possible. High-frequency units should be elevated and as free of obstructions as possible. If a corner is not available, try to place the speaker system in the center of a short wall of a rectangular room, as close to floor level as possible. The bass response of a system is diminished as less desirable locations are chosen. Corner placement is best, the middle of a short wall at floor level is next best, and positions at eye level, at the center of a room, or behind diffusing or obstructing objects are least desirable.

Your choice of a speaker unit or system should be established by your budget, existing amplifying equipment available, room for placement, and common sense, which tells you that one can put too many large speaker systems in a room that is too small for them.

The mechanical rules of good practice are in the main determined by your enclosure. If you are mounting the speaker system in a factory- or kit-assembled enclosure, you are almost sure to use the mounting board supplied by the manufacturer. Manufacturers, for the most part, realize the importance of having a securely braced mounting board at least $\frac{3}{4}$ inch thick. In some better grade enclosures these mounting boards go up to $2\frac{1}{2}$ inches in thickness.

In assembling a homemade enclosure from the plans furnished by a manufacturer, you will be wise to follow his instructions to the letter, without substituting parts. Kits are laid out with all sections ready for assembly, and substitution is impractical.

The actual mounting of a loudspeaker to a mounting or baffle board requires good mechanical practice. Since a loudspeaker is a device that depends upon concentric motion of a voice coil over a magnetic pole piece without any warping stresses on the paper cone diaphragm, it is absolutely essential that the mounting surface be flat and that the speaker be set firmly upon it. When placing a speaker over factory-tightened mounting bolts, take care not to puncture the diaphragm. After the speaker is positioned it is wise to tighten the units all around the speaker frame, tightening each only slightly until all are secure. If each nut were tightened fully in turn, warping of the speaker frame might occur. After the speaker has been mounted, but before the grille cloth is stapled in place, see that the speaker cone is free of wood splinters or obstructions.

THE MAINTENANCE OF LOUDSPEAKERS: There is very little that can be done in the way of preventive maintenance for the conventional loudspeaker except to use it with care. In this day of the high-powered amplifier, it is wise to install fuse protection in the leads feeding the speaker. Without this protection it is possible to burn out the voice coil windings should the speaker be played at extremely loud levels or during large transient peaks of power. The amperage rating of the fuse should be less than the maximum current the speaker is designed to carry. Some amplifiers provide fuse holders for both the a.c. power line and the speaker line. In high-power public address speakers, protective devices similar to circuit breakers are employed to safeguard the speaker voice coil.

As for the actual use of your equipment, it is not wise to move a loudspeaker and enclosure onto a porch or patio, where moisture and dampness might attack and dissolve the paper pulp speaker diaphragm. Most high-fidelity speaker units are designed for conditions of average indoor temperature and humidity. If necessary, special outdoor weatherproof speaker units with metal re-entrant horn-type enclosures are available.

When installing your loudspeaker or checking it, a wise maintenance procedure is to take care that no small particles of iron or steel, such as might be found on a workbench or a basement floor, get into it. Iron filings and steel wool are fatal to a high-fidelity loudspeaker with the usual high-powered magnetic system.

It is often necessary to solder wire leads to voice coil terminals; during this process drops of solder may fall into the space between the speaker basket

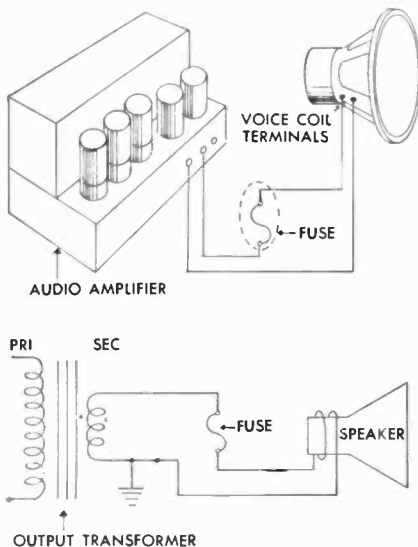

Left: Pictorial and schematic diagrams of a fuse in the speaker line. Below: A simple ohmmeter resistance-checks voice coil

Meter furnished by Heath Co.; speaker by Wharfedale



frame and the diaphragm. Being hot and still fluid, these drops will adhere to the soft fibrous cone material. While not noticeable at the time, they can come loose during operation and cause rattles in the speaker. Care should be exercised to avoid such particles, which could also cause wedging of the cone.

CORRECTIVE MAINTENANCE FOR LOUDSPEAKERS: High-fidelity loudspeakers have become such complicated mechanisms that even skilled technicians have trouble repairing them. Factory facilities are the best bet for any major speaker repair, especially of non-cone-diaphragm-type tweeter units.

The problems that can occur in speakers include: open voice coils due to burn-out or broken wires; broken flexible connection leads between speaker frame and voice coil terminals on the cone diaphragm (these two leads seldom burn out, but may be broken by constant flexing); and diaphragm failures, including warping, tearing, or loose rim and/or suspension systems.

Should the voice coil of a speaker burn out with no broken wire apparent, it is a problem for factory repair. A test with a simple volt-ohmmeter, an instrument easy for anyone seriously interested in high fidelity to use, will show where the open is. Broken or open flexible leads can be replaced by the semi-skilled with a small soldering iron and very flexible woven wire. Stiff or solid wire will tend to drag down the movement of the diaphragm.

Cone problems can sometimes be corrected by a layman. However, warped or off-center cones are factory jobs. Sometimes, a cone rim will come loose in spots from the frame due to dryness. Glue can be used if the whole rim is not loose and the diaphragm off center. With the modern covered diaphragm and suspension system, centering shims are out of the question except for factory repair shops. Slight tears or holes in a cone can be repaired: clean both sides of both edges with fine garnet sandpaper, being careful not to allow grit and dust to get into the opening between the voice coil and the magnetic pole piece. Then a thin coat of rubber cement or Goodyear Ply-O-Bond can be applied to each side. Thin strips of onionskin paper can be used to cover both sides of the break in the cone. If the hole was caused by a mounting bolt, and is not a large rent (less than $\frac{1}{4}$ inch), it is sometimes best to clean out the hole so that the edges will not vibrate together, and then leave it open. Or, it can be covered in the same manner as explained above, with a small circle of onionskin paper applied only to the face of the cone, formed to the shape of the cone or suspension rim. If you are not sure about the problem, your best bet is a factory repair job. Be sure you have proper instructions for

Right: An early speaker enclosure by Jensen.
Below: An early multiple-speaker enclosure provided with an Atwater Kent radio



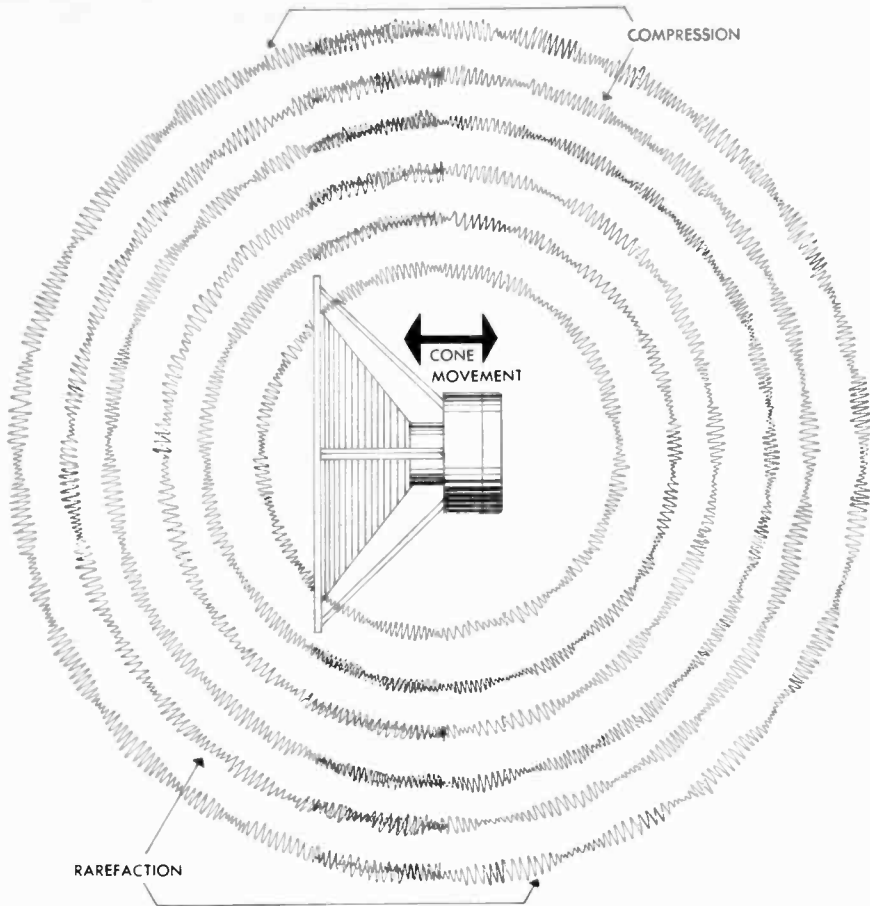

A compression wave from the front of a loudspeaker diaphragm occurs at the same time as a rarefaction cycle from the back of the diaphragm. Unless the back waves are interfered with or altered by means of some type of baffle, they will mingle with and negate the front waves. The physical dimensions of the loudspeaker are such that high-frequency sounds are diminished less than low-frequency sounds. The result of operating a speaker without a baffle is a dropping-off of bass response

packing and shipping to avoid further damage. In following this procedure you will find that your repairs will usually be made not only quickly but inexpensively.

THE LOUSPEAKER ENCLOSURE: Audible sound is dependent upon the transfer from one air particle to another of the energy of a vibrating body, which finally enters the human ear. These air particles must be set in motion by some means. In the case of high fidelity, the loudspeaker and enclosure do the job.

To push any object from one spot to another, force or motion must be applied. Application of force implies some sort of contact or mechanical coupling. For the distribution of sound energy in air, there must be a contact or coupling between the air particles and the vibrating object. As has been explained earlier, it is the cone diaphragm of the direct-radiator loudspeaker and the flared column of air in the horn speaker that provide the mechanical coupling necessary to move air for sound.

A violin string can be stretched between two points in open air; a sound can be produced by plucking this string. However, the characteristic sound of

the violin would not be there without the resonating wooden body of the violin. An open string with a small contact area could not be heard as easily as could the string and violin body combination. No direct comparison between the body of a violin and a loudspeaker enclosure is intended, for the violin body acts as a resonator, adding color and character to the music played on its strings. We desire a loudspeaker enclosure, on the other hand, to act upon or change the energy given off by the speaker *as little as possible*. In essence, we depend upon the speaker and the enclosure to work together in unison to accurately convert the signals from an amplifier.

Since the reproduction of high-fidelity sound is, in normal cases, secondary to other elements of life in our homes, it is ordinarily adapted to fit these conditions rather than adapting everything else for hi-fi. The cost, size, and location of an enclosure should be fairly well defined before a high-fidelity system has been purchased. Even with unlimited funds, size and location govern the final choice. In most cases all three factors (plus the sharp-eared neighbors) effect control.

As an individual unit, a loudspeaker will function in any position and without any enclosure, so long as energy is applied to its voice coil terminals. It could be set face up on any flat surface. It could be hung from a string in the center of a living room or placed alone on the floor. The resulting sound would be intelligible, however undersirable it was to listen to, or however limited its range. The usual first impulse would be to get it out of the way, of course, for its purely mechanical appearance would add nothing to a room. Now, if the thing is to be hidden, let's see how we can most effectively do the job, enhancing the sound and appearance at the same time. This combination of needs is what has led to the high-fidelity enclosure-and-loudspeaker combination.

Sound is produced by the back of a loudspeaker diaphragm or cone as well as the front. Due to the in-and-out motion of the diaphragm, the two sounds are 180° out of phase with each other. When air is compressed in front of the diaphragm, it is simultaneously rarefied in back of it. When a compression of a substance meets an equal but opposite rarefaction, the result is a cancellation. In practice, because the size of a loudspeaker results in some physical interference, this cancellation is most prevalent in the low-frequency range. The only way to utilize the full low-frequency response of a loudspeaker is thus to eliminate the sound from one side of the speaker, or to alter it in such a way that it will no longer cancel the sound from the other side. Usual practice is to alter or eliminate the sound from the back of a speaker rather than the front.

BAFFLES WHICH ELIMINATE BACK WAVES FROM THE LISTENING AREA

INFINITE BAFFLES: Theoretically, perfect speaker baffling would necessitate placing the speaker in a wall between two identical rooms. The mounting wall would have to be insulated against speaker vibration. All the sound from the front of the speaker would go into one room; all the sound from the back of the speaker would go into the other room. Since the volume of air enclosed by each room would be identical, the cushion effect on the speaker diaphragm would be the same front and back. No mingling of sound would occur; baffling would be perfect. This is not often a practicable solution, but it is one that can for all instances and purposes be duplicated either by wall-mounting a speaker between two fairly isolated rooms or by mounting the loudspeaker on a solid closet door, backed by sound-absorptive clothes. Effectiveness can be improved through the use of interior weatherstripping around the closet door.

While the usual infinite baffle is not exactly what its name connotes, if properly constructed it can very closely approach the perfect baffle. In the

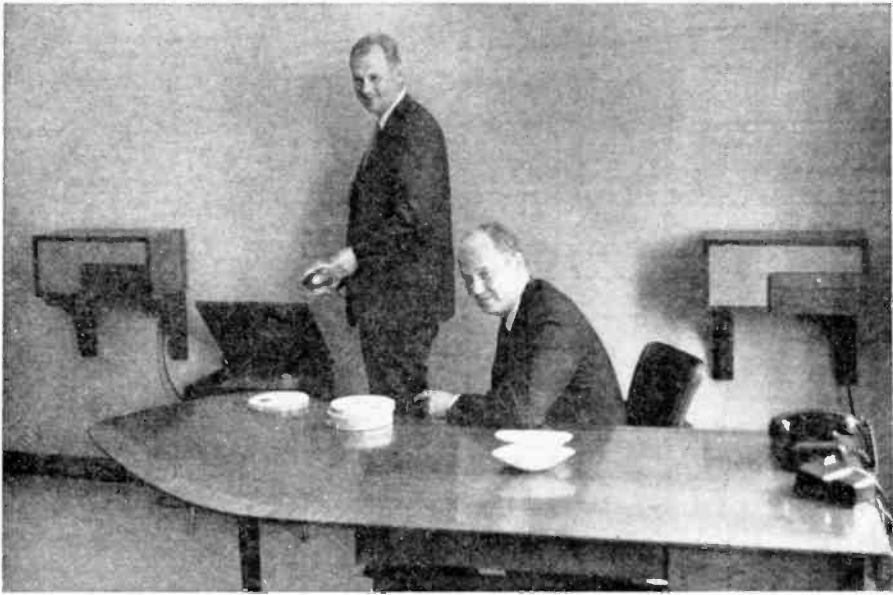

Courtesy Sonie Arts, Inc.

Two infinite-baffle enclosures of the air-suspension type are seen in use in a stereophonic set-up for a business office

early days an infinite baffle was simply a tightly sealed box with only one opening, filled by the loudspeaker. It was of heavy construction to avoid vibration, and usually contained sound-absorptive padding to reduce the effect of higher sounds on the speaker diaphragm.

To be effective, the size of an infinite enclosure has to be large to reduce the effect a small volume of air has in raising the resonant point of a speaker. Each particular speaker has a low resonant point resulting in a practical limit in its ability to reproduce bass notes. If a loudspeaker with a resonant point in free air of 50 cycles were placed in a large infinite baffle enclosure, that point of resonance could be maintained. However, if the size of the enclosure were reduced to about half the volume, due to this smaller and stiffer air cushion, bass would be lost through an increase in the apparent diaphragm resonance to perhaps 60 cycles. Very little can be done with most typical speaker suspension systems to reduce diaphragm resonance to a point where an infinite baffle of extremely small dimensions will not destroy the low-frequency portion of the sound.

A new and practical step has recently been taken by Acoustic Research, Inc., of Cambridge, Massachusetts, in their AR-1 and AR-2 speaker systems. It was thought that a loudspeaker could employ the air cushion sealed in an infinite enclosure as a spring-suspension element in the speaker system. AR produced a speaker with only 10% of the suspension stiffness of the usual speaker, providing a subsonic resonant point of around 10 cps. The AR systems use a totally enclosed, acoustically sealed cabinet of less than 2 cubic feet to gain the additional 90% of needed elastic stiffness. The small volume of air enclosed in the cabinet acts like a spring, "stretching" as the diaphragm moves out and compressing as it moves in. The resulting system resonant point is 45 cycles for a 12-inch speaker and a cabinet volume of 1.7 cubic feet. Performance is comparable to any conventional 12-inch speaker in an infinite baffle, yet much less space is taken. The use of a critical amount of glass-fiber damping material eliminates the possibility of standing waves in the higher frequency ranges. (Too much internal filling will affect the smoothness

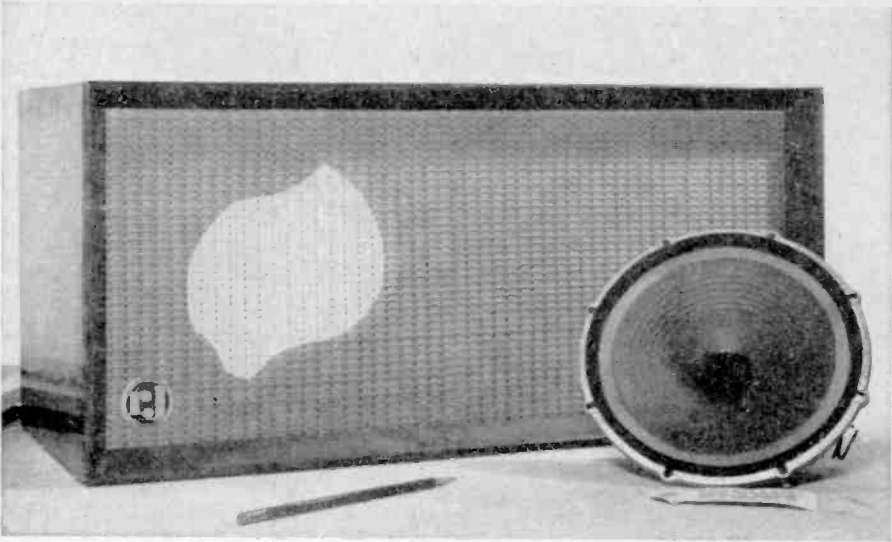

Back-illumination of the grille cloth shows the unusual configuration of the opening in the front panel of the R-J enclosure. The 8-inch Wharfedale speaker has a foam plastic suspension rim

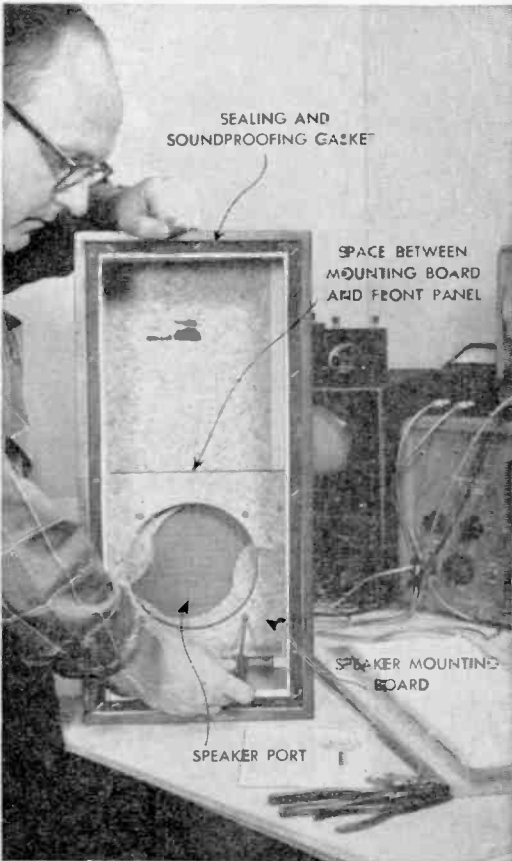

Left: The R-J enclosure from the back as an engineer prepares to install the speaker. Below: The AR-2 air-suspension enclosure. Note the padded interior

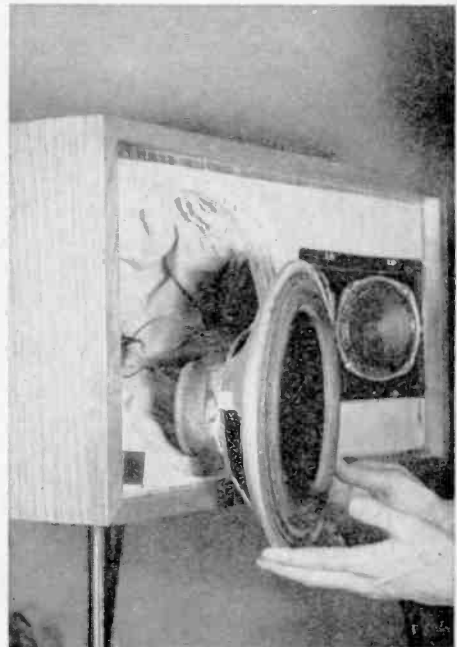

Equipment for evaluation from British Industries, Inc.

Equipment for evaluation from Acoustic Research, Inc.

The components of the AR-2 infinite-baffle speaker system. The tweeter units are angled toward each other to provide greater horizontal dispersion

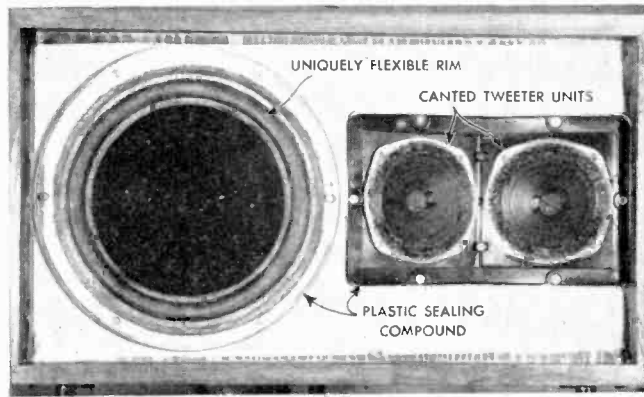

Equipment for evaluation furnished by Acoustic Research, Inc.

of the bass response; too little can cause a marked drop-off of bass response under 100 cycles.) The sole disadvantage of the AR system is that a good deal of amplifier power is required to drive it; efficiency is rather low. The infinite baffle in this smaller modified form will become more and more common where lightweight equipment is desirable.

THE FLAT BOARD BAFFLE: A large, flat, acoustically treated board 100 feet square with a loudspeaker placed exactly in the center might be used as a baffle. By the time the sound waves traveled from the back of the speaker around the edge of this enormous flat baffle, they would be so weak that no effect would be noticed; for all practical purposes we would hear only the front waves. As the size of such a flat board was reduced to practical dimensions, the effects of the two waves together would grow, destroying the effectiveness of the baffle. Most of us will remember the open-back radio cabinet, prevalent from the late 1930's up to the present day, which was in effect simply a flat baffle with its edges turned back to form a box. Better than previous speaker enclosures, it provided the listener with a false or "booming" bass, with every instrument producing low-frequency notes sounding pretty much the same. In such baffles attention was seldom given to size relationships between

The AR-2 loudspeaker system as supplied by the manufacturer

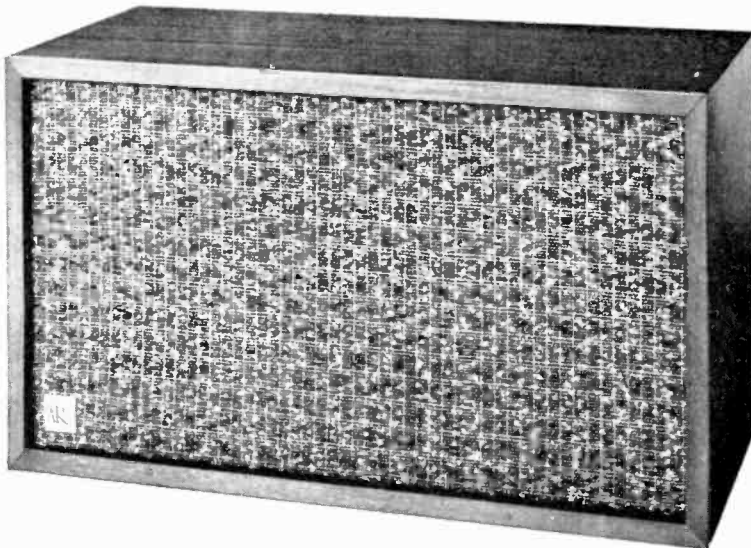

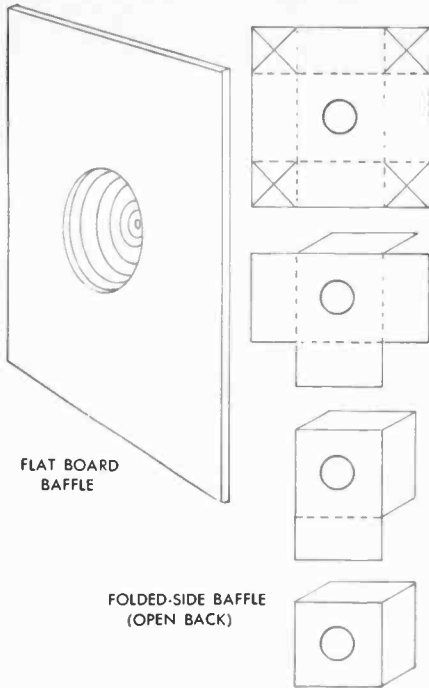

Equipment for evaluation furnished by Allied Radio Corp.
 Above: The port and the shelf are acoustically important parts of this bass reflex enclosure.
 Left: A baffle and its folded-side equivalent

the front and depth dimensions and to the strength and thickness of the walls of the box. The thin walls of such baffles vibrated violently, producing their own characteristic sounds, which, combined with the sounds from the front of the speaker, produced completely unnatural "noise."

BAFFLES WHICH MODIFY AND UTILIZE THE BACK WAVES FROM A LOUDSPEAKER: Early in the history of loudspeaker enclosures someone thought it might be a good idea to use the sound energy coming from the back of a loudspeaker rather than trying to get rid of it. Several enclosures have been designed which do just this; the first successful design was the bass-reflex enclosure. A bass-reflex baffle is an enclosed cabinet with two openings at the front, one for a loudspeaker and another called the reflex port. With an en-

The operating characteristics of a bass-reflex loudspeaker enclosure

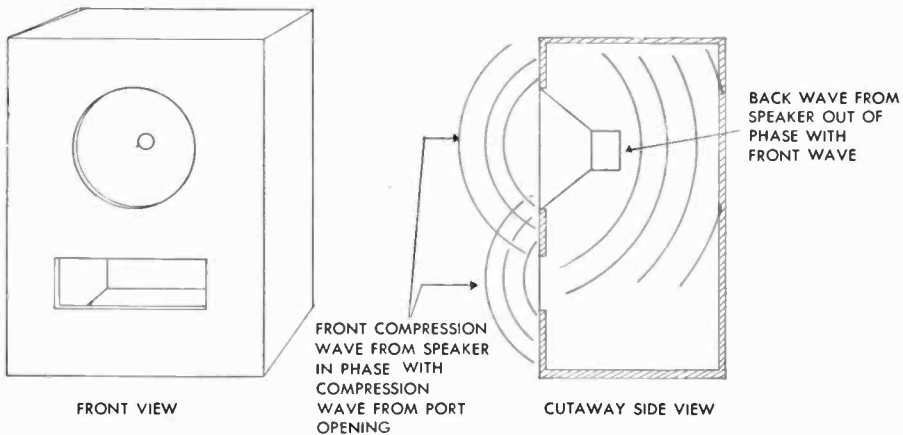

closure of correct size and with the right openings in relationship to a particular speaker, it is possible to reverse the phase of the sound energy coming from the back of the speaker. This reversal occurs near the resonant point of the system. Back waves are fed into a room in phase with, and in the same direction as, the frontal energy from the speaker. When correctly designed and constructed, the bass-reflex remains today one of the best enclosures at a reasonable price. The outstanding feature of such units is that by changing the size of the port opening (called "tuning the port") an enclosure can be made to operate with almost any loudspeaker. Tuning the port to the resonant point of the speaker limits the diaphragm excursion at this point. Tuning is accomplished by experimentally changing the size of the opening temporarily, using something solid as a cover. As a small d.c. voltage from a 1.5-volt flashlight cell is applied to the speaker wires either a "click" or a ringing thump will be heard, since the speaker diaphragm is relatively undamped (uninhibited) at its low-frequency resonant point. This is an undesirable condition, caused by a too-free motion of the diaphragm at this one particular frequency. By tuning the port, the movement of the diaphragm can be limited at this point, causing the thump or bong to become a "click" as the battery voltage is applied and removed.

Once port tuning has been accomplished the speaker will function at its optimum, and a permanent tuning cover can be put in place from the inside. If the speaker is changed or if the location of the enclosure is altered, retuning is wise. The general effect of a properly constructed and tuned bass reflex cabinet is that of smoother and lower bass response with little transient distortion, the mid- and high-frequency ranges being reproduced in quality consistent with the loudspeaker employed and the size of the enclosure.

The desire for small bass-reflex enclosures giving smooth response over a wide range has brought about several design innovations. These include variations in internal construction, in which the port is covered at the top by a shelf extending into the enclosure's interior. This increases the effective isolation of the speaker and the port while still maintaining proper baffling at reduced enclosure sizes. Certain other internal dividers and spacers are said to give additional smoothness of transition between the low- and high-frequency ranges. The additional cost of such complicated structures over that

Right: The design of the Acoustical Labyrinth (TM Stromberg-Carlson) enclosure forces the back waves from a speaker to travel a measured distance before emerging. Below: The straight-line equivalent: Back waves emerge with 180-degree phase reversal

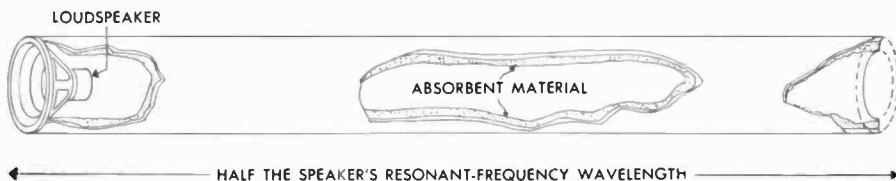
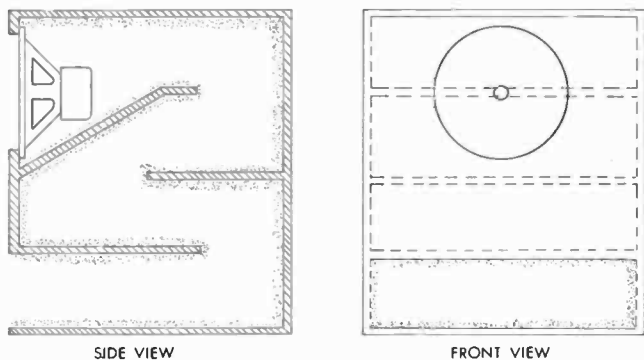

of the conventional bass-reflex unit is not warranted by the slight increase in quality.

THE ACOUSTICAL LABYRINTH BAFFLE: One of the oldest and most successful baffles is the acoustical labyrinth, used for so many years by the manufacturers of Stromberg-Carlson radios at a time when all other set manufacturers were still employing less-than-adequate open-backed cabinets. Every loudspeaker diaphragm has one dominant point of resonance in the range of frequencies it will reproduce. At this point, low in the scale of frequencies, the cone moves in and out more easily and does not come to rest quite so quickly as at other frequencies. The labyrinth enclosure was designed to lower the resonant point by introducing behind the loudspeaker a tuned (to a specific size and length) column of air which maintains a definite loading value at the resonant frequency point. The length of the column of air is exactly one-fourth of the wavelength of the frequency of the resonant point of the speaker being used. This column forms an anti-resonant chamber that restrains the motion of the speaker at the resonant point, smoothing out and lowering the otherwise peaking bass end.

Labyrinth enclosures are most conveniently constructed in box form, with the tuned air column formed by dividers placed in such a way that a bent path is formed. Once constructed, the inner surface of the path is lined with sound-absorptive material to kill any high-frequency reflections or standing waves that might have an effect on the diaphragm of the direct-radiating loudspeaker. The port at the end of the labyrinth forms bass reinforcement at a frequency where the air column represents $\frac{1}{2}$ wavelength.

HORN AND FOLDED HORN ENCLOSURES: The flared-horn shape was recognized as a superior means of coupling speaker diaphragm motion to air as early as 1919. At that time Dr. A. G. Webster patented the exponential-horn shape. Webster suggested in his patent that anyone building such a horn would do well to make certain that it formed a "reasonably rigid boundary for an air column."

FOLDED HORNS: It wasn't until electro-dynamic loudspeakers came into use in motion-picture theaters that horn designs became a permanent part of the sound-reproduction art. However, the honor of devising and putting to work the first folded corner horn of practical size went to Paul W. Klipsch in 1940. This system is unique in that it has the air column required for reproducing very low-range sounds, yet does not use up half the area of a room. The Klipsch-horn does this by using the walls of a room as an extension of the folded horn, which is placed in a corner of the room.

A horn loudspeaker for the lower ranges of sound reproduction would of necessity be very large and long. If the horn went straight out into a room without being folded, the device would resemble a large square-sided funnel, over 3 feet square at the front opening, tapering back for 6 feet to a 12-inch

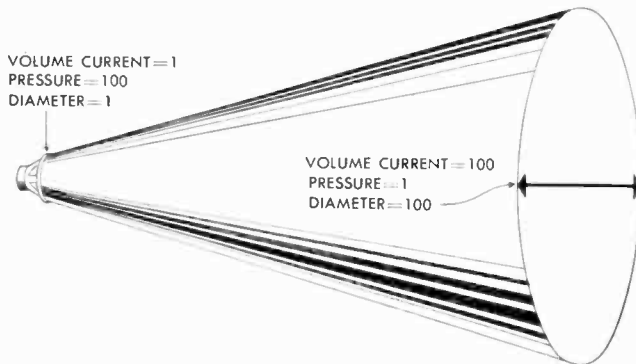

The multiplying action of a loudspeaker horn. Usual practice is to fold horns intended for low-frequency reproduction for the sake of compactness

A. A straight, unfolded horn of exponential shape. B and C. Two compact folded horns. D. A folded-horn loudspeaker enclosure intended for reproduction of low-frequency sounds

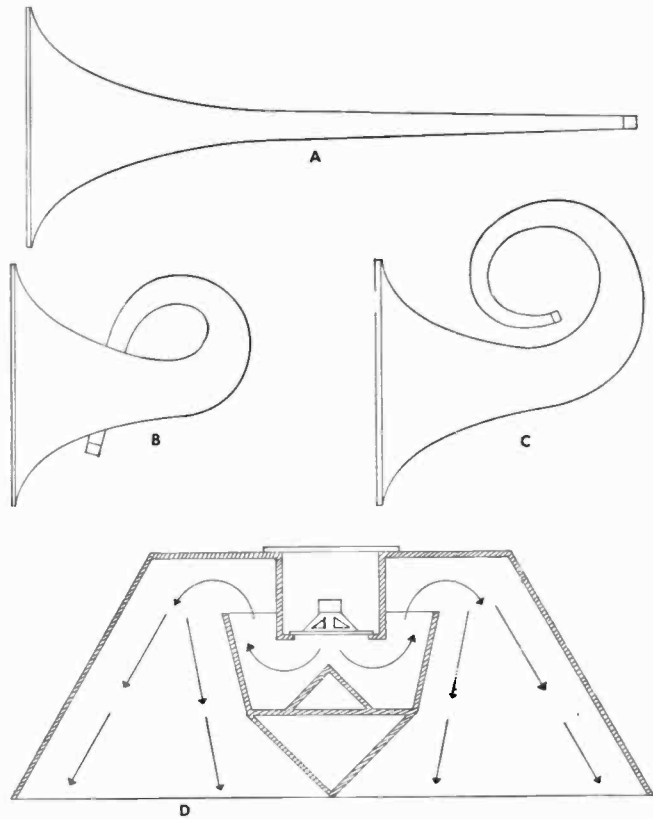

loudspeaker at the rear in a corner of the room. It would be anything but inconspicuous, and at that it would only reproduce sounds well down to 60 cycles.

In order to conserve space, the folded horn was developed and has come into popular use. If constructed correctly, it will reproduce the intended sounds without adding to or subtracting from them. In "folding" a horn, it is very important for the designer and manufacturer to regard the ratio of sharpness of the bends to their lateral dimensions, which may approach a half wavelength at the crossover point between low and mid ranges. Serious attenuation may occur at this point, noted by a change in character of mid-range "color" and power output. In many less-expensive folded horns, thinner construction materials and poor design produce undesirable changes in reproduced sound due to internal structural vibrations and standing waves.

A horn or folded-horn loudspeaker is not necessarily intended for corner placement. Many horn units are intended for side-wall placement and function with exceptional fidelity. Most motion-picture theaters employ some form of flat wall positioning of a horn speaker behind the motion-picture screen. In any application of horn or folded-horn loudspeakers one must consider the fact that the horn itself is simply a means of guiding sound into the listening area; it must not radiate or vibrate itself. If it does, the horn will be no more efficient than a plain direct-radiator loudspeaker diaphragm. Often stressed as a sales point for horn speaker systems is their better than 50% efficiency, as compared to 15% or lower for direct-radiator speaker systems. However, it should be remembered that efficiency has no direct bearing on quality. Naturally, an inefficient loudspeaker will not function well with an amplifier which

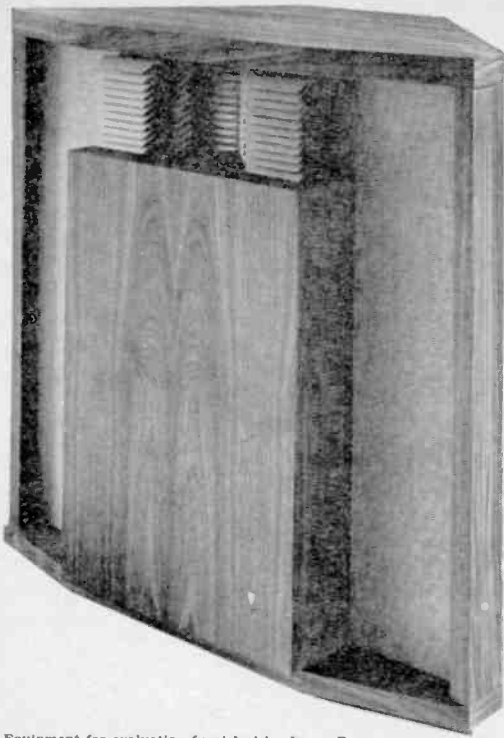

Equipment for evaluation furnished by James B. Lansing Sound, Inc.

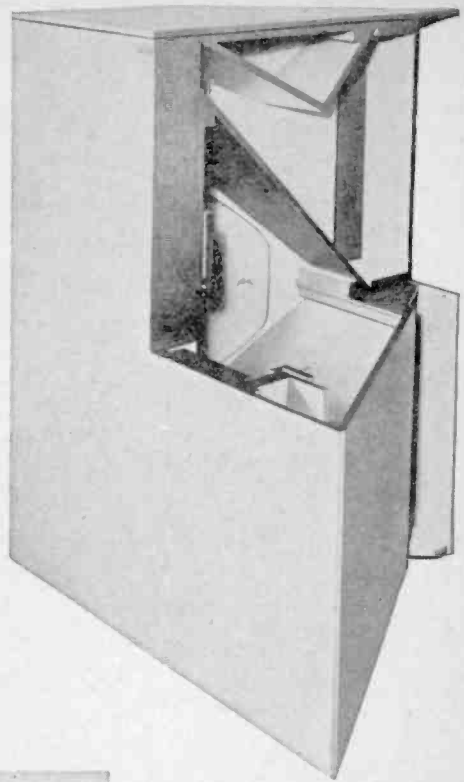

Equipment for evaluation furnished by Klipsch Associates

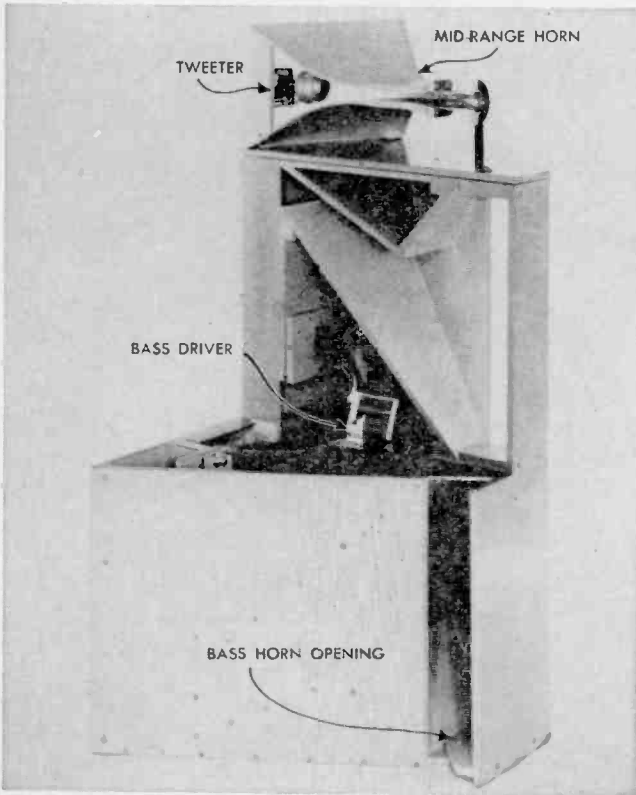

Above, left: The James B. Lansing Hartsfield speaker system features heavy-duty construction and well-integrated driver units. The full audio spectrum is reproduced accurately with such equipment. Above and left: Cutaway views of the Klipsch folded-horn enclosure. The walls of a room act as extensions of the corner enclosure.

Rigid cast-metal multicellular horn features wide dispersion. Horn is attached to a high-frequency driver

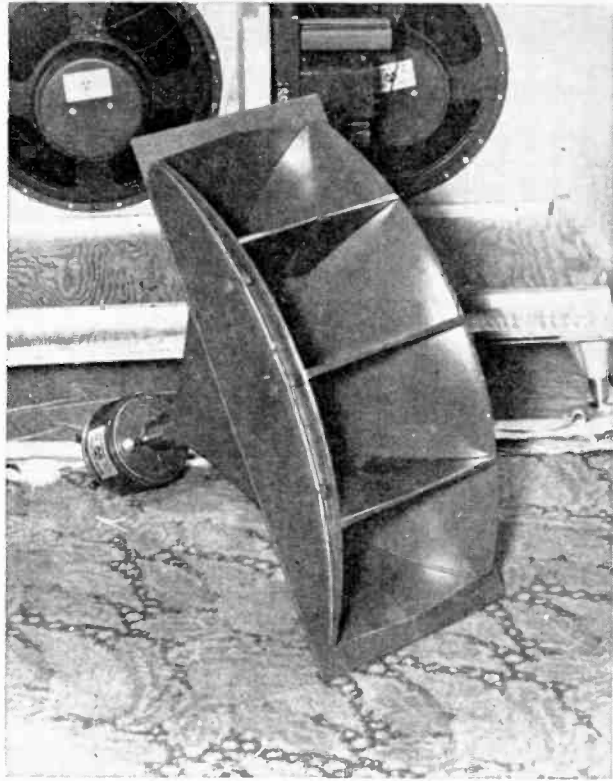

is seriously overtaxed by its requirements. In A-B switching tests with one amplifier and two speakers, the more efficient speaker will seem to have the edge, due to its greater loudness. Loudness, of course, is not the criterion.

HIGH-FREQUENCY HORNS: Contrary to popular belief, horn enclosures are not directional at low frequencies. In the higher ranges, however, a horn's directivity increases. The dispersion of high-frequency sounds over a wide area constitutes a problem for manufacturers of high-fidelity speaker systems. In some cases manufacturers depend simply upon increased flare in the exponential horn shape, but too often the problems of acoustical phasing detract from gains in dispersion.

THE MULTICELLULAR HORN: The multicellular horn comprises several individual horns directed outward into the listening room at slightly different angles; all are powered by one high-frequency driver unit. Cast in rigid metal, these horns may have as many as 15 sections, and may cover an angle of 130° horizontally and 90° vertically. Though used in some high-fidelity speaker systems, most frequent application is in motion-picture sound installations.

THE ACOUSTICAL LENS: While it is not exactly correct to refer to an exponentially shaped metal horn as an enclosure, in some ways it accomplishes the same thing. An exponential horn is a coupling device between the diaphragm of a driver unit and a listening area. If the horn is correctly designed it will beam sound over quite well-defined areas. The higher the frequency of the sound to be beamed, the more restricted the area of dispersion in front of the speaker, until at the high end of the audible spectrum—needed for good high-fidelity reproduction of sound—the area is almost too limited to be practical. While acoustical lenses have been the subject of much investigation by Bell Telephone Laboratories over the past two decades, the James B. Lansing Sound Corporation put the "Koustical" lens to work in the high-fidelity field.

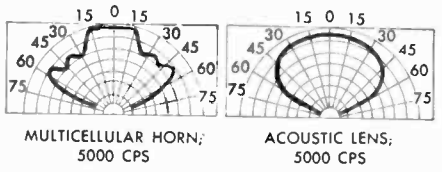
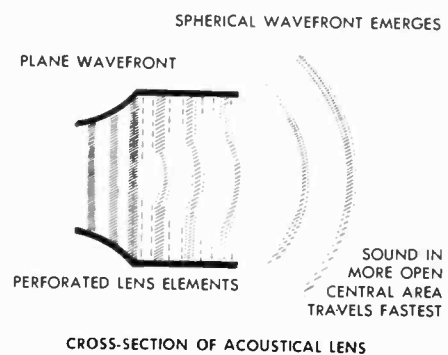
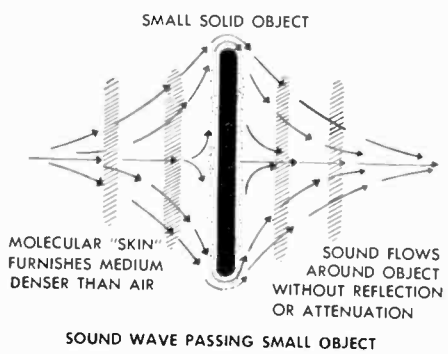
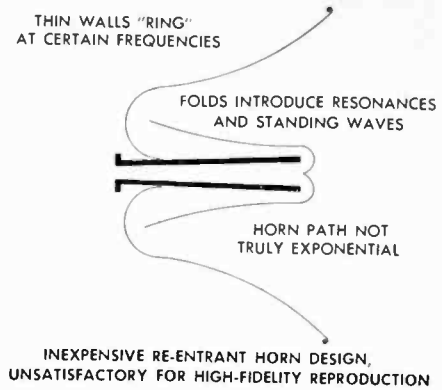
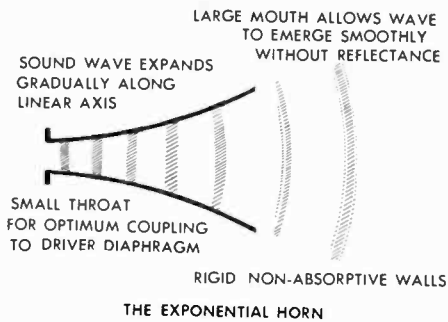

Above: The operation of the James B. Lansing acoustical lens high-frequency driver and dispersion unit. Left: the horizontal dispersion characteristics of a standard horn and an acoustical lens

It was once thought that the use of lenses applied only to light. We now know that this is not true; that there can be, in effect, lenses for any type of wave motion, providing a substance exists which can be "transparent" to this wave motion (radio, radar, infrared, x-rays, etc.), and yet effect a change in speed of transference. As far as a lens system for sound was concerned, all that was needed was a medium denser than the air through which sound usually travels. This material had to be "transparent" to sound, yet still provide a medium denser than air.

Air must travel at great speeds in order to enable an aircraft to have lift. Researchers in aerodynamics have found that a layer of air molecules covers the entire surface of an airfoil at high speed. These molecules cannot be disturbed by any force. This layer of air is called the "boundary layer," and in the acoustical lens it is put to work.

Any perforated material, regardless of how substantial or durable it may be, is transparent to sound to a degree governed by the size, number, and placement of the holes. In the acoustical lens system designed by the James B. Lansing Corporation, many perforated metal screens are arranged together much as a lens system might be put together for a telescope. The so-called transparency of the perforated screens and the all-over boundary layer of air molecules provide a denser-than-normal air path for the sound waves as they

leave the driver unit and pass through the exponential horn. In the "Koustical Lens" 175DLH assembly there are 14 separate lens elements arranged to form a double-concave lens which refracts sound energy evenly over a solid 90° angle. In the course of this refraction in the acoustical lens system, less sound is absorbed than the percentage of light absorbed in a high-quality glass lens system.

With the acoustical lens, the listener's position need not be centered on the loudspeaker system for him to enjoy the full range of sound, otherwise often restricted in the higher end due to the directional characteristics of most tweeters.

MONAURAL HIGH-FIDELITY ENCLOSURE PLACEMENT: With the exception of stereophonic systems, corner placement of any enclosure is considered best by most experts. The corner should be chosen with regard to frontal obstructions, and, in the case of some horn-type enclosures, adjacent wall areas should be free of obstructions for several feet on either side. Since it is not always possible to have absolutely free wall space in a living room, a simple solution to the problem is to move the furniture a few inches away from the walls. When positioning the bass unit, try to get it as near the floor as possible; the high-frequency tweeter should be elevated more and as free of obstructions as possible. If a corner is not available, try to place the enclosure in the center of a short wall of a rectangular room, as close to the floor as possible. The bass response of any enclosure will be diminished as



Equipment for evaluation furnished by James B. Lansing Sound, Inc.

Above: The components of an acoustical lens. There are 32 interior elements. Right: The James B. Lansing Koustic Lens with high-frequency driver model 175 DCH. Below: Cutaway view of lens structure

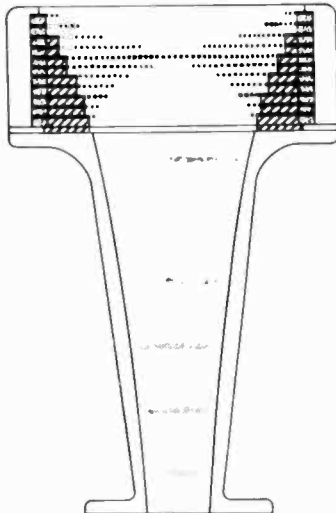

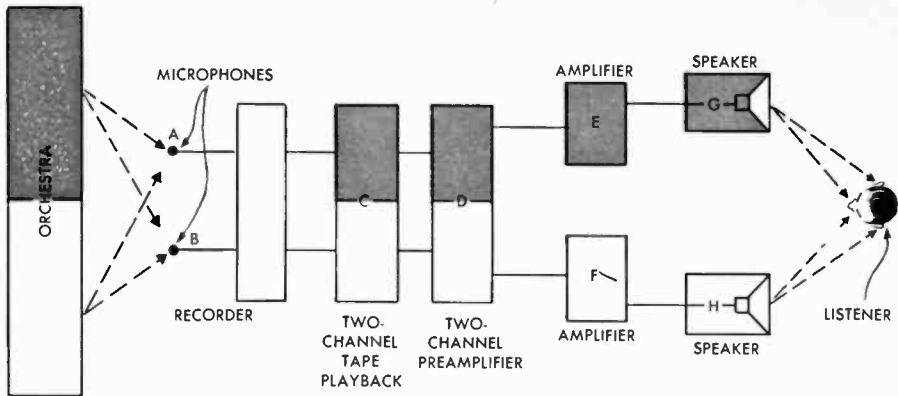

The two-channel stereophonic tape recording and playback process. The separation of the two microphones approximates the separation of the ears

other and less desirable locations are chosen. A corner is best, the middle of a short wall at floor level next best. Positions at eye level, at the center of a floor area, and behind diffusing, absorbing, and obstructing objects are least desirable.

STEREOPHONIC SOUND: The ultimate goal of high fidelity is to reproduce in the listening room exactly the same sounds that a listener sitting in the best seat of the best concert hall might hear. Since people have differences of opinion regarding the best seat of the best concert hall, or may even prefer music which is never performed in a concert hall, it is unlikely that we will ever have conformity in high-fidelity recordings. Let us assume for the moment that everyone agrees on the best seat of the best concert hall. What are the sounds the listener will hear? Amazingly enough, only a small percentage of the sound reaching his ears comes directly from the orchestra; most of it is sound which has been reflected from the walls of the hall. Yet the listener's ears and brain are able to analyze this sound, coming to him from every conceivable direction. He can locate with some accuracy the various instruments in the orchestra, and at the same time distinguish the direct from the reflected sound. If a microphone is substituted for the listener, and the sound recorded for later playback on a high-fidelity system, monaural or monophonic sound results. The microphone, unfortunately, cannot duplicate the feats of the listener's two ears. All the sounds reaching the microphone are mixed together, never to be separated again; thus, directionality is gone. Also, the direct and reflected sounds are mixed, resulting in poor definition and listening fatigue. If, on the other hand, two microphones are substituted for the listener's ears, binaural sound results; this very nearly approaches the ultimate goal of high fidelity. Sound recorded and played back binaurally does not seem to emanate from earphones. Instead, the walls of the listening room seem to disappear; the big acoustics of the concert hall surround the listener; the orchestra is spread out in space. Unfortunately, wearing earphones is uncomfortable and impractical for prolonged listening.

It has been found that a successful illusion of three-dimensional sound can be gained by the use of two loudspeakers instead of two earphones. In this case, the recording microphones are spaced farther apart, usually from 5 to 25 feet; the loudspeakers are spaced from 3 to 10 feet apart. Roughly speaking, we are able to judge direction by virtue of the fact that an instrument will be closer to one microphone than the other, and will thus appear closer to one loudspeaker than the other. We can also distinguish between direct and reflected sound because one speaker can supply the direct sound while the other emits reflected sound *from another direction*, an occurrence similar to

that in an actual concert hall. There is an additional complication in stereo in that the sound from the speakers is reflected from the walls of the listening room, reaching the ears from all directions. The time delay of this reflected room sound is much smaller in most cases than that in a concert hall. Evidently, the ear favors the larger room acoustics, since nothing could be more ridiculous than having a 100-piece orchestra perform in the average listening room. Thus, the function of stereophonic sound is to enlarge the listening room acoustically, as well as to supply a sense of direction to the instruments in the orchestra. If directionality only were supplied, the equivalent would be putting the orchestra in the listening room, depriving the music of the acoustics of the concert hall.

The ultimate goal of high fidelity is perhaps in sight, when speakers can be hung as pictures on each wall of a room, the sound from each being equivalent to what would emanate from the comparable direction in a concert hall. Experiments along this line are already being carried out by the Philips Co. in Holland, known in this country as Norelco. The problem of cost will perhaps be solved by electrostatic speakers of great efficiency, requiring low-power amplifiers.

STEREOPHONIC SPEAKER-ENCLOSURE PLACEMENT: Placement of speakers and enclosures for stereophonic sound reproduction has been a subject of considerable controversy. This is to be expected, since individual listen-

The home of co-author Robert Oakes Jordan. Two AR-2 speaker units are driven by a Dynakit Mark III amplifier (not shown.) An Ampex 612 stereophonic tape player is used

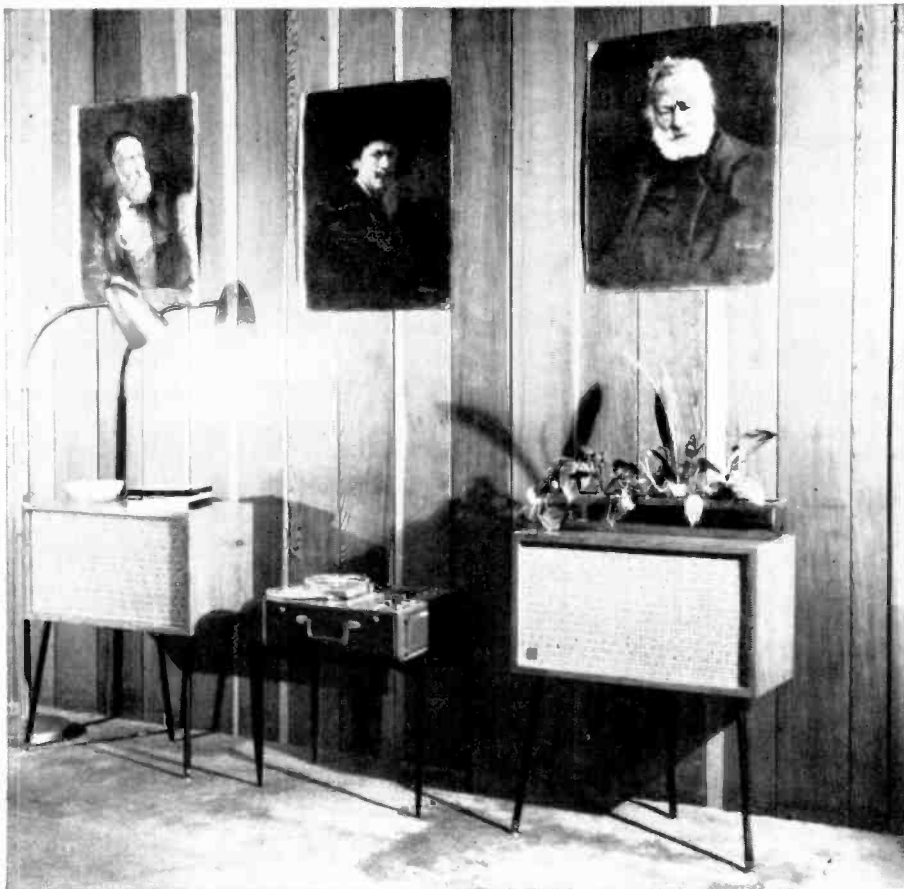

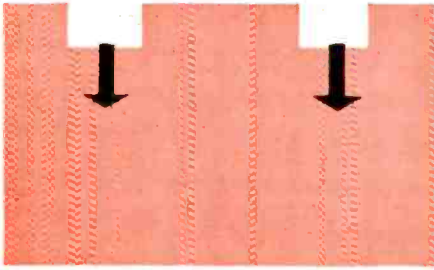

The most-used stereo arrangement. Distance between speakers should be determined by experiment

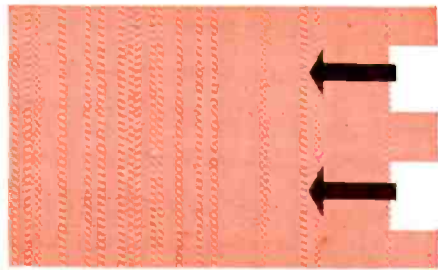

This arrangement may be preferable to the others if the long walls of a room are heavily draped

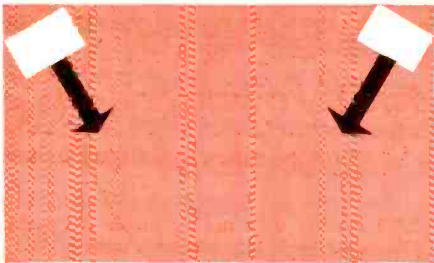

Listener's position is restricted here, but corner placement of speakers produces better low-frequency sound

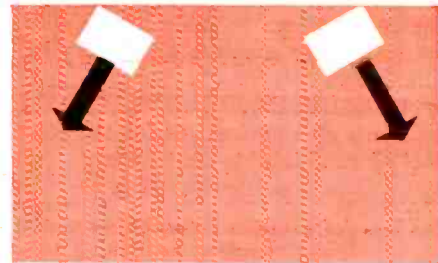

This arrangement gives the best stereo effect. Mixing is limited because of the toe-out of the speakers

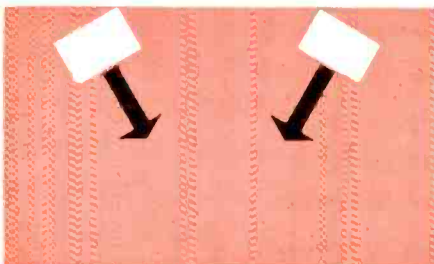

This arrangement is good for rooms with highly reflective walls, but the listener's position is restricted



An unusual arrangement. Sound is reflected from the back wall to the two adjacent walls, then finally to the listener

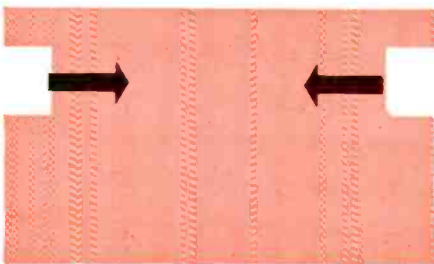

Not recommended. This arrangement has all the disadvantages of corner placement and none of the advantages

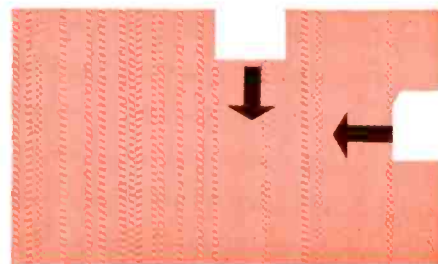

Possibly the only arrangement suitable for L-shaped rooms. Facing walls must be non-reflective

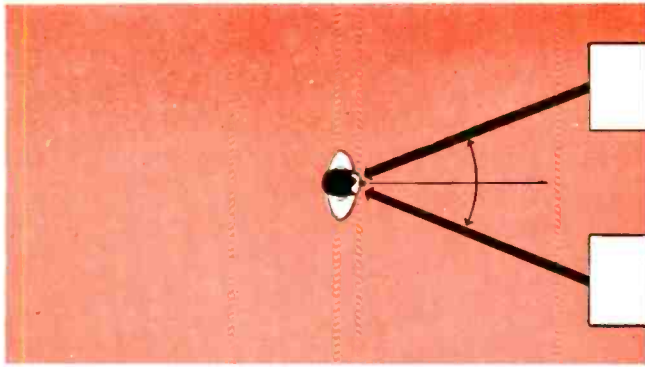

For good stereo results, a listener's ears should subtend at least a 20-degree angle with the centers of the loudspeakers. A position too distant from the speakers will result in mixed sound

Movement of a listener away from a central position affects stereo balance. Corner placement of speakers upsets balance most with movement

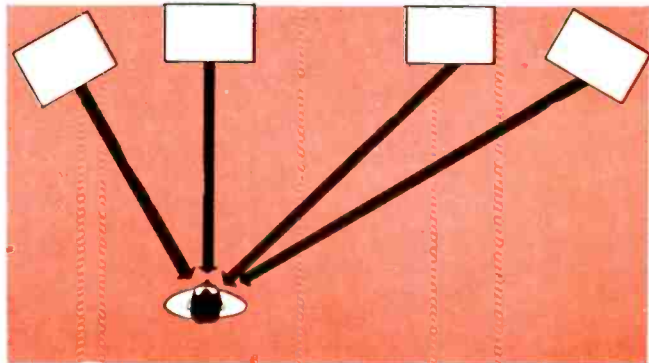

ing rooms, and the preferences of the people who listen, vary widely. No hard-and-fast rules can be laid down to cover the placement of speakers for "stereo," but we will propose a number of suggestions which have been tried and tested and have been found satisfactory, some more so than others. Some experimenting on the part of the listener will lead to good stereo speaker placement for most rooms.

There are several "packaged" stereophonic systems which are complete in one cabinet, carefully designed to function well in the home listening room. The stereophonic effect is produced in your room by a combination of intensity, time, and frequency differences at the two loudspeakers. It follows that these conditions must be maintained by correct loudspeaker placement. For example, if the loudspeakers are arranged so that the general listening position is much closer to one speaker than the other, the balance of time and intensity will be upset, resulting in a poor stereo effect. It is preferable to have the wall opposite the two speakers as non-reflective as possible. By hanging drapes, tapestries or rough wallpaper on this wall, you can eliminate undesirable reflections. The latter can cause general diffusion of the sound, which would destroy the important intensity differences that should exist between the two loudspeakers. An interesting experiment is to set up your stereophonic speaker system outdoors on a quiet summer day. Here all reflections are eliminated and the resulting effect is rather astounding and pleasant.

The most common successful stereo speaker set-up is one in which the two speakers face outward from a short wall of the listening room, faces parallel to the wall, 6 to 12 feet apart. The distance between the speakers should be arrived at by experiment. For your tests it is wise to use an acknowledged high-quality stereophonic tape, playing the same tape for each change of speaker position. The authors suggest a stereophonic demonstration tape

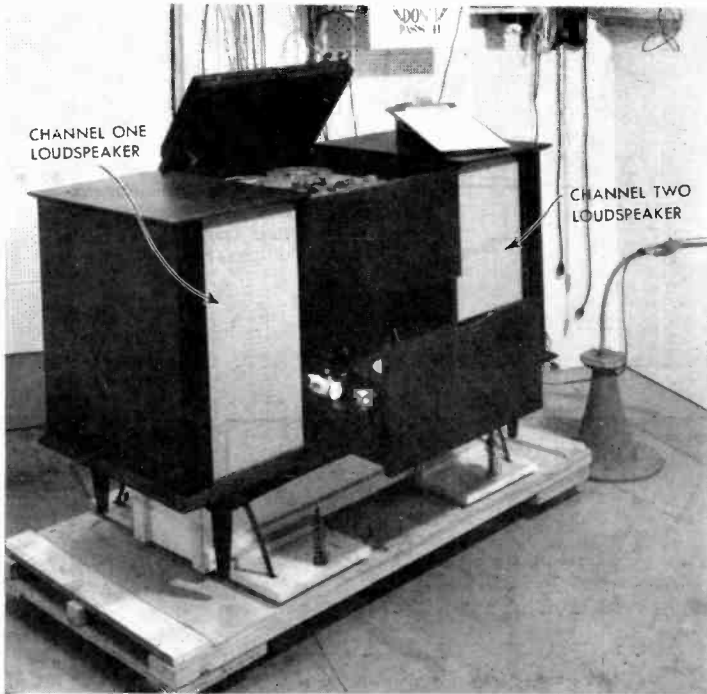

Equipment for evaluation furnished by Ampex Audio, Inc.

Speakers are usually positioned at each end of a stereo console machine to achieve the required stereo separation. Other components are positioned between the speakers

called *Sound in the Round* (in two volumes), marketed and sold nationally by Concertapes of Wilmette, Illinois, as your test tape.

If your speakers are too close together there will be little stereophonic effect because the sound from the two speakers will be mixed together before it reaches our ears. Of course, some acoustical mixing takes place in any stereo set-up, but in order that the spatial effect be natural you must be able to perceive the direct sound coming from one location and the delayed sound from the other. Should the speakers be too far apart there will seem to be a "hole," or lack of sound, midway between the two units, making some types of sounds and music quite unpleasant to listen to for very long. The isolation caused by speakers placed too far apart makes the listening area more critical, since any movement to one side or the other will cause greater time and intensity differences between the speakers. Ideally, the listener's ears should subtend an angle of not less than 20° with both loudspeakers. Corner speaker placement has some merit, since most loudspeakers radiate more low frequencies in a corner position than any other. However, the position of the listener will be seriously limited to the exact center between the two units.

The best stereo effect of any of the speaker positions discussed here is one in which the speakers are toed out by a small angular displacement from the wall. This placement gives the least mixing before hearing and therefore the best stereo effect. This placement does not work well where the two side walls are heavily non-reflective: this causes the higher frequencies to be absorbed, rather than reflected into the room. The walls should be highly reflective for this type of speaker situation, with the far wall covered with drapes or some other type of absorbent material. In such a room this placement can give an interesting "spread" to the stereo effect, with no feeling of a "hole" in the center of the sound. In some cases there might be too much mixing for some listeners, since sound has a tendency to become more evenly dispersed in such reflective areas. An unusual speaker set-up for stereophonic sound is one in which the two speakers are enclosed in the wings of an easy chair at ear

High-quality infinite-baffle enclosure and driver kit features heavy construction, two low-frequency drivers, heavy cast multicellular horn with high-frequency driver

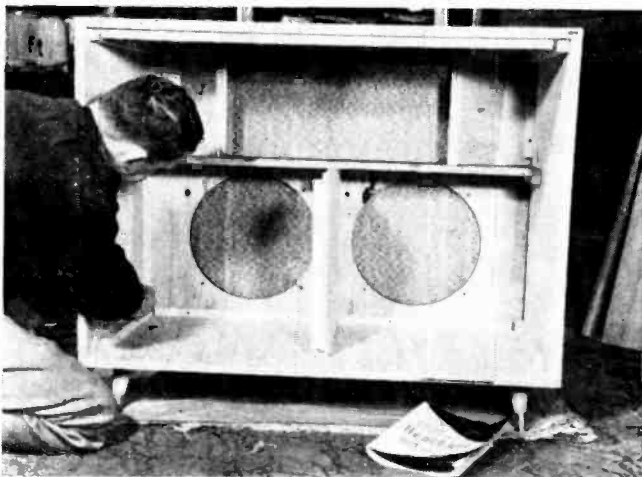

Equipment for evaluation furnished by Heath Co.

level. Much like earphones, this placement is for only one person at a time, but for the real fan there is much to be said for this stereo easy chair.

It is of great importance that your two speaker and enclosure systems be as much alike as possible. However, this does not mean you cannot have stereophonic sound if you are not able to have duplicate equipment. The main thing is to get started, obtaining the best possible sound with what equipment you can afford, improving your system as you go.

LOUDSPEAKER ENCLOSURES IN KIT FORM: Even before the days of commercial kits, audio enthusiasts frequently put together their own baffles or enclosures. There was very little information on either exact size or methods of construction. In recent years an ever-increasing number of commercial kits and plans have become available. As with other do-it-yourself kits produced by reputable manufacturers, no amount of advice from an outside source can supplant the directions given with such kits. If a reader intends to design and construct an enclosure from his own plans, he would be wise to stick to simpler enclosures, like the infinite or the reflex baffle; the more difficult and complex horn enclosures are well left to the more experienced.

THE INFINITE OR CLOSED-BACK ENCLOSURE: As in all enclosures, the speaker and the baffle work together to produce the sound. The resonant point of any loudspeaker is raised if the size of the enclosure is too small. If it is sized according to dimensions evolved from the basic resonant point of the particular speaker to be used, a minimum number of cubic inches of volume must be provided.

Except for loudspeakers with especially low resonant points, the volume requirements given here are minimums, and require completely lined inner surfaces. It is recommended that you use a speaker with the lowest possible resonant point at any given diameter.

Minimum inner-enclosure volume requirements:

- 8-inch diameter requires 4,000 cubic inches
- 10-inch diameter requires 6,000 cubic inches
- 12-inch diameter requires 8,000 cubic inches
- 15-inch diameter requires 10,000 cubic inches

Example:

For an infinite baffle using a good quality 12-inch speaker (e.g., the James B. Lansing D-123) having a cone resonance of about 35 cycles, the approximate dimensions might be 31 inches high, 24 inches wide, and 14 inches deep. Actually, any dimensions which produce the minimum interior volume requirements will work just as well.



Equipment for evaluation furnished by Allied Radio, Inc.

A compact ducted bass-reflex enclosure. Speaker leads are fastened to a terminal strip on the back of the air-tight cabinet

All enclosures should be constructed from $\frac{3}{4}$ -inch plywood; 1-inch glass fiber interior padding should be used. In constructing the box, it is wise to glue all joints to prevent unwanted vibrations and air leaks. However, a hole $\frac{1}{16}$ inch in diameter should be drilled through one wall of the box to provide a slow air leak so that changes in temperature and pressure will not move the cone from its natural position of rest around the magnetic pole piece.

KIT-TYPE INFINITE Baffle ENCLOSURES: Large multiple-speaker enclosures are available in the infinite-baffle type. The speaker combination provides full-range coverage in one box. Two woofers cover the range from 25 to 500 cycles, with an exponential-horn-type tweeter covering the rest of the range to 20,000 cycles through a crossover network. As complicated as these large kits may appear, each manufacturer provides adequate detailed instructions; a minimum of woodworking and electronic experience is necessary.

THE BASS-REFLEX ENCLOSURE: The bass-reflex baffle is perhaps more desirable for the novice to build from "scratch" or from a kit, since it can be adapted to employ any loudspeaker simply by tuning the port. The bass-reflex enclosure has specific minimum external dimensions and critical speaker and port opening sizes. Apart from these two factors, construction involves little skill. The most important thing to remember is that a port in the enclosure face does not necessarily insure good bass response; the port must be tuned even on commercial reflex enclosures.

Minimum external bass-reflex dimensions and critical port size:

Speaker Size	Height	Width	Depth	Port Size
8-inch	24"	18"	11.5"	9.5" x 4"
10-inch	29"	24"	12"	12" x 6"
12-inch	36"	24"	15"	13.5" x 7"
15-inch	42"	30"	18"	15.5" x 10"

These sizes conform to the most economical lumber sizes. All sections should be at least $\frac{5}{8}$ inch thick or better. Glass fiber padding at least 1 inch thick should be fastened on back, one side, and top or bottom interior surfaces. All pieces should be securely glued and nailed together.

KIT-TYPE BASS-REFLEX ENCLOSURES: Several good kits are available for the construction of either ordinary reflex port or ducted-port reflex encl-

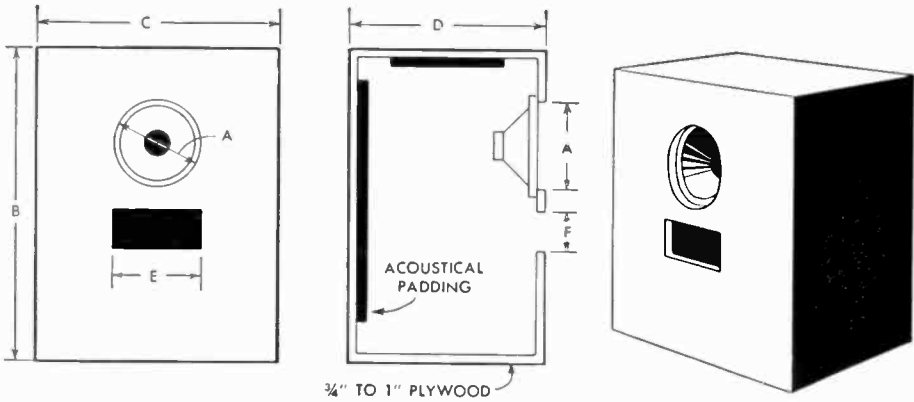

The construction of a bass-reflex enclosure. Proper dimensions for different speakers are given in the text. Three sides of the enclosure should be padded

sures. May we repeat some valuable advice again: *Follow the directions furnished by the manufacturer of the kit you are constructing.*

CROSSOVER NETWORKS: The electrical crossover network has become an important part of high-fidelity systems since the development of modern wide-range audio amplifier and loudspeaker combinations. A single cone-diaphragm speaker has difficulty reproducing all the possible audio frequencies available from an amplifier. A good low-frequency unit will tend to "break up" in the higher ranges, and a speaker that will produce good highs has difficulty operating in the lower end of the frequency response curve. A simple and logical conclusion leads to the provision of one or more speaker units for each portion of the response curve to be acoustically represented. This is accomplished through the use of crossover networks.

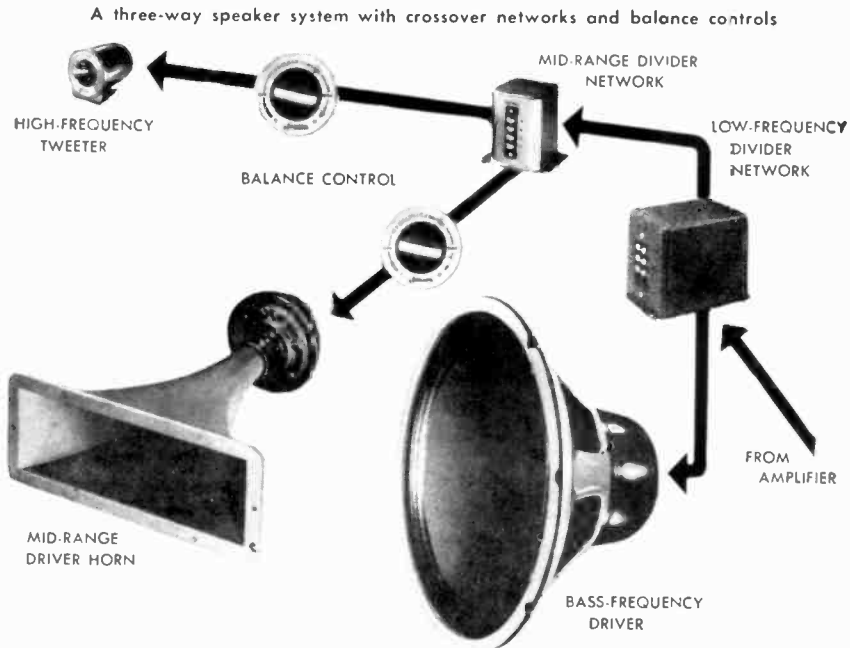

Equipment for evaluation furnished by Jensen Mfg. Co.



Equipment for evaluation furnished by Jensen Mfr. Co.

Above: The Jensen G-600 Triaxial speaker with crossover network and balance controls

Below: Electro-Voice 4-way speaker system with dividing network and balance controls

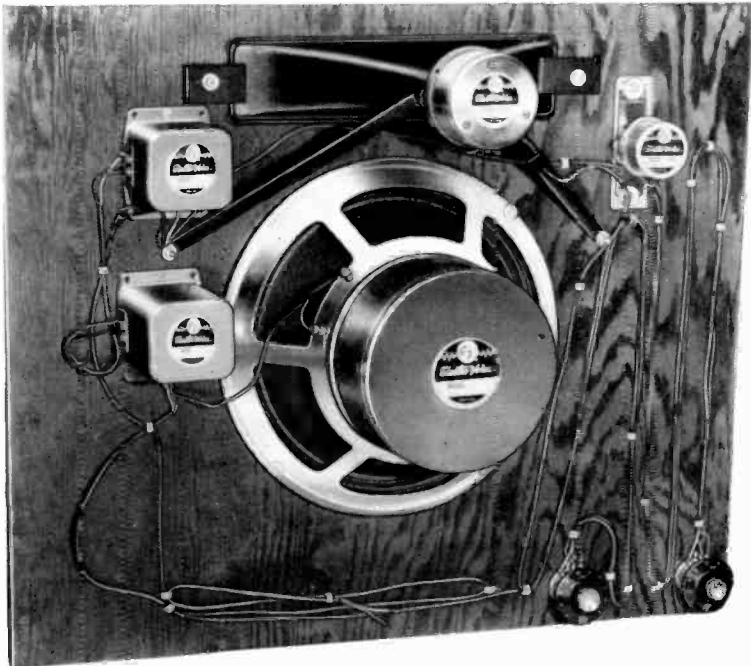

Equipment for evaluation furnished by Electro-Voice, Inc.

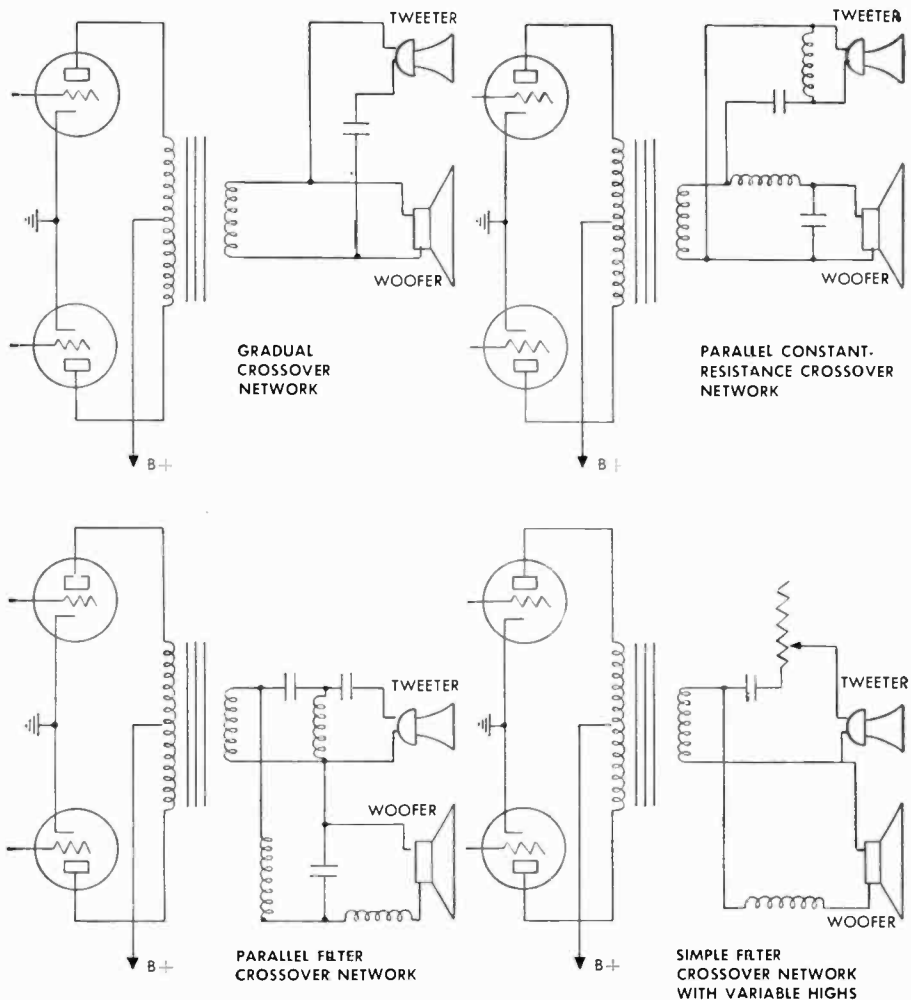

Different types of loudspeaker crossover networks

Crossover networks serve to divide the various frequency ranges needed for each speaker in a system. As the top of the frequency division for each speaker is reached, the particular speaker drops off in effective operation, and the next speaker takes over in such a way that there is a smooth transition between the two. As the mid-range unit drops off in effectiveness, the high-range tweeter system takes over; through this division of operation the complete frequency response range available from the amplifier is represented acoustically.

A designer has a choice of crossover points, depending on the loudspeaker units he intends to use. It is fairly hard to find a combined middle- and high-range speaker unit that will carry its response low enough to have a point of optimum crossover with a low-frequency driver. It is also hard to find a low-frequency driver with a range extended to a point where it will cross over efficiently with the majority of single mid- and high-range units. To meet this difficulty, three- and four-speaker systems have been developed; these have a drawback of added cost. For the most part, speaker designers have been able to make two-speaker units function well.

Some experts extol the virtues of concentric placement of whatever speakers

they intend to use; others prefer separate mounting of the various components on a single mounting board. This is, however, largely a point of personal preference, the quality of the entire system remaining the most important factor.

In any speaker system, account must be taken of the difference in efficiency of the various units. A direct-radiating loudspeaker is apt to be far less efficient than a mid- and high-range horn tweeter unit. Some manufacturers include variable resistance controls in one or both speaker lines as they leave the crossover dividing network and enter the voice coil of each speaker; others provide a means of switching in and out different values of capacitors and inductances in the network itself. Both devices may accomplish a lowering of the efficiency of the horn unit and a limiting of the higher frequencies. However, the more competent manufacturers will have made provisions to account for these differences.

TYPES OF ELECTRICAL CROSSOVER SYSTEMS: The operation and effect of a crossover network is essentially the same in all cases; the variations occur only in the point of crossover frequency and the parts necessary to build each system. As the crossover point between the woofer or low-range speaker and the mid- and high-range unit is lowered, the inductors and capacitors used in the network must be larger in size, and hence cost more; not only does a network itself cost more, but the necessity for better speakers boosts the cost of the complete system. For example, in a constant-resistance crossover system, using a woofer for the range between 20 and 500 cycles would involve a series network with a crossover frequency of 400 cycles, using two capacitors and low inductances. The capacitors would be approximately 28 mfd and 55 mfd, the inductances 2.8 millihenries. These are relatively expensive; if the crossover point were raised to 1000 cycles, the parts would be far less costly.

A crossover system can be made by combining a low-frequency driver that has a decided drop-off at the high end of the scale and a smaller high-frequency unit that has had the lower notes excluded from its circuit by the high reactance of a series capacitor. When the output of the low-range speaker drops off, more and more high-range energy is delivered gradually to the tweeter unit. Very effective coverage can thus be accomplished with a modest expenditure. Most low-cost speaker systems are of this gradual-crossover type.

THE FILTER-TYPE CROSSOVER NETWORK: To provide more accurate power distribution between two speakers, a dividing filter network is employed, with which it is not necessary for the low-range speaker to handle and absorb high-frequency energy, nor for the high-frequency speaker to handle the lows. A combination of an air-core inductance in series with the low-frequency speaker lines and a capacitor in series with the high-frequency speaker lines accomplishes this result. With a crossover point of about 1200 cycles these components are small in size, relatively inexpensive, and quite effective.



The crossover network employed in the Klipschorn loudspeaker system uses inductances and capacitors to divide the different frequency ranges

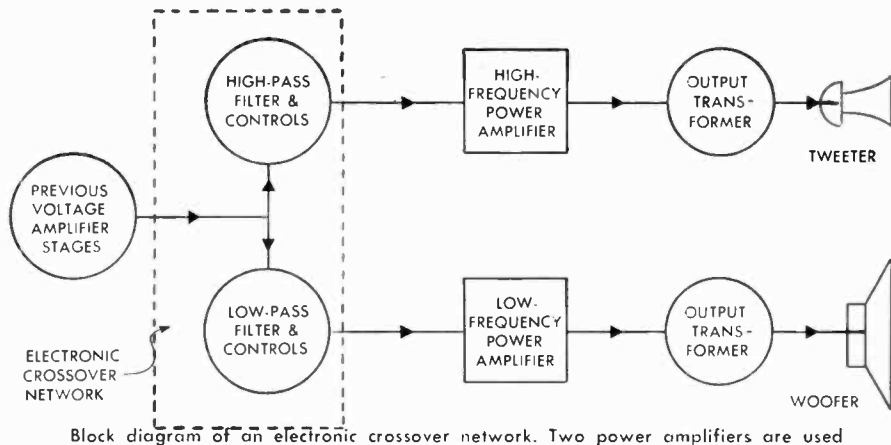

ELECTRONIC CROSSOVER SYSTEMS: The previously discussed crossover networks are all designed for operation in the low-impedance circuits that exist between the output transformer of an amplifier and a loudspeaker. However, there are cases where it is desirable to have a more versatile and variable system. The electronic crossover system is such a device; it can be found in a number of versions, but all work in essentially the same way: by splitting the frequency range of the sound into two or more channels. This can be accomplished by a complete dual amplifier and speaker set-up, by dual filter network and output stages on the same chassis, or by an electronic crossover, a device which has its own power and is situated after the preamplifier but ahead of the power amplifiers.

A main advantage of such electronic systems is that they are connected into a circuit at a point where they need not handle power, as they would if they were connected after the power amplifiers. With each channel variable within its own range of frequencies, it is possible to compensate for differences in speaker quality and efficiency. Drawbacks to this type of adjustable system lie in the fact that the person operating the controls may not realize the importance of smooth crossover between the two ranges. The filter networks which divide the composite full range signal from the preamplifier can be adjusted for narrow or wide bandpass features. If the lower end of the upper band begins too sharply there may be a noticeable separation between the highs and the lows. Proper control settings will effect a smooth transition for any combination of speakers.

DISC RECORDS

THE PHONOGRAPH CARTRIDGE: Regardless of the type of phonograph cartridge used, and regardless of cost, the cartridge has but one function: to get sound off a disc. The restrictions and requirements imposed upon the cartridge in use alone call for differences. Only a handful of types of cartridges exist, but within those few are hundreds of variations, past and present. As with the old soundbox on the acoustic phonograph, every inventor has his own ideas on the subject. There is one difference, however: the electrical phonograph cartridge calls for complicated industrial equipment to process even the simplest design concepts. The results are about the same as in the days when a kitchen table was good enough to support the experimentations of dreamers and doers; there are some bad and some good products. The major difficulty still remains: how does one know the difference?

Of the major types of units, the crystal, the ceramic, the magnetic (all forms), the electrostatic, and the strain-sensitive, none is perfect, and all have their limitations. Electronics and electro-mechanical design have done much to overcome these defects, but they still remain to some extent. If the perfect cartridge were to be designed, these would be the requirements for a standard monaural pick-up (they will vary for single-groove stereophonic disc cartridges):

1. The widest possible frequency response in the unequalized state, so that no extensive equalization circuits will have to be used, thus keeping down the cost of amplifier equipment.
2. Low stylus pressure against the record to prevent wear.
3. High lateral compliance of the stylus as it moves back and forth in the grooves.
4. Reasonably high signal output to eliminate the more complicated pre-amplifying circuits.
5. Low distortion from mechanical and electrical sources.
6. As little stylus "talk" as possible. Stylus or needle talk occurs as the stylus itself vibrates, causing an audible sound at the record surface.
7. No noticeable hum signal at normal or low volume levels.
8. No signal voltages produced from vertical movement of the stylus in the groove, such as the pick-up of turntable rumble or other distracting noises.
9. No effect from heat and humidity.
10. Small but rugged design.
11. Low cost.

The construction of a bimorph Rochelle salt crystal element. When such an element is stressed, a small current is produced between the contacts

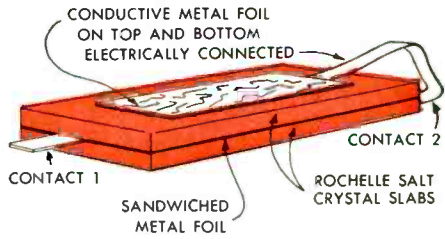

CRYSTAL PICKUP CARTRIDGES: Since the piezoelectric effect was applied to phonograph cartridges, much improvement in output quality has taken place, but the principle of operation remains the same. The effect got its name from the fact that certain crystalline configurations, if pressed or twisted, produce a potential difference between two surfaces. A Rochelle salt crystal in a modern phonograph cartridge is about half the size of a postage stamp and less than $\frac{1}{8}$ inch thick. Without its protective black plastic covering, it appears to be made from very thin frosted glass. Actually, two slabs cut from a large crystal block are cemented together with one electrode between the two, and one electrode connected to the outer surfaces of the crystal. Depending upon how these slabs are cut from the large block, a voltage is produced by either a torque (twisting) motion or a bending or flexing motion. This voltage is directly proportional to the distance of movement of a stylus in a record groove. The natural frequency characteristics of crystal pickups are such that they may produce 1 volt of signal at 1000 cycles, but will produce as high as 3 volts of signal for recorded frequencies of only 250 cycles. This is not a desirable trait for a pickup. However, in manufacture, resistive and capacitive equalization can be added to smooth out the bass frequencies. Depending on the natural

A lever-type crystal cartridge. By means of a lever assembly, torque is increased 5:1

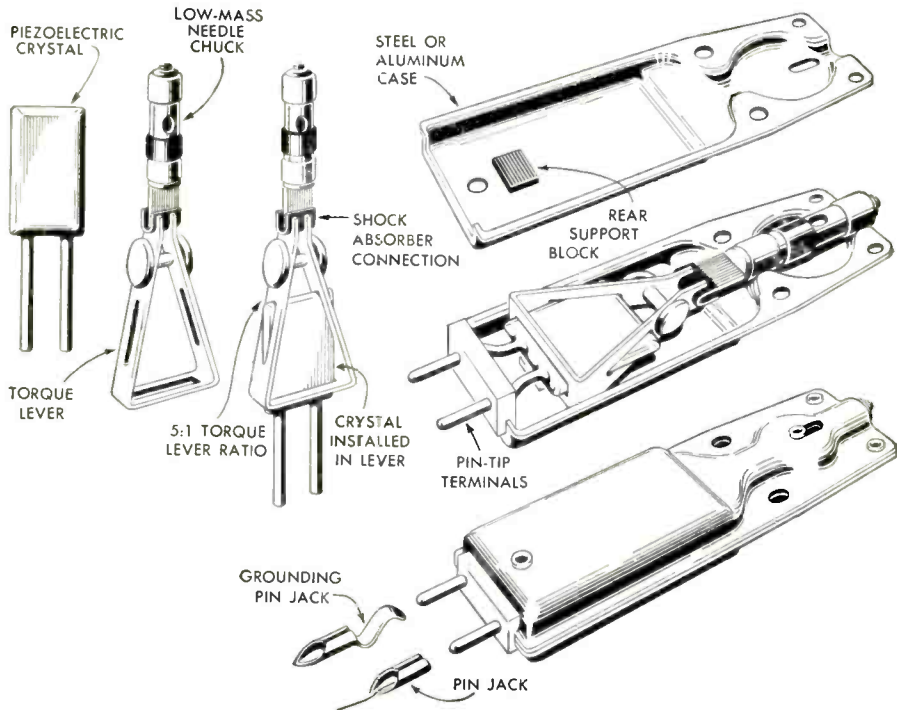

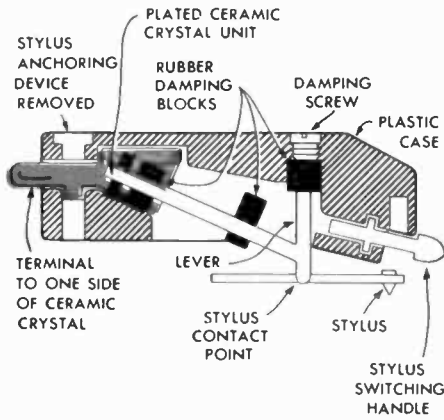

Above: A modern ceramic cartridge in cross-section. Right: Conventional crystal cartridges of different styles

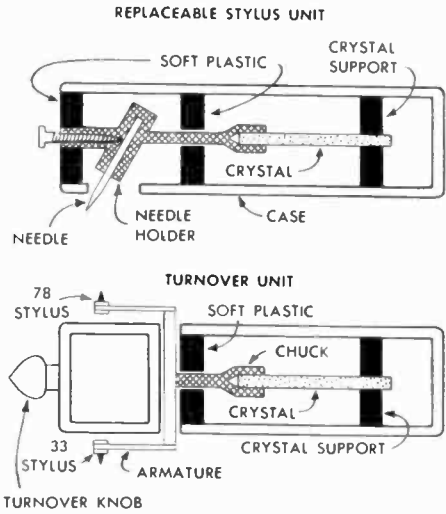

point of resonance in the high-frequency end of the pickup's response, an effective rise in the otherwise drooping high end can be corrected by proper mounting of a unit within its case.

The earlier crystal units were protected from moisture by black asphalt coatings, but little could be done against harmful rises in temperature except to warn the owner. Now, with new crystal materials such as ammonium dihydrogen phosphate and others, heat and temperature are not such important factors. Total response has been raised in crystal units, while distortion and weight have been reduced. Crystal and ceramic pickups still provide high fidelity at moderate prices.

THE CERAMIC PICKUP CARTRIDGE: A piezoelectric effect occurs in ceramic cartridges as it does in crystals. Because of unusual manufacturing techniques, ceramic cartridges are in some ways superior to magnetic cartridges. Composed of barium and calcium titanate, the material for a unit is first mixed in a watery solution and allowed to dry in a mold, much as a small porcelain object would be formed. After it becomes hard and dry at normal temperatures, it is exposed to intense baking heat. The ceramic casting is allowed to cool while under the influence of a very strong electrical field. After this process, the unit will exhibit piezoelectric effects when bent or twisted. The actual structure of the cartridge unit is very similar to the bimorph Rochelle salt crystal in that it usually consists of two thin slabs of ceramic material separated by a metal contact plate. The other contact is taken from the open sur-

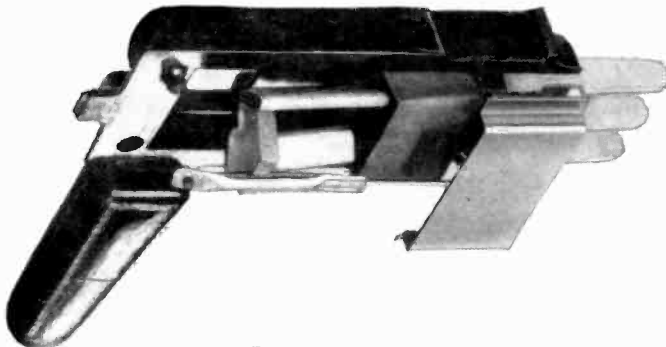

Ceramic stereo cartridge by Electro-Voice. Note the built-in finger lift

Equipment for evaluation furnished by Electro-Voice, Inc.

faces. Since ceramic cartridges are not affected by humidity and temperature, no special protective coating need be applied.

Placement and mounting are very important to the correct operation of ceramic cartridges. They have relatively smooth, distortion-free response and high output signal level over a range from 50 to 10,000 cycles when unequalized. As does the modern crystal unit, the ceramic cartridge will provide high-fidelity operation at minimum cost, and has thus become almost universal in low-priced phonograph units. Some manufacturers have perfected ceramic cartridges to such an extent that they can compete on an even basis with conventional magnetic pickups. Equalization networks are available that can be used in conjunction with a ceramic unit when it is to be plugged into an amplifier's magnetic cartridge input.

THE MAGNETIC PICKUP CARTRIDGE: There are three electromagnetic pickup types: moving armature in a magnetic field, moving coil in a magnetic field, and moving magnet in a stationary coil. The earliest was the moving armature in a magnetic field, where magnetic power was supplied by an old-style horseshoe magnet of limited power. The whole unit weighed more than 3½ ounces, or over 100 grams. Compared with late-model cartridge-and-arm combinations, some of which track at just one gram, this old unit could not do much more than wear out shellac records. In tracking a groove the stylus-armature combination moved in the center of the coil, producing a small signal voltage, which was amplified into audible sound.

Modern versions of this moving armature, or variable-reluctance, cartridge have become very popular with high-fidelity enthusiasts for their low tracking force, high compliance, and good frequency response. The major drawback to most magnetic units is that their low output signal requires additional

Equipment for evaluation furnished by Norelco

Right: A cartridge operating on the moving-magnet principle. The armature, M, rotates in bearings R, P within the mu-metal core, J. Below: A ceramic stereophonic cartridge by Electro-Voice

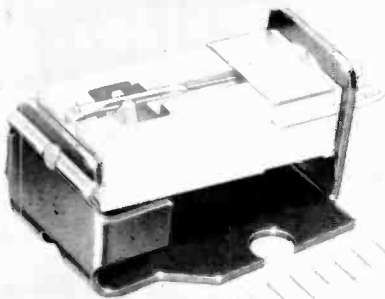
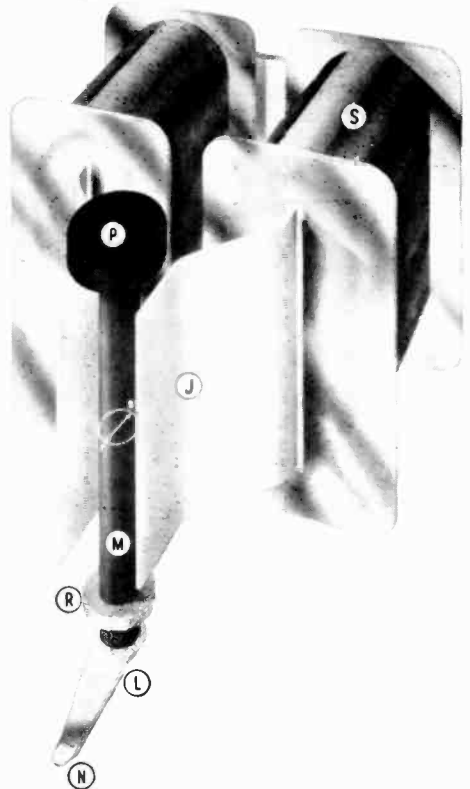

stages of amplification. The earlier high-fidelity magnetic units were subject to hum pickup and magnetic attraction to iron or steel turntables. Developments both in electronic circuits and in pickup cartridges have just about negated these problems in modern high-fidelity systems.

THE MOVING-COIL MAGNETIC PICKUP: The second type of electromagnetic pickup cartridge is the moving-coil device. A magnetic field is set up by a strong magnet, and the coil is forced to move through the lines of force created by the field. In the process, a small signal voltage is produced in the coil and fed into an amplifier. There are several methods of introducing such a coil into the field. In one case, a coil of microscopic wire is wound along the long axis of a stylus and armature and centered between two magnetic poles. In another case coils already centered in the field area are actuated by a stylus-lever assembly. The moving-coil pickup has exceptionally good low-frequency response with low distortion. As in all magnetic pickups, the moving-coil unit is subject to hum pickup from a turntable motor or through the high-ratio transformer used with this type of low-output-voltage device. Special mu-metal shielding has all but eliminated this problem in present-day units.

MOVING MAGNET PICKUP: The third and newest type of magnetic pickup employs a moving magnet in a stationary coil. With high-permeability shielding and special hum-bucking coils, there is no problem with annoying hum signals. Since the effective mass of the stylus magnet is so much lower than that of the other magnetic types, tracking force is lowered to about 1 gram, permitting this type of cartridge and arm to be used safely to play master discs, from which molds are made for LP recordings. In laboratory tests conducted on this type of magnetic pickup, the authors found a new arm and cartridge combination called the Dynetic, manufactured by Shure Brothers of Evanston, Illinois, to be a standard by which most magnetic devices of this nature might well be judged.

Working on the moving magnet principle, the Dynetic unit has friction-free suspension through a system of jeweled pivots and thrust bearings. It has a unique system of stylus and cartridge retraction through a remote pushbutton on the arm. The tone arm itself is counterbalanced on a damped suspension

The ESL P60-1 cartridge and 310 tone arm



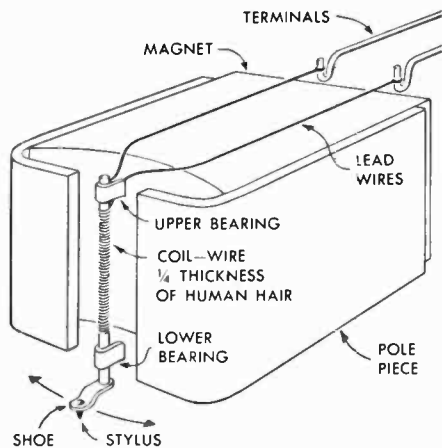

The moving-coil magnetic cartridge. Above: Components identified. Right: A typical cartridge, the ESL C60

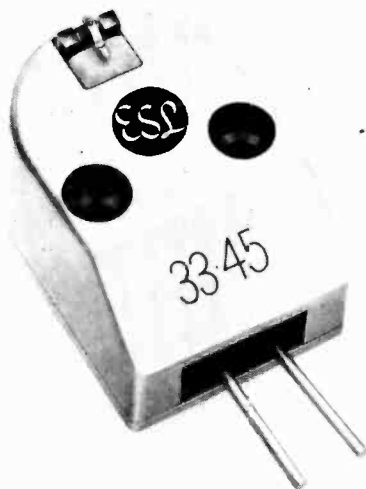

Equipment for evaluation furnished by Electro-Sonic Laboratories

bar, which provides critical damping even at subsonic frequencies without impeding the lateral movement of the arm. The arm is so constructed that it has no vertical movement, swinging only in a lateral direction across the recording. Cartridge and stylus clearance and pressure are provided by a hinged joint between the arm and cartridge.

SPECIAL PICKUP CARTRIDGES: In science and industry there are many devices that will produce signal voltages which correspond to a variety of applied external influences. Most of these devices have been tried as signal-producing elements in phonograph cartridges. Of this group there have been few that could compete commercially with piezoelectric or magnetic units. The most successful of these is the strain-sensitive pickup.

THE STRAIN-SENSITIVE PICKUP: This pickup cartridge is based upon the principle that the resistance of some conductors will change as the conductor is twisted or strained. If direct current is passed through such an element as its resistance is changed according to the movements of a stylus, a signal voltage can be introduced into a vacuum-tube amplifier. Strain-sensitive elements have been used with great success in industrial processes where the mechanical motion is greater than ordinary stylus motion and where the additional voltage supply to the pickup element and associated amplifiers is not a problem. They have, however, not gained much success on the high-fidelity scene.

THE CAPACITANCE PICKUP: Movement of a stylus against capacitive elements in this type of pickup can cause a slight variation in the total capacity of the device. It is possible to obtain a very small signal from this motion and, through many stages of amplification, to produce an audible signal from a high-fidelity loudspeaker. It is more practical to connect this varying capacity to an oscillator, causing it to be frequency modulated, and later to be detected into a usable signal.

THE STEREOPHONIC SINGLE-GROOVE PICKUP CARTRIDGE: The dual track magnetic recorder developed after World War II gave the start to practical stereophonic sound on tape. However, the first stereophonic recording on disc records employed a system devised by Emory Cook, requiring two separate bands of recording on the disc. In playback, two separate pickup cartridges, spaced apart on the end of a bifurcated arm, were required. Problems arose in the fact that no two discs could contain these simultaneously

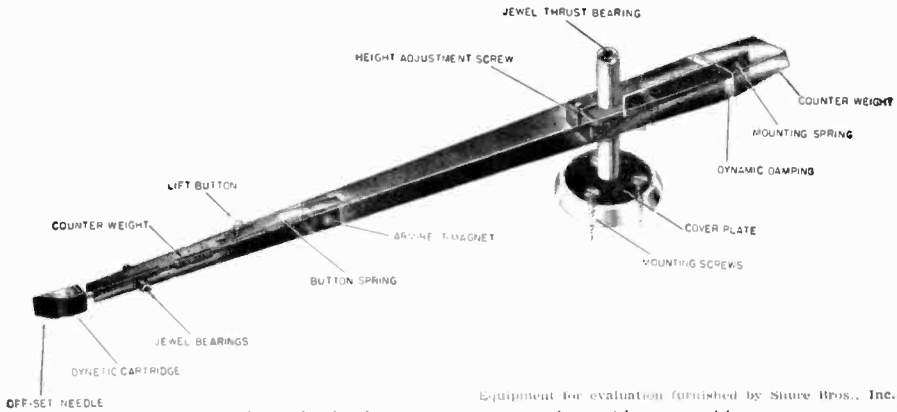

Shure Brothers' Studio Dynetic tone arm and cartridge assembly

Equipment for evaluation furnished by Shure Bros., Inc.

recorded bands of grooves at exactly same distance apart; consequently, much adjustment was necessary to keep the stereophonic effect. The amount of material recorded on a disc was cut in half, thereby raising the cost per minute of music to twice that of the average monaural LP.

It would not be fair to say that stereophonic disc records originated recently; the idea goes back to the turn of the century, when the disc record itself was a new idea. Dating back to 1904 there are nearly 400 patents pertaining to stereophonic sound recording and reproduction. Some of these concern multi-channel devices and some single-channel methods. Needless to say, these inventions were left by the wayside until the present day, when stereophonic disc recording is a reality.

Several single-groove stereophonic disc recording methods have recently been under consideration by the industry. One is a combination of lateral and vertical recording in the same groove; one channel is supplied with the conventional lateral cut and the other channel with the vertical, or hill-and-dale cut, as used in Edison's machines. Obvious problems exist with this type

Right: An early stereophonic disc record system employing two pickup cartridges and a dual-channel disc. Below: Operational diagram of a moving magnet cartridge

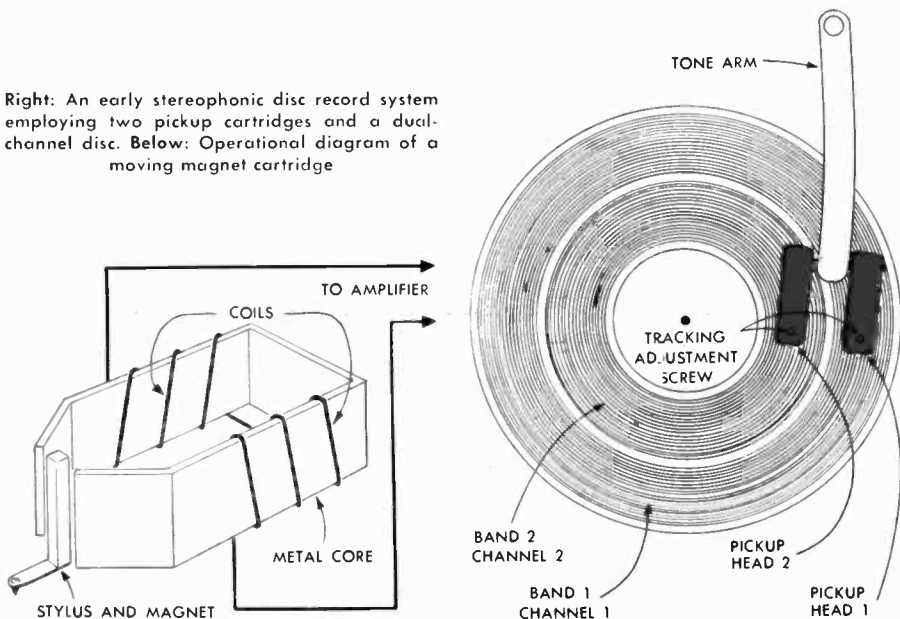

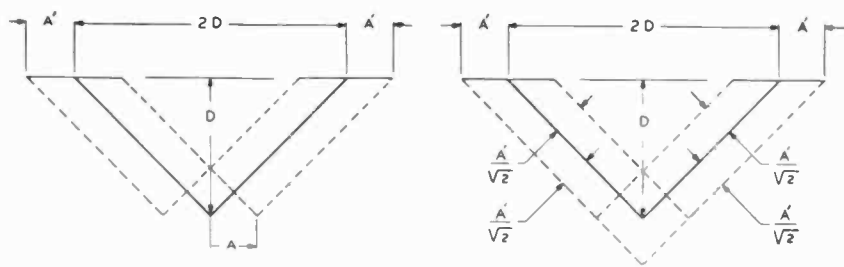

LATERAL

45-45 STEREO

MAXIMUM GROOVE EXCURSION

$$2D + 2A'$$

$$2D + 2A'$$

RELATIVE OUTPUT PER CHANNEL

$$A$$

$$\frac{A}{\sqrt{2}}$$

RELATIVE DB PER CHANNEL

$$0$$

$$-3.0$$

Stylus movement in standard lateral and 45-45 stereophonic pickups

of system, since modern amplifying equipment would bring to the fore all the unwanted sound produced by most turntables and record changers. It is entirely possible that the vertically recorded portions of the grooves would wear out quickly, causing a signal loss in one channel and hence a loss of stereo effect. Dirt, imperfections, and other plaguing conditions would mar the general over-all worth of stereophonic sound. The authors do not intend to say that this system is impractical and cannot be worked out successfully, but there is not sufficient information available at this time to make any sort of judgment.

Macrophotographs of stereophonic record grooves cut with Westrex 45-45 equipment

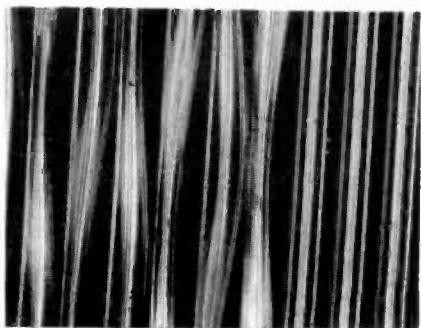
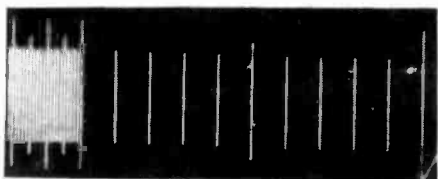
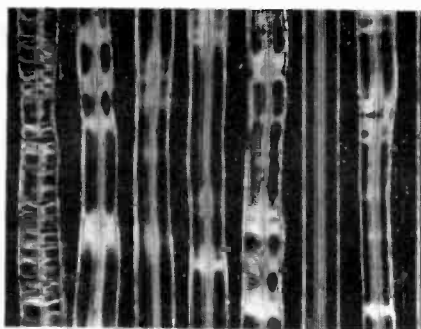
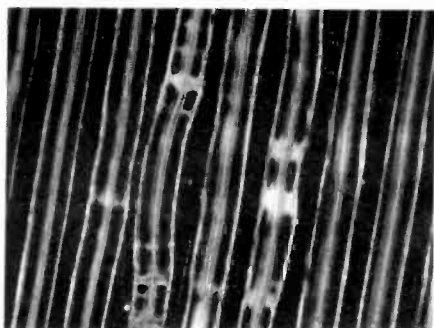

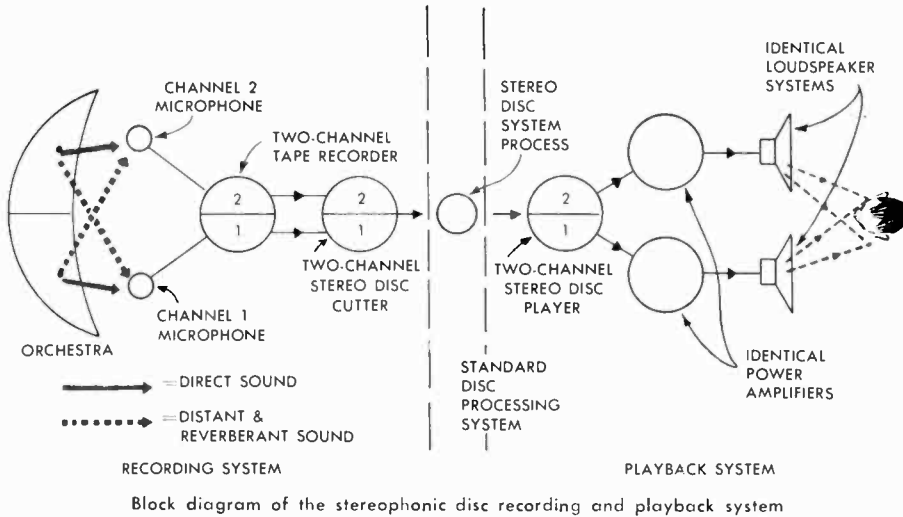

Another system, one that has recently gained industry acceptance, is the system designed and perfected by the Westrex Corporation. Manufacturers of pickup cartridges have produced both ceramic and magnetic single-stylus cartridges for stereophonic playback using this system. The Westrex system employs 45° movement of the stylus in one direction for channel 1 and 45° movement in the other direction, at right angles to the first channel, for channel 2. As a single stylus moves through the grooves of a stereophonic disc, it is impulsed to the right or left at a 45° angle from the vertical, giving a composite vertical and horizontal movement to the signal-making elements. This system is a combination of both lateral and vertical recording, but overcomes the drawback, experienced in all vertical recording, of distortion due to the recording cutter having to remove different amounts of material from a disc. In lateral recording, the cutting stylus removes essentially the same amount of material regardless of the intensity and frequency of the cut. With the new feedback cutters now used in master cutting, there is no reason why the 45/45 Westrex disc should have any less quality than a standard LP recording. The pickup heads themselves can employ two ceramic elements, two coils, or even two moving magnets to gain the two signals necessary for dual-channel stereophonic operation.

TONE ARMS: It is difficult to separate the interaction between a tone arm and a pickup cartridge. Each has a specific and important, but not mysterious, job to do. If one were to read and believe advertisements, each different manufacturer would have his tone arm and cartridge accomplishing a different

Left: a magnetic stereo cartridge. Right: two coil assemblies distinguish the stereo cartridge
Equipment for evaluation furnished by Shure Bros., Inc.

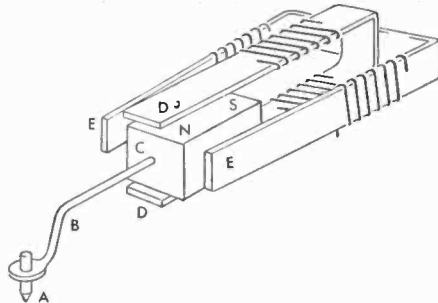

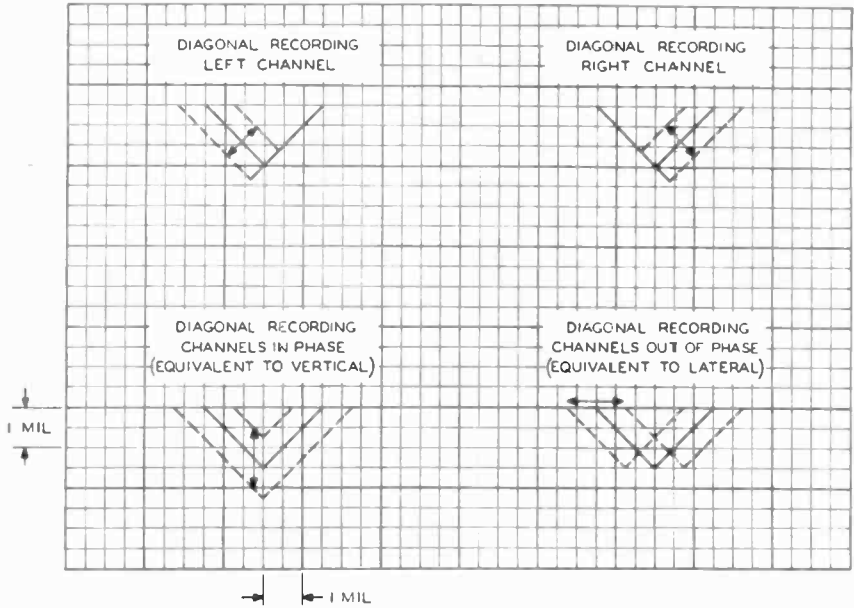

The Westrex 45-45 disc recording principle. Each of the two channels is cut diagonally. Equal signals in phase result in vertical stylus movement. Equal signals out of phase result in horizontal stylus movement

The Westrex model 3A StereoDisk cutting head in operation, producing a master disc

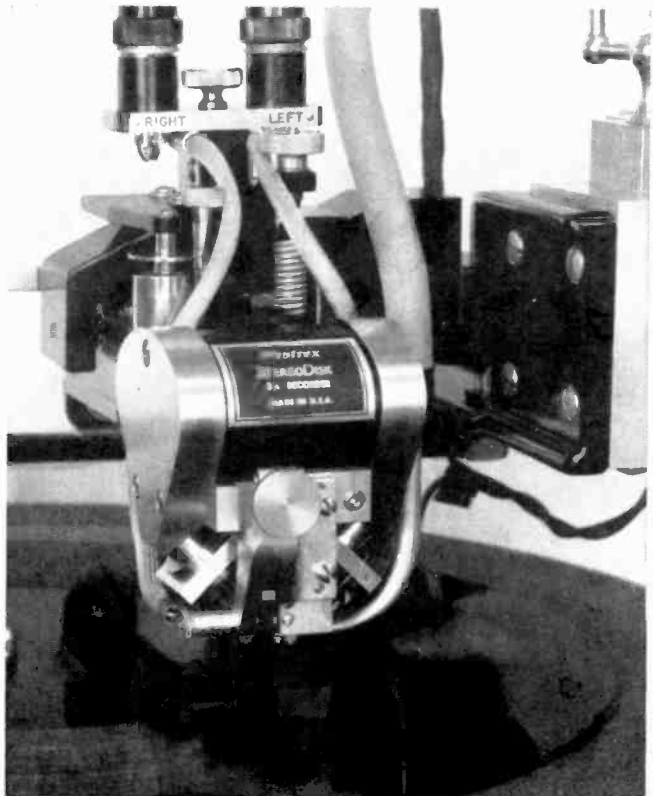

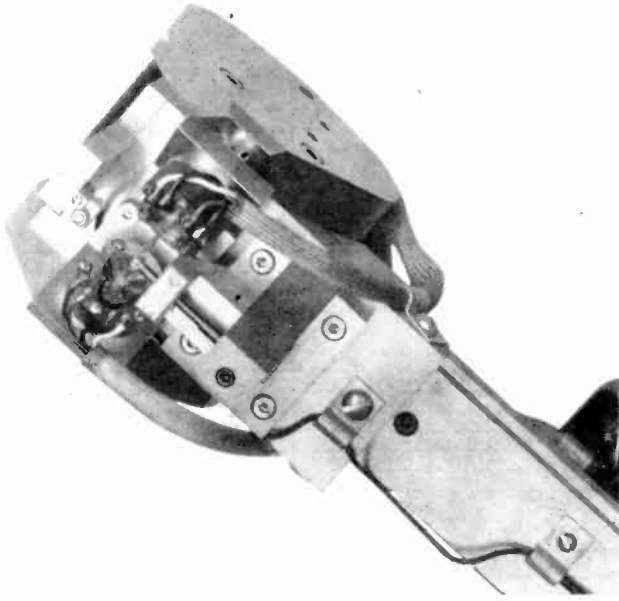

A closeup view of the Westrex 45-45 cutting head for stereophonic disc masters. The cutting stylus is actuated by the angled connecting rods near the tip of the stylus lever

purpose. We have defined the job of the pickup cartridge, and now let's look at the work cut out for the tone arm.

The tone arm (a term dating from the acoustical phonograph) is a moving device holding the sensing element called the cartridge. It does not have any other job but to carry this cartridge unit over a disc record as the disc revolves. The facility with which any tone arm accomplishes the job establishes its difference in quality and price from any other tone arm. To define the requirements more exactly:

1. A tone arm must move freely over the horizontal surface of a disc recording.
2. A tone arm must allow a stylus to be easily set down on a record and removed.
3. A tone arm must be so designed that it comes as close as possible to accurate tangential tracking of each successive groove as it moves toward the center of the turntable.

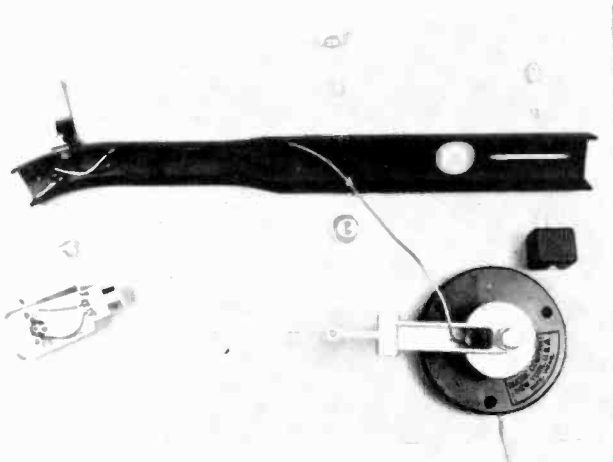

Some tone arm kits are available. This high-quality kit requires only a small screwdriver and a minimum of manual skill

Equipment for evaluation furnished by Audax, Inc.

Wrapped up in the requirements for the perfect arm are, as always, the problems that inhibit perfection. Any material object has a resonant frequency at which it can vibrate if set in motion by some force. This resonant frequency is the point at which it will vibrate more easily than at any other frequency. This resonant point is governed largely by size, mass, and configuration. The functions of a tone arm involve audible frequencies. Unfortunately, most tone arms are of such a size that their resonant frequency points are somewhere below 100 cycles. If an arm is set into resonance by motor rumble or vibration of the rotating mechanism of a turntable, this vibration is easily transmitted to the cartridge and stylus element and translated into audible sound. Both vertical and horizontal elements of vibration can cause tone arm resonance to occur. By damping the lateral and vertical motion of the arm, the mechanical coupling between the arm and its mounting can be eliminated. A series of high-grade pivots or viscous-controlled joints will aid in this. However, these elements of damping also resist the force of the groove walls which move the stylus from groove to groove, and faulty tracking or disc damage can occur. If the record is not centered, or is slightly warped, the arm will not stay in the groove. If arm resonance is unchecked, the stylus may have a tendency to jump the groove through the force of a high-amplitude signal recorded at the resonant frequency of the tone arm. The choice of construction materials and methods of design should be such that the arm resonant frequency, undamped, is below the low-frequency limit expected to be reproduced. Various techniques have been employed to damp tone arms through added weight, interior packing of the arm channel with a viscous plastic material, or solid construction of lightweight wood or plastic.

Designing a tone arm with the facility for getting the stylus into the first groove and removing it at the end of the disc involves an internal lift lever where the arm has no vertical motion, or simply an external finger lift on the cartridge element. Other systems may employ a jointed arm, hinged either

Right: A completed tone arm, as constructed from a kit. Below: The head-lifting device on the Shure Studio Dynetic tone arm



Equipment for evaluation furnished by Audax, Inc.



Equipment for evaluation furnished by Shure Bros., Inc.

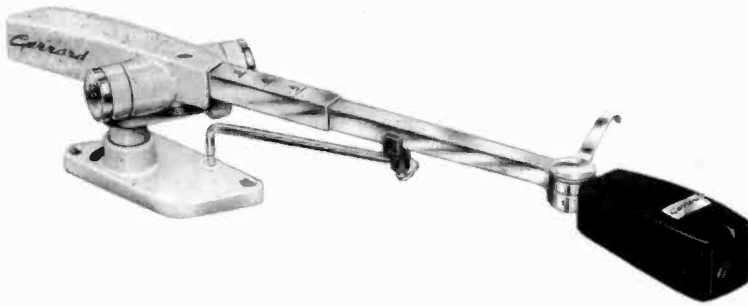

Equipment for evaluation furnished by British Industries, Inc.

Modern tone arms have adjustments allowing them to be fitted to a variety of turntables

at the head or at the rear pivot. There is no real advantage in any particular system, providing the pivot joints are secure and non-vibratory. Mechanically operated arm systems do not usually maintain their hold on the arm once it is in contact with the first groove of a record; they are simply an added convenience.

One of the most difficult problems with any pivoted tone arm is that of tracking the grooves of a disc at the right angle. The disc might be considered to be a series of many hundreds of concentric circles, decreasing in diameter toward the center. As a pivoted tone arm moves in toward the center, the angle between the axis of the arm and the tangent to the groove must change constantly. Most arms are of fixed length; they are expected to play all sizes of discs equally well. Since the arm is set in a mounting board at one spot,

Refer to the text to find the proper position for straight, left, and angled, right, tone arms

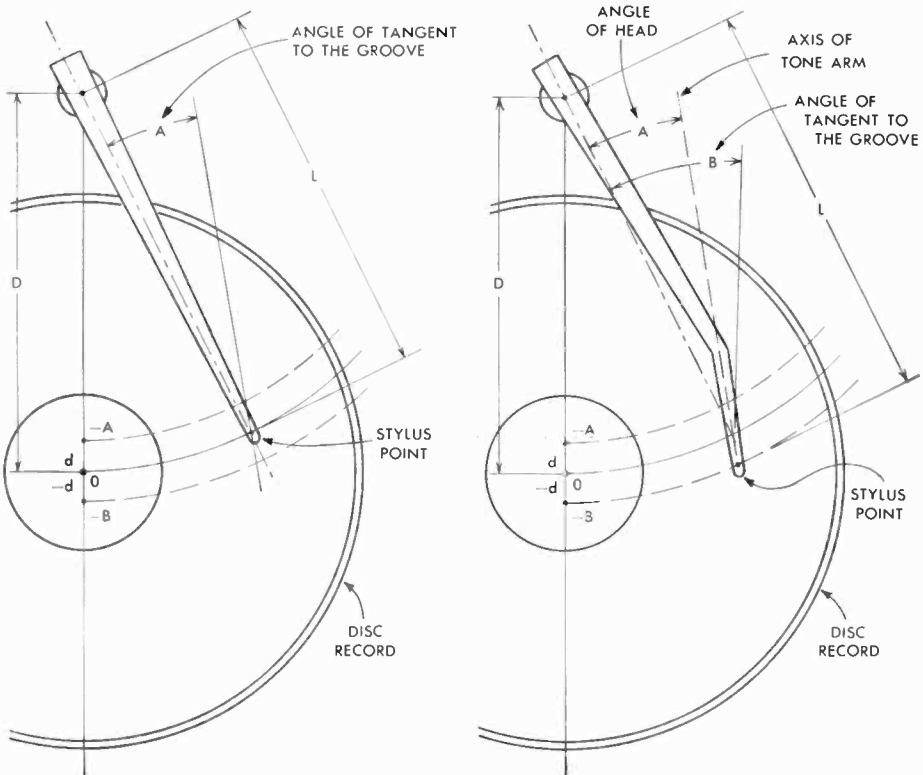

little can be done to eliminate this complex problem. Incorrect tone arm placement can cause harmonic distortion, stylus "talk," and abrasive side thrust on the grooves. It is interesting to note that tone arm placement for minimum tracking error will not produce a condition of minimum distortion, since tracking error is most critical at the inner grooves. The placement of any particular pivoted tone arm is at best a compromise; yet, if manufacturers' recommendations and installation templates are followed, the results will be highly satisfactory.

For a straight tone arm without an angled head it is best that the stylus fall short of the center of the record. Follow this formula:

L represents the length of the tone arm as measured from the pivot point to the tip of the stylus:

$$\text{For 12" discs . . . } d = \frac{3.18}{L}$$

d represents the distance from the center of the disc to the stylus as it rests over the center pin of the turntable.

For a tone arm with an offset or angled head, it is best that the stylus pass beyond or below the center of the disc. In the following formula, d represents this distance, and L again represents the length of the tone arm from pivot to stylus point.

$$\text{For 12" discs . . . } d = \frac{4.60}{L}$$

High-fidelity tone arms of today incorporate several standard adjustments, including stylus weight adjustments through a counterbalance system and adjustments for height relationships to various turntables. One arm produced by Garrard is fully adjustable in length from 12 to 16 inches, with a template to guide the user in selecting the proper length. It provides for differences in turntable height and stylus pressure, and has a fully adjustable head for selection of the proper tracking angle in relationship to the length of the arm, with instructions and a protractor provided for perfect installation. The TPA-10 Garrard tone arm is designed to suit the needs and requirements of installations where adjustment is important.

In recent years, designers have tried to overcome the problem of tracking error by employing an overhead lathe structure that lies above the turntable, parallel to the radius of the disc. A pickup, mounted on the horizontal travel-

Modern turntable and tone arm combinations are supplied with instructions and templates to insure correct mounting



Equipment for evaluation furnished by British Industries, Inc.

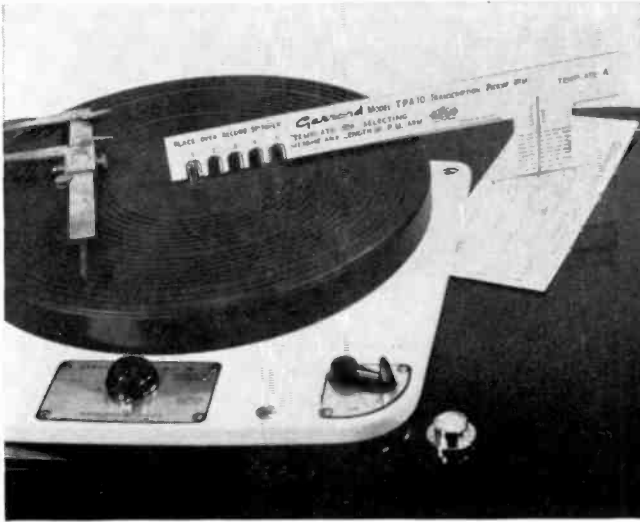

A cardboard template serves as a guide for positioning this tone arm assembly correctly on a Garrard turntable base

Correctly positioned holes have been drilled in the turntable base to accept the tone arm and mounting hardware



The completed turntable and tone arm assembly rests on a vibrationproof shock-mounted base

Equipment for evaluation furnished by British Industries, Inc.

Rek-O-Kut Rondine turntable with Audax tone arm assembly mounted in correct position



Equipment furnished by Rek-O-Kut and Audax

ing rod. is allowed to move freely over the disc without the constantly changing arm and tangent relationship introduced by the pivoted arm.

THE HIGH-FIDELITY SINGLE DISC TURNTABLE: The first electric turntables employed standard-speed motors with some sort of geared speed reducer. In early days, the acoustical and first electronic phonographs had very little bass response, hence the rumble of metal gears produced no audible sounds. With the advent of better amplifier electronics, rumble in the drive system of any turntable was untenable; better drive systems had to be devised. Any sort of vibration or speed variation transmitted to a cartridge will result in audible disturbances.

The most widely used turntable power system is the rim drive system. Any type of induction motor can be used; drive power and speed reduction are accomplished through a series of rubber-tired wheels, one of which is driven by the motor armature. The former in turn powers another wheel, which has been placed in contact with the rim of the turntable. This system has found wide usage because of several features: speed reduction is easily

Heavy cast-aluminum turntable and single-point bearing combine with soft rubber drive wheels to provide constant speed and low rumble content

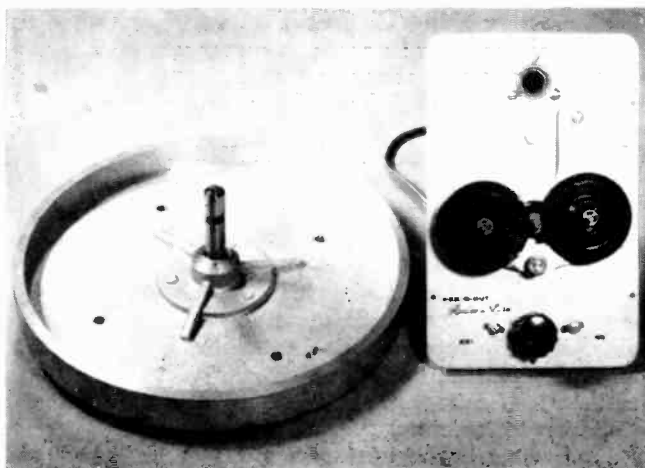

Equipment furnished by Rek-O-Kut

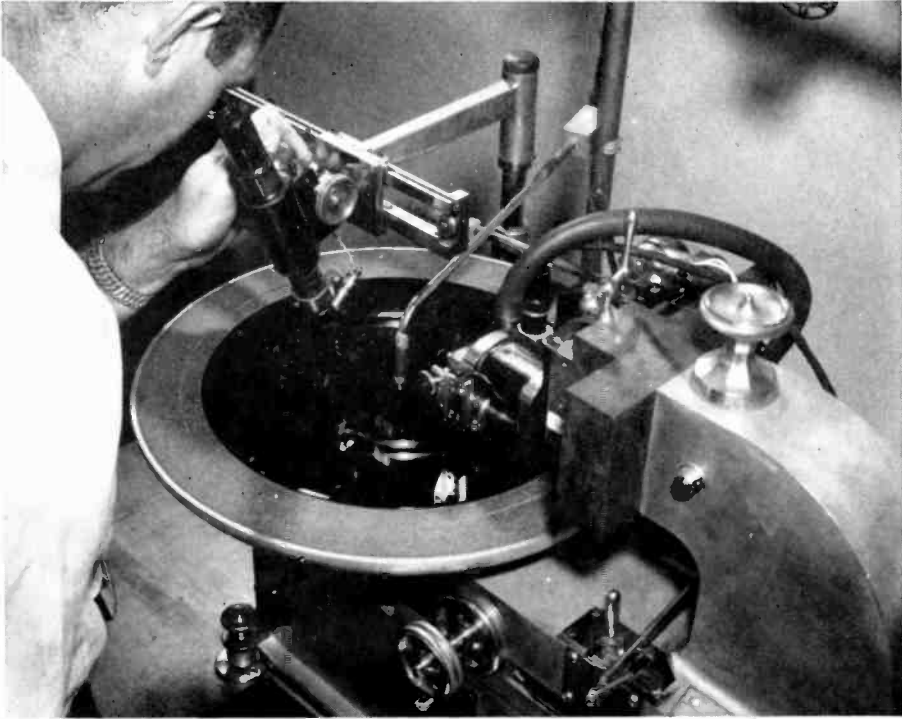

Courtesy R.C.A.

Direct-drive turntable in use with a professional recording lathe

accomplished; vibration and rumble are reduced through the use of rubber-tired drive wheels; a wide price range of standard motors can be used; while the turntable is driven at the rim, the center hub can be used during change cycles to power a mechanical disc changer; and the complete mechanism can be made small enough for general usage. One disadvantage of the rim drive system is the possibility that "flats" or indentions will be formed on the rubber wheels during periods of idleness as the wheels press against either the motor shaft or the turntable rim. In some of the better turntables and changers all rubber wheels are disengaged when not in use.

Direct drive turntables appear mainly in professional equipment where the added cost of special slow-speed motors is not important. The system of operation involves the placement of the turntable directly on the shaft of a slow-speed motor. The cost of a motor designed to revolve at 33 $\frac{1}{3}$ rpm would far exceed the cost of the rest of the high-fidelity equipment of a non-professional. In reality, most direct-drive systems employ some sort of gear-reduction mechanism which has in it a series of nylon or teflon gears to inhibit motor vibration from creeping into the cartridge and stylus unit.

Belt-drive and shockproof mechanically coupled turntables have found their way into all price groups except the very inexpensive. They work on a principle of coupling the power of a motor to the center shaft of a turntable through a flexible shaft or belt. In this way the full torque power of the motor can be transmitted to the turntable without vibration. The motor can be placed on its own shock mounting at a considerable distance from the turntable. In some types of belt-drive turntables the belt is connected to a pulley below the unit; in one case it is run around the outside rim of the turntable itself. Speed changes are accomplished by shifting the belt to motor pulleys of different diameters.

Regardless of the turntable power system used, performance is dependent

upon sufficient motor torque power to maintain speed with constancy, and low hum coefficient. Mechanical speed regulation depends upon the quality and alignment of bearings, and the balance of the armature and all rotating parts. Garrard of England has for years insisted that each of its turntable armatures be dynamically balanced. Any rotating device can be balanced through the use of added weights, as automobile wheels are balanced. Close static balance can be effected by adding weights according to slow-moving balance. However, effective balance can only be accomplished by correcting eccentricities and checking the final balance dynamically at the proposed rotating speed of the armature. A high-quality turntable should be rumble free, with speed constancy within $\frac{1}{2}$ of 1%. High-quality synchronous motors of several types account for the major differences between so-called budget turntables and the true high-fidelity units. To counteract slight speed variations in disc recordings, some manufacturers have incorporated stroboscopic speed-checking devices, with a means of varying the speed of the turntable mechanically.

Right: The operating parts of a gear-drive turntable with a vibrationproof shaft coupling. Below: The three-speed turntable features stroboscopic speed adjustment

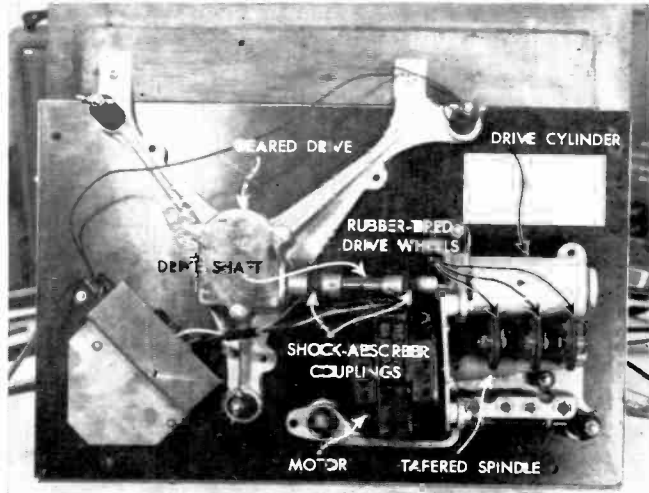

Equipment for evaluation furnished by H. H. Scott Corp.

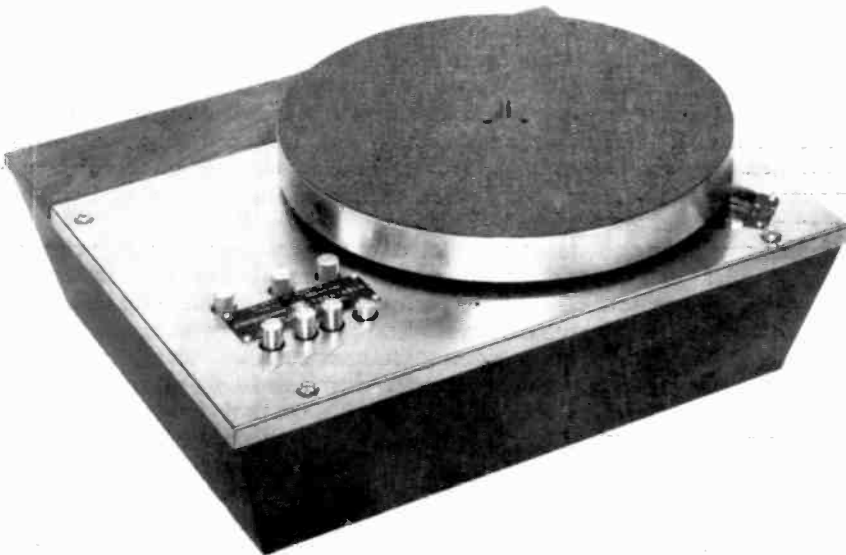



Armature-balancing device used by Garrard of England to check armatures dynamically

DISC RECORD CHANGERS: The first record changers were manufactured while acoustical recordings were still being made. At that time, all recordings were made so that alternate sides were in sequence. The first changers were given the job of turning the records over. The legendary device of this type was the oversized Capehart which could, with "human" dexterity, sort through piles of discs of various sizes and play at least two hours of music. And, like human beings, it could be temperamental and imperfect. The advent of the automatic or drop changer allowed a series of records to be handled: all the listener had to do was to tend the machine once during the course of play to turn over the stack of discs. During the period of 78-rpm shellac recordings, manufacturers began to put out sequential albums intended for changers.

Most early changing devices were mechanically imperfect and sources of constant trouble, in addition to being very hard on valuable record collections. Garrard of England brought out the first really practical disc record changer of high quality. The familiar bent spindle and balanced tone arm with a rotating head for ease of stylus replacement were all part of this first unit. Low rumble noise and ease of operation with a minimum of record chipping and damage were characteristic of this early English changer.

Present-day changers are available in a very wide range of price and quality. The less expensive devices are often underpowered, with unconstant, weak shaded-pole motors. Still, they perform the job of changing discs about as well as the most expensive changers. The drop changer has become standard, with various manufacturers adding features such as variable speed control and intermixing of all sizes of records. New extra-long-playing recording techniques have brought about the 16 $\frac{2}{3}$ -rpm disc, but few manufacturers have been able to produce, for the average budget, a changer or player that will play these discs without the drawbacks of rumble and wow. Each year, progress in changer design eliminates some of these problems. The modern changer, compared to the changers of 15 years ago, can provide up to 20 hours of continuous LP programming.

Right: A stroboscopic turntable chart, used in conjunction with a 60-cycle lamp (preferably fluorescent), provides an accurate means of checking turntable speeds

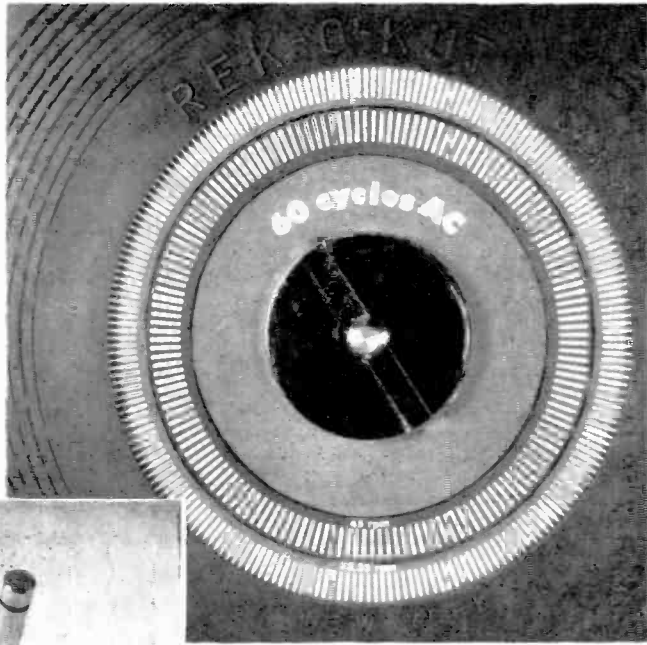

Equipment furnished by REK-O-KUT

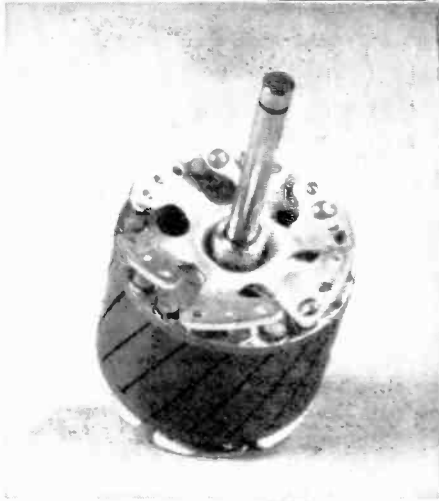

Above: The armature of a Garrard record changer. Holes and rivets on the fan blades are added for balance. Right: Small speed adjustments are effected by shifting the positions of screws on turntable mechanism

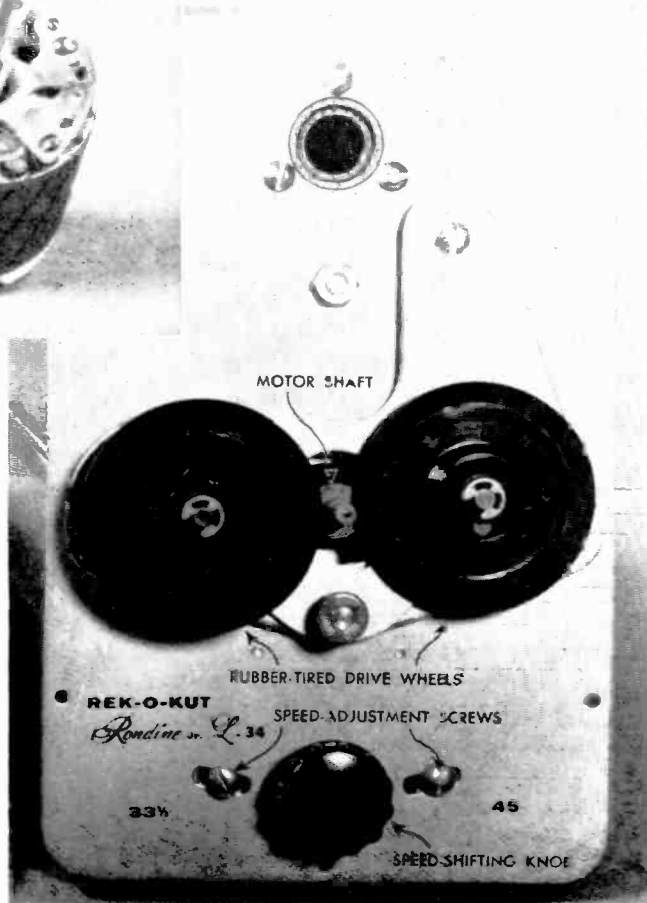



The record-handling side of a three-speed Garrard record changer

THE HIGH-FIDELITY PHONOGRAPH STYLUS: The subject of the correct stylus for playing phonograph recordings has had widespread discussion in the past, each expert proposing his own special type of needle. Edison, from the first, proposed that the hardest substance would be the best; present-day experts agree with his diamond stylus precept. Others in the past have tried various kinds of metals, woods, and glass, each inventor claiming that his system was the only one that could get everything out of an acoustical recording without damage to the record. In later years bamboo, cactus spines, plastic, fingernail parings, and other and odder materials were tried. As better manufacturing techniques came to the fore the choice of stylus resolved itself into three materials: metal osmium, synthetic sapphires, and diamond points. No matter how hard the stylus material or how soft the vinyl LP disc, a stylus still wears out and must be replaced; the materials wear out in the order listed above. Eventually the diamond, because its range of damage-free playing time runs from 500 to 2000 hours, will take over from the osmium utility point, which has virtually no durability, and the sapphire, which has an average life of 200 hours.

The underside of the record changer pictured above

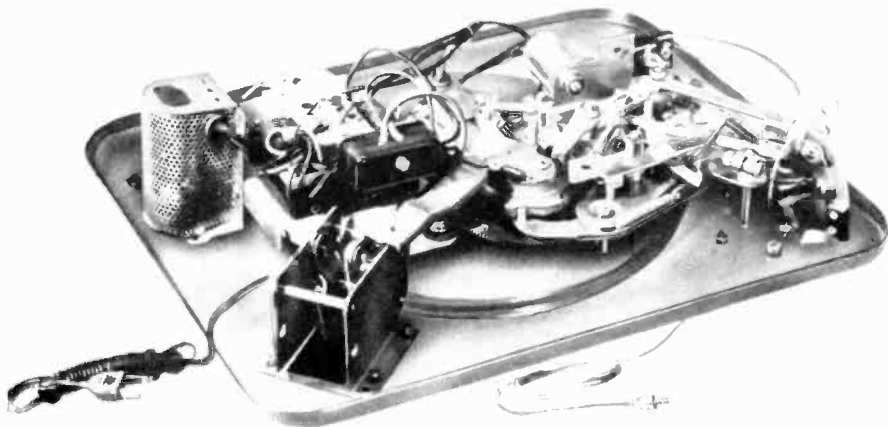

Equipment for evaluation furnished by British Industries, Inc.

A modern four-speed record changer by Garrard (16 $\frac{2}{3}$, 33 $\frac{1}{3}$, 45, and 78 RPM)

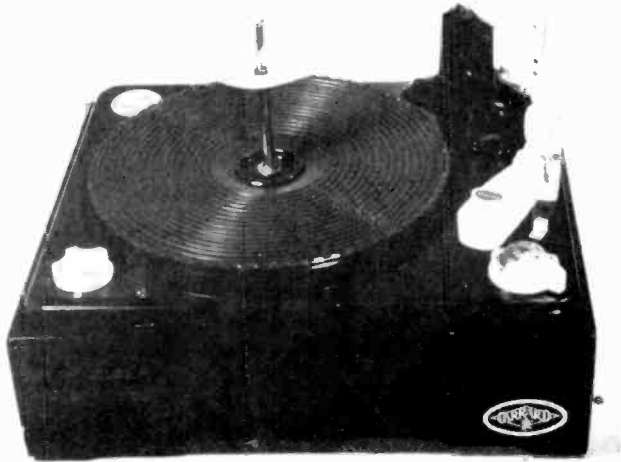

Equipment for evaluation furnished by British Industries, Inc.

The size of disc grooves has, by and large, determined stylus tip size from the old acoustic groove size of 5 mils to the modern LP of 1 mil or less (1 mil = $\frac{1}{1000}$ inch). The leaf spring and bent-shank stylus shapes are intended to add a measure of vertical compliance to otherwise stiff cartridges.

THE INSTALLATION OF DISC PLAYING EQUIPMENT: It is not advisable to separate units in installing the group of composites making up a high-fidelity phonograph. There is a special relationship between a stylus, a cartridge, and a tone arm, and a further relationship of the arm and the turntable mounting base with the turntable in place. Each manufacturer will provide specific instructions for his particular piece of equipment; because he would like to have this piece of equipment enjoy the widest sale possible, he will include instructions for its application with most allied devices. *Follow these instructions to the letter.*

Various styles of old phonograph needles. Left, metallic; right, fibrous

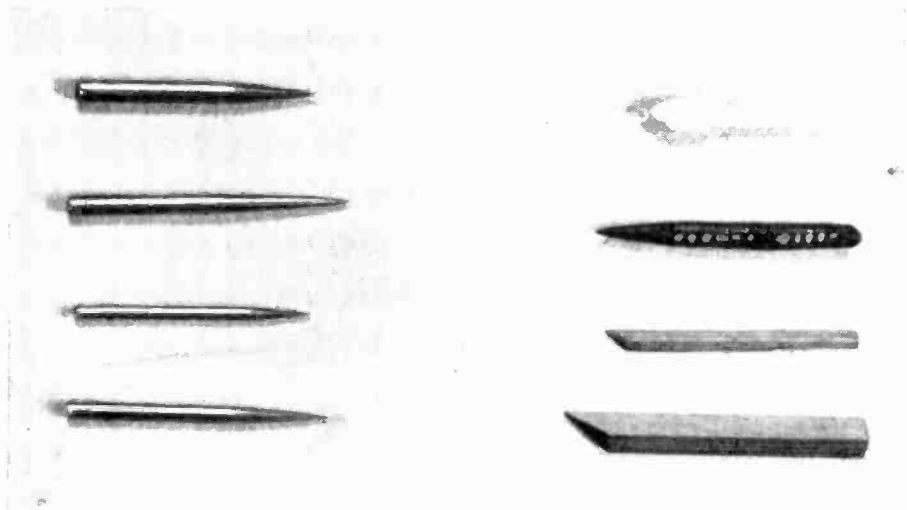

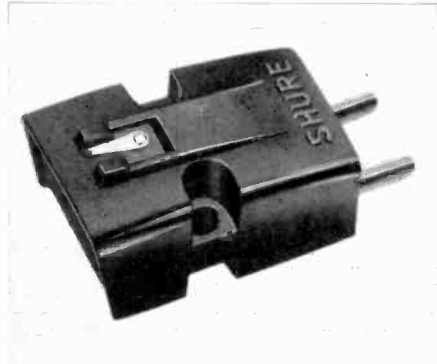
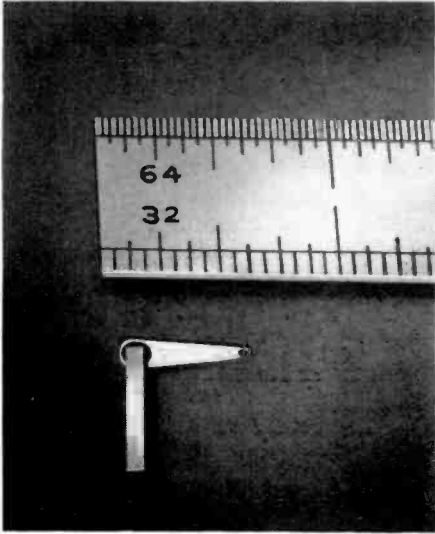

Equipment for evaluation furnished by Shure Bros., Inc.

Above: A moving-magnet monaural cartridge.
Left: The stylus and magnet assembly used in the above cartridge

Basic rules must always apply; they are not always emphasized by manufacturers' instructions. They are:

1. Try to install your disc-playing equipment away from the vibratory influence of your loudspeaker system.
2. Try to install your disc-playing equipment away from the hum-producing electric fields created by power transformers and a.c. power lines.
3. Pick a spot that is convenient for ease in handling disc equipment. Most people prefer to have it at table height for accessibility to all but small children.
4. Make sure the tone arm is positioned correctly in relationship to the turntable; it must not touch or drag on the cabinet sides during the inner portion of its swing.
5. It is wise to check both signal wire and power connections against badly soldered or protected joints.
6. The mounting board and turntable surface should be as nearly level as possible. A small spirit level can be used to position the unit correctly.
7. After the turntable or changer has been installed, check all spring-loaded shock mounts and mounting screws to make sure that the turntable or changer base is actually floating freely and not bolted or fastened securely to the mounting board at any point.

MAINTENANCE FOR DISC-PLAYING EQUIPMENT: Maintenance for disc-playing equipment comes under the category of preventive maintenance, but it is quite important. The following simple steps can be performed by anyone interested in keeping his disc-playing equipment in top shape:

Stylus and cartridge assembly

- a. Keep a time chart on the use of the stylus and replace it when necessary.
- b. Keep the stylus clean and free from dust and dirt where it enters the cartridge element.
- c. Check to see that the screws holding the cartridge in place are secure.
- d. Check all leads for secure fastening to the terminals of the cartridge.

Tone arm assembly

- a. Keep all pivots free of dirt and gumming materials that might inhibit the normal movement of the tone arm.
- b. If called for by the manufacturer, *lightly* oil the main vertical pivot of the tone arm.

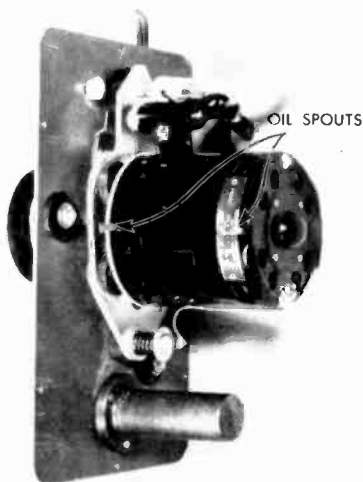

Equipment for evaluation furnished by Rek-O-Kut

Above: Lubrication points on a Rek-O-Kut turntable motor. Right: Garrard turntable spindle has a grease fitting

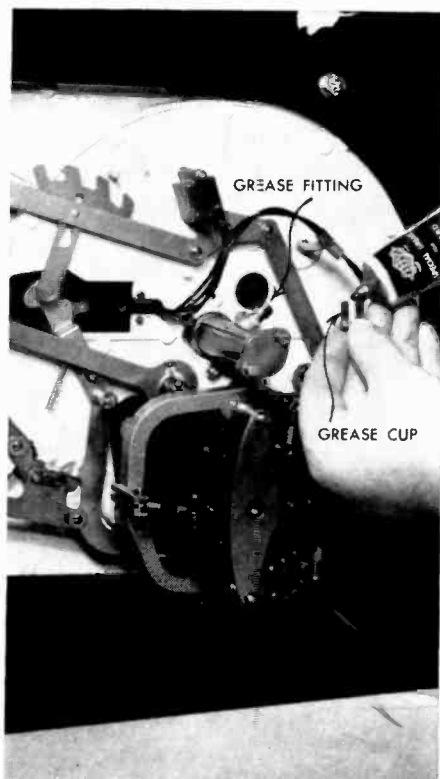

Equipment for evaluation furnished by British Industries, Inc.

c. Make sure all construction bolts and hardware are securely fastened as designed.

d. Check for proper adjustment of tracking weight in the tone arm.

e. Be sure that lead wires are not pulled too tightly through the arm and mounting hole; the normal swing of the arm must not be hindered.

Turntable equipment:

a. Check for level turntable and mounting base.

b. All rubber-tired drive wheels and the inner rim of the turntable itself should be cleaned occasionally with isopropyl alcohol (denatured). They should be free of any oil or grease.

c. *Do not* oil or grease the turntable mechanism except where the manufacturer has made provision for such maintenance. Too much oiling can be more serious than too infrequent oiling.

d. Clean the air vents on the drive motor with a small brush to get rid of lint and dust, which might cause overheating of the motor.

e. Check periodically for obstructions that might become wedged under the spring-mounted turntable base and contribute to added mechanical vibration.

f. In disc-changing equipment, the turntable is usually rim-driven; a cam and gear arrangement near the center of the turntable powers the changer during recycling. Often, in less expensive units, the changer will seem to lack power during the changing process; this can be accounted for by either dehydrated rubber drive wheels (which should be replaced) or by a gummed-up vertical turntable center bearing. In the latter case, cleaning with isopropyl alcohol and reoiling will ease the situation.

6

TUNERS

THE HIGH FIDELITY AM AND/OR FM TUNER: Tuners are more temperamental than any other piece of hi-fi equipment. While there are several combinations of tuners, AM-FM, TV, and those for short wave, the separate AM and FM sections only will be covered here.

AM (AMPLITUDE MODULATION) BROADCASTING: Every radio station is assigned a basic carrier frequency of operation within the AM radio spectrum. Some large stations are given clear channels, with no other station sharing the same point on the dial. Others, far distant from each other, are given the same frequency, but allowed to operate only during daylight hours so that they will not interfere with each other at night, when radio waves travel farther.

The Fisher model 500 AM-FM tuner-amplifier needs only a speaker to function as a complete unit



Equipment for evaluation furnished by Fisher Radio Corp.

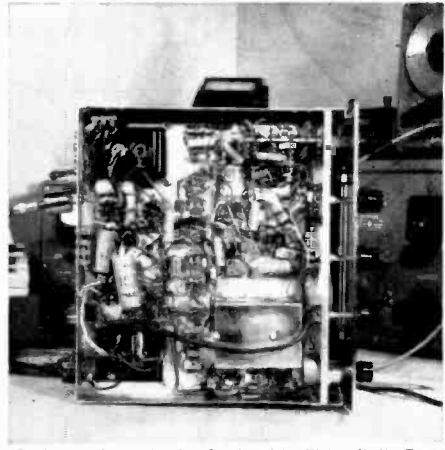
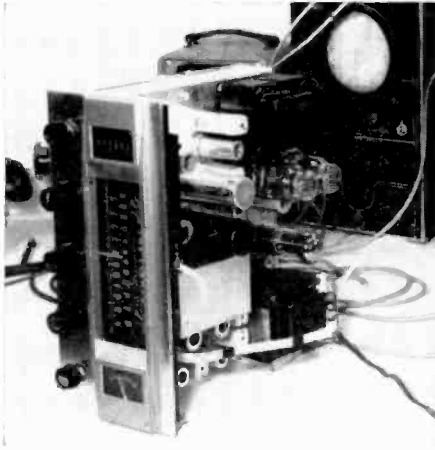

Complexity of Fisher model 500 AM-FM tuner-amplifier is indicated in top and bottom views

Equipment for evaluation furnished by Fisher Radio Corp.

A station dial number such as 670 means that the frequency of the electromagnetic carrier is 670,000 cps. The frequency of this radiation is so high that we cannot see, hear, or feel its vibrations. The only way we can know it is there is to detect it electronically, with a radio set. Such a carrier frequency is similar to perceptible vibrations, but its rate of oscillation is higher. The frequency range of the broadcast band runs from 550 kc (i.e., 550,000 cps) to 1650 kc. A carrier signal must be modulated, just as we modulate the basic frequency from our vocal cords, if it is to produce sound. Modulation of steady vibrations is the key to any form of communication. With a human's movements of mouth, lips, and tongue, recognizable sounds are formed. As a carrier is modulated—that is, changed or varied by the program material—the radio set sorts these variations from the carrier wave, and the radio “plays.” The term *amplitude modulation* (AM) simply denotes the method of modulation. In this case, as opposed to FM, or frequency modulation, the carrier is changed in amplitude according to the characteristics of the program being impressed upon it. This is the reason any type of electrical interference can affect AM-broadcast sound. Electromagnetic radiation is susceptible to electrical influence, and in AM radio there is virtually no way of eliminating its effects. FM accomplishes this quite easily.

FM (FREQUENCY MODULATION) BROADCASTING: In FM broadcasting, a transmitter sends out a carrier signal similar to that of an AM transmitter, except that its basic frequency is much higher in the radio spectrum. The allotment of wavelengths to stations is governed by the F.C.C., just as in the case of AM radio: these lie between 88 mc and 108 mc (i.e., 88,000,000 to 108,000,000 cps). Basic carrier waves are transmitted much like those of any AM radio station, the difference lying in the mode of modulation.

In AM radio, the carrier stays at one specific frequency; in FM, the basic carrier frequency is shifted back and forth, higher and lower than the allotted channel. For example: the frequency of a carrier is 100 mc; this would be 100,000,000 cycles per second. In the process of frequency modulation this basic carrier frequency deviates from its normal position according to the character of the modulation signal. In the case of a high-fidelity FM station, this deviation will be 75,000 cycles on either side of the allotted carrier slot. In the course of operation the carrier will operate in a range from 99,925,000 cycles to 100,075,000 cycles.

The detection of carrier variations is accomplished in the discriminator section of a receiver and just as in the case of an AM receiver the modulating signal is removed from the carrier; the latter is then rejected and not used.

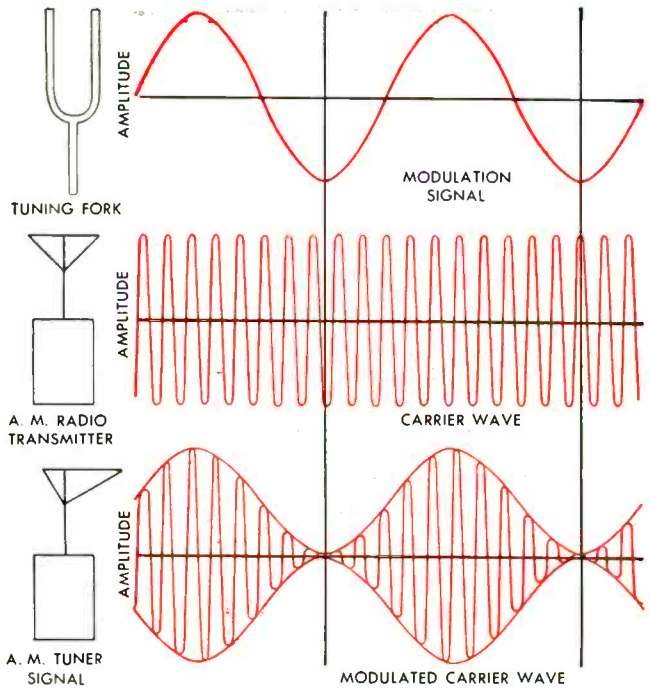

In AM radio, the amplitude of a carrier signal of constant frequency is altered by the program material received by a listener. The high-frequency carrier signal is filtered out in the 2nd detector section of the listener's radio

The audible portion of the transmission remains as the high-fidelity, noise-free FM program. Any static or noise impressed upon the FM carrier has been clipped off by limiters in the receiver.

HIGH FIDELITY TUNERS IN GENERAL: Whether the tuner you have in mind is a single unit designed to receive just AM or just FM, whether it combines the two or has incorporated preamplifiers for phonograph or tape recorder, or if it has its own self-contained power amplifier, there are certain requirements it must meet or you will not get the proper service from it. Each tuner is designed to meet a specific need dictated by the amount and type of equipment already in the high-fidelity system.

REQUIREMENTS FOR A HIGH-FIDELITY AM TUNER: Several sections make up the modern radio tuner; we will undertake to describe simply what takes place in each section rather than go into all the variations of systems and components.

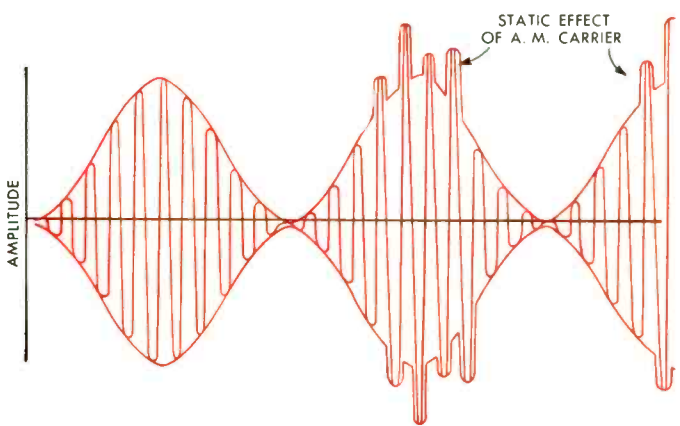

Static alters the amplitude of an AM carrier signal, causing distortion in the program material received by a listener

In FM radio, the frequency of a carrier signal of constant amplitude is altered by the program material received by a listener. The variable-frequency carrier signal is filtered out in the listener's radio

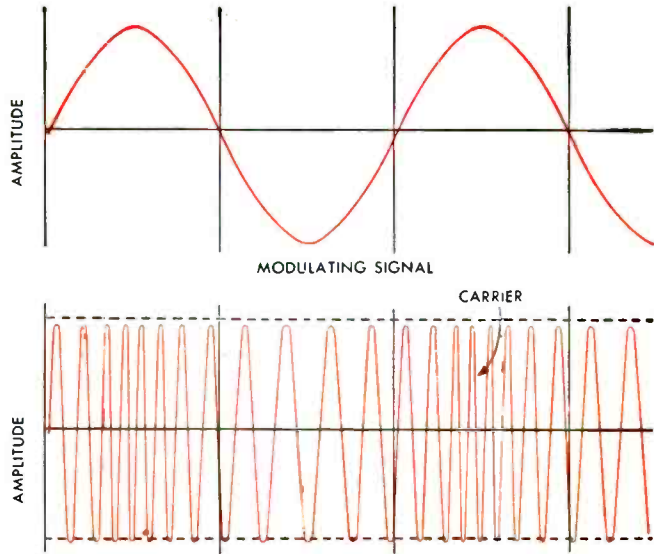

The antenna is essential for the reception of radio frequency energy from the air. In the early days of radio, the antenna was one of the most important parts of a tuner since the power of radio stations was limited. There were fewer stations, and distance reception was desirable, but the sensitivity of receivers themselves was limited. Today every major city has several 50,000-watt stations and many of lesser power. Seldom, however, does a radio listener try for distance reception because network coverage in his own area is probably satisfactory. Present-day receivers are much more powerful and selective. These factors have limited the need for old-style outside antennas; now they are almost always contained within the set.

In most high-quality tuners, there will be one or two stages of amplification for the basic carrier wave before the essential conversions are made. The radio frequency (called *rf*) section affords coupling between the antenna and the *rf*-amplifying vacuum tubes. The chief purpose of this section is to provide the tuner with selectivity of desired signals on the radio band over undesired signals. It must provide for constant transfer of the right amount of energy from each signal over the entire frequency band. It must accomplish perfect tracking of the tuned input (radio frequency amplifier) section, and of other adjustable circuits in the tuner. Tuning the station-finder dial on a radio

Static affects only the amplitude of a carrier signal. Since frequency relationships remain the same, FM program material is not distorted by static

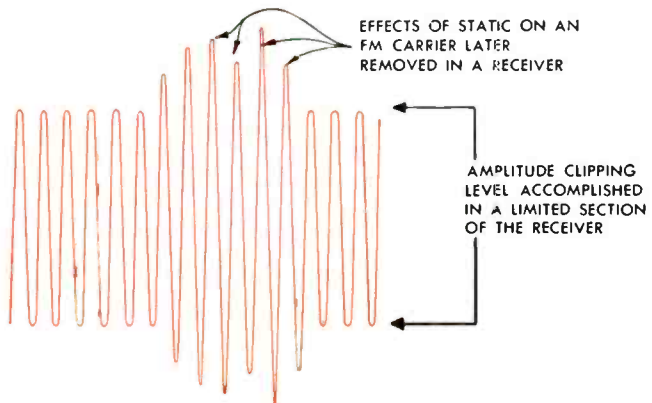



Courtesy Fisher Radio Corp.

A precision AM tuner of high quality

is something like turning on a series of water valves in a long pipeline all at once, so that water flows instantaneously.

After the incoming waves at one particular frequency have been amplified by means of the tuned-*rf* section, it is necessary to change the character of the wave. The next stage in the tuner is really two units, the oscillator and converter section. If two tuning forks are struck together, the resulting sound is composed of several notes: one is the difference between the two fundamental notes. For example, if two forks emit 200 cycles and 300 cycles, the resulting notes would be 100 cycles and 500 cycles. In a radio tuner we have one frequency coming in from the air; we provide another by means of a vacuum-tube oscillator circuit. These two frequencies are heterodyned (beat) together to produce a difference frequency, in this case called the intermediate frequency. Tuning across the broadcast band changes the incoming radio frequency, which would change the intermediate frequency relationship if the oscillator frequency were not changed at the same time. As these two radio frequencies are put together in a converter, sometimes called the first detector, they produce a constant intermediate frequency of 455 kilocycles, which still contains all the modulation information but which being constant, can now be more easily handled. Separate oscillator and converter sections can give a tuner a low noise level.

The course of a compound AM radio signal through a receiver

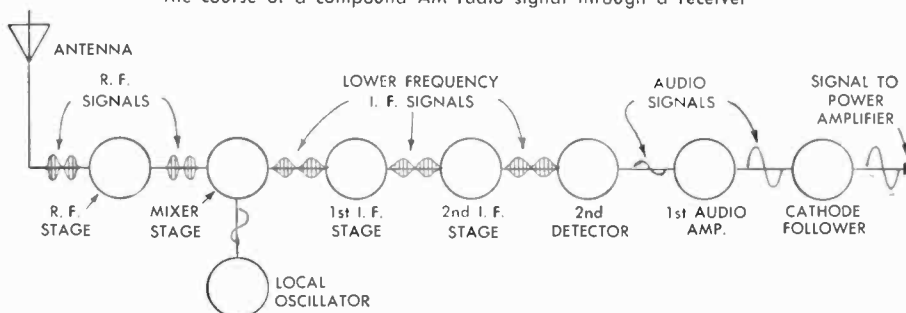

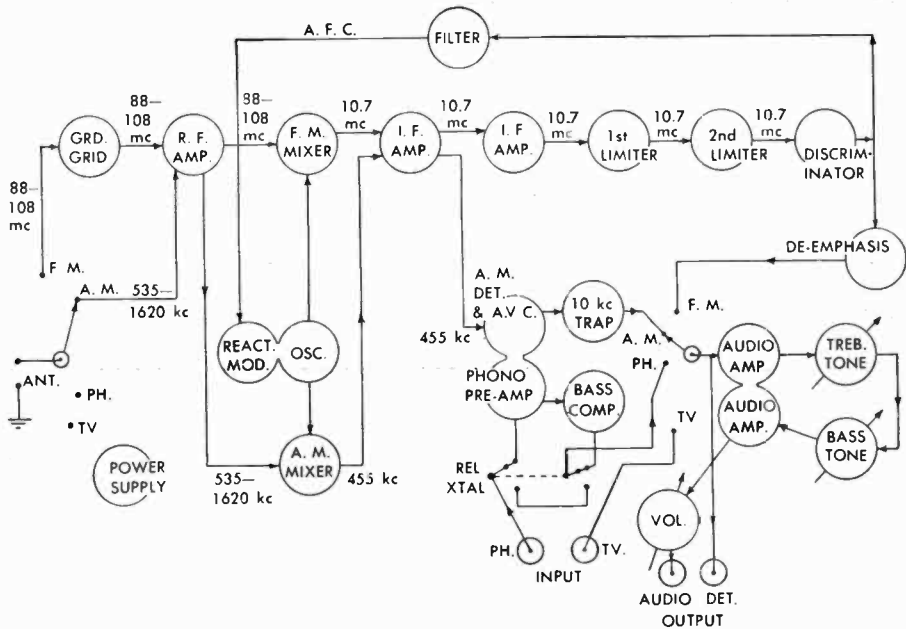

Block diagram of a modern AM-FM tuner with preamplifier, tone controls, and selector switch

The intermediate frequency section of a tuner consists primarily of vacuum tube amplifiers and coupling networks between the converter section and the 2nd detector. The purpose of these IF stages is to provide a maximum amount of signal gain before the modulation information is detected from the radio frequency carrier. It is possible to have a large amplification factor in the IF section because there need not be any provision for amplifying any frequency but the 455 kc intermediate frequency.

After sufficient gain has been realized in the IF section it is time to separate the radio frequency and the modulation signal frequencies. The 2nd detector section accomplishes this through diode rectification, passing the radio frequencies to ground and the modulation signal to the first audio amplifier. In the case of a high fidelity tuner, the signal from the first amplifier tube is fed from a special circuit arrangement, called a cathode follower, to a remote power amplifier. The cathode follower is simply a transfer arrangement which results in no quality loss in the signal in transit.

One circuit feature common to almost all tuners is automatic volume control (A.V.C.). Wide signal strength variations exist from station to station across the broadcast band. If it were not for A.V.C., these changes would necessitate manual resetting of the audio volume control. A.V.C., through special circuits fed from the 2nd detector back to previous rf stages, maintains constant carrier voltage at the detector by instantly sensing any great change in carrier signal, and then altering the amplification factor at these first stages.

The usual kitchen radio or console radio seldom can produce more than 5000 cps in audio response from an AM signal. The bandwidth of a high-quality receiver's circuits must be widened to provide a wider audio frequency spectrum. As a wider audible range is made available to the ear, less amplitude distortion will be tolerated. As fidelity improves, noise levels are more noticeable, hence, more care must be given to the necessary increase in signal-to-noise ratio. A filter must be employed to remove the 10,000-cycle note that appears because of the beating together of two adjacent radio channel (station) carriers. This filter must be very narrow so that it removes only the beat at 10,000 cycles, but allows the audio response to go above that level.

REQUIREMENTS FOR THE HIGH-FIDELITY FM TUNER: Though different in concept and execution from the AM tuner, the FM tuner must accomplish essentially the same job: producing audible signals from radio waves in the air. The differences between the two can be shown as replacements in the block diagram of the AM tuner. Radio waves are picked up in much the same manner as in any radio and sent through an RF amplifier; the system of oscillator and converter and intermediate frequency amplifiers is similar except all must be designed to accommodate a much wider band width because of the inherently wider range through which the carrier is modulated.

The first actual changes lie in the substitution of a frequency-modulated detector, called a discriminator, for the 2nd detector of the AM tuner, and in the addition of one or two carrier amplitude limiting stages which will remove any static or amplitude interference signals from the FM carrier. An additional increase is usually associated with these changes of gain between the signal from the antenna and the discriminator. Oscillator drift, resulting in stations going out of tune, is a frequent source of annoyance in FM tuners, particularly during warmup. Most high-quality tuners compensate for drift by employing automatic frequency control (A.F.C.) circuits. In many, the A.F.C. feature may be bypassed for fine tuning on weak station signals.

To try to cover the relative merits of various types of detector circuits, discriminator circuits, and limiting methods would be pointless for the average consumer. Too much of the technical element has already crept into advertising literature, where it does no one much good. However, how to judge any tuner for quality operation is not a question the authors can answer very easily, either. The tuners pictured in this book have been laboratory tested and were found to be honestly represented within their price ranges.

THE INSTALLATION OF THE HIGH-FIDELITY TUNER: While a tuner is not a power-producing device, it has a considerable number of heated vacuum tubes, along with a power rectifier-and-transformer circuit. All these produce heat which, if not dissipated, will cause a noticeable shortening of the useful life of the tuner. No special placement precautions need be taken for the average tuner unless it has its own power amplifier circuit on the same chassis. It must, of course, be so situated that good natural ventilation is obtained. It is not wise to stack two units together on one shelf unless some sort of forced ventilation can be accomplished; otherwise one unit will tend to overheat the

Right: Sherwood FM tuner underchassis. Below: view of cascade tuner

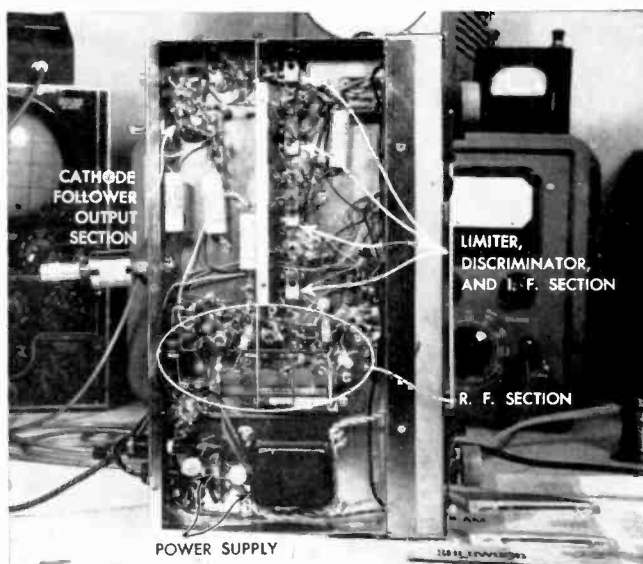
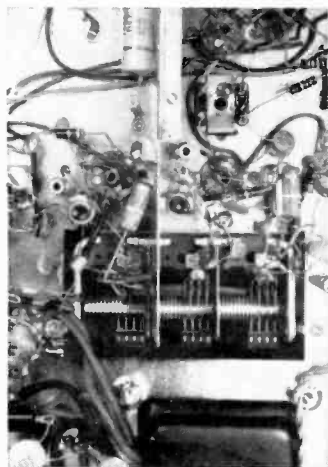

Equipment for evaluation furnished by Sherwood Electronics, Inc.

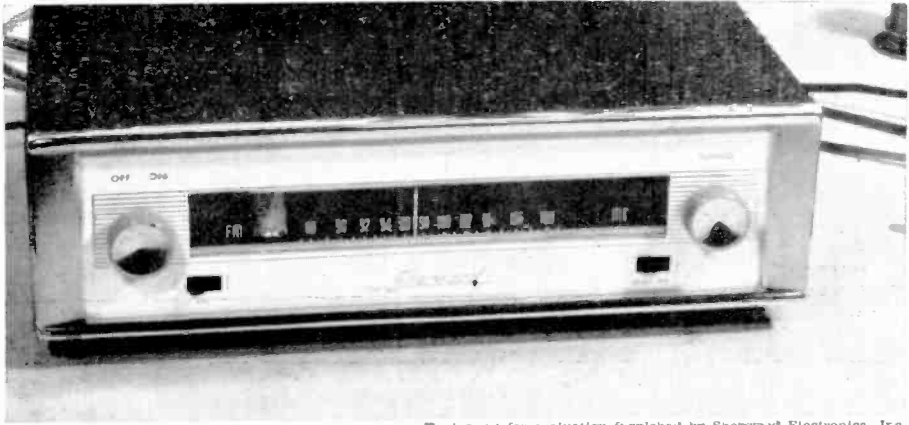

Equipment for evaluation furnished by Sherwood Electronics, Inc.
 Sherwood FM tuner after undergoing the extensive tests carried out on all equipment depicted

other, effectively shortening the operating life of both. The tuner should be placed where it is accessible to an operator.

FM tuners require external antennas. In areas where almost everyone has a TV antenna, it is possible to purchase a coupler that allows two or more sets to operate from the same antenna. The conventional all-channel antenna will cover FM channels quite nicely. In remote areas away from strong FM signals special antennas can be installed to receive maximum signal levels. In major metropolitan areas, FM signal strength is sufficient that signals from the larger stations may be received by use of a dipole antenna constructed from 300-ohm television feed-in line.

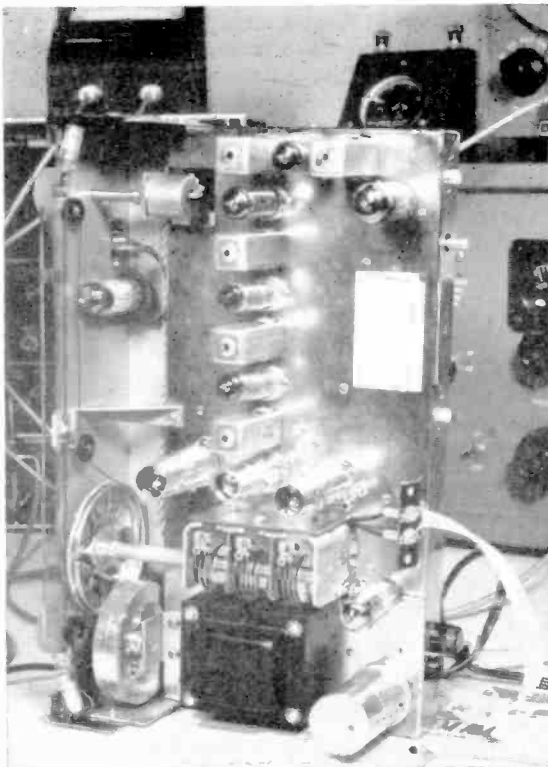

Left: Top view of the Sherwood FM tuner. Below: Scott FM tuner under test

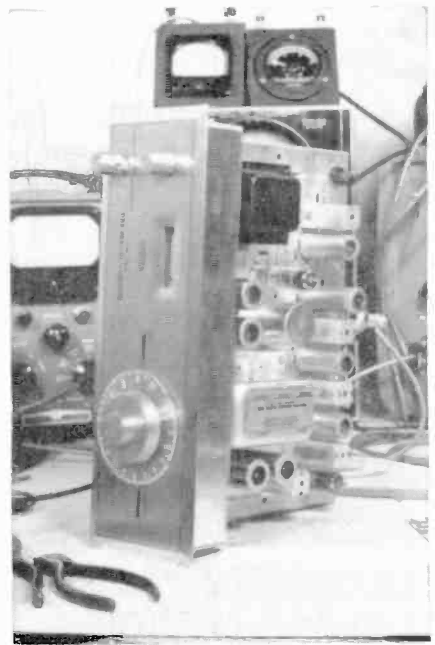

Equipment for evaluation furnished by H. H. Scott Corp.

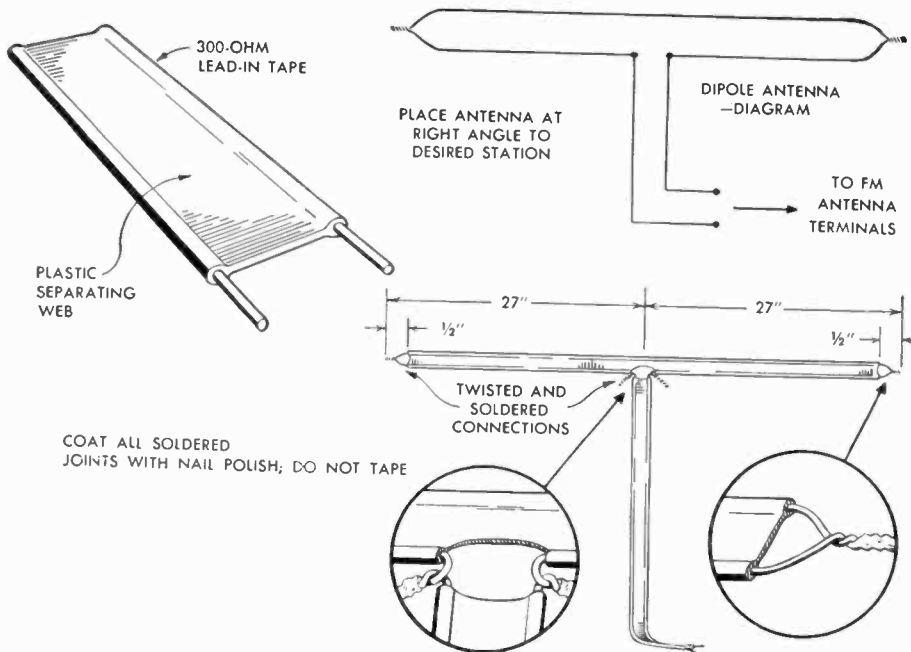

The construction of a temporary FM dipole antenna

THE HIGH-FIDELITY TUNER KIT: One of the more difficult kits to build, a tuner presents a real challenge to the novice. The operation of any tuner depends upon tuned circuits composed of inductances and capacitances. Often, the position of a single wire lead in relationship to the metal chassis can alter the tuning of the circuit. Other parts relationships exist which cannot always be planned for in the construction of any kit. Pre-tuning is not always practical in the case of such parts as IF transformers, trimming and padding condensers, etc. Relative values of these parts may change after the parts have been installed in the circuit. However, the printed or etched circuit boards used in the better tuner kits eliminate, as much as possible, the necessity for care in placement of internal wiring. If instructions are followed to the letter,

Printed-circuit wiring board has numbered holes for connections, calls for little experience



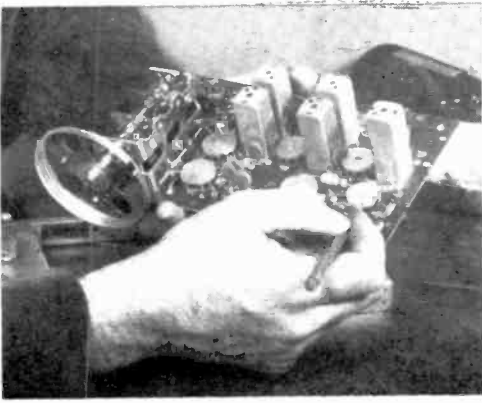

Above: Parts mounted on printed-circuit board should be checked before connections are made.
Right: Underside of printed circuit board used in Allied tuner kit



chances are that extensive retuning will not be necessary. Care should be taken by the builder not to adjust or tune any components without first having read the manufacturer's suggestions. Since correct and complete tuning is a job for laboratory instruments, especially where FM circuits are concerned, it is wiser not to depend upon tuning by ear. A competent serviceman should be called in, or the kit should be returned to the manufacturer.

THE STEREOPHONIC AM-FM TUNER: Stereophonic simulcasting on AM and FM radio has brought some of the tuner manufacturers to market with receivers equipped to receive two signals simultaneously and separately. In reality, these units are two separate receivers on one chassis; each can be

Top view of Allied Radio tuner kit using printed-circuit board with all components wired in place

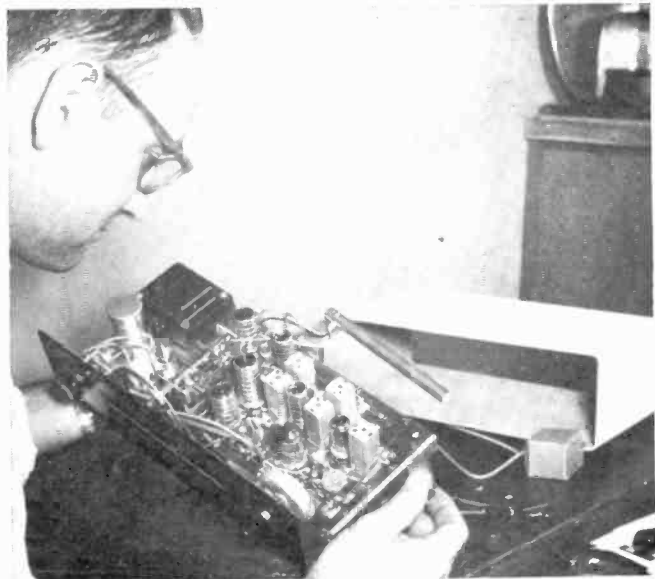

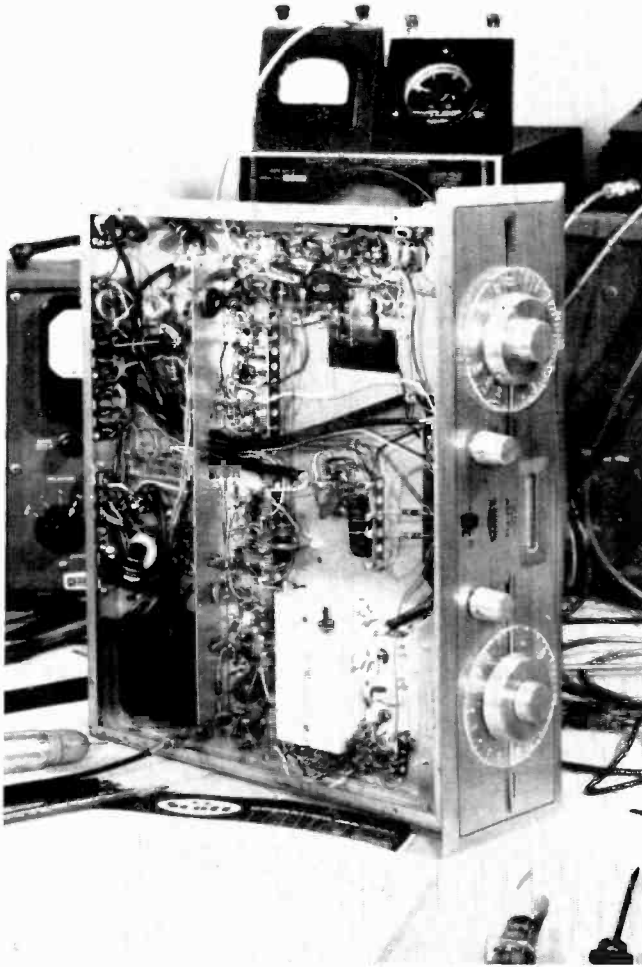

Above: Stereophonic AM-FM tuner by H. H. Scott features independent tuning controls. Left: An underchassis view of the Scott stereophonic tuner

Equipment for evaluation furnished by H. H. Scott

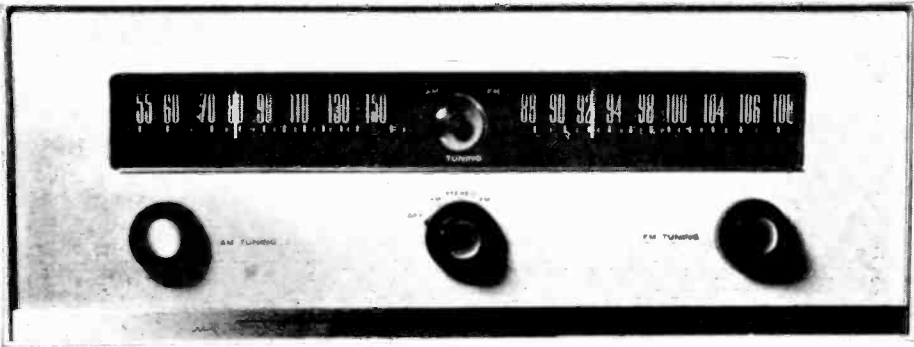

Stereophonic AM-FM tuner with dual tuning controls by Madison-Fielding

tuned independently of the other. The outputs can be sent to separate amplifiers for the two halves of a stereo broadcast. A switching arrangement for sending the same AM or FM program to both amplifiers is usually incorporated.

THE MULTIPLEX FM TUNER: One unique feature of FM broadcasting is the possibility of multiple signal transmission. In the case of multiplexing, two or more signals can be sent out on the same carrier frequency using the natural sidebands which occur as part of FM. An FM tuner designed to receive this type of broadcast is essentially two receivers on one chassis, with either individual or coupled tuning. This system seems the most likely to succeed as a means for multi-channel stereophonic broadcasting, since it involves only relatively minor changes at the transmitter level. The receiver has a conventional FM circuit with an additional special circuit for each sideband program to be received at the same time.

In the communications field, multiplexing already exists as an important feature of FM. In military communications, multiplex provides a number of channels with the same antenna and transmitter. In civilian radio, an FM station may employ its major carrier for broadcast programming and its multiplex for additional income through some form of police or taxi radio service.

MAINTENANCE OF THE HIGH FIDELITY TUNER: Little preventive

Right: Fisher tuner has jack for later addition of Multiplex unit. Below: Separate tuning sections on Madison-Fielding receiver

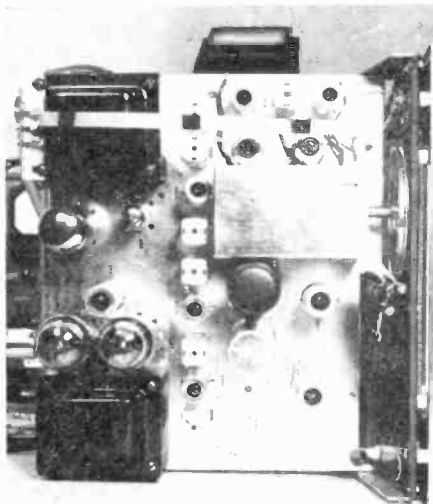
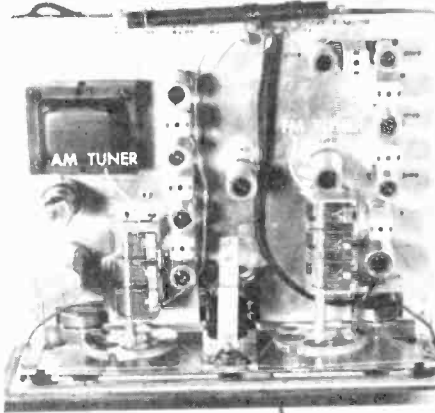

Equipment for evaluation furnished by Fisher Radio Corp.

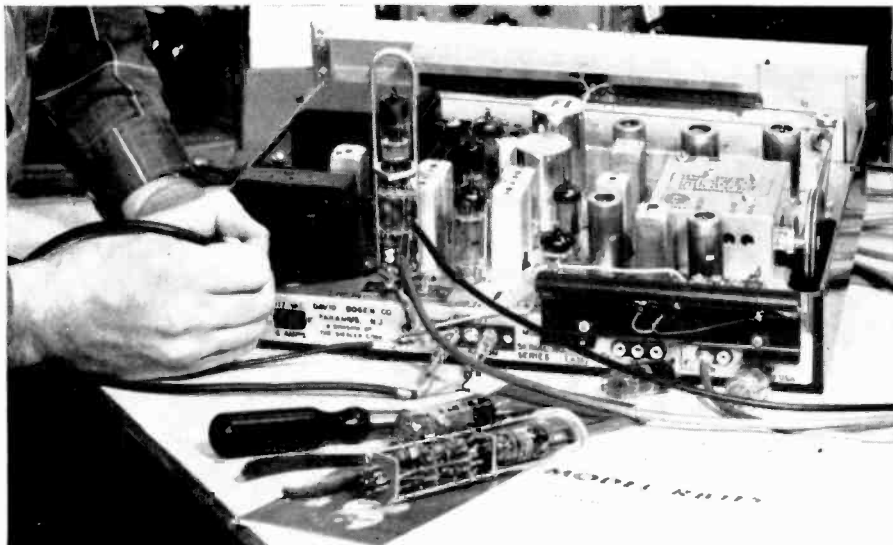

Engineer checks output stage of Bogen RB 115 AM-FM tuner-amplifier. Similar tests were performed on all equipment included here

maintenance is needed for a modern high fidelity tuner, except for dusting the variable tuning condensers with a small camel's-hair brush to keep dust from forming between the rotating plates. Apart from tube replacement, corrective maintenance on either AM or FM tuners is a job for a skilled technician. Present-day vacuum tubes are carefully designed to last about 1000 hours, but not much more. In some equipment, either by design or by accident, tubes are driven at excessive plate voltages; this tends to further shorten the life of a tube. If adequate ventilation is not provided, the life of a vacuum tube can be measurably shortened through overheating.

In operation, vacuum tubes begin to lose their ability to emit electrons from the cathode; as this occurs, the performance of the tube suffers. Low emission in a power rectifier could cause low operating voltages throughout a system, and thus allow more distortion to creep into the final sound. Low emission in the power amplifier tubes could cause additional distortion by changes in the operating characteristics of the tubes at saturation level. In a tuner, low emission can cause changes in operating sensitivity over a wide range. Noise in tubes due to loose elements can be very disturbing. It may produce a variety of noises, from the familiar microphonic noises to sizzling sounds. Replacement is the only cure, but often several tubes may have to be tried before the trouble is found. Though a certain tube may be used in one circuit, it may not work at all well in another circuit. When removing tubes for testing, mark each one and replace it in its own socket. Do not interchange tubes of the same number; often a weakened tube in one circuit may not be as important to the operation of the tuner as it might be in another place. **DO NOT ATTEMPT TO REPAIR OR RETUNE YOUR OWN TUNER UNLESS YOU HAVE BOTH THE TEST EQUIPMENT AND THE KNOWLEDGE TO USE IT.**

Learn Radio-Television

— Servicing or Communications

by Practicing at Home

in Spare Time

N. R. I. SENDS kits with which you practice building circuits common to Radio and TV sets. You LEARN-BY-DOING to locate Radio-TV troubles. As part of N. R. I. Servicing Course, you build Vacuum Tube Voltmeter and AC-DC receiver. Use VTVMs to conduct experiments. Earn extra money fixing sets in spare time.

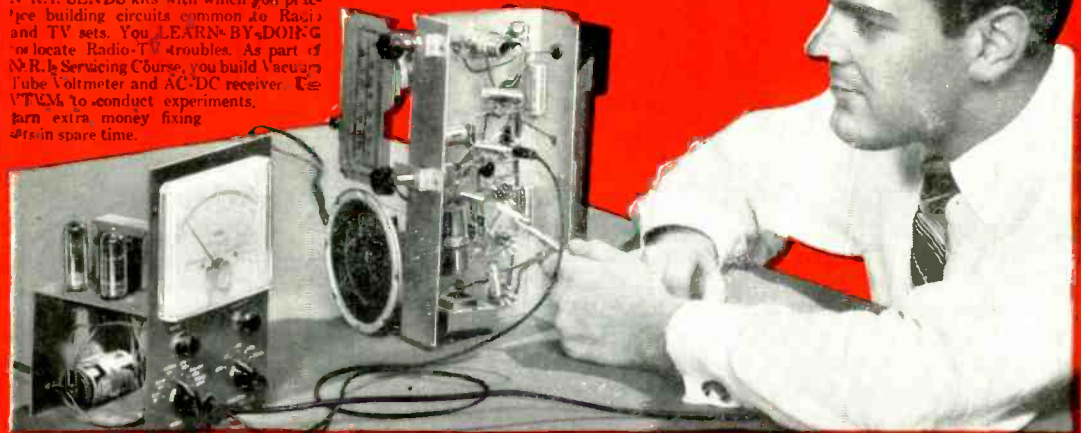

RADIO-TV BROADCASTING (see above) offers important positions as Operators and Technicians. RADIO-TV SERVICING Technicians are needed in every community. Their services are respected, their skill appreciated.



Fast Growing Field Offers You Good Pay, Success, Bright Future



J. L. SMITH
founder

Bigger, than ever and still growing fast. That's why Radio-TV has special appeal to ambitious men not satisfied with their job and earnings. More than 4,000 Radio and TV stations. More than 150 million home and auto Radios, 40 million TV sets. Color TV promises added opportunities. For the

trained man, there are good jobs, bright futures in Radio-TV Servicing or Broadcasting. Training PLUS opportunity is the ideal combination for success. So plan now to get into Radio-TV. The technical man is looked up to. He does important work, gets good pay for it. Radio-Television offers that kind of work. NRI can supply training quickly, without expense of going away to school. Keep your job while training. You learn at home in your spare time. NRI is the OLDEST and LARGEST home study Radio-TV school. Its methods have proved successful for more than 40 years.

Added Income Soon - \$10, \$15 a Week in Spare Time

Soon after enrolling, many NRI students start to earn \$10, \$15 a week in spare time fixing sets. Some pay for their training and enjoy extra luxuries this way. Some are able enough to start their own Radio-TV shop. NRI training is practical—gets quick results. Easy to understand, well illustrated lessons teach you basic principles. And you LEARN-BY-DOING by practicing with kits of equipment which "bring to life" things you

Find Out What NRI OFFERS

NRI has trained thousands for successful careers in Radio-TV. Study fast or slow, as you like. Diploma when you graduate. Coupon now. Paste it on a postcard or manila envelope. ACTUAL LESSON FREE. Also a 64-page catalog that shows opportunities, shows equipment you get. Cost of NRI courses low. Easy terms. NATIONAL RADIO INSTITUTE, Dept. 8JA4, Washington 16, D.C.

N.R.I. TRAINED THESE MEN FOR SUCCESS



"I was repairing Radios by 10th lesson. Now have good TV job." M. R. LINDEMUTH, Fort Wayne, Ind.



"Doing spare time repairs on Radio and TV. Soon servicing full time." CLYDE HIGGINS, Waltham, Mass.

"I had a successful Radio repair shop. Now I'm Engineer for WHPE." V. W. WORKMAN, High Point, N. C.



"There are a number of NRI graduates here. I can thank NRI for this job." JACK WAGNER, Lexington, N. C.



VETERANS Approved Under G. I. Bills

SEND FOR BOTH FREE

National Radio Institute

Dept. 8JA4, Washington 16, D.C.

Mail me Sample Lesson and 64-Page Catalog FREE. (No salesman will call. Please write plainly.)

Name _____ Age _____

Address _____

City _____ Zone _____ State _____

Accredited Member National Home Study Council

The ABC's of SERVICING

Job and Career Opportunities for RADIO-TV TECHNICIANS

7

TAPE RECORDING

TECHNICAL ASPECTS OF MAGNETIC RECORDING: Magnetic recording depends upon the fact that the magnetic characteristics of materials can be varied. The two most important materials in magnetic recording are the metal from which the laminations in recording head structures are made and the metallic oxides used on recording tape. The most important characteristic of these magnetic materials used in recording is coercivity. Coercivity is the force of resistance of any material, once magnetized, to changes in its magnetic state. The metal used in head structures should be capable of being magnetically changed thousands of times a second without much trouble. The metallic oxide used on tape should, once magnetized, resist firmly any effort to demagnetize it without its being sent through the recorder mechanism again. The head is said to have "low coercivity," and the tape "high coercivity."

The small oxide particles on tape can be influenced by magnetic force and can become magnetized according to the magnitude of such force. In magnetic recording the tape, bearing millions of particles, must pass the head structure of a tape recorder at a constant speed. As this process occurs, different sets of magnetic particles come under the changing magnetic influence of the head structure, and recording takes place. Since no physical change

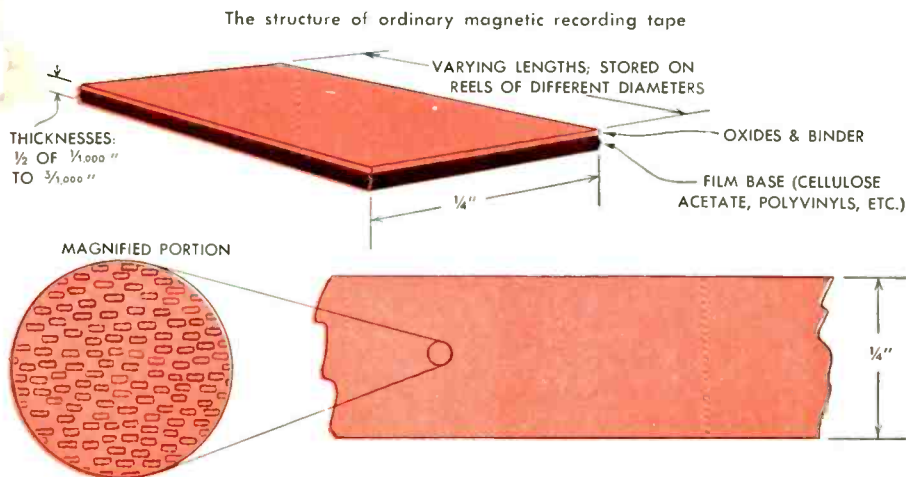

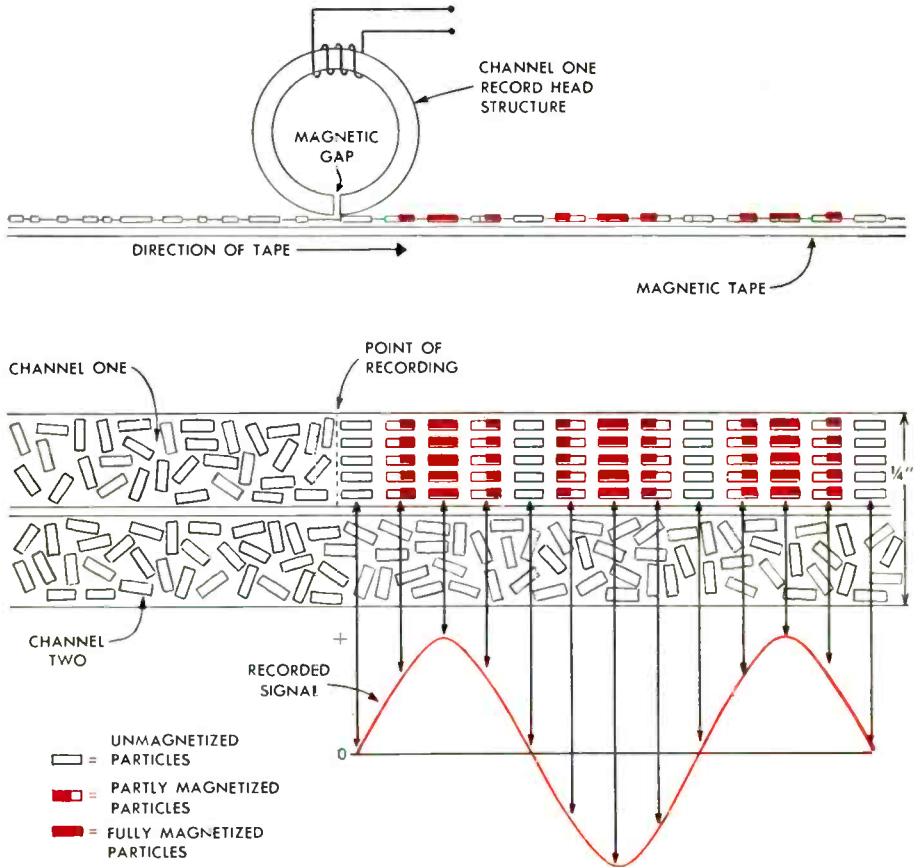

The effect of a recording signal on the magnetizable tape particles

takes place on the tape, the resultant recording is constituted in the changing amount of magnetism at any one point on the tape. More simply, for a loud recorded sound the magnetism on the tape would be heavy in comparison with the magnetism for a soft sound.

THE TAPE TRANSPORT MECHANISM: The major job of a tape transport system is to get tape off the supply reel, past the head structure at a very even speed, and then wound on the take-up reel at the other side. Variation in tape speed or tension will produce audible changes in the sound or music being played from the tape. "Flutter" and "wow" are the terms used to designate such variations. Complicated instrumentation is necessary to register the amounts of flutter and wow in a properly working tape device. Less expensive tape machines employ cheap motors, which by their inherent unsmoothness of operation contribute to the ultimate inconstancy of operation of the whole machine. As motor quality is raised and as manufacturers make more use of smooth-operating hysteresis synchronous motors, the over-all quality of tape recorders will rise.

As tape from the supply reel is pulled into the head structure of a machine, it first meets the erase head. The function of the erase head is to remove by demagnetization any audible signals that might be on the tape. It accomplishes this by means of a very small high-frequency signal. As the tape passes this head, the magnetic particles are remagnetized according to the strength and character of the inaudible a.c. erase signal. For all intents and purposes, the tape then has no signal on it, and is ready to receive the recording signal. The

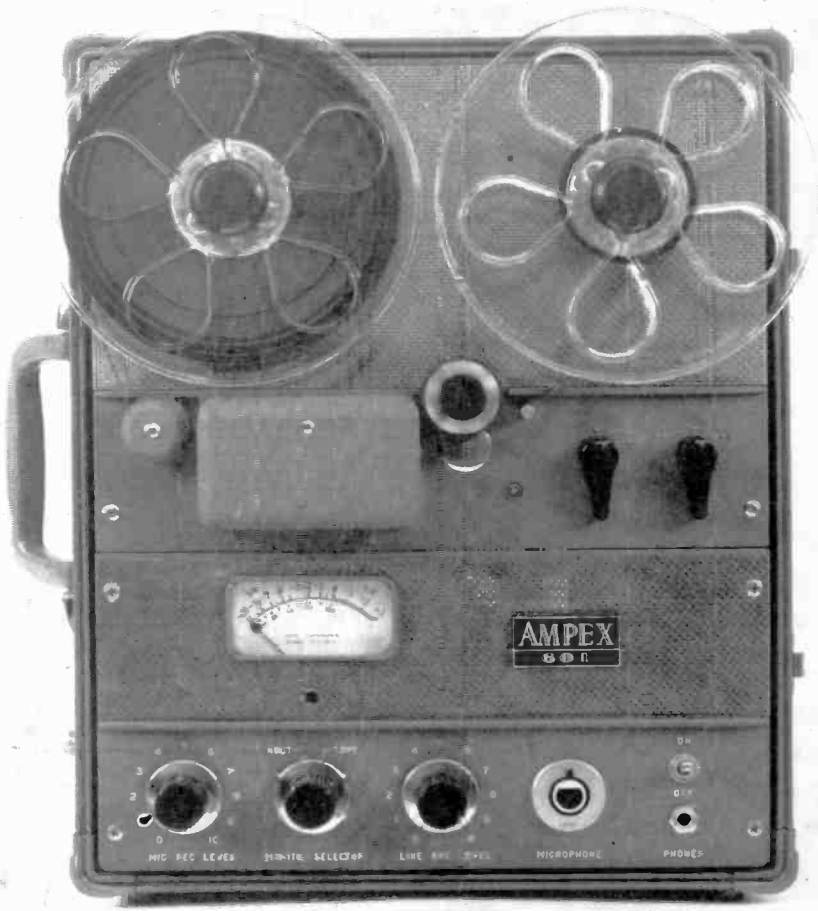

Above: Ampex 601 monaural tape recorder. Below: Ampex "A" series tape deck with cover removed. Note erase, record, and in-line stereophonic playback heads



latter is arranged magnetically upon the tape by the next head in the series, the record head. Because of the magnetic nature of the recording material on the tape, a preconditioning signal called *bias* must be applied to the tape at the same time as the recording signal. The bias signal is produced in an electronic circuit of the recorder; it is taken from the same vacuum-tube oscillator which produces the erase signal. Its essential effect on the signal being recorded on the tape is in establishing linearity where it would not otherwise exist. As has been mentioned before, the essential feature of any audio amplifier is that it simply amplifies the audio signal without otherwise changing it. This same feature of linearity must also be a part of the recording amplifier in a magnetic recorder to ensure undistorted output.

The audio signal provided by a microphone and a recording amplifier has now been magnetically impressed on the recording tape. In most of the better-quality tape recorders a separate playback head is provided for monitoring the signal on the tape during recording and, of course, for later playback service. This head, similar to the recording head in structure but with a finer gap in the pole piece, is influenced by the magnetic energy on the tape. It produces a small signal voltage in an associated playback head circuit and amplifier, later to be fed into the power amplifier and speaker system.

Because of the fact that the erase current and record bias are on only during recording, it is possible to use a single head structure for erase and record or, alternately, playback. The head has two gaps separated by a short distance; the first gap provides the erase feature and the second is for record or playback. During the recording cycle the same signal is supplied to the erase winding and bias coil on the head structure. The recording signal is fed to the record winding, energizing the second gap. It is not possible to monitor the signal on the tape during recording. In playback, no signal is supplied to either the erase or bias coils, and the magnetic impulses on the tape produce a small signal voltage in what was formerly used as the record coil, now operating as the playback coil. Used in most non-professional machines, this type of head structure provides an incomplete but adequate coverage of the audible frequency range.

Four-channel stereophonic record-playback head with two pole pieces

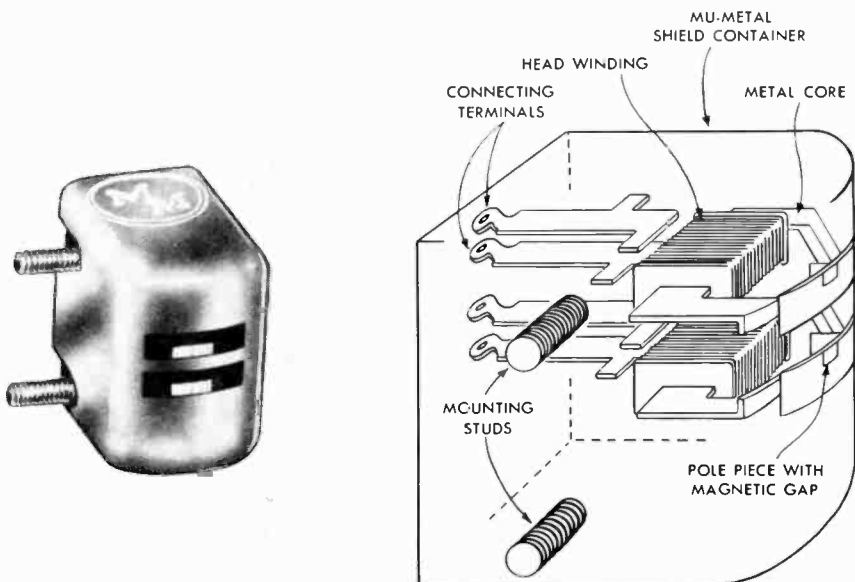

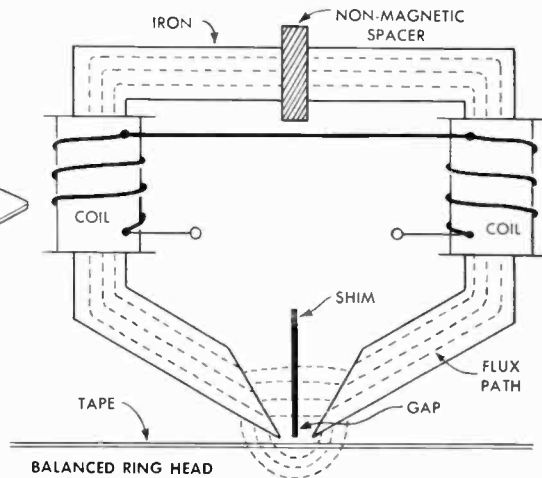
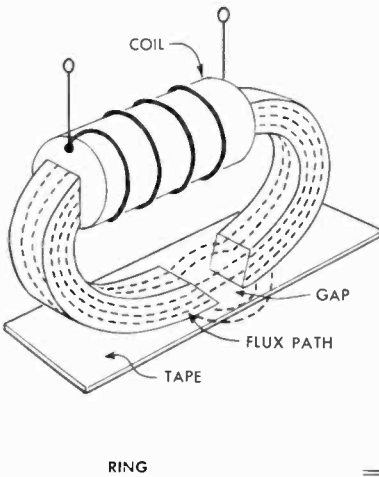
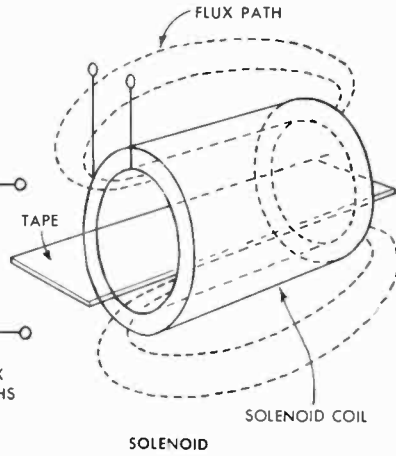
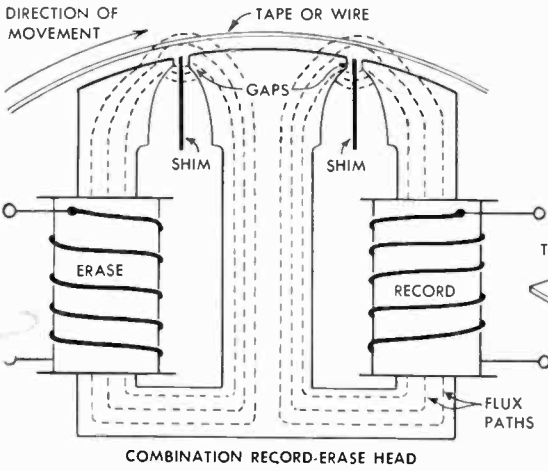
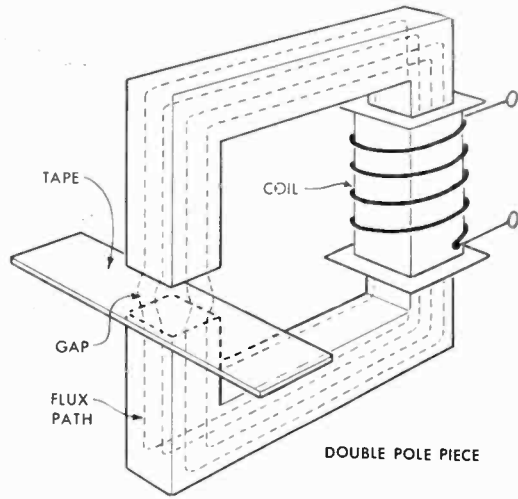
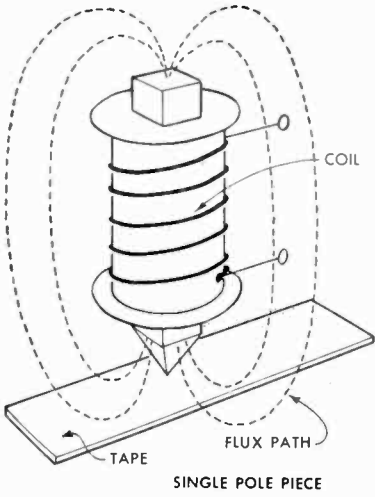

Opposite page: Different types of tape-recorder heads. Right: Experimental tape magazine unit incorporated into a stereophonic radio-phonotape console by Ampex Audio



STEREOPHONIC RECORD/PLAYBACK HEAD STRUCTURES: One of the problems that first beset stereophonic recording and playback for home sets was the lack of good quality stacked, or "in-line," heads. It was possible to combine two tape channels in one head, but the cost was more than the cost of a complete home system. Heads of this quality were reserved for the professional tape machines. Even those who called their machines professional often used poor heads.

Due to the problem of cross talk (influence between two heads in one structure), stereophonic sound was first recorded and played back using two separate heads some distance apart, called "staggered" heads. The signal on the top channel was magnetically isolated by distance from the channel on the bottom track, but splicing and editing were almost impossible. However, it

Block diagram of a typical monaural home recorder with stereophonic playback

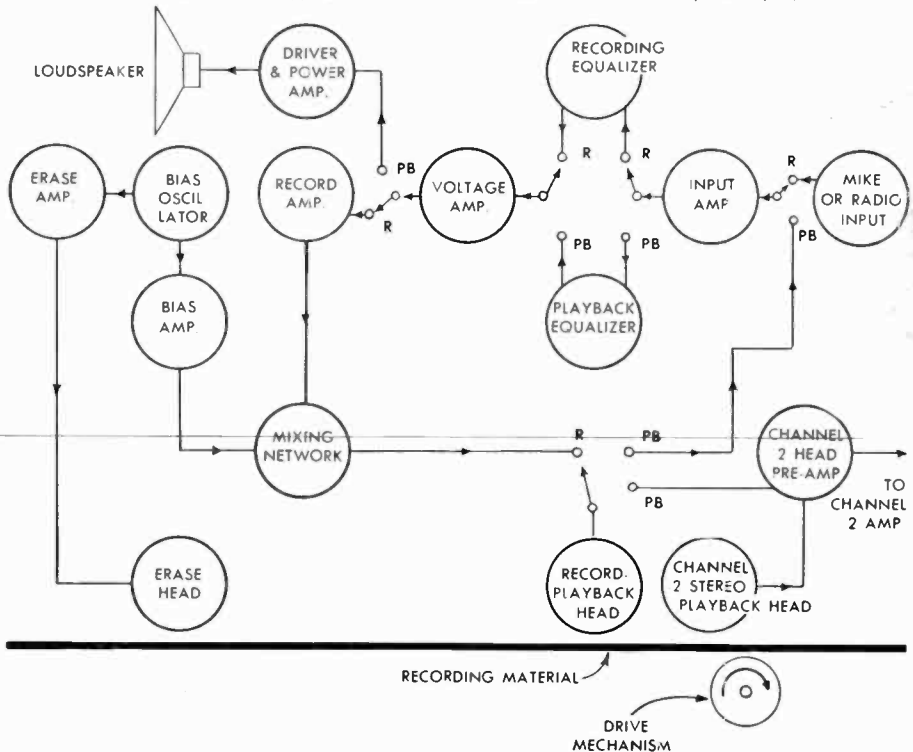

was cheaper for manufacturers to install a second head in their machines to provide stereophonic sound playback.

As inexpensive stacked, or in-line, heads became available all manufacturers switched to them, and frequently supplied kits for the conversion of older sets. Solving the problem of inductive influence between the coils in each stacked-head section has made it possible to have four channels on one 1/4-inch tape. By the use of certain combinations of these tracks it is possible to double the amount of stereophonic material that can be recorded on any tape. This step makes tape magazines practical in the pre-recorded tape industry. A complete program can be recorded on tape and put into a magazine either in an endless loop or so that as the tape comes to the end of one pair of channels another set of channels is switched into operation as the tape reverses direction. No threading of reels or manipulating of the machine is necessary to play a tape. The convenience of discs is not quite matched, but the quality of tape will usually be better.

ASSOCIATED ELECTRONIC COMPONENTS: We have discussed the transport systems and the head structures of tape recorders. Associated with these two important elements are the record and playback amplifiers and the bias oscillator circuit. In a two-channel tape machine designed for both stereophonic recording and playback, it is necessary to duplicate both the record and the playback amplifiers, one set for each channel. The bias-oscillator circuit can be so arranged as to supply both recording circuits with erase and record bias.

The function of the record amplifier is to take a signal from a microphone or other external signal device and amplify it sufficiently to drive the recording head structure. This amplifier has essentially the same job as any audio amplifier. The differences are mainly of a technical nature involving equalization within the amplifier circuit. The unique characteristics of the magnetic tape call for special care to get the maximum undistorted signal output so that background noise caused by the tape and the electronic circuitry is at a minimum. The relationship between background noise and recorded signal is called the "signal-to-noise ratio," which must be maintained at a maximum level. It is not possible to cause a constant magnetic influence on the tape for a constant input current over the audio range. Distortion does not remain constant for all ranges of reproduction. For instance, a given signal strength in the low range will have more distortion than the same signal strength at some middle frequency. In the high end of the range additional distortion occurs, due to the beating of the signal with the bias frequency. Limitations imposed by the head structure add to the importance of limiting the amount of recording current at both low and high ends of the audio response curve.

This is accomplished within the amplifier circuit, and is a fixed adjustment which can only be changed with laboratory instruments. Technically, this adjustment is a form of equalization, but it is called *pre-emphasis*. In this fashion, the record amplifier and the playback amplifier are bound together in their operation, since the playback amplifier must make up for the de-emphasis that takes place during recording so that a flat response in the output is obtained.

The playback amplifier receives the signal induced in the playback head by the magnetic impulses on a tape. Its job is to amplify, and, through post-emphasis, to correct for the changes made in the record amplifier. In most professional machines the output of the playback amplifier terminates in either a line output transformer or a cathode follower and from there connections can be made to any external loudspeaker and amplifier combination. In commercial home units an inexpensive power amplifier is included within the tape machine, making a self-contained unit out of the device. The advantage of this type of system lies mainly in user convenience rather than in quality audio output.



Above: Pentron stereo tape deck with record-playback amplifiers. This unit records and plays back stereophonically. Right: Rear view of the Pentron stereo tape deck showing drive mechanism. Below: Ampex 900 series universal tape recorder

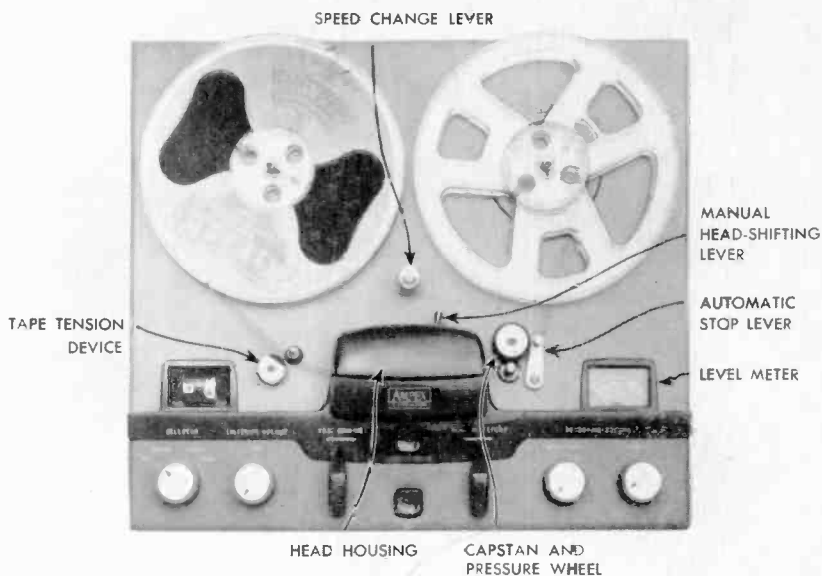
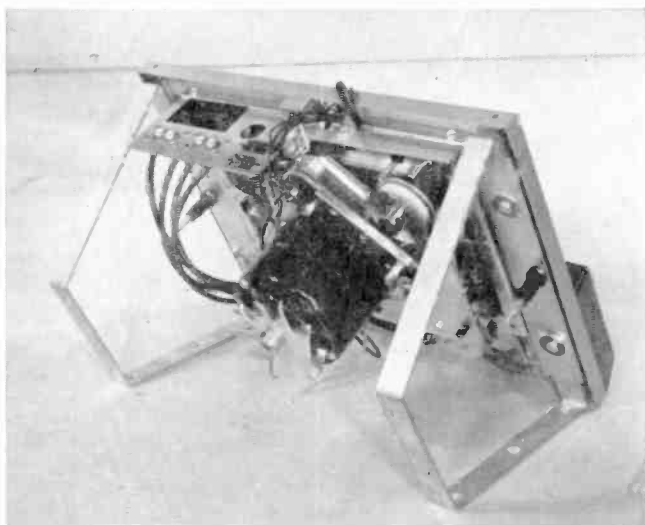

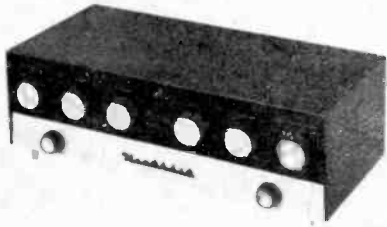
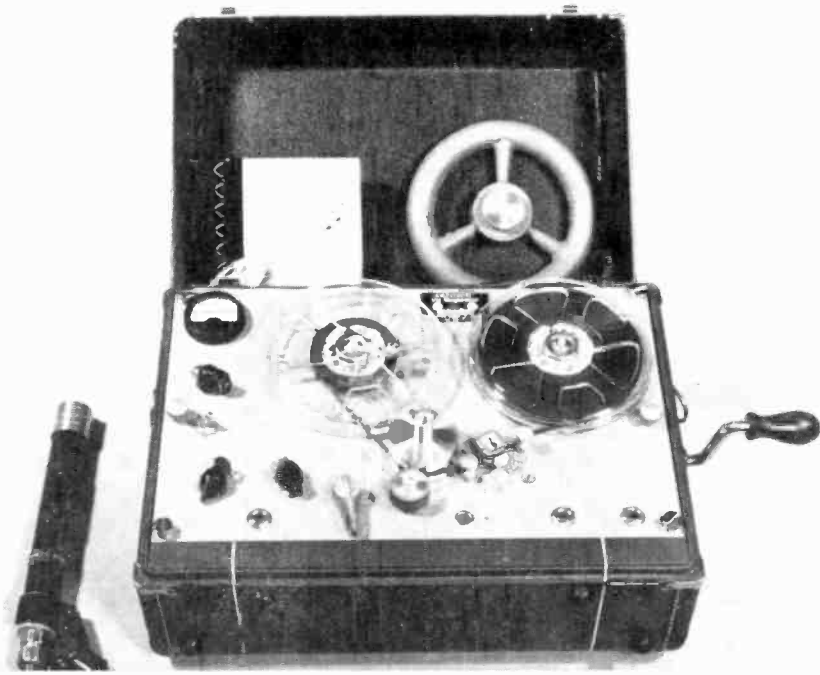

Above: A fine, fully portable tape recorder used by many professionals, the VU Magnemite, made by Amplifier Corporation of America. Left: Stereo amplifier constructed from kit. Below: Heath-kit kit-constructed recorder



TAPE RECORDERS IN KIT FORM: The outstanding tape recorder kit is sold by the Heath Company. It can be constructed by anyone with a minimum of technical knowledge. Its electronic and mechanical elements have been so well designed and explained that it is possible for any beginner to have a high-quality tape machine at minimum cost.

THE MAINTENANCE OF TAPE RECORDING EQUIPMENT: Perhaps the most difficult member of any high-fidelity system to maintain is the tape recorder. Every function of the combined electronic and mechanical units must be performed correctly in relationship to each of the others. Perhaps as important as anything is preventive maintenance. It is not with regard to the machine itself that maintenance is stressed here, but with regard to the quality of the recorded tape. As gradual deterioration takes place the quality of the tape drops, often so gradually that it is not readily apparent. Through oversight, a valuable master tape may be seriously diminished in quality or lost completely.

Preventive maintenance consists mainly in following instructions provided by the manufacturer. However, some less expensive machines do not include suggestions for lay-maintenance of any type. In these cases, the following preventive maintenance steps can be followed by the owner:

1. Any part of the machine that is touched by the oxide side of the tape should be cleaned regularly with grain or isopropyl alcohol. These parts include tape guides, capstan, capstan roller, and head surfaces. Contrary to some maintenance instructions, carbon tetrachloride should *never* be used anywhere on the tape machine because of its ability to dissolve not only plastic parts, but the resin that holds the laminated head structures together. Other types of alcohol, such as the denatured types, often have solvents such as acetone in them, which would also be bad for tape recorder parts.

2. During the process of recording and playback either the record head or the playback head may become slightly magnetized. This small amount of magnetization will add noise to the final tape, may cause part of the signal to be erased, and will generally lower the signal-to-noise ratio. Demagnetization of head structures is of prime importance. A small demagnetizing device is sold by several companies, among them Audio Devices, which manufactures Audiotape. This device will help keep up the over-all quality of your tape recordings. The head demagnetizer demagnetizes a head by influencing it with a small 60-cycle alternating current field in close contact with the head. Slowly drawing the device away from the head slowly diminishes this field, leaving the head completely demagnetized.

3. Lubrication of the tape mechanism itself is very difficult since there are specific places that must be oiled periodically, yet all other parts of the device must be absolutely free of oil or grease. Random lubrication can seriously damage or destroy rubber drive wheels, drive belts, and felt clutch pads. *Lubrication must not be attempted without specific instructions from the manufacturer.*

4. Mechanical adjustments for brake tension, tape position, correct wind and rewind features are jobs for the skilled technician and should not be attempted by the layman owner.

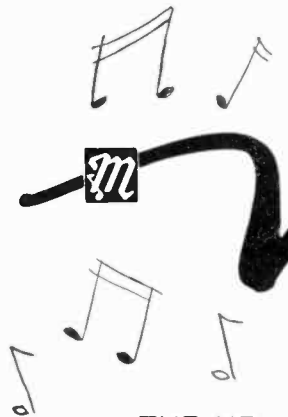

the wonderful sound of

STEREO

by

Magnecord

first and foremost
in tape recorders

THE NEW
MAGNECORDETTE

At your
hi-fi dealer
or write to

MAGNECORD
Division of Midwestern
Instruments, Inc.
41st and Sheridan,
Tulsa, Oklahoma

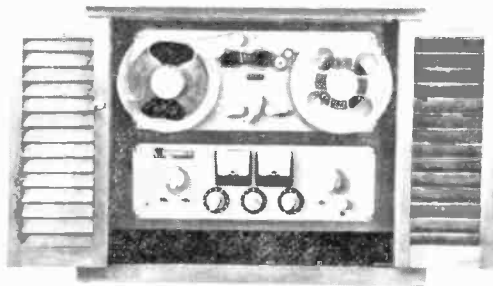

*"A Perfectly
Matched Team"*

OXFORD HIGH FIDELITY 3 SPEAKER SYSTEM

with 3 Way Crossover Network

Kit No. 3W20 includes 12" woofer; 8" midrange speaker; 3 1/2" tweeter, hardware, and 3 way - 3 element network with nominal crossover frequencies of 600 cycles and 5000 cycles; attenuation rate of approximately 6db per octave on either side of crossover frequencies and insertion loss of approximately 1cb.

Cabinets Available For Three Speaker Systems

Cabinet Model	Audiophile Net
BR - 1M Red Mahogany	\$111.00
BR - 1C Cherry	117.00
BR - 1B Blonde Oak	117.00



OXFORD COMPONENTS INC.

Subsidiary of Oxford Electric Corp.

556 WEST MONROE STREET
CHICAGO 6, ILLINOIS

EXPORT: ROBURN AGENCIES, NEW YORK CITY
IN CANADA: ATLAS RADIO CORP., LTD., TORONTO



TEMPO SERIES 3 WAY SYSTEM

Item	Model No.	Ship. Wt.	Audiophile Net
3 Way System & Crossover Network Complete, Less Cabinet	3W20	14 lbs.	\$39.00

Sold at Leading Electronics Parts Distributors
High Fidelity catalog available upon request

DO IT YOURSELF RADIO

Reg. U. S.
Pat. Off.



CIRCUITS AT HOME ONLY \$ **295**
with the New Deluxe 1959
PROGRESSIVE RADIO "EDU-KIT"

A Practical Home Radio Course

- Now Includes
- ★ TRANSMITTER
 - ★ SIGNAL TRACER
 - ★ SIGNAL INJECTOR
 - ★ CODE OSCILLATOR
 - ★ No Knowledge of Radio Necessary
 - ★ No Additional Parts or Tools Needed
 - ★ EXCELLENT BACKGROUND FOR FI-FI
 - ★ School Inquiries Invited
 - ★ Sold in 75 Countries

YOU DON'T HAVE TO SPEND HUNDREDS OF DOLLARS FOR A RADIO COURSE

The "Edu-Kit" offers you an outstanding **PRACTICAL HOME RADIO COURSE** at a rock-bottom price. Our Kit is designed to train Radio & Electronics Technicians, making use of the most modern methods of home training. You will learn radio theory, construction practice and servicing. **THIS IS A COMPLETE RADIO COURSE IN EVERY DETAIL.**

You will learn how to build radios, using regular schematics; how to wire and solder in a professional manner; how to service radios. You will work with the standard type of punched metal chassis as well as the latest development of Printed Circuit chassis.

You will learn the basic principles of radio. You will construct, study and work with RF and AF amplifiers and oscillators, detectors, rectifiers, test equipment. You will learn and practice code, using the Progressive Code Oscillator. You will learn and practice troubleshooting, using the Progressive Signal Tracer, Progressive Signal Injector, Progressive Dynamic Radio & Electronics Tester and the accompanying instructional materials.

You will receive training for the Novice, Technician and General Classes of F.C.C. Radio Amateur License. You will build 16 Receiver, Transmitter, Code Oscillator, Signal Tracer and Signal Injector circuits, and learn how to operate them. You will receive an excellent background for Television, Hi-Fi and Electronics.

The Absolutely Irresistible Knowledge of Radio or Science is required. The "Edu-Kit" is the product of many years of teaching and engineering experience. The "Edu-Kit" will provide you with a basic education in Electronics and Radio, worth many times the price of the entire Kit, price of \$22.95. The Signal Tracer alone is worth more than the price of the entire Kit.

THE KIT FOR EVERYONE

You do not need the slightest background in radio or science. Whether you are interested in Radio & Electronics because you want an interesting hobby, a well paying business or a job with a future, you will find the "Edu-Kit" a worth-while investment.

Many thousands of individuals of all ages and backgrounds have successfully used the "Edu-Kit" in more than 75 countries of the world. The "Edu-Kit" has been carefully designed, step by step, so that you cannot make a mistake. The "Edu-Kit" allows you to teach yourself at your own rate. No instructor is necessary.

PROGRESSIVE TEACHING METHOD

The Progressive Radio "Edu-Kit" is the foremost educational radio kit in the world, and is universally accepted as the standard in the field of electronics training. The "Edu-Kit" uses the modern educational principle of "Learn by Doing." Therefore you construct, learn schematics, study theory, practice double-shooting—all in a closely integrated program designed to provide an orderly, learned, thorough and interesting background in radio.

You begin by examining the various radio parts of the "Edu-Kit." You then learn the function, theory and wiring of these parts. Then you build a simple radio. With this first and trouble-shooting. Then you build a more advanced radio, learn more advanced theory and techniques. Gradually, in a progressive manner, and at your own rate, you will find yourself constructing more advanced multi-tube radio circuits, and doing work like a professional Radio Technician.

Included in the "Edu-Kit" course are sixteen Receiver, Transmitter, Code Oscillator, Signal Tracer, and Signal Injector circuits. These are not unprofessional "breadboard" experiments, but genuine radio circuits, constructed by means of professional wiring and soldering on metal chassis, plus the new method of radio construction known as "Printed Circuitry." These circuits operate on your regular 110-120 AC house current.

THE "EDU-KIT" IS COMPLETE

You will receive all parts and instructions necessary to build 16 different radio and electronics circuits, each guaranteed to operate. Our Kits contain tubes, tube sockets, variable, electrolytic, mica, ceramic and paper dielectric condensers, resistors, tie strips, coils, etc. hardware, tubing, punched metal chassis, Instruction Manuals, hook-up wire, solder, etc.

In addition, you receive Printed Circuit materials, including Printed Circuit chassis, special tube sockets, soldering iron, and a self-powered Dynamic Radio and Electronics professional electric hardware and instructions. You also receive a useful set of tools, a Tester. The "Edu-Kit" also includes Code Instructions and the Progressive Code Oscillator. You in addition to F.C.C.-type Questions and Answers for Radio Amateur License training. You will also receive lessons for servicing with the Progressive Signal Tracer and the Progressive Signal Injector, a High Fidelity Guide and a Quiz Book. You receive Membership in Radio-TV Club. Free Consultation Service. Certificate of Merit and Discount Privileges. You receive all parts, tools, instructions, etc. Everything is yours to keep.

Unconditional Money-Back Guarantee

The Progressive Radio "Edu-Kit" has been sold to many thousands of individuals, schools and organs in public and private throughout the world. It is recognized internationally as the ideal radio course.

By popular demand, the Progressive Radio "Edu-Kit" is now available in Spanish as well as English.

It is understood and agreed that should the Progressive Radio "Edu-Kit" be returned to Progressive "Edu-Kits" Inc. for any reason whatever, the purchase price will be refunded in full, without quibble or question, and without delay.

The high recognition which Progressive "Edu-Kits" Inc. has earned through its many years of service to the public is due to its unconditional insistence upon the maintenance of perfect engineering, the highest instructional standards, and 100% adherence to its Unconditional Money-Back Guarantee. As a result, we do not have a single dissatisfied customer throughout the entire world.

FREE EXTRAS

• SET OF TOOLS

- SOLDERING IRON
- ELECTRONICS TESTER
- PLIERS-CUTTERS
- ALIGNMENT TOOL
- WRENCH SET
- VALUABLE DISCOUNT CARD
- CERTIFICATE OF MERIT
- TESTER INSTRUCTION MANUAL
- HIGH FIDELITY GUIDE • QUIZZES
- TELEVISION BOOK • RADIO TROUBLE-SHOOTING BOOK
- MEMBERSHIP IN RADIO-TV CLUB
- CONSULTATION SERVICE • FCC AMATEUR LICENSE TRAINING
- PRINTED CIRCUITY

SERVICING LESSONS

You will learn trouble-shooting and servicing in a progressive manner. You will practice repairs on the sets that you construct. You will learn symptoms and causes of troubles in home, portable and car radios. You will learn how to use the professional Signal Tracer, the unique Signal Injector and the dynamic Radio & Electronics Tester. While you are learning on this practical way, you will be able to do many a repair job for your friends and neighbors, and charge fees which will far exceed the price of the "Edu-Kit." Our Consultation Service will help you with any technical problems you may have.

FROM OUR MAIL BAG

J. Statistic, of 25 Poplar Pl., Waterbury, Conn., writes "I have repaired several sets for my friends, and made money. The "Edu-Kit" did for itself. I was ready to spend \$240 for a course but I found your ad and sent for your Kit.

Ben Valerio, P. O. Box 21, Magna, Utah: "The Edu-Kits are wonderful. I am sending you the questions and also the answers for them. I have been in Radio for the last seven years, but like to work with Radio Kits, and like to build Radio Testing Equipment. I enjoyed every minute I worked with the different kits, the Signal Tracer works fine. Also like to let you know that I feel proud of becoming a member of your Radio-TV Club.

Robert L. Shuff 1534 Monroe Ave. Huntington W. Va.: "Thought I would drop you a few lines to say that I received my Edu Kit, and was really amazed that such a bargain can be had at such a low price. I have already started repairing radios and phonographs. My friends were really surprised to see me get into the swing of it so quickly. The Troubleshooting Tester that comes with the Kit is really swell, and finds the trouble, if there is any to be found."

ORDER DIRECT FROM AD—RECEIVE FREE BONUS RESISTOR AND CONDENSER KITS WORTH \$7

- Send "Edu-Kit" postpaid. I enclose full payment of \$22.95.
- Send "Edu-Kit" C.O.D. I will pay \$22.95 plus postage.
- Send me FREE additional information describing "Edu-Kit."

Name _____
Address _____

PROGRESSIVE "EDU-KITS" INC.

PROGRESSIVE BUILDING, DEPT. 501AK
1184-86 BROADWAY, HEWLETT, N. Y.

Most Highly Recommended
Enclosure in Hi-Fi

Karlson

PATENTED* ENCLOSURE

As Featured in Popular Mechanics, July '58

The Karlson Enclosure is not just a box, but a thoroughly engineered and patented musical instrument, used to perfect the bass response, high frequency dispersion, tonal definition and efficiency of all full range Hi-Fi speakers.

*Pat. No. 2,816,619

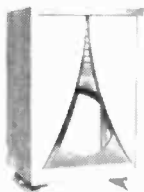

12U

KARLSON "12" For 12" Speakers
Finished Models
12CH, 12MH, 12HB, 12FR \$99.60
Unfinished—12U ready for
finish \$66.00
Kit—12K \$42.00
Size: 24 $\frac{3}{4}$ x 16 $\frac{3}{4}$ x 13 $\frac{3}{4}$
Ship. Wt.: 45 lbs.

KARLSON "8" For 8" Speakers
Finished Models
8CH, 8HB, 8FR, 8MH \$42.60
Unfinished 8U ready for finish
Same patented structure be-
hind full grill \$26.70
Kit—8K \$18.60
Recorder—Mate 8—assembled
unit as above with speaker—\$10.00 extra.
Size: 17 $\frac{1}{4}$ x 11 $\frac{3}{4}$ x 9 $\frac{3}{4}$. Ship. Wt.: 14 lbs.



8CH



15FR

KARLSON "15" For 15" Speakers
Finished Models
15CH, 15HB, 15FR, 15MH \$129.00
Unfinished—15U ready for
finish \$ 87.00
Kit—15K \$ 57.00

All Prices Audiophile Net. Subject
to Change Without Notice

Standard Karlson Finishes
HB—Honey Blonde • FR—Fruitwood •
CH—Cherry • MH—Cordovan Mahogany

Outstanding High Fidelity Experts Say—

Joseph Marshall, RADIO ELECTRONICS "It can put out an amazing bass, completely out of proportion to its size and far beyond the design capacity of the speaker used."

Donald Hoefler, HI-FI MANUAL "A truly beautiful piece of scientific reasoning, with an ultimate solution which should please even the most highly critical." "A new standard of performance."

Lothar Stern, ELECTRONICS MADE EASY "Offers the utmost in versatility, outstanding bass response and unusual styling."

write for name of nearest dealer

KARLSON ASSOCIATES, INC.
Dept. SMF9, 433 Hempstead Ave., W. Hempstead, N. Y.

for Ultimate Fidelity

SHERWOOD*



*outstanding honors bestowed, unsolicited, by most recognized testing organizations

No matter where your music comes from—FM, your own discs, or tape—you will enjoy it at its best coming from Sherwood's complete home music center... most honored of them all! Sherwood tuners for example...

First to achieve under one microvolt sensitivity for 20 db FM quieting increases station range to over 100 miles. Other important features include the new "Feather-Ray" tuning eye, automatic frequency control, fly-wheel tuning, output level control and cathode-follower output.

Model S-2000 FM-AM Tuner \$139.50 net
Model S-3000 FM (only) Tuner \$99.50 net

For complete specifications, write Dept. S-1

SHERWOOD

ELECTRONIC LABORATORIES, INC.

4300 N. California Ave., Chicago 18, Illinois

The "complete high fidelity home music center."

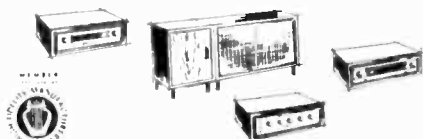

In New York, hear "Accent on Sound" with Skip Weshner, WBAI-FM, weeknights, 9 P.M. In Los Angeles, KRHM-FM, 10 P.M.

FOR ADVANCED THINKING, PRECISION ENGINEERING
AND PURE, CLEAN ACCURATE SOUND REPRODUCTION

Nothing comes close to JBL precision transducers

JBL Signature loudspeakers embody feats of audio craftsmanship never duplicated. JBL extended range speakers are made with large voice coils of edge-wound aluminum ribbon for brilliant highs, crisp lows, rich mid-range, highest efficiency. Frames are rigid castings, dural center dome is attached directly to voice coil for clean sound, free of spurious resonances.

Left to right are the virtuoso 15" Model D130 with 4" voice coil; the versatile 12" D123, 3" voice coil; the singular 12" D131, 4" voice coil; precision miniaturized 8" D208, 2" voice coil.

Then, above, there are the famed JBL low frequency drivers, the 130 series with curvilinear cone, 4" voice coil, for 1200 cps crossover; and the fabulous 150-4 series with 4" voice coil and straight-sided cone for 500 cycle crossover.

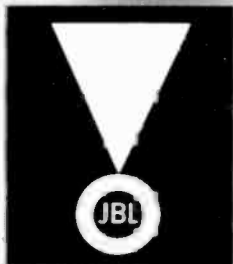

JBL acoustical enclosures are engineered for JBL transducers. Pleasingly proportioned, precision built, impeccably finished, there is one for every taste.

At top, the sensational Ranger-Paragon integrated stereophonic speaker system. Next, the mighty Hartsfield, universally acclaimed the finest of monaural speaker systems, and the extremely popular C40 Harkness back-loaded folded horn.

Below, the JBL C37—criterion for reflex enclosures, and the C39 Harlan corner reflex enclosure of provocative design and extraordinary versatility. Detailed prints for constructing the C37, C39, and C40 are available at \$3.00 a set from the factory.

Original concepts distinguish JBL high frequency units.

Greatest of all high frequency drivers is the massive, thirty-pound JBL 375. Of unsurpassed efficiency and faultless coverage, the 375 is designed for 500 cycle crossover. Used in the Hartsfield and Ranger-Paragon. Shown here with the 537-509 horn-lens combination which gives wide horizontal and narrow vertical coverage to minimize floor and ceiling reflections.

The JBL 175DLH assembly combines precision driver and complex phasing plug with machined aluminum exponential horn and the exclusive JBL acoustical lens which distributes highs evenly over a 90° solid angle.

The solid JBL 075 is made with the original ring radiator and annular exponential horn for immaculate reproduction of highs over 2500 cps.

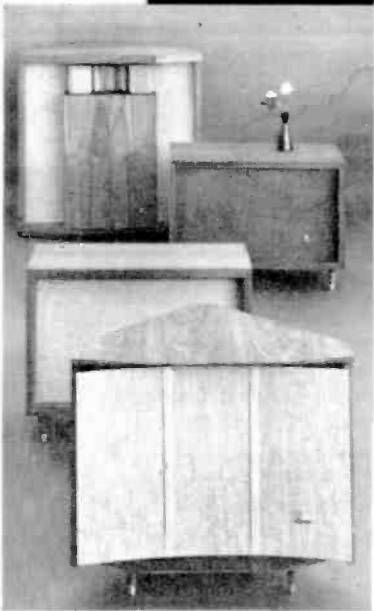

Write for free catalog, name of your JBL Dealer, and information on plans

JAMES B. LANSING SOUND, INC.

3249 Cas tas Avenue, Los Angeles 39, Calif.

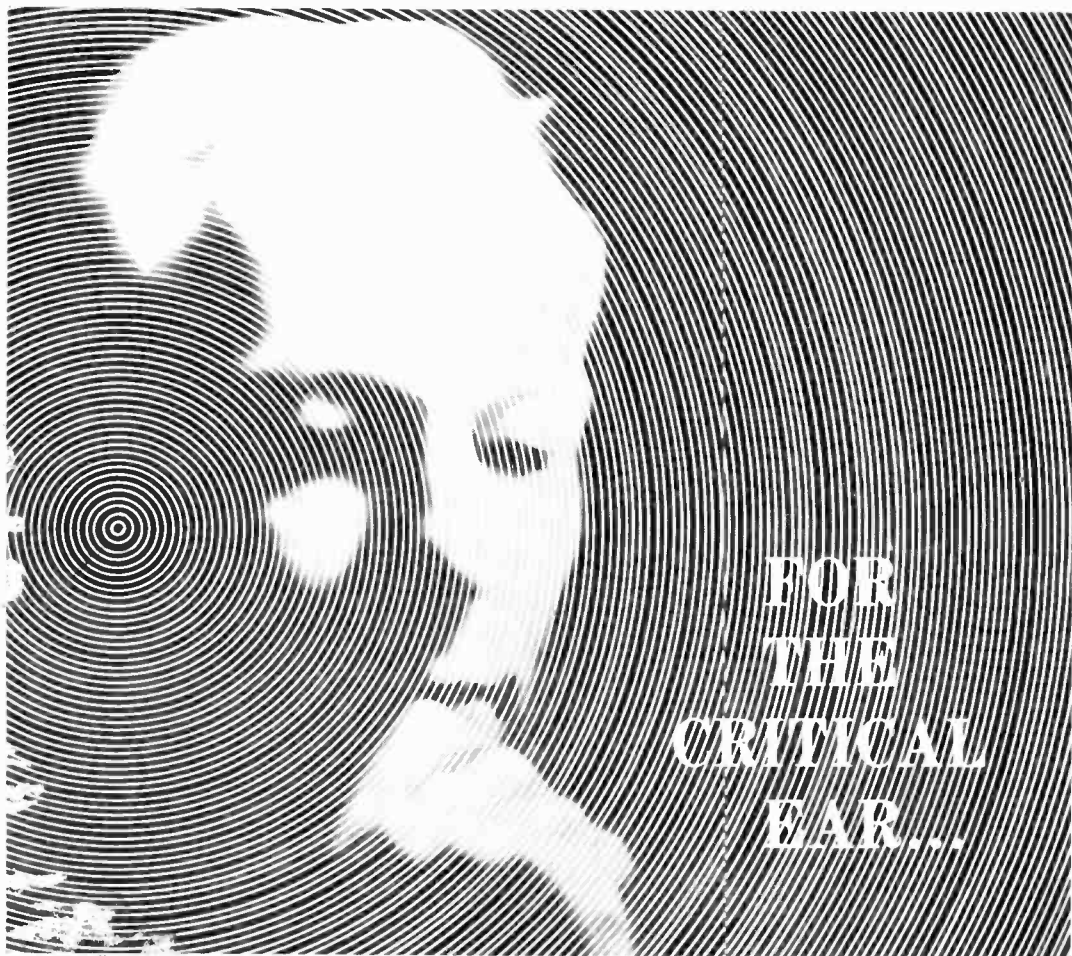

FOR
THE
CRITICAL
EAR...

the incomparable

SHURE
PROFESSIONAL

Stereo Dynetic

C A R T R I D G E

The Shure Stereo Dynetic Cartridge is designed and built specifically for the listener who appreciates accuracy and honesty of sound. It separates disc stereo sound channels with precise clarity. It is singularly smooth throughout the normally audible spectrum... and is without equal in the re-creation of clean lows, brilliant highs, and true-to-performance mid-range. Completely compatible... plays monaural* or stereo records. It is manufactured in limited quantities for the music lover—is available through responsible high fidelity consultants and dealers at \$45.00. Audiophile net, complete with 0.7 mil diamond stereo stylus.

*For those who prefer a monaural cartridge with monaural records: Shure Professional Dynetic Cartridge or Studio Dynetic Tone Arm, Studio Dynetic tracks at one gram. (If conversion to stereo is desirable later, Shure "Plan-of-Protection" guarantees 75% trade-in allowance until Dec. 31, 1959.)

Literature available: Dept. M-1

SHURE BROTHERS, INC.
222 Hartrey Street • Evanston, Illinois

SHURE ALSO MANUFACTURES HIGH-QUALITY PICKUP ARMS, MICROPHONES, AND MAGNETIC RECORDING HEADS



a note to the technically inclined:

Shure Stereo Dynetic Cartridges are individually tested and must meet or exceed the following specifications before being placed on the market:

Frequency response: 20 to 15,000 cps
Compliance: 4.0×10^{-6} centimeters per dyne
Channel separation: More than 20 db throughout the critical stereo frequency range.

Recommended Tracking Force: 3 to 6 grams.
The M3D fits all 4-lead and 3-lead stereo changers and arms. 10 second stylus replacement.

To Introduce You to the RCA VICTOR POPULAR ALBUM CLUB

THESE FIVE OR **ANY FIVE** OF THE
24 ALBUMS LISTED BELOW FOR
ONLY \$3⁹⁸ [RETAIL VALUE AS HIGH AS \$24.90]

... if you agree to buy five albums from the Club during
the next twelve months from at least 100 available

Thus exciting new plan, under the direction
of the Book-of-the-Month Club, enables you
to have on tap a variety of popular music for
family fun and happier parties... and at an
immense saving. Moreover, once and for all, it
takes bewilderment out of building such a well-
balanced collection. You pay far less for albums
this way than if you buy them haphazardly.
For example, the extraordinary introductory
offer described above can represent as much as a
40% saving in your first year of membership.
Thereafter you can save almost 33%. After
buying the five albums called for in this offer, you
will receive a free 12-inch 33 1/3 R.P.M. album,
with a nationally advertised price of at least \$3.98,
for every two albums purchased from the Club.
A wide choice of RCA Victor albums will be
described each month. One will be singled out as
the album-of-the-month. If you want it, you do
nothing; it will come to you automatically. If you
prefer one of the alternates—or nothing at all in
any month—you can make your wishes known on
a simple form always provided. You pay the
nationally advertised price—usually \$3.98, at
times \$1.98 (plus a small charge for postage
and handling).

RCA VICTOR
PERRY COMO: WE GET LETTERS



ALL ALBUMS ARE
12-INCH 33 1/3 R.P.M.
LONG-PLAYING



Belafonte

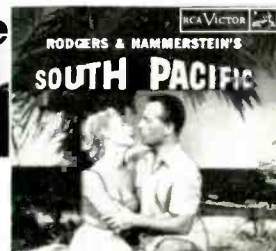

YES INDEED!
TOMMY
DORSEY
AND HIS
ORCHESTRA



Moods in Music
Music for Dining
THE MELACHRINO SPRINGS

SINGING STARS • BROADWAY MUSICALS • JAZZ
DANCE MUSIC • MOOD MUSIC • COLLECTOR'S ITEMS

**CHECK THE FIVE ALBUMS YOU WANT
DO NOT DETACH FROM THE COUPON**

- | | |
|---|--|
| <input type="checkbox"/> WE GET LETTERS.....Perry Como | <input type="checkbox"/> FAMILY ALL TOGETHER.....Boston Pops |
| <input type="checkbox"/> BELAFONTE | <input type="checkbox"/> PORGY AND BESS.....Merrill & Stevens |
| <input type="checkbox"/> FRANKIE CARLE'S SWEETHEARTS | <input type="checkbox"/> MUSIC FOR DINING.....Melachrino Orchestra |
| <input type="checkbox"/> NEW GLENN MILLER ORCH. IN HI FI | <input type="checkbox"/> BOUQUET OF BLUES.....Dinah Shore |
| <input type="checkbox"/> BRASS & PÉRCUSSION.....Morlon Gould | <input type="checkbox"/> SWEET 17.....Ames Brothers |
| <input type="checkbox"/> JAMAICA.....Original Cast | <input type="checkbox"/> LET'S CHA CHA WITH PUENTE |
| <input type="checkbox"/> STUDENT PRINCE.....Mario Lanza | <input type="checkbox"/> EYES OF LOVE.....Hugo Winterhalter |
| <input type="checkbox"/> BING WITH A BEAT.....Bing Crosby | <input type="checkbox"/> THINKING OF YOU.....Eddie Fisher |
| <input type="checkbox"/> TOWN HALL CONCERT PLUS.....Louis Armstrong | <input type="checkbox"/> MOONGLOW.....Artie Shaw |
| <input type="checkbox"/> LET'S DANCE with the THREE SUNS | <input type="checkbox"/> IN A MELLOW TONE.....Duke Ellington |
| <input type="checkbox"/> SOUTH PACIFIC.....Original Sound Track | <input type="checkbox"/> VICTORY AT SEA.....Rodgers' TV Score |
| | <input type="checkbox"/> YES INDEED!.....Tommy Dorsey |
| | <input type="checkbox"/> BLUE STARR.....Kay Starr |

THE RCA VICTOR POPULAR ALBUM CLUB P68-9
c/o Book-of-the-Month Club, Inc., 345 Hudson St., N.Y. 14, N.Y.
Please register me as a member of The RCA VICTOR Popular Album Club and
send me the five albums I have checked at left, for which I will pay \$3.98, plus a
small postage and handling charge. I agree to buy five other albums offered by the
Club within the next twelve months, for each of which I will be billed at the nationally
advertised price; usually \$3.98, at times \$4.98 (plus a small postage and
handling charge). Thereafter, I need buy only four such albums in a twelve-
month period to maintain membership. I may cancel my membership any time
after buying five albums from the Club in addition to those included in this
introductory offer. After my fifth purchase, if I continue, for every two albums I
buy I may choose a third album free.

Name _____
Address _____
City _____ Zone _____ State _____
NOTE: If you wish to enroll through an authorized RCA VICTOR dealer, fill in here:
Dealer's Name _____
Address _____

PLEASE NOTE: Send no money. A bill will be sent. Albums can be sent
only to residents of the U. S., its territories and Canada. Albums for Ca-
nadian members are made in Canada and shipped duty free from Ontario.

BIG NEWS!



A RONDINE TURNTABLE IN KIT FORM

only \$39⁹⁵

Also see the all-new improved
factory-assembled Rondines at your dealer!

REK-O-KUT

HIGH FIDELITY TURNTABLES • TURNTABLE ARMS

Engineered for the Studio • Designed for the Home



A revolutionary breakthrough in the industry! A stereo turntable kit with traditionally superior Rek-O-Kut performance! It's engineered to give Rek-O-Kut's famous silent operation, eliminating all traces of record changer rumble in stereo disc playback.

The kit contains the same exclusive, precision-machined turntable and bearing-well used on all Rondine models. Assembles easily and quickly to the deck plate. The motor installs on a specially-made mounting plate.

A minimum number of working parts go together accurately, in 30 minutes or less... reflecting the simplicity and trouble-free operation of Rek-O-Kut design. This new Rondine offers you superb quality...unmatched performance, the kind you need for better monaural reproduction...the kind you must have for stereo!

ADVANCED FEATURES OF NEW RONDINE K-33 STEREO TURNTABLE!

- Single-speed (33 $\frac{1}{3}$ Crown-Spindle Belt Drive. Custom-made endless-woven fabric belt with thickness held to $\pm .001$. Adjustment for belt tension.
- Assembly time: about 30 minutes with simple tools.
- Noise level: 47db. (NARTB standards.)*
- Motor: 4-pole induction, designed and built to Rek-O-Kut specifications.
- Built-in strobe disc: for checking speed.
- Turntable: Heavy Cast Aluminum, lathe-turned. Tapered for easy disc handling.

*National Association of Radio and Television Broadcasters specifications.

PERFECT TURNTABLE MATE...AUDAX TONEARM
the only stereo tonearm in kit form!



Assembles in just 15 minutes...no mechanical skill needed! A professional tonearm precision-engineered to highest broadcast standards. You save over 50% simply because you assemble it yourself. Ingeniously simple for foolproof operation dependable performance. Takes all stereo cartridges. 12" arm—KT-12—\$15.50. 16" arm—KT-16—\$18.50.

Rek-O-Kut Co., Inc., Dept. A, 38-19 108th St., Corona 68, N.Y.

Please send me your new 1958 Catalogs.

NAME _____

ADDRESS _____

CITY _____ ZONE _____ STATE _____