

NEW HI-FI SOUND GUIDES 20p

Introduction to Hi-Fi

1

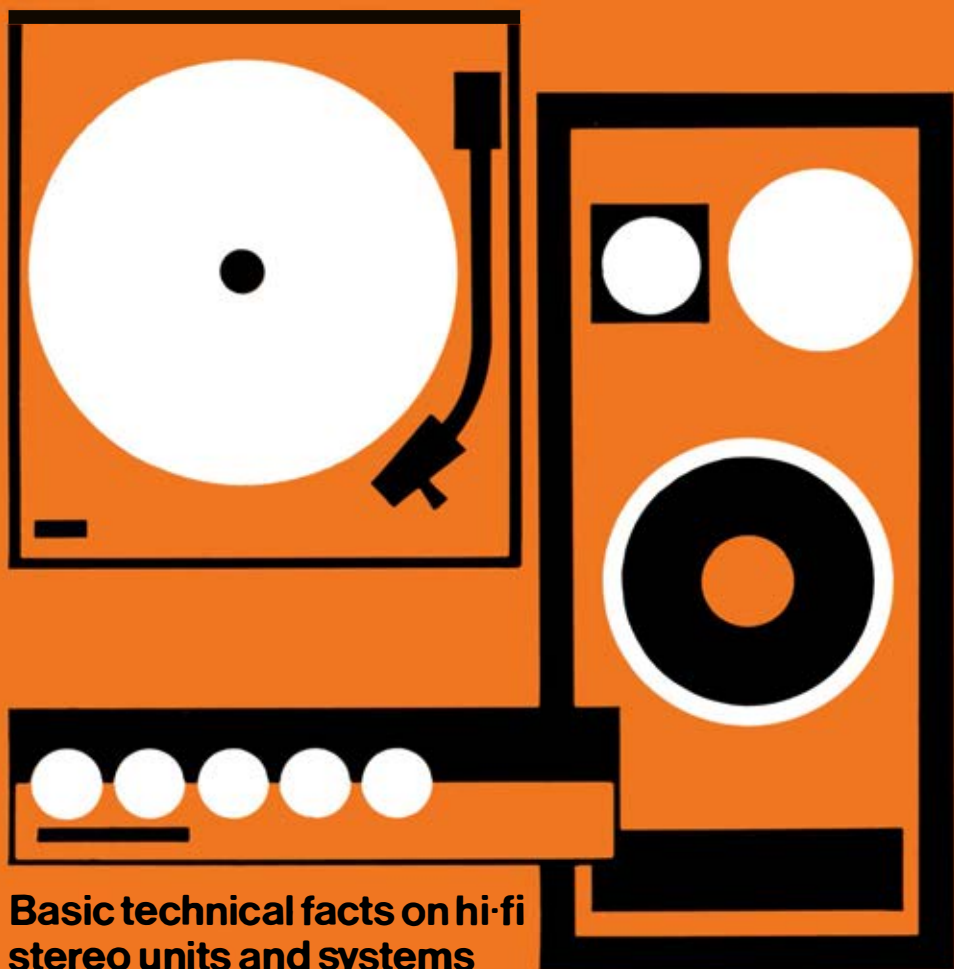

**Basic technical facts on hi-fi
stereo units and systems**

by Clement Brown editor HI-FI SOUND magazine

KÖRTING TRANSMARE

HIGH-FIDELITY SOUND
SURPASSES SEVERAL TIMES
DIN 45.500 STANDARD!!!



KÖRTING 'TRANSMARE' A500 STEREO AMPLIFIER £42.15.0

- 21 Transistors, 1 Rectifier
- 2 x 12 Watts Output
- Magnetic or Ceramic Inputs

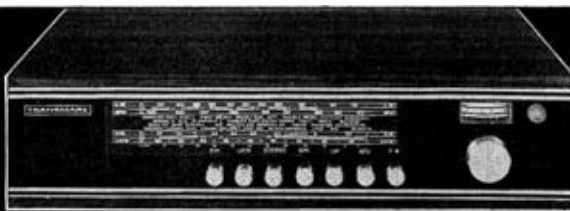
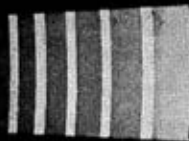

KÖRTING 'TRANSMARE' T500 STEREO TUNER £48.15.0 inc. P.T.

- 12 Transistors, 11 Diodes, 1 Rectifier
- FM with AFC, LW, MW and SW
- Including Multiplex Decoder

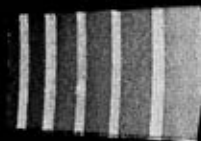

Sole UK concessionaires

EUROPA ELECTRONICS LTD.
HOWARD PLACE, STOKE-ON-TRENT

Introduction to Hi-Fi

WHAT IS HI-FI and why is its appeal so strong? How does one set about choosing equipment and ensure it is kept at peak performance? How does stereo work and what are its advantages? Will new developments affect the choice of system? Answers to such questions form the basis of these booklets. Written by Clement Brown, editor of *Hi-Fi Sound*, and closely linked with the policy of the magazine, these concise guides are of special value to the beginner but also meet the need of the more advanced amateur enthusiast for a survey of his chosen subject.

Titles to follow in this series are: All about Stereo, Hi-fi Planning and Buying, Using your Hi-fi, and Practical Hi-fi Guide.

© 1971 Haymarket Publishing Ltd,
Haymarket Publishing Ltd., Gillow House,
5 Winsley Street, London W1

The first Eagle TSA. 151 stereo amplifier that Gerry Adler got his hands on he broke

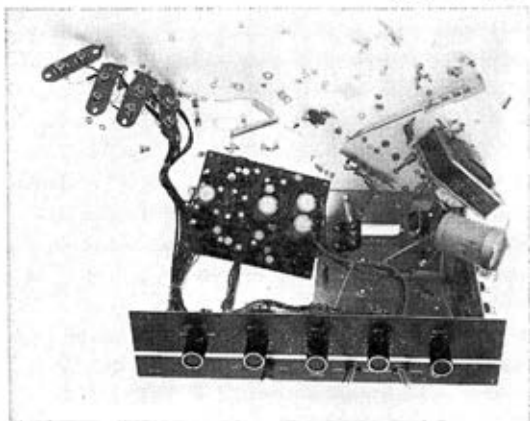

The TSA 151. The largest of the Eagle new generation Amplifiers. It uses a completely new solid-state silicon output device to provide a powerful clean 15 watts RMS per channel. It gives an incredible signal to noise ratio. In its attractive all-wood cabinet it even looks good.

And yet Gerry Adler broke it. Quite deliberately. Because Gerry Adler is like that. Just plain destructive. He'll take a piece of equipment and mistreat it. Until he breaks it. Then he'll fix it. Improve it and break it again. And again. And again.

And if it doesn't take more punishment than anything else on the market it doesn't get to carry the Eagle name.

Gerry Adler has a simple business philosophy. Build a better piece of equipment than anyone else on the market, put a good price on it, and you'll sell all you can make.

It's a great reason for buying the TSA 151 or its matching stereo tuner TST 152.

Eagle International

we don't stand still

Write or phone Precision Centre,
Heather Park Drive, Wembley, Middlesex
HAO 1SU Tel: 01-903 0144 for a copy of
our new catalogue.

CONTENTS

1	INTRODUCING HI-FI	11
2	FACTS, FIGURES AND FALLACIES	14
3	THE HI-FI WAY	20
4	PICKUPS AND TURNTABLES	23
5	AMPLIFIERS AND TUNERS	33
6	LOUDSPEAKERS	40
7	TAPE EQUIPMENT	47
8	HI-FI MANUFACTURERS	50
	USEFUL DATA	57
	SOME TECHNICAL TERMS	58
	QUESTIONS AND ANSWERS	61

Specialists in Sound

High Fidelity equipment can only safely be bought from a SPECIALIST DEALER. When buying from KEN ROSE AUDIO you get only the best equipment PLUS:—

1. *A 24 month unconditional warranty — ALL PARTS and LABOUR FREE.*
2. *FREE Loan equipment while yours is being repaired.*
3. *Hire purchase terms or Paybonds Personal Loan Scheme, NO DEPOSIT CREDIT.*
4. *Speaker comparison facilities—All outfits installed before purchase.*

ACCREDITED DEALER FOR

Quad, B & O, Sony, Tannoy, Revox, KEF and all the other quality manufacturers.

Please Note:- *We sell Hi-fi only—we do not stock “Audio” quality components.*

Complete Hi-fi outfits from about

£125.00



KEN ROSE AUDIO

283 FLEET RD, FLEET, HANTS. tel: 5053

When the most subtle tonal
qualities in the world need amplifying
and the amplification equipment
just must not obtrude
the obvious answer is

QUAD*



QUAD

for the closest approach
to the original sound

QUAD 33/303 Amplifiers
QUAD FM3 Stereo & AM3 Tuners
QUAD Electrostatic Loudspeakers

Send postcard for illustrated leaflet to Dept. HFSG
Acoustical Manufacturing Co. Ltd., Huntingdon. Tel. (0480) 2561
*QUAD is a registered trade mark.

Buying Hi-Fi can be a tricky business

So many models. Too many technicalities. Bits and pieces which you have to solder together and carefully adjust. Or complete like-it or lump-it "systems" which offer you no choice of important things like speakers and pickups. You could spend a fortune and still be disappointed.

Unless you come to MASTERSOUND

We'll give you as much help and advice as you need. In our new Showroom you'll find only the best equipment in every price range. We can arrange a demonstration without obligation in your own home (if you live within 30 miles of Muswell Hill) and when you've decided on the right combination, we'll install it, free of charge—to make sure you get optimum performance. Then we'll add a full year's guarantee covering labour as well as parts.

Sounds too good to be true? Find out for yourself.

Call in or telephone

Mastersound Electronic Services
Limited

152 Fortis Green Road, Muswell Hill, London N10 3DU.
01-444 7788 01-368 8891 (ansaphone)

A knob here a button there and sockets too!

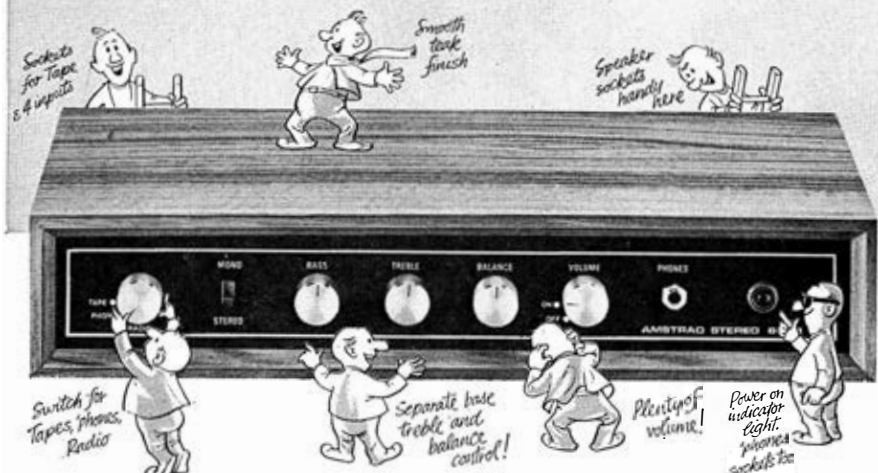

AMSTRAD STEREO 8000-only £25.95

Yes, we've done it! We have developed a stereo amplifier of outstanding performance yet at the incredible price of only £25.95. Although low priced the performance is without parallel. You'll be astounded at its performance.

The elegant low line styling with satin teak finish; black facia with silver trim and brushed aluminium controls houses some ingenious electronic circuitry and components.

SPECIFICATIONS: 7 watts per channel RMS (12 watts per channel peak music power). Frequency response 35-20,000Hz. Facilities for headphones, tape recorder, tuner and magnetic, ceramic and crystal cartridge inputs. Transistorised. Size: $16\frac{3}{4}'' \times 7'' \times 3\frac{1}{4}''$. Full manufacturers' guarantee.

Sounds great! Rush me literature on the AMSTRAD STEREO 8000 and address of my nearest Amstrad stockist.

AMSTRAD ELECTRONICS LTD.

34-35 Great Sutton Street,



London, E.C.1.

Telephone: 01-251 0241

Fill in coupon for free literature

Available at: PREMIER RADIO . HENRY'S RADIO LTD . LASKY'S RADIO LTD . COMET HI-FI DISCOUNT WAREHOUSE and most reputable Hi-Fi Dealers.



Name

Address

.....H.F.G.1

The media...

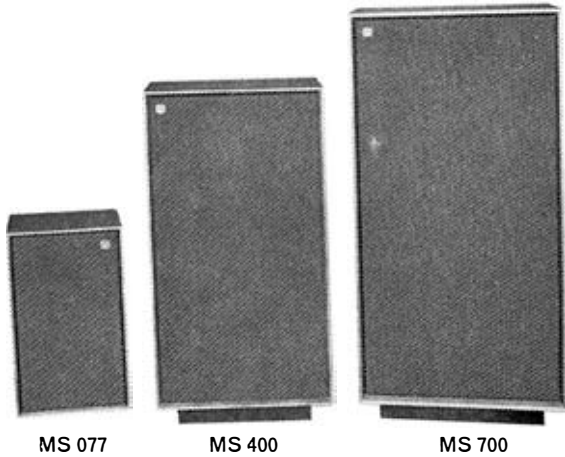

The Mordaunt-Short range of quality loudspeaker systems.

...for the utmost.

When you choose your high-fidelity audio equipment, you will be seeking not the requisite components in themselves or their respective particulars and technicalities, but those ultimate objectives, those benefits, which may be attained only through such media: enhancement of your pleasure in music . . . enjoyment and inspiration within your own home . . . enrichment of your experience of living.

To us at Mordaunt-Short, ourselves lovers of music of many kinds and manufacturers of audio products of the highest specification and performance, this is our 'raison d'être'. If your appreciation of fine sound faithfully reproduced . . . your concern for quality . . . your delight in all that is best in life . . . may be fulfilled by our endeavours, we too shall have achieved the utmost.



Mordaunt-Short Ltd

The Courtyard Heath Road
Petersfield Hampshire Tel. 0730 4761

Designers and Manufacturers of Quality Loudspeaker Systems

1 INTRODUCING HI-FI

IF YOU already enjoy music in the home and have gained some experience of the way in which a high standard of sound reproduction is achieved, you will have recognised two important things. One is that there is no internationally accepted definition of 'hi-fi'. The other is that the lack of general agreement about high fidelity neither prevents the design and manufacture of high-grade equipment nor spoils our enjoyment of the superior results obtainable today.

For the beginner, attracted to the subject and looking forward to buying a sound system, the most useful reminder is that use of the term hi-fi indicates an attempt to produce sound quality well above the average. If you accept this you will also understand that high fidelity, despite its increasing popularity, is still the interest of a minority.

The ordinary standard, represented by the stereogram, cheap record player or radio, provides basic information and entertainment. Hi-fi goes well beyond basics and leads you to consider fidelity—to make a comparison between what you hear and the live, unfettered sound. You can begin to talk about realism, impact and an honest, detailed representation of the music. Not an orchestra in the lounge, of course, but a scaled-down version, rich in detail and tonal beauty, with certain characteristics that suit it to domestic consumption.

When we come to consider these characteristics we can be far more objective, for much has been learned about them. It is the purpose of this booklet, and those that follow it, to discuss such matters. But for the moment let us complete the introduction.

How high should the fidelity be? Everyone asks the question sooner or later. To be practical, your own budget determines what you can have. Otherwise, the limit is set by the technology, and *that* advances steadily. Today's hi-fi is likely to be tomorrow's mid-fi, and we can do better—at least in some departments—than we could ten years ago.

Anyone can enjoy the results of this technology—if they can afford it. At the other extreme we find there is a lower limit down in the fringe area of economy-class products, where the sound is somewhat better than radiogram calibre and at least the more obvious hi-fi principles are applied.

It is reasonable to say that hi-fi starts where the old traditional approaches are found unsatisfactory by the listener. However, many discerning listeners would quickly become dissatisfied with the minimum standard that this implies. Really good sound systems are never cheap. Obviously, if budget audio at well under £100 could provide the desired illusion of realism and presence, only cranks would spend several times that sum.

However that may be, we can perhaps agree that hi-fi has to do with the elimination or control of factors that degrade the quality of sound reproduction. The more of these factors we can understand and influence, the better our chance of achieving good results. This matters a great deal to the man who spends the money—whether he is a music-lover lacking technical knowledge or an enthusiast for whom technical aspects provide the main interest.

How hi-fi emerged

In any field—not least in consumer or household products—better quality will usually become available if there is a positive demand for it and provided there are designers and producers able to respond to the need. As far as radio and electronics are concerned there have been steady improvements, as expected from a growing industry, and even if sound has at times seemed a poor relation of vision, it is now true that sound reproduction of great realism and refinement can be obtained.

The last 25 years have seen the most important developments—the transistor, the general use of tape recording, commercial stereophony, a national VHF/FM radio service, and the rapid refinement of components and systems associated with a fast-moving technology.

Older readers will know that the idea of better sound quickly gripped the imaginations of practical-minded enthusiasts, many of them benefitting from training in the armed services, in the years immediately following the second world war. Huge speaker boxes were constructed, elaborate valved amplifiers were painstakingly wired, tested and modified. At one stage the state of the hi-fi art seemed heavily dependent on the availability of government-surplus components. A few basic requirements for good mono sound emerged and the process of development and refinement was under way. If component supplies were limited and new designs few, enthusiasm and the determination to do better were unbounded.

Hi-fi and stereo

The average music-loving enthusiast, asked to name the most important big development, will probably choose stereo. For the benefit of the beginner the role of stereo should perhaps be briefly explained. Hi-fi started with single-channel recording, transmission and reproduction—mono, short for monophonic—and standards in mono hi-fi were being raised by the pioneers long before stereo became commercially practicable.

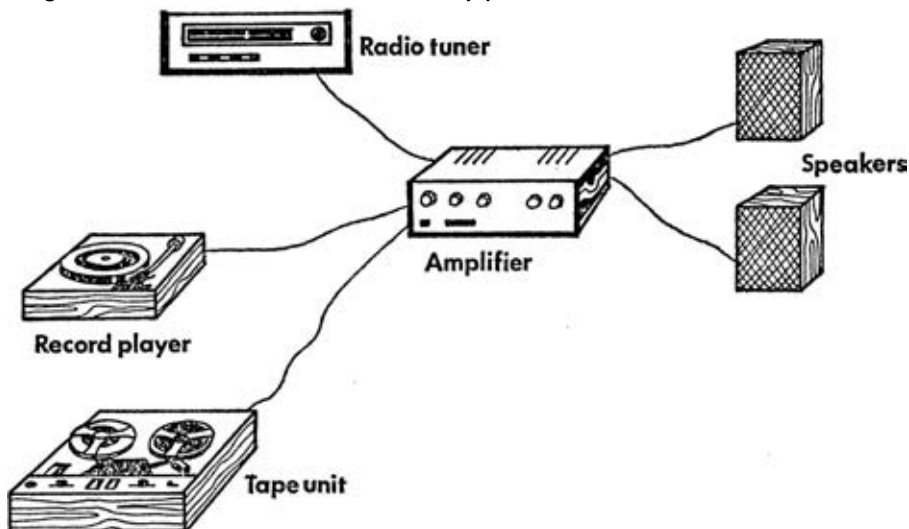

Stereo hi-fi system. Speakers and tape unit are always separate items as shown. The player is usually separate but the amplifier may be associated with it in a common housing in small systems. Tuner and amplifier may be combined as a tuner-amplifier. All items except speakers can be brought together in an equipment console if preferred.

Thus it was possible to talk about hi-fi without having any stereo to go with it. Similarly we can have stereo without hi-fi. Many people have that in their homes! Any old gramophone can have the necessary two channels, terminating in two speakers, permitting the stereo label to be hung on it; but that has nothing to do with high fidelity, as you can discover for yourself by visiting a department store and trying the latest all-in-one, big-name stereogram.

Nowadays it is accepted by quality-conscious listeners that stereo is added to good audio practice to take us further along the road to high fidelity. For the hi-fi enthusiast, mono is part of history: he is interested, not in comparing stereo with mono, but in the possibility of improving stereo. Further, he appreciates that the emergence of stereo (over a decade ago) has had a big influence on the design and quality of components and systems used for hi-fi. We have not seen the end of developments associated with stereophonic sound reproduction.

Sources of sound

Main sources of programmes for the domestic system are disc records, tapes (commercially recorded or otherwise) and VHF/FM radio. We can add microphones, since some enthusiasts with musical, dramatic or other interests record 'live'.

So far the disc has had the greatest appeal to those who simply wish to listen to music. Everyone knows how to use a record; the results obtained can be outstandingly good, assuming care in choice and use; and the greatest variety of music and other material is available in this form. Whatever the attractions of other types of recording, the fact of the matter is that at present the majority of domestic sound systems give the disc pride of place, the other programme sources coming in as auxiliaries. Some mono discs are marketed but the companies have been following a stereo-only policy with LPs, at least in the areas of interest to the hi-fi user.

Although one can use tapes simply for music reproduction, recording on magnetic tape exerts a strong appeal for the hobbyist and creative enthusiast whose interests may not be primarily musical. Again with care in choice and use, superior results are achieved. In fact it is possible to do better than with discs, but generally the cost is higher. To meet the needs of listeners—rather than 'doers'—there are tape records in open-spool form and a rapidly increasing variety of tape cassettes, both stereo and mono.

Most readers will be aware of the deficiencies of AM broadcasts (medium and long waves) and many will know how remarkable is the contrast provided by the startlingly clear reception of VHF/FM broadcasts. AM can be dismissed as far as hi-fi is concerned. Fortunately the coverage of FM in the UK is considerable and the cost of associating this kind of radio reception with a sound system is moderate. A proportion of FM transmissions are stereo and there is no shortage of equipment suited to their reproduction.

Making the best of these programme sources is the special concern of the sound enthusiast. Technical aspects and a number of outstanding requirements will be covered as we go along.



Moving away from the stereogram. Separating one speaker would aid stereo accuracy but have little further effect. Separating both speakers is fundamental in hi-fi.

2 FACTS, FIGURES AND FALLACIES

ONE AMPLIFIER offers 100 watts 'music power' yet is surprisingly small and suspiciously cheap. Another, much bigger and three times the price, apparently gives a third of the power. A receiver has a fet front-end, integrated circuits and what-all but costs as much as many people would be prepared to spend on a complete system. Can it possibly be worth all that money?

In one advertisement we are promised 'new levels in distortion-free stereo' (whatever that may mean); and in another we read of a 'fantastic frequency response of 10 to 120,000Hz'. Elsewhere we are introduced to something called class A: the text is heavy with the implication that class-everything-else is behind the times. A pickup manufacturer evidently specialises in magic wands—his product has been tracked at a tenth of a gram. A speaker manufacturer reckons *his* products are so good that you can forget about outmoded things like frequency range and dynamics. All this and discounts too: how can you possibly lose?

But every day thousands of would-be audio owners settle down with their hi-fi magazines or the manufacturers' literature and groan at the technical specifications, the claims and the counter-claims. Why does it have to be so technical? And why is the technicality so obviously fostered by the industry and those who report its work?

In fact the situation is not so very different from that in other fields where products depend on various technologies and branches of science (hi-fi depends on engineering, physics, plastics moulding and much else besides). For instance, you can buy a car after studying specifications, consumer reports and accounts of technical and road tests, and you may also take a wider interest in performance and design. On the other hand you can buy on reputation, recommendation and the likelihood of the vehicle meeting your known needs.

You can certainly buy sound systems on reputation and after satisfying yourself, by careful listening and examination, that the equipment is going to meet your requirements. The chances of this are improved by the increase in variety of matched, prepared systems, ready to plug in and use.

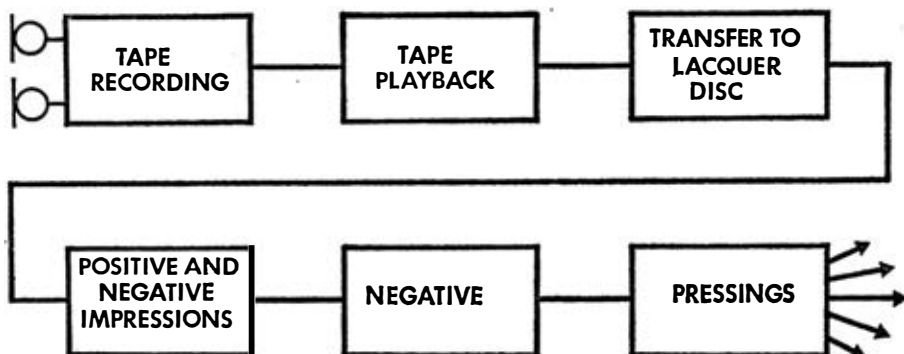

Disc production sequence, stereo or mono. Stereo involves two separate channels at all stages.

The fact remains that a great deal of complexity is involved in the best of hi-fi systems, and it is also true that a study of principles and practice proves uncommonly interesting to very many people. Sooner or later they find that most technical discussions can be related to musical results. Better tracking of pickups, improvements in speaker design, more sensitive radio receivers, better recording tape, lower amplifier distortion—all such things have a direct influence on the music you hear. Hi-fi depends on so many elements, all serving an art which is very widely enjoyed.

So the technical side is there for a purpose. In particular the expert cannot usefully report on technical products without testing all or most details of performance. Well-meaning commentators often suggest that the sound is what matters and that technicalities cannot influence the customer. Of course the sound matters—more than anything else—but standards cannot be maintained and advanced without questioning the details. This is important if for no other reason than that the inexperienced listener needs guidance—beyond the evidence of his ears—on matters that affect value for money.

First things first

There are three main headings under which technical requirements can be considered. It is as well to explain them briefly for the benefit of the beginner—before any more detailed guidance is offered. Some of the technical terms can be understood in their context but there is a glossary at the end of this booklet.

1. Dynamic range. Anyone interested in music will know that dynamics are the concern of composers and performers. Listeners to reproduced sound also are interested in this subject, and they will appreciate the idea that a wide range of dynamics makes for realism and impact, particularly in complex music involving subtlety of effect. Records and radio transmissions have a built-in restriction of range, but with these at their very best a range of about 55-60dB becomes practicable (though the ideal is nearer 70dB).

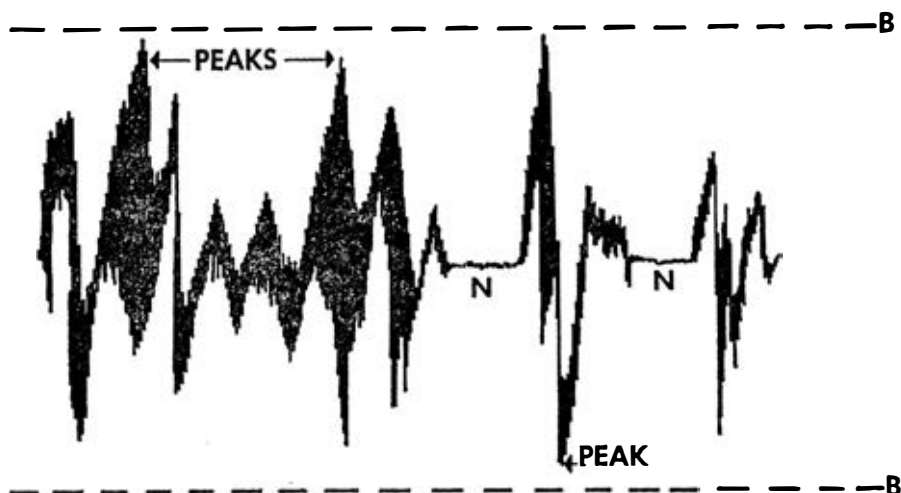

Diagram of musical waveform aids understanding of dynamic range in reproduction. The quietest passages descend into the noise level of the system at N, and the peaks are near to boundary lines B, which represent the system's handling capacity.

In domestic sound reproduction there are limits imposed by the characteristics of the equipment and the conditions in which it is used. The potential of the recordings may or may not be realised. For instance, in given circumstances it will be necessary to have the quietest parts of the music at a certain level of loudness to override the general background noise (there is always something going on—traffic, the hum of town life—though it is reduced to very little if you happen to listen in the middle of the night!); and then the loudest parts should be reproduced cleanly.

It takes little technical knowledge to appreciate that adequate power handling capacity of the system is a major factor. It may not at first be so evident that the noises caused in the sound system are just as important. In fact noise is always hostile to hi-fi. This accounts for the experts' pre-occupation with hum, turntable rumble, and tape and circuit hiss.

It is particularly important to understand that recordings and broadcasts vary a great deal. Very wide dynamic range is not always conveyed, and sometimes it is not even intended. Further, a hi-fi system does not produce 'impact' where this is lacking in the recording. The job of the equipment is to preserve or convey a convincing range—but it has to take what comes. We should also note that pop music, though intended to be loud and create its own kind of impact, is usually short on dynamic range. A range of 20dB is considered to be great—and it is certainly unusual!

2. Distortion. The aim is stated easily enough: we wish to reduce distortions as much as possible. In general, amplifiers and other electronic units, working within their capabilities, generate less distortion than we suffer from transducers—the links at the ends of the chain such as pickups and loudspeakers. Common distortions are those due to inaccuracy in tracing the record groove and to resonances in speakers and other items.

'Harmonic distortion' is the generation of harmonics of the original signal. 'Intermodulation' is the result of signals of different frequency interacting with each other to provide additional, spurious signals at the output of the system. 'Amplitude distortion' is the result of stronger signals not being amplified to the same extent as weaker signals. Then there is 'crossover distortion', much discussed in these days of transistor amplifiers: it results from the shape of ac signals being altered at the point where they change polarity.

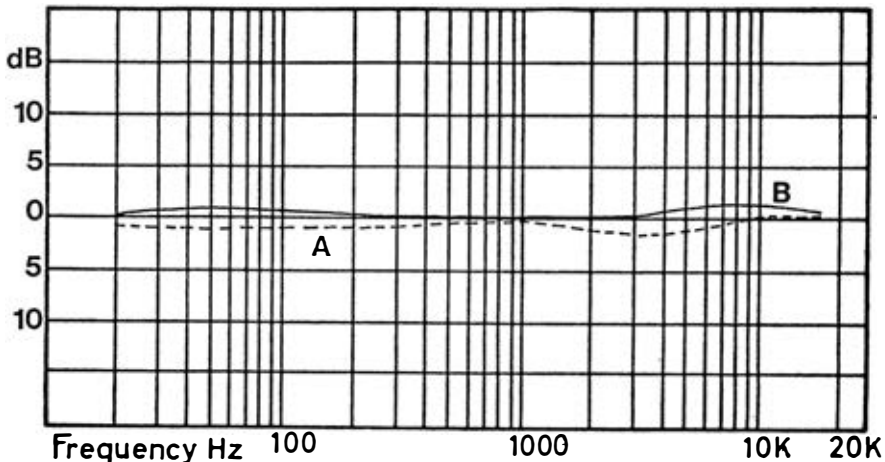

Two examples of a frequency response stated as 20-18,000Hz \pm 2dB.

Even deficiencies of frequency response (see next section) are forms of distortion. 'Transient distortion' arises from the inability of the system to respond to signals of very short duration. To the beginner this one may seem comparatively rare but in fact it is extremely important, for it concerns the effective reproduction of details in the sound—the very stuff of which hi-fi is made—and a study of it can tell us something about why one speaker or pickup sounds better than another.

Disturbances in the pitch of the sound can also be included at this stage. Usually they arise from mechanical shortcomings—in turntables and tape mechanisms. Hence the appropriately named wow and flutter. The recording companies are not always free from blame: recorded pitch fluctuations are not unknown (the same can be said about rumble).

3. Frequency response. At one time frequency response was the main talking point among hi-fi enthusiasts. This is mainly because the idea of response was (and is) reasonably easy to grasp. Such aspects as power ratings and the refinements of pickup design were less popular. The situation has changed very considerably.

There is no doubt that we require a wide and smooth frequency response. A system that does not reproduce sounds evenly through the audible range does not deserve the hi-fi label—and that is *that*. It is not unduly difficult to make a good job of response and there is no reason why we should accept second-best. A slight curtailment of response may be involved in making economies; but the emphasis is on 'slight' and it is for the listener to weigh the loss against the saving.

What is the audible range? Roughly 20-18,000Hz is a fair bet. Hearing response narrows as the years accumulate, but senior listeners should not despair as there are so many delights—stereo and the aforementioned dynamics, transients, negligible distortions and the rest—to ensure that the hi-fi listening experience keeps its attraction. Whatever the age of the listener, smoothness of response has priority and is more important than a few Hertz (Hz) at each end of the range.

A number of design considerations affect our ideas about frequency response. In practice it is found that certain items of equipment should do better than just cover the audio range. The best amplifiers have a very great bandwidth, usually reflecting excellence of design. It is somewhat more difficult to make a pickup that responds very far beyond the top limit of audibility (smoothness of response is important here). It is much more difficult to make loudspeakers that show a very smooth frequency response—but then, speakers are difficult propositions at the best of times.

DECIBELS ▼

120	110	100	90	80	70	60	50	40	30	20	10	0
Threshold of pain	Nearby jet planes	Very noisy factory	Tube train	Large orchestra City street	Average street	Hi-fi in room	Average conversation	Noise in restaurant	Quiet conversation	Whisper	Soundproof room	Threshold of audibility

Decibel levels of sounds. Noise is surprisingly great in surroundings we normally accept as 'quiet'.

A straight statement of frequency coverage, such as 20-18,000Hz, is not a 'response', though this is the only information appearing under that heading on some specifications. Frequency response is stated with information (in decibels) about the departure from linearity—that is, the undulations in the response curve. Thus: 20-18,000Hz \pm 2dB is a precise statement of response that could apply to a pickup cartridge; and 30-20,000Hz \pm 5dB is a possible response for a speaker. It is rewarding to study the response in its graphical form. Words are not really adequate: the graph shows you *where* that 2dB undulation occurs. The unqualified statement of coverage is properly called 'frequency range'.

These are a few of the basics which the enthusiast can further explore in reading about hi-fi—especially equipment test reports. Other factors affecting the understanding of hi-fi equipment and its performance will be dealt with as they arise.

A few fallacies

To round off this section—a few fallacies. One concerns the use of 'hi-fi' in a pejorative sense by a lot of people, including the musically knowledgeable, who should know better. You have to be a fanatic to interest yourself in good quality, they seem to say. Or again, if it shrieks with hard, glassy 'top' and has a thunderous bass, it's hi-fi. (Presumably it is acceptable if it sounds 'mellow' and has no top at all.) But of course, the whole idea is to reduce distortions and produce smooth, realistic sound. Hard, brittle and boomy sound can be found—all too easily—but it is hardly crankiness to seek ways of avoiding such deficiencies.

Another oddity: it is widely believed that a quiet sort of chap who likes music but wants to remain unobtrusive will be content with 'just a few watts'; and at the same time it is said that the advanced hi-fi man will not rest until he has a kilowatt (although no-one knows why he wants it).

Not surprisingly, manufacturers respond with 3 $\frac{1}{2}$ -watt mini-fi outfits as well as amplifiers for the power-hungry. What is so seldom acknowledged is that the 'power' figure does not have a great deal to do with promoting peace and quiet or making an intolerable noise. However, the difference between minimal power and plenty of power may mean the difference between hi-fi and no fi at all. Power has to suit the circumstances, as we shall see.

Yet another fallacy: the beginner does not spend much but is content with a 'modest' system. This may be true if the beginner is feeling his way, or is not accurately advised, or is not really very committed to the idea of high-class sound in the home. Otherwise, why should it be thought that the music-lover is to be satisfied with second-best?

In practice an inexpensive system is a small low-powered system. It is not necessarily of poor quality, but by its nature it will be suited to a small room. Push it to the limit in a large room and the results will be dreadful. If you cannot afford to make your ambitions take practical shape, wait a while. Although there are some opportunities to effect savings, hi-fi is really more to do with applying high standards than with practising economies.

Possibly the most serious misconception is not only shared by many who profess an interest in using high fidelity but is also often fostered by the retail trade. It concerns the idea that hi-fi equipment 'improves' all the programmes fed through it. In general this is *not* so. This function of a very good system is to reveal everything, not to modify the programme.

If the record or broadcast has deficiencies (distortions, poor frequency range and so on) these will be exposed, not magically cured. An absurdly simple example: if the transmission brings you a frequency range of only 50-12,000Hz, your hi-fi' greater bandwidth will not offer you any significant

advantage. It may sound pleasant enough, but that is because you are adequately reproducing what *is* there.

There are instances where the use of hi-fi controls can take the rough edges off distortions; and it is possible that one pickup will be better than another at tracking an awkward disc. This has little to do with the main argument. In order to enjoy hi-fi you have to give as much attention to the programme quality as you do to the hi-fi system.

3 THE HI-FI WAY

YOU DO not have to be a hi-fi enthusiast to know that, in order to play records, you need a turntable and with it a pickup to coax the music from the groove; and then an amplifier to make more of what comes from the pickup; and finally loudspeakers to reproduce the sound.

One can arrange to do all this very well or very badly. One can obtain equipment that leaves records in mint condition after dozens of playings; or one can use a groove-grinder that chisels bits from the disc the first time round.

Obviously all the bits and pieces to reproduce sound are incorporated in the ordinary commercial record player or radiogram, and the results achieved by this kind of made-to-a-price instrument are acceptable to many people. Possibly they are not keenly interested in music, though they may like a reminder of the tune and the rhythm, or perhaps they would appreciate a higher standard if they heard it.

The hi-fi enthusiast knows that it is not at all difficult to do better the hi-fi way. This is true even in the low-budget area. As mentioned earlier, hi-fi—the attempt to produce above-average quality of sound—starts when the discredited radiogram ceases to give satisfaction. As a prelude to explaining the main features of audio systems it will be useful to look at the deficiencies of the traditional radiogram—or stereogram, as it will be these days. This kind of product may be very expensive or, more often, sold at prices (under £100) at which small audio unit outfits become feasible.

The attitude to stereogram design is markedly different from that brought to bear on the assembly of hi-fi systems, although all concerned are in business to make a profit while meeting a need. To ensure that it is acceptable special attention has to be paid to the furniture-look of the stereogram—its styling and various details of appearance. It is usually a one-piece reproducer, fairly bulky, which has to find its place alongside other furniture.

It carries tax as a single package, and this affects what the manufacturer can offer at a competitive price. And in fact very little is offered. There will most often be a cheap record changer and a high-output crystal or ceramic cartridge. If the output of the pickup is high, the sensitivity of the amplifier can be low, and this helps minimise the cost of the electronics.

A pair of cheap speakers completes the components. It is at this end of the chain that we find the most unsatisfactory feature of stereograms. In a cabinet of moderate size the speakers are too close together for stereo and, in any case, are incorrectly orientated. In all but a few instances there is also the objection that the speaker units are working in poor conditions, probably on small baffle-boards and close to the 'works' of the stereogram; but if they are cheap units it would be difficult to make much of them anyway!

What this means is that the average one-piece stereogram plays stereo records—it may also receive stereo radio—but does not *reproduce* stereo. Its output is nominally twin-channel but closer to mono than to stereo, considerations of sound quality aside.

At the higher price levels there may be attempts to satisfy the basic requirements. There may be more powerful amplifiers, more costly speakers or even a better pickup. In some cases the speakers may benefit from the application of a little science, and one or both may be separately housed and movable so that the stereo effect can be improved.

As for stereogram sound quality generally, the characteristics are restricted

frequency response and dynamic range (adequate for background music), high distortion and a confined, unnatural bass output. A synthetic, 'gramophony' quality is usual.

There may be attempts to improve the treble sound by the inclusion of 'tweeters'—separate high-note speakers—but this rarely proves to be anything more than a sales feature. It is unlikely that the pickup cartridge would generate any significant output in the part of the frequency range in which tweeters operate. To all this we can add the very poor playing conditions imposed on expensive records in the average stereogram with its record changer and cheap cartridge.

Even the most expensive stereogram is poor value for the listener who really *listens*. Hi-fi places the emphasis on basics—the features that contribute to the sound quality and the accuracy of the stereo. It need not be an untidy amalgam of contrasting shapes, sizes and styles. On the contrary, with care in choice from the vast range now available, and with commonsense in installation, the audio system can look neater and seem less obtrusive than the stereogram.

Audio units

If the stereogram suffers through having all its parts jumbled up together in a cabinet, surely the answer is to separate all these components? Indeed this does have something to do with hi-fi but the components must be purpose-built to a high standard if high fidelity sound reproduction is to result.

The typical hi-fi system for playing stereo discs comprises a turntable/pickup unit, an amplifier and a pair of loudspeakers. Most often these three main parts will be separate from each other, although it is sometimes permissible to combine the first two. In the more advanced systems they are separate because they are fairly heavy and bulky; and in any case the manufacturers of high-grade amplifiers do not design their products with an eye on any particular physical combination with other items.

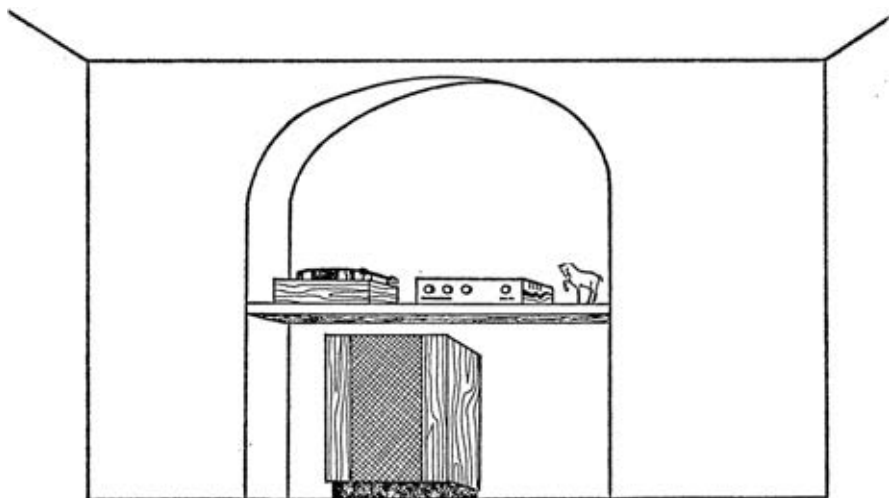

Equipment solidly shelf-mounted in an alcove. One speaker of the pair is shown. The player is effectively isolated from the speaker vibrations.

If VHF/FM radio is required it can be included at any time by adding a radio tuner—possibly a unit made by the amplifier manufacturer. If radio is considered essential in the first place (and it is the cheapest hi-fi source, remember) it is convenient to install a combined tuner-amplifier—that is, a hi-fi receiver. If tape recording and replay are favoured, a stereo or mono tape unit can be connected to the amplifier.

Finally, there are the loudspeakers, chosen to suit the listener, the system and the space available. Separate speakers can and should be located to give the best stereo reproduction and the most acceptable listening arrangement in relation to the room layout. The amplifier and player, plus the tuner, etc if used, are easily installed in a cabinet, which can also provide storage space for records and tapes. However, shelf-mounted outfits are much more popular.

The simplest arrangement is a stout shelf, solidly bracketed to the wall, to carry everything except the speakers, which should be kept well away from the pickup—despite the pictures you see in the advertisements. Or you can make use of existing furniture, alcoves, built-in cupboards and so on.

But that is an aspect of installation, to be dealt with at the appropriate time. For the moment it is important to emphasise that the variety of audio units is very considerable, and no-one should encounter any serious problem in choosing items that are of good quality while lending themselves to neat and compact layouts.

Obviously the several hi-fi components needed to form the system can be purchased from various places and at different times. Putting them together is not unduly hazardous—provided they were sensibly chosen in the first place, after some planning and a little study of the basic principles.

In fact most systems are assembled from units of different makes. It comes as no surprise to find that manufacturers specialising in pickups do not usually make speaker cabinets as well; and it is understandable that a firm with an electronic production line does not also have the tools and machines to make turntables. The buyer may decide for himself which items to put together, or he may ask his supplier to work to a 'specification' and a budget and then assemble everything so that it is ready to switch on and use.

Some readers will by now be wondering whether the audio industry is not introducing complication just for its own sake. Even if a company cannot make everything, why does it not buy up suitable parts to put with its own? The result can be a matched system, tested as a whole and presented as a going concern—down to the cables and plugs.

Of course, there are such firms and they have increased in number recently in response to the developing interest in high fidelity. A very few of them (foreign firms) make practically everything. Others make some parts and choose other items that will be compatible with their own. Out of this comes the matched system with one trade name. The first on the scene were one or two large radio organisations with their unit schemes—not really high fidelity (and not claimed to be) but certainly a step in the right direction. One can only welcome the general trend, as it is helpful to those who want quick and sure results while avoiding technical matters.

However, it should not be assumed that there must be some intrinsic merit in a matched system from one source. Most of the finest systems—those in the highest price range—are assembled in the way already mentioned, from a number of specialist sources. The aim is to seek out the most suitable equipment—and freedom of choice is very important.

In the following sections you will find an explanation of the main hi-fi components, presented as an outline of basic technical features. A more critical approach, with further details of performance, will follow later.

4 PICKUPS AND TURNTABLES

AS WITH most explanations it is best to start at the beginning and go on until we reach the end. That, at any rate, is the way to further an understanding of audio components.

There is plenty of specification mystique and a certain amount of jargon to entertain those who enjoy studying developments in sound reproduction and it will be useful to pick our way through some of it in easy stages. First let us ask what the pickup *does* and then outline the important features.

The first question is easily answered. The record groove causes the pickup stylus to move, and these movements are conveyed to a generator within the pickup—a sort of dynamo—which produces a small electrical voltage. This output is passed to the amplifier.

Of course, a complete pickup consists of the generator—the cartridge or head—and an arm. The pickup's job is to trace the groove and move freely as the groove spiral carries the stylus from the run-in groove to the end of the side. The free movement must be in all directions, for the pickup must not be upset by small undulations (up, down, sideways) of the disc which, being mass-produced from a plastics material, is not (and cannot be) absolutely flat.

Besides, the task of tracing the modulations in the stereo groove—the tiny waveforms representing the music—is a difficult one, but for hi-fi results we demand a high degree of accuracy. In fact the whole area of record reproduction—the groove, the stylus, the cartridge mechanism, the arm—is remarkable for its precision engineering. And precision is the key word in high fidelity.

Types of pickup

Whatever the pickup, the part that actually does the picking up—a type of transducer—is in the form of either a cartridge or a head. The label 'head' is conveniently reserved for the plug-in head that is designed as part of one specific, complete pickup (the Decca ffs is well known). 'Cartridge' describes the version with a bracket, normally with $\frac{1}{2}$ in. between fixing centres, suitable for use in any suitable universal arm, the latter having a headshell to accept the simple bracket arrangement.

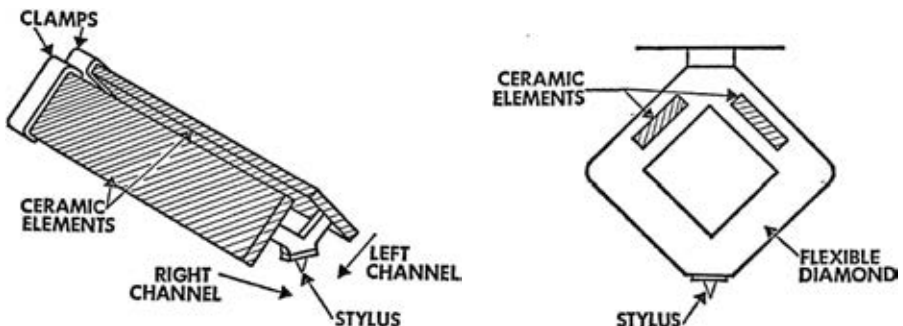

Functional parts of piezo-electric cartridges: A with simple coupler for the stylus, and B with a diamond shaped coupler.

Cartridges and heads fall into two main categories, to which we can add a third small category of rarities, and the principles that were applied in mono pickups years ago are nowadays used with great refinement in their stereo counterparts. The category depends on the method by which the electrical signal voltages are generated.

The first category is the 'piezo-electric'—the ceramic or crystal cartridge used in portable players and most stereograms. A few above-average examples are suitable for use in economy-class audio unit outfits, but their performance is not usually as good as that of magnetic cartridges. Nearly all ceramic and crystal cartridges are cheap (£2 or so, with a few at more than twice that figure) and that is one of the main attractions in low-cost, simple systems.

Cartridges in this category by such well known makers as Acos, Decca and Sonotone generate their outputs by the flexing or bending of their ceramic or crystal elements, which are coupled to the stylus by means of plastics components, all contained on or within the cartridge body. Surprisingly big voltages can be generated, and it is possible to devise a veritable power-house that will produce 3 volts or more. Generally the cartridge with the biggest output yields the least satisfactory sound quality and tracks at the highest tracking weight (downward pressure).

Examples of better quality may generate only a fraction of a volt—typically 100mV. However, the high-output cartridges are made in the largest quantities. It will be appreciated that if the cartridge output is generous, the amplifier need not be so sensitive at its input; and therefore the electronics can be simple and cheap. As for hi-fi, magnetic cartridges have become cheaper—or rather, the price-range is now wider (£5 to more than £60). Again, transistor amplifiers are being made sensitive enough to cope with the tiny voltages from this type of transducer, and the circuits involved do not lead to great expense. So there is really no need to consider any other type of cartridge for high fidelity systems.

The most un-technical of readers will have an idea that electricity can be generated by wagging a wire near a magnet (or vice versa). Hence the earlier use of the word 'dynamo'. Indeed, magnetic cartridges generate output as a result of the relative movement of a magnetic field and metallic parts. In the moving-magnet cartridge the stylus—i.e. the stylus tip and the bar or cantilever that carries it—also moves an extremely small magnet. The latter moves in relation to the coils from which the signal voltages are taken. The moving-magnet cartridge was pioneered by Elac; this maker and others, among them Shure and Audio Technica, make modern examples.

There are several other varieties, all depending on electromagnetic

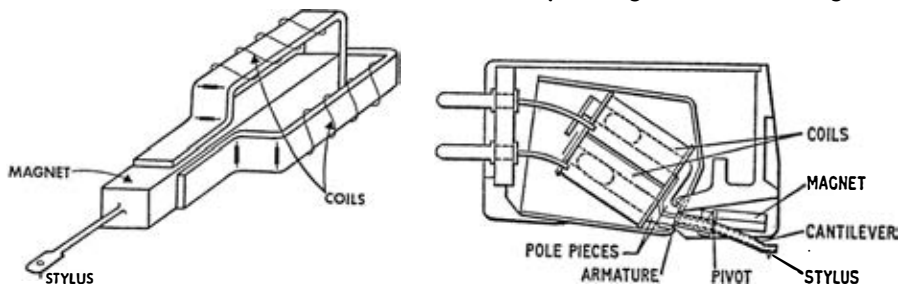

Left: functional parts of moving-magnet cartridge. The stylus/magnet assembly pivots in relation to the rest of the magnetic circuit. Signals are generated by motions in planes at mutual right-angles.

Right: principal parts of an ADC 'induced magnet' cartridge.

principles. In the moving-coil cartridge (Ortofon, Sony, Micro Seiki, etc.) the coils are coupled to the stylus and the magnet is fixed. In the variable-reluctance type (Decca, Ortofon) the coils and the magnet are fixed and the moving part, though not a permanent magnet, is of magnetic material. In the induced-magnet cartridge (ADC, Goldring and others) we find a moving armature, fixed coils and a fixed magnet which is remote from the coils.

Pickups in the 'rarities' category—when available—allow us to study quite different principles, all of them applicable with varying degrees of technical difficulty to the intricate job of tracing the record modulation. Types that

Pickup arm geometry. The axis through the cartridge or head is a tangent to the groove at only one or two points across the disc radius, but correct design and installation ensure minimum distortion due to tracking error at the end of the side.

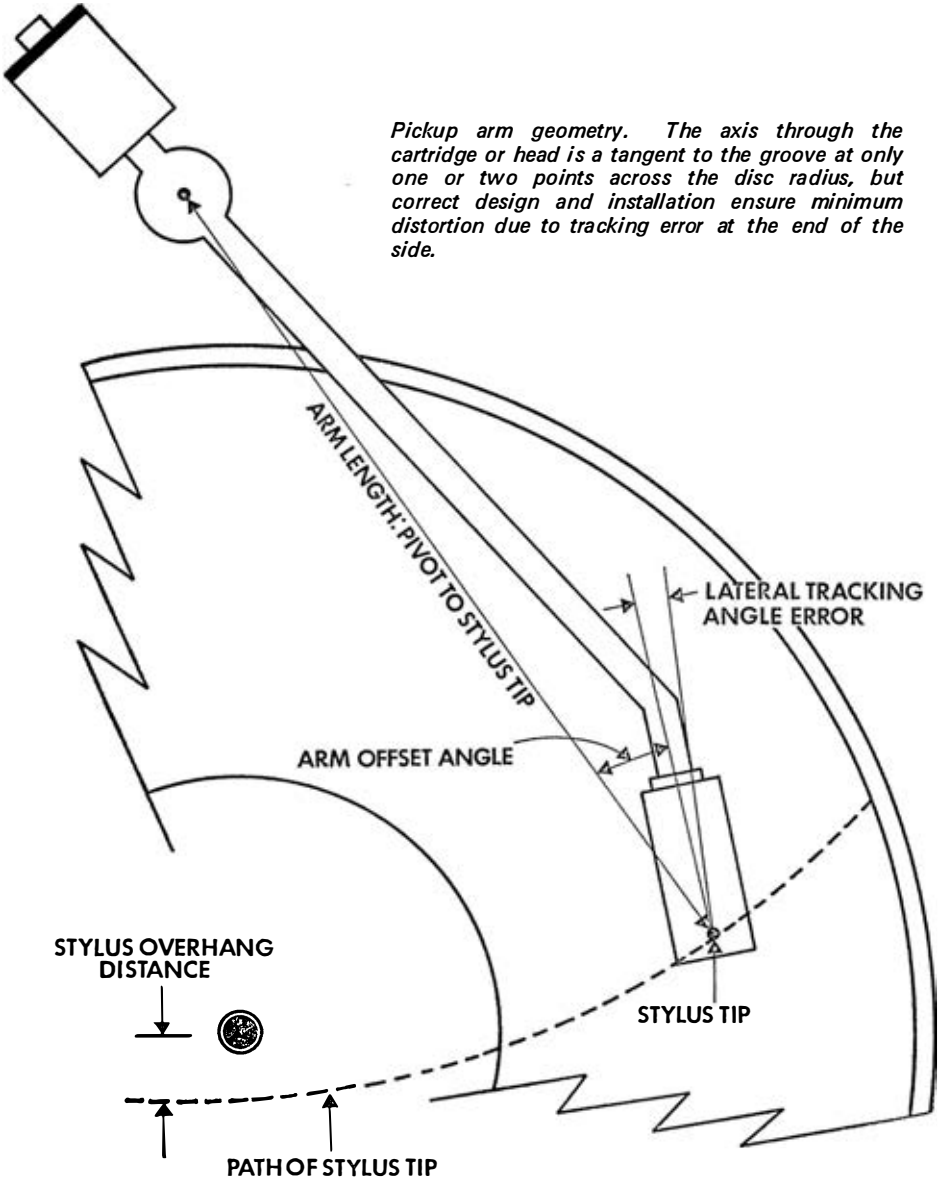

have been developed include photo-electric, strain-gauge and capacitance cartridges. Interesting as they are, these pickups are beyond the scope of this introductory account.

Pickup arms

We leave electromagnetism for a while and look at mechanical engineering and some geometry. The pickup arm's job is to carry the cartridge or head and make possible stable and secure tracking at the appropriate downward pressure. Although we sometimes encounter some unnecessary elaboration in arms, it is true that some important requirements of a technical kind must influence the design of a high quality component fit for genuine high fidelity systems.

For instance, we require a fairly small inertia in an arm intended for delicate modern cartridges; at the same time the pivots should introduce the least possible friction; and there should be a good range of adjustment so that the pickup can be set-up for optimum performance.

Pickup arm geometry seems to mystify a lot of hi-fi enthusiasts who otherwise get on quite well with the basics of audio. Accordingly a page of this booklet is devoted to a display of the main dimensions and angles involved. This type of arm, used by most people, is essentially a tube or rod with a mounting device for the cartridge at one end and pivots (for vertical and lateral movement) at the other.

Such an arm is not straight: it has a bend, or 'offset' in it somewhere, and it would be useless if it did not have this feature. The offset can occur in the tube (as shown) or in the headshell carrying the cartridge—that does not affect the basic principle. This feature and others are incorporated because of the lateral 'tracking error'—not quite such a bogey as some people try to

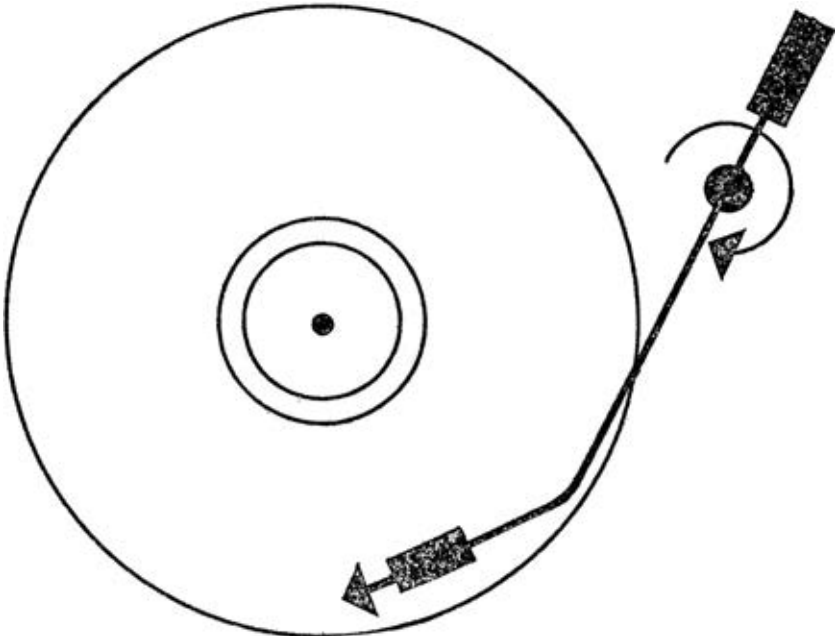

Combination of pickup shape and pull due to the groove moving past the stylus produces a clockwise force (bias), and the pickup tends to move inwards. A bias corrector produces a torque opposing the clockwise force.

insist but still important enough to require an explanation.

When the master disc is cut, at the stage prior to mass-production of the records you buy, the cutting head moves across the disc in a straight line, i.e. the radius of the disc. In reproduction, the pickup arm turns about a pivot, so that the stylus moves in an arc.

If the pickup arm were straight the fore-and-aft axis through the cartridge would be correct—that is, a tangent to the groove—at only one point in the arm's travel. In other positions there would be a large error and the motion of the stylus in the groove would be far from correct. It would not follow the motions of the cutting stylus which formed the modulations. The result—considerable audible distortion. The discrepancy is the lateral tracking error.

The designer has two tricks for reducing the error. He puts an offset in the arm or head, as already mentioned, and he arranges for the stylus to overhang the centre-spindle of the turntable when the pickup is swung over the centre of the disc. By careful attention to these matters—and the user must watch points too, if he sets-up the pickup—the error can be kept very small over the recorded part of the disc. That is, the axis through the cartridge remains *nearly* a tangent to the groove.

In practice an arm of 9in. nominal length (stylus to pivot is the arm length) may have, say, a 23° offset angle and a small stylus overhang. The resulting tracking error is likely to be held down to $\pm 1\frac{1}{2}^\circ$ approximately; it varies from point to point and will probably be a maximum at the outside of the record.

Modern arms are designed to provide minimum distortion due to tracking error and this means that the geometry and final adjustment aim to produce zero error at the inner spiral of the groove ($2\frac{3}{8}$ in. radius on the disc), where distortion hazards are in any case greatest.

It should be understood, then, that there is always some lateral tracking error and that it can be reduced to a small amount. What is left is not too troublesome; and besides, there are more severe problems in hi-fi than small geometrical errors. Study of the arm drawing will show that increasing the arm length would further reduce the error; but this reduction would be balanced by the greater inertia of the longer component. Just to emphasise the point, it is found that very little audible decrease in distortion (if any) follows from using a 12in. arm, compared with a 9in. arm; and anyway,

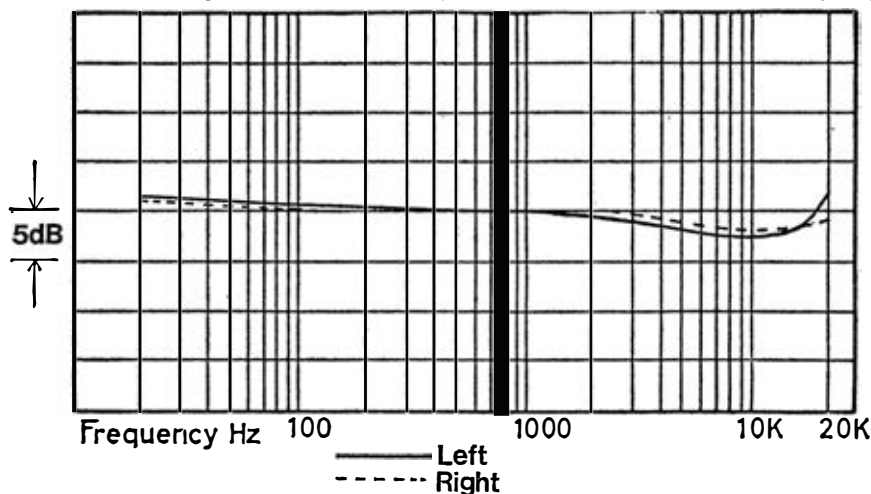

Frequency response of a magnetic cartridge.

long arms were invented for professional use, e.g. playing large master discs in studios.

The error can be eliminated if the pickup tracks radially, just like the cutting head. Such radial arms are made but they are of course more complicated and costly. Again, there have been, and still are, 'tangential-tracking' arms in which the head offset is automatically adjusted as the pickup traverses the disc. Extra bearings and other parts are involved.

Another cause of confusion is the sidethrust to which ordinary pivoted arms are prone. (Sometimes the rather daunting and not very appropriate term 'skating' is used.) Again a drawing helps illustrate the point. It is found that a pickup with the usual offset and overhang design tends to pull inwards slightly when playing. The effect arises from friction of the groove moving past the stylus tip and the geometry already explained.

As pickups become more refined, tracking at low pressures and exhibiting very small pivot frictions, it is advantageous to correct this sidethrust. A suitable device can exert the correcting force—a small outward pull—and most arms for hi-fi use have a gravity (suspended weight) arrangement, a device working by magnetic repulsion, or some other gadget.

Obviously, if a pickup *should* function at, say, 1 gm. tracking weight and there is appreciable sidethrust, some extra weight is needed for security of tracking. Correct the sidethrust and the tracking conditions can be optimised. But this is hardly important with no-fi pickups that track heavily and have large pivot frictions!

Universal pickup arms for use with hi-fi cartridges are in the approximate range £10-50. Good as a stereo pickup may be, its peak performance cannot be enjoyed unless it is correctly installed and adjusted. Vital setting-up procedures will be covered later in this series.

Specifications

A pickup specification, with its assorted electrical and mechanical data, looks a curious mixture. If the user is buying a good cartridge separately, taking as much care as he would over a loudspeaker (and that degree of care is recommended), he will be interested in making comparisons to which

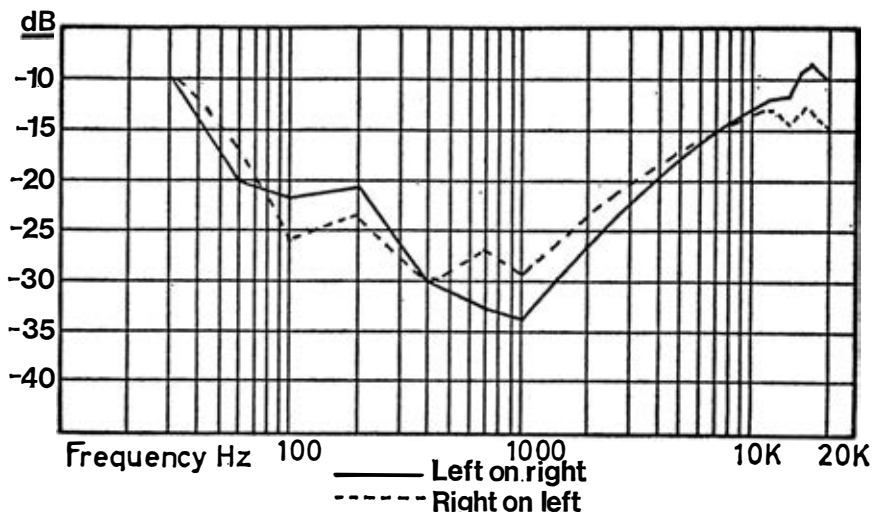

Crosstalk of a magnetic cartridge. Channel separation is greatest in the middle of the range.

an understanding of specifications is a valuable introduction. For the moment we can restrict ourselves to basic spec figures and to magnetic cartridges—and even then the list is long.

Frequency response. If the leaflet quotes (for example) 20-18,000Hz, this is a frequency range, not a response. The statement 20-18,000Hz±2dB is a response for it indicates the limits of deviation (2dB one way or the other) from a level response.

Even then it gives no clue to the annoyance value of the deviation; a 2dB droop ('suck-out' is a term often used) in the middle of the range may be more serious than a gentle roll-off towards the extreme treble even if the latter amounts to a greater dB figure. Best of all is a response in graphical form, for it shows the location and size of the deviations from linearity.

Crosstalk We may read about crosstalk, which refers to the unwanted output arising on one stereo channel while the other is active; or the reference may be to absolute separation between channels. Crosstalk influences the width and general excellence of the stereo image. Usually only one figure is quoted in a specification—for example, 25dB. This applies at 1kHz unless otherwise specified.

The crosstalk is worse (dB figure lower) towards the ends of the frequency range. Small differences in crosstalk are not readily detected by the majority of listeners but a very good figure usually goes with other good figures (assuming the manufacturer is telling the truth).

Tip mass. When this is quoted—on many specs it is not—it refers to the effective moving mass due to the moving parts (cantilever, armature, etc) and can be thought of as the mass that gives the groove modulations some hard work to do. Obviously it is very important. A tip mass as small as 1mg (a milligram) may be quoted, and few people will be in a position to question it because measurements are difficult.

Compliance. This is introduced by the pivoting arrangement in which the stylus is held. The figures quoted indicate a relationship between force and distance, thus: 20×10^{-6} cm/dyne, lateral or vertical. In other words, the compliance relates to the displacement of the stylus by a certain force. However, this is usually obtained by test-bench methods that may not bear on practical conditions. It would be more useful to know how the compliance really works!

High compliance is not difficult to achieve in a cartridge—and it is not necessarily desirable or safe. Much depends on whether other factors are right and, particularly, what sort of pickup arm is to be used. A really good set of figures—suitable compliance thrown in—will belong to a fairly costly model, appropriate to a high-grade arm. But compliance alone, as generally quoted tells you little and cannot be allowed to lead you into choosing a cartridge. A figure of (say) 20×10^{-6} cm/dyne is sometimes written as 20 c.u. (compliance units), and this seems a welcome simplification. It would actually mean something if everyone used it in the same way.

Tracking weight. If compliance is dangerously close to mumbo-jumbo, tracking weight (or playing weight) really *is* important. Honestly specified, it tells you something about 'goodness'. For a good hi-fi stereo cartridge the manufacturer's recommended range will be fairly narrow—a range of 0.75 to 1.5gm is typical. (Tracking weight is always in grams.) A wide claimed range of, say, 1 to 5gm is silly and offers no useful guidance. Remember that a claimed figure does not guarantee that any and every disc can be tracked with complete security at that weight. More likely, it will be found that no further improvement in tracking results from exceeding the recommended maximum.

Weight. This is the physical weight of the cartridge—typically 4 to 11gm. It is useful to know this when considering the properties of the arm. Read test reports for observations that may influence choice.

Output. With magnetic cartridges we are interested in the velocity of the recorded modulations implanted in the groove. Thus the output of the cartridge is referred to a stated recorded velocity. The specification may quote output as (for example) 1mV per cm/sec velocity. For each centimetre per second velocity, therefore, we get a millivolt (on each channel).

However, a nominal velocity of 5cm/sec is widely accepted and quoted. Thus the above example gives us 5mV at this velocity, and this is typical of a magnetic cartridge. Generally, the most advanced cartridges generate the lowest voltages—simply because they have the lowest-mass moving parts. Miniaturisation leads to better performance at the expense of output.

The recorded waveform does of course run up to much higher velocities at times. For instance, the 5mV cartridge would generate, fleetingly, an output of 25mV on a peak of 25cm/sec. But these peaks come along rather frequently!

Distortion. Harmonic and intermodulation distortions are not easily measured, and figures are not often quoted in specifications. Occasionally we find a figure of around 1% for a good cartridge, reminding us that distortion in transducers (e.g. pickups, speakers) is much higher than in amplifiers. However—better no figure than a misleading claim.

Load. The manufacturer usually quotes the recommended terminating impedance—the 'load' to be applied to the pickup. For most magnetic cartridges this is 47kohms (47,000 ohms) per channel, or sometimes slightly higher. The impedance is actually the input impedance of the amplifier: you simply plug in without more ado unless instructed to the contrary. The part played by the connecting leads will be mentioned later.

Stylus. The figure is the stylus tip radius and is usually quoted in fractions of a thousandth of an inch. A spherical-tipped stylus with a radius of 0.0005in (half-thou.) is in common use for stereo. A 0.7 thou. tip is sometimes advocated for its better results on some mono LPs as well as on stereo, and it is also more appropriate in the cheaper pickups where the tracking weight is on

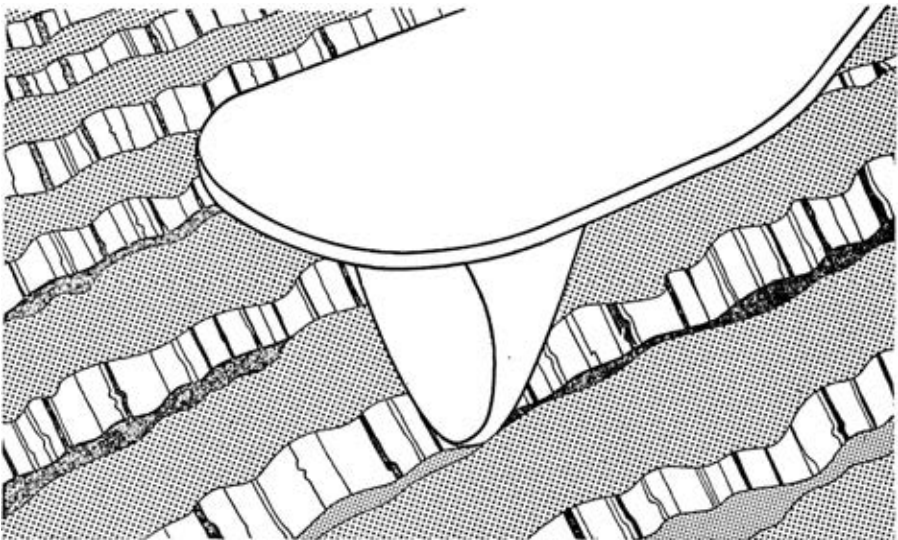

How the elliptical stylus tip fits across the stereo groove.

the high side. However, the 0.5 thou. tip is acceptable in lightweight pickups on recent monos.

The elliptical (or bi-radial) tip has come into general use in high fidelity cartridges tracking at low pressures. It reduces distortion arising in the tracing of the groove and is acceptable on stereo and mono LPs, offering a much better fit in the recorded modulations. Tip radii of 0.0002×0.0007 in. are typical.

All hi-fi cartridges have diamond tips. Sapphire is cheaper but not economic in the long run because of rapid wear. In most cartridges the stylus assembly, in a plastics moulding, is a push-fit in the cartridge body. Since the assembly includes all the moving parts, replacement of the stylus returns the cartridge to its original condition. Replacement often provides also the opportunity to change types of stylus—e.g. spherical replaced by elliptical.

A few other specification points may be encountered. One of them is vertical tracking angle, to be considered when stereo is discussed.

Turntables

The turntable is a worthy but unglamorous component in the hi-fi system. Enthusiasts sometimes ask about the 'performance' of turntables but their requirement is best expressed in another way. A good example lacks any very memorable features: it must rotate quietly and reliably, week after week, year after year; and above all it must be unobtrusive, contributing an absolute minimum of background noise and pitch fluctuation to the music. It should be well suited to the system—and for a really good system it will be a fairly expensive item. The best turntable is so good that you forget it is there.

Although there is always a demand for simple and cheap turntables, especially for modest stereo outfits in what may be called the mid-fi class, a robust transcription turntable is necessary for hi-fi and will cost something in the range £25-80, very approximately, if separate from the pickup arm.

The label 'transcription' is borrowed from professional practice and implies fine engineering—it will probably be fairly massive—and complete dependability. Some of the hi-fi units in this class would perhaps be too 'domestic' for professional use; but nevertheless 'transcription' remains a key word in high fidelity and it is most unwise to stray outside this general category if a really good system is being planned.

Turntable specifications do not offer much solid information apart from a general description of construction and operational features. Details of immensely heavy platters and cleverly devised stroboscopes are no guarantee of good results, but just the same we should examine the main points. Rumble (noise due to the mechanism) and the aptly named wow and flutter are of most interest, but it is difficult to make comparisons between products on the basis of claimed figures as there are no internationally agreed methods of measurement.

All turntables generate *some* rumble, for which the motor and bearings are responsible. Although techniques vary, the basic method of investigation involves the use of a test disc to establish a reference level (a tone), and then the associated pickup is made to track unmodulated grooves. Thus it is possible to quote the rumble level in dB below the reference level. A figure of -45 dB is typical.

This yields what is called an unweighted figure, embracing a lot of rumble but giving no indication of the annoyance value of the noise. It is possible to obtain a weighted figure reflecting the practical importance of the elements of the noise, which inevitably will cover a range of frequencies.

Whatever the methods and results, it is essential to understand that rumble can ruin hi-fi, for it effectively reduces the dynamic range of the reproduction.

If the speakers are good and big, with a beefy bass response in the rumble region, choose the turntable with special care.

As with rumble, all turntables cause *some* pitch fluctuation. In hi-fi units, bad (really audible) wow and flutter may be attributable to faults or lack of maintenance. Apart from that, musical ears are rather sensitive to these effects in even small doses, so seek evidence that wow and flutter are likely to be very slight.

Wow is associated with a speed variation of up to ten times per second (10Hz) and flutter with variations above this rate. Quoted figures usually lump the two together, and a total of 0.1% is not uncommon for a high-grade unit.

Hum radiation also is important but the possibility of running into problems depends on the pickup used. Technical details are rarely quoted by manufacturers.

For hi-fi use the player may be a combined turntable/arm or separate components. Convenience guides choice. Further, the man who buys a separate turntable will obviously have a range of arms from which to choose. The better the arm, the more ambitious he can be over selection of cartridges.

It is necessary to play LPs one at a time, treating the discs carefully—as befits a vulnerable and heavily taxed product. Pickup lift/lower devices should eliminate handling accidents. This kind of facility will be provided by a transcription-type assembly.

For those who insist on automatic pickup set-down and lift-off there are auto players having characteristics similar to those of non-auto transcription units. The player *must* provide for single discs. This is the case with some popular examples having short centre-spindles, interchangeable with the auto (stacking) spindle designed for record-changing, the latter being convenient if many 7in. 45s are to be played. However, auto-changing of LPs implies the worst possible playing conditions and is definitely ruled out if hi-fi is the aim.

One of the more obvious features of hi-fi turntables—most but not all—is a control for fine adjustment of speed, possibly $\pm 3\%$ of the nominal speed. A stroboscope for checking that the speed is correct may be built into the unit or used separately in the form of a printed disc. Although there is much talk in hi-fi circles of the importance of speed adjustment, it seems very likely that the majority of listeners would be content with a non-adjustable turntable—provided they could start with the assurance that the speeds were at their nominal value.

However, speed adjustment is in vogue. Although the systems used enable one to compensate for subtle changes due to mechanism wear, supply voltage variations or load changes, the check made with the strobe cannot take supply frequency variation into account, for the same supply powers the motor and the light used to view the strobe. In fact for the most painstaking checks the musical enthusiast would have to use a tuning fork or some other reference.

For completeness it must be noted that a few turntables incorporate servo-controlled drive systems which lock onto speed. There is electronic speed-changing, and drive is transmitted by belt from motor to platter. Indeed, belt drive is in use for conventional two-speed systems as well and has much to commend it where suppression of rumble is concerned. Other drive and speed-reduction systems employ an idler wheel between motor and platter.

As for the speeds required these are, for most people, $33\frac{1}{3}$ and 45rpm—and many users need only the first of those. There are no discs to play at the $16\frac{2}{3}$ speed, which is sometimes included. Fewer new models have 78rpm.

5 AMPLIFIERS AND TUNERS

ALL THE signal sources—pickup, tape machine and so on—generate very small voltages. The amplifier's task is to boost these voltages and give them enough power to drive loudspeakers. Into one end go fractions of a volt: from the other come considerable amounts of power. The necessary energy comes from your mains supply.

There is much more to it, of course. The enthusiast regards the amplifier as the nerve centre of his hi-fi and he is probably aware that this unit's qualities can influence the sound. But he should not think that an amplifier, if properly suited to the system, has a really *big* say in the sound. In a typical system, the speakers and the pickup have a much greater influence.

However, the amplifier is versatile and has many tasks. Most important, it provides a switching and linking centre for the signal sources and at the same time enables volume to be adjusted. It provides enough power for the conditions of use and in doing so introduces the least possible distortion; or at least that is the aim.

Ideally we require a basically linear frequency response—as flat as if it was drawn with a ruler—but we may sometimes want to modify this and unbalance the response a little. Therefore tone controls—treble and bass—are needed. For instance, we may use a pickup that tends to droop in response towards the treble end: a touch of boost can correct this. Or the speakers may sound better if more low-frequency power is driven into them: a few notches on the bass control will do the trick. Another essential is a stereo balance control. Extras include filters, headphone connections and outputs for tape recording.

At one time, many amplifiers were in two linked parts—control unit and power amplifier chassis. This arrangement is still encountered but most models are now in integrated form—on one chassis and in one housing. The use of transistors and other small parts makes this possible. Integrated or separate: it has no bearing at all on performance.

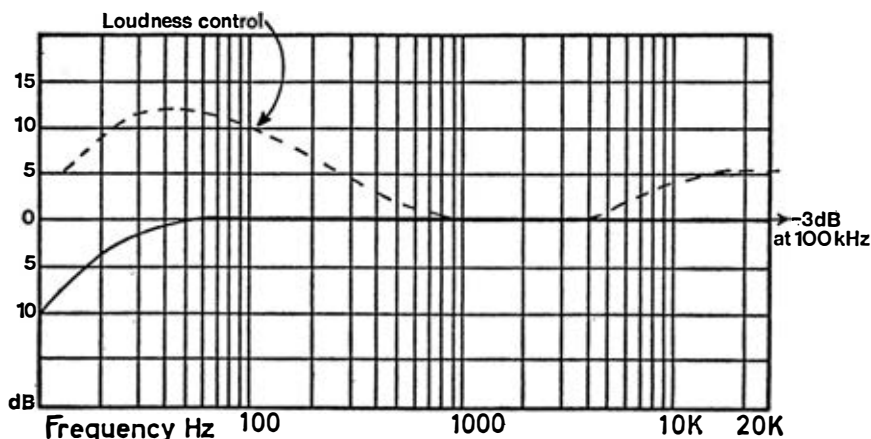

Frequency response of an amplifier. The hf response extends well beyond the audio spectrum in any good unit.

A lost battle

Newcomers to hi-fi often ask—even argue—about the relative merits of transistors and valves. But the battle was waged long ago and nearly all audio equipment is transistorised. It is true that a very good, professional-grade valved amplifier takes some beating, but that hardly matters now that the whole radio and audio industry runs on semiconductor devices. Some early transistor designs were disappointing, but today's units, even at the economy level, are as good as similarly rated and priced valved units—often much better. And they run cooler and are more efficient.

Amplifiers for hi-fi range from around £30, which buys about 10 watts per channel, a basic array of controls and a modest turn of performance of the 'budget stereo' order, to £100 and more for powerful well equipped units suited to systems of the highest calibre. There is a tendency for hi-fi power ratings to go up; and while the economy class yields nothing in popularity there is wider acceptance of de luxe audio at higher powers.

We shall be returning to the power game a number of times. For the moment let us be clear that, where ratings and their direct effects are concerned, the difference between, say, a 12W and a 16W model is negligible, though there may well be other factors influencing choice of the one or the other. If you are changing models, a doubling of power is the smallest change that is likely to have any practical significance. As for assessing power requirements, the rating you need depends on the size of the room and the type of speakers used.

Class A, class B

The means of obtaining the power are of some small interest, and the output stages of the circuit deserve a brief comment. Unlike valved amplifiers, the modern transistor unit of true hi-fi quality has no output transformer to link circuits to speakers. A heavy and costly component is eliminated. Everyone agrees this is a good thing. Debate centres more on the technical byways of the output stages, and references to class A and class B operation make news of a parochial sort in the technical press.

In amplifiers the transistors handling the output share the work in a 'push-pull' arrangement—there are several variants—and the mode of working most used is known as class B. Here, only a small 'quiescent' current passes while no signal is going through, but one transistor in the partnership conducts heavily on one half-cycle when the signal arrives; it subsequently goes to zero current and the other transistor comes in for the other half-cycle.

If there is any lack of precision in this operation of switching through the signal cycle, we suffer an effect called 'crossover distortion'—particularly apparent with low-volume listening. Care in design and manufacture can take care of this snag.

There are some transistor amplifiers in which class A operation is used (it was general in valved equipment). Here, both output devices pass a large steady current, and the signal makes one increase while the other decreases, and vice versa. This can be shown to have a beneficial effect on distortion, but the output stage runs hot and special care must be taken with cooling (examine the heatsinks on which the transistors are mounted).

In practice this tends to be costly and is hardly in tune with attempts to make equipment smaller. Indeed, as far as it goes in 1971, class A turns out to be an expensive way of buying a few watts, although it works well. It is a fact, too, that extremely good results are obtained with class B designs. It is also a fact that speakers and pickups produce comparatively large distortions which do at times mask any subtleties of the amplifier.

Specifications

Amplifiers, like other items, do not have 'absolute' specifications implying that all units manufactured are precisely the same, although the customer, studying the sales literature, may conclude that it all looks very positive. Of course, a spec can have tolerances—upper and lower limits—and that does not make the claims fraudulent. The expert who tests equipment and publishes his findings shows how the results look against the advertised performance: hence the importance of test reports to the customer.

Output power. This is expressed in watts (W). In British practice this is the continuous power, and is the square of the rms voltage across the load divided by the load value in ohms. A sinewave test signal is used. Thus you will see references to 'watts rms', although it would be more precise to refer to rms-based power. The number of watts delivered depends on details of measurement! It is good practice for the tester to advance the output until the signal waveform viewed on an oscilloscope is *just* not clipped (distorted).

'Music power' is an American rating, based on an IHF (Institute of High Fidelity) standard. It is supposed to take into account the comparatively low mean value of music signals as against a continuous sinewave signal. That is, the amplifier can be said to yield more power on music than on signals that are peculiar to the laboratory. There is no means of 'converting' music power figures into continuous ratings, for the difference depends on details of measurement. Roughly, a 30W music power rating might correspond to 12 to 15W in terms of our continuous rating.

This 'music power' method seems to be of less benefit to the customer than to the manufacturer. Fortunately, specifications very often quote both the continuous rating and the IHF figures. The presence of the former enables the buyer to make comparisons with many other competitive products. If only the music power or some other unfamiliar value is quoted, ask the manufacturer for the continuous rating in honest, rms-based power. If this information is not forthcoming, it may be wise to transfer your attentions to some other product.

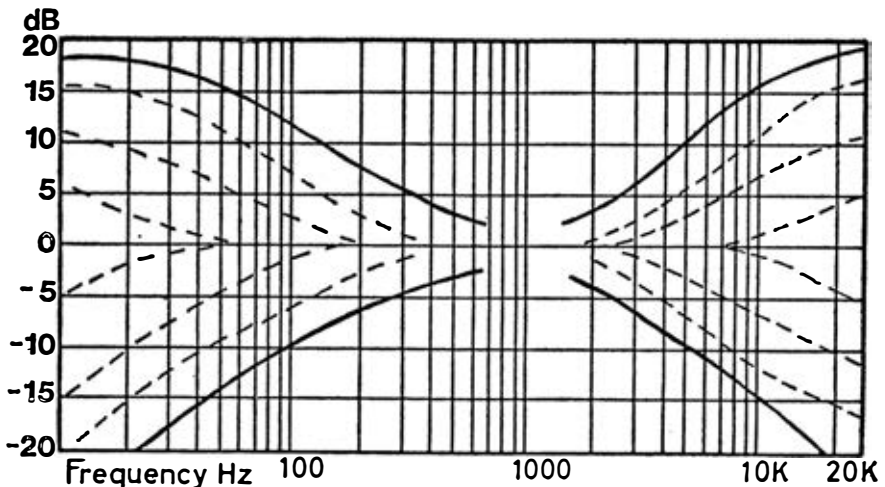

Characteristics of tone controls of the feedback type, showing how their influence is confined to the ends of the frequency range.

A 'peak' power figure, though uncommon, is not entirely unknown. Its appearance raises some doubts about the motives of the advertiser. In any event, halve the peak figure to get the rms-based rating.

Power bandwidth. At one time this was rarely mentioned, probably because the figures would have looked unattractive. It is the frequency range over which the full power is delivered for a particular distortion. It is now common to see the range quoted with lower and upper frequencies where the power drops by half (3dB). In this way the statement may be along these lines: 20-25,000Hz (-3dB).

If power is stated simply as a rating without a bandwidth, the figure can be assumed to apply at 1kHz. However, none of these figures mean anything unless the load impedance is specified. Very many transistor amplifiers deliver maximum power into 8 ohms, but there are some for which 4 ohms is specified. (The 15 ohms of the valve era does not appear very often; an amplifier for 8 ohms delivers less power into 15 ohms.)

Distortion. Total harmonic distortion (THD) is generally quoted, and low figures are achieved even in fairly cheap amplifiers. THD informs us about the percentage of spurious harmonics added to the signal on its way through the amplifier, causing (if bad) harshness or roughness. Distortion rises as output increases, so that power must be related to a specified value of THD. Thus one amplifier manufacturer states: 0.08% for all powers up to 30W at 1kHz, 8 ohms. This is very slight—far below distortions introduced by transducers.

Intermodulation distortion (IMD) arises from the interaction of signals of different frequencies passing through the amplifier together. A muddling or thickening effect can result, but IMD is very slight in modern equipment and, while it does not always feature in specifications, it will be low if the THD is low. **Frequency response.** This is not the same as the bandwidth already mentioned. The response is checked at low power and will be linear and extended (well beyond the upper audio limit) in hi-fi units—typically 10Hz—50kHz \pm 1dB. Although it must be wide and flat, frequency response in isolation tells us less than do most spec. features about amplifier goodness.

Noise. Earlier the importance of dynamic range was emphasised. Noise, in the form of hum and hiss, militates against dynamic range and must be minimised. A 60dB ratio of signal to noise is a good and practical figure as a focal point for investigation and argument, and it means that the noise at the

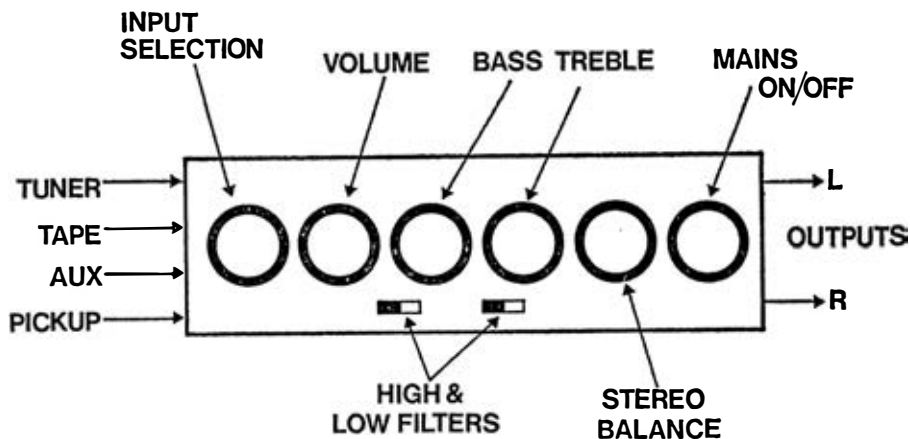

Typical control line-up on an amplifier.

output, under certain conditions of test, should not exceed one millionth of the rated power. Amplifiers of outstanding quality yield even better figures.

It is easier to obtain such a result via some inputs than elsewhere: the high-sensitivity magnetic cartridge input is particularly noise-prone yet obviously very important. The higher the dB figure, the better the hum/noise performance.

Input sensitivity. This is the rms voltage required at an input to produce maximum power output with the volume control fully advanced. The figure for a magnetic pickup input will be in the range 2 to 5mV approximately. Other inputs (tuner, recorder, etc) will be 50mV to 500mV or thereabouts, according to function. The lower the mV figure, the greater the sensitivity.

Input impedance (that presented by the input to the device connected) is: 47kohms for magnetic pickups (possibly slightly higher); and 100kohms-2Megohms for other inputs according to function.

An input signal voltage greater than that specified can be applied but eventually a point will be reached where the circuit overloads and distortion sets in. For instance, a pickup with a nominal output of 5mV can, and often will, be connected to an input of 2-3mV sensitivity. What matters is that the input circuits can handle the intermittent peaks of signal from the pickup, rising far above the nominal value.

Recorded velocities can be high, as explained in the section on pickups, and the '5mV' pickup can generate several times this voltage. The peaks may be fleeting, but this is no reason for the overload capability to be restricted. A generous overload margin is good hi-fi practice, not yet observed by all designers. For example, an amplifier inspected when these notes were being prepared had a 2mV input which overloaded at 35mV, giving a margin of about 25dB. This is poor and raises doubts about the hi-fi status of the product.

Typical specification

Here are the major items from a published specification. This is a typical medium-powered amplifier of good quality.

CONTINUOUS RATING

25W per channel into 8 ohms, one channel driven.

20W per channel into 8 ohms, both channels driven.

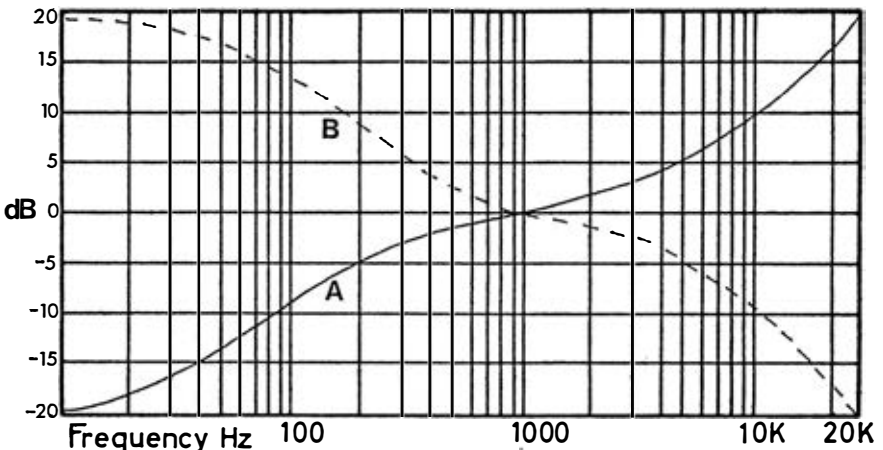

Standard disc recording curve, A. The replay characteristic B is applied in the hi-fi amplifier, and the resulting response is linear.

IHF MUSIC POWER

60W total, both channels.

POWER BANDWIDTH

15-28,000Hz (-3dB).

FREQUENCY RESPONSE

15-40,000Hz \pm 1dB, Aux. input.

HARMONIC DISTORTION

Not exceeding 0.3%, rated output, 1kHz (8 ohms).

INPUT SENSITIVITY (for rated output)

Phono 1 2.5mV 47kohms

Phono 2 2.5mV 47kohms

Tuner 180mV 100kohms

Aux/tape in 180mV 100kohms

RECORDING OUTPUT

150mV

HUM & NOISE

Phono 1 -62dB

Phono 2 -62dB

Tuner -70dB

Aux -70dB

OUTPUT IMPEDANCE

Suitable 4 to 16 ohms

DAMPING FACTOR

50 at 8 ohms

BASS & TREBLE CONTROLS

Range \pm 12dB

LOW FILTER

-12dB at 50Hz

HIGH FILTER

-10dB at 10kHz

HEADPHONES

Outlet for 8-50 ohms 'phones

Equalisation

This feature of record reproduction often bothers amateur enthusiasts. They hear about something called RIAA and learn that there is something special about the pickup input on the amplifier.

When the original LP stereo or mono disc is cut the signals are processed in accordance with a recording characteristic—a sloping response curve (see illustration) depicting a bass attenuation, to restrict recorded amplitude, and a boosted high-frequency end, to aid discrimination against noise. The agreed RIAA curve, the same as that in the relevant British Standard, is generally applied to LP recording.

When the record is reproduced the bass is boosted and the treble attenuated, restoring the balance in the response sense. The equalising circuits are built into the hi-fi amplifier input section and provide a mirror-image characteristic, so that the emerging signal is nominally 'flat'. Obviously the accuracy of this equalisation is of great importance, and special mention of it is often to be seen in test reports on amplifiers.

The need for this tailor-made equalising arises because the magnetic pickup follows the characteristic, passing on the bass cut and treble emphasis. The amplifier restores the balance and the user does not have to concern himself with it beyond ensuring the correct input sockets are used. However, all this applies to magnetics only. Ceramic and crystal pickups can provide their own equalising, of a rough and ready kind, and are normally connected to a different input. Practically all high fidelity amplifiers have high-sensitivity

inputs for magnetic pickups, and it is in this type of input stage that the equalisation is incorporated.

A different curve was applied to 78rpm discs and if you play these through a modern amplifier the equalisation will be wrong, but you can help it out by experimenting with the tone controls.

VHF/FM radio

For the music-lover with a taste for high quality sound, radio via the VHF/FM transmissions is almost as attractive a programme source as records and tapes. In the UK this high quality service—an intrinsically local service involving a large number of transmitters for extensive coverage—has existed for well over 20 years on Band II, 87.5–100MHz. For the hi-fi enthusiast, FM stands for fidelity. AM, with crowded broadcast bands and noisy reception, is of no use at all.

In the FM band we find Radio 2, 3 and 4 and also the more recently introduced local radio stations. One attractive thing about FM is its cheapness as a quality programme source. A FM or FM/AM tuner can be used with a hi-fi amplifier of different make, and some manufacturers of amplifiers also make tuners. Or a combined tuner-amplifier (hi-fi receiver) can be used. There are many such integrated receivers, often the equivalent of separate tuner and amplifier (though this is rarely true of tuner-amplifiers at the lower end of the price range). Separate tuners generally cost about the same as amplifiers, especially in the middle of the price range.

Principal advantages of FM can be summed up as follows. The use of the VHF band gives scope for a wide frequency range and superior dynamic range; there is discrimination against AM noise, embracing a great deal of local electrical interference, provided the incoming signal is strong enough; and with 'live' broadcasts and generally good conditions the distortion generated may be less than from discs or tapes.

Obviously a lot of programmes involve recordings, and others depend on methods of production or distribution that are less than ideal. But FM at its best is impressive and should be judged on the basis of live broadcasts. If the BBC happens to be broadcasting a LP with a range of 50-12,000Hz, then that is the response you will enjoy via your tuner. You might as well play your records; and they will sound better if you happen to use a cartridge that is better than the one the BBC favours.

The important advantages will not be realised if the aerial is not suited to the circumstances. A dipole aerial is required, and it may be a simple dipole or a more elaborate array, depending on any local problems of reception. Many complaints arise simply because of inadequate aerials. The BBC can advise on problems of reception, but for guidance on local conditions and aerial requirements consult a local radio or components supplier.

Early experiments with broadcast stereo involved two transmitters and two receivers. In due course a system for the transmission of both channels simultaneously was devised by General Electric and Zenith in the USA, and this Zenith-GE 'multiplex' system came into general use. It is a compatible system: stereo transmissions can be received and reproduced as mono by mono tuners and radio sets. In the UK, stereo is transmitted on Radio 3 via certain of the FM stations. Details of these broadcasts, together with frequencies of all services, are given in *Radio Times*.

Stereo can be regarded as the sum of the two channels or the difference: $L+R$ and $L-R$. In the multiplex system the sum gives the usual mono, and the difference signal undergoes processing, or encoding, and is later presented along with the sum. For stereo reception a decoding process, involving special circuits, has to be applied in the tuner. Only a stereo tuner, equipped with a decoder, will sort out the complex information into left and right.

6 LOUDSPEAKERS

THERE ARE hundreds of loudspeakers of all shapes and sizes from which the hi-fi enthusiast can choose. As far as measurable properties are concerned they embrace the good, the bad and the in-between. Each sounds a little different from the next—a finding that may trouble the new student of the subject who, while feeling overwhelmed by fast-moving developments in electronics, considers that the basic facts about speaker operation are at least accessible.

After all, the source of the sound is a vibrating diaphragm or cone which, for hi-fi, is expected to radiate the widest possible range of frequencies with the least possible distortion. Rather homely and obviously simple. Or is it?

In fact the subject is a complex one, and good loudspeakers are not all that simple. Measuring their performance can be troublesome, and describing their qualities can be even more of a problem. You know what you like when you hear it, and you will choose according to your experience of listening, the price, size and so forth. Meanwhile it is helpful to assemble the technical background, starting with the simplest elements.

Nearly all commercial speaker systems incorporate the moving-coil drive unit, some parts of which are illustrated. This type of unit radiates from front and rear. Considering the front radiation, the output tends to 'beam', rather than spread widely, as frequency is increased; but down in the bass region the output spreads out in all directions. While the diaphragm is pushing air to its front it is tending to rarefy the atmosphere behind.

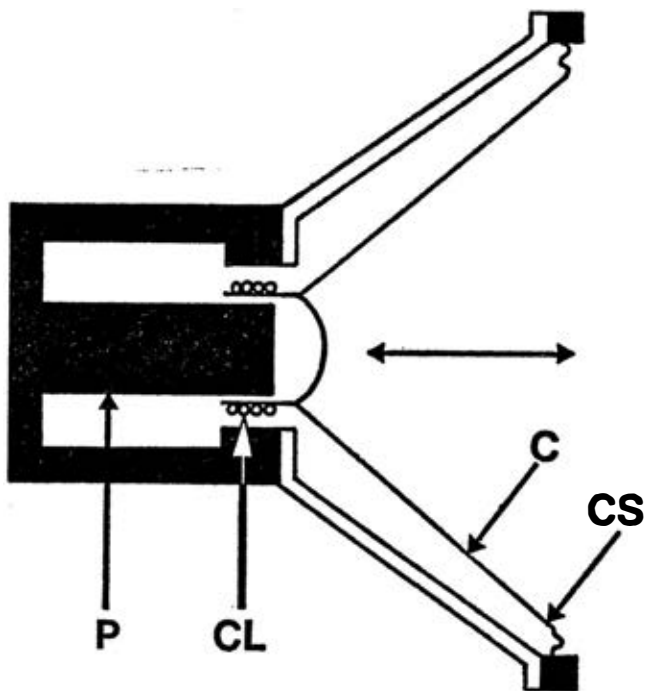

Moving-coil speaker unit: C cone or diaphragm. CS surround (suspension). CL coil. P magnet pole-piece. Another suspension device is located behind the apex of the cone. Compliance of the spring-like suspensions and the mass of the diaphragm give the fundamental resonance of the unit.

low frequencies, where the output is diffuse, the air at the front rushes round to the rear, and the front and rear radiations cancel.

Prevention of this cancellation is one job of the enclosure (cabinet), which enables low bass to be reproduced. In the simplest terms it prevents the frontal radiation reaching the back of the drive unit. An apparent solution would be to mount the driver on a flat baffle, but the dimensions would be inconveniently large for reproduction of the lowest frequencies. Or the unit could be sealed into a hole in the wall dividing two rooms. However, for convenience and manoeuvrability we really need enclosures.

Although the enclosure strongly influences what we hear in the low part of the spectrum, it has no such part to play at the highest frequencies. It does have *some* influence on design but that is outside the scope of this introductory account. The fact that there are good reasons for considering bass and treble separately does, however, concern us.

A single drive unit is not generally capable of radiating smoothly and efficiently right through the audio spectrum. The relatively big bass unit is good at bass reproduction; the purpose-built treble unit, known as a 'tweeter', cannot produce any bass at all. Practically all high fidelity speaker systems employ at least two units: some have three or four. The actual number is not a guide to quality, and an imposing array of tweeters is likely to betray a lack of knowledge of speaker design.

The important point is that speaker units are 'specialised' and can be combined to give the required results. This integration involves the use of filters—crossover networks—which share out sections of the frequency range to the drive units. Further, the mechanical/acoustical characteristics of the units have to be considered in association with the filter design.

Even the coaxial or dual concentric speaker is of this sort, for the units are still separate though concentric, and they are electrically separated by a filter. In all such instances the requirements are a small, light diaphragm to radiate high frequencies and larger, heavier diaphragms to handle the mid-range and the lows.

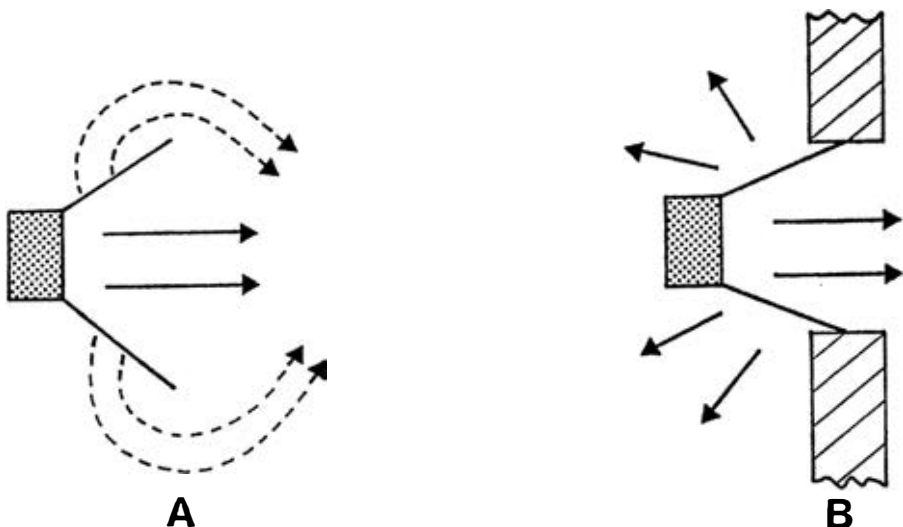

Loudspeaker drive unit. A: front and rear radiations cancel. B: baffle prevents this interaction.

The necessary components are brought together in systems of various sizes and capabilities, in variety to suit everyone, and at prices from around £15 for a miniature to well over £100 for a high-grade speaker of professional quality.

Of the less commonly exploited principles of operation the electrostatic is particularly important. Operation depends on the attraction between electrically charged surfaces. In practice a light plastics diaphragm is located between metal plates in a push-pull arrangement, and movement is caused by varying charges. A polarising voltage and an audio input are required. Both treble and wide-range examples are made.

Then there is the 'ionophone' of which there is a commercial version. Here, the air in a small tube is ionised and the density of ionisation is modulated by the audio; and the output is coupled to the outside air by a horn, radiating high frequencies only. Another unit is the ribbon speaker in which the main parts are an aluminium ribbon and a magnet system. Again the device is presented as a horn-loaded tweeter.

Specifications

One speaker manufacturer suggests that we use published specifications as a guide—no more than that. But are they even a guide? In the face of difficulty in expressing anything useful, very many manufacturers settle for a short list which includes cabinet dimensions, drive-unit complement, an optimistic frequency range, a 'power rating' and some oddments, none of which tell us much about the model's capabilities. However, there is more than that to be said about the technical side of this subject. Here is an introduction.

System resonance. This is sometimes quoted for speaker systems of the total-enclosure variety—the great majority of popular models in low and middle price ranges. The bass driver has its own resonant frequency, as measured in free air (out of its enclosure), and the system resonance will be higher than that due to the effect of the air trapped in the enclosure. In a typical small speaker the drive unit might have a fundamental bass resonance at 30Hz but the system resonance would be an octave or so higher. We cannot expect much low-distortion output below system resonance, and in good designs the frequency is kept as low as possible.

Frequency response. Rarely does one see a frequency response quoted. On the other hand, frequency ranges without benefit of dB limits are common enough, and these may or may not have been obtained scientifically—by

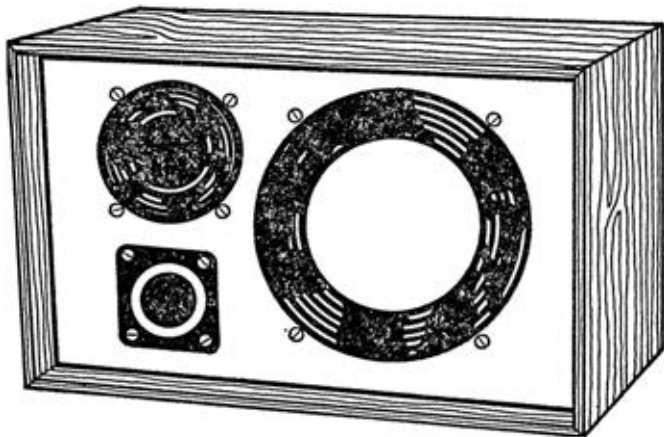

Drive units in a three-way speaker system.

measurements in an anechoic chamber. A response of $60-16,000\text{Hz}\pm 4\text{dB}$ would be uncommonly good. As with pickups it is most useful to see the response in graphical form, but a little experience is necessary for ready interpretation of results obtained under anechoic conditions.

Under test conditions the exploration of response on and off the axis of the speaker forms polar diagrams, which tell the expert a lot about the dispersion characteristics of the system and provide guidance on how successful a pair will be for stereo and, indeed, how likeable the speakers will be to live with. Very rarely does a manufacturer publicise this aspect, but reference to it will sometimes be found in critical reporting on performance.

Distortion. Perhaps we should not be surprised that distortion is mentioned in very few specifications. It is higher in speakers than in other components, and it is not very easy to interpret laboratory data except when figures are obtained for a group of speakers tested under the same conditions. Typical harmonic distortion figures are in the range 1-10% for popular systems. We should remember this when admiring the latest piece of low-distortion audio electronics.

Efficiency. Another difficult one. Test reports may provide a clue by quoting the sound pressure level obtained for a specified input. All speaker systems are inefficient, but that bothers few users—and there is no relationship between efficiency and quality. Typical efficiencies for total-enclosure and small vented systems are 1-5%. Horns are somewhat more efficient (so the amplifier rating can be lower) but they are also complicated and little used.

Power rating. Few manufacturers state very clearly what they mean by the power rating or handling capacity they quote. And if you want to know more it is difficult to obtain an unequivocal reply! A quoted rating will remind you not to go to extremes in driving power. It is pointless to use a 8W per channel with large speakers that have 25W mentioned in the specification; and it is risky to connect a 50W amplifier to 8W speakers. These are extremes. It is reasonable to have reserve power and thus finish up using a 50-watt amplifier with 25-watt speakers, assuming we are talking about music programmes and not sine waves! Finally, a power rating has *nothing at all* to do with how loud the music sounds.

Impedance. The user is concerned with the nominal impedance quoted by the manufacturer. This is often 8 ohms, but some European makers work to a lower matching impedance. In fact the nominal impedance applies

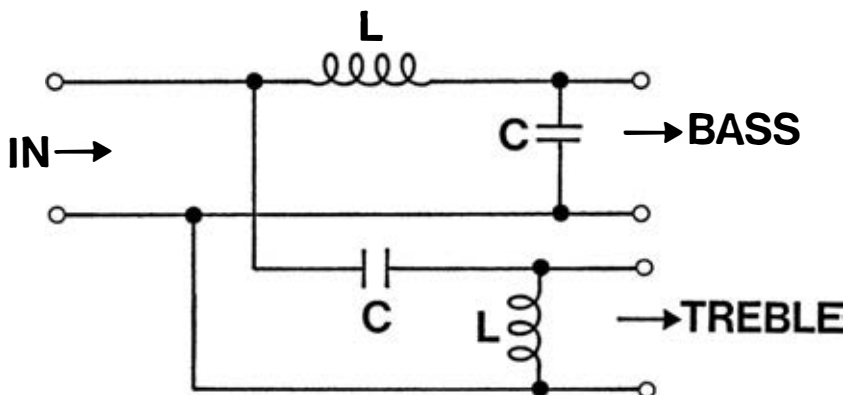

Crossover network—one of several possible arrangements to feed separate bass and treble drive units.

at one or a few frequencies. An impedance curve is included to show how the impedance may vary through the range. We shall return to impedance matching, and for the moment the equipment user may care to note that, as with some other requirements, it is a matter of not going to extremes when linking one item to another. Gross mismatching of amplifier to speakers will result in some loss of available power or possibly faulty amplifier operation.

Enclosures

As we have seen it is necessary to prevent interaction between the two sides of the diaphragm. In conventional speaker systems an enclosure of wood, particle board or other material is employed, and an important question then arises—what is to be done with the energy inside the enclosure? With some designs it is possible to use the energy to some extent—to ‘redirect’ it.

In others, efficient absorption is vital lest it prove a nuisance by actually ruining the sound quality. In the worst instance it may even be reflected back through the drive unit so that the wanted sound is highly coloured by a mess of reflections. Unless the designer pays very close attention to such matters it is unlikely that his product can be elevated to hi-fi status.

For every elaborate speaker on the market there are dozens of total-enclosure designs—the closed box often, though inappropriately, called an ‘infinite baffle’ (what is infinite about a one-cubic-foot box?). This principle is widely exploited because it lends itself to quick and cheap production, and successful *small* speakers can be made this way to suit most tastes. Otherwise there is no special merit in the idea.

A notable characteristic is a falling bass response, but a good example will behave well when extra power is fed in to adjust the treble/bass balance. This is done by advancing the bass control on the amplifier. Total-enclosure systems most often have two, three or (occasionally) four drive units, the bass unit having a compliant suspension and low fundamental resonance.

At one time very popular and still seen on occasion, the simple vented, or reflex, enclosure offers a bonus in the low-frequency region where the phase-reversing property of the enclosure brings internal energy out from the vent to augment that radiated from the front of the diaphragm. (Those intent on deeper study, please look up Helmholtz resonators in the physics text-book.)

Instead of being out of phase with the frontal radiation, the bass energy from the vent of this resonant system is in phase, giving a reinforcing effect. ‘In phase’ in this context means in step: two radiations that are complementary. There are variants such as an enclosure in which the vent is treated with material that will present resistance—in the acoustical sense—to influence the resonant behaviour.

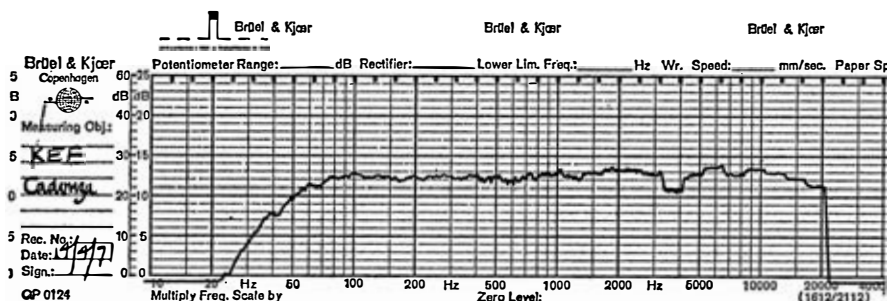

Frequency response obtained by measurement in an anechoic chamber.

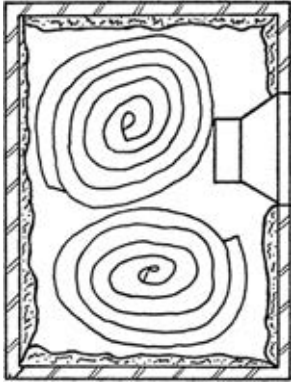

A

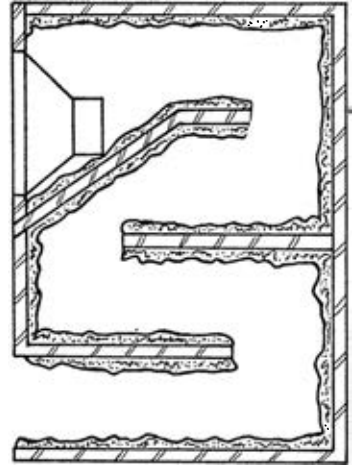

B

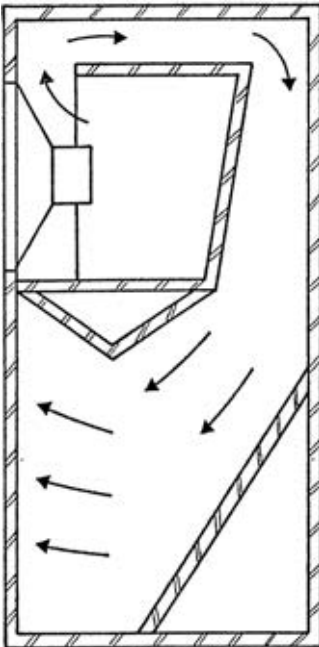

C

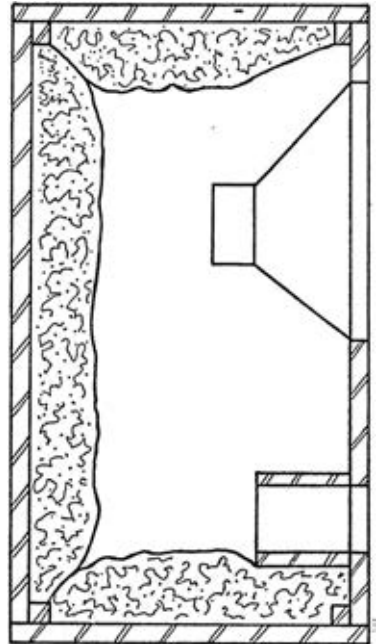

D

Enclosures. A, total enclosure (infinite baffle). B, labyrinth. C, folded horn. D, vented (reflex). Type A and forms of D are in common use. B and C are less common but favoured for more costly designs.

Acoustically loading a drive unit by placing a flared horn in front of it raises efficiency and gives low distortion because the diaphragm movements can be smaller. For deep bass the horn has to be inconveniently large but a compromise can be reached by folding the horn back on itself, and in practice the folds are contained within the shell of a cabinet. In this case a wide-range unit can be forward-facing and loaded at the rear by the horn.

Other types include columns, pipes and the very successful labyrinth with its variant the transmission line in which a long folded and tapered pipe within an enclosure shell contains materials to give progressive absorption of energy and add acoustic mass to the bass diaphragm.

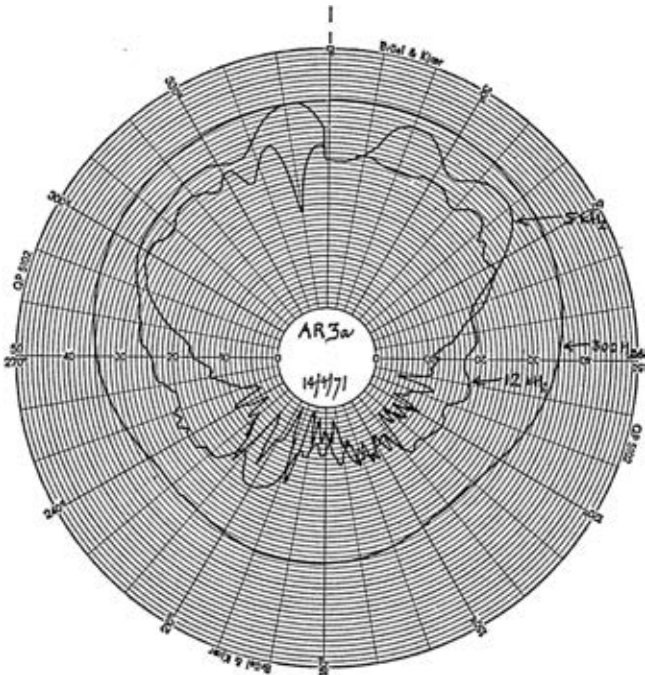

Polar response of a modern speaker.

7 TAPE EQUIPMENT

THE CREATIVE sound enthusiast who admires tape recording for its versatility, and is interested in it as a hobbyist and experimenter rather than a music-lover, will have a clear idea of his special needs. For the hi-fi enthusiast one of the most useful topics is a comparison of tape and disc—with an eye on costs and quality. Shall tape be included in the system and will it offer advantages? Will it in any case supersede discs?

Certainly these aspects claim attention, especially when it comes to planning systems, buying the equipment or making additions. For the moment a summary of specification points relevant to hi-fi will provide an introduction.

Tape speeds. Running speed influences frequency response and signal-noise ratio. With spool-to-spool domestic recorders of high quality it is usual to run at $7\frac{1}{2}$ ips for best results, although with some really good machines all but the most demanding of listeners will derive much pleasure from programmes recorded at $3\frac{3}{4}$ ips. So far the $1\frac{7}{8}$ ips speed has been acceptable for speech and background sounds but new developments in cassettes lead to some cautious revision of attitude.

Wow flutter are lower in open-spool machines than in cassette machines, and combined figures of 0.15-0.2% at $7\frac{1}{2}$ ips and 0.2-0.3% at $3\frac{3}{4}$ ips are often noted.

Frequency response. As always, a response is quoted with dB limits to indicate departures from linearity, although often the manufacturers reveal only a range. A response of 40-16,000Hz ± 2 dB at $7\frac{1}{2}$ ips, though not spectacular, is acceptable in a robust, semi-professional machine for which honest claims are made. An upper limit of 16-20kHz with a fall-off not exceeding -3dB would be very good indeed, provided signal-noise is not worse than about -50dB.

The problem is that manufacturers do not follow a standard method of specifying response. Is the 'response' simply derived from a test tape?

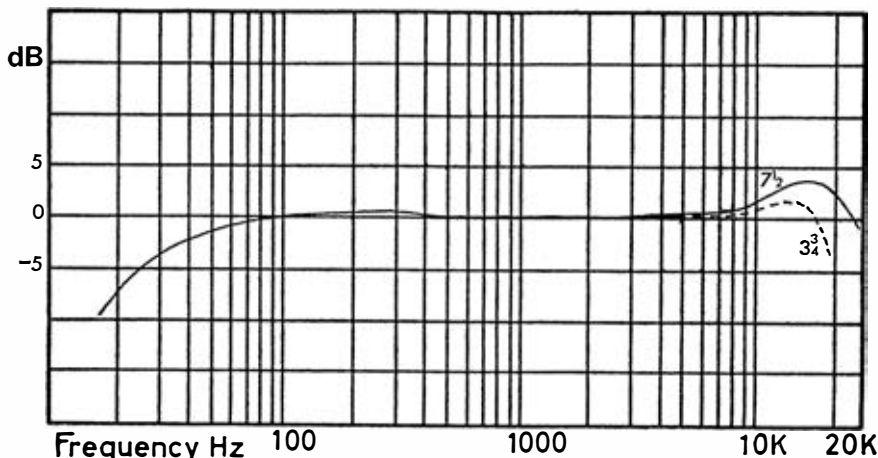

Record-to-replay frequency response of a tape recorder. Note that the hf end is more extended at $7\frac{1}{2}$ ips.

Does it take in the recording circuits? Does it apply right through the process from record to replay? There is no ready answer: we can only ask the questions and hope the problems will be resolved. Let the buyer beware: specifications of different makes of machine are not readily comparable.

Signal-to-noise. Throughout the audio system the signal-noise ratio is all-important, influencing as it does the dynamic range that can be achieved. A high noise level spells disaster for hi-fi. Earlier it was implied that a figure of -60dB should be the focus of attention as things stand at present. A performance of this order is secured consistently with only the finest equipment, and it is out of the question if economies are necessary.

A figure nearer -50dB is much more realistic when we come to consider commercial equipment at moderate prices. But what sources of noise are taken into account? There is hum from the mains; there is noise from the bias/erase oscillator; there is noise from the tape; and we must remember that signals pass through circuits twice, collecting noise on the way—during recording and replay. Really a signal-noise ratio of -50dB at $7\frac{1}{2}\text{ips}$, honestly specified, is not too bad; but one could wish for clear qualifications: 'record to replay', 'referred to full output from fully modulated tape. . .' and so on.

Track width affects performance. Usually, half-track operation is a little better than quarter-track. Most important: low noise level is much more important than a few extra Hz at the top end of the range.

Crosstalk. The crosstalk between stereo channels is usually not worse than -40dB , including head leakage. Quoting circuits only may give a better figure, such as -55dB , but is dishonest. In any event channel separation on tape replay is better than on disc.

Distortion. Figures are rarely quoted. Distortion, typically 1-5%, is higher than in disc replay.

Tape for hi-fi. Stereo and mono recording and replay using a stereo machine can be associated with high fidelity systems. There are comparatively few mono machines of good quality—the majority of recorders imported from Japan and Europe are stereo, employing the quarter-track system. Although those seeking a general-purpose recorder will require facilities that include output stages and perhaps speakers of some kind, the music enthusiast really needs no more than a tape record/replay unit

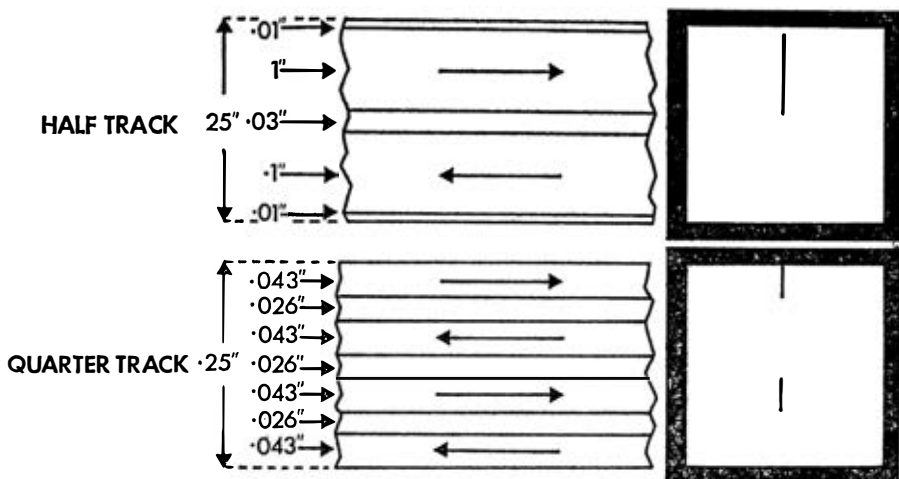

Tape track arrangements, half-track and quarter-track.

for direct connection to the hi-fi amplifier. This does not prevent the use of microphones; nor does it rule out practical work involving tape editing. Prices of stereo units are in the approximate range £75 to £200 or more.

Recent developments include the more widespread use of the Philips compact cassette. This is a spool-to-spool system employing $\frac{1}{8}$ in. tape at $1\frac{7}{8}$ ips (four tracks: two used in each direction for stereo) in a small plastics housing. Although most generally used in strictly lo-fi portables where high noise levels, restricted response and poor speed stability are accepted, the cassette appears capable of better performance—as evidenced by a few advanced machines incorporating superior mechanisms and heads and the Dolby noise-reduction system. Not at present of interest for hi-fi is the American closed-loop tape 'cartridge' system with eight tracks (two or four used at a time) employing $\frac{1}{2}$ in. tape at $3\frac{3}{4}$ ips.

8

HI-FI MANUFACTURERS

MANY ENTHUSIASTS start on the road to hi-fi by reading about the subject, and a certain amount of technical literature is usually required to aid short-listing of products. Manufacturers' and importers' leaflets and brochures are freely available. The following is not claimed to be a comprehensive listing but includes many leading names.

CARTRIDGES, PICKUP ARMS

Acos	Cosmocord Ltd., Eleanor Cross Road, Waltham Cross, Herts.
Audio Developments	B. H. Morris & Co., (Radio) Ltd, 84 Nelson Street, London E1.
ADC	Hisonic Ltd, Tovil, Maidstone, Kent.
Audio Technica	Shriro (UK) Ltd, 42 Russell Square, London WC1.
Bang & Olufsen	Bang & Olufsen UK Ltd, Eastbrook Road, Gloucester.
Connoisseur	A. R. Sugden & Co. (Engineers) Ltd, Market Street, Brighouse, Yorks.
Decca	Decca Special Products, Ingate Place, Queenstown Road, London SW8.
Eagle	B. Adler & Sons (Radio)Ltd, Coptic Street, London WC1.
Elac	Unilet Products Ltd, Compton House, Malden Road, New Malden, Surrey.
Empire	Rank Audio Visual, PO Box 70, Great West Road, Brentford, Middlesex.
Goldring	Goldring Mfg Co., (GB) Ltd, 10 Bayford Street London E8.
GH	G. F. C. Hadcock, The Old Vicarage, Doveridge, Derby.
Micro Seiki	B. H. Morris & Co. (Radio) Ltd., 84 Nelson Street, London E1.
Monks	Keith Monks (Audio) Ltd, 5 Fleet Road, Fleet, Hants.
Neat	Howland-West Ltd, 2 Park End, South Hill Park, London NW3.
Ortofon	Metrosound (Sales) Ltd, Cartersfield Road, Waltham Abbey, Essex.
Orbit	Highgate Acoustics, 184 Great Portland Street, London W1.
Philips	Philips Electrical Ltd, Century House, Shaftesbury Avenue, London WC2.
Pickering	Highgate Acoustics, 184 Great Portland Street, London W1.

Shure	Shure Electronics Ltd, 84 Blackfriars Road, London SE1.
Stanton	Metrosound (Sales) Ltd, Cartersfield Road, Waltham Abbey, Essex.
SME	SME Ltd, Steyning, Sussex.
Sonotone	Brush Clevite Ltd, Thornhill, Southampton.
Sony	Sony (UK) Ltd, Pyrene House, Sunbury-on-Thames, Middlesex.
Transcriptors	Transcriptors Ltd, 2 Theobald Street, Boreham Wood, Herts.
Worden	Worden Audio Developments Ltd, 54 Chepstow Road, London W2.
TURNTABLES	
Acoustic Research	Bell & Howell Ltd, Alperton House, Bridgewater Road, Wembley, Middlesex.
Bang & Olufsen	Bang & Olufsen Ltd, Eastbrook Road, Gloucester.
BSR McDonald	BSR Ltd, Monarch Works, Cradley Heath, Warley, Worcestershire.;
Connoisseur	A. R. Sugden & Co. (Engineers) Ltd, Market Street, Brighouse, Yorks.
Decca	Decca Special Products, Ingate Place, Queenstown Road, London SW8.
Dual	Dual Electronics Ltd, Paramount Industrial Estate, Stokenchurch, Bucks.
Garrard	Garrard Engineering Ltd, Newcastle Street, Swindon, Wiltshire.
JP	Howland-West Ltd, 2 Park End, South Hill Park, London NW3.
Lenco	Goldring Mfg Co, (GB) Ltd, 10 Bayford Street, London E8.
Micro Seiki	B. H. Morris & Co, (Radio) Ltd, 84 Nelson Street, London E1.
PE	Highgate Acoustics, 184 Great Portland Street, London W1.
Philips	Philips Electrical Ltd, Century House, Shaftesbury Avenue, London WC2.
Pioneer	Shriro (UK) Ltd, 42 Russell Square, London WC1.
Sansui	Vernitron Ltd, Thornhill, Southampton,
Sanyo	Sanyo Marubeni (UK) Ltd, Bushey Mill Lane, Watford, Herts.
Sony	Sony (UK) Ltd, Pyrene House, Sunbury-on-Thames, Middlesex.

Thorens	Metrosound (Sales) Ltd, Cartersfield Road, Waltham Abbey, Essex.
Transcriptors	Transcriptors Ltd, 2 Theobald Street, Boreham Wood, Herts.
AMPLIFIERS, TUNERS	
AR	Bell & Howell Ltd, Alperton House, Bridgewater Road, Wembley, Middlesex.
Alba	Alba (Radio & Television) Ltd, Tabernacle Street, London EC2.
Alpha	Highgate Acoustics, 184 Great Portland Street, London W1.
Akai	Rank Audio Visual, PO Box 70, Great West Road, Brentford, Middlesex.
ARD	Audio Research & Development Ltd, PO Box 73, Hounslow, Middlesex.
Armstrong	Armstrong Audio Ltd, Warlters Road, London N7.
Bang & Olufsen	Bang & Olufsen Ltd, Eastbrook Road, Gloucester.
Bryan	Bryan Amplifiers Ltd, 18 Greenacres Road, Oldham, Lancs.
Bush	Rank Bush Murphy, Power Road, London W4.
Cambridge	Cambridge Audio Laboratories Ltd, The River Mill, St. Ives, Huntingdon.
Chapman	Reslosound Ltd, Spring Gardens, Romford, Essex.
Dual	Dual Electronics Ltd, Paramount Industrial Estate, Stokenchurch, Bucks.
Dulci	Lee Products Ltd, 10-18 Clifton Street, London EC2.
Dynaco	Howland-West Ltd, 2 Park End, South Hill Park, London NW3.
Dynatron	Dynatron Radio Ltd, St. Peter's Road, Furze Platt, Maidenhead, Berks.
Eagle	B. Alder & Sons (Radio) Ltd, Coptic Street, London WC1.
Ferrograph	Ferrograph Co, Ltd, The Hyde, Edgware Road, London NW9.
Goldring	Goldring Mfg Co, (GB) Ltd, 10 Bayford Street, London E8.
Goodmans	Goodmans Loudspeakers, Lancelot Road, Wembley, Middlesex
Grundig	Grundig (GB) Ltd, Newlands Park, London SE26.
Korting	Europa Electronics Ltd, Howard Place, Shelton, Stoke-on-Trent.

Lafayette	Barnet Factors Ltd, 147 Church Street, London W2.
Leak	H. J. Leak & Co Ltd, Idle, Bradford, Yorks.
LL	LL Electronics Ltd, 9 Brydges Road, London E15.
Lowther	Lowther Mfg Co, St. Marks Road, Bromley, Kent.
Lux	Howland-West Ltd, 2 Park End, South Hill Park, London NW3.
Metrosound	Metrosound Mfg Co, Ltd, Cartersfield Road, Waltham Abbey, Essex.
National	Unamec Ltd, PO Box 1, United Africa House, Blackfriars Road, London SE1.
Nikko	Howland-West Ltd, 2 Park End, South Hill Park, London NW3.
Nivico	Denham & Morley Ltd, 453 Caledonian Road, London N7.
Peak Sound	Peak Sound (Harrow) Ltd, 32 St. Judes Road, Englefield Green, Egham, Surrey.
Philips	Philips Electrical Ltd, Century House, Shaftesbury Avenue, London WC2.
Pioneer	Shiro (UK) Ltd, 42 Russell Square, London WC1.
Quad	Acoustical Mfg. Co. Ltd, Huntingdon, Hunts.
Radford	Radford Audio Ltd, Ashton Vale Estate, Bristol, BS3 2HZ.
Revox	Revox, Lamb House, Church Street, London W4.
Richardson	Richardson Electronics Ltd, 57 Jamestown Road, London NW1.
Rogers	Rogers Developments (Electronics) Ltd, Barmeston Road, London SE6.
Rotel	Rank Audio Visual, PO Box 70, Great West Road, Brentford, Middlesex.
Sansui	Vernitron Ltd, Thornhill, Southampton.
Scott	A. C. Farnell Ltd, 81 Kirkstall Road, Leeds 3.
Sharp	Sharp Electronics Ltd, 48 Derby Street, Manchester M8 8HN.
Sinclair	Sinclair Radionics Ltd, 22 Newmarket Road, Cambridge.
Shure	Shure Electronics Ltd, 84 Blackfriars Road, London SE1.
Sony	Sony (UK) Ltd, Pyrene House, Sunbury-on-Thames, Middlesex.
Sugden	J. E. Sugden & Co. Ltd, Bradford Road, Cleckheaton, Yorks.

Telefunken	AEG (GB) Ltd, Chichester Rents, Chancery Lane, London WC2.
Teleton	Teleton Electro (Distributors) Ltd, Robjohns Road, Widford, Chelmsford, Essex.
Toshiba	Hanimex (UK) Ltd, 15-24 Great Dover Street, London SE1.
Tripletone	Factory 1, 138 Kingston Road, London SW19.
Trio	B. H. Morris & Co (Radio) Ltd, 84 Nelson Street, London E1.
Uher	Bosch Ltd, Rhodes Way, Watford, Herts.
Wharfedale	Rank Wharfedale, Idle, Bradford, Yorks.
LOUDSPEAKERS	
AR	Bell & Howell Ltd, Alperton House, Bridgewater Road, Wembley, Middlesex.
Arena	Highgate Acoustics, 184 Great Portland Street, London W1.
Bang & Olufsen	Bang & Olufsen UK, Eastbrook Road, Gloucester.
Brimham	P. F. & A. R. Helme, Summerbridge, Harrogate.
B & W	B & W Electronics Ltd, Littlehampton Road, Worthing, Sussex.
Cambridge	Cambridge Audio Laboratories Ltd, The River Mill, St. Ives, Huntingdon.
Celestion	Rola Celestion Ltd, Foxhall Road, Ipswich, Suffolk.
Decca	Decca Special Products, Ingate Place, Queenstown Road, London SW8.
Derwent	Nichols Acoustical Fitments, Church Street, Bubwith, Selby, Yorks.
Dual	Dual Electronics Ltd, Paramount Industrial Estate, Stokenchurch, Bucks.
Dynastatic	Electrostatic Loudspeaker Co, 82 East Barnet Road, New Barnet, Herts.
Francis	J. J. Francis Ltd, 123 Alexandra Road, London N8.
Goodmans	Goodmans Loudspeakers Ltd, Lancelot Road, Wembley, Middlesex.
Heathkit	Heath (Gloucester) Ltd, Gloucester.
Howland-West & Dynaco	Howland-West Ltd, 2 Park End, South Hill Park, London NW3.
IMF	IMF Products (GB), 62-8 Silver Street, Reading, Berks.
Jordan-Watts	Boosey & Hawkes (Sales) Ltd, Deansbrook Road, Edgware, Middlesex.
KEF	KEF Electronics Ltd, Tovil, Maidstone, Kent.
Keletron	K & K Electronics, 25 Roman Road, London E2.
J. B. Lansing	Feldon Recording, 126 Great Portland Street, London W1.

Leak	H. J. Leak & Co Ltd, Idle, Bradford, Yorks.
LNB	LNB Audio Ltd, 25 Cambridge Street, Loughborough, Leics.
Lockwood	Lockwood & Co, 63 Lowlands Road, Harrow, Middlesex.
Lowther	Lowther Mfg. Co, St. Marks' Road, Bromley, Kent.
Metrosound	Metrosound Mfg. Co. Ltd, Cartersfield Road, Waltham Abbey, Essex.
Monks	Keith Monks (Audio) Ltd, 5 Fleet Road, Fleet, Hants.
Michelsen	Edward Michelsen, 153 Plumstead Road, London SE18.
Mordaunt-Short	Mordaunt-Short Ltd, The Courtyard, Heath Road, Petersfield, Hants.
Nivico	Denham & Morley (Overseas) Ltd, 453 Caledonian Road, London N7.
Peak Sound	Peak Sound (Harrow) Ltd, 32 St. Judes Road, Englefield Green, Egham, Surrey.
Philips	Philips Electrical Ltd, Century House, Shaftesbury Ave, London WC2.
Pioneer	Shriro (UK) Ltd, 42 Russell Square, London WC1.
Quad	Acoustical Mfg. Co. Ltd, Huntingdon, Hunts.
Radford	Radford Audio Ltd, Ashton Vale Estate, Bristol BS3 2HZ.
Radon	Radon Industrial Electronics Co. Ltd, Brooklands Trading Estate, Orme Road, Worthing, Sussex
Richard Allan	Richard Allan Radio, Bradford Road, Gomersal, Cleckheaton, Yorks.
Rogers	Rogers Development (Electronics) Ltd, Barmeston Road, London SE6.
Sheppard	Sheppard Audio, 31 New Berries Parade, Radlett, Herts.
Sonab	Sonab Ltd, 136 Mansfield Road, London W3.
Sony	Sony UK Ltd, Pyrene House, Sunbury-on-Thames, Middlesex.
Tannoy	Tannoy Products Ltd, West Norwood, London SE27.
Wharfedale	Rank Wharfedale, Idle, Bradford, Yorks.
Whiteley	Whiteley Electrical Radio Co. Ltd, Victoria Street, Mansfield, Notts.
Worden	Worden Audio Developments Ltd, 54 Chepstow Road, London W2.
TAPE RECORDERS	
Akai	Rank Audio Visual, PO Box 70, Great West Road, Brentford, Middlesex.
Bell & Howell	Bell & Howell Ltd, Alperton House, Bridgewater Road, Wembley, Middlesex.
Bang & Olufsen	Bang & Olufsen UK Ltd, Eastbrook Road, Gloucester.

Brenell	Brenell Eng. Co. Ltd, 231 Liverpool Road, London N1.
Chilton	Magnetic Tapes Ltd, Garden Road, Richmond, Surrey.
Crown International	Carston Electronics Ltd, 71 Oakley Road, Chinnor, Oxon.
Ferrograph	Ferrograph Co Ltd, The Hyde, Edgware Road, London NW9.
Grundig	Grundig (GB) Ltd, Newlands Park, London SE26.
Harmon-Kardon	Highgate Acoustics, 184 Great Portland Street, London W1.
Kellar	Kellar Electronics Ltd, Maryland Works, London E15.
Luxor	Luxitone Ltd, 84 Bolsover Street, London W1.
Nagra	Hayden Laboratories Ltd, Chiltern Ave, Amersham, Bucks.
National	Unamec, PO Box 1, United Africa House, Blackfriars Road, London SE1.
Philips	Philips Electrical Ltd, Century House, Shaftesbury Avenue, London WC2.
Pye	Pye Radio & Television, St. Andrews Road, Cambridge.
Revox	Revox, Lamb House, Church Street, London W4.
Sanyo	Sanyo Marubeni (UK) Ltd, Bushey Mill Lane, Watford, Herts.
Scepetronics	Crown Works, Church Road, Kingston-on-Thames, Surrey.
Sony	Sony (UK) Ltd, Pyrene House, Sunbury-on-Thames, Middlesex.
Tandberg	Farnell-Tandberg Ltd, 81 Kirkstall Road, Leeds 3.
Telefunken	AEG (GB) Ltd, Chichester Rents, London WC2.
Toshiba	Hanimex (UK) Ltd, 15-24 Great Dover Street, London SE1.
Trio	B. H. Morris & Co, (Radio) Ltd, 84 Nelson Street, London E1.
Uher	Bosch Ltd, Rhodes Way, Radlett Road, Watford, Herts
Wharfedale	Rank Wharfedale, Idle, Bradford, Yorks.

USEFUL DATA

Abbreviations

AM	Amplitude modulation
FM	Frequency modulation
af	Audio frequency
hf	High frequency
VHF	Very high frequency
Hz	Hertz (cycles per second)
dB	Decibels
A	Amps
V	Volts
W	Watts
C	Capacitance (or capacitor)
L	Inductance (or inductor)
R	Resistance

rms	Root-mean-square
ips	Inches per second (tape speed)
rpm	Revolutions per minute
afc	Automatic frequency control
agc	Automatic gain control
rf	Radio frequency
vf	Video frequency
μ	micro (millionths), as in μV (microvolt) and μF (microfarad)
m	milli (thousandths), as in mV (millivolt) and mS (milliseconds)
k	kilo (thousands), as in kHz (kilo-Hertz)
M	Mega (millions), as in Megohms (Mohms)

Equivalents

Metric/British conversions:

1 metre	=39.37in.
1 centimetre	=0.394in.
1 micron (μ)	=0.39thou. (say, 0.00004in.)
1 litre	=0.035 cu. ft.
1 gm.	=0.035oz.

British/Metric conversions:

1 yard	=0.91 metre
1 inch	=2.54cm.
1 thou.	=25.4 μ
1 cu. ft.	=28.3 litres
1 lb	=0.453kgm.
1 oz.	=28.35gm.

Metric equivalents of tape speeds:

15ips	7 $\frac{1}{2}$ ips	3 $\frac{3}{4}$ ips	1 $\frac{7}{8}$ ips
38cm/ sec	19cm/ sec	9.5cm/ sec	4.8cm/ sec

Approx. equivalents of disc sizes:

12in.	10in.	7in.
30cm.	25cm.	17.5cm

Approx. equivalents of stylus tip radii (μ =micron):

0.001in.	0.0007in.	0.0005in.	0.0003in.
25 μ	18 μ	13 μ	7 μ

SOME TECHNICAL TERMS

ABR. Auxiliary bass radiator. Refers to a type of speaker unit, not driven by the input power but mounted in the enclosure with a conventional drive unit to influence bass performance.

Acoustic feedback. Transfer of some of the system's output back to the input, causing continuous or intermittent noise (oscillation). For example, the output from the speaker may affect the pickup.

Aerial. May also be referred to as an antenna. Metallic device for picking up radio signals. Types include long wire, tuned dipole and ferrite rod.

Afc. Automatic frequency control. Circuit may be used in a tuner helping it to lock on to a station.

Ambience. Acoustic information: characteristics of concert-hall, studio, room, etc.

Anechoic. This means 'without reverberation.' The anechoic chamber is an acoustically 'dead' room, used for testing loudspeakers and for other experimental work.

BAF. Bonded acetate fibre (wadding). One of the materials commonly used as an acoustic absorbent and for damping in speaker enclosures.

Bandwidth. The width of the frequency range between stated upper and lower limits.

Bias correction. Correction of pickup sidethrust by means of a scientifically designed device on the pickup arm. Exerts small outward force to counteract the inward bias.

Bias. Signal of high frequency, supplied by an oscillator, used in tape recording to influence the magnetisation of the tape. Term also used in connection with the operation of transistors and valves and to describe the sidethrust of a pickup.

Binaural. Means: heard with two ears. Could therefore be used to describe stereo but is conveniently reserved for headphone reproduction.

Capstan. Spindle in a tape machine. Capstan and pinch wheel together drive the tape past the heads.

Cardioid. Refers to the heart-shaped polar response of one kind of microphone. This response makes the microphone most sensitive in one direction, less so behind and at the sides.

Cartridge. Part of a pickup comprising the transducer and its stylus. Term also applied to continuous-loop tape device, particularly the American version designed for eight-track systems at $3\frac{3}{4}$ ips speed.

Cassette. Tape device incorporating two spools and designed for use at $1\frac{7}{8}$ ips speed.

Clipping. Distortion of waveform, as seen on oscilloscope in amplifier testing.

Compliance. Quality of 'give' or yield due to springiness. The reciprocal of stiffness.

Crosstalk. Interference between stereo channels.

Damping. Reduction of resonance effects in loudspeakers, pickups and other equipment. Achieved through use of resistance—acoustic, mechanical or electrical.

Damping factor. Ratio of speaker impedance to amplifier source impedance. Important for damping of diaphragm motion.

dB Decibel. Logarithmic unit representing ratios. The dB figure equals the logarithm of a voltage ratio multiplied by 20, or the logarithm of a power ratio multiplied by 10. Used to indicate relative levels of sounds, powers, voltages and so on. Makes it possible to depict quantities graphically in a compact form.

Drop-out. Fluctuation or momentary cessation of signal due to deficiency in magnetic tape.

Dyne. Unit of force equal to a milligram.

Efficiency. Ratio of output to input power. Multiply the ratio by 100 to obtain percentage efficiency.

Elliptical stylus. Stylus tip with large radius across the groove and small radius in contact with groove wall (fitting into the recorded modulations). Designed to reduce tracing distortion, which is due to inaccurate fit of tip in groove. Also referred to as 'bi-radial'.

Fet. Field effect transistor.

Fundamental. Lowest frequency component in a complex wave, the latter comprising fundamental and harmonics.

Gain. Amplification.

Headshell. Head housing on pickup arm to accommodate the cartridge. Usually detachable; or the shell may be fixed and contain a removable carrier for the cartridge.

Heatsink. Metal part used to conduct heat away from transistors, thus preventing undue temperature rise.

Hz. Hertz. Unit of frequency. Same as cycles per second.

Intensity. Sound level—i.e. level of acoustic energy.

Impedance. In ac electricity, opposition to flow of current. Incorporates reactance (due to capacitors or inductors) as well as resistance. By analogy, acoustic and mechanical impedances are encountered.

Loudness. Subjective impression or sensation (in contrast to objective 'intensity', above).

Master. Original recording from which copies are made. Term applied to the original studio tape and to the disc which is cut prior to mass-production of records.

Modulation. Audio signal as it appears in the recording or transmitting process. For example, the constantly changing shape of the record groove is a modulation representing the music signals.

Mono. Monophonic. Single-channel recording and reproduction.

Multiplex. Stereo radio system—that employed on VHF/FM in the UK.

Ohm. Unit of electrical resistance or impedance.

Oscillation. Regular vibration of object, which may be electrical, acoustical or mechanical.

Oscillator. Electronic circuit for producing oscillations.

Piezo-electric. The piezo-electric effect refers to the generation of electricity by certain materials when they are subjected to mechanical stress.

Polar response. Diagram, or graph, showing variation of loudspeaker output in various directions. Also applicable to aerials and microphones.

RIAA. Record Industry Association of America. Refers to a disc record replay characteristic.

rms. Root mean square. Effective value of ac, providing for comparison with dc. Value of alternating quantity that would have the same effect in producing power in dc terms. Power is proportional to the square of the current (or voltage) ; therefore we have to find the mean of instantaneous values squared, and then find the square root of the result.

Semiconductor. Special material used in transistors, diodes and other components. Includes silicon and germanium.

Sine wave. Waveform of a pure tone (i.e. single frequency).

Solid-state. Term indicating use of transistors and other semiconductor devices in equipment.

Stereo. Stereophony. Sound recording or transmission carrying spatial information and employing two or more channels.

Tracking weight. Downward force of pickup (at stylus tip) on the record. Also called playing weight, stylus pressure, etc.

Transcription. Means 'copying' and, in hi-fi, is a term borrowed from professional practice and applied to the more costly and robust turntables. Implies high standard of performance.

Transient. Quick, fleeting signal involving a sudden change (e.g. zero to high value) as with sharp wavefronts associated with percussive sounds (cymbals, piano, strings, brass). Excellence of system or transducer transient response is outstandingly important.

Transducer. Device that converts one form of energy to another. Examples: loudspeaker, microphone, pickup.

Questions and Answers

? Are there any guidelines for the allocation of a fixed budget?

Many people seem to spend more on the speakers than on the amplifier, but I have seen advice to the effect that the pickup is the more important item.

A full explanation of planning and budgeting will be included in another booklet in this series. Assuming you have settled the most important basic matters, such as the power rating appropriate to the conditions of use, you should ensure that the allowance for the transducers—pickup and speakers—is adequate. It is possible to give only a rough guide to budgeting. For instance, for a small economy-class outfit for a small room you might divide £100-120 thus: player 25%, amplifier 35%, speakers 40%, approximately.

This sort of allocation would not apply very often to more ambitious systems, when money is available for specialised components offering special facilities. It is not at all unusual to choose speakers worth £120 a pair to use with an amplifier costing half as much; and in the same system an outlay of £100 on turntable and pickup may be money well spent.

? Although diamond is the hardest material and generally used for pickup styli, the once-popular sapphire is very much cheaper. Why not change the stylus more often and take advantage of manufactured sapphire's low cost? Or why not use another cheap material?

Any hard material that takes the right shape and gives noise-free groove tracing would be acceptable. However, the problem is that generally available, practical materials, like sapphire, begin to lose their stylus-tip shape quite quickly. At the early stage of deterioration the effect is a reduction of accuracy of tracing rather than damage to the groove (which comes soon enough, of course). Very frequent replacement would surely be a nuisance, and it is likely that some users would be forgetful, leaving the stylus in use and risking groove damage. Further, the stylus is part of an assembly and perhaps not all that cheap in its hi-fi versions.

? If I settle for a small and limited system now for reasons of economy, can I improve its performance later when more money is available? Please mention some points to look out for.

If the budget is likely to be more generous in the fairly near future, wait a while and enjoy the more rewarding job of planning on the basis of really high quality. Otherwise you can make certain provisions now if you intend to buy a small system. You cannot improve individual purpose-built units but you can upgrade your installation in stages.

Start with a separate-unit system that will permit gradual change. In particular, even for an economy-class gramophone you can start with an amplifier that accepts typical magnetic pickups. Models at £30-40 qualify. Then at first you can buy a 'budget' player with a cheap magnetic cartridge. However, such a player is suited to cheap cartridges *only*, so your first step towards better performance would be to change one day to a superior turntable and arm. The turntable will be more dependable and cause less rumble noise and the arm will allow you to fit and safely use a more advanced cartridge.

No doubt you will start with bookshelf speakers—on account of low cost and not because of any special merit. Later you will probably seek the much

better performance of bigger speakers and you may find they are usable, at least for a while, with the original amplifier. However, the original power rating may not be adequate for the revised system or for your room, and many good speakers need bigger inputs, so it is pretty certain you will need a more powerful amplifier.

? I like the headphone reproduction I have heard. Is there any problem about matching them to modern equipment? Can I use them to the exclusion of speakers?

Headphone sound can be pleasing and it is certainly convenient at times. Low-impedance 'phones (8-50 ohms or thereabouts) match modern amplifiers. Listen for smoothness and an airy, low-distortion quality and also consider comfort in wear. You can use them all or most of the time if you have to—but you will be missing a lot of the experience of high quality stereo. For those who have no space for speakers there are one or two headphone amplifiers providing enough power for 'phones only.

? I have derived much pleasure from my stereogram and would like to put it to further use now that I have become interested in hi-fi, possibly by fitting a more up-to-date player and using external speakers. How should I start?

Your stereogram, in its original form or altered, has nothing in common with hi-fi systems. Money spent on additions and substitutions will be wasted. Dispose of it and start again. Or if you like the cabinet keep it to house an amplifier, turntable, tuner, etc.

? I seldom see references to 45rpm records in the technical press. They are not very hi-fi but sometimes I play them on my system. Are there any special points to remember and can I damage my pickup?

As you say, they are not very hi-fi, and that is why you do not see many references to them. Your equipment does not mind what size or type of disc it plays, so damage will not be caused. But mind your ears! In the case of hi-fi systems treat 45s like LPs but you may have to experiment with the tone controls because the general quality tends to be unpredictable. It is tedious to play 45s on a manual player. Some hi-fi owners with a lot of 45s buy a separate, cheap record changer with appropriate magnetic cartridge, plugging this unit into the hi-fi when needed. Some people have those 7-inch EP discs, some of which were of passable quality—rather like playing a small LP.

? Which new developments will interest me as I plan or upgrade my equipment? Is the stereo record as good as dead?

Look out for new tape materials and methods of housing tapes (cassettes, etc.); systems for reducing noise levels from tape and other sources; use of integrated circuits; better pickups; multi-channel sound. No, the disc is far from dead—you will use it for years. You can obtain quadrasonics from disc and it will continue to be important for hi-fi. But other media will compete more effectively.

Teleton has a great deal worth listening to



LIKE THESE TWO TOP-OF-THE-RANGE STEREO RECEIVERS. If you've been reading the hi-fi and 'product testing' magazines lately, you can hardly have escaped seeing the nice things that independent evaluators are saying about Teleton stereo equipment. So whatever stands at the top of the Teleton stereo range stands very high indeed. The TFS-50LA (50 watts) and the CR-55 (80 watts) receivers are right at the top. Both feature full FM/AM reception (including the 145-285kHz LW band on the TFS-50LA), automatic indication and switchover to stereo when stereo is being broadcast, optional muting between FM stations, optional loudness compensation and many other top-of-the-range controls and functions. Top-of-the-range performance, too. Hear for yourself at your Teleton dealer's soon.

Teleton Electro (UK) Co. Limited, 16 Savile Row, London W1X 1AE.
Telephone: 01-437 6796.

Recommended retail prices : TFS-50LA, £89.75 ; CR-55, £129.75.

Teleton  a great deal for the music lover

TEAC announces a current event: BiaTron



A-2300 STEREO TAPE DECK

eered decks to be found anywhere. No wonder it delivers this kind of high-performance characteristics: 30 to 20,000 Hz frequency response, 50 dB or better signal-to-noise ratio, 0.12% or less wow and flutter at 7½ ips.

Add to that such TEAC exclusives in a deck of this class as MIC and LINE mixing, TAPE and SOURCE monitoring, turntable height adjustment, independent headphone monitoring with built-in volume control.

Then to double your enjoyment, we added an auto-reverse mechanism to the A-2300, and called it the A-2500.

Whatever your choice, you can't help keeping current when you stay tuned to TEAC.

It's the latest and greatest in dual capability: TEAC has incorporated a bias-current switch in the superlative A-2300 stereo deck. We call this feature BiaTron because it lets you choose the right bias for both standard and low-noise, high-output tapes.

The A-2300 has lots of other good news going for it, too. Like the remarkable Edi-Q Pause Control that lets you edit and cue the leanest, click-free, pro-quality tapes while recording. And three precision motors: hysteresis-synchronous for capstan drive, eddy current types for turntable drive. TEAC constant-contact hyperbolic heads. And hair-trigger solenoid controls that makes this one of the most humanly engin-



A-2500 AUTO REVERSE STEREO TAPE DECK

TEAC

TEAC EUROPE N.V., Kabelweg 45-47, Amsterdam, Holland. Tel: 020-12 44 04

All TEAC models are available from:

LASKY RADIO LTD., 42/45, Tottenham Court Road, London, W.1. Tel: 01-580-2573

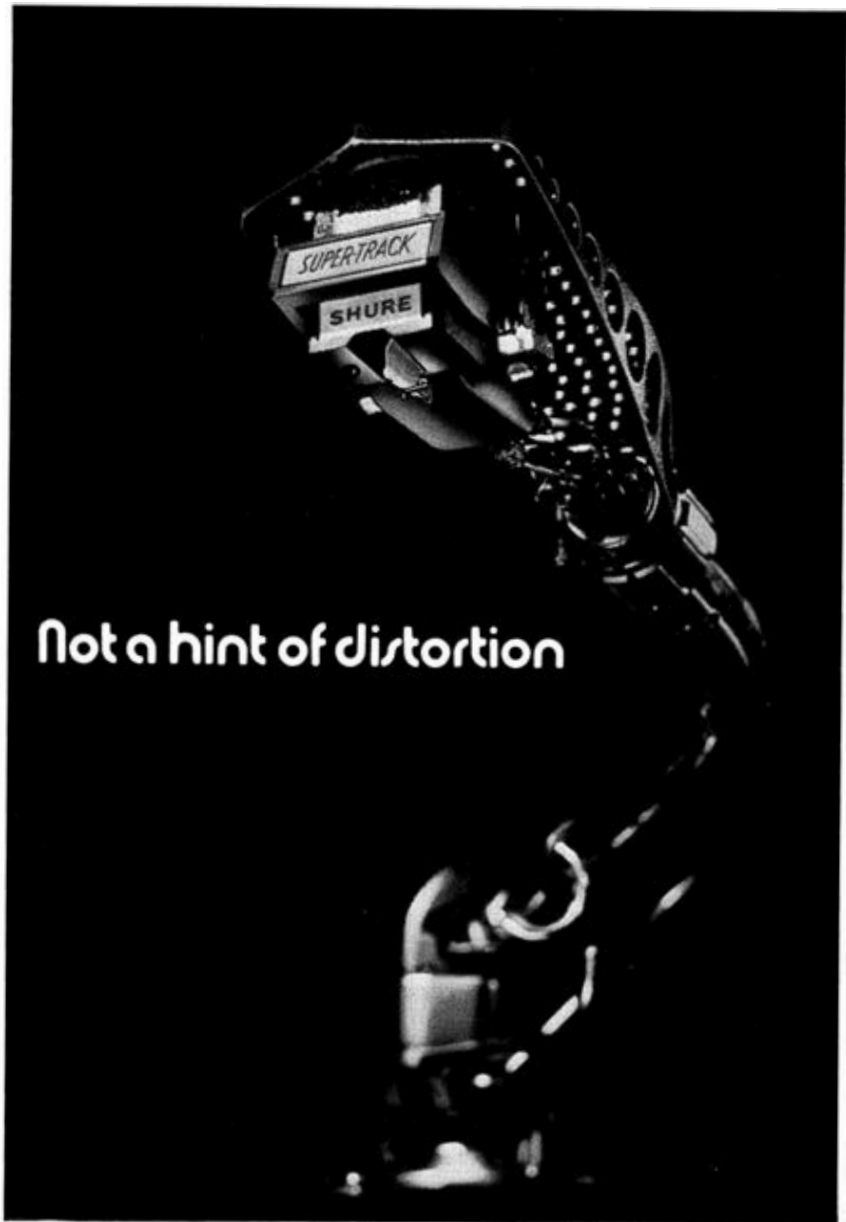

Not a hint of distortion

SHURE V-15 Type II
(Improved) SUPER-TRACK
with bi-radial elliptical
stylos (0.0002" x 0.0007")
- 15° tracking - unique
"flip-action" built-in stylus guard.



Please send me full information on the
SHURE V-15 Type II. (Improved)

Name

Address



SHURE

Shure Electronics Ltd.
84 Blackfriars Rd., London SE1. Tel: 01-928 3424

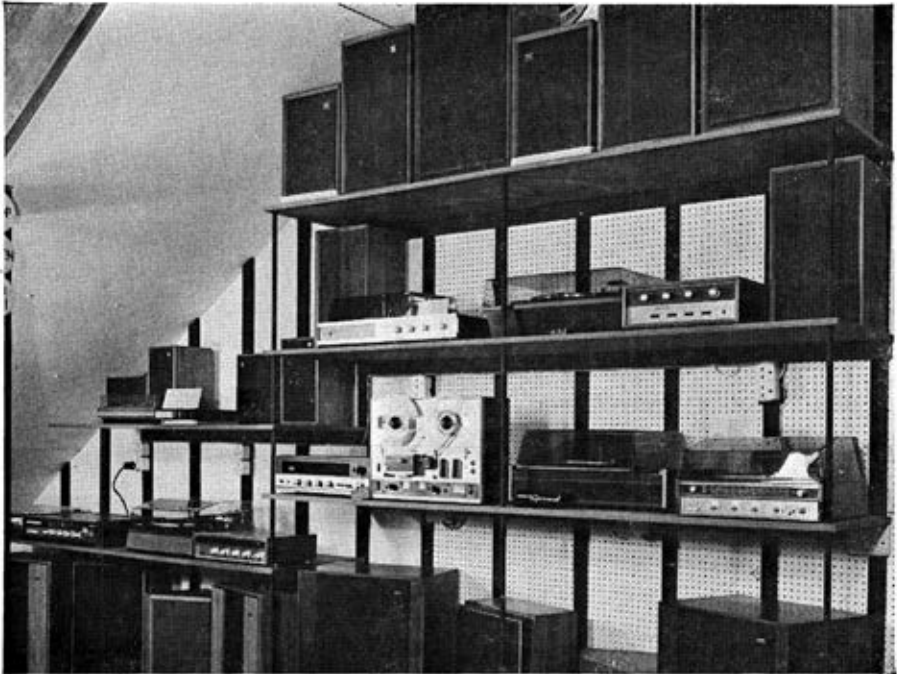

- Over 700 alternative combinations of equipment on tap for demonstration.
- Package deal offers for your own selection of equipment.
- Recommended package deals for top value in each price bracket.
- All package deals supplied ready to plug in and operate, with one year free service and reductions on recommended prices.
- Hear our exclusive CLEEN stereo headphones.
- HOURS: Mon; Tues; Thurs; Fri: 9.00 a.m.—6.00 p.m.
Sat: 9.00 a.m.—5.30 p.m.
A pre-arranged appointment will ensure personal service.

KIRKMAN OF CRAWLEY

40 THE BROADWAY, CRAWLEY, SUSSEX. (next to Mac Fisheries) Telephone: 26670

2 INTO 1 CAN GO!

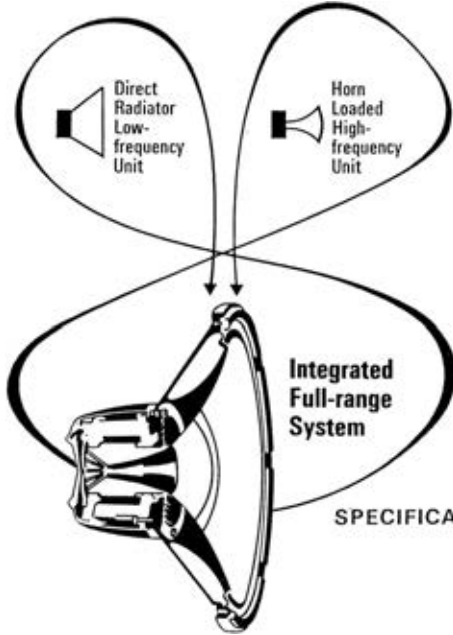

THE *Monitor*
GOLD *

DUAL CONCENTRIC

... provides the perfect integrated source needed for stereo. The Monitor Gold is two separate transducers in a single assembly fed by a sophisticated cross-over and treble control network.

SPECIFICATION Frequency Response: 30-20,000 Hz.

Power Handling Capacity:
 15" 50 Watts, 12" 30 Watts, III LZ 15 Watts.

Impedance: 8Ω nominal, 5Ω minimum.

AND IT SOUNDS BEST IN A **TANNOY** ENCLOSURE

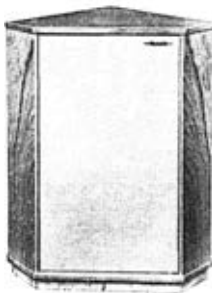

"Lancaster" free-standing fitted with 12" or 15" Dual Concentric. Height 2'9½", width 1'9½", depth 1'0½".

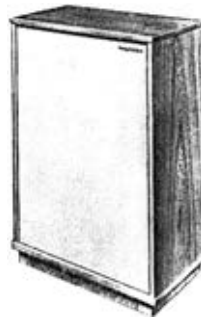

"Lancaster" corner mounting fitted with 12" Dual Concentric. Height 2'9", width 2'1". Front to rear corner 1'4¾".

70% OF THE MONITOR GOLDS PRODUCED ARE EXPORTED TO:

- U.S.A.
- JAPAN
- CANADA
- SOUTH AFRICA
- AUSTRIA
- ITALY
- SINGAPORE
- HOLLAND
- GERMANY
- BELGIUM
- SWITZERLAND
- NORWAY
- SPAIN
- AUSTRALIA
- NEW ZEALAND
- THAILAND
- ZAMBIA
- KENYA
- HONG KONG
- MALAYSIA
- FRANCE

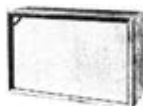

"III LZ Mk. II" Aperiodic enclosure with III LZ unit. Height 1'3", width 1'11", depth 9¾".

TANNOY
 NORWOOD ROAD • WEST NORWOOD
 LONDON • S.E.27
 TELEPHONE 01-670 1131

The Majority of Recording and TV Studios use TANNOY Monitors

REMARKABLE VALUE FOR MONEY!



The Excellent Sinclair Project 60 Modules.
Integrated **FREE OF CHARGE** into a Hi-Fi System
of your own choice. Exceptionally neat and compact.
Superb performance.

Built, tested, guaranteed, ready for immediate use.
Wide selection of matching loudspeakers available.

Please send stamp for detailed literature



DEPTFORD CAMERAS AND Hi-Fi DESIGN CENTRE LTD.
494 New Cross Road, London, S.E.14 01/692/2981

*In association with EDWARD MICHELSEN CUSTOM CABINETS
now at above address*

OMAR
CABINETS
FOR SPEAKERS
IN KIT FORM FOR
TRADE AND RETAIL
READY MADES TRADE
STANDARD DESIGN
AND
REPRODUCTION

OMAR SKINNER & SONS
WARFIELD PARK
WORKSHOPS, WARKFIELD
PARK, BRACKNELL,
BERKS RG 12-6RG



Manufacturer
of Audio &
Equipment Cabinets
OMAR Speakers

KLINGER

*proudly present their new Comprehensive High Fidelity
Stereo System KC94*



AMPLIFIERS

25v r.m.s. per channel from stabilised power supply. Distortion level below .1% at 20 watt. Precision tone controls. High and low pass filters. Compensated loudness control. Full tape facilities with A/B switching. Input for external signal sources including dynamic microphone. Sockets for two pairs of stereo headphones.

STEREOPHONIC FM TUNER with push button selector

Automatic mono/stereo switching with manual override. Stereo indicator light. Automatic frequency control. Channel separation better than 36db. Sensitivity 2uV for 26db quieting.

GARRARD SP 25/III TURNTABLE with Goldring G800 free field magnetic pickup.

Substantial teak cabinet with transparent folding lid.

Recommended Price—£135.00 including £25.70 Purchase Tax.

KLINGER CONTROLS

7 CHALCOT ROAD, LONDON, NW1 8LU

Telephone: 01-586 2922/3

Cables: KLINKENE LONDON



*Relive the performance
with Pioneer—
creators of true sound*

 **PIONEER**

For details of the complete range
write to the U.K. Distributors

SHRIRO (UK) LIMITED (HI-FI DIVISION) 42, RUSSELL SQUARE, LONDON, WC1. TELEPHONE: 01-580 6996



Handel or The Who.
Whatever your music scene
‘Scotch’ cassettes and tapes
give you professional quality.

Scotch Cassettes and Magnetic Tapes

Scotch is a trademark of the 3M Company