

*Engl. - Am. - ...
Volume 29*

JOURNAL OF THE A. I. E. E.

FEBRUARY 1929



PUBLISHED MONTHLY BY THE
AMERICAN INSTITUTE OF ELECTRICAL ENGINEERS
33 WEST 39TH ST. NEW YORK CITY

MEETINGS

of the

American Institute of Electrical Engineers

REGIONAL MEETING, Middle Eastern District No. 2, Cincinnati, Ohio, March 20-22, 1929

REGIONAL MEETING, South West District No. 7, Dallas, Texas, May 7-9, 1929

SUMMER CONVENTION, Swampscott, Mass., June 24-28, 1929

PACIFIC COAST CONVENTION, Santa Monica, Calif., September 3-6, 1929

REGIONAL MEETING, Great Lakes District No. 5, Chicago, Illinois, December 2-4, 1929

For future A. I. E. E. Section Meetings see page 158.



MEETINGS OF OTHER SOCIETIES

The American Institute of Mining and Metallurgical Engineers, Annual Meeting, Engineering Societies Building, New York, N. Y., February 18-21, 1929

Institute of Radio Engineers, Annual Convention, Mayflower Hotel, Washington, D. C., May 13-15, 1929

The Society of Naval Architects and Marine Engineers, 37th Annual Meeting, Engineering Societies Building, New York, N. Y., November 14-15, 1929

JOURNAL

OF THE

American Institute of Electrical Engineers

PUBLISHED MONTHLY BY THE AMERICAN INSTITUTE OF ELECTRICAL ENGINEERS
33 West 39th Street, New York

PUBLICATION COMMITTEE
W. S. GORSUCH, *Chairman*, H. P. CHARLESWORTH, F. L. HUTCHINSON, DONALD McNICOL, E. B. MEYER
GEORGE R. METCALFE, *Editor*

Changes of advertising copy should reach Institute headquarters by the 15th day of the month for the issue of the following month.
Subscription: \$10.00 per year to United States, Mexico, Cuba, Porto Rico, Hawaii and the Philippines, \$10.50 to Canada, Central America, South America, Haiti, Spain and Colonies, and \$11.00 to all other countries.
Single copies \$1.00.

Entered as matter of the second class at the Post Office, New York, N. Y., May 10, 1905, under the Act of Congress, March 3, 1879. Acceptance for mailing at special rate of postage provided for in Section 1103, Act of October 3, 1917, authorized on August 3, 1918.

Vol. XLVIII

FEBRUARY 1929

Number 2

TABLE OF CONTENTS

Papers, Discussions, Reports, Etc.

Notes and Announcements	91	High-Voltage Interborough Cables	121
Theory of the Deion Circuit Breaker (Abridged), by J. S. Slepian	93	1927 Lightning Experience on the 132-Kv. Transmission Lines of the A. G. & E. Co. (Abridged), by Philip Sporn	122
The Structural Development of the Deion Circuit Breaker (Abridged), by R. C. Dickinson and B. P. Baker	96	Use of the Oscillograph for Measuring Non-Elec- trical Quantities, by D. F. Miner and W. B. Batten	126
Higher Voltages for Generator	100	Totalizing of Electric System Loads (Abridged), by P. M. Lincoln	129
Field Tests of the Deion Circuit Breaker (Abridged), by B. G. Jamieson	101	The Fundamental Theory of the Capacitor Motor (Abridged), by H. C. Specht	134
Lighting Airways in Hudson and Mohawk Valleys Proposed	104	Movements of Overhead Line Conductors during Short Circuits (Abridged), by Wm. S. Peterson and H. J. McCracken, Jr.	138
Uses of Radio as an Aid to Air Navigation, by J. H. Dellinger	105	Electrical Instruments Used in the Measurement of Flow, by W. H. Pratt	142
Research as a Business Help	109	Purified Textile Insulation for Telephone Central Office Wiring (Abridged), by H. H. Glenn and E. B. Wood	146
A Precision Regulator for Alternating Voltage, by H. M. Stoller and J. R. Power	110	Illumination Items	
A Graphical Theory of Traveling Electric Waves (Abridged), by Vladimir Karapetoff	113	International Commission on Illumination ..	150
Some Photoelectric and Glow Discharge Devices (Abridged), by J. V. Breisky and E. O. Erickson	118		

Institute and Related Activities

The Winter Convention	152	Midwinter Dinner of Pittsburgh Section	158
Cincinnati Regional Meeting	152	Joint Section and Branch Meeting at Louis- ville	159
Dallas Regional Meeting	153	Joint Meeting of Virginia Sections of National Societies	159
Institute Meetings for 1929	153	Recent Developments in Electrical Industry ..	159
Midwest Power Engineering Conference	153	Past Sections Meetings	159
Professor Rudenberg to Lecture at M. I. T.	153	A. I. E. E. Student Activities	
Standards News		Conference on Student Activities in Great Lakes District	161
New Index Now Available	153	Student Activities Discussed at Cincinnati Regional Meeting	161
A. I. E. E. Test Codes Suggested	153	Electrical Engineering Exhibition at Yale University Branch	161
Measuring Temperature of Secondarily Ven- tilated Motors	153	Student Branch Conference at Pittsburgh ..	161
Lamme Medal Awarded to Allan B. Field	154	Past Branch Meetings	162
A. I. E. E. National Regional Prizes	155	Engineering Societies Library	
Presentation of Washington Award	155	Book Notices	164
Triennial Montefiore Prize	155	Engineering Societies Employment Service ..	
American Engineering Council		Positions Open	167
Annual Meeting at Washington, D. C.	155	Men Available	167
National Hydraulic Laboratory Bill	156	Membership	
Boulder Canyon Dam Legislation	156	Applications, Elections, Transfers, Etc	168
Personal Mention	157	Officers A. I. E. E.	173
Obituary	157	List of Sections	173
A. I. E. E. Section Activities		List of Branches	174
New York Section Meeting	158	Digest of Current Industrial News	176
Future Section Meetings	158		
Speaking Contest Held at Los Angeles Section	158		

A REQUEST FOR CHANGE OF ADDRESS must be received at Institute headquarters at least ten days before the date of issue with which it is to take effect. Duplicate copies cannot be sent without charge to replace those issues undelivered through failure to send such advance notice. With your new address be sure to mention the old one, indicating also any changes in business connections.

Copyright 1929. By A. I. E. E.

Printed in U. S. A.

Permission is given to reprint any article after its date of publication, provided proper credit is given.
(The Journal of the A. I. E. E. is indexed in Industrial Arts Index.)

Current Electrical Articles Published by Other Societies

Institute of Radio Engineers, December 1928 Proceedings

Notes on the Effect of Reflection by the Microphone in Sound Measurements,
by Stuart Ballantine

The Receiving System for Long-Wave Transatlantic Radio Telephony, by
Austin Bailey, S. W. Dean, and W. T. Wintringham

Sound Measurements and Loudspeaker Characteristics, by Irving Wolff

The Design of Transformers for Audio-Frequency Amplifiers with Preassigned
Characteristics, by Glenn Koehler

A Bridge Circuit for Measuring the Inductance of Coils while Passing Direct
Current, by V. D. Langdon

National Electric Light Association

Design of High-Voltage Outdoor Substations, December 1928

Part I, by Raymond Bailey

Part II, by S. M. Dean

JOURNAL OF THE A. I. E. E.

DEVOTED TO THE ADVANCEMENT OF THE THEORY AND PRACTISE OF ELECTRICAL ENGINEERING AND THE ALLIED ARTS AND SCIENCES

*The Institute is not responsible for the statements and opinions given in the papers and discussions published herein.
These are the views of individuals to whom they are credited and are not binding on the membership as a whole.*

Vol. XLVIII

FEBRUARY, 1929

Number 2

“**H**E was a live wire in our Student Branch”

So reads a sentence in a letter answering an inquiry regarding a recent graduate. But the graduate had overlooked the importance of continuing his contact with the Institute after leaving college and had thus missed what would have been an advantage in seeking the position he desired.

Question:—Is it better for the graduate to maintain his Institute connection unbroken, even at some sacrifice, or to drop out and join later when he finds what a help membership can be to him in his professional progress?

The principal function of the branches is to make available to students opportunities to carry on activities very similar to those carried on by Institute members in their meetings, conventions, and committee work. Branch meetings can thus be made to serve very effectively in the development of the latent abilities of the students by supplying important training in leadership and preparing them in general for active participation in the broader field of Institute affairs. One who has been a live wire in branch work can very soon become a live wire in section meetings, regional meetings, and the national conventions. The greatest benefits of membership in the Institute are received by those individuals who are most interested and most active.

Young men who have graduated should be encouraged to retain their connection with the Institute by becoming Associates before their periods of Student enrolment expire, and to enter immediately into active participation.

A recent action by Mr. Ludvig C. Larson, Secretary, of the Madison Section, is certainly a step in the right direction. Mr. Larson prepared a list giving the name of every 1928 graduate who had been a member of the University of Wisconsin Branch, giving his present address and the Institute section nearest to him. To the secretary of each section shown on this list a copy of it was sent together with a letter urging the section to invite the graduates to meetings. The list was also sent to each graduate with a letter suggesting that he get in touch with the section, attend meetings, and take part in the activities.

Mr. Larson's letter to the sections expresses the hope that a general plan may be adopted which would make the annual sending of such lists regular practise for all the branches. The lists would be sent to Institute headquarters in New York. There the names would be grouped by location with respect to nearest section and the proper group list then sent to each section that has any of the graduates in its locality.

Counselors, this sounds like a call to you. If you will prepare the lists, headquarters office will see that they are sent to the interested sections. The sections officers, I am confident, will take the necessary next step, and all will profit.



President.

Some Leaders of the A. I. E. E.

Howel H. Barnes, Jr., District Manager of the General Electric Company, New York, N. Y., Fellow of the Institute since 1913, one of its Managers, 1910-1913, and its Vice-President, 1913-1915, was born in New York City, December 15, 1875.

In 1897 he was graduated from the Polytechnicum in Stuttgart, Wuerttemberg as Electrical Engineer. He then entered the Charlottenburg Works of Siemens & Halske for special test experience, and in 1899 was sent by them to the City of Mexico as General Superintendent of the Mexican Electric Works, which had a contract for lighting that city and its suburbs and also carried on a general lighting and power business. In 1902 he joined the Stanley Electric Manufacturing Company at Pittsfield under Mr. C. C. Chesney, who was then its Chief Engineer and with whom Mr. Barnes remained in close association until 1907 when the company was merged with the General Electric Company. During 1904 he conducted tests on an experimental transmission line at the Stanley Works, using voltages up to 120,000 volts, to determine the relation between corona loss and line spacing, size and type of conductors and other factors. Other engineering assignments led to work not only in all parts of the United States, but in Canada and Europe as well. Mr. Barnes' transfer to the New York Office of the General Electric Co. as consulting engineer took place in 1907 and a year later he was placed in charge of engineering and construction as district engineer which brought him constantly in touch with power problems in his territory and the engineers and executives handling them. During the war he was engrossed in the ship-building program and in 1920, was chosen Assistant Manager of the New York District in addition to his engineering work, which he finally relinquished in 1927 in order to devote his entire activity to executive duties. In May, 1928, upon the retirement of Mr. Theodore Beran, Mr. Barnes was made District Manager for his Company.

He has served as President of the New York Electrical Society, President of the Engineers' Club, is an Associate of the Explorers Club and a member of various other social and scientific organizations. He represented the Institute on the Board of Trustees of the United Engineering Society, 1912-1917 and 1921-1926, and has also served it on its Board of Examiners, the Law Committee, the Edison Medal Committee and others. He was an organizer of its New York Section, and its Chairman 1924-1925. His paper, "Notes on Fly Wheels," before the Institute in 1904 was a valuable contribution to technical literature, in that it not only showed the agreement between observed values and the Boucherot formula, for the natural period of oscillation, but made manifest the application of this formula to determine the proper size of fly-wheel to be used,

selection by this means giving in most cases a much lighter wheel than would have been chosen by other methods in use at that time.

1928 Progress in Physics

In summarizing the great progress in physics in 1928, Professor M. I. Pupin refers to three outstanding groups of experiments: (1) concerning the relations of waves and particles, as typified by light rays and electrons; (2) the interaction between atoms and light quanta; (3) the relation between mass and energy, and the production of matter in interstellar space.

"In the first group are the experiments of Davisson and Germer on the scattering of narrow beams of electrons by single crystals of nickel. They found complete analogy between this phenomenon and the scattering of X-ray beams by crystals, thus confirming the theory of the French physicist, de Broglie, that electrons or electric particles may behave like waves.

The "equivalent wave-length" of an electron is found to depend on its velocity. Similar results were obtained by G. P. Thomson by passing electrons through crystals and observing the diffraction patterns formed, and by E. Rupp, who diffracted electrons with a ruled grating.

These results mean that just as light rays, ordinarily considered to be waves, have been found to act like corpuscles, so electrons, ordinarily considered to be corpuscles, are now found to act like waves.

Concerning the second group of experiments, Prof. Arthur H. Compton discovered that a quantum of X-rays may interact with a free electron, according to the ordinary laws of mechanics, giving the electron a part of its energy and momentum, which energy and momentum is lost by the X-ray.

The experiments of Raman, Davis and Mitchell extend this result to the case of electrons which are not free, but are held by forces of attraction inside the atom. A striking difference is that here the X-ray quantum may either gain or lose energy, depending on the condition of the electron with which it reacts. The energy gained or lost correspond to the energy differences between two states of the scattering electron.

The third group referred to consists of the experiments of R. A. Millikan on cosmic rays, which had previously been discovered and studied in Europe by Hess, Kolhorster, and others.

He has been able to measure the approximate wave-lengths and hence the energy of the cosmic ray quanta. One of these quanta was of such magnitude as to suggest that it may be produced in interstellar space by the union of four hydrogen atoms to form an atom of helium. Since the mass of an atom of helium is less than that of four hydrogen atoms, the excess mass must be emitted as an energy quantum according to the mass-energy equation of Einstein.

Abridgment of Theory of the Deion Circuit Breaker

BY J. S. SLEPIAN

Fellow, A. I. E. E.

Synopsis.—Three major features incorporated in the Deion circuit breaker are discussed. They are deionization at solid surfaces, the function of the static balancer, and cold electrode arcs.

THE switching of electric power circuits calls for elements which, subject to control, shall function sometimes as good electrical conductors and at other times as good insulators. When "closed" the element must pass hundreds or thousands of amperes with at most only a few volts drop; its resistance or impedance must be of the order of a fraction of an ohm. When "open" it must withstand hundreds or thousands of volts, with the passage of at most a few milliamperes; its resistance must be in the hundreds of thousands of ohms. Also it must be able to change from one state to the other in a fraction of a second. So far, the only materials found which can meet these requirements are the gases and arcs in air; and arcs in the vapors and decomposition products of oil are serving regularly to control power circuits. Careful study shows that the arc, instead of being merely an unpleasant accompaniment of the opening of a switch, plays a very necessary and desirable part, and that if the arc did not occur spontaneously on separating contacts, it would have been necessary for us to discover or invent it or its equivalent for the purpose of circuit interruption.

Recognizing the importance of the arc in switching equipment, five years ago the Westinghouse Electric & Manufacturing Company began an extensive theoretical and experimental study of the electric arc as it appears in switches, and more particularly the study of what happens when the change-over occurs from the state of conductor to the state of insulator; that is, at the moment of extinction of the arc. Some of the results of this study have already been presented.¹ As was perhaps to be expected, the study revealed some new and interesting possibilities in the application of arcs to circuit interruption, and the Deion a-c. circuit breaker in which these possibilities have been developed promises for certain classes of high power work to take its place with, or perhaps replace, the oil circuit breaker.

While there are many details of the Deion circuit breaker which are of great scientific interest and which required months, and even years, of intensive work for their mastery, there are three general principles which are outstanding and will be described here.

I. DEIONIZATION AT SOLID SURFACES

The subject of the rate of recovery of the dielectric

1. J. Slepian, *Extinction of an A-c. Arc*, A. I. E. E. Quarterly TRANS., Vol. 47, October 1928, p. 1398.

Presented at the Winter Convention of the A. I. E. E., New York, N. Y., Jan. 28-Feb. 1, 1929. Complete copies upon request.

strength of the space carrying a short a-c. arc immediately after arc extinction has been treated in some detail in a previous paper,¹ when it was shown that the ability to withstand the first few hundred volts was recovered almost instantly, but that later increments of dielectric strength were recovered at a very much slower rate. This is brought out in the curve of Fig. 1, derived from the data of Fig. 6 of the previous paper.

Theory and experiment indicate that the first 250 volts are borne almost entirely by a thin layer of gas immediately adjacent to the cathode. Electrons readily leave this layer, but others to replace them cannot enter from the metal. The positive ions discharge into the cathode; thus this cathode layer is deionized very rapidly. The subsequent slow growth of dielectric strength is due to the growth of the deionized cathode layer, and the disappearance

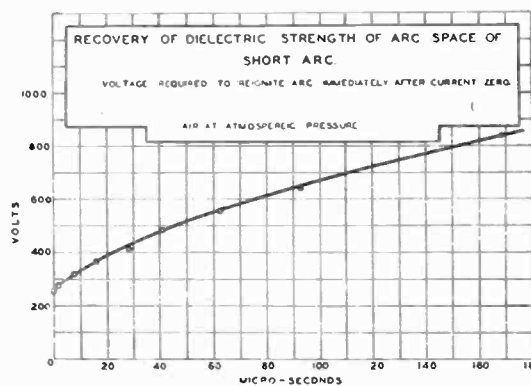

FIG. 1

of the ions in the other parts of the gas space by recombination.

It is evident then that it is the slow rate of recombination of the ions in the arc space away from the electrodes which limits the applicability of the arc in air for interrupting high voltages. A fairly obvious suggestion would be to reduce so far as possible the arc space remote from a cathode, and also, so far as possible, to cause all the arc to play in space close to a cathode. In other words, to use a large number of short arcs in series. This is what is done in the Deion circuit breaker.

As now developed, the Deion breaker consists of a stack of copper plates 1/16 in. thick, separated by 1/16-in. spacers. The arc which is drawn on contacts below this structure is blown by a magnetic field into the stack, and is thus broken into short arcs in series,

each 1/16 in. long. Therefore in each inch of structure, there are eight cathodes with their eight immediately adjacent rapidly deionizing gas layers. Immediately after the current passes through its zero value in its normal cycle, each cathode layer is almost instantly deionized, and acquires the ability to withstand 250 volts much faster than any practical power circuit of corresponding voltage can supply the 250 volts. Thus the voltage necessary to reignite the arcs after the current zero is eight times 250 or 2000 volts per inch of structure. Hence the structure will interrupt circuits whose voltage is not over $2000/\sqrt{2}$ or 1414 volts r. m. s. per inch length.

This seems like a very high voltage for arcs in air, but it by no means represents the limit. The plates in the Deion circuit breaker have been made 1/16 in. thick for the sake of thermal capacity, so that it may operate many times without an excessive rise in temperature. So far as concerns extinction of the arcs, the plates could be 1/32 in. thick or 1/64 in. thick. The spacing between the plates was made 1/16 in. so as to permit free motion of the individual arcs. Experiment shows that 1/32 in. spacing still leaves sufficiently free motion of the arc. Using these last figures, there would be 21.3 plates per inch, and therefore the structure would interrupt 3760 volts r. m. s. per inch.

In the present Deion breaker the circuit volts per plate is kept very much less than the theoretical limit of 175 volts r. m. s., in fact it is less than 130 volts. This is partly for the sake of having a factor of safety, and partly because when a voltage is impressed upon a long stack of plates insulated from one another, the potential does not divide among the plates in a uniform manner. This lack of uniform voltage distribution is compensated for in the Deion breaker by a static shield as described in the next section, but the compensation cannot be made exact, so that a sufficient margin between the theoretical limit and the working volts per plate is necessary.

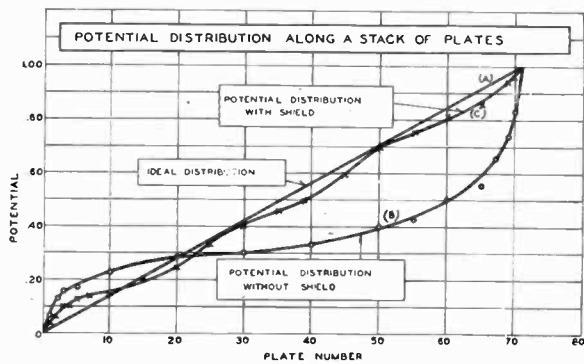

FIG. 2

II. THE FUNCTION OF THE STATIC SHIELD

When voltage is applied to the ends of a long uniform stack of plates insulated from one another, the potential does not divide uniformly among the plates, but the potential differences between successive plates at the

end of the stack may be many times the potential differences between successive plates in the middle of the stack. This is in consequence of the elementary principles of electrostatics and need not be gone into in greater detail here. The example of this phenome-

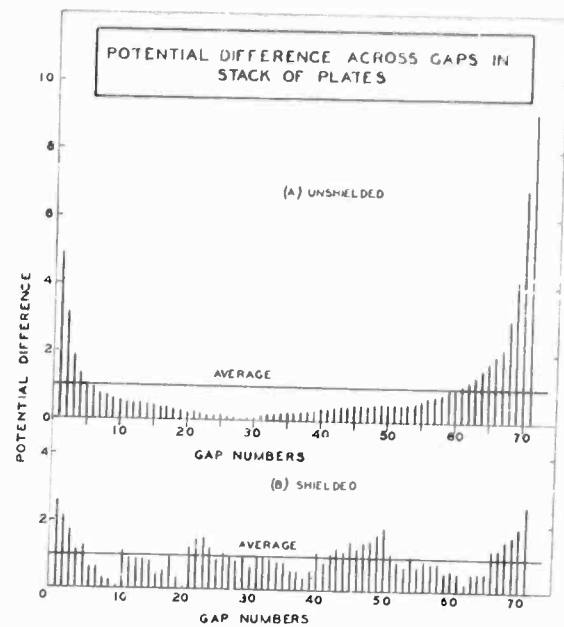

FIG. 3

non best known to the electrical engineer is probably the non-uniform distribution of potential among the units of a long string of suspension insulators.

The distribution of potential among the members of a stack of plates in a Deion breaker has been studied experimentally by B. P. Baker. A resistance bridge method with telephone receiver as null instrument proved satisfactory. The stack studied consisted of 72 plates of 1/16 in. copper, spaced 1/16 in. apart, each plate having the shape of a P with the round part 17 cm. diameter, and the straight part 17 cm. long.

When unshielded, the potential distribution was found to be that shown by curve (b) Fig. 2. The departure from uniform distribution given by curve (a) is very great. The point of inflection of curve (b) marks the potential of space remote from the stack. That it did not occur at the center of curve (b), and that curve (b) was not symmetrical is due to the influence of the frame supporting the stack.

Fig. 3a gives the relative potential differences across the gaps formed by the plates. It shows that the end gap received an impressed potential 9.1 times as great as the average voltage per gap. So large a ratio might be expected to seriously diminish the average volts per gap upon which the breaker could operate, and this had been found to be the case.

A static shield consisting of a micarta cylinder formed to fit over the stack, and with pieces of tin foil imbedded in it of such shape and size as to make uniform the distribution of potential among the plates was then made up. The resulting curve as determined experimentally is given by (c) of Fig. 2. This curve follows

the ideal distribution more closely, and as shown in Fig. 3 (b), the maximum gap potential is 2.6 times the average as compared with 9.1 for the unshielded stack. The curve of Fig. 2 (c) is for the first static shield made. Later designs of static shield give still better results.

At first thought it would seem that the average volts per gap at which the unshielded stack would operate in a Deion breaker would be reduced in the ratio 9.1 so that if 176 volts r. m. s. is the theoretical limit for a single gap, $176/9.1$ or 19.4 volts per gap would be the limit for the unshielded stack and 1375 volts r. m. s. would be the limit for the whole stack. Similarly for the shielded stack, $176/2.6$ or 67.8 volts r. m. s. would be the limiting average voltage per gap, and 4810 volts r. m. s. would be the limit for the whole stack.

Actually, however, by test, the unshielded stack was found to be good for nearly 6000 volts r. m. s. and the shielded stack for more than 10,000 volts; how much more was not determined. The limit for the case of perfect uniformity of voltage distribution would be about 12,500 volts.

To explain these results it is necessary to examine in greater detail the mechanism of the reignition of an arc immediately following a current zero. It is very probable that in the course of breakdown to an arc, for a brief moment the discharge takes the form of a glow. If the current in the discharge is sufficiently small, this glow may be stable, in which case the broken down gap may continue to withstand more than its proportionate share of the total voltage on the stack.

III. COLD ELECTRODE ARCS

As explained in Section I, the efficacy of the Deion breaker rests in having all parts of the arc in close proximity to deionizing surfaces. This is accomplished in the heavy current switch by blowing the arc into a stack of closely spaced plates, so that no part of an arc is farther than $1/16$ of an inch from a deionizing cathode. If the short arcs in this structure stood still for the duration of one-half a cycle, $1/120$ second, the structure would quickly be destroyed by the welding together of some plates and the burning of holes through others.

At the time this work was begun it was believed that the cathode of an arc was necessarily at a very high temperature; in fact, the theory generally accepted then required thermionic emission of electrons from the cathode for the maintenance of the arc, and for most metals the temperature for so intense a thermionic emission is far above the boiling point. How well entrenched this theory was may be seen by referring to the writings of K. T. Compton² and Seeliger.³ On this account much work was done on speeding up the deionization of an arc by causing it to play through the

openings of gauze sheets, thus avoiding the development of arc terminals on the deionizing structure.

In the course of this work, however, it was forced upon the author's attention that sometimes arcs were obtained which did not have a hot cathode. Therefore, although it required considerable courage to take a stand opposite that espoused by so many eminent authorities, the thermionic emission theory of the cathode of an arc was abandoned, and arcs with cold cathodes were accepted as possible. Experiment soon showed that by moving the terminals of the arc sufficiently rapidly over the electrode surfaces melting could be avoided even for very heavy currents. Arcs of more than 20,000 amperes have thus been carried on copper electrodes for more than 0.01 seconds with only slight oxidation of the electrodes.

A theory of the cathode of an arc also was developed based on the hypothesis that the metal itself is not necessarily at a temperature sufficient for thermionic emission but that a layer of gas or vapor immediately adjacent to the cathode is so intensely ionized, perhaps by virtue of very high temperature, that the arc current can be carried to the cathode by positive ions only.⁴

Shortly after this, papers by Stolt⁵ described experiments with rapidly moving arcs of moderate current (up to 12 amperes) which seemed incompatible with the thermionic theory of the cathode of an arc, and this, with some theoretical work on heat balance at the cathode, is causing general abandonment of the thermionic theory.⁶ Another theory of the cold cathode arc has been proposed by Langmuir,⁷ who states that electrons are drawn from the cathode by intense electrostatic forces arising from space charges developed close to the cathode. A theory of the cold cathode arc, however, is not essential for the understanding of the Deion breaker. Merely the possible existence of arcs with cold cathodes must be accepted.

In the Deion breaker, the melting of the electrodes is prevented by causing the arc terminals to move very rapidly over the electrode surface by means of a magnetic field. The first experiments were carried out with a stack of long straight plates as the deionizing structure. It was found, however, that the velocity of the arc terminals necessary to prevent the melting of electrodes was so great that for 10,000 amperes, plates more than 10 ft. long would be necessary. These would be prohibitive from the standpoint of size for most applications, and would require too expensive a magnetic field structure.

This difficulty was surmounted by causing the arcs moving with high velocity to retrace over and over

4. J. Slepian, *Phys. Rev.*, 27, p. 407, 1926. *Jour. Franklin Inst.* 201, 1926, p. 79.

5. H. Stolt, *Ann. d. Physik* 74, 1924, pp. 80-104. *Zeits. f. Physik* 262, 1924, pp. 95-101.

6. K. T. Compton, *TRANS. A. I. E. E.* 46, 1927, p. 868.

7. I. Langmuir, *Zeits. f. Physik* 46, 1927, p. 282.

2. *Phys. Rev.*, v. 21, p. 269, 1923.

3. *Physik der Gasentladungen*, Leipzig 1927, p. 360 et seq.

again an annular path. On adopting this expedient, a very important new advantage was obtained. The deionizing structure became an almost completely closed structure. The arc, when once driven in, could

not get out again, and had to stay in until its extinction at the end of the half cycle. Thus the danger of the arc getting across live parts outside the switch and causing short circuits, was practically eliminated.

Abridgment of The Structural Development of the Deion Circuit Breaker up to 15,000 Volts

R. C. DICKINSON
Applicant for Membership

and

B. P. BAKER¹
Associate, A. I. E. E.

INTRODUCTION

UP to the present time, the interruption of an a-c. circuit has been accomplished generally in one of two ways. The arc may be drawn between contacts located in some insulating liquid such as oil. In this case, the insulating value of the oil depreciates with each current interruption until it reaches a point where it must be renewed. On the other hand, the arc may be drawn in air with no means of extinguishing it other than lengthening it to such an extent that the generated voltage is no longer able to maintain it. For modern generating voltages, this requires arcs of great length and, for the upper range of transmission voltages, results in arc lengths which are impractical. As a result of this limitation, the oil circuit breaker has assumed a position of paramount importance on modern operating systems.

For some time there has been a growing demand on the part of operators for a circuit-interrupting medium which does not involve the use of oil. The chief reasons for this demand are the removal of possible fire hazards and simplification of maintenance problems. The demand has been recognized by manufacturers, and although research work toward this goal has been carried on for a number of years, no satisfactory general purpose apparatus of this kind has been placed on the market up to the present time.

At the Westinghouse Electric and Manufacturing Company, fundamental research in this field has been carried on for a long period and has served to give a deeper insight into the nature of arc conduction. It has suggested the use of means for deionizing the path of an arc drawn in air other than by merely extending it to a great length. Experimental circuit interrupters have been made utilizing such deionizing means in a variety of forms and the name "Deion Circuit Breaker" has been applied to these devices.

The work on all of the methods of deionizing an arc stream has contributed much to the fundamental

1. Electrical Engineer, Westinghouse Elec. & Mfg. Co., East Pittsburgh, Pa.

Presented at the Winter Convention of the A. I. E. E., New York, N. Y., Jan. 28-Feb. 1, 1929. Complete copies upon request.

knowledge of arc phenomena, and some of them may be further developed for practical application in the future. One of the most promising of these various methods was developed and applied to the Deion circuit breaker described in this paper, and in which an arc is drawn in air and forced into a deionizing chamber, where it is broken up into a multiplicity of short arcs which are moved over metal plates at a velocity sufficient to prevent burning. This movement of the arc is maintained over an annular path until the current wave reaches zero, after which the arc stream between the metal plates is deionized, quickly changing from a good conductor to a good insulator. A further discussion of this theory of deionization is found in other papers presented before this and previous Institute meetings.²

Development of the "deion" principle has been carried to the point of building and testing circuit breaker structures up to 15-kv. ratings with rupturing capacities comparable to some present day heavy duty oil circuit breakers in the power-house class. These breakers have been subjected to extensive laboratory and field tests, successfully interrupting three-phase grounded and ungrounded short circuits in excess of 15,000 amperes at 12,000 volts consistently. The results of a recent series of field tests with one of these breakers is the subject of another paper presented before the Institute.³

GENERAL CONSTRUCTION

The 15-kv. Deion circuit breaker shown in Fig. 1 is made up of three single-pole units, each consisting of a deionizing chamber, an arc-drawing mechanism with main contacts for carrying load current, and a controlling mechanism. The deionizing chamber consists essentially of a stack of thin copper plates spaced a short distance apart to form a series of gaps. In these gaps are placed insulating spacers which enclose arc runways each having a straight entering portion and a circular portion. One of these plates with its insulating

2. J. Slepian, *Theory of the Deion Circuit Breaker*, Winter Convention, A. I. E. E., 1929, and *Extinction of an A-c. Arc*, A. I. E. E. Quarterly TRANS., Vol. 47, 1928, p. 1398.

3. B. G. Jamieson, *Field Tests of the Deion Circuit Breaker* Winter Convention, A. I. E. E., New York, 1929.

spacers, in position is shown in Fig. 2. These gaps formed by the plates and spacers are divided into groups and separated by coils connected in such a way that the magnetic fields of adjacent coils are in opposition, which causes flux to be diverted radially through the gaps, as shown in Fig. 3.

In the blow-in magnet for moving the arc from the contacts into the deionizing chamber the coils are wound so as to cover the entire space in which the arc is drawn and extended. The cores on which these coils are wound are fabricated of iron and insulating material in such manner that the field in the air gap is concentrated at the necessary points for rapid movement of the arc. The cores and coils are supported by a laminated

blow-in magnet, has layers of metal foil embedded in it. These layers of metal foil are so shaped and located that each plate is forced to assume its proper electrostatic potential. The deionizing chamber, the blow-in

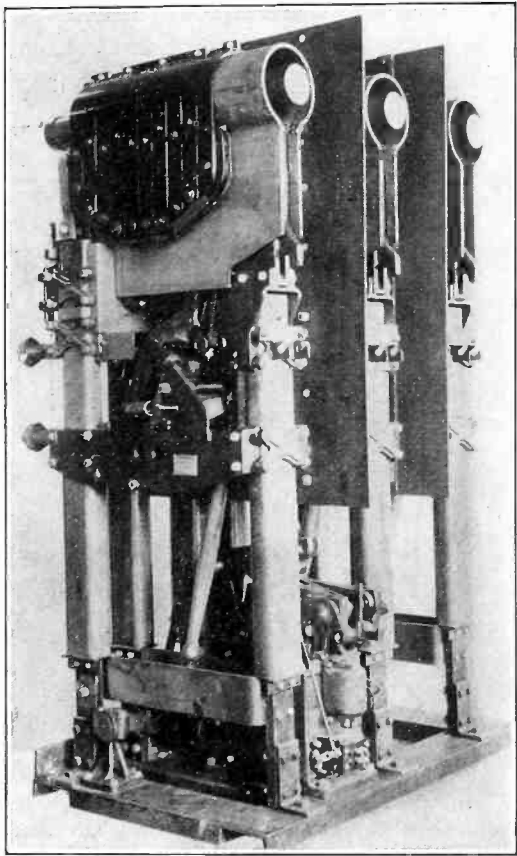

FIG. 1—THREE-POLE DEION CIRCUIT BREAKER WITH CONTINUOUS RATING OF 2000—AMPERES—15,000 VOLTS

return circuit passing over the top of the deionizing chamber. This return circuit acts also as a partial return path for the flux of the radial field coils previously referred to. The general appearance of this magnet may be seen by referring to Fig. 1.

A practically uniform distribution of recovery voltage over the gaps between metal plates in the deionizing chamber is an essential condition for satisfactory operation of the Deion circuit breaker. In the longer deionizing chambers required for the higher voltages, it is necessary to use a shielding device to prevent a concentration of voltage across the end gaps due to the electrostatic capacity of the metal plates to surrounding space. The electrostatic shield, which also serves as insulation between the deionizing chamber and the

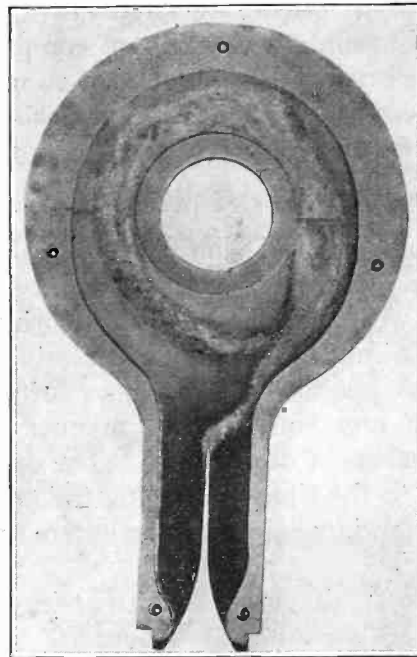

FIG. 2—PLATE FROM DEIONIZING CHAMBER WITH INSULATING SPACERS IN POSITION, SHOWING THE TRAILS LEFT BY THE ARC TERMINALS IN MOVING OVER THE RUNWAY

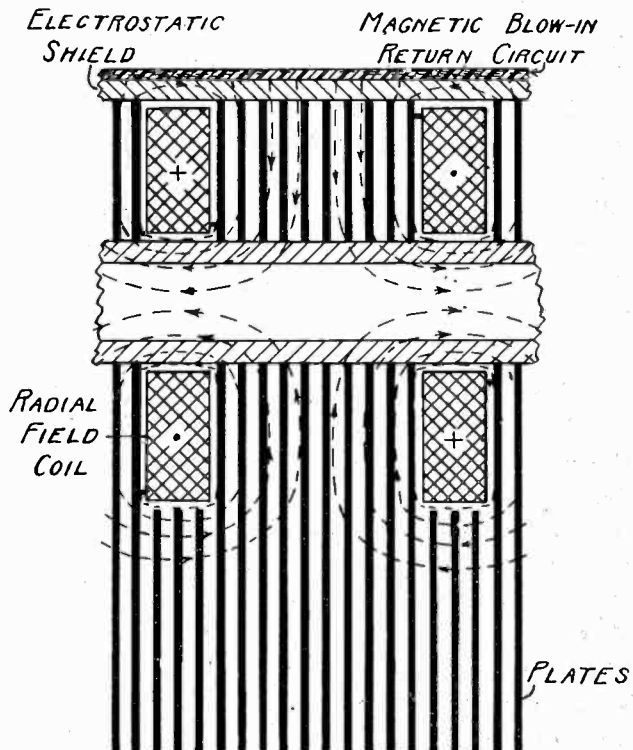

FIG. 3—SCHEMATIC RELATIONSHIP OF PLATES AND RADIAL FIELD COILS FOR THE DEIONIZING CHAMBER, SHOWING THE MANNER IN WHICH THE RADIAL FIELD IS PRODUCED

magnet and the electrostatic shield form a complete structural unit which is hinged at the rear support so that it may be rotated upward for inspection.

The insulating uprights carrying the deionizing chamber and the arc-drawing mechanism comprise a

complete pole unit which may be operated by its own individual closing mechanism as a single-pole breaker. Three of these pole units may be assembled on a structural steel base and operated by a single closing mechanism, for three-phase service. Barriers between pole units permit a spacing the equivalent of that in a modern oil-insulated breaker of comparable rating. This circuit breaker is well adapted to use in isolated-phase service either with individual closing mechanisms or through remote control from a common mechanism.

OPERATION

The theory of the Deion circuit breaker deals only with an arc after it has been drawn and is in no way connected with the method of securing a tripping impulse. Inasmuch as standard closing mechanisms are used to operate this breaker, tripping may be obtained in any conventional manner applicable to modern breakers of other types. The operation of the breaker up to the time of drawing the arc is similar to that of conventional circuit interrupters drawing an arc in air.

When the arc is drawn on the arcing contacts, the action of the blow-in field moves its terminals onto stationary arc horns very quickly, permitting the movable arcing contact to continue its opening stroke independent of the motion of the arc. To prevent possible retardation due to movement of the arc into a closed chamber, vents are provided at each end, as shown in Fig. 7. As the arc travels up the horns past the vents, it impinges on the metal plates of the deionizing chamber. As illustrated in Fig. 2, the lower end of these plates have a tapered slot. When a number of these plates are stacked together, these slots form a groove, roughly V-shaped, into which the arc is forced. The contour of the groove is such that as the arc moves upward, its cross-section is decreased and the current density increased with a corresponding increase in arc voltage. When a sufficiently high arc voltage is reached, the arc strikes to the plates forming a series of short arcs which move into the circular portion of the plates under the influence of the blow-in field. Under the influence of the radial fields, the short arcs trace on annular path around the circular portion of the plates. This motion continues until a zero of current is reached, at which time deionization prevents further flow of current. Under these conditions, arcs have been found to move around this path more than 15 times in a half cycle with a velocity several times that of sound. This high speed results in what has been termed "The Cold Cathode Arc."⁴

Fig. 2 shows a plate taken from a Deion Circuit Breaker on which approximately 300 rupturing tests were made, where arc terminals of currents up to 14,000 amperes have passed over the metal surface thousands of times without deterioration. The mottled area extending

from the end of the slot upward and around the circular portion of the plate is the retraced trail left by the arc. This mottled marking is only a very thin film of copper oxide and does not affect the operation of the breaker.

TESTS

The first experimental Deion circuit breakers built and tested were single-pole units. A large number of tests were made at 13,200 volts, 60 cycles, with two 20,000-kv-a. generators supplying the short-circuit current. Currents interrupted varied from one ampere to 17,000 amperes, r. m. s. at 13,200 volts and to 28,000 amperes, r. m. s. at 6600 volts.

Fig. 4 shows a typical oscillogram made during these tests. The most noticeable features are the short period of arcing and the shape of the arc voltage wave. This is the characteristic form of arc voltage produced by a Deion circuit breaker. It will be noted, in contrast to most conventional wave forms, that the arc

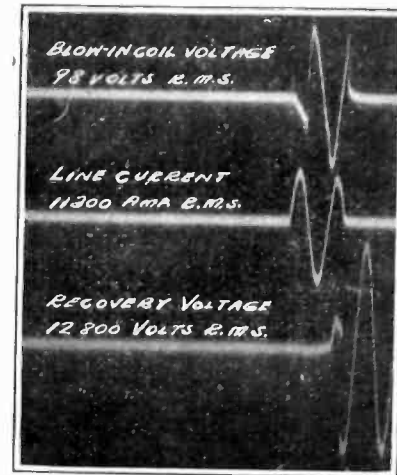

FIG. 4—OSCILLOGRAM OF SINGLE-PHASE INTERRUPTION ON A SINGLE-POLE DEION CIRCUIT BREAKER. (NOTE THAT VOLTAGE ACROSS THE BLOW-IN COIL WAS MEASURED IN THIS CASE)

voltage is roughly proportional to the current. Actually it has been found that the maximum arc voltage occurs at the highest value of current existing while the arc is in the deionizing chamber.

The three-pole, 15,000-volt Deion circuit breaker described in this paper was given several series of interrupting tests, a part of which were laboratory tests and the remainder field tests. The most comprehensive laboratory series consisted of 250 rupturing tests at currents varying from 13,100 amperes to 586 amperes at 13,200, 7600, and 6600 volts, grounded and ungrounded, with both star and delta generator connections. These tests were made at average of 12 tests per day, the highest number on a single day being 32. The total of 250 tests were made without a failure to clear the circuit and with very little maintenance. One hundred and fifty of these tests were made with no maintenance whatever. During the remainder, only minor adjustments were made and several of the arcing

4. J. Slepian, *Jour. Franklin Inst.*, 201, 1926, p. 79; J. Slepian, *Phys. Review*, 27, 1926, p. 407.

contacts were renewed. At the end of these tests, the breaker was in satisfactory operating condition.

Fig. 5A shows current and voltage characteristics of an ungrounded short circuit interrupted by this Deion circuit breaker. The generator voltage in this test was 13,200 line-to-line and the average current in the three phases was 8170 amperes, r. m. s. The oscillogram shown in Fig. 5B was made on the same test by means of instantaneous watt oscillograph elements and from it the total arc energy can be obtained. Fig. 5C is a side view of the breaker made simultaneously with these oscillograms, while the breaker was interrupting the circuit. Fig. 6 is similar to Fig. 5A except that the short circuit is grounded, the average of the three currents in this case being 9630 amperes, r. m. s.

12,000 amperes, r. m. s. At the end of each one of these series of tests, the breaker was in satisfactory condition to perform further interrupting duty. In all series of tests in which the deionizing structure was heated to its limiting temperature, it was only necessary to allow the breaker to cool before further interruptions could be made.

APPLICATION

From the manner in which the Deion circuit breaker functions, it is apparent that zero points in the current wave play a most important part in its operation, which makes it most effective as an a-c. device. Strictly speaking, the type of deionizing chambers referred to in this paper is applicable to d-c. circuit interrupters but

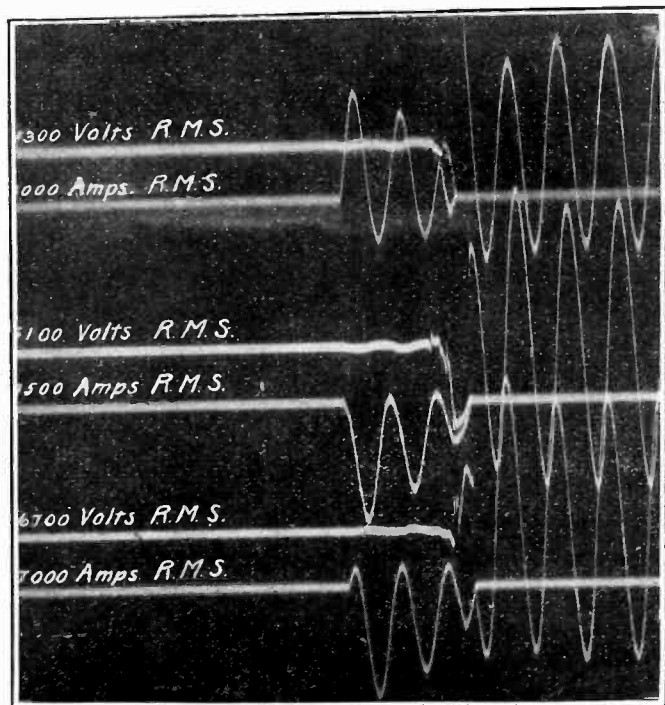

5A

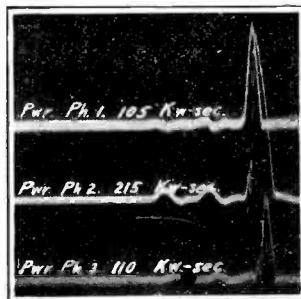

5B

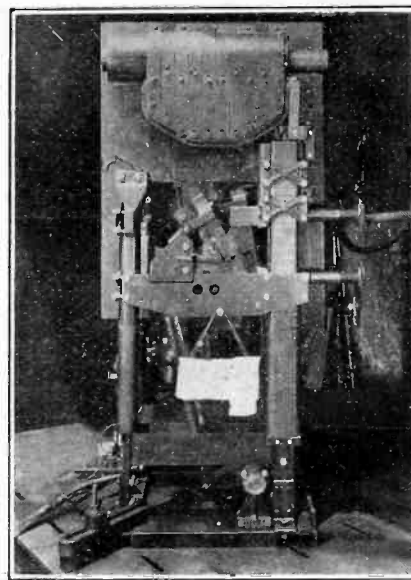

5C

FIG. 5—A THREE-POLE DEION CIRCUIT BREAKER INTERRUPTING A THREE-PHASE UNGROUNDED SHORT-CIRCUIT WITH OSCILLOGRAMS SHOWING LINE CURRENT, LINE-TO-NEUTRAL VOLTAGE, AND INSTANTANEOUS ARC POWER

The photograph made with this oscillogram is reproduced in Fig. 7, which is a rear view of the breaker.

It is apparent that a large part of the arc energy liberated in interrupting a short-circuit will be absorbed by the metal plates of the deionizing structure. The average arc energy per interruption per pole is small in comparison to the large thermal capacity of the deionizing structure, so that the breaker is capable of withstanding much more severe operating duty than is encountered in modern applications. To investigate this, several series of laboratory tests were made on the three-pole breaker described in this paper. These series consisted of 12 CO interruptions at two-minute intervals in a total time of 24 minutes with the average value of the r. m. s. currents interrupted exceeding 8000 amperes. Currents interrupted in individual phases varied from approximately 5000 amperes to

there are some indications at present that the voltage at which a given structure will function on d-c. may be in the order of 0.2 of the limiting a-c. voltage, so that the advantages to be gained by the use of this form of structure on d-c. circuits are not at the present time outstanding. Due to extensive development over a long period, sufficient data and experience have been obtained to make possible the extension of the Deion principles to a large number of different classes of commercial a-c. switching apparatus. Industrial contactors operating on the Deion principles have been in service in considerable numbers for periods up to one year operating at as high as 440 volts. For more than one year a limited number of three-phase Deion circuit breakers has been operating under service conditions on 2300-volt circuits. The performance of both the industrial contactors and the 2500-volt circuit breakers

has been entirely satisfactory and represents a considerable advance over results obtained with conventional magnetic blowout devices applied to this class of service. Extensive tests have been made also on

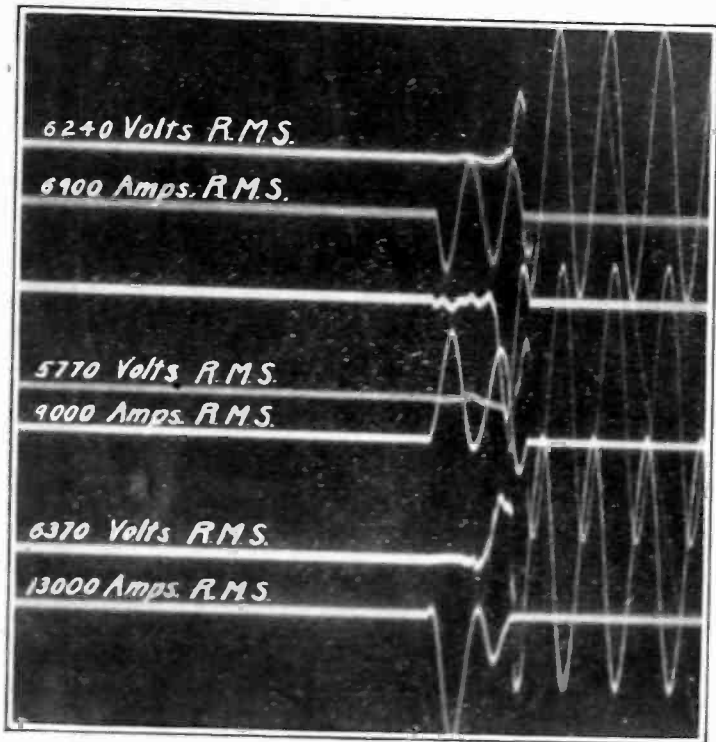

FIG. 6—OSCILLOGRAM OF A THREE-PHASE GROUNDING SHORT CIRCUIT INTERRUPTED BY A THREE-POLE DEION CIRCUIT BREAKER

Deion circuit breakers at 4500 and 7500 volts, the results of which warrant the belief that they can be placed in heavy duty service without encountering serious difficulties. This general development has led up to the building and testing of heavy-duty three-pole Deion circuit breakers for operation in the

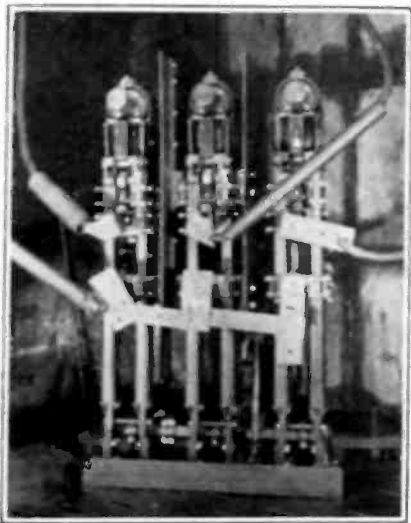

FIG. 7—VIEW TAKEN WITH OSCILLOGRAM SHOWN IN FIG. 6

15,000-volt class. The results obtained in laboratory and field tests, as presented in this and other papers before the Institute, warrant the belief that Deion circuit breakers as at present developed are applicable

through the power-house class of breakers at modern generating voltages.

With reference to higher voltages, there appears to be no great difficulty in extending the Deion principles beyond 25 kv. There are, however, certain detail problems involved which are not yet worked out, and the discussion of developments along this line will be left for future papers.

ACKNOWLEDGMENT

This paper would be incomplete without acknowledgment to the Commonwealth Edison Company of Chicago for its courtesy in extending the use of its operating equipment for test purposes and to various members of its engineering and testing organization for their efficient arrangements made for conducting the tests.

Acknowledgment is also made to Mr. H. M. Wilcox for his guidance in carrying on some phases of work on the Deion circuit breaker and for his very material assistance in the preparation of this paper.

HIGHER VOLTAGES FOR GENERATORS

Generators ever grow in size, transmission lines ever grow in length and voltage, but the generator voltage remains forever. So it would seem when looking back upon the enormous development of the electrical industry in the last few years. Nothing stood still; everything seems to have progressed except the generator voltage. Is there a law of nature or a constitutional amendment against the use of a generator voltage over 13,800? To be sure there are difficulties. But were there no difficulties in designing huge transformers and turbines or 220-kv. oil breakers? The study and development of insulating materials, iron and other features affecting generator design has not stood still; a great deal more is known about these features than was known twenty years ago, and more can be done with them.

Radical changes in apparatus are only seldom initiated by manufacturers. They are more often brought about by the intelligent and farseeing purchaser, who goes about finding out what can be done and then requests that quotations be submitted accordingly. For many years distribution and transmission in large cities were done at 13,800 volts; but 22,000 volts is becoming quite common for such purposes, and 33,000 volts will soon be very popular. Generators rated at 22,000 volts are now being asked for by some purchasers, and in the near future many utilities will no doubt request manufacturers to bid on 33,000-volt units, and the manufacturers will find means to build such units. They found means in the past to build 13,800-volt generators when anything over 2300 volts, or at most 6600 volts was considered impossible.

The 33,000-volt generator will come as a result of the recent tendency of public utilities to simplify their stations. It will eliminate troublesome transformation and unnecessary switching.—*Electrical World*.

Abridgment of Field Tests of the Deion Circuit Breaker

BY B. G. JAMIESON¹

Fellow, A. I. E. E.

Synopsis.—The operating principles of a new type of air circuit breaker for alternating currents are herein outlined, together with results of field test of a 2000-ampere, 15,000-volt, three-phase unit. The special testing facilities of the Commonwealth Edison

Company used for the test, the performances of the air circuit breakers under test, and the effects of the test currents on the power system are described.

* * * * *

IT was with considerable interest that the author of this paper received information from a representative manufacturer of switching apparatus that a new type of circuit breaker, operating without oil, had been developed to the point of interrupting consistently the maximum short-circuit current available from a 40,000-kv-a. test circuit operating at 13,200 volts. The interrupting function of this device called the Deion circuit breaker is based on a means for deionizing the arc stream at the zero point of the current wave to such an extent that the impressed voltage is not sufficient to reestablish the circuit and permit current to pass on the succeeding alternation. By this means, an arc is extinguished in air without resorting to the expedient of extending it to great length as is characteristic of the present day conception of the air-break circuit breaker. A discussion of the theory of this device and its operation is contained in other papers² to be presented before this meeting of the Institute and need not be presented in further detail here.

Arrangements were made for a series of tests at the Crawford Avenue Station of the Commonwealth Edison Company.

The breaker supplied for these tests was a three-pole, 2000-ampere, 15,000-volt, electrically-operated Deion circuit breaker of the multiple single-pole form of construction as shown in Fig. 1. The three pole units were mounted upright on a common structural steel base at 16-in. centers, and were operated through a single shaft by means of a conventional solenoid mechanism. The base or common mounting frame was at ground potential but the contact operating linkage for each pole unit is alive at line potential and is mounted on upright insulating posts supported by the grounded base. The deionizing chamber, which is the real interrupting medium is mounted at the top of the structure in such relationship to the contacts that an arc drawn from the arcing members is moved into the chamber by a magnetic blow-in field of new design especially developed for this device.

At the end of the initial series of tests with the breaker in the form supplied by the manufacturer, arrangements were made for a further series of tests on the basis of an isolated phase application. The three pole units were accordingly mounted on individual structural steel bases, each with its individual solenoid closing mechanism, and connected to the testing circuit as individual units with no mechanical tie between poles other than the short-circuiting bar, which was connected across the terminals of the three units.

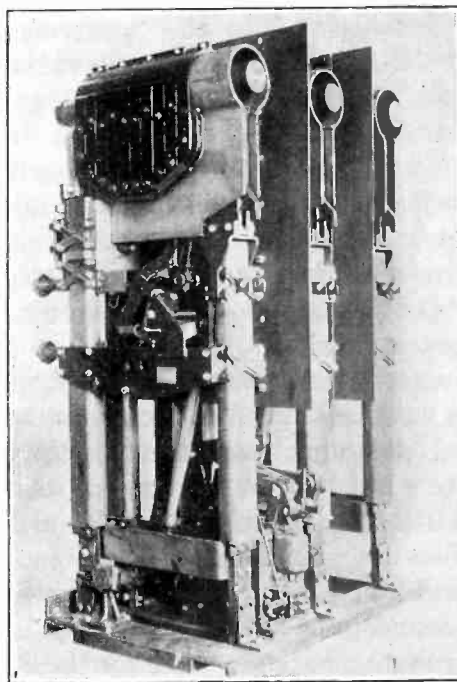

FIG. 1—THREE-POLE, 2000-AMPERE, 15-KV., DEION CIRCUIT BREAKER

Used at Crawford Avenue test circuit for the group-phase tests

TEST EQUIPMENT AND METHODS

A testing circuit with permanently installed recording equipment had been set up at Crawford Avenue Station over two years ago in connection with the general oil circuit breaker testing program of the Commonwealth Edison Company. The purpose of this installation was not solely to conduct interrupting tests on circuit breakers but to make a study as well of the effects of a fault and its interruption on the remainder of the system linked to the fault. For some time it has been apparent that inability of large operating systems to

1. Engineer of Inside Plant, Commonwealth Edison Company, Chicago, Ill.

2. *Theory of the Deion Circuit Breaker*, by Dr. J. Slopian. *Structural Development of the Deion Circuit Breaker up to 15,000 Volts*, by R. C. Dickinson and B. P. Baker.

Presented at the Winter Convention of the A. I. E. E., New York, N. Y., Jan. 28-Feb. 1, 1929. Complete copies upon request.

withstand shocks is a serious limitation to their usefulness as sources of power for commercial and industrial purposes. The question assumes increasing importance as the trend continues toward larger and larger concentrations of generating equipment, on the one hand, and the linking of heavy systems through interconnection on the other.

Through suitable switches in Crawford Avenue Station the test circuit proper is derived from the 12,000-volt distribution system. It consists essentially of approximately 500 feet of 22-kv. underground cable and roughly the same length of three-phase overhead line mounted on wooden poles and insulated for 66-kv. Test houses of portable construction are located at intervals directly under the overhead line with tapped connections bringing the three phases into a rack in each house. Hand-operated disconnecting switches are located in the overhead line at the pothead connection to the cables, permitting complete isolation of all test apparatus without recourse to switches in the station. Two backing-up oil circuit breakers are permanently connected on the test circuit side of the disconnecting switches. In the event of tests being made on the "CO" basis one of these breakers is used for closing purposes and in order that its opening operation may not cloud the results to be obtained from the test breaker its controls are arranged to retain the contacts in the closed position until tripped manually. The second breaker is arranged to open through relay control at a predetermined time interval after the short circuit has been applied to clear the circuit in event of failure of the test breaker.

A larger house of the same general construction as the test cells is used as a control room with all circuit controls and recording instruments permanently installed. There is a 125-volt battery for solenoid operation, and 110- and 220-volt a-c. circuits for control purposes when desired. The control room is used also as an observation post when tests are in progress. Telephone connections to the load dispatcher's desk and to other stations are available for the coordination of test operations with the general operation of the system.

The main control table has been specially developed for use with this circuit. All test operations are controlled through a motor-driven controller, consisting essentially of a number of adjustable cams rotating on a common shaft and so arranged as to close or open the desired control circuits in proper sequence and at predetermined time intervals. Two years' experience with this controller indicates that it is greatly preferable to control through relay operation, since all operations are related to a common source,—the revolving shaft,—and variables are thus reduced to a minimum. Strictly speaking, test operations conducted with this device are electrically non-automatic, but it is felt that the ability to increase or decrease the duration of short

circuit accurately in very short steps is a valuable feature in conducting tests of this nature.

Two six-element Westinghouse oscillographs are mounted on the control table and permanently connected to the motor-driven controller.

As a part of the study of the system under fault conditions, Hall Recorders were installed at points in the system where experience indicates the greatest voltage disturbance will occur. In this manner, valuable information is obtained as to the transient effects at different points due to various system set-ups under fault conditions. The operation of this device and the results obtained through its use have been discussed in a paper previously presented before the Institute.³

When tests with the Deion circuit breaker had reached the point of maximum current obtainable with the portion of the system connected, the breaker's performance in interrupting the circuit with a very short duration of arcing had been sufficiently consistent to warrant the belief that it would function satisfactorily over the next succeeding steps in the current range and a generator was, accordingly, connected direct to the test bus in Crawford Avenue Station in order to increase the current value at the point of short circuit. This means of securing additional power had never been attempted before in previous circuit breaker tests due to the fear of severe system disturbance following a prolonged duration of fault with the current values involved. The results obtained were therefore regarded with considerable interest aside from performance of the test breaker.

Three different generating units, varying in capacity from 60,000 to 75,000 kv-a., were used in this manner during the series of tests with the Deion circuit breaker. These generators are driven by steam turbines and in order to minimize the possibility of tripping out the steam end it was considered advisable to have them carrying some load rather than running light when the short circuit was applied. Accordingly, they were operated to feed power into the system during these tests in amounts varying from 10,000 to 38,000 kw. The circuits were so arranged that closing in on the short in the test circuit had the effect of short-circuiting the generator, and clearing the test circuit automatically returned the generator to the system. Permanent generator reactors to the value of one-eighth of an ohm were connected between the generator and the test bus. The generator neutral was grounded through approximately four ohms resistance with no neutral ground other than this on the various busses involved in the circuit. Tests made with the system alone were ungrounded on the rewinding of the transformer. No extensive cable system was directly connected to the test bus except that two idle three-phase cables were

3. *The Hall High-Speed Recorder*, E. M. Tingley, A. I. E. E. Quarterly TRANS., Vol. 47, January 1928, p. 252.

allowed to remain connected at times to note the effect on arc rupture.

The addition of steam-driven generating capacity proved very satisfactory on the Deion circuit breaker tests, and added quite materially to the current values obtained on the test circuit. For tests made on the "OCO" basis, the load on the generator was varied from 10,000 to 28,000 kv. With this maximum load, the first-cycle short-circuit current was approximately 19,000 amperes r. m. s., and the current interrupted approximately 14,000 amperes, average for the three phases. For "CO" tests, the generator load was increased to a maximum of 38,000 kw. for tests where the motor-driven controller was set to give a duration of short circuit of from two to three cycles. This maximum load gave first-cycle short-circuit currents of approximately 30,000 amperes r. m. s., and the current interrupted was approximately 22,000 amperes, average for the three phases.

A total of 38 tests was made with a generator feeding varying amounts of load into the system, and in all cases the generator returned automatically to feeding the system as soon as the short circuit was cleared, without system disturbance other than four-volt dips in lamp voltage in a few cases and without injury to the generator. The maximum duration of short circuit was 16 cycles, varying from this time down to four cycles for maximum currents except for two tests in which difficulty was encountered in operation of the test breaker and in which the circuit was cleared by the backing-up breaker after a period of 49 cycles (as determined by the motor-driven controller). On none of these tests did the generator drop out of step, nor was any effect noted on low-voltage releases on the system and but very little effect on lamps in the station. No so-called transients appeared during the course of these tests.

Connection of the generator to the test bus produced a noticeable effect on short-circuit characteristics as compared with tests which involved use of the system alone, and this effect becomes more marked as the loading of the generator was increased. Considerable variation appears between the values of short-circuit current for the individual phases, the degree of asymmetry is more pronounced, the current decrement becomes larger and at the maximum currents tested, several cycles were required for the delta recovery voltage to approximate the initial voltage.

SUMMARY OF OBSERVATIONS AND DEDUCTIONS

Severity of Test Duty Imposed. It was anticipated in arranging for these tests that on the same test duty the Deion circuit breaker would yield a performance superior to that of an oil breaker because of the absence of oil, higher speed, and definiteness of arc suppression. Accordingly, the number of cycles of operating duty was increased from two to three, and the time interval between cycles reduced from two minutes to one

minute. Also, while no special effort was made to increase the number of tests to a maximum in a repetitive sense as in all system tests certain time allowances must be made for necessary supervisory functioning and for ascertainment of effects on the system, it was realized that the factors which were assumed would enable the more severe operating duty would also allow a considerable increase in the number of tests possible within a given period. Also it was appreciated that the service requirements for this type of breaker would not necessitate the extremes required of breakers in industrial service from the standpoint of frequent operation.

It was expected that the choice of this more severe operating duty would expedite the whole schedule of tests toward the end, that the limitations of the breaker would become apparent more quickly, and, in a sense, procedure on this basis might be regarded as an approach towards a destruction test rather than the establishing of safe operating interrupting capacity rating.

Speed of Test Program. On the first day of the group phase tests, a total of 21 three-phase interruptions, with currents varying from 2000 to 10,000 amperes, was made in a period of two hours and 23 min. without evidence of limitation on the part of the breaker. On the succeeding day, nine three-phase operations with currents varying from 11,000 to 15,000 amperes were made in a period of one hour and 9 min. This series of tests was ended by a disability of the breaker which, upon investigation, appeared to be partially due to heating of the deionizing chamber.

On the first day of the isolated phase tests, 12 three-phase interruptions with currents varying from 7000 to 13,000 amperes were made in the period of one hour and 42 min. The test breaker interrupted all of these short circuits when difficulty of a mechanical nature ended this series.

On the final day of the isolated phase unit tests, a total of 15 three-phase operations with currents varying from 12,600 to 22,400 amperes were made in the period of two hours and forty minutes. These tests were made in the afternoon with breaker starting at a temperature somewhat above the ambient due to seven three-phase interruptions at varying currents made during the morning. This series of tests was ended by the temperature of the deionizing chamber becoming excessively high at the beginning of the final group of tests.

Performance of Test Breaker. In the foregoing text, mention was made of the fact that the group phase breaker had undergone a protracted series of tests in the factory, and it should be stated that the isolated phase breaker was assembled on short notice especially for the field tests and perhaps, therefor, not a commercial standard to the same extent as the group phase breaker. Considerable difficulty was experienced in the mechanical adjustments on the isolated phase breaker,

but all of the original contacts with the exception of one remained intact throughout the tests.

Very few renewals were required for the group phase breaker. Throughout its test there was no renewal of insulation except that following the final interruption which was a failure due to the excessive temperature, the renewal of insulated parts in the vicinity of the arc contacts would have been required for further testing. During the tests there were no renewals of arcing of auxiliary contacts and despite the previous factory tests the main current carrying contacts were apparently in a condition to carry normal rated current with excessive heating at the end of the Chicago tests.

Summarizing the performance, the two breakers jointly interrupted 92 short circuits. Of the 82 operations, two were unsuccessful in clearing the circuit. These two failures are especially interesting from the point of view comparable with oil breaker failures. In neither of these cases was there any damage to the test house or barriers or other equipment in the test circuit. There was no resultant fire and due to the absence of oil-throwing the work of preparing the test cell for succeeding tests was very much expedited. The fact that practically instantaneous determination of the extent of the damage was possible should be a feature of paramount interest to all operating companies.

Another feature of interest in these tests was the extent to which it was possible to visualize the performance. In contrast to the oil breaker, witnesses at a distance of one hundred yards could judge from the flashes any irregularities in the closure or displacement of time with regard to the sequential phase operations or inequalities in amount of gas or smoke emitted. Moving pictures which were taken disclosed the presence of gas and sparks to an extent not possible with the naked eye, and it might be well to reemphasize the importance of such records. At the same time it is realized that only experience in judging the performance by the movie camera films, or actual presence at the same tests, justifies conclusions from either of these visual indications of performance.

Limiting Factors in Interrupting Capacity. In this series of tests certain factors recognized as determinants of interrupting capacity were carefully measured or observed. They are, maximum current values, resultant temperatures, mechanical strength, arcing time and also restoration voltage. Of these the current values reached 25,800 amperes without definite signs of distress on the part of the breaker. On account of the rapidity of successions of the test cycles the temperatures reached a value which appeared to limit the safe interrupting capacity of the breaker. Need of reinforcement of the mechanical strength in the construction of blow-out coils was indicated. One factor, however, which is regarded as a limiting influence in the operation of oil breakers, namely, the production of restoration voltage of relatively high value, as far as this factor may be attributed to the action of the

breaker, was absent and since according to the theory of the Deion breaker the extinguishing of the current at the zero value is a fundamental characteristic of its operation, the Deion breaker should be given full credit for the absence of this limiting feature of performance.

Indeterminate Factors of Interrupting Capacity. While these tests indicated a superiority of performance of the Deion breaker from relatively low ranges of current values, its performance at extremely low values such as that due to magnetizing current or charging current of cables was not disclosed, and this test must be made before the performance of the breaker can be compared to that of an oil breaker. Neither did the tests permit observation of the action of the breaker on closure under the maximum current duty since these values were employed only in the "CO" tests.

Attention is again invited to the fact that while the performance of the breaker must be ultimately judged from service on an operating system, the advantages of the Deion breaker expected were established by the test performance. It also appears that the limitations of the breaker are more capable of definite determination than those of oil breakers, and finally it should be remembered that the tests as conducted were but test of a unit the first of a type and that as such they may be fairly construed to indicate ultimate results from the deionizing type of circuit breaker not possible with types having a less scientific principle of arc disposal.

LIGHTING AIRWAYS IN HUDSON AND MOHAWK VALLEYS PROPOSED

Plans for the lighting of airways through the Mohawk and lower Hudson valleys, which have been under survey by the Airway Division, U. S. Department of Commerce, took form recently when the New York Power & Light Corporation submitted a definite proposal to supply service for government beacons and fields lying in its territory.

The proposal includes service to beacons on the Albany-New York airway between Albany and the Dutchess county line, and on the Albany-Cleveland airway between Albany and Syracuse. On the first route, beacons will be located near Bethlehem, Schodak, Columbiaville, Blue Hill, south of Hudson, and Nevis. At Columbiaville an intermediate landing field will be provided. On the Albany-Cleveland route, beacons will be built at Florida, Tribes Hill, Yosts, St. Johnsville, and Canastota. An intermediate landing field will also be located near Yosts.

The airway beacons will be placed on steel towers from 40 to 80 feet high and will have a beam illumination of three million candlepower. They are so constructed that if a lamp burns out, another automatically takes its place. Landing fields will be equipped with boundary, landing and obstacle lights.

The proposal for service submitted by the New York Power and Light Corporation is believed to be the first of its kind in the Empire State.—*Transactions I. E. S.*

Uses of Radio as an Aid to Air Navigation

BY J. H. DELLINGER¹

Non-member

Synopsis.—Use of radio for guiding airplanes along fixed airways during fog or other conditions of low visibility is the principal topic of this paper. A directive radio beacon system is described together with a receiving system which gives simple and direct

visual indications of the location of the airplane. Methods of air navigation on other than established courses are also discussed as well as simple radio communication between plane and ground.

* * * * *

THE possibilities of radio as an aid to flight are being actively developed. This development includes the following lines:

- A. Communication
- B. Course navigation
- C. Field localizing
- D. General

Under D are included miscellaneous developments, for example, the use of radio methods in connection with altimeter devices. This paper is largely devoted to item B, presenting a successful system of guiding airplanes along fixed airways during fog or low visibility. I shall speak particularly of the work of the Bureau of Standards because I am most familiar with that. It is, however, only one of many organizations pursuing active work and making contributions in this field. These organizations include transport companies, communication corporations, and research organizations, as well as government departments.

At the present time the transportation of passengers by air is far from the ideal service expected in the future. Genuine service of interest to the public can hardly be said to be available until the air traveler can count on a scheduled service as regular as the railway trains, independent of weather or other contingencies. The present nullification of the most essential feature of the air passenger travel as a serious service arises entirely from the hazards of weather. As we shall doubtless learn from other accounts of progress in the various phases of aviation, all other limitations are in a fair way to be overcome. Airways and airports are being provided in abundance, aircraft of adequate strength and stability are more and more available, every provision of comfort and convenience is offered the air traveler, and yet air traffic can still be halted when low visibility prevents the pilot from seeing his landmarks or lights on the ground.

It is impossible to exaggerate the solitude and helplessness of an airplane flying in dense fog. Deprived of all landmarks, under incessant strain at the controls

¹ Chief of Radio Section, U. S. Bureau of Standards, Washington, D. C.

Presented at the Winter Convention of the A. I. E. E., New York, N. Y., Jan. 28-Feb. 1, 1929.

to maintain equilibrium and direction, the aviator must frankly abandon dependence upon his senses and navigate according to the information conveyed by his instruments. It is contrary to all human instinct to throw overboard the testimony of the senses and stake life itself on a mute instrument dial. Not every pilot can do it, and unquestionably the oceans hide the sad remains of more than one hero whose only mistake was failure to learn "instrument flying" before he essayed the great adventure.

By means of the familiar instruments such as the altimeter, turn indicator, and compass, a pilot can continue flying in fog, but it is only by radio means that he can be certain to keep on a given course and find his landing field when the ground is invisible. Accurate as a compass may be, it cannot tell the pilot how much he is drifting sidewise due to cross winds, nor what actual progress he is making forward because of the unknown effects of head or tail winds. Unless radio aids are used, fog always brings the hazard of getting off the desired course into unfamiliar or dangerous areas, and also makes even the possibility of a landing unknown.

By radio means, however, particularly by the use of the radio beacon system which is being established on the airways of the United States, the pilot can, regardless of fog, keep accurately on his course, know the points he is flying over, and proceed unerringly to the landing field. This, I believe, largely destroys the menace of fog. When this system is fully established there is every reason to believe that the last great obstacle to safe flying will have been conquered, scheduled flights will be dependable, and passenger flying can be considered established as a serious service.

Directional Radio Off the Airways. Before describing the radio beacon system I should like to indicate briefly the possibilities of navigation by radio on other than the established airways. The beacon system will mark out the airway routes but will give no aid to the flyer on an independent course. There are several ways in which radio can be adapted to this navigational need.

One is the system used in Europe: radio direction-finding stations are maintained by the governments at

various airports, and each airplane carries both a transmitting and a receiving set. Upon request by radio from an airplane, two or more of the direction-finding stations determine the direction of travel of radio waves from the airplane; combining their determinations they calculate the airplane's position and send this information by radio to the airplane.

A second means of radio navigation for the independent flyer is the use of a radio direction finder on the airplane. By steering a course in the indicated direction of a radio station on the ground, the airplane can be certain of reaching that point, the accuracy of the

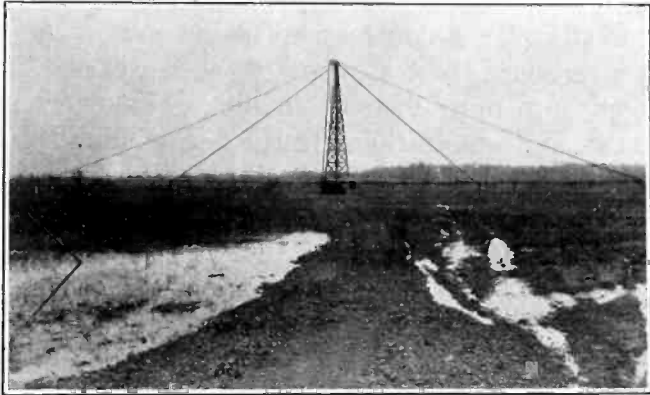

FIG. 1—THE FIRST RADIO BEACON TOWER ON THE CIVIL AIRWAYS

Experimental station of the Bureau of Standards at College Park, Md

indicated direction increasing as the objective is approached. Direction finders are used extensively as a navigational instrument on marine vessels and on lighter-than-air craft. On airplanes their use is difficult. It is considerably more difficult to protect them from error and disturbances caused by the engine ignition and other sources aboard an airplane. They have been used successfully to some extent, and their use will doubtless increase; they do, however, require expert handling. This method of navigation has the inherent limitation that it does not prevent wind-drift from shifting the airplane off its course; the method does eventually bring the airplane to its destination, although by a circuitous route if there is a side wind.

A third method of furnishing navigational aid to the independent flyer is the rotating radio beacon. This is a radio transmitting station, located at an airport, which has a rotating directive antenna. This causes a sort of beam of radio waves to sweep constantly around. A special signal indicates when the beam sweeps through the north. A pilot listening for this beacon's signal with his receiving set can determine his direction by the time elapsing between the north signal and the instant when the beam is heard with maximum (or minimum) intensity. The elapsed time is determined by means of a stop-watch, which can be calibrated to read direction.

The Airway Radio Beacon. The radio beacon system

for the United States airways has been designed to operate with the minimum of apparatus and attention on the airplane. The objective in its development was to place a simple visual indicator on the airplane instrument board to tell the pilot whether he is on the course or how far off, which should operate without any effort or attention by the pilot. This has been successfully accomplished, and navigation over the official air routes thus has the advantage of a superior means of radio navigation not available to the independent flyer off those routes. The three methods of radio navigation for the independent flyer described in the foregoing require the pilot to listen with headphones through the roar of noise on the airplane. Also, each of them requires other apparatus besides a radio receiving set; thus in the first method the airplane must carry a radio transmitting set, in the second a direction finder, and in the third a special type of stop-watch.

While the radio beacon system for the airways attained practical development only this year, its origin goes back to 1920. At the request of the War Department, the Bureau of Standards undertook to develop a directive radio system for airplane navigation. A method was devised in which radio waves were trans-

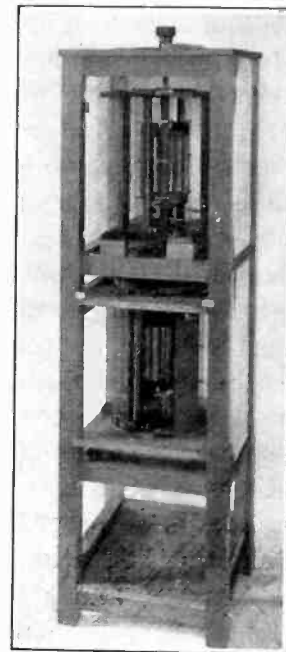

FIG. 2—GONIOMETER USED IN RADIO BEACON STATION
To orient the course marked out by the beacon in any desired direction.

mitted alternately from two directive antennas placed at an angle with each other. Equality of signal intensity from the two antennas along a certain line or zone determined a course which an airplane could follow. The system was tried out successfully in Washington and in Dayton, Ohio. In succeeding years the Army engineers at Dayton developed the system further.

When the Aeronautics Branch was formed in the Department of Commerce in 1926, it determined that radio aids would be necessary on the civil airways, and

assigned their development to the Bureau of Standards. As part of this work, the Bureau undertook to perfect the radio beacon, particularly by developing a visual indicator so that a pilot would have a direct indication, on his instrument board, of his location.

315 to 350 kilocycles. These are allocated to air service by the 1927 International Radio Convention. For the present the beacons are adjusted to the frequency of 290 kilocycles, and the telephone stations to 333 kilocycles.

The directive radio beacon is a special kind of radio station, usually located at an airport, just off the landing field. Instead of having a single antenna like an ordinary radio station, it has two loop antennas at an angle with each other. Each of these emits a set of waves which is directive, *i. e.*, it is stronger in one direction than others. When an airplane flies along the line exactly equidistant from the two beams of radio waves, it receives signals of equal intensity from the two. If the airplane gets off this line it receives a stronger signal from one than the other.

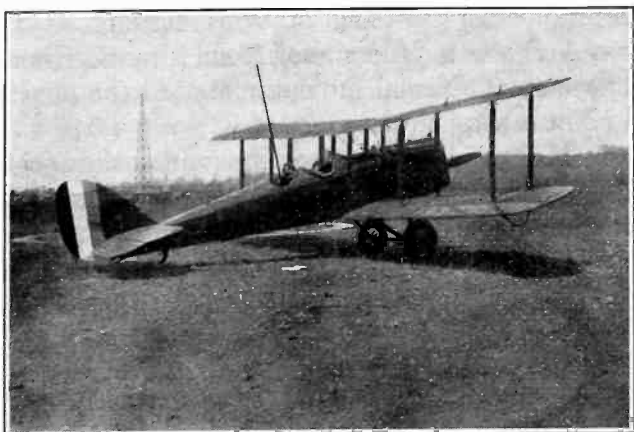

FIG. 3—AIRPLANE SHOWING 10-FOOT VERTICAL ROD ANTENNA

The required radio equipment on the airplanes is reduced to a short pole antenna and a simple receiving set weighing a few pounds, plus the indicator on the instrument board which tells the pilot whether he is on the course or how far off. All of the expensive and



FIG. 4—INSTRUMENT BOARD WITH BEACON INDICATOR MOUNTED ABOVE THE OTHER INSTRUMENTS

powerful apparatus necessary for the system is on the ground, maintained by the Government.

The radio beacons operate in the frequency band 285 to 315 kilocycles. Airway radio telephone stations are to communicate with airplanes in flight, in the band

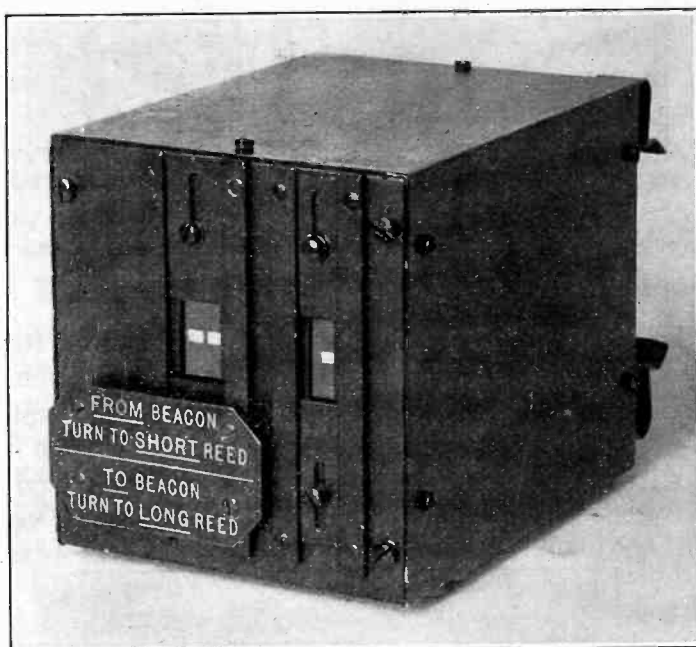

FIG. 5—VISUAL BEACON INDICATOR

Comprising the pair of reeds to show deviations to either side of course and single reed (at right) which indicates when airplane is passing over a marker beacon

The current in the two antennas is of exactly the same frequency, but is modulated at a different low frequency in each, *i. e.*, the current in one antenna has a tone of 65 cycles impressed on it, and the current in the other antenna has a tone of 85 cycles impressed on it.

The indicator on the instrument board of the airplane shows when the signals from the two beams are received with equal intensity, by means of two small vibrating reeds. When the beacon signal is received the two reeds vibrate. The tips of these reeds are white in a dark background so that when vibrating they appear as a vertical white line. The reed on the pilot's right is tuned to a frequency of 65 cycles and the one on the left to 85 cycles. It is only necessary for the pilot to watch the two white lines produced by the vibrating reeds. If they are equal in length, he is on his correct

course. If the one on his right becomes longer than the other, the airplane has drifted off the course to the right. If he drifts off the course to the left, the white line on the left becomes longer. Thus if the pilot leaves the regular course either accidentally or to avoid a stormy area, the radio beacon will show him the way back.

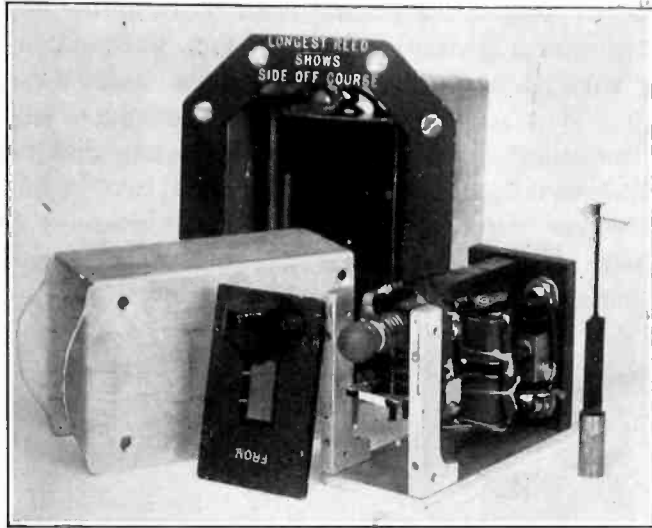

FIG. 6—INTERIOR OF BEACON INDICATOR

Showing electromagnets, pair of reeds in place, lamp, and detail of detached reed

The whole receiving system comprises a small indicator unit on the instrument board weighing one pound, a receiving set weighing less than 10 pounds, and a 10-pound battery. The same receiving set can be used to receive radiotelephone messages, by plugging in a pair of headphones. The receiving system is very

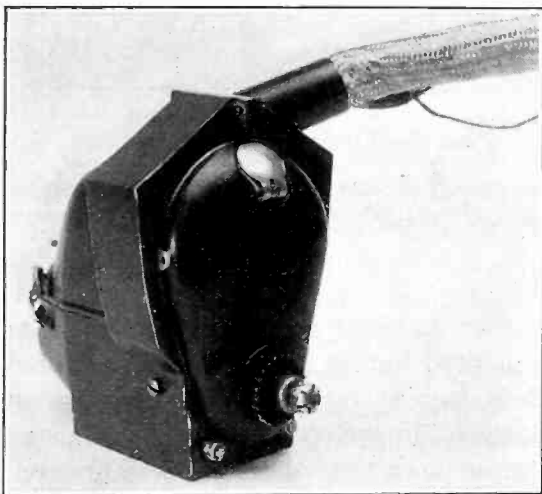

FIG. 7—COMPLETELY SHIELDED MAGNETO

Illustrating how all parts of the electrical circuits on the airplane have to be enclosed in a grounded metal sheath

little affected by interference, including static, other radio stations, and airplane ignition interference, which has hitherto been the bar to satisfactory use of radio on airplanes.

The beacon stations will probably be placed at airports in general averaging about 200 miles apart.

The Airways Division of the Department of Commerce Aeronautics Branch has begun a program of installing them on the various airways. The directive beacons, with a straight airway between them, will be supplemented by small marker beacons at intervals (perhaps 20 miles) along the route. These are simply very low-power radio transmitting stations serving as mile-posts. A characteristic signal from a marker beacon will show on the visual indicator aboard the airplanes what point is being flown over.

Thus the radio beacon system guides the airplane along the airway regardless of fog, informs the pilot of the distance passed over, and brings him to the landing field. There are two other services which directional radio can eventually perform to complete the conquest over fog, the providing of a field localizer and a landing altimeter; *i. e.*, to mark out clearly the landing area and to indicate distances above ground in the act of landing. While it is not yet certain whether radio or

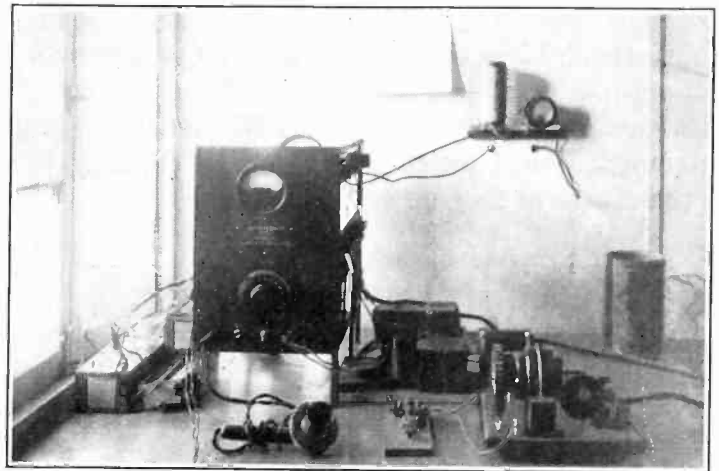

FIG. 8—TRANSMITTER FOR MARKER BEACON

A 10-watt transmitter located at intermediate points between airports to show distance flown along the airway

other methods will be the best means to provide these two services, the need of a field localizer is already partially met. When the pilot arrives at the radio beacon station and flies over it, there is a sudden deflection of his indicator which enables him to ascertain the location of the radio beacon station within 100 feet. This is accomplished by virtue of the peculiar properties of the vertical pole antenna on the airplane, and is of material assistance when landing during poor visibility.

The practicability of this system, both for course navigation and field localizing, may be illustrated by a recent trial flight. On a day of low visibility, a pilot unfamiliar with the route took the air in Philadelphia for Washington with no maps or instructions as to landmarks; he was told to proceed to Washington (a distance of 120 miles) and land at College Park field solely in accordance with the guidance given by the beacon indicator on his instrument board. He not only flew in a straight line to Washington, but when over College Park field, which he had never seen before,

the special deflection of the indicator told him he was at his journey's end, whereupon he landed.

Valuable as directional radio is, it is perhaps not as fundamental a service to the aviator as simple radio communication between airplane and ground. On the United States civil airways, radio telephone stations are being installed to inform the pilots of weather and landing conditions. This instantaneous service is a powerful addition to flight safety. The radio telephone messages may be received by the same simple receiving set used for the radio beacon signals.

As time goes on there will be more and more demand for two-way telephony between airplane and ground.

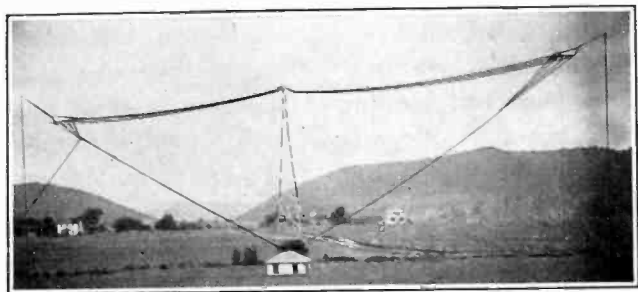

FIG. 9—RADIO TELEPHONE TRANSMITTING STATION AT BELLEFONTE, PA.

The first of the airways stations established to give weather and other information to airplanes in flight

A number of demonstrations has shown that such communication can readily be provided with quality sufficiently good to justify connection to the regular telephone exchange. In some of the demonstrations, officials sitting at their desks in Washington had two-way conversations on their regular desk telephones with other persons in an airplane. On one of these occasions Assistant Secretary MacCracken at his desk in Washington demonstrated the applicability of this service by warning the occupants of the airplane of the rising of a severe storm near the landing field.

The possibilities of radio in flying have been illustrated in some of the spectacular transoceanic flights. The Southern Cross, on its remarkable trip from California to Australia in the summer of 1928, was in touch with the world throughout the trip, by means of high-frequency (short wave) radio communication. The successful flight of Goebel and Davis from California to Hawaii in 1927 was made by the aid of the radio beacon of the aural type. A long flight over sea, terminating in a relatively small objective like the Hawaiian Islands, is extremely hazardous if undertaken without radio aid. Navigation by compass is subject to the indeterminate effects of wind drift, and the airplane's path may easily be shifted entirely away from the objective.

Any practical scheme for transoceanic air service would seem to require directional radio aid. It would be imperative for a system such as that involving a number of seadromes anchored at intervals across the ocean. Navigation on such a system without directional radio could not be considered; there is no other

known means of being sure to arrive at the next air-drome.

Exploration by air is another instance where radio must be used. An exploring party takes unnecessary risks if it neglects directional radio aids to reach its objective or to find the way back to its base. This is recognized by Commander Byrd who is taking direction finding equipment along on the airplanes which he will use in exploring the Antarctic Continent.

The principal use of radio, however, will doubtless come on the regular commercial airways. The radio beacon system developed for airways is now being subjected to the test of routine operation.

As the radio aids have been slow in coming, compared with the advances in airplane design, engine reliability, and airway development, there has been a constantly increasing percentage of aviation accidents due to the hazards of weather. Radio seems the answer to those hazards, and there is ground for hope that not only this percentage of accidents but the whole number of accidents will become vanishingly small when the present possibilities of radio are realized in practise. Commercial reliability of air travel seems to depend directly upon the use of radio.

RESEARCH AS A BUSINESS HELP

Research is no longer considered a business philanthropy. It is no longer a side issue or hobby to be supported or neglected in the degree that money is donated by its friends. On the contrary, as recently stated by Irving Langmuir: "The leaders of industries are frequently conscious of the need of improvement in their processes and even of the need of new discoveries or inventions to extend their activities." Research is the modern tool by which to work out commercial success in any industry.

But beyond the commercial incentive to survive under highly competitive conditions there are broader aspects of research that affect business directly. Heretofore the world has been built and operated largely through the wasteful use of raw natural resources. Many of these have now been reduced in volume, but, despite this, man-made products derived from researches have supplied the public demand with cheaper and better products than those made from the original materials. For example, cheap lumber for building is a thing of the past, but cement, steel and special building materials have replaced lumber, and construction methods have changed, so that buildings today are better and cheaper than those made from raw lumber.

Under the spur of a diminished supply, research comes into being to replace old materials with new, and business today realizes that only through scientific research can it remain prosperous under modern conditions. No organization economies can replace research as a direct method for maintaining business success.—*Electrical World*.

A Precision Regulator for Alternating Voltage

BY H. M. STOLLER¹

Member, A. I. E. E.

and

J. R. POWER¹

Non-member

Synopsis.—A recently developed precision voltage regulator for use with alternating current is described. It will maintain its output voltage constant to within 0.03 per cent over an input voltage range of 10 per cent and a load range of from zero to full load.

This regulation is accomplished by means of a small transformer inserted in one of the lines which boosts or bucks the impressed voltage by the required amount. The transformer is controlled by a vacuum tube circuit acting through an inductance bridge.

INTRODUCTORY

MODERN industrial conditions are making it more and more imperative that the voltages used for testing purposes be held within precise limits. In some cases the requirements have far exceeded the regulation obtainable by the commonly used types of regulators.

This paper will describe a vacuum tube type of a-c. regulator which will maintain the output voltage within 0.03 of 1 per cent over the extreme range from maximum load minimum input voltage to minimum load maxi-

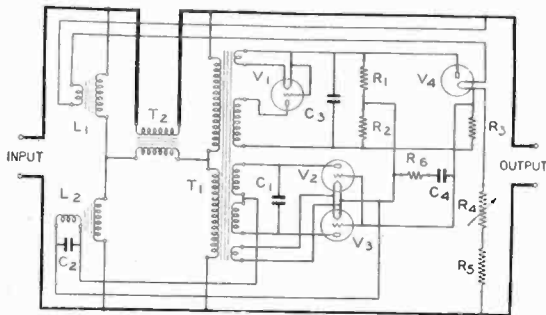

FIG. 1

imum input voltage. This regulator is employed in the inspection of telephone equipment and is designed for operation on a line whose voltage fluctuates between 85 and 90 volts, 20 cycles.

For the great majority of tests, the line voltage limits are sufficiently precise, but there are frequent cases where a much higher degree of precision is necessary. It is therefore advisable to use a regulator of small power rating situated at the test position rather than at the power source because of line drop and because it would be uneconomical to regulate the entire alternator output so precisely.

APPARATUS

The circuit employs a small transformer whose secondary is in series with the line so that any voltage induced in it either aids or bucks the line voltage. The primary voltage supplied to this transformer is derived from a bridge circuit. Referring to Fig. 1, this circuit consists of the two halves of the primary

1. Both of Bell Telephone Laboratories, Inc., 463 West St., New York.

¹ Presented at the Winter Convention of the A. I. E. E., New York, N. Y., Jan. 28-Feb. 1, 1929.

winding of the power transformer T_1 , the fixed retardation coil L_1 , the variable retardation coil L_2 and the output transformer T_2 . In the variable arm L_2 of this bridge, the inductance is varied by the commonly known method of changing the degree of magnetic saturation of the reactor by means of a direct current in an auxiliary winding. For this purpose a three legged core with a winding on each leg is used (Fig. 2). The two outer windings consist of an equal number of turns and are connected in series so as to aid each other in producing flux in the outer legs of the core. As they are very carefully balanced no flux is set up in the middle leg by these windings. Any flux set up by the middle winding divides equally between the two outer legs. If, then, a direct current is sent through the middle winding it tends to saturate the entire core and so reduce the impedance of the outer windings to alternating current. In the present instance the ratio of turns of the d-c. winding to the a-c. winding is large. By this means a direct current of a few milliamperes can control the impedance of a reactor capable of handling several amperes of alternating current.

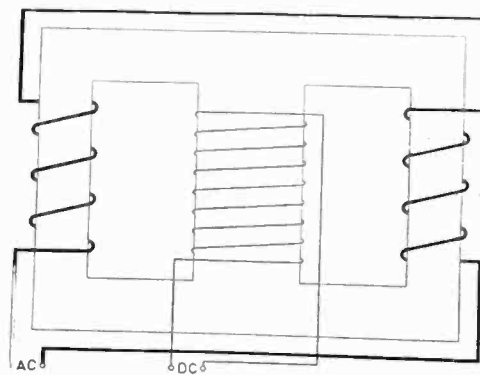

FIG. 2

The important feature of the fixed retardation coil (L_1 , Fig. 1) is that it must be so designed that it will not saturate over the working range. This condition is met by the use of a large air-gap. An auxiliary winding used for compensation is placed on the same core and is connected in the regulating circuit.

The two element vacuum tube, V_4 , is the primary source of control. It is supplied with an excess of plate potential (from the rectifier tube V_1) so that the space current is entirely controlled by filament emission.

The filament is made of tungsten² and is 0.001 inch diameter so as to have small time lag between current and temperature. This filament is connected in series with a resistance across the voltage output terminals so that a change in voltage produces a proportional change in filament current. A change of 0.1 per cent in filament current will cause about a 2 per cent change in the space current or, in other words, the tube has an effective amplification factor for current of about 20.

The tubes V_2 and V_3 are amplifier tubes supplying

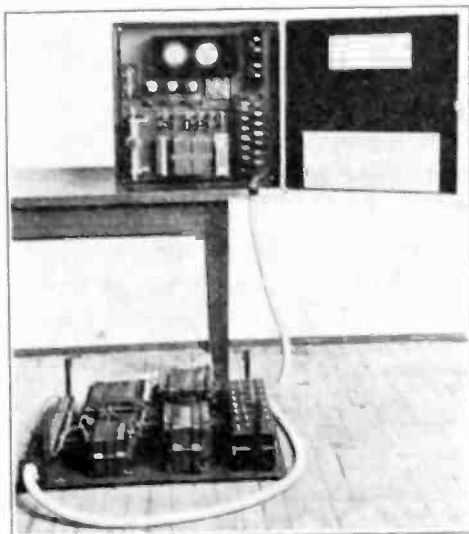

FIG. 3

rectified current to the d-c. winding of the inductance L_2 .

The plate-voltage supply for these tubes is derived from the transformer T_1 which is connected across the output circuit of the regulator. Thus the tubes have a constant source of potential which is essential to satisfactory operation of the circuit.

The assembled apparatus is shown in Fig. 3.

PRINCIPLE OF OPERATION

Referring again to the circuit in Fig. 1, the secondary of the transformer T_2 is in series with the line. Its primary is connected across the mid-points of the bridge formed by the transformer T_1 and the retardation coils L_1 and L_2 . When the impedance drop across L_2 is equal to that across L_1 , the bridge is balanced, and no potential is applied to the output transformer and none, therefore, is induced in the line. Under this condition the output voltage is equal to the input voltage except for the impedance drop in the transformer. If the impedance of the variable reactor changes, this balance is disturbed and a voltage is induced in the line that either bucks or boosts the line voltage. As described above, the impedance of this reactor is a function of the direct current through it. This current is controlled by the vacuum tube circuit.

If the input voltage should increase, the instantaneous

effect would be an increase in output voltage. This would cause the filament current of the regulator tube to increase and, as a result, its space current would increase at a much greater rate as shown in Fig. 4. The space current flowing through the coupling resistance R_3 would change the balance of the resistance bridge of which the tube and this resistance form one side. This change is in such a direction as to bring the potential of the junction between the tube and the resistance R_3 nearer to that of the junction between the resistances R_1 and R_2 which form the other side of the resistance bridge. By this means the negative bias on the grids of the amplifier tubes is reduced and their output increased. This increased output flowing through the winding of the variable reactor decreases its impedance which changes the balance of the inductance bridge and either reduces the aiding voltage supplied to the line by the transformer T_2 or increases the bucking voltage, depending upon previous conditions. This change in induced voltage will bring the output voltage almost back to its original value. In practice the operation of this sequence of events is sufficiently rapid to prevent the transient increases in output voltage from attaining noticeable proportions except on a very sudden and severe change in input voltage.

This reaction to an increase in input voltage would restore the output voltage almost, but not quite, to normal except for the action of the compensating auxiliary winding on L_1 . With the aid of this winding the required increase in filament current through tube V_4 is secured without raising the output voltage at all. This effect is secured by making use of the increased voltage across L_1 due to the changed condition in the inductance bridge.

By using the proper number of turns in the auxiliary

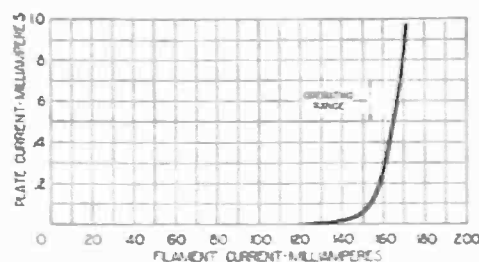

FIG. 4

winding, the voltage may be kept constant or even be caused to rise. This feed-back effect does not cause hunting because there is a slight time lag in its action due to the high inductance of the d-c. winding on the variable retardation coil L_2 .

In the case of load variation, the action of the regulator circuit is similar to its operation with voltage variation, an increase of load causing the same action as a decrease in applied line voltage and a decrease of load the same action as an increase in applied voltage.

2. The tungsten is pure and contains no thorium or other materials having thermionic activity.

There are two pieces of auxiliary apparatus that contribute to the precision of the regulator. They are the capacity C_1 and the a-c. by-pass circuit composed of the capacity C_4 and the resistance R_6 . The by-pass circuit smooths out the pulsating current through the coupling resistance R_3 . This pulsation is due to the cooling of the regulator tube filament between peaks of the alternating current through it. As there are two peaks per cycle the pulsation will be at twice the line frequency. If these pulses were in phase with the line voltage they would be permissible as the resultant pulsation in the grid potential of the amplifier would be in phase with its plate voltage and an acceptable output could be obtained from the amplifier. This phase relation does not exist, however, on account of the time lag introduced by the heating characteristics of the regulator tube filament. If capacity alone is used in the filter an oscillation is set up that causes the output voltage to hunt or, with an excess of capacity, the regulator is sluggish in its reaction to transients. In order to prevent these effects a small capacity is used and a resistance placed in series with it. The effect of this resistance is to damp the oscillation to such an extent that hunting is prevented but without causing a marked decrease in the filtering action.

The capacity C_1 aids the regulation with respect to load. The cause of a change in output voltage with a change in load is two fold. The first is a change in the impedance drop across the winding of the output transformer in series with the line. The other (the more important cause) is that the line current in the secondary of this transformer causes a corresponding current to flow in the primary. The path of this current is from the line through the fixed retardation coil, the primary of the output transformer and half of the primary of the power transformer to the other line. This current changes the balance of the bridge in such a direction as to reduce the output voltage. The condenser C_1 is placed across the high-voltage secondary of the power transformer. The volt-ampere input to this capacity is made large compared to the watts drawn by the transformer T_1 and results in a large leading component in its primary current. This adds a steady leading component to the line current through the output transformer. Any output current of the regulator adds vectorially to this steady current. This vectorial addition decreases the importance as viewed from the bridge circuit of all load variation on the regulator, especially lagging, and unity power factor loads. At the low frequencies employed in this case it was not considered probable that the leading component of the load would exceed 25 per cent of the rated full load of the regulator and the operation under these conditions was found to be satisfactory. Other important functions of this capacity are that of power factor correction for the entire regulator and the by-passing of harmonics in the amplifier circuit.

PERFORMANCE CHARACTERISTICS

The output characteristics of the regulator are shown in Fig. 5. The curves show the output voltage plotted against the input voltage with the load on the regulator as a parameter. These curves are plotted in per cent of normal voltage instead of in volts because the normal voltage may be adjusted over a range of several volts by means of the variable resistance R_4 .

The regulator is not critical to frequency over a range of about ± 10 per cent of the normal frequency. Also the normal frequency can be adjusted over a range of about 30 per cent by adjustment of the by-pass circuit C_4 and R_6 and of the inductance L_1 .

The distortion of wave form due to the regulator is slight. In the worst condition, that of low input voltage, the harmonics introduced are barely noticeable when viewed on a cathode ray oscillograph, and were estimated to be less than one-fourth of 1 per cent.

The limits of the regulating range with respect to input voltage are due largely to amplifier characteristics.

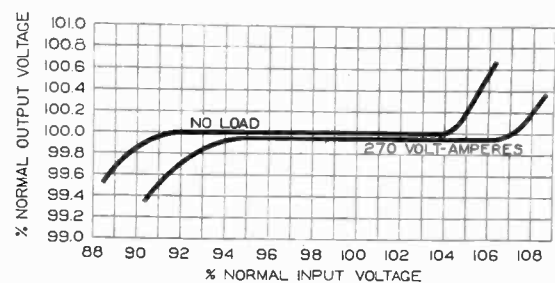

FIG. 5

The upper limit is fixed at the point where the grids of these tubes draw current. The lower limit is due to the ineffectiveness of a change in grid potential near the cut-off value and also to the insensitivity of the variable reactor at low values of direct current.

Fig. 5 shows clearly the effect of a load on the regulator. It will be noted that this effect consists entirely of a shift of the regulating range and does not impair the regulation within this range. As a result, the maximum load that the regulator can carry depends upon the input voltage.

It is estimated that the life of the tubes should be about 3000 hr. It is necessary to readjust the resistance R_4 about once in 100 hr. of operation in order to compensate for the gradual reduction in the size of the filament of V_4 due to evaporation of the tungsten. The other apparatus in the circuit has a practically indefinite life.

It should be noted that no auxiliary sources of power supply are required for the plates or filaments of the tubes so that the circuit is well adapted for practical shop testing purposes.

DISCUSSION

The precision obtainable from a regulator of the type described is determined by the following factors:

1. The intrinsic precision of the voltage measuring device. (In this case, the emission characteristic of the tungsten filament of tube V_4).

2. The amplification between the measuring device and the controlling means.

3. The use of a suitable compensating means to offset the small change in output voltage which would otherwise be required to actuate the regulating circuit.

As regards the first factor, the tungsten filament gives a good intrinsic precision. If operated at a low emission it will give a long tube life.

The second factor is a matter of balancing cost against the value of the precision and range attained. In the circuit of Fig. 1 only one stage of amplification is employed. Another limiting factor in amplification is the tendency to hunting of the regulator. This tendency is reduced by reducing the time elements in the circuit between the measuring means and the control means. In this circuit the time factors are the heating lag in the tungsten filament, the time required to change the charge on the condenser C_4 across the grid circuit of tubes V_2 and V_3 and lastly, the time required to

change the current in the highly inductive d-c. winding of L_2 .

The third factor of compensation is essential in order to realize the full benefit of the circuit. For example, the circuit described would show a precision of only 0.70 of 1 per cent without compensation as compared with 0.03 of 1 per cent with compensation. The means of compensation must be such as to avoid impairing the stability of the circuit. This is most readily accomplished by introducing a small time element between the operation of the regulator and its compensation.

It may be concluded therefore that the limiting factors in the design of this type of regulator are economic rather than physical. By employing more amplification and suitably reducing the time factors in the circuit, it appears that a still higher degree of precision or a wider operating range could readily be obtained.

The circuit could of course be equally well designed to operate on 60 cycles or any other frequency of that order; in fact, the higher the frequency, the smaller and cheaper the apparatus would become.

Abridgment of

A Graphical Theory of Traveling Electric Waves Between Parallel Conductors

BY VLADIMIR KARAPETOFF¹

Fellow, A. I. E. E.

Synopsis.—The analytical theory of simple traveling waves along parallel conductors is well known. Its disadvantage is that the relationships among the incoming, reflected, transmitted, and absorbed currents and voltages are expressed by a number of simultaneous equations difficult to grasp, from a physical point of view, in their entirety. For this reason, a graphical theory has been developed according to which all the quantities involved are represented in a so-called star diagram and the whole phenomenon conveyed to the eye quantitatively.

The star diagram is then applied to the following practical cases of a simple rectangular-front non-attenuated long traveling wave:

(a) Reflection from and absorption in a non-inductive terminal resistance;

(b) Reflection from an open-circuited and from a short-circuited end of a line;

(c) The case of critical resistance;

(d) Repeated reflections from the ends of a line;

(e) Discharge of a wave to the ground, directly or through a resistance;

(f) Passage of a wave through the junction point of two conductors having different values of surge impedance;

(g) Same as (f), only the junction provided with a series or shunted resistance,

(h) Effect of a lumped series inductance or shunted capacitance in reducing the steepness of a wave front.

In each case, the results agree with those deduced analytically, for example by R. Rüdenberg in his book "Elektrische Schaltvorgänge." Some reciprocal relationships are pointed out at the end and further problems suggested to which the star diagram may be applied.

INTRODUCTION

THE purpose of this paper is to explain graphically the fundamental properties of electric traveling waves between parallel conductors (such as transmission lines), especially where a wave strikes an obstacle, for example, a resistance, an inductance, an open end, a junction point between a cable and an overhead line, etc. While the general analytical

theory of such waves is well known (see the references below), a graphical representation of the quantities involved is believed to be new, and it may give a clearer idea of the important relationships useful in the solution of some practical problems. The so-called *star diagram*, developed for this purpose, is the foundation of the graphical treatment given below.

1. GENERAL PROPERTIES OF ELECTRIC WAVES TRAVELING ALONG PARALLEL CONDUCTORS

Whenever some electric or magnetic conditions in a circuit are changed suddenly, a traveling electro-

¹ Professor of Electrical Engineering, Cornell University, Ithaca, N. Y.

² Presented at the Winter Convention of the A. I. E. E., New York, N. Y., Jan. 28-Feb. 1, 1929. Complete copies upon request.

magnetic wave starts from the point of disturbance and is propagated into the various conductors which constitute the circuit or the network. The wave is gradually attenuated because of the resistances of the circuit, is reflected at local obstacles, experiences changes in the values of its current, voltage, and shape upon entering conductors of different characteristics, etc. Ultimately, its energy is completely converted into heat.

Traveling hydraulic waves of similar character occur, for example, in a city water supply system. Should a pipe burst and the pressure be suddenly lowered locally, a wave of depression would start from the fault and spread over the whole system. Should a valve be suddenly closed in one of the branch pipes, the water hammer so created would also spread in the form of a pressure wave throughout the system, and after numerous reflections its power converted into vibrations and heat.

In this paper, only long rectangular-front waves (Fig. 1) are considered, first, because they are simpler to be treated theoretically, secondly, because other kinds of waves may be composed out of such simple waves, and thirdly because they are at least as harmful for electrical apparatus (if not more so) as any other waves known. In Fig. 1 the voltage wave, e , and the current wave, i , are shown separately, although in reality e and i are but two characteristics of the same traveling wave of electric energy. The direction of propagation is indicated by the arrowheads and the wave front is denoted by f .

The actual physical conditions corresponding to the symbolic representation in Fig. 1 are shown in Fig. 2. B is a battery, s is a switch, and a and b two parallel

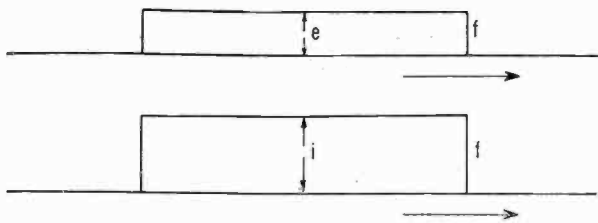

FIG. 1—A LONG RECTANGULAR-FRONT TRAVELING WAVE OF CURRENT AND VOLTAGE

conductors. When the switch is closed, a wave starts to the right, charging the conductors. This means that an electrostatic field is established, shown by the vertical lines, and a magnetic field, indicated by the dots and the crosses. These two fields, together with a cross-section of the conductors, are also shown to the right.

Theory and experience show that such a wave, between two parallel conductors of comparatively small cross-section, is propagated nearly at the velocity of light (or of other electromagnetic disturbances) in the

dielectric medium in which the conductors are immersed. Thus, for overhead lines the wave velocity is that of light in air, for a cable it is that of electromagnetic waves in impregnated paper, etc. This does not mean that the actual carriers of electricity in the conductors (ions) move at such enormous velocities, nor is it necessary to assume this velocity of motion for the electrostatic and magnetic lines of force. All we know is that the electromagnetic state advances at this velocity. This difference between the velocity of

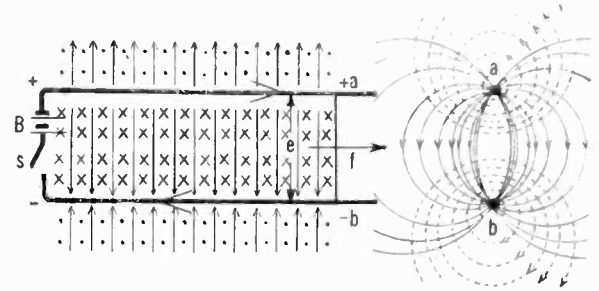

FIG. 2.—THE MAGNETIC AND ELECTROSTATIC FLUXES ACCOMPANYING A TRAVELING WAVE BETWEEN PARALLEL CONDUCTORS

propagation of a wave (or state) and that of the material particles in it, is well illustrated for water waves in W. S. Franklin's "Electric Waves," pp. 15 to 25. If the depth of a canal (Fig. 3) is D , the velocity of propagation of the wave front is

$$v = \sqrt{g D} \tag{1}$$

where g is the acceleration due to gravity. On the other hand, the average velocity, v , of the particles of water is much lower, being represented by the expression

$$v = V (h/D) \tag{2}$$

In an electric conductor, the velocity of motion of electrons which constitute the current is quite low, but as soon as the electrons in a cross-section begin to move, they disturb the equilibrium and cause the electrons in the next cross-section also to move. So the velocity of the wave itself simply characterizes the rate at which consecutive carriers of electricity are set in motion. Similarly, it is not necessary to assume the lines of force to be traveling at the velocity of light. New lines of force are built up as soon as a voltage and a current reach a point on the line, while the older lines of force remain at places where they have been created.

This difference between the two velocities may be also illustrated as follows: Think of a front of soldiers with their heads turned to the right, and let each be instructed to begin turning his head slowly to the left as soon as he sees the preceding man beginning the motion of his head. It will take but a fraction of a second for each man to begin his motion after his neighbor, so that the wave front of motion will be propagated

along the row quite *rapidly*, whereas the actual motion of the heads may be quite *slow*.

There is nothing contradictory in the fact that the current in Fig. 2 seems to flow in an open circuit. Positive electricity may be thought of as flowing through the upper conductor to the right, creating a displacement current in the dielectric downward and thereby forcing a flow of positive electricity in the lower conductor to the left. Or else, the same process may be thought of in terms of negative electrons, with the polarity and direction of motion reversed. Similarly, there is no contradiction in the existence of a considerable voltage difference, e , between two adjacent points of the same conductor, just before and behind the plane f . New magnetic lines of force arising in that plane induce an e. m. f. which balances the voltage e . The relationship shown in Fig. 2 could not exist if f were a stationary plane, but as the front of the wave moves at the proper velocity, the transient conditions at new points of the conductors make stationary values of e and i possible behind.

We shall limit our discussion to conductors whose ohmic resistance and leakage conductance are negligible. In other words, the attenuation of a wave will be disregarded. Not only is the theory much simplified thereby, but in a study of destructive action of traveling waves it is not safe to count on an attenuation because in a most unfavorable case a wave may originate in the immediate vicinity of a device upon which it impinges, so that there is practically no attenuation.

With this assumption, and denoting the inductance of

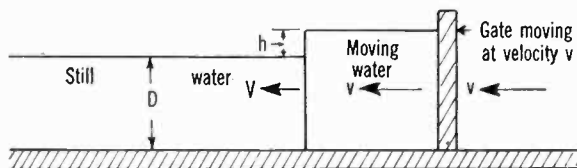

FIG. 3—A WATER WAVE IN A CANAL AS AN ANALOG TO AN ELECTRIC TRAVELING WAVE

a line or cable by L and its capacitance by C , both per unit length, the following well known relationships hold true.²

(a) The velocity of propagation of a traveling wave is

$$V = 1/\sqrt{LC} \tag{3}$$

With proper units, for overhead conductors, V comes out equal to the velocity of light in air. In a power cable, the velocity of propagation is much lower, of the order of magnitude of one-half of that along overhead conductors.

(b) When a wave is propagated along an ideal

2. For a proof, see the references at the end of the paper.

conductor with uniformly distributed L and C , its shape remains undistorted and identical with that at the entrance into this particular conductor. A sudden change in line constants, or a concentrated (lumped) impedance, causes changes in the values of e and i , and in the shape of the wave front.

(c) For a given conductor, the ratio of a wave voltage to its current is constant; that is

$$e = Zi \tag{4}$$

where

$$Z = \sqrt{L/C} \tag{5}$$

Z is known as the *surge impedance* of the line. The reciprocal of Z ,

$$Y = \sqrt{C/L} \tag{5a}$$

is called the *surge admittance* of the line. In prelimi-

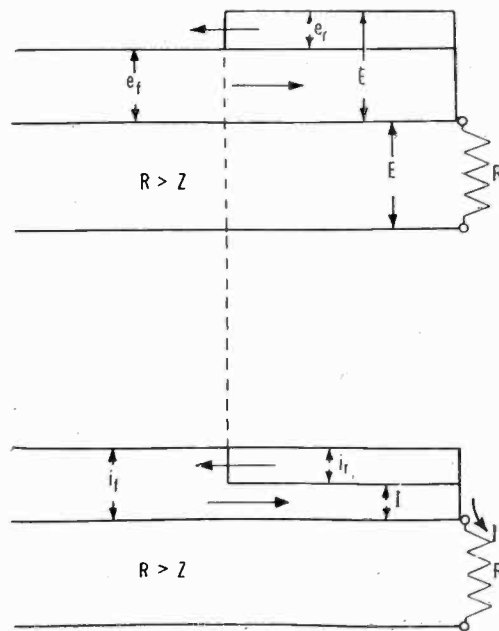

FIG. 4—REFLECTION OF CURRENT AND VOLTAGE WAVES AT THE END OF A LINE BRIDGED BY A RESISTANCE

nary estimates, Z may be taken equal to 500 ohm for overhead lines and to 50 ohm for power cables. Whereas L and C usually are understood to be per unit length, Z is expressed in ohms (not in ohms per unit length).

(d) The electrostatic energy of a traveling wave, per unit length, is $0.5 C e^2$; the corresponding electromagnetic energy is $0.5 L i^2$. In a pure traveling wave, such as are considered here, the amounts of these two energies are equal, so that

$$C e^2 = L i^2 \tag{6}$$

Extracting a square root of both sides of this equation, gives Equation (4). Thus, the law of surge impedance follows from that of equipartition of energy, or vice versa. At a terminal, or at a joint of two

conductors with different values of Z , some magnetic energy is converted into electrostatic, or vice versa.

2. THE STAR DIAGRAM OF A RESISTANCE TERMINAL LOAD

In Fig. 4, a single-phase line of surge impedance Z is shown bridged by a lumped resistance R at one end. A traveling electric wave which is propagated from left to right, is partly reflected and partly enters the resistance, to be absorbed there. Knowing the voltage and the current in the original wave, it is required to determine those in the reflected and absorbed parts of the wave. The voltage notation is shown in the upper sketch, the current notation in the lower sketch. Of course, the same transmission line and the same wave of energy are meant in both sketches, the division having been made for the sake of clearness.

The quantities in the impinging or *forward-going* wave are provided with the subscript f (corresponding to the subscript v in Rüdénberg's book); the quantities in the reflected or *return* wave are distinguished by the subscript r . The arrowheads shown are in fact superfluous because the subscript itself indicates the direction of the motion of the wave with respect to R . The quantities e_f and i_f are shown above the axes of abscissas to indicate that in this particular case they are positive. The positive sign of i_f means that the current is flowing to the right. If i_f were negative, the current (positive ions) would be flowing to the left, whereas the wave itself (the front of the electromagnetic state) would still be moving to the right. This happens in a wave of depression.

The wave e_r is shown on top of e_f to indicate that its voltage is also positive and is added to e_f . On the other hand, i_r is shown negative, that is, subtracted from i_f . The negative sign of i_r means that the current flow is to the left. In this case, this happens also to be the direction of the motion of the wave front. In other cases, however, for example if R were quite low, i_r may be positive, the actual motion of positive ions being to the right, and the motion of the wave front to the left.

In this paper, the fronts of the waves marked e_f and i_f are always assumed to move to the right, and those of e_r and i_r to the left. The actual current flow, whether in the wave i_f or i_r , is always to the right when these currents are shown positive, and vice versa.

The quantities i_r and e_r have no real existence. After the incoming wave, e_f, i_f , has reached the resistance R , the voltage changes from e_f to E and the current from i_f to I . The region in which this change has taken place spreads to the left at a velocity equal to that of the incoming wave. It is more convenient, however, to consider the actual voltage E as a result of superposition of the incoming voltage e_f and a fictitious reflected voltage, e_r , so that

$$E = e_f + e_r \tag{7}$$

Similarly, the actual current I , flowing into the resistance R , may be thought of as an algebraic resultant of the currents i_f and i_r ; in other words,

$$I = i_f + i_r \tag{8}$$

In addition to these equations, we also have the following relationships, according to Equation (4):

$$e_f = Z i_f \tag{9}$$

$$e_r = -Z i_r \tag{10}$$

The minus sign in Equation (10) is necessary because when e_r is positive and moves to the left the actual current in the reflected wave also flows to the left, so that i_r is negative. For the resistance R itself, we have

$$E = I R \tag{11}$$

The foregoing five equations contain six quantities, e_f, e_r, i_f, i_r, E , and I . If one of these quantities, for example e_f , is given, the equations may be solved for the remaining five. The algebraic solution and an analysis of the results will be found in some of the references

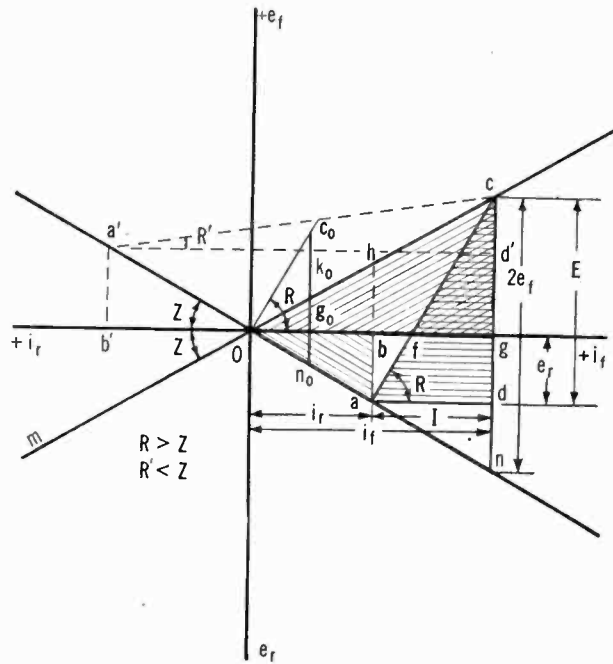

FIG. 5—A STAR DIAGRAM OF THE CURRENTS AND VOLTAGES SHOWN IN FIG. 4

given below. Here we propose to solve the problem graphically, using the *star diagram* shown in Fig. 5.

In Fig. 5, positive values of i_f are measured along the axis of abscissas, to the right of O ; positive values of i_r to the left of O . Positive values of e_f are measured along the axis of ordinates upward, positive values of e_r downward. The two inclined axes, mc and $a'n$, are drawn at an angle to the axis of abscissas corresponding to the surge impedance Z . This means that if, on the chosen scale of currents, Og_0 equals one ampere, then g_0k_0 and g_0n_0 are each numerically equal to Z volts on the chosen scale of voltages. Consequently, in accordance with Equation (9), any point on the line mc , such as c or h , gives values of e_f and i_f which satisfy Equation (9). In other words, the line mc takes the

place of Equation (9). For the same reason, the line $a'n$ takes the place of Equation (10). It will be seen that for points on this line to the right of O , e_r is positive and i_r is negative. The opposite is true for points to the left of O .

Let now Og_0 be numerically equal to one ampere, as before, and let g_0c_0 be numerically equal to R volts. Then any right-angle triangle similar to Og_0c_0 will give values of E and I which will satisfy Equation (11). It remains to choose the size and the position of a triangle in such a manner as to satisfy Equations (7) and (8) as well. It will be seen that the triangle acd satisfies these conditions. Its vertical side, E , is equal to the sum of the voltages e_f and e_r , and its horizontal side, I , is equal to the difference between i_f and i_r . However, in this particular case i_r is negative so that in reality I is equal to the algebraic sum of i_f and i_r .

Thus, in place of solving the foregoing five simultaneous equations, we simply mark on the star diagram the point c corresponding to the given value of e_f , draw ca parallel to c_0O and complete the triangle acd . All the five unknown quantities can then be scaled off.

The product of the wave voltage by the corresponding current gives the power in the wave, that is, the electric energy which passes through a given point on the line, per unit time. Therefore, the area of the triangle Ocg is a measure for the energy flowing towards the resistance R , per unit time. Similarly, the area Oab is a measure for the energy reflected and flowing into the line per unit time. The area acd represents the energy absorbed in the resistance per unit time. Accordingly we must have

$$\text{area } acd = \text{area } Ocg - \text{area } Oab \quad (12)$$

This relationship may be proved geometrically as follows: The areas ahc and $abgd$ are equal because the altitude ad is the same, and the base, ah , of the triangle is twice the base, ab , of the rectangle. Subtracting the area abf from both and adding fcg , we find that

$$\text{area } acd = \text{area } bhcg \quad (13)$$

But the area $bhcg$ is equal to the difference between the areas Ocg and Ohb , and this proves Equation (12).

Throughout this paper, the important triangles which characterize electric power are cross-hatched in the same manner, as indicated in the following table:

TABLE I

Kind of energy	Direction of shading
Incoming wave.....	diagonally rising to the right
Reflected wave.....	diagonally rising to the left
Locally absorbed.....	horizontal
Transmitted through the junction.....	vertical

The latter shading is not used in Fig. 5, but will be found in some other star diagrams below, for example in Figs. 13 and 16.

Instead of scaling off the unknown currents, voltages, or impedances from the diagram, they may also be determined analytically from the geometry of the figure. For example, the triangles acn and Oc_0n_0 being similar, we have

$$2e_f/E = (Z + R)/R \quad (14)$$

from which any of the four quantities may be computed if the remaining three are known.

In the particular case shown in Fig. 5, R is greater than Z , and, as a result, the reflected voltage is positive and the reflected current negative, as shown in Fig. 4. For another value, R' , less than Z , the relationships become those indicated by the dotted triangle $a'c'd'$. The reflected voltage, $a'b'$, is negative and the reflected current, $O'b'$, is positive.

Critical Resistance. An important case arises when R equals Z . The triangle of reflected energy, Oba , collapses to point O and the triangle acd coincides with Ocg . This means that $e_r = i_r = 0$, and the whole energy of the incoming wave is absorbed in the resistance R . This fact is receiving an increasing attention, both in the design of protective apparatus and in impulse testing where reflected waves are liable to vitiate the results.

When $R > Z$, the wave is reflected without a reversal in the sign of the voltage, but with a current reversal (Fig. 4). Consequently, the total "piled up" voltage E is higher than that in the incoming wave. Such a combination of Z and R (or of Z and some other device) may be conveniently called a *step-up joint*, by analogy with a step-up transformer. Also, a resistance R , greater than Z , may be called a step-up load. On the other hand, when $R < Z$, the voltage E at the joint is lower than e_f , because e_r is negative. In such a case, I is greater than i_f because i_r is positive. Such a joint may be called a *step-down joint*. A resistance R , which is lower than Z , may be called a step-down load.

Whether a load is of step-up or step-down nature, some energy of an incoming wave is reflected and has to be dissipated elsewhere. Thus, from the point of view of energy absorption, a critical resistance, $R = Z$, deserves serious attention. It is possible that in the future lightning arresters and other over-voltage protective devices will be provided with such a series resistance (as is sometimes recommended in European literature). This resistance would absorb an incoming wave and thus prevent subsequent line oscillations due to repeated reflections, sometimes accompanied by high-voltage resonance oscillations in transformer windings. On the other hand, it must be remembered that such resistances would be large and expensive because the line current may follow the breakdown.

Abridgment of Some Photoelectric and Glow Discharge Devices and Their Applications to Industry

BY J. V. BREISKY¹ and E. O. ERICKSON¹

Synopsis.—During the past few years, intensive research work has been carried out on some photoelectric and glow-discharge devices. More recently, certain applications of these devices to the industry have been undertaken. This paper presents some of the results attained. A more complete discussion of the devices themselves and of their applications is given in the unabridged paper.

INTRODUCTION

PHOTOELECTRIC phenomena and phenomena attending the passage of electricity through gases have been the subject of much concentrated study. Some of the devices resulting from such study found their way into general use long ago. Others, however, such as the photoelectric cell, even though of not very recent origin, have had only recent applications.

The general skepticism as to the applicability of vacuum devices is gradually decreasing and it is felt that as the possibilities of such apparatus become more and more evident the devices will find a wide application in the industry.

It is the purpose of this article first to describe these recently developed vacuum devices: Photoelectric cells, selenium cells, photo-glow tubes, and grid-glow tubes, some of which have attained a state of perfection where they may be depended upon like any other kind of well developed apparatus. Second, we shall consider their applications, as in smoke recorders, smoke, fire, and flash detectors, apparatus for the sorting of materials, paper machine control, oil-burner safety devices, etc.

For a fuller understanding of the principles involved, as well as for details of application, reference should be made to the unabridged paper.

LIGHT SENSITIVE DEVICES

1. *Photo-Electric Cell.* A cell of the type developed by Dr. Zworykin of the Westinghouse Research Laboratories is shown inserted in the Amplifier Unit in Fig. 4. The spherical portion of this cell is 2½-in. in diameter. The cell is mounted in a standard tube base for ease in mounting and making connections. A smaller cell 1¼-in. in diameter has also been developed. In both sizes the photo-electrically active alloy is deposited on the inner surface of the spherical portion of the cell. A central mounted wire ring serves as the second electrode.

1. Both of the Supply Engineering Dept., Westinghouse Elec. & Mfg. Co., East Pittsburgh, Pa.

Presented at the Regional Meeting of the Southern District of the A. I. E. E., Atlanta, Ga., Oct. 29-31, 1928. Complete copies upon request.

Both sizes are made in the high vacuum and in the gas-filled types. A typical curve of cell response plotted as current in microamperes per lumen of light flux at various voltages for a high vacuum cell is shown in Fig. 1a. Curve 1 of Fig. 1b shows the relation between the same quantities for a gas-filled cell.

The high vacuum cells are seen to yield their saturation current at a comparatively low voltage. The gas-filled cells, which display a similar behavior at the lower voltages, show a rising characteristic on the higher voltage due to the added conductivity resulting from the ionization of the gas. Curve 2 of Fig. 1b is the illumination limit curve applying to a gas-filled cell, showing the maximum illumination to which the cell can be subjected for various applied voltages without glowing. Obviously, the high vacuum photo cell, by reason of its tendency towards saturation, is not subject to these limitations.

2. *Photo Glow Tube.* The photo glow tube is a light sensitive glow-discharge device and is discussed under the heading of Glow-Discharge Devices.

3. *Selenium Cells.* The selenium cell is a form of light sensitive device which functions by reason of the variation in conductivity of the metal selenium with illumination.

The current output of a selenium cell at constant voltage varies with the square root of the illumination.² Some cells have appeared on the market, but they have been very low voltage cells capable of delivering only small amounts of energy in the output circuit, which energy is insufficient to control sturdy relays.

GLOW-DISCHARGE DEVICES

1. *Grid-Glow Tube.* The grid controlled glow tube, as developed by D. D. Knowles,³ consists essentially of a cylindrical aluminum cathode, an anode and a grid, both of the latter being of heavy nickel wire. The three electrodes are enclosed in a glass tube containing neon gas at a low pressure. A photograph of the tube is shown in Fig. 2a, while the details of the tube construction are shown in Fig. 2b.

A unique feature of the grid-glow tube is the fact

2. "Photoelectric Conduction in Selenium," R. J. Piersol, *Phys. Rev.* 30, p. 664, November, 1927.

3. "The Grid-Glow Tube Relay," D. D. Knowles, *Electric Journal*, April, 1928.

that the main discharge is subject to control by means of the grid or third electrode. The controlling effect of a leakage resistance connected between the grid and the anode is shown in Fig. 3.

A condenser can also be used as a leakage path.

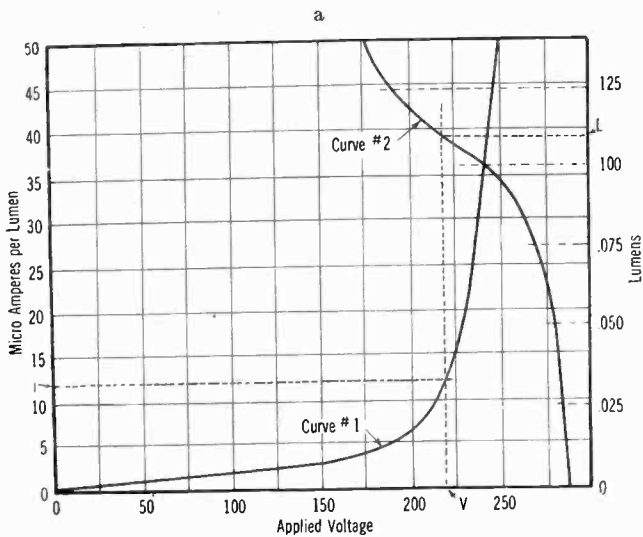
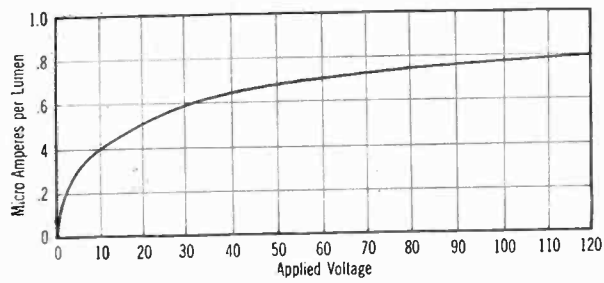

FIG. 1—CURVES SHOWING PHOTO-CELL CURRENT IN MICRO-AMPERES PER LUMEN OF LIGHT FLUX AS A FUNCTION OF APPLIED VOLTAGE FOR (a) THE HIGH VACUUM AND (b,1) THE GAS FILLED CELL

(Plotted in the above manner the characteristics of the 2 1/2 in. and the 1 1/4 in. diameter cells are identical). In (b, 2) is shown the illumination limit curve

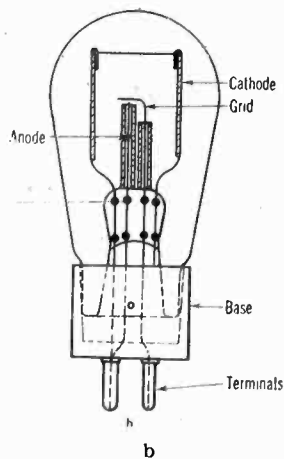
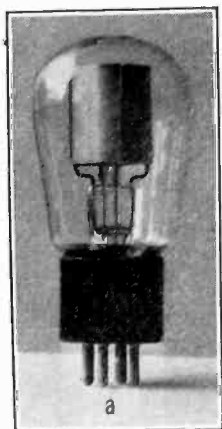

FIG. 2—(a) PHOTOGRAPH OF THE GRID-GLOW TUBE (b) SKETCH SHOWING DETAILS OF CONSTRUCTION OF THE GRID-GLOW TUBE

The sensitivity can further be varied by connecting in a second leakage path between the grid and the cathode. The two impedances function as a potentiometer with the mid point at grid potential.

2. *The Photo-Glow Tube.* The photo-glow tube as developed by D. D. Knowles is a device in principle essentially the same as a gas-filled photoelectric cell with the exception that it is designed to operate at a voltage above what is called the glow point voltage in the case of the photoelectric cell.

The voltage at which the tube will begin to pass current is dependent upon the incident illumination, being lower for an increase in illumination. The response of the photo-glow tube is practically instantaneous and the current is of sufficient magnitude to operate small relays directly.

As developed at the present time the life of the tube is not very long; hence its application is limited to those

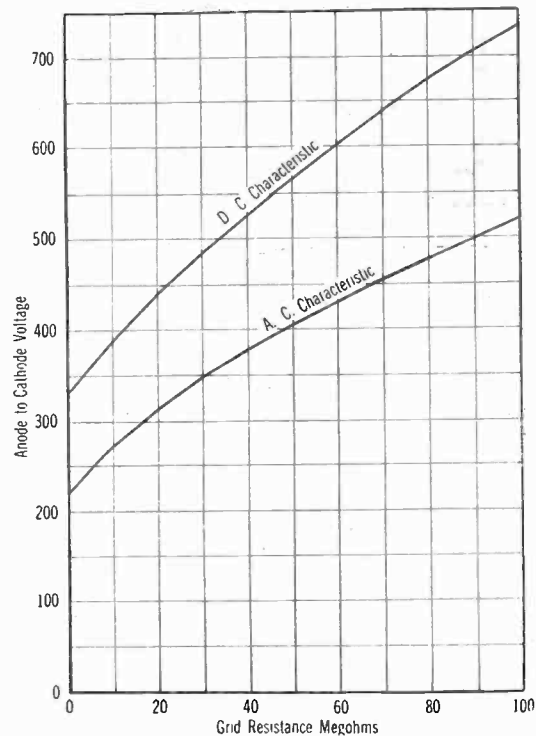

FIG. 3—GRID-GLOW GRID-RESISTANCE CONTROL CHARACTERISTICS FOR A-C. AND D-C. CIRCUITS

cases wherein the tube is not called upon to glow continuously.

Applications

LIGHT SENSITIVE DEVICES

Photo-Cell Amplifier Unit. The normal current output of the photoelectric cell being of the order of microamperes is not readily put to use directly except through the use of very sensitive instruments; it requires that a degree of amplification be given it in order that less sensitive associated apparatus may be employed.

The photoelectric-cell amplifier unit provides in convenient form a stage of vacuum tube amplification resulting in amplified currents of the order of several milliamperes. A change in cell illumination causes a change in grid bias on the amplifier tube, thereby resulting in a change in the amplifier plate current. A photograph of the amplifier unit is shown in Fig. 4.

A layout of the panel, wiring diagram, typical

amplifier tube characteristic and performance curves for the complete unit are shown in Fig. 5.

Sorting and Counting. Irregularities in the reflecting power of the surfaces of materials can be detected photoelectrically and automatic devices arranged to bring



FIG. 4—ILLUSTRATION PHOTO-CELL AMPLIFIER UNIT SHOWING A 2½-IN. DIAMETER PHOTO CELL AND A STANDARD 201-A RADIO TUBE IN POSITION ON THE PANEL

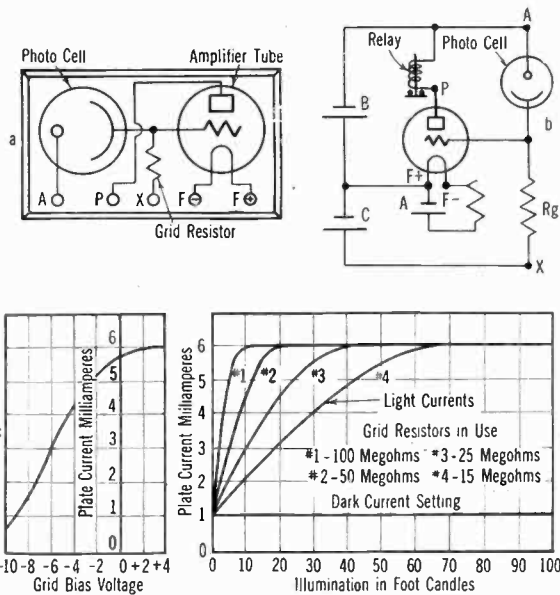

FIG. 5—(a) INTERNAL WIRING DIAGRAM OF THE PHOTO-CELL AMPLIFIER UNIT
 (b) SCHEMATIC DIAGRAM SHOWING SIMPLE CIRCUIT FOR USE WITH PHOTO-CELL AMPLIFIER UNIT
 (c) TYPICAL DYNAMIC PLATE CURRENT—GRID BIAS CHARACTERISTIC FOR AN AMPLIFIER TUBE
 (d) TYPICAL CURVES SHOWING THE AMPLIFIER PLATE CURRENT AS A FUNCTION OF ILLUMINATION ON THE PHOTO CELL FOR VARIOUS VALUES OF THE GRID RESISTOR

about the sorting of the materials according to the degree of those irregularities.

By means of apparatus similar to the smoke detector herein described, the passage of opaque objects through a beam of light can be detected for the purpose of automatic counting.

By the use of color filters, photoelectric cell circuits can be used for matching the colors of materials.

Smoke Recorder. A photoelectric smoke recorder has been developed for power plants for the purpose of recording the smoke density in the smoke stack.

Fig. 6 shows a sketch of an outdoor installation. A pipe extends through the breaching or stack; on one end of this pipe is mounted a light source and lens. On the other end is located the photoelectric cell and amplifier unit, similar to that shown in Fig. 4, plus other control equipment. In the boiler room is located the indicating or recording meter, calibrated in degrees of smoke, as well as an alarm which rings whenever the

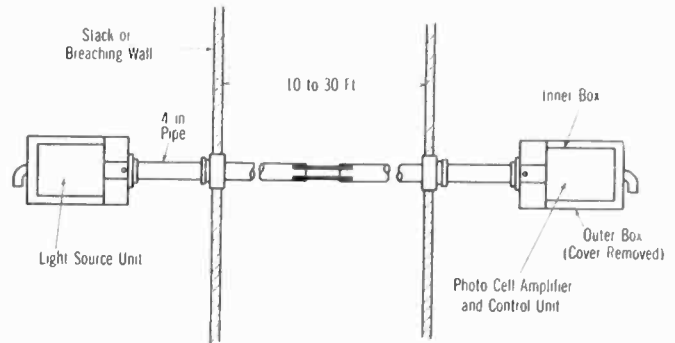

FIG. 6—PHOTOELECTRIC SMOKE RECORDER INSTALLATION FOR MEASURING SMOKE DENSITY IN SMOKE STACK

smoke density reaches a predetermined amount. Both of the outdoor units are in weatherproof housings.

Photoelectric Smoke Detector. This device is similar to the smoke recorder except that it is simplified mechanically. It consists of two units, the light source and the photo cell amplifier unit, shown respectively in Figs. 7a and 7b.

Whenever smoke interrupts the beam of light, or cuts off part of the light, a relay in the amplifier circuit

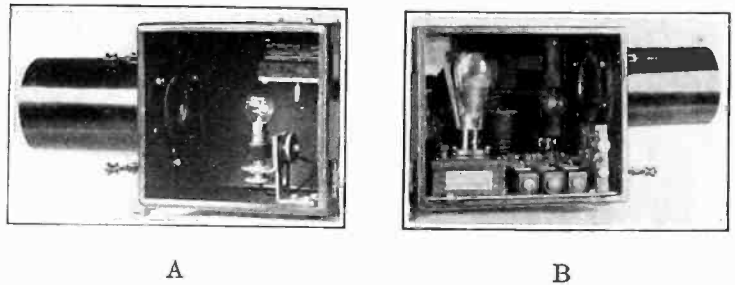

FIG. 7—PHOTOELECTRIC SMOKE DETECTOR

- a. Light source unit
- b. Photo-cell amplifier and control unit

operates. An important application of this device is in connection with fire extinguishing apparatus, such as CO₂ equipment. It can be used for protection of electrical machinery such as generators, transformer and switch vaults and in many industrial fields, particularly where a fire is apt to spread quickly and cause damage in a short time, as in dipping tanks, lacquer spray booths, etc. This device can also

be used for counting objects, as mentioned previously.

GLOW DISCHARGE DEVICES

Grid-Glow Tube Used with Contacting Arrangements. The leakage resistance control of the grid glow tube as presented in Fig. 3 provides a means for relaying by means of very low energy primary contacts. A pair of contacts placed in series with the grid resistor are called upon to make and break currents of the order of microamperes while the relay whose coil is placed in the main discharge circuit can handle currents of

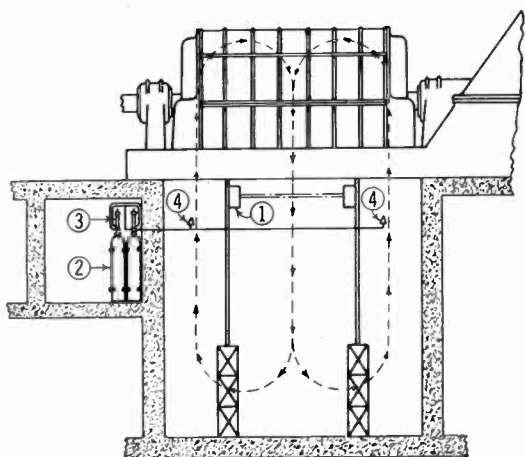

FIG. 8—APPLICATION OF PHOTOELECTRIC SMOKE DETECTOR TO GENERATOR PROTECTION

1. Smoke detector
2. Carbon dioxide cylinders
3. Electric-automatic-manual head
4. Discharge

the order of an ampere. Such a device can also be used for counting passing objects.

Grid-Glow Tube Oil Burner Control. The domestic oil burner installation with complete automatic control

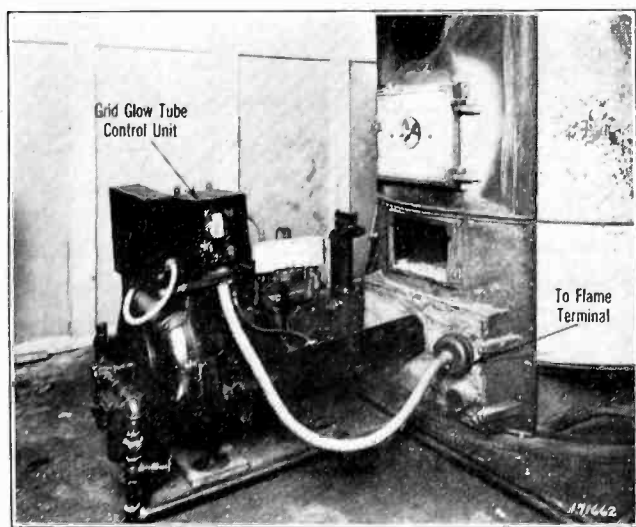

FIG. 9—DOMESTIC OIL BURNER INSTALLATION, USING GRID-GLOW TUBE CONTROL UNIT AND FLAME TERMINAL

using a grid-glow tube combustion safety device is shown in Fig. 8.

Oil burner control devices are called upon to cope with the problem of prevention of puff backs or more serious explosions due to (a) belated electric ignition

in starting the burner, (b) flame failure while the burner is operating.

Thermostatic devices operated by the heat of the flame or of the flue gases are inherently slow. The grid-glow tube unit does not operate on the heat of the flame, but on its electrical conductivity, the conductivity being zero with no flame. This conductivity is measured either between a flame terminal and ground, if the flame or the conducting gases reach the grounded metallic furnace structure, or between two flame terminals. The description of the resistance control of the grid-glow tube given in the paragraphs relating to Fig. 3 will serve as an explanation of the theory of operation.

Brief reference has been made in this paper to the initiative of our Research Department and interested research engineers in the development of the devices described in this paper, which is really a basis on which the art rests. The authors also wish to acknowledge the important work rendered by Dr. V. Zworykin, D. D. Knowles, and L. Sutherlin, as well as the Research Department as a whole, in the development of the applications and complete apparatus described in this paper.

CONCLUSIONS

On account of the wide scope of the subject discussed in this article and also in the unabridged paper, it was not possible to cover the theory nor the applications of these devices in as much detail as might be desirable. However, it is intended to discuss several of the topics touched upon in this paper more specifically in other publications.

It is hoped that this article will act as a stimulus toward a broader recognition of the possibilities of tube devices in the industry, and that it will bring forth suggestions which will result in other important applications.

HIGH-VOLTAGE INTERBOROUGH CABLES

The laying of five submarine electric cables, each 2935 feet long, under the East River between 132nd Street, Bronx, and Lawrence Point, Queens, has just been completed, thus further knitting together, as an operating unit, the five metropolitan electric companies recently consolidated under the presidency of Matthew S. Sloan.

Having a capacity of about 15,000 kilowatts (20,000 horsepower) each, the cables will operate at 27,600 volts which is believed to be the highest ever attained on rubber insulated cables. They will be able to transmit enough energy to light 1,500,000 fifty-watt lamps. They will be fed from the Hell Gate Generating Station of the United Electric Light and Power Company located on the river front and will supply current to the New York and Queens Electric Light and Power Company for distribution to the rapidly growing Borough of Queens.

Abridgment of 1927 Lightning Experience on the 132-Kv. Transmission Lines of the American Gas and Electric Company

BY PHILIP SPORN¹

Member, A. I. E. E.

INTRODUCTION

WITHIN the past two years a series of papers,^{2,3,4} was presented before the Institute on the performance of a number of 132-kv. steel tower lines on the system of the American Gas and Electric Company during the years 1925 and 1926.

It is proposed in this paper to continue and give the 1927 history of the 132-kv. transmission system investigated and described in the previous three papers.

GENERAL

Fig. 1 shows the 132-kv. transmission network in question. As has been previously pointed out, it comprises approximately 948 mi. of line, which was in service for all or a part of 1927; the total circuit miles being approximately 1266 in service for the same period. Details with regard to the territory traversed, the nature of the country, and details with regard to the generating stations, and the points where they feed into the network have already been described.³

1927 PERFORMANCE

A brief summary of the principal characteristics of the various lines, together with their 1926 and the 1927 lightning performance, is given in Table I. It should be noted in this connection that while no quantitative data are available, the opinion gathered from all parts of the system indicates that in general, 1927 was a year of less severe and less frequent lightning than 1926.

DISCUSSION OF 1927 EXPERIENCED WITH REGARD TO SEVERAL PHASES OF DESIGN

1. *Effect of Ground Wire.* On the two circuit lines with ground wire in service during all of 1927, there occurred 16.2 outages per one hundred miles of line. On the two circuit lines without ground wire in service all of 1927, there occurred 59.2 outages per one hundred miles per line, a ratio of 3.7. In the case of one of the single circuit lines—a single circuit wood pole line—although the insulation is considerably higher than the average, there occurred 33.3 outages per one hundred miles of line. The Windsor-Canton line with two

ground wires had only 3.6 outages per one hundred miles per line per year. It is believed that this experience has further and effectively demonstrated the positive value of the ground wire in reducing the lightning voltages on the transmission line and even more effectively reducing the number of outages.

2. *One vs. Two Ground Wires.* The Windsor-Canton line with two ground wires showed the lowest number of outages per one hundred miles of line per year, namely, 3.6. The average for the entire system is 16.4, including single and double circuit lines and also those with and without ground wires. This average, it is to be noted, covers only those lines that were in service the entire year. On the other hand, it must be borne in mind that the Windsor-Canton line is a much shorter span line than all of the other steel tower lines (the Windsor-Canton average is 8.85 towers per



FIG. 1

mile). However, the employment of two ground wires has undoubtedly contributed to this performance.

3. *Relative Shielding of the Three Phases by Ground Wires.* In Table II is shown the location of trouble on insulators and wire, separated into the top, middle, and bottom conductors. Disregarding the Turner-Logan line (because of the fact that it had no ground wire) and the Lima-Fostoria and Lima-Twin Branch lines (because of the fact that the trouble discovered in 1927 represented, without a doubt, trouble that had accumulated from previous years and that had not previously been noted) we find 21 cases of conductor damage on the top phases, 21 on the middle, and 29 on the bottom. This would indicate that for the case where one ground wire was employed immediately above and centrally with respect to the two top conductors,

1. Electrical Engineer, Amer. Gas and Elec. Co., New York, N. Y.

2. *Lightning and Other Experience*, Sindeband and Sporn, A. I. E. E. TRANS., Vol. 45, p. 770.

3. *1926 Lightning Experience on 132-Kv. Transmission Lines*, Philip Sporn, A. I. E. E. TRANS., Vol. 47, p. 668.

4. *Surge Voltage Investigation on the 132-Kv. Transmission Lines of Amer. Gas and Elec. Co.*, Philip Sporn, A. I. E. E. Quarterly TRANS., Vol. 47, October 1928, p. 1132.

Presented at the Winter Convention of the A. I. E. E., New York, N. Y., Jan. 28-Feb. 1, 1929. Complete copies upon request.

TABLE I
CHARACTERISTICS AND PERFORMANCES OF 132-KV. LINES OF AMERICAN GAS AND ELECTRIC COMPANY 1926 AND 1927

Characteristics	2	3	4	5	6	7	8	9	10	11	12	13	14	15	16	17	18	19	
Column No. 1	Glen Lyn	Glen Lyn	Lima	Lima	Logan	Philo	Philo	Philo	Roa- noke Dan- ville	Roa- noke Reusens	Rutland	Saltville	Switchback	Switchback	Turner	Tw. Branch	Windsor	So. Bend	
Line designation	Roanoke	Switch- back	Fostoria	Tw. Branch	Sprigg	Canton	Crooks- ville	Turner	ville	ville	So. Point	Kingsport	Logan	Saltville	Logan	So. Bend	Canton	Mich. City	
Length of line (miles).....	65.0	30.0	45.6	128.5	21.0	73	15.4	118.7	65.0	43.0	50.3	56.0	50.0	46.0	40.2	4.9	55.0	40.0	
Number of circuits.....	2	2	1	1	1	2	1	1	1	1	1	1	2	1	2	2	2	1	
Number of ground wires.....	1	1	1	1	None	1	1	1	1	1	1	1	1	1	None	1	2	1	
Rings and horns.....	No	Yes	No	Yes	No	Yes	No	No	No	Yes	No	Yes	Yes	Yes	Yes	Yes	No	No	
1926 LIGHTNING PERFORMANCE																			
One circuit only out.....	16		9	23	3	13	3	11	0	13	3				16	0	9		
Both circuits out.....	4					2									2	0	2		
Total outages.....	20		9	23	3	15	3	11	0	13	3				18	0	11		
Circuit outages for 100 mi. of line per yr. 1926.....	48*	0†	19.8	17.9	31*	20.5	19.5	10.6*	0*	36.6*	6.3*	0†	0†	0†	44.8	0	20		
Circuit outages per 100 mi. of circuits per year 1926	24*	0†	19.8	17.9	31*	10.3	19.5	10.6*	0*	36.6*	0.3*	0†	0†	0†	22.4	0	10		
1927 LIGHTNING PERFORMANCE																			
One circuit only out.....	21†		4	8	7	3†	1	7	16	16	7				20	1	2†	4	
Both circuits out.....	3					1									4	1	0		
Total outages.....	24	0	4	8	7	4	1	7	16	16	7				24	2	2	4	
Circuit outages per 100 mi. of line per yr. 1927.....	37	0*	8.8	6.2	33.3	5.5	6.5	5.9	24.6	37.2	13.9	0*	0*	0*	57.2	41	3.6	10.0	
Circuit outages per 100 mi of circuit per yr. 1927.....	18.5	0*	8.8	6.2	33.3	2.8	6.5	5.9	24.6	37.2	13.9	0*	0*	0*	28.6	20.5	1.8	10.0	
Damage to insulators.....	17	1	7	28	0†	0	0	2	14	2	0	0	0	0	2	1	0	1	
Damage to conductor and hardware.....	14	3	5	0	0†	3	0	1	5	7	0	0	0	0	4	0	0	0	
Total cases of damage.....	20	3	9	28	0†	3	0	2	14	7	0	0	0	0	5	1	0	1	

*Corrected for 1 calendar year (in service only part of year.)

†Not in service.

‡One circuit out of service at the time of F. O. in 1 case.

§Superficial inspection—Towers not climbed.

¶Probably partly accumulation of 2 previous years.

the shielding furnished by the ground wire to the top and middle conductors is such that the net average lightning voltage on the two, in spite of the difference in height between the two, is the same; but the bottom conductor, in spite of its still lower level and therefore lower induced lightning potentials, receives so much less shielding than the other two that the result is a

TABLE II
LOCATION OF TROUBLE ON INSULATORS AND WIRE
1927

Line	Total	Top	Middle	Bottom
Glen Lyn-Roanoke	20	6	10	12
Glen Lyn-Switchback	3	1	2	2
Lima-Fostoria	9	8	0	1
Lima-Twin Branch	28	27	2	0
Philo-Canton	3	2	1	1
Philo-Turner	2	2	0	1
Roanoke-Danville	14	5	3	8
Roanoke-Reusens	7	3	4	4
Turner-Logan	5	3	4	0
Twin Branch-South Bend	1	1	0	0
South Bend-Michigan City	1	1	1	1
Totals	93	59	27	30
Totals excluding Lima-Fostoria and Lima-Twin Branch	56	24	25	29
*Totals excluding Lima-Fostoria Lima-Twin Branch & Turner-Logan	51	21	21	29

*Lima-Fostoria and Lima-Twin Branch excluded as damage appears to be accumulation of trouble since line was first built, and not for 1927 only Turner-Logan excluded, being a line without ground wire.

higher net induced voltage on it than on the upper two conductors. It would seem, therefore, that another ground wire properly placed with respect to the bottom conductor, would more nearly equalize the net induced voltages and therefore the numbers of flashovers and number of damages on all three phases. This experience is extremely interesting since calculations on its shielding effect made before the installation of the ground wire, based on the work of Mr. Peek, indicated an expected lightning voltage on the top and middle wires of approximately the same value and an approximately 15 per cent higher value on the bottom wire.

The Turner-Logan line, having no ground wire, had three cases of trouble or damage on the top, four on the middle, and none on the bottom conductors.

The large number of cases of trouble on the top conductor on the Lima-Fostoria and Lima-Twin Branch line, it is confidently believed, is due to cases of trouble accumulated from the time when no ground wire at all was used on the line. It has already been pointed out that the first complete tower inspection by climbing was made in 1927.

4. *Use of Protective Devices.* Assuming that the cases of trouble on the Lima-Twin Branch line date back mostly to the period preceding the use of the ground wire and the arcing protective devices, we find on that line, on the Roanoke-Danville line, on the South Bend-Michigan City line, and on the Glen Lyn-Roanoke line, 67 per cent of the observed cases of trouble, although these lines represent only 31.5 per cent of the total line mileage. As already pointed out

in the discussion of the individual lines, the damage to the lines where rings and horns were employed was in general confined to blistering of the wire and a marking or slight blistering of one or two insulators and only very rarely was a strand burned in two. On the other hand, many cases of burning were found on the rings and horns, although these were in no case serious enough to require replacement of the assembly. Where no rings or horns were employed, however, the damage was not only numerically more plentiful, but from a severity standpoint, was far heavier, and in one case actually burned one side of a double string right through.

5. *Ground Resistances.* Table III shows the tower ground resistance in cases where damage was found. It will be seen that in most cases the resistance was of the order of from two to five ohms, although in one case a resistance of 28 ohms was found, and in another, a resistance of 16 ohms.

Table IV shows the maximum, minimum, and average tower ground resistance of the lines tested. The order of resistance encountered is of such low level that the data do not seem to warrant any definite

TABLE III
TOWER GROUND RESISTANCE AT TOWERS WHERE
FLASHOVER OCCURRED

Lima-Twin Branch	Ohms Gr. resist.	Tower	(Ohms) Gr. resist.	
7	1.2	176	2.4	
111	2.5	186	2.2	
112	2.5	189	2.2	
138	2.8	221	Not measured beyond Tower 210	
139	2.4	222		
141	2.8	240		
142	2.2	244		
143	2.3	252		
144	2.2	265		
152	2.0	281		
165	1.3	288		
169	2.0	291		
170	2.0	296		
175	2.0			
Philo-Canton				
82	28.0	160		6.9
83	2.4			
Philo-Turner				
3	1.5	55	Not measured	
Turner-Logan				
86	6.25*	115	1.5*	
94	Ground resistance too high for instrument to record	152	16 and 12*	
95	1.0*			

*Includes effect of ground wire as well as tower

conclusions with regard to the effect of ground resistance on the frequency of flashover at a particular point. The data on ground resistance which are being obtained at the present time on the Glen Lyn-Roanoke, Roanoke-Danville, and Roanoke-Reusens lines, may give some additional information on this point.

6. *Single-Circuit vs. Double-Circuit Flashovers.* On the two circuit lines in operation throughout the

entire period of 1927, with and without ground wires, 16 per cent of the outages tripped both lines, only one line tripping in the remaining 84 per cent of the cases. This would tend to confirm further the theory put forth previously that in the case of a double circuit line, the flashover reduces the energy in the surge sufficiently to lower the head of the wave to such an extent that the second circuit will not be subject to enough potential to

the order of 1400 kv. no flashover would be expected, while with 2100 kv. flashover always resulted.

3. The 1927 experience showed, further, that the damage as a result of flashover was confined to a single tower. This checked the data on attenuation of lightning which were obtained in both the 1927 and 1928 klydonograph investigations. The klydonograph data show that the destructive value of even a very high surge is lost in from one to five miles.

TABLE IV
TOWER GROUND RESISTANCES (Ohms)
Tower Only—Ground Wire Detached

	Maximum	Minimum	Average
Glen Lyn—Roanoke			
Glen Lyn—Switchback			
Lima—Fostoria	7.0	0.5	2.0
Lima—Twin Branch	11.4	0.8	2.5
Logan—Sprigg			
Philo—Canton	74.0	0.6	7.7
Philo—Crooksville	21.0	0.8	5.0
Philo—Turner	24.0*	0.7*	3.2*
Roanoke—Danville			
Rutland—South Point			
Saltville—Kingsport			
Switchback—Saltville			
Turner—Logan	100.0‡	1.0	11.8‡
Twin Branch—South Bend			
Windsor—Canton			
South Bend—Michigan City			
Turner—Cabin Creek	110.†	0.5	4.5

*Test on 20 towers.

†12 towers, readings not obtainable due to high resistance of ground

‡3 towers, readings not obtainable due to high resistance of ground

¶74 towers out of 156.

flash it over after flashover on the first wire has once started. The fact that the percentage of flashovers on two circuit lines with ground wire, in which both circuits went out, is the same as the general percentage, would further confirm this.

1927 HISTORY IN LIGHT OF KLYDONOGRAPH INVESTIGATION

A brief description of the 1927 klydonograph investigation was given before the Institute last summer.⁴ Reviewing the 1927 experience in the light of that investigation the following stand out:

1. The effectiveness of the ground wire which the 1927 experience has indicated was shown by the low voltage recorded on the ground wire at the time of surge. About 20 kv. maximum was recorded which is small in comparison with the line lightning voltage. Its effectiveness is further indicated by the relative voltages recorded on the three phases. These agreed fairly well with theory. Although the klydonograph investigation was not extensive enough to be definitely conclusive, the operating experience gathered in 1927 reinforced the klydonograph data in so far as they went on that point.

2. On some of the lines 2100 kv. was recorded in the klydonograph investigation with a resulting line outage. On the other hand, a recorded voltage of 1450 kv. resulted in no line outage. This tends to confirm laboratory tests made with artificial lightning applied to insulator strings, that is, with lightning voltages of

SUMMATION OF EXPERIENCE

Summarizing the 1927 experiences, it is believed that the following have been fairly definitely established or have been more definitely indicated:

1. The effectiveness of the ground wire was further established.

2. Some data were obtained that would indicate very definitely the effectiveness of two ground wires where properly employed.

3. It was shown that the ground wire equalizes the lightning voltages on all three wires of a vertically arranged line, besides reducing the lightning voltages. Where one wire was employed, if equalization did not result, it was in the direction of reducing the lightning voltage on the top and middle conductors to a value below that on the bottom conductor where the ground wire was placed immediately above the top wire.

4. The use of properly designed arcing protective devices has in all probability resulted in a certain reduction in the number of flashovers, and has very definitely minimized cascading where flashovers did finally result. Where cascading does occur, the use of arcing protective devices results in the reduction of the damage to such an extent as to be of minor importance from an operating standpoint.

5. In cases where tower resistances are not particularly high the data showed nothing conclusive with regard to the effect of resistance on lightning flashover.

6. The two-circuit line having its circuits arranged vertically on the same tower has shown itself to be very reliable from the continuity of service point of view. In approximately only 15 per cent of the cases does outage result on both circuits, one circuit only going out in the remaining 85 per cent of the cases.

7. The localization of damage in case of flashover confirms very definitely the field data obtained by klydonograph and indicates a very rapid attenuation of surges. In fact, attenuation indicated would appear to be more rapid than would be expected from the relationship as given by any heretofore published formula.

The author acknowledges with thanks the cooperation and help furnished by the operating organizations of the Appalachian Electric Power Company, of the Indiana & Michigan Electric Company, and of the Ohio Power Company in gathering the field data, and the assistance of Mr. I. W. Gross in co-relating it and in the preparing of the paper.

the shielding furnished by the ground wire to the top and middle conductors is such that the net average lightning voltage on the two, in spite of the difference in height between the two, is the same; but the bottom conductor, in spite of its still lower level and therefore lower induced lightning potentials, receives so much less shielding than the other two that the result is a

TABLE II
LOCATION OF TROUBLE ON INSULATORS AND WIRE
1927

Line	Total	Top	Middle	Bottom
Glen Lyn-Roanoke	20	6	10	12
Glen Lyn-Switchback	3	1	2	2
Lima-Fostoria	9	8	0	1
Lima-Twin Branch	28	27	2	0
Philo-Canton	3	2	1	1
Philo-Turner	2	2	0	1
Roanoke-Danville	14	5	3	8
Roanoke-Reusens	7	3	4	4
Turner-Logan	5	3	4	0
Twin Branch-South Bend	1	1	0	0
South Bend-Michigan City	1	1	1	1
Totals	93	59	27	30
Totals excluding Lima-Fostoria and Lima-Twin Branch	56	24	25	29
*Totals excluding Lima-Fostoria Lima-Twin Branch & Turner-Logan	51	21	21	29

*Lima-Fostoria and Lima-Twin Branch excluded as damage appears to be accumulation of trouble since line was first built, and not for 1927 only Turner-Logan excluded, being a line without ground wire.

higher net induced voltage on it than on the upper two conductors. It would seem, therefore, that another ground wire properly placed with respect to the bottom conductor, would more nearly equalize the net induced voltages and therefore the numbers of flashovers and number of damages on all three phases. This experience is extremely interesting since calculations on its shielding effect made before the installation of the ground wire, based on the work of Mr. Peek, indicated an expected lightning voltage on the top and middle wires of approximately the same value and an approximately 15 per cent higher value on the bottom wire.

The Turner-Logan line, having no ground wire, had three cases of trouble or damage on the top, four on the middle, and none on the bottom conductors.

The large number of cases of trouble on the top conductor on the Lima-Fostoria and Lima-Twin Branch line, it is confidently believed, is due to cases of trouble accumulated from the time when no ground wire at all was used on the line. It has already been pointed out that the first complete tower inspection by climbing was made in 1927.

4. *Use of Protective Devices.* Assuming that the cases of trouble on the Lima-Twin Branch line date back mostly to the period preceding the use of the ground wire and the arcing protective devices, we find on that line, on the Roanoke-Danville line, on the South Bend-Michigan City line, and on the Glen Lyn-Roanoke line, 67 per cent of the observed cases of trouble, although these lines represent only 31.5 per cent of the total line mileage. As already pointed out

in the discussion of the individual lines, the damage to the lines where rings and horns were employed was in general confined to blistering of the wire and a marking or slight blistering of one or two insulators and only very rarely was a strand burned in two. On the other hand, many cases of burning were found on the rings and horns, although these were in no case serious enough to require replacement of the assembly. Where no rings or horns were employed, however, the damage was not only numerically more plentiful, but from a severity standpoint, was far heavier, and in one case actually burned one side of a double string right through.

5. *Ground Resistances.* Table III shows the tower ground resistance in cases where damage was found. It will be seen that in most cases the resistance was of the order of from two to five ohms, although in one case a resistance of 28 ohms was found, and in another, a resistance of 16 ohms.

Table IV shows the maximum, minimum, and average tower ground resistance of the lines tested. The order of resistance encountered is of such low level that the data do not seem to warrant any definite

TABLE III
TOWER GROUND RESISTANCE AT TOWERS WHERE
FLASHOVER OCCURRED

Lima-Twin Branch	Ohms Gr. resist.	Tower	(Ohms) Gr. resist.
7	1.2	176	2.4
111	2.5	186	2.2
112	2.5	189	2.2
138	2.8	221	Not measured beyond Tower 210
139	2.4	222	
141	2.8	240	
142	2.2	244	
143	2.3	252	
144	2.2	265	
152	2.0	281	
165	1.3	288	
169	2.0	291	
170	2.0	296	
175	2.0		
Philo-Canton			
82	28.0	160	6.9
83	2.4		
Philo-Turner			
3	1.5	55	Not measured
Turner-Logan			
86	6.25*	115	1.5*
94	Ground resistance too high for instrument to record	152	16 and 12*
95	1.0*		

*Includes effect of ground wire as well as tower

conclusions with regard to the effect of ground resistance on the frequency of flashover at a particular point. The data on ground resistance which are being obtained at the present time on the Glen Lyn-Roanoke, Roanoke-Danville, and Roanoke-Reusens lines, may give some additional information on this point.

6. *Single-Circuit vs. Double-Circuit Flashovers.* On the two circuit lines in operation throughout the

entire period of 1927, with and without ground wires, 16 per cent of the outages tripped both lines, only one line tripping in the remaining 84 per cent of the cases. This would tend to confirm further the theory put forth previously that in the case of a double circuit line, the flashover reduces the energy in the surge sufficiently to lower the head of the wave to such an extent that the second circuit will not be subject to enough potential to

the order of 1400 kv. no flashover would be expected, while with 2100 kv. flashover always resulted.

3. The 1927 experience showed, further, that the damage as a result of flashover was confined to a single tower. This checked the data on attenuation of lightning which were obtained in both the 1927 and 1928 klydonograph investigations. The klydonograph data show that the destructive value of even a very high surge is lost in from one to five miles.

TABLE IV
TOWER GROUND RESISTANCES (Ohms)
Tower Only—Ground Wire Detached

	Maximum	Minimum	Average
Glen Lyn—Roanoke.....			
Glen Lyn—Switchback.....			
Lima—Fostoria.....	7.0	0.5	2.0
Lima—Twin Branch.....	11.4	0.8	2.5
Logan—Sprigg.....			
Philo—Canton.....	74.0	0.6	7.7
Philo—Crooksville.....	21.0	0.8	5.0
Philo—Turner.....	24.0*	0.7*	3.2*
Roanoke—Danville.....			
Rutland—South Point.....			
Saltville—Kingsport.....			
Switchback—Saltville.....			
Turner—Logan.....	100.0‡	1.0	11.8‡
Twin Branch—South Bend.....			
Windsor—Canton.....			
South Bend—Michigan City.....			
Turner—Cabin Creek.....	110.†	0.5	4.5

*Test on 20 towers.

†12 towers, readings not obtainable due to high resistance of ground

‡3 towers, readings not obtainable due to high resistance of ground

§74 towers out of 156.

flash it over after flashover on the first wire has once started. The fact that the percentage of flashovers on two circuit lines with ground wire, in which both circuits went out, is the same as the general percentage, would further confirm this.

1927 HISTORY IN LIGHT OF KLYDONOGRAPH INVESTIGATION

A brief description of the 1927 klydonograph investigation was given before the Institute last summer.⁴ Reviewing the 1927 experience in the light of that investigation the following stand out:

1. The effectiveness of the ground wire which the 1927 experience has indicated was shown by the low voltage recorded on the ground wire at the time of surge. About 20 kv. maximum was recorded which is small in comparison with the line lightning voltage. Its effectiveness is further indicated by the relative voltages recorded on the three phases. These agreed fairly well with theory. Although the klydonograph investigation was not extensive enough to be definitely conclusive, the operating experience gathered in 1927 reinforced the klydonograph data in so far as they went on that point.

2. On some of the lines 2100 kv. was recorded in the klydonograph investigation with a resulting line outage. On the other hand, a recorded voltage of 1450 kv. resulted in no line outage. This tends to confirm laboratory tests made with artificial lightning applied to insulator strings, that is, with lightning voltages of

SUMMATION OF EXPERIENCE

Summarizing the 1927 experiences, it is believed that the following have been fairly definitely established or have been more definitely indicated:

1. The effectiveness of the ground wire was further established.

2. Some data were obtained that would indicate very definitely the effectiveness of two ground wires where properly employed.

3. It was shown that the ground wire equalizes the lightning voltages on all three wires of a vertically arranged line, besides reducing the lightning voltages. Where one wire was employed, if equalization did not result, it was in the direction of reducing the lightning voltage on the top and middle conductors to a value below that on the bottom conductor where the ground wire was placed immediately above the top wire.

4. The use of properly designed arcing protective devices has in all probability resulted in a certain reduction in the number of flashovers, and has very definitely minimized cascading where flashovers did finally result. Where cascading does occur, the use of arcing protective devices results in the reduction of the damage to such an extent as to be of minor importance from an operating standpoint.

5. In cases where tower resistances are not particularly high the data showed nothing conclusive with regard to the effect of resistance on lightning flashover.

6. The two-circuit line having its circuits arranged vertically on the same tower has shown itself to be very reliable from the continuity of service point of view. In approximately only 15 per cent of the cases does outage result on both circuits, one circuit only going out in the remaining 85 per cent of the cases.

7. The localization of damage in case of flashover confirms very definitely the field data obtained by klydonograph and indicates a very rapid attenuation of surges. In fact, attenuation indicated would appear to be more rapid than would be expected from the relationship as given by any heretofore published formula.

The author acknowledges with thanks the cooperation and help furnished by the operating organizations of the Appalachian Electric Power Company, of the Indiana & Michigan Electric Company, and of the Ohio Power Company in gathering the field data, and the assistance of Mr. I. W. Gross in co-relating it and in the preparing of the paper.

Use of the Oscillograph for Measuring Non-Electrical Quantities

D. F. MINER*
Member, A. I. E. E.

and

W. B. BATTEN*
Associate, A. I. E. E.

Synopsis.—The electromagnetic oscillograph has proved to be a useful instrument for obtaining recorded measurements of non-electrical quantities. The problems of application involve the trans-

lation of mechanical phenomena into electrical changes which are proportional. Several typical applications are described showing how motion, time, stress, pressure, etc., are measured.

ALTHOUGH the electromagnetic oscillograph was developed primarily for, and has found its principal application in, recording electrical quantities in terms of current, voltage, and watts, its inherent characteristics have made it useful for non-electrical applications. This oscillograph offers a means of recording photographically phenomena which are of too short a duration for the eye to watch or for other types of instruments to record. Furthermore, it is frequently desirable to record simultaneously both electrical quantities and mechanical actions of some apparatus. For this, the oscillograph is admirably adapted. However, these quantities must be of such a nature that they can be translated into electric potentials or currents which have a definite relation to the quantities to be recorded.

The element of the instrument is a low inertia galvanometer, the two ribbons of which move with respect to each other in a magnetic field. The motion tilts a mirror and through an optical lever causes a beam of light to be deflected on a screen or film. The motion is proportional to current in the ribbons so that equal increments of current through the galvanometer or equal increments of potential applied to the galvanometer with series resistance are faithfully recorded.

The problem in adapting the oscillograph for other than electrical uses lies in the translation of the phenomena to be recorded, into proportionate electrical values. It is the aim of this paper to show a number of typical applications illustrating how this object was obtained. Many phenomena, such as changes in pressure, vibrations, stresses, and time intervals, give rise to mechanical motion, either linear or angular, resulting in a variation of speed or an acceleration of the body as a whole or in part. If this motion can be made to vary an impedance in an electrical circuit as a function of this motion, the current through the circuit, or the potential across a portion of this impedance, may be utilized to actuate the galvanometer for a record.

TRAVEL INDICATOR

Where the motion of a part of a machine is to be studied for uniformity, acceleration, rebound, etc., a

*Both of Westinghouse Electric & Manufacturing Co., East Pittsburgh, Pa.

Presented at the Winter Convention of the A. I. E. E., New York, N. Y., Jan. 28-Feb. 1, 1929. Printed Complete in this Issue.

resistance wire can be placed along a stationary part, and a moving contact attached to the moving part. The contact slides along the wire and changes the resistance included in the galvanometer circuit as in Fig. 1, in which AB , the resistance, may be either of continuous length or steps in a wound resistor. C is the sliding contact for indicating relative motion between the moving member to which it is attached and the fixed member to which AB is fixed. In such a circuit, a constant current flows from a battery through AB . The resistance of the galvanometer circuit AGC is made sufficiently high so that changes in the position of C do not alter the potential distribution along the resistor AB appreciably. The proportions of current in the two circuits (resistor and galvanometer) can be adjusted to secure any reasonable degree of accuracy.

A device of this kind has proved particularly useful

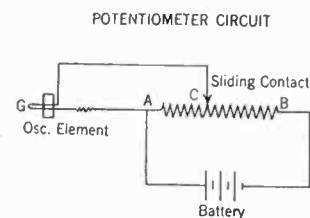

FIG. 1—POTENTIOMETER FOR TRAVEL INDICATOR

in studying the travel of circuit breaker parts. As shown in Fig. 2, the resistor wire is wound on the edge of an insulating disk which can be rotated against the action of a special spring. The device is clamped to the frame at a convenient point and a cord, connected to the disk and wrapped around a drum on its shaft, is attached to the moving part to be studied.

SPEED RECORDER

When a rotational speed record is desired in a form, such as an oscillogram, particularly adjacent to some other record for the purpose of timing, rotation must be translated into an electrical current in the oscillograph element proportional to the speed. A magneto or other constant field generator has a voltage characteristic proportional to the speed, but the usual electric tachometer has a wave form that is very bad, being full of high-frequency harmonics. At various times homopolar generators have been used but they usually

develop current collection troubles and generate a very low potential. A remedy to the magneto trouble can be obtained by using a special oscillograph element, which is equipped with a damping vane and will not respond to high frequencies.

Fig. 3 is a section of an oscillogram recording the operation of two reversing mill motors. The top record shows the speed of one motor as measured with a magneto and oscillograph element having a damping vane. The fifth record from the top shows the speed of a second motor as measured with a magneto and standard oscillograph element. These two records show the

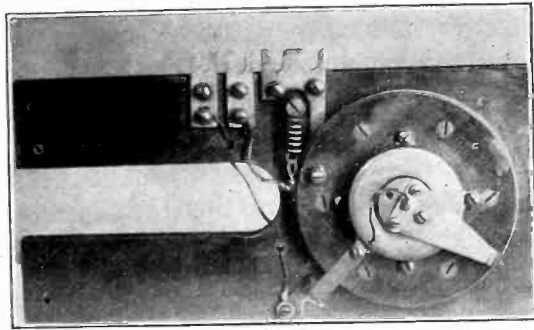

FIG. 2—CIRCUIT-BREAKER TRAVEL INDICATOR

effect of a damping vane on an oscillograph element when making this type of record.

It is sometimes desirable to record minute speed variations of rotating parts as when investigating governor action. This may be accomplished by coupling or belting a small magneto or constant field generator to the machine under test. The magneto or generator is connected in series with a battery, the potential of which opposes and equals the magneto voltage during steady state condition. The oscillograph records the differential potential and can be adjusted to respond to a fraction of one per cent change in speed.

VIBRATION

If vibratory motion of small amplitude can be made to change the reluctance of a magnetic circuit of proper design an electrical equivalent of the motion can be obtained. This was used in exploration of turbine blade vibration by placing a vibration converter on the end of the turbine shaft. This device is really a small generator with a permanent magnet field. It is so designed that the normal position of a field pole is midway between two armature teeth. As the field moves with respect to the armature, the flux shifts from one tooth to the other and induces a potential in the coils on the armature teeth. In practise, the armature is clamped rigidly to the end of the turbine shaft and hence follows the motion of the turbine rotor. The field of the vibration converter is free to move with respect to its armature and its inertia is such that it does not follow the high-frequency vibrations which may be present in the turbine shaft, though it rotates at the same average speed as its armature.

TIMING

Sequence of operation without reference to magnitude of motion or resulting phenomena can be shown nicely by the oscillograph. Two factors are necessary, one an indication of operation, and the other a time scale. If, for example, the relation between the opening or closing of several switches is desired, each unit can be so arranged as to short-circuit a resistor in the galvanometer circuit or insert resistance. At each operation the recording line makes a jump up or down. The time scale may be made by an a-c. wave of known frequency, simultaneously recorded a timing record from a tuning fork or the tick of a watch. In the last case a small mirror mounted on the hair spring deflects a beam of light giving impulses on the film. This is accomplished by removing a small section from the edge of the watch case opposite the hair spring. The mirror, which is about 0.017 by 0.070 in. in size, is fastened directly to the hair spring at a point near the place where the hair spring is secured to the frame. Hence the mirror moves only slightly this motion causing a small rotational movement about its transverse axis. The light spot reflected from the mirror moves up and down as the hair spring moves. As the light spot passes the slit in the oscillograph film holder, a spot on the film is exposed. Hence the record consists of a series of dots or dashes, such as that shown at the bottom of Fig. 3 for slow speed work. This device is very dependable. It has

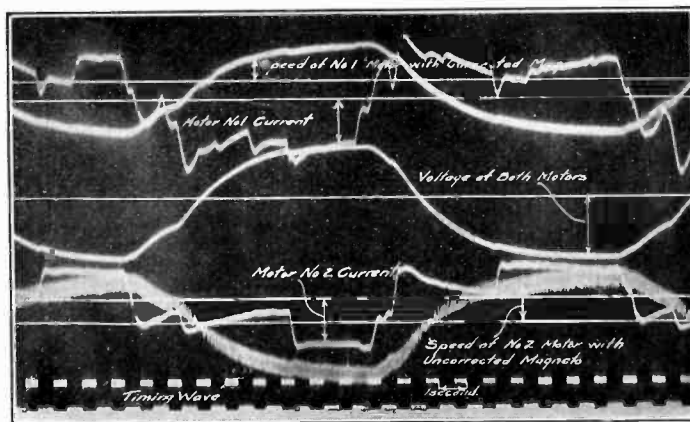

FIG. 3—OSCILLOGRAM SHOWING SPEED RECORD WITH AND WITHOUT CORRECTED MAGNETO WAVE

the advantage of not requiring a regular oscillograph element, thus leaving an extra element for some other measurement. The mirror affects the speed of the watch only slightly.

STRESSES

For most materials the strain from load on a mechanical member is proportionate to stress within the elastic limit, so that a record of stretch or compression can be interpreted in terms of stress. Usually the amount of motion is small, so that slide wire scheme is not applicable. However, other methods such as change in resistance of a pile of carbon disks with small motion

or change in reluctance in a magnetic circuit in combination with suitable coils, are available.

The strain gage is an interesting form for studying railroad track and locomotive side rod stresses. This

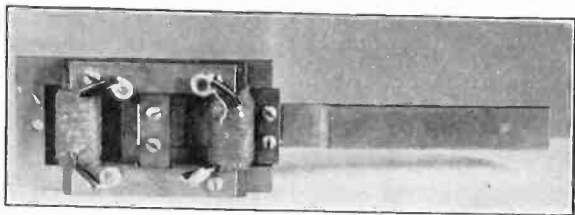

FIG. 4—THE STRAIN GAGE

can be applied wherever it is desired to obtain oscillographic records of mechanical movements of very small amplitude (a few thousandths of an inch). The gage consists of two stacks of U-shaped sheet-steel punchings

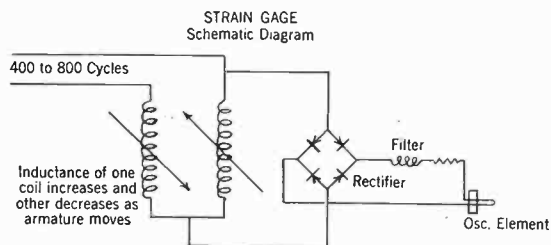

FIG. 5—STRAIN GAGE CIRCUIT

with a coil on each and an armature of sheet-steel punchings as shown in Fig. 4. The open ends of the two stacks of punchings are placed facing each other, with the armature between them, and the gap between the

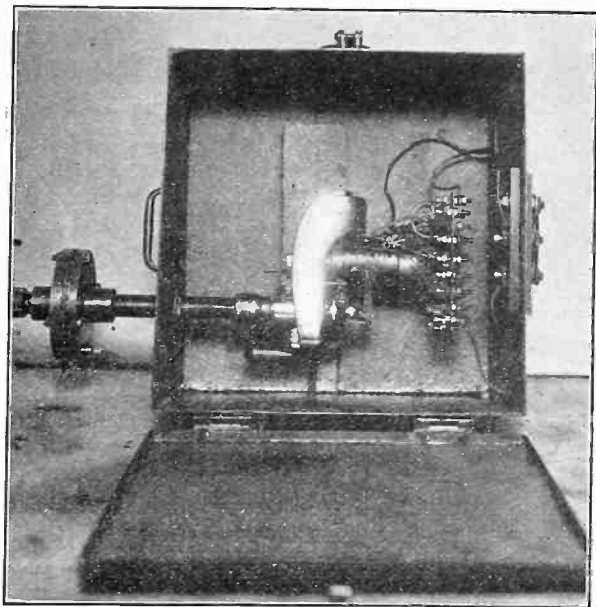

FIG. 6—PRESSURE RECORDER

armature and U-punchings is sufficient to permit the armature to move with respect to the punchings. In other words, the strain gage records the movement of the point to which the armature is fixed with respect to

the part to which the U-punchings are attached. The two coils are connected in series and a fixed current at relatively high frequency (400 to 800 cycles) is sent through them. The oscillograph records the voltage across one of the coils. This potential varies with the distance between the armature and U-punchings. Experience has proved that practically a straight line relation exists between potential across one coil and armature position as long as the armature does not actually touch either stack of U-punchings. The record shows a modulated high-frequency current; hence vibrations having a frequency higher than about 15 per cent of the frequency of the current through the coils cannot be recorded accurately. Inasmuch as the modulated high-frequency wave occupies a large space on the film, it is difficult to record six stress measurements simultaneously without overlapping, giving a record confusing to analyze. To eliminate this condition, the voltage to be recorded is sent through a full-wave copper-oxide disk rectifier, and then through a choke coil before reaching the oscillograph galvanometer. The

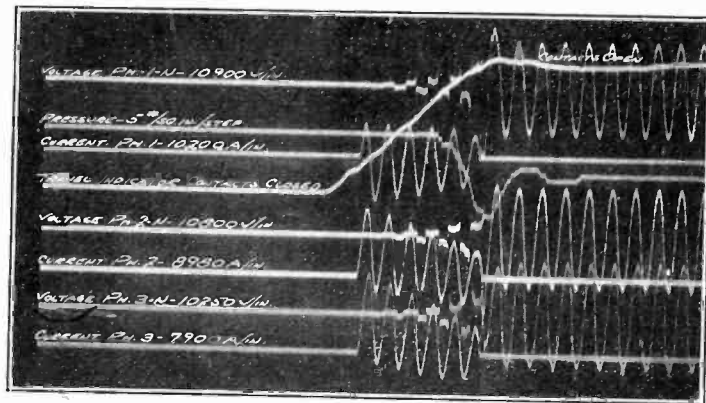

FIG. 7—OSCILLOGRAM SHOWING CIRCUIT-BREAKER TEST WITH TRAVEL INDICATOR AND PRESSURE RECORDS

choke coil is of such value that the rectified high frequency is practically ironed out, but is low enough so that it does not affect the envelope curve (40 cycles or less). This arrangement gives a straight line record, the position of the line being varied only by a change in the position of the strain indicator armature or in other words by the stress in the member to which the strain gage is attached.

PRESSURE RECORDER

A great deal of effort has been expended upon the subject of recording transient steep wave front pressures. Strictly speaking, any device in which motion occurs due to the pressure cannot give a true record, for the motion has changed the volume and consequently the pressure. Furthermore, the motion of a piston or diaphragm involves time lag. But for ordinary purposes we can be satisfied with much less than the idea. Probably the piezo crystal comes as near being perfect as anything. Certain crystals exhibit electrical changes when subjected to pressure which, however, alter their shape very little. For many commercial uses, how-

ever, such a crystal is far too delicate a device, and the electrical change much too feeble.

The carbon pile is often used but even though a bridge arrangement is employed it is difficult to maintain a constant calibration and it is too delicate for rough handling.

A much better instrument for circuit-breaker pressure records was developed later using a very light-weight gas-engine indicator modified to translate the piston motion into change in resistance. The pointer which is ordinarily used for tracing an indicator card was made part of an electrical circuit and travels over a drum made up of alternate copper and insulating disks, the copper being connected to suitable external resistance units. An inch of travel on the pointer tip covers 20 steps. Thus each step represents a pressure of 1/20 of the piston spring calibration. This makes the record self-calibrating. The pressure record is shown in steps but if these are made of the proper magnitude there is no objectionable lack of smoothness in the curve. The device is very convenient and withstands test floor handling without damage. For protection during tests the recorder is placed in a fireproof metal box and a short length of metal hose is used for the connection to

the circuit-breaker tank. It is interesting to relate that at first a two ft. length of heavy rubber hose was used. Records were obtained of explosion pressures long after the phenomena was over. There was a time delay in propagation of the wave of pressure through the rubber sufficient to cause this. Substituting a rigid metal connection eliminated this.

We have described above a few interesting uses of the oscillograph outside of the purely electrical field. Many more could be cited but these will suffice to show the inherent usefulness and versatility of this instrument.

Bibliography

J. W. Legg, "The Multi-Element Oscillograph," *Elec. Journal*, Nov. 1927.

J. W. Legg, "Six-Element Portable Oscillograph," *Elec. Journal*, Mar. 1925, p. 108.

J. W. Legg, *Portable Oscillograph*, A. I. E. E., July 1920, p. 674.

The following bibliographies previously published contain many references to the application of the oscillograph to non-electrical measurements.

TRANSACTIONS A. I. E. E., Vol. XLIV, 1925, p. 257.

TRANSACTIONS A. I. E. E., Vol. XLVI, 1927, p. 709.

TRANSACTIONS A. I. E. E. Quarterly TRANS., Vol. 47, October, 1928, p. 1168.

Abridgment of Totalizing of Electric System Loads

BY P. M. LINCOLN*

Fellow, A. I. E. E.

Synopsis.—The importance of measuring an electric system load at any distance from that load is emphasized. The use of thermal wattmeters in conjunction with thermal couples is suggested. Time of response of such devices is discussed: temperatures attained are

also discussed. Characteristics of circuits for transmitting the thermal e. m. f. from the load to the point of measurement are discussed in detail. A list of users together with data pertaining to the measurement-transmitting circuits is given.

THE problem of load dispatching requires that the load dispatcher shall know at all times not only the aggregate load on his own system but also how much load he is supplying to other systems and how much they are supplying to him. When the generating stations are widely separated and when the points of contact with contiguous systems are still more widely separated, as is the case in all large systems, how is the load dispatcher to obtain this essential information?

It is the object of this brief paper to indicate one solution of this problem. The fundamental idea in the solution proposed is the same as that in the instrument described by the writer in a paper before the A. I. E. E. in October 1915.¹ Fig. 1 herewith is a reproduction of

*Director, School of Electrical Engineering, Cornell University, Ithaca, N. Y.

1. *Rates and Rate Making*, P. M. Lincoln, A. I. E. E. TRANS., 1915, p. 2279.

Presented at the Winter Convention of the A. I. E. E., New York, N. Y., Jan. 18-Feb. 1929. Complete copies upon request.

Fig. 2 of that paper and shows the elements of a thermal wattmeter. In the appendices of the 1915 paper is submitted a mathematical proof that, with circuit connections as shown in Fig. 1, the difference in temperature between resistances a and b of Fig. 1 is proportional to watts.

In the 1915 paper above referred to, a number of methods is proposed for measuring the difference in temperature between these two resistances a and b —among them the use of thermocouples. Still another method is described in the present author's paper² read before the A. I. E. E. on Feb. 15, 1918. This latter method has been incorporated into a commercial demand meter and has found considerable use among public utilities, particularly in Canada. Although this latter method is excellent for use in a demand meter, it does not lend itself readily to a solution of the total-

2. *The Character of the Thermal Storage Demand Meter*, P. M. Lincoln, A. I. E. E. TRANS., 1918, p. 189.

izing problem outlined above. The use of thermocouples, however, does so lend itself in an ideal manner. As shown in the 1915 paper, the difference in temperature of the resistances *a* and *b*, Fig. 1, is proportional to watts. If thermocouple junctions are associated with these resistances, the resulting thermal e. m. fs. are then proportional to watts for each individual thermal wattmeter. By connecting these thermal e. m. fs. in series, and measuring the resultant total, the sum of all of the readings of the individual thermal wattmeters may easily be obtained at any desired point.

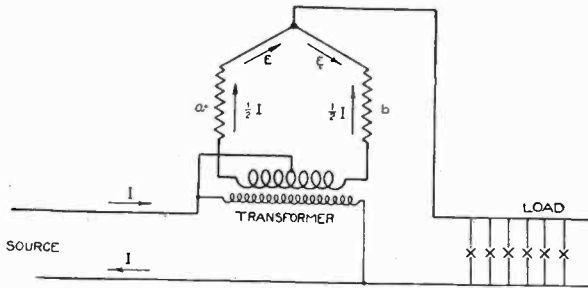

FIG. 1—ELEMENTARY DIAGRAM OF THERMAL WATTMETER

It should be noted that the thermal wattmeter shown in Fig. 1 is reversible. If the power flow is in one direction, resistance *a* becomes hotter than resistance *b* by a given amount. If the direction of wattage flow is reversed, resistance *b* becomes hotter than *a* by exactly the same amount—assuming, of course, that the watt

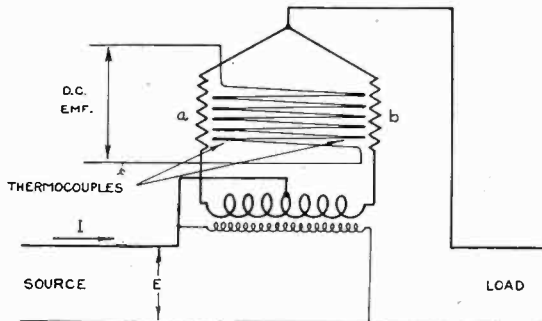

FIG. 2—ELEMENTARY DIAGRAM OF THERMAL WATTMETER USING THERMOCOUPLES AS MEASURING PRINCIPLE

value is the same in each case. In one case, therefore, the resultant thermal e. m. f. is in one direction and in the other case in the opposite direction. These thermal wattmeters may therefore be used to subtract a given load from the total as well as add its value; the thermal wattmeter is completely and accurately reversible.

All that is necessary to obtain a total indication is an electrical circuit connecting the thermal wattmeters to be totalized and some means of reading the total resultant thermal e. m. f.—preferably a potentiometer. This briefly is the basis of the method that is now proposed for load totalization. There is a number of points that warrant further discussion.

THE THERMAL CONVERTER

For the sake of convenience, the instrument incorporating the metering circuit shown in Fig. 1, together

with the necessary thermocouples and adjustments, has been called a "thermal converter." Fig. 2 shows such a thermal converter in diagram and Fig. 3 is a photograph of two such thermal converters mounted in a single case and comprising a complete polyphase wattmeter—one converter in each phase. Fig. 4 shows a diagrammatic section of one of these thermal converters. The form and arrangement of parts in Fig. 4 is due to the suggestions of Mr. H. S. Baker, Meter Supervisor of the Hydro Electric Power Commission of Ontario at Niagara Falls.

The experimental work necessary to convert Baker's suggestion into a successful commercial instrument was carried out by Louis A. Paine of the Lincoln Meter Co. Ltd., Toronto, with numerous suggestions by Mr. Perry A. Borden, at that time an engineer in the laboratories of the Hydro Electric Power Commission of

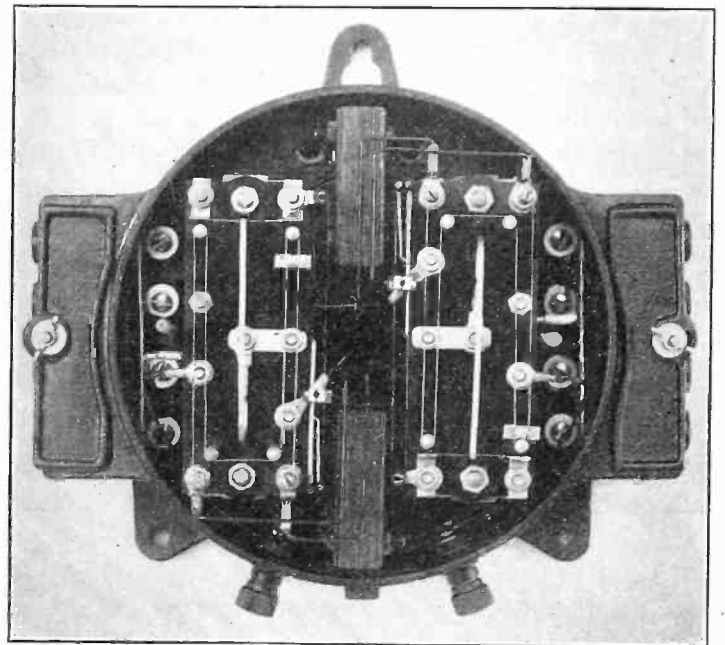

FIG. 3—THERMAL CONVERTER WITH COVER REMOVED SHOWING ADJUSTMENTS

Ontario, now an engineer with the Bristol Co., Waterbury, Conn.

Referring to Fig. 4, *A* is a heavy metallic plate, brass or copper. Around this plate, and insulated from it by pure sheet mica on the sides and by a grooved bakelite tube top and bottom, are the thermocouples *T*. Over these thermocouples is placed another layer of pure sheet mica and then the heaters *R*. After still another layer of insulation, the plates *P* are applied and firmly clamped together by suitable bolts. The terminal *B. B* of the heaters are associated in close thermal contact (but of course electrically insulated from each other), thereby eliminating errors that might be due to thermal conduction between leads and heaters.

Fig. 5 shows in diagram the adjustments that are provided. With either line current alone in the heaters or current from the voltage transformer alone, the two heaters must obviously attain exactly the same tem-

perature. This may be accomplished by proper adjustment of the small resistances labeled "current balance adjustment" and "potential balance adjustment" in Fig. 5. After these adjustments have been made, there is necessary a still further adjustment so that with a given value of watts applied to the thermal converter there will be a given thermal e. m. f. from the thermocouples. It is of course necessary that all of the thermal converters used to totalize a given load shall have the same thermal e. m. f. per watt; this final adjustment is secured by the shunting resistance marked "shunt" in Fig. 5. The thermal e. m. f. that has been adopted and found suitable in practise is ten millivolts per meter element; that is, with full normal load on the metering element of a thermal converter, the resulting thermal e. m. f. is ten millivolts. For a polyphase unit, where two thermal converters are used (one in each phase), the resulting thermal e. m. f. at normal full load is, of course, 20 millivolts. The relation between watts and the resulting thermal e. m. f. is a perfectly straight line; the thermal e. m. f. is always proportional to watts input. It might be pointed out here that this perfectly straight line relationship is secured by properly designed compensation. It is well known that the thermal e. m. f. of most couples increases slightly with increasing temperature; it is also well known that heat emissivity and heat conductivity decrease with increasing temperature—at least within the temperature range used in this device. By proper combination of these two tendencies complete compensation is secured. Also, the device is relatively free from temperature error, being less than one-tenth per cent per degree centigrade. This temperature error is positive, the thermal e. m. f. per watt increasing slightly as the atmospheric temperature rises.

The total thermal e. m. f. that is produced at the totalizing point is, of course, dependent on the number

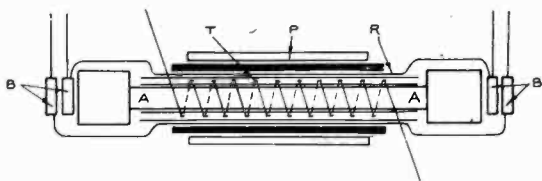

FIG. 4—DIAGRAMATIC SECTION OF THERMAL CONVERTER

of thermal converters that are used in series on any particular project, as well as upon the load on each individual thermal converter. There is no limit to the number of thermal converters that may be thus connected in series. The maximum number so far actually used on a single installation is 19 thermal converters used by the Hydro Electric Power Commission of Ontario to measure the power supplied to the Toronto Hydro Electric System.

TIME OF RESPONSE

No thermal device can respond instantly to the action of the currents that do the heating. This principle is utilized in the thermal demand meter and the sizes of

the various parts are so adjusted as to secure the desired time of response. The most widely used time of response for demand meters is ten minutes to reach 90 per cent of the final indication. The thermal converter shown in Figs. 2, 3, and 4 has a very much shorter time, viz., between 8 and 9 sec. to reach 90 per cent of its final reading. The reasons for this much shorter time may be worthy of further discussion.

As shown in Appendix 3 of the writer's paper¹ referred to previously, the instantaneous difference in

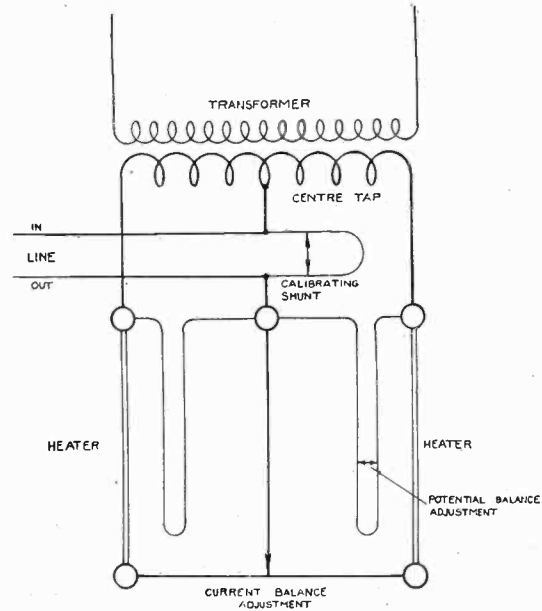

FIG. 5—DIAGRAM SHOWING ADJUSTMENTS ON THERMAL CONVERTER

temperature of two heaters arranged as in Fig. 1 is given by the expression

$$\theta_1 - \theta_2 = \frac{H_1 - H_2}{SE + 2Q} \left(1 - e^{-\frac{(SE + 2Q)t}{M}} \right) \quad (1)$$

where

- ϵ_1 = instantaneous temperature of heater *a* above environment
- ϵ_2 = instantaneous temperature of heater *b* above environment
- H_1 = rate in gram calories per sec. at which heat is applied to *a*
- H_2 = rate in gram calories per sec. at which heat is applied to *b*
- S = surface area in sq. cm. of *a* or *b* (similar)
- E = heat emissivity of *a* or (*b*) in gram calories per sec. per deg. cent. per sq. cm. of surface
- Q = thermal conductivity between *a* and *b* in gram calories per sec. per deg. cent. of temperature difference
- M = amount of heat in gram calories stored in *a* (or *b*) per deg. cent. of temperature rise
- t = time in seconds after first application of heat to *a* and *b*
- e = base of Napierian logarithms

In Appendix 2 of this same paper, it is shown that $H_1 - H_2$ is proportional to watts when the arrangement

is that shown in Fig. 1. From Equation (1), it is evident that the instantaneous temperature difference between *a* and *b*, Fig. 1, rises along an exponential

between *a* and *b* will reach 90 per cent of its final value (assuming a steady load application) when

$$t = \frac{2.302 M}{S E + 2 Q} \tag{2}$$

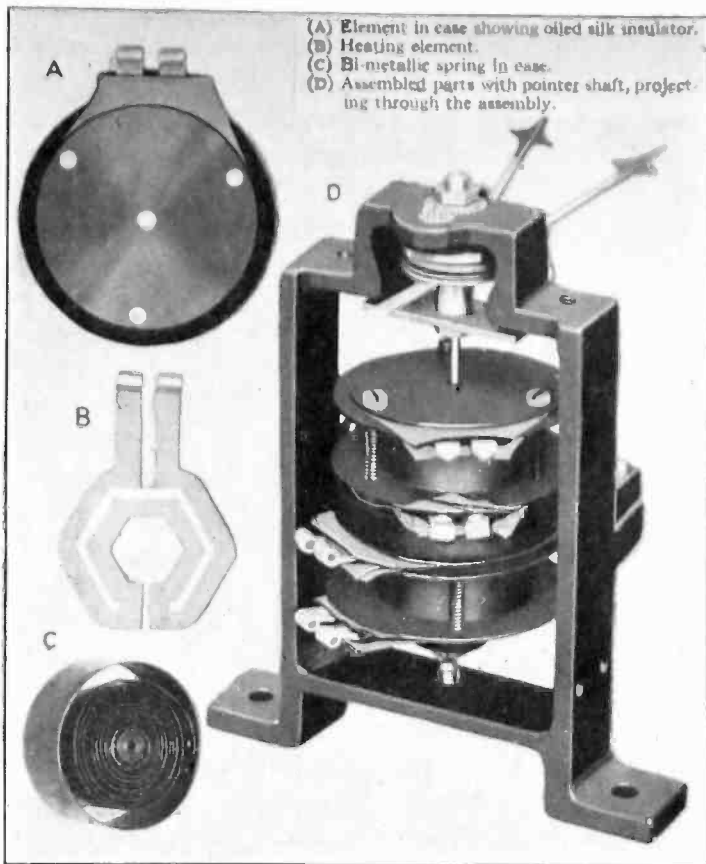

Fig. 6 shows a photograph of the parts and the assembled element of a demand meter having a time of response of ten minutes (to reach 90 per cent of final value). Comparing Fig. 6 with Fig. 4 and comparing

FIG. 6—PARTS AND ASSEMBLY OF THE MEASURING ELEMENTS OF A DEMAND METER (THERMAL STORAGE TYPE)

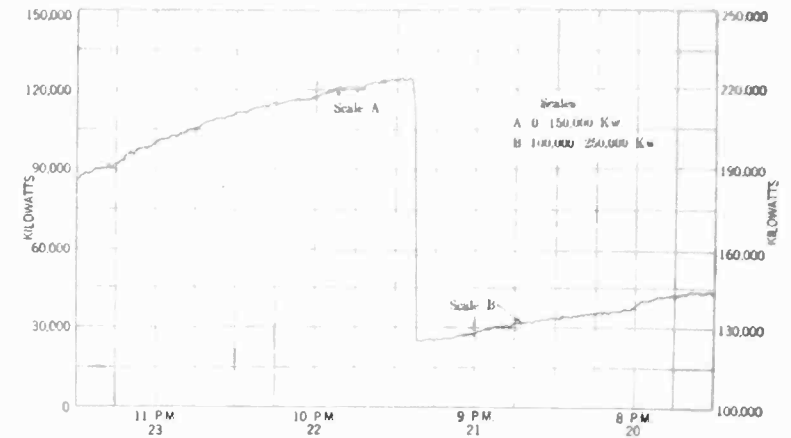

FIG. 7—FOUR HOURS RECORD OF THE TORONTO INSTALLATION SHOWING ZERO SUPPRESSION

curve and that it finally becomes proportional to watts, when *t* becomes infinite. It is further evident that the time of response is governed by the coefficient of *t*, viz., the quantity $\frac{S E + 2 Q}{M}$. The temperature difference

them with reference to the relation shown in Equation (2), the reasons for the much shorter time of response of the structure of Fig. 4 becomes apparent. The value of *M*, Fig. 4, is very much less than that of Fig. 6—less than 10 per cent. The value of *Q* in Fig. 6 is nearly zero, while in Fig. 4 it is comparatively very large. These two factors alone are sufficient to account for the fact that the structure shown in Fig. 4 will respond to the application of power in approximately one-seventieth of the time of that shown in Fig. 6. It is obvious,

TABLE III

Company	Location	No thermal converters (polyphase)	Total conductor miles	Total resistance ohms	Kind of conductor	Began operation	Max. power measured
Hydro Elec. Power Commission	Toronto, Ont.	19	25	530	Paper ins.—lead covered	Sept. 1926	166,000 kw.
Ottawa Gas and Elec. Co.	Ottawa, Can.	3	3.5	74	Style B telephone wire rubber ins-duplex	May 1926	20,000 kw.
London Public Utilities	London, Ont.	4	1.9	10	No. 10 B and S overhead wires on poles	?	20,000 kw.
Shawinigan Water and Power Co.	Three Rivers, Quebec	4	Within a single station	No data	Inside wiring	Aug. 1927	40,000 kw.
Wayagamac Pulp and Paper Co.	Three Rivers, Quebec	4	0.57	No data	No data	July 1927	8,400 kw.
Shawinigan Water and Power Co.	Thetford Mines, Quebec	3	2.5	53	No. 12 Style B copper weld overhead	Sept. 1927	7,000 kw.
Montréal Light, Heat and Power Company	Montreal, Quebec	2	Within a single substation		Inside wiring	Oct. 1927	No data
Price Bros.	Isle Maligne, Quebec	3	1.5	65	No. 16 style B	?	No data
Port Arthur Public Utilities	Port Arthur, Ont.	4	10	198	Paper ins. lead-covered cables	Oct. 1927	24,000 kw.
Windsor Hydro Elec. System	Windsor, Ont.	5	2.5	20	Underground control cables	?	20,000 kw.

further, that the time of response of the structure shown in Fig. 4 (or 6) may be modified if desired by modifying the design. However, the $8\frac{1}{2}$ sec. (approximately) time of response of the structure shown in Fig. 4 has been found to be quite suitable for the purposes of a totalizing meter.

TEMPERATURE ATTAINED DURING OPERATION

The total number of couples used in series in each thermal converter is usually 21. The microvolts per couple per degree of temperature difference is approximately 42. To attain a total of 10 millivolts at full load, the resulting difference in temperature of the two elements *a* and *b*, Fig. 1, is therefore approximately 11 deg. cent. The actual rise in temperature of the hotter element above the surrounding air depends on power factor. The lower the power factor the higher will be the resulting temperature rise, since the total heat dissipated in both elements dictates the maximum temperature rise and this in turn is dictated by the total current flowing in resistances *a* and *b*. This total current obviously increases as power factor decreases. With the designs used in practise, the maximum temperature attained at 50 per cent power factor does not exceed 60 deg. cent. above the surrounding air at full load in watts. Since the insulation used is pure mica, there is obviously ample margin for safety in so far as temperature rise is concerned.

CIRCUIT CHARACTERISTICS

There are two characteristics of the circuit connecting the thermal converters with the central point of measurement that should be considered. These are:

1. Line resistance in series with thermocouples.
2. Possibility of stray e. m. fs. in connecting line.

The first of these is of relatively minor importance while the second is of vital importance.

1. *Resistance in series with thermocouples.* (For discussion of this see full paper.)

2. *Possibility of stray voltage in connecting line.*

The matter of stray voltage on the transmitting conductor is of much more importance. However, the only stray voltage that need be seriously considered is a direct (or continuous) voltage. The means of detecting and measuring the resultant thermal e. m. f. consists, as has been mentioned, of a galvanometer of the D'Arsonval type. Such a galvanometer recognizes direct currents only and a superposed alternating voltage is of no particular moment, unless it becomes unduly large. The filtering out of these superposed alternating voltages may be quite readily accomplished.

Neighboring circuits may affect the transmitting circuit either by induction or by leakage. Induction may be either electrostatic or electromagnetic; either of these forms of induction, however, can induce only alternating e. m. f. into the transmitting circuit and therefore this source of stray e. m. f. is of no particular moment. The same is true of conduction effects so long as the conducted current is purely alternating. If, however, this conduction is of such a nature as to

cause a direct current e. m. f. to appear in the transmitting circuit, an error in the transmitted reading will be caused equal in amount to the proportion that the parasitic e. m. f. bears to the thermal e. m. f. of the thermal converters under measurement. The thermal e. m. f. is, at full load on each thermal converter, 20 millivolts per polyphase thermal converter. The total useful e. m. f. to be measured varies therefore from perhaps one or two millivolts as a minimum to perhaps 500 millivolts as a maximum, depending on the number of thermal converters used and the loads on each. It is obvious, therefore, that a relatively small amount of leakage from an external source would be fatal to the accuracy of this method of measurement. The transmitting circuit *must* be properly protected from leakage. However, with proper construction and proper precautions there is no need to anticipate any difficulty from this source. Perhaps the best proof of this statement is to enumerate existing installations and indicate the length and character of the transmitting lines. This information is given in Table III.

Fig. 7 shows about four hours record of one of these totalizers on the Toronto installation. This particular portion of the chart has been selected to show one of the advantages of this system of totalization, *viz.*, the ability to suppress the zero and thus increase the virtual scale length. On the right hand portion of this chart, the bottom represents 100,000 kw. and the top 250,000; the zero has been suppressed to the extent of 100,000 kw. At the left the zero suppressor has been removed and now the bottom is zero and the top 150,000 kw. With this type of measuring device it is a very simple matter thus to suppress the zero; it can be done to any extent desired.

In conclusion, while actual experience with this new totalizing system in practise has been limited to only about three years, nothing has developed to lead to the anticipation of any difficulty. Direct current leakage into the transmitting wires is the only thing that need be zealously guarded against and experience thus far indicates that with proper installation, no fear need be entertained from this source.

PLAN TO PRESERVE NIAGARA FALLS

A plan to preserve the scenic beauty of Niagara Falls by preventing further erosion of the Horseshoe Falls has been submitted to Governor Roosevelt of New York by Paul A. Schoellkopf, president of the Niagara Falls Power Company.

The project was drafted by federal power authorities in co-operation with the Niagara power officials, and provides for the erection of concrete wings in the river above the falls to divert a greater flow of the water to the sides of the Horseshoe Falls. By arrangement between the federal government and Canada the plan may be tried over an experimental period of seven years. The estimated cost would be \$150,000, which would be met by the Niagara Falls Power Company.

Abridgment of The Fundamental Theory of the Capacitor Motor

BY H. C. SPECHT*

Member, A. I. E. E.

Synopsis.—A fundamental theory of the motor and capacitor is given partly by the algebraic method and partly by graphical method. The variables in the design of a complete capacitor motor unit for any desired performance are discussed. A few examples of unbalanced phases and performance are given. The suitability for various classes of service is discussed briefly.

INTRODUCTION

AN ordinary two-phase motor may be used as a capacitor motor, one phase being connected directly, and the other in series with a condenser, to a single-phase circuit. The performance, however, may not be all that is desired. The hp. rating, especially, may have to be reduced from its normal two-phase value, in order to obtain sufficient relative pull-out torque.¹ By varying the capacitor continuously as the load changes, operating characteristics approximating those of the two-phase motor could be obtained. This, however, is not practical, and only one or two taps from the capacitor are permissible, generally one for the starting and one for the running load.

The capacitor motor could be designed with a power factor of nearly 100 per cent and an efficiency nearly equal to a similarly rated two-phase motor. However, in order to obtain a smaller capacitor, a reasonable sacrifice in power factor and efficiency may be accepted.

In order to have a clear understanding of the various characteristics of the capacitor motor it may be well to deal first with the general theory of a capacitor motor, assuming the stator to be wound two phase and the windings spaced 90 electrical degrees apart.

GENERAL THEORY

(A) Motor at Stand Still.

The fundamental equation of starting torque for any kind of an electrical motor is as follows:

Starting torque = Rotor ampere turns \times flux \times cosine of the angle between their vectors \times a constant.

- Φ_1 = Flux of main phase.
- Φ_c = Flux of condenser phase.
- i_1 = Stator amperes in main phase.
- i_{1c} = Stator amperes in condenser phase.
- i_2' = Current in the rotor of main phase and reduced to stator winding turns.
- i_{2c}' = Current in rotor of condenser phase and reduced to stator winding turns.

- $e_1 = e_2'$ = Rotor voltage induced by Φ_1 , and reduced to stator winding turns.
- $e_{1c} = e_{2c}'$ = Rotor voltage induced by Φ_c and reduced to stator winding turns.
- E = Line voltage.
- E_c = Terminal voltage of the capacitor phase.
- e_c = Capacitor voltage.
- t_1 = Stator winding turns in main phase.
- t_{1c} = Stator winding turns in capacitor phase.
- k_1 & k_2 = Main phase winding distribution factors.
- k_{1c} & k_{2c} = Capacitor phase winding distribution factors.
- f = Line frequency.
- s = Slip.
- p = Number of poles.
- C = Capacity microfarads.
- r_1 = Resistance in ohms of stator main phase.
- r_{1c} = Resistance in ohms of stator winding in capacitor phase.
- r_2' = Ohmic resistance of rotor reduced to main phase winding turns.
- r_{2c}' = Resistance in ohms of rotor reduced to stator condenser phase winding turns.

x_1, x_{1c}, x_2'
and x_{2c}' = The corresponding leakage reactances.

$$x_c = \frac{10_c}{2 \omega f C} \text{ Capacitance in ohms.}$$

- ψ_1 = Angle between i_2' and Φ_c .
- ψ_2 = Angle between i_{2c}' and Φ_1 .
- α = Angle between Φ_1 and Φ_c .
- T_1 = Torque in kgm developed by main phase.
- T_2 = Torque in kgm developed by condenser phase.

$$T_1 = 2.3 \times p \times \Phi_c \times i_2' \times t_1 \times \frac{k_1}{k_2} \times \cos \psi_1 \times 10^{-10} \text{ kg m} \quad (1)$$

$$T_2 = 2.3 \times p \times \Phi_1 \times i_{2c}' \times t_{1c} \times \frac{k_{1c}}{k_{2c}} \times \cos \psi_2 \times 10^{-10} \text{ kg m} \quad (2)$$

$$T_1 + T_2 = \text{Total starting torque.}$$

If the windings of the two phases have equal amounts

*Electrical Engineer, Westinghouse Elec. & Mfg. Co., Springfield, Mass.

1. See I. Biermanns, *Archiv. für Elektrotechnik*, Vol. XVII, p. 519; Franklin Punga, *Archiv. für Elektrotechnik*, Vol. XVIII, p. 267; B. F. Bailey, *Elec. Wld.* 1928, pp. 597, 647.

Presented at the Winter Convention of the A. I. E. E., New York, N. Y., Jan. 28-Feb. 1, 1929. Complete copies upon request.

of copper the formula for torque may be written as follows:

$$*T = \frac{e_2' \times e_{2c}'}{2 \pi f} \times p \times \frac{r_2'}{(r_2')^2 + (x_2')^2} \times \sin \alpha \times 10^{-9} \times \text{Const.} \quad (3)$$

From this formula it follows that the maximum starting torque for different rotor resistances occurs when $r_2' = x_2'$ providing all other values remain the same. The induced voltage in the rotor depends on the stator impedance drop and in the capacitor phase also on the capacity. As the induced voltage varies the torque changes proportionately. Further, the torque depends on the angle α and this, for maximum starting torque, should be close to 90 deg. When figuring the torque it is convenient to use the graphical method as this gives a clear picture and helps in making changes necessary to obtain the best results. First of all the currents and their power factors are figured.

$$i_1 = \frac{E}{\sqrt{(r_1 + r_2')^2 + (x_1 + x_2')^2}} \quad (4)$$

$$\cos \varphi_1 = \frac{r_1 + r_2'}{\sqrt{(r_1 + r_2')^2 + (x_1 + x_2')^2}} \quad (5)$$

$$i_{1c} = \frac{E}{\sqrt{(r_{1c} + r_{2c}')^2 + (x_{1c} + x_{2c}' - x_c)^2}} \quad (6)$$

$$\cos \varphi_{1c} = \frac{r_{1c} + r_{2c}'}{\sqrt{(r_{1c} + r_{2c}')^2 + (x_{1c} + x_{2c}' - x_c)^2}} \quad (7)$$

The other values are obtained from the graphical method. (See Fig. 1.)

The locus of the vector e_{1c} is a circle with the diameter

of $\frac{E}{r_{1c} + r_{2c}'}$ and its center on the vertical line of $O E$.

Therefore the locus of the voltage vectors is also a circle, the center M_{c1} of which is determined by the intersection of the perpendicular erected at the center of $O E$ and $A E$.

Also the locus of the vector of the induced voltage in the rotor is a circle and its center M_{c2} is determined by the intersection of the perpendiculars through the center of $O B$ and $O C$. $O B$ represents the rotor voltage of the capacitor phase at a given capacity and $O C$ represents the rotor voltage at resonance. After the circles are determined it is an easy matter to pick from the diagram the voltages for any current because the angularity in regard to the individual vectors must be the same. The maximum starting torque for the various capacities occurs when $\sin \alpha \times e_{2c}' = \text{maximum}$, which is at the point where the tangent at this rotor voltage circle of e_{2c}' is parallel to vector e_1 . This point is marked in Fig. 1 with T_m , the corresponding point is also indicated on the circle for the condenser

voltage e_c and the current i_{1c} . The point T_m on the current circle is the tangent point to i_1 and T_m on the voltage circle E_c and e_c is the tangent point to $O E$ or line voltage.

It will be noted from the diagram, that with an appreciably smaller value of current and capacity near the point T_m , the torque is not much smaller. Therefore, in order to keep the starting current as low as possible, it will be advisable to stay below the maximum point.

Since the capacity required to give a starting torque equal to or more than full load torque is so great, the capacitor may cost more than the motor, a series transformer should be used in connection with the condenser. The connection diagram most commonly used is shown in Fig. 2.

The advantage of this scheme is indicated very well by the fact that the capacity required decreases in-

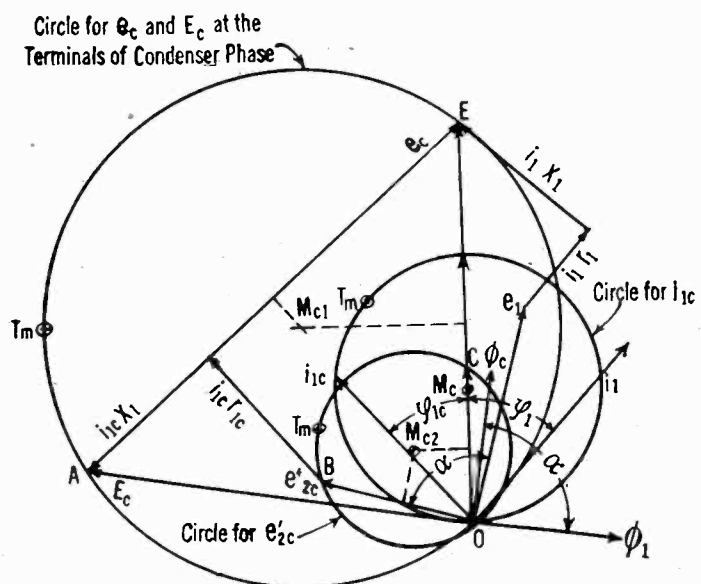

FIG. 1—VECTOR DIAGRAM OF MOTOR AT STANDSTILL

versely with the square of the transformer voltage ratio and that at a certain voltage the cost of the condenser for the same volt-amperes is the lowest. The transformer also makes possible, by means of a transfer switch, the use of different effective capacities for both the starting and running conditions without breaking the condenser circuit. This is highly desirable. This transfer switch may be of the centrifugal type or the magnetically operated type. The magnet coil of the latter type is connected, preferably, in the main winding circuit since the current of this winding varies through a wider range.

In designing the transformer it should be observed that the magnetizing reactance reduces the effective capacity, and that the watts loss also reduces the overall motor efficiency. Therefore, the transformer must be of ample size.

Considering starting torque only, it will be the cheapest proposition to work the main phase of the motor heavy and the capacitor phase light. How the

*See E. Arnold, *Wechselstrom Technik*, Volume 5.

value of the starting torque changes with an unbalanced winding system, is illustrated as follows.

Example. The amount of copper in both phases may be assumed as equal. The capacitor phase may, however, have twice as many turns as the main phase and therefore only half the cross section. The ohms resistance and the leakage reactance will be four times, and for simplicity the capacity may be only $\frac{1}{4}$. Therefore,

$$i_{1c} = \frac{1}{4} \text{ with its power factor remaining the same.}$$

According to formulas (1) and (2) we find:

$T_1 = \frac{1}{2}$ the value of the motor with balanced windings because the flux is half as great.

$T_2 = \frac{1}{2}$ the value of the motor with balanced windings as the current is only $\frac{1}{4}$ as great and winding turns twice as many.

The resultant torque is therefore only decreased $\frac{1}{2}$ while the condenser capacity has been reduced to $\frac{1}{4}$. The starting current in the line is decreased to 73 per cent of value with balanced windings, providing both current vectors remain 90 deg. apart.

Generally it can be stated that the starting torque decreases approximately in the inverse ratio of the winding turns in the capacitor phase providing the amount of copper in both phases is kept the same and the capacity decreased in the inverse ratio of winding turns squared. If the ratio of the amount of copper in the two phases is changed, the results are certainly different because the induced voltage in the rotor or the corresponding flux depends on the impedance drop in the stator winding. For commercial reasons, however, it is in some cases permissible to reduce the total copper section of the capacitor phase and still meet the

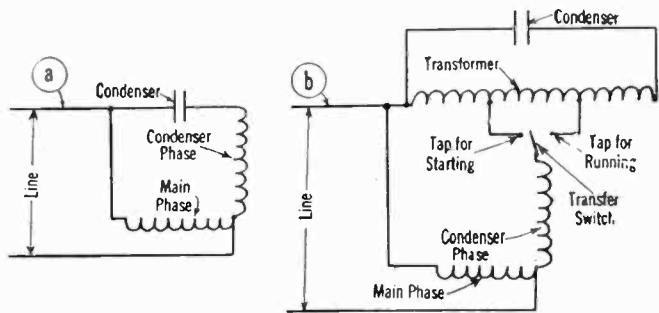

FIG. 2—(A) CONDENSER IN SERIES WITH AUXILIARY PHASE
(B) CONDENSER IN PARALLEL WITH TRANSFORMER

required torques. However, in doing this the change in the performance of the motor under running load must also be given consideration.

(B) *Motor under Running Load.*

When the motor is running each phase will, in addition to its main flux produce due to rotation a flux at right angles to the main flux. This field is a little smaller than the main field due to the rotor impedance drop. Therefore, for satisfactory operation it is necessary that the flux produced by the main and capacitor phase are at least approximately equal and displaced 90 deg. in time phase. If this is not the case, the rotational voltage produced by the main phase will

not be equal to the transformer voltage of the capacitor phase and vice versa. This unbalanced voltage will cause a circulating current of such magnitude as to establish equilibrium. Such circulating currents result in a motor of lower performance and therefore in practise the capacitor motor will be designed with balanced flux condition without circulating current at normal operating load.

Although the method of calculation given in the following is limited in application to the balanced flux condition, it is a short and simple method for getting quick results which are sufficiently accurate for practi-

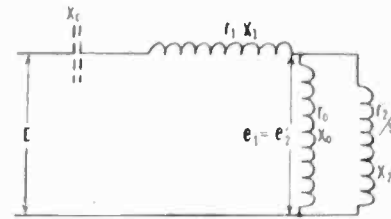

FIG. 3—CIRCUIT DIAGRAM OF MOTOR IMPEDANCE

cal use. The impedance of an induction motor may be represented by the well known circuit diagram shown in Fig. 3.

In determining the complete vector diagram it is simplest to start out with the induced voltage in the rotor winding. According to the size of the motor the induced rotor voltage is generally from 4 to 8 per cent less than the line voltage. If at the end of the calculation this assumed voltage be found incorrect, the corrections can easily be made.

Since the magnetizing circuit is in parallel with the rotor circuit the corresponding conductance and susceptance must be used in our calculations.

$$i_1 = e_1 \sqrt{(g_0 + g_2)^2 + (b_0 + b_2)^2}$$

$$\cos \alpha_1 = \frac{g_0 + g_2}{\sqrt{(g_0 + g_2)^2 + (b_0 + b_2)^2}}$$

$$g_0 = \frac{r_0}{r_0^2 + x_0^2} \qquad g_2 = \frac{r_2'/s}{(r_2'/s)^2 + x_2'^2}$$

$$b_0 = \frac{x_0}{r_0^2 + x_0^2} \qquad b_2 = \frac{x_2'}{(r_2'/s)^2 + x_2'^2}$$

Having thus determined the value i_1 , for both windings, lay off (Fig. 4) first the vectors i_{1c} and e_{1c} for the capacitor phase, then add the impedance drop of the stator winding. The vector OA then represents the terminal voltage at the capacitor phase winding.

A line from A at right angles to i_{1c} and an arc with a radius equal to the line voltage around the point O as a center will determine the voltage e_c for the capacitor.

Then the capacitance in ohms is $\frac{e_c}{i_{1c}}$ and in micro-

farads it is $\frac{i_{1c} \times 10^6}{2 \times \pi \times f \times e_c}$. If a capacitor with a

transformer is used, the impedance drop of the transformer which is in series with the stator winding is also to be added.

The vector e_1 must be nearly equal to and at right angles to e_{1c} . By the angle α_1 the vector i_1 is determined. The stator impedance drop added to e_1 should end again in the point B. If the two windings of the stator are not alike the induced voltage e_{1c} will be

$$= e_1 \times \frac{t_{1c} \times f_{1c}}{t_1 \times f_1}$$

where t_1 and t_{1c} represent the corresponding winding turns and f_1 and f_{1c} their winding distribution factors. If the capacity obtained should not give the desired pull-out torque, the windings or the

transformer is used, the impedance drop of the transformer which is in series with the stator winding is also to be added.

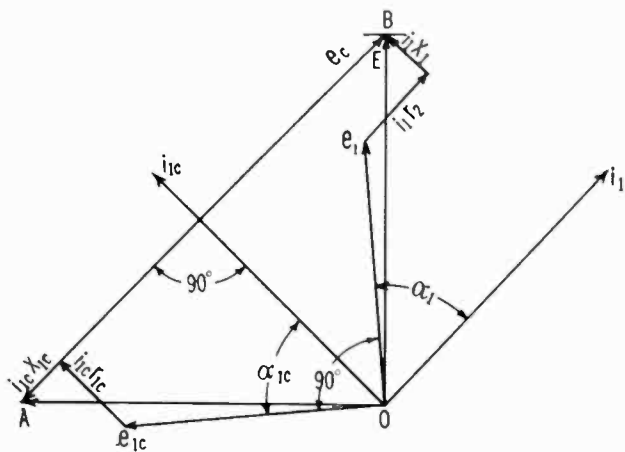

FIG. 4—VECTOR DIAGRAM OF MOTOR UNDER RUNNING LOAD

value of microfarads of the capacitor may be changed. It will then be found that the induced voltage e_{1c} in the rotor will change very little as long as the change stays within reasonable limits, because the voltage e_{1c} is governed somewhat by the induced voltage e_1 of the main phase. Certainly the current in the capacitor phase will change almost in ratio with the change of capacity. If the capacity is made considerably greater than a balanced condition would require, the voltage in the capacitor phase will go up, and by its transformer action, will reduce the amperes and watts in the main phase considerably. The watts may even become negative. On the other hand, the capacitor phase will take more load in both current and watts. Naturally the line amperes and watts input will go up, resulting

the square of the voltage, makes possible and desirable the use of a series auto transformer, as shown in Fig. 2. How far the voltage on the capacitor may be raised economically depends on the cost of the capacitor per kilovolt-ampere capacity and on the cost of the transformer. The cost of the transformer is quite an item. In cases where the line voltage is relatively high or where the starting torque required is low, the capacitor

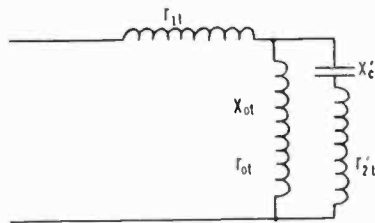

FIG. 9—IMPEDANCE DIAGRAM OF CAPACITOR

unit using a condenser only without a transformer may be more economical. By adding a transformer some of the capacitor effect is sacrificed, due to the magnetizing volt-amperes in the transformer.

The impedance diagram of the capacitor shown in Fig. 2B may be represented as shown in Fig. 9.

r_{1t} = The ohmic resistance of the primary winding of the transformer.

r_{2t}' = The ohmic resistance of the secondary winding reduced to primary turns.

r_{0t} = The ohmic resistance due to iron loss.

x_{0t} = The magnetizing reactance.

x_c' = The inductive resistance of the condenser reduced to primary turns.

Since the leakage reactance of the transformer is very small, it is neglected. The admittance of the parallel circuit in Fig. 9 is:

$$Z = \sqrt{\left(\frac{r_{0t}}{r_{0t}^2 + x_{0t}^2} + \frac{r_{2t}'}{r_{2t}'^2 + x_c'^2}\right)^2 + \left(\frac{x_{0t}}{r_{0t}^2 + x_{0t}^2} - \frac{x_c'}{r_{2t}'^2 + x_c'^2}\right)^2}$$

Since, in this equation, the reactive resistances are much greater than the ohmic resistances, it will be sufficiently accurate to add the primary resistance r_{1t} in quadrature. Thus the total impedance of the capacitor is:

$$Y_t = \sqrt{r_{1t}^2 + \frac{1}{\sqrt{\left(\frac{r_{0t}}{r_{0t}^2 + x_{0t}^2} + \frac{r_{2t}'}{r_{2t}'^2 + x_c'^2}\right)^2 + \left(\frac{x_{0t}}{r_{0t}^2 + x_{0t}^2} - \frac{x_c'}{r_{2t}'^2 + x_c'^2}\right)^2}}}$$

in lower efficiency and correspondingly increased heating of the motor.

Capacitor. As was mentioned before, the capacity required to insure a good capacitor motor is relatively high. The fact that the effective capacity varies with

For low watt losses in the capacitor resulting in not much reduction in over-all efficiency of the capacitor motor, the resistances r_{0t} and r_{2t}' will be comparatively so small that they may be neglected and the above equation may be simplified and condensed as follows:

$$Y_t = \sqrt{r_{1t}^2 + \frac{1}{\left(\frac{1}{x_{0t}} - \frac{1}{x_{e'}}\right)^2}}$$

The equation shows very clearly how much damage the magnetizing reactance x_{0t} may do. As the saturation in the transformer iron increases, the reactance x_{0t} decreases and the impedance Y_t will increase. For a given voltage this results in a smaller current through the capacitor phase and hence less torque. The general rule that the starting torque of an induction motor increases as the square of the voltage holds true on a capacitor motor only as long as the iron in the transformer is not saturated. When the iron becomes highly saturated the torque may even decrease with increasing line voltage.

The saturation of the transformer iron exists only at the starting connection because at the running connection the primary winding turns are much greater. Generally the designing engineer is inclined to increase the flux density at starting to the highest possible limit; however in this case it is not wise to do so because the magnetizing volt-amperes directly reduce the

capacity and with it the starting torque. It is somewhat different with the condenser itself as the voltage applied to it for such a short time may be greatly increased over its normal continuous rating.

SUMMARY

A summary of the above article on the capacitor motor is as follows:

1. The motor has good performance in respect to power factor, efficiency, starting current, and torques.
2. The motor is simple in construction and has no objectionable commutator or brushes. The rotor can be wound either squirrel cage or polyphase with slip rings.
3. The field of application for the capacitor motor is broader and less limited than for any other type of single phase motor.
4. The unit takes up more space on account of the capacitor.
5. Generally the total unit cost is higher than for any other type of single-phase motor. This is probably the only factor which may react against its present day use.

Abridgment of

Movements of Overhead Line Conductors During Short Circuits

BY Wm. S. PETERSON¹

and

H. J. McCracken, Jr.¹

Associate, A. I. E. E.

Associate, A. I. E. E.

Synopsis.—When overhead lines carry large short-circuit currents, the resulting magnetic forces on the conductors are such as to cause the cables to be repelled to greater distances than the usual spacings. The elementary principles involved are stated. A single-phase short circuit is shown to be the one producing the greatest movements. A theoretical calculation of the forces and actual experience showed the necessity of making tests to study the problem. A description of the tests indicates how photographic records of the movements of relatively large cables were obtained. The results of over 330 tests are shown by pictures and curves. The

effects of a variation in each of the five principal variables, cable size, span length, spacing, tension and current are discussed. A mathematical expression is derived by means of which the maximum movement of conductors in a horizontal plane can be determined approximately. It has been found possible to set up a miniature test with small wire that very closely duplicates to a small scale the movements of a larger conductor. The results indicate that it is necessary for moderately large systems to take account of these short-circuit forces in the design of their overhead systems. There is a large field for research on this subject and more work should be done.

OBJECT

THE object of this paper is to present the results of investigations recently made on overhead line conductors in order to determine the movements of those conductors when they are carrying the heavy short-circuit currents that exist in large electric distributing systems. It will give the essential data from over 330 tests that were made by the Los Angeles

Bureau of Power and Light, on full sized conductors, at various spacings, spans and tensions that might be used in practise.

ELEMENTARY STATEMENT OF THE PROBLEM AND FUNDAMENTAL THEORY

The fundamental principle is that two wires carrying currents in opposite directions are repelled from each other. If currents varying as a sine wave are assumed, then the instantaneous values of force vary as a sine wave of double frequency, similar to that for instantaneous power in a-c. circuits.

Since a conductor has an appreciable mass, its move-

2. See Appendix A.

1. Both of the Bureau of Power and Light of the City of Los Angeles, California.

Presented at Section Meeting of the A. I. E. E., Los Angeles, Calif., Dec. 6, 1927, and Pacific Coast Convention of the A. I. E. E., Spokane, Wash., Aug. 28-31, 1928 and Initial Paper Prize Paper for year 1927. Complete copies upon request.

ment is more influenced by the average of these impulses than by their instantaneous values. It can be shown that the average value of force, in lb. per ft. of conductor, is given, for a single-phase circuit, by the following formula:²

$$F = \frac{0.045 I^2}{10^6 D} \quad (2)$$

where I is the effective value of current in each of the conductors, D is the distance between conductors in feet, and F is the force per ft.

The worst condition is a single-phase short circuit between adjacent conductors. The two currents are 180 deg. out of phase, and the maximum repulsion effect is obtained. The discussion will be limited to the single-phase condition.

For any given type of spacing we find that the problem contains six independent variables, namely: wire size, span length, sag (or tension), spacing, current, and the length of time the current is flowing. The resulting mathematical complexity of the problem made advisable full scale tests to determine the laws of action.

DESCRIPTION OF TESTS

The large number of variables made a complete experimental determination of values impossible. Therefore a set of standard conditions was established and then each variable was investigated with respect to this standard point. Excepting for a few special tests, the variable, time, expressing duration of current, was eliminated by leaving the current on long enough for the cable to reach the end of its first throw. The standard condition was 3/0 cable, 150 ft. span, 12,000 lb. per sq. in. tension, 4 ft. spacing and the highest value of current obtainable from the equipment available for the test.

The cable sizes tested were No. 2, 3/0, 500,000 cir. mils, and 4/0 weather-proof. The spans used were 150, 300, 450, and 600 ft. The stringing tensions used were 12,000, 18,000 and 24,000 lb. per sq. in., approximately. The spacings were 2, 4, 8, and 12 ft. Currents varied from 4000 to about 13,000 amperes.

In making the tests two spans were set up and the movements of each were measured simultaneously to save time. Two dead-end H-frame structures were set up 750 ft. apart. At an intermediate point was placed another similar structure. By moving this latter pair of poles, the span lengths were varied. The cable was dead-ended through suspension type insulators and clamped to pin type insulators at the intermediate poles. At one end of the line the two cables were connected through an oil switch to the low-voltage side of the transformers supplying power for the test. The far ends were short circuited. To obtain the highest currents a jumper was placed across the cables at the end of the first span.

The record of the movement of the wire was made photographically at night. In order to do this, an auto-

mobile headlight bulb was fastened by means of an insulated clamp to the cables at the center of each span. The power for the light was supplied through flexible leads from a storage battery. The cameras used to record the movements of the lights were mounted as nearly as possible on a horizontal line from the lights so no corrections for angularity would have to be made in scaling distances from the pictures. In order to have a record of the time for the cable to reach any point a disk with one or two holes in it was resolved in front of the lens by means of a synchronous motor. Thus a dotted line record of the movements of the wire was obtained.

The wiring diagram, Fig. 3, shows the equipment and connections used for the test.

By means of the disconnect switches in this circuit, the number of transformers could be varied and therefore a variation in current could be obtained. The

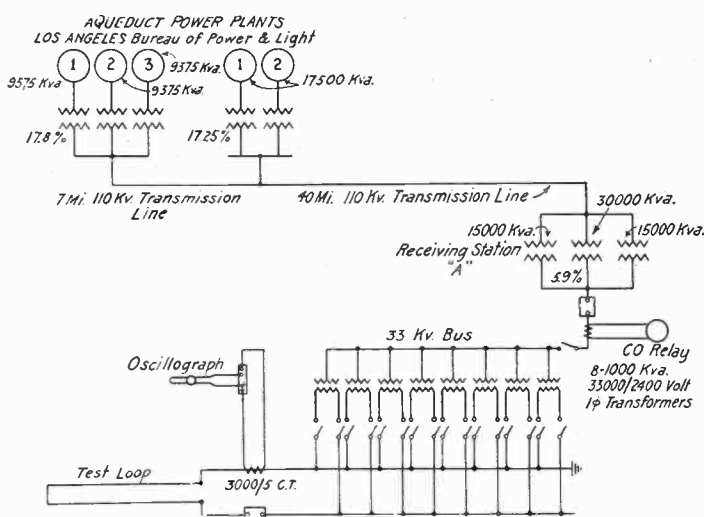

FIG. 3—WIRING DIAGRAM FOR TEST

circuit was closed through the solenoid operated oil circuit breaker in the 2400-volt circuit and opened by a relay operating the 33-kv. breaker.

RESULTS OF TESTS

Horizontal Spacing. In presenting the results, only a few of the many pictures that were taken can be shown. Complete data obtained from all the tests are given in Appendix B of the complete paper.

Fig. 4 shows the movements of a 3/0 copper cable on a 600 ft. span for three different tests. These pictures show the variation in the deflection for different values of current. The distance between the large dots where the cable started from is 4 ft. (1.22 m.), so there is an indication that the cable moved 12.8 ft. (3.91 m.) from its initial position with a current of only 7430 amperes. The time to reach the point of maximum deflection in Fig. 4 is approximately 1.2 sec. The current was interrupted very close to the point of maximum deflection. This gives the worst condition for the tangling of the cables on the return movement. In the lower picture, the cable acquired a velocity of 18 ft. (5.49 m.) per sec. near the center of its travel. At the end of the throw,

the sag distance was increased to 19.4 ft. (5.91 m.), or nearly 6 ft. (1.83 m.) greater than the initial sag of 13.5 ft. (4.12 m.).

Approximately the same general characteristics of movement were observed for spans of 450, 300 ft. and 150 ft. excepting that the maximum deflection and the time to reach that point was reduced.

Due to the fact that in the great majority of cases



FIG. 4—COMPARISON OF CONDUCTOR MOVEMENTS FOR DIFFERENT CURRENTS WITH 3/0 CABLE, 4 FT. HORIZONTAL SPACING, 600 FT. SPAN, 12,800 LB. PER SQ. IN. TENSION, 13.5 FT. SAG

Top, 5470 amperes; middle, 6150 amperes; bottom, 7430 amperes

the movement of the conductors was so nearly horizontal, it was possible to develop a formula by which could be calculated approximately the maximum deflection

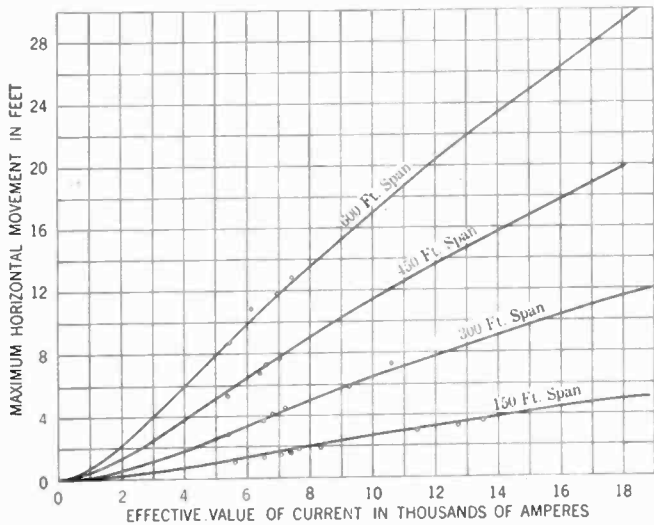

FIG. 9—RELATION BETWEEN MAXIMUM HORIZONTAL MOVEMENT OF CONDUCTORS AND CURRENT FOR VARIOUS SPANS

3/0 copper cable, 4 ft. horizontal spacing, approximately 12,500 lb. per sq. in. tension
 O—Test points—calculated curve

and the sag of the conductors at this point. The results of such calculations and the points obtained by test are shown in Fig. 9. See Appendix C for complete development of formula. The extension of the results by means of the curves, derived from a purely theoret-

ical basis and fitting the data as closely as they do, gives one confidence in their use in extrapolating to high current values.

In order to reduce the large deflections noted in the foregoing curves the use of higher tensions suggests itself. Fig. 15, shows the variation in horizontal movement with tension for various span lengths. These curves indicate that the movement is varying approximately inversely as the square root of the tension. The movement is therefore not cut down as rapidly as the sag, which is varying inversely as the tension. Very high values of tension cannot be used because of other loadings imposed on the cable by wind and ice in addition to that produced by the magnetic forces.

The effect of spacing is shown in curve form in Fig. 18. The curves are drawn for a current of 7000 amperes. Although it can be observed that spacing reduces the movement of the individual conductor, there is not a

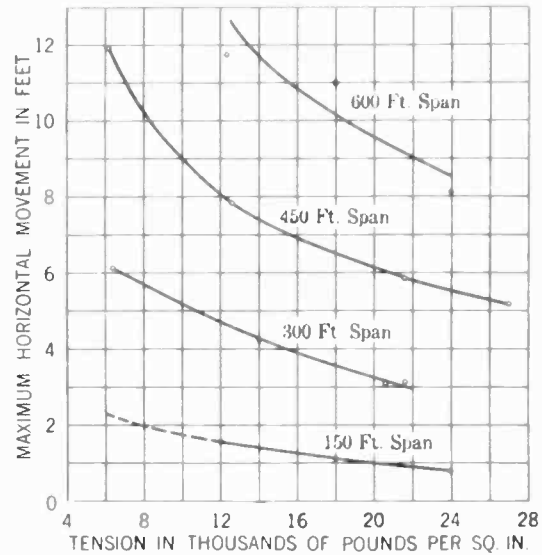

FIG. 15—RELATION BETWEEN MAXIMUM HORIZONTAL MOVEMENT OF CONDUCTORS AND TENSION FOR VARIOUS SPANS

3/0 copper cable, 4 ft. horizontal spacing, approximately 7000 amperes.

great change in the total space occupied by the swinging conductors.

Fig. 22 indicates how the use of heavy conductors will decrease the movements. Fig. 25 is also an example of a heavy conductor, but is also interesting because it is representative of conditions on a feeder circuit.

Results with Vertical Spacing. In making tests on cables arranged above one another, it is found that the movements are primarily vertical, which leads to a confusion of dots, so that only the maximum points can be determined. The results are therefore best presented by means of curves. Only a limited investigation was made with respect to vertical construction. A few miscellaneous results are shown in Fig. 29 and Fig. 31 where the zero ordinate is midway between the conductors.

In general the movements for vertical construction are less than for horizontal, except at the higher current values.

MINIATURE TESTS

On the basis of formulas that have been developed it is possible to determine the proper dimensions of a miniature test to reproduce the same conditions to a smaller scale. Assume some scale multiplier n ; that is, some number by which the small scale distances will be multiplied to equal the large test. It can then

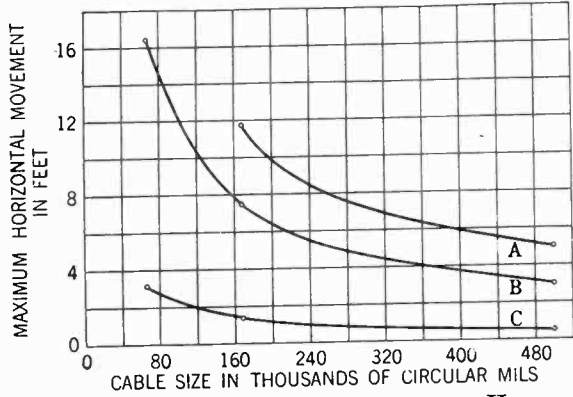

FIG. 22—RELATION BETWEEN MAXIMUM HORIZONTAL MOVEMENT OF CONDUCTORS AND WIRE SIZE

Four ft. horizontal spacing, approximately 12,500 lb. per sq. in. tension
 A—7000 amperes, 600 ft. span. B—4800 amperes, 600 ft. span. C—7000 amperes, 150 ft. span

be shown³ that circular mils, spacing, sag, movement, and current all have the multiplier n . Unit tension and time have a multiplier $n^{3/2}$ and the multiplier for span length is $n^{3/4}$.

INTERPRETATION OF RESULTS

In almost all line design, the main factor considered in

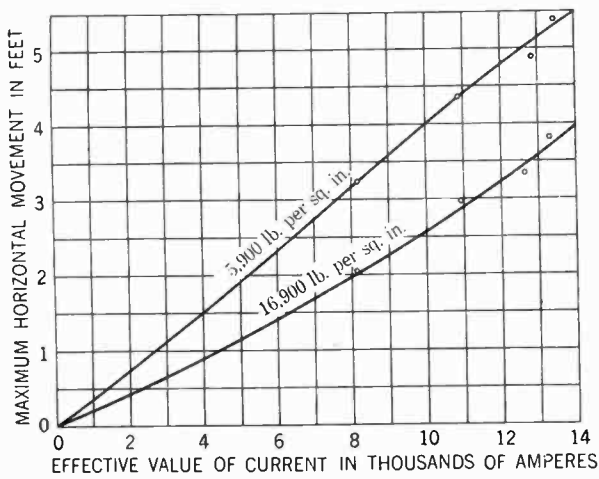

FIG. 25—RELATION BETWEEN MAXIMUM HORIZONTAL MOVEMENT OF CONDUCTORS AND CURRENT FOR 4/0 WEATHER-PROOF TRIPLE BRAID CABLE WITH 1.5 FT. SPACING AND 150 FT. SPAN AT TWO DIFFERENT TENSIONS

determining the spacing between wires has been voltage. Only to a small extent has span length been considered as affecting the necessary spacing. From the data in this paper it seems that an additional factor, namely, short-circuit currents and the movements which they cause, must be considered. On large systems it will

3. See Appendix D.

apparently be necessary to so correlate the choice of reactors, spacing, span length, conductor size, and tension, so as to obtain the most economical line that will not be subject to trouble due to swinging conductors.

Possibly one of the most satisfactory solutions of this problem will come from the use of parallel lines between stations in a network. Then in case of a short circuit on a line, it may be permissible to let that line interfere with itself, while carrying the total short-circuit current, but the lines on the remainder of the system would be so designed that they would give no interference while

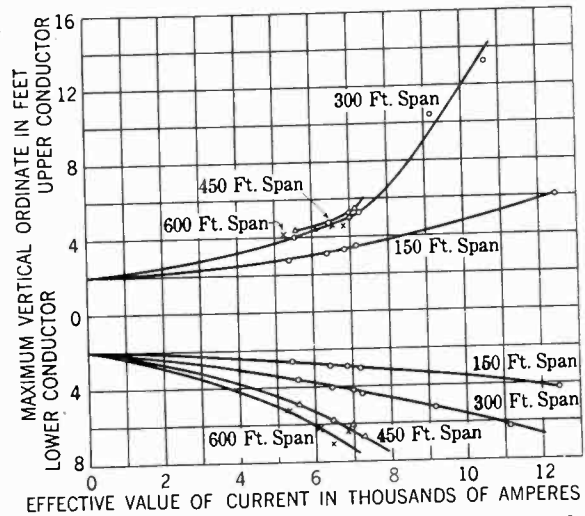

FIG. 29—RELATION BETWEEN MAXIMUM VERTICAL MOVEMENT OF CONDUCTORS AND CURRENT FOR VARIOUS SPANS

3/0 copper cable, 4 ft. vertical spacing, approximately 12,000 lb. per sq. in. tension

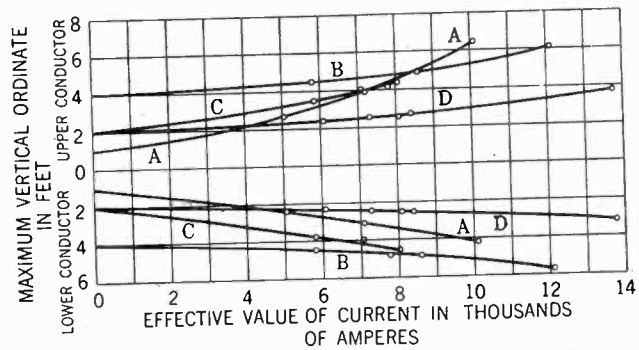

FIG. 31—RELATION BETWEEN MAXIMUM VERTICAL MOVEMENT OF CONDUCTORS AND CURRENT

500,000 cir. mil copper cable, vertical spacing, approximately 12,500 lb. per sq. in. tension
 A—300 ft span, 2 ft. spacing. B—300 ft. span, 8 ft. spacing. C—600 ft. span, 4 ft. spacing. D—150 ft. span, 4 ft. spacing

carrying their share of the short circuit, which would be a much smaller value of current than that in the line which is in trouble. As the magnetic forces vary as the square of the current, conditions are readily improved by designing in this way.

The one thing that seems most evident is that the spans on a large system must be small. This refers to those parts of the system where the voltage is low enough that large currents are encountered. Also, it is likely that an overhead network of too large capacity

would not be economical, as the advantages due to diversity, etc., would be lost in excessive line cost. This leads to the advocacy of the idea that a central station company should have its total system consist of several nearly independent, relatively small capacity networks, practically complete in themselves; but loosely coupled, that is, coupled through high reactance to each other for standby service. This reduces the short-circuit currents to moderate values, and should lead to a lower cost system.

CONCLUSIONS

In closing, the following conclusions should be drawn from the results described in the paper:

1. It is necessary to take account of short-circuit forces in designing overhead lines.

2. Present mathematical and experimental data on the movements of overhead conductors during short circuits are very incomplete. A large field exists for research on this problem.

3. It would seem that the improvements in system and line design that can come from a study of this problem would justify various central station companies in extending and making public the research on this subject.

Acknowledgment is made to Messrs. M. O. Bolser, J. C. Albert, H. H. Cox, C. P. Garman, and R. Martindale, who, as members of the Los Angeles Bureau of Power and Light Technical Committee, made this investigation possible, and contributed many valuable suggestions.

Electrical Instruments Used in the Measurement of Flow

BY W. H. PRATT¹

Fellow, A. I. E. E.

Synopsis.—This paper outlines some important flow-measurement problems and points out the character of electrical apparatus that may be used with other equipment for measuring flow.

IN the measurement of fluid flow by electrical means, the electrical devices, though frequently a major portion of the equipment, are essentially auxiliaries. Fundamentally, fluid measurement is a problem in hydromechanics and electrical apparatus is used as a convenient supplement to the mechanical actions which are generally utilized to make manifest the behavior of the fluid. The significance of this statement will appear as we proceed.

Measurements of the flow of water, oil, air, fuel gas, and steam are, as far as numbers of applications, the most important, but there are many other actual and possible occasions for utilizing similar ideas and apparatus. Certain instruments described in the latter part of this paper are as electrical devices, instruments for measuring the relation of two electrical quantities and as such are capable of a wide variety of applications. As here described they are for the measurement of flow.

A broad division of the quantities to be measured may be made according to the conditions of measurement; *i. e.*, 1, measurements of unconfined flow, 2, measurements of flow in confined channels or pipes. The first is illustrated by the measurement of wind velocities and by the determination of the air speed of an aeroplane, the second by the flow of steam in a steam main.

Other divisions may be made following the ideas

1. Engineer, General Electric Co., West Lynn, Mass.

Presented at the Winter Convention of the A. I. E. E., New York, N. Y., Jan. 28-Feb. 1, 1929.

utilized in effecting a connection between the fluid flow and the electrically responsive measuring devices; for example, we may have an anemometer wheel whose speed response to the fluid flow is used to determine a voltage or a frequency of electrical impulses, or a drop in pressure may be brought about by an orifice or by a venturi tube and the resulting pressure difference communicated to electrically responsive apparatus, or again the change by convection of the temperature of electrically heated wires when exposed to the moving fluid may be the means of establishing a connection with the electrically responsive apparatus.

In measurements of unconfined flow the quantity determined is essentially a velocity or a velocity-density function, and the first stage of measurement is to establish a pressure, a displacement, a motion, or a temperature change which is a function of that velocity or function.

- I. If the first alternative is chosen, *i. e.*, if the pressure resulting from the relative motion of the fluid and the measuring apparatus is employed, it may be utilized to change a resistance as for instance that of a carbon-pile, or indeed it is conceivable that through the ministrations of the piezoelectric effect a suitable electrical measurement could be achieved if not directly at least by the use of amplifying devices.

- II. Displacements may be used to alter the capacity of a capacitor, to change the inductance of a reactor, or to change the resistance or conductance of a suitable

conducting circuit. There are many ways in which electrical effects may be derived from such combination.

III. If the third alternative is chosen the motion will undoubtedly be that of the wind-wheel of an anemometer. From here on to the indication or record the connection may be electrical and may take one of the many forms of electrical speed indicators among which may be mentioned,

1. A magneto, which produces a voltage proportional to speed, connected to a suitable voltmeter.

2 (a) A contact maker which releases electrical impulses at a rate proportional to the speed of the moving member. These may be condenser discharges which thus may release a quantity of electricity proportional to the speed, which may be indicated on a milliammeter acting as a ballistic instrument; or the impulses may control an independent source of mechanical motion which may be indicated by the magnetic drag induced by the relative motion of permanent magnets and a body of conducting material or by purely mechanical forms of indication.²

(b) Instead of electrical contacts periodic variations of electrical capacity or of inductance may be used to control electrical pulses which in such cases will probably be used in connection with vacuum tubes and electrical oscillations of audio or higher frequencies. The final indications will be proportional to the rate of pulses and the actual apparatus closely paralleling that indicated under (a).

IV. The heat imparted to the surrounding medium by a wire carrying an electric current is a function of certain properties of the medium itself, of the temperature and surface conditions of the wire, and of the relative motion of medium and wire. If now energy at a constant rate is supplied to the wire and other conditions remain unchanged the temperature of the wire will be a function of the relative motion of medium and wire. By using a wire having a suitable temperature coefficient of resistance the resistance becomes a function of the fluid flow and a measurement of undisturbed flow resolves itself into a measurement of resistance after the necessary constants have been determined.³

The measurement of flow of fluids in pipes has much in common with the measurement of the relative motion of an unconfined fluid medium, and a measuring device. The measurement of steam or of air under pressure is generally carried out by recourse to pressure drop through an orifice or by the pressure-velocity relations determined by pitot and static-pressure tubes. In general the quantities of interest are the mass of fluid

2. These ideas have been employed for the distant indication of electrical quantities.

3. This idea in a modified form is used in the Thomas Gas Meter.

per unit of time passing the point of observation, and the total amount of fluid which shall have passed between the epoch of start and any chosen times for observation. Generally these measurements are made at pressures fairly near chosen standards; the one is a velocity density function, the other an integration with respect to time of this function.

The electrical apparatus used generally consists of two portions, 1, a container and a body of mercury whose configuration is changed to correspond to the pressure changes communicated to it and which thereby alters, by shorting out resistance or inductively, the conductivity of an electric circuit. 2, an electrically responsive member which will translate the changes of conductance or admittance into indications or integrate an appropriate function of one of these quantities with respect to time.

In the measurement of the flow of liquids, mechanisms quite similar to those used for gaseous flow may be employed. From the hydromechanic point of view the problem is simplified by the absence of change of density.

Electrical power is thus utilized to perform the work incident to indication or integration and the hydro-mechanical organizations determine the magnitude or other characteristic of the electrical action.

For most of the measurements here discussed alternating current has many advantages over direct current. In any case an instrumentation whose indications are independent, within moderate limits of the supply voltage and in the case of alternating current, independent of the frequency changes that may be expected, is much to be preferred as compared with one which must rely on a fixed or automatically controlled source.

When a body of mercury is caused to change its level by being subjected to a differential pressure it can be caused successively to make contacts which thus change the resistance or impedance of an electric circuit, and in so doing no pressure reaction should result. On the other hand a finite and practically a rather limited number of steps is imposed.

If the body of mercury is so disposed that it acts as the secondary of a transformer, a change of level in the mercury surface may be made to change correspondingly the amount of mercury in the secondary path and consequently the characteristics of the primary circuit. Measurements made in the primary circuit will correspond to conditions in the secondary and these in turn correspond to the equilibrium conditions established by the hydromechanical portion of the equipment. For an arrangement of this kind the electro-magnetic reaction between primary and secondary circuit must be limited to an amount that will not importantly change the mercury level. Small changes can be provided for in the calibration and voltage compensation of the instruments.

In the remaining portion of this paper two mecha-

nisms are described both actuated by alternating current. The one is intended for indication on a scale or for recording on a chart flow as determined by a flow meter in which a body of mercury acts as a secondary and thus influences the characteristics of the circuit in which the instrument is connected; the other integrates with respect to time a quantity similarly determined.

1. An instrument that indicates the conductance of an electric circuit.

This instrument indicates the ratio between the power expended in a standard circuit and that of another whose admittance is controlled by a flow meter or other device. It consists of two elements, similar to the electromagnetic system of the ordinary induction watt-hour meter, arranged to oppose their torques on a common disk. The disk is so modified that the torque developed by one of the elements, or if conditions should require it, of each of the elements, is inter alia dependent on the position, with regard to deflection, of the disk. Thus for a steady indication, the torques acting on the disk are balanced and

$$k_1 E I_1 \cos \phi_1 f_1(\alpha) = k_2 E I_2 \cos \phi_2 f_2(\alpha)$$

$$k_1 \frac{E^2}{Z_1} \cdot \frac{R_1}{Z_1} f_1(\alpha) = k_2 \frac{E^2}{Z_2} \cdot \frac{R_2}{Z_2} f_2(\alpha)$$

$$k_1 G_1 f_1(\alpha) = k_2 G_2 f_2(\alpha)$$

$$\frac{G_1}{G_2} = \frac{k_2}{k_1} \frac{f_2(\alpha)}{f_1(\alpha)} = F(\alpha)$$

in which

α represents the angular position of the moving system

k_1, k_2 are constants

E is the e. m. f. of the circuit

I_1 is the current in the first circuit

I_2 is the current in the second circuit

G_1 is the conductance of the first circuit

G_2 is the conductance of the second circuit

ϕ_1 is the lag angle of the first circuit

ϕ_2 is the lag angle of the second circuit

If the constants of the second circuit are fixed and this circuit is used as a standard

$$G_1 = G_2 F(\alpha)$$

If now each value of G is uniquely determined by the quantity we seek to measure, the angular position of the instrument pointer gives an indication of that quantity and a scale may be appropriately marked in terms of it.

2. To integrate a quantity $f(G)$ with respect to time we may utilize an induction watt-hour meter structure and by changing the proportioning of its part cause the damping effect of the magnetic field from the voltage coil to be large enough to supply all the damping necessary to maintain the speed at a suitable value. As then constituted the torque of the meter will be proportional to the square of the voltage since this torque is determined by the reaction of currents in two

circuits in each of which the flow is proportional to the voltage. Also the damping effect is proportional to the square of the voltage, for the magnetic field and hence the Foucault current induced thereby are both proportional to the voltage. The interaction of this field and current produces the damping.

With a simple structure as outlined above a change of frequency would produce an inconsequential change of torque but the current in the voltage coil would vary inversely as the frequency and thus the damping would change inversely as the square of the frequency.

If, however, a capacity is introduced in the voltage circuit, as shown in the diagram, and if its value is so chosen that the resonant frequency of that circuit shall be about double the actual frequency, the current in the potential circuit instead of decreasing in inverse ratio as the frequency will increase with increasing frequency and the damping which increases as the square of the current in the potential circuit can be made to change at the same rate as the resulting change of torque thus making the speed of the meter independent of the frequency over moderate ranges of frequency. The conditions that make for independence of voltage remain effective. The constants of the circuit are such that resonance from the fundamental frequency of the circuit or its harmonics is precluded.

The first of the two instruments described is clearly one that indicates the ratio between two similar electrical quantities and so can be utilized to measure the ratio between any two quantities that can be represented by suitable electrical quantities, as for instance, temperature. In this case, standard temperature may be represented by a standard resistance having a small or zero temperature coefficient, while the temperature to be measured may be represented by a resistance that varies suitably with that temperature.

Instead of measuring flow as such, two pressure-sensitive devices may be used one to influence the one, the other the second element of the instrument whereby a ratio of flows may be measured. The ratio of steam delivered to air used might be one application or the measurement of the ratio of steam extracted to total steam used, another.

An instrument could be constructed with two moving systems and associated elements, the two indicators arranged to move in closely parallel surfaces over a single scale in such a way that the reading point should be the intersection between the two indicators. In this way indications of such functions of four quantities

as may be expressed in the form $F\left(\frac{X}{Y}, \frac{U}{V}\right)$

could be obtained as a single reading. Non-electrical quantities that can be represented by suitable electrical quantities can be so measured. The only application (of which the author is aware) of such a structure was for the measurement of the product, or ratio of electrical quantities for the measurement of another electrical

quantity, namely power factor, $\frac{P}{E I}$. The actual rela-

tion made use of in the instrument was $\frac{P}{E^2} \cdot \frac{P}{I^2}$ but

the occasion may easily arise in connection with other measurements, and a not impossible application may be in the determination of a compound ratio of the flow of several fluids.⁴

Induction instruments of the ratio type are nearly free from one of the drawbacks that characterize certain other forms, notably induction voltmeters and wattmeters in that the indications result from the equilibrium of two torques that have the same characteristics with respect to temperature. Small residual errors are cared for by a small amount of temperature-sensitive magnetic material in the air gaps.

In the integrating meter, temperature errors are self-eliminating.

It is not expected by the author that this paper more than outlines the nature of some important fluid measurement problems and points out the general character of the electrical apparatus that may be employed. The essence of fluid measurement is contained in the subject of hydromechanics. The electrical apparatus which generally may be advantageously used has characteristics that suggest its usefulness in connection with other types of measurement that may have nothing in common with fluid measurement aside from the electrical apparatus used for giving final indication.

Numerous bibliographical references may be found in the bibliographies relating to the Measurement of Non-Electrical Quantities by Electrical Means which have appeared in the A. I. E. E. TRANSACTIONS.⁵

Appendix

By way of explanation of the diagrams:

In Fig. 1 the disk is represented as divided by a curved line into two parts. The main portion is of high conductivity material and the irregular boundary of this part is so chosen that the torque of the back element is a function of the angular position of the disk as well as of the current, voltage, etc., to which that element is subjected. The smaller part of this disk is of high resistance material and its purpose is solely to give mechanical balance to the element.

Fig. 2 gives the connections of the electrical elements associated with the moving system shown in Fig. 1. In Fig. 2, *M* represents a flow meter element, a transformer with a mercury secondary.

4. Pratt patent 719,609, Feb. 3, 1903. Induction elements could replace the electro-dynamometer elements illustrated therein.

5. A. I. E. E. TRANS., XLIV, 1925, p. 258.

A. I. E. E. TRANS., XLVI, 1927, p. 710.

A. I. E. E. Quarterly TRANS., Vol. 47, October 1928, p. 1168.

G, K, N, N..... laminated iron cores

B.....the disk shown in Fig. 1.

L.....the exciting coil of the back element which also serves as a primary to which the circuit including *R*₁, *R*₂, and *J* is a secondary. The resistance *R*₁ + *R*₂ constitutes the standard electrical quantity with

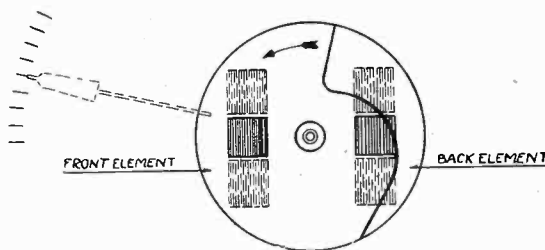

FIG. 1—DISK OF CONDUCTANCE METER

reference to which the indications of the instrument are determined.

In Fig. 3, *C* and *K* are laminated iron cores. The magnetic flux which crosses the gap between them in which disk *E* rotates not only produces the torque but also supplies all the damping.

The circuit including *B* and *I* is highly reactive, leading, thus with increasing frequency, the current in this circuit increases and the damping, which may be taken as proportional to the square of the current in *B*, increase at a rate sufficient to compensate for the increases of torque which also increases with the fre-

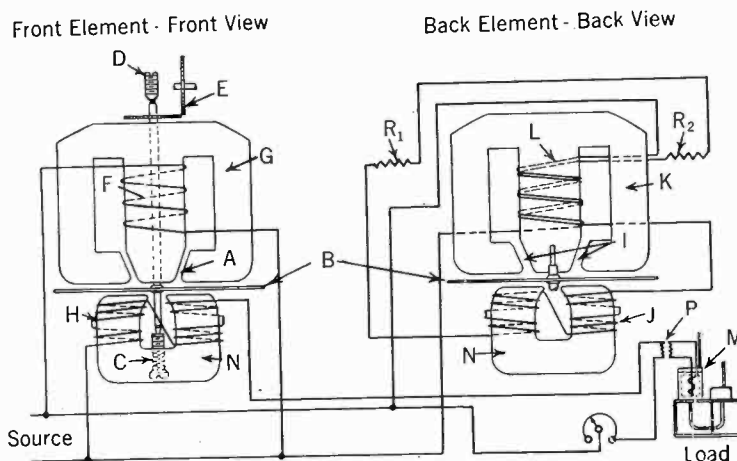

FIG. 2—SCHEMATIC DIAGRAM OF CONDUCTANCE METER

quency. In the absence of the capacitor *I* the torque would remain almost unchanged with change of frequency while the damping would vary inversely as the square of the frequency, since the predominant part of the damping is due to the flux from coil *B*. The circuit including coil *F* and resistors *R*₁ and *R*₂ is of high resistance. Its purpose is to supply a small amount of torque to balance out the excitation losses of the transformers *O* and *M*. *H* is the main current winding and *L* is an adjustable reactive shunt to effect calibra-

Fig. 1 as determined by samples prepared and tested by the method and testing apparatus shown in Figs. 6, 7 and 8 and described later. The same comparison is shown in Fig. 2 except that these graphs show the insulation resistance of wire insulated with the washed and unwashed textiles. In addition to the insulation

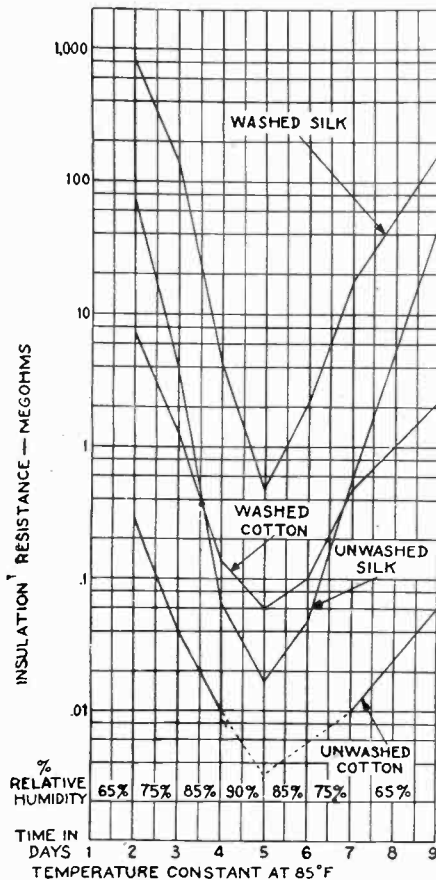

FIG. 2—D-C. INSULATION RESISTANCE OF 50 FT. OF TWISTED PAIR WIRE INSULATED WITH DOUBLE SERVINGS OF EQUAL THICKNESS

resistance requirement, it is required that the energy losses at talking and carrier current frequencies must be maintained at the minimum point consistent with the space limitations permitted for the conductors. The effect of purification of the textiles on this characteristic expressed in capacitance and conductance, measured at 1000 cycles per sec. between the wires of twisted pairs is shown in Fig. 3 and Fig. 4. It should be noted that the graphs are illustrative of the effects of purification on the electrical properties of cotton and silk as insulation and should not be considered as applying quantitatively to telephone circuits.

From a telephone transmission point of view, perhaps the most significant fact to be observed is the large reduction in capacitance and conductance at relative humidities of 75 per cent and higher. These characteristics which largely determine transmission efficiency are relatively low for both silk and cotton at 65 per cent and below, but in commercial textiles in general use for insulating purposes they increase very rapidly as the relative humidity increases. The characteristics of purified textiles are not as markedly different from those

of unpurified textiles at 65 per cent relative humidity as at higher humidities, but their rate of increase as the humidity increases is greatly reduced. This fact is of particular importance in the maintenance of a standard level of voice transmission through toll offices where suitable repeater gains and balance must be maintained. Losses, if fixed in value and not excessively large, can be compensated for, but if they change with every change in atmospheric moisture content the compensation problem becomes serious.

METHOD OF TESTING

Two fundamental characteristics of silk and cotton made it necessary to do a large amount of experimental work before a practicable shop test method could be established to determine whether or not the textiles were washed to the point of meeting the requirements established. One of these characteristics is the high electrical resistance of both washed and unwashed textiles at the lower relative humidities and the other the extreme sensitivity to change, with minor change in relative humidity especially at the higher humidities. The first mentioned characteristic precludes the use of any but measuring instruments of the highest degree of sensitivity and makes desirable the use of comparatively high humidities, and the second characteristic means that the specimen must be tested under exceedingly well controlled relative humidity conditions. Furthermore, the problem is complicated by the polarization effect discussed in the paper by Williams and Murphy and the fact that this effect varies in magnitude with

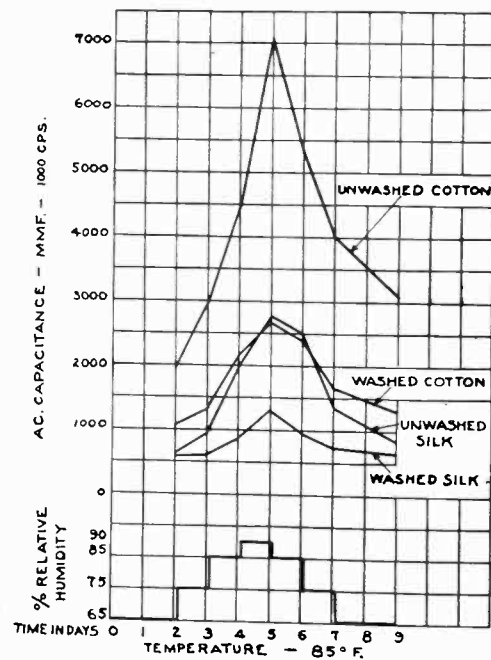

FIG. 3—A-C. CAPACITANCE OF 50 FT. OF TWISTED PAIR WIRE INSULATED WITH DOUBLE SERVINGS OF EQUAL THICKNESS

humidity and with the degree of purity of the textiles. The problem was finally solved by the development of the test equipment shown in Figs. 6, 7 and 8.

Figs. 6 and 7 show a heat insulated glass tank of about one cubic foot capacity fitted with an insulating cover in which holes normally closed with stoppers are

used to introduce the test samples. The humidity is maintained by means of sulphuric acid or a saturated salt solution in the bottom of the tank and constant temperature within very narrow limits is maintained in the tank by placing the entire assembly inside a cabinet or oven automatically controlled to ± 0.5 deg. Fahr. Due to the heat insulation it has been found that temperature variations within the tank are reduced to the vanishing point for all practical purposes.

improvement in quality of electrical characteristics by using washed silk, or may substitute washed cotton for silk and realize substantial economies without degrading the product. As an example of how this applies to Bell System apparatus, central office distributing frame wire with annual requirements of more than 400 million conductor feet is now insulated with two coverings of silk where three were formerly required. The resultant wire is superior electrically to the old wire and the annual saving in silk amounts to about 70,000 pounds.

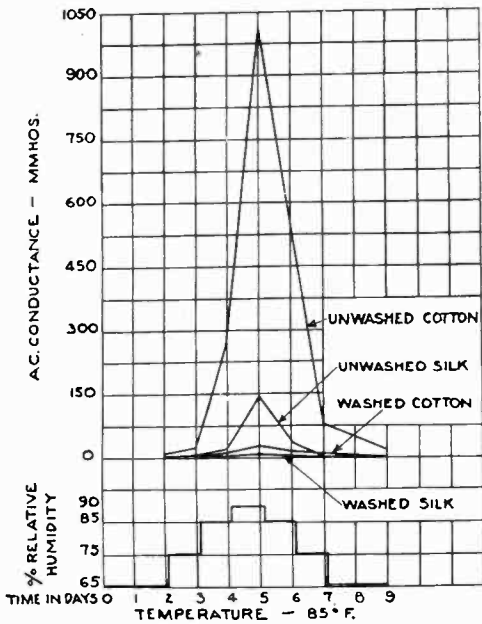

FIG. 4—A-C. CONDUCTANCE OF 50 FT. OF TWISTED PAIR WIRE INSULATED WITH DOUBLE SERVINGS OF EQUAL THICKNESS

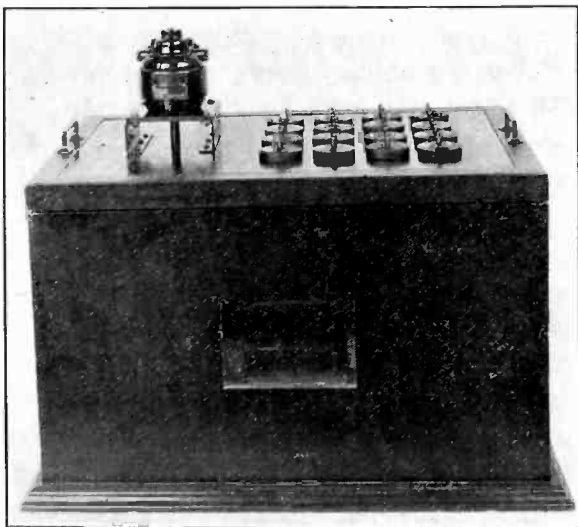

FIG. 6—HUMIDITY CABINET FOR CONDITIONING SAMPLES

APPLICATION TO APPARATUS

From an economic standpoint the most important conclusion to be drawn from the graphs is that cotton can be improved by washing to such an extent that it becomes a better insulator than the ordinary commercial insulating silk in general use. Since the cost of washing silk and cotton is nominal, usually less than 5 per cent of the cost of the material, the engineer given purified textiles may either take advantage of marked

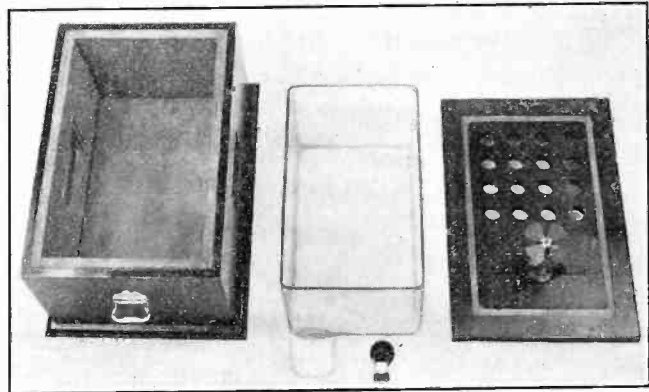

FIG. 7—HUMIDITY CABINET DISASSEMBLED

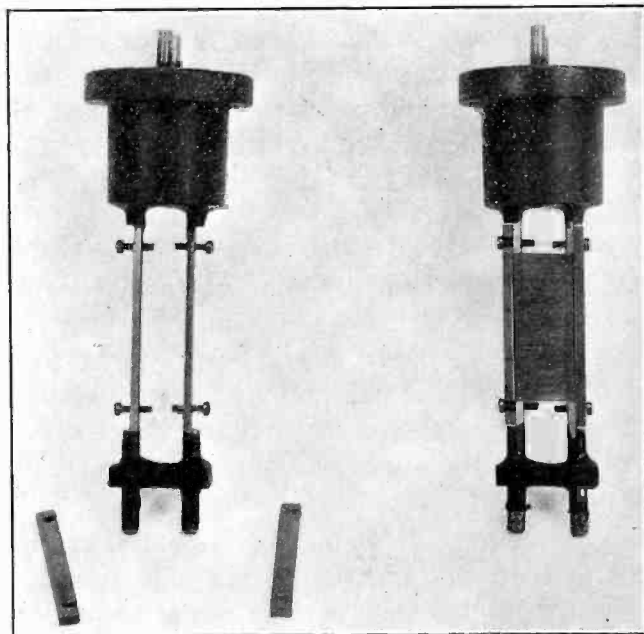

FIG. 8—ELECTRODES ON WHICH SAMPLES ARE WOUND FOR TEST

As another example, telephone cords of various types have been reduced substantially in cost with no impairment in quality by substituting two washed cotton braids for the cotton and silk braids formerly used. Altogether, various types of textile insulated wire aggregating annual requirements in excess of two billion conductor feet have either been changed to employ washed textile insulation or are scheduled for change as soon as possible because of corresponding economies in manufacturing cost or improvement in electrical properties.

The foregoing is intended to show what has been accomplished on a commercial scale at reasonable cost in the way of improving the insulating properties of silk and cotton. There still exists a rather wide margin in insulating properties between washed silk and washed cotton at high humidities which further study may show can be reduced. The graphs do not show the magnitude of improvement in cotton which has been obtained occasionally in laboratory experiments which leads us to hope that presently it may be possible to process cotton in a way that will result in its having electrical properties equal to those of washed silk for many practical purposes.

CONCLUSION

The discussion has been confined primarily to telephone central office cabling where silk and cotton are used in the cable core without impregnation. However, it is believed that the whole subject of purification of textiles becomes of general interest when it is stated that the improvements obtained by washing are not nullified by the supplementary use of impregnating waxes or varnishes. That is, the improvement in dielectric properties and reduced electrolysis obtained by washing and by impregnating are apparently substantially additive. These findings are in line with the generally known fact that impregnation of textiles with wax compounds does not prevent, though it does retard, the absorption of moisture which in the presence of soluble salts causes conducting paths to be established, probably through the embedded textile fibers. Consequently, such materials as fabric base insulating tapes, varnished linens and cambrics, electro-magnet coil winding insulation, all being sensitive electrically to moisture, should be benefited to a substantial degree by purification of the fibrous components.

Therefore, while there is still much to be learned about the behavior of silk and cotton with respect to their electrical characteristics under various treatments and conditions, the study has progressed to the point where the following statements can be made.

1. The removal of water soluble salts which are present in both silk and cotton not only results in a very decided improvement in their insulating properties, but reduces the sensitivity to change of the a-c. characteristics with changes in atmospheric moisture conditions.

2. The improvement which can be realized is great enough to permit the substitution of washed cotton for silk where ordinary commercial silk has been found to give satisfactory results.

3. The use of purified textiles in cables carrying continuous d-c. potential will reduce electrolysis and consequently prolong the useful life of such cables about in proportion to the extent to which the purification process is carried.

In presenting the foregoing discussion, the authors wish to acknowledge their indebtedness to engineers of

the Western Electric Company whose work in cooperation with silk suppliers has been largely responsible for the development of commercial methods of purifying insulating silk. Acknowledgment must also be made of the importance of the fundamental and research work which underlies the engineering result briefly described by this paper.

ILLUMINATION ITEMS

By Committee on Production and Application of Light
INTERNATIONAL COMMISSION ON ILLUMINATION

The Saranac Meetings of the week of September 22d constituted the most comprehensive gathering of lighting engineers and scientists ever held in America.

Preceded as they were by the tour and the Toronto Convention, an atmosphere of friendship and understanding was created which did much to facilitate the splendid accomplishment.

Many engineers who had known each other by reputation only met, discussed their mutual interests, and formed cordial friendships. Variations of practise were frequently explained as resulting from differences of conditions, economic or otherwise, rather than perversity.

The work of the Commission included not only the establishment of illumination fundamentals and scientific data but also the coordination of ideas and information regarding lighting practises in the various fields.

Some 56 papers and reports were printed in advance of the meetings, and these, with the discussions, are soon to become available in a bound volume.

In order to reach the most complete worldwide agreement possible, vocabulary, definitions, symbols, units, and photometric standards were considered.

The more important of the recent researches came in for attention. Some of these laboratory investigations have to do with the characteristics of illumination with reference to the eye, glare, visibility, etc.

Of the practise subjects, street lighting probably received the greatest amount of attention. More difference of opinion appeared than in any other field, and in this the alinement of the national groups differed for the various phases. Street lighting was presented under the auspices of the German secretariat, with a Swiss engineer presiding, and led by an urgent initiative from the British delegation. So extensive was the discussion that two adjourned sessions were held before compromise understandings were reached.

Motor vehicle headlighting under an American secretariat was another warmly discussed topic. It might have been difficult to explain certain features of American practise had not the foreign visitors had an opportunity of witnessing the heavy night traffic which often has to be handled in this country.

Much interest was expressed in the American traffic signal practise, and admiration was expressed at the excellence of some of our systems, accompanied by sur-

prise that other places managed to get along with inferior methods.

A number of delegates regarded the center-line mark on the highway pavement one of the most valuable ideas in the interest of safety observed on the trip.

Interior lighting was not neglected, although perhaps less fully covered at Saranac because of the attention devoted to these fields at the Toronto Convention.

Factory, school, residence, show window and cinema or moving picture theater lighting, were among the more prominent applications discussed.

A British secretariat report on Daylight was supplemented by a paper on the relation to public health.

Among the miscellaneous subjects may be mentioned railway signals, signal glasses, diffusing materials, and methods of preventing fading.

An expert from the Louvre explained his methods of using ultra-violet light, and other radiations, to determine the authenticity of paintings.

The French are leading in the development of lighting equipment expressing the so-called modern art; and some valuable information was forthcoming in that connection.

Any Americans who may have been under the impression that this country was far in advance of the rest of the world in lighting must necessarily have discovered that European development is proceeding at a tremendous rate.

Undoubtedly our guests learned much of value, but certain it is that they contributed much which will be helpful in this country.

The American lighting science and art will surely need to press forward to hold its own with the rest of the world.

GOOD AS NEON LIGHTS

Red neon lights, suggested as beacons for airports, are not any better able to penetrate fog, as its advocates have claimed, than ordinary incandescent lamps, equipped with colored screens. This was announced by Dr. Lyman J. Briggs, of the U. S. Bureau of Standards. Neon lights are familiar to everyone because they are used in the newest tubular advertising signs.

Tests carried out by Bureau of Standards scientists were made under actual field conditions. The neon lamp was compared with incandescent lamps so arranged that the color, size and shape of each lamp appeared identical to the aviator.

"The test showed that there is no real difference in the fog-penetrating quality of the light from the two sources," said Dr. Briggs. "In beacons of moderate candlepower any advantages due to the distinctive color of a neon lamp may be obtained more conveniently and simply and more reliably by means of an incandescent filament lamp equipped with a suitable color screen."

As a matter of fact, putting a red filter in front of a light does not increase its fog-penetrating power, he said. Tests were also made with incandescent lamps, one of which was covered with a red screen. The lamps

were both of the same power. In every case it was found that the uncovered light could be seen through a greater thickness of fog.—*Science News-Letter*.

MOBILE COLOR FLOODLIGHTING

Not content with the countless honors that have long been hers, Philadelphia now lays claim to "the most beautifully lighted business building in America." And therein lies something for the electrical industry to think about.

As one motors westward out of Philadelphia at night, along the Westchester Pike, he passes over a grade in the highway approaching Sixty-ninth Street and suddenly finds his gaze captured by a magnificent spectacle. A store and office building four stories high is surrounded by sixteen three-story pilasters of art glass, each brilliantly lighted and radiating harmonious tints and hues and colors. The pilasters mark the bays of the building from the sidewalk upward. And from the top of each pilaster a finger of light points skyward to the gilded eagle above. Constantly the colors change. All colors of the spectrum make their appearance. A complete cycle of thirty color changes takes place every ten minutes. The process is continuous. No traveler can fail to see the spectacular color combinations.

This remarkable illumination has a very definite significance for the electrical industry. If the display were that of a theatre or an amusement park, it perhaps would not be so significant. But it is the display of a store and office building. The owner of the building, Mr. John H. McClatchey, is a successful builder. He has sensed the tremendous advertising value of mobile color lighting and has had the courage to pioneer his idea in this new building. The display advertises not only the building itself but also the business center in which it is located. And it is certainly evident that the spectacle is a splendid sales argument for electrical illumination also.

Commercial buildings began to experiment with floodlighting several years ago and recently they began to try out color in floodlighting, but it is doubtful that any building has yet made the astonishing use of mobile color floodlighting found in the McClatchey Building. *Electrical Record* believes that this illumination installation in Philadelphia is only the forerunner of literally hundreds of such installations that will be made during the next three or four years. Mobile electrical illumination in colors is here to stay, and it is up to the industry to prepare itself to meet the demand for it. This means that manufacturers, central stations and contractors must acquire a better knowledge of color itself, of illumination, and of the equipment and installation methods necessary to the successful sale of this kind of electrical service. Indeed, one may in all confidence look forward to the day not far distant when America's business buildings will be characterized by magnificent color illuminations at night in a way that will make the present orgy of signboards seem crude indeed.—*Electrical Record*.

INSTITUTE AND RELATED ACTIVITIES

The A. I. E. E. Winter Convention

As we go to press, all arrangements for the Winter Convention have been completed, and by the time this issue of the JOURNAL is mailed the Convention will have adjourned. A complete report of the proceedings will be printed in the March JOURNAL.

Cincinnati Regional Meeting, March 20-22.

A wide range of interesting technical subjects is on the program of the Regional Meeting of the Middle Eastern District, which will be held at Cincinnati, March 20-22, with headquarters at the Gibson Hotel. Four technical sessions are scheduled under the general headings of Communication and Aeronautics, Automatic Stations and Welding, High-Speed Instruments and Welding, and Electric Power Systems. Titles of the papers are given in the accompanying tentative program.

Other features of the meeting will be inspection trips, a dinner with some notable speakers, and a Student session.

The session on Student Activities will be held on the morning of March 21 and there will also be luncheon meetings for Branch Counselors and Branch Chairmen.

On the Committee in charge of the meeting are: J. L. Beaver, Chairman (Vice-President A. I. E. E. in Middle Eastern District); R. C. Fryer, Vice-Chairman; E. S. Fields, H. L. Swift, H. D. Rei, W. E. Beaty, F. S. Dewey, F. S. Caldwell, A. M. Wilson and L. J. Gregory.

TENTATIVE PROGRAM OF CINCINNATI REGIONAL MEETING

(All sessions will be held in Ballroom of Gibson Hotel)

WEDNESDAY, MARCH 20

- 9:00 a. m. Registration.
10:00 a. m. Address, J. L. Beaver, Vice-President Middle Eastern District, A. I. E. E.
Address, Hon. Murray Seasongood, Mayor, City of Cincinnati.
Address, R. F. Schuchardt, President A. I. E. E.
10:30 a. m. First Technical Session.

COMMUNICATION AND AERONAUTICS

1. *Recent Developments in Telephone Construction Practises*, B. S. Wagner and A. C. Burroway, Cincinnati & Suburban Bell Tel. Co.
2. *Illumination of Airports and Airways*, H. E. Mahan, General Electric Co.
3. *Electrical Applications in Aeronautics*, by member of U. S. Government Experimental Station, Wright Field.

- 2:00 p. m. Second Technical Session.

AUTOMATIC STATIONS AND WELDING

4. *Street-Railway Power Economics*, J. A. Noertker, Cincinnati Street Railway Co.
5. *Automatic Mercury-Arc Rectifier Substations in Chicago*, A. M. Garrett, Commonwealth Edison Co.
6. *Arc Welding of Steel Buildings and Bridges*, F. P. McKibben, Consulting Engineer, General Electric Co.
7. *Fabrication of Large Rotating Machinery*, H. V. Putman, Westinghouse Elec. & Mfg. Co.
8. *Rolling of Continuous Steel Sheets*, J. B. Ink, American Rolling Mill Co.

THURSDAY, MARCH 21

- 10:00 a. m. Student Activity Session, Prof. F. C. Caldwell, Ohio State University presiding.
Report on the Work of the Student Branches, by L. A. Doggett, Counselor—Pennsylvania State College, Delegate to Denver Conference on Section and Branch Activities.
The Student Convention, Its Purpose and Procedure, by Moreland King, Counselor, Lafayette College.
Notable Features of Branch Work, by Student Chairmen, a series of two-minute reports. A prize of \$10.00 will be awarded for the best report.
The Student Branch as a Part of the Institute Organization, by H. H. Henline, Assistant National Secretary, A. I. E. E.
2:00 p. m. Third Technical Session.

HIGH-SPEED INSTRUMENTS AND MEASUREMENTS

9. *High-Speed Photography in Electrical Engineering*, H. W. Tenney, Westinghouse Elec. & Mfg. Co.
 10. *Automatic Oscillographs*, W. A. Marrison, Bell Telephone Laboratories.
 11. *A New Type of Hot-Cathode Oscillograph and Its Application to Automatic Recording of Lightning and Switching Surges*, R. E. George, Purdue University.
 12. *A New Development in Bushing-Type Current Transformers for Metering*, A. Boyajian and W. F. Skeats, General Electric Co.
 13. *Excitation of Current Transformers Under Transient Conditions*, D. E. Marshall and P. O. Langguth, Westinghouse Elec. & Mfg. Co.
- 7:00 p. m. Regional Meeting Dinner.
Dinner will be served at the Gibson Hotel. Notable speakers at the dinner will be, Messrs. R. F. Schuchardt, President A. I. E. E., C. M. Newcomb and C. F. Kettering.

FRIDAY, MARCH 22

- 10:00 a. m. Fourth Technical Session.

ELECTRIC POWER SYSTEMS

14. *Fused Horns and Grading Rings on 66-Kv. Transmission Lines*, Philip Stewart, Union Gas & Elec. Co.
 15. *Operating Experience with the Low-Voltage A-C. Network in Cincinnati*, F. E. Pinckard, Union Gas & Elec. Co.
 16. *Recent Additions to Generating Capacity on the System of the Columbia Gas and Electric Corp.*, E. S. Fields, Columbia Engg. & Mgt. Corp.
 17. *Investigation of Transmission Lines with Artificial Lightning*, K. B. McEachron, General Elec. Co.
 18. *Iron Losses in Turbine Generators*, C. M. Laffoon and J. E. Calvert, Westinghouse Elec. & Mfg. Co.
- 2:00 p. m. Inspection Trips.

SATURDAY, MARCH 23

- 9:00 a. m. Inspection Trips.

Dallas Regional Meeting, May 7-9

Dallas, Texas, will be the location of the Regional Meeting of the South West District of the Institute, which will be held May 7-9.

The program will include four technical sessions, two Student meetings, inspection trips, a luncheon and a dinner. The technical papers will be on the subjects of distribution, inter-connection, oil-pipe-line electrification, lightning research, illumination of flying fields and airways, telephone and railway signals.

Further details on this meeting will be published in succeeding issues of the JOURNAL.

1929 Institute Meetings

In addition to the Winter Convention and the Cincinnati and Dallas Regional Meetings, three other Institute meetings will be held during this year; namely, the Summer Convention, the Pacific Coast Convention, and a Regional Meeting in Chicago.

The Summer Convention will be held at Swampscott, Mass., June 24-28. At present it is planned to have sessions on distribution, transportation, electrical machinery, shielding in electrical measurements and other subjects. The annual reports of the Technical Committees will also be presented. The Section and Branch Committees will hold annual conferences.

The Pacific Coast Convention will be held at Santa Monica, Calif., on September 3 to 6.

The Regional Meeting in Chicago will be held December 2 to 4 under the auspices of the Great Lakes District.

More details of the programs of these meetings will be announced in later issues of the JOURNAL.

Midwest Power Engineering Conference in Chicago February 12-15

The fourth Midwest Power Engineering Conference will be held February 12-15 with headquarters at the Palmer House, Chicago, Ill. Six technical sessions will be held with seventeen papers on production and utilization of power. The program in outline is as follows:

TENTATIVE PROGRAM

FEBRUARY 10

12:00 noon Luncheon.

2:00 p. m. Session devoted to "Power Plant Substructure Problems."

FEBRUARY 13

10:00 a. m. Session devoted to "Metallurgical and Chemical Problems."

12:00 noon Luncheon Meeting under auspices of American Institute of Electrical Engineers, Chicago Section. R. F. Schuchardt, President American Institute of Electrical Engineers presiding.

2:00 p. m. Session devoted to "Electrical Engineering Problems."

FEBRUARY 14

10:00 a. m. Session devoted to "Heating, Ventilating and Refrigeration Problems."

12:00 noon Luncheon Meeting under auspices of the Western Society of Engineers.

2:00 p. m. Session devoted to "Power Plant Operation."

7:00 p. m. Banquet.

FEBRUARY 15

10:00 a. m. Session devoted to "Power Plant Economics."

An exhibition of power equipment will be given in the Midwestern Engineering and Power Exposition at the Coliseum, February 12-16, and all members of the societies sponsoring the Conference are invited to the exposition.

The Conference is being sponsored by local sections and regional and professional divisions of nine associations including

the American Institute of Electrical Engineers. All members of these associations are eligible to attend.

Special railroad rates on the certificate plan are available and certificates should be obtained from ticket agents when tickets to Chicago are purchased.

Information may be obtained from the Secretary of the Conference, G. E. Pfisterer, 53 West Jackson Boulevard, Chicago, Ill.

Professor Rudenberg to Lecture at M. I. T.

Professor Reinhold Rudenberg, Chief Electrical Engineer of the Siemens-Schuckert Works in Berlin, and Honorary Professor of Electrical Engineering at the Technische Hochschule in Charlottenburg, will deliver a series of lectures at the Massachusetts Institute of Technology from February 5 to 26, 1929, inclusive. The Department of Electrical Engineering announces that all members of the profession who are interested are cordially invited to attend any or all of the lectures.

The lectures will be given from 3:00 to 4:30 o'clock in the afternoon in Room 10-275. The titles and dates are as follows:

Feb. 5. Main and Stray Fields in A-C. Machines I.

Feb. 6. Main and Stray Fields in A-C. Machines II.

Feb. 8. Harmonic Fields and Pulsating Losses in A-C. Machines.

Feb. 11. Rotating Hysteresis in D-C. Armatures.

Feb. 12. Tolerances in Electrical Machines and Associated Equipment.

Feb. 13. The Action of Inertia in the Acceleration of Electrical Machines and in Their Parallel Operation.

Feb. 18. Magnetic Saturation and Non-harmonic Oscillations.

Feb. 19. Transmission of Power Over Very Great Distances.

Feb. 25. Earth Currents and Interference.

Feb. 26. Traveling Waves on Transmission Networks.

Standards

NEW INDEX AVAILABLE

There has just been issued to the entire membership of the Institute a new Standards Index and Order Form. The Index is a six page pamphlet containing a general outline of the history of Institute standardization, a listing of each of the thirty-four sections now available with a brief outline of the scope of each, price, etc. Members should carefully check this list over to be sure that their file of Standards is complete.

A. I. E. E. TEST CODES SUGGESTED

At the meeting of the Standards Committee of December 5, 1928, the question of the desirability of the development of A. I. E. E. Test Codes somewhat similar to the A. S. M. E. Power Test Codes was discussed. These codes would probably give a detailed description of actual methods of testing all types of electrical machinery. The suggestion met with favor but was referred to the Electrical Machinery Committee for study, other committees such as the Instruments and Measurements Committee to assist.

MEASURING TEMPERATURE OF SECONDARILY VENTILATED MOTORS

Another question coming before the Standards Committee on December 5th was the proper method of measuring the temperature of secondarily ventilated motors and also the development of a proper nomenclature for such motors. This was also referred to the Electrical Machinery Committee for study.

INDEX TO A. S. T. M. STANDARDS

The American Society for Testing Materials has just issued a ninety-six page pamphlet index of their Standards. Members of the Institute interested in A. S. T. M. Standards and Tentative Standards may obtain without charge a copy of the Index by writing A. S. T. M. headquarters at 1315 Spruce St., Philadelphia, Pa.

Lamme Medal Awarded to Allan B. Field

The Lamme Medal Committee of the Institute has awarded the first (1928) Lamme Medal to Mr. Allan Bertram Field "for the mathematical and experimental investigation of eddy current losses in large slot-wound conductors in electrical machinery." Arrangements for the presentation of the Medal will be announced later.



ALLAN B. FIELD

The Lamme Medal was founded as a result of a bequest in the will of the late Benjamin G. Lamme, Chief Engineer of the Westinghouse Electric and Manufacturing Company, who died on July 8, 1924, to provide for the award by the Institute of a gold medal (together with a bronze replica thereof) annually

to a member of the A. I. E. E. "who has shown meritorious achievement in the development of electrical apparatus or machinery" and for the award of two such medals in some years if the accumulation from the funds warrants.

Mr. Lamme made similar bequests to the Society for the Promotion of Engineering Education and the Ohio State University, providing in the former for the annual award of a medal "for accomplishment in technical teaching or actual advancement of the art of technical training," and in the latter for the award every five years of a medal to a graduate of the Ohio State University in any branch of engineering for meritorious achievement in engineering or the technical arts. The three organizations have adopted a common obverse for their medals and each has prepared a suitable reverse.

Allan Bertram Field, Consulting Engineer of the Metropolitan-Vickers Electrical Company, Ltd., Manchester, England, was born in New Barnet, Hertfordshire, England, December 28, 1875. After receiving his early education in London, he attended the Finsbury Technical College in that city (1890-1893), and was awarded diplomas in both electrical and mechanical engineering. Following studies at St. Johns College, Cambridge, from 1896 to 1899 and the passing of the Mathematical Tripos examination, he was awarded the Honours B. A. degree. He was later awarded the M. A. degree in the regular course. He took the Honours Science examinations of the University of London, and received the Honours B. Sc. degree in 1900.

Previous to his education at St. Johns College, Mr. Field had been employed in shop work and drafting in and near London for about two years. From 1899 to 1902, he was engaged in engineering work in traction, power, and lighting projects with the British Thomson-Houston Company in London. In order to become more familiar with American practise, he joined the General Electric Company in 1902 and spent more than a year in the Testing Department in Schenectady, afterward being engaged in transformer design. From January 1905 to October 1908, he was employed by the Bullock Electric Manufacturing Company and the Allis-Chalmers Company in the design of a-c. generators and motors. He joined the engineering forces of the Westinghouse Electric and Manufacturing Company in 1909 and was engaged in the design of salient pole alternators. In 1911 he was appointed engineer-in-charge of turbine-generator design. During the next two years he was responsible for the development and commercial introduction of the built-up rotor

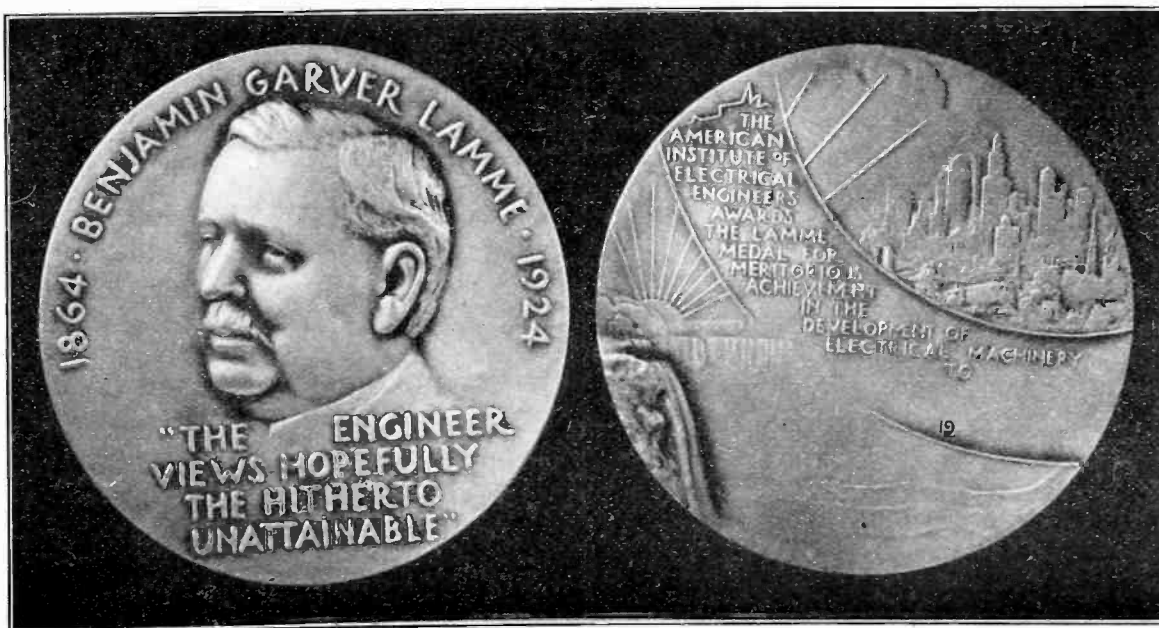

THE A. I. E. E. LAMME MEDAL

design, which has ever since been followed by that company, and solved, in collaboration with Mr. Lamme, many problems of turbine-generator design.

He was Consulting Engineer and Professor of Mechanical Engineering at the University of Manchester, England, from 1914-1917, and during the next three years was with Vickers, Ltd., in London. Since 1920 he has been Consulting Engineer with the Metropolitan-Vickers Electrical Company, Ltd., Manchester, England. In 1918, he was temporarily appointed by the British Admiralty as first technical director of the Admiralty Experiment Station (anti-submarine), Shandon, Scotland.

Mr. Field is the author of a number of important papers on electrical machinery which appeared in the TRANSACTIONS of the Institute and other engineering publications. He joined the Institute in 1903, was transferred to the grade of Member in 1909, and became a Fellow in 1913. He is a member of the American Society of Mechanical Engineers, Institution of Electrical Engineers (Great Britain) and Institution of Mechanical Engineers (Great Britain).

A. I. E. E. National and Regional Prizes

The following is a complete list of the prizes awarded each year:

National Prizes

1. The "NATIONAL FIRST PRIZE" in each of three classes, namely, "Engineering Practise," "Theory and Research," and "Public Relations and Education," consisting of \$100 and a certificate, may be awarded to the author or authors of the best original paper presented at any National, Regional, or Section meeting of the Institute.

2. The "NATIONAL PRIZE FOR INITIAL PAPER," consisting of a certificate and \$100 in cash, may be awarded the author or authors of the most worthy paper presented at any National, Regional, or Section meeting of the Institute, provided the author or authors have never previously presented a paper which has been accepted by the Meetings and Papers Committee.

3. The "NATIONAL PRIZE FOR BRANCH PAPER," consisting of a certificate and \$100 in cash, may be awarded to the author or authors of the best paper based upon undergraduate work presented at a Branch or other Student meeting of the Institute, provided the author or authors are members of a Student Branch.

Regional Prizes

1. The "REGIONAL FIRST PRIZE," consisting of a certificate of award issued by the officers of the Geographical District and \$25 in cash, may be awarded to the author or authors, located within the District, of the best paper presented at any Regional, Section, or Branch Institute meeting in the Geographical District during the calendar year.

2. The "REGIONAL PRIZE FOR INITIAL PAPER," consisting of a certificate of award issued by the officers of the Geographical District and \$25 in cash, may be awarded to the author or authors, located within the District, of the best paper presented at an Institute meeting in the District, provided the

author or authors have never before presented a paper before the Institute at any National, Regional, or Section meeting.

3. The "REGIONAL PRIZE FOR BRANCH PAPER," consisting of a certificate of award issued by the officers of the Geographical District and \$25 in cash, may be awarded to the author or authors, located within the District, of the best paper based upon undergraduate work presented at a Branch or other Student meeting of the Institute, provided the author or authors are members of a Student Branch.

The conditions of award of the various National and Regional Institute Prizes have been printed in pamphlet form, and during the month of January, a copy of this pamphlet was mailed to all District and Section officers and to the Counselors of all Student Branches.

Attention is directed to the fact that the conditions require that all papers presented during the calendar year 1928 and to be offered in competition for the National Prizes; must be received at National Headquarters in New York on or before February 15, 1929. These papers may be submitted by the author or authors, by an officer of the Institute, or by the Executive Committees of Sections or Geographical Districts.

Papers to be considered in competition for Regional Prizes should be submitted by the authors or by the officers of the Branch, Section, or District concerned, to the District officers or District Committee on Award of Prizes.

Any author or other member who is interested may obtain full information from the local Section or Branch officers, or by addressing Institute Headquarters, at New York.

Triennial Montefiore Prize

The competition for the triennial prize of the George Montefiore Foundation will close on April 30. The prize this year amounts to 29,000 Belgian francs.

The prize is awarded for the best original work on scientific advancement and progress in the technical applications of electricity in all its branches, excluding popularizations and compilations, written during the past three years. The jury consists of five foreign and five Belgian electrical engineers, including the Director of the Montefiore Electrotechnical Institute, who presides.

Works must be written in English or French, in printed or typewritten form. Twelve copies of a paper must be submitted. They should be plainly marked "Paper submitted in the competition of the George Montefiore Foundation, 1927-1929," and addressed to: The Secretary of the George Montefiore Foundation, 31 Rue Saint-Gilles, Liege, Belgium.

Presentation of Washington Award

The Washington Award for the year 1928 has been made to Bion J. Arnold, Past President of the Institute, and presentation will occur on February 21, at a dinner meeting at the Palmer House, Chicago. This award, established in 1917, is made "to an engineer whose work in some special instance or services in general have been noteworthy in promoting public works."

American Engineering Council

ANNUAL MEETING, WASHINGTON, D. C.

The Annual Meeting of the American Engineering Council was held in Washington, D. C., at the Mayflower Hotel, January 14-15, 1929. Delegates were present from the various national, state, and regional engineering societies constituting the membership of the Council; President Arthur W. Berresford, of New York, presiding.

The following constitutes a brief summary of the more important actions taken:

The annual reports of the President and the Executive Secretary indicated that the Council was growing in influence, and that 1929 promise a broader sphere of usefulness in the public service. At all the sessions the agenda were large and varied, and at no meeting in the Council's history has greater clarity been imparted to the Council's aims. Organization problems occupied much of the time of the Executive Committee, the Administrative Board, and the Assembly. The American Institute of Consulting Engineers was elected to membership in the Council.

The report of the Council's Committee on Street Traffic Signs, Signals, and Markings, received final approval, and will be published in the near future. It represents the findings of surveys made in thirty-five states. All conditions and methods of traffic control are believed now to be covered.

The Council discussed two radio bills; one to extend the power and authority of the present Federal Radio Commission; a second to establish a Federal Communications Commission. The Council approved the first of these bills, but the second was described by various members as "too broad." Difficulty and danger were seen in attempting to establish a single commission having charge of telephone, telegraph, radio, and all other means of communication of the country. The Council will work for a larger engineering representation on the Radio Commission to be appointed by February 23, 1929.

The Council opposed the Cramton Patent Bill, characterizing it as "vicious" and "class legislation." This bill provides "that it shall be unlawful for any person who has not complied with the rules and regulations of the Commissioner of Patents to aid or assist, directly or indirectly, in the preparation, presentation, or prosecution of any patent application." Members of the Council believed that this bill, if passed, would interfere with the advisory capacity of engineers, preventing them without being subjected to the danger of fine or imprisonment from giving technical assistance, even in a non-professional way, on matters affecting patents.

The report of E. J. Prindle, of New York, Chairman of the Committee on Patents, which recommended that efforts to increase the salaries of Patent Office employees be continued, was adopted.

The Council voted to appoint a committee "to study and report to the Council on the activities and performances of the Corps of Engineers." This action was precipitated by the opposition of the Corps to bill S 1710 providing for the establishment of a National Hydraulic Laboratory in the Bureau of Standards. This has passed the Senate, and is now before the Rivers and Harbors Committee of the House. President Berresford explained that the study would be in thorough accord with engineering methods, and that the Corps of Engineers would be invited to name a representative on the committee.

The Council will seek to have the number of man-hours worked in the manufacturing establishments of the United States reported in the next and succeeding census of manufacturers. Such a record, it is suggested, will be of value in estimating industrial efficiency and the extent of employment, as well as providing guidance to executives and investors in gaging the soundness of industries. Man-hour data will, it is thought, also be useful in a development of safety programs by revealing the number of hours that workers are exposed to hazard.

The annual dinner of the Council was held at the Mayflower Hotel, January 14. Addresses were delivered by Senator Hiram Bingham of Connecticut, and Dr. A. E. Morgan, President of Antioch College, Yellow Springs, Ohio.

Senator Bingham's topic was "Commercial Airports." Dr. Morgan, a member of the Council's Flood Control Committee, discussed the constitutional authority of the Federal Government to deal with such questions as are involved in the Mississippi River problem.

The officers elected were: Vice-Presidents—O. H. Koch, of Dallas, Texas, representing the Technical Club of Dallas; and L. P. Alford, of New York, representing the American Society of Mechanical Engineers. Dr. Harrison E. Howe, of Washington, representative of the American Institute of Chemical Engineers, was re-elected Treasurer; Mr. Lawrence W. Wallace, of Washington, was re-elected Executive Secretary. The hold-over officers for another year are: Messrs. Arthur W. Berresford, of New York, President; I. E. Moulthrop, of Boston, and Gardner S. Williams, of Ann Arbor, Vice-Presidents.

The representatives of the A. I. E. E. present were: Messrs.

H. H. Barnes, A. W. Berresford, F. L. Hutchinson, H. A. Kidder, William McClellan, L. F. Morehouse, and Farley Osgood, of New York; C. O. Bickelhaupt, of Atlanta; F. J. Chesterman and C. E. Skinner, of Pittsburgh; John H. Finney, of Washington; M. M. Fowler and R. F. Schuchardt, of Chicago; I. E. Moulthrop, of Boston; and Charles F. Scott, of New Haven.

The delegation selected to represent the A. I. E. E. upon the Administrative Board of the Council (in addition to President Berresford and Vice-President Moulthrop), is composed of John H. Finney, M. M. Fowler, H. A. Kidder, Farley Osgood, R. F. Schuchardt, and C. E. Skinner.

NATIONAL HYDRAULIC LABORATORY BILL IN GRAVE DANGER

For almost seven years, the engineers of America have been endeavoring to establish a National Hydraulic Research Laboratory. The Bill known as Senate Bill 1710 authorizes "the establishment of a national hydraulic laboratory in the Bureau of Standards of the Department of Commerce and the construction of buildings therefor" and was introduced by Senator Joseph Randell of Louisiana. It went before the House of Representatives and thence was referred to the Committee on Rivers and Harbors, which has consistently refused to take action upon it. Many of our noted engineers have testified in favor of the bill and many others have submitted written statements of endorsement; among the latter is President-Elect Herbert Hoover's. The principal opposition appears to be with General Edgar Jadwin, Chief of Engineers, U. S. A.; by the hearings it is disclosed that this attitude is based upon an apparent desire that the Chief of Engineers maintain exclusive control of the laboratory. Previous bills have given to the Chief of Engineers authority to conduct all research investigations and to take such action as he might deem necessary in the solution of flood control. The S. 1710 would give the Corps of Engineers a third interest in the control of the hydraulic laboratory established in the Bureau of Standards. Not only has the bill been passed by the Senate, but it already has the approval of the Director of the Bureau of the Budget as in no way conflicting with the President's financial policy. In the event that it is reported out by the Rivers and Harbors it has been assured right of way by the leaders of the House. As a distinct step forward in the engineering research activities of our government it is of great importance, watched by all engineers throughout the country as a demonstration of whether an officer of the U. S. A. who is not a member of Congress will be permitted to dictate a national engineering policy to Congress and the nation by his domination of one of its committees.

BOULDER CANYON DAM LEGISLATION

Following the President's message to Congress on this subject, as reported December 22, the Senate passed the amended Boulder Canyon Dam Bill, H. R. 5773, on December 14, by a vote of 64 to 11. Four days later the Senate amendments were concurred in by the House by a vote of 166 to 122, and on December 21, the President signed the bill, making it Public Act No. 642 of the seventieth Congress.

This Act lays the foundation for one of the three most expensive undertakings the U. S. Government has ever financed, the other two being the Mississippi Flood Control Plan at approximately \$400,000,000 and the Panama Canal, approximately \$382,000,000. With the enactment of this legislation the popularly known Boulder Canyon Dam project has become a misnomer, since the dam on this river is to be constructed at Black Canyon and not at Boulder Canyon. Hence, this undertaking will probably be known in the future as the Colorado River project.

The Colorado River Board, appointed by the Secretary of the Interior and approved by the President of the United States, revised the estimates of the Bureau of Reclamation as follows:

Dam, 550 ft. high, from \$41,500,000 to \$70,600,000; power plant, 1,000,000 horsepower installation, from \$31,500,000 to \$38,200,000; All-American Canal, from Laguna Dam, to connect with distribution system of Imperial Valley, a distance of 75 miles, from \$31,000,000 to \$38,500,000; interest during construction for a period of seven years, instead of ten years, \$21,000,000 to \$17,700,000. Total, \$165,000,000.

PERSONAL MENTION

G. B. PULHAM, Chief Erecting Engineer for India, Burma, and Ceylon for Metropolitan-Vickers Electrical Co., Ltd., leaves India for England in March.

FRANK G. BAUM, Consulting Hydroelectric Engineer of San Francisco, and Fellow of the Institute, has announced his marriage to Miss Oldwiga Dagmar Von Natzmer, at Wiesbaden, Germany, on December 20, 1928.

H. C. PRADO, of Santander, Cauca, Colombia, S. A., is in charge of the construction for the "Carretera nacional Santander-San Julián," highway joining the town of Santander with the City of Cali.

ANDREW WELLS ROBERTSON, of Pittsburgh, President of the Philadelphia Company, was unanimously elected Chairman of the Board of Directors of the Westinghouse Electric and Manufacturing Company in a meeting of that Board held January 16.

J. A. SOLTURA on April 30 severed his connections with the The Cuban Cane Sugar Corporation, of which he was Assistant Chief Electrical Engineer, to become Chief Engineer of Power, Light, and Water of the Cuban Portland Cement Company, at Cayo Mason, Cuba.

R. W. SHOEMAKER AND **M. M. MCINTIRE** are Superintendent of the Electrical Department and Consulting Engineer, and Electrical Engineer, respectively, of the Turlock Irrigation District, which is contemplating the construction of a \$2,100,000 hydroelectric generation and distribution system utilizing the existing drops in the irrigation canal system.

H. L. R. EMMET has been appointed manager of the Erie, Pa., works of the General Electric Company, Schenectady, New York, and **J. E. BROBST** has been named manager of its Bloomfield, N. J., plant of the same company, succeeding Matthew Griswold at Erie and **C. D. Knight** at Bloomfield, both of whom retired from active service on January 1.

Obituary

F. R. Wheeler, recognized leader in civil and electrical engineering circles and a Member of the Institute since 1916 after an illness which confined him to his home for several months, died January 13, 1929. He was born in Washington, D. C., February 16, 1880, and in his engineering work, here and in the South, has organized a number of utilities companies. At the time of his death he was President of the Allied Utilities Company, the North Alabama Utilities Company, the Mississippi Gas Company, and the Consumers' Gas Company. He took an active part in charitable work as the recently elected president of the Board of Catholic Charities, a trustee of St. Joseph Home and School and as Vice-President of the Community Chest of Washington. He was one of the Board of Directors of the Washington Board of Trade, the Federal-American Bank, the East Washington Savings Bank, and the Washington Wimsett Company. He was also a lieutenant commander of the Naval Reserves. He held membership in the Rotary Club, the Columbia Club, the City Club, Congregational Country Club, Chain and Sprocket Club, Knights of Columbus, Columbia Historical Society, the American Society of Civil Engineers, and the Society of Washington Engineers of which he was a charter member.

Gunnar Jensen, General Engineer of Testing and Inspection for the Westinghouse Electric & Manufacturing Company,

East Pittsburgh, and an Associate of the Institute since 1921, died in Florida December 28, 1928. He had been identified with the Testing Department of the Westinghouse Company twenty-three years.

Mr. Jensen was a native of Wemb, Denmark, and acquired his early education through the local school, supplemented by a home study course under tutor, reaching the equivalent of a college education. In all of his work he was most diligent. An associate of over ten years' standing in endorsing Mr. Jensen for membership in the Institute stated that he knew of few engineers whom he could recommend so highly from every point of view. In testing work and the development of testing methods for electrical testing, and standardizing methods for testing small apparatus, Mr. Jensen did much valuable work for his company, and his ability and energy won for him a reputation which was outstanding in his field of engineering service.

Joseph Willard Legg, one of the foremost engineers in the study of oscillography, died January 2, 1929 in Columbia Hospital, Wilkesburg, Pa. from pneumonia. He had been ill less than a week.

As a member of the Meter Engineering Staff of the Westinghouse Electric & Manufacturing Company, Mr. Legg was responsible for the development of many electrical devices. His greatest fame resulted from his invention of the "Osiso," a small portable oscillograph for which many unusual uses have been found. An "Osiso" is now being used experimentally in St. Louis as a means to helping teach deaf persons to speak by making visual records of their voice waves; another is with Commander Byrd's expedition in the Antarctic, where it is being used in the study of radio "dead spots" and the reflection of radio waves; others are being used for measuring intelligence, for measuring nerve response, for studying musical overtones, for locating oil wells, for measuring vibrations on trains, ships and elevators, and for recording the history of transient phenomena taking place in electric circuits. Perhaps the most important phase of Mr. Legg's work was his adaptation of the "Osiso" to perform the functions of an electric cardiograph, which enables physicians to obtain a complete permanent record of the action of the heart.

Another invention of Mr. Legg's is the polar high-speed camera, which is capable of taking 3000 photographs per second. It is used in the study of rapidly moving electric arcs.

Mr. Legg was 41 years of age. He was born in Worcester, Mass., where he attended grade and high schools, following his high school course with a trip around the world. In 1915 he received a Bachelor of Science degree from Worcester Polytechnic Institute, and in 1917 a degree of Electrical Engineer from the same institution.

In 1915 he entered the employ of the Westinghouse Company. His first work was in the research department, where he assisted in the development of the mercury arc rectifier. Becoming interested in oscillograph work, he made a number of improvements in oscillograph design, notably the use of incandescent rather than arc lamps, which led to the Westinghouse Company's entering the oscillograph business, which has since risen to great volume. In the years that followed, he originated many schemes for automatic oscillographic work, and numerous improvements in oscillographic instruments resulted from his intensive study of the subject. Mr. Legg once traveled to South America on the steamship *Southern Cross* for the purpose of studying the vibrations that took place within the ship's turbines.

He was the author of many technical articles, a member of the American Institute of Electrical Engineers since 1920 when he joined as an Associate, Sigma Xi and Tau Beta Pi, honorary fraternities.

Clark E. Diehl, Manager of the Postal Telegraph Cable Company, and City Electrician, City of Harrisburg, died suddenly of pneumonia January 3, 1929. Mr. Diehl was 67 years old, born in Northumberland County, Pennsylvania, May 2,

1862. Through public school and practical experience he obtained his early education and he had been Manager in charge of Repeater Stations for his Company ever since 1887. He was

City Electrician in charge of signalling systems and of electric lighting from 1896 to the present date. Mr. Diehl became an Associate of the Institute in 1921.

A. I. E. E. Section Activities

NEW YORK SECTION MEETING

Recent Developments in International Electrical Communication

On the evening of Thursday, February 14, 1929 the New York Section of the Institute will listen to a presentation of some of the most recent developments in the field of international electrical communication. Four speakers, one each from the American Telephone and Telegraph Co., the International Telephone and Telegraph Co., the Radio Corporation of America and the Western Union Telegraph Company. The speakers and their subjects are, as follows: "Short Waves and Long Waves in Transatlantic Radio Telephony," by Ralph Bown, A. T. & T. Co.; "South America Transcontinental Telephone Circuits Connecting Argentina, Uruguay and Chile," by F. A. Hubbard, Assistant Chief Engineer, International Telephone and Telegraph Company; "Short Wave Technique Especially as Adapted to Facsimile," by Major R. H. Ranger, Radio Corporation of America; "The Construction and Laying of the Western Union Telegraph Company's 1928 Newfoundland—Azores Loaded Cable," by G. A. Randall, Western Union Telegraph Company. Motion pictures of the laying of the cable will be shown.

This meeting will be of particular interest to members of the Institute concerned with communication matters. The meeting will be in Engineering Auditorium, 33 West 39th St., New York, N. Y., Thursday, February 14, 1929 at 8.15 p. m.

FUTURE SECTION MEETINGS

Cleveland

Development in Power Machinery, by F. D. Newbury, Mgr., Power Engg. Dept., Westinghouse Electric & Mfg. Co. Hotel Statler. February 21.

Joint meeting with Case School of Applied Science Branch. March 19.

Detroit-Ann Arbor

Lighting, by Frank Penford, General Electric Co. February 19.

Columbus

Transmission Line Stability, by C. L. Fortescue, Consulting Transmission Engr., Westinghouse Electric & Mfg. Co. March 1.

Madison

Through Electrical Eyes (talking movies), by representatives of the Bell Telephone Laboratories, Inc. Engineering auditorium, University of Wisconsin. February 19.

Pittsburgh

The Extinction of an Alternating Current Arc, by Dr. Joseph Slepian, Consulting Engr., Westinghouse Electric & Mfg. Co., Dinner meeting. February 12.

Long Distance Toll Cable Transmission, by J. A. Cadwallader, Engr. of Transmission and Outside Plant, The Bell Telephone Co. of Pa. March 12.

Pittsfield

My Life with the Foreign Legion, by Bennett J. Doty. Masonic Temple. February 5.

Conowingo and 200 Kv. Interconnection Developments, by R. A. Hentz, Philadelphia Electric Co. February 19.

St. Louis

February 20.

March 20.

Saskatchewan

Radio Stations in the Arctic Circle and Their Application to Navigation and Forest Patrol, by Capt. H. A. Young, R. C. C. S. February 22.

Seattle

Welding of Steel Buildings and Bridges, by F. P. McKibben, Consulting Engr. February 12.

Annual Joint Meeting of the "Founder Societies." Address by C. E. Skinner, Assistant Director of Eugg., Westinghouse Electric & Mfg. Co. March 19.

Sharon

The Role of Physics in Industry, by L. O. Grondahl, Director of Research, Union Switch & Signal Co. March 5.

Utah

The Photo-Electric Cell and Its Applications, by Dr. H. T. Plumb, General Electric Co. February 18.

Manufacture of Insulators, by G. L. Wilder, Locke Insulator Co. March 18.

Vancouver

Industrial Control, by D. Robertson, C. G. E. Co. March 5.

Washington

Automatic Train Control, by W. H. Reichard, Consulting Elec. Engr., General Railway Signal Co. February 12.

The Diesel Electric Locomotive, by N. W. Storer, Consulting Railway Engr., Westinghouse Electric & Mfg. Co. March 12.

SPEAKING CONTEST HELD BY LOS ANGELES SECTION

As a result of certain suggestions made by President Schuehardt that Section members be encouraged to participate more actively in meetings, the Los Angeles Section held a speaking contest as part of its meeting on December 4, 1928. Nine men spoke upon the subject *More Kilowatt-Hours Per Home*, each being limited to three minutes. First and second prizes were awarded and the third contestant received honorable mention. This contest proved to be very interesting and successful.

The principal address was given by F. G. Philo, Superintendent of Steam Generation, Southern California Edison Company, on the *Operating and Design Features of the New Long Beach Steam Plant No. 3*, and was of great interest to the 130 persons present. The program was preceded by a dinner.

MIDWINTER DINNER MEETING OF PITTSBURGH SECTION

The Midwinter Dinner Meeting of the Pittsburgh Section and the Electrical Section of the Engineers Society of Western Pennsylvania was held at the Fort Pitt Hotel, Pittsburgh, on January 8, 1929. Student activities held during the day and sponsored by the Sections are reported in the Student Activities department of this issue.

Professor H. E. Dyehe, Chairman of the Pittsburgh Section, A. I. E. E., presided and the entire program of talks was devoted to the subject "How the Institute Can Be of Greater Service." The following talks were given:

J. B. Luck, Chairman of the University of Pittsburgh Student Branch, representing the Student Group.

E. C. Stone, Director, A. I. E. E., Duquesne Light Co., representing the Utility Group (Power).

F. J. Chesterman, Director, A. I. E. E., Bell Telephone Co., of Pa., representing the Utility Group (Telephone & Telegraph).

F. C. Hanker, Director, A. I. E. E., Westinghouse Electric & Mfg. Co., representing the Manufacturers Group.

J. L. Beaver, Vice-President, A. I. E. E., Lehigh University, representing the Educators Group, and

H. H. Henline, Assistant National Secretary, A. I. E. E., representing the Institute.

The attendance at the dinner was about 200, including 53 students, and all present seemed to enjoy the program of talks and the entertainment features which were given at various times during the program and at its close.

JOINT SECTION AND BRANCH MEETING IN LOUISVILLE

The Louisville Section and the University of Louisville Branch held a joint meeting on December 19, 1928, in the rooms of the Engineers and Architects Club. The following talks were given: Report on Regional Meeting in Atlanta, October 29-31, by N. C. Pearcy, Secy., Louisville Section.

Report on Student Activities Conference in Atlanta, by Prof. D. C. Jackson, Jr., Counselor, University of Louisville Branch.

Samuel Evans, Chairman, University of Louisville Branch, gave his paper on *Student Activities* for which he was awarded the cup at Student Activities session in Atlanta.

My Impressions of Cooperative Work, Hugh Nazor, Student.

Opportunities for the Young Engineer in Communication, H. H. Walker, Southern Bell Telephone and Telegraph Co.

Opportunities for the Young Engineer in the Electric Power and Light Utilities, A. W. Lee, Louisville Gas and Electric Co.

Opportunities for the Young Engineer in Manufacturing, Robert Tafel, Nachod and U. S. Signal Co.

Refreshments and smokes were supplied after the program. The attendance was 35, including 15 students.

JOINT MEETING OF VIRGINIA SECTIONS OF NATIONAL SOCIETIES

The Virginia Sections of the American Society of Civil Engineers, American Society of Mechanical Engineers, and American Chemical Society, and the Southern Virginia Section of the Institute held the annual fall joint meeting at the Virginia Military Institute, Lexington, on October 19 and 20, 1928. The principal events of the meeting are given in the following program.

Friday Morning

COLONEL WILLIAMSON, Presiding

Address of Welcome, General W. H. Coeke, Supt., Virginia Military Institute.

Mechanical Effects of Heat Treatment of Steel, Dean Earl B. Norris, Virginia Polytechnic Institute, Blacksburg, Va.

Railway Electrification, A. V. Schoch, General Engineer, Westinghouse Electric & Manufacturing Co., East Pittsburgh, Pa.

Platinum, Dr. J. L. Howe, Dean, School of Applied Science, Washington and Lee University, Lexington, Va.

A complimentary luncheon was furnished by the Virginia Military Institute.

Friday Afternoon

PROFESSOR J. S. A. JOHNSON, Virginia Polytechnic Institute, Chairman Virginia Section A. S. M. E., Presiding

Air Port Development in Virginia, H. G. Shirley, Chairman, State Highway Commission, Richmond, Va.

Planning for the Town and Small City, Prof. W. T. Lyle, Head, Department of Civil Engineering, Washington and Lee University.

Drill and parade by Corps of Cadets.

Friday Evening

Those present were guests of the Virginia Military Institute at a supper and smoker.

Address by Colonel Frederick Stuart Greene, Superintendent of Public Works, State of New York, Albany, N. Y.

Saturday Morning

The Railroads and the New South, Geo. B. Elliott, President, A. C. L. Railway, Wilmington, N. C.

New Construction on the Norfolk and Western Railway, F. P. Turner, Assistant to Chief Engineer, N. & W. Ry., Roanoke, Va.

Addresses on local Sections and Student Branches, by Calvin W. Rice, Secretary, A. S. M. E., and Professor W. S. Rodman, Chairman, Southern Virginia Section, A. I. E. E.

Resolutions were adopted expressing the appreciation of those present for the manner in which they had been entertained by the Virginia Military Institute and reaffirming the policy which has been in effect for several years of holding joint meetings, with one meeting each year at one of the three centers of engineering education in the state.

The only event on the program for Saturday afternoon was the annual football game between the University of Virginia and the Virginia Military Institute.

RECENT DEVELOPMENTS IN ELECTRICAL INDUSTRY DISCUSSED AT DALLAS SECTION MEETING

The Dallas Section devoted its meeting of December 17, 1928, to the general subject *Developments in the Electrical Industry During 1928*, and brief papers were presented as follows:

Electrical Apparatus, L. T. Blaisdell, General Electric Co.

Electro-therapy and Radiology, Dr. C. O. Bailey, St. Paul's Sanitarium.

Communication, H. P. Lawther, Southwestern Bell Telephone Co.

Electric Transportation, B. R. Brown, Dallas Railway & Terminal Co.

Underground Cable Systems, T. C. Ruhling, Chas. L. Ward Co.

Generating and Transmission Systems, S. M. Sharp, Central Southwest Utilities.

Utilization and Household Apparatus, L. G. Melton, Westinghouse Electric & Mfg. Co.

The meeting was held at the Southern Methodist University in order to give the engineering students the benefits of attending.

The total attendance was 64.

PAST SECTION MEETINGS

Akron

Oil Circuit Breakers, by J. T. Bronson and K. C. Moberly, General Electric Co. Film, entitled "The Age of Speed," was shown. December 14. Attendance 39.

Boston

Engineering Developments in the Electric Power Field, by F. D. Newbury, Westinghouse Elec. & Mfg. Co. January 9. Attendance 150.

Cincinnati

Traffic Control Systems, by S. C. Rogers, Engr., General Electric Co. Illustrated. Various Committee Chairmen called upon for brief reports. December 13. Attendance 47.

Cleveland

Aviation Lighting, by Major John Berry, Supt., Cleveland Airport;

Methods of Lighting Airports and Airways, by T. P. Brown, Illuminating Engr., Edison Lamp Works. Illustrated.

Experiments Now under Way in Perfecting Proper Lighting Equipment for Use on the Plane when Landing at Night, by W. M. Johnson, Illuminating Engr., National Lamp Works. A dinner for the speakers was given. Joint meeting with Illuminating Engineering Society. December 20. Attendance 103.

Connecticut

A Mental Cruise through the General Electric Research Laboratory at Schenectady, by L. A. Hawkins, Executive Engr., Research Laboratory, General Electric Co. October 9. Attendance 200.

Radio Interference from Power Systems, by J. A. Vahey, Edison Electric Illuminating Co. Motion pictures, entitled "Now You're Talking," "The Service of Preparedness" and "The Trans-Atlantic Telephone Service," were presented. December 13. Attendance 110.

Dallas

Developments in the Electrical Industry during 1938. (Complete report elsewhere in Section Activities department of this issue.) December 17. Attendance 64.

Denver

Development and Application of Carrier Current, by R. N. Stoddard, Radio Engg. Dept., Westinghouse Elec. & Mfg. Co. Illustrated. A dinner preceded the meeting. December 14. Attendance 42.

Erie

Industrial Applications of Electrical Heating, by R. M. Cherry, Special Engr., Heating and Welding Division, General Elec. Co. A motion picture covering the methods now used in about twenty of the largest plants in America was shown. December 18. Attendance 110.

Houston

Static and Transient Stability of Transmission Systems, by P. H. Robinson, Transmission Engr., Houston Lighting & Power Co. The meeting was preceded by a dinner. December 12. Attendance 36.

Los Angeles

Operating and Design Features of the New Long Beach Steam Plant No. 3, by F. G. Philo, Supt. of Steam Generation, Southern California Edison Co. Illustrated. Speaking contest on the subject of "More Kilowatt-Hours per Home." (Complete report elsewhere in Section Activities department of this issue.) December 4. Attendance 130.

Inspection trip to the Pacific Goodrich Tire & Rubber Company's Plant at Montebello. December 8. Attendance 72.

Louisville

Inspection and business meeting held jointly with University of Louisville Branch. May 17. Attendance 48.

Inspection trip to Kentucky Oxygen-Hydrogen Company's Factory. October 25. Attendance 26.

Joint meeting with University of Louisville Branch. (Complete report elsewhere in Section Activities Department of this issue.) December 19. Attendance 33.

Lynn

Engineering Analysis by Machine, by Dr. V. Bush, Prof. of Elec. Engg., Mass. Inst. of Tech. Illustrated. December 12. Attendance 110.

Inspection trip to plant of H. P. Hood & Sons, milk distributors. December 15. Attendance 100.

Nebraska

Motion pictures on Telephone Communication. Joint with Y. M. C. A. night class in engineering. December 6. Attendance 25.

The Televox, by J. L. McCoy, Westinghouse Elec. & Mfg. Co. A dinner preceded the meeting. January 4. Attendance 365.

Philadelphia

Handling Toll Calls—Philadelphia and Vicinity, by G. E. Wiltbank, Traffic Engr., Bell Tel. Co. of Pa. Illustrated. A dinner preceded the meeting. October 8. Attendance 87.

Recent Developments in A. C. Network Systems, by H. Richter, General Engr., Westinghouse Elec. & Mfg. Co. Illustrated. A dinner preceded the meeting. November 12. Attendance 122.

Translations between Sound and Light, by J. B. Taylor, Consulting Engr., General Electric Co. A dinner preceded the meeting. December 10. Attendance 85.

Pittsburgh

Facsimile Picture Transmission, by H. A. Iams, Westinghouse Elec. & Mfg. Co. Demonstration of picture transmission. Comedy motion pictures. Joint meeting with Electrical Section, Engineers Society of Western Pa. December 11. Attendance 152.

Mid-Winter dinner meeting with Electrical Section, Engineers Society of Western Pa. and neighboring Student Branches. (See complete reports in Student Activities and Section Activities departments of this issue.) January 8. Attendance 200.

Pittsfield

Modern Chemical Developments, by Dr. Ellwood Hendricks, Columbia University. The speaker was entertained at dinner. December 4. Attendance 100.

Under the Northern Lights, by Donald B. MacMillan. Illustrated with motion pictures. The speaker was entertained at dinner prior to the meeting. December 18. Attendance 1000.

Mussolini and European Politics, by Dr. Bruno Roselli, Vassar College. The speaker was entertained at dinner. January 8. Attendance 500.

Portland

Some Features of Hydroelectric Design, by A. F. Darland, Supt. of Electrical Construction and Design, City of Tacoma. Joint meeting of all the Engineering Societies under the auspices of the Oregon Technical Council. December 19. Attendance 65.

St. Louis

Automatic Block Signals, by Paul Gault, Chief Signal Engineer, Missouri-Pacific Railroad Co. Attendance prizes awarded to O. H. Danielson, W. H. Millan and L. M. Richards. December 19. Attendance 65.

San Francisco

The 37,500 Kw. Turbo Generator Installation of the Pacific Gas and Electric Company at Station "C," Oakland, by R. C. Powell. Dinner served by host. November 23. Attendance 125.

Saskatchewan

Canadian Electric Code, by W. P. Dobson, Chief Test Engr., Hydro Power Commission of Ontario, and B. Stewart McKenzie, Secretary of the Canadian Engineering Standards Association. Dinner meeting. August 3. Attendance 20.

Dinner and theatre party. October 9. Attendance 30.

Telephone Transmission with Particular Application to Carrier Systems, by C. Heatfield, Traffic Engr., Saskatchewan Government Telephones. November 30. Attendance 28.

Dinner and theatre party. December 13. Attendance 24.

Schenectady

The Geological History of the Schenectady Region, by Prof. E. S. C. Smith, Union College. December 14. Attendance 300.

Sharon

The Psychology of Laughter, by Charles Milton Newcomb. Banquet meeting. June 4. Attendance 200.

Fascism—A Challenge to Democracy, by Col. M. W. Howard. Banquet. December 11. Attendance 278.

Southern Virginia

Joint meeting of A. S. C. E., A. S. M. E., A. C. S. and A. I. E. E. Sections. (Complete report elsewhere in Section Activities department of this issue.) October 19 and 20.

Spokane

Some Recent Engineering Developments, by C. W. Fick, General Electric Co. Motion passed that Chairman of the Meetings and Papers Committee of the Section be instructed to arrange for meetings, at which papers would be presented by Section members, and that a committee be appointed to arrange for prizes. October 26. Attendance 15.

Long Distance Telephone Service, by Mr. Yeager, Traffic Supt., Home Telephone and Telegraph Co. November 23. Attendance 18.

A Problem in Vertical Transportation, by A. C. Stevenson, Elec. Engr., Hecla Mining Co., and

The Televox, by V. B. Wilfley, Westinghouse Elec. & Mfg. Co. December 21. Attendance 100.

Springfield

The Televox, by R. J. Wensley, Westinghouse Elec. & Mfg. Co. Joint meeting with Engineering Society of Western Massachusetts, preceded by a dinner. December 11. Attendance 350.

Syracuse

General Principles of Lubrication, by R. P. Tobin, Chief Engr., Vacuum Oil Co. Joint meeting with A. S. M. E. December 17. Attendance 150.

Toledo

Single-Phase Condenser Motors, by Prof. J. S. Gault, University of Michigan, Illustrated. December 14. Attendance 40.

Toronto

Research Activities of the Bell Telephone Laboratories, Inc., by John Mills, Director of Publication. Demonstrations of interesting new developments. December 14. Attendance 500.

Urbana

My Associations with Steinmetz and What I Learned from Him, by R. E. Doherty, Consulting Engr., General Electric Co. December 13. Attendance 200.

Utah

Some Electrical Developments in the Mining Industry, by R. W. McNeill, General Engr., Westinghouse Elec. & Mfg. Co. Illustrated. After a short talk by H. S. Kerr, President, Engineering Council of Utah, it was moved and seconded, and carried unanimously to instruct the Secretary of the Engineering Council of Utah as follows: "That it is the consensus of opinion of the members of the Utah Section of the American Institute of Electrical Engineers that all officers in the Technical Engineering staff employed by the State of

Utah should be placed under Civil Service regulation." December 17. Attendance 40.

Vancouver

High Frequency Bridge Measurements, by Dr. H. Vickers, University of British Columbia. January 8. Attendance 35.

Washington

The Principles of the Mechanical Telephone, by E. H. Goldsmith, Engr., New York Telephone Co. Illustrated. A dinner preceded the meeting. December 11. Attendance 104.

Worcester

Electric Welding of Steel Structures, by F. P. McKibben, Consulting Engr., General Electric Co. October 17. Attendance 325.

Value of Research, by Dr. W. R. Whitney, Director, Research Laboratory, General Electric Co. November 14. Attendance 178.

Mr. Televox—The Mechanical Man, by R. J. Wensley, Westinghouse Electric & Mfg. Co. December 10. Attendance 300.

A. I. E. E. Student Activities

CONFERENCE ON STUDENT ACTIVITIES IN GREAT LAKES DISTRICT

The annual Conference on Student Activities of District No. 5 was held in the rooms of the Western Society of Engineers, Chicago, Illinois, December 3, 1928. Each of the fourteen Branches in the District was represented by the Counselor or Chairman and the majority were represented by both.

The Committee adopted rules governing its activities and providing for a small executive committee, composed of three Counselors, each serving three years provided he continues as Counselor and one retiring on August 1 each year, and also one practising engineer who may be appointed upon nomination of the Vice-President for a period not to exceed one year. The senior member of the committee is to be Chairman and to serve as Counselor Delegate to the Summer Convention. In accordance with the provision in the rules that the Vice-President should appoint the first committee, Vice-President Ryan appointed the following members: Prof. C. M. Jansky, Counselor, University of Wisconsin Branch, Chairman; Prof. A. N. Topping, Counselor, Purdue University Branch; Prof. J. H. Kuhlmann, Counselor, University of Minnesota Branch, and Mr. H. E. Wulffing, Commonwealth Edison Co. The terms of the Counselors are to expire on August 1, 1929, '30, and '31, respectively, and Mr. Wulffing's term expires on August 1, 1929. Prof. F. A. Rogers, Counselor, Lewis Institute Branch, was unanimously elected incoming member of the Committee to take office August 1, 1929.

Prof. C. M. Jansky, Counselor, University of Wisconsin Branch, then took the chair and gave an abstract of the minutes of the 1927 meeting of the Committee. Each Branch Chairman present gave a report upon the activities of his Branch, and there was a general discussion of these activities.

Philip C. Neumann, Chairman, Marquette University Branch, and Chairman of the District No. 5 Committee on Student Branch Finance, gave the report of that Committee, containing results received in reply to a questionnaire which was sent to all Branches.

The Committee decided to hold a Student Convention in connection with the Regional Meeting of the Great Lakes District, which is to be held in Chicago, December 2-4, 1929, and discussed the type of program which would be most desirable. It was the general opinion that each Branch should be responsible for at least one paper.

A motion was passed instructing the Secretary to write a letter to the Western Society of Engineers, thanking that Society for the excellent accommodations provided for the Conference.

STUDENT ACTIVITIES TO BE DISCUSSED AT CINCINNATI REGIONAL MEETING

The Committee on Student Activities of the Middle Eastern District has planned a session on Student Branch Activities for Thursday morning, March 21, during the Regional Meeting which is to be held in Cincinnati, Ohio, March 20-22, 1929. The program for the session is included in the announcement of the Regional Meeting elsewhere in this issue.

The Counselors and the Branch Chairmen will hold separate luncheon meetings on Wednesday, March 20, and the two groups will meet together at luncheon on Thursday, March 21.

Students who attend these meetings are urged to attend all sessions of the Regional Meeting and thus become better acquainted with Institute members and the work they are doing.

ELECTRICAL ENGINEERING EXHIBITION HELD BY YALE UNIVERSITY BRANCH

The Yale University Branch held its annual electrical engineering exhibition on December 14 and 15, 1928. Some of the principal exhibits were the breakdown of air at high voltage around various types of insulators, Tesla coil, operation of power plant equipment, radio transmitter, oscillograph, electric furnace, mercury arc rectifier, and traffic control systems. Many other applications of electricity were shown and several types of class work, including industrial control apparatus, were demonstrated. On one evening, talks by engineers were broadcast by station WDRC. Nearby members of the Connecticut Section of the Institute were invited to attend, and the exhibition was well attended by Yale students and the general public of New Haven. A. F. Metzger was exhibition chairman.

STUDENT BRANCH CONFERENCE AT PITTSBURGH

The Second Annual Conference of the Student Branches at the Carnegie Institute of Technology, University of Pittsburgh, and West Virginia University was held in Pittsburgh on January 8, 1929, in connection with the Midwinter Dinner Meeting of the Pittsburgh Section and the Electrical Section of the Engineers Society of Western Pennsylvania.

About 100 students of the three institutions were conducted on a tour of inspection through the Westinghouse Electric & Mfg. Company's plant in East Pittsburgh during the morning. They were guests of the Westinghouse Electric & Mfg. Company for luncheon.

The Joint Conference of the Branches was held in the afternoon and was opened by Professor H. E. Dyche, Chairman of the Pittsburgh Section. He introduced C. C. Coulter, Chairman of

the West Virginia University Branch, who presided during the first part of the session. An address of welcome was given by C. S. Coler, Director Educational Department, Westinghouse Electric & Mfg. Company, who traced briefly some of the early developments in alternating current systems. The following program was then presented:

Engineering as a Profession, by I. F. Vannoy, West Virginia University.

Experiences in London, by H. S. Young, Carnegie Institute of Technology.

New Hydroelectric Projects in Russia, by N. J. Damaskin, University of Pittsburgh.

G. M. COOPER, Chairman

Carnegie Institute of Technology, presiding.

Value of the A. I. E. E. to the Student, by Robert Lockwood, Carnegie Institute of Technology.

Are Branches Worth While?, by J. G. Hoop, University of Pittsburgh.

How to Increase the Interest and Enthusiasm of the Students in the Student Branch, by F. H. Baekus, West Virginia University.

Address, Professor J. L. Beaver, Vice-President, Middle Eastern District, A. I. E. E.

J. B. LUCK, Chairman

University of Pittsburgh, presiding

Address, H. H. Henline, Assistant National Secretary.

Branch Activities from the Viewpoint of the Recent Graduate, by A. N. Curtiss, '27, University of Pittsburgh, and C. L. Parks, '28, West Virginia University.

The attendance at this Conference was about 100 and the talks were enjoyed very much by all the students present. About 53 students attended the dinner and evening meeting. For a complete report on that meeting, see Section Activities department.

PAST BRANCH MEETINGS

Alabama Polytechnic Institute

Discussion of possibilities of a monthly joint meeting of all the engineering societies on the campus. Committee appointed to discuss the matter with officers of other societies. December 13. Attendance 28.

Business Meeting. The following officers were elected: Chairman, J. J. O'Rourke; Vice-Chairman, J. D. Neeley; Secretary-Treasurer, C. E. Meyer; Plainsman Reporter, P. Brake; Auburn Engineer Reporter, O. T. Allen. January 3. Attendance 38.

University of Arizona

Television, by George Harding, student. November 14. Attendance 10.

Hyperbolic Angles, by George Linn, student. November 21. Attendance 10.

The Handling and Uses of Rope in Construction Work, by Sam Headman, Construction Engr., Federal Light and Traction Co. Smoker. December 5. Attendance 23.

Loud Speaker Characteristics, by J. Sigler, student. December 19. Attendance 5.

Brooklyn Polytechnic Institute

Application of the Sperry Gyroscopes, by R. E. Witham, Sperry Gyroscope Co. Four reels of film on the Gyro-Compass and the Gyro-Stabilizer. December 7. Attendance 47.

Case School of Applied Science

Safety First Policies and Resuscitation. Glenn E. Smith, Ohio Bell Telephone Company, with four assistants showed a National Safety Council picture and gave demonstrations and talks. November 20. Attendance 36.

Clemson College

Early Power Development at Niagara Falls, by J. M. Prim, student;

Invention and Development of Bakelite, by M. T. Geddings; student;

Series Capacitors on Three-Phase Transmission Lines, by J. H. Clippard, student, and

Current Events, by J. A. Graves, student. Discussion of means of increasing the attendance; committee of three appointed to prepare suggestions. December 6. Attendance 32.

University of Denver

Inspection tour through the Denver Tramway Power Plant. December 10. Attendance 21.

Business Meeting. It was decided to have capable students give papers on interesting topics at future meetings. December 20. Attendance 11.

Business Meeting. January 11. Attendance 15.

Drexel Institute

Dr. Michael I. Pupin, by Mr. LePane, student. Plans for the Student Convention discussed. A representative of Branch was appointed to the Drexel Scholastic Council. December 7. Attendance 15.

University of Florida

Electrical Contracting, by L. Doub, student. December 10. Attendance 12.

Georgia School of Technology

Operation of Manual and Panel Central Office Equipment of The Southern Bell Telephone Co., by Mr. Sheppard. Inspection trip through the entire building. December 14. Attendance 53.

University of Idaho

Televox, by Prof. J. H. Johnson, Head of the Dept. of Elec. Engg., and Counselor, and

1928 Summer Convention, by C. L. Farrar, Instructor in Elec. Engg. Chairman O. C. Mayer reported on a meeting of the Spokane Section. October 26. Attendance 27.

Iowa State College

Business Meeting. Several committees appointed to prepare for smoker. December 19. Attendance 20.

University of Kansas

Business session followed by student reports on the annual engineers trip, as follows: Commonwealth Edison Company's Power Stations, Chicago, by Mr. Howell; Inland Steel Co., Indiana Harbor, by Mr. Westfall; Underwriters Laboratories, Chicago, by Mr. Douglas; International Harvester Co., Chicago, by Mr. Douglas; Western Electric Co., Chicago, by Mr. Gardner; Allis-Chalmers Co., by Mr. Baxter; Norberg Co., Milwaukee, by Mr. Novak; Westinghouse Lamp Works, Chicago, by Mr. Stanton; Lakeside Power Plant, Milwaukee, by Mr. Lowe; and Keokuk Power Plant, Keokuk, by Mr. Ruggie. December 6. Attendance 38.

Lehigh University

Parallel Resonance Phenomena, by H. G. Wiest, Jr., '29. Student paper and demonstration.

My Five Nights in Paris, by Prof. J. L. Beaver, Counselor. Adoption of By-laws. Appointment of committee to judge student papers for the year and award the \$10 prize. Program followed by refreshments and short entertainment. December 13. Attendance 73.

University of Louisville

Joint meeting with Louisville Section (Complete report in Section Activities department of this issue). December 19. Attendance 35.

University of Maine

Joint engineering smoker with Alpha Chi Sigma, A. S. M. E. and A. S. C. E. Talks by Dean Paul Cloke and Professor Charles Weston. Refreshments. December 6. Attendance 275.

Signal Corps, by Merton Morse, student. Film entitled "Big Deeds." January 10. Attendance 20.

University of Michigan

Origin and Development of the A. I. E. E., by Dr. B. F. Bailey, E. E. Dept. Dean Sadler, Engineering School, gave his ideas of student societies. Discussion of the program for the remainder of year. October 9. Attendance 29.

Vacuum Tubes, by W. T. L. Cogger, General Electric Co. November 3. Attendance 50.

Motion picture, entitled "The Single Ridge," November 28. Attendance 50.

School of Engineering of Milwaukee

Chairman Henkel gave a report on Conference on Student Activities held in Chicago, December 3, 1928. Two committees were appointed, one to audit the books and the other to arrange meetings and papers. December 12. Attendance 22.

University of Minnesota

Inspection trip to the High Bridge Station where the Northern States Power Company provided a free dinner. G. O. House, Manager of the St. Paul Division of the Company, gave a short talk on the plant and presented a motion picture showing the construction. The plant was inspected in groups of 10. December 5. Attendance 130.

Missouri School of Mines & Metallurgy

Motor Assembly & Repairs at Emerson Electric Co., by H. C. Page, student;

The Student Training Course of the Commonwealth Edison Co., by C. E. Gutke, student and

Distribution System Problems of the Union Electric Light and Power Co., by A. T. Gargner, student. Program committee appointed to make plans for future meetings. The following officers were elected: President, Fred B. Beatty; Secretary Treasurer, E. J. Gregory. November 6. Attendance 20.

Montana State College

Editorial from the Electrical World for July 14, 1928, read by H. A. Morton. December 6. Attendance 73.

Electrical Show. (Complete report in Student Activities department of January issue.) December 8. Attendance 275.

University of Nebraska

Telephone Equipment and Testing, by R. A. Vanderlippe, Lincoln Telephone Co. and Junior in E. E.

Choice of a Profession, by Dr. E. B. Roberts, Westinghouse Elec. & Mfg. Co. Announcement that the Branch had received a prize of \$10.00 for securing the greatest number of subscriptions to the Nebraska Blue Print. John Byron was elected to represent the Branch on the staff of the Blue Print. December 10. Attendance 44.

Electrolytic Condensers, by S. W. Cowley, Chairman, and

Why Should We Be Members of the A. I. E. E.?, by Dean O. J. Ferguson, Vice-President, District No. 6. Prof. F. W. Norris, Counselor, discussed the proposed Constitution of a new student organization to be known as the Nebraska Engineering Council. January 10. Attendance 33.

Newark College of Engineering

Diesel Engines as Used on Ships, by P. J. Dumont, student. Slides.

Telephone Relays, by Mr. Reiger, student. Samples. Arrangements for inspection trip to New Jersey Telephone Company's building in Newark announced. Other trips discussed. December 17. Attendance 25.

A. C. Printing Press Control, by J. A. Heperland. January 7. Attendance 25.

University of New Hampshire

Starting as an Engineer and Engineering Aptitudes, by John Mills, was read by the members of the class. January 5. Attendance 30.

College of the City of New York

Inspection trip to the Long Distance Exchange of the A. T. & T. Co. December 12. Attendance 9.

Business Meeting. The following officers were elected: Chairman, Daniel Klatzko; Vice-Chairman, Quirino Galante; Secretary, Walter Broleen; Treasurer, Robert Fassnacht. January 10. Attendance 19.

University of North Dakota

Electrification of Railroads, by Burke Bair, student, and

The Business Side of Engineering, by Gustave Glass. Refreshments. January 10. Attendance 15.

Northeastern University

Design of Radio Frequency Apparatus, by H. W. Lamson, General Radio Co. Refreshments. December 11. Attendance 84.

University of Notre Dame

Cathode Ray Tube Used as an Oscillograph, by B. J. South, student; and

Television-Pickup-Amplification-Transmission-Reception, by J. P. Kennedy, student, and South Bend radio service man. November 13. Attendance 45.

Movietone, by W. H. Luedtke, student;

Biographical Sketch of Andre Ampere, by E. W. Brieger, student;

The Radio-Acoustic Method of Hydrographic Survey, by Wilbur Kingseed, student, and

A Few of the More Important Uses of Electricity in Mining Operations, by K. F. Smith, Professor of Mining Engineering. Refreshments. November 26. Attendance 45.

The Sun and Some of Its Properties, by Richard Grimm, student; *Biographical Sketch of Dr. Charles P. Steinmetz*, by J. J. O'Brien, student;

Audion Tube, by Eugene A. Milliff, student, and

Criticism of an Article entitled, "Fortune Awaits the Man who Can Conquer Static," by B. F. Dashield, U. S. Weather Bureau, in New York Times of December 2, 1928, Daniel Hull, Associate Professor of Mathematics and Physics. Refreshments. December 11. Attendance 71.

Ohio Northern University

The Electromagnetic Theory, by T. W. Rundell, student, and

Frequencies, by H. Rosebrook, student. January 10. Attendance 20.

Ohio State University

Convention held by Ohio State University, Case School of Applied Science, Ohio University, Ohio Northern University, and Akron Municipal University Branches. (Complete report in Student Activities department of January JOURNAL.) December 7 and 8.

Oklahoma A. & M. College

Air Port Lighting, by Chairman E. L. Weathers. Motion pictures, entitled "Big Deeds" and "The Light of the Race," were shown. December 14. Attendance 15.

University of Oklahoma

Motion pictures on The Cascade Tunnel and "The Single Ridge." November 15. Attendance 38.

Problems of Overhead Distribution, by Virgil Pendleton, Distribution Engineer, Oklahoma Gas and Electric Co., and

Underground Distribution Problem, by John Shawner, Supt. of Underground Distribution, Oklahoma Gas and Electric Co. December 13. Attendance 22.

Pennsylvania State College

Mr. Yeakel read a paper on Electric Welding prepared by Mr. Warner. Practical demonstration of Electric Welding given by Prof. Woelful. The following officers were elected: Vice-President, W. C. Mason; Assistant Secretary, M. Long. January 9. Attendance 55.

University of Pittsburgh

The Use of Neon Tubes in Signs, by C. B. Rodgers, Gardner Sign Co. Demonstration of several types of tubes and mounting. Films entitled "Arteries of Industry" and "So This is Eden." November 23. Attendance 41.

Oxygen-Acetylene Torches in Industry, by G. E. Hareke, Air Reduction Sales Co. Film. Demonstration of the properties of liquid oxygen. Joint meeting of all the student engineering societies. December 7. Attendance 115.

Joint Student Branch Conference and inspection trip, in connection with Midwinter dinner meeting of Pittsburgh Section and Engineers Society of Western Pa. (See reports in Student Activities and Section activities departments of this issue). January 8.

Rensselaer Polytechnic Institute

Waves, by Dr. G. H. Carrigan, Dept. of Physics and Elec. Engg. Illustrated by experiments and slides. Dr. W. L. Robb, Head, Dept. of Elec. Engg., asked that the Branch support him in an electrical exposition during January at the Institute. By-laws adopted. December 18. Attendance 261.

Rhode Island State College

Early History of Electrical Engineering, by Prof. A. E. Watson, Head, Dept. of E. E., Brown University. November 14. Attendance 22.

Motion picture, entitled "Manufacture of Radio Tubes." Music by student orchestra. December 12. Attendance 61.

Rutgers University

Traction, by Mr. Hobson, student. Discussion of plans for New York Section Student Convention. December 10. Attendance 18.

University of South Carolina

Motion picture, entitled "Electrified Travelog." A motion was passed requiring that each member of the Branch be furnished with a copy of the By-laws. January 9. Attendance 17.

South Dakota State School of Mines

Aeronautics, by Russ Halley. Instructor and part owner of "Rapid City Air Lines." January 8. Attendance 29.

University of South Dakota

The Coolidge Multiple Dome Dam, by Paul Schell, Secretary, and *Hydroelectric Power and Its Possibilities in the State of Washington*, by Kenneth Hayward, student. November 19. Attendance 12.

Stanford University

The Screen-Grid Radio Tube, by Birney Dysart. December 11. Attendance 19.

Stevens Institute of Technology

Airplane Wings, by Walter Haessler, student, and *Smoke Nuisance in the Metropolitan District*, by Robert Cole, student. 3-reel motion picture "Natures Frozen Credits." Discussion of plans for joint smoker early in February. Joint meeting with A. S. M. E. January 4. Attendance 27.

Swarthmore College

Transatlantic Telephony, by W. F. Denkhau, Bell Telephone Co. of Pa. Films. Refreshments. December 13. Attendance 28.

Texas A. & M. College

Houston Power Plant, by S. M. Richie, student. Motion picture, entitled "From Coal to Electricity." January 4. Attendance 46.

University of Texas

Use of Neon Tubes in Advertising, by W. V. Sippola, student. December 13. Attendance 15.

University of Vermont

The Barkhausen Effect, by Laurence Cowles, Secretary. Demonstration. December 11. Attendance 7.

University of Washington

The Regulation of Public Utilities, by Wellington Rupp, Consulting Engr. December 7. Attendance 15.

West Virginia University

The New Portable Oil Testing Set, by J. E. Winters, student; *Death-Whisper*, by G. H. Hollis, student; *The Value of Electrification of the Steel Industry*, by C. E. Moyers, student; *Hearing Light and Seeing Sound*, by C. W. Thrall, student; *Electro-Metallurgical Plant at Glenferris, W. V.*, by Geo. C. Barnes, student, and *New Developments in the One-Man Street Car*, by B. J. Paladino, Student. November 26. Attendance 28.

Worcester Polytechnic Institute

Gasoline Talk, by Prof. C. S. Allen. Consisted largely of experiments on inflammability of gasoline and kerosene. Joint meeting with A. S. M. E. and A. S. C. E. January 9. Attendance 300.

Yale University

Electrical Engineering Exhibition. (Complete report elsewhere in Student Activities department of this issue.) December 14 and 15.

Engineering Societies Library

The Library is a cooperative activity of the American Institute of Electrical Engineers, the American Society of Civil Engineers, the American Institute of Mining and Metallurgical Engineers and the American Society of Mechanical Engineers. It is administered for these Founder Societies by the United Engineering Society, as a public reference library of engineering and the allied sciences. It contains 150,000 volumes and pamphlets and receives currently most of the important periodicals in its field. It is housed in the Engineering Societies Building, 29 West Thirty-ninth St., New York.

In order to place the resources of the Library at the disposal of those unable to visit it in person, the Library is prepared to furnish lists of references to engineering subjects, copies or translations of articles, and similar assistance. Charges sufficient to cover the cost of this work are made.

The Library maintains a collection of modern technical books which may be rented by members residing in North America. A rental of five cents a day, plus transportation, is charged.

The Director of the Library will gladly give information concerning charges for the various kinds of service to those interested. In asking for information, letters should be made as definite as possible, so that the investigator may understand clearly what is desired.

The library is open from 9 a. m. to 10 p. m. on all week days except holidays throughout the year except during July and August when the hours are 9 a. m. to 5 p. m.

BOOK NOTICES, DEC. 1-31, 1928

Unless otherwise specified, books in this list have been presented by the publishers. The Society does not assume responsibility for any statement made; these are taken from the preface or the text of the book.

All books listed may be consulted in the Engineering Societies Library.

A. E. F. VERHANDLUNGEN DES AUSSCHUSSES FUR EINHEITEN UND FORMELGROSSEN in den Jahren 1907 bis 1927.

Edited by J. Wallot. Berlin, Julius Springer, 1928. 49 pp., 12 x 9 in., paper. 5.-r. m.

This pamphlet is a new edition (revised) of the decisions of the Committee for units and symbols representing the principal German physical and electrical societies, containing the mathematical symbols and units of measurement approved by the committee and the decisions regarding their use. To students of German works and to all interested in the standardization of symbols and terminology, the book will be of much interest.

ACCOUNTING AND COST FINDING FOR THE CHEMICAL INDUSTRIES.

By George A. Prochazka. N. Y., McGraw-Hill Book Co., 1928. (Chemical engineering series). 242 pp., graphs, forms, tables, 9 x 6 in., cloth. \$3.00.

Presents economical methods of finding costs in a practical form. The book shows how a chemical industry may devise, install and operate a cost system that will be satisfactory.

THE AIRPLANE AND ITS ENGINE.

By Charles Hugh Chatfield and Charles Fayette Taylor. N. Y., McGraw-Hill Book Co., 1928. 329 pp., illus., diags., tables, 8 x 6 in., cloth. \$2.50.

This book attempts to fill a middle ground between the wants of those interested in romantic aviation and those in search of

highly technical information. It appeals to those who wish a sound knowledge of basic facts and theories but do not wish to give to the subject the intensive study required of the designer or builder. We have here a sound, yet simple, discussion of the principles, construction and capabilities of airplanes and airplane engines.

ANNUAL SURVEY OF AMERICAN CHEMISTRY, v. 3, July 1927—July 1928.

Edited by Clarence J. West. N. Y., Published for National Research Council by Chemical Catalog Co., 1928. 395 pp., 9 x 5 in., cloth. \$3.00.

A review of the work published by American chemists during the last year. The field is divided into forty-six divisions, each of which is reviewed by an expert. Many divisions, such as those devoted to fuels, petroleum, cement, iron and steel, and water and sewage, are also of direct usefulness to engineers.

AUTOMOTIVE GRINDING.

By Fred B. Jacobs. Cleveland, O., Penton Publishing Co., 1928. 146 pp., illus., 9 x 6 in., cloth. \$2.00.

Illustrates and describes the numerous types of grinding operations now used in automobile factories, such as cylindrical grinding, internal grinding, surface grinding, disk grinding, cam grinding, centerless grinding, and piston grinding. Advice is given on the selection of wheels and on testing, on the design of grinding machines and the handling of work. Although the book is confined to grinding in automobile factories, the methods shown can be applied to precision grinding in all lines of work.

DIE BELASTBARKEIT DER WALZLAGER.

By Helmut Stellrecht. Berlin, Julius Springer, 1928. 98 pp., illus., 10 x 7 in., paper. 9.-r. m.

The author's aim is to provide a more scientific basis for designing ball bearings and roller bearings. He analyzes the stresses

to which these bearings are subjected and derives formulas by which the load that a given bearing can carry may be calculated accurately. These formulas enable the designer and manufacturer to select suitable dimensions for a bearing and to avoid the use of unduly large safety factors.

DIE BERLINER MASCHINEN-INDUSTRIE UND IHRE PRODUKTIONSBEDINGUNGEN SEIT IHRER ENTSTEHUNG.

By K. Doogs. Berlin, Julius Springer, 1928. 121 pp., maps, tables, 9 x 6 in., paper. 10.-r. m.

A historical and economic study of the manufacture of machinery in the Berlin district. The development of the industry is traced historically from the beginning of the eighteenth century and also from various economic and technical points of view. The reasons and effect of this development are traced and future prospects discussed.

BONBRIGHT SURVEY OF ELECTRIC POWER AND LIGHT COMPANIES OF THE UNITED STATES.

Edited by G. F. Wittig. 5th edition. N. Y., McGraw-Hill Publishing Company, 1928. 196 pp., maps, 11 x 9 in., paper. \$10.00.

This survey lists the cities and towns in the various states with a population of over 2500, shows the electric companies serving them, and gives financial statistics concerning these companies. Statistics are also given of the population, use of electricity, income, etc., of each state.

LES CHEMINS DE FER URBAINS PARISIENS.

By Louis Biette. Paris, J.-B. Baillièrre et fils, 1928. 523 pp., illus., diags., 9 x 6 in., paper. 90 fr.

A very complete description of the rapid-transit system of Paris. Full details are given on the engineering features of the subways and elevated lines, on the methods used in constructing these, on the financial arrangements and on their history.

LES CYCLES IRREVERSIBLES ET LA TURBINE VAN DEN BOSSCHE.

By J. Van den Bossche. Paris, Chaleur & Industrie, 1928. 38 pp., diags., 9 x 6 in., paper. Price not quoted.

The Bossche turbine, in place of the customary reversible Rankine cycle, uses an irreversible-cycle which is not governed by the second law of thermodynamics and hence does not require a drop in temperature. The pamphlet explains the principle of the irreversible cycle, discusses the theoretical advantages of the new turbine, and describes its construction and operation in detail.

DIELECTRIC PHENOMENA, v. 2; Electrical Discharges in Liquids.

By S. Whitehead. Lond., Ernest Benn, 1928. 137 pp., diags., 9 x 6 in., fabrikoid. 12/6.

The second of a series of volumes being prepared by the British Electrical and Allied Industries Research Association, giving a critical résumé of available information on dielectric phenomena, with particular attention to the theoretical basis, and particular reference to the failure of insulation in service. This volume deals with discharge phenomena in liquids.

ELECTRICAL SUBSTATIONS.

By H. Brazil. Lond., Edward Arnold; N. Y., Longmans, Green & Co., 1928. 215 pp., illus., diags., tables, 9 x 6 in., cloth. \$5.00.

A concise treatise on substation design and arrangement, on the equipment and on operation. Gives especial attention to English practice and conditions.

ELEMENTARY FOUNDRY TECHNOLOGY with special reference to Gray Iron and Steel.

By Lawrence A. Hartley. N. Y., McGraw-Hill Book Co., 1928. (Vocational Texts). 423 pp., illus., 8 x 6 in., cloth. \$3.00.

In preparing this text the editor, who is Director of Education to the National Founders' Association, has had assistance of many leading founders. The result is a textbook giving an accurate description of the principles of founding in simple, clear language that beginners can understand. The book is the first of a series of texts for industrial schools and home study which are being prepared to conform to the Minimum Standard of Four-Year Foundry Apprenticeship in the United States.

ELEMENTS OF GEOPHYSICS AS APPLIED TO EXPLORATIONS FOR MINERALS, OIL AND GAS.

By Richard Ambronn. N. Y., McGraw-Hill Book Co., 1928. 372 pp., diags., tables, 9 x 6 in., cloth. \$5.00.

This is the first attempt, apparently, at a systematic account in the English language of the geophysical methods of exploration as applied in mining and hydraulics. Dr. Ambronn's book

explains the methods with sufficient fulness to make the geologist and the engineer conversant with their possibilities, and so to enable them to use the help of the physicist intelligently. In addition a very comprehensive and valuable bibliography is included.

FERTIGKONSTRUKTIONEN IM BETON-UND EISENBETONBAU.

By A. Kleinlogel. Berlin, Wilhelm Ernst & Sohn, 1929. 91 pp., illus., 10 x 7 in., paper. 8, 60 r. m.

An interesting review of the present use of precast concrete and reinforced concrete structural elements in the construction of buildings, bridges, retaining walls, harbor works, dams, railroads and conduits. The book is purely descriptive and is chiefly confined to German structures. The illustrations are profuse.

GRAPHISCHE STATIK, v. 2. 2nd edition.

By Otto Henkel. Ber. u. Lpz., Walter de Gruyter & Co., 1928. 176 pp., diags., 6 x 4 in., cloth. 1,50 r. m.

A text-book for the student who wishes to acquire a knowledge of the more important applications of graphic statics without extended theoretical study, and a concise reference book for engineers in practice.

HANDBOOK OF DOMESTIC OIL HEATING.

Edited by Harry F. Tapp. N. Y., American Oil Burner Assoc., 1928. 383 pp., illus., diags., tables, 8 x 5 in., fabrikoid. \$3.00.

A practical treatise on the heating of residences by oil-fired furnaces. The subjects include the calculation of the heating equipment necessary, the properties of fuel oil, comparative heating costs, oil-burning equipment, heating systems, installation, testing, etc.

HANDBUCH FÜR FLUGZEUGFUHRER.

By H. G. Bader. Berlin, V. D. I. Verlag, 1928. 193 pp., illus., 8 x 6 in., cloth. 12.-r. m.

In the eight papers here published, eight experts discuss the influence of design upon the flying qualities of airplanes, power plants, instruments, test flying, the organization of air traffic, the commercial flyer, meteorology, and airplane building. The work is intended as a handbook for builders and organizers of air services.

HISTORY OF MATHEMATICAL NOTATIONS, v. 1; Notations in Elementary Mathematics. Chic., Open Court Publ. Co., 1928. 451 pp., illus., 9 x 6 in., cloth. \$6.00.

Professor Cajori gives an elaborate account of the way in which the symbols of elementary mathematics originated, of their spread among different writers and of the competition that they encountered. The volume opens with a description of the numerical symbols used by various nations of antiquity, and of the introduction and adoption of the present system. Following this, the symbols used in elementary arithmetic, algebra and geometry are discussed. The book is illustrated by numerous interesting facsimiles of early texts and contains extensive bibliographic notes. It will not only be useful to students of the history of mathematics and of present-day problems of notation, but also of general interest to all users of mathematics.

HUTTE; Taschenbuch für Betriebsingenieure. 3rd edition.

By Akademische Verein Hütte, E. V. in Berlin. Berlin, Wilhelm Ernst & Sohn, 1929. 1215 pp., illus., diags., tables, 8 x 5 in., cloth. 35.-r. m.

This recent addition to the library of concise handbooks is intended for the factory superintendent and works manager. The subjects discussed include the principles of interchangeable manufacturing, machine drives, balancing of machinery, factory buildings, works organization, labor laws, foundry practice, welding and brazing, forging and stamping, hardening and heat treating, metal cutting, and spray painting. This edition contains new sections on a number of important topics.

INDUSTRIAL EXPLORERS.

By Maurice Holland and Henry F. Pringle. N. Y., Harper & Bros., 1928. 347 pp., ports., 9 x 6 in., cloth. \$3.00.

Nineteen biographical sketches of living Americans of note in industrial research work. Through the lives of these leaders, the authors emphasize the importance of science to industry and call attention to the contributions of industrial research to the comfort of modern life. A readable, interesting book.

INORGANIC CHEMICAL TECHNOLOGY.

By W. L. Badger and E. M. Baker. N. Y., McGraw-Hill Book Co., 1928. (Chemical engineering series). 228 pp., illus., diags., tables, 9 x 6 in., cloth.

Prepared to meet the desire of its authors for a college text-book upon the technology of the heavy chemical industries

which would represent current American practice without too great detail. The industries described include salt, sulfuric acid, nitric acid, sodium carbonate, caustic soda, chlorine, bleaching powder, and various other products. The work differs from most others on these industries, in presenting them from the point of view of the engineer rather than of the industrial chemist.

INTRODUCTION TO THE THEORY OF EDDY-CURRENT HEATING.

By C. R. Burch and N. Ryland Davis. Lond., Ernest Benn, 1928. 72 pp., illus., diags., 9 x 6 in., cloth. 12/6.

The authors of this little book, two Cambridge physicists engaged in industrial research, have developed the mathematical theory of the induction furnace and applied it to furnace design and construction. Their efforts have resulted in formulas by which the capital cost, running cost, and properties of a furnace of given dimensions may be predicted, and furnaces based on their predictions have operated most successfully.

DIE KRANKHEITEN DES BLEI-AKKUMULATORS.

By F. E. Kretzschmar. 3rd edition. Mün. u. Ber., R. Oldenbourg, 1928. 181 pp., diags., 9 x 6 in., cloth. 10, 50 r. m.

A practical book on the care of lead storage batteries. The author discusses the origin of all the various real and apparent difficulties that may occur, and the methods of determining their causes and removing them. Preventive methods are also given. The information is unusually complete and definite.

MACHINES HYDRAULIQUES.

By Louis Bergeron. Paris, Dunod, 1928. 881 pp., illus., diags., 8 x 5 in., paper. 108, 75 fr.

This volume, based upon the practical experience of the author and upon numerous special investigations of hydraulic problems, is a concise encyclopedia of hydraulic machinery. The essential theory is developed entirely with elementary mathematics and the descriptive portion covers an unusual variety of pumps, rams, turbines, hydraulic presses, etc.

MECHANICAL POWER TRANSMISSION.

By William Stanier. N. Y., McGraw-Hill Book Co., 1928. 409 pp., illus., tables, 9 x 6 in., cloth. \$5.00.

A practical exposition of all phases of the subject, covering not only belting, but also all the accessories, such as bearings, shafting, pulleys, chains, speed controllers and reducers, belt shifters, etc. Discusses also the maintenance and lubrication of transmission machinery. The author describes current methods in detail and explains how and where to use them. Theory is omitted, the treatment being based on operating results and experiences. The book is based on the author's experience in the plants of E. I. du Pont de Nemours & Company and the General Motors Company.

METHODES GRAPHIQUES POUR L'ETUDE DES INSTALLATIONS DE CHAUFFAGE ET DE REFRIGERATION EN REGIME DISCONTINU.

By André Nessi and Léon Nisolle. Paris, Dunod, 1929. (Physique Industrielle). 168 pp., graphs, diags., 11 x 8 in., paper. 96.25 fr.

A thorough mathematical discussion of the design of heating plants, in which the calorific capacity of building materials and variations in external temperature are taken into account. This complicated problem the authors solve analytically, and finally express their results in a series of graphic charts which can be applied directly to the determination of the proper sizes of heating plants and to their economical operation under varying temperatures. The method is applicable, the authors state, not only to the heating of buildings, but also to all problems of industrial heating and of refrigeration.

METHODS IN NON-FERROUS METALLURGICAL ANALYSIS.

By Robert Keffer and Charles L. McNeil. N. Y., McGraw-Hill Book Co., 1928. 335 pp., diags., tables, 9 x 6 in., cloth. \$4.00.

A manual of methods for analyzing non-ferrous ores, mill and concentrator products, intermediate furnace products, fluxes, by-products, metals and alloys. The methods given are chiefly those used in the laboratory of the Anaconda Copper Mining Company, and are designed to give a high degree of accuracy combined with speed in obtaining results.

MOLECULAR REARRANGEMENTS.

By C. W. Porter. N. Y. Chemical Catalog Co., 1928. (American Chemical Society. Monograph series). 167 pp., 9 x 6 in., cloth. \$4.00.

This monograph presents our knowledge of unimolecular reactions which modify the structure of the molecule, and pro-

vides references to the original researches. The author reviews and classifies the important types of rearrangements and presents the principal theories relating to mechanisms.

PHOSPHORESZENZ UND FLUORESCENZ, v. 2.

By P. Lenard, Fred. Schmidt and R. Tomaschek; also, Lichtelektrische Wirkung, by P. Lenard and A. Becker. Leipzig, Akademische Verlagsgesellschaft, 1928. (Handbuch der Experimentalphysik, v. 23, pt. 2). p. 745-1544, illus., tables, 10 x 7 in., cloth. 72.-r. m.

This volume contains the conclusion of the treatise on phosphorescence and fluorescence, together with the section on photoelectricity. The treatment is encyclopedic and thorough, bringing together our knowledge on these subjects in convenient form for reference, and providing references to original sources. Will be useful to all engaged in research.

LA PHYSIQUE DE LA GRAVITATION ET LA DYNAMIQUE DE L'UNIVERS.

By Thomas Tommasina. Paris, Gauthier-Villars et cie., 1928. 301 pp., port., 10 x 7 in., paper. 50 fr.

A critical study of the fundamental notions of physics and astronomy. The authors view with disfavor many modern theories, particularly those of Einstein, and offers instead a purely mechanical and material explanation of the nature of all physical and astronomical phenomena.

PITMAN'S TECHNICAL DICTIONARY OF ENGINEERING AND INDUSTRIAL SCIENCE IN SEVEN LANGUAGES. Lond. & N. Y., Isaac Pitman & Sons, 1928-29. 10 x 8 in., paper. 36 issues complete the vol.; 15 parts already published. 75c. each. Bound vols. to sell for about \$30.00.

Sir Isaac Pitman and Sons are issuing, in fortnightly parts, a new technical dictionary, which they expect to complete early in 1929. The dictionary covers the entire field of engineering and will contain some two thousand pages of technical terms, in English, French, German, Italian, Russian, Spanish and Portuguese. The equivalents appear accurate and the book will be a welcome addition to the translator's equipment.

PRINCIPLES AND PRACTICE OF THE DILUTION METHOD OF SEWAGE DISPOSAL.

By W. E. Adeney. Cambridge (Eng.), University Press, 1928. (N. Y., Macmillan Co.) (Cambridge Public Health series). 161 pp., illus., tables, 9 x 6 in., cloth. \$5.00.

An account of the investigations that have been carried out by the Royal Commission on Sewage Disposal, the Metropolitan Sewerage Commission of New York, the author and other workers, so far as they have led to the recognition of the principles which must underlie the successful application of the dilution method, and have rendered it possible to determine definitely the extent to which the waters of a given river can assist in the disposal and purification of the sewage of a community.

PRINCIPLES OF ELECTRIC POWER TRANSMISSION BY ALTERNATING CURRENTS.

By H. Waddicor. N. Y., John Wiley & Sons, 1928. 399 pp., diags., tables, 9 x 6 in., cloth. \$6.00.

A textbook intended primarily for college students but also aiming to be a reference work for designers and operators. Gives a systematic exposition of the principles involved. Contains good lists of references, appended to each chapter.

PRINCIPLES OF SCIENTIFIC PURCHASING.

By Norman F. Harriman. N. Y., McGraw-Hill Book Co., 1928. 301 pp., graphs, forms, 9 x 6 in., cloth. \$3.00.

Treats concisely of fundamental economic, technical, financial, legal, psychological and allied aspects of purchasing. Inspection and the budgetary control of purchasing are also treated, and the purchasing organizations and procedures of several large companies. A bibliography is included.

Hitherto books on purchasing have been chiefly concerned with standard forms and routine office methods. Such discussions of general principles as the present are rare.

REFRIGERATION, including Household Automatic Refrigerating Machines.

By James A. Moyer and Raymond U. Fittz. N. Y., McGraw-Hill Book Co., 1928. 431 pp., illus., diags., tables, 9 x 6 in., cloth. \$4.00.

Intended both as a textbook and work of reference, this book discusses quite thoroughly modern methods of industrial and domestic refrigeration. The information is up to date and is presented in a form useful to operators of plants.

REMINISCENCES.

By R. E. Crompton. Lond., Constable & Co., 1928. 238 pp., illus., ports., 9 x 6 in., cloth. 14s.

Colonel Crompton's activity as an engineer began when, as a boy, he undertook, about 1860, the construction of a steam road engine. Ten years later he was in charge of mechanical road transport for the Indian army. About 1875, on his return to England, he became interested in the new field of electric lighting, with which his name is so closely associated.

His brief biography gives an interesting account of his multifarious activities as a pioneer in electrical and automobile engineering.

SOLUBLE SILICATES IN INDUSTRY.

By James G. Vail. N. Y., Chemical Catalog Co., 1928. (American Chemical Society. Monograph series). 443 pp., illus., diags., tables, 9 x 6 in., cloth. \$9.50.

Although water glass has many important industrial uses, there have been very few general treatises on it, and the literature is widely scattered. Mr. Vail has therefore performed a real service in preparing this critical résumé of our knowledge of the soluble silicates and their uses.

Starting with an account of their constitution, forms and reactions, the book then describes the preparation of these silicates, the commercial forms and their properties. The uses as cements, adhesives, sizes, coatings, deflocculents, detergents, films, gels, water purifiers, etc., are then described in a practical way. An extensive bibliography is given.

UBER DIE ANLASSVORGANGE IN ABGESCHRECKTEN CHROM-UND MANGANSTAHLN.

By Hans Goerisch. Berlin, Julius Springer, 1928. (Berichte aus dem Institut für Mechanische Technologie und Materialkunde der Technischen Hochschule zu Berlin. Heft 2). 36 pp., illus., diags., tables, 9 x 6 in., paper. 3,60 r. m.

An investigation of the extent to which chromium and manganese affect change in properties, especially length, that occurs in hardened steel bars during annealing. The research has practical interest because it throws light on the more or less metastable condition of steel at ordinary temperatures, a question of importance to makers of gauges and measures.

UNBILDSAME ROHSTOFFE KERAMISCHER MASEN.

By Rudolf Niederleuthner. Wien, Julius Springer, 1928. 577 pp., illus., diags., tables, 9 x 6 in., bound. 39.-r. m.

While numerous books are extant upon the plastic materials of the ceramic industry, there has been no general description

of the non-plastic materials available. Professor Niederleuthner has filled the gap with this book, which contains information hitherto accessible only in widely scattered places.

After a general discussion of the materials used to reduce plasticity, as fluxes and to increase refractory qualities, the various materials used for the last purpose are discussed, with special attention to their physical and chemical properties. The book will be useful as a reference work to manufacturers generally.

UNTERSUCHUNGEN AN DER DIESELMASCHINE. By Kurt Neumann.

UNTERSUCHUNGEN ZUR DYNAMIK DES ZUNDEVORGANGES. By Otto Klüsener.

Berlin, V. D. I. Verlag, 1928. (Forschungsarbeiten, heft 309) 35 pp., illus., diags., tables, 12 x 8 in., papers. 6.-r. m.

The first of these reports describes an investigation of the phenomena occurring in the preliminary combustion chamber and the cylinder of precombustion Diesel engines. It is based on elaborate tests made upon an 18-hp. Koerting engine under full load.

The second is a study of explosions in cylindrical vessels, undertaken to determine the velocity of explosion and the influence of fortexes upon it.

DER VERBRENNUNGSVORGANG IM GAS-UND BERGASER-MOTOR.

By Wilhelm Endres. Berlin, Julius Springer, 1928. 80 pp., diags., tables, 10 x 7 in., paper. 6,80 r. m.

To determine mathematically the combined effect of the various factors that affect combustion in internal-combustion engines, such as the chemical properties of the fuel, the compression, the shape of the combustion chamber, etc., is very difficult. Dr. Endres, an experienced engine builder, here attempts to appraise the combined action of these various influences. The formulas that he has derived make possible a certain quantitative view of the phenomena of combustion in the engine.

VOITURES ET WAGONS.

By J. Netter. Paris, J.-B. Baillièrre et fils, 1927. 602 pp., illus., diags., 9 x 6 in., paper. 80 fr.

The greater portion of this book is devoted to passenger cars. The various elements, wheels, springs, draft gear, brakes and bodies are discussed at length, and chapters are given to heating and lighting. The descriptions are chiefly of French equipment, but a few types from other countries are included. Freight cars are discussed more briefly.

Engineering Societies Employment Service

Under joint management of the national societies of Civil, Mining, Mechanical and Electrical Engineers cooperating with the Western Society of Engineers. The service is available only to their membership, and is maintained as a cooperative bureau by contributions from the societies and their individual members who are directly benefited.

Offices:—31 West 39th St., New York, N. Y.,—W. V. Brown, Manager.

1216 Engineering Bldg., 205 W. Wacker Drive, Chicago, Ill., A. K. Krauser, Manager.

57 Post St., San Francisco, Calif., N. D. Cook, Manager.

MEN AVAILABLE.—Brief announcements will be published without charge but will not be repeated except upon requests received after an interval of one month. Names and records will remain in the active files of the bureau for a period of three months and are renewable upon request. Notices for this Department should be addressed to **EMPLOYMENT SERVICE, 31 WEST 39th Street, New York City**, and should be received prior to the 15th day of the month.

OPPORTUNITIES.—A Bulletin of engineering positions available is published weekly and is available to members of the Societies concerned at a subscription of \$3 per quarter, or \$10 per annum, payable in advance. Positions not filled promptly as a result of publication in the Bulletin may be announced herein, as formerly.

VOLUNTARY CONTRIBUTIONS.—Members obtaining positions through the medium of this service are invited to cooperate with the Societies in the financing of the work by contributions made within thirty days after placement, on the basis of one and one-half per cent of the first year's salary; temporary positions (of one month or less) three per cent of total salary received. The income contributed by the members, together with the finances appropriated by the four societies named above will it is hoped, be sufficient not only to maintain, but to increase and extend the service.

REPLIES TO ANNOUNCEMENTS.—Replies to announcements published herein or in the Bulletin, should be addressed to the key number indicated in each case, with a two cent stamp attached for reforwarding, and forwarded to the Employment Service as above. Replies received by the bureau after the positions to which they refer have been filled will not be forwarded.

POSITIONS OPEN

ENGINEER, 23-25, preferably college degree E. E. or B. S. in E. E. Minimum two years' university. Experience not essential as six months training program is arranged. Experience in telephone engineering or associated work desirable. Must be energetic, ambitious and have good personality, with ability to meet people from other organizations in conference. Must have initiative and potential supervisory ability.

Salary, \$32-\$40 a week with revision at end of six months, when training is completed. Apply by letter. Location, New York. X-6800.

ELECTRICAL ENGINEER, with two or three years' experience since graduation, in testing and experimental work on motors and control apparatus with a large manufacturing company,—General Electric or Westinghouse Test—desired. Apply by letter. Location, New York City. X-7054.

MEN AVAILABLE

EDITOR, 33, married, technical school and college trained, with 15 years' experience in publishing field covering practically every phase of editorial and advertising work. Thoroughly familiar with electrical, radio and general technical practise. Successful record of accomplishments. Desires responsible position with future. Location, New York City. C-820.

ASSISTANT TO ENGINEER OR SUPERINTENDENT, graduate electrical engineer, 34, single; 14 years' experience in the design, installation, testing, operation, and maintenance of generating, switchboard, transmission, and substation equipment of steam, diesel and hydro operated municipal, public utilities and industrial plants. Location preferred, Midwest or Southwest. C-5404.

PUBLIC UTILITY OR SALES ENGINEER married, 42. Five years' experience with electrical manufacturers. Eight years electrical construction work. Nine years' electrical power sales and other commercial activities with public utilities. Available one month. No location complex. C-3919.

YOUNG SALES ENGINEER. Electrical training at W. P. I. One year manufacturing, three years sales experience. Would like opportunity to develop sales or assist in sales management. C-5431.

ENGINEERING EXECUTIVE, graduate engineer with 21 years' experience in electrical and mechanical design, manufacture and sales; 12 years with the General Electric Company, factory and district office; 9 years present position, smaller company. Now chief engineer and assistant manager. Experienced in engineering, manufacture and sales of mechanical and electrical products. Available upon one month's notice. Location preferred, East or South. C-5433.

SALES ENGINEER, electrical with 15 years' successful sales and merchandising record, desires position with manufacturer which offers opportunity to increase present earnings. Keenly aggressive, possesses abundant health, fully capable of analysing market, to get products into every potential outlet. Vast acquaintance among electrical jobbers, contractor-dealers, central stations, appliance manufacturers throughout United States. A-986.

ELECTRICAL ENGINEER, 29, single, one year Westinghouse Student Test course. Two years supervising general test of electrical and mechanical apparatus. Desires engineering position with public utility or mining company in Latin America. Working knowledge of Spanish. C-2312.

1928 GRADUATE of Bliss Electrical School, 28, married, desires an opportunity with an engineering organization or construction department of public utility. Approximately 10 years' practical experience in construction, maintenance and operation of electrical equipment. Location immaterial, provided opportunity for future is good. C-5444.

GRADUATE ELECTRICAL ENGINEER desires position with public utility or industrial firm. Two years Westinghouse Test. Five years electrical engineering work on industrial plant. Five years electrical design of power plants and substations and some transmission line calculations. Would like a substantial connection with an opportunity. B-8379.

MAINTENANCE ELECTRICIAN, 30; five years' light and power wiring and modern factory maintenance, desires position with reliable concern where advancement commensurate with ability can be assured. C-5446.

SALES ENGINEER, 34. Desires immediate connection with concern dealing with public utilities. Has desirable connections with a number of Eastern public utilities. Graduate Elec-

trical Engineer M. I. T., 1913. Good health, active, mature judgment. Has successful background. Excellent references. Salary \$6000. C-5441.

TECHNICAL GRADUATE, 24, married. Five years' diversified electrical utility experience as switchboard operator and maintenance man, in sub and generating station, would like position as assistant to electrical engineer of large industrial plant or group of plants. C-3909.

ELECTRICAL ENGINEER, desires position doing research or development work. Thoroughly trained and competent meter engineer. Experienced in combustion and general laboratory and power plant testing. Have been successful along development lines. Also extensive public utility experience. C-5258.

ASSISTANT EXECUTIVE, 37, married, technically trained. Connections with large public utility, manufacturers and industrial consultants on work of administrative and commercial research nature. Especially qualified as assistant to busy executive needing man with management ability. Well endorsed. Prefer East. B-9122.

SUPERINTENDENT OF CONSTRUCTION OR MAINTENANCE, 39, married; electrical, mechanical engineer; desires new connection as superintendent of construction or maintenance with mining or power company. Fifteen years' experience steam, hydro and large mining operations, construction and operation. Speaks, reads and writes Spanish fluently. Excellent references past and present. Invites correspondence. Locations, Southwest, Mexico, Central America. B-3699.

A BUSINESS GETTER. SALES EXECUTIVE, 40, with broad knowledge of production, construction and sales and a record as a successful sales engineer, district manager and assistant sales manager will consider position leading to a sales or district managership in either electrical or mechanical line. B-3065.

PLANT AND POWER ENGINEER, 44, married. Wide experience in industrial design, maintenance, construction, cost estimating; includes factory buildings, power generation, distribution, application, also power and industrial reconstruction during uninterrupted operation. Particularly successful developing organizations for maintenance, construction. Education includes commerce and engineering. Capable of accepting management responsibilities. Registered Electrical Engineer. Available immediately. B-8152.

ELECTRICAL ENGINEER, four years' public utility, electrical construction generating and substation work. Three years' electrical superintendent of mine property with Pelton Wheel generating plants. Four years' inspection and testing laboratory. Two years' Westinghouse test. Desires position in Metropolitan District or Pacific Coast. B-8430.

GRADUATE ENGINEER, 18 years' experience with contracting and engineering companies, both sales and as executive in charge of office and design and installation of mechanical equipment of industrial plants, power plants, etc. Capable taking complete charge engineering or contracting office or as sales representative. Location, New York City. B-5050.

ELECTRICAL ENGINEER AND DESIGNER, 31, B. S., 8 years' experience with

public utilities and engineering corporations covering design, specifications and inspection. Speaks German. Desires position as field engineer in New York City or vicinity. C-5473.

PLANT ENGINEER, graduate Massachusetts Institute of Technology. American descent. Over 20 years' experience in design, construction, maintenance of factory buildings, power plants, etc. Has reorganized nonproductive departments with large savings and reconstructed buildings without stopping operation. Registered Mechanical Engineer, New Jersey, Pennsylvania. Excellent references. B-5714.

TWO TECHNICAL GRADUATES, with engineering and business experience, leaving June 20th for an extended tour of Europe and Asia, desire to execute foreign commissions of any nature. Excellent references. C-5481.

JUNIOR ELECTRICAL ENGINEER, 22, married, graduate of well known University. Desires position with power company or consulting engineer. Especially interested in distribution and transmission engineering and in substation work. Eight months Westinghouse test course, several years' business experience. Good personality, best references. Location desired, south of Mason-Dixon Line. C-4303.

ELECTRICAL ENGINEER, member of A. I. E. E. and W. S. E., 20 years' experience in design, construction, operation and management. Transmission lines, distribution systems, substations, railway equipment, power plants. Desires to make a change from present position to a position of responsibility with opportunities. Public Utility or industrial company. C-2217.

GRADUATE ELECTRICAL-MECHANICAL ENGINEER, 36, married; desires position with industrial or public utility. Fifteen years' practical experience covering design, construction, maintenance of distribution and transmission systems, outdoor transformer substations, generating stations. Eight years charge of both electrical and mechanical departments for coal mines. Two years' efficiency and research engineer. C-5277.

TRANSMISSION LINE ENGINEER, 35, University graduate; twelve years' experience in transmission design. Formulation and application of safety codes, design of structures, standardization, sag and tension calculations, etc. At present employed but would like change. C-2014.

GRADUATE ENGINEER, twenty years' electrical and mechanical experience in responsible charge of design, specifications, construction, operation and management, power-plants, transmission and distribution systems; and industrial plants. Wide experience in shop production methods. Licensed professional engineer, New York State. Permanent connection desired. Available at once. B-8170.

ELECTRICAL ENGINEER, 35, married; graduate University California, B. S. Electrical Engineering. Seven years' experience charge hydro-electric power house construction, plants 30,000 kw. and smaller, substations, and distributing systems. Field and office experience construction, operation, distribution extending over period twelve years. Desires position construction or operation engineer power concern. Anywhere, prefer Western United States. C-2614-72-C-7. San Francisco.

MEMBERSHIP—Applications, Elections, Transfers, Etc.

APPLICATIONS FOR TRANSFER

The Board of Examiners, at its meeting held January 16, 1929, recommended the following members for transfer to the grade of membership indicated. Any objection to these transfers should be filed at once with the National Secretary.

To Grade of Fellow

HEHRE, FREDERICK W., Associate Professor of Electrical Engineering, Columbia University, New York, N. Y.

KIDDER, HARRY A., Superintendent of Motive Power, Interborough Rapid Transit Co., New York, N. Y.

KONGSTED, LUDVIG P., Research Engineer, American Bosch Magneto Corp., Springfield, Mass.

KOBITZKY, G. A., Chief Engineer, Ohio Bell Telephone Co., Cleveland, Ohio.

LOIZEAUX, ALFRED S., Electrical Engineer, Consolidated Gas, Electric Light & Power Co., Baltimore, Md.

LYNN, SCOTT, Vice-President and General Manager, Sangamo Electric Co. of Canada Ltd., Toronto, Ontario, Canada.

To Grade of Member

BIRCH, LELAND W., Assistant Manager, Railway Division, Ohio Brass Co., Mansfield, Ohio.

BRUBAKER, CHARLES N., Engineer, Transformer Dept., General Electric Co., Erie, Pa.

- CURRY, WALTER A., Assistant Professor of Electrical Engineering, Columbia University, New York, N. Y.
- FUCHS, JOHN O., Operating Engineer, Central Hudson Gas & Electric Corp., Poughkeepsie, N. Y.
- GRAY, GEORGE H., Transmission Engineer, International Standard Electric Corp., New York, N. Y.
- HANDLEY, HARRISON K., Design Engineer, Dallas Power & Light Co., Dallas, Texas.
- NOBLE, CLAUDE S., Superintendent of Transmission, Tampa Electric Co., Tampa, Florida.
- RILEY, GEORGE A., Assistant Superintendent of Electrical Distribution, Los Angeles Gas & Electric Corp., Los Angeles, Calif.
- WHEELLOCK, FRANK O., Maintenance Engineer, Southern California Telephone Co., Los Angeles, Calif.
- WINJE, SEVERT W., Distribution Engineer, Indiana Service Corp., Fort Wayne, Ind.
- WOLF, KARL, Assistant Designing Engineer, Thomas E. Murray, Inc., New York, N. Y.
- Davis, P. F., Northern New York Utilities, Inc., Watertown, N. Y.
- Davis, T. E., Bell Tel. Laboratories, Inc., New York, N. Y.
- Didszuns, F., (Member), Otis Elevator Co., Yonkers, N. Y.
- Dieringer, W. H., South Norwalk Electric Works, South Norwalk, Conn.
- Doran, C. S., (Member), Sperry Gyroscope Co., Brooklyn, N. Y.
- Dorey, R. C., Atmospheric Nitrogen Corp., Hopewell, Va.
- Dortort, I., American Brown Boveri Elec. Corp., Camden, N. J.
- Doty, O. C., Pacific Tel. & Tel. Co., Portland, Ore.
- Dowell, H. L., (Member), General Electric Co., New York, N. Y.
- Dumas, H. S., Southern Bell Tel. & Tel. Co., Birmingham, Ala.
- Dunn, E. R., Consumers Power Co., Jackson, Mich.
- Dunn, W. F., New York Edison Co., New York, N. Y.
- Dunnigan, F. A., Pacific Tel. & Tel. Co., Spokane, Wash.
- Eaton, M., Shawinigan Chemicals Ltd., Shawinigan Falls, Que., Can.
- Ehrisman, H. O., Atlantic Precision Instrument Co., Akron, Ohio.
- Eininger, R. S., Jr., General Electric Co., Schenectady, N. Y.
- Elsen, G. F., Brooklyn Edison Co., Brooklyn, N. Y.
- Erdelsky, E. J., Rutgers University, New Brunswick, N. J.
- Erlandson, N. H., Carolina Power & Light Co., Asheville, N. C.
- Felt, G. S., Wurdock E. & M Co., Omaha, Nebr.
- Fielding, W. S., General Electric Co., Pittsfield, Mass.
- Finlayson, K. M., Court House, Worcester, Mass.
- Ford, J. V., Penn State College, State College, Pa.
- Fox, J. J., Pacific Electric Mfg. Corp., San Francisco, Calif.
- Freedman, H. J., Keystone Electric Co., Philadelphia, Pa.
- Gibson, F. L., West Virginia Pulp & Paper Co., Covington, Va.
- Gillette, E. G., Seven Troughs Gold Mines Co., Lovelock, Nevada.
- Gioga, P. C., Radio KSMR, Santa Maria Valley R. R. Co., Santa Maria, Calif.
- Glass, G. K., Detroit Edison Co., Detroit, Mich.
- Greenstein, P., New York University, New York, N. Y.
- Griggs-Fegan, W. J., (Member), Cia. Agricola y De Fuerza Camargo, Chihuahua, Mex. (Electrica Del Rio Conchos S. A.)
- Groat, F. J., General Electric Co., Schenectady, N. Y.
- Gross, E. L., Western Electric Co., Kearny, N. J.
- Guild, F. M., Western Light & Power Corp., Salina, Kans.
- Guldi, F. G., Public Service Elec. & Gas Co., Newark, N. J.
- Guthrie, W. H., Omaha Electrical Works, Omaha, Nebr.
- Hamm, C. L., General Electric Co., Pittsfield, Mass.
- Hansson, H. H., Sargent & Lundy, Inc., Chicago, Ill.
- Harley, D. J., Pittsburgh Steel Products Co., Stockdale, Pa.
- Harper, H. W., American Tube & Stamping Plant, Bridgeport, Conn.
- Haselton, W. R., Nebraska Power Co., Omaha, Nebr.
- Hausmann, E. O., Celoron Co., Bridgeport, Pa.
- Hayes, A. W., Bell Tel. Laboratories, Inc., New York, N. Y.
- Hayward, H. N., 913 Lexington Ave., Lawrenceville, Ill.
- Helm, R. B., Roosevelt Water Conservation District, Higley, Ariz.
- Heye, G. D., General Electric Co., Pittsfield, Mass.
- Hook, E. B., Jr., (Member), General Cable Corp., Atlanta, Ga.
- Horan, M. A., Public Service Elec. & Gas Co., Paterson, N. J.
- Hubbard, W. L., Chicago, Milwaukee, St. Paul & Pacific Ry., Tacoma, Wash.
- Huff, B. L., (Member), Stevens & Wood, Jackson, Mich.
- Ishimura, M., 1611 W. Front St., Selma, Calif.
- Jackson, H. E., I. R. T. Co., New York, N. Y.
- Jacobs, P. M., Air Corps, U. S. Army, San Antonio, Tex.
- Jensen, G. G., General Electric Co., Fort Wayne, Ind.
- John, K. W., Graham Paige Motors Corp., Detroit, Mich.
- Johnson, D. T., New York Edison Co., New York, N. Y.
- Johnston, W. D., Bell Tel. Co. of Pa., Pittsburgh, Pa. (Applicant for re-election.)
- Kalb, R. M., Bell Tel. Laboratories, Inc., New York, N. Y.
- Keene, J. V., Electric Bond & Share Co., New York, N. Y.
- Kellerman, M. W., Appalachian Electric Power Co., Huntington, W. Va.
- Kelsey, C. H., (Member), Stone & Webster, Boston, Mass.
- Kleff, A. J., Jr., Pennsylvania Water & Power Co., Baltimore, Md.
- Krieger, G. W., Jr., Gas & Electric Appliance Co., Cincinnati, Ohio.
- Kroeger, W. J., Westinghouse Elec. & Mfg. Co., East Pittsburgh, Pa.
- Lamson, J. V., Chicago, Milwaukee, St. Paul & Pacific Ry., Seattle, Wash.
- Lang, W. T., Student Engineer, General Electric Co., Graduate Student, Union College, Schenectady, N. Y.
- Laning, W. A., Jr., Bell Tel. Co. of Pa., Pittsburgh, Pa.
- Larlee, H. A., Bell Tel. Laboratories, Inc., New York, N. Y.
- Larmoth, G. W., Allis-Chalmers Mfg. Co., Chicago, Ill.
- Larsen, G. R., U. S. Bureau of Reclamation, Guernsey, Wyo.
- Lefler, H. E., Caldwell Electric Co., Seattle, Wash.
- Lenzen, T. L., Standard Oil Co. of Calif., San Francisco, Calif.
- Livingston, O. W., General Electric Co., Schenectady, N. Y.
- Lorraine, R. G., General Electric Co., Schenectady, N. Y.
- Lovell, T. J., So. Calif. Edison Co., Los Angeles, Calif. (Applicant for re-election.)
- Lovett, M., New York & Queens Elec. Lt. & Pr. Co., Flushing, N. Y.
- Loxley, B. R., Southern Calif. Edison Co., Los Angeles, Calif.
- Maohen, C. R., Pacific Gas & Electric Co., Oakland, Calif.
- Maier, W., Safety Car Heating & Lighting Co., New Haven, Conn.
- Marquette, F. W., Ohio Power Co., Canton, Ohio.
- McKim, J. B., So. Calif. Tel. Co., Los Angeles, Calif.
- McLeod, E. W., Square D Co., Detroit, Mich.
- McMurry, C. J., Jr., Standard Underground Cable Co., New York, N. Y.
- Mercer, W. D., Southern Bell Tel. & Tel. Co., Birmingham, Ala.
- Messex, L. C., Procter & Gamble Co., Ivorydale, Ohio.
- Meyers, L. O., Electric Storage Battery Co., Seattle, Wash.
- Mills, W. G., Houston Lighting & Power Co., Houston, Tex.
- Miyamoto, T. C., Contractor, 1207-4th St., Sacramento, Calif.
- Molsberry, C. A., General Electric Co., New Haven, Conn.
- Montcalm, S. R., (Member), International Tel. & Tel. Corp., New York, N. Y.

APPLICATIONS FOR ELECTION

Applications have been received by the Secretary from the following candidates for election to membership in the Institute. Unless otherwise indicated, the applicant has applied for admission as an Associate. If the applicant has applied for direct admission to a grade higher than Associate, the grade follows immediately after the name. Any member objecting to the election of any of these candidates should so inform the Secretary before February 28, 1929.

- Adler, E. H., Central West Public Service Co., Omaha, Nebr.
- Aime, J., Spring Canyon Coal Co., Spring Canyon, Utah
- Archila, F., Interborough Rapid Transit Co., New York, N. Y.
- Ayres, H. B., 905 Post Dispatch Bldg., Houston, Tex.
- Bailey, J. F., West Public Service Co., Omaha, Nebr.
- Baker, W. W., Hydro Electric Power Comm. of Ont., Toronto, Ont., Can.
- Bauer, W. M., Harvard University, Cambridge, Mass.
- Beck, B. O., Underwriters Laboratories, Chicago, Ill.
- Bell, D. G., Texas Power & Light Co., Dallas, Tex.
- Blair, S. R., International Power & Paper Co., Ltd., Corner Brook, Newfoundland, Can.
- Blankenburg, R. C., Southern Calif. Edison Co., Los Angeles, Calif.
- Bobis, S., Bell Telephone Laboratories, New York, N. Y.
- Boehne, E. W., General Electric Co., Schenectady, N. Y.
- Boland, E. J., General Electric Co., Lynn, Mass.
- Bolton, W. E., Willis & Hall Electric Co., Regina, Sask., Can.
- Brown, M. A., Southern California Edison Co., Alhambra, Calif.
- Burns, H. E., H. E. Burns Co., Pittsburgh, Pa.
- Burns, L. L., Southwestern Bell Tel. Co., Dallas, Tex.
- Calloway, R. T., (Member), Electrical Engineers Equipment Co., Melrose Park, Ill.
- Cassidy, C. F., General Electric Co., Chicago, Ill.
- Cella, L. C., Western Electric Co., Inc., New York, N. Y.
- Clayton, H. H., General Electric Co., Fort Wayne, Ind.
- Compton, F. A., Jr., General Electric Co., Erie, Pa.
- Conlon, W. J., International Standard Electric Corp., New York, N. Y.
- Daggett, G. O., Public Service Co. of Colo., Denver, Colo.
- Davis, C. W., (Fellow), Dallas Power & Light Co., Dallas, Tex.
- Davis, E. L., Duke Power Co., Spencer, N. C.
- Davis, L. L., Kansas City Public Service Co., Kansas City, Mo.

- Moog, G. C., New York & Queens Elec. Lk. & Pr. Co., Flushing, N. Y.
- Moray, M., John Simmons Co., New York, N. Y.
- Murphy, L. P., Howell Electric Motors Co., Howell, Mich.
- Murray, J. M., Simplex Wire & Cable Co., Cambridge, Mass.
- Nickel, J. E., General Electric Co., Erie, Pa.
- Northshield, L. E., General Electric Co., Fort Wayne, Ind.
- Nye, E. C., (Member), Instrument Service Laboratories, St. Louis, Mo.
- O'Brien, J. E., The Catholic University of America, Washington, D. C.
- Ord, B. R., Ferranti Electric Co., Ltd., Toronto, Ont., Can.
- Ordmann, T., Max D. Ordmann, Patent Attorney, New York, N. Y.
- Ost, F. L. E., Westinghouse Elec. & Mfg. Co., East Pittsburgh, Pa.
- Pahren, H. S., Elliott Co., Jeannette, Pa.
- Painting, J. A., Reliable Radio Service, Brooklyn, N. Y.
- Palermo, J. J., General Railway Signal Co., Rochester, N. Y.
- Palmer, F. H., Consolidated Mining & Smelting Co., Ltd., Trail, B. C., Can.
- Peirce, R. M., American Steel & Wire Co., Worcester, Mass.
- Perry, P. G., Freeport Sulphur Co., Freeport, Tex.
- Pierson, A. B., Penna-N. J. Power System, Reading, Pa.
- Poch, W. J., General Electric Co., Schenectady, N. Y.
- Purnell, C. S., Westinghouse Elec. & Mfg. Co., New York, N. Y.
- Rahmes, R. E., Western Electric Co., New York, N. Y.
- Rancourt, L. E., Westinghouse Elec. & Mfg. Co., East Pittsburgh, Pa.
- Randall, C. W., General Electric Co., Minneapolis, Minn.
- Reed, R. T., Premier Red Ash Coal Corp., Red Ash, Va.
- Regan, P. T., Constant Angle Arch Dam Co., San Francisco, Calif.
- Robertson, D. C., Manitoba Paper Co., Pine Falls, Manitoba, Can.
- Robinson, L., Mountain States Tel. & Tel. Co., Denver, Colo.
- Robison, R. D., Northern Ohio Pr. & Lt. Co., Akron, Ohio
- Rugg, P. N., Edison Elec. Ill. Co. of Boston, Boston, Mass.
- Ruus, E., Electric Storage Battery Co., St. Louis, Mo.
- Sadler, E. K., (Member), Kelman Electric & Mfg. Co., Los Angeles, Calif.
- Saffer, F. J., Graybar Electric Co., Omaha, Nebr.
- Salber, W. E., The Toledo Edison Co., Toledo, Ohio
- Samwick, R., Brooklyn Polytechnic Institute, Brooklyn, N. Y.
- Schreiber, T. W., National Carbon Co., Springfield, Mass.
- Schuck, G. A., New York Edison Co., New York, N. Y.
- Schuknecht, R. C., Northwestern Electric Co., Portland, Ore.
- Schwarz, L. P., J. Livingston & Co., Inc., New York, N. Y.
- Schofield, M. W., American Woolen Co., Lawrence, Mass.
- Scoville, R. R., Electrical Research Products, Inc., Hollywood, Calif.
- Sessoms, O. V. P., Jr., Virginia Electric & Power Co., Suffolk, Va.
- Sherry, G., Safety Cable Co. Division, New York, N. Y.
- Shirley, J. Y., Kelly Springfield Tire Co., Cumberland, Md.
- Short, D. M., Central West Public Service Co., Omaha, Nebr.
- Shotwell, H. H., Operadio Mfg. Co., St. Charles, Ill.
- Slegelin, C. O., Bell Tel. Laboratories, Inc., New York, N. Y.
- Sims, W. B., Southeastern Underwriters Association, Atlanta, Ga.
- Smith, C. O., Mass. Institute of Technology, Cambridge, Mass.
- Smith, F., National Teleregister Corp., New York, N. Y.
- Smith, H. W., (Member), Toronto Hydro-Elec. System, Toronto, Ont., Can.
- Somers, R. M., Thomas A. Edison, Inc., West Orange, N. J.
- Sorensen, A. V., McGraw Electric Co., Omaha, Nebr.
- Spencer, P. L., Raytheon Mfg. Co., Cambridge, Mass.
- St. Oyr, A. L., Western Union Telegraph Co., New York, N. Y.
- Stene, M., Delta Star Electric Co., Chicago, Ill.
- Stephens, H. D., (Member), Westinghouse Elec. & Mfg. Co., New York, N. Y.
- Stepp, J. B., Carolina Power & Light Co., Asheville, N. C.
- Steuerwald, C. B., Interborough Rapid Transit Co., New York, N. Y.
- Stine, C. F., Tenn. Eastern Electric Co., Johnson City, Tenn.
- Stockler, O., American Brown Boveri Electric Corp., Camden, N. J.
- Strout, P. E., Western Union Telegraph Co., New York, N. Y.
- Tarbox, A. M., Westinghouse Elec. & Mfg. Co., Worcester, Mass.
- Ten Broeck, R. L., General Electric Co., Pittsfield, Mass.
- Thompson, B. F., American Smelting & Refining Co., Chihuahua, Mexico
- Thyse, R. G., Carolina Power & Light Co., Asheville, N. C.
- Todnom, O. H., Bureau of Power & Light, Los Angeles, Calif.
- Treat, G. H., Century Electric Co., Atlanta, Ga.
- Trenberth, T. H., Nebraska Power Co., Omaha, Nebr.
- Trimble, O. R., Puritan Mfg. & Supply Co., Omaha, Nebr.
- Trimble, R. F., (Member), Sun Ray Neon Corp., Rochester, N. Y.
- Troedsson, K. T., Gibbs & Hill, New York, N. Y.
- Tuttle, T. W., International Tel. & Tel. Corp., New York, N. Y.
- Upham, W. A., United Illuminating Co., Bridgeport, Conn.
- Volkenant, G. W., Lucker Sales Corp., Minneapolis, Minn.
- Wade, L. W., Acoustic Products Mfg. Corp., Stamford, Conn.
- Watts, R. S., Commonwealth Edison Co., Chicago, Ill.
- Welch, J. E., Western Electric Co., Kearny, N. J.
- West, G. B., (Member), Illinois Bell Tel. Co., Chicago, Ill.
- Whatley, J. A., Ohio Brass Co., Atlanta, Ga.
- Wheeler, R. C., University of Arkansas, Fayetteville, Ark.
- White, M., Toronto Hydro-Electric System, Toronto, Ont., Can.
- Whitestone, J. T., Bureau of Power & Light, Los Angeles, Calif.
- Williams, F. L., New York Edison Co., New York, N. Y.
- Woodmansee, E. R., Electrical Engineers Equipment Co., Chicago, Ill.
- Woodward, J. A., Woodward & Co., Leetonia, Ohio
- Wright, T. J., New York Edison Co., New York, N. Y.
- Young, W. A., Wisconsin Tel. Co., Milwaukee, Wis.
- Total 205.

Foreign

- Alken, E. H., Porto Rico Rwy. Light & Power Co., San Juan, Porto Rico
- Brice, A. L., B. B. & C. I. Railway, Ajmer, Rajputana, India
- Calvert, J. R., Sunsheen Art Wilk Works, Ballymena, Ireland

- Clothworthy, S. E., Allminum (H) Ltd., Aldwyeh, London, Eng.
- Duncan, H. W., Municipal Council of Sydney, Sydney, Australia
- Halat, H., Robert College, Constantinople, Turkey
- Humphreys, C. F., B. T. H. Co., London, Eng.
- Machado de Filho, O. A., The Sao Paulo Tramway Lt. & Pr. Co., Ltd., Sao Paulo, Brazil, So. America
- McClenaghan, J. S., Messrs. Hugh J. Scott & Co., Ltd., Belfast, Ireland
- Nuttall, A., Trinidad Leasholds Ltd., Trinidad, B. W. I.
- Russell, W. F., Litchfield City Council, Litchfield Staffs, Eng.
- Wallace, H., Shanghai Municipal Council, Shanghai, China
- Total 12.

STUDENTS ENROLLED

- Abbot, Leonard H., Worcester Polytechnic Inst.
- Abernethy, Oren E., University of North Carolina
- Acton, Herbert R., North Carolina State College
- Adams, Harold R., Northeastern University
- Africano, Alfred, Stevens Institute of Technology
- Albert, Earl C., Lafayette College
- Allen, Gibbert, Northeastern University
- Allen, Owen T., Alabama Polytechnic Institute
- Anderson, Harold L., University of Wyoming
- Angus, Robert H., Stanford University
- Arnold, Robert E., Brown University
- Avila, Charles F., Harvard University
- Badrow, J. Dallas, Rutgers College
- Baird, Douglas O., Alabama Polytechnic Institute
- Baker, Rhea W., Georgia School of Technology
- Bambeck, Victor R., Ohio State University
- Barnes, Lewis E., Detroit Institute of Technology
- Barraford, Jerome, Clarkson College
- Bassett, Lloyd R., University of Florida
- Bauman, Norman C., Cornell University
- Bayer, Carl F., Ohio State University
- Becker, David E., Marquette University
- Beeman, Donald L., Stanford University
- Berger, Andrew, Detroit Institute of Technology
- Berner, John A., University of Minnesota
- Bice, James C., Louisiana State University
- Bigwood, Robert F., University of Vermont
- Bindschadler, George W., University of Denver
- Blass, Earl G., Detroit Institute of Technology
- Blender, Florian J., Detroit Inst. of Technology
- Block, Irving S., University of Pennsylvania
- Boardman, Frank G., Northeastern University
- Bolender, George L., University of Pittsburgh
- Boyd, Glenn G., Louisiana State University
- Briggs, Rollin H., Detroit Institute of Technology
- Bruning, August C., Iowa State College
- Buckmaster, Roy A., University of Wyoming
- Burgess, Montague S., Massachusetts Institute of Technology
- Burnham, John R., Detroit Inst. of Technology
- Burns, Richard F., Iowa State College
- Byrne, James J., Montana State College
- Campbell, James R., Jr., Cornell University
- Campbell, Robert L., University of Minnesota
- Cappa, Lawrence B., University of Wisconsin
- Caress, Arthur E., University of Nebraska
- Carr, C. Russell, Cornell University
- Ceccarelli, Dino L., University of Santa Clara
- Chamberlin, Wilbur, Kansas State Agricultural College
- Chen, Shih-Heng, Massachusetts Institute of Technology
- Chrisman, Roger W., University of Kansas
- Church, Benjamin A., Jr., Brown University
- Oisler, Marvin C., Iowa State College
- Clifton, Clifford C., Iowa State College
- Cobb, Lynn M., Detroit Institute of Technology
- Connors, William I., Brooklyn Polytechnic Inst.
- Converse, Kenneth E., Kansas State Agricultural College
- Convery, Richard B., University of Denver
- Cooke, Frank E., Milwaukee School of Engg.
- Coolidge, George D., Detroit Institute of Tech.
- Coomes, Edward A., University of Notre Dame
- Corona, Nicholas J., Louisiana State University
- Coursey, Ralph W., Oklahoma University

- Coyle, John, Cornell University
 Crain, Richard W., Colorado Agricultural College
 Crawford, Donald M., Yale University
 Cutcliffe, Wendell W., University of Minnesota
 Dahlem, Gordon, Marquette University
 Darnell, Walter E., Cornell University
 David, Charles J., Louisiana State University
 Davies, John E., Carnegie Institute of Technology
 Davis, Stark L., Jr., Louisiana State University
 Deady, John A., Jr., Brown University
 Deibel, Al. J., University of Pittsburgh
 Demarest, Kenneth D., Brown University
 Deucher, Theodore F., Ohio State University
 Dial, Gregory T., Yale University
 Diaz, Manuel S., West Virginia University
 Dick, Winfred O., Northeastern University
 Diehl, Arthur C. V., Yale University
 Dixon, Isaac H., Princeton University
 Douthitt, James B., University of Denver
 Downie, Emerson G., Kansas State Agricultural College
 Drapkin, Jack, Detroit Institute of Technology
 Drummond, John W., Cornell University
 Dubinski, Leo, Stanford University
 Duncan, Don C., University of Illinois
 Dunlap, Robert S., University of Missouri
 Eastman, Frank H., Jr., Yale University
 Ecevido, Abundio E., Detroit Institute of Tech.
 Eddy, Everett, Lewis Institute
 Edelman, Walter E., Engg. School of Milwaukee
 Eichna, Oscar L., Drexel Institute
 Einstein, Abraham J., Northeastern University
 Elg, George W., Cornell University
 Elmstrom, Raymond E., University of Minnesota
 Ely, James K., University of Pittsburgh
 Everett, Erwin B., University of Minnesota
 Felarca, Silverio L., Purdue University
 Feldman, Nathan H., Yale University
 Field, William J., University of Minnesota
 Finch, James B., Jr., University of Minnesota
 Fitzgerald, W. George, University of Minnesota
 Fleischer, Frank H., Cornell University
 Foley, Roland B., Northeastern University
 Foote, Alton G., Cornell University
 Foy, Francis D., Clarkson College of Technology
 Franklin, William S., Ohio State University
 Frincke, Paul, Detroit Institute of Technology
 Fujii, R. Masuo, Purdue University
 Fuller, Ellis E., University of Colorado
 Furman, Horace E., Cornell University
 Gage, Guy G., Detroit Institute of Technology
 Gardner, Theodore, University of Kansas
 Geohegan, William A., Jr., Cornell University
 Gerber, Paul D., Pennsylvania State College
 Gibbons, Donald R., Princeton University
 Giebler, Clyde E., California Institute of Tech.
 Gilbert, Arthur E., Jr., Worcester Polytechnic Institute
 Gittleston, Edgar L., Yale University
 Gleason, Robert J., University of Washington
 Goetz, Laurence W., Marquette University
 Goldsmith, O. Bruce, University of Michigan
 Gordon, Floyd J., Clarkson College of Technology
 Gordon, Raymond L., University of Colorado
 Greer, David McK., Stanford University
 Greer, J. Walter, University of Notre Dame
 Gruenberg, Walter E., University of Denver
 Haefl, Andrew V., California Inst. of Technology
 Halbach, Edward A., Marquette University
 Hall, Graydon B., Yale University
 Hall, Matthew A., Cornell University
 Hamilton, Hanse H., Cornell University
 Hansen, Carl H., Yale University
 Hardman, William F., Kansas State Agricultural College
 Harris, John F., Cornell University
 Hawks, Glen L., University of Nebraska
 Hayath, Mahomed, Union College
 Hathaway, J. Lewis, University of Colorado
 Heil, Herman R., Ohio State University
 Heilman, James M., Lehigh University
 Heinzelman, George J., Jr., Ohio State University
 Henry, William R., Brown University
 Hively, J. Paul H., Pennsylvania State College
 Houts, Westley, M., University of Minnesota
 Hulse, Harry A., Jr., University of Colorado
 Huntsman, Orlando A., University of Utah
 Hutchins, Dwight C., Yale University
 Iijima, John H., New York University
 Irvine, George L., Iowa State College
 Jenkins, George H., Kansas State Agricultural College
 Jewell, Richard G., University of Wisconsin
 Jivatode, Ramkrishna, S., North Carolina State College
 Johns, I. Jefferson, University of Arkansas
 Johnson, Francis E., Kansas State Agricultural College
 Jones, Donald R., Drexel Institute
 Kallio, Wilho, University of Minnesota
 Kaniss, Samuel, Drexel Institute
 Kasky, Bernard W., Detroit Institute of Tech.
 Keachie, James H., University of Colorado
 Kegelman, William, Drexel Institute
 Keller, Henry W., University of Illinois
 Keller, Nelson O., Louisiana State University
 Kennedy, W. B., Iowa State College
 Kershaw, John H., Kansas State Agricultural College
 Kim, Homer T., Massachusetts Institute of Tech.
 Kimberly, Harbert D., University of Nebraska
 Kingrey, Con L., University of Nebraska
 Kirk, Harold, Iowa State College
 Klein, Charles J., University of Nebraska
 Klotzbach, Martin S., Kansas State Agricultural College
 Knauss, Edison, University of Minnesota
 Koch, Elmer E., University of Nebraska
 Kohli, Wilson W., Ohio State University
 Kotila, Theodore A., University of Michigan
 Kune, Herald M., Cornell University
 Lafranchi, Vincent, University of Washington
 Lancaster, R. A., North Carolina State College
 Lane, George O., Georgia School of Technology
 Langenberg, George W., University of Minnesota
 Larime, Louis H., Detroit Institute of Technology
 Lazo, Nicholas, Brooklyn Polytechnic Institute
 Lehmann, Herbert G., Rutgers College
 Lepone, Raymond G., Drexel Institute
 Lichtenfels, Ira W., University of Pittsburgh
 Lincoln, Powell R., Harvard University
 Lindfors, Onni, University of Minnesota
 Lingle, Ralph G., Bucknell University
 LoBuono, Alfred E., University of Pittsburgh
 Lofgren, John A., Brown University
 Lorenz, Joseph H., Yale University
 Ludwigen, Lester, University of Wisconsin
 Luikart, Paul D., Ohio Northern University
 Lusher, Miles H., Iowa State College
 Lutzen, Clarence C., Marquette University
 MacDougall, Drew D., State University of Iowa
 Machael, Russell L., Wisconsin University
 MacCorkle, Emmett W., Jr., Cornell University
 Mann, Lee B., Georgia School of Technology
 Marples, Herbert F., Cornell University
 Marshall, Joseph C., Cornell University
 Martin, Paul N., Cornell University
 Mason, James F., Yale University
 Mason, Loren F., Cornell University
 Maulsby, John T., University of Utah
 McAliley, Charles C., Georgia School of Tech.
 McCracken, Guy I., University of Pittsburgh
 McCurrach, John D., Cornell University
 McDonald, Wayne A., Detroit Institute of Tech.
 McKay, J. W., University of Florida
 McMillan, John D., Detroit Institute of Tech.
 Mears, Leon A., University of Minnesota
 Meier, H. Herbert, Rutgers College
 Meier, Otto, Jr., University of Pennsylvania
 Merriman, John H., University of Minnesota
 Metcalfe, Donald, Cornell University
 Metrailler, M. Francis, University of Notre Dame
 Meyer, John C., Marquette University
 Meyer, John M., Marquette University
 Michal, William N., University of North Carolina
 Milans, Robert S., Cornell University
 Mildo, Edward C., Worcester Polytechnic Inst.
 Miller, Ralph L., Kansas State Agricultural College
 Miller, Sidney E., University of Michigan
 Monsulat, Konstantine J., Massachusetts Institute of Technology
 Motter, James T., Princeton University
 Mulford, Kenneth E., George Washington Univ.
 Nadeau, Joseph I., Marquette University
 Namlik, Joseph S., Jr., University of Pittsburgh
 Nealy, M. Allan, University of Minnesota
 Nelson, Floyd J., University of Florida
 Newhouse, J. C., University of Minnesota
 Norman, Vernon R., University of Minnesota
 Novak, Louis C., Iowa State College
 Oberbauer, Carl T., Montana State College
 Oliver, S. Kemble, Yale University
 Painter, Brookman R., Harvard University
 Pallange, Eugene P., Marquette University
 Parr, Forrest L., University of Pittsburgh
 Paslay, Leroy C., Kansas State Agricultural College
 Patterson, Robert B., Pennsylvania State College
 Paulson, Ray C., Kansas State Agricultural College
 Pecquet, Howard P., Louisiana State University
 Peiffer, Erwin N., Marquette University
 Percy, John, Montana State College
 Perkins, Robert B., Brown University
 Perry, John, Jr., North Carolina State College
 Peshek, Ronald J., Detroit Institute of Technology
 Peters, John R., Louisiana State University
 Peterson, Floyd V., University of Nebraska
 Peterson, Francis H., University of Wyoming
 Petit, Amos M. H., Marquette University
 Petrillo, Salvatore E., Yale University
 Pfafman, Robert F., Purdue University
 Phelps, Austin M., Yale University
 Pomeroy, Allen F., Brown University
 Preston, Sidney W., Cornell University
 Prim, Jaime M., Clemson Agricultural College
 Pritchard, Maurice R., Detroit Institute of Tech.
 Punkari, Helgi V., University of Minnesota
 Ramirez, Artemio O., Detroit Institute of Tech.
 Randall, Jack, A., Lewis Institute
 Randall, Gordon E., Ohio State University
 Rankin, Floyd C., University of Pittsburgh
 Rappaport, Morris, Brooklyn Polytechnic Inst.
 Regan, Charles W., Yale University
 Rich, Theodore A., Harvard University
 Riggs, Herman G., Purdue University
 Ringelstetter, Leo, Marquette University
 Ringler, George F., Brown University
 Rist, Paul E., University of Notre Dame
 Roberts, David P., Purdue University
 Roberts, Merle W., University of Nebraska
 Robinson, Travillis B., University of Pittsburgh
 Rockwood, Robert B., Northeastern University
 Roe, John H., University of Minnesota
 Rogers, Owen G., Kansas State Agricultural College
 Rasco, Adam J., Worcester Polytechnic Institute
 Ross, Thomas G., Cornell University
 Roth, Charles W., Cornell University
 Royle, Norman H., Northeastern University
 Ruhl, C. Kenneth, Case School of Applied Science
 Russ, Lloyd A., University of Minnesota
 Russell, John D., Cornell University
 Rys, Frank E., Northeastern University
 Samow, Jack H., Detroit Institute of Technology
 Saxon, Paul M., University of Minnesota
 Schaul, Stanleigh E., Cornell University
 Schenck, Alfred K., Pennsylvania State College
 Schmid, Russell F., Engg. School of Milwaukee
 Schneider, E. Darrell, University of Nebraska
 Schutt, Norman G., New York University
 Selke, Gilbert H., Detroit Institute of Technology
 Shad, Willis H., Iowa State College
 Shaner, Richard E., Cornell University
 Sharp, J. Vernon, University of Utah
 Shaw, Wayne L., University of Utah
 Shepard, Robert K., Rutgers College
 Shepp, Robert O., University of Kansas
 Shoemaker, Lester E., University of Nebraska
 Shumway, Donald D., University of Minnesota
 Siegfried, Victor, Stanford University
 Simkins, Edgar A., Jr., North Carolina State College
 Smith, Gordon P., Detroit Institute of Technology
 Smith, Lorin E., Colorado Agricultural College
 Smith, William L., Detroit Inst. of Technology
 Smithers, Leon O., Clarkson College
 Snowe, Arnold, Rutgers College
 Snyder, Irving W., Iowa State College
 Solley, James P., Jr., Cornell University

Soufal, Roman N., University of Minnesota	Tidd, Warren H., Cornell University	Wilkins, William G., Illinois University
Speed, Alonzo C., Alabama Polytechnic Institute	Trench, Robert B., Yale University	Wills, Walter P., Lehigh University
Springer, Leo T., Marquette University	Urban, Charles, Newark College of Engineering	Willson, Edwin A., University of Minnesota
Stahl, Harold, Iowa State College	Van Arsdale, Elvin R., Cornell University	Wiltse, Homer G., University of Nebraska
Stanbery, Elwood M., Ohio State University	Van Lennep, David, University of Nevada	Wing, Arthur K., Jr., Yale University
Starrs, Theodore E., Newark College of Engg.	Vickery, Harold C., Georgia School of Technology	Wolf, Louis, Rutgers College
Stauber, Theodore W., Rutgers College	Volpicelli, Louis A., Yale University	Wood, Winchester R., Univ. of New Hampshire
Stauder, Lawrence F., University of Notre Dame	Wald, Reuben E., University of Minnesota	Woodrow, James, Montana State College
Stellwagen, Frank W., Columbia University	Walmsley, James E., Iowa State College	Wright, Harry A., Carnegie Inst. of Technology
Stillwell, Robert M., University of Missouri	Wang, Harold S., University of Minnesota	Wright, Lowell J., University of Denver
Stowe, George E., University of Minnesota	Ward, Eldred O., Bucknell University	Wright, Norwood G., Cornell University
Subar, Abraham, Detroit Institute of Technology	Ward, Harry H., University of Denver	Wroten, Cecil R., University of Arkansas
Sussman, Louis, Lehigh University	Weatherby, Joseph, Jr., Cornell University	Wylie, David N., University of Pittsburgh
Svehla, Joseph G., Ohio State University	Weglener, George E., Rutgers College	Yagodkin, Constine C., Carnegie Institute of Tech.
Takemoto, S., Ohio State University	Wegner, Ernest A., University of Wisconsin	Yard, William B., Cornell University
TeGrotenhuis, Theodore A., Case School of Applied Science	Weigand, Karl R., University of Notre Dame	Young, Elmer L., Ohio State University
Terrell, Warren E., Northeastern University	Weigle, Russell M., Carnegie Inst. of Technology	Zatayevitch, I. A., Cornell University
Thompson, Harold W., Rutgers College	Weltmer, Wilton W., North Carolina State College	Zeaser, John E., Lehigh University
Thompson, Howard H., Purdue University	Wertz, Hugh S., George Washington University	Zilm, W. Everett, Drexel Institute
Thompson, Leland E., University of South Dakota	Whitney, Forrest J., Jr., Lehigh University	Zoeller, Anthony J., Marquette University
Thurston, Robert S., Cornell University	Whittredge, Robert B., Yale University	Total 372.
	Wilde, Cecil B., Detroit Institute of Technology	

OFFICERS A. I. E. E. 1928-1929

President
R. F. SCHUCHARDT

Junior Past Presidents
C. C. CHESNEY

Vice-Presidents
O. J. FERGUSON
E. R. NORTHMORE
J. L. BEAVER
A. B. COOPER
C. O. BICKELHAUPT

Directors
M. M. FOWLER
E. C. STONE
C. E. STEPHENS
I. E. MOULTROP
H. C. DON CARLOS
F. J. CHESTERMAN

National Treasurer
GEORGE A. HAMILTON

Honorary Secretary
RALPH W. POPE

BANCROFT GHERARDI
E. B. MERRIAM
H. A. KIDDER
W. T. RYAN
B. D. HULL
G. E. QUINAN

F. C. HANKER
E. B. MEYER
H. P. LIVERSIDGE
J. ALLEN JOHNSON
A. M. MACCUTCHEON
A. E. BETTIS

National Secretary
F. L. HUTCHINSON

General Counsel
PARKER & AARON
30 Broad Street, New York

LOCAL HONORARY SECRETARIES

T. J. Fleming, Calle B. Mitre 519, Buenos Aires, Argentina, S. A.
H. W. Flashman, Aus. Westinghouse Elec. Co. Ltd., Cathcart House, 11 Castlereagh St., Sydney, N. S. W., Australia.
F. M. Servos, Rio de Janeiro Tramways, Light & Power Co., Rio de Janeiro, Brazil.
Charles le Maistre, 28 Victoria St., London, S. W. 1, England.
A. S. Garfield, 45 Bd. Beausejour, Paris 16 E., France.;
F. W. Willis, Tata Power Company, Bombay House, Bombay, India.
Guido Semenza, 39 Via Monte Napoleone, Milan, Italy.
P. H. Powell, Canterbury College, Christchurch, New Zealand.
Axel F. Enstrom, 24a Greftevegatan, Stockholm, Sweden.
W. Elsdon-Dew, P. O. Box 4563, Johannesburg, Transvaal, Africa.

A. I. E. E. COMMITTEES

(A list of the personnel of Institute committees may be found in the January issue of the JOURNAL.)

GENERAL STANDING COMMITTEES AND CHAIRMEN

EXECUTIVE, R. F. Schuchardt
FINANCE, E. B. Meyer
MEETINGS AND PAPERS, H. P. Charlesworth
PUBLICATION, W. S. Gorsuch
COORDINATION OF INSTITUTE ACTIVITIES, H. A. Kidder
BOARD OF EXAMINERS, E. H. Everit
SECTIONS, W. B. Kouwenhoven
STUDENT BRANCHES, J. L. Beaver
MEMBERSHIP, J. E. Kearns
HEADQUARTERS, R. H. Tapscott
LAW, C. O. Bickelhaupt
PUBLIC POLICY, D. C. Jackson
STANDARDS, F. D. Newbury
EDISON MEDAL, Samuel Insull
LAMME MEDAL, Charles F. Scott
CODE OF PRINCIPLES OF PROFESSIONAL CONDUCT, H. B. Smith

COLUMBIA UNIVERSITY SCHOLARSHIPS, W. I. Slichter
AWARD OF INSTITUTE PRIZES, H. P. Charlesworth
SAFETY CODES, F. V. Magalhaes

SPECIAL COMMITTEES

ADVISORY COMMITTEE TO THE MUSEUMS OF THE PEACEFUL ARTS, J. P. Jackson
LICENSING OF ENGINEERS, Francis Blossom

TECHNICAL COMMITTEES AND CHAIRMEN

AUTOMATIC STATIONS, W. H. Millan
COMMUNICATION, H. W. Drake
EDUCATION, Edward Bennett
ELECTRICAL MACHINERY, W. J. Foster
ELECTRIC WELDING, A. M. Candy
ELECTROCHEMISTRY AND ELECTROMETALLURGY, George W. Vinal
ELECTROPHYSICS, V. Karapetoff
GENERAL POWER APPLICATIONS, J. F. Gaskill
INSTRUMENTS AND MEASUREMENTS, Everett S. Lee
APPLICATIONS TO IRON AND STEEL PRODUCTION, M. M. Fowler
PRODUCTION AND APPLICATION OF LIGHT, B. E. Shackelford
APPLICATIONS TO MARINE WORK, W. E. Thau
APPLICATIONS TO MINING WORK, Carl Lee
POWER GENERATION, F. A. Allner
POWER TRANSMISSION AND DISTRIBUTION, H. R. Woodrow
PROTECTIVE DEVICES, E. A. Hester
RESEARCH, F. W. Peek, Jr.
TRANSPORTATION, W. M. Vandersluis

A. I. E. E. REPRESENTATION

(The Institute is represented on the following bodies; the names of the representatives may be found in the January issue of the JOURNAL.)

AMERICAN ASSOCIATION FOR THE ADVANCEMENT OF SCIENCE, COUNCIL
AMERICAN BUREAU OF WELDING
AMERICAN COMMITTEE OF ELECTROLYSIS
AMERICAN ENGINEERING COUNCIL
AMERICAN MARINE STANDARDS COMMITTEE
AMERICAN STANDARDS ASSOCIATION
AMERICAN YEAR BOOK, ADVISORY BOARD
BOARD OF TRUSTEES, UNITED ENGINEERING SOCIETY
CHARLES A. COFFIN FELLOWSHIP AND RESEARCH FUND COMMITTEE
COMMITTEE OF APPARATUS MAKERS AND USERS, NATIONAL RESEARCH COUNCIL
COMMITTEE ON ELIMINATION OF FATIGUE, SOCIETY OF INDUSTRIAL ENGINEERS
COMMITTEE ON HEAT TRANSMISSION, NATIONAL RESEARCH COUNCIL
ENGINEERING FOUNDATION BOARD
JOHN FRITZ MEDAL BOARD OF AWARD
JOINT COMMITTEE ON WELDED RAIL JOINTS
JOINT CONFERENCE COMMITTEE OF FOUR FOUNDER SOCIETIES
LIBRARY BOARD, UNITED ENGINEERING SOCIETY
NATIONAL FIRE PROTECTION ASSOCIATION, ELECTRICAL COMMITTEE
NATIONAL FIRE WASTE COUNCIL
NATIONAL RESEARCH COUNCIL, ENGINEERING DIVISION
NATIONAL SAFETY COUNCIL, ELECTRICAL COMMITTEE OF ENGINEERING SECTION
THE NEWCOMEN SOCIETY
RADIO ADVISORY COMMITTEE, BUREAU OF STANDARDS
SOCIETY FOR THE PROMOTION OF ENGINEERING EDUCATION, BOARD OF INVESTIGATION AND COORDINATION
U. S. NATIONAL COMMITTEE OF THE INTERNATIONAL COMMISSION ON ILLUMINATION
U. S. NATIONAL COMMITTEE OF THE INTERNATIONAL ELECTROTECHNICAL COMMISSION
WASHINGTON AWARD, COMMISSION OF

LIST OF SECTIONS

Name	Chairman	Secretary	Name	Chairman	Secretary
Akron	John Grotzinger	H. C. Paiste, No. Ohio Pr. & Lt. Co., Akron, Ohio	Dallas	G. A. Mills	A. Chetham-Strode, Dallas Pr. & Lt. Co., Interurban Bldg., Dallas, Texas
Atlanta	H. L. Wills	W. F. Bellinger, Elec. & Gas Bldg., Atlanta, Ga.	Denver	L. N. McClellan	R. B. Bonney, Telephone Bldg., P. O. Box 960, Denver, Colo.
Baltimore	W. B. Kouwenhoven	R. T. Greer, Cons. Gas Elec. Lt. & Pr. Co., Lexington Bldg., Baltimore, Md.	Detroit-Ann Arbor	A. H. Lovell	L. F. Hickernell, Commonwealth Power Corp., 212 Michigan Avenue, West, Jackson, Mich.
Boston	H. B. Dwight	G. J. Crowdes, Simplex Wire & Cable Co., Sidney Street, Cambridge, Mass.	Erie	M. L. Elder	A. W. Wennerstrom, General Electric Co., Erie, Pa.
Chicago	P. B. Juhnke	T. G. Le Clair, Commonwealth Edison Co., Rm. 822, 72 W. Adams St., Chicago, Ill.	Fort Wayne	C. F. Beyer	J. F. Eitman, 1841 Broadway, Ft. Wayne, Ind.
Cincinnati	R. C. Fryer	L. O. Dorfman, Westinghouse E. & M. Co., 3rd & Elm Sts., Cincinnati, Ohio	Houston	C. A. Williamson	L. K. Del Homme, Houston Lighting & Power Co., Houston, Texas
Cleveland	E. W. Henderson	P. D. Manbeck, National Carbon Co., Madison Ave. & West 117th St., Cleveland, Ohio	Indianapolis-Laf.	Herbert Kessel	G. R. Anderson, 2060 Northwestern Ave., Fairbanks, Morse & Co., Indianapolis, Ind.
Columbus	W. E. Metzger	R. A. Brown, 87 E. Dunedin Road, Columbus, Ohio	Ithaca	R. F. Chamberlain	H. H. Race, School of Elec. Engg., Cornell University, Ithaca, N. Y.
Connecticut	E. J. Amberg	R. G. Warner, Yale Univ., 10 Hillhouse Ave., New Haven, Conn.	Kansas City	B. J. George	A. B. Covey, Southwestern Bell Tel. Co., Kansas City, Mo.
			Lehigh Valley	H. D. Baldwin	E. F. Weaver, Pa. Pr. & Lt. Co., 901 Hamilton St., Allentown, Pa.

LIST OF SECTIONS—Continued

Name	Chairman	Secretary	Name	Chairman	Secretary
Los Angeles	H. L. Caldwell	N. B. Hinson, Southern Cal. Edison Co., 3rd and Broadway, Los Angeles, Cal.	Rochester	H. B. Gordon	C. P. Estwick, c/o General Railway Signal Co., Rochester, N. Y.
Louisville	E. D. Wood	N. C. Pearcey, Louisville Gas & Electric Co., 311 W. Chestnut St., Louisville, Ky.	St. Louis	C. P. Potter	E. G. McLagan, 2188 Railway Exchange Bldg., St. Louis, Mo.
Lynn	Charles Skoglund	V. R. Holmgren, Turbine Engg. Dept., G. E. Co. Bldg. 64 G, Lynn, Mass.	San Francisco	B. D. Dexter	A. G. Jones, General Electric Co., 804 Russ Bldg., San Francisco, Calif.
Madison	L. J. Peters	L. C. Larson, Dept. of Elec. Engg., University of Wisconsin, Madison, Wisconsin	Saskatchewan	E. W. Bull	S. R. Parker, 2400 Montague St., Regina, Sask., Canada
Mexico	P. M. McCullough	F. Aubert, 2 A de Queretaro 22, Mexico City, Mexico	Schenectady	E. S. Lee	E. E. Johnson, Room 435, Bldg. No. 2, General Electric Co., Schenectady, N. Y.
Milwaukee	E. R. Stoekle	R. R. Knoerr, Engr., Knoerr & Fischer, 553 Milwaukee St., Milwaukee, Wis.	Seattle	C. R. Wallis	Ray Rader, Puget Sound Pr. & Lt. Co., Seattle, Wash.
Minnesota	M. E. Todd	V. E. Engquist, Northern States Pr. Co., Rice & Atwater Streets, St. Paul, Minn.	Sharon	H. B. West	J. B. Gibbs, Westinghouse Electric & Mfg. Co., Sharon, Pa.
Nebraska	C. D. Robison	L. F. Wood, Room 1319, Telephone Bldg., Omaha, Neb.	Southern Virginia	W. S. Rodman	J. S. Miller, Box 12, University, Va.
New York	R. H. Tapscott	H. S. Sheppard, Dept. of Dev. & Research, Amer. Tel. & Tel. Co., 105 Broadway, New York, N. Y.	Spokane	Bernhard Olsen	H. L. Vincent, General Electric Co., 402 Paulsen Bldg., Spokane, Wash.
Niagara Frontier	G. H. Calkins	E. P. Harder, Buffalo General Electric Co., 205 Electric Bldg., Buffalo, N. Y.	Springfield, Mass.	J. F. Murray	B. V. K. French, Am. Bosch Magneto Corp., Springfield, Mass.
Oklahoma	C. V. Bullen	C. T. Alquist, Dept. of Elec. Engg., Univ. of Oklahoma, Norman, Okla.	Syracuse	W. R. McCann	F. E. Verdin, 614 City Bank Bldg., Syracuse, N. Y.
Panama			Toledo	W. T. Lowery	Max Neuber, 1257 Fernwood Ave Toledo, Ohio
Philadelphia	L. F. Deming	R. H. Silbert, Philadelphia Electric Co., 2301 Market St., Philadelphia, Pa.	Toronto	E. M. Wood	W. P. Sutherland, Toronto Hydro Elec. System, 225 Yonge St., Toronto, Ont., Canada
Pittsburgh	H. E. Dyche	J. A. Cadwallader, The Bell Telephone Co. of Pa., 416 7th Ave., Pittsburgh, Pa.	Urbana	J. K. Tuthill	M. A. Paucett, University of Illinois, 301-A Elec. Engg. Laboratory, Urbana, Ill.
Pittsfield	J. R. Rue	V. M. Montsinger, General Electric Co., Pittsfield, Mass.	Utah	C. B. Shipp	A. C. Keim, 133 So. West Temple St., Salt Lake City, Utah
Portland, Ore.	L. M. Moyer	H. H. Cake, Pacific State Elec. Co., 5th and Davis Streets, Portland, Ore.	Vancouver	C. W. Colvin	J. Teasdale, British Columbia Elec. Railway Co., Vancouver, B. C., Canada
Providence	A. E. Watson	F. W. Smith, Blackstone Valley Gas & Elec. Co., Pawtucket, R. I.	Washington	L. D. Bliss	R. W. Cushing, Federal Pr. Comm., Interior Bldg., 18th & F Sts., N. W., Washington, D. C.
			Worcester	A. F. Snow	F. B. Crosby, Morgan Constr. Co., 15 Belmont St., Worcester, Mass.
			Total	54	

LIST OF BRANCHES

Name and Location	Chairman	Secretary	Counselor (Member of Faculty)
Akron, Municipal University of, Akron, Ohio	C. D. Tinley	G. E. Burkholder	J. T. Walther
Alabama Polytechnic Institute, Auburn, Ala.	J. J. O'Rourke	C. E. Meyer	W. W. Hill
Alabama, University of, University, Ala.			
Arizona, University of, Tucson, Ariz.	J. H. Hopper		J. C. Clark
Arkansas, University of, Fayetteville, Ark.		B. H. Dorman	W. B. Stelzner
Armour Institute of Technology, 3300 Federal St., Chicago, Ill.	C. J. McDonald	J. E. Wack	D. P. Moreton
Brooklyn Polytechnic Institute, 99 Livingston St., Brooklyn, N. Y.	H. F. Steen	F. J. Mullen	Robin Beach
Bucknell University, Lewisburg, Pa.	R. E. Snauffer	J. E. Bridegum	W. K. Rhodes
California Institute of Technology, Pasadena, Calif.	G. R. Crane	A. W. Dunn	R. W. Sorensen
California, University of, Berkeley, Calif.	C. E. Cherry	L. G. Levoy, Jr.	T. C. McFarland
Carnegie Institute of Technology, Pittsburgh, Pa.	G. M. Cooper	J. H. Ferrick	B. C. Dennison
Case School of Applied Science, Cleveland, Ohio	W. A. Thomas	J. O. Herbster	H. B. Dates
Catholic University of America, Washington, D. C.			T. J. MacKavanaugh
Cincinnati, University of, Cincinnati, Ohio	C. E. Young	W. C. Osterbrock	W. C. Osterbrock
Clarkson College of Technology, Potsdam, N. Y.	D. R. Carpenter	C. H. Joy	A. R. Powers
Clemson Agricultural College, Clemson College, S. C.	Laird Anderson	J. F. Callaham	S. R. Rhodes
Colorado State Agricultural College, Fort Collins, Colo.	G. W. Mitchel	D. P. Nohr	H. G. Jordan
Colorado, University of, Boulder, Colo.	H. R. Arnold	E. E. Stoekly	W. C. DuVall
Cooper Union, New York, N. Y.	Wilfred Henschel	H. H. Reuter	N. L. Towle
Denver, University of, Denver, Colo.	J. N. Petrie	D. S. Cooper	R. E. Nyswander
Detroit, University of, Detroit, Mich.	E. T. Faur	Wm. F. Haldeman	H. O. Warner
Drexel Institute, Philadelphia, Pa.	D. M. Way	C. W. Kenyon	E. O. Lange
Duke University, Durham, N. C.	W. E. Cranford	C. W. Berglund, Jr.	W. J. Seeley
Florida, University of, Gainesville, Fla.	A. W. Payne	N. J. Rogers	J. M. Weil
Georgia School of Technology, Atlanta, Ga.	E. M. Burn	K. W. Mowry	E. S. Hannaford
Idaho, University of, Moscow, Idaho	O. C. Mayer	K. P. Kenworthy	J. H. Johnson
Iowa State College, Ames, Iowa	R. R. Law	C. E. Rohrig	F. A. Fish
Iowa, State University of, Iowa City, Iowa	Drew MacDouga		A. H. Ford
Kansas State College, Manhattan, Kansas	H. C. Lindberg	J. W. Schwanke	R. G. Kloeffler
Kansas, University of, Lawrence, Kans.	A. E. Keefe	R. O. Shepp	G. C. Shaad
Kentucky, University of, Lexington, Ky.	C. W. Daniel	L. L. Massie	W. E. Freeman
Lafayette College, Easton, Pa.	H. W. Lovett	C. W. Zook	Morland King
Lehigh University, Bethlehem, Pa.	S. R. Van Blarcom	R. S. Taylor	J. L. Beaver
Lewis Institute, Chicago, Ill.	A. Gaimari	Leo Weinshank	F. A. Rogers
Louisiana State University, Baton Rouge, La.	J. C. Bice	J. J. Bridges, Jr.	M. B. Voorhies
Louisville, University of, Louisville, Ky.	Samuel Evans	J. S. Overstreet	D. C. Jackson, Jr.
Maine, University of, Orono, Maine	A. V. Smith	G. A. Whittier	W. E. Barrows, Jr.
Marquette University, 1200 Sycamore St., Milwaukee, Wis.	P. C. Neumann	W. E. Schmitz	J. F. H. Douglas
Massachusetts Institute of Technology, Cambridge, Mass.	R. M. Durrett	F. O. Urban	W. H. Timbie

LIST OF BRANCHES—Continued.

Name and Location	Chairman	Secretary	Counselor (Member of Faculty)
Michigan State College, East Lansing, Mich.	M. H. Blivin	W. G. Keck	M. M. Cory
Michigan, University of, Ann Arbor, Mich.	W. R. Hough	H. L. Scofield	B. F. Bailey
Milwaukee, School of Engineering of, 163 East Wells St., Milwaukee, Wis.	G. E. Henkel	T. J. Coleman, Jr.	J. D. Ball
Minnesota, University of, Minneapolis, Minn.	C. L. Elliott	C. J. Johnston	J. H. Kuhlmann
Mississippi Agricultural & Mechanical College, A. & M. College, Miss.	R. S. Kersh	L. L. Stokes	L. L. Patterson
Missouri School of Mines & Metallurgy, Rolla, Mo.	F. B. Beatty	E. J. Gregory	I. H. Lovett
Missouri, University of, Columbia, Mo.	G. L. Crow	C. B. Holt	M. P. Weinbach
Montana State College, Bozeman, Mont.	J. M. Field	G. E. West	J. A. Thaler
Nebraska, University of, Lincoln, Neb.	G. W. Cowley	L. T. Anderson	F. W. Norris
Nevada, University of, Reno, Nevada	Alden McCullom	A. B. Chace	S. G. Palmer
Newark College of Engineering, 367 High St., Newark, New Jersey	C. P. Hurd	W. R. Ackor	J. C. Peet
New Hampshire, University of, Durham, N. H.	N. J. Pierce	M. W. Cummings	L. W. Hitchcock
New York, College of the City of, 139th St. & Convent Ave., New York, N. Y.	Daniel Klatzko	Walter Broleen	Harry Baum
New York University, University Heights, New York, N. Y.	G. A. Taylor	A. W. Schneider	J. L. Arnold
North Carolina State College, Raleigh, N. C.	O. M. Carpenter	W. E. Moseley	R. S. Fouraker
North Carolina, University of, Chapel Hill, N. C.	W. N. Michal	C. P. Hayes, Jr.	P. H. Daggett
North Dakota, University of, University Station, Grand Forks, N. D.	J. K. Walsh	O. A. Aaker	D. R. Jenkins
Northwestern University, 316 Huntington Ave., Boston 17, Mass.	R. W. Cleveland	H. F. Wilder	W. L. Smith
Notre Dame, University of, Notre Dame, Ind.	J. J. Donahue	F. J. Weiss	J. A. Caparo
Ohio Northern University, Ada, Ohio	R. F. Rice	R. A. Lash	F. W. Norrish
Ohio State University, Columbus, O.	R. H. Spry	G. W. Trout	F. C. Caldwell
Ohio University, Athens, O.	Clarke Kenney	H. W. Giesecke	A. A. Atkinson
Oklahoma A. & M. College, Stillwater, Okla.	Benny Fouts	H. E. Bradford	Edwin Kurtz
Oklahoma, University of, Norman, Okla.	C. K. Itner	Le Roy Moffett, Jr.	F. G. Tappan
Oregon State College, Corvallis, Ore.	Harry Loggan	A. W. Swingle	F. O. McMillan
Pennsylvania State College, State College, Pa.	H. W. Bair	J. F. Houldin	L. A. Doggett
Pennsylvania, University of, Philadelphia, Pa.	J. B. Luck	H. W. Brown, Jr.	C. D. Pawcett
Pittsburgh, University of, Pittsburgh, Pa.	W. V. G. Eakins	J. G. Hoop	H. E. Dyche
Princeton University, Princeton, N. J.	J. F. Nuner	C. F. Nesslage	Malcolm MacLaren
Purdue University, Lafayette, Indiana	S. E. Benson	P. C. Sandretto	A. N. Topping
Rensselaer Polytechnic Institute, Troy, N. Y.	F. E. Caulfield	David Younger	F. M. Sebast
Rhode Island State College, Kingston, R. I.	R. H. Downen	A. Z. Smith	Wm. Anderson
Rose Polytechnic Institute, Terre Haute, Ind.	John Cost	G. P. Brosman	C. C. Knipmeyer
Rutgers University, New Brunswick, N. J.	J. L. Quinn	H. M. Hobson	P. S. Creager
Santa Clara, University of, Santa Clara, Calif.	W. E. Eargle	T. L. Selna	L. J. Neuman
South Carolina, University of, Columbia, S. C.	L. M. Becker	L. A. Griffith	T. F. Ball
South Dakota State School of Mines, Rapid City, S. D.	C. R. Cantonwine	Vern Hagmann	J. O. Kammerman
South Dakota, University of, Vermillion, S. D.	D. R. Stanfield	Paul Schell	B. B. Brackett
Southern California, University of, Los Angeles, Calif.	N. R. Morgan	A. B. Cutts	P. S. Biegler
Stanford University, Stanford University, Calif.	F. C. Gilman	W. G. Snyder	T. H. Morgan
Stevens Institute of Technology, Hoboken, N. J.	D. B. Spangler	George Habach	F. C. Stockwell
Swarthmore College, Swarthmore, Pa.	F. C. Casavant	B. C. Algeo	Lewis Fussell
Syracuse University, Syracuse, N. Y.	O. D. Fleming	J. H. Behm	C. W. Henderson
Tennessee, University of, Knoxville, Tenn.	Ab Martin	E. E. Moyers	C. A. Perkins
Texas, A. & M. College of, College Station, Texas	N. M. Chapman	H. L. Willke	H. C. Dillingham
Texas, University of, Austin, Texas	F. L. Sulloway	H. A. Tankersley	J. A. Correll
Utah, University of, Salt Lake City, Utah	Lomax Gwathmey	Garnett Littlefield	L. P. Dickinson
Vermont, University of, Burlington, Vt.	J. L. Rothgeb	L. G. Cowles	S. W. Anderson
Virginia Military Institute, Lexington, Va.	C. E. McMurdo	R. A. Wright	Claudius Lee
Virginia Polytechnic Institute, Blacksburg, Va.	J. B. Danielson	Labon Backer	W. S. Rodman
Virginia, University of, University, Va.	H. J. Miller	L. R. Quarles	R. D. Sloan
Washington, State College of, Pullman, Wash.	C. W. Huffine	L. H. Wollenberg	H. G. Hake
Washington University, St. Louis, Mo.	R. E. Kepler	W. L. Knaus	G. L. Hoard
Washington, University of, Seattle, Wash.	C. C. Coulter	R. C. Leithead	R. W. Dickey
Washington and Lee University, Lexington, Va.	Eugene Odbert	Bernard Yoepp, Jr.	A. H. Forman
West Virginia University, Morgantown, W. Va.	F. J. McGowan, Jr.	C. B. Seibert	C. M. Jansky
Wisconsin, University of, Madison, Wis.	E. C. Moudy	A. L. Sweet	E. W. Starr
Worcester Polytechnic Institute, Worcester, Mass.	R. W. Miner	J. K. Fullerton	G. H. Sechrist
Wyoming, University of, Laramie, Wyoming		J. R. Sutherland	C. F. Scott
Yale University, New Haven, Conn.			
Total 99			

AFFILIATED STUDENT SOCIETY

Brown Engineering Society, Brown University, Providence, R. I. S. A. Woodruff

ORDER FORM FOR REPRINTS OF PAPERS ABRIDGED IN THE JOURNAL

(February 1929) Number	Author	Title
<input type="checkbox"/> 29-25	J. S. Slepian	Theory of the Deion Circuit Breaker
<input type="checkbox"/> 29-35	R. C. Dickinson and B. P. Baker	The Structural Development of the Deion Circuit Breaker
<input type="checkbox"/> 29-37	B. G. Jamieson	Field Tests of the Deion Circuit Breaker
<input type="checkbox"/> 29-3	Vladimir Karapetoff	A Graphical Theory of Traveling Electric Waves
<input type="checkbox"/> 28-146	J. V. Breisky and E. O. Erickson	Some Photoelectric and Glow Discharge Devices
<input type="checkbox"/> 29-7	Philip Sporn	1927 Lightning Experience on the 132-Kv. Transmission Lines of the American Gas & Electric Company
<input type="checkbox"/> 29-2	P. M. Lincoln	Totalizing of Electric System Loads
<input type="checkbox"/> 29-8	H. C. Specht	The Fundamental Theory of the Capacitor Motor
<input type="checkbox"/> 28-112	Wm. S. Peterson and H. J. McCracken, Jr.	Movements of Overhead Line Conductors during Short Circuits
<input type="checkbox"/> 29-32	H. H. Glenn and E. B. Wood	Purified Textile Insulation for Telephone Central Office Wiring

Name

Address

Please order reprints by number. Address Order Department A. I. E. E., 33 West 39th Street, New York, N. Y.

DIGEST OF CURRENT INDUSTRIAL NEWS

NEW CATALOGUES AND OTHER PUBLICATIONS

Mailed to interested readers by issuing companies

Substations. Bulletin 57. Describes the new Delta-Star type "F" high voltage substation with rotating busses. The number of insulators ordinarily used have been reduced one-half in the new design. Delta-Star Electric Company, 2400 Block Fulton Street, Chicago.

Manual of Electrical Testing.—Bulletin 138, 20 pp. On testing single-phase and poly-phase motors, and on testing transformers for core loss, copper loss, polarity, insulation, temperature rise and efficiency. Wagner Electric Corporation, 6400 Plymouth Avenue, St. Louis.

Fused Quartz.—Bulletin GEA-848, 16 pp. Describes the recently perfected material developed in General Electric laboratories. The physical properties and electrical characteristics are outlined, as well as applications. General Electric Company, Schenectady, N. Y.

Miniature Transformer.—Illustrated circular describes the new Weston miniature transformer, styled Model 539, for use in connection with a one ampere a-c. instrument. When so used, measurements can be made all the way from 0.2 to 200 amperes. Weston Electrical Instrument Corporation, 584 Frelinghuysen Avenue, Newark, N. J.

Arc Welding Manual.—44 pp., "Electric Arc Welding with Alternating Current." Compiled by the Martindale Electric Company, 1254 West 4th Street, Cleveland, which has recently taken on national distribution of the Seneca Electric Arc Welder, manufactured at Seneca, Kansas. This is an alternating-current type of welder, operating on either 110, 220 or 440 volts, 60 cycles and is rated at 40 to 160 amperes, (200 amperes for manual welding). It is oil cooled.

Circuit-Breaker.—Bulletin 21, 12 pp. Describes the new Pacific Electric, type "JC-17," oil circuit-breaker, designed to meet the need for a low voltage oil circuit-breaker with rupturing capacity commensurate with established distribution circuit requirements. This breaker has a rupturing capacity of 100,000 kv-a. and is equipped with motor-wound, spring-actuated control, which gives it a very fast operating speed. Pacific Electric Manufacturing Corporation, 5815 Third Street, San Francisco.

Wiring Troughs.—Bulletin 150, 8 pp. Describes "Duct," a new enclosed metal raceway or trough and fittings for carrying wires or cables, affording ample protection against damage and at the same time having them instantly accessible at all points throughout their entire length, so that splicing, tapping or other changes can be made to the wiring, or additional cables run through in the quickest and easiest manner. By making "Duct" square, only one-half the usual number of fittings is required. Bull Dog Electric Products Company, 7610 Jos. Campau Avenue, Detroit.

The Evolution of the Screw.—Booklet, 22 pp., illustrated. Traces the development of the screw from the earliest stages up to the present time. The historical facts have been compiled from authentic sources. Several pages of the booklet are devoted to various types of self-tapping screws, widely used in the production of electrical apparatus for making fastenings to switchboards and other electrical equipment made from metals, slate, bakelite, fibre, etc. Such screws cut their own threads in the material as they are being driven, eliminating tapping operations. Parker-Kalon Corporation, 198 Varick Street, New York.

NOTES OF THE INDUSTRY

G-E. Orders Increased in 1928.—Orders received by the General Electric Company during 1928 amounted to \$348,848,512 compared with \$309,784,623 for 1927, an increase of 13%, according to President Gerard Swope. The orders for the December quarter amounted to \$88,162,049, compared with \$76,708,532 for the last quarter of 1927, an increase of 15%.

Delta-Star Has Canadian Associate.—The Delta-Star Electric Company, Chicago, and the Monarch Electric Company, St. Johns, Quebec, have formed an association whereby the Canadian factory will now have full advantage of Delta-Star designs, engineering and research facilities. A complete line of Unit Type, standardized equipment will be produced at St. Johns, for Canadian distribution.

Arc Welding Used in Adding Seven Stories to WOR.—The Electric Arc Cutting and Welding Company of Newark, N. J., announce that their system of welding is being employed in increasing the height of the present 8-story Bamberger building in that city, housing the broadcasting station WOR. Every column from the basement to the roof is being strengthened by the welding of four angles properly placed, and the joint between floors and to the old building is also accomplished by arc welding. The work is now in progress and will be completed in the Spring.

Cutler-Hammer Changes Name.—Announcement has been made of a change in the name of the Cutler-Hammer Manufacturing Company, Milwaukee, manufacturers of electric motor control, wiring devices and allied lines. The new name of the company will be Cutler-Hammer, Inc. The new company is organized as a Delaware corporation with the following officers: chairman of the board, F. R. Bacon; president, B. L. Worden; vice-presidents, F. L. Pierce and J. C. Wilson, treasurer, H. F. Vogt; secretary, W. C. Stevens. In the change from a Wisconsin to a Delaware corporation, the Cutler-Hammer Mfg. Co., Milwaukee, the Cream City Foundry Co., Milwaukee, and Cutler-Hammer Mfg. Co., New York are united under one name.

Thomas E. Murray, Inc., have moved their New York offices to 88 Lexington Avenue, where they occupy the entire eighth floor of the American Book Company's new building, at the corner of 26th Street. They have also opened an office in the Eaton Tower building, Detroit, Michigan. The company is widely known for its work in the power plant and industrial fields, the Hell Gate, East River and Hudson Avenue Stations, being among the most prominent plants designed by them in the public utility field. Cannon Manufacturing Company, Chrysler Corporation and General Motors, are numbered among the industrial concerns for whom extensive work has been performed.

Thomas E. Murray (*Fel. A.I.E.E.*) president of the company, and for many years, general manager, senior vice president and vice chairman of the board of directors of The New York Edison Company, and an official and director of several other electric utility companies of greater New York and Westchester, has recently severed these connections, and intends to devote his time to Thomas E. Murray, Inc., and to the development of his patents, which cover a very wide field. He is one of the most prolific inventors in the country and stands third on the list showing the number of patents issued to individuals, by the patent office. Many of his inventions have played an important part in the development of power plant practise, the water cooled furnace being perhaps the best known among these.

Spain a Promising Market for U. S. Electrical Equipment.—Spain is one of our most promising foreign markets for electrical goods, according to a trade bulletin just issued by the Department of Commerce. During the past five years electrical exports to this market have averaged in the vicinity of \$2,000,000 annually, almost every class of electrical goods being represented in these shipments. Despite a well-organized Spanish manufacturing industry and active competition from other European manufacturers, American electrical equipment is considered standard, the report states. This situation is partly accounted for because of the extensive investments of American capital in Spanish factories and utilities.

Spain's water-power resources are far beyond her present needs, the report discloses. While many projects have been advanced for its development it is probable that the power of the country will not be fully utilized for many years to come.

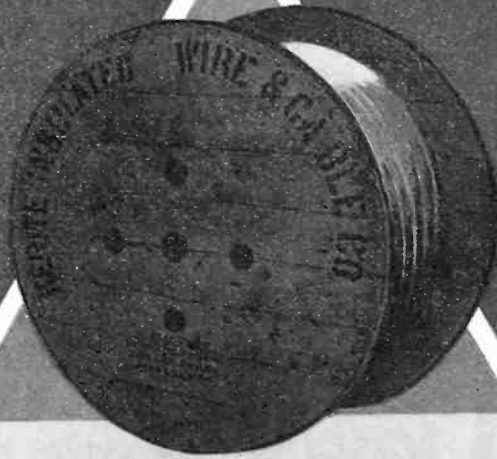

The careful investor judges a security by the history of its performance.

KERITE

in a half-century of continuous production, has spun out a record of performance that is unequalled in the history of insulated wires and cables.

Kerite is a seasoned security.

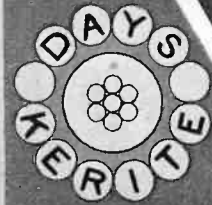
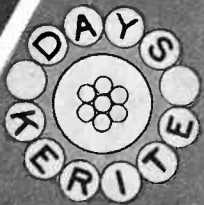

THE KERITE INSULATED WIRE & CABLE COMPANY INC
 NEW YORK SAN FRANCISCO CHICAGO

AUTOMATIC PUMPING

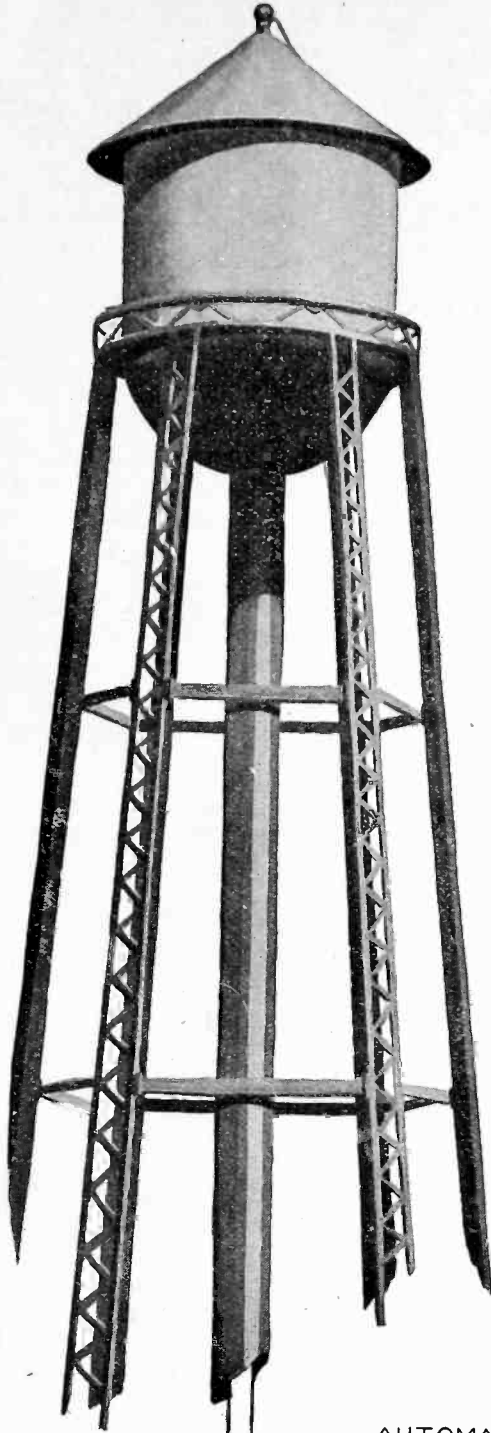

Pumps that operate automatically day after day, without an attendant on the job, are a real economy; no station attendants, no expensive boilers and standby equipment, no dependence upon the human element.

Electrically driven pumps can be started and stopped automatically as the water level in the storage tank varies and you will always be assured of a ready water supply. EC&M Automatic Pump Control Equipment is your guarantee.

Your pumping stations can be controlled by EC&M Float Switches or Altitude Gauges through EC&M Oil-immersed Automatic Compensators or Across-the-line Starters for A. C. motors and through EC&M Direct Current Starters for D. C. motors.

An EC&M Altitude Regulator will maintain the water level in a storage tank fifty feet high within limits of one foot. This is done automatically through the electrical contacts in the Regulator which are a part of the circuit that controls the starting and stopping of the pump motor.

The EC&M Cushion Tank and Valve installation, as shown in the diagram below, is designed to prevent those pulsations of the Regulator needle which result from the surging of the water in the pump discharge line. Spasmodic starting and stopping of the pump motor will not occur where this cushion tank is provided.

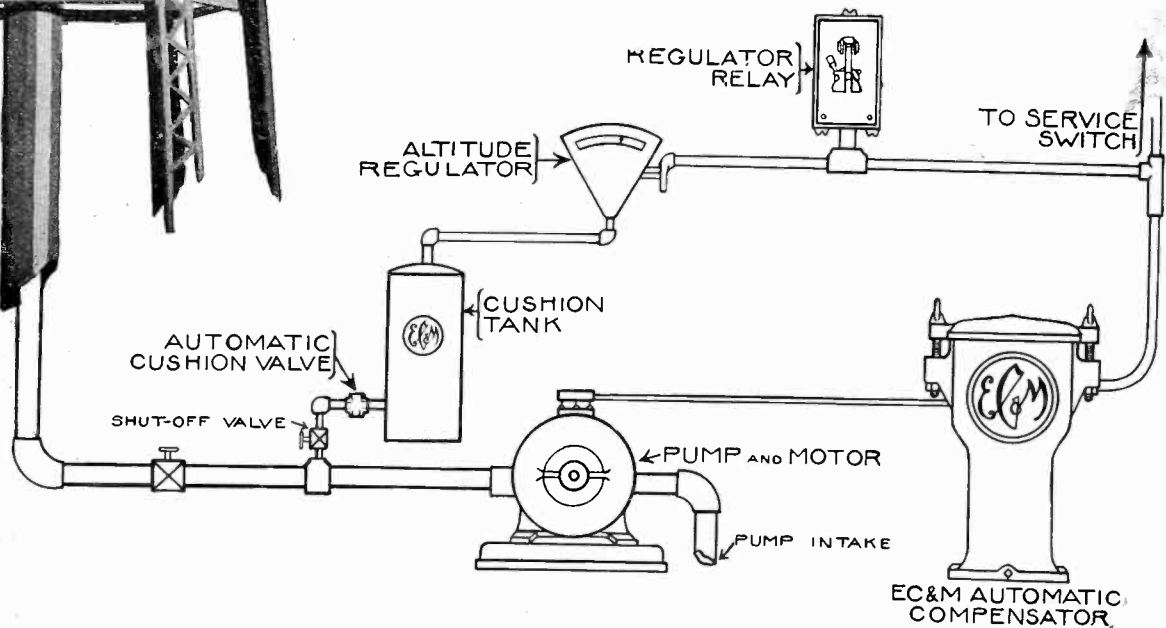

Send for Specification Sheets S-21 and S-25 and Bulletins 1016-B, 1020-A, 1033-B and 1042-F.



THE ELECTRIC CONTROLLER & MFG. CO.

NEW YORK-50 CHURCH ST. CLEVELAND, OHIO PHILADELPHIA-WITHERSPOON BLDG.
 CHICAGO-CONWAY BLDG. HOUSTON-1006 WASHINGTON AVE. PITTSBURGH-OLIVER BLDG.
 DETROIT-DIME BANK BLDG. LOS ANGELES-912 E. THIRD ST. SAN FRANCISCO-CALL BUILDING
 BIRMINGHAM-BROWN-MARX BLDG. SALT LAKE CITY-228 SO. W. TEMPLE MONTREAL-CASTLE BLDG.
 CINCINNATI-NATIONAL BANK BLDG. TORONTO-REFORD BLDG. TULSA-217 E. ARCHER ST.



Please mention the JOURNAL of the A. I. E. E. when writing to advertisers.

**New Departure
Equipped**

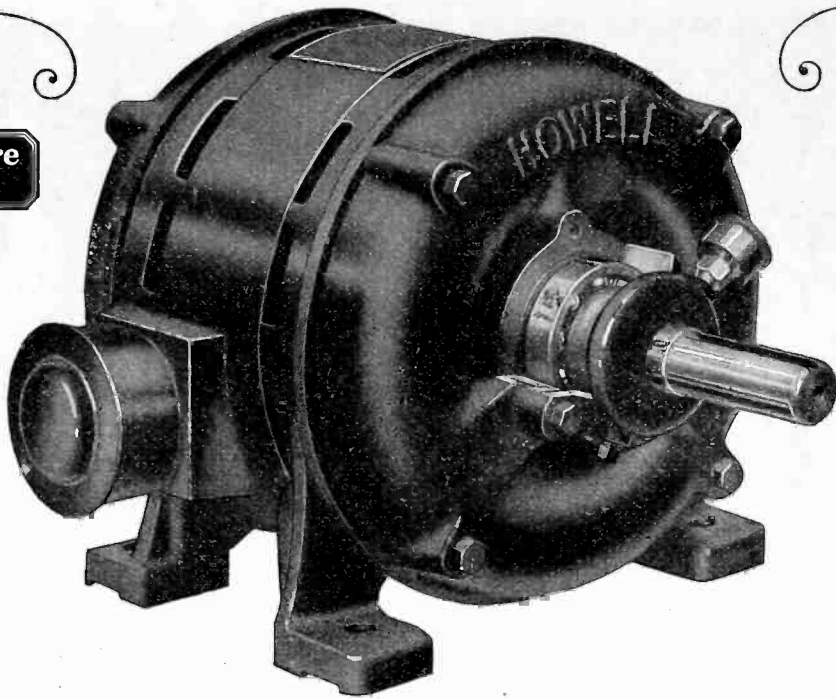

For Peak Efficiency— Mechanical as Well as Electrical

HOWELL "Red Band" Motors of the higher speed type are equipped with New Departure Ball Bearings—another of the more than fifty manufacturers of general purpose electric motors using ball bearings as optional or standard equipment.

Howell uses New Departures be-

cause of the fact that the electric motor will not retain its full efficiency electrically unless it also *retains its efficiency mechanically.*

New Departure Ball Bearings not only assure *peak* mechanical operation but are a guarantee that such efficiency is built to last.

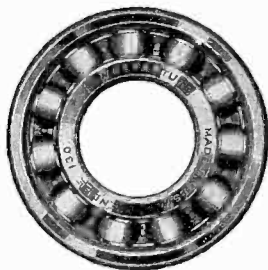

New Departure Ball Bearings

The New Departure Manufacturing Co.,
Bristol, Connecticut
Chicago • Detroit • San Francisco

1068

Please mention the JOURNAL of the A. I. E. E. when writing to advertisers.

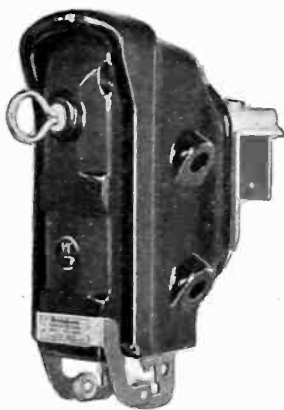
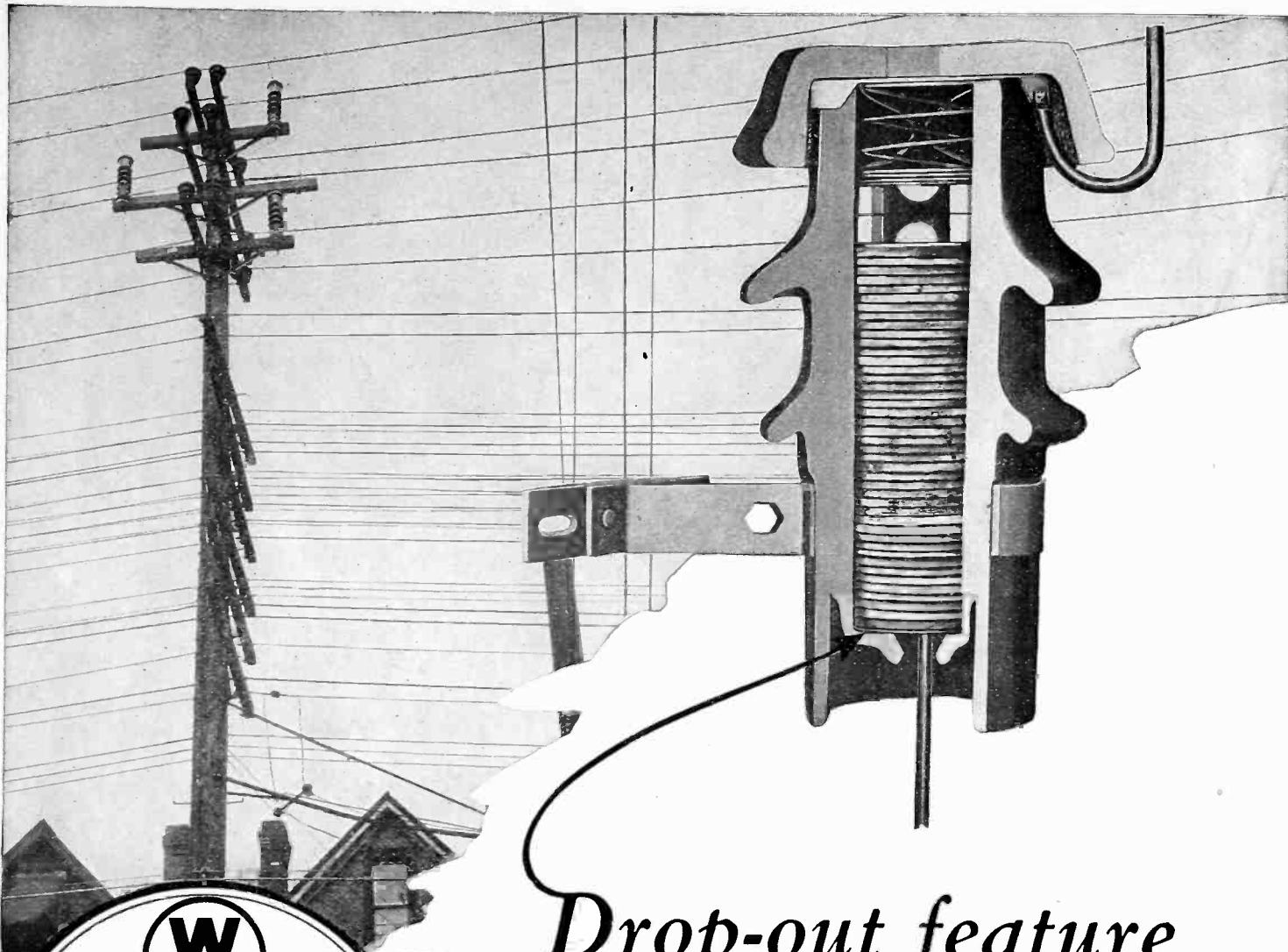

Double Protection

The ES Porcelain cutout has both *housing* and *door* of wet-process porcelain.

Autovalve arresters and ES cutouts assure complete safety and maximum protection of distribution transformers.

Drop-out feature provides security

THE drop-out feature provides an automatic circuit-clearing device to meet the abnormal condition such as a heavy power surge. The arrester disconnects itself from the line, preventing continued grounds with the resulting outages.

The drop-out feature also helps the troubleshooter. He can spot at a glance the destroyed arrester—the ground lead hangs loose.

This safety feature, obtainable only in the Westinghouse LV Autovalve Arrester, increases the assurance of uninterrupted power service—an assurance further supported by the wet-process porcelain housing which sheds water like a duck's back.

Westinghouse Electric & Manufacturing Company
East Pittsburgh Pennsylvania

Sales Offices in All Principal Cities of
the United States and Foreign Countries

Westinghouse

X98184

Please mention the JOURNAL of the A. I. E. E. when writing to advertisers.

{ONE OF A SERIES SHOWING AMERICAN TRANSFORMERS IN MANY DIVERSIFIED INDUSTRIES}



RELIABLE CONTROL

WELL known manufacturers* of electric control apparatus for standard and special applications use American Transformers for the power control in their installations.

In this, as in other fields, their success has been due to

1. Flexibility—(transformers to suit any circuit)
2. Reliability—(24 hour service, without interruption, if necessary)
3. Economy—(long life with a minimum of repairs)

Bulletin 1040- J giving detailed data will be sent on request. There is an American Transformer for every industrial service. Let our engineers advise you on *your* problem — no obligation, of course.

*Names upon request

AMERICAN TRANSFORMER COMPANY

176 EMMET STREET

NEWARK, N. J.

Representatives

Chicago, Ill.
L. C. Herrmann
4433 North Richmond Street
Ravenswood Station

Philadelphia, Pa.
L. D. Joralemon
112 South 16th Street

Knoxville, Tenn.
Arthur L. Pollard

Montreal, Canada
W. O. Taylor & Co., Ltd.
415 Canada Cement B'ldg.

Minneapolis, Minn.
Elliott Equipment Co.
708-6th Avenue, South

San Francisco, Calif.
James H. Southard
682 Mission Street

St. Louis, Mo.
J. W. Jones, 432 Pennant Building

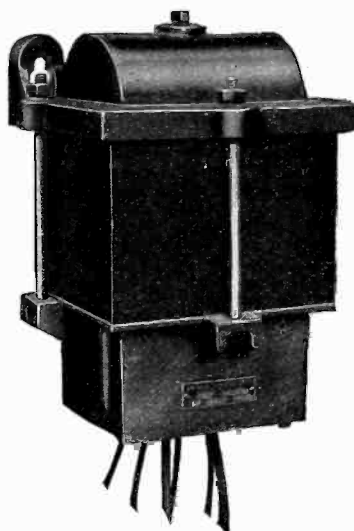

Double wound compound-filled sizes 100 watt—5000 watts. Standard voltage 220 or 440. Any special voltage requirement can be met up to and including 550 volts.

AMERICAN TRANSFORMER

Please mention the JOURNAL of the A. I. E. E. when writing to advertisers.

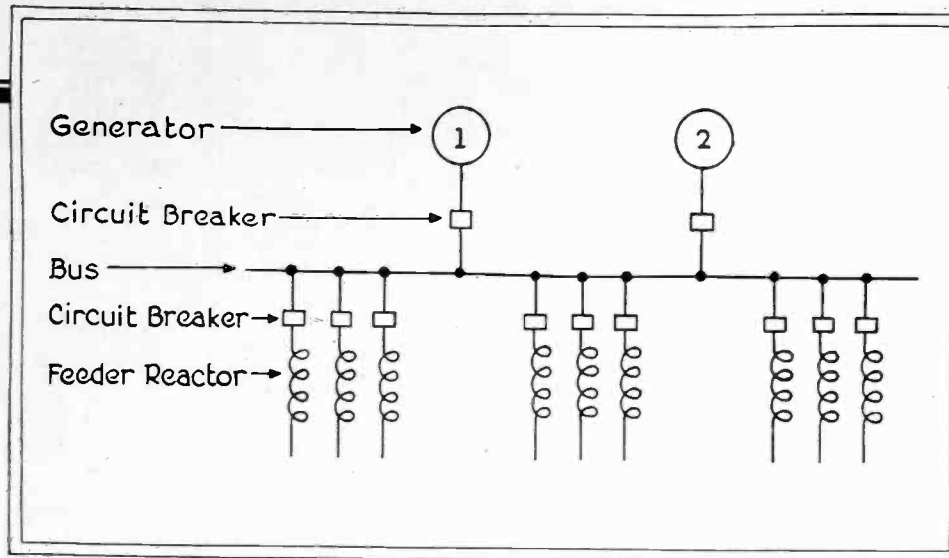

Straight line bus arrangement. Simplified illustration of the use of feeder reactors

Use Reactors

TO INSURE GOOD SERVICE

Install them now even though, on account of the limited total capacity of the connected generators, they may not be needed to protect the apparatus. A short circuit on any feeder in such a system, without current-limiting reactors, may cause a shutdown of the station and a total interruption to the service—but reactors would so localize the fault that service would be continued on all except the affected feeder.

With the growth of the system and the addition of generator capacity, current-limiting reactors may be necessary to protect the apparatus against heavy short circuits. Install them *now* and obtain the benefits of improved service in the meantime. Good service and continued growth go hand in hand.

For description of G-E cast-in-concrete reactors, ask for Bulletin GEA-976

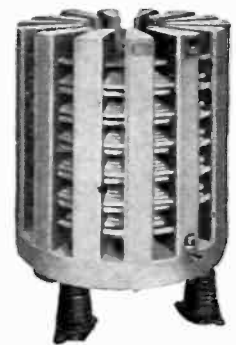

Current-limiting reactors have two general functions: (1) to protect service by localizing the effects of a short circuit; (2) to protect apparatus by limiting the short-circuit current to a safe value. Every circuit, feeder, tie-line, and generator should be connected to the power-station bus through a reactor, so that a short on any one of these does not constitute a dead short on the generator bus. Further to localize the short circuits, this bus should be sectionalized with reactors.



GENERAL ELECTRIC

GENERAL ELECTRIC COMPANY, SCHENECTADY, N. Y., SALES OFFICES IN PRINCIPAL CITIES

411-4

Husky

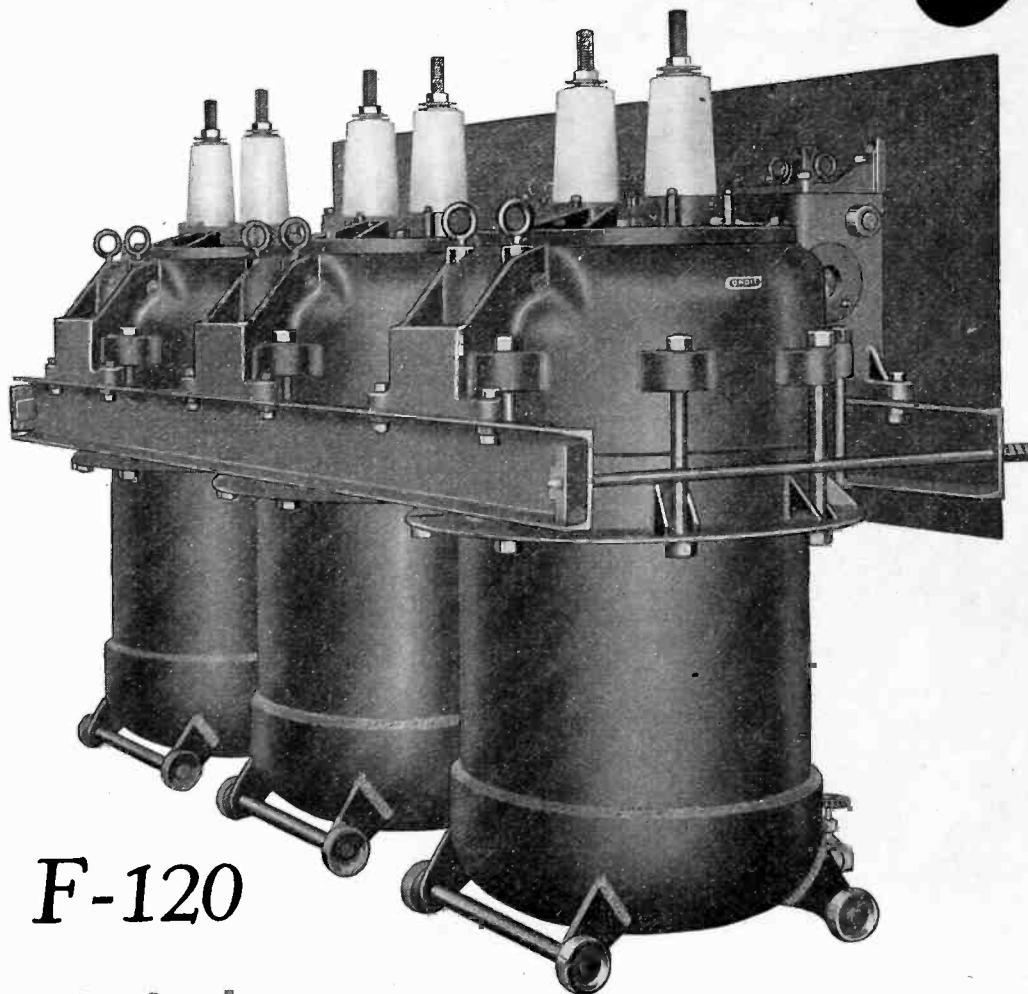

Type F-120

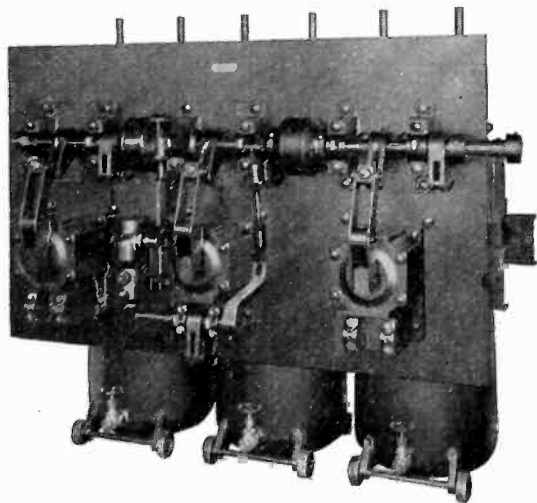

Look at it! It's a husky brute of a breaker. You couldn't find a better for its rated duty.

Husky, dependable, adaptable to individual requirements, and installed at relatively low cost.

"Get in touch with Condit"

CONDIT ELECTRICAL MFG. CORPORATION

Manufacturers of Electrical Protective Devices
BOSTON, MASS.

Northern Electric Company

LIMITED
Distributor for the Dominion of Canada

SPECIFICATIONS: Ampere capacity 3,000 or less; voltage 15,000 or 25,000; interrupting capacity 1,500,000 kv-a or less.

CONDIT

ALLIS-CHALMERS

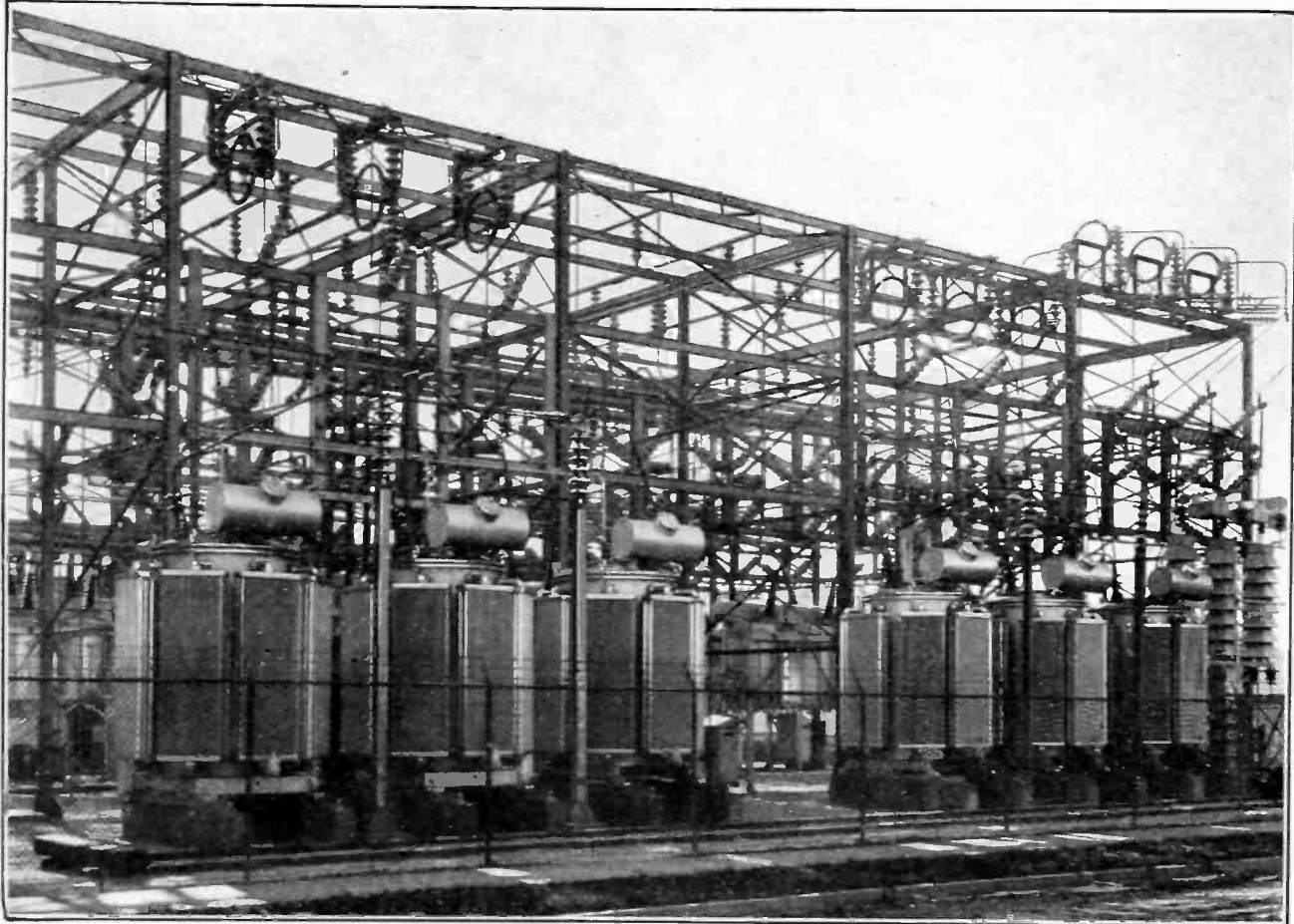

Power Transformers

Installation view of six oil-insulated, self-cooled, outdoor type transformers rated at 5000 KV-A, 60 cycle, 1 phase, H. V., 66000 volts-L. V., 13200 volts, in the Hamilton substation of the Union Gas & Electric Company.



ELECTRICAL MACHINERY

Gas Engines
 Steam Engines
 Steam Turbines
 Condensers
 Oil Engines
 Hydraulic Turbines
 Pumping Engines
 Centrifugal Pumps
 Mining Machinery
 Metallurgical Machinery
 Crushing Machinery
 Cement Machinery
 Flour Mill Machinery
 Saw Mill Machinery
 Air Compressors
 Air Brakes
 Steam and Electric Hoists
 Farm Tractors
 Power Transmission Machinery

ALLIS-CHALMERS MANUFACTURING CO.
MILWAUKEE, WIS. U.S.A.

District Offices in All Principal Cities

Please mention the JOURNAL of the A. I. E. E. when writing to advertisers.

—then they install

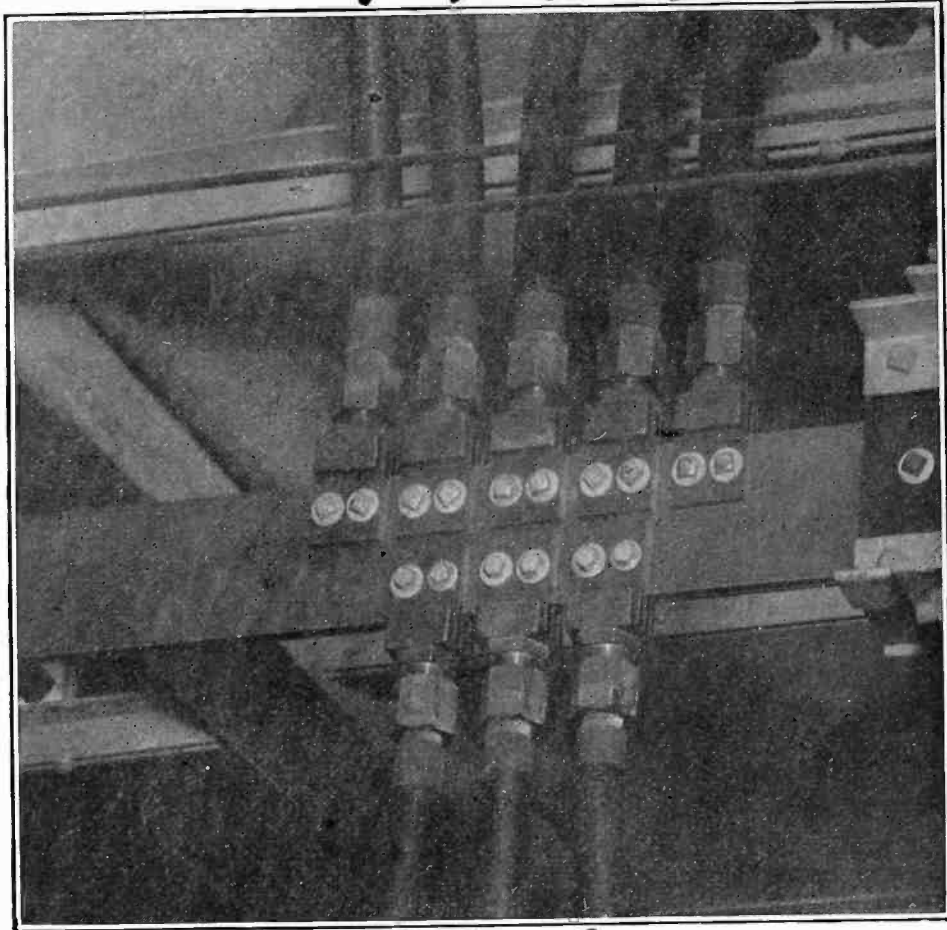
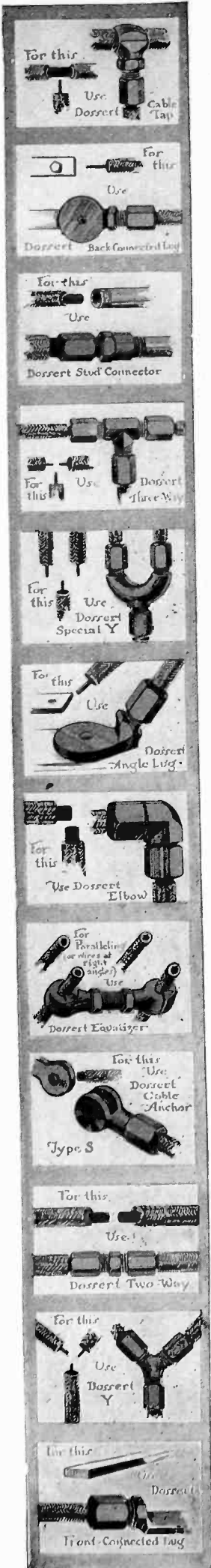
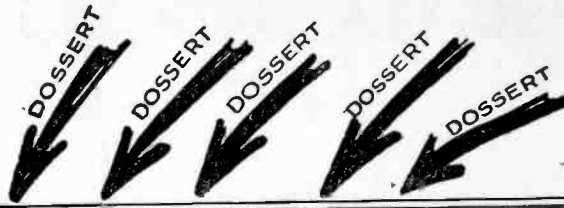

Installation by
W. V. PANGBORNE & CO.
Constructing Engineers
Philadelphia, Pa.

DOSSERT Connectors tying feeders
to negative track bus on columns
at Carlisle Street Substation,
Broad Street Subway, Philadel-
phia.

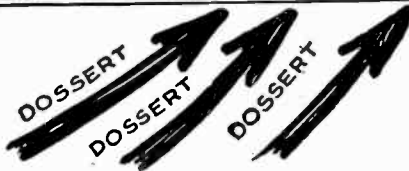

DOSSERTS

WHEN engineers lay out a substation, with knowledge of the trouble and cost of old fashioned joints . . .

—when they have had proof of the trim appearance, effective performance and low installed cost of DOSSERTS

—then they install them.

The Dossert year book shows numerous applications of

DOSSERTS, with measurements that can well be written into standard specifications for connections and terminals.

A copy will be mailed you on request.

DOSSERT & CO.

H. B. LOGAN, President
242 West 41st Street
New York, N. Y.

The best
cable
shop
in the
country

....

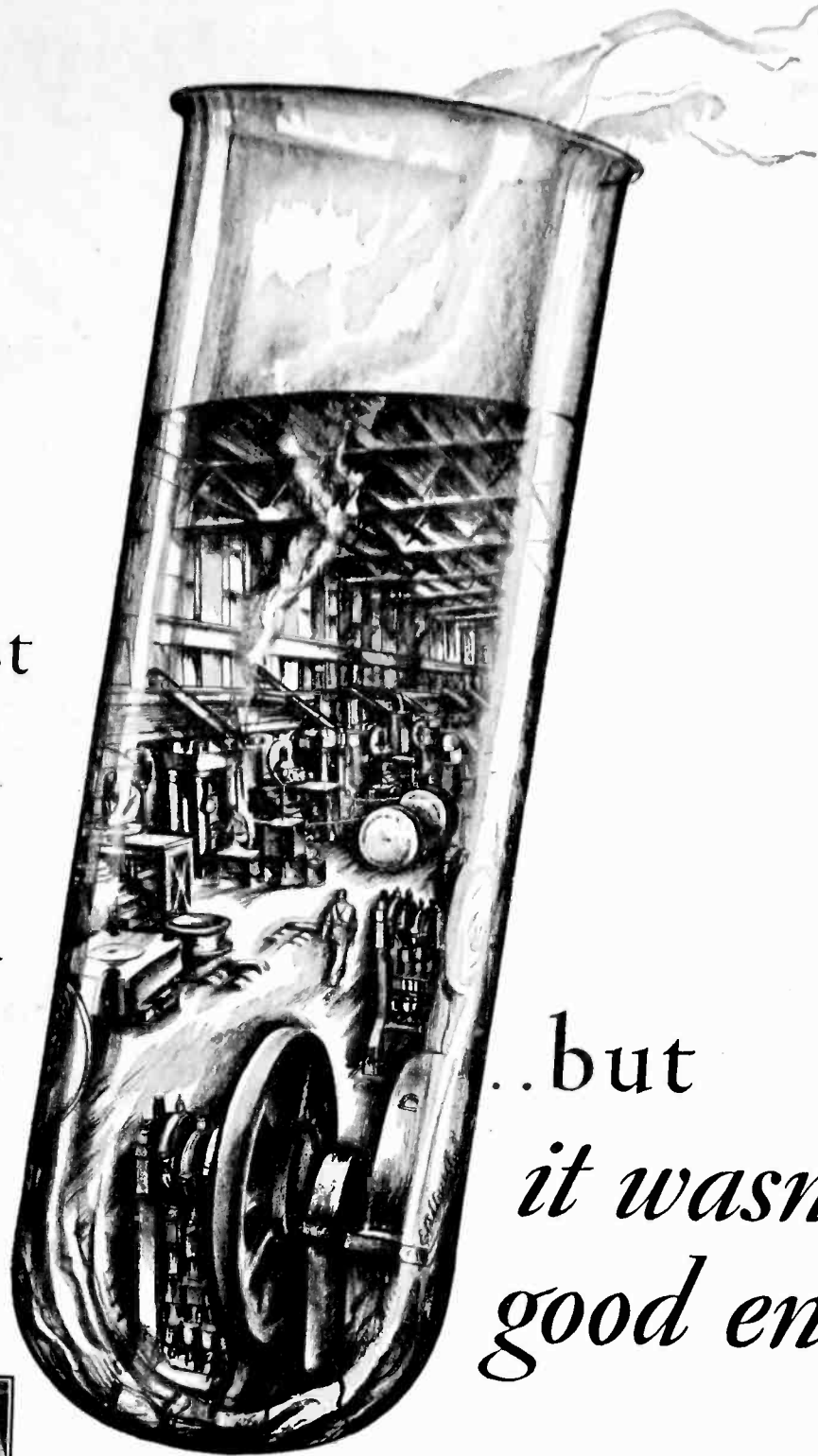

..but
*it wasn't
good enough*

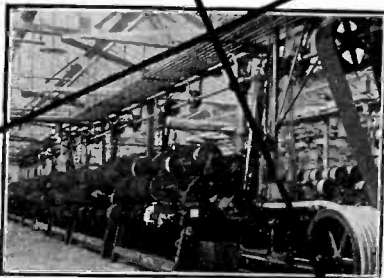

The old way. This machine for stranding cable was the best in the country, but—

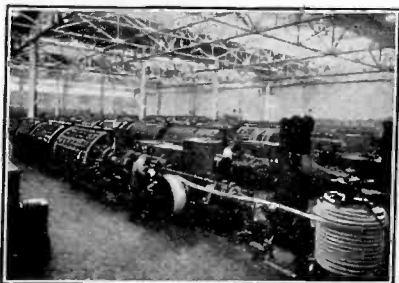

Western Electric engineers worked out a new way, stranding cable more quickly, more safely, more economically.

IN equipment and methods the Western Electric telephone cable plant of 1927 set the pace. But that didn't satisfy the company's manufacturing engineers. They put the plant in the test tube of critical judgment—and they came out with something even better.

It meant revising processes, re-designing machines, rebuilding a

factory which occupied sixteen huge structures. But it was worth it!

Whether making cable or any of the 10,000 items of telephone apparatus, Western Electric seeks till it finds the better and more efficient and more economical way. As manufacturer for the Bell System this is its share in good telephone service.

Western Electric

MAKERS OF YOUR TELEPHONE

Please mention the JOURNAL of the A. I. E. E. when writing to advertisers.

dependable

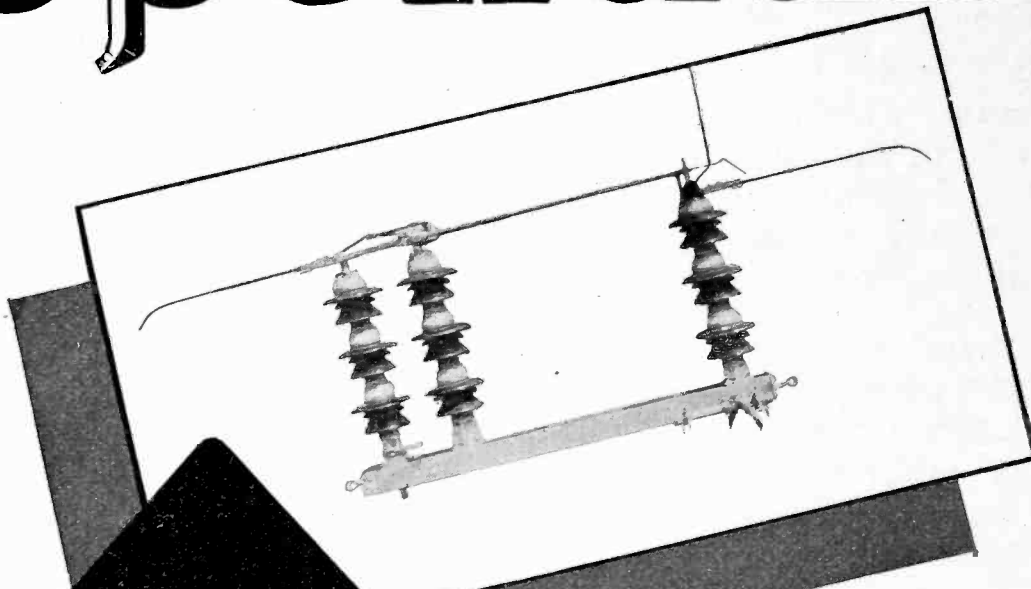

R. & I. E.
uses
MONEL METAL

110 K.V. 600-ampere Type TTR air-break switch for Hi-Pressure contact, fitted with Monel Metal bolts and pins as standard in the assembly of all parts above insulation units. Manufactured by RAILWAY & INDUSTRIAL ENGINEERING CO. of Greensburg, Pa.

MONEL METAL bolts and pins at Rochester station

THE Rochester Gas & Electric Company has made many records for efficient and economical operation. Some of the credit must be given to the wise and well-considered selection of equipment and materials.

Like many other economically operated companies, the Rochester Gas & Electric Co. has found that Monel Metal bolts and pins used for outdoor switching equipment, insure dependable performance—trouble-free operation—even when conditions are most severe.

Monel Metal has been adopted by leading equipment manufacturers and specified by prominent en-

gineers because it furnishes a rare combination of essential physical properties.

Neither rust nor corrosion-cracking will undermine its proven strength of well over 100,000 lbs. per square inch. It will not twist or distort under the pull of a wrench. It resists the corrosive attacks of weather and atmospheric conditions.

If you are desirous of building a greater degree of dependability into your outdoor equipment, we suggest that you investigate the superiority of Monel Metal.

Ask your regular manufacturer, or if you wish, write direct to us.

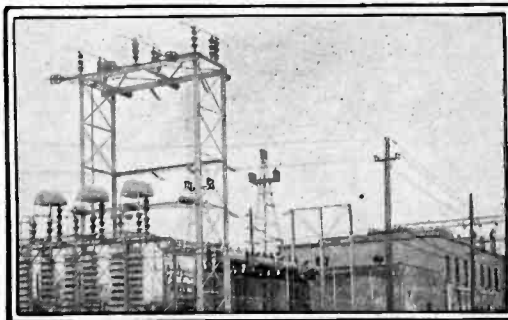

Switching station of Rochester Gas & Electric Company, Rochester, N. Y., using 3 pole Type TTR—132 K. V. switches, with Monel Metal pins and bolts, manufactured by the Railway & Industrial Engineering Co.

SEND FOR NEW BOOKLET—"FOR OUTDOOR SERVICE"

Monel Metal is a technically controlled Nickel-Copper alloy of high Nickel content. It is rolled, annealed, refined, rolled and marketed solely by The International Nickel Company, Inc. The name "Monel Metal" is a registered trade mark.

MONEL METAL

THE INTERNATIONAL NICKEL COMPANY, INC.



67 WALL STREET, NEW YORK, N. Y.

Please mention the JOURNAL of the A. I. E. E. when writing to advertisers.

For high-voltage testing

General Electric high-voltage testing transformers, which embody the results of years of high-potential research and manufacture, can be accepted as the standard of accuracy and durability. Apparatus of this class built over 20 years ago is still giving service of the highest order.

Probably no other organization has conducted so many high-potential tests or has equipped so many high-voltage laboratories as the General Electric Company, and all of this experience is incorporated in G-E testing equipment. Transformers now in service cover all voltages up to 2,100,000.

General Electric is prepared to furnish high-voltage testing transformers for any requirements.



300,000-volt testing set consisting of two 150,000-volt chain-connected transformers. Voltage can be controlled with either induction voltage regulator or a sine-wave generator. Over-all height 10 feet 8 inches

50,000-volt testing equipment with truck, regulator, and circuit breaker. Over-all height 46 inches

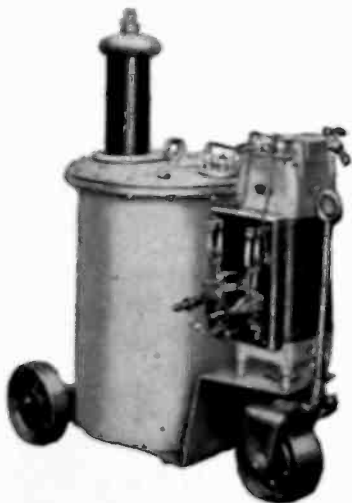

GENERAL ELECTRIC

GENERAL ELECTRIC COMPANY, SCHENECTADY, N. Y., SALES OFFICES IN PRINCIPAL CITIES

Please mention the JOURNAL of the A. I. E. E. when writing to advertisers.

THE KEOKUK UNIT

Way back in 1912, the first "Keokuk Type" insulators were placed in service. Since that day, sixteen years ago, 2,000,000 of these O-B suspension units have followed into widespread geographical locations; into temperature changes, both wide and sudden; into operating conditions severe. It is not unsafe to say, that few insulators, if any, have ever received such thorough, complete and edifying service tests in the field of practical, everyday operation.

Therefore, here is something significant. This insulator, now Number Twenty-five-sixty-two, has been improved, to be sure, by the application of such things as the Treated Sanded Surface Joint and the distinctive O-B Resilient Pin. But of equal importance is the fact that the electrical design of 1912, the design which has withstood these ravages of time and operation over the globe is the same in the year of 1928.

The virtue of initially correct design is well exemplified by "Keokuk Type" O-B Suspension Insulator Number Twenty-five-sixty-two.

Ohio Brass Company, Mansfield, Ohio
 Canadian Ohio Brass Co., Limited
 Niagara Falls, Canada

981 H



Ohio Brass Co.



NEW YORK CHICAGO
 PHILADELPHIA

PITTSBURGH ATLANTA CLEVELAND
 ST. LOUIS SAN FRANCISCO LOS ANGELES

PORCELAIN
 INSULATORS
 LINE MATERIALS
 RAIL BONDS
 CAR EQUIPMENT
 MINING
 MATERIALS
 VALVES

Please mention the JOURNAL of the A. I. E. E. when writing to advertisers.

LOCKE

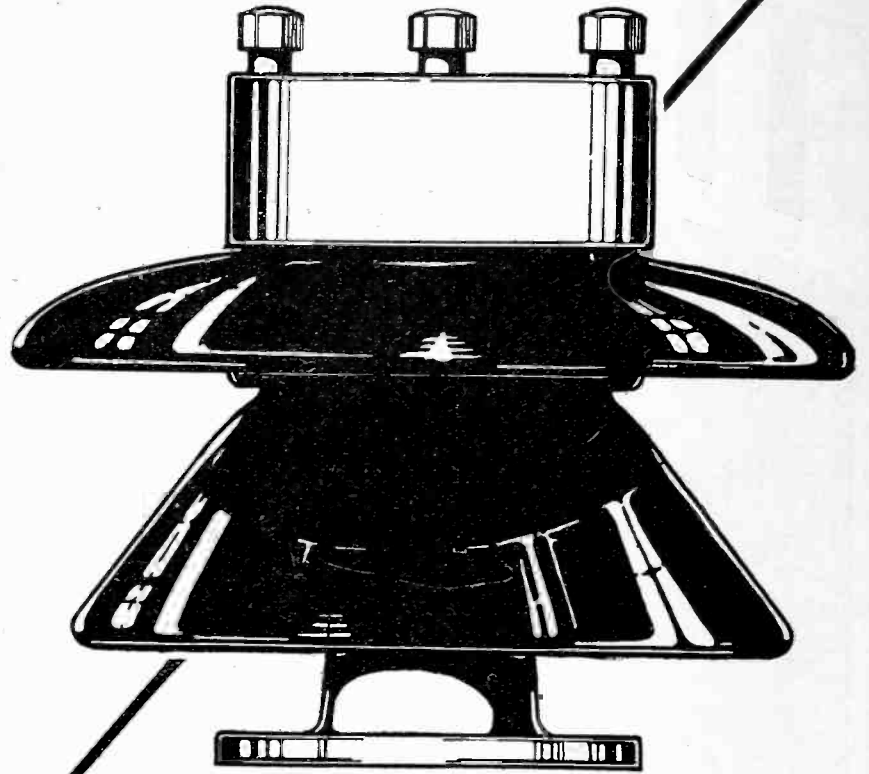

The design and development of Locke Pin Type Pedestal Insulators were the reflection of years of experience and continuous research and experiment. That this was worthwhile effort is amply demonstrated by the fact that today more Locke Switch Type Insulators are in use than those of any other make.

Locke 8888 Insulator is one of the most widely used station insulators. The combination of high electrical values, medium high mechanical strength and compactness coupled with a record of unfailing service have been responsible for this preference.

LOCKE INSULATOR CORPORATION
BALTIMORE MARYLAND

PORCELAIN INSULATORS

Please mention the JOURNAL of the A. I. E. E. when writing to advertisers.

Wagner Transformers



For minimum losses, there must be no sharp, ragged edges on the laminations of a transformer core. Such edges prick the insulation and form paths for eddy currents. That is why every lamination that goes into a Wagner transformer is cut by sharp shears. It is also annealed to burn off all traces of burrs and to form an iron oxide over the entire sheet and edges. Wagner details make Wagner...Quality.

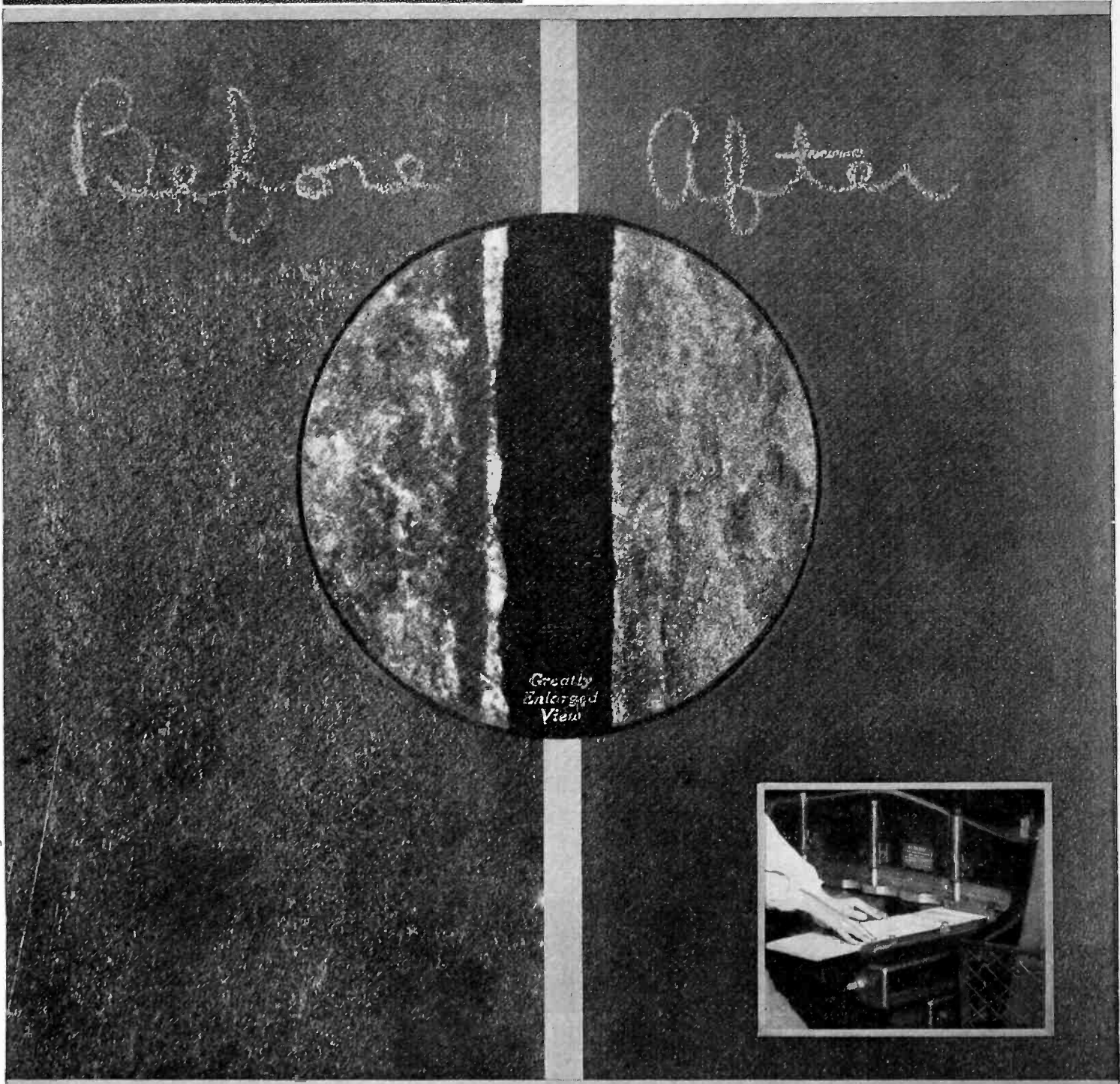

Greatly Enlarged View

Write for complete details of Wagner Distribution, Power and Subway Type Transformers.

Literature on Request

WAGNER ELECTRIC CORPORATION
6400 Plymouth Avenue, St. Louis, U. S. A.

Wagner Sales Offices & Service Stations in 25 Principal Cities

Products: FANS Desk, Wall and Ceiling
TRANSFORMERS . . . Power, Distribution and Instrument
MOTORS . . . Single-phase, Polyphase and Direct Current.

Wagner ... quality

Dependability



DEPENDABILITY is always the first consideration in the design and building of Kuhlman power, distribution and street lighting transformers. Except for this fact, the high operating economy and other desirable characteristics of Kuhlman transformers would be meaningless.

For more than a third of a century, Kuhlman has had this constantly in mind—and the result has been a steady increase in the use of Kuhlman Transformers by the light and power companies.

**KUHLMAN
TRANSFORMERS**
KUHLMAN ELECTRIC CO.
BAY CITY MICHIGAN

Sales Offices:

Akron, Ohio
Electric Motor & Repair Co.
High and Barges Sts.

Atlanta, Ga.
E. K. Higginbottom
411 Glenn Bldg.

Baltimore, Md.
Industrial Power Equip. Co.
421 W. Camden St.

Boston, Mass.
Geo. H. Wahn Co.
69-71 High Street

Buffalo, N. Y.
John E. Hoffman
280 Carolina St.

Chicago, Ill.
John R. Smith
844 Rush St.

Cleveland, Ohio
Public Service Supply Co.
627 Union Trust Bldg.

Dallas, Texas
F. T. Morrissey & Co.
1408 Allen Bldg.

Denver, Colo.
Electric Sales Co.
1535 Broadway

Detroit, Michigan
Richard P. Johnson
10-230 General Motors Bldg.

Indianapolis, Indiana
Scott Jaqua Co., Inc.
202 Indiana Terminal Whse.

Lincoln, Neb.
Enterprise Electric Co.
1425-35 M. St.

Los Angeles, Cal.
Thomas Machinery Co.
912 E. 3rd St.

Milwaukee, Wis.
Wm. H. Fernholz
1031 Clybourn St.

Minneapolis, Minn.
Joseph L. Barnard
1727 Lagoon Ave.

Montreal, Quebec
W. O. Taylor & Co.
415 Canada Cement Bldg.

New Orleans, La.
Lyman C. Reed
1230 Hibernia Bank Bldg.

New York, N. Y.
D. F. Potter, Jr.
Graybar Bldg.

Omaha, Neb.
J. H. Nicholson
6315 N. 33rd St.

Philadelphia, Pa.
J. Edward Bollich
1015 Chestnut St.

Pittsburgh, Pa.
Continental Sales & Eng. Co.
839 Oliver Bldg.

Rochester, N. Y.
Geo. W. Foote
601 Temple Bldg.

Saint Paul, Minn.
E. H. Heins
4179 Blair St.

San Francisco, Cal.
C. F. Henderson
Call Building

Seattle, Wash.
Equipment Sales Co.
514 Lloyd Bldg.

Tampa, Fla.
Tampa Hardware Co.
Polk & Morgan Sts.

Toledo, Ohio
Howard J. Wittman
319 Spitzer Bldg.

York, Pa.
Harry W. Motter
25 N. Duke St.

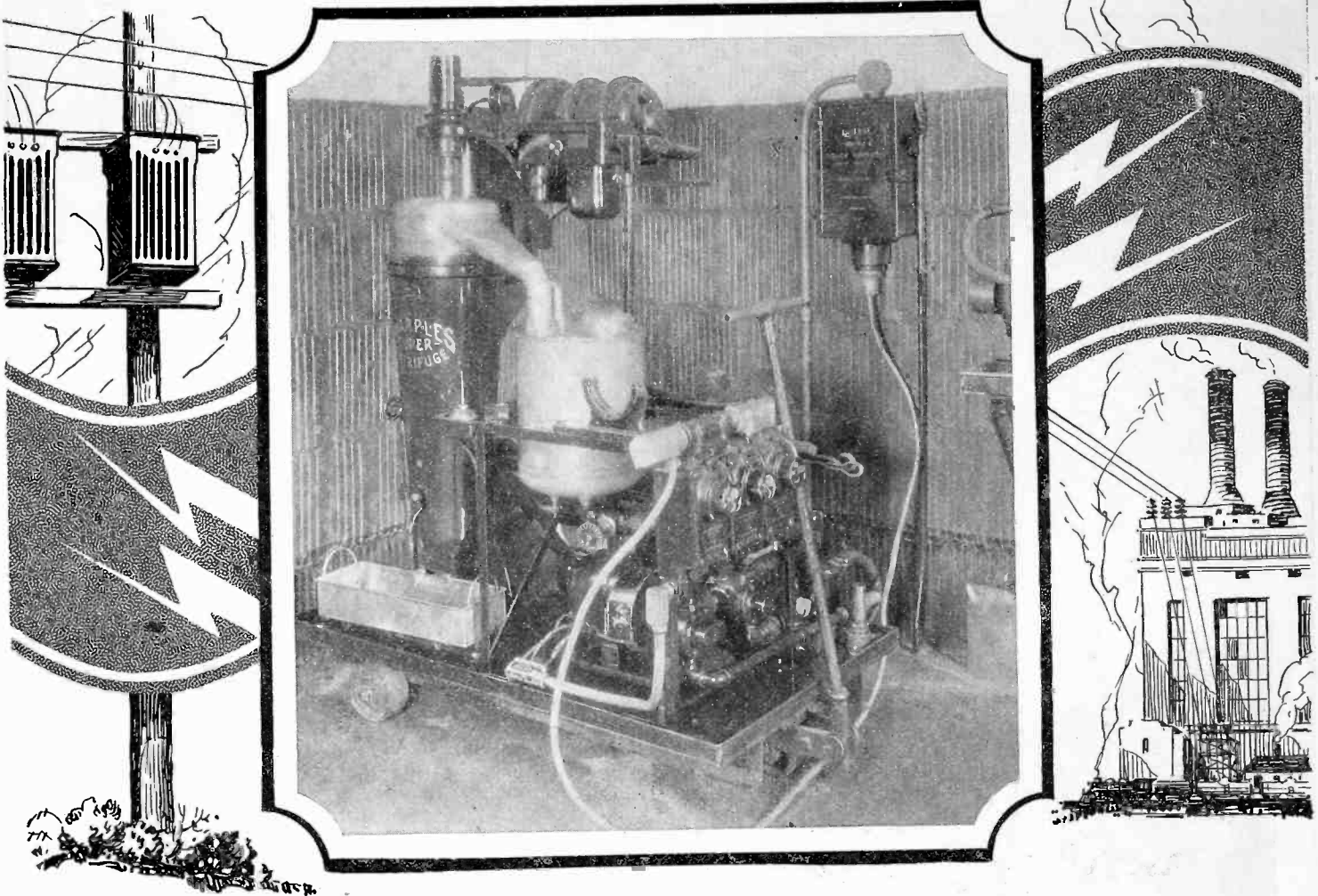

Cleaning 50,000 gallons of oil every year

Four years ago last June one of the largest electric power companies in New England installed a Sharples Portable for purifying transformer oil.

This machine is stationed in the oil house, ready at all times to clean up the old oil that is brought in or to purify the oil from transformers which are brought to the oil house and dumped.

Last year 50,000 gallons of oil were cleaned, 40,000 gallons of which was transformer oil. To handle this volume of oil, the Sharples Purifier was in operation every working day. Careful tests showed that the oil, which was purified and returned for re-use, was of high dielectric strength and in excellent condition to protect the plant against transformer failures and shut-downs.

THE SHARPLES SPECIALTY COMPANY, 2324 WESTMORELAND STREET, PHILADELPHIA. Boston, New York, Pittsburgh, Chicago, Detroit, Tulsa, New Orleans, San Francisco, Los Angeles, Toronto, London, Paris, Tokio.

SHARPLES

A GREAT FORCE

Please mention the JOURNAL of the A. I. E. E. when writing to advertisers.

FERRANTI TRANSFORMERS

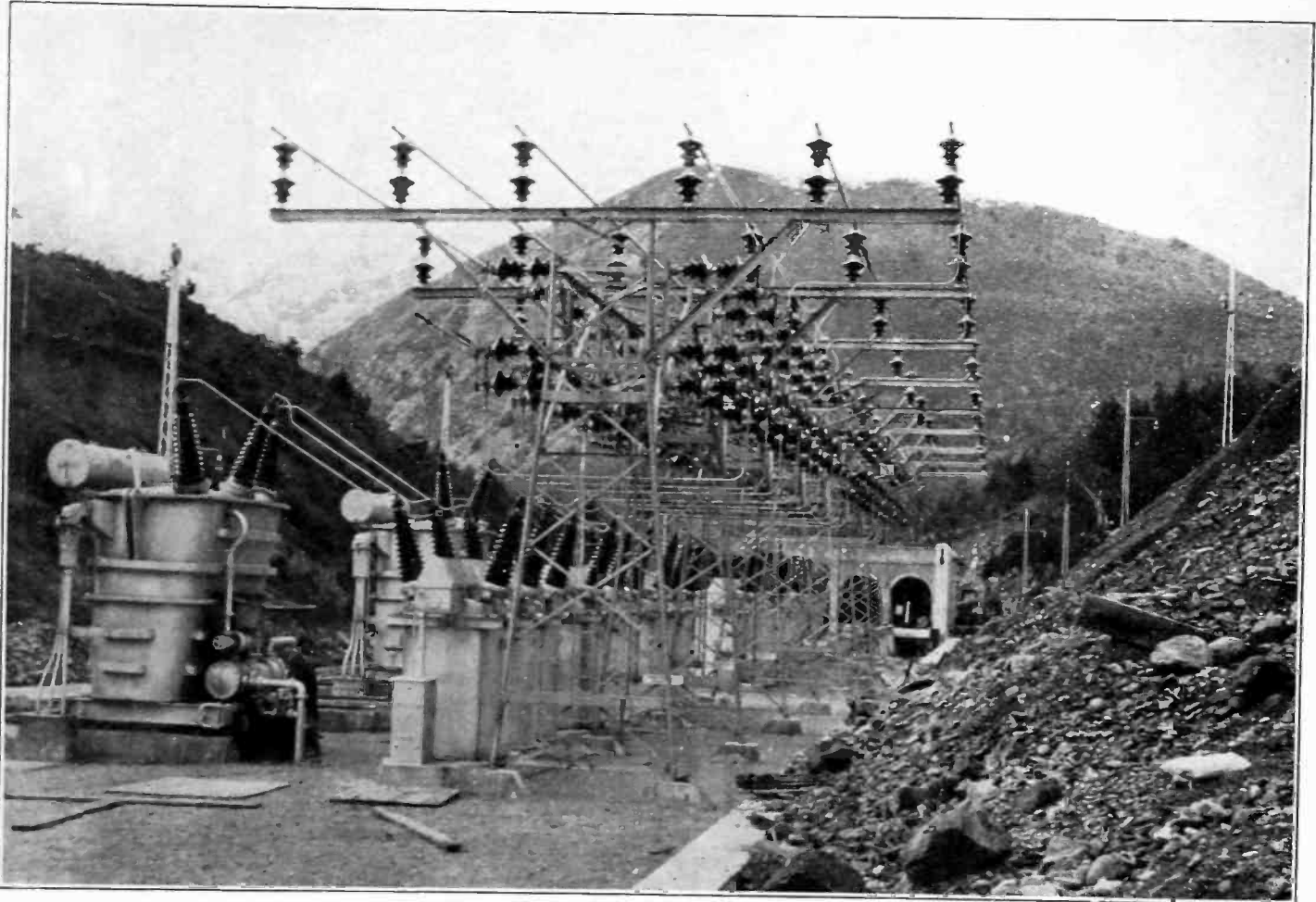

13,333 K. V. A., 110 K. V., 3-phase, 50 cycles forced oil cooled transformers in the outdoor installation at the new plant of the Compañia Chilena de Electricidad Limitada, which supplies the power for the cities of Santiago and Valparaiso, Chile, and for the electrified section of the Chilean State Railways.

FERRANTI, INC.
130 W. 42nd Street
New York

FERRANTI, LTD.
Hollinwood
England

FERRANTI ELECTRIC
Limited
Toronto, Canada



in all types—Aerial, Underground and Submarine. Made to the most rigid specifications, in any quantity, size or length for any voltage. Finished for any service, single or multiple conductor or concentric laid. Only highest quality materials enter into the construction of these cables.

A fully equipped cable department with long experienced and able engineers are prepared to help you with cable problems.

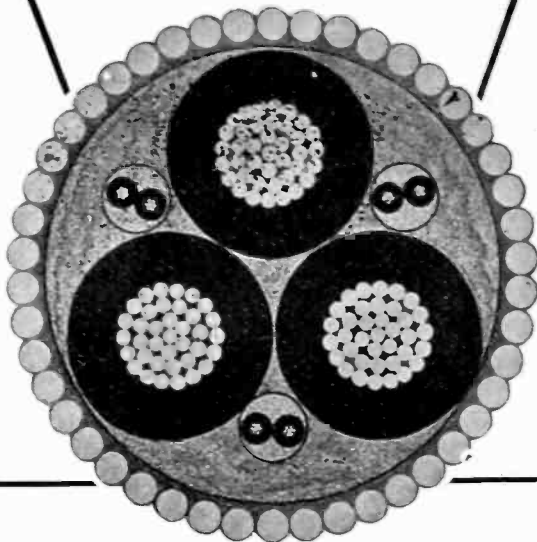

Section of a 500,000 C. M. Stranded 3-conductor rubber insulated Steel Wire Armored Submarine Power Cable for 11,000 volts W. P. with three sets of telephone conductors.

If you have not a copy of our present "Electrical Wires and Cables" handbook, we will gladly send you copy upon request.

AMERICAN STEEL & WIRE COMPANY

Subsidiary of United States Steel Corporation

208 S. La Salle Street, Chicago

30 Church Street, New York

Other Sales Offices: Boston Cleveland Worcester Philadelphia Pittsburgh Buffalo Detroit Cincinnati Baltimore
 Wilkes-Barre St. Louis Kansas City Minneapolis-St. Paul Oklahoma City Birmingham Atlanta Memphis Dallas Denver Salt Lake City
 U. S. Steel Products Company: San Francisco, Los Angeles, Portland, Seattle Export Representatives: United States Steel Products Co., 30 Church St., New York, N. Y.

Please mention the JOURNAL of the A. I. E. E. when writing to advertisers.

A NEW LINE OF CABLE SUPPORTS WITH SPOOL INSULATORS

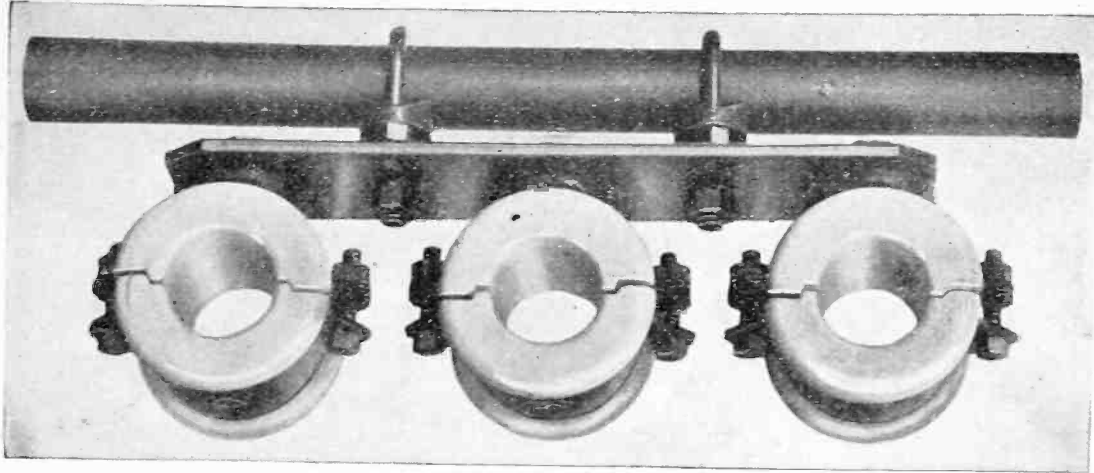

31-F

31-F

- porcelain spools with smooth surfaces, uniform glazing and good appearance.
- malleable supporting castings the same in quality as used in our standard high voltage equipment.
- springy bands to firmly clamp the porcelain spools against the malleable fittings—eliminating looseness.
- bolts with clean-cut threads so that the nuts will easily run on and set against heavy lock washers.
- identification marks on the parts and fittings—saving your time.
- Ask for our 48-page thumb and picture indexed bulletin Thirty-one-F.



THE DARK HORSE

Delta

MAKERS OF
UNIT  TYPE
EQUIPMENT

Star



THE DARK HORSE

DELTA-STAR ELECTRIC COMPANY, 2400 BLOCK, FULTON ST, CHICAGO, ILLINOIS.

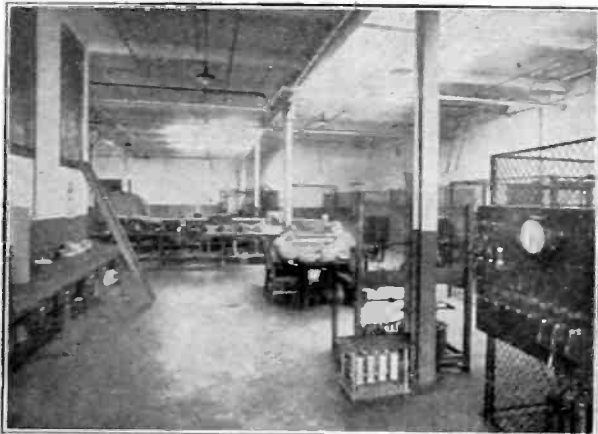

A corner in our Electrical Research Laboratory

All the materials used are approved by our electrical and chemical staffs as best suited for the purpose. The carefully selected paper of proper width is applied at the correct angle of lay and suitable tension to produce best results.

After being thoroughly dried it is completely saturated with an approved impregnating and insulating compound.

Lead sheaths are properly applied and completely sealed to prevent moisture and air from reaching the insulation.

To insure highest possible success during construction as well as upon completion of the cables, ample testing facilities keep a check on materials and workmanship.

POWER CABLES FOR CENTRAL STATIONS

The quality of paper insulated cable depends largely upon the paper selected and the impregnating compound used, but engineering ability and expert workmanship are of equal importance.

Simplex Paper Insulated Cables are made in a factory equipped with the most modern machinery, operated by skilled workmen and supervised by engineers who know how to produce cables that are second to none.

In addition, thoroughly equipped electrical and chemical research laboratories are constantly obtaining new information which is used as the basis for improvement in Simplex Cables.

SIMPLEX WIRE & CABLE CO

MANUFACTURERS

201 DEVONSHIRE ST., BOSTON

BRANCH SALES OFFICES

CHICAGO, 564 W. Monroe St. SAN FRANCISCO, 390 Fourth St.
NEW YORK, 1328 B'way CLEVELAND, 2019 Union Trust Bldg.
JACKSONVILLE, 1010 Barnett Nat'l Bank Bldg.

Please mention the JOURNAL of the A. I. E. E. when writing to advertisers.

*An unusually durable
metal for outdoor engineer-
ing purposes*



〔 A Copper-Manganese-Silicon Alloy 〕

FOR outdoor service over long periods of time, only a high-strength, corrosion-resisting metal, such as Everdur, can withstand temperature changes, sleet loading, wind stress, electromechanical shock, exposure to fumes, dust, smoke, corrosive gases, and the vibration of alternating current apparatus.

In addition to these properties, the ductility of Everdur, as shown by elongation tests, makes it particularly serviceable for outdoor use, where temperature and seasonal changes cause considerable variations in length.

Everdur is manufactured by The American Brass Company in the form of plates, sheets, rods, wire, pipe, hot-pressed parts, forging blanks and casting ingots—and fabricators are prepared to furnish Everdur castings, pipe fittings, bolts, nuts, rivets, woven wire, etc. Further information is contained in Bulletin E-2, Second Edition, sent free to Engineers upon request.

THE AMERICAN BRASS COMPANY

GENERAL OFFICES: WATERBURY, CONN.

Offices and Agencies in the Principal Cities

Canadian Mill: ANACONDA AMERICAN BRASS LIMITED
New Toronto, Ontario

ANACONDA

COPPER ANACONDA BRASS

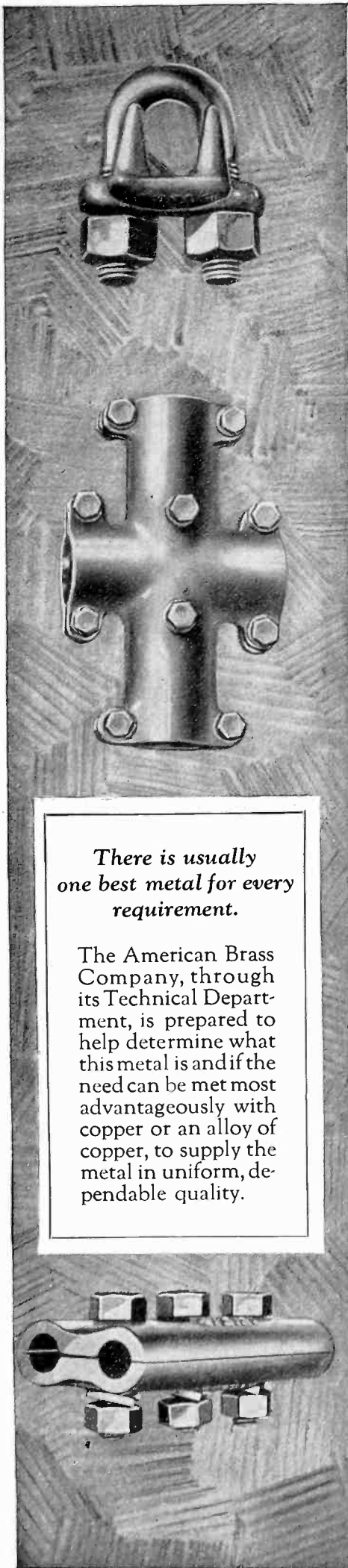

*There is usually
one best metal for every
requirement.*

The American Brass Company, through its Technical Department, is prepared to help determine what this metal is and if the need can be met most advantageously with copper or an alloy of copper, to supply the metal in uniform, dependable quality.

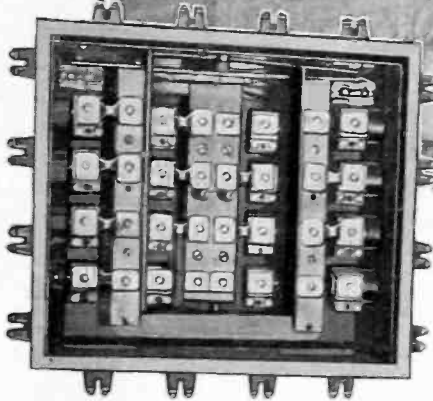
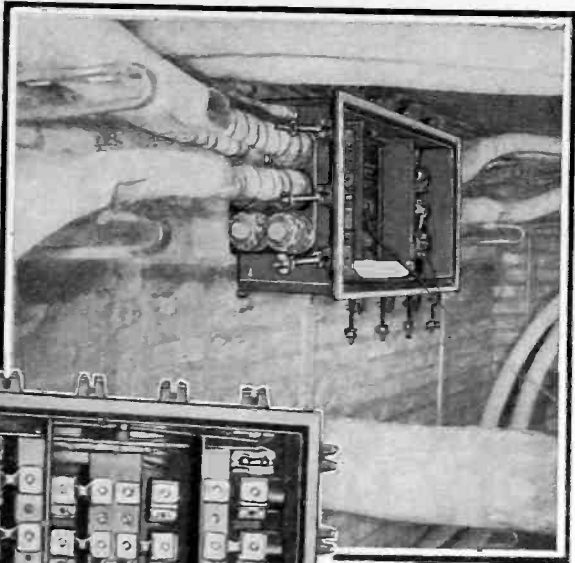

***For a Compact Cable Installation
in an Ordinary Size Manhole in
High Load Density District***

The Type FS Box requires but small wall space on one side of a manhole and is particularly desirable for use in an ordinary size manhole in a high load density district. Though compact the FS Box accommodates as many as 16—2000 Mcm cables, entering from sides and leaving plenty of wall space for other cables.

Here again is G & W heavy, rugged construction, safety and ease of installation. Jumper and plugs by-pass the fuses during replacement. Each cable is independently connected to bus and sealed under compound. All boxes air-tested at factory.

G&W Electric Specialty Co.
7780 Dante Ave., Chicago, Ill.

Designed for AC and DC—250-volt circuits and made in 4, 6, 8 ways for cables 1000 Mcm to 2000 Mcm—for link fuses.



Exactly What You Want!
G & W design and manufacture practically every device for the end of a cable. See Catalog No. 27.

More than Protection **POTHEADS AND BOXES** for the Cable Ends

MOLOONEY TRANSFORMERS

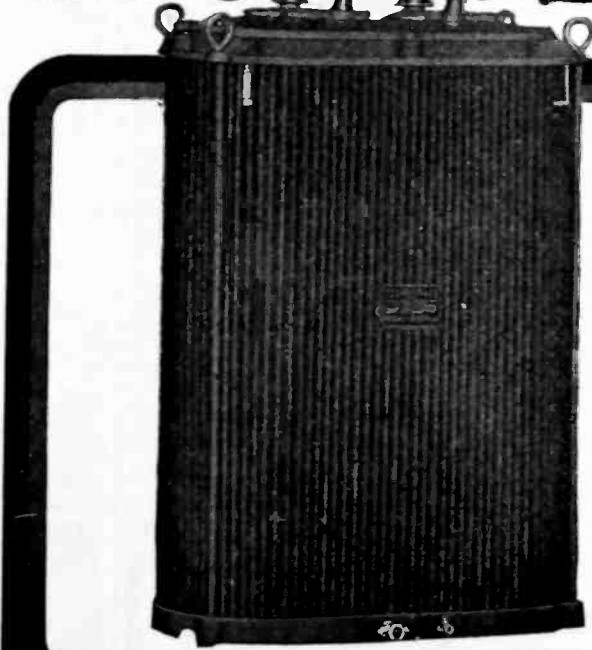

The many refinements that characterize Moloney Transformers have resulted from long and applied study. Moloney Transformer performance is outstanding because of these betterments in design and construction. Specify Moloney Transformers for Power, Transmission, and Distribution.

MOLOONEY ELECTRIC COMPANY
Main Office and Factories: ST. LOUIS, MO.
Sales Offices in Principal Cities

Another Protection Problem Solved by I.T.E.

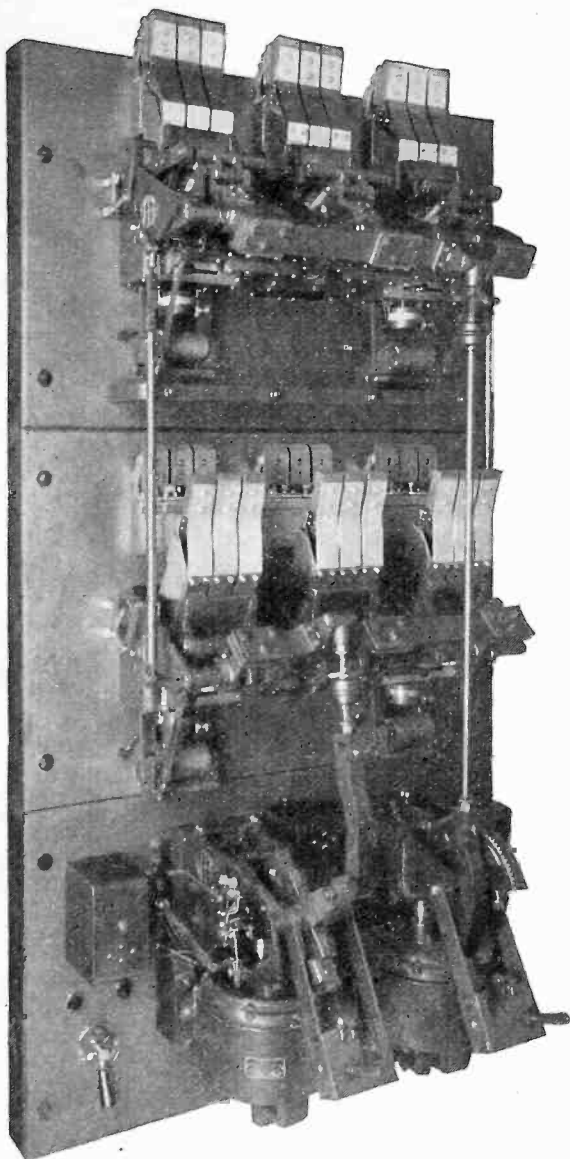

I-T-E FULL AUTOMATIC
TRANSFER SWITCH

the problem

In a large office building having a combined power and lighting load of 15,000 amperes: —

1. To insure uninterrupted service by automatic switching of the load from one source to another.
2. To provide overload and short circuit protection for the system.

the solution

The use of two I-T-E full Automatic Transfer Switches, each consisting of 2 — 7500 ampere, 3-pole circuit breakers with direct acting series overload and short circuit trip coils, mechanically and electrically interlocked to give these functions: —

1. Failure of normal circuit automatically trips the normal circuit breaker and closes the emergency circuit breaker.
2. Return of normal circuit automatically trips the emergency circuit breaker and closes the normal circuit breaker.
3. If either circuit breaker opens on overload or short circuit both circuit breakers remain open until proper one is closed by control switch. This prevents transfer of overload or short circuit from one source to the other.



Whether your protection problems are simple or difficult, I-T-E circuit breakers will solve them correctly and dependably.

The assured performance of I-T-E is based upon the experience of forty years in specializing on the design and manufacture of circuit breakers.

I-T-E CIRCUIT BREAKER COMPANY — 19th and Hamilton Streets, Philadelphia

Birmingham, American-Traders Bank Bldg.; Boston, 201 Devonshire; Buffalo, Ellicott Sq. Bldg.; Chicago, 333 N. Michigan Ave.; Cincinnati, Union Trust Bldg.; Cleveland, 1740 E. 12th; Dallas, 1410 Allen Bldg.; Denver, Tramway Bldg.; Detroit, Penobscot Bldg.; Duluth, 611 Providence Bldg.; Kansas City, Midland Bldg.; Los Angeles, 106 W. 3rd; Minneapolis, Plymouth Bldg.; Montreal, P. O., 35 Notre Dame St., West; New Orleans, Hibernia Bank Bldg.; New York, 12 E. 41st.; Omaha, Electric Bldg.; Philadelphia, 1505 Race; Pittsburgh, Park Bldg.; St. Louis, Bank of Commerce Bldg.; San Francisco, Russ Bldg.; Seattle, 2518 Western; Toronto, 24 Adelaide, E.; Vancouver, 500 Beatty St.; Tulsa, Oklahoma, Box, 1141.

I-T-E PROTECTION

URELITES ~ ~ I-T-E CIRCUIT BREAKERS



350,000

KVA Accurately measured for ONE Canadian System

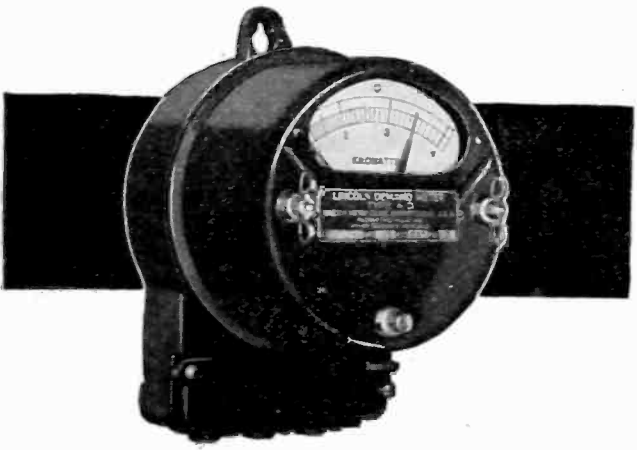

NOW BUILT IN THE UNITED STATES, the Lincoln Meter merits your investigation because of its success in Canada.

Lincolns are metering 350,000 KVA for ONE Canadian system alone! Over the entire Dominion, thousands of Lincolns are enabling suppliers to bill on a MEASURED ENERGY AND DEMAND basis.

For these users, rate and billing controversies have ended—happily—all due to the sustained accuracy and easy maintenance of the simple thermal Lincoln principle of operation.

Write today, please, for new Bulletin outlining the Lincoln story and describing the various Lincoln instruments. This book will be sent to you at once.

LINCOLN METER COMPANY, INC.
SPRINGFIELD, ILLINOIS

**LINCOLN—THE METER WHICH ESTABLISHED
SUCCESSFUL DEMAND MEASUREMENT IN CANADA**



Is your Instrument Equipment Sufficient for Your Needs?

THE cost of good measuring instruments is negligible compared with the service they render. Do not wait until an emergency arises—be prepared at all times with suitable equipment in sufficient quantity.

By placing your orders in conformance with your anticipated needs, deliveries can be made on a more advantageous basis to all concerned, and you will save time and money in the end.

Our factory stocks are always sufficient to meet normal immediate requirements for standard models and ranges. But we cannot always guarantee to fill an unusually large order for a certain model and range at a moment's notice. A Weston meter—whether standard or special—must meet the most exacting specifications for quality and performance known to the art of instrument making.

Even a Weston miniature instrument, costing but a few dollars, receives the same careful attention in manufacture, undergoes the same intricate processes and is subjected to rigid inspections and tests of the same character as for a precision laboratory standard.

No Weston instrument of any design or price can be unduly hurried through production to the sacrifice of even the least of those qualities for which the Weston name is universally famous. Safeguarding this reputation is, after all, your best protection.

WESTON ELECTRICAL INSTRUMENT CORP.
584 Frelinghuysen Ave., Newark, N. J.



A. C. "Junior"
Portable
Instruments



Fan-shaped Switch-
board Instruments

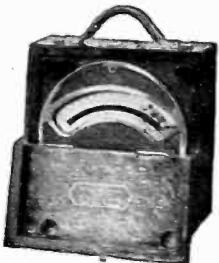

Model 45
D. C. Portable
Instruments



Please mention the JOURNAL of the A. I. E. E. when writing to advertisers.

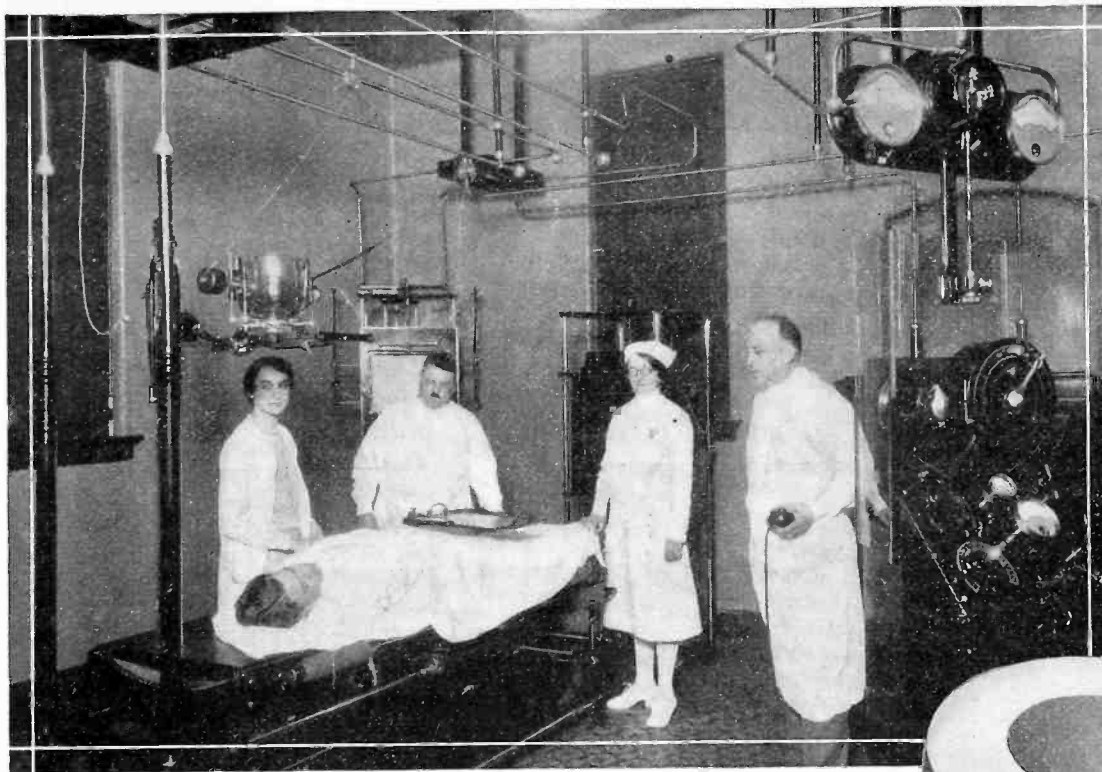

The Jewell Electrical Instrument Company makes a complete line of high grade A. C. and D. C. instruments for every purpose, including switchboard instruments from 2" to 9" in diameter, and portable instruments from small pocket sizes to laboratory precision standards.

Jewell Instruments have served exacting needs of X-Ray for more than 25 Years

ON X-RAY and Electro-Therapeutic equipment electrical instruments are subjected to the most difficult and critical tests. For effective results in X-Ray work they must accurately measure currents of tremendously high voltages under conditions most unfavorable for instruments.

In this exacting service Jewell Instruments have met every requirement. For more than 25 years they have been standard equipment on 85% of the X-Ray apparatus manufactured in this country.

You will find the same high quality and the same unfailing reliability, which has made Jewell Instruments supreme on X-Ray and Electro-Therapeutic apparatus, in Jewell Instruments for your requirements.

Like the manufacturers of X-Ray equipment you, too, can benefit by the experience of Jewell Engineers in the selection of instruments which most adequately, efficiently and economically meet your needs.

Call on the nearest Jewell office for aid in the solution of your instrument problems.

Jewell Electrical Instrument Company
1650 Walnut Street, Chicago, Illinois

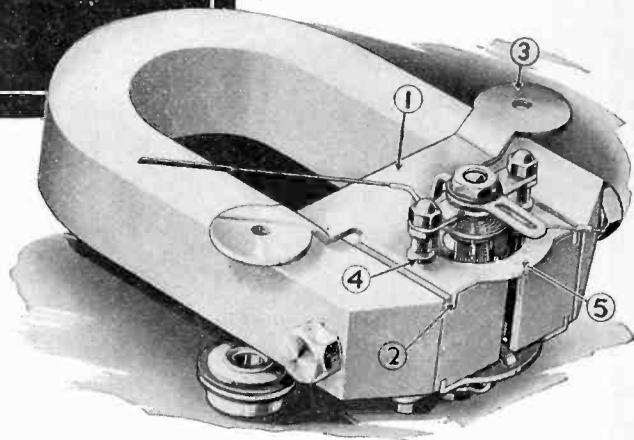

JEWELL Movement Assembly

Precision in the alignment of pole pieces, core, and armature of an instrument is essential to uniform performance.

Not only are many Jewell parts made to tolerances of one ten-thousandth of an inch, but the patented Jewell design assures the utmost precision in their assembly.

In the movement illustrated the die-stamped plate (1) is held in perfect alignment by slots in the pole pieces (2); provides dial supports (3); is held rigidly in place by posts carrying the bridge (4); and supports the die-stamped core bracket which engages it (5).

It is the infinite pains taken with countless details of this kind that make Jewell Instruments outstandingly dependable.



29 YEARS MAKING GOOD INSTRUMENTS

Please mention the JOURNAL of the A. I. E. E. when writing to advertisers.

*Where
Performance
Counts*

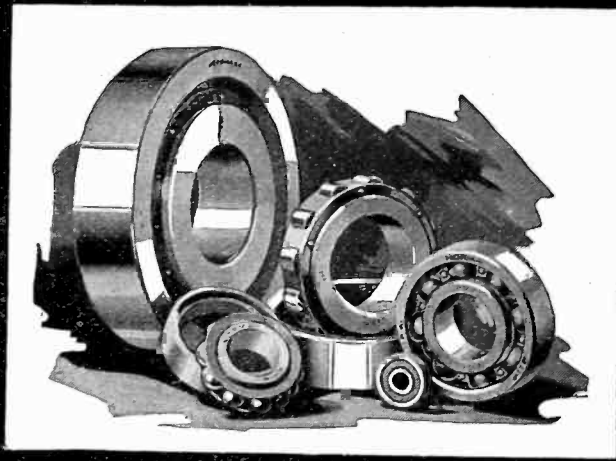

EACH YEAR sees a substantial increase in the number of machinery manufacturers who, building their business upon the performance records of their product, find that the **PRECISION** distinctive of "NORMA" Ball and "HOFFMANN" Roller Bearings is a large factor in longer machine life, improved performance, greater customer satisfaction.

NORMA-HOFFMANN BEARINGS CORPORATION
Stamford, Conn., U. S. A.



**BALL AND ROLLER
PRECISION BEARINGS**

Please mention the JOURNAL of the A. I. E. E. when writing to advertisers.

A Plating Generator

Designed

by

Electroplating

Engineers

7500 Amperes of plating current that you can depend on . . . a half century of experience . . . and the combined knowledge of HANSON-MUNNING engineers are concentrated in HANSON-MUNNING generators.

The simple compact design saves space. The open arrangement allows easy inspection.

The brush rigging and commutators are designed for long life and reliable service.

The unusual service required in electroplating has been the guide to the selection of each detail of design by electrical engineers who understand electrochemical requirements.

HANSON-MUNNING generators are built to *serve and last*. Let us give you some of the reasons why.

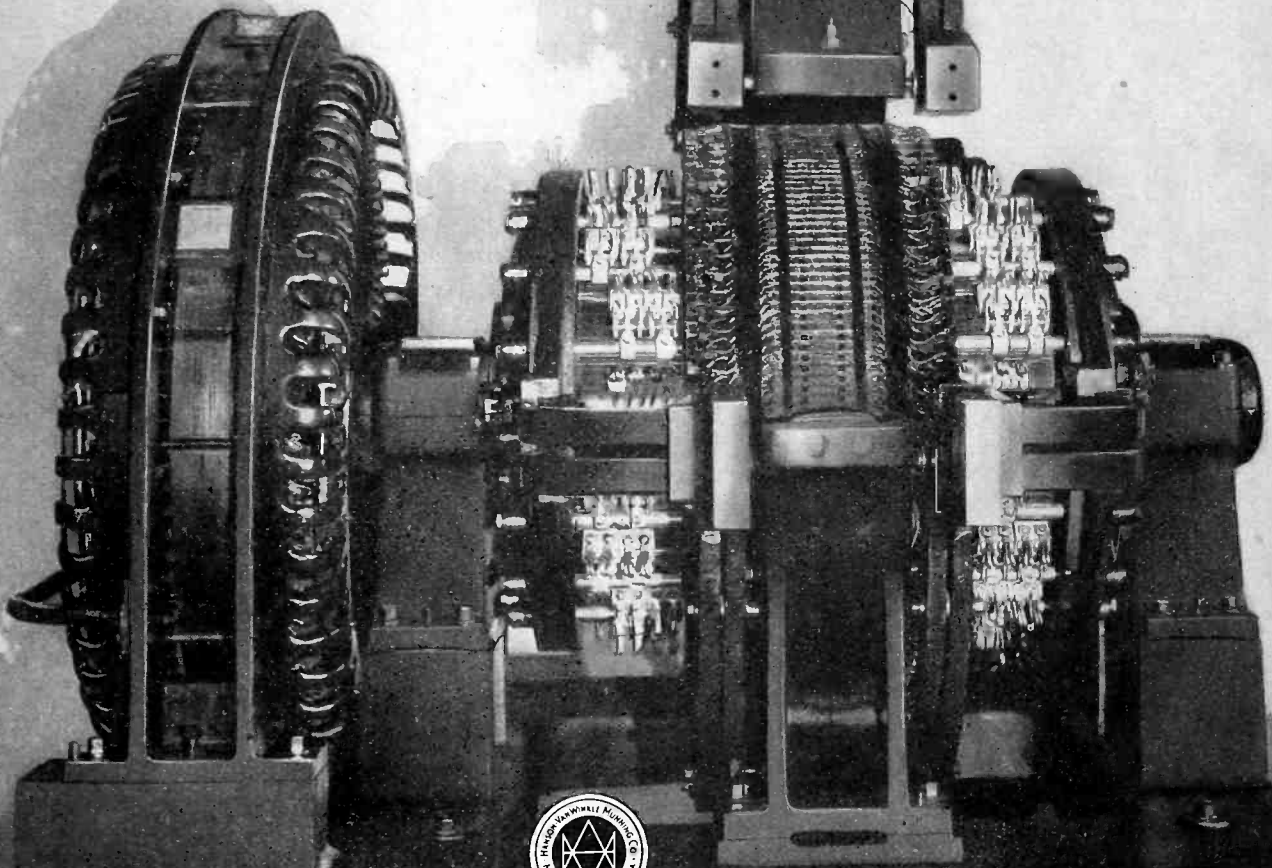

HANSON-VAN WINKLE-MUNNING COMPANY

Manufacturers of Electroplating and Polishing Equipment and Supplies
104 CHURCH STREET, MATAWAN, NEW JERSEY

Factories: Matawan, New Jersey; Newark, New Jersey; Chicago, Ill., Sales Offices in all principal cities

3194



from the smallest to the largest...

solid commutator rings of Micanite



DENTAL drills and locomotives — enormous differences in motor horse-power — identical in their demand for dependable insulation. That is why they specify commutator rings and segments of Micanite—the original pasted mica insulation.

Whatever the size or form our manufacturing facilities and methods permit us to fulfill your specifications—to satisfy your production schedule—and to maintain a uniformity in dimension, and in physical, chemical and electrical characteristics to an unexcelled degree.

One of the solid Micanite Commutator rings recently furnished one of America's largest builders of electric locomotives.

MICA INSULATOR COMPANY

New York: 200 Varick St. Chicago: 542 So. Dearborn St.
Works; Schenectady, N. Y. London, England
Cleveland Pittsburgh Cincinnati Seattle
San Francisco Montreal Toronto Los Angeles



Electrical

INSULATION

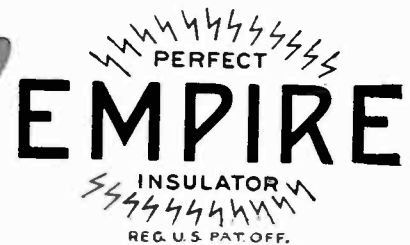

MICA INSULATION

OILED CLOTH INSULATION

Please mention the JOURNAL of the A. I. E. E. when writing to advertisers.

“THEY KEEP A-RUNNING”



200 Horsepower

*Century 60 Cycle 440 Volt 1800 R. P. M.
3-Phase Squirrel Cage Induction Motor*

Century Type SC Motors are built to insure the continuous operation necessary at high speeds required by centrifugal pumps and similar apparatus, and also—in slower speeds—to meet the hard service conditions encountered in the broad range of general purpose applications—particularly in chain and gear-drive installations... They are well balanced in design, sturdy and rigid in construction, thoroughly ventilated but not easily clogged, well protected, and can be easily cleaned with an air nozzle.

The motor illustrated is equipped with Timken Double-row, Self-contained roller bearings, which are interchangeable with Double-row ball bearings.

Century 3 and 2 Phase Squirrel Cage Induction Motors are built in standard sizes from ¼ to 200 horse power. Temperature rating, 40°C.

CENTURY ELECTRIC COMPANY

1806 Pine St.

St. Louis, Mo.

40 U. S. and Canadian stock points and more than 75 outside thereof

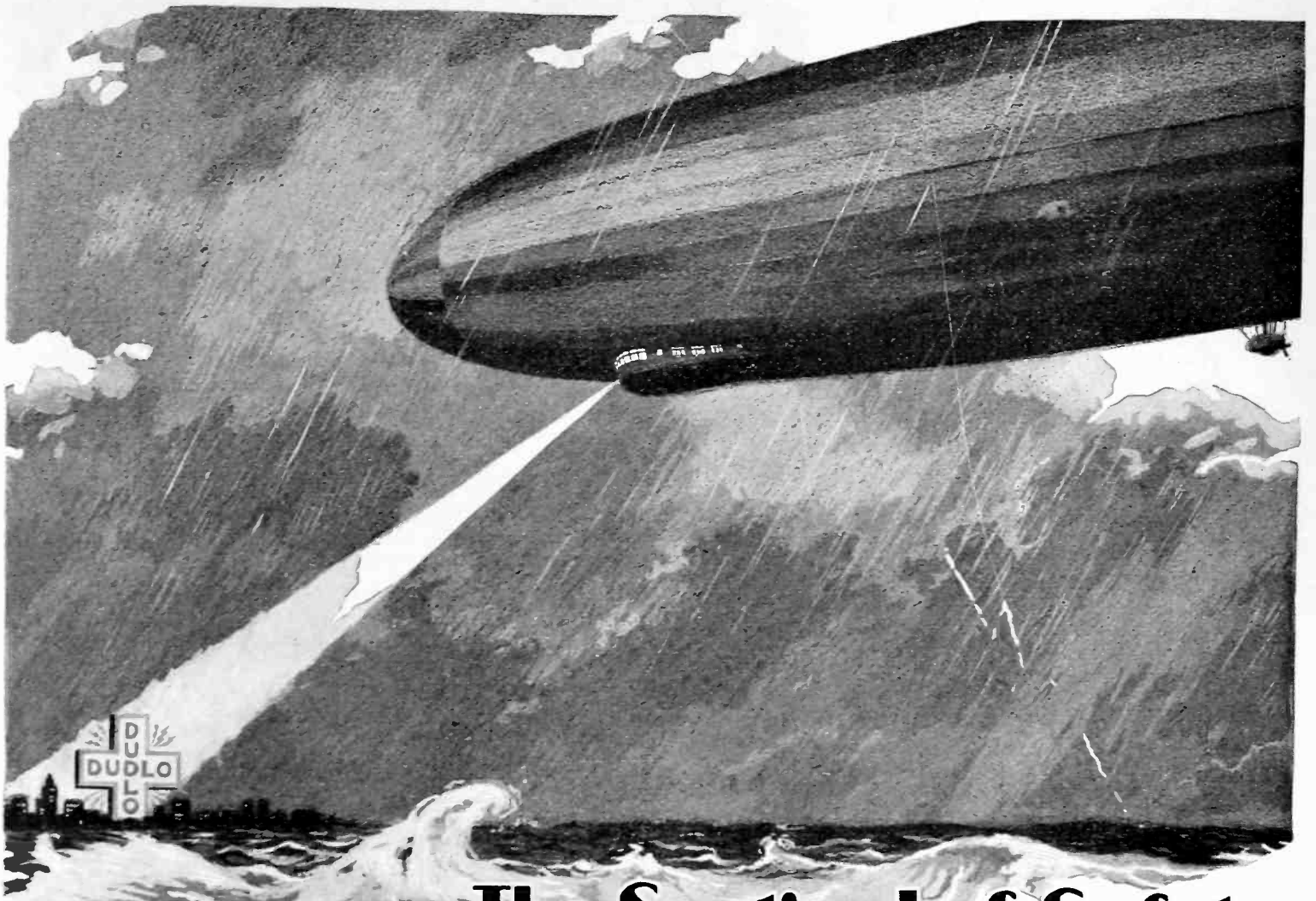

The Sentinel of Safety



Out of the darkness . . . a giant spectre . . . thrusting its nose fearlessly through the storm. Hours of flying over a raging sea . . . throbbing motors . . . dense blackness . . . then . . . faint points of light ahead on the mainland. A new chapter in the stirring history of man's conquest of the air.

Every precaution has been taken in building and equipping the great ship . . . every chance of failure guarded against by the use of proven materials. And deep in the vital organs of the dirigible . . . the ignition and radio . . . Dudlo coils and wire, like unseen sentinels of safety, are doing their bit in making the great experiment a successful reality.

No test too severe, no strain too great for Dudlo magnet wire and coils. That great proving ground—aeronautics—has shown them superbly adapted to every requirement of the electrical and radio industry.

DUDLO

DUDLO MANUFACTURING COMPANY, FORT WAYNE, INDIANA

420 Lexington Ave.
New York City

105 W. Adams St.
Chicago, Ill.

Division of
THE GENERAL CABLE CORPORATION

274 Brannan St.
San Francisco, Cal.

4143 Bingham Ave.
St. Louis, Mo.

Please mention the JOURNAL of the A. I. E. E. when writing to advertisers.

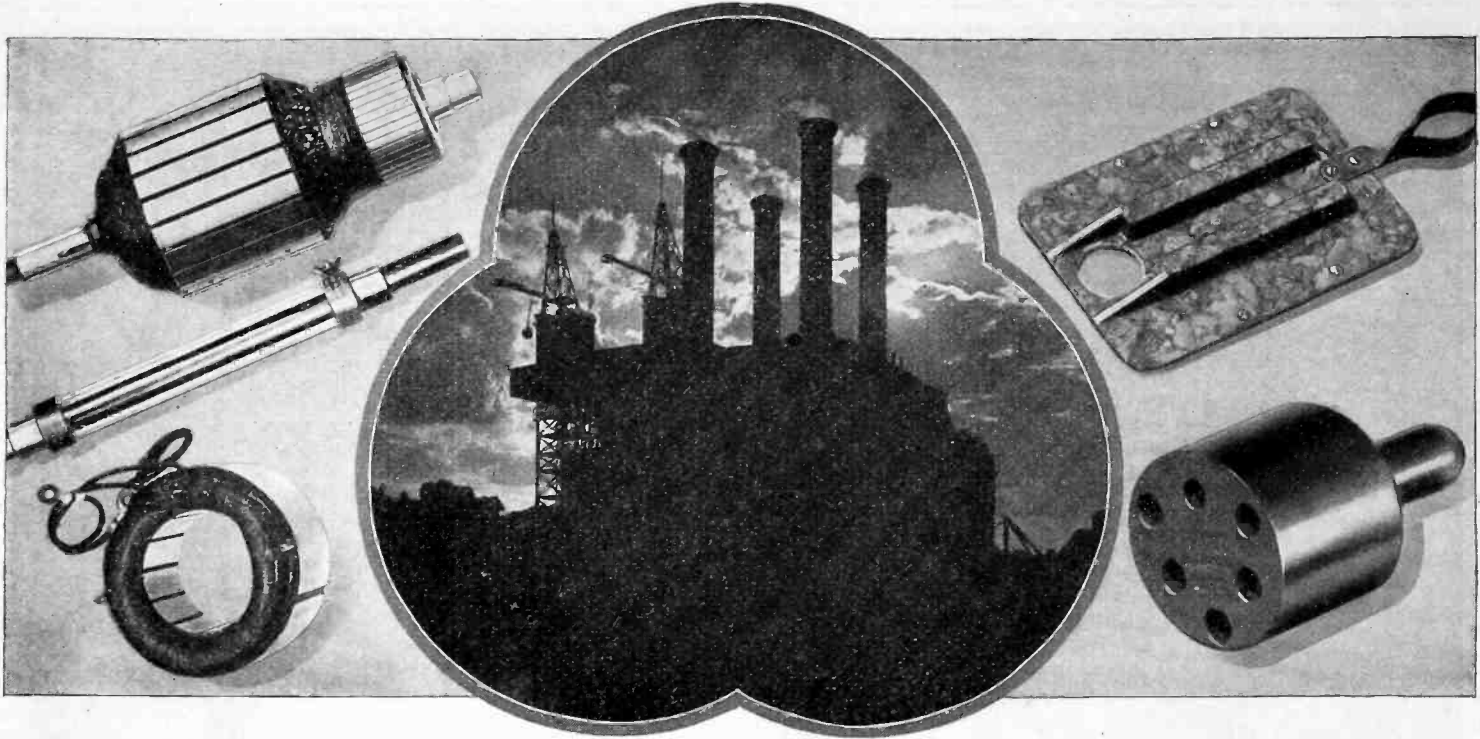

In Central Station "peak-load" hours *Bakelite Materials* prove their worth

AN inherent advantage of Bakelite Materials is that they provide insulation which neither deteriorates nor disintegrates. Their dielectric strength is unimpaired by long years of service. It is the stability—the dependability of these materials, under "peak-load" and all other conditions, that has brought about their steadily expanding use in the Central Station field.

Because they are produced in several different forms, Bakelite Materials are available for the insulation of a wide range of Central Station equipment. A few of the more recent of these varied uses include:—

Bakelite Molded clamp for 3-wire conductors; terminal indicators; disconnect card holders; high tension plugs and cable connectors.

Bakelite Laminated switch panels; arc

shields; switch assembly parts; tap boxes; runners for trolley-line intersections; insulation for tree trimmers and live-wire tongs.

Bakelite Varnish for armature impregnation; transformer gaskets; and as a seal for oil line joints. *Bakelite Cement* is used extensively for lamp basing.

Booklet 3-M, "Bakelite Molded," and 3-L, "Bakelite Laminated," will give you an insight into the many and varied uses for these materials. Copies will be mailed promptly upon receipt of your request.

Bakelite Engineering Service

Intimate knowledge of thousands of varied applications of Bakelite Materials combined with eighteen years' experience in the development of phenol resinoids for electrical uses provides a valuable background for the cooperation offered by our engineers and research laboratories.

BAKELITE CORPORATION

247 Park Avenue, New York, N. Y. Chicago Office, 635 West 22nd Street
BAKELITE CORPORATION OF CANADA, LTD., 163 Dufferin Street, Toronto, Ont.

BAKELITE

REGISTERED

U. S. PAT. OFF.



THE MATERIAL OF A THOUSAND USES

"The registered Trade Mark and Symbol shown above may be used only on products made from materials manufactured by Bakelite Corporation. Under the capital "B" is the numerical sign for infinity, or unlimited quantity. It symbolizes the infinite number of present and future uses of Bakelite Corporation's products."

Please mention the JOURNAL of the A. I. E. E. when writing to advertisers.



There is no standing still . . .

*An Advertisement of the
American Telephone and Telegraph Company*

DURING the past two years 6000 switchboards have been reconstructed in the larger cities served by the Bell System to enable the operators to give a more direct and faster service.

Previously in towns where there were more than one central office, your operator would hold you on the line while she got the operator at the other central office on an auxiliary pair of wires. Now she connects directly with the other central office and repeats the number you want to the other operator. You hear her do this so that you can correct her if there is any mistake.



This little change cost millions of dollars. Likewise, it saves millions of minutes a day for the public and it has cut down the number of errors by a third.

It is one of the many improvements in methods and appliances which are constantly being introduced to give direct, high-speed telephone service.

There is no standing still in the Bell System. Better and better telephone service at the lowest cost is the goal. Present improvements constantly going into effect are but the foundation for the greater service of the future.

“THE TELEPHONE BOOKS ARE THE DIRECTORY OF THE NATION”

Please mention the JOURNAL of the A. I. E. E. when writing to advertisers.

A typical Balkite installation on a time recording clock system. Thousands of similar installations have been made on burglar and fire alarm systems, emergency lighting systems, power plant control, substation control, instrument control systems, door bell and buzzer systems, and emergency power systems for household appliances.

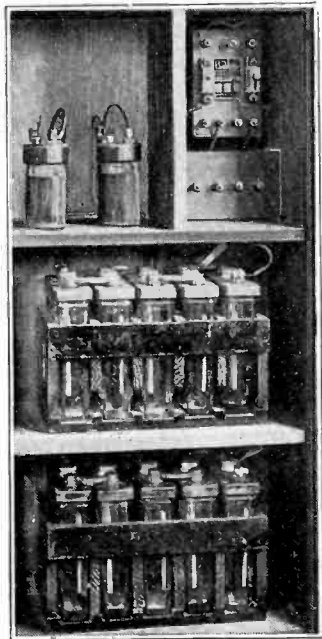

Wherever Batteries are used

Wherever power must be constant
Balkite Trickle Charging is applicable

If you are now using batteries for any purpose, Balkite Trickle Charging may be the means of giving you more economical and reliable power.

If you are using primary batteries, Balkite Trickle Charging will do away with the need for replacements and run-down power.

If you are already using storage batteries, Balkite Trickle Charging provides a simple means of keeping them charged. It does away with periodic charging, duplicate batteries, the necessity for an attendant, power failure while batteries are being changed or charged.

If it is essential that your power be uninterrupted Balkite Trickle Charging is particularly necessary. The charger is connected to the power line and allowed to charge the battery continuously at a low rate. The battery is thus always kept at full charge. In case the power line fails temporarily the reserve power in the battery entirely removes the possibility of power failure. The installation once made is permanent. It has no moving parts, has nothing to get out of order. Initial cost is low. And in most cases the cost of operation is actually reduced.

Write for our booklet giving a complete description of the system and its applications. Or better still tell us what your power requirements are and we will tell you frankly whether Balkite Trickle Charging is desirable in your case.

FANSTEEL PRODUCTS COMPANY, Inc., North Chicago, Ill.

FANSTEEL Balkite Battery Chargers

FANSTEEL PRODUCTS COMPANY, Inc., North Chicago, Illinois

Gentlemen: Please send me your bulletin TC-8 with complete information on Balkite Chargers.

Name _____

Company _____

Address _____

Position _____

A.I.E.E.--2-29

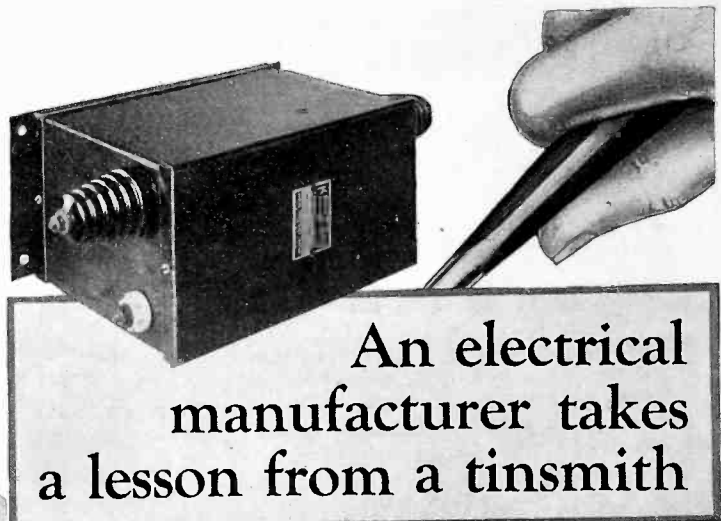

An electrical manufacturer takes a lesson from a tinsmith

... and saves 40% to 50% on an assembly operation by using Self-tapping Screws

AN engineer of the Kenyon Transformer Co., New York, one day watched a tinsmith making fastenings to sheet metal with some unique Screws. First, a hole was drilled, and then the Screw was turned in with a screwdriver—without tapping. The Screw cut its own thread, like a tap, as it was turned in, and the sheet metal was drawn tightly together.

Noting how quickly and easily the fastening was made; and how substantial it was, even in light metal, this engineer inquired and learned that the tinsmith was using Parker-Kalon Self-tapping Sheet Metal Screws.

Remembering the slow, troublesome tapping necessary to assemble the sheet metal case of the Kenyon Transformer with machine screws the engineer got samples of Sheet Metal Screws and tried them for this assembly. He found that these Screws cut the cost of the assembly operation from 40% to 50% by saving the time and expense of tapping. In addition, production was speeded-up.

The Kenyon Transformer Co., in adopting Self-tapping Screws for sheet metal assembly follows the lead of such well known electrical manufacturers as: General Electric, Western Electric, Westinghouse, Delta Electric and many others who use Self-tapping Screws for making fastenings to sheet metal.

These Screws are so hardened and threaded that they cut their own thread, like a tap, as they are turned in. Fastenings made with Sheet Metal Screws stand up under vibration and severe service conditions. In addition to sheet metal assembly applications, there is a type of Sheet Metal Screw especially for making fastenings to aluminum, die castings, Bakelite, etc.

You, too, may be able to use Self-tapping Sheet Metal Screws to advantage. Try them. Tell us what you want to fasten and we will send suitable samples.

Parker-Kalon Corp., 198 Varick St., New York, N.Y.
Distributed in Canada by Aikenhead Hdw., Ltd.,
19-21 Temperance St., Toronto

PARKER-KALON HARDENED SELF-TAPPING Sheet Metal Screws

PATENTED
APR. 1, 1919 - No. 1299232 - MAR. 28, 1922 - No. 1411184
AUG. 14, 1923 - No. 1465148 - FEB. 10, 1925 - No. 1526182
OTHERS PENDING

Just two simple operations:



Punch or drill a hole as in Fig. 1, or pierce a hole as in Fig. 2.

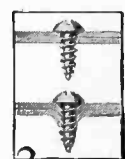

Turn in the Screw with a screw driver.

Please mention the JOURNAL of the A. I. E. E. when writing to advertisers.

ANNOUNCE

2 NEW MATTHEWS FUSWITCHES



The 700

Rating

60 amperes. 2500/4400 volts.
Rupturing Capacity 3000
amperes. Dry Flashover
Value 43,500 volts. Wet
Flashover Value 20,000 volts.

The 700 is easily converted
into a disconnecting switch
by substituting a Matthews
Disconnecting Blade for the
Cartridge.

ADJUSTABLE HANGERS

DIELECTRIC DOORS

NO LIVE PARTS ON DOORS

4 ENTRANCE HOLES

NO RADIO INTERFERENCE

MATTHEWS PATENTED
DOUBLE TUBE
CARTRIDGE

RUPTURING CAPACITIES
MANY TIMES AMPERE
RATINGS

FLASHOVERS MANY
TIMES VOLTAGE
RATINGS



N C I N G

with

HOUSINGS OF GENUINE WET PROCESS PORCELAIN

In presenting this new line of Fuswitches, Matthews Engineers desire to call the attention of members of the industry to the careful study and experimentation that preceded this announcement. A Matthews product must be right in every respect before it is offered to the public, as we feel that through many years of serving we have built a trust which must be guarded. Write for bulletins describing these Fuswitches in detail.

W.N. MATTHEWSCORPORATION
Engineers and Manufacturers
3702 Forest Park Blvd. / St. Louis, Mo.



The 800

Rating:
60 amperes. 7500 volts. Rupturing Capacity 4000 amperes. Dry Flashover 48,000 volts. Wet Flashover 34,000 volts.

Another porcelain housed Fuswitch with a rating of 150 amperes and 7500 volts will be announced soon. It will be known as the 900.

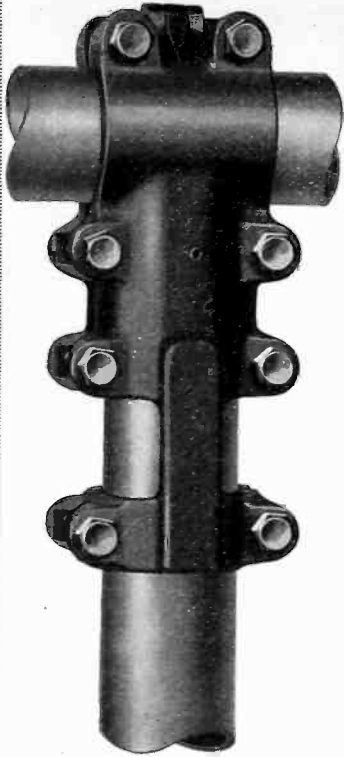

BURKE

Positive Grip Connectors

The only connector which can be partially assembled on the ground.

Made from high conductivity copper Tobin Bronze or Monel Metal Bolts.

Bulletin on Request.

BURKE ELECTRIC CO.
ERIE, PA.

Offices in Principal Cities

Pacific Coast—JONES-LYMAN, INC., San Francisco, Los Angeles

COMPLETE SWITCHING EQUIPMENT

OIL CIRCUIT BREAKERS STEEL STRUCTURES
AIR BREAK SWITCHES FUSE CUTOUPS
FUSES CHOKE COILS

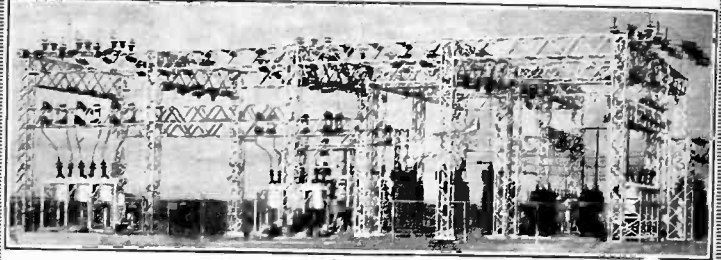

Pacific Electric Manufacturing Corp.

5815 THIRD STREET, SAN FRANCISCO, CALIF.

Representatives in Principal Cities

SUNDH ELECTRIC COMPANY

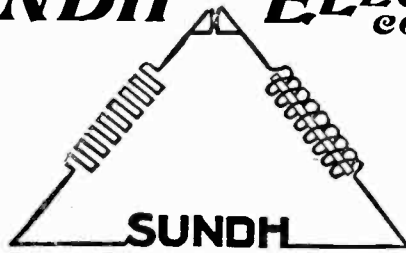

Automatic Starters
Circuit Breakers
Float Switches
Hand Starters
Magnet Switches

Pressure Regulators
Remote Switches
Speed Regulators
Transfer Switches
Valve Control

SUNDH ELECTRIC CO., INC.

Parkhurst St. at Ave. C

NEWARK, N. J., U. S. A.

Branch Offices or Sales Representatives in Principal Cities

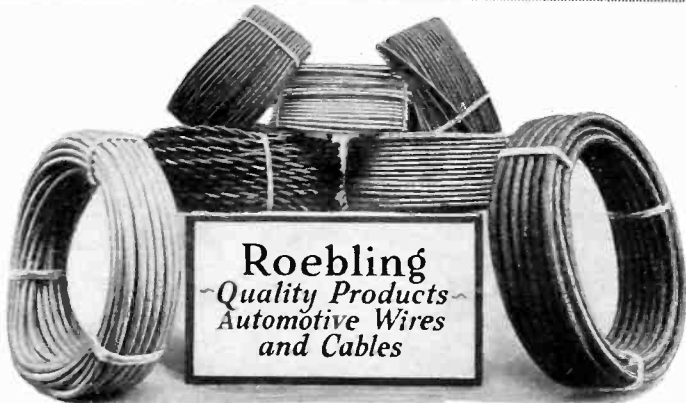

Roebing
Quality Products
Automotive Wires
and Cables

John A. Roebing's Sons Company
Trenton, New Jersey

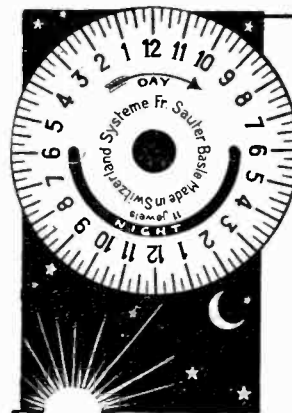

SAUTER

Electric TIME SWITCHES

These "astronomic" time switches are carried in stock for circuits of
250 Volts: 10, 25, 40, 60, 100, 200, 300 Amps.
4600 Volts: 25 and 50 Amps.
8000 Volts: 25 and 50 Amps.

Ask for new catalog S-1.

R. W. CRAMER & COMPANY, INC.
136 Liberty St. New York City

MARING

"The Nation's Finest Value in Magnet Wire."

Plain Enamel	Single Silk Covered
Single Cotton Enamel	Double Silk Covered
Double Cotton Enamel	Single Cotton Covered
Single Silk Enamel	Double Cotton Covered
Double Silk Enamel	

MARING WIRE COMPANY, Muskegon, Mich., U. S. A.
Branches in Principal Cities

Symbol of **MARING PROCESS** Quality **MAGNETWIRE**

Diversified or Specific Experience

whichever may be your preference, is available to fill your position.

The resources of the membership of the American Society of Civil Engineers, the American Society of Mechanical Engineers, the American Institute of Mining and Metallurgical Engineers, and the American Institute of Electrical Engineers cover many technical, economic and executive needs.

Send your requirements to

The Engineering Societies Employment Service

31 West 39 St.
New York

205 W. Wacker Dr.
Chicago

57 Post St.
San Francisco

WIRES

CABLE

ACCESSORIES

INSTALLATION

STANDARD
is a complete
SERVICE

Standard Underground Cable Co.
Division of General Cable Corp.
General Offices: Pittsburgh, Pa.

What Is Cable Pulling Compound?

It is a material generally used in installing Underground Cable. The compound is applied right after the Cable leaves the reel.

In passing through the duct it acts as a lubricant; thus, the strain of pulling is lessened to such an extent that the cable does not experience the usual wear and tear incident to this work. It means a saving in labor and material.

We recommend—

MINERALLAC CABLE PULLING COMPOUND No. 150.

Write for Bulletin No. 130

MINERALLAC ELECTRIC COMPANY

25 North Peoria St.

Chicago, Illinois

Non-Rusting "COPPERWELD" Overhead Ground Wire

A thick layer of copper, molten-welded to the strong steel core, gives protection from rusting, great strength and *perfect electrical properties* for the overhead ground wire.

Copperweld Steel Company

MAIN OFFICE & MILLS:—GLASSPORT, PENNA.
NEW YORK, 30 CHURCH ST. CHICAGO, 129 S. JEFFERSON ST.
DALLAS, 823 S. EDGEFIELD ST. SAN FRANCISCO, RIALTO, BLDG.
IN CANADA: NORTHERN ELECTRIC CO., LTD.

BURNDY
T-CONNECTORS

Especially designed and constructed for severe outdoor service. All sizes and combinations of tube and cable are accommodated.

Our handbook, "The High Tension Bus," sent on request.

BURNDY ENGINEERING CO., Inc.
10 East 43d Street New York

The Path of Professional Progress

THE preference of architects, draftsmen and engineers for VENUS Pencils is almost universal. Their superior drawing qualities, their unusual responsiveness, uniformity and durability, inspire finer craftsmanship and more satisfaction with the final result.

The largest selling quality pencil in the world

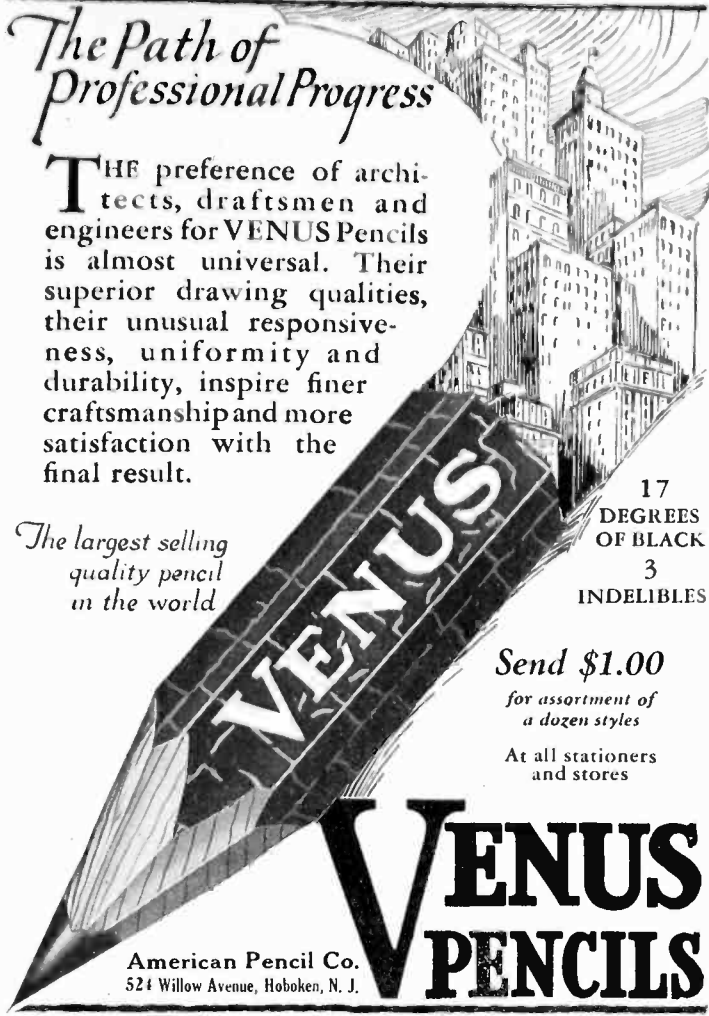

17 DEGREES OF BLACK
3 INDELIBLES

Send \$1.00 for assortment of a dozen styles
At all stationers and stores

VENUS PENCILS

American Pencil Co.
524 Willow Avenue, Hoboken, N. J.



LAPP HIGH VOLTAGE INSULATORS

of Vacuum Process Porcelain are made only by

LAPP INSULATOR COMPANY, INC.
LE ROY, N. Y., U. S. A.



Thomas Quality

PORCELAIN INSULATORS
LINE HARDWARE
WIRING PORCELAINS
and
Porcelain Specialties

An American Standard since '73

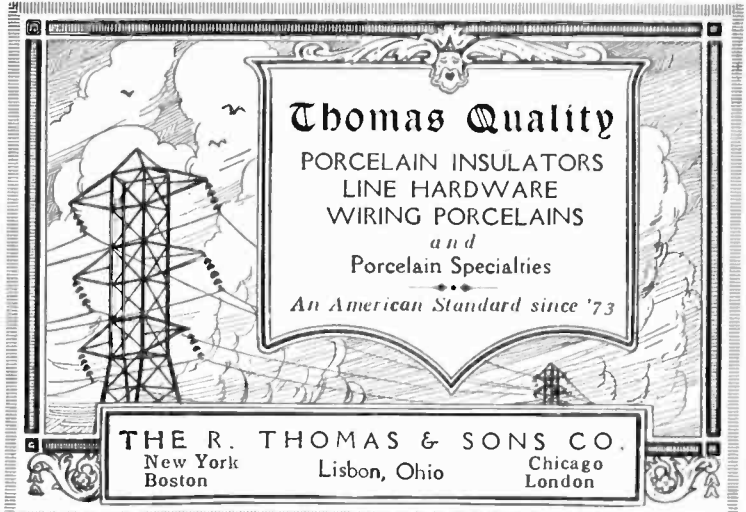

THE R. THOMAS & SONS CO.
New York Boston Lisbon, Ohio Chicago London

HEMINGRAY GLASS INSULATORS

The transparency of Hemingray Glass Insulators makes line inspection very simple. The lineman can tell at a glance whether the insulator is intact or not. Hemingray insulators are mechanically and dielectrically dependable, non-porous and uniform in structure. They defy moisture and age.

Send for Bulletin No. 1.

HEMINGRAY GLASS COMPANY
Muncie, Indiana

INSULATORS

CANADIAN PORCELAIN CO., Ltd.
Hamilton—Ontario—Canada

Quebec District Office 612 Transportation Bldg. Montreal, Qu.
London Office 343 Abbey House, 4 Victoria Street London, S. W. 1.

KEARNEY
MANUFACTURERS OF

Preheated Certified Malleable Iron Screw Type Anchors
Outdoor Type Fuse Switches, Disconnecting Switches,
Choke Coils, and Combinations, 7500 and 15000 volts
Aluminum, Copper, and Galvanized Iron Guy Wire Clips
Extension Sleeve Twisters with Interchangeable Dies
Solderless Service Connectors
Expulsion Porcelain Plug Cutouts
Tap Off Clamps

Write for Catalog

JAMES R. KEARNEY CORPORATION
4220 Clayton Avenue ST. LOUIS, MO.

Hubbard and COMPANY
PITTSBURGH • OAKLAND, CAL • CHICAGO

*{ The Hardware makes the line
Hubbard makes the Hardware }*

DECADE BRIDGE

TYPE 193

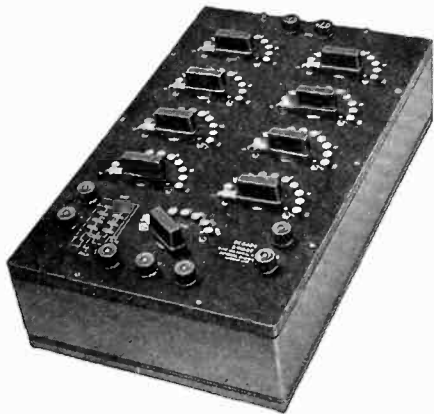

The Type 193 Decade Bridge is a general utility bridge designed for measurement of resistance and reactance at commercial and audio frequencies.

The dial-switch method of adjustment greatly facilitates adjustment of the bridge.

The provision of 11 stops (0 and 10) further adds to the convenience of the instrument.

The bridge may be made direct reading by means of a suitable choice of standards and ratio.

PRICE \$115.00

Laboratory catalog describing complete line of electrical laboratory equipment on request.

GENERAL RADIO COMPANY

Manufacturers of Radio and Electrical Apparatus

30 State Street

Cambridge, Massachusetts

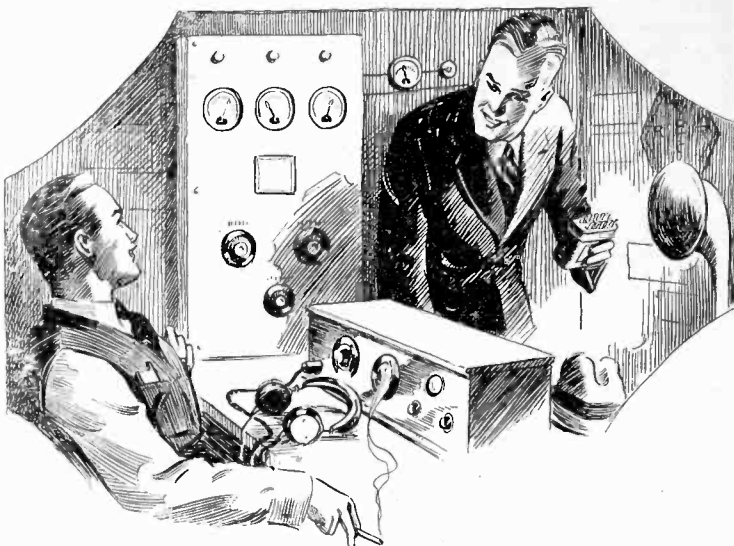

In radio engineering circles—

the widespread utilization of Faradon Capacitors is conclusive evidence of ability to deliver dependable service under all conditions.

Of course this result was not obtained over night. More than 20 years of painstaking fabrication experience with each step

based on sound radio engineering data is behind it.

You are invited to avail yourself of the Faradon engineering cooperation on special applications not covered by the more than 200 types of Faradon Capacitors in regular production.

WIRELESS SPECIALTY APPARATUS CO.
Jamaica Plain, Boston, Mass., U. S. A.
Established 1907



2595

Electrostatic Condensers for All Purposes

Remember

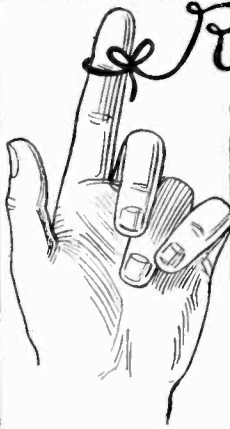

**JEFFERSON
BUILDS
SPECIAL SMALL
TRANSFORMERS**

to order for Engineers and Experimenters. Submit your specifications or problems to us without obligation.

CHICAGO-JEFFERSON FUSE & ELECTRIC CO.
1582 W. 15th Street, Chicago, Ill.



Write for literature

CORNING GLASS WORKS
Industrial and Laboratory Division
CORNING, N. Y.

“We wish to comment on the value of your service in emergency”

Says an Ohio Utility

Our relations with this customer cover a period of more than four years. During that time we have handled the rewinding of transformers aggregating over 5100 KVA., and have many times been able to help out in emergency through our wide experience and the stock of 4000 transformers, in all sizes from 1 to 1000, and 110 to 68,000 volts, which we carry on hand. Name on request.

The same service is, of course, available to all our customers. Maybe it is just what YOU have been looking for. Monthly Bulletin and rewinding prices on request.

WE BUY MODERN TYPE TRANSFORMERS—ANY SIZE—ANY QUANTITY

The **ELECTRIC SERVICE CO.** Inc.
America's Used Transformer Clearing House
212 Walnut Street
Cincinnati, Ohio

Please mention the JOURNAL of the A. I. E. E. when writing to advertisers.

PROFESSIONAL ENGINEERING DIRECTORY

For Consultants in the Fields of Engineering, and Related Arts and Sciences

AMBURSEN DAMS
Hydroelectric Developments
Water Supply and Irrigation Dams
DAMS ON DIFFICULT FOUNDATIONS
AMBURSEN CONSTRUCTION CO.
Incorporated
Grand Central Terminal, New York
Kansas City, Mo. Atlanta, Ga.

HAROLD A. DANNE
LIGHT AND POWER PLANTS
Valuation : Equipment : Design
41 Park Row, New York Tel. Cort. 2142-3

Dugald C. Jackson
Edward L. Moreland
JACKSON & MORELAND
CONSULTING ENGINEERS
81 St. James Ave. Boston, Mass.

W. S. BARSTOW & COMPANY
Incorporated
Financial and Operating
Managers of
Public Utilities
50 Pine Street New York

DAVID V. FENNESSY
Consulting Power Engineer
MILLS BUILDING EL PASO, TEXAS

E. S. LINCOLN
Consulting Electrical Engineer
Designs Investigations Reports
Electrical Research Laboratory
Graybar Building
420 Lexington Avenue NEW YORK

BATTEY & KIPP
Incorporated
ENGINEERS
Complete Industrial Plants
Power Plants & Electrical Installations
Engineering Reports, Analyses & Appraisals
231 South LaSalle Street CHICAGO

Card space limited
to 1" x 2" for each
advertiser.

MCCLELLAN & JUNKERSFELD
Incorporated
Engineering and Construction
Power Developments—Industrial Plants
Electrifications—Examinations
Reports—Valuations
NEW YORK
68 Trinity Place
Chicago St. Louis

BLACK & VEATCH
Consulting Engineers
Water, Steam and Electric Power Investiga-
tions, Design, Supervision of Construction,
Valuation and Tests.
Mutual Building KANSAS CITY, MO.

FORD, BACON & DAVIS
Incorporated
ENGINEERS
115 Broadway, New York
Philadelphia Chicago San Francisco

WALLACE MONTGOMERY
Mem. A. I. E. E., A. S. M. E.
Electrification — Remodelling
CANE AND BEET SUGAR
FACTORIES
104 Mills Street Morristown, N. J.

ROBERT C. BURT, E. E., Ph.D.
DONALD H. LOUGHRIDGE, Ph.D.
Consulting Physicists
Designers and Makers of
Scientific Instruments
327 So. Michigan Ave. PASADENA
California

FRANK F. FOWLE & CO.
Electrical and Mechanical
Engineers
MONADNOCK BUILDING CHICAGO

N. J. NEALL
Consulting Engineer
for
Electrical and Industrial Properties
12 PEARL STREET BOSTON, MASS.

BYLLESBY
ENGINEERING AND MANAGEMENT
CORPORATION
231 S. La Salle Street
CHICAGO
New York San Francisco

FREY ENGINEERING COMPANY
Industrial Electric Power
Generation—Application—Purchase
Combustion Engineering
Electric Furnace Installations
810 South Michigan Ave. CHICAGO

NEILER, RICH & CO.
Electrical and Mechanical
Engineers
Consulting, Designing and
Supervising
431 So. Dearborn St. — — — Chicago

EDWARD E. CLEMENT
Fellow A. I. E. E.
Attorney and Expert
in Patent Causes
Soliciting, Consultation, Reports,
Opinions
McLachlen Bldg. Washington, D. C.
700 10th St., N. W.

A. BARNETT GREEN
Mem. A. I. E. E.
Editorial Work—
Book Revisions—
Compilations and Reports—
Preparation of Technical Copy—
1328 Broadway NEW YORK
Tel. Wisconsin 4525

OPHULS & HILL, Inc.
Formerly Ophuls, Hill & McCreery, Inc.
CONSULTING ENGINEERS
112-114 WEST 42nd ST., NEW YORK CITY
Ice Making and Refrigeration
Investigations and Reports

Refer to this Directory
when the services of
a consulting engineer
are required.

HOOSIER ENGINEERING CO.
Erectors of
Transmission Lines and Substations
100 W. Monroe Street
CHICAGO
NEW YORK INDIANAPOLIS
31 Nassau Street 5 E. Market Street

To be printed in the
following issue, copy for
cards must be received
by the 20th of the month.

PROFESSIONAL ENGINEERING DIRECTORY

For Consultants in the Fields of Engineering, and Related Arts and Sciences

FARLEY OSGOOD
 Consultant
 Design, Construction, Operation
 Inter-Connection
 of
PUBLIC UTILITIES
 National Bank of Commerce Building
 31 Nassau Street, New York, N. Y.
 Tel.: Rector 7878 Cable Address: Fargoood

SCOFIELD ENGINEERING CO.
 CONSULTING ENGINEERS
 Utility and Industrial Plants
 Design, Construction, Operation
 Valuations and Appraisals
PHILADELPHIA

STONE & WEBSTER
 Incorporated
 DESIGN AND CONSTRUCTION
 EXAMINATIONS REPORTS
 APPRAISALS
 INDUSTRIAL AND PUBLIC SERVICE
 PROPERTIES
 New York Boston Chicago

W. P. POWERS
 (Formerly with Stevens Institute of Technology)
CONSULTING ENGINEER
 Mechanical and Electrical Tests
 U S. Tool Company, Inc.,
 Ampere (Newark) N. J.

JOHN A. STEVENS
 CONSULTING POWER ENGINEER
 16 Shattuck Street
LOWELL MASSACHUSETTS

PERCY H. THOMAS
 Consulting Engineer
ELECTRIC POWER
 Generation—Transmission
 Applications
 120 BROADWAY NEW YORK

SANDERSON & PORTER
 ENGINEERS
PUBLIC UTILITIES & INDUSTRIALS
 Design Construction Management
 Examinations Reports Valuations
 Chicago New York San Francisco

STEVENS & WOOD
 INCORPORATED
 Engineers and Constructors
 20 PINE STREET, NEW YORK
 Youngstown, O.

THE J. G. WHITE
 ENGINEERING CORPORATION
 Engineers — Constructors
 Oil Refineries and Pipe Lines,
 Steam and Water Power Plants,
 Transmission Systems, Hotels, Apartments,
 Offices and Industrial Buildings, Railroads
 43 EXCHANGE PLACE NEW YORK

SARGENT & LUNDY
 Incorporated
 Mechanical and Electrical
 Engineers
 1412 Edison Bldg., 72 West Adams Street
CHICAGO ILLINOIS

STOCKBRIDGE & BORST
 Patent Law
 41 PARK ROW NEW YORK CITY

J. G. WRAY & CO.
 Engineers
 J. G. Wray, Fellow A. I. E. E. Cyrus G. Hill
 Utilities and Industrial Properties
 Appraisals Construction Rate Surveys
 Plans Organizations Estimates
 Financial Investigations Management
 2130 Bankers Bldg., Chicago

YOUR CARD in each issue of this publication—12 times a year, will keep your name and specialized service constantly before the electrical industry. Qualified advertisers in the Engineering Directory are invited to send for rates.

ELECTRICAL TESTING LABORATORIES
 80th Street and East End Ave.
NEW YORK

Inspections — Tests — Research
 Tests may be used by the purchaser for the following purposes:
 (1) To determine the quality of competing samples. This enables the purchase of the best quality for the money.
 (2) To make sure that shipments comply with specifications. This makes possible the assurance to the customer that shipments match buying samples.
 (3) To furnish an impartial decision in case of disputes between purchaser and manufacturer.
 Testing places the whole buying problem on a sound basis.

STOCK QUOTATION TELEGRAPH COMPANY
 24 Moore Street
 New York City New York

PRINTING TELEGRAPH SYSTEMS
 NEWS AND QUOTATION TICKERS — FOR ALL PURPOSES
EXPERIENCE of the world's greatest stock markets and news distributing agencies, establishes the efficiency of the narrow and broad tape "ticker" systems for the dissemination of quotations and news.
Complete Plants for Export

Please mention the JOURNAL of the A. I. E. E. when writing to advertisers.

Classified Advertiser's Index for Buyers

Manufacturers and agents for machinery and supplies used in the electrical and allied industries.

Note: For reference to the advertisements see the Alphabetical List of Advertisers on page 48.

- AIR COMPRESSORS**
Allis-Chalmers Mfg. Co., Milwaukee
General Electric Co., Schenectady
- AMMETER COMPENSATING COILS**
Minerallac Electric Co., Chicago
- AMMETER, VOLTMETERS**
(See INSTRUMENTS, ELECTRICAL)
- ANCHORS, GUY**
Copperweld Steel Co., Glassport, Pa.
Hubbard & Co., Pittsburgh
Kearney Corp., Jas. R., St. Louis
Matthews Corp., W. N., St. Louis
- ARMS FOR STREET LIGHTING**
Hubbard & Co., Pittsburgh
- BATTERY CHARGING APPARATUS**
Electric Specialty Co., Stamford, Conn.
Fansteel Products Co., Inc., North Chicago
General Electric Co., Schenectady
Wagner Electric Corp., St. Louis
Westinghouse Elec. & Mfg. Co., E. Pitts-
burgh
- BEARINGS, BALL**
New Departure Mfg. Co., The, Bristol, Conn.
Norma-Hoffmann Bearings Corp., Stamford,
Conn.
- BOXES, FUSE**
General Electric Co., Schenectady
Kearney Corp., Jas. R., St. Louis
Metropolitan Device Corp., Brooklyn, N. Y.
Westinghouse Elec. & Mfg. Co., Pitts-
burgh
- BOXES, JUNCTION**
Chicago-Jefferson Fuse & Elec. Co., Chicago
G & W Elec. Specialty Co., Chicago
Metropolitan Device Corp., Brooklyn, N. Y.
Standard Underground Cable Co., Pittsburgh
- BRACKETS AND PINS, METAL**
Hubbard & Co., Pittsburgh
- BRUSHES, COMMUTATOR**
Carbon
Morganite Brush Co., Inc., L. I. City, N. Y.
National Carbon Co., Inc., Cleveland
Westinghouse Elec. & Mfg. Co., E. Pitts-
burgh
Copper Graphite
Morganite Brush Co., Inc., L. I. City, N. Y.
National Carbon Co., Inc., Cleveland
Westinghouse Elec. & Mfg. Co., E. Pitts-
burgh
- BRUSHES, INDUSTRIAL**
Hanson-Van Winkle-Munning Co., Mata-
wan, N. J.
- BUS BAR FITTINGS**
Burndy Engineering Co., Inc., New York
Delta-Star Electric Co., Chicago
General Electric Co., Schenectady
Ohio Brass Co., Mansfield, O.
Westinghouse Elec. & Mfg. Co., E. Pitts-
burgh
- BUSHINGS, PORCELAIN**
Ohio Brass Co., Mansfield, O.
- CABLE ACCESSORIES**
Delta Star Electric Co., Chicago
Dossert & Co., New York
G & W Electric Specialty Co., Chicago
General Electric Co., Schenectady
Minerallac Electric Co., Chicago
Standard Underground Cable Co., Pittsburgh
- CABLE RACKS**
Hubbard & Co., Pittsburgh
Metropolitan Device Corp., Brooklyn, N. Y.
- CABLES**
SEE WIRES AND CABLES
- CABLEWAYS**
American Steel & Wire Co., Chicago
Roebbling's Sons Co., John A., Trenton, N. J.
- CAMBRIC, VARNISHED**
Belden Mfg. Co., Chicago
General Electric Co., Bridgeport, Conn.
Westinghouse Elec. & Mfg. Co., E. Pitts-
burgh
- CARRIER CURRENT TELEPHONE EQUIP-
MENT**
Wireless Specialty Apparatus Co., Boston
- CIRCUIT BREAKERS**
Air—Enclosed
I-T-E Circuit Breaker Co., The, Philadelphia
Roller-Smith Co., New York
Sundh Electric Co., Newark, N. J.
Oil
Condit Electrical Mfg. Corp., Boston
General Electric Co., Schenectady
Pacific Elec. Mfg. Corp., San Francisco
Westinghouse Elec. & Mfg. Co., E. Pitts-
burgh
- CLAMPS, GUY & CABLE**
Burndy Engineering Co., Inc., New York
Hubbard & Co., Pittsburgh
Kearney Corp., Jas. R., St. Louis
Matthews Corp., W. N., St. Louis
- CLAMPS, HOT LINE**
Hubbard & Co., Pittsburgh
Kearney Corp., Jas. R., St. Louis
- CLIPS, CABLE**
Hubbard & Co., Pittsburgh
Kearney Corp., Jas. R., St. Louis
- CLOCKS**
Cramer & Co., Inc., R. W., New York
Sangamo Elec. Co., Springfield, Ill.
- COILS, CHOKE**
Burke Electric Co., Erie, Pa.
General Electric Co., Schenectady
Kearney Corp., Jas. R., St. Louis
Westinghouse Elec. & Mfg. Co., E. Pitts-
burgh
- COILS, MAGNET**
Belden Mfg. Co., Chicago
Dudlo Mfg. Corp., Ft. Wayne, Ind.
General Electric Co., Schenectady
Westinghouse Elec. & Mfg. Co., E. Pitts-
burgh
- COMMUTATOR SEGMENTS AND RINGS**
Mica Insulator Co., New York
- CONDENSATION PRODUCTS**
Bakelite Corporation, New York
- CONDENSERS, COUPLING**
For Carrier Current Telephone
Wireless Specialty Apparatus Co., Boston
- CONDENSERS, RADIO**
General Radio Co., Cambridge, Mass.
Sangamo Elec. Co., Springfield, Ill.
Wireless Specialty Apparatus Co., Boston
- CONDENSERS, STEAM**
Allis-Chalmers Mfg. Co., Milwaukee
General Electric Co., Schenectady
Westinghouse Elec. & Mfg. Co., E. Pitts-
burgh
- CONNECTORS, SOLDERLESS**
Dossert & Co., New York
Kearney Corp., Jas. R., St. Louis
Westinghouse Elec. & Mfg. Co., E. Pitts-
burgh
- CONNECTORS AND TERMINALS**
Belden Mfg. Co., Chicago
Burke Electric Co., Erie, Pa.
Burndy Engineering Co., Inc., New York
Dossert & Co., New York
G & W Electric Specialty Co., Chicago
Westinghouse Elec. & Mfg. Co., E. Pitts-
burgh
- CONTACTS, TUNGSTEN**
Fansteel Products Co., Inc., North Chicago
General Electric Co., Schenectady
- CONTROLLERS**
Electric Controller & Mfg. Co., Cleveland
General Electric Co., Schenectady
Sundh Electric Co., Newark, N. J.
Westinghouse Elec. & Mfg. Co., E. Pitts-
burgh
- CONVERTERS—SYNCHRONOUS**
Allis-Chalmers Mfg. Co., Milwaukee
Electric Specialty Co., Stamford, Conn.
Wagner Electric Corp., St. Louis
Westinghouse Elec. & Mfg. Co., E. Pitts-
burgh
- COPPER CLAD WIRE**
Belden Mfg. Co., Chicago
Standard Underground Cable Co., Pittsburgh
- COPPERWELD WIRE**
Copperweld Steel Co., Glassport, Pa.
- CROSS ARMS, STEEL**
Hubbard & Co., Pittsburgh
- CUT-OUTS**
Condit Electrical Mfg. Corp., S. Boston
General Electric Co., Schenectady
G & W Electric Specialty Co., Chicago
Kearney Corp., Jas. R., St. Louis
Metropolitan Device Corp., Brooklyn, N. Y.
Wagner Electric Corp., St. Louis
Westinghouse Elec. & Mfg. Co., E. Pitts-
burgh
- DYNAMOS**
(See GENERATORS AND MOTORS)
- DYNAMOTORS**
Burke Electric Co., Erie, Pa.
Electric Specialty Co., Stamford, Conn.
- ELECTRIFICATION SUPPLIES, STEAM
ROAD**
General Electric Co., Schenectady
Ohio Brass Co., Mansfield, Ohio
Westinghouse Elec. & Mfg. Co., E. Pitts-
burgh
- ELECTROPLATING EQUIPMENTS, COM-
PLETE**
Hanson-Van Winkle-Munning Co., Mata-
wan, N. J.
- ENGINEERS, CONSULTING AND CON-
TRACTING**
(See PROFESSIONAL ENGINEERING
DIRECTORY)
- ENGINES**
Gas & Gasoline
Allis-Chalmers Mfg. Co., Milwaukee
Oil
Allis-Chalmers Mfg. Co., Milwaukee
Steam
Allis-Chalmers Mfg. Co., Milwaukee
- FANS, MOTOR**
Century Electric Co., St. Louis
General Electric Co., Schenectady
Wagner Electric Corp., St. Louis
Westinghouse Elec. & Mfg. Co., E. Pitts-
burgh
- FIRE EXTINGUISHING APPARATUS**
Walter Kidde & Co., Inc., New York
- FLOW METERS**
General Electric Co., Schenectady
- FURNACES, ELECTRIC**
General Electric Co., Schenectady
Westinghouse Elec. & Mfg. Co., E. Pitts-
burgh
- FUSES**
Enclosed Refillable
Chicago-Jefferson Fuse & Elec. Co., Chicago
General Electric Co., Schenectady
Westinghouse Elec. & Mfg. Co., E. Pitts-
burgh
Enclosed Non-Refillable
Chicago-Jefferson Fuse & Elec. Co., Chicago
General Electric Co., Schenectady
Open Link
Chicago-Jefferson Fuse & Elec. Co., Chicago
General Electric Co., Schenectady
Metropolitan Device Corp., Brooklyn, N. Y.



Is your
name on our
mailing list
for bulletins
and catalog?

Morganite Brushes

Morganite
Brush Co., Inc.
3302-3320 Anable Ave.,
Long Island City,
N. Y.

Please mention the JOURNAL of the A. I. E. E. when writing to advertisers.

ROLLER-SMITH ANNOUNCES

a New

Polyphase Ammeter

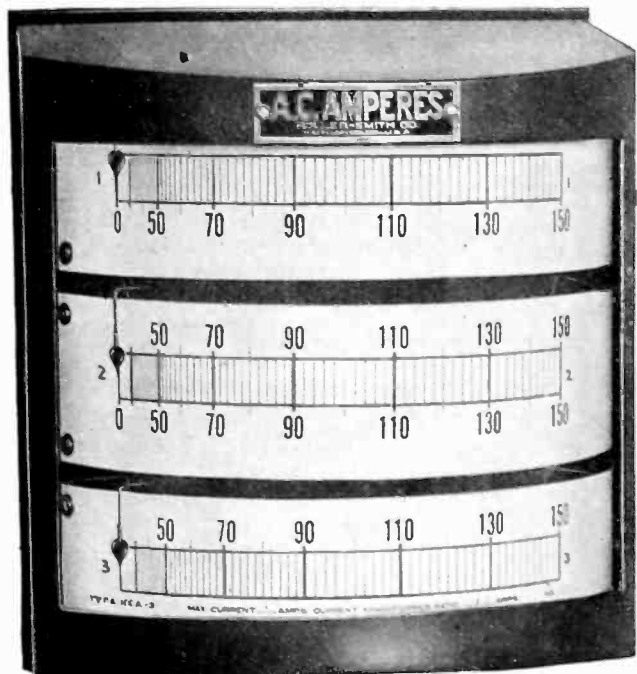

Type—HEA-3.

Size— $8\frac{3}{8}$ in. by $9\frac{5}{8}$ in. by $6\text{-}29/32$ in.

Scales— $7\frac{1}{8}$ in. long.

Purpose—Indication simultaneously of the current in amperes in each phase of a three phase circuit.

Advantages—Three ammeters in one (thus conserving space) and very long scale— $7\frac{1}{8}$ inches.

Quality—Up to the ROLLER-SMITH standard.

New Supplement No. 1 to Bulletin No. AE-450 gives all the details. Send for your copy.

"Over thirty years' experience is back of "ROLLER-SMITH"

Offices in principal cities
in U. S. A. and Canada

ROLLER-SMITH COMPANY
Electrical Measuring and Protective Apparatus

Representatives in Australia,
Cuba and Japan

MAIN OFFICE
12 Park Place, NEW YORK



WORKS
Bethlehem, Penna.

Science Abstracts

ALL electrical engineers actively engaged in the practice of their profession should subscribe to "Science Abstracts."

Published monthly by the Institution of Electrical Engineers, London, in association with the Physical Society of London, and with the cooperation of the American Institute of Electrical Engineers, the American Physical Society and the American Electrochemical Society, they constitute an invaluable reference library.

Through "Science Abstracts" engineers are enabled to keep in touch with engineering progress throughout the world, as one hundred and sixty publications, in various languages, are regularly searched and abstracted. "Science Abstracts" are published in two sections, as follows:

"A"—PHYSICS—deals with electricity, magnetism, light, heat, sound, astronomy, chemical physics.

"B"—ELECTRICAL ENGINEERING—deals with electrical plant, power transmission, traction, lighting, telegraphy, telephony, wireless telegraphy, prime movers, engineering materials, electrochemistry.

Through special arrangement, members of the A. I. E. E. may subscribe to "Science Abstracts" at the reduced rate of \$5.00 for each section, and \$10 for both. Rates to non-members are \$7.50 for each section and \$12.50 for both.

Subscriptions should start with the January issue. The first volume was issued in 1898. Back numbers are available, and further information regarding these can be obtained upon application to Institute headquarters.

American Institute of Electrical Engineers
33 West 39th Street, New York



Please mention the JOURNAL of the A. I. E. E. when writing to advertisers.

Classified Advertiser's Index for Buyers—Continued

FUSES—Continued

High-Tension

Delta-Star Electric Co., Chicago
Metropolitan Device Corp., Brooklyn, N. Y.

FUSE PULLERS

Kearney Corp., Jas. R., St. Louis

GEARS, FIBRE

Fibroc Insulation Co., Valparaiso, Ind.
General Electric Co., Schenectady

GENERATORS AND MOTORS

Allis-Chalmers Mfg. Co., Milwaukee
Burke Electric Co., Erie, Pa.
Century Electric Co., St. Louis
Chandeysson Electric Co., St. Louis
Electric Specialty Co., Stamford, Conn.
Electro-Dynamic Co., Bayonne, N. J.
General Electric Co., Schenectady
Hanson-Van Winkle-Munning Co., Matawan, N. J.
Lincoln Electric Co., The, Cleveland
Wagner Electric Corp., St. Louis
Westinghouse Elec. & Mfg. Co., E. Pittsburgh

GENERATING STATION EQUIPMENT

Allis-Chalmers Mfg. Co., Milwaukee
Burke Electric Co., Erie, Pa.
General Electric Co., Schenectady
Westinghouse Elec. & Mfg. Co., E. Pittsburgh

GROUND CONNECTIONS

Hubbard & Co., Pittsburgh

GROUND RODS

Copperweld Steel Co., Glassport, Pa.
Hubbard & Co., Pittsburgh

HARDWARE, POLE LINE AND INSULATOR

Hubbard & Co., Pittsburgh
Ohio Brass Co., Mansfield, O.
Westinghouse Elec. & Mfg. Co., E. Pittsburgh

HEADLIGHTS

Ohio Brass Co., Mansfield, O.
Westinghouse Elec. & Mfg. Co., E. Pittsburgh

HEATERS, INDUSTRIAL

General Electric Co., Schenectady
Westinghouse Elec. & Mfg. Co., E. Pittsburgh

IGNITION SYSTEMS, AUTOMOBILE

Wagner Electric Corp., St. Louis

INDICATORS, SPEED

Roller-Smith Co., New York

INDICATORS, REMOTE, WATER LEVEL

Cramer & Co., Inc., R. W., New York

INSTRUMENTS, ELECTRICAL

Graphic

Ferranti, Ltd., Hollinwood, England
Ferranti, Inc., New York
Ferranti Electric, Ltd., Toronto, Ont.
General Electric Co., Schenectady
Lincoln Meter Co. Inc., Springfield, Ill.
Westinghouse Elec. & Mfg. Co., E. Pittsburgh

Indicating

Ferranti, Ltd., Hollinwood, England
Ferranti, Inc., New York
Ferranti Electric, Ltd., Toronto, Ont.
General Electric Co., Schenectady
Jewell Elec. Instrument Co., Chicago
Lincoln Meter Co. Inc., Springfield, Ill.
Roller-Smith Co., New York
Westinghouse Elec. & Mfg. Co., E. Pittsburgh

Weston Elec. Inst. Corp., Newark, N. J.

Integrating

Duncan Elec. Mfg. Co., Lafayette, Ind.
Ferranti, Ltd., Hollinwood, England
Ferranti, Inc., New York
Ferranti Electric, Ltd., Toronto, Ont.
General Electric Co., Schenectady
Roller-Smith Co., New York
Sangamo Elec. Co., Springfield, Ill.
Westinghouse Elec. & Mfg. Co., E. Pittsburgh

Plating Solution Control

Hanson-Van Winkle-Munning Co., Matawan, N. J.

Radio

General Radio Co., Cambridge, Mass.
Jewell Elec. Instrument Co., Chicago

Repairing and Testing

Electrical Testing Laboratories, New York
Jewell Elec. Instrument Co., Chicago
Martindale Electric Co., The, Cleveland

Scientific Laboratory, Testing

Cramer & Co., Inc., R. W., New York
General Electric Co., Schenectady
Jewell Elec. Instrument Co., Chicago
Metropolitan Device Corp., Brooklyn, N. Y.
Roller-Smith Co., New York
Westinghouse Elec. & Mfg. Co., E. Pittsburgh
Weston Elec. Inst. Corp., Newark, N. J.

INSULATING MATERIALS

Board

General Electric Co., Bridgeport, Conn.
West Va. Pulp & Paper Co., New York

Cloth

General Electric Co., Bridgeport, Conn.
Mica Insulator Co., New York
Minerallac Electric Co., Chicago
Westinghouse Elec. & Mfg. Co., E. Pittsburgh

Composition

American Lava Corp., Chattanooga
Bakelite Corporation, New York
Belden Mfg. Co., Chicago
Fibroc Insulation Co., Valparaiso, Ind.
General Electric Co., Bridgeport, Conn.
Westinghouse Elec. & Mfg. Co., E. Pittsburgh

Compounds

General Electric Co., Bridgeport, Conn.
Mica Insulator Co., New York
Minerallac Electric Co., Chicago
Standard Underground Cable Co., Pittsburgh
Westinghouse Elec. & Mfg. Co., E. Pittsburgh

Fibre

Belden Mfg. Co., Chicago
Fibroc Insulation Co., Valparaiso, Ind.
General Electric Co., Bridgeport, Conn.
West Va. Pulp & Paper Co., New York

Lava

American Lava Corp., Chattanooga, Tenn.

Mica

Mica Insulator Co., New York
Westinghouse Elec. & Mfg. Co., E. Pittsburgh

Paper

General Electric Co., Bridgeport, Conn.
Mica Insulator Co., New York
Westinghouse Elec. & Mfg. Co., E. Pittsburgh

Silk

General Electric Co., Bridgeport, Conn.

Tape

Belden Mfg. Co., Chicago
General Electric Co., Bridgeport, Conn.
Mica Insulator Co., New York
Minerallac Electric Co., Chicago
Okonite Co., The, Passaic, N. J.
Westinghouse Elec. & Mfg. Co., E. Pittsburgh

Varnishes

General Electric Co., Bridgeport, Conn.
Mica Insulator Co., New York
Minerallac Electric Co., Chicago
Westinghouse Elec. & Mfg. Co., E. Pittsburgh

INSULATORS, HIGH TENSION

Composition

General Electric Co., Schenectady

Glass

Hemingray Glass Co., Muncie, Ind.

Porcelain

Canadian Porcelain Co., Ltd., Hamilton, Ont.
General Electric Co., Schenectady
Lapp Insulator Co., Inc., LeRoy, N. Y.
Locke Insulator Corp., Baltimore
Ohio Brass Co., Mansfield, O.
Thomas & Sons Co., R., Lisbon, O.
Westinghouse Elec. & Mfg. Co., E. Pittsburgh

Post Type

Delta-Star Electric Co., Chicago
Ohio Brass Co., Mansfield, O.

INSULATORS, TELEPHONE & TELEGRAPH

Hemingray Glass Co., Muncie, Ind.
Ohio Brass Co., Mansfield, O.

INSULATOR PINS

Hubbard & Co., Pittsburgh
Ohio Brass Co., Mansfield, O.
Thomas & Sons Co., R., Lisbon, O.

LAMP GUARDS

Matthews Corp., W. N., St. Louis

LATHES, BUFFING AND POLISHING

Hanson-Van Winkle-Munning Co., Matawan, N. J.

LAVA

American Lava Corp., Chattanooga

LIGHTNING ARRESTERS

Delta-Star Electric Co., Chicago
General Electric Co., Schenectady
Hubbard & Co., Pittsburgh
Westinghouse Elec. & Mfg. Co., E. Pittsburgh

LOCOMOTIVES, ELECTRIC

General Electric Co., Schenectady
Westinghouse Elec. & Mfg. Co., E. Pittsburgh

LUBRICANTS

Texas Co., The, New York

MAGNETIC SEPARATORS

Electric Controller & Mfg. Co., Cleveland

METERS, ELECTRICAL

(See INSTRUMENTS ELECTRICAL)

METER SEALS

Metropolitan Device Corp., Brooklyn, N. Y.

MICA PRODUCTS

Westinghouse Elec. & Mfg. Co., E. Pittsburgh

MOLDED INSULATION

Bakelite Corporation, New York
Belden Mfg. Co., Chicago
Burke Electric Co., Erie, Pa.
Westinghouse Elec. & Mfg. Co., E. Pittsburgh

MOLYBDENUM

Fansteel Products Co., Inc., North Chicago

MOTORS

(See GENERATORS AND MOTORS)

OHMMETERS

Jewell Elec. Instrument Co., Chicago
Roller-Smith Co., New York
Weston Elec. Instr. Corp., Newark, N. J.

OIL SEPARATORS & PURIFIERS

Sharples Specialty Co., The, Philadelphia
Westinghouse Elec. & Mfg. Co., E. Pittsburgh

PANEL BOARDS

(See SWITCHBOARDS)

PATENT ATTORNEYS

(See PROFESSIONAL ENGINEERING DIRECTORY)

PLATING GENERATORS

Burke Electric Co., Erie, Pa.
Chandeysson Elec. Co., St. Louis
Electric Specialty Co., Stamford, Conn.
Hanson-Van Winkle-Munning Co., Matawan, N. J.

PLUGS

Delta-Star Electric Co., Chicago
General Electric Co., Schenectady
Westinghouse Elec. & Mfg. Co., E. Pittsburgh

POLE LINE HARDWARE

Hubbard & Co., Pittsburgh
Ohio Brass Co., Mansfield, O.

POTHEADS

G & W Electric Specialty Co., Chicago
Ohio Brass Co., Mansfield, O.
Standard Underground Cable Co., Pittsburgh

PRINTING TELEGRAPH SYSTEMS

Stock Quotation Telegraph Co., New York

PROTECTIVE DEVICES

Metropolitan Device Corp., Brooklyn, N. Y.

PULLERS, SLACK

Matthews Corp., W. N., St. Louis

PUMPS

Allis-Chalmers Mfg. Co., Milwaukee

RADIO LABORATORY APPARATUS

General Radio Co., Cambridge, Mass.
Westinghouse Elec. & Mfg. Co., E. Pittsburgh

RAILWAY SUPPLIES, ELECTRIC

General Electric Co., Schenectady
Ohio Brass Co., Mansfield, O.
Westinghouse Elec. & Mfg. Co., E. Pittsburgh

REACTORS

General Electric Co., Schenectady
Metropolitan Device Corp., Brooklyn, N. Y.

RECTIFIERS

Fansteel Products Co., Inc., North Chicago
General Electric Co., Schenectady
Wagner Electric Corp., St. Louis
Westinghouse Elec. & Mfg. Co., E. Pittsburgh

REELS, PAYOUT AND TAKEUP

Matthews Corp., W. N., St. Louis

REGULATORS, VOLTAGE

Burke Electric Co., Erie, Pa.
General Electric Co., Schenectady
Westinghouse Elec. & Mfg. Co., E. Pittsburgh

RELAYS

Cramer & Co., Inc., R. W., New York
Electric Controller & Mfg. Co., Cleveland
General Electric Co., Schenectady
Westinghouse Elec. & Mfg. Co., E. Pittsburgh

RESISTOR UNITS

General Electric Co., Schenectady
Westinghouse Elec. & Mfg. Co., E. Pittsburgh

Please mention the JOURNAL of the A. I. E. E. when writing to advertisers.



LAMINATED BAKELITE SHEETS RODS TUBES

SILENT GEAR MATERIAL

In most applications, electrical insulation must be more than just an insulator.

It must be able to withstand sudden temperature changes, and extremes of heat and cold—be impervious to oil and moisture—be chemically stable, and must not deteriorate with age or from exposure.

Such insulation is FIBROC, and since with these qualities it combines great mechanical strength, thereby adapting it to many structural applications, many manufacturers find it the one material that successfully meets their requirements in every respect.

Fibroc is furnished in sheets, rods and tubes, or in the form of special punched or machined parts ready for assembly.

Fibroc silent gear material is furnished in sheets, blanks or in moulded gear blanks with or without metal hubs.

Specify FIBROC on your blue prints.

FIBROC INSULATION COMPANY
 510 Lincoln Avenue
 VALPARAISO - INDIANA

ELECTRITE

A high grade fibre board for electrical insulation.

A material of quality possessing high tensile and dielectric strength.

Tested and approved by the Underwriters' Laboratories.

Pulp Products Department

WEST VIRGINIA PULP & PAPER COMPANY
 200 Fifth Avenue, New York, N. Y.

732 Sherman Street
 Chicago, Ill.

503 Market Street
 San Francisco, Cal.



LAVA INSULATORS

Manufacturers adopt Lava because, in the manufacture of electrical appliances, the properties of Lava insure dependable parts. Made to special design each Lava insulator becomes an important component part of the finished product.

AMERICAN LAVA CORPORATION
 27-67 Williamson St.,
 Chattanooga Tennessee
Manufacturers of Heat Resistant Insulators



MICA INSULATION SHEETS TUBES TAPE
PUNCHED PARTS READY FOR ASSEMBLY

Through a resourcefulness in manufacturing methods and processes, comparable to those developed within the electrical industry itself—MICABOND has developed outstanding electrical, chemical and mechanical properties which more than ever stamp it as, the Standard Mica Insulation.

For more than 29 years MICABOND has kept step with the rapid growth of the industry. As higher voltages and greater stresses were encountered, MICABOND met each new condition with a quality that has insured manufacturers against insulation troubles.

Micabond is furnished in sheets, strips, tubes, tape and specially punched or moulded parts to specification. Let us tell you more about the advantages of Micabond—Send your blue prints or specifications for prices.

CHICAGO MICA COMPANY
 432 Campbell Street
 VALPARAISO INDIANA

Classified Advertiser's Index for Buyers—Continued

RHEOSTATS

General Electric Co., Schenectady
Sundh Electric Co., Newark, N. J.
Westinghouse Elec. & Mfg. Co., E. Pitts-
burgh

RHEOSTATS, PLATING TANK

Hanson-Van Winkle-Munning Co., Mata-
wan, N. J.

ROPE, WIRE

American Steel & Wire Co., Chicago
Roebing's Sons Co., John A., Trenton, N. J.

SCREWS

Drive Hardened Metallic
Parker-Kalon Corp., New York
Self-Tapping Hardened
Parker-Kalon Corp., New York
Sheet Metal, Hardened Self-Tapping
Parker-Kalon Corp., New York

SEARCHLIGHTS

General Electric Co., Schenectady
Westinghouse Elec. & Mfg. Co., E. Pitts-
burgh

SLEEVE TWISTERS

Kearney Corp., Jas. R., St. Louis

SOCKETS AND RECEPTACLES

General Electric Co., Schenectady
Westinghouse Elec. & Mfg. Co., E. Pitts-
burgh

SOLENOIDS

Belden Mfg. Co., Chicago
Dudlo Mfg. Co., Ft. Wayne, Ind.
Electric Controller & Mfg. Co., Cleveland
General Electric Co., Schenectady
Roebing's Sons Co., John A., Trenton, N. J.
Sundh Electric Co., Newark, N. J.
Westinghouse Elec. & Mfg. Co., E. Pitts-
burgh

SPRINGS

American Steel & Wire Co., Chicago

STARTERS, MOTORS

Condit Electrical Mfg. Corp., Boston
Electric Controller & Mfg. Co., Cleveland
General Electric Co., Schenectady
Sundh Electric Co., Newark, N. J.
Westinghouse Elec. & Mfg. Co., E. Pitts-
burgh

STOKERS, MECHANICAL

Westinghouse Elec. & Mfg. Co., E. Pitts-
burgh

SUB-STATIONS

General Electric Co., Schenectady
Westinghouse Elec. & Mfg. Co., E. Pitts-
burgh

SWITCHBOARDS

Allis-Chalmers Mfg. Co., Milwaukee
Bull Dog Electric Products Co., Detroit
Condit Electrical Mfg. Corp., Boston
General Electric Co., Schenectady
Metropolitan Device Corp., Brooklyn, N. Y.
Westinghouse Elec. & Mfg. Co., E. Pitts-
burgh

SWITCHES

Automatic Time

Cramer & Co., Inc., R. W., New York
General Electric Co., Schenectady
Minerallac Electric Co., Chicago
Sundh Electric Co., Newark, N. J.
Westinghouse Elec. & Mfg. Co., E. Pitts-
burgh

Disconnecting

Burke Electric Co., Erie, Pa.
Condit Mfg. Corp., Boston
Delta-Star Electric Co., Chicago
General Electric Co., Schenectady
Kearney Corp., Jas. R., St. Louis
Matthews Corp., W. N., St. Louis
Pacific Elec. Mfg. Corp., San Francisco
Westinghouse Elec. & Mfg. Co., E. Pitts-
burgh

Fuse

Bull Dog Electric Products Co., Detroit
General Electric Co., Schenectady
Kearney Corp., Jas. R., St. Louis
Matthews Corp., W. N., St. Louis
Metropolitan Device Corp., Brooklyn, N. Y.

Knife

Condit Electrical Mfg. Corp., Boston
Cramer & Co., Inc., R. W., New York
Electric Controller & Mfg. Co., Cleveland
General Electric Co., Schenectady
Matthews Corp., W. N., St. Louis
Westinghouse Elec. & Mfg. Co., E. Pitts-
burgh

Oil

Condit Electrical Mfg. Corp., Boston
General Electric Co., Schenectady
Pacific Elec. Mfg. Corp., San Francisco
Westinghouse Elec. & Mfg. Co., E. Pitts-
burgh

SWITCHES—Continued

Remote Control

Condit Electrical Mfg. Corp., Boston
Cramer & Co., Inc., R. W., New York
General Electric Co., Schenectady
Sangamo Elec. Co., Springfield, Ill.
Sundh Electric Co., Newark, N. J.
Westinghouse Elec. & Mfg. Co., E. Pitts-
burgh

TANTALUM

Fansteel Products Co., Inc., North Chicago

TELEPHONE CONNECTORS

Kearney Corp., Jas. R., St. Louis

TESTING LABORATORIES

Electrical Testing Labs., New York

TRANSFORMERS

Allis-Chalmers Mfg. Co., Milwaukee
American Transformer Co., Newark, N. J.
Chicago-Jefferson Fuse & Elec. Co., Chicago
Duncan Elec. Mfg. Co., Lafayette, Ind.
Electric Service Co., Cincinnati
Ferranti, Ltd., Hollinwood, England
Ferranti, Inc., New York
Ferranti Electric, Ltd., Toronto, Ont.
General Electric Co., Schenectady
Kuhlman Electric Co., Bay City, Mich.
Moloney Electric Co., St. Louis
Sangamo Elec. Co., Springfield, Ill.
Wagner Electric Corp., St. Louis
Westinghouse Elec. & Mfg. Co., E. Pitts-
burgh

Factory

American Transformer Co., Newark, N. J.
Kuhlman Electric Co., Bay City, Mich.
Moloney Electric Co., St. Louis
Wagner Electric Corp., St. Louis

Furnace

Allis-Chalmers Mfg. Co., Milwaukee
American Transformer Co., Newark, N. J.
Moloney Electric Co., St. Louis
Westinghouse Elec. & Mfg. Co., E. Pitts-
burgh

Metering

American Transformer Co., Newark, N. J.
Ferranti, Ltd., Hollinwood, England
Ferranti, Inc., New York
Ferranti Electric, Ltd., Toronto, Ont.
Sangamo Elec. Co., Springfield, Ill.

Radio

American Transformer Co., Newark, N. J.
Chicago-Jefferson Fuse & Elec. Co., Chicago
Ferranti, Ltd., Hollinwood, England
Ferranti, Inc., New York
Ferranti Electric, Ltd., Toronto, Ont.

Street Lighting

Kuhlman Electric Co., Bay City, Mich.

TRANSFORMERS, USED

Electric Service Co., Cincinnati

TROLLEY LINE MATERIALS

General Electric Co., Schenectady
Hubbard & Co., Pittsburgh
Ohio Brass Co., Mansfield, O.
Westinghouse Elec. & Mfg. Co., E. Pitts-
burgh

TURBINES, HYDRAULIC

Allis-Chalmers Mfg. Co., Milwaukee

TURBINES, STEAM

Allis-Chalmers Mfg. Co., Milwaukee
General Electric Co., Schenectady
Westinghouse Elec. & Mfg. Co., E. Pitts-
burgh

TURBO-GENERATORS

Allis-Chalmers Mfg. Co., Milwaukee
Westinghouse Elec. & Mfg. Co., E. Pitts-
burgh

VALVES, BRASS

Gas, Water, Steam

Ohio Brass Co., Mansfield, O.

VARNISHES, INSULATING

General Electric Co., Bridgeport, Conn.
Mica Insulator Co., New York
Minerallac Electric Co., Chicago
Westinghouse Elec. & Mfg. Co., E. Pitts-
burgh

WELDING MACHINES, ELECTRIC

General Electric Co., Schenectady
Ohio Brass Co., Mansfield, O.
Westinghouse Elec. & Mfg. Co., E. Pitts-
burgh

WELDING WIRES & RODS

American Steel & Wire Co., Chicago
Ohio Brass Co., Mansfield, O.

WIRES AND CABLES

Armored Cable

American Steel & Wire Co., Chicago
Belden Mfg. Co., Chicago
General Electric Co., Schenectady
Kerite Ins. Wire & Cable Co., New York
Okonite Company, The, Passaic, N. J.
Roebing's Sons Co., John A., Trenton, N. J.
Simplex Wire & Cable Co., Boston
Standard Underground Cable Co., Pittsburgh

Asbestos Covered

American Steel & Wire Co., Chicago
Belden Mfg. Co., Chicago
General Electric Co., Schenectady
Rockbestos Products Corp., New Haven,
Conn.

Automotive

American Steel & Wire Co., Chicago
Belden Mfg. Co., Chicago
General Electric Co., Schenectady
Kerite Ins. Wire & Cable Co., New York
Roebing's Sons Co., John A., Trenton, N. J.
Simplex Wire & Cable Co., Boston
Standard Underground Cable Co., Pittsburgh

Bare Copper

American Steel & Wire Co., Chicago
Anaconda Copper Mining Co., Chicago
Belden Mfg. Co., Chicago
Roebing's Sons Co., John A., Trenton, N. J.
Standard Underground Cable Co., Pittsburgh

Copper Clad

Standard Underground Cable Co., Pittsburgh

Copperweld

Copperweld Steel Co., Glassport, Pa.

Flexible Cord

American Steel & Wire Co., Chicago
Belden Mfg. Co., Chicago
General Electric Co., Schenectady
Okonite Company, The, Passaic, N. J.
Roebing's Sons Co., John A., Trenton, N. J.
Simplex Wire & Cable Co., Boston
Standard Underground Cable Co., Pittsburgh

Heavy Duty Cord

American Steel & Wire Co., Chicago
Belden Mfg. Co., Chicago
Okonite Company, The, Passaic, N. J.
Simplex Wire & Cable Co., Boston

Fuse

American Steel & Wire Co., Chicago
General Electric Co., Schenectady
Roebing's Sons Co., John A., Trenton, N. J.

*Lead Covered (Paper and Varnished Cambric
Insulated)*

American Steel & Wire Co., Chicago
Anaconda Copper Mining Co., Chicago
General Electric Co., Schenectady
Kerite Ins. Wire & Cable Co., New York
Okonite Company, The, Passaic, N. J.
Okonite-Callender Cable Co., The, Inc.,
Passaic, N. J.
Roebing's Sons Co., John A., Trenton, N. J.
Simplex Wire & Cable Co., Boston
Standard Underground Cable Co., Pittsburgh

Magnet

American Steel & Wire Co., Chicago
Belden Mfg. Co., Chicago
Dudlo Mfg. Corp., Fort Wayne, Ind.
General Electric Co., Schenectady
Maring Wire Co., Muskegon, Mich.
Roebing's Sons Co., John A., Trenton, N. J.
Standard Underground Cable Co., Pittsburgh

Rubber Insulated

American Steel & Wire Co., Chicago
Belden Mfg. Co., Chicago
General Electric Co., Schenectady
Kerite Ins. Wire & Cable Co., New York
Okonite Company, The, Passaic, N. J.
Roebing's Sons Co., John A., Trenton, N. J.
Simplex Wire & Cable Co., Boston
Standard Underground Cable Co., Pittsburgh

Tree Wire

Okonite Company, The, Passaic, N. J.
Roebing's Sons Co., John A., Trenton, N. J.
Simplex Wire & Cable Co., Boston

Trolley

American Steel & Wire Co., Chicago
Anaconda Copper Mining Co., Chicago
Copperweld Steel Co., Glassport, Pa.
Roebing's Sons Co., John A., Trenton, N. J.
Standard Underground Cable Co., Pittsburgh

Weatherproof

American Steel & Wire Co., Chicago
Anaconda Copper Mining Co., Chicago
Copperweld Steel Co., Glassport, Pa.
General Electric Co., Schenectady
Kerite Ins. Wire & Cable Co., New York
Okonite Company, The, Passaic, N. J.
Roebing's Sons Co., John A., Trenton, N. J.
Simplex Wire & Cable Co., Boston
Standard Underground Cable Co., Pittsburgh

Please mention the JOURNAL of the A. I. E. E. when writing to advertisers.

Principal A. I. E. E. Publications

JOURNAL. Published monthly.

An engineering periodical containing in full or in abstract engineering and theoretical papers as presented before meetings of the Institute and its Sections and Branches; descriptions of new developments characterized by notable advances, and items relating to the activities of the Institute and other organizations.

Subscription price \$10.00 per year. Agents, publishers and dealers are allowed 20 per cent discount; a special discount of 50 per cent is allowed on single subscriptions received directly from college or public libraries. Postage to Canada on annual subscription \$0.50 additional, and to foreign countries, \$1.00. (Postage should not be included when computing discounts).

JOURNAL BINDERS. A loose leaf binder, especially designed for the JOURNAL of the A. I. E. E. is now available. The new binder is attractively finished in a long-wearing, processed material, resembling brown leather. From one to six copies of the JOURNAL can be inserted. The name of the publication is embossed in gold on the front cover and backbone. The binders are sold in sets of two at \$2.25 or \$1.25 for one.

TRANSACTIONS. Published quarterly.

Contains such of the technical papers and reports published by the Institute in the JOURNAL and elsewhere as are selected and authorized by the Publication Committee; also the discussions on the technical papers. The TRANSACTIONS form a permanent record of the progress of electrical engineering.

The subscription price to A. I. E. E. members is \$2.00 per year for pamphlet binding and \$4.00 for cloth binding. To non-members the cost is \$10.00 per year for pamphlet binding, and \$12.00 for cloth binding.

Available volumes of the TRANSACTIONS published prior to 1921 may be obtained at reduced prices. The volumes in stock and prices will be supplied upon request.

Discounts allowed on the current volume are as follows: 20 per cent to publishers and subscription agents 50 per cent to college and public libraries upon direct subscription to Institute headquarters.

INDEX TO TRANSACTIONS. Published every ten years. Vol. III of the TRANSACTIONS Index (Jan. 1, 1911 to Jan 1, 1922) is a practical bibliography (168 pp.) of all A. I. E. E. papers and discussions printed during the period 1911-1922. Price to members and non-members \$2.00, with dealers' discount of 20 per cent.

A. I. E. E. STANDARDS.

The work of revision of the A. I. E. E. Standards which has been in progress for several years has now reached a stage where a large number of sections of the Standards have been approved by the Board of Directors and are available in pamphlet form, as follows:

1—General Principles Upon Which Temperature Limits are Based in the Rating of Electrical Machinery, (.20); 4—Measurement of Test Voltages in Dielectric Tests, (.30); 5—Direct-Current Generators and Motors and Direct-Current Commutator Machines in General, (.40); 7—Alternators, Synchronous Motors and Synchronous Machines in General, (.40); *8—Synchronous Converters, (.40); 9—Induction Motors and Induction Machines in General, (.40); 10—Direct-Current and Alternating-Current Fractional Horse Power Motors, (.30); *11—Railway Motors, (.30); 13—Transformers, Induction Regulators and Reactors, (.40); *14—Instrument Transformers, (.30); *15—Industrial Control Apparatus, (.40); *16—Railway Control and Mine Locomotive Control Apparatus, (.40); *17f—Mathematical Symbols, (.30); 17g1—Letter Symbols for Electrical Quantities, (.20); 19—Oil Circuit Breakers, (.30); 22—Disconnecting and Horn Gap Switches, (.30); 26—Automatic Stations, (.30); 30—Wires and Cables, (.40); 33—Electrical Measuring Instruments, (.30); 34—Telegraphy and Telephony, (.30); *36—Storage Batteries, (.20); *37—Illumination, (.30); 38—Electric Arc Welding Apparatus, (.40); 39—Electric Resistance Welding Apparatus, (.30); 41—Insulators, (.30); *42—Symbols for Electrical Equipment of Buildings, (.20); 45—Recommended Practice for Electrical Installations on Shipboard, (1.50); *46—Hard Drawn Aluminum Conductors, (.20); *60—Specifications for Tinned Soft or Annealed Copper Wire; *61—Specifications for Soft or Annealed Copper Wire, (No. 60 and 61 published as one pamphlet), (.30); *63—Specifications for 30 Per Cent Rubber Insulation for Wire and Cable for General Purposes, (.30); *69—Specifications for Cotton Covered Round Copper Magnet Wire; *70—Specifications for Silk Covered Round Copper Magnet Wire; *71—Specifications for Enameled Round Copper Magnet Wire, (No. 69, 70 and 71 published as one pamphlet), (.30). *Approved as American Standard.

A discount of 50% is allowed to Institute members. Numbers of the Standards Sections should be given when ordering.

STANDARDS BINDERS. The various sections of the Standards can be kept in bound form with the practical binder which has been designed for this purpose. Capacity of the binder is from 10 to 30 sections or pamphlets. Finished in brown fabrikoid with imprint on stiff back. Price \$1.75.

YEAR BOOK OF THE A. I. E. E.

A directory, published annually in March, of the membership of the A. I. E. E. Gives in alphabetical order, the names, occupations and addresses of all members. The membership is also listed in geographical order. The Year Book contains general information regarding the scope and activities of the Institute, including the Constitution and By-Laws, lists of Sections and Branches, the various committees, governing body, etc. Single copies will be supplied to members without charge upon application.

American Institute of Electrical Engineers

33 West Thirty-ninth Street, New York, N. Y.

Trade "ESCO" Mark

ELECTRIC SPECIALTY CO.

Engineers and Manufacturers

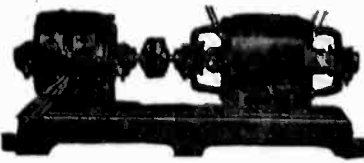

DESIGN —
DEVELOP —
PRODUCE —

Small Motors, Generators, Dynamotors,
Motor Generators, Rotary Converters, Etc.

FOR SPECIAL PURPOSES—Send Us Your Problems

222 South Street, STAMFORD, CONN., U.S.A.

To Engineers Manufacturers ✦ Inventors

We possess exceptional facilities for doing your experimental work... models, dies, tools, instruments, light machinery... general manufacturing... inventions developed. Customer's supervision in machine shop permitted. Over thirty years' specialized experience. Clients include Bell Telephone Laboratories, All-America Cables, Inc., and other well known organizations.

MANUFACTURERS' & INVENTORS' ELECTRIC CO.
Incorporated 1897
228 West Broadway, New York
(Smith Building at Franklin St.)
Tel. Walker 2210-2211 Cable Address "MANDIELECO"

The Pioneer Manufacturer

— of —

Interpole & Ball Bearing Motors

½ to 1000 H. P. D. C. and A. C.

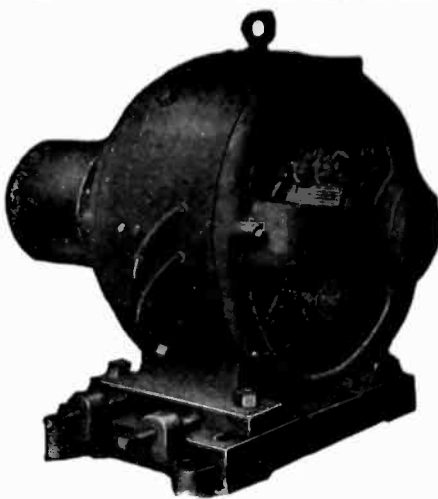

Type "S" Ball Bearing Motor
with base and pulley

ELECTRO DYNAMIC COMPANY

Manufacturers of Ball Bearing Motors Since 1904
BAYONNE, N. J.
Sales Offices in Principal Cities

"Quality for Half a Century"

ALPHABETICAL LIST OF ADVERTISERS

PAGE		PAGE		PAGE	
Allis-Chalmers Manufacturing Co.	8	Fibroc Insulation Company	45	New Departure Manufacturing Co., The	3
Ambursen Construction Company, Inc.	40	Ford, Bacon & Davis, Inc.	40	Norma-Hoffmann Bearings Corporation	26
American Brass Company	21	Fowle & Company, Frank F.	40	Ohio Brass Company, The	13
American Lava Corporation	45	Frey Engineering Company	40	Okonite Company, The	Third Cover
American Lead Pencil Company	38	G & W Electric Specialty Company	22	Okonite-Callender Cable Co., Inc.	Third Cover
American Steel & Wire Company	19	General Electric Company	6, 12	Ophuls & Hill, Inc.	40
American Telephone & Telegraph Co.	32	General Radio Company	39	Osgood, Farley	41
American Transformer Company	5	Green, A. Barnett	40	Pacific Electric Mfg. Corporation	36
Bakelite Corporation	31	Hanson-Van Winkle-Munning Co.	27	Parker-Kalon Corporation	33
Barstow & Company, Inc., W. S.	40	Hemingray Glass Company	38	Powers, W. P.	41
Battey & Kipp, Inc.	40	Hoosier Engineering Company	40	Publications of A. I. E. E.	47
Belden Manufacturing Company	Fourth Cover	Hubbard & Company	38	Roebbling's Sons Company, John A.	36
Black & Veatch	40	International Nickel Company	11	Roller-Smith Company	43
Burke Electric Company	36	I-T-E Circuit Breaker Company	23	Sanderson & Porter	41
Burndy Engineering Company, Inc.	37	Jackson & Moreland	40	Sargent & Lundy, Inc.	41
Burt, Dr. Robert C.	40	Jewell Electrical Instrument Company	25	Science Abstracts	43
Byllesby Engineering & Management Corp.	40	Kearney Corporation, James R.	38	Scofield Engineering Company	41
Canadian Porcelain Company, Ltd.	38	Kerite Insulated Wire & Cable Co., Inc.	1	Sharples Specialty Company	17
Century Electric Company	29	Kuhlman Electric Company	16	Simplex Wire & Cable Company	20
Chicago-Jefferson Fuse & Electric Co.	39	Lapp Insulator Company, Inc.	38	Standard Underground Cable Company	37
Chicago Mica Company	45	Lincoln, E. S.	40	Stevens, John A.	41
Clement, Edward E.	40	Lincoln Meter Company, Inc.	24	Stevens & Wood, Inc.	41
Condit Electrical Manufacturing Corp.	7	Locke Insulator Corporation	14	Stock Quotation Telegraph Company	41
Copperweld Steel Company	37	Manufacturers' & Inventors' Elec. Co.	48	Stockbridge & Borst	41
Corning Glass Works	39	Maring Wire Company	36	Stone & Webster, Inc.	41
Cramer & Co., Inc., R. W.	36	Matthews Corporation, W. N.	34, 35	Sundh Electric Company	36
Danne, Harold A.	40	McClellan & Junkersfeld, Inc.	40	Texas Company, The	49
Delta-Star Electric Company	20	Metropolitan Device Corporation	50	Thomas, Percy H.	41
Dossert & Company	9	Mica Insulator Company	28	Thomas & Sons Company, The R.	38
Dudlo Manufacturing Company	30	Minerallac Electric Company	37	Wagner Electric Corporation	15
Electric Controller & Mfg. Co., The	2	Moloney Electric Company	22	West Va. Pulp & Paper Company	45
Electric Service Company, Inc., The	39	Montgomery, Wallace	40	Western Electric Company	10
Electric Specialty Company	48	Morganite Brush Company, Inc., The	42	Westinghouse Elec. & Mfg. Company	4
Electrical Testing Laboratories	41	Neall, N. J.	40	Weston Electrical Instrument Corp.	24
Electro Dynamic Company	48	Neiler, Rich & Company	40	White Engineering Corp., The J. G.	41
Engineering Directory	40, 41			Wireless Specialty Apparatus Company	39
Engineering Societies Employment Service	36			Wray & Company, J. G.	41
Fansteel Products Company, Inc., The	33				
Fennessy, David V.	40				
Ferranti, Incorporated	18				

(For classified list of Advertisers see pages 42, 44 and 46)

Please mention the JOURNAL of the A. I. E. E. when writing to advertisers.

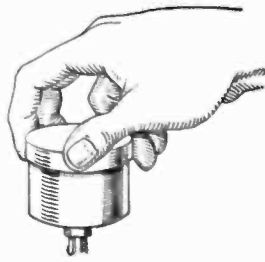

Pressure Lubrication Involves more than this Now-a-days!

Pressure lubrication, in the old days, meant giving a few turns to the caps of the grease cups—and trusting that the lubricant would get to the spot required.

Now-a-days, with speeds and pressure far different than what they used to be, more positive means of oil or grease application are required.

Consequently, industry has turned extensively to mechanical pressure lubrication.

With this change, the human element in regulating lubricating pressures has been largely eliminated; but the necessity for alertness in the *kind* and *amount* of lubricant to use has been increased.

We speak with authority on this subject. We have studied it extensively; and much of our information is the result of actual experience on machinery within our own plants and throughout plants of thousands of satisfied TEXACO customers.

We can furnish you a time tested TEXACO Lubricant that will work most effectively and economically on any system of pressure lubrication you are using.

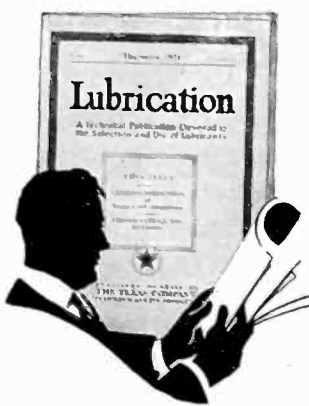

The December 1928 issue of this magazine, "LUBRICATION," is devoted entirely to the subject of Pressure Lubrication. We shall be glad to send you a copy and put you on the free mailing list to receive "LUBRICATION" monthly. Write to the address below.

THE TEXAS COMPANY
Texaco Petroleum Products
Dept. W2, 17 Battery Place, New York City
OFFICES IN PRINCIPAL CITIES



USERS

Brooklyn Edison Company
 Chicago, Lake Shore & S. Bend
 R. R.
 Consolidated Gas, Elec. Lt. & Pr.
 Co.
 East Hampton Gas Company
 Illinois Steel Company
 Merced Irrigation District
 N. Y. N. H. & H. R. R. Co.
 Potomac Electric Company
 Tennessee Power Company
 United Electric Lighting Co.
 Union Gas & Electric Company,
 Cincinnati
 Warren & Company
 Yonkers Electric Light & Power
 Company
 Hydro-Electric Pr. Commission
 Victoria Falls & Transvaal P. Co.
 Havana Electric Light & Power
 Company
 Brooklyn Rapid Transit Co.
 Cohoes Light & Power Corp.
 Dayton Power & Light Co.
 Edison Electric Illuminating
 Company
 Interborough Rapid Transit Co.
 Municipal Gas Company
 New York & Queens Electric
 Light & Power Company
 Public Service Electric Co.
 Toledo R. R. & Light Company
 United Electric Light & Power
 Company
 Union Electric Light & Power
 Company, St. Louis
 Westchester Lighting Co.
 Shawinigan Hydro-Electric Power
 Company
 French General Electric Company
 Bronx Gas & Electric Co.
 Carnegie Steel Company
 Commonwealth Edison Co.
 Detroit Edison Company
 El Paso Power & Railroad Co.
 Kings County Gas & Electric
 Company
 New York Edison Company
 Philadelphia Electric Company
 Southern Wisconsin Power Co.
 Turners Falls Power Company
 United States Steel Corporation
 Utica Gas & Electric Company
 Youngstown Sheet & Tube Co.
 Calgary Municipal Electric Co.
 Public Works Department, N. Z.
 Cataluna Power Company

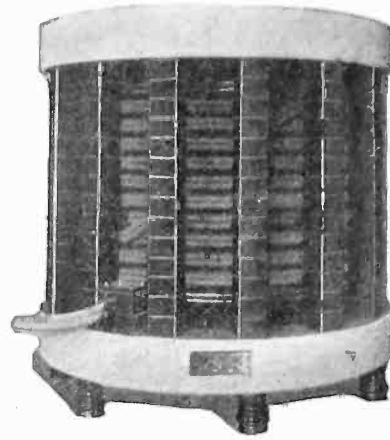

METROPOLITAN

Current Limiting REACTORS

*Highest all year efficiencies and maximum short
circuit protection*

A 32-page booklet, "A Manual of Reactor Protection" will be found helpful in planning your reactor needs. On Page 29 we have outlined the information to supply when in the market for reactor protection. Upon receipt of this information (size of generators, frequency and a diagram of high tension connections) we will be able to suggest the type of coil which you require.

Read the list of users.

Metropolitan Device Corp.
 1250 Atlantic Ave.
 Brooklyn, New York



OKONITE TREE WIRE

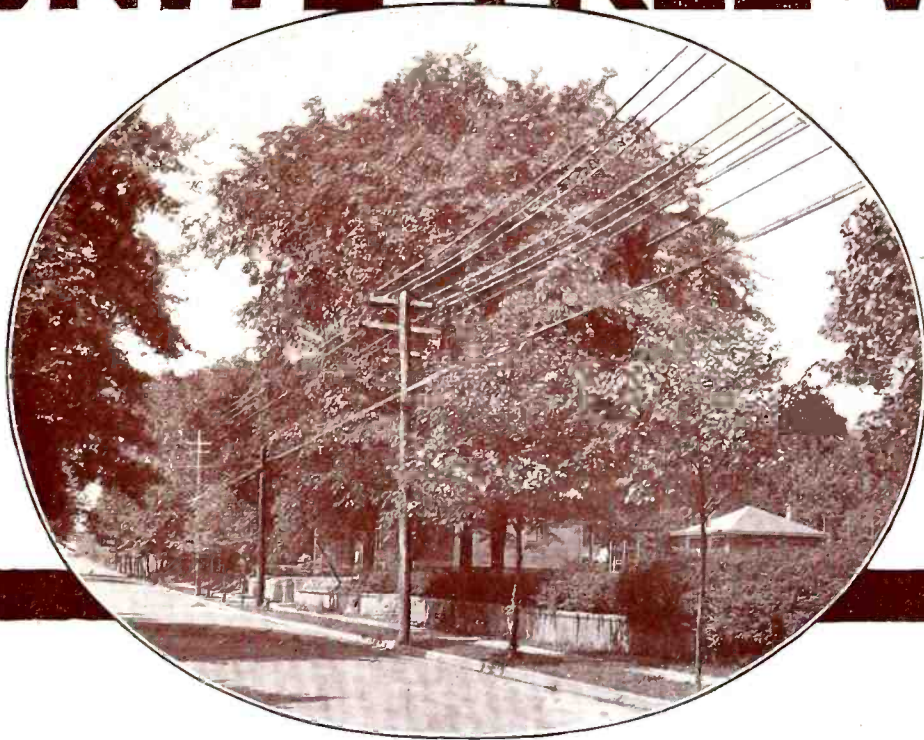

Proof of the Pudding

In one Electric Company's plant alone, Okonite Tree Wire has been used in great quantities, year after year, for twenty years. This company serves over 800,000 customers in a thickly settled territory of 2,000 square miles which includes over 200 cities and towns in most of which trees are on every street. This situation presents conditions of the severest kind of use where the real merits of a tree wire are bound to be disclosed.

The Okonite Tree Wire in this plant has given entirely satisfactory service during all of this long period. Such a perfect record

should be interesting to every company contemplating the installation of tree wire. In this unparalleled demonstration, Okonite Tree Wire has stood up mechanically and electrically because of its excellent design and the superior methods and high quality of materials employed in its manufacture.

Our illustrated booklet—TREE WIRE—contains detailed descriptions with practical information showing where and how to install tree wire. A copy of this booklet and sample of Okonite Tree Wire will gladly be mailed upon receipt of the coupon below.

J.A.I.E.E. 2-29

The Okonite Company
501 Fifth Avenue
New York, New York

- Please send me a copy of your booklet—**TREE WIRE.**
- Please send me a sample of Okonite Tree Wire.

Name

Company

Street

City State

The Okonite Company

THE OKONITE-CALLENDER CABLE COMPANY, INC.

Factories: Passaic, N. J. Paterson, N. J.

Sales Offices: New York Chicago Pittsburgh St. Louis Boston Atlanta
Birmingham San Francisco Los Angeles Seattle Dallas

Novelty Electric Co., Philadelphia, Pa. F. D. Lawrence Electric Co., Cincinnati, O.

Canadian Representatives:
Engineering Materials Limited
Montreal

Cuban Representatives:
Victor G. Mendoza Co.
Havana



*Okonite Quality Standards
Unchanged for Half a Century*



The shank of the Soft Rubber Plug protects the cord at the worst wearing point. It also forms a handy handle for inserting and withdrawing the plug. Does not scratch or mar furniture.

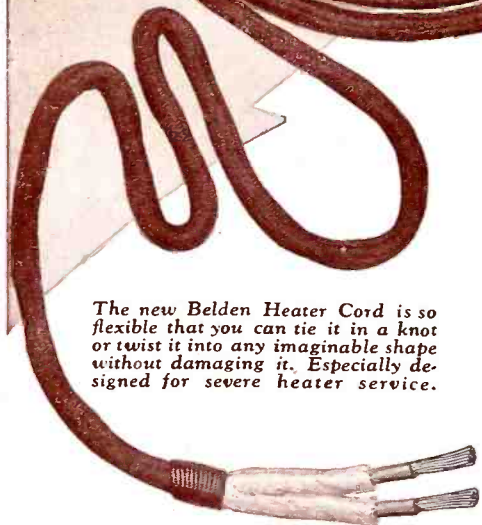

The new Belden Heater Cord is so flexible that you can tie it in a knot or twist it into any imaginable shape without damaging it. Especially designed for severe heater service.

A SUPER Heater Cord with the Unbreakable Belden Soft Rubber Plug

An important addition to the Belden Cut Cord Service is the New Belden Heater Cord in conjunction with the Belden Soft Rubber Plug.

This New Belden Heater Cord far exceeds the standards of Underwriters' Laboratories for flexibility. It is so flexible that it will withstand years of wear in difficult heater service.

The neat appearance and long wearing qualities of the glazed cotton braid make

this New Belden Heater Cord unusually popular with housewives.

The remarkable popularity of Belden Soft Rubber Plugs on radio sets, washing machines, vacuum cleaners and electrical refrigerators assures a hearty welcome for the Belden Soft Rubber Plug on Heater Cords.

Write today for sample of the New Belden Heater Cord with Unbreakable Soft Rubber Plug.

BELDEN PRODUCTS

- Beldenamel and Textile Magnet Wire*
- Coil Windings*
- Beldenmold (Molded Bakelite Products)*
- Automotive Wires and Cables*
- Airplane Assemblies*
- Radio Wires, Cords and Cables*
- Rubber Covered Wires*
- Armored Cables*
- Flexible Armature Wires*
- Motor Lead Wires*
- Braided and Stranded Copper Cables*
- Cotton Sleeving*

Belden Manufacturing Company
2316-B South Western Ave. Chicago, Ill.

Specify Belden