

# JOURNAL OF THE A. I. E. E.

JUNE \* \* 1927



PUBLISHED MONTHLY BY THE  
AMERICAN INSTITUTE OF ELECTRICAL ENGINEERS  
33 WEST 39<sup>TH</sup> ST. NEW YORK CITY

SUMMER CONVENTION NUMBER

# Detroit—The Summer Convention City



AIRPLANE VIEW OF DETROIT

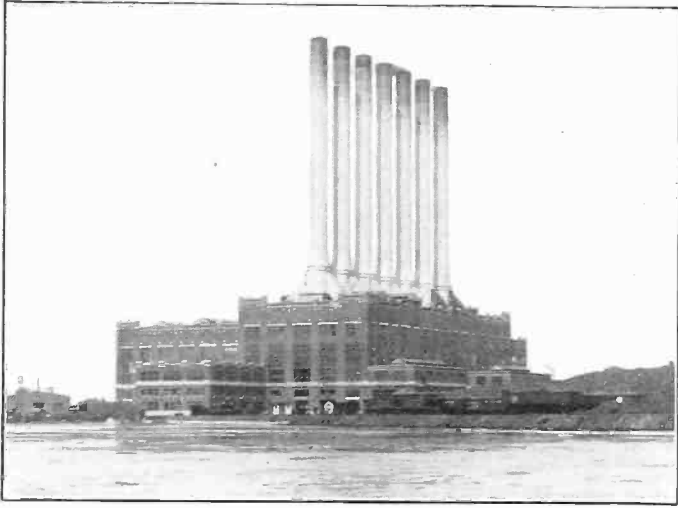

TRENTON CHANNEL POWER HOUSE

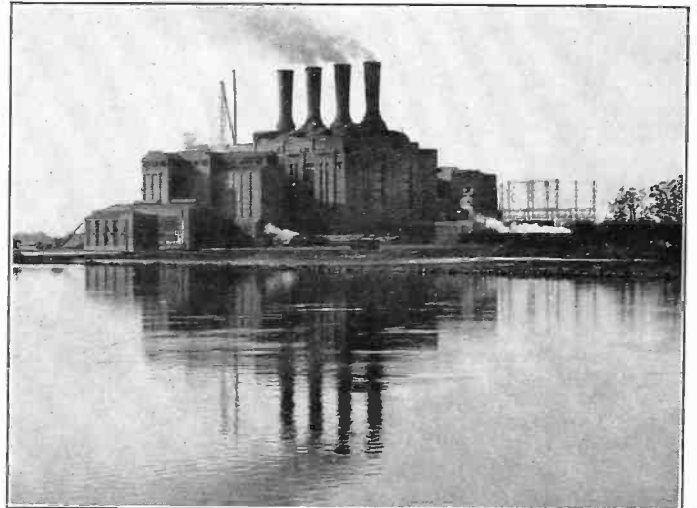

CONNOR'S CREEK POWER STATION

TWO NOTABLE DETROIT GENERATING PLANTS



AIRPLANE VIEW OF BELLE ISLE, DETROIT'S MUNICIPAL PARK

# JOURNAL

OF THE

## American Institute of Electrical Engineers

PUBLISHED MONTHLY BY THE AMERICAN INSTITUTE OF ELECTRICAL ENGINEERS  
33 West 39th Street, New York

Subscription. \$10.00 per year to United States, Mexico, Cuba, Porto Rico, Hawaii and the Phillipines, \$10.50 to Canada and \$11.00 to all other Countries. Single copies \$1.00.

Entered as matter of the second class at the Post Office, New York, N. Y., May 10, 1905, under the Act of Congress, March 3, 1879. Acceptance for mailing at special rate of postage provided for in Section 1103, Act of October 3, 1917, authorized on August 3, 1918.

Vol. XLVI

JUNE, 1927

Number 6

### TABLE OF CONTENTS

#### Papers, Discussions, Reports, Etc.

Notes and Announcements.....	549	Discussion at Winter Convention	
The Holtwood Steam Plant, by F. A. Allner (Abridged).....	551	Klydonograph Surge Investigations (Cox, McAuley and Huggins).....	606
Joints in High-Voltage Multiple-Conductor Cable, by T. F. Peterson.....	559	Transmission-Line Voltage Surges (Cox).....	606
The Oscilloscope; a Stabilized Cathode-Ray Oscillograph, by Frederick Bedell and Herbert J. Reich.....	563	The Measurement of Surge Voltages, etc. (Lee and Foust).....	606
A Limit to the Speed of Vision.....	567	Papers on Graphical Determination of Magnetic Fields, (Stevenson and Park, Johnson and Green, Wieseman).....	614
Quantitative Determination of Radio Receiver Performance, by H. D. Oakley.....	468	Tests on Oil Circuit Breakers (Sporn and St. Clair).....	620
Additional Losses of Synchronous Machines, by C. M. Laffoon and J. F. Calvert (Abridged).....	573	Additional Losses of Synchronous Machines (Laffoon and Calvert).....	623
Flood Control and Hydroelectric Development.....	582	Constant-Current Regulating Transformer Characteristics (Louis and Albaugh).....	626
Power Systems Aid many Flood Towns.....	582	Discussion at Kansas City Meeting	
Graphical Determination of Magnetic Fields, by E. E. Johnson and C. H. Green.....	583	Electric Welding of Pipes (Lincoln).....	628
Carrier-Current Selector Supervisory Equipment, by C. E. Stewart and C. F. Whitney.....	588	Current Analysis in Circuits Containing Resistance Modulator (Grandy).....	630
Electricity used for Melting Metals.....	592	Carrier-Current Selector Supervisory Equipment (Stewart and Whitney).....	631
Electric Welding of Pipes, by J. F. Lincoln.....	593	Illumination Items	
Steel-Tank Mercury Arc Rectifiers, by E. B. Shand.....	597	The Roxy Theater.....	632
Testing, Inspecting and Maintaining Automatic Stations, by Chester Lichtenberg.....	603	Lighting Research Problems.....	632

#### Institute and Related Activities

Summer Convention, Excellent Technical and Entertainment Program.....	633	Addresses Wanted.....	643
Northeastern District's Fourth Meeting.....	635	Past Section Meetings.....	643
Plans for Pacific Coast Convention.....	636	Student Activities	
Report of Committee of Tellers of Election.....	636	Nebraska Section has Student Program.....	645
Board of Directors' Report for Year Ending April 30, 1927.....	636	Joint Section and Branch Meeting at Corvallis.....	645
Bancroft Gherardi, President-Elect.....	637	Joint Section and Branch Meeting at University of Utah.....	645
A. I. E. E. Director' Meeting.....	637	Electrical Engineers' Party at University of Minnesota.....	645
Thirtieth Annual Meeting of A. S. T. M.....	638	The Transmission of Motion Pictures by Radio.....	645
Annual Meeting and New York Section Meeting..	638	Direct-Current Transmission Considerations... ..	646
Institute Prizes Awarded for 1926.....	638	Northeastern District Awards Best Branch Paper Prize.....	646
Report on Standards for Storage Batteries Available.....	639	General Engineering Council Organized at Stanford University.....	646
Doctor Coolidge Honored.....	639	Electrical Vaudeville at Louisiana State University.....	647
General Electric Appoints Engineering Council... ..	639	M. I. T. Branch Distributes Problem Solutions.....	647
American Engineering Council		Branch Meetings.....	647
United States Patent Office Procedure.....	639	Engineering Societies Library.....	650
Pan American Conference Urges Standardization.....	640	Engineering Societies Employment Service.....	652
Bureau of Standards Year Book for 1927.....	641	Membership	
Electrophysics Committee Cooperates with American Physical Society.....	641	Applications, Elections, Transfers, etc.....	653
National Museum of Engineering and Industry... ..	641	Officers of A. I. E. E.....	659
French Chemical Combine Proposed.....	641	List of Sections.....	661
Personal Mention.....	641	List of Branches.....	662
Obituary.....	642	Digest of Current Industrial News.....	664

A REQUEST FOR CHANGE OF ADDRESS must be received at Institute headquarters at least ten days before the date of issue with which it is to take effect. Duplicate copies cannot be sent without charge to replace those issues undelivered through failure to send such advance notice. With your new address be sure to mention the old one, indicating also any change in business connections.

Copyright 1927. By A. I. E. E.

Printed in U. S. A.

Permission is given to reprint any article after its date of publication, provided proper credit is given.  
(The Journal of the A. I. E. E. is indexed in Industrial Arts Index.)

# MEETINGS

of the

## American Institute of Electrical Engineers

(See Announcements This Issue)

---

SUMMER CONVENTION, Detroit, Mich., June 20-24  
*Lake Trip - - June 25*

PACIFIC COAST CONVENTION, Del Monte, Calif.,  
September 13-16



### MEETINGS OF OTHER SOCIETIES

National Electric Light Association, Atlantic City, N. J., June 6-10

Association of Iron and Steel Electrical Engineers, Exposition,  
Syria Mosque, Pittsburgh, June 13-18, (J. F. Kelly, Empire  
Building, Pittsburgh)

Pacific Coast Electrical Association, Santa Cruz, Calif., June 14-18

American Society for Testing Materials, French Lick, Ind.,  
June 20-24

Northwest Electric Light and Power Association, Elmira, N. J.,  
June 21-24

National Electric Light Association

*North Central Division*, on board Lake Superior steam-  
boats from Duluth, June 24-28, (J. W. Lapham, 351 Loeb  
Arcade, Minneapolis)

*East Central Division*, Cedar Point, Ohio, July 12-15

American Society of Civil Engineers, Denver, Colo., July 13-16

# Journal of the A. I. E. E.

*Devoted to the advancement of the theory and practise of electrical engineering and the allied arts and sciences*

Vol. XLVI

JUNE, 1927

Number 6

## Some Leaders of the A. I. E. E.

Robert Andrew Millikan, Director of the Norman Bridge Laboratory of Physics of the California Institute of Technology, Edison Medalist for 1922 and one of the best known physicists of the country, was born at Morrison, Illinois, March 22, 1868. He was granted his A. B. from Oberlin College in 1891, and his Ph. D. from Columbia in 1895. In the years 1895-96, he attended the universities of Berlin and Göttingen. Oberlin awarded him the Sc. D. in 1911; the Northwestern University granted him like degree in 1913; University of Pennsylvania, in 1915; Columbia University and Amherst College in 1917, and the University of Dublin in 1924. He was also awarded an LL.D. degree from the University of California in 1924, and from Yale in 1925; in 1926, a Ph. D. degree from the King John Casimir University of Poland. From 1891 to 1893 he tutored in physics at Oberlin. In 1896 he became assistant in physics at the University of Chicago, from which he rose to assistant professor in 1902; 1906-10 he was associate professor, when he was chosen professor of physics at the University of Chicago. In all this work of instruction, he evidenced rare ability to impart his own extraordinary scientific knowledge to those with whom he was working as well as applying it significantly to problems of research; in fact, Doctor Millikan was one of the initiators of the National Research Council—a development which has proved its worth innumerable. It has ever been Doctor Millikan's contention that "the way men *think* is the most important and most practical thing in human progress" and since the days of his own early training, it has been his unceasing ambition to teach men to think. The cognomen "producer of men" has been aptly bestowed upon him, for his efforts have been untiringly loyal to the cause of scientific progress. He has been an inspiration to others, especially to the young men, who look up to him for advice from a clear thinker with high ideals, scientific wisdom, great humanity and absolute intellectual integrity. His is the ability to stimulate in individuals an almost superhuman activity, which, in conjunction with his many other creditable characteristics, has made his field of achievement practically unlimited.

Probably the best known of Doctor Millikan's works are his "oil drop" experiments, whereby the absolute value of the charge of the electron was determined. Previous experiments had been made by condensing a

cloud of free electrons in gas and observing the behavior of the cloud. Doctor Millikan discovered that it was possible to watch the single drops and thus detect many inaccuracies which had previously hampered the undertaking. His final arrangement was with a small drop of oil or mercury, watched through a microscope as it slowly fell under gravity, or, receiving a charge, rose in an electric field. And of only second importance is his work in the accurate determination of the so-called  $h$  constant, by experiments on the photoelectric effects. This is a universal physical constant of fundamental importance, notably in the structure of the atom and relations between matter and radiation. By the identification and measurement of this constant through the agency of photoelectric phenomena, Doctor Millikan contributed inestimably to modern physics.

Of later development was his work toward the definite bridging of the gap between light and X-ray phenomena. He has pushed the ultra-violet spectrum down approximately two octaves—almost, if not quite to the long wavelength X-ray.

All of Doctor Millikan's important contributions to experimental physics have been of special importance to electrical engineers, opening up the vast new areas of exploration and advancement which may be made upon the substantial bulwark of established fact. Throughout the war, he served not only as Lieutenant-Colonel in the Signal Corps and Director of its scientific work, but he also served as a member of the Navy Department's Special Board on Anti-Submarine Matters and as the executive head of the National Research Council, which was, by the President's proclamation, charged with the duty of advising upon the scientific work of the Government.

Doctor Millikan joined the Institute in 1921. In 1923 he was awarded the Nobel prize for physics by the Royal Swedish Academy, and he earlier received from the National Academy of Science, the Comstock prize for research in electricity. He is also the recipient of the Hughes Medal of the Royal Society of Great Britain, of the Faraday Medal of the London Chemical Society, of the Matteucci Medal of the Societe Italiana della Scienze, and of the gold medal of the American Society of Mechanical Engineers. He is a Fellow of the American Academy of Arts and Sciences, the American Association for the Advancement of Science; a member of the National Academy of Sciences, the American Philosophical Society, past-president of the American

Physical Society; a Sigma Xi and Phi Beta Kappa. He has contributed liberally to technical literature in his works *A Course of College Experiments in Physics*, 1898; *Theory of Optics* (translated from German) 1900; *Mechanics, Molecular Physics and Heat*, 1901; *A First Course in Physics*, 1906; *A Laboratory Course in Physics for Secondary Schools*, 1906; *Electricity, Sound and Light*, 1908; *Practical Physics*, 1920; *The Electron, etc.*, 1917, *Elements of Physics*, 1927 (a revision of *Practical Physics*),—beside other articles published in the various technical journals. Reference should be made here to the *Physical Review Papers* of 1923, on the coefficient of slip, the reflection of molecules, and the complete law of the fall of a particle through gas at all densities, definitely settling one of the historical problems of the kinetic theory, so incompletely treated, both theoretically and experimentally, by a score of papers during the past twenty-five or thirty years. The *urge to know*, Doctor Millikan claims, is the thing that is pushing pioneers of science out beyond even the present frontiers of human knowledge, leading each year to deeper research and the establishing of valuable working facts.

### Membership of the A. I. E. E.

The objects towards which this Association is continuously striving have been, since the adoption of the constitution, the advancement of the theory and practise of electrical engineering and of the allied arts and sciences, and the maintenance of a high professional standing among its members. The successful efforts of the organization in accomplishing these objects is evidenced by the results.

The Association is of necessity faced by the inevitable march of time and the attendant demand for new blood. The activities of the Membership Committee as outlined in the by-laws have for many years been carried on with such success as to maintain a constant succession of members ready and capable of continuous achievement of the objects set before us. In fact, the committee's work during the past years in bringing the advantages of membership to the attention of desirable candidates for admission to the Institute has resulted in a roster of approximately 18,000 members. This enrollment covers all branches of electrical engineering, including, consulting engineers, professors of electrical engineering, chief engineers, managers and other officers associated with electric light, railway, telephone, telegraph, power, and manufacturing companies, as well as many other persons interested in the electrical profession. A very notable fact in connection with the present enrollment is its widespread character, for it not only contains members from all parts of the United States but includes as well, from all the countries of the earth, members actively engaged in the practise and associated arts and sciences of electrical engineering.

During the current year, the Committee has been able

to do no more than carry on the well worked out plans founded by its predecessors; and the results have, as usual, been good. The first activity of the Committee in the fall consisted in bringing before each individual member, by means of circular letters, his own interest in securing new members having the right qualifications. This plan should be the most productive of new members of the desirable type in comparison with any of the systems used. It is self-evident that among our professional associates there must be continuously developing men of the younger generation who are of the type who will advance to leadership in the field of electrical engineering. And so, it is desirable that the advantages of the Institute be brought to their attention by those of us who are immediately associated with them. This method has been used for several years and may be becoming slightly threadbare; but the fundamental principle back of it is correct. It is a scheme that permits of actual participation in the doing of something for the Institute and should serve to show to the membership at large that there is a possibility, even in a small way, of promoting the obtainment of the Institute's objectives.

The next plan, which is put into effect practically at the same time each year as the one previously noted, is the organization of the Section Membership Committees. These local committees are in a position to follow up the returns obtained from the individual membership campaign and answer questions that may come up. In practically all of the urban sections it has become the custom to have the membership committee made up of individuals who are connected in a responsible way with the unit electrical industries of their particular community. This policy places a representative of the membership committee in an available position for consultation by his fellow workers who may become interested in the Institute and results in numerous applications being received from highly desirable candidates.

During the past year a large number of the sections have been visited and a direct appeal to the membership for cooperation in the work of this Committee has been made in a meeting of each section. This appeal has taken the form of outlining in a general way the aims and objects of the Institute and the attendant responsibility of the active members, and a caution as to the type of candidates to be considered for admission.

Of the three activities covered, the second has proven to be the most successful during the year just closing and with this success in mind, we may anticipate a modification and perhaps a recasting of the future membership work.

From the foregoing, it is obvious that the work of the Membership Committee falls among the non-spectacular phases of Institute activities but we may hope that like many other non-spectacular tasks it has its relative importance.

L. S. O'ROARK, *Chairman,*  
Membership Committee.

# Abridgment of The Holtwood Steam Plant Design and Operation in Coordination With Water Power

BY F. A. ALLNER<sup>1</sup>

Member, A. I. E. E.

**Synopsis.**—The Holtwood Steam Plant is located in Lancaster County, Pa., on the Susquehanna River, about 24 miles above tide-water, adjacent to and closely coordinated with the 111,000-kw. hydroelectric plant of the Pennsylvania Water & Power Company, and through the latter company's customers, it is a part of a hydro-steam system including Baltimore, Md., and Lancaster, York, and Coatesville, Pa., with a total installed generator capacity of about 370,000 kw. and with high-tension connections to two other large systems. It is a pulverized fuel burning station, containing at present two 10,000-kw. generators and three 1400-h. p. boilers. The plant is laid out for an ultimate capacity of at least 120,000 kw.

The station went into operation in July 1925. The paper gives the reasons for building a steam plant at Holtwood, some of them being general advantages in such a location for a plant, which is supplementary to a run-of-river hydroelectric plant, and others being the particular advantage, in this instance. In general, during the low-flow period, the steam plant carries the base load or bell generation, and during high flow, when the hydroelectric plant is operated at maximum capacity whenever the load permits, the steam plant carries the peaks. This station was especially planned to suit such conditions of operation and was designed for mechanical sturdiness, reliability of service, quick starting, ability to float in at no load and for maximum coordination with the hydroelectric plant rather than for maximum economy or minimum first cost. A number of special features incorporated to carry out this aim is described in the paper, among them being arrangements to facilitate quick starting and floating in, and a special governor so constructed

that the speed regulation may be changed by remote control while the unit is running. A comparative analysis of starting times of hydroelectric and steam units at Holtwood is given, showing that in spite of special design, the steam unit requires a much longer time than the hydroelectric unit.

The pulverized fuel process was adopted in order to secure better sustained efficiency over a wide range of boiler rating, to reduce banking losses and because it was desired to burn bituminous coal of various grades in the same furnaces with river bottom anthracite coal which is dredged from the upper end of the pond formed by the Holtwood dam. This has been successfully accomplished, approximately one-third of all the coal burned, so far, having been river anthracite. During short periods, anthracite alone has been burned, but most of the time the two kinds of coal are mixed before being dried and pulverized. Maintenance costs at the pulverizing plant when burning 100 per cent anthracite are very high.

Data are presented showing the first cost of the plant, fuel rates, costs of preparing river anthracite, outage time of the generating units and other operating results. A brief summary is given also of minor difficulties.

On account of the unusual operating requirements as to loading, fuel supply, etc., the design and operation of this plant involved a number of interesting problems in design and operation, for the solution of which only a limited amount of experience was available. It is believed that nearly all of the major problems have been solved satisfactorily, but there is still need for further experimentation to secure the best possible results from the equipment installed.

## BRIEF DESCRIPTION OF SYSTEM

THE Pennsylvania Water & Power Company is a generating and transmission company, selling power at wholesale to public utilities. Its system consists of a combined hydroelectric and steam power development at Holtwood, Pa., on the Susquehanna River about 10 miles (16.1 km) above the Pennsylvania-Maryland state line, with high-tension steel tower lines radiating like the spokes of a wheel (Fig. 1) to Baltimore, Maryland, 40 miles (64.4 km.) distant; Lancaster, Pa., 14 miles (22.5 km.); York, Pa., 23 miles (37.0 km.); and Coatesville, Pa., 30 miles (48.3 km.).

The Holtwood (formerly called the McCalls Ferry) hydroelectric development (Fig. 2) is a low-head run-of-river plant with a weighted average head under present conditions of about 52 feet (15.8 m.). The first unit went into operation in October 1910 and after the initial five unit installation the plant was extended in several successive steps, reaching its present rated generator capacity of 111,000 kw. early in 1924. The rated capacity of the waterwheels varies from 13,500

h. p. for the older type of double-runner turbines to 20,000 h. p. for the latest single-runner type. The first eight units are 25-cycle, this frequency having been adopted to meet the requirements of Baltimore and Lancaster. The last two units installed in 1923-1924 are 60-cycle to meet the needs of York and Coatesville and what is now the larger and rapidly growing part of the Lancaster load, which is supplied over a 60-cycle line built in 1924. The 25- and 60-cycle systems can be tied together by a total capacity of 25,000 kw. in seven synchronous frequency changers, of which two 5000-kw. sets are located at the hydroelectric plant, and the balance of 15,000 kw. at Lancaster. The latter equipment was formerly used for supplying the 60-cycle load in that city when only two 25-cycle circuits were available from Holtwood.

The normal full-load discharge of the hydroelectric plant is now about 30,000 cubic feet (850 cu. m.) per second, with a maximum under favorable hydraulic conditions of 31,500 (892 cu. m. per sec.). The former flow is available in the average year 41 per cent of the time. The flow of the Susquehanna is unusually variable. The lowest 24 hour flow recorded at Holtwood since the plant went into operation in 1910 (from which time more reliable flow measurements are available than had theretofore existed) was 3200 cu. ft. per sec. (90.7 cu. m. per sec.), and the lowest

1. General Superintendent, Pennsylvania Water & Power Co., Baltimore, Md.

Abridgment of paper to be presented at the Summer Convention of the A. I. E. E., Detroit, Mich., June 20-24, 1927. Complete pamphlet copies upon request.

Physical Society; a Sigma Xi and Phi Beta Kappa. He has contributed liberally to technical literature in his works *A Course of College Experiments in Physics*, 1898; *Theory of Optics* (translated from German) 1900; *Mechanics, Molecular Physics and Heat*, 1901; *A First Course in Physics*, 1906; *A Laboratory Course in Physics for Secondary Schools*, 1906; *Electricity, Sound and Light*, 1908; *Practical Physics*, 1920; *The Electron, etc.*, 1917, *Elements of Physics*, 1927 (a revision of *Practical Physics*),—beside other articles published in the various technical journals. Reference should be made here to the *Physical Review Papers* of 1923, on the coefficient of slip, the reflection of molecules, and the complete law of the fall of a particle through gas at all densities, definitely settling one of the historical problems of the kinetic theory, so incompletely treated, both theoretically and experimentally, by a score of papers during the past twenty-five or thirty years. The *urge to know*, Doctor Millikan claims, is the thing that is pushing pioneers of science out beyond even the present frontiers of human knowledge, leading each year to deeper research and the establishing of valuable working facts.

### Membership of the A. I. E. E.

The objects towards which this Association is continuously striving have been, since the adoption of the constitution, the advancement of the theory and practise of electrical engineering and of the allied arts and sciences, and the maintenance of a high professional standing among its members. The successful efforts of the organization in accomplishing these objects is evidenced by the results.

The Association is of necessity faced by the inevitable march of time and the attendant demand for new blood. The activities of the Membership Committee as outlined in the by-laws have for many years been carried on with such success as to maintain a constant succession of members ready and capable of continuous achievement of the objects set before us. In fact, the committee's work during the past years in bringing the advantages of membership to the attention of desirable candidates for admission to the Institute has resulted in a roster of approximately 18,000 members. This enrollment covers all branches of electrical engineering, including, consulting engineers, professors of electrical engineering, chief engineers, managers and other officers associated with electric light, railway, telephone, telegraph, power, and manufacturing companies, as well as many other persons interested in the electrical profession. A very notable fact in connection with the present enrollment is its widespread character, for it not only contains members from all parts of the United States but includes as well, from all the countries of the earth, members actively engaged in the practise and associated arts and sciences of electrical engineering.

During the current year, the Committee has been able

to do no more than carry on the well worked out plans founded by its predecessors; and the results have, as usual, been good. The first activity of the Committee in the fall consisted in bringing before each individual member, by means of circular letters, his own interest in securing new members having the right qualifications. This plan should be the most productive of new members of the desirable type in comparison with any of the systems used. It is self-evident that among our professional associates there must be continuously developing men of the younger generation who are of the type who will advance to leadership in the field of electrical engineering. And so, it is desirable that the advantages of the Institute be brought to their attention by those of us who are immediately associated with them. This method has been used for several years and may be becoming slightly threadbare; but the fundamental principle back of it is correct. It is a scheme that permits of actual participation in the doing of something for the Institute and should serve to show to the membership at large that there is a possibility, even in a small way, of promoting the obtainment of the Institute's objectives.

The next plan, which is put into effect practically at the same time each year as the one previously noted, is the organization of the Section Membership Committees. These local committees are in a position to follow up the returns obtained from the individual membership campaign and answer questions that may come up. In practically all of the urban sections it has become the custom to have the membership committee made up of individuals who are connected in a responsible way with the unit electrical industries of their particular community. This policy places a representative of the membership committee in an available position for consultation by his fellow workers who may become interested in the Institute and results in numerous applications being received from highly desirable candidates.

During the past year a large number of the sections have been visited and a direct appeal to the membership for cooperation in the work of this Committee has been made in a meeting of each section. This appeal has taken the form of outlining in a general way the aims and objects of the Institute and the attendant responsibility of the active members, and a caution as to the type of candidates to be considered for admission.

Of the three activities covered, the second has proven to be the most successful during the year just closing and with this success in mind, we may anticipate a modification and perhaps a recasting of the future membership work.

From the foregoing, it is obvious that the work of the Membership Committee falls among the non-spectacular phases of Institute activities but we may hope that like many other non-spectacular tasks it has its relative importance.

L. S. O'ROARK, *Chairman,*  
Membership Committee.



# Abridgment of The Holtwood Steam Plant Design and Operation in Coordination With Water Power

BY F. A. ALLNER<sup>1</sup>

Member, A. I. E. E.

**Synopsis.**—The Holtwood Steam Plant is located in Lancaster County, Pa., on the Susquehanna River, about 24 miles above tide-water, adjacent to and closely coordinated with the 111,000-kw. hydroelectric plant of the Pennsylvania Water & Power Company, and through the latter company's customers, it is a part of a hydro-steam system including Baltimore, Md., and Lancaster, York, and Coatesville, Pa., with a total installed generator capacity of about 370,000 kw. and with high-tension connections to two other large systems. It is a pulverized fuel burning station, containing at present two 10,000-kw. generators and three 1400-h. p. boilers. The plant is laid out for an ultimate capacity of at least 120,000 kw.

The station went into operation in July 1925. The paper gives the reasons for building a steam plant at Holtwood, some of them being general advantages in such a location for a plant, which is supplementary to a run-of-river hydroelectric plant, and others being the particular advantage, in this instance. In general, during the low-flow period, the steam plant carries the base load or belt generation, and during high flow, when the hydroelectric plant is operated at maximum capacity whenever the load permits, the steam plant carries the peaks. This station was especially planned to suit such conditions of operation and was designed for mechanical sturdiness, reliability of service, quick starting, ability to float in at no load and for maximum coordination with the hydroelectric plant rather than for maximum economy or minimum first cost. A number of special features incorporated to carry out this aim is described in the paper, among them being arrangements to facilitate quick starting and floating in, and a special governor so constructed

that the speed regulation may be changed by remote control while the unit is running. A comparative analysis of starting times of hydroelectric and steam units at Holtwood is given, showing that in spite of special design, the steam unit requires a much longer time than the hydroelectric unit.

The pulverized fuel process was adopted in order to secure better sustained efficiency over a wide range of boiler rating, to reduce banking losses and because it was desired to burn bituminous coal of various grades in the same furnaces with river bottom anthracite coal which is dredged from the upper end of the pond formed by the Holtwood dam. This has been successfully accomplished, approximately one-third of all the coal burned, so far, having been river anthracite. During short periods, anthracite alone has been burned, but most of the time the two kinds of coal are mixed before being dried and pulverized. Maintenance costs at the pulverizing plant when burning 100 per cent anthracite are very high.

Data are presented showing the first cost of the plant, fuel rates, costs of preparing river anthracite, outage time of the generating units and other operating results. A brief summary is given also of minor difficulties.

On account of the unusual operating requirements as to loading, fuel supply, etc., the design and operation of this plant involved a number of interesting problems in design and operation, for the solution of which only a limited amount of experience was available. It is believed that nearly all of the major problems have been solved satisfactorily, but there is still need for further experimentation to secure the best possible results from the equipment installed.

## BRIEF DESCRIPTION OF SYSTEM

THE Pennsylvania Water & Power Company is a generating and transmission company, selling power at wholesale to public utilities. Its system consists of a combined hydroelectric and steam power development at Holtwood, Pa., on the Susquehanna River about 10 miles (16.1 km) above the Pennsylvania-Maryland state line, with high-tension steel tower lines radiating like the spokes of a wheel (Fig. 1) to Baltimore, Maryland, 40 miles (64.4 km.) distant; Lancaster, Pa., 14 miles (22.5 km.); York, Pa., 23 miles (37.0 km.); and Coatesville, Pa., 30 miles (48.3 km.).

The Holtwood (formerly called the McCalls Ferry) hydroelectric development (Fig. 2) is a low-head run-of-river plant with a weighted average head under present conditions of about 52 feet (15.8 m.). The first unit went into operation in October 1910 and after the initial five unit installation the plant was extended in several successive steps, reaching its present rated generator capacity of 111,000 kw. early in 1924. The rated capacity of the waterwheels varies from 13,500

h. p. for the older type of double-runner turbines to 20,000 h. p. for the latest single-runner type. The first eight units are 25-cycle, this frequency having been adopted to meet the requirements of Baltimore and Lancaster. The last two units installed in 1923-1924 are 60-cycle to meet the needs of York and Coatesville and what is now the larger and rapidly growing part of the Lancaster load, which is supplied over a 60-cycle line built in 1924. The 25- and 60-cycle systems can be tied together by a total capacity of 25,000 kw. in seven synchronous frequency changers, of which two 5000-kw. sets are located at the hydroelectric plant, and the balance of 15,000 kw. at Lancaster. The latter equipment was formerly used for supplying the 60-cycle load in that city when only two 25-cycle circuits were available from Holtwood.

The normal full-load discharge of the hydroelectric plant is now about 30,000 cubic feet (850 cu. m.) per second, with a maximum under favorable hydraulic conditions of 31,500 (892 cu. m. per sec.). The former flow is available in the average year 41 per cent of the time. The flow of the Susquehanna is unusually variable. The lowest 24 hour flow recorded at Holtwood since the plant went into operation in 1910 (from which time more reliable flow measurements are available than had theretofore existed) was 3200 cu. ft. per sec. (90.7 cu. m. per sec.), and the lowest

1. General Superintendent, Pennsylvania Water & Power Co., Baltimore, Md.

Abridgment of paper to be presented at the Summer Convention of the A. I. E. E., Detroit, Mich., June 20-24, 1927. Complete pamphlet copies upon request.

seven day average was 3600 cu. ft. per sec. (102 cu. m. per sec.); the maximum 24-hour flow was 441,000 cu. ft. per sec. (12,470 cu. m. per sec.).

The pond or reservoir formed by the Holtwood dam has an area of about four square miles and a draw-down capacity of approximately 800 million cu. ft. (22,700,000 cu. m.). Under present conditions of system load demands this drawdown gives complete weekly pondage to effectually equalize differences in daily flow and shape of load curve up to an average weekly river stage of 4200 cu. ft. per sec. (119 cu. m.

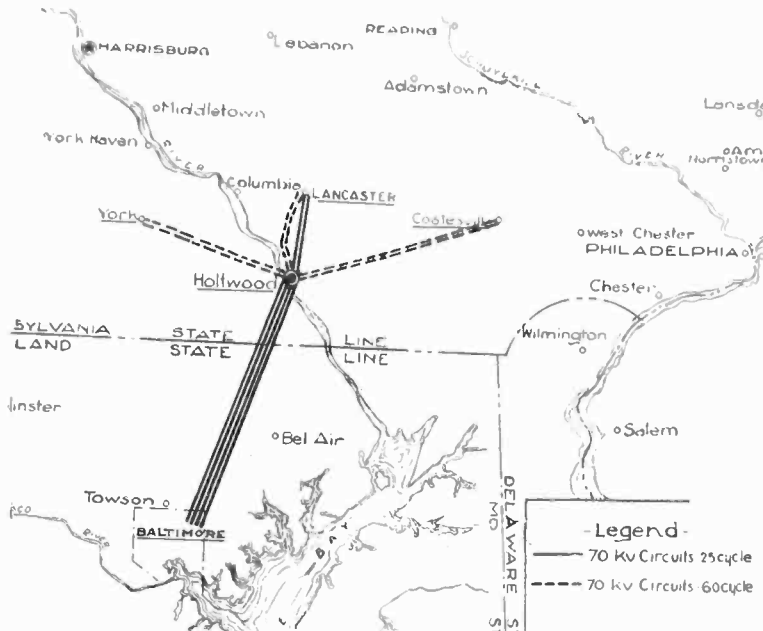

FIG. 1—MAP OF HOLTWOOD TRANSMISSION SYSTEM

per sec.). The term "complete" pondage means that if the hydroelectric plant carries the entire system load above a certain base steam line, and the forebay on Friday evening is brought to a point not below the desired minimum level, the pond will just fill up again by Monday morning without spilling. In other words, the inflow of the river between Friday evening and Monday morning, minus whatever is used for a small amount of generation during that period, will be discharged during the period from Monday morning to Friday evening, in addition to the inflow of the river on these five days.

With an average weekly flow of 4200 cu. ft. per sec. (119 cu. m. per sec.) the average five day draft can be increased by 1800 cu. ft. per sec. (51 cu. m. per sec.), to approximately 6000 cu. ft. per sec. (170 cu. m. per sec.); but with an average weekly flow of only 3600 cu. ft. per sec. (102 cu. m. per sec.), the effective five day average draft can be raised to only about 5200 cu. ft. per sec. (147 cu. m. per sec.), because the inflow at the rate of 3600 cu. ft. per sec. is not sufficient to completely refill the pond after maximum draw down as in the case of 4200 cu. ft. per sec. inflow. For average weekly flows in excess of 4200 cu. ft. per sec. the increase in the daily discharge on the five weekdays will be limited to approximately 1800 cu. ft. per sec.

on account of the minimum desired forebay level at the time of maximum drawdown, and the inflow over the weekend will be more than sufficient to completely refill the pond before Monday morning.

The installed capacity of the Baltimore steam plants of the Consolidated Gas, Electric Light & Power Company is about 220,000 kw. At Lancaster the Edison Electric Company has a standby steam plant with rated generator capacity of 7000 kw. At York, the Edison Light & Power Company has a steam generating station of 8500 kw. capacity and a tie-in connection of 7500 kw. with the large hydro-steam system of the Metropolitan Edison Company, from which it receives approximately one-half of its load requirements. At Coatesville, the Chester Valley Electric Company has a steam plant of a rated capacity slightly in excess of 3000 kw. and also a 5000-kw. tie-in connection with the Philadelphia Suburban Gas & Electric Company.

#### GENERAL SYSTEM OPERATION

The method of operating the system for maximum coordination of waterpower and steam has been explained in a previous paper<sup>2</sup> and will not be discussed in detail here. Generally speaking, during high or excess flow the aim is to deliver the maximum amount of energy from the river. As long as there is water wasted over the dam, hydraulic efficiency is of no importance. The hydroelectric units are operated at full load as

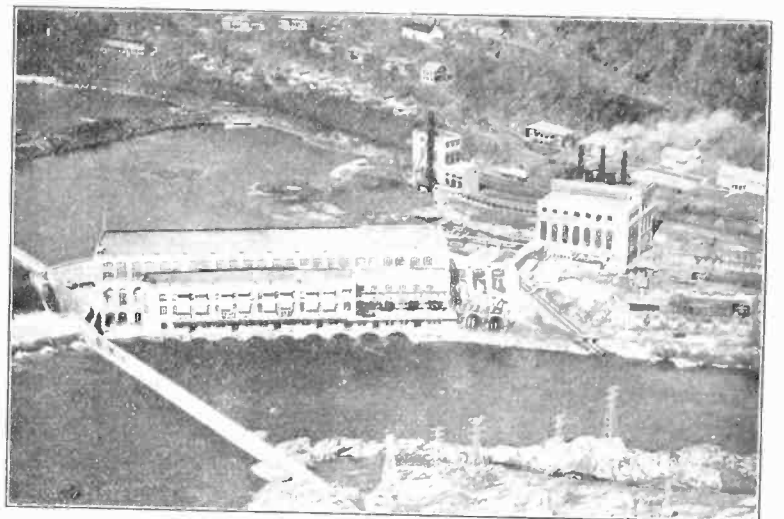

FIG. 2—VIEW OF HOLTWOOD WATER POWER PLANT AND STEAM STATION

long as possible and carry as much of the system load as is practicable when this is less than the hydroelectric capacity. The steam plants then operate "on the peaks" and carry all swings. In low or deficient flow, conditions are reversed. The steam plants are given the base load or belt generation and the hydroelectric plant operates "on the peaks," and takes care of load fluctuations during the peaks, and takes care of load fluctuations during the hour, even though such operation under average low-flow conditions causes an energy loss of about 7 per cent, and at very low river stages as much as 15 per cent, compared with 100 per cent load factor,

2. A. S. M. E. Transactions, 1925, p. 379.

belt load generation. These differences are due more to the large hydraulic gradient of the tailrace than to the carrying of swings and the uneconomical loading of individual units.

Under normal conditions the pond is drawn upon only to the extent of compensating for daily and weekend fluctuations in inflow and load demand and restoration of maximum pond level is aimed at on the morning of every weekday. Thus the maximum practical amount of pondage is held in reserve to meet major emergency conditions or temporary outages at the steam plants.

#### REASONS FOR BUILDING THE HOLTWOOD STEAM PLANT

Until recently the Power Company depended entirely upon its customers' steam plants for makeup steam generation. The company's contracts give it the right to call on any of the steam plants previously listed for generation under certain conditions. In 1925, however, the company, through a subsidiary, the Holtwood Power Company, built a steam plant at Holtwood. Additional steam capacity was required for the system. The Consolidated Gas, Electric Light & Power Company of Baltimore was ready to proceed with its new Gould Street plant, but after careful joint study it was decided that Holtwood was the logical place for the next step in steam station construction and arrangements were made with the Baltimore company to temporarily postpone the Gould Street project. The principal reasons for this decision were as follows:

1. The 60-cycle load in Pennsylvania was increasing rapidly and additional capacity was essential. None of the Pennsylvania customers' steam plants is modern and well adapted for economical extension, and existing power agreements did not provide for the use of more than the capacity available at the time when Holtwood supply had started.

2. The transmission of primary power from Baltimore to the Pennsylvania 60-cycle system to take care of the growth of the Power Company's load commitments, would have required additional frequency changers at Holtwood, with consequent conversion losses in addition to increased transmission losses. A direct connection of the Baltimore 62½-cycle system with the 60-cycle system in Pennsylvania was not possible without extensive changes in Baltimore.

3. A plant at Holtwood, being at the hub of the wheel, so to speak, could offer the maximum protection to all of the radial lines. The transmission of power from any customer city to Holtwood and thence to another city requires a reversal of flow, with consequent complication of voltage regulation. From this point of view the logical place for a steam plant supplementary to hydro is at the water-power site.

4. Since the Lancaster dual frequency supply had grown to about 25,000 kw. it was desired to always maintain two sources of supply, which during very low river stages required an appreciable amount of 60-cycle hydroelectric generation during off-peak hours. Sixty-cycle supply from the Holtwood steam plant enabled the system to conserve the entire hydroelectric energy exclusively for peak service, thus indirectly gaining ineffective peak supply for the system appreciably more than the steam capacity proper.

5. There are large deposits of river bottom anthracite coal in the Holtwood pond. The location of a steam plant at Holtwood made it possible to use some of this coal and store same eventually in very large quantities, thus providing a more

economical and effective emergency insurance of fuel supply than is practical with bituminous coal at the city stations.

6. The installation of a steam plant adjacent to a variable flow run-of-river hydroelectric plant makes it possible to effect considerable savings in operating expense through the coordination of operation and maintenance work. In such a system so far as possible, all maintenance work at the hydroelectric plant is done during low flow, whereas repairs at the steam plant are concentrated in the high-flow period. This makes it possible for the same force, at least in part, to be used at both plants.

#### BRIEF DESCRIPTION OF STEAM PLANT (FIGS. 3 & 4)

It is not the purpose of this paper to give a detailed description of the entire plant and an itemized list of equipment. However, the principal physical characteristics will be mentioned as a ground work for a discussion of special features and of the reasons for making certain decisions.

The generating equipment proper consists of two

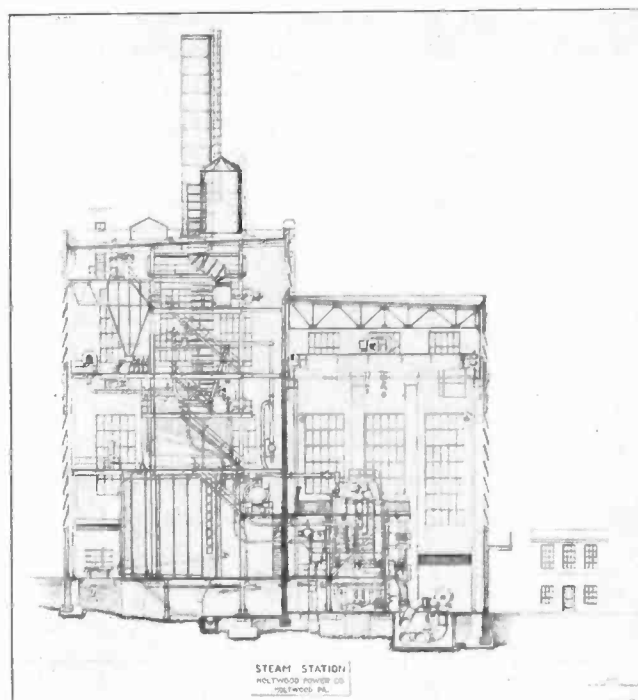

FIG. 3—CROSS SECTION THROUGH BOILER ROOM AND TURBINE HALL

10,000-kw., 80 per cent power factor, 1800-rev. per min., three-phase, 60-cycle, 13,200-volt generators driven by nine-stage turbines designed for 350 lb. (23.8 atm.) gage at the throttle. Initial operation is at 550 deg. fahr. (287.7 deg. cent.), but the turbines are guaranteed to operate successfully at 700 deg. fahr. (371.7 deg. cent.) if the superheat should be increased later. Each unit has a 75-kw., 250-volt shaft-end exciter. Steam is bled from the turbines at three stages—the third, fifth and seventh. Each turbo generator is equipped with a 13,000 sq. ft. (1208 sq. m.) single pass condenser.

The boiler installation consists of three cross drum vertically baffled three-pass B. & W. boilers, each with a heating surface of 14,056 sq. ft. (1305.7 sq. m.), exclusive of the water screen at the bottom and back of the furnace which has an additional surface of 775 sq. ft. (72.0 sq. m.). The working pressure is 385 lb.

(26.2 atm.) gage. Each boiler is equipped with a convection type superheater above the top row of water tubes, designed to give a steam temperature of 560 deg. Fahr. (293.3 deg. cent.) at 250 per cent rating. Each boiler has its own stack with a height of 126 feet (38.4 m.) above the burners. There are two induced draft fans above each boiler. Neither economizers nor air preheaters are installed, although provision is made to add such equipment later on, if found advisable. Makeup water is furnished by two horizontal single effect evaporators which are supplied with filtered river water.

The furnaces have air-cooled side and front walls. Each furnace has a volume of 11,500 cu. ft. (325 cu. m.) above the water screen. The vertical burners, of which there are eight to a boiler, are set under the high end of the boiler. Pulverized coal feeders are arranged in four motor-driven pairs per boiler. There are three primary air fans. The boilers are arranged in a single row parallel to the turbine hall, in which the turbines are placed lengthwise. The boilers and furnaces are guaranteed to give 300 per cent rating for twenty-four

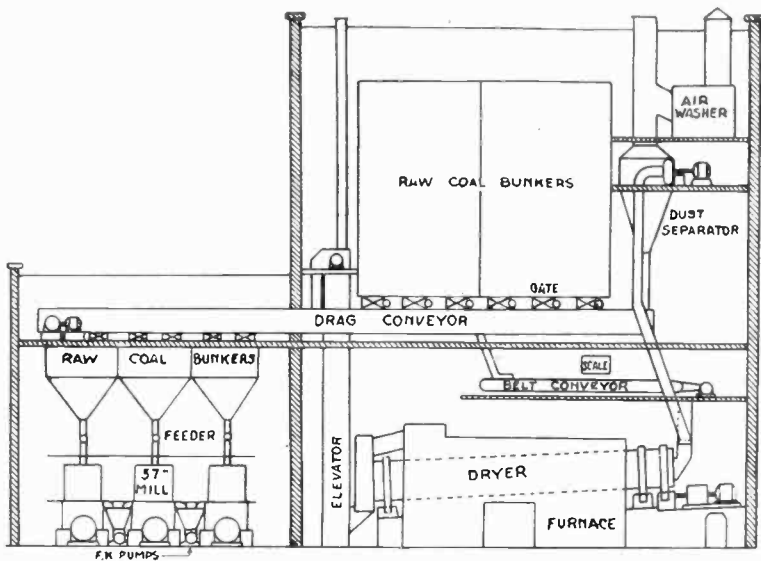

FIG. 4—LONGITUDINAL SECTION THROUGH COAL PREPARATION PLANT

hours or 400 per cent for twelve hours when using bituminous coal, and 250 per cent for 24 hours or 325 per cent for 12 hours using river anthracite.

All auxiliaries are motor-driven with the exception of one steam turbine driven boiler feed pump. Each of the two circulating water pumps has a dual drive consisting of one 25-cycle and one 60-cycle motor. All other a-c. motors are 60-cycle. The 60-cycle hydroelectric units provide an independent source of power, which is considered of greater reliability than shaft-end auxiliary generators or house turbines. The boilers and furnaces are equipped with Bailey automatic combustion controls which operate the coal feeders, the induced draft fans and the stack dampers.

The coal preparation plant occupies a separate building located upstream from the boiler house. At the

top of the building there are two raw coal bins with a total capacity of 1000 tons to which coal is elevated by a skip hoist. From the raw coal bunkers coal is fed by a drag conveyer to a 6½-ft. by 50-ft. (1.98 m. by 15.2 m.) rotary dryer with a capacity of 25 net tons of bituminous or 24 net tons of river anthracite coal per hour. There are three dry coal bins each with a capacity of 20 net tons. The pulverizing equipment consists of three Fuller 57 inch (1.45 m.) screen type mills, each with a guaranteed capacity of 7½ net tons per hour of bituminous or 4½ net tons of river coal when grinding to a fineness of 83 to 87 per cent through a 200 mesh screen. Pulverized coal is pumped to the boiler house by two Fuller-Kinyon pumps through two five-in. pipe lines with a horizontal length of about 350 ft. (106.7 m.) and a vertical rise of 85 ft. (25.9 m.).

Bituminous coal is received by railroad car and dumped into a track hopper mounted over a crusher. River coal is for the most part scowed to the forebay ramp where it is transferred to a railroad car and hauled to the track hopper.

At present the coal storage facilities consist of a drag scraper storage yard with a capacity of about 10,000 tons. Coal is also stocked out and reclaimed by locomotive crane from several areas adjacent to railroad sidings. With the increase in plant capacity the main storage will be gradually extended by filling in a large shallow area of the forebay.

#### CONTROLLING FACTORS AND SPECIAL FEATURES OF DESIGN

The Holtwood plant was designed not so much for maximum economy or minimum first cost, but primarily for mechanical sturdiness, reliability of service, quick starting, ability to float in at no-load and for facilitating the proper division of load between hydroelectric and steam plants. In carrying out these aims a number of interesting questions arose and several special features were incorporated which will be discussed below.

*Choice of Site.* The forebay of the hydroelectric plant, which is protected from floating ice and debris by a rock fill ramp, skimmer wall and floating booms, offered an ideal source for circulating water. The exact location of the steam plant, however, presented an interesting problem. The site finally selected for the initial section of the power house was immediately below (*i. e.*, on the downstream side) and abutting on the wing wall from the river shore to the hydroelectric plant. Circulating water for the condensers is taken from the forebay and returned to the gate house of the hydroelectric plant, the tunnels having been cut through the wing wall.

Serious consideration was given to a site along the tailrace below the hydroelectric plant. The natural head from forebay to tailrace would then have been used for discharging water through the condensers, thus doing away with pumping equipment. This

scheme looked particularly attractive from the point of view of saving a few minutes in the starting operation. The head, however, is considerably greater than that required to overcome the frictional resistance of the condensers and water conduits. Supplementary to this scheme, a plan was also considered of using the excess head to drive auxiliary hydraulic turbines, but this was an added complication.

As the heaviest steam generation and maximum draft of circulating water would be at times of very low flow, the use of water in this manner would reduce the hydroelectric plant output during these low river stages. During the high-flow period there would be a gain in the combined net output of the hydro and steam plants. If arrangements were made to utilize the excess head beyond the condensers, and if the hydroelectric plant operated 24 hours a day as during moderate low flow, the reduction in hydroelectric plant output would be less than the equivalent amount of electrical energy consumed in the motors. However, in very low flow the hydroelectric plant shuts down at night and all the available hydroelectric energy is thrown in on the peaks. The diversion of water through the condensers during the 24 hours of steam operation would still show a net gain in energy output, but would cause an appreciable reduction in the peak service rendered by the hydroelectric plant on account of the concentration of all the hydroelectric energy during the short period of peak generation. Maximum peak service in very low flow is of prime importance, particularly as there is a tendency for the peak service corresponding to a certain amount of hydroelectric energy to increase from year to year with the growth of the system load.

Perhaps the greatest advantage of the site selected was the greater amount of space available. The plant is laid out for six turbine bays and its ultimate capacity will be approximately 120,000 kw. The future extensions will be made to the north of the wing wall into a shallow portion of the forebay area where little coffer-damming will be required. The initial two-bay section of the power house was built entirely in the dry, the wing wall acting as a bulkhead.

Another advantage of the layout adopted is that the injection of warm condenser discharge into the end of the gate house is of value in reducing the chances of capacity reductions caused by frazil ice on the hydroelectric units at that end of the power house. It has been calculated that for the completed plant, enough heat would be discharged in the condenser water to raise the temperature of all the water entering the hydro units, if perfectly mixed with it, by nearly 0.2 deg. fahr. (0.11 deg. cent.) exclusive of the heat required to melt the ice. Experts on ice have declared that a rise of less than 0.01 deg. fahr. (0.0055 deg. cent.) may be enough to remove the "stickiness" of frazil ice.

*Centralized Control.* Electrically speaking, the steam plant is essentially a part of the 60-cycle section of the

hydroelectric plant. The steam generator leads are carried through a cable duct to oil switches located in the hydroelectric plant switchroom. The control panels for the steam units are a part of the 60-cycle switchboard in the hydroelectric plant. The Tirrill element and the controls for the Keilholtz-Ricketts booster regulator used on the steam units are located on this switchboard.

*Size and Type of Generating Units.* From the point of view of low first cost and of economy of operation, under base load conditions, larger generating units would have been desirable. However, as previously stated, these considerations were subordinated to sturdiness, reliability of service, quick starting and maximum coordination with the hydroelectric plant. Furthermore, under the existing conditions, these initial steam units must often operate at a comparatively small load, either when separated from the rest of the generating system or in high flow when operating on the peaks so as to "skim off" the top of the load and give the hydroelectric units maximum load. All of these considerations pointed toward relatively small sturdy units for the initial installation, approximating in capacity the hydroelectric units.

*Auxiliary Power System.* The number of oil circuit breakers on the auxiliary power system has been kept to a minimum. Magnetic contactors have been employed for all switching purposes, except on main feeders between distribution boards. Tests were made on different types of contactors to determine their ability to rupture the maximum expected short circuits. The control for contactors on essential auxiliaries is so arranged that either a contactor will not open on low-voltage, or will immediately reclose on restoration of voltage.

Special precautions to avoid explosion hazard have been taken in the installation of the electrical system; in the coal preparation plant, distribution switchboard and contactors for the main auxiliaries are located in a special switchroom, isolated from the main building by concrete fire walls. All push buttons, and such manual controllers as are necessary in the mill and dryer rooms, are of the Navy standard vaporproof type. All lighting fixtures are dust proof and vaporproof.

*Quick Starting of Hydroelectric and Steam Units.* In a hydroelectric system in high flow, when the system load is less than the hydroelectric capacity the steam plant should be shut down at night and theoretically should not operate in the morning until the load becomes equal to the hydroelectric capacity, when it should pick up that portion of the load over and above the hydroelectric capacity. Modern steam turbines designed with small clearances and operating at high temperatures require normally approximately one hour for starting. This, of course, entails the use of steam before it is really required. If it is desired always to have spare steam capacity available for immediate

use in the event of breakdowns, it is necessary to operate normally a larger number of units than would be required for most economical generation.

Hydraulic turbines operating at low or medium heads or having only short penstocks are inherently quick starting machines. Temperature differences are practically nil, clearances are relatively large and construction is sturdy. The starting time can be further reduced by special arrangement of control valves and instruments, by automatic starting of pumps supplying the pressure

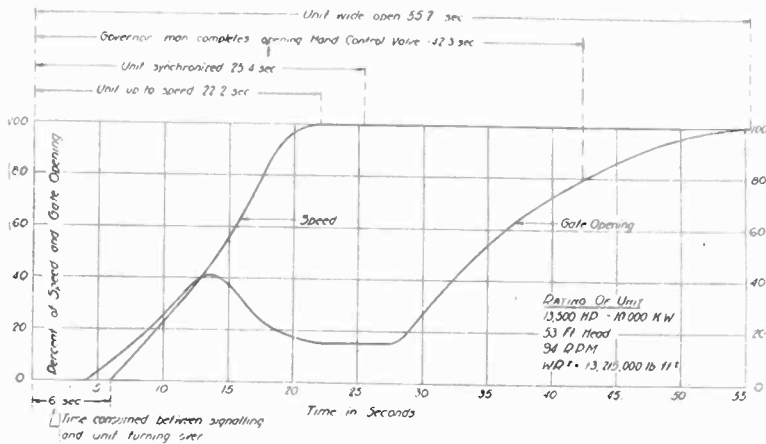

FIG. 5—ANALYSIS OF TIME CONSUMED IN STARTING A 10,000-KW. HYDRO UNIT

fluid of servo motors, etc., and by training the operators. At the Holtwood hydroelectric plant any of the 10 units, ranging in capacity from 13,500 to 20,000 h. p. is commonly started from standstill without preliminary preparation and synchronized in less than one minute, and frequently in less than half a minute. Fig 5. gives an analysis of the few steps involved in this operation, requiring only two men—the governor man and the switchboard operator. The low-flow standby service of a low-head hydroelectric plant equipped with pondage has well been called “a-c. storage battery service,” i. e., its ability to synchronize the entire capacity in a few minutes and maintain full output for several hours or days, and thus tide over temporary emergencies at the steam plants. During the high-flow period this emergency service is not available at the hydroelectric plant, because all hydroelectric units are operating at maximum gate opening.

When going into the field of steam generation at Holtwood, the power company desired to extend so far as practicable this quick starting ability to its steam plant, thus giving to the hydroelectric steam combination a certain amount of quick emergency service also during the high-flow period. This was one of the reasons for selecting a particularly sturdy type of turbine of relatively small size. The specifications provide that “every effort is to be made in the construction of these machines to make them suitable for starting up in the minimum time.” Under normal conditions a Holtwood steam unit is paralleled in twenty-five minutes and in emergency the time can be reduced to fifteen minutes from the time the start signal is given.

Fig. 6 gives an analysis of the operation. A total of four men are engaged in this operation and the time consumed and the number of steps required are still in striking contrast to hydroelectric starting.

The desire to facilitate quick starting was the chief reason for limiting the superheat in the initial installation to a total temperature of 550 degrees at the throttle. In future extensions it is planned to install larger units, using the first two for quick starting purposes. At that time radiant type superheaters may be installed, giving a total steam temperature of 725 degrees. Various schemes have been proposed for maintaining the quick starting feature on the first units, if and when this step is taken, such as omitting the radiant superheater in one boiler, use of a Ruths accumulator, etc.

*Floating In.* As a practical matter, in a case such as the above mentioned building up of load, and whenever the load is at or near the hydroelectric capacity, it is necessary to have spare capacity on the bus. At such a time in high flow any load carried by a steam unit causes a net loss of the equivalent amount of water power. It is therefore highly desirable to have steam units able to float in or motor at no load. On the Holtwood units a by-pass is provided around the

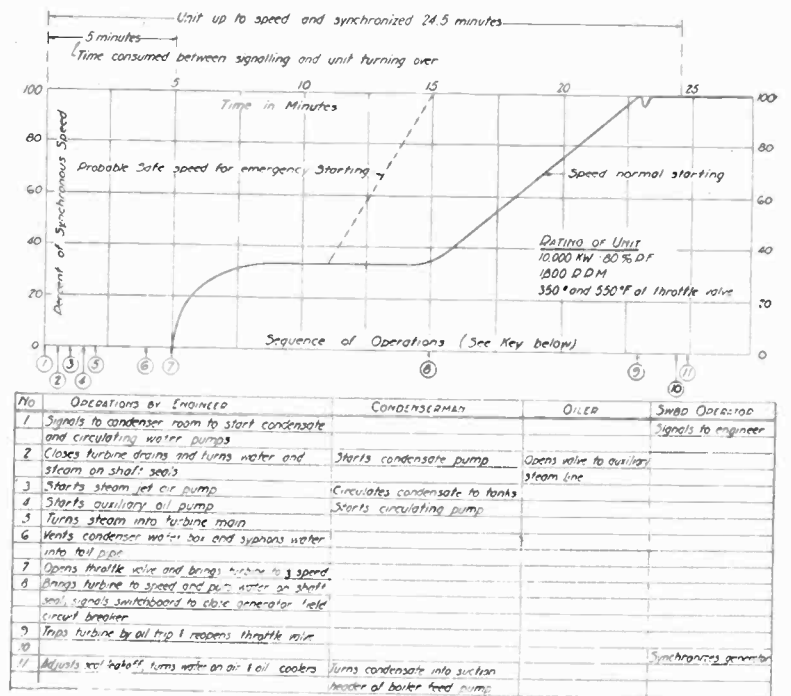

FIG. 6—ANALYSIS OF TIME CONSUMED IN STARTING A 10,000-KW. STEAM UNIT

main steam control valves to admit enough steam to the turbine to keep it cool. The manufacturers' guarantee provides that with this by-pass connection open “it will be possible to motor the turbine by means of its generator with the control valves shut off a period of one hour without overheating any parts of the turbine.”

A 3/4-in. (1.9 cm.) orifice is at present installed in the by-pass. It has been found that this discharges enough steam to drive the unit at slightly more than synchronous speed under excitation. This is more than

is necessary for cooling and prevents lowering of speed for synchronizing unless the speed is reduced by manual manipulation of the vacuum or the throttle. Tests are not yet completed to determine the safe minimum size of orifice.

Fig. 7 illustrates the division of load between a 12,000-kw. hydroelectric unit and one of the steam units over the noon hour drop when operating in parallel on the Lancaster 60-cycle load separated from the rest of the system. Until about 11:55 a. m. the hydroelectric unit is "wide open," with the steam turbine taking the momentary swings and the more gradual load changes. When the customer's load drops below the hydroelectric capacity, the hydroelectric governor begins to function or to "maintain the frequency" as the operators say, and the steam unit "floats in" or motors. Occasionally small amounts of power are momentarily supplied by the steam turbine, due to slight decreases in frequency which draw on the kinetic energy stored in the rotor and also in a few cases probably cause the steam

tions or peaks and the hydroelectric units are carrying the base load the steam unit regulation should be relatively small. The Holtwood steam units operate also in parallel with a number of other steam units, where regulation cannot be adjusted while running. In order to control Holtwood steam generation in respect to these other steam stations, either towards assigning to the Holtwood units a steady load or a fluctuating load, it was thought desirable to be able to change from one condition to the other without shutting down the unit. Hence a special motor driven device was installed for changing the governor regulation. This device is controlled from the switchboard in the hydroelectric plant. The specifications provide for an adjustment range from 1 per cent to 5 per cent, although the guaranteed range is only 2 per cent to 5 per cent. Tests made on the governors at the factory showed a range from 1.6 per cent to 7.4 per cent).

The manufacturer's guarantees provide that the characteristics of the governors are such that there will not be any hunting between the steam turbines and the hydro units or between the two steam turbines under either of the two following operating conditions:

1. Steady continuous load carried on waterwheel generators, and fluctuating load carried on the steam turbines.
2. Steady continuous load carried on steam turbines and fluctuating load carried on waterwheel-driven generators.

The guarantees also provide that the speed regulation and the speed of operation of the governor and control mechanism of the turbine will be such that with full load thrown off the generator and the field circuit breaker opened simultaneously, the speed will not exceed that for which the emergency trip is set (the latter is to be not over 110 per cent).

In order to make it possible to restore normal frequency in case of a sudden overload due to the breakdown of a generating unit or other cause, by paralleling a steam unit without cutting off customers' load, a particularly wide range is provided in the governor control of the Holtwood units. The speed can be changed by remote control from 107 per cent or 64 cycles to 85 per cent or 51 cycles, but in the latter case the by-pass around the control valves must be throttled which, as stated previously, is at present too large.

*Condensers.* The heaviest duty on the steam units falls in the period of very low flow, which usually is also a warm weather period. Also in cold weather, as for example, in case of a frazil ice run, it may be desired to throw the maximum possible overload on a steam unit for a short time. This was the cause of conservatism in condenser design. For ordinary conditions probably a 9000-sq. ft. (836-sq. m.) single-pass condenser would have sufficed, but in line with the policy of insuring a safe margin of capacity and maximum coordination with the hydroelectric plant, even at the expense of first cost, a 13,000-sq. ft. (1208-sq. m.) single pass condenser was installed on each unit. Sustained gross generating capacity for highest water temperature in

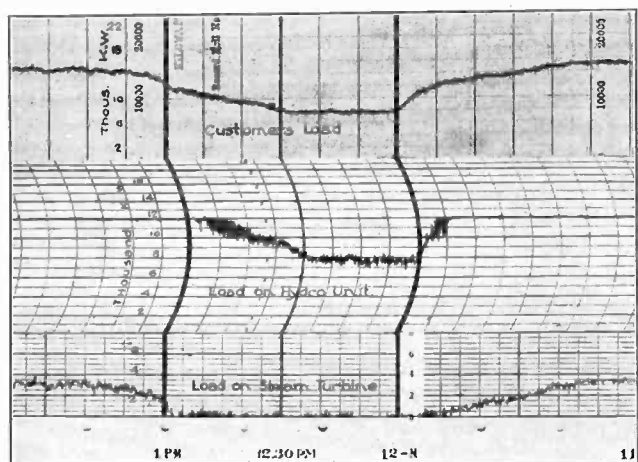

FIG. 7—WATTMETER CHARTS DURING FLOATING-IN PERIOD OVER THE NOON HOUR

governor to open a control valve momentarily. The graphic chart of steam turbine output does not show input when momentarily motoring because of a zero stop on the meter.

When the load has increased to the capacity of the hydroelectric unit the conditions prevailing before the noon hour are restored. The boiler operation is approximately as follows: a short time before noon the rate of coal feed is reduced so as to lower the steam sufficiently to avoid "blowing-off" as the load drops. The burner flames are extinguished just before the beginning of the motoring period, but are relighted occasionally as required to maintain the pressure within the desired range.

*Special Governors.* In order to change the per cent speed regulation on the standard type of governor it is usually necessary to shut down the steam turbine. In a hydroelectric steam system such as has been described, when the steam unit is carrying the base load it is desirable that its regulation should be relatively large, whereas when it is carrying the load fluctua-

December, 38 deg. fahr. (3.3 deg. cent.), was found to be 15,200 kw. limited by the turbine, and for highest water temperatures in September, 75 deg. fahr. (23.9 deg. cent.), 13,200 kw. at 100 per cent power factor, limited by the heating of the generator field.

**Pulverized Fuel.** The principal reasons for installing a pulverized coal burning plant were as follows:

1. It was believed that during the low-flow period when the steam units would carry heavy base loads as well as during the high-flow period with its fluctuating loads, the pulverized system would have an advantage over stokers in being able to maintain good efficiencies over a wider range of load with varying grades of fuel.
2. It was desired to reduce the starting and banking losses to a minimum. With a stoker-fired plant these would have been particularly great during the high-flow period when the steam plant carries peaks and fluctuations as outlined above.
3. Any known and tried stokers suitable for burning fine sizes of anthracite coal would not have been adapted to the use of eastern bituminous coal. It was believed that it would be possible by adopting the pulverized coal process to prepare and burn either or both types of coal with the same equipment. It will be shown later under operating results that this hope has been fulfilled. The high speed ball type of pulverizing mill was adopted because it is best suited for the preparation of anthracite as well as bituminous coal.
4. Economies could be effected in preparation of coal by utilizing surplus off-peak hydroelectric energy in high flow for operating the pulverizing plant.

CONSTRUCTION AND COST DATA

Decision to build the steam plant was made April 2, 1924. The turbo generators were ordered May 23rd, and excavation began June 24, 1924. The first generat-

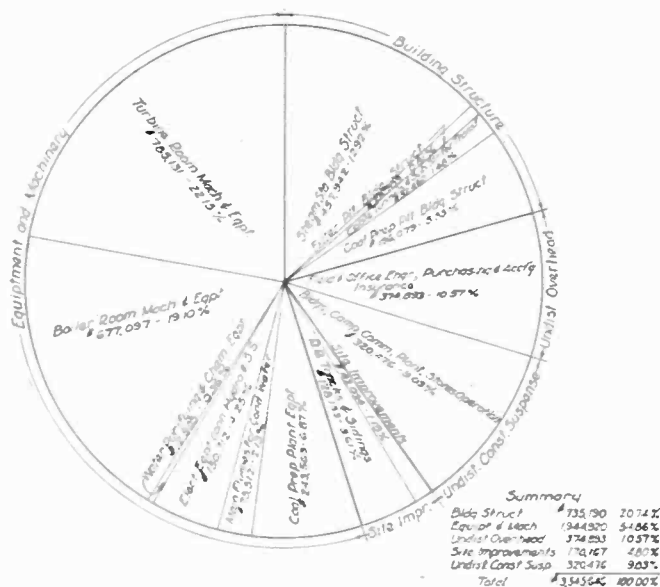

FIG. 8—ANALYSIS OF CONSTRUCTION COSTS

ing unit went into regular commercial operation July 20, 1925, and the second on August 4, 1925.

The design work was carried out by the Consolidated Gas, Electric Light & Power Company of Baltimore. The field engineering and construction work was handled by the power company's own forces.

Fig. 8 is a summary of the cost of the plant, ex-

clusive of property, legal and corporate expenses, housing for employees, interest during construction and exclusive of any contractors' fees. There are several factors which should be borne in mind in comparing these costs with those of other plants. The present boiler installation is larger than needed for the first two turbines, and surplus pulverizing capacity on a bituminous rating was installed to off-set partially the reduction in capacity when milling river coal. Switching equipment is installed for two more units and the cable tunnel to the hydroelectric plant will take care of the ultimate station. The intake and discharge tunnels are built for two more units of a capacity up to 35,000 kw. each. The width of the power house is sufficient to accommodate units up to 35,000-kw. capacity and larger boilers.

It may be of interest to note that the cost of the preparation plant per net ton of pulverized output per hour on a bituminous rating was \$8,720 for structures and \$10,830 for equipment, or a total of \$19,550.

OPERATING RESULTS AND EXPERIENCE

**General Results.** In the calendar year 1926, the gross output of the steam plant was 60,870,000 kw-hr. The station uses, including coal handling and preparation, amounted to 4,200,000 kw-hr., or 6.9 per cent, giving a net generation of 56,670,000 kw-hr. The one-hour peak load was 26,600 kw. or 33 per cent more than the nominal rating of the two units. The annual load factor was 26.1 per cent and the annual capacity factor based on gross generation was 34.8 per cent. The variable character of the plant load is shown by the fact that the highest net output was a little over 10,000,000 kw-hr. in the month of July, whereas the lowest output was only about 2,500,000 kw-hr. in the month of October. 1926 was a year of better than average river flow, which accounts for the relatively low output of the steam plant.

The average economy for the year was 21,160 B. t. u. (5331 kg-cal.) per net kw-hr. The best weekly economy reported was 18,350 B. t. u. (4623 kg-cal.) per net kw-hr. burning 100 per cent bituminous, the best weekly economy burning 100 per cent anthracite was 19,800 B. t. u. (5010 kg-cal.) per net kw-hr. The average boiler and furnace efficiency for the year was 79.6 per cent without allowance for dryer fuel or for energy requirements of the boiler auxiliaries.

The boilers have operated up to 385 per cent rating for a few hours at a time. The average rating for the total steaming period was 201 per cent.

Of the total coal used, 35.4 per cent was river anthracite and 64.6 per cent bituminous.

The balance of the paper, which is printed in full in pamphlet form, compares the plant operation with river anthracite and with bituminous fuels, describes the excellent outage record of the Holtwood steam units in 21 months of operation, and gives details of various minor difficulties which have been met and remedied since the plant was put into operation.



# Joints in High-Voltage Multiple-Conductor Cable

BY THOS. F. PETERSON<sup>1</sup>

Associate, A. I. E. E.

*Synopsis.*—In this paper the author has outlined the evolution of multiple conductor joints and explained in detail the development of a three-conductor, high-voltage joint for use with belted and metal sheathed cables or combinations of these.

In the final design, spreaders and barrier tubes have been replaced

by specially reinforced crotches and hand-wrapped insulation. To date, all tests,—short time and accelerated life, a-c. and d-c.,—have produced failures in cable rather than in joints so constructed. Many other claims of superiority over existing types are presented.

\* \* \* \* \*

LITERATURE on high-voltage cable theory, design, testing and operation is remarkably voluminous. This fact is especially noticeable when comparison is made with the meager data available on joints or splices and characteristics of jointed cable systems. Only recently have questions pertaining to the last mentioned been treated or emphasized in technical papers and discussions. It is quite pleasing however, to note their appearance in papers such as Del Mar's on the Effect of Internal Vacua, and others on the use of reservoirs and design of joints. This paper falls in the same category as the latter and constitutes a presentation of data on design, installation and operation of joints on high-voltage systems with which the author has been intimately associated.

In its final analysis a joint may be considered as a reconstruction of cable brought into being because it is physically impossible to maintain continuity of cable from one end of a feeder to the other. Most efficient design would dictate using a joint somewhat stronger electrically than the cable with which it is made. Except in a few cases, this is theoretically possible, although often it would appear as though "Brute strength" tactics were used in its accomplishment. Single conductor joints, those in metal sheathed and braided cable with immense amounts of insulation and those in multiple-conductor cable of monstrous size, typify these. The evolution of joints, with improvements gained partly from experience and more recently by the application of scientific principles of design, constitutes an extremely interesting subject for study.

When viewed in its entirety, one notices that the trend in joint design has followed rather closely that in cable design and quite justly so, since joint construction is, in a sense, cable reconstruction. When the old Edison tube was in use splices were made in enlarged coupling boxes, these being filled with hard compound as was the tube. Following this, various types of taped and rubber covered cable were developed. However, joints were made as before, except for the introduction of barrier tubes. Increase in operating voltage then gave rise to changes in impregnating compounds. At the same time difficulties with voids in hard compounds which were unavoidably produced during filling and

with charring of paper, necessitated the use of such filling compounds as petrolatum and the introduction of hand wrapping, still however, retaining the barriers. In more recent developments based on knowledge of cable breathing, migration of compound into cable, stress distribution, etc., oil and reservoirs have been used at joints, barriers eliminated, crotches reinforced and, from one point at least, it would seem that joint construction has overtaken that of cable inasmuch as very little oil filled cable has as yet been placed in operation.

It is quite evident that in old designs, creepage paths were considered as the most important factors determining dielectric strength, this probably being derived from experience with joints on d-c. systems in which moisture, condensation, poor workmanship, impurities

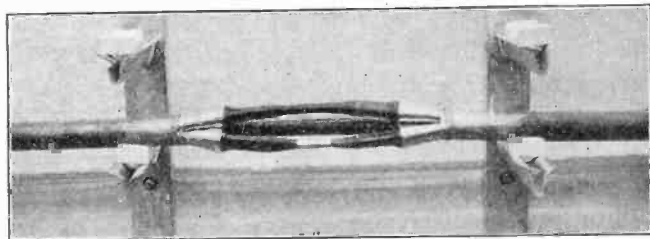

FIG. 1—METAL SHEATHED CABLE JOINT IN CONSTRUCTION

and the like contributed largely to failures. There seemed to have been no regard for stress distribution, dielectric constant relations of insulating materials and so we find barriers, tubes, porcelain, mica, paper, compounds, etc., in series with one another in various proportions and placed indiscriminately in the electric fields. These statements are not intended to belittle the importance of leakage paths but rather to encourage consideration of all phases of design.

Quite general practise today consists in operating with alternating current and testing with direct current. Under alternating potentials at standard frequencies, the dielectric stress distribution is dependent on the configuration of electrodes and the constants of the dielectric circuits. On the other hand such distribution exists only at the moment of application of direct or steady potential differences. After this, redistribution takes place in the form of a slow transient with end conditions depending on the resistivities of paths. If then, total stress is sufficiently high, failure will occur along the path of minimum resistance. Though the

1. With the Brooklyn Edison Co., Inc.

To be presented at the Summer Convention of the A. I. E. E., Detroit, Mich., June 20-24, 1927.

stress distribution under alternating current is determined primarily by dielectric constant relations, a component may always be determined acting in the direction of the leakage path and tending to produce this type of failure. It is obvious that the direct potentials with total voltage applied to path, are more severe. However, it is felt that defects brought to light by the comparatively high tests based on cable requirements are well worth removing and that the testing does not necessarily invite trouble. The importance of consideration of leakage paths as well as dielectric constant relations is thus brought out.

While the company with which the author is connected, was contemplating operation at 27 kv., many tests were made on multiple-conductor joints. Inasmuch as this was done under pressure of time no radical departures from standard types or accepted practises were made. Finally, one, hand wrapped, petrolatum filled, with porcelain spreaders and mica barrier tubes was adopted. Results with this type were fairly satisfactory. After several years of operation, however, a rather high percentage of failures was experienced on test which, on examination, were almost all found to have started at connectors, then continuing along pencilling and conductor insulation or barrier tubes to ground. These were due to such causes as follows:

1. Copper dust produced by filing connectors.
2. Jagged pencilling of conductor insulation.
3. Wrinkled conductor insulation. (2 and 3 giving rise to voids).
4. Compound having been driven from mill insulation at pencilling by heat during sweating of connectors.
5. Migration of compound into cable, making most probable location of voids on contact surface between mill insulation and hand wrapping.
6. Sharp edges of solder, connectors, etc.

It is quite obvious why, with such causes as these conspiring to produce trouble, direct-current tests, at 95 kv., conductor to ground, and 135-kv., conductor to conductor, were so effective in weeding out defects.

The cures for these evils were soon found. Advances were made in cable manufacture, (wrinkles being practically eliminated), pencilling was improved, one or two layers of varnished cambric tape was used over connectors, etc. These, with pressure filling, gave rise to a fairly satisfactory joint but, like "Champions and Records," this did not stand long, for tests at the laboratory under three-phase, alternating current revealed other weak places, namely, at the crotches and porcelain spreaders. Just about this time one Company whose experience in this direction was very similar to ours began to experiment with wooden spreaders, the idea being that with a dielectric constant more nearly equal to that of impregnated paper better results would be obtained. Our progress was along different lines.

For some time manufacturers and those engaged in testing of cable had suffered a serious handicap in not being able to carry tests of three-conductor cable to

satisfactory completion because of breakdowns which invariably occurred at the crotches. The author was confronted with and quite successfully solved this problem about 2½ years ago. Examinations of crotch failures of cable tested under oil indicated that there were three outstanding causes for these, namely:

1. Ruptured conductor insulation due to sharp bending.
2. Breakdown of film of oil and then paper at crotch.
3. Circumferential stresses on conductors.

The first was removed by fanning out legs in stages, that is, removing part of belt and bending legs, using edge of belt as a fulcrum.

The second did not yield so readily to the corrective measures applied. The attack was based on observations made during two tests devised to bring out the existence of this cause.

A roll of impregnated tape was used as a spreader in

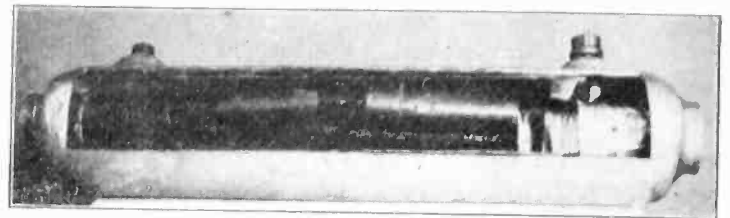

FIG. 2—CUT-AWAY OF JOINT IN BELTED CABLE

Joints of this type tested: 120-kv. three-phase, 10-65 hours.  
Failures in cable: 130 kv. 15 hr. and 276 kv. instantaneous failure in cable.

a crotch. After application of three-phase voltage, the roll was badly burnt due to breakdown of oil at its center. At another time a sample was prepared and the crotch placed in a glass jar of clear oil. Spark discharge across film of oil in crotch was very much in evidence.

The dielectric constant of oil is approximately 2.5 and that of impregnated paper 3.2 to 4.1. When insulations are in series in a dielectric circuit distribution of stress is in inverse proportion to dielectric constant. It is seen, therefore, why oil or compound was stressed beyond its rupturing strength, broke down and the resultant heating, charring, etc., finally culminated in breakdown of adjacent paper<sup>2</sup>.

Circumferential stresses on conductors manifested themselves by the appearance of tree formations at crotches through several layers of paper on the backs of conductors of certain types of cable, though these very rarely resulted in failure.

A rather simple solution for the above difficulties was arrived at after making some exhaustive tests using barriers, cotton and the like jammed into crotches, short circuiting oil by wrapping legs with electrostatic shields, using wrapping of wick. Finally, after carefully

2. See author's discussion of paper on a 132-kv. joint, by D. M. Simons, presented at A. I. E. E. Winter Convention, 1927.

bending conductors, each leg was built up conically with black varnished cambric tape starting deep in the crotch and extending out 5 inches, the maximum thickness being  $\frac{3}{8}$  in., 4 inches from belt edge. (See Figs. 2 and 4). The conductors were drawn together and a varnished cambric belt was applied at crotch to the level of the factory belt. Then the lead sheath of cable was extended, using lead foil, to the point of maximum thickness of varnished cambric. The lead foil and varnished cambric belt were punctured to allow oil to enter where normally fillers would be. With this type of con-

ductors equal to the distance inward to the actual neutral axis of the cable. Similar crotches were used in testing metal sheathed cables, except that after building up individual legs with varnished cambric the metallic tape of cable was extended and carried over each leg to the point of maximum thicknesses of varnished cambric (see accompanying illustrations).

Results with this construction were highly satisfactory yielding failures in cable after runs of 35 to 50 hours at 120 kv., three-phase as compared with 3 to 8 hour crotch failures previously obtained and so it was recommended for use in crotches of joints on our 27 kv. system. In the latter role, the applied varnished cambric served not only as a reinforcement, but also as pacer, thus eliminating another objectionable features of existing joint, namely, the porcelain spreader. (See Fig. 4).

Before its adoption for use in connection with metal sheathed cable, comparative high-voltage tests were made on joints in which metal foil was ended at crotch, *i. e.*, cut off and tied down, carried across connectors, over hand-wrapped insulation, etc. In all these, the decided superiority of the built up construction was shown. Joints with metal tape carried across the hand-wrapped insulation failed after about twenty minutes at 120 kv., while those with tape ended at crotch were but a little better. In the first, failures occurred across stepped and conical penciling. This type of joint would seem unsatisfactory at first sight (despite the fact that some manufacturers stand by it because radial stresses are maintained throughout) since filling compound is of no avail in taking up stress and the total voltage is applied to a comparatively weak path between pencil and hand wrapped insulation. Joints made in manner described, that is, using built up crotches, have withstood tests at 120 kv. for 10 to 60 hours without failure. In all cases rupture has occurred in cable. This is quite favorable, when compared with the results obtained on standard Conducell joints which have averaged 3 to 10 hours at 120 kv., three-phase.

Hand wrapping of joints with tape has always been a long and tedious operation in which the personal equation of the worker is a most important item.

Prior to making the aforementioned studies and tests, an attempt was made to reduce manual labor involved in joint construction by substituting barrier tubes and spacers made of bakelite and the like, for the hand wrapping. Results of voltage tests were very discouraging since failures occurred at 120 kv. after from one-half to one hour, the higher values being obtained with the thinner tubes. Careful examination and investigation indicated that such devices which had high dielectric constants and were of such shape as to place small thicknesses of compound in series with them thus greatly overstressing the latter, were of no use and should be avoided. Barrier tubes were accordingly eliminated from final design (see Figs. 4 and 5) and some additional paper hand wrap was applied over connectors,

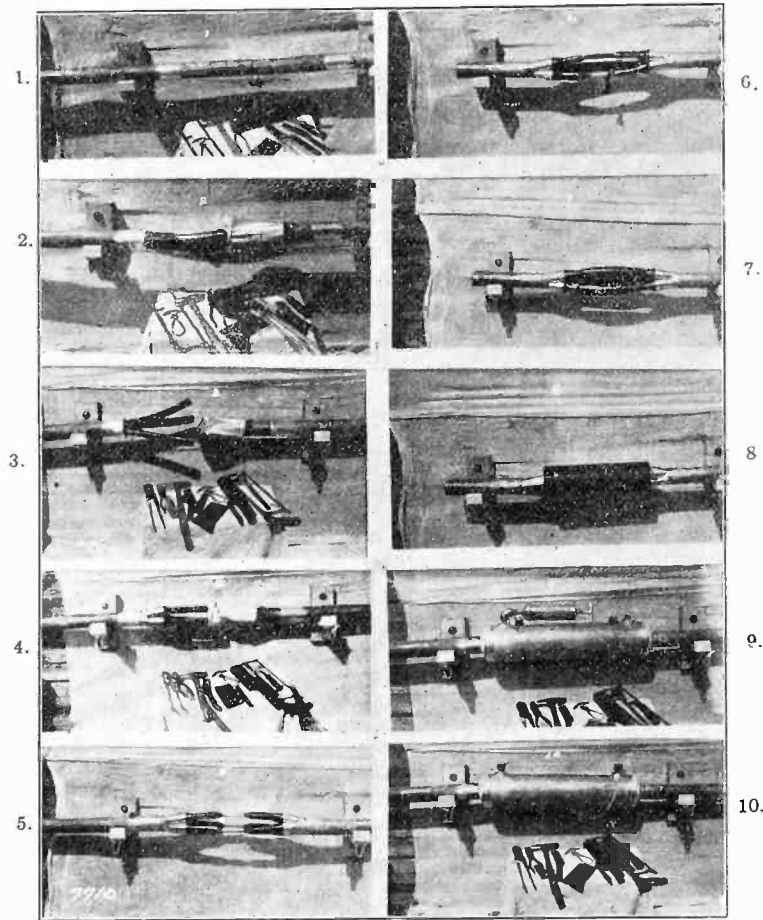

FIG. 3—SHOWING STAGES OF CONSTRUCTION

1. Cable butted
2. Fanning conductors
3. Conductors covered with one layer of tape
4. Crotch built up metal foil applied
5. Connectors sweated
6. Hand wrap
7. Hand wrap
8. Barrel slipped into place
9. Pressure filling
10. Caps on—completed joint

struction, overstressed oil films at crotch were replaced with varnished cambric. The latter with its high dielectric constant (approximately 5) in comparison with impregnated paper (approximately 3) assumed very little of the total stress between conductors, but still took a sufficient per cent to relieve the paper at crotch and make the stress in it considerably lower than in the rest of the cable. The foil served to eliminate circumferential stresses by maintaining a zero potential surface at a distance outward from the center of the con-

a very reasonable change, considering the facts that the paper serves as the necessary barrier in compound and makes it possible to retain comparatively long paths through compound thus increasing strength of joint, without over-stressing component parts.

Confirmatory test results similar to those recorded

95-kv., direct potential differences, conductor to ground, have been made without the slightest indication of any developing failure. These data, together with very satisfactory operating experience serve as evidence for claims of superiority of this joint.

Joints installed in practise do not differ materially from

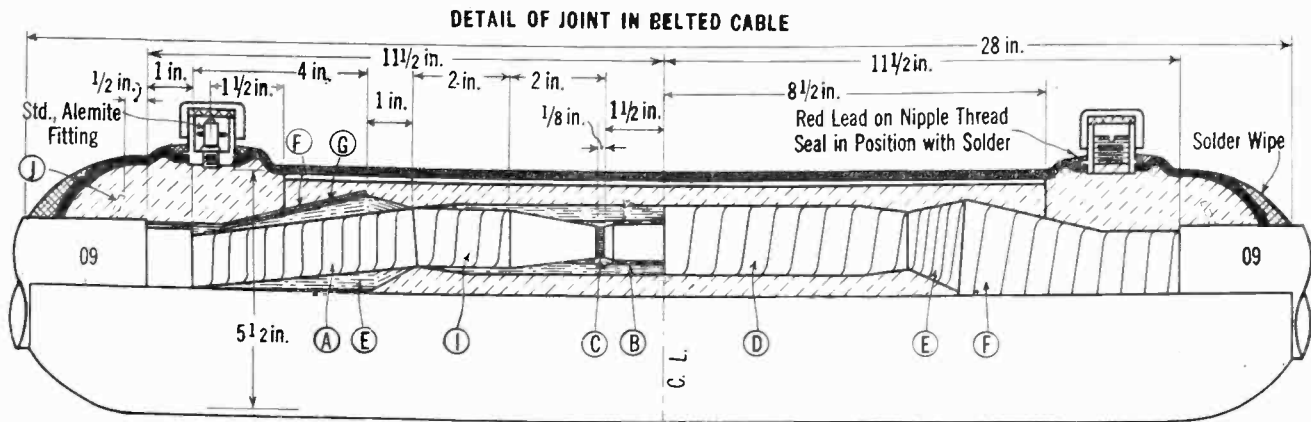

- A. One layer, 3/4-in., black varnished cambric on each conductor.
- B. One layer, 3/4-in., black varnished cambric on each connector.
- C. Varnished cambric strips 1/8 in. to 3/4 in. wide to level of connector diameter.
- D. Paper tape
- E. 3/4-in. black varnished cambric conical wound as shown.
- F. One layer 5/8 in. lead foil around all three conductors.
- G. Black varnished cambric around all three conductor.
- H. Varnished cambric 5/16 in. thick 4 in. from belt.
- I. Remove v. c. tape 2 in. from edge of pencil, also one layer of conductor insulation before applying paper tape.
- J. Bell to be beat into original position after crotch is finished.

FIG. 4—SPECIFICATIONS FOR 3-CONDUCTOR, 27,000-VOLT, 09 CABLE JOINT 27-3

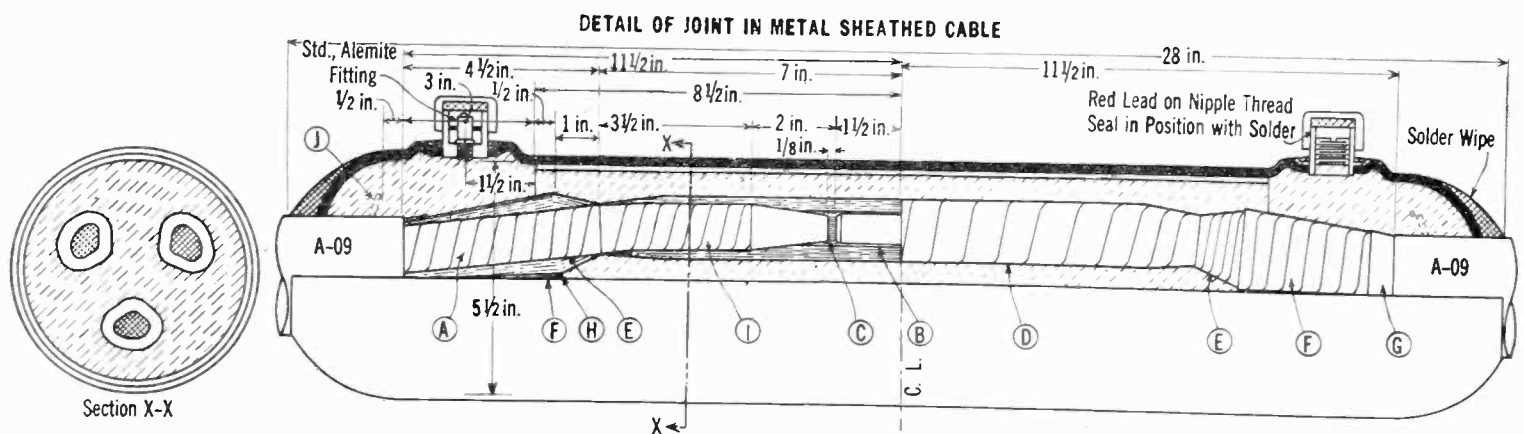

- A. One layer, 3/4-in. black varnished cambric on each conductor.
- B. One layer 3/4-in. black varnished cambric on each connector.
- C. Varnished cambric strips 1/8 in. to 3/4 in. wide to level of connector diameter.
- D. Paper tape.
- E. 3/4 in. black varnished cambric conical wound as shown.
- F. One layer, 5/8-in. lead foil on each conductor from highest point to bottom of crotch and in contact with copper foil on conductors.
- G. 5/8 in. lead foil two layers around all three conductors and in contact with outer metallic tape of cable.
- H. Varnished cambric 5/16 in. thick 4 in. from bell.
- I. Remove v. c. tape 3 1/2 in. from edge of pencil; also one layer of conductor insulation before applying paper tape.
- J. Bell to be beat into original position after crotch is finished.

FIG. 5—SPECIFICATIONS FOR 3-CONDUCTOR, 27,000-VOLT, A-09 CABLE JOINT, 27-3

have recently been obtained by another of the Metropolitan companies which has adopted this type of joint for metal-sheath cable. In addition to the above alternating-current tests, run of five hours duration at

those described. Conductors are carefully fanned out and covered with one layer of tape to exclude foreign matter, crotches are built up, connectors are sweated, insulation pencilled conically (approximately 2 in. long) and sand-

papered. Then gaps between insulation and connectors are built up with thin strips of varnished cambric and one layer is applied over connector. One layer of mill insulation is removed from conductors and finally each leg is built up with hand-wrapped tape. An insulating barrel is used inside of lead sleeve, merely for mechanical protection and joint is either pressure filled with petrolatum, or oil filled and equipped with a collapsible reservoir or the like. Though this joint is somewhat more difficult to make than the usual type and depends quite largely on the ability of the splicer, little difficulty is experienced in the field, when men are properly trained.

In the foregoing we have been concerned more particularly with electrical rather than mechanical characteristics of joints. The latter, however, are of immense importance. Absolute cleanliness should be exercised. Wipes, plugs and material must be such as to insure against introduction of moisture. Though voids are not likely to exist at time of filling, they may develop in practise, hence fittings, location in manholes, etc., must be arranged to facilitate periodic inspection, refilling of joints, or installation of reservoirs. These can best be dealt with as individual problems.

Summarizing, then, it may be said that a joint has been developed having high leakage resistance, good

stress distribution and on which our test results, both alternating-current and direct-current, and operating experiences, are quite satisfactory. (Note: No studies have been made of dielectric loss because to date nothing in our experience has indicated the need for consideration of same). Furthermore, barriers and spreaders have been eliminated and a zero potential surface has been established around the crotch which gradually extends out toward sleeve, thus tending to maintain radial stresses throughout joint. In addition, due to removal of tubes, phasing out of cables is more easily accomplished since conductors in joint do not have to be run parallel to cable. Instead of having two bends in the conductors one at each end of the joint, and then a straight run through cells or tubes as is necessary in the barrier type joint, the lay or twist may be continued through the joint. Last, and perhaps most important, is the universality of the joint. Not only can it be used with belted cable and metal sheathed cable, round or sector conductor, but also with combinations of these.

It is not intended that these statements be construed to mean that perfection in joint design has been reached. The author expects to attempt improvements from time to time and profit by criticism which will undoubtedly accompany its more general adoption.

## The Oscilloscope: a Stabilized Cathode-Ray Oscillograph With Linear Time-Axis.

BY FREDERICK BEDELL<sup>1</sup>

Fellow, A. I. E. E.

and HERBERT J. REICH<sup>1</sup>

Non-member

*Synopsis.*—A method is described for using a cathode-ray oscillograph for the simultaneous observation of a number of variable quantities by means of a distributor. A linear time-axis, obtained by means of a gas-discharge lamp connected to a source of direct-current through a resistance or thermionic tube, is stabilized by introducing into this circuit a small e. m. f. derived from the same source that supplies the unknown quantities under observation. By

making stabilization definitive rather than casual, distortion is avoided. The unknown quantities are thus shown in a form convenient for observation, appearing as stationary curves plotted with time as abscissa. The curves may be superposed about a common zero line, or displaced with reference to each other with separate zero lines. The name oscilloscope is applied to the apparatus here described, assembled as an instrument.

THE oscillograph employing a vibrating cathode ray, first used by Braun and later so admirably developed by Ryan and others, has certain distinct advantages over the oscillograph of the Blondel or Duddell type in which a vibrating mirror is used. Foremost among these advantages is the fact that the cathode beam is free from inertia and can readily follow the variations of an electric or magnetic field even at high frequencies. The cathode-ray oscillograph, as hitherto commonly employed, has, however, the disadvantage that it has not been possible with it to show the variations in a number of quantities at the same time, nor to show these variations, as is done

with the vibrating mirror oscillograph, as curves with time as abscissa in rectangular coordinates with which everyone is familiar.

While the cathode-ray oscillograph has proved a highly valuable tool for a wide range of engineering and scientific investigations, including both cyclic and transient phenomena, and, in certain respects, is superior to the oscillograph of the mirror type, it has suffered by the two limitations just described. These limitations, however, may be removed and the field of usefulness of the cathode-ray oscillograph so widened that it becomes practically a new instrument. As the instrument developed for this purpose, (shown in Fig. 1), is primarily intended for visual observation, we have given it the name "oscilloscope." Permanent record may be obtained, when desired, by a photograph in the

1. Both of Cornell University.

Presented at the Regional Meeting of District No. 1 of the A. I. E. E., Pittsfield, Mass., May 25-28, 1927.

usual way. On the other hand, an *oscillograph* of the Blondel or Duddell type, both in name and in fact, is primarily for graphical record.

Not being limited to a single cyclic phenomenon, the oscilloscope is polycyclic; furthermore, it is stabilized so that the wave or waves stand stationary for observation and this becomes particularly important when several waves are observed at one time. Recurrent

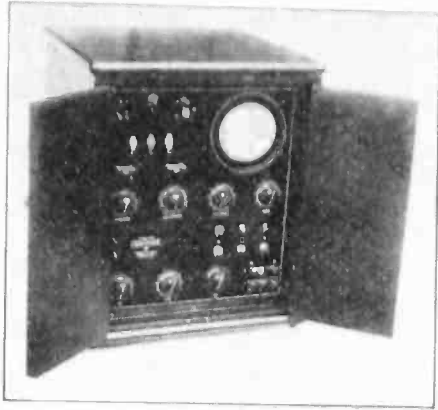

FIG. 1—STABILIZED OSCILLOSCOPE, FIELD TYPE

transients, as well as more usual periodic phenomena, may be observed.

The cathode-ray oscillograph tube is so well known that it needs no description. The cathode beam, focused on a fluorescent screen or photographic plate, is deflected in one direction by one set of plates or coils, and in a perpendicular direction, by another set of plates or coils.

An admirable and full account of various types of cathode-ray oscillographs and their development from the beginning is given by A. B. Wood and others in the *Journal I. E. E.* (Nov., 1925), with 63 pages and 125 references. So complete is this account, (with its bibliography), and so admirable is the presentation that further discussion here is unnecessary.

#### THE POLYCYCLIC DISTRIBUTOR

In using the cathode-ray oscillograph, it occurred to the writers that if one pair of deflecting plates or coils could be successively switched by a distributor from

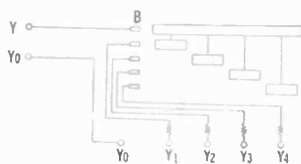

FIG. 2—POLYCYCLIC DISTRIBUTOR

circuit to circuit in rapid succession, the cathode beam would follow each in turn, making possible the simultaneous observation of several unknown quantities. We have found this to be the case and that when switched at proper intervals, the curves appear to the eye as simultaneous and continuous, due to persistence of vision, and likewise so appear in a photographic record.

The development of a four-way experimental distributor for this purpose is shown in Fig. 2. A resistance is included in each of the four circuits as protection in case of short-circuit. A brush *B* bears on a continuous slip-ring to which are connected staggered quadrants. Each of the remaining four brushes comes in contact, in turn, with one of these quadrants. The terminals  $Y_0 Y$  are connected to one pair of deflecting plates of the oscilloscope, the terminals  $Y_0 Y_1$ ,  $Y_0 Y_2$ ,  $Y_0 Y_3$ ,  $Y_0 Y_4$  being connected to the several circuits under test. It will be noted that  $Y_0$  is a common terminal; if any of the circuits cannot be so connected, an insulating transformer should be interposed between such circuit and the distributor terminals. Avoiding the common terminal, a double distributor can be used in a special case when necessary.

#### LINEAR TIME-AXIS

A linear time-axis, desirable for the observation of a single quantity, becomes almost a necessity in order to make a satisfactory interpretation possible when several quantities are simultaneously studied.

The need for a linear time-axis with the cathode-ray oscillograph has long been recognized and various ingenious methods have been proposed for its accomplishment, often, however, with but limited application. Mechanical devices are limited in range of frequency; electrical devices, although not thus limited, are liable to be unstable, and stability, as has been pointed out, assumes prime importance when several curves are simultaneously observed, as any motion of the curves creates hopeless confusion. Even for a single curve, stability is needed if the curve is to be carefully studied and perhaps sketched, traced or photographed. Furthermore, electric devices without proper precautions are liable to produce distortion.

A linear time-axis may be obtained if we have available either a synchronous mechanical switch or a synchronous electric valve. Thus, if a condenser is charged at a uniform rate through a resistance, or otherwise, and is periodically discharged by a synchronous switch, the difference of potential across the condenser terminals will increase linearly with time while the switch is open, and drop suddenly to zero each time the switch is closed.

#### THE CORONA VALVE

A mechanical synchronous switch is cumbersome and can be operated only at low frequency. A synchronous electric valve that would automatically perform the same function at high or low frequency would evidently be better. Such a valve is found in the gas-discharge lamp, containing commonly neon or argon, the characteristics of which are well known. (See bibliography). When subjected to an increasing voltage, no current will flow through such a lamp until a certain critical "ignition" voltage is reached. Current then flows (analogous to the closing of the switch) and continues to flow until a definite lower "extinction" voltage is

reached. Current then stops, analogous to the opening of the switch. The difference between the ignition and extinction voltages depends upon the frequency and type of lamp.

Each gas-discharge lamp possesses a certain capacity, so that, when connected to a source of e. m. f. through a resistance (in excess of a certain "critical resistance"), the lamp will light and re-light at definite frequency. This frequency may be varied through a wide range by varying the resistance and capacitance of the circuit.

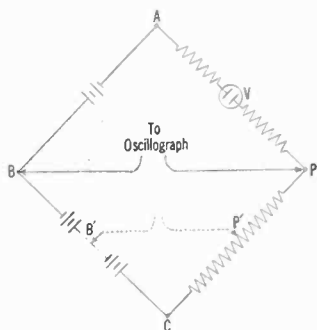

FIG. 3—BATTERY OPERATION

The gas-discharge lamp acts as a synchronous electric valve, performing the functions of a synchronous mechanical switch. Due to its nature, it may be referred to as the "corona valve."

Many theoretical and experimental studies (see bibliography) have been made of this phenomenon. Suffice it to say that the oscillation frequency is under control by adjustment of resistance and capacitance, the maximum frequency being obtained by reducing capacitance—including the capacitance of all circuit connections—to a minimum. Capacitance may be obtained by means of condensers in parallel with the corona valve or in parallel with a series resistance.

While the oscillating circuit can be adjusted for audio,

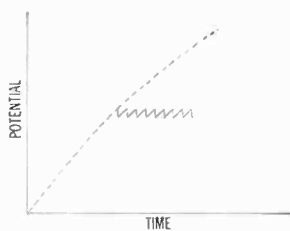

FIG. 4—POTENTIAL VARIATION

commercial and lower frequencies, frequencies much higher than audio-frequencies are not readily obtainable with usual apparatus. A frequency of 95,000, however, is reported by Oschwald and Tarrant, using a resonant circuit; but resonance tends to produce a sine-wave oscillation rather than the straight saw-toothed wave required for a true linear time-axis, and is to be avoided in an oscilloscope in which accurate reproduction of wave-form is sought. On the other hand, low frequencies, of, say, one every minute or, indeed, every hour, are obtainable and there is no

obvious reason why with sufficient capacitance, (and patience), one could not reduce the lower limit almost indefinitely, if there were any object in so doing.

OSCILLATING CIRCUIT

Circuit connections for obtaining a linear time-axis, are shown in Fig. 3. In the resistance circuit *A P C*, connected to the battery *A B C*, is inserted the corona valve *V*, which, either alone or with supplemental condensers in parallel with it, has a capacitance *c*, and a potential difference  $v = q/c$ . The corona valve passes no current, acting as an open switch, until the potential difference between its terminals, as charge accumulates, reaches the ignition voltage. Current then flows and the potential difference drops until extinction voltage is reached; the current then stops, the potential difference again builds up and the cycle is repeated.

Fig. 4 shows the variation in the difference of potential between a point *P* in the resistance circuit and a point of reference *B* of fixed potential. The curve of potential-rise is exponential, as shown by the dotted curve. By using only a short element of this curve, the

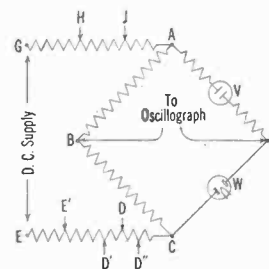

FIG. 5—RESISTOR OPERATION

rising part of the saw-toothed curve is sufficiently straight to give the desired linear time-variation, when *P* and *B* are connected directly or through an amplifier to the deflecting elements of the oscillograph. Other points, as *P'* and *B'*, give a similar but smaller variation, the amplitude of the time variation being capable of adjustment in this manner. The short, falling part of the saw-tooth curve, corresponding to the brief interval during which current is flowing through the corona valve, is so rapid that the spot of light on the oscilloscope screen shows only a negligible trace as it sweeps back to repeat the cycle.

Fig. 5 shows the connections for operating the oscillating circuit when a thermionic tube *W* replaces part or all of the resistance in series with the corona valve. A constant current through *W*, when operated above saturation, gives a uniform increase in *v* during the rising part of the saw-tooth curve, and so assures a linear time-axis.

Connections are likewise shown in Fig. 5 for operating the oscillating circuit when resistors, supplied with direct current from a generator or battery eliminator, are used in place of batteries. The same resistor system may supply the accelerating potential for the cathode-

ray tube as well as any voltages that may be needed for bias or for the vertical or horizontal displacement of the cathode-ray beam. Operation with such a resistor system is very convenient, giving a nicety of adjustment not possible with batteries, provided precautions are taken to design the circuits, (including the circuits of a battery eliminator, if used), so that the several adjustments are sufficiently independent. The use of more than one eliminator would, of course, obviate the difficulty, but a single eliminator, properly compensated and designed for the purpose, will suffice. After the use of such an eliminator, batteries seem cumbersome and are a source of error when they do not give just the proper voltage. When a generator supply is used, commutator ripples may be filtered out, if necessary.

### STABILIZING

In order that the curves shown by the oscilloscope may be stationary, it is necessary first to synchronize and then to stabilize the oscillating circuit; that is, the frequency of the oscillating circuit is first so adjusted that the cathode beam sweeps back once every half cycle, or some multiple of it, of the varying quantity under observation, and is then locked in step and so stabilized. As an automobile engine is first synchronized and then thrown into a particular gear, the oscillating circuit is synchronized and then thrown into the desired gear, electrically, so the curve shown includes one or more cycles, or half cycles, of the quantity observed, as may be desired. Without being thus stabilized, the curves are liable to move and make observation difficult.

Stabilization may be effected in various ways, the simplest method being by introducing into the oscillating circuit a very small e. m. f. of the same frequency as the circuit under observation. This may occur in a way that is *casual* and uncontrolled, (whether by accident or design), through leakage or induction; thus, under certain conditions, we found that curves stood still when the operator merely raised his hand as though warning an animate being. Such stabilizing was promising and fascinating. Casual stabilizing, however, produces distortion; for, unless the stabilizing e. m. f. is controlled, some of it will affect the oscillograph circuit. To avoid distortion, stabilizing must be *definitive*, and the e. m. f., whether introduced conductively or inductively, so localized and controlled as not to affect the oscillograph. Thus, without attempting to discuss all possible methods of stabilizing, it is obvious that the distortion produced by the introduction of an e. m. f. at *J D*, (Fig. 5), while appreciable, would be far less than if the e. m. f. were introduced at *P B*. The authors have found that, for the apparatus employed, it is possible to obtain a definitive stabilization without distortion and with an amount of energy so small that the disturbance to the circuit under test, even when it is very sensitive, is practically negligible.

The oscillating circuit may be brought to the proper frequency and then stabilized so as to show a single cycle or half cycle; or it may be brought to a lower frequency, (whereby more time is taken for the spot to sweep across the screen along the time-axis) so that several cycles or half cycles are shown. In observing 60-cycle phenomena, the oscillating frequency may, for example, be stabilized at 30, 15, 10 or 5 cycles, with,

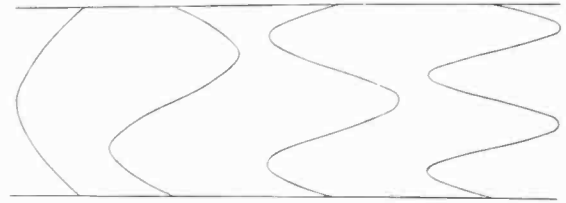

FIG. 6—STABILIZING WITH GEAR RATIOS  $\frac{1}{2}$ , 1,  $1\frac{1}{2}$  AND 2

however, a decrease in stability. In this way, for the same phenomenon, different gear ratios may be used and curves as shown in Fig. 6 be obtained.

### ZERO LINE

Curves are ordinarily superposed, as in Fig. 7, either

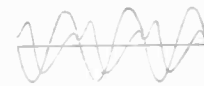

FIG. 7—SIMULTANEOUS CURVES, SUPERPOSED, WITH OR WITHOUT ZERO LINE

with or without a zero line. A zero line is obtained by a short-circuiting connection between  $Y_0$  and  $Y_1, Y_2, Y_3$  or  $Y_4$ , in Fig. 2.

### DISPLACEMENT

A curve may be displaced (raised or lowered) with respect to the others by interposing a battery, or other source of d-c. voltage, between it and the common terminal  $Y_0$ . Several curves may be so displaced, up or down, by varying amounts, depending upon the voltage and polarity of the battery.

A displaced zero line is similarly obtained by using a battery instead of a short-circuiting connection referred

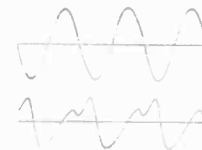

FIG. 8—SIMULTANEOUS CURVES, DISPLACED, WITH OR WITHOUT ZERO LINES

to above. Two zero lines may be used, one displaced with respect to the other, as in Fig. 8.

When a resistor system as shown in Fig. 5 is used for supplying accelerating potential to the cathode tube, displacement without batteries may be obtained by connecting the unknown not to  $Y_0$  (and so to some point as *D* on the resistor) but to  $D'$  or  $D''$  displaced therefrom.



## USES

The oscilloscope may be used not only in the varied fields of investigation in which the vibrating mirror or cathode-ray oscillograph is used but, on account of the characteristics here described, in additional fields as well. The stability of the linear time-axis, together with the multiple use of the oscilloscope by means of the polycyclic distributor, at once opens the way to many varied applications. With the oscillating circuit switched off, the instrument becomes available for all the uses of a cathode-ray oscillograph in the usual manner. The stabilized linear time-axis is an added feature extending its usefulness.

On the other hand, the oscillating circuit may be used independently as a convenient source of current of controllable frequency. An ammeter in circuit may be used to indicate the frequency. A loud speaker connected through an amplifier becomes a source of sound of controllable, known pitch.

Although not limited to any one type of cathode-ray tube, a well-known low-voltage tube described by Johnson (*Journal Opt. Soc.*, 6, 701, 1922) has been found well adapted for the oscilloscope and arrangements have been made for its use.

The principles of operation of the oscilloscope are simple. Practically, we have found that, in order to avoid error due to leakage or induction, many details though simple in principle are perplexing in execution, particularly when we are not seeking an elaborate laboratory equipment, limited in use on account of its scattered complexity, but an assembled, self-contained instrument, simple in operation and readily portable. Its availability adds materially to its usefulness. The senior author desires to express his appreciation of the assistance rendered by his colleague in the development and construction of the finished instrument.

## Bibliography

## GAS DISCHARGE LAMPS

1. Appleton and Barnett, *Proc. Camb. Phil. Soc.*, 22, 434, 1924.
2. von Baeyer and Kutzner, *Zeitsch. f. Physik.*, 21, 46, 1924.
3. Bailey, A., *Phys. Rev.*, (2), 25, 585, 1925.
4. Bartlett, A. C., *Jour. Sc. Inst.*, 1, 281, 1924.
5. Child, C. D., *The Electric Arc*, Van Nostrand Co., New York, 1913, with copious references.
6. Geffken, H., *Physik. Zeitsch.*, 26, 241, 1925.
7. Ghose, B. N., *Phys. Rev.*, (2), 25, 66, 1925.
- 7a. Gutton, Mitra and Ylostalo, *Jour. de Physique*, 4, 420, 1923.
8. Karrer and Poritsky, *Jour. Opt. Soc. of Am.*, 9, 323, 1924.
9. Klein, E., *Phys. Rev.*, (2), 29, 610, 1927.
10. Klein and Rouse, *Jour. Am. Opt. Soc.*, 14, 274, 1927.
- 11-12. Kipping, N. V., *Electrical Communication*, 3, July, 1924. *Proc. Phys. Soc., Lond.*, 37, 265, 1925.
13. MacGregor-Morris, Dowty and Privet, *Lond. Elect.*, 89, 626, 1922.
14. Mauz and Seeliger, *Physik. Zeitsch.*, 26, 47, 1925.
15. Osewald and Tarrant, *Proc. Phys. Soc., Lond.*, 36, 241 and 262, 1924.
16. Palm, A., *Zeitsch. f. tech. Phys.*, 4, 233, 1923.
17. Penning, F. M., *Physik. Zeitsch.*, 27, 187, 1926.

18. Pearson and Anson, *Proc. Phys. Soc., Lond.*, 34, 175 and 204, 1922.
19. Porter and Prideaux, *Gen. Elect. Rev.*, 30, 149, 1927.
20. Reiche, E., *Ann. d. Phys.*, 52, 8, 1917.
21. Robinson, E. H., *Experimental Wireless*, 1, 1, 1923.
22. Ryde, J. W., *Nature*, 112, 944, 1923.
23. Schroeter and Vieweg, *Arch. f. Elektrot.*, 12, 358, 1923.
24. Sellarlo, A., *L'Eletrtecnica*, 12, 881, 1925.
25. Shaxby and Evans, *Proc. Phys. Soc., Lond.*, 36, 253, 1924.
26. Shering and Vieweg, *Zeitsch. f. Instrumentenkunde*, 40, 139, 1920.
27. Skaupy, F., *Zeitsch. f. tech. Physik.*, 3, 61, 1922.
- 28-9. Taylor, J., *Jour. Sc. Inst.*, 4, 78, 1926. *Philos. Mag.*, 3, 368 and 753, 1927; *Experimental Wireless*, 3, 762, 1926.
- 30-3. Taylor and Clarkson, *Jour. Sc. Inst.*, 1, 173, 1924. *Proc. Phys. Soc., Lond.*, 36, 269, 1924. *Phil. Mag.*, 49, 336, 1925. *Proc. Phys. Soc., Lond.*, 37, 130, 1925.
- 34-5. Taylor and Sayce, *Phil. Mag.*, 50, 916, 1925. *Jour. Sc. Inst.*, 2, 289, 1925.
- 36-7. Taylor and Stephenson, *Jour. Sc. Inst.*, 2, 50, 1925. *Phil. Mag.*, 49, 1081, 1925.
38. Watson, H. E., *Proc. Camb. Phil. Soc.*, 17, 90, 1912.
39. Watt and Appleton, *Proc. Royal Soc., (A)* 103, 84, 1923.
- 40-1. Valle, G., *Physik. Zeitsch.*, 26, 495, 1925. *Physik. Zeitsch.*, 27, 473, 1926 (with 93 references).

## A LIMIT TO THE SPEED OF VISION

Recent years have witnessed a great increase of interest in the relation of illumination to effective vision and efficient work. Better lighting makes it possible to see more quickly and more accurately than under poor lighting conditions. Although there are many other factors involved in vision and its relation to production, the speed of vision is one of great interest. It has been known for a long time that the retinal image must be stationary if it is to be seen clearly or even at all. Just what the minimum exposure time of the stationary image must be has been only approximately known. The eyes are always more or less in motion, and often they are engaged in trying to discriminate details which are moving. In reading, for example, the movement of the eyes consists chiefly of rapid sweeps with brief pauses between them. During the sweeps it is impossible for the details to make a sufficient impression, since the image is rushing across the retina. It is only during the fixational pauses in the eye movements, when the image is nearly or quite at rest on the retina, that an adequate impression is made.

Dr. P. W. Cobb and Mr. F. K. Moss recently measured the least duration of the fixational pause of the eyes which resulted in discriminating an object. Under the conditions of the investigation and using eleven subjects who make thousands of observations, the average fixational pause was found to be 0.15 second. Very few observations ran as low as 0.08 second and few as high as 0.25 second. Obviously, therefore, there is a limit to the increase in speed of vision due to increase in intensity of illumination. A limit of the speed of vision has by no means been reached by the lighting improvements in most workplaces.—*Electrical World*.

# Quantitative Determination of Radio Receiver Performance

BY H. D. OAKLEY<sup>1</sup>

Associate, A. I. E. E.

*Synopsis.*—The practise of making quantitative measurements on the individual units of radio receivers is quite general, but seldom are such measurements made on receivers as a whole because of certain difficulties encountered in this type of measurement. This paper describes apparatus developed to overcome these difficulties and to

make possible a study of the performance of receivers as such. The over-all characteristics of receivers are classified and described, the method of tests for obtaining measurements on them explained, with some curves shown to illustrate the results obtained from these tests.

\* \* \* \* \*

## INTRODUCTION

IN the development and design of a device consisting of more than a single unit, it is advantageous to subject it to a series of tests to determine its operating characteristics as a whole, as well as the characteristics of the individual units alone. A radio receiver is comprised of apparatus performing, as a rule, five main functions: (1) Selecting a voltage of a particular radio frequency from among several co-existing voltages, the frequency of each one being different from that of the desired voltage; (2) amplifying the selected voltage; (3) deriving from this amplified voltage an audio-frequency voltage; (4) amplifying the audio-frequency voltage; (5) converting it into sound energy. Present day receivers perform functions (1) and (2) simultaneously in the radio-frequency selector amplifier, function (3) in the detector, (4) in the audio frequency amplifier and (5) in the loud speaker. Testing the apparatus performing any one of these five functions is relatively easy but to make measurements of the whole assemblage is rather difficult.

It is the purpose of this paper to describe briefly the test apparatus used by the General Electric Company, to explain the quantities measured, and the method of test, and to present some results obtained from over-all tests on receivers.

To obtain satisfactory results from over-all tests, three main conditions must be satisfied. 1. To the input terminals of the receiver must be supplied a radio-frequency voltage of a character and magnitude comparable with normal operating conditions. 2. The testing apparatus must be so constructed and arranged that the receiver is subjected to the signal in a known manner and is not affected by unknown stray signal effects. 3. The test conditions must be so controlled that the receiver is not influenced by electrical disturbances other than the test signal.

## DESCRIPTION OF TEST APPARATUS

The apparatus developed to meet these conditions consists of a signal generator, a current-controlling and measuring device, a voltage attenuator, a dummy

1. General Engg. Laboratory, General Electric Co., Schenectady, N. Y.

Presented at the Regional Meeting of District No. 1 of the A. I. E. E., Pittsfield, Mass., May 25-28, 1927.

antenna, and an output voltmeter. The first two units are in a shielded room and in another are the last three, as is also the receiver to be tested. The signal generator is a miniature broadcast transmitter employing the Heising system of modulation, and is composed of five main units: (1) An audio-frequency oscillator with a range of 40 to 10,000 cycles; (2) a radio-frequency oscillator, having a range of from 550 to 1500 kilocycles; (3) a modulator, with its grid controlled by the audio-frequency oscillator and its plate controlling the plate voltage of the modulated radio-frequency amplifier; (4) a modulated radio-frequency amplifier the grid of which is excited by the radio-frequency oscillator and whose output is varied at an audio-frequency rate by the modulator; (5) a power amplifier, (provided with a modulation indicator), excited by the radio-frequency amplifier. The power amplifier supplies current to the current controlling and measuring device. This is a variable mutual inductor with its primary connected to the signal generator and in its secondary circuit a tuning condenser, a thermoammeter and a voltage attenuator. The value of the current flowing in the voltage attenuator is measured by the thermoammeter, and is controlled by varying the mutual inductance. The attenuator is a special form of self inductor, first proposed and used by Dr. N. H. Williams of the University of Michigan. It consists of a coaxial metal shell and rod, which terminate at one end in a metal plate perpendicular to their axes. At the point where the rod meets the plate it is connected to ground. The design of this inductor is such that its inductance per unit length is easily calculated. This particular inductor has three taps providing inductances of approximately 0.001, 0.0055, and 0.02 microhenrys. With these taps and an input current, range of from 0.5 to 350.0 milliamperes, a voltage range of from 1.5 to 22,000 microvolts may be obtained at the lower frequency end of the broadcast range, (550 to 1500 kilocycles), and three times these values at the higher end. The dummy antenna is a circuit so designed that its characteristics are representative of those of the average broadcast receiver antenna. An arbitrary value of ten meters is given as its effective height, because it is believed that this is the average value of antennas commonly used. The output voltmeter

measures the effective value of audio-frequency voltage existing across the output of the receiver. It has a range of 0.2 to 250 volts and its indications are independent of frequency. The impedance (160,000 ohms) of the voltmeter is so great compared with that of the loud speaker that the extra load imposed upon the circuit by the voltmeter is negligible.

This concludes a description of the apparatus used in making the usual over-all characteristic tests. The quantities measured will be explained now; then the test procedure for obtaining them.

#### QUANTITIES MEASURED

The characteristics commonly measured are sensitivity, selectivity and quality. In some special cases, the radiation from the set is also measured. Sensitivity is defined as the degree to which a radio receiving set responds to signals of the frequency to which it is tuned. The output of a receiver is not directly proportional to the input field strength. Therefore, sensitivity cannot be expressed by a single figure, but takes the form of a curve. Sensitivity can be expressed by an input-output curve; *i. e.*, a curve showing the relation between the potential induced in the antenna circuit and the voltage existing across the loud speaker. It is convenient, however, to express sensitivity as the ratio of output voltage to input field strength at various output voltages. This method is somewhat analogous to transformer practice wherein relations are found between the transformer ratio and the voltage supplied to the load at various loads, rather than between impressed primary voltage and voltage supplied to the load. The ratio of output voltage to input field strength, expressed by a dimensional formula, reduces to a length. Since this is so and since the field strength is expressed as a certain potential per meter, the unit of sensitivity has been called the meter. A receiver is said to have a sensitivity of one meter when a field with strength of one volt per meter acting upon the antenna circuit causes a potential of one volt to exist across the loud speaker.

Selectivity is the degree to which a receiving set is capable of differentiating between signals of different frequencies. As measured, selectivity is a curve showing the input field strength required to maintain a constant signal voltage in the output as the frequency of the field is changed. Of course, the field strength is lowest at the frequency of the desired signal, and increases in value as the frequency becomes greater or less than that of the desired signal.

The definition of quality is the degree to which sound is faithfully reproduced. To be strictly in accord with this definition, quality measurements made on receivers should be such that the sound wave modulating the radio wave actuating the receiver can be compared with the sound wave generated by the loudspeaker of the receiver. Then the results of these measurements should be expressed in such a way that the nature and

magnitude of the discrepancies between the original and the reproduced sound waves can be shown. The measurements as actually made are not so rigid. The assumption is made that the radio-frequency voltage induced in the antenna circuit is of such a nature that, were the receiver and sound reproducing apparatus perfect, the reproduced sound would be identical with that which acted upon the microphone of the transmitter. The measurements as made furnish data showing the relation between the receiver output voltage and the modulation frequency, as this frequency is varied from 40 to 10,000 cycles, without changing either the voltage induced in the antenna or the degree of modulation. A perfect receiver subjected to this test would maintain a constant value of voltage across its output and therefore its quality curve would be a straight line parallel to the modulation frequency axis. In order to compare the quality of different receivers, it has been the practice to plot these curves as output voltage in percentage of output voltage at some one frequency (usually 1000 cycles), against frequency. The more nearly the output voltage remains constant, the better is the quality.

The last receiver characteristic to be considered is radiation. Radiation is defined as the process of emitting electromagnetic waves into space. Obviously it is impossible to measure a process, so that when radiation measurements are discussed, the act in mind is not that of measuring the process but rather that of measuring the quantities causing the phenomenon of radiation. The relative distances to which transmitters can maintain communication depend upon their antenna height and the current flowing in the antenna. The antenna height is expressed ordinarily in meters and the current in amperes, so that it is customary to express the radiating power of a transmitter in meter amperes—the product of the antenna height and the current. Some receivers contain an oscillating tube and it is possible to so adjust the controls of certain others that one or more tubes will oscillate. In both cases disturbances are sent out which seriously interfere with the operation of neighboring receiver sets. Tests are made to determine both the magnitude and frequency of this disturbance. The results are expressed in meter amperes, since, in this case, the receiver is considered as a transmitter and the strength of its field at various distant points can be determined if the equivalent meter amperes and the distances are known.

#### METHOD OF TEST

Sensitivity, selectivity and quality are more or less inter-related so that, in general, it is impossible to adjust a receiver to obtain a maximum of one of these quantities without a decrease in one or both of the other two. In making tests on a receiver an attempt is made to so adjust it that a satisfactory compromise among the three is reached. This condition is considered as the average normal operating one. Fig. 1 is

a schematic layout of the test apparatus and an antenna type receiver which is undergoing test. An RCA model-100 loud speaker is used as the output load, and across it is measured the output voltage.

*Sensitivity.* To determine sensitivity, the signal generator is set to some desired carrier frequency and adjustments are made so that the current is modulated 50 per cent at 1000 cycles. The current flowing through the voltage attenuator is adjusted to some convenient

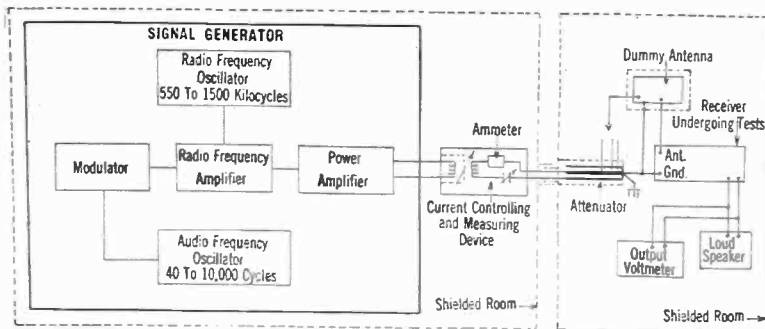

FIG. 1—SCHEMATIC LAYOUT OF RECEIVER TEST APPARATUS

value and the receiver antenna circuit is connected to one of the attenuator taps. The receiver is then tuned to the signal and other adjustments made so that the receiver is operating normally. The test is then begun by adjusting the input to the receiver, (input current to the attenuator or changing taps), so that some low value of output voltage is obtained. The input is increased in steps and at each step the corresponding output voltage is recorded. The test is continued until the grid of one of the receiver tubes becomes positive during a part of the cycle (this usually occurs first in the tube located in the last stage of the audio frequency amplifier). This point is considered the operating limit of the set, since any further increase in input will result in a distorted output. During this test the following data were recorded: Carrier frequency, current flowing through attenuator, attenuator tap used, and output voltage. To plot sensitivity curves the field strength for the different output voltages must be known. It is found in this way; knowing the current flowing through the attenuator and its frequency, and the inductance corresponding with the tap used, the voltage induced in the antenna circuit can be calculated. This voltage, divided by the height of the antenna in meters, (in this case 10 meters), is considered as the field strength of the signal. The sensitivity of the receiver in meters is then found by dividing a given output expressed in microvolts by the corresponding field strength expressed in microvolts per meter.

The test just described is made with the receiver tuned to 560 kilocycles. The signal generator is then reset to give the same sort of signal as before except that the frequency is now 1000 kilocycles. The receiver is tuned to this new frequency and the test repeated. A third setting of the generator and retuning

of the receiver to 1300 kilocycles completes the sensitivity tests. The complete test then shows not only how the sensitivity varies for different input field strengths but also gives an idea of how it varies for different carrier frequencies. Tests to determine the other receiver characteristics are also made at these same three carrier frequencies so the whole set of curves obtained furnishes a very good picture of the behavior of the receiver over the entire broadcast range.

*Selectivity.* With the receiver tuned to 560 kilocycles, the frequency of the signal generator is set to a value such that with the receiver connected to the highest tap of the attenuator and the maximum obtainable current flowing through it, no signal exists in the receiver output. The frequency is brought nearer and nearer to the tuning frequency of the receiver until a point is reached where some low value of signal (0.5 volt) exists in the output. From this point on, through resonance and beyond as far as it is possible to go, the frequency is changed in steps, and at each step, the current through the attenuator and the attenuator tap is chosen so that the voltage in the output remains constant. As the frequency of the signal generator is changed, its modulation frequency and degree of modulation remains unchanged. These data are recorded: Frequency, value of current flowing through attenuator, attenuator tap used and the value at which the output voltage was maintained. The field strength corresponding with the several frequencies is then calculated in the manner explained under sensitivity tests. The curve obtained by plotting field strength required to maintain a constant output voltage against carrier frequency is the selectivity curve for this particular tuning point. After this test, another is made with the receiver tuned to 1000 kilocycles and after that a third test is made with the tuning point at 1300 kilocycles.

*Quality.* A preliminary test is made to determine at what audio frequency the maximum output voltage is obtained. After finding this point the input to the receiver is adjusted so that at this frequency the grid of the last tube does not at any time become positive. The input is then maintained at this value while the modulation frequency is varied from 40 to 10,000 cycles and the degree of modulation is held constant at 50 per cent. At each frequency, the output voltage is recorded. A plot is then made of output voltage in per cent of output voltage at some one frequency (usually 1000 cycles), against modulation frequency and the quality can then be judged by the amount the curve deviates from a horizontal straight line—the greater the deviation, the poorer the quality.

*Radiation.* These measurements fall into two classes: (1) Measurement of radiation from loop or antenna alone; (2) measurement of radiation from receiver and loop or antenna combined. In the case of sets operating with an antenna, the amount of radiation from the set

itself as compared with that from the antenna is usually small, so that on this type of set measurements are confined to radiation from the antenna itself. But in the case of sets operating with loops, the electrical dimensions of them and of the receiver circuits are comparable, so that quite a large part of the radiation may originate in the receiver. Thus, measurements on this type of set include both loop and set radiation.

The first mentioned type of measurement is made in this manner. The receiver to be tested is set up in the same room with the signal generator and in the other room is another receiver which will be designated as the indicator. The two current leads of the attenuator are disconnected from the current controlling and measuring unit and are connected to the antenna circuit of the receiver. The indicator is connected to the highest tap of the attenuator. Tests are made to be certain the receiver is tuned to some carrier frequency, and then if it is radiating it will be sending current through its antenna circuit, which consists of the dummy antenna and the attenuator. This current flowing through the attenuator will set up a voltage across the input of the indicator resulting in a certain value of output voltage. The current leads of the attenuator are then removed from the antenna circuit and returned to their normal connection. The indicator is connected to the lowest tap on the attenuator and the signal generator supplies current (of the same frequency as that generated by the receiver) the value of which is so adjusted that the output voltage of the indicator is the same as before. This current, multiplied by the ratio of the inductance of the lowest tap to that of the highest, gives the value of current that was in the receiver antenna circuit. This current, in amperes, multiplied by the height of the antenna in meters, (in this case 10 meters), expresses the radiation of the receiver in meter amperes.

To measure the combined radiation from a receiver and a loop, they are set up near the attenuator; and in the same room, but at a distance from them, is another receiver called the indicator. The receiver is properly tuned to receive some carrier frequency. If the receiver is radiating it will cause a voltage to exist in the indicator. The value of this voltage is noted, the receiver and its loop removed, and in their stead is set up a loop circuit whose effective height and resistance are known. With the aid of the attenuator and signal generator a current is set up in the loop circuit, of such a value that the voltage in the indicator is the same as before. Multiplying this current in amperes by the effective height of the loop in meters—not the receiver loop—the combined radiation of the receiver circuits and its loop is expressed in meter amperes.

#### EFFECTIVE HEIGHT OF RECEIVER LOOPS

The sensitivity, selectivity and quality tests described were for the antenna type of receiver. These tests are the same for loop receivers, but the method of determining field strength needs an explanation. When

testing this type of receiver, the dummy antenna, of course, is not used but the attenuator is connected directly in the low side of the loop circuit. The connections are as shown in Fig. 2. The voltage induced in the loop circuit is found in exactly the same manner as it was in the case of the antenna circuit. The same dummy antenna is used for all antenna receivers and its height is always considered to be 10 meters; but when testing loop receivers, the loop belonging to the particular set undergoing tests is used. It is therefore necessary to determine the effective height of this loop in order to find the input field strength. The effective height of a loop is simply a figure which, multiplied by the field strength of the electric component of an electromagnetic wave, gives the value of the voltage induced in the loop. In other words, if a loop and an antenna were simultaneously subjected to the influence of a moving electromagnetic field, and the height of the antenna happened to be such that the voltage induced in the antenna was equal to that induced in the loop, then the effective height of the loop would be considered

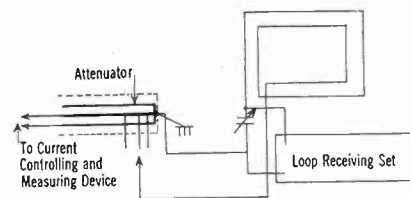

FIG. 2—DIAGRAM OF CONNECTIONS FOR TESTING A LOOP TYPE RECEIVER

equal to the height of the antenna. It can be shown that the effective height of a loop is dependent upon the frequency of the field, the area of the plane enclosed by the loop winding, and the number of turns in the loop. The relation is:

$$H_m = 0.66 N A F 10^{-9}$$

where

- $H$  = Loop height in meters
- $N$  = Number of turns in loop
- $A$  = Area in sq. cm. enclosed by loop winding
- $F$  = Frequency of the field in kilocycles

#### CURVES OBTAINED FROM TEST DATA

A number of different types and makes of receivers have been tested, but for purposes of illustration, the curves plotted from data obtained from tests on one well-known make of receiver are shown here (see Fig. 3 to 6). These curves are typical of those obtained for other receivers and show up the faults of present day sets. The sensitivity is different at different carrier frequencies within the broadcast range. This is not a desirable characteristic, and receivers are now being designed so that the sensitivity will be more nearly uniform. Another bad feature is that a weak input signal produces an output voltage that is proportionately very much smaller than that produced by a stronger input signal. This condition is due to the type of detector in use today. There exist special

forms of detectors which overcome this difficulty, but they are not generally used because of their lack of simplicity as compared with the usual form.

The selectivity of a receiver should be such that there is very little discrimination among frequencies over a

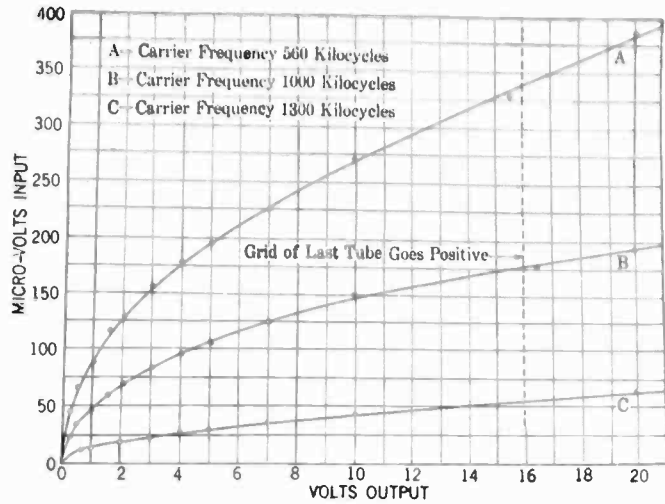

FIG. 3—CURVES SHOWING THE RELATION BETWEEN THE POTENTIAL INDUCED IN THE ANTENNA CIRCUIT AND THE VOLTAGE EXISTING ACROSS THE LOUD SPEAKER OF A RECEIVER

range of from 10 kilocycles below to 10 kilocycles above the resonant frequency and outside the band the receiver should be unresponsive. The first condition is set down so that there will be no impairment in

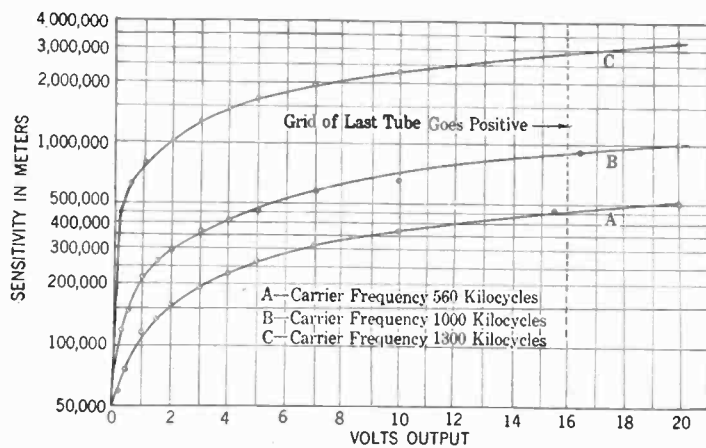

FIG. 4—CURVES SHOWING THE RELATION BETWEEN THE SENSITIVITY OF A RECEIVER AND THE VOLTAGE EXISTING ACROSS ITS LOUD SPEAKER

quality of the audio output of the receiver and the second condition so that undesired signals can not affect the receiver and thus also impair the quality. Fig. 5 shows the selectivity curves. At 560 kilocycles the selectivity is very good with respect to eliminating undesired signals, but is too selective for good quality. At 1000 and 1300 kilocycles the selectivity is not so good so far as eliminating interference is concerned but is good from the standpoint of quality. Selectivity is then another characteristic that may be improved upon, and the ideal to be reached is constant selectivity throughout the broadcast range, complete suppression of all undesired signals, and non-discrimination among frequencies over a limited range both sides of the resonant one.

Fig. 6 is an example of how far the quality of modern receivers departs from the ideal. The falling off of the low frequency part of the characteristic can be attributed to faults in the audio-frequency amplifier and loud speaker circuits. The drooping of the high-frequency end is due partly to these faults, partly to too great selectivity, and a great deal to the characteristics of the detector.

SUMMARY

Over-all measurements supply the means for obtaining first, a picture of the performance of a receiver as a whole and, with such pictures, the per-

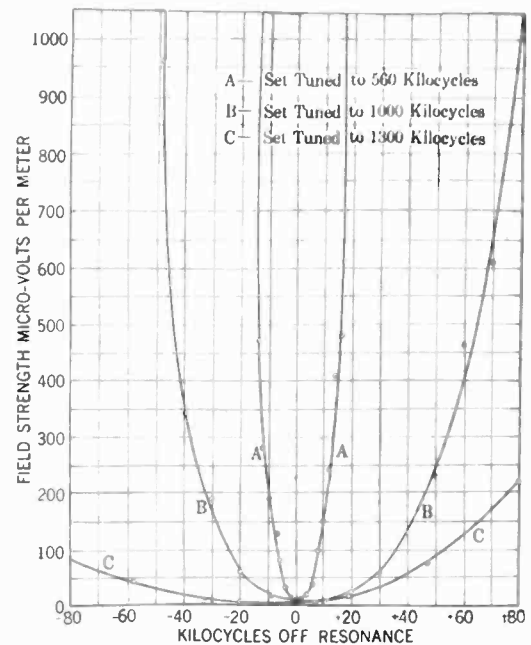

FIG. 5—CURVES SHOWING THE RELATION BETWEEN THE FREQUENCY AND THE STRENGTH OF THE FIELD FOR CONSTANT VOLTAGE ACROSS THE LOUD SPEAKER OF THE RECEIVER

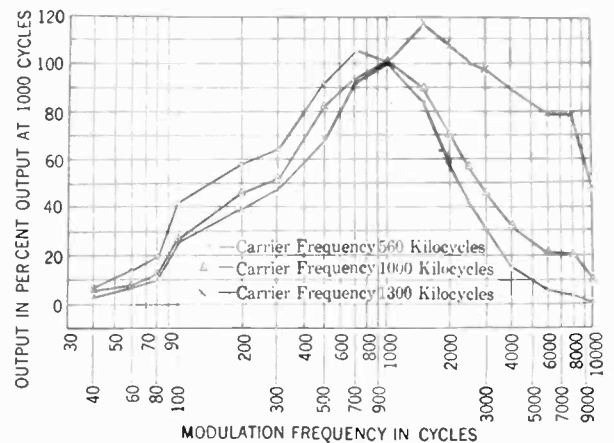

FIG. 6—CURVES SHOWING THE RELATION BETWEEN VOLTAGE ACROSS THE LOUD SPEAKER AND MODULATION FREQUENCY WHEN THE FIELD STRENGTH AND DEGREE OF MODULATION ARE HELD CONSTANT

formance of various receivers may be easily compared; and second, quantitative data which are particularly valuable in development work because they enable one to determine accurately the degree and manner in which improvements in individual units affect the characteristics of the receiver as a whole.

# Abridgment of Additional Losses of Synchronous Machines

BY C. M. LAFFOON<sup>1</sup>  
Associate, A. I. E. E.

and J. F. CALVERT<sup>1</sup>  
Non-member

**Synopsis.**—In the case of high-speed turbine generators, the most reliable means of determining the losses under actual operating conditions is to measure the weight and temperature rise of the cooling medium and to estimate the small part of the losses which is dissipated from the frame to the surrounding medium. The temperature rise of the cooling medium can be obtained by means of temperature detectors located at the inlet and outlet sections of the generator. In order to obtain reliable values of the average temperature rise for the machine, it is necessary to have approximately uniform velocities at both inlet and outlet sections and to measure the temperature rise at a large number of incremental sections.

The volume of cooling medium passing through the machine can be determined by (a) introducing a definite amount of heat energy into the cooling medium and measuring its temperature rise, or (b) measuring the mean velocity head at the outlet section of a properly designed stock.

Loss tests were made on five 3600-rev. per. min. turbine generators

when operated as synchronous condensers. In the case of these machines, the additional losses including the increase in core loss at full kv-a. and zero per cent power-factor load varied from 3 to 22 per cent of the total losses. This corresponds to approximately 0.14 to 1.0 per cent of the generator input. The additional losses as measured under sustained short-circuit conditions were from 5 to 10 per cent less than the corresponding values for full kv-a. at zero per cent power factor.

It is suggested that data can be obtained for predetermining the magnitude of the total additional losses by measuring the loss in each structural part and determining graphically the magnetizing flux which produces it. The magnetizing flux distributions at different parts of the machine were plotted for different ampere-turn relations.

Additional studies are being made on methods of calculating the magnitude of the additional losses and the increase in core loss with load.

## METHODS OF MEASURING THE LOSSES OF STEAM TURBINE-DRIVEN GENERATORS UNDER LOAD CONDITIONS

THE loading-back and calorimeter methods are the two outstanding means of measuring the losses of high-speed synchronous machines under different load conditions. In the loading-back method two duplicate machines, which are electrically and mechanically coupled together, are driven at synchronous speed. When one unit operates as a motor and the other as a generator at definite current, voltage and power-factor conditions, the only power required from an external source is that which is necessary to supply the losses of the two units. With this method of test, the total losses of the two machines can be measured with a satisfactory degree of accuracy, but there is question in regard to the division of the losses on account of the fact that the two machines do not have the same excitation and consequently do not have the same internal flux conditions. This method has the further limitation in that two machines are required and a complicated coupling or frame shifting mechanism is required if it is desired to operate at different power factors.

With the calorimeter method, the losses of the machine are determined by measuring the weight and temperature rise of the cooling medium. Obviously this method is only applicable to machines with forced ventilation, such as rotating machines and water- or oil-cooled transformers. When such an electric machine is operating at any given load condition, and constant temperatures have been reached, a major portion of the losses within the frame is carried away by

the cooling medium, and the remainder is dissipated to the medium surrounding the frame of the machine. In the case of steam turbine driven generators, the magnitude of the loss to the cooling medium can be measured quite accurately and the small part of the loss which is dissipated from the frame to the surrounding medium can be estimated with a sufficient degree of accuracy to make this method the most reliable one for this class of machines. If the machine has a closed circuit ventilating system and the surface type of cooler for the cooling medium of the generator, the loss given up by the cooling medium can be obtained by measuring the weight and temperature rise of the water passing through the surface cooler. In addition to estimating the loss dissipated from the frame of the machine, it is necessary in this case to estimate the portion of the loss which is lost by the cooling medium in passing from the outlet of the machine to the inlet of the cooler, and also the loss dissipated from the frame of the cooler. With these three corrections to make, instead of one, the magnitude of the error in the estimated portion of the losses is probably three times as great as in the previous case. Moreover, the energy transferred from the cooling medium to the water cannot be measured with as great accuracy as that from the machine to the cooling medium on account of the fact that (a) the temperature rise of the cooling water is only about one-fourth of that of the cooling medium in passing through the machine and hence, for the same numerical error in the temperature rise, the percentage error would be four times as great; and (b) equally reliable measurements of the temperature rise of the cooling water cannot be made on account of the difficulty of getting a sufficient number of accurate-reading temperature detectors in intimate contact with the water at the inlet and outlet sections of the cooler. In

1. Both of the Westinghouse Elec. & Mfg. Co.

Presented at the Winter Convention of the A. I. E. E., New York, N. Y., February 7-11, 1927.

general, the direct measurement for determining the weight and temperature rise of the cooling medium is the simplest and most reliable calorimeter method of determining the total losses of steam driven turbine generators under any load condition.

#### MEASUREMENT OF THE TEMPERATURE RISE OF THE COOLING MEDIUM

The temperature rise of the cooling medium can be obtained by measuring its temperature at the inlet and discharge sections of the machine or by measuring it directly by means of differentially connected temperature detectors. The measurement of the temperature rise of the cooling medium would be very easy to make if the temperature were constant at both inlet and discharge sections. In actual machines, neither the temperatures nor the velocities of the cooling medium are uniform at either the inlet or discharge sections of the generator. Consequently, in order to determine the average temperature rise of the machine, it is necessary (a) to divide the inlet and outlet sections into a large number of incremental sections and measure the temperature and the volume of the cooling medium which flows across each incremental section; or (b) to obtain uniform velocities at both inlet and outlet sections and then obtain the temperature at a sufficient number of incremental sections so that a simple algebraic average can be used. The latter is the preferable method to use on account of the fact that the velocity variable of the cooling medium is eliminated and the temperature rise can be obtained at a sufficient number of incremental sections by measuring the difference in e. m. fs. induced in thermocouple junctions or the difference in potential drops across resistance elements. Satisfactory results can be obtained by either type of detector provided the necessary precautions are exercised, and the choice of method will depend to a large extent on general preference and previous experience. When the thermocouple type of detector is used, the number of junctions in series can be chosen such that the indicating instrument operates at the most accurate part on its scale. Rubber insulation should be used on the wires between junctions in order to eliminate erratic results due to short circuits and grounds which are usually experienced when less reliable insulation is used. If the inlet air temperature periodically fluctuates over an appreciable range, the measured temperature rises will also be irregular because the pulsations are damped out or absorbed by the generator and do not appear to an appreciable extent in the outlet air temperature. The variation in inlet air temperature must be corrected for by taking a relatively large number of readings, or the temperature detectors must be compensated so that a close average temperature rise can be obtained. In order to damp out variations in the temperature rise after the machine has reached constant temperatures, thermal storage capacity should be added to the detector located at the

inlet air section. From a theoretical consideration, the heat storage capacity of the detectors which are located at the inlet air section should be equivalent to that of the machine but actually the mass of the heat storage materials for the inlet detectors cannot be made very large without obstructing the air flow. Marked improvements can be obtained, however, by making the heat storage capacity of the detectors located in the inlet air stream as large as practical, without obstructing or seriously disturbing the air flow. In order to obtain sufficient thermal storage capacity in the inlet detectors, and yet not interfere with the air flow, a satisfactory procedure is to measure the temperature rise between two arbitrarily chosen incremental sections at the inlet and discharge by means of a set of thermocouples connected in differential series. Correction for the variation in temperature at both the inlet and discharge section can be made by measuring the temperature variation of all other points of each section with respect to the arbitrarily chosen reference points, by means of another set of thermocouples connected in differential series but which have no appreciable thermal storage capacity.

#### MEASUREMENT OF WEIGHT OR VOLUME OF THE COOLING MEDIUM

The calorimeter method can also be used to measure the volume of the cooling medium which passes through the machine. If a known amount of power is absorbed by the cooling medium and the corresponding temperature rise is measured, the volume of the cooling medium can be calculated from its specific heat constant, barometric pressure, and absolute temperature. If air is used as the cooling medium the volume can be calculated from the following formula<sup>5</sup>.

$$V = \frac{0.177 (273 + T_1)}{\beta} \frac{W}{T_2} \quad (1)$$

where  $V$  = the mean volume in the meter in cu. ft. per min.,

$T_1$  = the mean temperature in deg. cent.,

$B$  = room barometric pressure, and approximately the mean static pressure in the meter in inches of mercury,

$W$  = watts input to the air,

$T_2$  = temperature rise of the air in deg. cent. due to  $W$ .

In order that satisfactory values of air volume be obtained with this method of measurement, the following conditions and requirements must be fulfilled:

a. Either uniform air velocities or uniform air temperatures must exist in the air stream at the sections where the temperature detectors are located,

b. The heat input to the air stream should be uniform over its entire cross-section, or else the air must be thoroughly mixed after heating so that uniform air temperature will exist at the outlet section,

5. See Bibliography, 8 in complete article.



c. The temperature of the heating elements must be sufficiently low, and the lead arrangement such that the percentage of heat radiated and conducted from these elements is negligible as compared to percentage of heat input which is convected away by the air stream.

d. The walls surrounding the air stream at the place where the heat is introduced should be insulated so that a negligible percentage of the heat input is dissipated to the surrounding atmosphere,

e. A sufficient length of time should elapse, after the heat is applied, before making the temperature rise measurements, in order for the walls, bus bars, and wiring connections to reach constant temperatures,

f. The degree of accuracy in measuring the temperature rise of the air should be comparable with the accuracy of the temperature rise measurement of the generator under load conditions.

The volume of the cooling medium can also be obtained by measuring its velocity head at the discharge section. This necessitates the discharge of the cooling medium from the machine from a nozzle or stack which must be designed so that the velocities of the cooling medium at the outlet are practically uniform and the direction of flow is normal to the outlet section. When the cooling medium is discharged directly into a large room, the discharge velocity heads for the incremental section of the outlet section can be measured with an impact tube and an inclined pressure gage. From these velocity head measurements the respective velocities can be calculated in feet per minute for any specific cooling medium. The derivation of the formula for air as the cooling medium is as follows:

$p$  = velocity head in inches of water for any incremental section,

$a$  = area of any incremental section in sq. ft.,

$v$  = velocity in ft. per min. for any incremental section,

$q$  = volume in cu. ft. per min. for any incremental section,

$\theta$  = air temperature in deg. cent.,

$T = 273 + \theta$  = absolute air temperature,

$K$  = constant,

$\alpha$  = density of air in lb. per cu. ft.,

$\beta$  = barometric pressure.

Subscript  $o$  indicates values corresponding to standard air conditions which are assumed to be 25 deg. cent. or 298 deg. cent. absolute temperature, and a barometric pressure of 29.92 in. of mercury. Subscript 1 indicates values applying to an actual test condition, and subscript  $i$  indicates values applying to intake air conditions.

Since the variations in temperature of the outlet air are small, practically no error in the total volume is introduced by considering  $T_1$  constant for all of the incremental sections. The total volume in terms of intake condition is

$$Q_i = Q_o \frac{T_i}{T_o} = \frac{6 \times 10^3 (273 + \theta_i)}{\sqrt{\beta_i (273 + \theta_i)}} \sum_1^n \sqrt{p_i} \quad (3)$$

For the intermediate steps see the complete paper.

Since it is necessary to measure the temperature rise of the air passing through the machine, it is desirable to have the temperature at the outlet of the stack the same as at the outlet of the machine. The loss of heat energy from the walls of the stack can be made inappreciable by applying a sufficient amount of cork and felt insulation.

In comparing these two methods of measuring the volume of air passing through steam driven turbine generators, both require practically uniform velocities at particular sections. The calorimeter method requires special wiring, and considerable care in the thermocouple measurements. The velocity head readings at the outlet section of the stack can be easily obtained and consistently repeated. The number of points at which these pressures are read can be increased indefinitely and thus the accuracy of the results can be made as high as it is advisable to go. The number of thermocouple junctions cannot be increased beyond a particular value without restricting the air flow. The stack is simple to build, sturdier of construction, easier to maintain, and in general gives more consistent results than the calorimeter method of measuring air volumes. Both methods will give reliable results provided the elements are properly designed and the necessary precautions exercised in making the measurements.

#### LOSS MEASUREMENTS ON HIGH SPEED TURBINE GENERATORS

Temperature and loss measurements were made on five three-phase, 3600-rev. per min. 80 per cent power-factor turbine generators with rating characteristics as indicated in Table I. The generators were operated as

TABLE I

Generator number	Rating		Remarks
	Kv-a.	Volts	
1	2500	600	Generator had same fan as generator No. 2. One conductor per slot type of stator winding.
2	3125	2400	Stator end plates of magnetic material.
3	3125	2400	Same as generator No. 2 except non-magnetic end plates.
4	6250	2400	Axial system of ventilation. Armature punchings of medium loss steel.
5	6250	2400	Multiple path radial system of ventilation. Larger fan than on generator No. 4. Armature punchings of low loss silicon steel.

synchronous condensers, and the losses were determined by the calorimeter method for several different kv-a. load. The power factor varied from 100 per cent at no-load to approximately zero per cent at 100 per cent kv-a. load.

The loss from the generator to the cooling air was calculated by the following formulas:<sup>6</sup>

6. See Bibliography, 8, loc. cit.

$$KW_1 = \frac{Q_a \theta \times 10^{-3}}{1.765} \quad (4)$$

$KW_1$  = Loss to the air in kw.

$Q_a$  = Air volume in cu. ft. per min. at standard temperature and barometric pressure conditions.

$\theta$  = Average temperature rise of the cooling air in deg. cent.

The loss dissipated from the frame by natural convection was calculated on the basis of a dissipation



FIG. 1—CALORIMETER

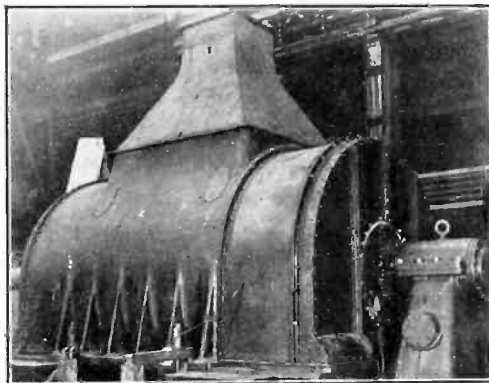

FIG. 2—DISCHARGE STACK ON GENERATOR

constant of 0.012 watts per sq. in. per deg. cent. temperature difference between the surface of the machine and the surrounding air.

$$KW_2 = 0.012 - S(\theta_s - \theta_a) \quad (5)$$

where

$KW_2$  = Loss in kw. dissipated from the surface of the frame,

$S$  = Effective dissipating surface of the frame in sq. in.,

$\theta_s$  = Average temperature of the frame surface in deg. cent.,

$\theta_a$  = Average temperature of the surrounding air in deg. cent.

The total loss within the frame of the generator is the sum of the two losses as defined above.

The temperature rise of the cooling air for all of the

machines was measured by means of thermocouples located at the inlet and outlet sections and connected in differential series. The volumes of cooling air for machines Nos. 1 to 4 inclusive were determined by the

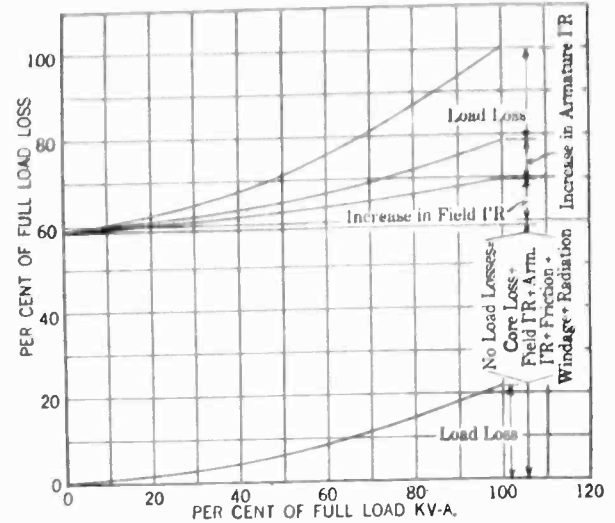

FIG. 3—SHOWING RATIO OF LOSS TO LOAD (Generator No. 1, 2500-kv-a., 600-volt, three-phase, 60-cycle, 3600-rev. per min.)

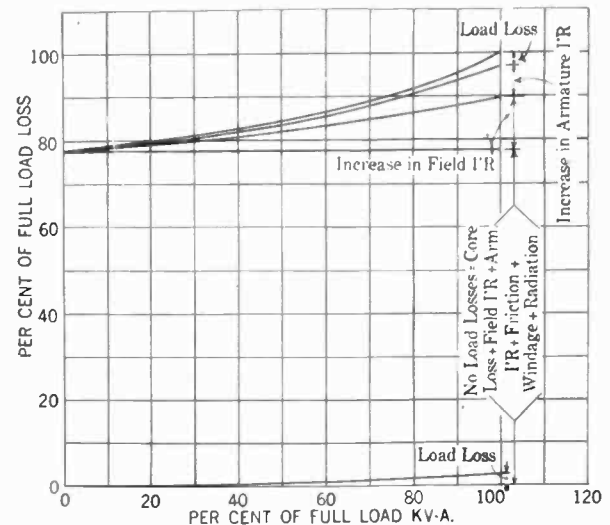

FIG. 4—SHOWING RATIO OF LOSS TO LOAD (Generator No. 2, 3125-kv-a., 3300-volt, three-phase, 60-cycle, 3600-rev. per min.)

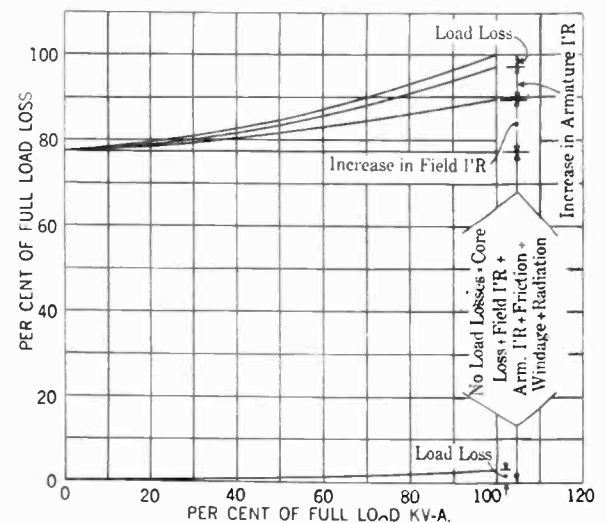

FIG. 5—SHOWING RATIO OF LOSS TO LOAD (Generator No. 3, 3125-kv-a., 2300-volt, three-phase, 60-cycle, 3600-rev. per min.)

calorimeter method and equation (1). Fig. 1 shows the type of calorimeter which was used to make the measurements. The volume of cooling air for generator No. 5 was determined from the velocity head

Figures 3 to 7 show the test results obtained on five machines by the calorimeter method. For a more complete description of the results see the complete paper.

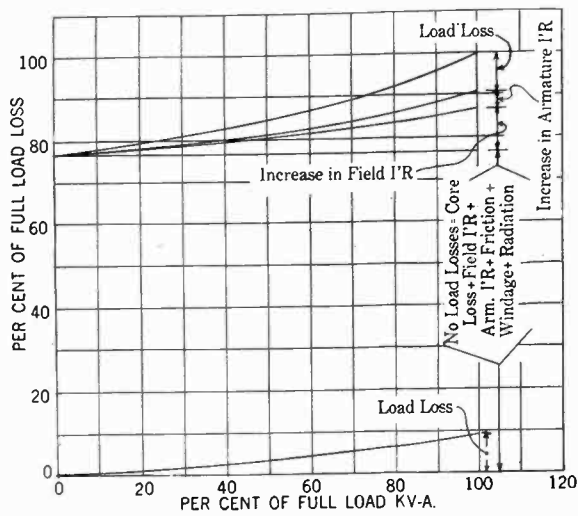

FIG. 6—SHOWING RATIO OF LOSS TO LOAD

(Generator No. 4, 6250-kv-a., 2400-volt, three-phase, 60-cycle, 3600-rev. per min.)

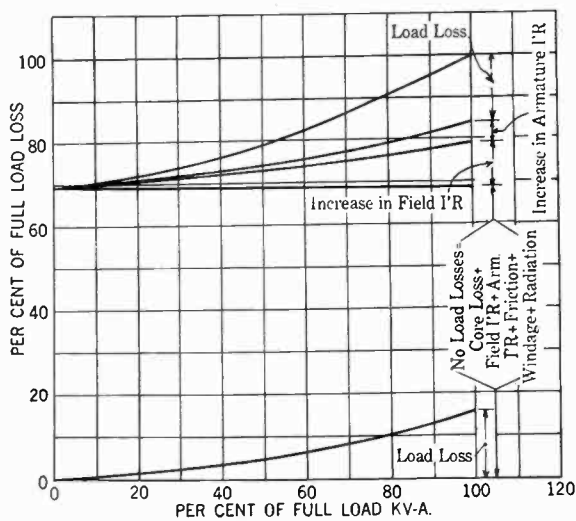

FIG. 7—SHOWING RATIO OF LOSS TO LOAD

(Generator No. 5, 6250-kv-a., 2400-volt, three-phase, 60-cycle, 3600-rev. per min.)

measurements at the outlet of a discharge stack and the calculations were made by using equation (3). Fig. 2 shows the stack as assembled on this generator for the test.

It can be seen from the data in Table II that the additional loss varies from approximately 3 to 22 per cent of the total loss for these machines. Hence, if the total loss represents 4.5 per cent of generator input, the additional loss in the case of these machines would represent from 0.14 to 1.0 per cent of the total kw. input. The highest percentage additional loss occurred for machine No. 1, which had a 600-volt stator winding with only one conductor per slot. The one-conductor-per-slot type of winding usually results in a relatively large per cent additional loss on account of the higher current per slot and the greater concentration of current in the end connections of the winding. This loss handicap for low-voltage windings cannot ordinarily be eliminated without departing appreciably from the design proportions which are satisfactory for the more desirable higher voltages. Such changes usually result in increased development and manufacturing costs, and consequently, from the standpoint of generator costs alone, the use of special low-voltage windings should not be encouraged.

The additional loss of the machines at full kv-a. and approximately zero per cent power factor is of the same order of magnitude as the additional losses of the machine under sustained short-circuit conditions. The additional loss for full kv-a., full voltage conditions includes the increase in iron loss over the no-load values, whereas the additional loss at short-circuit conditions includes only the iron loss due to a magnetizing flux which depends on the magnitude of the leakage reactance.

TEMPERATURE LOAD CURVES

Thermocouples were located on the stator end bells, end plates, finger plates which support the stator teeth, and on the surface of the stator teeth near the finger plates. The final temperature rises which were obtained at these points are plotted against per cent kv-a. load as shown by the curves in Figs. 9 to 13. Figures 9, 12 and 13 are shown in the complete paper.

TABLE II

Generator number	Rating in per cent			Generator Losses Expressed in Per Cent				
	Kv-a.	Volts	Amp.	Total	Fan + friction + iron	Field copper	Armature copper	Additional
1	100	100	100	100	56.35	12.9	8.91	21.84
	..	0	100	59.5	28.0	3.06	8.48	20.0
2	100	100	100	100	74.2	15.6	7.39	2.80
	..							
3	100	100	100	100	74.0	15.56	7.55	2.9
	..							
4	100	100	100	100	73.8	12.7	3.92	9.5
	..	0	100	50.2	35.0	1.87	3.92	9.4
5	100	100	100	100	66.5	12.5	5.28	15.6
	..	0	100	68.4	46.8	2.48	5.15	14.0

The outstanding points in connection with these curves are as follows:

a. The final temperatures which were reached at full kv-a. load were very low. The temperature rise did not exceed 20 deg. cent. at any of the points on any machine. The temperature rise of finger plates was practically the same as for the adjacent stator tooth laminations. On the basis of these results, it can be

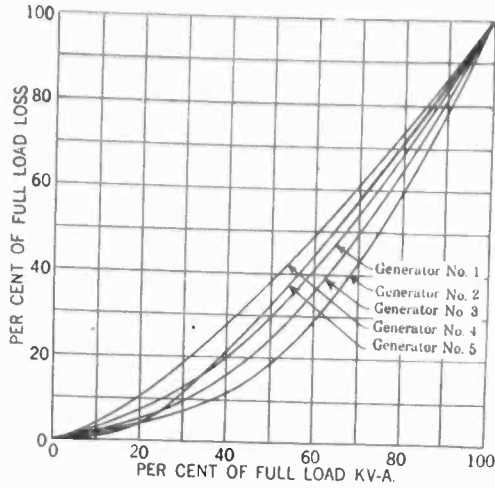

FIG. 8—LOAD LOSS IN PER CENT OF FULL LOAD LOSS VS. PER CENT OF FULL LOAD FOR FIVE GENERATORS

concluded that the additional loss in these parts of these machines must not be very large.

b. In all cases, the temperature rise decreased slightly

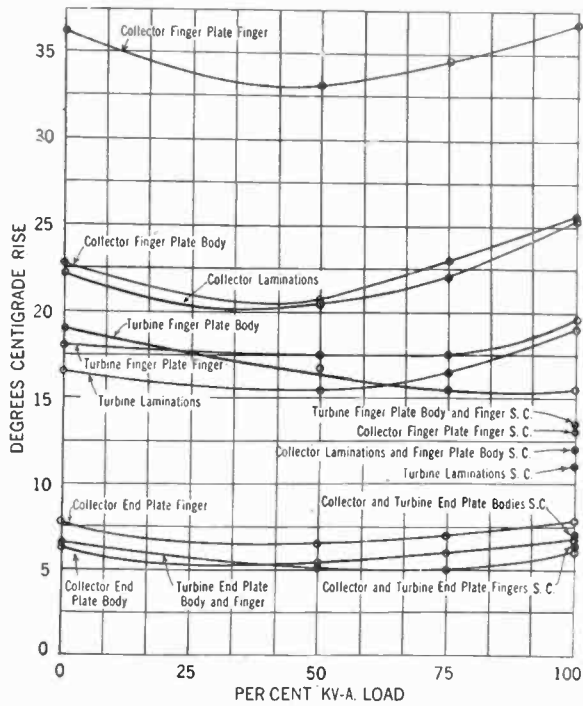

FIG. 10—TEMPERATURE RISE ABOVE INGOING AIR OF FINGER PLATES, END PLATES AND LAMINATIONS, MAGNETIC END PLATES (Generator No. 3)

as the load increased from zero to approximately 25 per cent of the full load kv-a. rating. While this is of little or no practical importance, it is of interest from a theoretical standpoint because it shows that the resultant flux in these parts due to the stator and rotor

m. m. fs. is smaller than at no-load due to the field acting alone.

MEASUREMENT OF THE LOSSES IN DIFFERENT PARTS OF THE MACHINE

In order to predetermine the magnitude of the additional loss of a synchronous machine, it is necessary to know the relative proportions of the loss that exist in the different parts of the machine and also how these loss components depend on the different variable factors. While the calorimeter method is quite satisfactory for measuring the total value of the additional losses of a high speed synchronous machine, it is not applicable for measuring the loss that occurs in the different parts of the machine, due to the fact that the loss in each part represents a too small percentage of the total value of the measured loss. A satisfactory method for determining the proportion of the additional

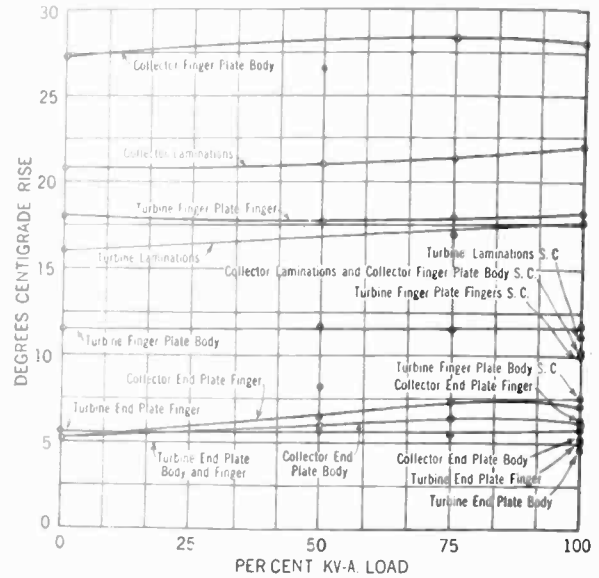

FIG. 11—TEMPERATURE RISES ABOVE INGOING AIR OF FINGER PLATES, END PLATES AND LAMINATIONS, NON-MAGNETIC END PLATES (Generator No. 3)

loss which occurs in each part of the machine should measure the loss in that part alone and not measure it in combination with other losses of considerably greater magnitude. Such tests can be made on models which represent the different parts of the magnetic circuit and which are artificially subjected to the electric and magnetic conditions as exist in the machine. Such loss measurements can be made quite accurately, but in most cases it is difficult to reproduce the actual magnetic conditions which exist at different load and operating conditions. The losses which occur in the different parts of the machine due to any change in operating conditions can be obtained by measuring the energy absorbed by these parts when the machine is operating at constant temperatures and the change in operating condition is suddenly made. Under steady conditions, the heat flowing to any section plus the heat generated in that section must equal the heat flowing away from the section, since there is no change in stored

energy under steady temperature conditions. When the load is suddenly increased there is an instantaneous increase in the heat generated in the section. Since there must be a change in the temperature gradient before there can be any change in the heat flow, all of the increase in the generated energy in each section must be stored, at the first instant after the sudden change in load is made. The slope of the temperature time curve for the particular section is proportional to the rate at which energy is stored in it. The increase

constant of 55.8 watt-seconds per cu. in. per deg. cent., the loss in the stator teeth at the surface is 0.761 watts per cu. in. Since the density of the magnetizing flux in the stator teeth can be readily calculated, the loss constant can be obtained for the teeth with any kind of laminated iron as actually built in the machine. In a like manner, this method of measuring the loss and the analytical method of determining the magnetizing flux can be applied to all parts of the machine so that reliable loss constants can be obtained in terms of the different variable factors.

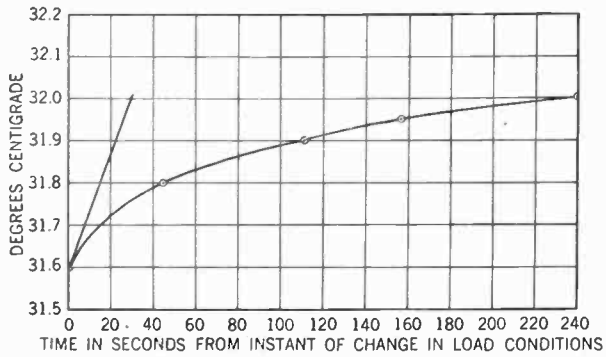

FIG. 14—TEMPERATURE RISE OF IRON VS. TIME

Couple No. 2—Location, turbine end lamination ---  $\frac{d\theta}{dt}$  in deg. cent. per sec., 0.01365 --- C, 55.8 --- watts per cu. in., 0.761

in loss in watts per cubic inch equals the slope in degrees centigrade per second, at the instant the load change is made, times the specific heat constant of the material in watt-seconds, per cubic inch, per degree

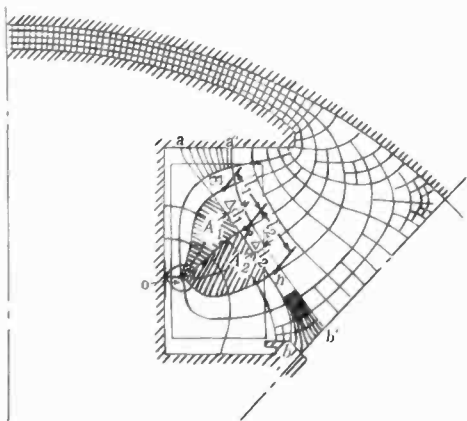

FIG. 15

centigrade. In order to check the feasibility of obtaining such temperature time curves, thermocouples were located at various points on a machine, and temperature readings were obtained for sudden load changes by means of a reliable potentiometer and a very sensitive galvanometer. The curve in Fig. 14 shows the change in temperature of the stator tooth laminations with respect to time when the load on generator No. 5 was changed from no-load, no-voltage condition to no-load, full-voltage condition. The rate of change of temperature with respect to time at zero time is 0.01365 deg. cent. per sec., and with a specific heat

GENERAL THEORY OF FLUX DISTRIBUTION IN AIR PARTS OF THE MAGNETIC CIRCUIT

In the first determination of the magnitude and distribution of the flux in the air parts of the magnetic

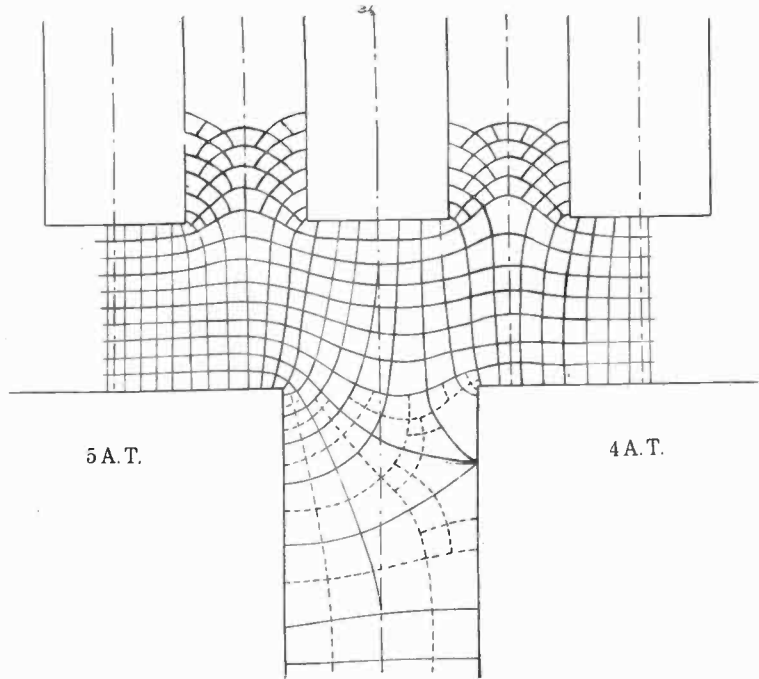

FIG. 16—FLUX DISTRIBUTION IN THE AIR-GAP AND ROTOR SLOT WITH RELATIVE M. M. FS. OF 5 AND 4 AMPERE-TURNS ACROSS GAP DUE TO ROTOR WINDING AND ZERO M. M. F. DUE TO STATOR WINDING

circuit of a high speed turbine generator, the iron parts were assumed to have infinite permeability. Later approximations were made, when necessary, to consider the effect of saturation. In laying out the flux fields, a family of orthogonal lines will be shown at right angles to the flux lines. Since the flux lines close and do not cross each other, the orthogonal lines, which are at right angles to flux lines, must always converge at the magnetomotive force centers. With a given set of magnetomotive forces and boundary conditions, it is assumed that the correct flux distribution is obtained when the stored energy in the magnetic circuit is a maximum. Uniform current densities are also assumed to exist at all sections of the electric conductors.

According to the accepted interpretation, the magnetomotive force produces closed lines of force or flux around the magnetic centers. There is no force,

however, acting along any of the orthogonal lines. This fact may be used to establish a simple relation between the orthogonal lines and flux lines which will greatly assist in the plotting of these curves. Referring to Fig. 15, the following notation will be used:

$A_1$  and  $A_2$  = the amperes in the respective shaded areas shown in Fig. 15.

$\Delta \phi$  = flux or number of lines of force going from  $a a'$  to  $b b'$  and are constant in value along this tube. This tube is to be considered of negligible width so that there is no difference in ampere turns acting on this circuit or path in the direction  $a' - a, b' - b$ , etc.

$l_1$  and  $l_2$  = the lengths of the path in the parts shown.

$\Delta d_1$  and  $\Delta d_2$  = the corresponding mean widths.

$H_1$  and  $H_2$  = mean field intensity along  $l_1$  and  $l_2$ .

The work done in moving a unit pole around the path  $o, m, p, o$  linking  $A_1$  is all done along  $m, p$  or  $l_1$ . Simi-

larly in moving a unit pole around  $o, p, n, o$  in linking  $A_2$ , the work is all done along  $p, n$  or  $l_2$ . Then

$$H_1 l_1 = \frac{4 \pi}{10} A_1 \tag{4}$$

$$H_2 l_2 = \frac{4 \pi}{10} A_2 \tag{5}$$

and since

$$\Delta \phi = H_1 \Delta d_1 = H_2 \Delta d_2 \tag{6}$$

by substituting equation (6) in (4) and (5),

$$\Delta \phi \frac{l_1}{\Delta d_1} = \frac{4 \pi}{10} A_1 \tag{7}$$

$$\Delta \phi \frac{l_2}{\Delta d_2} = \frac{4 \pi}{10} A_2 \tag{8}$$

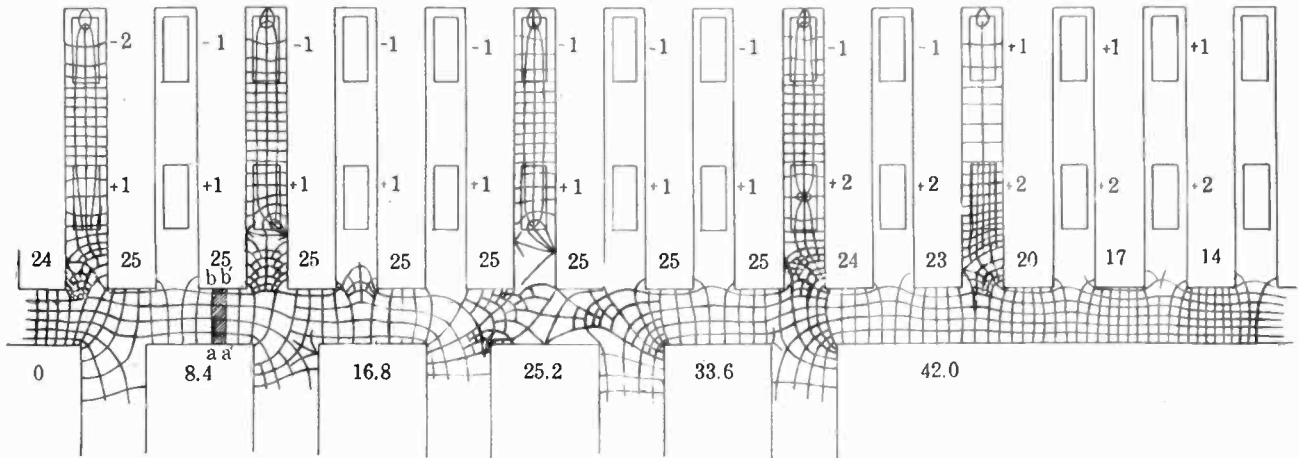

FIG. 18—TOTAL ARMATURE AMPERE-TURNS PER POLE = 13,260 AND ARE TAKEN AS PROPORTIONAL TO 25 IN THESE CALCULATIONS  
 Total field ampere-turns per pole = 22,277 and are taken as proportional to 42 in these calculations. Per inch perpendicular to the sheet the flux per tube  $a - a'$  to  $b - b'$  =  $3.19 \times 22,277 \times \frac{4}{42} = 6768$  lines

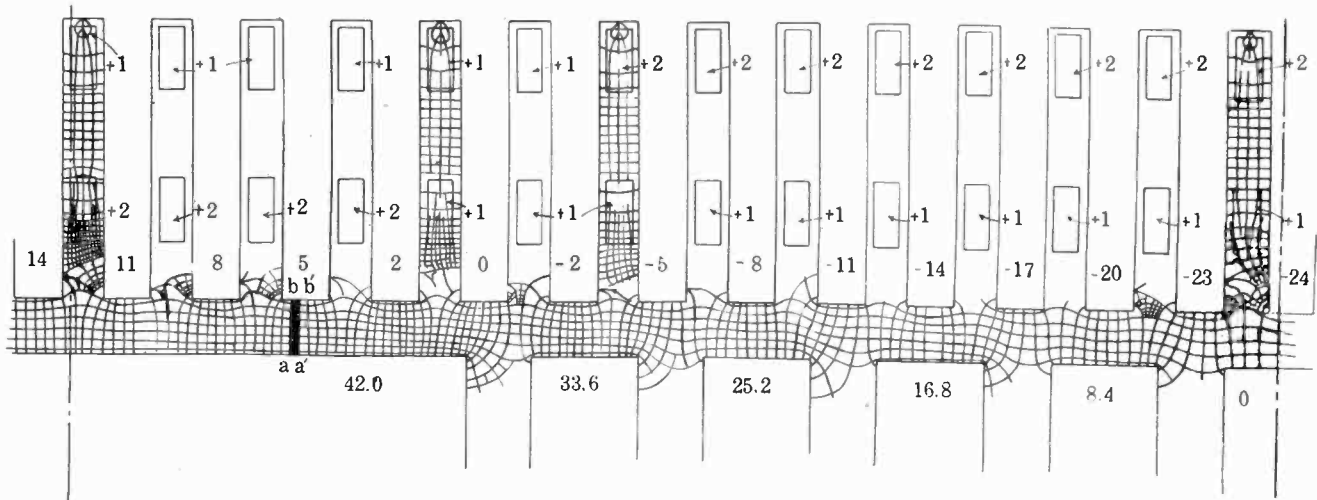

FIG. 19—TOTAL ARMATURE AMPERE-TURNS PER POLE = 13,200 AND ARE TAKEN AS PROPORTIONAL TO 25 IN THESE CALCULATIONS  
 Total field ampere-turns per pole = 22,277 and are taken as proportional to 42 in these calculations. Per inch perpendicular to the sheet the flux per tube  $a - a'$  to  $b - b'$  =  $3.19 \times 13,260 \times \frac{5}{25} = 8460$  lines

Let  $\Delta P_1$  and  $\Delta P_2 =$  the respective permeances in the two parts of the circuit shown above.

Then

$$\Delta P_1 \propto \frac{\Delta d_1}{l_1} \quad (9)$$

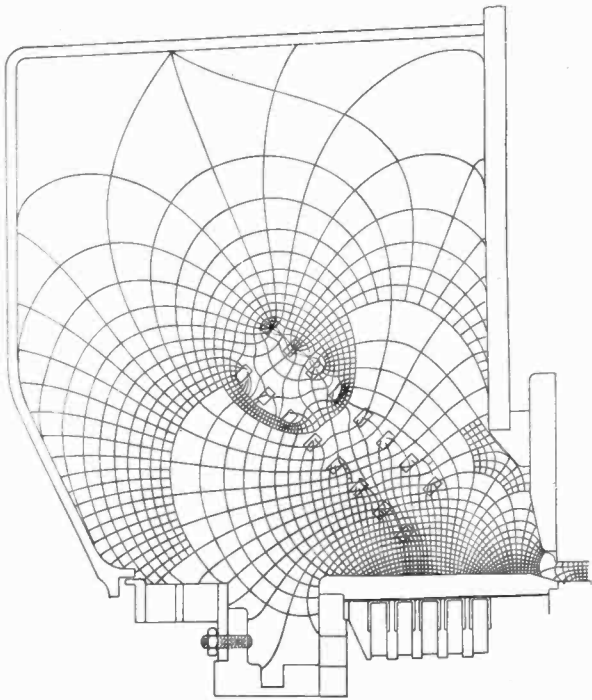

FIG. 20—TURBO GENERATOR END BELL LEAKAGE FLUX. Three-phase diamond coil armature winding section through radial plane of maximum flux densities for full load voltage and zero per cent power factor with armature current of 0.866 maximum value in two phases and zero in the third.

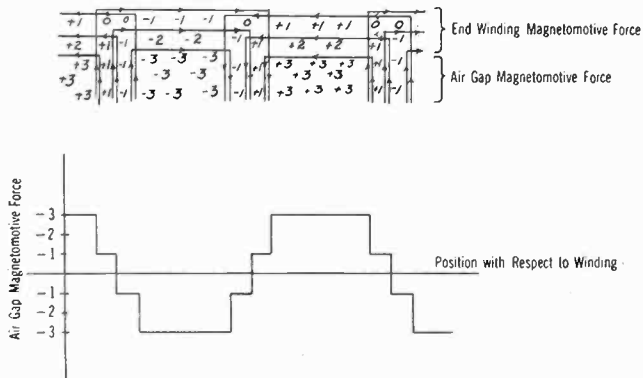

FIG. 22—FULL PITCH CONCENTRIC WINDING. CURRENTS OF EQUAL MAGNITUDE IN BOTH WINDINGS AND WITH DIRECTIONS INDICATED BY ARROWS

Numbers and signs indicate the relative magnitudes and directions of magnetomotive forces perpendicular to the surface through all the windings, on the assumption that the flux passes perpendicularly through that surface.

$$\Delta P_2 \propto \frac{\Delta d_2}{l_2} \quad (10)$$

Then

$$\frac{\Delta P_2}{\Delta P_1} = \frac{A_1}{A_2} = \frac{\text{area}_1}{\text{area}_2} \quad (11)$$

Since all the values in equation (11) can be easily estimated, graphical solutions for the flux distributions can be made fairly readily, where mathematical solutions would become too complicated in most irregularly shaped fields existing in electrical machines. As mathematical solutions would probably have to be based on the same assumption as this one, namely, iron paths of infinite permeability, even the increased

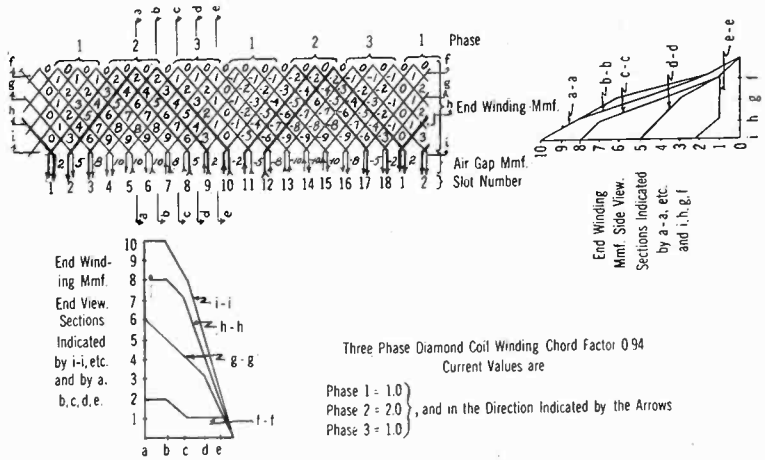

FIG. 23—THE NUMBERS AND SIGNS INDICATE THE RELATIVE MAGNITUDE AND DIRECTION OF THE MAGNETOMOTIVE FORCES PERPENDICULAR TO THE SURFACE THROUGH ALL THE WINDINGS ON THE ASSUMPTION THAT THE FLUX PASSES PERPENDICULARLY THROUGH THAT SURFACE

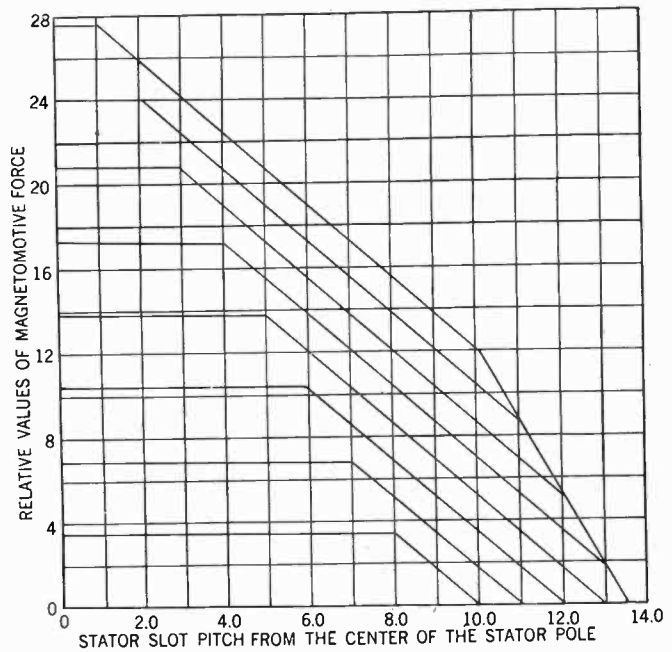

FIG. 24—END WINDING MAGNETOMOTIVE FORCES, END VIEW. THREE-PHASE, 54 SLOTS, PITCH 1-17. EQUAL CURRENTS IN TWO PHASES; ZERO IN THE THIRD

accuracy in determining the field probably would be unwarranted in many cases on the basis of this assumption.

While the foregoing theory of flux distribution applies specifically to the magnetomotive force of the armature or field winding acting alone, it can be extended to cover cases in which there are magnetomotive forces in both elements of the machine. In applying it to an actual machine, the magnitude and distribution

of the flux were determined for several different parts of the magnetic circuit, as shown in the following figures:

a. Fig. 16 shows the flux distribution in a portion of the air-gap with the field winding excited to give normal voltage, but with no current in the armature windings.

b. For Fig. 17 see the original paper.

c. Figs. 18 and 19 show the flux distribution in the air-gap when the generator is delivering 100 per cent kv-a. at 100 per cent voltage and power factor.

d. Fig. 20 shows the flux distribution in the air space between the end bells and the machine at the centerline of the poles for 100 per cent kv-a., 100 per

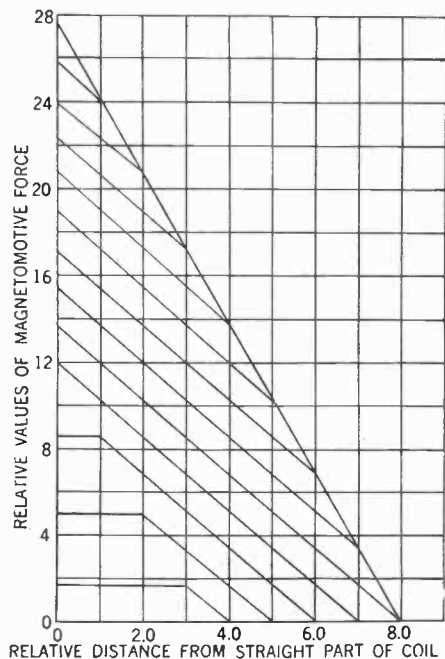

FIG. 25—END WINDING MAGNETOMOTIVE FORCES, SIDE VIEW. THREE-PHASE, 54 SLOTS, PITCH 1-17. EQUAL CURRENTS IN TWO PHASES; ZERO IN THE THIRD

cent voltage and zero per cent power factor. The instantaneous values of the currents in the three phases of the armature winding were 0, 86.6, and 086.6 per cent, respectively, of the maximum value at full load.

e. Figs. 24 and 25 show the magnetomotive force diagram due to the end connections of the armature winding of a 3600-r. p. m. turbine generator, for specific instantaneous values of current. In obtaining these diagrams, it was assumed that the magnetomotive force acts at right angles to the end winding surface determined by the end connections. The results which have already been obtained from preliminary experimental and analytical investigations indicate that this method should be satisfactory for determining the necessary data and constants for calculating the losses of electric machines which cannot be calculated or measured directly.

## FLOOD CONTROL AND HYDRO-ELECTRIC DEVELOPMENT

The appalling loss of life and property in the valley of the Mississippi and along its lower tributaries brings to the front the urgent necessity of remedial measures which will effectively and permanently put an end to this recurring scourge. For half a century at least the problem of controlling the floods of the Mississippi has been before the nation, but the awfulness of the present visitation shows how ineffectual the remedy has been. Civilization has greatly added to rather than subtracted from the danger of such floods, because roads, sewers, houses and the cutting down of forests hasten the run-off to the river. It is therefore obligatory in engineers to find a solution to the problem whose seriousness has thus been increased manifold by civilization itself, and toward that solution the electrical industry can contribute.

To mitigate damage from floods in a major stream like the Mississippi some control at the sources of its tributaries is essential. The erection of dams on these streams will suffice to hold the tributary waters in check and will also enable electricity to be generated in stations at or near the dams. Inasmuch as the water may also be used for irrigation, the outlay for hydroelectric development will be only a fraction of the total expenditure. Thus the electrical industry, which has already reduced the terrors of flood somewhat in the stricken area by keeping its circuits in condition to supply light, may also contribute to the harnessing and complete utilization of water for the service and not the destruction of mankind. The floods of the Mississippi can and must be checked. That job is for engineers, and engineers, if a chance be given them, will curb the Mississippi as they did the Miami, and render New Orleans and the other cities along the Father of Waters as secure from flood as they did Dayton, Ohio—overwhelmed fourteen years ago.—*Electrical World*.

## POWER SYSTEMS AID MANY FLOOD TOWNS

The great Mississippi River flood has demonstrated that the modern method of connecting up many cities and towns into systems in the distribution of electric power is one means of meeting emergencies. Throughout Arkansas and the other lower Mississippi states many a half-submerged community has electric light in its occupied houses for the reason that there was no local power plant "down by the river" to be drowned out by high water. Electricity continued available because it came in by way of a pole line that was a part of a wire system connecting several power plants in various parts of the country with many cities and towns.



# Graphical Determination of Magnetic Fields

## Comparison of Calculations and Tests

BY E. E. JOHNSON<sup>1</sup> and

C. H. GREEN<sup>2</sup>

Associate, A. I. E. E.

Non-Member

*Synopsis.*—This paper, which deals with the experimental determination of magnetic fields, is presented as a verification of some of the results described by Messrs. A. R. Stevenson, Jr., and R. H. Park in a companion paper, "Graphical Determination of Magnetic Fields—Theoretical Considerations," and to introduce new

and convenient methods of determining the flux distributions in air spaces and in regions occupied by current carrying media. The particular case dealt with is the determination of the leakage flux about the field poles of an alternator at no load, both in the copper and in the surrounding air spaces.

### TEST METHODS AND RESULTS

SINCE this investigation involves a large number of determinations of direction and intensity of magnetic flux in fields of intensity varying from, say, 50 to 40,000 lines per sq. in., it was essential to have a simple, reasonably accurate, and reliable device for the explorations. In deciding upon the methods to be



FIG. 1—FLUX MEASURING APPARATUS

This instrument consists of a small coil rotating at high speed which is inserted in the magnetic field to be measured. Connections are made from the coil to a commutator whose brushes are connected to an indicating meter. The revolving parts are enclosed in a non-magnetic casing. The entire instrument is about 6 in. long. The winding consists of two coils 2½ in. long, of 175 turns each. The rotating parts are driven through a flexible shaft by a 3600-rev. per min. synchronous motor. See Appendix A for further details

employed in measuring magnetic fields, due consideration was given to those which have been used by various investigators.<sup>3</sup> Finally two devices were chosen for use. One, due to Professor Dellenbaugh,<sup>4</sup> and developed by C. H. Green, measures the intensity by means of a revolving search coil equipped with a collecting device or commutator, and operating at a high and

constant speed. The direction of the field is determined by that position of the brush axis which gives either maximum or zero reading of the instrument. This device is shown in Fig. 1 and described in Appendix A. The other device used in this investigation measures the intensity of the magnetic field by the angular deflection of a small current carrying coil, the direction being determined by noting the position of the coil axis for zero deflection of the coil.<sup>5</sup> This device is shown in Fig. 2.

In order to get an experimental check of the plot of

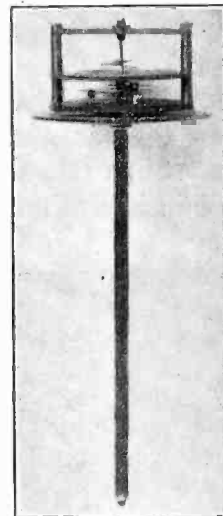

FIG. 2—COMPASS FLUXMETER

This device consists of a current-carrying coil which is inserted in the magnetic field to be plotted. The movement of the coil is opposed by a spring and flux direction is determined by the position of the coil axis for zero deflection. The coil and its shaft are enclosed in a non-magnetic case. The dimensions are as follows:

Length of hollow shaft, 6 in.; diameter of hollow shaft (outside), ¼ in.; diameter of hollow shaft (inside), 3/16 in.; length of armature coil (inside the shaft), ½ in.; diameter of armature coil, 5/32 in.; number of turns in armature coil, 20

field flux determined mathematically by Messrs. Stevenson and Park, a special pole structure having the required demensions was constructed of laminated iron. This is shown in Fig. 3.

5. A similar device employing a bar magnet in place of the coil was first used. It indicated the direction exactly as does a compass, the field strength being determined by offsetting the needle from its position of rest in the field and counting the oscillations resulting. The instrument had the objection that the bar magnet became saturated at high field intensities, thus changing its strength.

1. General Electric Company, Schenectady, N. Y.

2. Raytheon Manufacturing Co., Cambridge, Mass.; formerly of the General Electric Co., Schenectady, N. Y.

3. Bibliography, 1, 2, 3, 4, 5.

4. Bibliography, 6.

Presented at the Winter Convention of the A. I. E. E., New York, N. Y., February 7-11, 1927.

The following description of the experimental methods employed and the results obtained is divided into two parts: first, the Flux Distribution in Air Spaces; and second, the Flux Distribution in Current Carrying Regions.

### I. FLUX DISTRIBUTION IN AIR SPACES

The flux fields in the air spaces between the poles and between the poles and armature were explored by both types of measuring instruments and checked by the

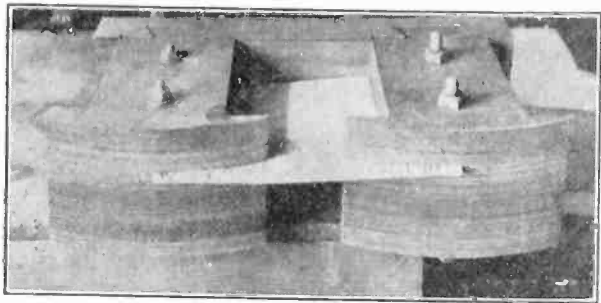

FIG. 3—EXPERIMENTAL SET-UP OF ALTERNATOR FIELD POLES

iron filing method. Fig. 4 is a reproduction of an actual photograph of the iron filing plot. The plot obtained by use of the instruments is shown and discussed in Part II.

The leakage flux at the end of the field poles of a generator is shown in Fig. 5A and B. The lines in Fig. 5B indicate the direction taken by iron filings and the arrows show the directions as indicated by the mea-

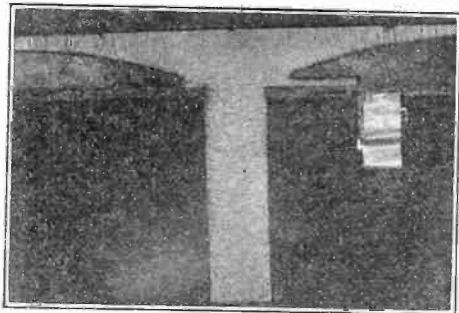

FIG. 4—FLUX FIELD IN THE INTERPOLAR SPACE OF THE SET-UP SHOWN IN FIG. 3, AS DETERMINED BY THE IRON FILING METHOD

suring instruments. Lines of constant magnetic intensity<sup>6</sup> of the end leakage flux are shown in Fig. 6.

### II. FLUX DISTRIBUTION IN CURRENT CARRYING REGIONS

Although a knowledge of the flux distribution within the current carrying regions of a field pole was made available by the mathematical method described in in the paper by Messrs. Stevenson and Park, no experimental determination had been made, as far as is known, until the present one.

6. These lines are lines along which the magnetic intensity is constant. They were useful in studying the effects of the rotating stray fields on the end structure of machines.

It was thought that the practical difficulty of exploring the field within the copper might be overcome by the substitution of a liquid conductor such as mercury, in the place of the copper, thus, of course, reducing the winding to one turn. The idea worked out successfully, the method of doing it in the case of the field poles being perhaps best explained by reference to Fig. 7.

As indicated in Fig. 7, the field winding consists of one

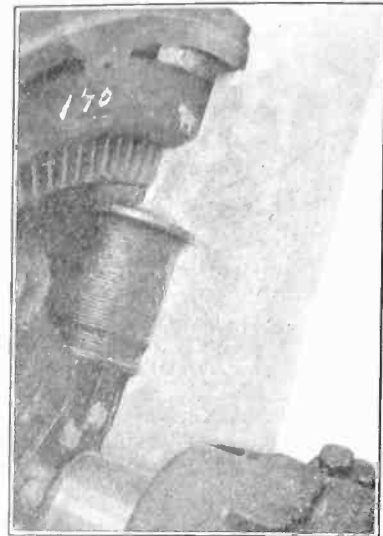

A

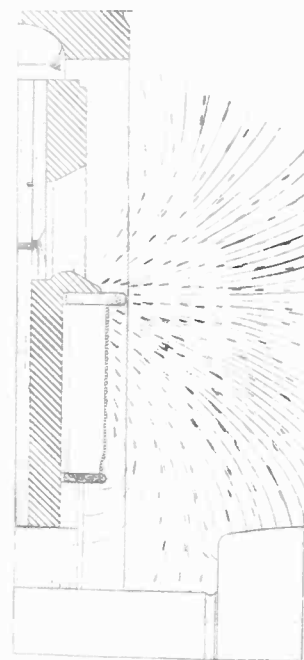

B

FIG. 5—MAGNETIC LEAKAGE FLUX AT ONE END OF A POLE OF A 6-POLE, 435-KV-A., 1200 REV. PER MIN., 4000-VOLT ALTERNATOR

A. As shown by iron filing method

B. As determined by use of the instrument, shown in Fig. 1

turn per pole. That part of the winding about pole S, which is labeled A, is a non-magnetic tank containing mercury. At the top of this tank is a copper plate perforated with  $\frac{1}{4}$ -in. holes, the plate being in electrical contact with the mercury. The holes in the copper plate are for the purpose of giving access to the inside of

the conductor. The armature structure has been purposely omitted from this figure in order to afford a view of the set-up. With the current flowing through the one turn field coils, the conditions as existing in an alternator at no load are practically duplicated, except that due to the high losses in the mercury it is impossible

The plot obtained by the free hand method is shown in Fig. 8A, the plot obtained by the mathematical method outlined in the paper by Stevenson and Park is shown in Fig. 8B, and the experimental plot is shown in Fig. 8C. It may be of considerable interest to know that the free hand plot was done first, the mathematical plot second, and the experimental plot third, each

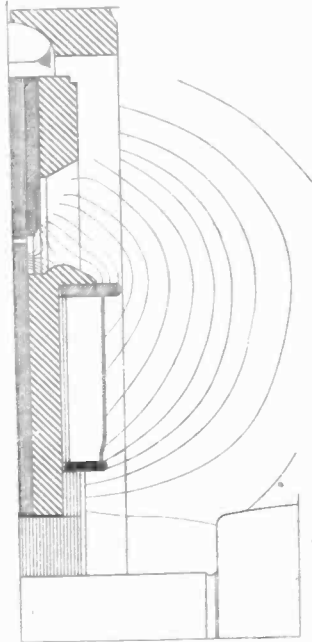

FIG. 6—LINES OF CONSTANT INTENSITY OF THE MAGNETIC FIELD SHOWN IN FIG. 5

to obtain conveniently the flux densities which exist in an alternator.<sup>7</sup>

The insertion of the measuring device displaces some of the mercury and hence some of the current. This involves an error the magnitude of which varies over the field but which, for the present investigation, is negligible except in places where the flux to be measured is of low intensity. In any event, the error is readily calculated and the necessary corrections made. A discussion of this point is given in Appendix A.

The exploring coil element of the measuring instru-

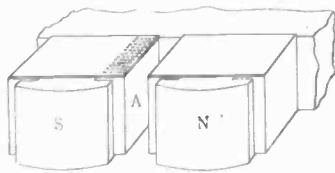
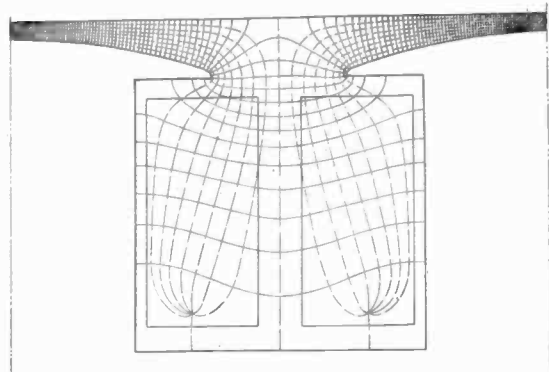

FIG. 7—EXPERIMENTAL SET-UP FOR DETERMINING THE FLUX DISTRIBUTION WITHIN THE FIELD WINDING OF AN ALTERNATOR

ment must necessarily carry a current, the effect of which is to distort the field. This field distortion is practically negligible in most magnetic fields about electrical machinery. This point is discussed in Appendix B.

7. The actual current employed in the single turn was 1000 amperes, thus producing an m. m. f. of 1000 ampere-turns per pole, which is considerably less than that which exists in an actual alternator.



A

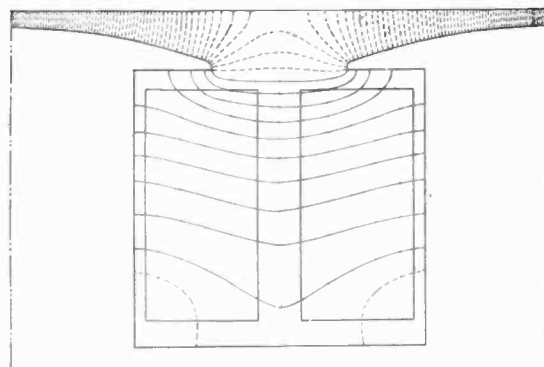

B

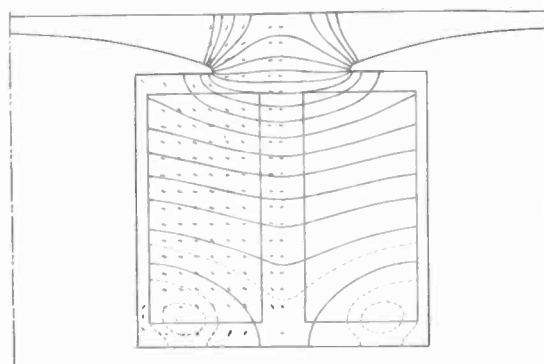

C

FIG. 8—FLUX DISTRIBUTION IN THE AIR-GAP AND INTERPOLAR SPACES OF THE SET-UP SHOWN IN FIGS. 3 AND 7

- A. As determined by the free hand graphical method
- B. As determined by mathematical method
- C. As determined experimentally

independently of the other, the theory preceding the experiment.

ACKNOWLEDGMENT

The authors gratefully acknowledge the assistance of Messrs. C. R. Barhydt and R. M. Ryan in performing much of the experimental work.

### Appendix A

#### DESCRIPTION OF THE FLUX-MEASURING DEVICE SHOWN IN FIG. 1

Complete investigation of both the useful and leakage flux distributions in the air spaces about an alternator requires the measurement of direction and densities in fields varying from, say, 50 to 40,000 lines per sq. in. The idea of using for this purpose a revolving search coil equipped with collecting device for commutator, is due to Mr. F. S. Dellenbaugh (Bibliography, 6).

The instrument developed by C. H. Green is designed to be simple and reasonably accurate, as well as portable and sturdy, for shop use. Fig. 1 shows the device, which is about 6 in. long overall, and therefore easily manipulated with one hand. The miniature armature runs within a protective stationary sleeve and is operated through a pair of small beveled gears driven in turn by detachable flexible drive shafts, from a  $\frac{1}{8}$ -h. p., 3600-r. p. m. synchronous motor. A dial graduated in degrees may be slipped over the knurled sleeve at the head end.

To obtain a maximum reading on an output meter, the brush position on the miniature commutator is varied by turning this friction sleeve between the fingers so that the direction of the flux being cut may be read off the dial.

The complete device is made of non-magnetic metal, with the exception of Bakelite where required for insulation. Brass is used for the casing, while aluminum monel, a stainless non-magnetic alloy of extremely high resistance, is used for the miniature armature spindle and commutator segments.

The spindle is four inches long, supported by a bearing at its outer end, and is 0.094 inch diameter. The winding consists of two coils each  $2\frac{1}{2}$  inches long, confined to the outer end of the spindle. Each coil is wound of 175 turns 0.002 inch enameled copper wire separated from each other and retained to the spindle with silk floss.

The completed armature is impregnated in lacquer to resist oil that might issue from bearings. Connections are made to the four-segment commutator,  $\frac{3}{8}$  inch diameter. The radio clearance of the armature within the  $\frac{1}{4}$  inch outside diameter sleeve is 0.015 inch.

The miniature armature is calibrated in a magnetic field of predetermined intensity, so that a factor between milli voltage output and flux density may be applied to subsequent meter readings when the instrument is used in the shop.

### Appendix B

#### INVESTIGATION OF THE ERROR INVOLVED DUE TO THE DISPLACEMENT OF CURRENT CARRYING MERCURY BY THE MEASURING INSTRUMENTS

It seems that in order to explore the magnetic field inside of a liquid conductor, such as mercury, it is necessary to displace some of the mercury. If the

measuring instruments were infinitesimally small, there would be no appreciable displacement of the mercury and hence no error due to that source would be involved in the field plot so obtained. The instruments used in this investigation, however, have a diameter of  $\frac{1}{4}$  inch and an error of some magnitude is to be expected.

The effect of the displacement of current carrying mercury is to remove a portion of the current. The

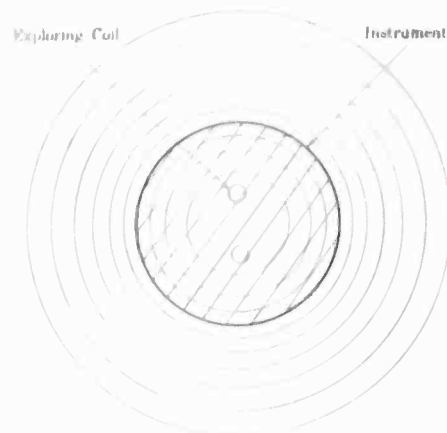

FIG. 9—FLUX DISTRIBUTION WHICH WOULD EXIST IF THE SPACE OCCUPIED BY THE MEASURING INSTRUMENT SHOWN WAS FILLED WITH A CURRENT FLOWING IN A DIRECTION PERPENDICULAR TO THE PLANE OF THE PAPER, AND NOT NEAR ANY OTHER ELECTRIC OR MAGNETIC CIRCUITS

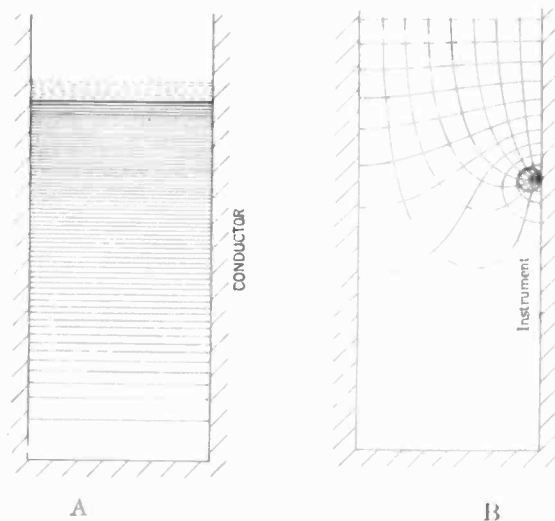

FIG. 10—FLUX DISTRIBUTION WHICH EXISTS IN AN INFINITELY DEEP IRON SLOT HAVING A LIQUID CONDUCTOR IN ITS BOTTOM

- A. Without the measuring instrument  
B. Due to a reverse current in the space occupied by the measuring instrument after insertion

removal of this current is equivalent to superposing upon the preexisting current in that portion a current of opposite direction and of the same density in that portion.<sup>8</sup> The magnetic field which results from the effect of the normal current distribution and of the superposed current is the same as that produced by the removal of the portion of current carrying mercury in the actual case.<sup>9</sup>

8. The instrument is properly insulated with varnish to prevent a flow of current through it.

9. Neglecting saturation, of course.

The problem, then, is to determine what effect the current in a cylindrical conductor has on an exploring coil placed in the magnetic field within that conductor for various configurations of the surrounding magnetic circuit.

If the lines of force in the conductor due to its own current are concentric with that conductor, there is no effect on the exploring coil, as may be seen by reference to Fig. 9. If, however, the lines of force are not concentric with the conductor, as when the conductor is brought very near an iron surface, there will be an effect upon the exploring coil.

As an extreme example of the above, consider the case, shown in Fig. 10, of an infinitely deep slot extending infinitely in the direction perpendicular to the paper, the bottom of which is filled with a liquid

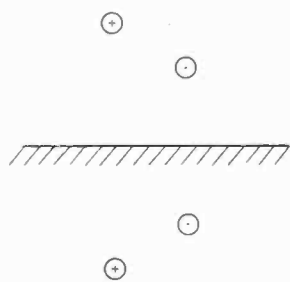

FIG. 11—IMAGE OF THE CURRENTS IN THE MEASURING INSTRUMENTS WHEN NEAR A PLANE IRON SURFACE

conductor, as indicated. A measuring instrument of the sort used in this investigation is inserted in the conductor and in contact with the iron.

The field around the exploring coil is the equivalent of the superposition of the two fields shown in Fig. 10, the first (Fig. 10A) being due to normal current distribution before the instrument was inserted, the second (Fig. 10B) being due to a reverse current in the space occupied by the measuring instrument after insertion.

The error in the magnitude and direction of the magnetic field in the space occupied by the measuring instrument is less than one per cent for the case shown in Fig. 10. The error will be the greatest where the field to be measured is the weakest, which, in the case shown in Fig. 10, is at the bottom of the slot. The error there is about 30 per cent, but this error does not render the method useless because it can always be calculated so that the field plot obtained experimentally may be corrected.

### Appendix C

#### ERROR DUE TO THE MAGNETIC REACTION OF THE MEASURING INSTRUMENTS UPON THE MAGNETIC FIELD TO BE MEASURED

The error due to this cause may be determined readily by making a plot of the magnetic field, which is caused by the current in the instruments and finding the magnitude and direction of the flux at the place occupied by the measuring instrument. If the instrument is near a particular plane iron surface, the mag-

netic field due to current in the instrument may be determined by the method of images; that is, the iron surface may be considered to be removed and another set of currents similar to those in the instrument placed at an equal distance from the iron surface and in the same direction, as shown in Fig. 11.

The error due to the cause encountered in this investigation is less than one per cent, except very near the kernel where the flux density of the field to be measured is zero.

### Bibliography

1. J. F. H. Doulgas and E. W. Kane, *Potential Gradient and Flux Density. Their Measurement By an Improved Method in Irregular Electrostatic and Magnetic Fields*, A. I. E. E. TRANSACTIONS. Vol. XLIII, 1924, p. 982.
2. W. Cramp and N. I. Calderwood, Calculation of Air-Space Flux, *I. E. E. Journal*, Volume 61, 1923, pp. 1061-71.
3. A. Still, Flux Distribution in Air-Gap and Teeth of Dynamos, *Electrician*, Lond., Volume 88, Feb. 10-17, 1922, pp. 152-53, 187-88.
4. B. Ell, New Method to Illustrate Direction and Density in an Electric Field by Means of Sensitized Paper or Plates. (In Swedish). *Tekn. Tidskr (Elektr.)*, Volume 51, April 6, 1921, p. 49-55. *E. T. Z.*, Volume 42, Oct. 20, 1921, p. 1194-96. A condensed account in German.
5. F. S. Dellenbaugh, Jr., *A Direct Recording Method of Measuring Magnetic Flux Distribution*. A. I. E. E. JOURNAL, Volume 39, June, 1920, p. 583-87.
6. F. Unger, Field Flux Distribution in Synchronous Machines (In German), *E. T. Z.*, Vol. 41, Apr. 22, 1920, p. 306-10. *Science Abstract, B*, Vol. 23, 1920, pp. 425-26. Abstract-translation.
7. J. F. H. Douglas, *Reluctance of Some Irregular Magnetic Fields*, A. I. E. E. TRANS., Vol. 34, 1915, Part 1, pp. 1067-1134.
8. R. Pohl, Magnetic Leakage of Salient Poles, *I. E. E. Journal*, Vol. 52, 1914, pp. 170-76.
9. Th. Lehmann, Graphical Method for Determining the Path of Lines of Force in Air (in German), *E. T. Z.*, Vol. 30, Oct. 21-28, 1909, pp. 995-98, 1019-22. *Science Abstract, B*, Vol. 12, 1909, pp. 511-12. Brief abstract-translation.
10. P. H. Powell, Air-Gap Correction Coefficient, *I. E. E. Journal* Vol. 40, 1907, pp. 228-34.
11. Th. F. Wall. Reluctance of the Air-Gap in Dynamo Machines, *I. E. E. Journal*, Vol. 40, 1907, pp. 550-76.
12. W. M. Thornton, Distribution of Magnetic Induction and Hysteresis Loss in Armatures. *I. E. E. Journal*, Vol. 37, 1906, pp. 125-39.
13. Hele-Shaw and others, Hydrodynamical and Electromagnetic Investigations Regarding the Magnetic Flux Distribution in Toothed-Core Armatures. *I. E. E. Journal*, Volume 34, 1904, pp. 21-53.
14. F. W. Carter, Air-Gap Induction, *Electrical World*, Vol. 38, Nov. 30, 1901, pp. 884-88.
15. F. W. Carter, Notes on Air-Gap and Interpolar Induction, *I. E. E. Journal*, Volume 29, 1900, pp. 925-33.

A demand has been presented recently for the revision of the special taxes which have been levied in France on luminous signs and other methods of using light for purposes of publicity. In France, for some years, taxes on luminous signs have been in effect with the result that there is a very general feeling amongst those interested that they form an excessive burden and should be repealed.

# Carrier-Current Selector Supervisory Equipment

BY C. E. STEWART<sup>1</sup> and C. F. WHITNEY<sup>2</sup>

Applicant for Membership

Non-Member

*Synopsis.*—The rapid advances made in the application of automatic principles to the control of electrical energy have produced many new and novel installations. This paper describes a supervisory system which centralizes the control and indication of all power used in operating a modern interurban railroad. Supervision is accomplished over a single circuit consisting of one insulated

wire with ground return. A single frequency carrier current is used for transmitting all signals over the circuit connecting all stations. Considerable attention has been given to make the equipment simple in design, rugged in construction, easy to install and convenient to maintain.

\* \* \* \* \*

THE application of automatic substations for supplying energy to suburban and interurban electric traction systems has undoubtedly added a very vital chapter in the economic life of these systems. From an operating viewpoint, however, the automatic station equipment has entirely eliminated the human intelligence at the station so essential to the former method of operation. In its place we have left a number of inanimate devices, arranged in electrical circuits to respond to certain definite electrical and mechanical laws. Thus, we obtain operations in a predetermined definite sequence, dependent upon the changes of the master devices within the substation.

Such a system operates very satisfactorily and would meet all requirements were it not for the occasional unusual occurrence which is foreign to any predetermined set-up, but which is nevertheless vital to unit operation. For example, to meet emergency conditions in this class of service, it is essential that means be provided for quickly opening all feeders supplying a particular trolley section. In many installations where load conditions permit, it has also been found profitable and advisable to shut down and lock out certain automatic substations during light load periods.

There is a demand, therefore, for some means of supervising these unattended automatic substations from a central point or dispatcher's station. A new class of equipment was developed several years ago, and is known as "automatic supervisory equipment." This equipment provides a dispatcher with a means of selectively controlling devices in the substations and automatically gives him a visual indication of the substation apparatus by means of standard indicating lamps located in cabinets at his office.

One of the most interesting and unique applications of automatic supervisory equipment to interurban railway service is that installed on the Chicago South Shore and South Bend R. R. which runs between Chicago and South Bend, Indiana. This gives supervision over a 1500-volt, d-c. electrification with converter and mercury arc rectifier substations. There are eight substations located between Hammond, Indiana, and South Bend, a distance of about 65 mi. The sta-

tions named in order along the right of way are as follows: Hammond, Gary, Wycliff, Furnessville, Michigan City, Tee Lake, New Carlisle, and Grandview. Columbia Avenue and Michigan City substations are manually operated but have automatic reclosing d-c. feeder equipment.

The power dispatcher is located in the Hammond Substation. He has direct supervision over the high-tension incoming line breakers and machine equipments. An indication is also given him of the d-c. feeder breakers in all eight substations.

The train dispatcher is located near the Michigan City substation. He has supervision over the d-c. feeder breakers in all eight substations and also indication of the machine equipments.

The supervisory equipment is of the carrier-current selector type and operates over one line wire and ground. A single No. 6 B and S copper wire is strung on standard 2300-volt insulators for the entire distance. For about five miles at one end of the system this wire is carried on the same pole as the 33,000-volt power circuits.

With the above picture in mind, it is interesting to note the following special conditions which effected, to a large extent, the choice of this particular class of equipment.

1. A problem was presented due to the severe sleet and ice conditions peculiar to this section of the country. Line wires as ordinarily constructed for telephony are subject to many breakages during the winter months. An attempt was made to increase the reliability of operation by installing larger wire and using distribution insulators. The choice of the No. 6, B and S line wire was due, therefore, to its mechanical qualities rather than its electrical characteristics, although the latter are highly desirable.

2. On account of the increase in cost of the specially constructed circuits, it was necessary, therefore, to use a minimum number of line wires, running between stations.

3. Since the supervisory circuits were exposed to high tension disturbances, it was essential to provide protection to connected apparatus. Where line wires are connected metallicly to sending and receiving equipments we have a very serious problem of obtaining proper protection. Protection of equipment so con-

1. Both of the General Electric Co., Schenectady, N. Y.

Presented at the Regional Meeting of District No. 7, of the A. I. E. E., Kansas City, Mo., March 17-18, 1927.

nected presents an entirely different problem from that experienced in telephony. It is impossible to use line insulating transformers and drainage coils are undesirable on account of the resultant losses. The use of insulating transformers is not possible where the operation of the system is dependent upon d-c. lock-out or holding circuits.

The supervisory equipment line wires can be run, in many instances, in lead sheath cable in order to obtain proper protection to the equipment. The cost of such construction becomes prohibitive on a right-of-way of this mileage.

4. The carrier-current system provides a satisfactory solution to the protection problem. The coupling between the station's equipment and the external circuit is readily made by means of high-voltage condensers which, from the standpoint of protection, serve, in effect, the same purpose as the insulating transformers. Low-frequency drainage units serve to remove the electrostatic induction from the line wires, and standard protective apparatus, consisting of gaps to ground, fuses, arresters and choke coils, can be employed to protect against unusual disturbances.

Carrier-current equipment as designed will satisfactorily operate over any circuit which will offer low impedance to the high-frequency carrier current. The equipment can be coupled, therefore, through suitable condensers to the high-tension power lines. In the installation referred to, the transmission lines did not offer a satisfactory circuit because of their interconnections and possible separation along the right-of-way.

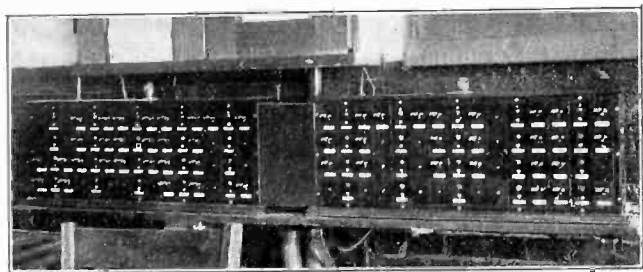

FIG. 1—DISPATCHER'S KEY CABINET (COLUMBIA AVE. SUBSTATION, HAMMOND, IND.)

The cost of the necessary by-pass equipment to secure a satisfactory carrier-current circuit was prohibitive.

A very important feature in connection with the design of this apparatus is that all devices are panel mounted. This applies to all equipment with the exception of the dispatcher's office key and lamp cabinet. The equipment is mounted on standard 90-in. switchboard panels. The panels are completely wired and all external circuit connections are made to standard connection blocks on the back of panel. Installation costs are reduced, therefore, to a minimum as it is only necessary to interconnect between major apparatus in the stations. All installation wiring can be of the standard control size ordinarily used on power switchboards.

The carrier-current system uses the same equipment which has been used so successfully for a number of years in the selector system. A carrier-current panel is added to the standard selector equipment at each station.

In the 90-in. carrier-current panel, a cover over the back affords protection to vacuum tubes, condensers and variometers. On this panel are mounted the selectors and polarized relays which set up the indication circuits on the key and lamp cabinet in accordance with coded signals received from the substations.

Fig. 1 shows a key and lamp cabinet. For each

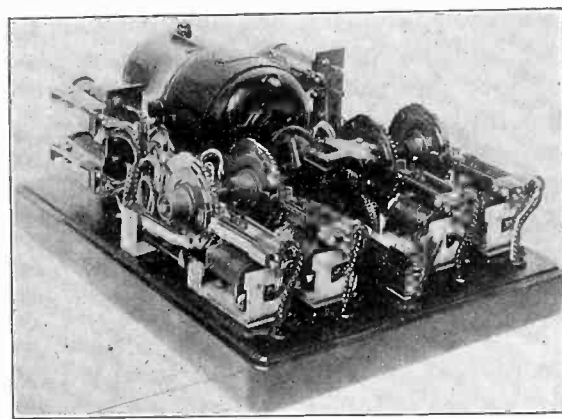

FIG. 2—SUBSTATION MOTOR SENDING KEY

substation unit supervised this cabinet contains two manually-operated, spring-driven code-sending keys and two indicating lamps. It also contains the master operating key, checking keys and common indicating lamps.

On a typical substation panel, the selectors in connection with an associated carrier-current panel respond to coded control signals from the dispatcher.

Mounted on this panel are the motor-driven sending keys (Fig. 2) which originate the code signals for each supervised substation unit. Associated with each motor sending key is a checking relay. This relay provides a means whereby the dispatcher can check the position of supervised equipment without operating it. This feature is important from a maintenance viewpoint because it provides a check on both the control and indication operation of the equipment.

All operating potentials are obtained from storage batteries. The supervisory system, therefore, is not affected by the momentary loss of the high-tension power circuits and renders reliable service under emergency conditions.

The selection of a carrier-current frequency is, in general, dependent upon the impedance characteristics of the circuit over which the equipment must operate. On an installation involving a number of stations it is desirable to obtain this from actual field tests at the time the equipment is placed in service. Such tests show that there are one or more frequencies to which the entire system will respond most effectively. The

carrier-current selector supervisory equipment, therefore, is designed so that frequency adjustments can be made over a wide range. Once the frequency is chosen for an installation, the tuning adjustments of all transmitters and receivers are locked in position and require no further attention.

The carrier-current circuits may be divided into two distinct divisions which may be designated as the transmitter and the receiver. The function of the transmitter is to transform the d-c. impulses originated by the code sending keys into a high-frequency form so that they may be impressed upon the carrier-current line. The function of the receiver is to take the high-frequency impulses from the line and, by means of a vacuum tube rectifier, reduce them to such a form that they may be used for operating the usual supervisory relays. Both the transmitter and the receiver depend upon the three-element vacuum tube or pliotron for their action.

The transmitter utilizes three vacuum tubes of the 50-watt size. One tube is used in the master oscillator circuit which generates the high-frequency oscillations. The other tubes form a part of the power amplifier circuit the function of which is to increase the output of the element. The master oscillator uses the Colpitts circuit for generating the high frequency. A 1000-volt, d-c. source is required between the plate and filament of the tube and a 10-volt, a-c. source heats the filament. The inductance of the oscillator circuit is in the form of a variometer having a movable rotor. Depending on the position of this rotor, the master oscillator can be made to generate any frequency between 20 and 80 kilocycles.

The elements of the two power amplifier tubes are connected in parallel and their plate and filament voltages are taken from the 1000-volt, d-c. source and 10-volt, a-c. source, respectively. The high-frequency voltage taken across one of the condensers in the oscillator circuit is applied between the grids and filaments of the power amplifier tubes. This high-frequency voltage applied to the grids results in a variation in the d-c. plate current to the power amplifiers of the same frequency. The primary of an output transformer is connected in the plate circuit of the power amplifiers and the high-frequency output of these tubes is utilized by connecting to the secondary of this transformer. The secondary is provided with taps so that the desired voltage may be obtained, the correct voltage being dependent on the line impedance at the frequency used. One side of the secondary of the output transformer is connected to ground and the other side through a coupling condenser to the carrier transmission line. A second variometer and a thermoammeter are in series with the coupling condenser. A resonant circuit is formed by the output transformer secondary, the output variometer, the coupling condenser and the impedance of the line to ground. This circuit is tuned to resonance for the frequency generated by the master

oscillator by varying the position of the rotor in the output variometer until maximum current is indicated by the output ammeter. The maximum input of power to the line at this frequency is then obtained. Two tubes are used in parallel in the power amplifier circuit in order that the desired output may be obtained from the transmitter without overheating the tube elements. The maximum output of the transmitter is 150 watts.

The high-frequency output from the transmitter is controlled by means of a relay called the transmitter keying relay. When the coil of the relay is energized, one pair of contacts completes the circuit from the 1000-volt, d-c. source to the plates of the transmitter tubes, causing the high frequency to be generated. A second pair of contacts connects the secondary of the output circuit to ground.

The 1000-volt, d-c. power for the plates of the transmitter tubes is derived from a 500-watt motor-generator set which is driven from a 120-volt storage battery. The motor is in reality a converter as it has slip-rings which supply 88 volts at 40 cycles. By means of a small transformer, this source is stepped down to 10 volts for lighting the filaments of the transmitter tubes. Two rheostats are mounted on the carrier-current panel, one for controlling the field current of the generator and the other is in series with the primary of the filament transformer for adjusting the filament voltage.

Test jacks and keys are provided on the panel to facilitate checking the operation of the transmitter. A jack, in series with the common grid connection to the tubes, allows a milliammeter to be connected in this circuit. If the master oscillator is not generating high frequency no reading will be obtained on this meter. If the master oscillator is functioning properly but the power amplifier is not, the meter will read about 80 milliamperes. If both master oscillator and power amplifier are functioning properly, a reading of approximately 150 milliamperes will be obtained. A jack across the filament circuit of the transmitter tubes provides for connecting an a-c. voltmeter in order to adjust the filament voltage. The output ammeter is normally shunted out of the circuit and is used for testing and maintenance purposes only. When it is necessary to start the transmitter for inspection purposes, a switch on the panel may be closed, operating the motor starting contactor. This switch also opens a circuit which delays the operation of the motor sending key until the inspection is completed. Another switch completes the circuit to the keying relay, causing the transmitter to generate and send out the carrier current. It is sometimes necessary for the maintainer to make inspections, on the back of the panel, which might cause him to come in contact with highpotential circuits if the motor-generator were running. A switch is provided to open the circuit to the motor starting contactor, thus preventing the generating of high voltage until his inspection is completed. All of these test switches are



plainly marked with individual nameplates on the front of the panel.

The receiver is connected to the carrier-current line by means of a coupler which consists essentially of two coils so mounted that their inductive relation to one another may be varied. One terminal of the primary coil is connected to ground and the other terminal is connected to the carrier-current line through the coupling condenser. A variable condenser is connected across the terminals of the secondary coil forming a resonant circuit which may be tuned to the carrier frequency by adjusting the condenser to the proper capacity. The voltage across this resonant circuit is applied to the grids of the detector tubes which are of the 7.5-watt type and are slightly larger than the average tube used in radio broadcast receiving sets. There are two of these tubes in the receiver with their elements connected in parallel. Plate voltage is supplied from the 120-volt station battery and the filaments are lighted from a 24-volt tap on the same battery. The grids are connected through the secondary of the coupler to the low potential end of the filament resistor. This makes the potential of the grid minus 18 volts with respect to the filaments when no high-frequency voltage exists across the secondary coil. This prevents any current from flowing to the plate and consequently the detector relay, which is operated by this plate current, is not energized. When the carrier frequency voltage exists between the carrier line and ground, a voltage of this frequency is superimposed upon the d-c. voltage applied to the grid of the detector tube. Due to the characteristics of the vacuum tube, this a-c. voltage superimposed upon the negative 18 volts of direct current causes the average voltage of the grids to be increased, allowing plate current to flow and energizing the detector relay. A jack is provided in the plate circuit by means of which a five-milliampere ammeter may be connected in this circuit. This provides a means of checking the operation of the receiver as well as a means of tuning the receiver to the desired frequency. When carrier current is being transmitted from some other station the capacity of the receiver tuning condenser may be varied until a maximum plate current is obtained. This indicates that the receiver is tuned to the proper frequency.

Two detector tubes are used in order to give a maximum reliability to the equipment since the operation of the receiver depends upon the proper functioning of the detector tube. The action of the receiver is equally as satisfactory with either tube alone as with both tubes. The failure of one tube, due to a broken filament or loss of emission, does not impair the operation of the equipment and the maintainer, during his regular inspection, will discover and replace an inoperative tube. The detector tube is of sturdy design and in this class of service has a life of approximately one year.

When the detector relay is energized it completes a

circuit from the 24-volt source to the reversing relay which, in turn, operates the selector according to the coded carrier-current impulses. The detector relay also breaks a circuit which prevents the dispatcher, or the motor key as the case may be, from using the associated transmitter for a definite time after the last carrier-current impulse. In order to prevent the receiver from detecting the carrier voltage generated by the associated transmitter, the keying relay is provided with contacts which disconnect the receiver from the carrier-current line and open the plate circuit of the detector tubes. In the dispatcher's station, the detector relay completes a circuit to a pilot lamp on top of the key cabinet, causing it to flash in accordance with the incoming code. The equipment is interlocked to prevent the dispatcher from using the transmitter while the receiver is in operation.

The operation of the system may be divided into two distinct functions; namely, the control operation and the

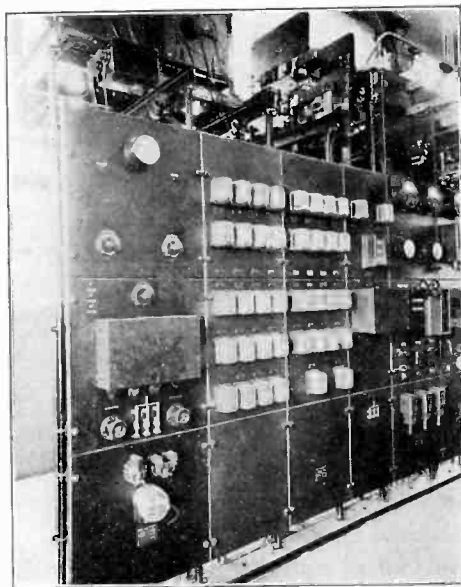

FIG. 3—DISPATCHER'S PANEL EQUIPMENT (COLUMBIA AVE. SUBSTATION, HAMMOND, IND.)

indication operation. The control operation is originated by one of the dispatchers and is for the purpose of starting or stopping one of the machines, or closing or tripping one of the breakers assigned to his supervision. The indication operation is originated by the starting or stopping of some machine or the closing or opening of some breaker in an outlying station. Either type of operation requires the use of only the transmitter at the originating station and the receivers in all of the rest of the stations. All of the operations of either type are transmitted on a single carrier-current frequency. In order that only one transmitter may be in operation at a time, the transmitters are interlocked with the receivers.

Before any station may transmit a coded signal it must send out a short impulse of carrier current called

the locking impulse. This is detected by all receivers which immediately interlock their respective transmitters. A transmitter may function only in case its associated receiver has not detected carrier current on the line for a definite period of time. This allows for the completion of any code which might be in the process of transmission.

In order to demonstrate more clearly the working of the system, a complete operation of each type will be followed through.

Assume that the dispatcher at station No. 1 wishes to trip the a-c. incoming line breaker at station No. 4. The red lamp corresponding to this breaker indicates that the breaker is closed. If the white lamp on top of the key and lamp cabinet is not flashing, no signals are being received and the dispatcher can use the line. He turns the master key 90 deg. in a clockwise direction and releases it. The spring which is wound up by this turn revolves a contact wheel. While revolving, this wheel completes a circuit through auxiliary devices to start the motor-generator set. The generator lights the filaments of the transmitter tubes and supplies the 1000 volts d-c. for their plates. A timing relay is energized and at a definite later time, a circuit to the keying relay of the transmitter is closed for 0.2 of a second to send out the locking impulse. At the termination of this locking impulse the circuit is completed to a green lamp opposite the dispatcher's master key. This indicates to the dispatcher that his transmitter is now ready for operation and that he has control of the line. He now turns the operation key, which in this case would be labeled "Trip a-c. breaker, station No. 4." When released, this key keeps the motor-generator set running and operates the keying relay in accordance with the code setting on its impulse wheel. This causes impulses of carrier current to be sent out over the line. The detector relays in all of the other stations are operated in accordance with this code and the selectors at all these points are actuated. Only the selector in station No. 4, however, closes its contact and trips the a-c. incoming line breaker. When the key released by the dispatcher completes its rotation, circuits are opened which shut down the motor-generator set and extinguish the green lamp opposite the master key.

Whenever a supervised unit at an outlying station changes its position, a circuit is established to the motor driven sending key. A circuit is also made to start the motor-generator set and energize a timing relay. If there has been no carrier current on the line for a definite period of time, this timing relay completes a momentary circuit to the keying relay and sends out the locking impulse. This prevents any other station from obtaining the line during the transmission of the coded signal. As soon as the locking impulse has been sent, the code wheel associated with the supervised unit is released. As this revolves it operates the keying

relay which transmits the coded group of carrier-current impulses.

These impulses of carrier current are received on the detector circuits in all other stations. Only one selector in the dispatcher's office notches up and completes its contact. Depending upon the code received, a circuit is established to light either the red or green indicating lamp on the dispatcher's key and lamp panel. In addition to any change made in the dispatcher's indicating lamps, there is also a bell which calls his attention to any change in the position of his supervised units.

When any station has completed the transmission of a signal the motor-generator set comes to rest and all associated transmitting circuits are de-energized. Only the receiving tubes in the entire equipment require current continuously.

It is expected that this class of supervisory equipment operating over a well constructed line wire will prove more dependable than a system operating over several wires between the respective stations. Experience indicates that more difficulties are encountered due to the line wires than with the actual selector equipment. Great care has been taken to obtain simplicity of circuits, well constructed and reliable devices as well as a design layout which invites and facilitates proper maintenance.

In conclusion, supervisory systems of reliable design have centralized in the person of the dispatcher, the human intelligence which was removed from the substations by the advent of the automatic station equipment. The dispatcher is able to operate his system more efficiently and is prepared to meet promptly any special problems which may arise. The supervisory and automatic equipments are waiting night and day to give immediate response to his orders.

## ELECTRICITY USED FOR MELTING METALS

The melting of certain metals by the use of electricity as compared with coal-fired furnaces has been described by the Chief of the Metallurgical Division of the Bureau of Standards in a statement recently released for publication.

The paper points out that aside from electric reduction in fused salts and the making of ferro-alloys, electrothermic reduction of ores of the non-ferrous metals is not commercially practised in America. Electrothermics finds some application in annealing and heat-treatment of non-ferrous alloys, but its chief application is in melting. About 25 per cent of the type metal is electrically melted. Electric melting is practically standard for nickel and its alloys. Around 90 per cent of the output of brass, bronze, and nickel silver from the rolling mills, and nearly 30 per cent of the output from foundries is melted in electric furnaces.

# Electric Welding of Pipes

BY J. F. LINCOLN<sup>1</sup>

Member, A. I. E. E.

*Synopsis.*—The advantages of arc welding in manufacturing, instead of riveting or using cast iron are set forth in this paper. These advantages for manufacturing pipe are especially emphasized and information is given on the manufacture of the pipe for one

particular pipe line, 90 mi. long, for which automatic arc welding is used. There is discussion, also, on the possibilities of arc welding pipe joints in the field.

\* \* \* \* \*

THE use of electric arc welding for repairs is too well and favorably known to be commented upon. The use of electric arc welding for manufacturing, however, is very much more recent and perhaps not nearly so well known.

While there is no doubt that the saving made by electric arc welding as applied to repair work exceeds many millions of dollars per year, its saving because of the possibilities in manufacturing by this method are enormously greater. The fundamental reasons for this are twofold:

When compared with riveting (which heretofore has been the favored method for joining steel parts), welding will make a joint equally as strong as the original sheet, while riveting makes a joint having only from 50 per cent to 70 per cent of the sheet strength if the usual type of single or double lap riveting is used. When it is considered that the cost of welding in general per foot of seam is less than the cost of the rivets alone, the enormous possibilities of economies in comparison with riveting can easily be seen.

There is another place, however, where welding will be of far greater importance than in either of the cases cited; and that is in the replacement of present parts which are made from cast iron by arc-welded structural steel. It is only necessary to say that steel is five times as strong and two and one-half times as stiff and twice as safe as cast iron and yet costs only one-third as much per pound, to show the enormous possibilities of this method of machinery manufacture. Putting the statement in another way, supposing by way of illustration, the bed of a lathe weighs 2000 lb.—the cost of the casting of one will be approximately \$120.00. If instead of cast iron, structural steel were used to obtain exactly the same stiffness with exactly the same depth of bed, the total cost of the structural steel would be approximately \$17.00, and because of the very nature of structural steel compared to cast iron, the bed would be very much cheaper to machine, would stay true very much longer, having no tendency to warp out of shape, as compared with its cast iron competitor.

In manufacturing a container which is subject to pressure (such as a heating boiler), the difference is even more marked.

Supposing a cast iron boiler is used and made just heavy enough to withstand certain pressure applied,

the total weight of this particular boiler being one ton, the cost of the boiler casting would be \$120.00. If an equivalent structure were made out of steel, the cost of the steel to make this structure would be \$8.00, and if an equivalent factor of safety were used so that both would be equally safe and the cast iron structure still weighed one ton and cost \$120.00, the steel structure would weigh 200 lb. and would cost \$4.00, since the factor of safety applied to cast iron is, in general, twice that applied to steel.

From this it is easy to see what will be the future of

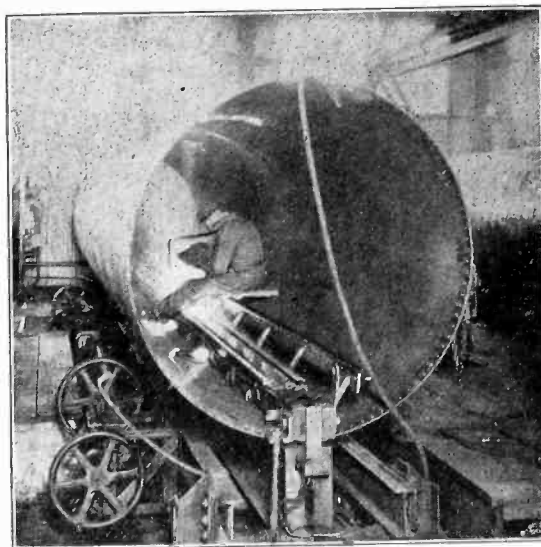

THIRTY-FOOT SECTION OF PIPE IN TESTING MACHINE

Hydrostatic pressure stresses plate to near elastic limit. The 19-lb. sledges are then dropped. This is the most severe test ever applied to commercial welds.

both riveted steel and castings. All structures now made from riveted steel or from cast iron will, in general, be made of welded steel, making the structure stronger, more reliable, lighter, and unbreakable. To show that the possibilities of these methods are not unused, the author wishes to say that at the present time, with greater profit to themselves and to their customers there are thousands of manufacturers in this country who are using welding for manufacturing parts which heretofore have been made from riveted steel and from cast iron.

It might be remarked that one of the large manufacturing companies has recently made the statement that the application of arc welding is saving it an amount in excess of \$1,000,000 per year compared with its previous methods of manufacture.

Within the last three years the company with which the writer is connected has by applying the methods outlined above, reduced the average cost of its product

1. The Lincoln Electric Co., Cleveland, Ohio.

Presented at the Regional Meeting of District No. 7 of the A. I. E. E., Kansas City, Mo., March 17-18, 1927.

by more than 20 per cent, at the same time making the product better from every point of view.

The application of this same process to the manufacture of pipe has peculiar advantages. At the present time steel pipe is made, in general, in two ways:

First, in the sizes 22 in. in diameter and less, it is made almost exclusively (where it is to be operated under pressure), by the method used in the usual tube mill, which, for lack of a better name, we shall call *roll welding*. The flat skelp is formed into a tube, the edges scarfed and brought to welding temperature. There they are run through a set of rolls in which the weld is made complete. This method is used at the present time in the manufacture of practically all pipe up to 22-in., which is the limit of commercial feasibility in present-day commercial tube mills.

Second, in sizes above that, riveting has been resorted

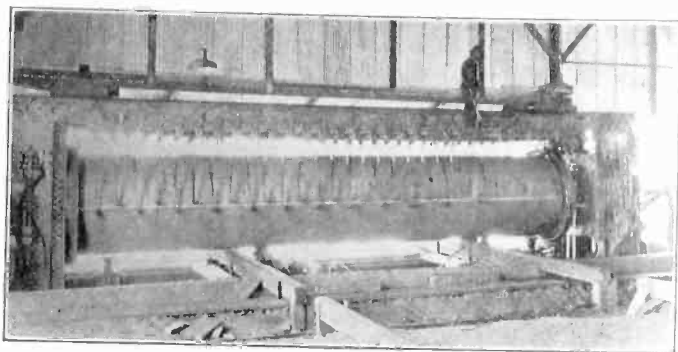

WELDING MACHINE IN OPERATION

(Note heavy bars in mandrel designed to prevent warping of plates due to heat of welding)

to to a very large extent, although the lock bar process (in which the edges of the plate are upset and then clamped between the projections of a peculiarly formed H-beam), has been used considerably with satisfactory results.

All of these methods, when compared to the cost of the plate itself, are extremely costly. Although the skelp from which the thing is made may have a cost of less than two cents per lb., the pipe when completed by the roll welded process has a cost of approximately five cents per lb., the riveted pipe, even in large sizes, has on an average a cost equally as great.

The other process, the lock bar, has approximately the same cost as riveting.

When it comes to the matter of tightness, there are other difficulties. The usual roll welded pipe is gas and water tight insofar as its longitudinal seam is concerned, and by the use of arc welding or gas welding, the joints may also be made tight although the screw joints which have been made heretofore leave much to be desired in that direction. Riveted pipe however, cannot be made tight in actual service over long periods of time. The leakage from a riveted pipe is a well known factor and is recognized in all riveted specifications. In general, too, it is necessary to use 50 per cent thicker plate for the manufacture of the riveted pipe compared to arc welded, the reason for this being that the strength of the joint is not more than two-thirds the strength of the

plate, even with a double lap riveted joint, and the projections of the rivet heads into the riveted pipe very seriously interfere with the rapid movement of liquid through it. For that reason the pipe, if riveted, must be made in larger diameters than if made by a process which will give a smooth interior. What these items amount to in total becomes staggering. As an illustration, The Mokelumne River pipe line which was made arc welded, is 90 mi. long and contains 78,000 tons of steel. If this same pipe line, with the same strength of joint and the same ability to carry water, had been made riveted, it would have required 128,000 tons of steel to accomplish the purpose, and the cost would be at least \$3,000,000 more.

If we now consider the matter of pipe making in general, we find a number of advantages other than mere cost. While it is true that pipe in all diameters can be made for a cost considerably less than that at which it can be bought from the tube mills at the present time, yet there are other advantages from the pipe buyer's point of view which are certainly equally important.

In the first place, arc welded pipe can be made in any diameter and in any length. It can also be made in any thickness of wall. This becomes an extremely important matter since, for many diameters, the minimum thickness is so great that the pipe must be very much heavier than required by the work to be done, so that not only is the cost per pound higher than would be the case with arc welded pipe, but the number of pounds used is also very considerably greater than would be necessary if the pressure to be carried were the controlling factor. This has to do with roll welded pipe only. There is one other factor in connection with this that is of equal importance; roll welded pipe can be made only of steel of a certain analysis. If it is desired, therefore, to make a pipe line from steel which is of greater strength than the usual mild steel, the successful welding of this is practically impossible with the roll welded process although it offers no particular problem to arc welding.

When it is considered that the arc welding process will make any of these sizes of pipe at a cost of as an average probably no more than 50 per cent above the cost of the plate itself compared to three times the cost of the plate in the case of the roll welded, lock bar or riveted process, the future of the pipe industry for many purposes can be easily foreseen. The effect of this will be far-reaching.

It is evident that with the same thickness of wall, the pressure per sq. in. in the pipe must be reduced in inverse ratio to the diameter; in other words, if a 10-in. pipe can carry 100-lb. pressure, a 20-in. pipe, with the same thickness of wall, can carry but 50 lb. pressure. The 20-in. pipe with 50-lb. pressure, however, will carry at least double the amount of fluid that the 10-in. pipe with double the pressure will. The economics of the proposition would therefore indicate that pressures will be reduced, diameters increased, and the number of

pumping stations or boosting stations, very largely used in the transport of water, gas, oil, or any other substance for which pipe lines are used.

The best illustration of the economic advantages of the above ideas are shown in the Mokelumne River pipe line which brings the water supply a distance of 90 miles to the East Bay Municipal Utility District in California. This line runs from the Mokelumne River to Oakland and supplies the water for all of the Bay cities with the exception of San Francisco. This job required, for the manufacture of the pipe, 78,000 tons of steel, the thickness of this steel being  $\frac{3}{8}$ -in.,  $\frac{7}{16}$ -in.,  $\frac{1}{2}$ -in.,  $\frac{9}{16}$ -in.



SPIRAL WRAPPING IN THE YARD

A car carrying the roll of covering and the heating kettle containing the molten metal moves along the rails as the pipe is slowly rotated.

and  $\frac{5}{8}$ -in., depending upon the part of the line in which the pipe was to be placed. It was manufactured in two lines—the first running from the San Joaquin River to Oakland and the second, from the Mokelumne River to the San Joaquin River.

The first section of this, running from the San Joaquin River to Oakland, is, at the present time, completed and has been under pressure now for a considerable period. Because of the newness of arc welding, the engineers determined not to proceed with the second section of this pipe line until after the first section had been completed. They have, within the last sixty days, let the contracts for the second section, the specifications remaining identical in every particular with those of the first, thus showing the complete success of this method of construction.

It is also interesting to note that, in spite of the fact that no such work as this had ever before been attempted, insofar as thickness of plate, diameter of pipe, etc. was concerned, the first forty miles was completed more than one month ahead of time, and this in the face of the fact that the building for the manufacture of this pipe had to be constructed, machines designed and built, and the whole plant put into operation. The second section of this line which is to be done in the same time as the first, will undoubtedly beat its schedule by many months.

The description of this line and of the problems involved, as concerns welding, can probably best be explained from the specifications which were drawn for it and under which the pipe was manufactured. The specifications covering the welding machines provided that the welding shall be done with an automatic electric welding machine, designed specifically for the work

covered by those specifications. This machine comprised among other necessary parts, a traveling carriage for carrying the carbon electrode, arranged to move, at a controlled rate, along a track located inside of the pipe above the bottom seam, and water-cooled mandrels located on the outside and inside of the pipe and extending along this seam throughout its length.

Next, the method of testing was specified as follows:

*Hydrostatic Test of Pipe Specimens.* After each section of the pipe has been welded, it shall be subjected to a hydrostatic test under internal pressure sufficient to develop a tensile stress of 20,250 lb. per sq. in. of plate and, while under this stress, shall be hammered vigorously on both sides of the weld with a 10-lb. hammer not more than once in every foot of pipe section. The pressure shall then be increased sufficiently to produce a tensile stress of 23,000 lb. per sq. in. of plate and so held until the efficiency of the seams can be determined by inspection. In the event of failure of the pipe section under this test, the contractor shall have the right to re-weld the pipe if practicable and re-submit it for test.

*Rejection.* Any section of pipe that does not conform to these specifications may be rejected.

The test specimens cut out of the pipe will also be of interest:

*Laboratory Test of Weld Specimens.* The test specimens cut from the sample welds as provided for in the preceding paragraph shall show under laboratory tests:

a. An ultimate tensile strength of not less than 45,000 lb. per sq. in., calculated upon the cross section area of the plate metal in the test specimen.

b. Withstanding being bent cold through 90 deg. around a bar having a diameter three times the thickness of the plate metal in the test specimen without serious fracture. The test specimens for this test shall be rectangular in form,  $1\frac{1}{2}$  in. wide by the thickness of metal by 18 in. in length, and on the sides, shall have the corners rounded to a radius of not over  $\frac{1}{16}$  in. The following procedure for the bend test shall be followed: The specimen shall be placed upon two hardened steel supports 12 in. apart, having rounded corners of approximately  $\frac{1}{4}$ -in. radius, and the pressure shall be applied centrally between the supports directly upon the bead of the weld. The pressure shall be applied through the bar around which the specimen is to be bent and shall be a slow, steady pressure and shall be applied continuously until the ends of the specimen are at an angle of 90 deg. with each other. In case a specimen fails to pass the above test satisfactorily, the welding machine shall be re-adjusted and a new specimen produced. All tension and bend tests may be witnessed by a representative of the contractor.

c. A comparatively smooth continuous bead of weld metal on both sides.

It is claimed in connection with this that it is probably the most severe test that was ever put on any pipe made by any process, and it is only necessary to say that possibly no other method of manufacturing large pipe now known could pass the specifications for test as outlined in these specifications. As a matter of fact, there are a number of cases where the test pressures were carried up so high and so far beyond the statement in the specifications, that a permanent set was actually put in the steel of the pipe. In one case that came to the author's attention the diameter was increased by more than three inches because the pressure that was used in testing went considerably beyond the elastic limit of the steel.

amperes at 600 volts d-c., although with occasional short-circuitings. A taper-plug valve was used to seal the rectifier from its vacuum pumps.

In the year 1911 many difficulties were encountered. When other rectifier tanks were constructed by welding it was found impossible to eliminate leaks entirely even though great care was used in this process. At that time the complications of pumps for high vacuum were such that it was deemed necessary to construct rectifiers of such a degree of vacuum-tightness that they would operate for indefinite periods without evacuation. This aim was maintained throughout the development and this fact should be kept in mind in comparing these earlier developments with those of the past few years. Because of that aim, every effort was made to eliminate

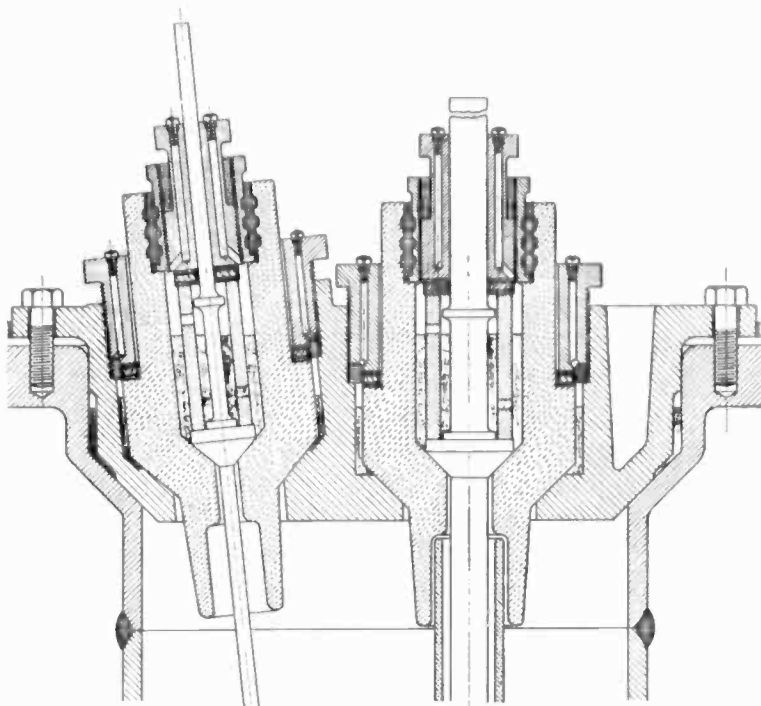

FIG. 1—CROSS SECTION OF UNIT NO. 4, SHOWING DETAILS OF SEALS IN MERCURY ARC RECTIFIER

the leaks and the effects of occluded gases. Following the experience of leaks in welded joints it was decided to use seamless pressed steel pots as tanks, and unit No. 7 was constructed on this principle. The tank was 24 in. in diameter. A further modification eliminated the insulated cathode as tests on former units without this feature seemed to indicate no difference in operation. The tightness of this unit was a considerable improvement over the two former ones.

The next difficulty encountered was that of obtaining heavy currents from the rectifiers. Although the loads could be made fairly large at low voltage, it was found that internal short circuits occurred when it was attempted to operate with the same currents at higher voltages. Due to the suggestions of Peter Cooper Hewitt, who was in close touch with this work at the time, several types of water-cooled steel anodes were tried out with very satisfactory results. During the latter part of this same year it was demonstrated that such anodes raised the

allowable current ratings greatly, and reduced the discrepancies between the results at low and higher voltages. A single water-cooled anode in a tank of 12-in. diameter could be made to deliver 300 amperes at 600 volts, while two such rectifiers could be operated together at double this rating. It may be noted that these single-anode rectifiers were the precursors of the rectifiers with anode shields.

The number and variety of problems brought up by the development of a piece of apparatus so different from the ordinary electrical machine were so great that a period of broadened investigation was entered into. There were also projects of building rectifiers and putting them into service to gain the necessary operating experience with them. Mr. S. W. Farnsworth was directing the development of the rectifiers during this period, and the present writer is indebted to him for the records of the work accomplished.

In order to prevent the serious trouble which had been experienced from short circuits, various types of barriers had been placed between the cathode and anode in the single-anode tanks. In 1913, however, when tanks were being designed with two or more anodes, precautions had to be taken to prevent the arc from breaking across between anodes under certain conditions. It was found that if an insulated metal shield or hood was placed around the anode, a pronounced improvement resulted. One of the earlier types of the shields developed has a main opening for the arc in the side next the rectifier wall with small perforations around the remainder of the shield at the same height. In all, more than one hundred different types of shields were tried out with varying degrees of satisfaction. It was found that by putting a glass window in the side of the rectifier tank a great deal of information could be obtained regarding the operation of these shields. This was tried out in units Nos. 9 and 29.

Some of the anode shields tried were water-cooled, and with such an arrangement a very considerable part of the total losses could be abstracted in this part of the cooling water. When an ordinary type of shield was used with a water-circulating coil introduced into the tank between the anodes, the relative loss abstracted was much less. These tests indicated very clearly the concentration of losses at the anodes.

It was found that somewhat different results were obtained with anodes of different designs and different types of construction. The most favorable results were obtained with anodes somewhat similar to those drawn from sheet steel. The temperature of the anode was found to have a pronounced relation to the occurrence of internal short circuits. As the temperature of the anode cooling water was lowered, it was found that internal short circuits began to occur, and then to increase in frequency. This phenomenon was studied by means of a device whereby a few drops of mercury could be projected against an anode while the rectifier was in operation, the process

being watched through a window in the tank. It was found that each treatment of this sort was followed in a few moments by a short circuit. It was determined from this that if an anode is kept at a temperature such that mercury will condense on it, or if it is unshielded so that a drop of mercury may fall in close proximity to it, there is danger of a similar occurrence in regular operation. The whole series of such tests indicated that the questions of anode shielding and anode cooling were closely interrelated to form a single problem and that it was of great importance from the standpoint of the elimination of internal short circuits.

As a result of this work, the knowledge of the electrical design of mercury arc rectifiers advanced rapidly. In May, 1915, some tests were made on a two-anode rectifier, unit No. 28, with a tank 19 in. in diameter. This rectifier carried a load of 1000 amperes at 1200 to 1500 volts d-c. for one hour, and a load of 2000 amperes for one minute at the same voltage. It was also operated at 2700 volts, d-c., with a load of 150 amperes which was the greatest load obtainable at that time. A similar rectifier, however, had already been loaded up to 350 amperes at this latter voltage.

Although the electrical design of the rectifier was considered to be satisfactory, its characteristics with respect to vacuum tightness (judged by the standard then aimed at) were still unreliable. There had been cases where units would operate on varying loads for a month or more without evacuation, but such performance was unusual. The use of seamless tanks had eliminated the problem of faulty welds, and although the occluded gases in the inner parts could not be easily disposed of, it was appreciated that the greatest cause of the increase of pressure in the tanks was due to leakage through the seals. Up to the middle of 1915 the mercury-filled seal supporting ground joints had been used in practically all rectifiers. Upon careful investigation it was found that all joints of this type leaked in minute amounts which rendered them inadequate for the requirements demanded. The tests showed that the mechanical contact between mercury and steel, or between mercury and porcelain, was not close enough to prevent minute quantities of air from working their way through, particularly if the surfaces were not absolutely clean. This was true even when the mercury in the seal was maintained at a considerable static head, and also though there was no drop in the mercury level to indicate that the mercury was passing into the sealed chamber. Confirming tests were made by pouring vapor-bearing liquids above the mercury. In a short time these vapors could be detected in the sealed chamber.

As a consequence of these tests, a very complete investigation was carried out by Mr. E. E. Rose to find a more suitable type of seal. Some of the first seals investigated were those composed of metallic gaskets of various kinds; lead, copper, iron, etc. In some individual cases these seals were satisfactory,

but they proved somewhat unreliable when taken as a whole, due mainly to the difficulty in forcing the gasket to conform to the irregular surface of the porcelains, even when these were ground. Much the same results were obtained when gaskets of asbestos were tried. Moreover, if the asbestos was used in the form of sheet it was found necessary to use some means of impregnation to close the pores. In this state it could be made "virtually tight." Rubber gaskets were found to give off vapors freely if raised beyond a moderate temperature.

A large number of combinations of pressure types of joints were tried out with only a fair degree of success. Their possibility of application was found to be limited. A high degree of vacuum tightness was found to be easily produced in soldered joints. They were found to be satisfactory in a number of cases where the lead or solder could be protected adequately from the action of the mercury. The average welded joint did not show the same degree of vacuum tightness, due, mainly, to porous slag pockets existing in the metal of the weld.

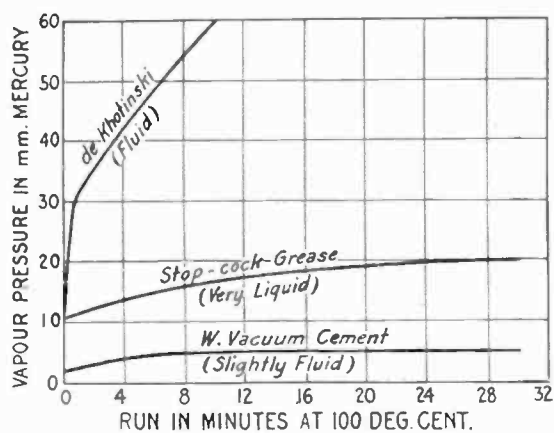

FIG. 2—CURVE OF COMPARATIVE VAPOR PRESSURES OF SEALING MATERIAL

Some of these pores were so small that they could hardly be detected with any practical method of test. Vitreous seals were tried and found to introduce a somewhat complicated group of problems.

It was found that tight joints could be made with certain kinds of enamels, varnishes, etc., under favorable circumstances. In the case of one baked enamel, two receptacles showed practically no deterioration of vacuum after having been sealed off for a year. The fragility of the seals made them inferior to some of the plastic cements which were also being tested, so that the investigation was concentrated on the latter. The de Khotinski cement, which is frequently used in scientific work, was tested and found to have a high vapor pressure so that efforts were directed to find something more suitable. J. W. Legg and others investigated many materials for this purpose. The cement finally adopted, the "vacuum cement," was found to be a great improvement over the first ones tried. Fig. 2 gives some comparative values or vapor pressure with

those of stop-cock grease and de Khotinski cement when maintained at a temperature of 100 deg. cent.

Following this work on vacuum seals, new designs of rectifiers were made up incorporating improved sealing methods and mechanical details, but without making great modifications in the electrical arrangements. The designs were all for single-phase, two-anode units, both because of the difficulty in obtaining large pressed steel tanks and because of the purpose of using them on single-phase railway applications which was a special object of the development. For six-phase operation, the cathodes of three units were to be connected together. One of the rectifiers built on these designs was rated at 700 amperes at 1200 to 1500 volts d-c. The tank, 19 in. in diameter and 26 in. deep, was of seamless steel. The mercury was in direct electrical contact with the tank although the arc was prevented from passing to the tank walls by means of a quartz cylinder. The top was closed with a single cover-plate sealed to the tank with solder which was reinforced with vacuum cement. This cover carried two water-cooled anodes of

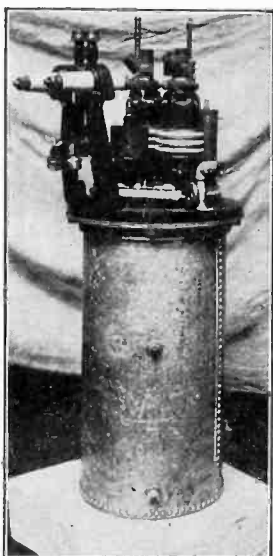

FIG. 3—SINGLE-PHASE RECTIFIERS DEVELOPED FOR HIGH VOLTAGES

seamless steel which were insulated by means of porcelain bushings, all of these seals being made with vacuum cement. The anodes were protected with steel shields insulated from the tank. The cover was also furnished with a vacuum valve of a special type, a mercury vapor pump and two vacuum gages of the "Pirani" (filament) type, one of which was connected directly with the tank and the other to the vacuum piping on the fore side of the valve. The starting anode was actuated by a solenoid magnet, and the exciting arc was then allowed to transfer itself to an auxiliary anode of steel. The power for the exciting arc was obtained from a small auxiliary rectifier. The whole rectifier tank was enclosed in a galvanized steel jacket in which cooling water was circulated. Fig. 3 shows a small unit (No. 54) which had fewer auxiliaries and which was designed for higher voltages and lower currents.

The vacuum tightness of these units was greatly improved over the former ones and the operation was more reliable. Some units maintained a remarkably good vacuum tightness over a period of years when not in use. The problem of whether rectifiers could be constructed to operate indefinitely without evacuation, however, was never completely solved, as there were still some difficulties remaining when the development was halted. In particular, the effects of occluded gases were still too great, although they had been greatly reduced. Since that time the improvement of vacuum pumps and vacuum-sealing valves, etc., has reduced the complexities of the pumping auxiliaries to such an extent that the solution of the problem is no longer essential. The evacuation of the rectifier tanks can now be supervised by the station operator with very little effort, or if desired, can be made entirely automatic by controlling the pumps from vacuum relays. For a similar reason it is no longer necessary to attain the high degree of seal perfection. Although the report on sealing methods referred to above mentions leaks having been found in nearly all types of seals tested, the following remarks represent a recent view of the seals in use at the present time. "Each type of seal used, whether mercury, lead or rubber, has certain advantages and disadvantages; a reliable and satisfactory seal can be obtained with any of these methods."<sup>3</sup> It can be concluded from this and from the other data given, that sealing methods need not be limited to those now in use and that under the present conditions of operation further developments are probable.

Although, on account of the wish to eliminate all unnecessary joints, the majority of the rectifiers described in this paper did not have insulated cathodes, it was appreciated that such construction was preferable from the standpoint of electrical operation. Experimental tests made with cathodes both insulated and uninsulated showed that with the rectifier operating at 200 amperes d-c., the tank, when uninsulated, would carry from 5 to 20 amperes of this current. Similar tests on metal anode shields gave very analogical results. Under certain abnormal conditions it was found to be possible for the current in the tank walls to increase to such an extent that iron vapor was liberated. This had a deleterious effect on the functioning of the rectifier. M. Schenkel<sup>4</sup> has made elaborate tests on this same subject which confirm the result given above.

#### THE FIRST APPLICATION OF RECTIFIERS

In the period of development referred to in this paper, a number of rectifier installations were made for regular service conditions to determine their reliability, the proper arrangement of auxiliaries, and to acquire

3. R. Schumacher, "The Efficiency of Large Rectifier Plants," *E. T. Z.*, 1926, March 25, pp. 354-356, April 1st, pp. 388-391.

4. "The Share which the Metal Chamber Takes in the Discharging Process of the High Capacity Rectifiers," *Scientific Publications of Siemens Concern*, Vol. II, 1923.



general operating experience. Three of these installations can be taken as typical. One of these was a small industrial power application in the Shadyside Works of the Westinghouse Electric and Manufacturing Company where the rectifier operated in parallel with existing gas-engine driven, 250-volt, d-c. generators. The equipment was installed early in 1913 and continued to operate for some four or five years. The load requirements from the rectifier varied from 50 to 300 amperes. No vacuum pumping auxiliaries were used. When a tank required evacuation it was removed temporarily. Most of the failures of vacuum experienced were due to faults of a mechanical nature. Several rectifiers operated for periods as long as from five to six months without pumping.

A second installation was made to determine the applicability of rectifiers to single-phase railway service when mounted on motor cars or locomotives. In May, 1913, two single-phase rectifiers with auxiliaries, transformers and control apparatus were mounted on a motor car belonging to the Pennsylvania Railroad Co. which was equipped with four 200-h. p., 600-volt, d-c. motors. The main auxiliary was a water-circulating system consisting of an automobile-type radiator, reservoir and circulating pump. A vacuum pumping equipment was added later to facilitate evacuation when necessary. The preliminary tests carried out at the manufacturer's works gave favorable results and the car was then taken to the New Canaan branch of the New York, New Haven and Hartford Railroad Co. for further service tests. For the month of October, 1914, the car was in regular revenue service covering a route of about 240 miles daily. In addition to its own weight of 72 tons it had a trailing load of two 32-ton coaches. The load peaks were from 500 to 800 amperes. Service was discontinued during the winter and resumed again in March. In all, the car covered 13,400 mi. in regular revenue service. One rectifier operated for a period of six weeks at this time "without noticeable impairment of vacuum." This performance, however, was considered unusually good.

When sufficient data had been collected these tests were discontinued. It was found that although the attention required by the rectifier was rather more than was desired for the class of service considered, the rectifier itself gave good results.

When the subject of the use of 5000 volts d-c. on an overhead trolley was being studied, a rectifier installation was made for this voltage. The equipment was erected in May, 1915, in a substation of the Michigan United Traction Company located at Grass Lake. Three single-phase rectifiers were connected in series on the d-c. side to supply the trolley voltage, each rectifier being connected to one phase of the three-phase supply circuit. A closed circulating cooling system was used for the anodes, with an electric heater to prevent the anodes from reaching too low a temperature in cold

weather when lightly loaded or with no-load. As before stated, the condensation of mercury which occurs on the cold anodes increases the possibility of internal short circuits. The electrical characteristics of the rectifiers proved good, dependent, of course, on the maintenance of good vacuum. The records indicate that rectifiers went for periods as long as 28 days without pumping. The rectifiers were enclosed behind screens as a safety precaution.

There was but one car on this branch which was fitted for 5000-volt operation so that when, in October, 1916, the car was seriously damaged in a wreck, operation at this voltage was discontinued. The performance of the rectifiers in this case was, on the whole, very encouraging.

In connection with the two latter rectifier installations, an extensive study was made on the effect caused by the rectified currents on neighboring telephone systems. This work was carried out in cooperation with engineers of the American Telephone and Telegraph Company and was, as far as the writer knows, the first work done in this important phase of the rectifier problem.

#### RESULTS OF THE INITIAL EXPERIMENTAL WORK

When the results of the 10 years' work of this development are summarized, it is found that many things of fundamental importance were accomplished. The investigation of sealing methods was carried out with breadth and thoroughness, with the result that the technique of constructing vacuum tight vessels for rectifiers was brought to a degree of perfection which has not been surpassed although it may not be necessarily the most suitable for present conditions. The electrical design was advanced to a point where the ratings obtained from rectifiers of a given size were surprisingly high. The fundamental principles governing the operation of rectifiers and their connected circuits were studied to allow the determination of operating characteristics, the most desirable circuit arrangement and the special requirements of rectifiers and connected equipment. The investigation of the causes and elimination of telephone interference already referred to, was included in this work. A further accomplishment consisted of the installation and operation of rectifiers and necessary equipment under actual service conditions of widely varied natures. This activity yielded valuable experience.

The patents resulting from experimental work of this character may form a gage of advances made in the art. A number of interesting patents were the outcome in the case considered. One of these is on the use of a balance coil, or auto-transformer, connected to the transformers of a polyphase rectifier to improve the effectiveness of transformer utilization and also to improve the voltage regulation<sup>5</sup>, etc. This type of connection is frequently used at the present time. Another patent which was

5. Patent No. 1,241,505, Fortescue, issued Oct. 2, 1917.

the outcome of the study of general principles is that on the interleaving of the secondary windings of the rectifier transformers to balance the inductances of the secondaries connected to different anodes.<sup>6</sup> This condition is essential to the best operation of the rectifier. Other patents cover the use of protecting shields on the anodes<sup>7</sup>; protective relays actuated by the degree of vacuum in the rectifier tank<sup>8</sup>; and the temperature of the cooling water<sup>9</sup>. There were also other patents covering the automatic control of the vacuum pumping equipment<sup>10</sup> to relieve the operator of this responsibility; and the automatic control of the entire equipment of a rectifier substation to eliminate the operator entirely<sup>11</sup>. These patents represent a pronounced advancement in the art of rectifier construction and operation.

#### THE RELATION TO RECENT PROGRESS

The account given in this paper cannot be considered complete, perhaps, without some reference to its effect

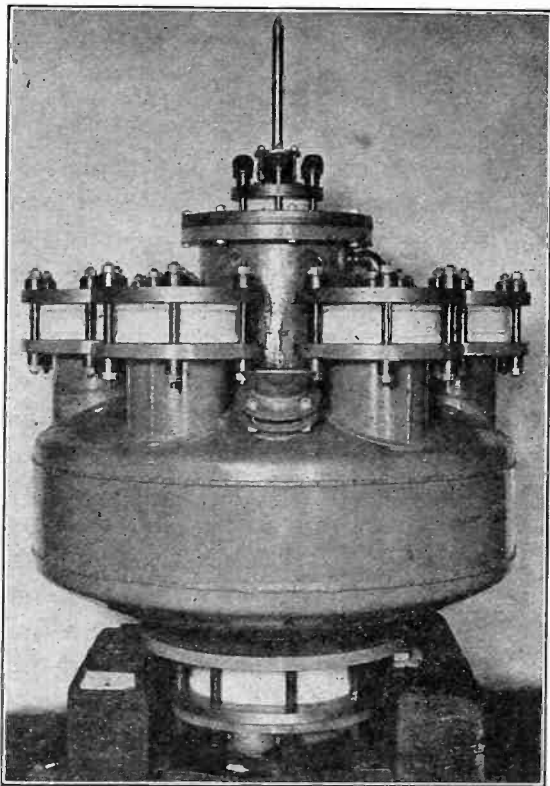

FIG. 4—ASSEMBLED TANK FOR SIX-PHASE RECTIFIER OF RECENT DESIGN

on what is being done at present. This experimental work which was carried on between the years 1908 and 1918 required the expenditure of large amounts of effort and money from which for some time it appeared that no return would be received. When, therefore, the operating engineers of this country evinced an interest in the application of large rectifiers in Europe, it was decided by the Westinghouse Electric & Mfg. Co.

6. Patent No. 1,239,896, Fortescue, issued Sept. 11, 1917.
7. Patent No. 1,285,947, Conrad, issued Nov. 26, 1918.
8. Patent No. 1,389,147, Lovell, issued Aug. 30, 1921.
9. Patent No. 1,358,713, Dillon, issued Nov. 16, 1920.
10. Patent No. 1,248,467, Eby, issued Dec. 4, 1917.
11. Patent No. 1,358,713, Dillon, issued Nov. 16, 1920.

that active resumption of the work would be deferred until it was assured that this interest was more than a transient desire for further experimentation with this new type of apparatus. Later, a study of conditions both here and in Europe led to the conclusion that the metal-tank rectifier then showed sufficient promise commercially to justify its development.

The rectifiers built on the resumption of this work represented a combination both of previous experience

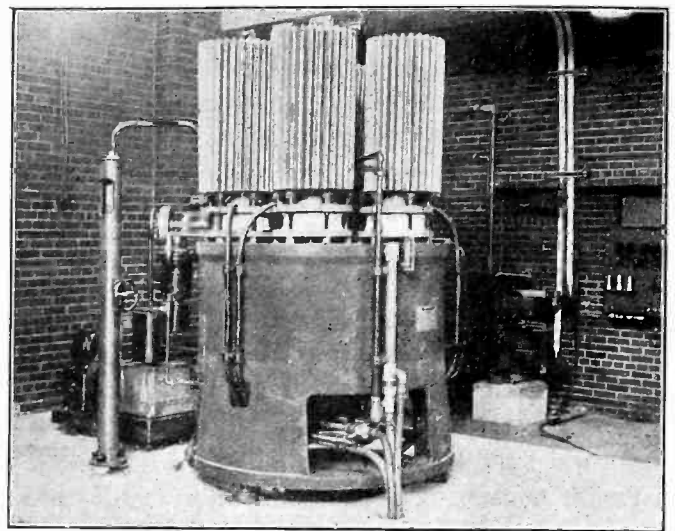

FIG. 5—SHOWING RECENT INSTALLATION OF A 1000-AMPERE, 600-VOLT, D-C. RECTIFIER

as represented in this paper and the experience from European development, particularly from the Siemens-Schuckert Company of Berlin. The use of a rectifier tank having six anodes and the insulated cathode were the main changes from the former designs which follow the general practise of European manufacturers. The vacuum-tight seals on the first of these units were made with rubber gaskets which were also adopted from some European practise. In this particular, however, a continuation of the experimental work on seals has developed new types which give promise of being more suitable for all requirements of rectifiers. Parts such as anodes, anode shields, methods of cooling, etc., have been constructed to follow both former Westinghouse and European practise. The vacuum pumping equipment is of the same general type as that used 10 years ago, but is much more effective and reliable. Fig. 4 shows an assembled rectifier tank without its anode radiators and external casing. The arrangement of the welded tank and insulators for the anodes and cathode is clearly shown. A completed installation in a substation of the Cleveland Railway Company is shown in Fig. 5. This unit was tested successfully on voltages up to 1500 volts, d-c.

Recently a series of tests was made on rectifier No. 56 of the initial development to obtain a direct comparison with the more recent rectifiers. The tank, which had been out of service for some eight years or more, was put into operating condition and furnished with new vacuum pumps. Load tests were carried up to the maximum rating of this rectifier (700 amperes, d-c.) and excellent results were obtained.

# Testing, Inspecting and Maintaining Automatic Stations

BY CHESTER LICHTENBERG<sup>1</sup>

Member, A. I. E. E.

*Synopsis.*—This paper is a general guide for inspection and maintenance practise in automatic stations. It suggests in a broad way how these duties should be performed and this should be helpful in drawing up definite schedules for particular stations.

## INTRODUCTION

Automatic stations for electrical power service of all kinds are now accepted as sound engineering solutions for many problems in the generation, transmission and distribution of electrical energy. The design and application have been treated in numerous papers<sup>2</sup> presented to the Institute. Some of the operating characteristics and performance records have been similarly described. Few public presentations, however, have been given to the problems which must be met in the successful operation of automatic stations over a long period of years.

## DEFINITION

A definition at this point will serve to fix definitely the kind of stations which will be discussed.

An automatic station or substation is one which, in response to an impulse given by a master element, starts and connects itself to an electric power system in a predetermined manner, continues to function with that electric power system during a set of predetermined conditions and then disconnects itself from that system and shuts down, all without the intervention of a human intelligence.

## APPLICATION

The application of automatic stations covers practically the entire range of electric power service. Synchronous converters, motor generators, hydroelectric generators, synchronous and static condensers, transformers, feeders, frequency converters and mercury arc rectifiers in all sizes, are now under successful automatic control. Steam turbines are now being considered and when they are successfully operated, the list will be quite complete.

## SERVICE

The service to be given by an automatic station determines many features of its detailed design, application and operation. It will have even a more important bearing upon its periodic test, inspection and maintenance.

A small transforming station supplying power for household purposes to a community of a few hundred people may be considered as one extreme case. A

large hydroelectric generating station for the supply of base load power to a large transmission and distribution network may be considered as the other extreme. Both may be automatic. One may be taken out of service for a few hours with little if any disturbance. The other must be kept operating at all costs.

Between these two extremes occur an almost infinite variety of service requirements. These will be in any specific case the factors which determine the kind and frequency of periodic test, inspection and maintenance.

## DEVICES

The devices and apparatus used in automatic stations are of necessity specially selected for that service. This is and will be true until designers improve their general product to meet the new and exacting requirements of automatic operation.

One of the simplest devices used in an automatic station is the overload relay. It usually consists of a coil, an armature and a set of contacts. Each of these elements requires attention in design, test, inspection and maintenance.

The coil must carry a wide range of current without overheating, and yet must function promptly and positively when required. The armature must be adjustable so that it may be set to operate at a predetermined current and it must always respond and operate the relay when this current value is exceeded. The contacts must make, carry and break successfully and repeatedly currents of definite magnitude, pressure and phase angle.

The failure of any one of these elements to perform its function will cause a station failure and may result in a costly service interruption.

The design, however, can only provide a device which, if given reasonable attention, will function successfully. The performance of the device in service will depend to a large extent upon the care with which it is tested, inspected and maintained.

Other automatic station devices are more or less complex to meet the requirements of operation. Some have time delay schemes. Some have combinations of armature coils and contacts to produce certain definite reactions to circuit conditions. All, however, are relatively simple in themselves, being modifications of commonly used devices. No extraordinary skill or unusual qualifications are necessary, therefore, to care for these devices.

1. General Electric Company, Schenectady, N. Y.

2. Refer to Bibliography.

Presented at the Regional Meeting of District No. 7 of the A. I. E. E., Kansas City, Mo., March 17-18, 1927.

### SCHEMES

Each automatic station is usually designed to perform a given set of functions in a definite sequence. A thorough understanding of the functions and of the sequence in which they are intended to operate is a prime qualification for an automatic station inspector or maintainer. Manufacturers usually provide diagrams, instruction books and other aids to convey the design information to the operator. Such information should be prominently located in each automatic station to assist in a ready understanding of the intended performance of the station.

The circuit designs are usually the result of experience in the combining of devices to produce a desired operating result. Each device is carefully picked for its service and represents the best the industry affords. The successful operation of the station, however, depends not only on correct design and careful manufacture but also upon reasonably perfect installation followed by regular test, inspection and maintenance.

### TESTS

Tests of automatic stations are required as a check upon design and performance. They may be divided into three classes as follows:

1. Factory tests
2. Installation tests
3. Periodic tests

Factory tests consist of a check of the performance of each device or piece of apparatus and of groups of devices and pieces of apparatus to insure design specifications being met. Tests of the individual pieces of the equipment follow well-established practice. Tests of groups of apparatus at the factory, however, are unique for automatic switching equipments. It is usually impracticable to assemble the power equipment and the automatic switching equipment at the factory and to test it under full load and abnormal load conditions. It has been customary, therefore, to test the power equipment and the switching equipment separately. The latter is given a sequence test to determine if the design requirements have been met. This serves to check the diagrams of connections, the size and connection of coils, resistors and contacts and the physical connections of these, as well as to disclose sneak circuits if any exist. It frequently requires as much time to test an automatic switching equipment at the factory as it does to assemble it.

Installation tests usually follow the erection of the power and switching equipment on the site where it will be placed in operation. In general, they follow the same procedure as do factory tests, except that they are a bit simpler and include all of the apparatus, power, switching and auxiliary, which will be used in the final installation. These tests also differ from the factory tests in that they disclose the settings required for the various devices to meet service conditions beside

checking the connections necessarily made during the installation work.

Periodic check tests of the equipment should be made semi-annually. These usually will be a check of the sequence and of device settings. Besides the periodic test is a check on the continuity of all circuits and the performance of all of the devices in the equipment.

All of the tests which have been mentioned may be as simple or as elaborate as conditions warrant. A simple reclosing feeder equipment can be given a factory test in a few hours, an installation test in an hour, and a periodic test in a few minutes.

An automatic substation or generating station containing two or three units and containing motor generators, or converters, or hydroelectric generators will require a factory test of several weeks and an installation test of several days. The periodic test of such equipments may well take a number of hours or even half a day.

The variety of equipments is so great and their complexity so varied that no general rule can be given. Instead, suggestions and approximate time limits only can be given.

### INSPECTION

Inspection of automatic stations requires for its complete comprehension a definite knowledge of the service which the station is expected to give. The average station requires a general inspection at frequent intervals and a detailed inspection at longer intervals.

A general inspection is, as its name implies, a cursory review by an inspector of the station and its equipment. The frequency of these inspections will depend upon the size and service importance of the station. Important stations, such as those feeding large urban and even some interurban loads, should be visited daily. Less important stations, such as those feeding the usual interurban trolley lines and small and moderate sized mines, industries and towns, may be visited weekly. The still less important stations, such as those used for sectionalizing or feeding small loads, may require general inspection only at monthly intervals.

During a general inspection the inspector should glance at each piece of equipment in the station, make note in the station log of the readings of all operation counters, and if necessary make minor adjustments in devices which require such adjustment. No really definite program can be given which will cover a general inspection of all kinds of automatic stations. Experience has indicated that a few months' training will give the usual inspector sufficient skill to know which pieces of equipment require attention from time to time and where it is necessary to look in anticipating faulty operation. Of prime importance is a record of each such inspection with the observations which have been made during the course of the inspection. These should be recorded in the station log book which should always be kept in the station.

Detailed inspection, as its name implies, is a thorough

inspection of the station and its equipment. The frequency of such inspections will vary from one a month for important centers to one a year for less important stations. The thoroughness with which detailed inspections are made depends entirely upon the service the station is called upon to give as well as the frequency with which it operates.

One feature of all detailed inspections, however, should be a careful check of the sequence of all operations which the station is designed to perform. This will serve to indicate if any device is failing to do its assigned duty in the prescribed manner.

Other features of all detailed inspections should be to insure all nuts, bolts and connections being tight, spring cotters opened, contacts clean and not overheating or burned, current carrying parts of the equipment in good operating condition, etc. All relays and similar devices provided with adjustments and calibrations should have these adjustments checked to be sure the devices are set to operate within the prescribed limits. For devices such as relays operating on small currents, a semi-annual check of the setting is of benefit to insure best operating performance. For series devices carrying large currents, a check of the settings may be made as local conditions permit or require.

Detailed inspection should not be made a burden or a costly procedure by including in it too much detail. There is always a limit. For example, if a circuit breaker is to be given a detailed inspection, one might completely disassemble it and then reassemble it and in doing so, might harm it. On the other hand, if it is partially disassembled so that the moving parts can be cleaned and very lightly lubricated, then it is of distinct advantage. So with this as an example, it may be seen that as with the testing, detailed inspection requires study on the part of the operating company engineers in order that it may prove a maximum benefit and yet be done with minimum expense.

#### MAINTENANCE

Maintenance of automatic stations is second only in importance to their inspection if the best service is to be obtained. The amount of maintenance required varies through very wide limits depending upon the equipment, its adjustment, its application and what it is expected to do. Included in maintenance is the periodic cleaning of the station and of the individual devices and pieces of equipment in it as well as the replacement of parts after fair wear and tear in service. In addition it includes a great many details required to keep the equipment in good operating condition. For example, the oil in the bearings of rotating machines should be changed as occasion demands. When the station is subjected to extreme temperatures at various seasons of the year, oil for the bearings should be so selected that it remains fluid throughout the temperature range experienced and still

gives the required lubrication. This may seem a little detail, but it is one of the many which differentiate between failure and success in operating automatic stations.

Many other examples could be given but of course these are obvious to the operators of automatic stations. It should be noted, however, that the simple stations, those for example having only feeders, require very little, if any, maintenance while the largest and most complicated automatic stations require even less maintenance than do manual stations of the same size.

The frequency of maintenance depends solely on local conditions. Some automatic stations have been known to run for years with almost no maintenance expense. Others seem to require the frequent visits of maintainers. As an average, however, reports from many sources have indicated that the usual automatic station costs only about three-fourths as much to maintain as does the equivalent attended manually operated station.

#### LOG

The station log book is a very important part of every automatic station. It should have entered in it the date when each inspection or visit to the station is made together with what occurs in the station during the inspection or visit and any other notations which will be helpful in following the performance of the station. The log book is a great help to the inspectors and maintainers, particularly where the personnel is likely to change every three or four years. It assists not only in giving to the inspectors and maintainers a complete history of the station but it also supplies the engineers as well as the manufacturers with data upon which to base future modifications or extensions in the design.

#### REPORTS

Reports of automatic stations are just as essential for the correct supervision of these stations as in the case of manually operated stations. The automatic station, however, does not require nearly so elaborate a report as does the manual station. It is well, therefore, to consider this point when placing an automatic station in service and when requiring data concerning its performance. A little thought and study on the part of the responsible engineers will indicate what data is necessary for each system and it will be found that most of this data can be automatically recorded in the station.

A number of the operators of automatic stations require that at intervals a transcript of the log of each station be sent to the general operating headquarters. Other operators send to the operating headquarters a report of each defect or service interruption. Some of the operating companies forward copies of these reports to the manufacturers of the equipment for their guidance in future designs.

The form of reports, of course, will be quite individual for each system, but it is believed that these should be

kept to a positive minimum in order that the highest efficiency may be obtained.

### Bibliography

- Automatic Railway Substation*, L. D. Bale, TRANS. A. I. E. E., Vol. 42, p. 127.
- Automatic Transmission of Power Readings*, B. H. Smith and R. T. Pierce, TRANS. A. I. E. E., Vol. 43, p. 303.
- Automatic Substations for Industrial Plants*, Chester Liehtenberg, TRANS. A. I. E. E., Vol. 43, p. 703.
- Application of Automatic Control to Mine Substations*, C. E. H. von Sothen, JOURNAL A. I. E. E., Vol. 43, p. 729. Discussion JOURNAL A. I. E. E., Vol. 44, p. 72.
- Application of Automatic Substations to Central Station Service in Metropolitan Districts*, C. W. Place, TRANS. A. I. E. E., Vol. 43, p. 745.
- The Cleveland Height Substation of the Cleveland Electric Illuminating Co.*, H. L. Wallau, TRANS. A. I. E. E., Vol. 43, p. 753.
- Automatic Substations for Supplying 1500 Volts Direct Current to Suburban Railways*, C. A. Butcher, TRANS. A. I. E. E., Vol. 43, p. 755.
- Automatic Edison Substation of the Indianapolis Light & Heat Co.*, H. Bany, TRANS. A. I. E. E., Vol. 43, p. 760.
- Operating Experience with Automatic Equipment on an Edison System*, F. D. Wyatt, TRANS. A. I. E. E., Vol. 43, p. 768.
- Present Practice in the Automatic Operation of Hydroelectric Generating Stations*, R. J. Wensley, TRANS. A. I. E. E., Vol. 43, p. 776.

- Report of Subcommittee on Automatic Stations for 1924*, W. H. Millan, TRANS. A. I. E. E., Vol. 43, p. 1095.
- Automatic Control of Substation Apparatus*, W. H. Millan, JOUR. A. I. E. E., Vol. 44, p. 588. Discussion JOUR. A. I. E. E., Vol. 44, p. 879.
- Report of Subcommittee on Automatic Stations for 1925*, W. H. Millan, JOUR. A. I. E. E., Vol. 44, p. 1226.
- Supervisory Systems for Electric Power Apparatus*, Chester Liehtenberg, JOUR. A. I. E. E., Vol. 45, p. 116.
- Automatic Substations and Converters*, F. P. Whitaker, *Jour. Inst. Elec. Engr.*, Vol. 60, p. 512.
- The Maintenance of Voltage on a D-c. Distribution System by Means of a Fully Automatic Substation*, P. J. Robinson, *Jour. Inst. Elec. Engr.*, Vol. 61, p. 417.
- Supervisory Control System*, G. A. Juhlin, *Jour. Inst. Elec. Engr.*, Vol. 62, p. 121.
- Automatic and Semi-Automatic Mercury Vapour Rectifier Substations*, G. Rogers, *Jour. Inst. Elec. Engr.*, Vol. 63, p. 157.
- Remote-Controlled Substations of the New York & Queens Electric Light & Power Co.*, W. C. Blackwood, JOUR. A. I. E. E., Vol. 54, p. 531.
- Automatic and Supervisory Control of Hydroelectric Generating Stations*, Frank V. Smith, JOUR. A. I. E. E., Vol. 45, p. 967.
- Report of Subcommittee on Automatic Stations for 1926*, W. H. Millan, JOUR. A. I. E. E., Vol. 45, p. 1098.
- An Example of the Reconstruction of an Ordinary Power Station for Automatic Operation Tunatsu Water Power Station*, Ikuzo Takaoka, *Jl. I. E. E. of Japan*, Sept. 1926, p. 1093.

## Discussion at Winter Convention

### KLYDONOGRAPH SURGE INVESTIGATIONS<sup>1</sup>

(COX, MCAULEY AND HUGGINS)

### TRANSMISSION-LINE VOLTAGE SURGES<sup>2</sup>

(COX)

### THE MEASUREMENT OF SURGE VOLTAGES ON TRANSMISSION LINES DUE TO LIGHTNING<sup>3</sup>

(LEE AND FOUST)

NEW YORK, N. Y., FEBRUARY 10, 1927

**K. B. McEachron:** In discussing the paper by Messrs. Cox, McAuley and Huggins, and also the paper by Mr. Cox, I wish to raise a question concerning the conclusions. It does not seem to me that the data given support the definite conclusions drawn. For instance, the first conclusion in the Cox, McAuley and Huggins paper states that the voltages due to lightning are unidirectional, and that the cloud which produces surges is of negative polarity resulting in positive induced voltages and negative direct-stroke voltages. The evidence which we have at the present time supports this conclusion but sufficient evidence to make such a positive statement appears to be lacking.

For instance, consider the direct stroke on a transmission line. Negative records have been obtained due to direct strokes but it does not necessarily follow that whenever a steep-wave negative surge appears on a transmission circuit, that it was the result of a direct stroke, nor does it necessarily mean that all direct strokes must be negative. Simpson's theory, which has been mentioned in the paper by Mr. Cox, appears to bear out the conclusions given by the author, but it is necessary to remember that it is a theory, and in the case of lightning phenomena a very large amount of experimental data is necessary to prove that such a theory is correct.

I would like to draw attention particularly to a statement

1. A. I. E. E. JOURNAL, May, 1927, p. 459.
2. A. I. E. E. JOURNAL, March, 1927, p. 263.
3. A. I. E. E. JOURNAL, February, 1927, p. 149.

made on the second page of the paper by Messrs. Cox, McAuley and Huggins. "It has been estimated that gradients as high as 100 kv. per ft. (330 kv. per meter) are reached near the earth's surface." On the same page the statement is made "It is believed that the flashover voltage of 220-kv. transmission-line insulation at the steepness of wave front of lightning surges is comparable to the maximum potential ordinarily induced by lightning." This same statement is also made in the conclusions.

Such a statement seems rather premature. Conditions have been experienced during the summer of 1926 on a 220,000-volt transmission circuit with fourteen disks of line insulation which were sufficient to flash over the line insulation several times. This indicates that 220,000-volt systems are not immune from lightning troubles provided those systems are where the lightning occurs.

Although the line flashovers may have been due to direct strokes yet the evidence is not clear and both positive and negative surges have been found whose potentials were between 1500 and 2100 kv.

Concerning the matter of attenuation which is given in the paper by Mr. Cox there is a factor in connection with the theory of bound charges which I believe has not been fully recognized.

Assume for instance a long transmission line with a charged cloud one mile in extent over the middle of the transmission line. When this cloud discharges, a voltage appears on the transmission circuit which is equal to the potential gradient multiplied by the height of the line assuming, of course, that the entire cloud discharges in zero time. Underneath the edge of the cloud, the voltage distribution along the conductor will conform to the distribution of potential gradient before the cloud discharges. As a matter of fact, however, the cloud requires time to discharge and therefore the charge will begin to move out along the line having moved a distance equal to the time required for the cloud to discharge. If this time is less than  $2\frac{1}{2}$  microsec. the voltage on the transmission line underneath the middle of the cloud will

reach an actual potential equal to the potential gradient, times the height of the conductor. A klydonograph located at this point would indicate a voltage of  $E$  volts, while another klydonograph located on the transmission line a few miles away would

not indicate a maximum voltage of more than  $\frac{E}{2}$  volts. This

reduction in voltage<sup>4</sup> is due to the fact that all of the energy in the bound charge is electrostatic, while the energy of the traveling wave is half electrostatic and half electromagnetic.

The attenuation to be considered is that, which takes place with reference to the traveling wave, rather than between the initial wave and the traveling wave. Measurements which have been made indicating that the voltage drops to a fractional part of its original value when passing over a distance of 15 or 20 mi., are probably due largely to this reduction in voltage which occurs when the bound charge becomes a traveling wave.

In connection with the paper by Messrs. Lee and Foust, considerable work has been done with the calibration of these figures with respect to their appearance, which the authors referred to in their paper. In Fig. 11, the first two positive figures are of the appearance which we have called type 3 figures, and the last two positive figures are of the type 2 class. From the information available it would be possible to predict roughly that these figures were made with a wave of the order of 2 or 4 microsec. Fig. 1 herewith gives the calibration curve<sup>5</sup> which shows roughly

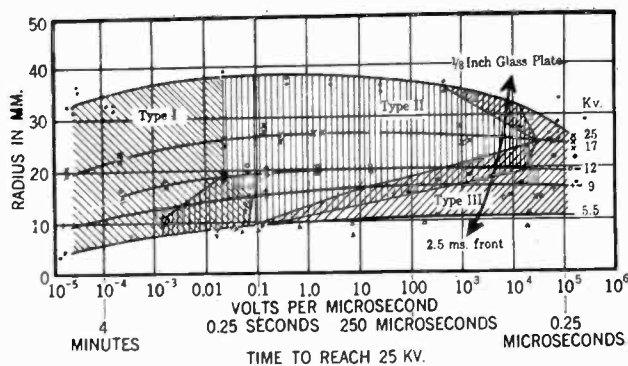

FIG. 1

how such an estimation of the wave front can be obtained. Locating on this curve a line representing type 2 figures for 15 or 20 kv., and type 3 figures for 5 and 10 kv., the curved line with the arrows shown on the figure is obtained. This line indicates a wave front of between two and three microsec. to reach crest value.

The statement is made that practically all figures obtained on transmission lines have been of the type 2 class and therefore come within the wide range of wave fronts which vary roughly from that of a slow 60-cycle wave to a surge which comes to its maximum in a fraction of a microsec. time. Referring again to the calibration curve given, the most abrupt wave front giving a type 2 figure was of the order of 1 microsec. to reach its crest value and this only for one particular voltage, namely 17 kv. as measured on the instrument. Thus the evidence indicates that for the waves measured, at least surges of more abrupt front than 1 microsec. did not occur and most of them were considerably slower than this.

**A. H. Schirmer:** Mr. Cox's paper, as well as the paper by Messrs. Cox, McAuley and Huggins, present a number of interesting conclusions, which in general are substantiated by the results obtained from a number of tests made on telephone lines during the past summer. These tests were made on a 5-mi.

4. Time Voltage and Current Characteristics of Lightning Arresters, K. B. McEachron, *G. E. Review*, Vol. 29, p. 678, 1926.

5. This curve is taken from "Measurement of Transients by Lichtenberg Figures" *A. I. E. E. JOURNAL*, Oct. 1926, V. 45, pp. 934-939.

open-wire line carrying eight wires. Approximately twenty recorders were in use during the major portion of the lightning season.

In no case did we obtain record of more than two surges during a single storm, and usually only one surge per storm was recorded. It should be noted that in our case the klydonographs were connected directly to the line, there being no line voltages to contend with, so that when only one surge was recorded, it means that during that storm no voltage in excess of 2000 volts was obtained on the line. The results also show that the surges produced by lightning are either unidirectional or highly damped oscillatory surges. Our data also agree with the conclusion given in the papers that lightning arresters do not protect the line against flashovers, even at relatively short distances from the arrester. For example, in one case six recorders were placed on a line wire within 1000 ft. of the protector. The first recorder, located at the arrester, showed no evidence of potential. The second recorder, located only 66 ft. from the protector, indicated a voltage of approximately 8000. The third recorder, located 224 ft. from the protector, showed voltage above the range of the instrument, and the fifth recorder, located 700 ft. from the protector, flashed over between the electrode and the ground plate.

Our data, however, do not support the conclusion that the clouds which produced surges are always of negative polarity, resulting in positive induced voltages or negative direct-stroke voltages. None of the telephone wires under test was directly hit by lightning during the period of observation. Nevertheless, extremely high surges of both positive and negative polarity were recorded. Both the positive and negative surges were of relatively steep wave fronts, which also does not support the conclusion that the surges from positive lightning strokes are slow, of the order of 0.01 sec. A summary of our results shows that five storms produced positive surges and three storms produced negative surges, while three other storms showed positive and negative surges. These last surges we have attributed to discharges between clouds, rather than between cloud and earth. Even in these cases, voltages induced were well above the range of the instrument.

As pointed out before, many high-voltage surges were obtained on the telephone line. However, these surges were of extremely short duration, and in no case, even where the recorders flashed over only a short distance from the protectors, did these surges cause any damage to telephone cables, or permanently ground telephone arresters, as usually occurs from lower voltages imposed on telephone lines either by induction from, or momentary accidental contact with, electric light and power circuits. While in the latter cases the voltage may be applied for only 0.1 sec., still, this time is so much longer than the period of application of the lightning potentials that the effects are more severe even though the maximum voltages reached are substantially smaller than the lightning voltages.

Fig. 8, in the paper by Messrs. Cox, McAuley and Huggins, gives a diagram of connections for lightning-arrester tests. This diagram shows the klydonograph connected to the same ground as the lightning arresters. With this connection, the klydonograph merely records the drop in potential across the lightning arrester, and not the potential of the line to ground. During heavy discharges the potential of the protector ground connection may be many volts above true earth. In order to obtain a record of the effectiveness of protection at a given location, it is necessary to connect the ground plate of the klydonograph to an independent ground.

**R. W. Atkinson:** Messrs. Cox, McAuley and Huggins in their paper state that transient voltages are a rare and unimportant cause of cable failure. These may of course be comparatively rare without being comparatively unimportant. Even a few failures per hundred miles per year for a given cause are evidently a matter of great concern to operating companies.

The writer shares what he believes is a general agreement in the industry with the opinion expressed by these authors, that transient voltages are not a major cause of cable failure. However, both of these papers throw a great deal of light on the fact, which has been known that a certain number of cable failures have resulted from transient voltages, particularly from unusual transient voltages. For instance, it is shown in these papers, that certain types of transients are of relatively low frequency such that they travel with substantially sustained peaks throughout the system. It is also pointed out that some of these are of the same character and thus materially more harmful than a single impulse. Probably the most direct application of this is in connection with the testing after installation with alternating current which fortunately is now becoming a thing of the past.

Thus, while a transient voltage of a given number of times the operating voltage may be only slightly or not at all destructive, a transient of the same number of times a test voltage may be very destructive.

There is an effect of even comparatively small over-voltage transients which is usually overlooked, but which, as has been pointed out previously, may well be of importance. The shape of the curve of power factor versus voltage of a cable is different depending upon the direction of the cycle, that is depending upon whether the voltage is being raised or lowered. To whatever extent this change of power factor with voltage is a measure of ionization of air spaces within the cable, this simply means that the amount of ionization at a given voltage depends on the previous history, and is greater if the cable has been subjected previously to a higher voltage. The action of a transient voltage has been likened to a trigger, which releases the energy from the normal operating voltage in such a way that its effect may be as severe as would be a steadily maintained operating voltage of considerably higher magnitude.

Published records show not only that there are individual instances where cable failures have been directly traceable to transient voltages but information is published in at least one instance concerning a system where a change with respect to the amount of transient voltages existing, produced an important effect on the number of cable failures experienced.

I wish to emphasize that transient voltages are important in connection with cable operation, and that it will be very valuable to continue to obtain information as to the transient conditions in various systems so that these may be evaluated in terms of what might be termed an equivalent steady operating voltage. Where a system is exposed to such transient voltages, it is obviously just as important to make the apparatus on it capable of meeting any transients which cannot be prevented, as it is important to have the apparatus and cable meet the steady operating condition.

Yet one more word as to a specific instance where the data shown by these authors explain that cable may be subjected to damaging transient voltages. If a cable insulated for relatively low voltage is connected to an overhead line insulated for considerably higher voltage, it is obvious that lightning potentials sustained by the cable may in this case be especially destructive.

**F. W. Peek:** The klydonograph is of special interest to me because it affords further means of checking conclusions regarding lightning which I arrived at several years ago. I am going to tell you a little about my work to show how well it is in agreement in the most important respects with the results of Messrs. Cox, McAuley, Huggins and Lee and Foust.

Several years ago I undertook to determine, if possible, the order of the voltage and other characteristics of lightning, the gradients produced, etc.; the magnitude and character of lightning on transmission lines; the strength of apparatus and line insulators when subjected to lightning voltages; and the value of the ground wire and other protective apparatus. With such information it is possible to make lines that are immune from lightning. Whether or not immunity is secured is, to a great

extent, an economic problem. The results of my investigation have already been given to the Institute.<sup>6,7</sup> As far as I know it was the first time that estimates of the actual values of lightning voltages on transmission lines were ever made. The rules for pre-determining lightning voltages and the lightning strength of insulators, etc. are quite simple. I will give a brief summary of my conclusions.

The voltage of a lightning flash is of the order of 100,000,000, the current 80,000 amperes and the energy 4 kw-hr. The maximum gradient is 100 kv. ft. (330 kv. m.). The discharges are usually non-oscillatory and some times take place in a few microseconds.

Lightning disturbances on transmission lines are generally steep waves of a few microsec. duration though the lower voltage disturbances may be of larger duration. The induced voltage increases directly with the height of the conductors. It is found by multiplying the apparent gradient by the height of the line, but is limited by the lightning flash-over voltage of the insulator. Thus  $V = g \alpha h = Gh$ . When  $h$  is the height in feet,  $g$  is the gradient in volts and  $\alpha$  is a factor depending upon how rapidly the cloud discharges.  $G$  is the apparent gradient. The maximum possible gradient is 100,000 volts/ft. (330,000 volts/meter). This value can usually apply only in case of a direct stroke. In practice, because of the time required to discharge the cloud,  $G$  is usually less than 50,000. A voltage wave is reduced in a few miles by corona losses. After the wave is well under way the voltage is also reduced to one-half because part of the energy becomes magnetic. The lightning flash-over voltage of insulators and the strength of insulation is always higher than the 60-cycle values. An insulator flash-over curve made by artificial lightning has been checked to 1,800,000 volts by natural lightning with good agreement.

The ground wire, by cutting lightning voltages in half, has the effect of increasing the line insulation and at the same time reducing the stress on apparatus. It must be properly installed.

If a line is over-insulated, apparatus failures may result if protective gaps or arresters are not used.

Reasons that more trouble is not experienced are that most high voltages originate at some distance from the station, and a large number of induced voltages are from slowly discharging clouds.

By comparing the lightning strength of apparatus and insulators with possible lightning voltages the probability of failures and outages can be estimated. Whether a line is made immune or not is a question of economics.

It can be seen that my conclusions agree, in most respects, very well with the conclusions arrived at in these papers.

I was particularly interested in the value of 1800 kv. given by Lee and Foust for the lightning flashover voltage of a 14-unit insulator string as measured by klydonographs on an actual line. Estimates were made of the maximum possible and usual highest lightning voltages for such a line, and are given in Table I in my paper<sup>6</sup>. The insulators are over values are given as 1800. For conductors 40 ft. high the maximum possible voltage is given as 4000 kv. and the usual highest 2000 kv. without ground wires. Either of these values is high enough to cause insulation flash-over. The maximum voltage would be limited to 1800 kv. by the insulator. This is the value actually measured by Lee and Foust. The values in Table I were made long before such a line had been built. Table I also shows the effectiveness of a ground wire on such a line.

**H. B. Vincent:** I want to ask a few questions of Messrs. Cox, McAuley and Huggins on their paper. In the data submitted were the lines in all cases energized, or were there any

6. F. W. Peek, Jr., *Lightning and Other Transients on Transmission Lines*, TRANSACTIONS, A. I. E. E., 1924, Vol. 43, page 1205. *Lightning*, Journal Franklin Institute, Feb. 1925.

7. F. W. Peek, Jr., *Lightning (A Study of Lightning Rods and Cages with Special Reference to the Protection of Oil Tanks)*, A. I. E. E. JOURNAL, December, 1926.



cases where the records were taken of the lightning voltage while the line was not energized?

There is no mention made of any so-called control devices in connection with the insulators, which might or might not affect the flashovers? Referring to their Table I, in case No. 2, which is a 140-kv. line, they recorded 2 flashovers with a voltage over 10 times normal, and on another line of the same kv. they had 15. Now, did the first line only have 2 and not 15 because there were fewer lightning storms, or were the insulators installed with some control device which presumably decreased the possibility of flashovers? If such records were kept, I am wondering whether it would throw any further light on the question of flashovers. I am not questioning the value of the klydonograph, which is beautifully shown and recorded. But, inasmuch as the cause is tied in with the effect, (the effect being the flash-over of the insulators), I simply question whether anything has been lost sight of in not mentioning the matter of control devices.

The operating man is also interested in the amount of damage that is done, as much as he is in whether the voltage is ten times or twenty times normal. I am wondering whether the data could not be amplified to show the effect a little more clearly, in addition to the cause.

**R. G. Hooke:** The Public Service Electric and Gas Company of New Jersey, with which I happen to be associated, have been using the klydonograph for nearly three years, and I want to amplify a little the data that have been given; particularly that in the paper by Messrs. Cox, McAuley and Huggins. In their Table V. they give the relation between causes of surges and magnitudes.

I compared this roughly with our own records, because it is given as the average that might be expected on any one system, and I wanted to see how nearly our system lined up with that average. I found that the percentages due to different causes were rather interesting in that we had only about half as many surges resulting from switching at the klydonograph station, whereas we had twice as many as they give caused by switching at other points in the system. From that table also it appeared that we had an unusually high percentage of surges of the larger magnitudes. This is brought out particularly, perhaps, in their Table VI.

I would call attention to their remarks that, "On one particular system the surges identified with short circuits were considerably higher than the average. For instance, this system accounted for 26 of the 32 oscillatory surges of 2.6 times normal voltage and over. Its only apparent difference from the other systems, all of which were grounded solidly or through a low resistance, is the presence of a 75-ohm resistor in the neutral ground." They also say that "The highest voltage recorded was 4.6 times normal. Only ten surges or 0.4 per cent of the total were over four times normal. Of these, six were on one cable-and-open-wire system, where certain contributory operating conditions prevailed."

The system referred to, happens to be that operated by Public Service Electric and Gas Company in what we call our Southern Division. We have in Trenton approximately 10 mi. of 26-kv. cable, connected through about 32 mi. of open wire, to a cable network in Camden. In the latter city there are about 20 more mi. of 26-kv. cable, including ties with the Philadelphia Electric Company. I am going to give the details of two or three of the higher surges in this area because I think they are of particular interest.

We have recorded about 500 surges there in two years; 4.6 per cent of these have been between three and four times normal and 1.4 per cent have been above four times normal. The highest was 4.7 times normal. That highest surge was caused by a cable failure in Trenton. A report was received at our office that a cable was smoking. We sent a man out to investigate, but before he could get there the cable failed. Simultaneously, we lost a cable in Camden not far from the klydonograph location. The disturbance, therefore, originated in Trenton and traveled

some 40 mi. to cause trouble at the other end of the system. This, however, is the only case in our records of a failure which may have resulted from a high surge. On the contrary, with one exception, all of the higher over-potentials appear to have been the result of cable breakdowns rather than their cause. The basis for this statement is the fact that insulation failures frequently are not accompanied by surges, but the surges, when they do occur, are always coincident with faults. This means that if we eliminate the cable faults, we shall practically eliminate the high voltages, as is brought out in the paper.

The one exception that I mentioned is interesting. It was a surge of 4.6 times normal and was the result of an accidental relay operation. A line was tripped out which happened to be carrying a fairly heavy load, together with the synchronizing power between our system and Philadelphia. We have no satisfactory explanation for the resulting surge. Similar switching operations are quite frequently performed. We often separate from Philadelphia intentionally and we never have had any such occurrence on any other occasion.

We have also had a klydonograph located in another transmission system containing something like 135 mi. of open wire and 51 mi. of cable. This system was operated for a good many months with a solidly grounded neutral, but it has now been in service for about six or eight months with a 75-ohm resistance in the neutral. At the time we changed the operating condition, we made some fairly extensive ground tests with different neutral resistances; we tried 75 ohms, 150 ohms, and 300 ohms, throwing grounds directly on the system. The object of these tests was not to see what surges we would get, but to try out the functioning of our relays. The surges which occurred, however, are very interesting.

While operating with a solidly grounded neutral, three transients of above four times normal were recorded due to the deenergizing of low-capacity equipment in the substation where the klydonograph was located. Surges of this nature are mentioned by the authors and since they are of very short duration, they are not considered to be important. They are, therefore, excluded from the following table which gives the results obtained with the different neutral resistances. Southern Division data are included for comparison.

	Central Div.				Southern Div.
	0	75	150	300	75
Neutral resistance, ohms. . . .	0	75	150	300	75
Number of surges recorded . . .	240	115	9	15	498
Per cent from 1 to 1.9 times normal voltage . . . . .	84.6	75.6	55.5	46.7	84.5
Per cent from 2 to 2.9 times normal . . . . .	15.4	21.8	44.5	46.7	9.5
Per cent from 3 to 3.9 times normal . . . . .	0	2.6	0	6.7	4.6
Per cent from 4 to 4.9 times normal . . . . .	0	0	0	0	1.4

These figures indicate very clearly that the higher the resistance in the neutral, the greater will be the percentage of surges of the higher magnitudes. Under no conditions, however, have transients in excess of four times normal occurred in the Central Division.

Comparing this with the data obtained in the Southern Division, as indicated in the table, it appears that nearly twice as high a percentage of surges between three and four times normal have been recorded in Camden on the 75-ohm resistor, and that seven, or 1.4 per cent of the total, have been above four times normal, whereas there was none of this magnitude in the Central Division. Obviously, there is some difference between these two transmission systems and the high surges on one cannot be explained on the basis of the neutral resistor. It happens that at numerous points in the Southern part of New Jersey, the soil is dry and sandy and we find it difficult

to obtain low-resistance grounds at our stations and substations. Since the high surges which have occurred seem, in general, to be due to faults in certain areas, while faults in other parts of the system cause much less voltage disturbance, we are of the opinion that the ground resistance at the point of fault is of particular importance. In fact, it is of more importance than the resistance which we find it necessary to use in the neutral in order to keep on friendly terms with the Telephone company whose lines parallel certain of our transmission circuits.

To summarize, then, with different neutral resistances, we have found that the higher the resistance the more surges might be expected of magnitudes of between two and three times normal, but there is very little likelihood of any transients of above four times normal occurring even with 300 ohms in the ground connection unless there are other causes either in the constants of the system or in the ground resistance at the point of fault. In connection with this general discussion, it is of interest that in one case an arcing ground in a cable joint caused surges of less than 2 times normal for a period of about 30 hr., the figures being obtained intermittently until complete failure finally developed.

In studying our particular problem, namely the high surges which occur in our Southern Division, we are now planning to install three or four more klydonographs in the area, attempting to find out whence the surges come and whither they travel. We have only had one instrument in that whole system thus far. We have, however, carried on some cooperative work with the Philadelphia Electric Company. They installed a klydonograph on their side of the Delaware River about  $4\frac{1}{2}$  mi. from our klydonograph station. We found that for a surge to be recorded simultaneously at both places it must be over two times normal on one side or the other. Attenuation amounted to about 45 per cent in the  $4\frac{1}{2}$ -mi. cable tie. We think that is very interesting because with the klydonograph at one point if we get such an attenuation we don't know very much about what the surges may be elsewhere. However, in spite of the surges which we have—and I think they have been as serious as any company has experienced—we tend to disagree with those who charge cable breakdowns to high-voltage transients. We feel that the cable which we are now able to buy, in view of the voltages which it stands on test, should be almost entirely unaffected by surges up to four or even five times normal. I don't see any way to draw definite conclusions on this point, but it would be very interesting if some manufacturing company could conduct tests to determine the effect of transient voltages on cable insulation.

**J. H. Cox:** In the development of the klydonograph, we found the probable error of a record to be about  $\pm 15$  per cent, with a possible error of about 30 per cent. It is encouraging to note that the Messrs. Lee and Foust check this value.

There are two principal points in which the authors' procedure has differed from ours. They have used two oppositely connected electrodes for each connection, and they have used a different form of potentiometer for connection to lines. The use of two oppositely connected electrodes has certain advantages as pointed out by the authors and it is to be commended under certain conditions. Its principal advantage is that it gives a positive measure of the maximum voltage when the potential is a damped oscillation and the initial impulse is negative. There is also some advantage in having a positive figure for a negative surge, but it must not be inferred that the negative figures are entirely useless. The hiding of the small negative figures by the normal voltage band in the single-element instrument, can be prevented, if desired, by setting the potentiometers to eliminate the normal voltage band. In any case, negative records above  $2\frac{1}{2}$  times normal will be detected and it is questionable if surges on transmission lines below this value are very important. The advantages of the double connected arrangement are gained at the sacrifice of certain others. The instrument has a higher electrostatic capacity and hence imposes a

greater burden on the necessary electrostatic potentiometer, which at best has a low capacity itself. It makes a more expensive arrangement both in installation and in operation as it eliminates the possibility of the multi-electrode instrument. With the inherent inaccuracy of spring clocks, having the records of three terminals on one film makes the time record much more complete. A double-electrode arrangement was considered when the first film-type klydonograph was designed, but it was discarded at that time in favor of our present arrangement. However, the method to be preferred for a particular test is determined by individual opinion and the nature of the test.

While the authors have gone to greater refinement in the instrument they have chosen the opposite trend in the potentiometers used. The use of a string of suspension insulators as a potentiometer was suggested for approximate work by Cox and Legg in their paper on page 869 in the 1925 TRANSACTIONS, A. I. E. E. When the klydonograph was first developed this form of potentiometer was investigated by Mr. Peters and discarded as unsatisfactory. The scheme works well as long as the surroundings remain constant, and as long as the insulators are dry, or wet and clean, but when the insulators become slightly dirty and get wet, as is inevitable in service, the leakage conductance disturbs the ratio. This can be readily seen by a comparison of the electrostatic capacities involved. The capacity of the singly connected film-type klydonograph is about 8 micro-microfarads per terminal. I have been told that the capacity of the doubly connected klydonograph is 23 micro-microfarads. Its greater capacity is due to the fact that it has two terminals and a ground sheet connected to one of them. The capacity of a single 10-in. insulator disk is about 25 micro-microfarads, which value is divided by the number of insulators in series. It is easy to see that a variable leakage path in parallel with a capacity which is smaller than the connected instrument will seriously disturb the ratio. As mentioned by the authors, this disturbance should be less for impulsive applications than for the normal frequency.

The authors mention the effect of a change in the lengths of the leads used. This is inevitable where such small capacities are involved. In an actual test it is often difficult to keep the lengths of the leads down to 5 ft. Altogether, the most desirable form of potentiometer is that having the highest capacity. At best this is none too high. The capacity of a 6 ft. ring of 2-in. iron pipe mounted 12 in. above a ground plate is from 100 to 200 micro-microfarads.

We have recently made use of condenser bushings as potentiometers. The klydonograph is connected from one of the condenser steps to ground. This scheme gives excellent results. The arrangement is not subject to as many variable leakage paths as the others. Furthermore these paths are not as important since the capacity across which the klydonograph is connected is from 250 to 800 micro-microfarads. No calibration in the field is necessary as the bushing can be designed for a definite ratio and this ratio remains fixed.

**H. L. Wallau** (communicated after adjournment): The following data as to the magnitude of voltage surges experienced when switching high-voltage (66-kv.) cable circuits may be of interest.

The circuit was as follows:

No. 1 Breaker—Connecting 11-kv. generating plant bus to 30,000-kv-a. transformer bank stepping up to 66 kv.

No. 2 Breaker—Connecting high-tension side of transformer bank to 66-kv. cable circuit.

No. 3 Breaker—Connecting 66-kv. cable to low-tension side of 66-kv./132-kv. transformer bank. Length of cable circuit  $8\frac{1}{4}$  mi. 3 single-conductor 500,000 cir. mil. cables 30/32-in. paper insulation 9/64 lead, spaced vertically  $6\frac{1}{2}$ -in. centers.

No. 4 Breaker—Connecting high-tension side of bank to 132-kv. 4/0 three-phase circuit 47 mi. long.

Tests were made at no load.

The magnitudes of the over-voltage surges were obtained from oscillograph records.

**CLOSING BREAKERS**

C, indicates breaker closed before test  
O, indicates breaker open before test  
X indicates breaker closing under test

Breaker number				Max. over-volt- ages on 66- kv. cable, per cent
1	2	3	4	
X	O	....	....	0.0
X	C	C	C	15.6
X	C	O	....	65.0
X	C	C	O	73.5
C	X	C	C	25.3
C	X	C	O	60.0
C	X	O	....	62.3
C	X	C	O	123.5
C	C	X	O	0.0*
C	C	X	C	25.9*
C	C	X	C	42.5
C	C	C	X	10.0

\*66-kv. neutral ground open at far end.

**OPENING BREAKERS**

C, indicates breaker closed before test  
O, indicates breaker open before test  
X indicates breaker opening under test

Breaker number				Maximum over- over-voltages on 66-kv. cable, per cent
1	2	3	4	
X	O	....	....	0.0
X	C	C	C	0.0
X	C	C	O	6.1
X	C	O	O	71.4
C	X	C	C	50.7
C	X	C	O	63.0
C	X	C	O	74.0*
C	X	O	O	105.0
C	C	X	O	0*
C	C	X	C	9.5
C	C	X	C	17.5*
C	C	C	X	37.0

\*66-kv. neutral ground open at far end.

The maximum over-voltages obtained were for both closing and opening operations when the first 66-kv. breaker (No. 2) was actuated. For the closing operation the highest surge obtained when the 132-kv. bank had been previously closed on the cable circuit through the No. 3 breaker, thus simultaneously energizing both the cable circuit and the transformer bank. For the opening operation the next highest surge resulted when deenergizing the cable circuit only.

**A. L. Atherton** (communicated after adjournment): We who deal with lightning arresters have what is perhaps the most indefinite problem in the electrical industry today. Although it is recognized that the results secured thus far do not cover all conditions and are not extensive enough to justify the drawing of final conclusions, there are several points of vital importance to the lightning-arrester question which warrant notice.

(a) First of these is the amazingly small number of times a lightning arrester is called upon to operate in a season. In the old days, when electrolytic lightning arresters were generally used, the manufacturers' recommendations for setting of the series gaps were rather indefinite, it being left to the user to adjust the gaps so that the arrester operated frequently but not too frequently. It was general practise to set the gaps so that the arresters operated quite often. The customer had invested some money and wished to have some visible evidence that he had bought something. It was not infrequently the case that these arresters would operate many times in a single storm and possibly several hundred times in a year. Observe now the date of Table IV, keeping in mind that voltages less than double

normal line-to-line voltage, which corresponds to 3½ times normal voltage to ground, are not in the dangerous class and do not require an arrester operation. It is to be presumed that the only times when the arrester would be required to operate, would be for those voltage values greater than 3.5 times normal for which a flashover did not occur along the line. The total number of these is less than two per year per location. If we include those cases when the line insulators flashover, the total number of voltages in excess of 3.5 times normal is less than 6 per year per location. Even including all cases of flashover, to consider the condition of line insulation so greatly increased beyond present practise as to eliminate flashover, the total is less than 18 per year per location. This is a very startling reduction below the previous conception of how many times an arrester should operate in a season.

These figures are averages for all voltages and the weight of data lies at the higher voltages. The variation with voltage will be touched on later.

(b) Along this same line is another point almost equally startling. For years we have considered that it is desirable to provide as short a path as possible between lines to take care of switching transients. It appears clear from the information available here that switching transients are practically negligible. Wherever the length of line involved is appreciable, the voltage is low, and in general the voltages in excess of the value 3½ times normal voltage to ground for which an arrester operation might appear to be required, occur on very short lines and therefore are practically negligible because of short duration. The function of a lightning arrester is definitely the protection against lightning voltages.

(c) All of this arouses renewed interest in the time-honored question as to whether arresters are required on the higher voltage systems, and if not, where the dividing line can be placed. From the data given, it is clearly evident that voltages dangerous to the insulation of any apparatus at present made or contemplated for commercial use may readily be induced in the line conductors, providing the circuit is located in a territory where lightning conditions are at all severe. It appears that the magnitude of voltage which reaches a station is determined in general by the flashover value of line insulation. Insulators flashover even on lines for the very highest voltages. One way to look at this question then is that the need for lightning arresters is dependent on the ratio between insulation strength of the apparatus and flashover of the line insulators both presumably under the same conditions of transient voltage. Considered on this basis, the line insulators probably offer the same order of protection to terminal apparatus throughout the voltage range and, if this line of thought is correct and complete, lightning arresters are as necessary at the higher voltages as at the lower.

To get a further idea as to the relative need for protection in the various voltage classes, and to try to take into account the number of overvoltages per year which was neglected in the line of thought we just followed, we may total the data of Table I by voltage classes as follows:

System		Surges per station per year		
		Without flashover 3.5 times normal and above	With and without flashover, 3.5 times normal and over	Without flashover, 3.5 times normal and above plus all with flashover
No.	Voltage			
26 and 27	6.6-13.2	0	6	29
20 to 25	22-23	5	8	23
9 to 19	44-66	2	8	18
1 to 8	100-220	1	3	13

In this summary, fractional values are given as the next higher whole number.

There may be indications of a slight trend toward higher

figures for the lower voltages, but there is no indication that the figures are of a different order of magnitude. On this basis, the need for arresters seems to be about the same for all voltages, neglecting any differences there may be in factors of safety of apparatus insulation and relative importance of serial continuity.

Assuming, for the moment, that the need is equal, we must not take this to mean that the justification for the use of present-day arresters is equal for all voltages. Justification for use still depends on economics and the cost per kv. of present-day arresters increases very rapidly with voltage in the higher ranges.

To get the correct idea from these thoughts, we must keep in mind that experience with and without lightning arresters at the middle voltage classes, 33 or 25 kv. and down, has clearly

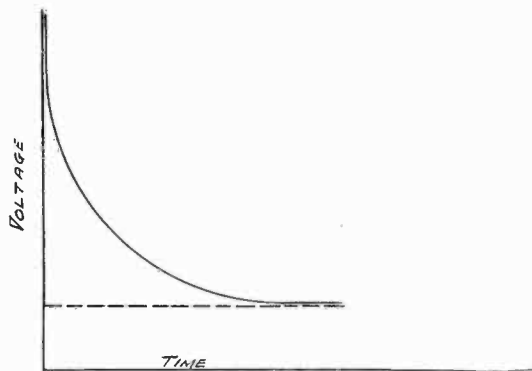

FIG. 2

demonstrated that good service cannot be rendered without lightning arresters if the circuit is in a location where lightning is prevalent.

We must also keep in mind that we cannot draw definite and final conclusions at this time. The data are not nearly complete enough to eliminate the possibility of large errors. It is interesting however to note the trend of opinion as the information accumulates.

(d) One further point in this connection bearing particularly on the question of line insulator flashover and the measurement

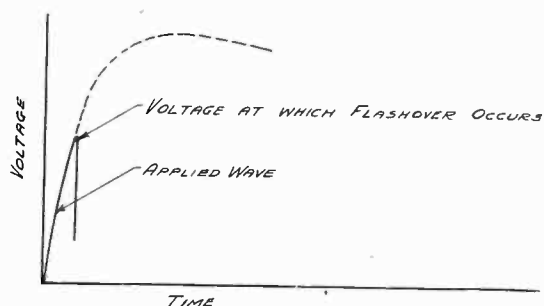

FIG. 3

of transient voltages which I should like to stress is the rather general present practise of referring to "Impulse Flashover Value" for insulators or insulation. It seems to me that this is a very dangerous practise. When we say impulse flashover voltage, we give the definite impression that there is one such voltage value for any particular piece of insulation. This is not the case. The impulse flashover voltage may be anything between the 60-cycle flashover voltage value and some value very close to infinite dependent on the duration of the application. If we apply a million volts to a path, and flashover occurs after one microsecond, it is evident that we can prevent flashover not only by reducing the voltage value but also by reducing the time. A curve something like that shown in the accompanying Fig. 2, doubtless exists. It is difficult to see

how we can justify speaking of such a curve by one voltage value and it is very easy to see how such a loose practise may get us into misconception and future trouble.

For example, if we determine the "Impulse Flashover Voltage" for a string of insulators by applying a rapidly increasing voltage and measuring the voltage at the flashover by means of a sphere gap or klydonograph, we measure the voltage value as indicated in Fig. 3, herewith. We get the same kind of value as a maximum by klydonograph tests in service at the time of flashover. When the klydonograph says 10 times normal voltage for a flashover, the induced voltage may have been on the way to 100 times normal when the flashover stopped it. If we refer to this kind of value as the "impulse flashover voltage," we give the impression that lower voltage values will not cause flashover. Suppose, however, that a transient voltage appears which never reaches this crest value but persists for some microseconds. It is entirely possible that such a transient will cause flashover, and if transient voltages on transmission circuits may be of appreciable duration, such as 10 to 20 microseconds, as is likely, this voltage value may be very much below "the impulse flashover voltage" above referred to. It is not unlikely that some of the flashovers with relatively low recorded voltages may be explained in this way.

There is a growing interest in the proper proportioning of line insulation, apparatus insulation, and protective equipment to make the design of systems consistent as a whole. If we base such system design on a single voltage value, as the tendency now is, we are liable to be in error. Even if we could assume that a test, as in Fig. 3, gives one point of the curve of Fig. 2, we would still have no assurance that this curve would have the same shape for various kinds of insulation, and when we are dealing with such widely different things as air flashover around insulators and dielectric puncture under oil in transformers, the difference is not likely to be negligible.

The manufacturers have been asked to give impulse flashover voltages for various kinds of apparatus and line insulation, particularly when applications are to be made on the very high-voltage systems in lightning territories. Such statements are meaningless and can only lead to misunderstandings and disagreements. Let us learn from past engineering experience that inaccuracies of speech are dangerous and adopt precise terms in this matter as we have had to in others. If we must specify a value for impulse flashover voltages, let us specify also the duration of this voltage or better yet, a curve of time against voltage.

**V. E. Goodwin** (communicated after adjournment): I fully agree with the comments of Mr. Atherton and wish to emphasize the importance of a proper understanding of the term "impulse flashover" or "impulse failure" of apparatus. It is, for instance, common practise to speak of insulators as having a definite flashover or of the impulse strength of an insulated structure such as a transformer. The flashover of an insulator may be taken as illustrative, although this discussion applies equally well to the puncture of insulation or to other apparatus subjected to the action of transient phenomena.

Whether or not a given insulator will flash over depends on both the voltage and the time of application. The lower the voltage applied, the longer the time of application to cause failure. This means that the body of the wave is important since the flashover may occur after the wave front has passed. On the other hand, if the voltage rises to a high enough value the insulator will flash over on the wave front, thus preventing further rise in voltage.

When stating that a piece of apparatus has a certain impulse flashover, it is necessary to specify the wave used in determining this value and state whether the arc-over occurs on the front, or if after the front has passed how long a time elapsed before the arc-over took place.

The terms "time lag" and "impulse ratio" are open to the same

criticism as the term "impulse strength." Time lag as ordinarily understood is an indefinite term since the wave is not specified and the lapsed time may involve a simultaneous voltage increase, as in the front of the wave or it may be a constant or decrease in voltage as in the body or tail of the wave.

One method of measuring time lags is to apply various over-voltages above that which this specimen will withstand continuously, and determine the times required in each case to cause breakdown. For this method to be satisfactory, the potential must rise to its maximum value in a time short compared to that required to cause breakdown. Until the cathode-ray oscillograph became available, this method could not be used for it was not possible to determine the time relations satisfactorily.

The other and more common method for measuring time lag is to determine the time required for the breakdown to occur on a steep wave front after the potential has reached a value which it could withstand if continuously applied. With this method, the exact wave front must be known and several points taken. Comparison of curves of these two methods for determining time lag will show quite different results.

The term "impulse ratio" does not have a definite value unless the impulse applied to the test specimen is prescribed and it is known that the breakdown occurred on the wave front and not after the voltage has reached its maximum value.

The terms "impulse strength, time lag, and impulse ratio" have come to have a variety of meanings and are terms which the Institute might well define to prevent confusion.

**H. H. Plumb** (communicated after adjournment): Mr. Cox has brought out some interesting data in his first paragraph under *Experimental Data*, applying to lightning discharges. His deductions appear to be somewhat in conflict with other conclusions in the paper, and I wish to submit a different deduction which will harmonize the conclusions.

That there are surprisingly few discharges indicated by the klydonograph during a thunder storm, and the figures showing positive, supports the deduction that only negatively charged clouds discharge with sufficient severity and swiftness to make a record on the klydonograph. The few negative Lichtenberg figures recorded may have been direct strokes in every case. The evidence thus analyzed shows that in a thunder storm, many discharges take place, from both positively and negatively charged clouds; the discharges from positive clouds are relatively slow and fail to register on the klydonograph; the negatively charged clouds are discharged swiftly and with severity, and these usually register, with a positive Lichtenberg figure if by induced or bound charge, but negative if by a direct hit on the line. This view is in complete accord with Dr. Simpson's theory and Dr. Norinder's results.

**J. H. Cox and P. H. McAuley**: Mr. McEachron has objected to certain of our conclusions as somewhat premature with present available data. It should be obvious that the inherent variations in the physical conditions under which lightning occurs are reflected in any data obtained, and that the reliability of the conclusions is relative to the amount of data from which they are drawn. Moreover, deductions from data of this nature are invariably influenced, to a certain extent, by individual experience. Several of the discussions illustrate this point. To make a paper complete, however, results must be summarized and conclusions indicated. As Mr. Peek has pointed out, the magnitude of an induced surge is influenced by the rate of discharge of the cloud and is less than the product  $Gh$ . Thus, although gradients as high as 100 kv. per ft. (330 kv. per meter) are reached near the earth's surface, it is entirely possible that surges high enough to flash over 220-kv. insulation seldom are induced. Furthermore, these higher gradients are present only in the vicinity of the lightning stroke. The division of an instantaneously released charge into two traveling waves,

each with a surge voltage of one-half that of the initial voltage, is one of the most elementary laws of wave propagation and was not neglected by the authors. The reduction referred to was from more than 1000 kv. to about 150 kv. This indicates a rapid attenuation in spite of a maximum initial reduction factor of one-half.

Mr. Schirmer has reported some results which appear to conflict with Simpson's theory of lightning. These, however, are not so inconsistent when it is remembered that the voltages measured on telephone lines are low compared to those on power lines. Mr. Schirmer has some interesting data which show that the drop across the protector ground on telephone circuits is relatively high. The drop across power-line lightning-arrester grounds has not been investigated, but tests on this are now being started.

Mr. Vincent has asked some questions regarding test conditions which may have affected the results. In some cases the lines were not energized during lightning storms. This did not appear to influence the results very greatly. The only influences of having the line energized are that terminal conditions are different, and that the net surge voltage to ground becomes the sum of the instantaneous applied voltage and the surge potential. Lines 2 and 3 in Table I were of similar construction, neither being equipped with control devices. The difference in the number of surges over ten times normal was due to difference in the lightning encountered. The only claims made for flashover control devices are that they increase the flashover voltage of the line, and therefore higher surge voltages should be recorded on lines so equipped. In our experience with the klydonograph, however, we were unable to detect this difference.

Mr. Plumb has made certain comments regarding the first paragraph under *Experimental Data* in the paper *Transmission Line Voltage Surges*. This paragraph merely includes a number of statements regarding the data recorded and what these indicate at first sight. The conclusions stated by Mr. Plumb are discussed in the remainder of Part II of the paper. For instance, it is explained that positively charged clouds discharge too slowly to cause surges on transmission lines and that the surges experienced, both induced and direct, are caused by negatively charged clouds.

**E. S. Lee and C. M. Foust**: Several phases of the work on Lichtenberg figure measurements of surge voltages have been touched upon during the discussion, particularly by Mr. Cox, and we wish to add a few remarks relating to the points raised.

Regarding the use of the positive Lichtenberg figures to record all surges whether of positive or negative polarity, it is felt that this practise is advantageous for three reasons:

1. Because negative surge voltages up to approximately 2.5 times normal give negative Lichtenberg figures upon a directly connected recorder which are entirely obscured by the normal line-voltage band, and the interpretation of negative figures somewhat above this value may be uncertain.
2. Because negative Lichtenberg figure sizes are dependent upon the rate of voltage rise to a much greater degree than the positive figures.
3. Because the availability of both figures for all high-voltage surges permits a more accurate determination of the nature of the surge producing the figures.

We do not consider the limitation of the two-recorder type of instrument to a single-phase instrument to be a disadvantage, since the certainty of the result obtained is greater. The use of the three-electrode type of instrument as a three-phase instrument requires that the conditions be arranged so that there is no interference between electrodes.

We have investigated both insulator and electrostatic-potentiometer methods of connecting the instrument to the transmission

line and have used the insulator-potentiometer method for several reasons, among which are the following:

1. Availability of normal line insulator units, ease of installation and small space occupied.
2. Requisite safety is assured by the use of an insulator-potentiometer string having a greater number of units than normal line insulation.
3. All measurements are made across a portion of the normal line insulation.
4. Laboratory tests have not demonstrated that the electrostatic-potentiometer method may be relied upon for any greater degree of accuracy than the insulator-string method.

While there is considerable evidence to support the contention that for 60-cycle voltages the distribution over a string of insulators may vary with conditions, such as indicated by the decrease in flashover under wet conditions, there also appears to be considerable evidence which indicates that this change in distribution does not take place where the applied voltages are of very steep wave front. This seems reasonable because of the much larger charging current present with very steep waves and the consequent unimportance of the low surface-leakage current. Data have been published which indicate that for steep waves the flashovers wet and dry do not differ greatly. Our laboratory test on insulator strings of various lengths seem to bear this out. Using a wave front of about two microseconds the distribution of voltage across the individual units of a string of six insulators was found to be independent of the magnitude of the voltage and similar to the 60-cycle distribution. These investigations check our ratio results on various insulator strings at 60 cycles and impulse voltage, and indicate that our ratio of line voltage to instrument voltage will be constant and identical both wet and dry on impulse voltages, and dry on 60 cycles.

The 60-cycle ratio with the string wet will vary somewhat due to the increase in surface-leakage currents. The use of the electrostatic potentiometer, however, does not seem to rectify this condition because the rings are still necessarily supported by porcelain insulators, again supplying surface-leakage paths which tend to disturb the normal frequency distribution. As regards the high capacitance of the electrostatic potentiometer, this may be a disadvantage since the higher the capacitance, the greater the distortion of the surge voltage from normal.

Mention has been made of the lead effect shown in Fig. 24 of the paper in connection with the insulator-string potentiometer. The results shown on this graph were, however, not obtained upon an insulator string but on an electrostatic potentiometer. While this potentiometer did not have the capacitance of some of those which have been used in practise, the results obtained do demonstrate a characteristic which will be obtained in any type of capacitance voltage-dividing arrangement used. In such devices, connecting leads should always be as short as possible. Therefore, Mr. Cox's statement "Altogether the most desirable form of potentiometer is that having the highest capacity" must necessarily be modified, since recognition must be given to the fact that high-capacitance potentiometers distort the line transient.

#### PAPERS ON GRAPHICAL DETERMINATION OF MAGNETIC FIELDS

(STEVENSON AND PARK, JOHNSON AND GREEN, WIEBEMAN)  
NEW YORK, N. Y., FEBRUARY 8, 1927

**C. H. Linder:** Any simple experimental method of magnetic field plotting is very useful in connection with a mathematical investigation of flux distribution. The accompanying Figs. 1 to 9 demonstrate the efficacy of the iron-filing method for determining the general form of a magnetic field.

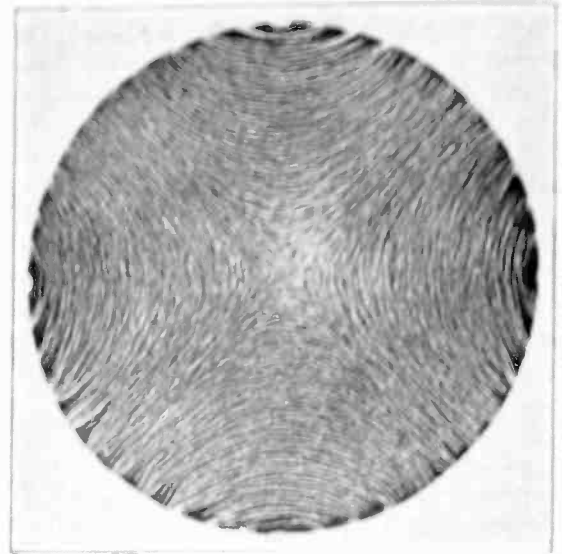

FIG. 1

This is a four-pole induction motor with the rotor removed and the stator windings excited with three-phase currents for a particular instant of balanced operation. The iron filings are aligned to indicate the  $^2/4$  poles of the stator winding. The tuft of the filings around the circumference of the stator is due to the presence of the stator teeth.

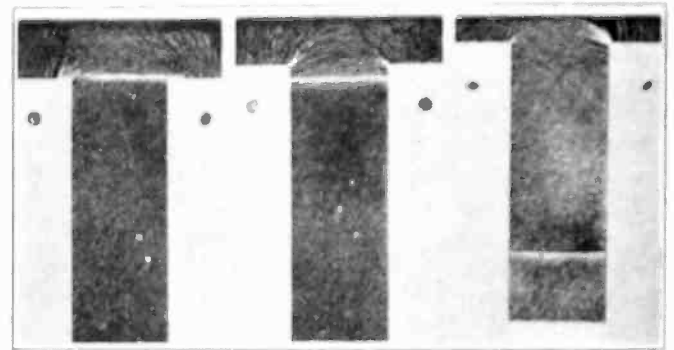

FIG. 2

The calculation of slot reactance is usually made on the assumption that a horizontal element of current in the slot produces no flux between the element and the bottom of the slot. The only flux produced by the horizontal element of current must cross the slot above the element, assuming no saturation. In these three cases the current is confined to a horizontal copper strip. Intense magnetic field exists above the element, whereas below no field is indicated by the filings.

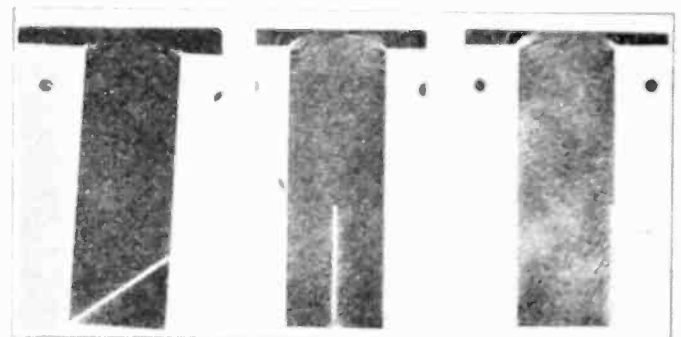

FIG. 3

The strip of current-carrying copper along the side of the slot in the right hand figure represents, after a manner, the current in the field winding of a salient pole machine. The flux indicated by the iron filings is equivalent to the field pole leakage flux. Evidently, the flux density increases from zero at the bottom of the slot to a maximum at the top of the current element. The center and left hand exposures have no practical application, but merely indicate flux distributions with the current element in two positions.

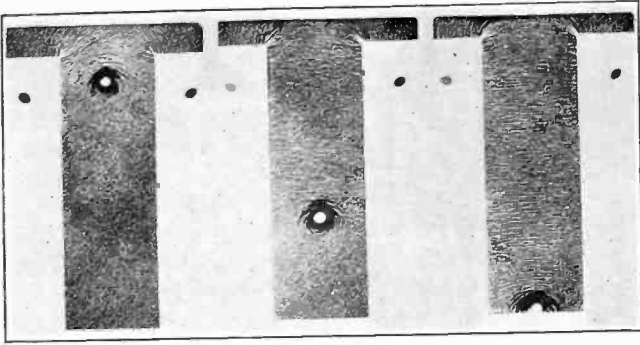

FIG. 4

By superposing the magnetic fields produced by a current carrying conductor located at a number of positions in the slot, the resultant magnetic field due to a current carrying armature coil can be obtained. Superposition of fluxes is only allowable where saturation does not exist.

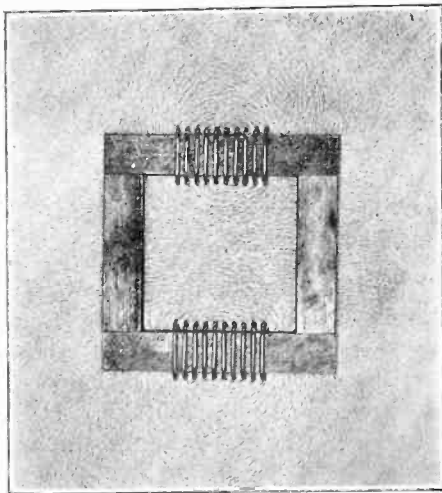

FIG. 5

A number of theoretical magnetic circuits have been studied, the magnetic field being plotted mathematically, graphically and experimentally. Such a circuit of rectangular form is shown here. The coils on the perpendicular legs are magnetized to send flux upward. Full potential, therefore, exists between the top and bottom horizontal arms. This accounts for the large amount of leakage flux in the perpendicular gap between the coils.

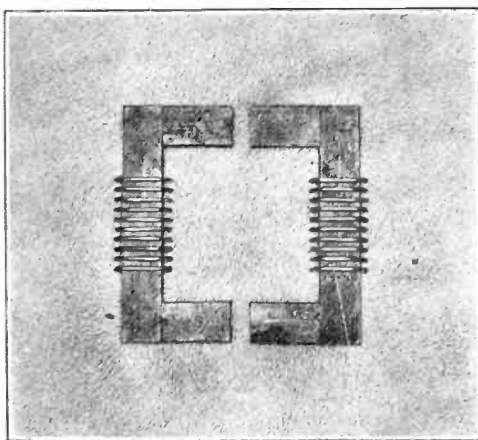

FIG. 6

This circuit is identical with No. 5 except for the air-gaps inserted in the horizontal arms.

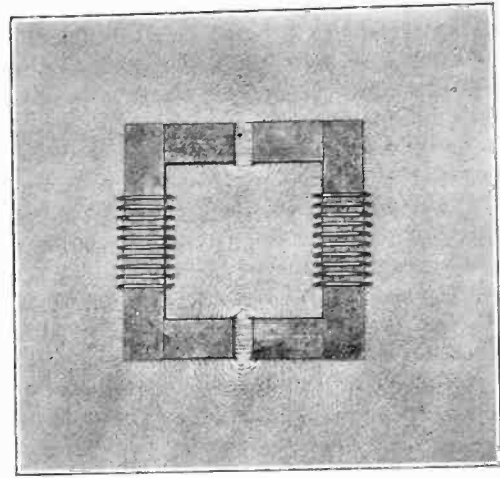

FIG. 7

This is similar to No. 6 except that the coils on the perpendicular arms are magnetized in the same direction; that is, with magnetomotive forces adding. The resultant flux around the circuit is the sum of that which would be produced by considering each coil alone, neglecting saturation. The flux density in the gap is very great, indicated by the tufting of the flux at the gaps.

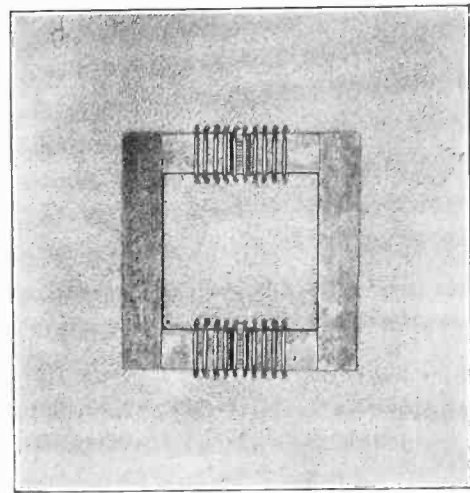

FIG. 8

The air-gaps are situated under the excited coils. Before this field was photographed extreme difficulty was experienced in an attempt to construct the field graphically. The difficulty was one of magnetomotive force distribution.

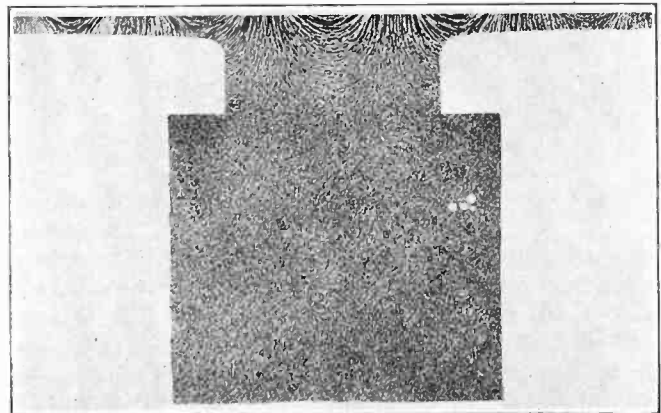

FIG. 9

The stator and a portion of two field poles of a synchronous machine with a fifth harmonic cosine of magnetomotive force impressed along the stator periphery. The flux distribution shown is the result. This particular circuit was employed in certain studies made in conjunction with the preparation of the paper "Synchronous Machines—Part I" by Messrs. Doherty and Nickle.

**C. M. Laffoon:** The graphical method of mapping electric and magnetic fields has been used by designing engineers for a large number of years to determine the physical dimensions and performance characteristics of electrical machines. In most instances, no particular effort was made to insure that the flux distribution satisfied all of the theoretical conditions, yet very accurate and reliable results were obtained. This was particularly true in calculating the magnitude and shape of the e. m. f. waves of rotating electrical machinery.

It has only been during the last two or three years that special consideration has been given to the problem of determining the distribution of the magnetic field in the space occupied by and adjacent to the electric conductors, with greater accuracy and refinement, by means of both mathematical and graphical methods of analysis. There can hardly be any question but that the mathematical method of analysis is the most rigorous and scientific, yet in most cases the graphical method is simpler and more convenient to use, and gives equally reliable results. It is for this reason that our own efforts have been confined to the use of the graphical method.

In Mr. Wieseman's paper, the graphical determination of magnetic fields has been applied to salient pole synchronous machines for the case in which the magnetization is produced by either the stator or rotor windings alone. The flux distribution for these cases are also given in the paper on *Additional Losses in Synchronous Machines*, by Mr. Calvert and myself. It is interesting to note that the results are essentially the same in the two papers. We have also applied the graphical method of determining magnetic fields to turbine-generators in connection with studies on additional losses and leakage reactances. In this connection, the distribution of the magnetic field in the following parts of the magnetic circuit of a turbine generator have been determined:

1. Air-gap space for the following load conditions:
  - a. No load with rotor excited to give normal voltage,
  - b. No load with the stator excited to give normal voltage,
  - c. Full load at power factors of zero, 80, and 100 per cent.
2. End-bell space under the same load conditions as for No. 1.
3. Rotor and stator core at no load with the rotor excited to give normal voltage.

Part of these results are given in our paper on *Additional Losses in Synchronous Machines*. Some of the remaining cases will be referred to in a discussion by Mr. J. F. Calvert.

**J. F. Calvert:** In making flux plots, the greatest assistance that one can have is another drawing of a similar field. If a sufficient number of type cases can be solved then the solution of

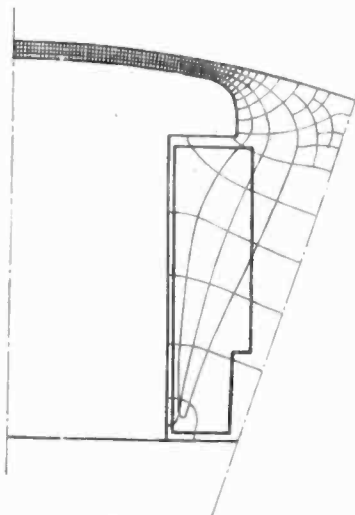

FIG. 10—AIR-GAP AND INTERPOLAR FLUX FOR A TEN-POLE MACHINE

any particular problem becomes quite easy. It is probable that twenty or thirty of these reference solutions would cover practi-

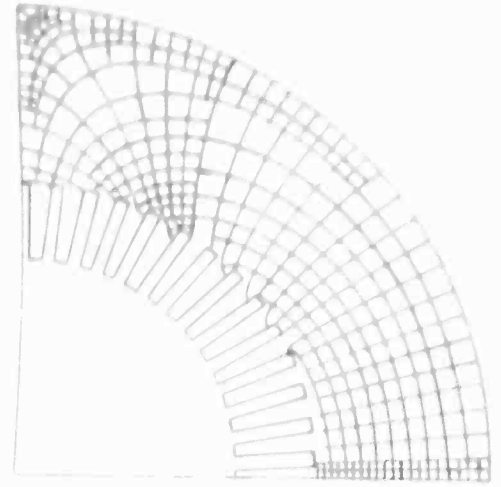

FIG. 11—FLUX DISTRIBUTION IN THE CORE OF A TWO-POLE TURBINE GENERATOR ON THE ASSUMPTION OF UNIFORM PERMEABILITY

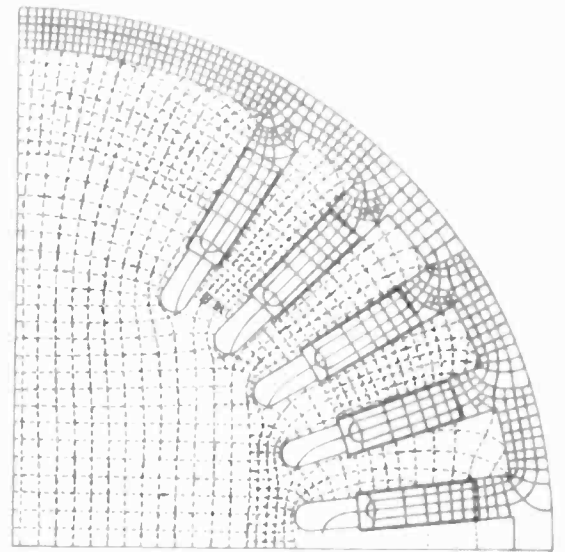

FIG. 12—FLUX DISTRIBUTION IN THE ROTOR OF A TWO-POLE TURBINE GENERATOR

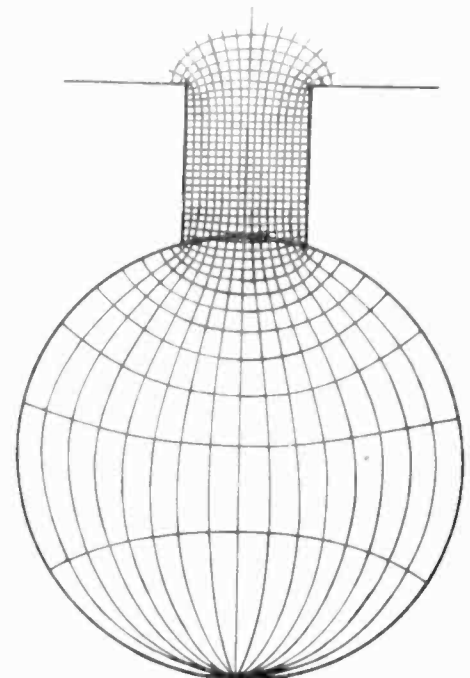

FIG. 13—FLUX DISTRIBUTION ACROSS A ROUND SLOT WHEN THE CONDUCTOR IS IN CONTACT WITH THE IRON



cally all of the special types of problems which could be found in making the two dimensional figures for rotating apparatus. In electrical machines the arrangement of the magnetomotive forces and the iron surfaces are usually such as to render a mathematical solution either very difficult or in many cases

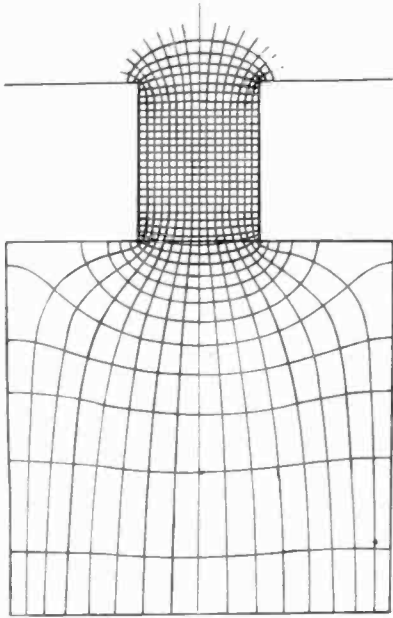

FIG. 14—FLUX DISTRIBUTION ACROSS A RECTANGULAR SLOT WHEN THE CONDUCTOR IS IN CONTACT WITH THE IRON

wholly impossible at the present time. Therefore, it would seem that a good procedure would be to project the work by graphical solutions which should later be verified or corrected by mathematical solutions whenever possible.

Somewhat recently we have been doing work along similar

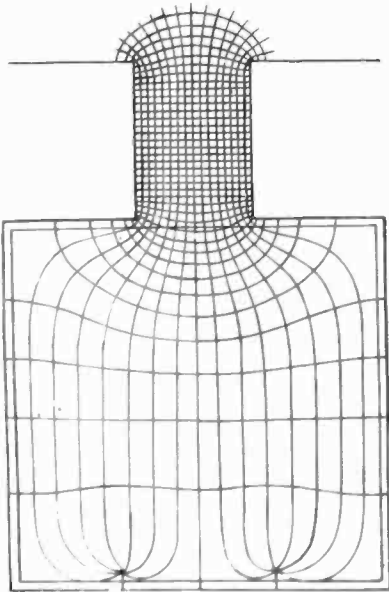

FIG. 15—FLUX DISTRIBUTION ACROSS A RECTANGULAR SLOT WHEN THE CONDUCTOR IS NOT IN CONTACT WITH THE IRON

lines to establish graphical solutions, but our work was done primarily in connection with loss studies. The theoretical basis of our work is described in the latter part of a paper on *Additional Losses of Synchronous Machines*. Examples are shown there of the application of the theoretical principles for plotting fields in the interpolar space on salient pole machines, and in the air-gap and end-bell zones of non-salient pole machines. In the latter

solutions for non-salient pole machines, both the stator and the rotor windings are assumed to be carrying currents.

In Figs. 10 to 15 accompanying this discussion are shown graphical solutions to some other magnetic problems of interest. In the figures showing the flux distribution inside of the damper bars under steady conditions, the exact location of the kernel or center is rather difficult. The location of this point makes a considerable difference in the appearance of the picture, but usually makes very little difference in the total amount of flux and much less difference in the flux turn interlinkages. Mathematical solution, however, should locate these points beyond a doubt.

**J. S. Woodward** (contributed after adjournment): In discussion of the paper by Messrs. Stevenson and Park, Mr. J. F. Calvert presented two figures showing the flux distribution

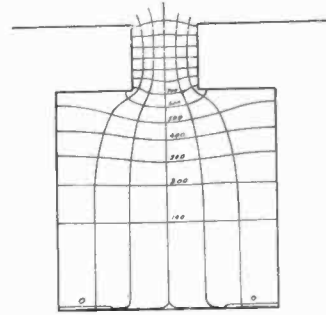

FIG. 16

in a slot containing a conductor carrying current. The correctness of these two flux plots presented was questioned, and Messrs. Stevenson and Park asked me to calculate the distributions by the mathematical theory, outlined in their paper. The result of such calculation is shown in Figs. 16 and 17 herewith.

Fig. 16 shows the flux distribution in a slot where the copper and iron are in contact with each other. Here, the calculations show there are two kernels, or foci, of the lines of no work, located in the lower corners of the slot.

Fig. 17 shows the flux distribution for the case of copper and iron insulated from each other, and here, there is but one kernel

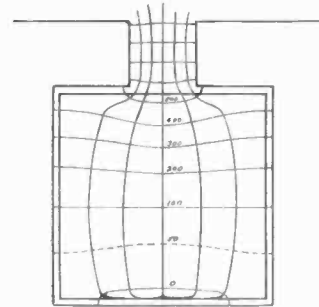

FIG. 17

located on the vertical center line slightly above the bottom edge of the copper.

In both cases the flux lines at any appreciable distance from the kernel are very nearly flat, and the lines of no work are nearly vertical as they approach the bottom of the slot. Near the bottom, they turn sharply toward the kernel and are crowded together in the bottom of the slot. An enlarged view of the flux in the bottom of the slot is shown in the accompanying Figs. 18 and 19, which refer to Figs. 16 and 17, respectively. The sharp curvature of the lines of flux and also of the lines of no work is of particular interest as it illustrates the general statement made in Part II of the paper as to the action of these lines in the vicinity of the kernel.

The two cases under discussion are of interest, as they bring up the question of the location of the kernel. In free-hand plotting, the location of this point is important as it furnishes a basis for

drawing in the lines of no work. The location of the kernel is determined by the boundary conditions of the copper.

In Fig. 16, were the slot of infinite depth and not partly closed at the top, the flux would go straight across the copper and the kernel would become the line at the bottom of the slot. If the slot were open at the top and not of infinite depth, the flux would be concave downward and there would be one kernel located on the vertical center line of the slot.

In Fig. 16, where the top of the slot is partially closed, the flux is concave upward, and this condition, carried to the bottom of the slot, causes the flux leaving the sides of the slot near the

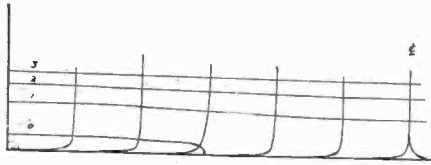

FIG. 18

bottom to enter the iron before reaching the vertical center line and as a result there are two kernels, one in each lower corner of the slot.

In Fig. 17, if the slot were not partially closed at the top there would still be but one kernel, located on the vertical center line, but this kernel would be farther from the bottom edge of the copper than is the case in the figure. Partially closing the slot causes the flux near the top of the slot to have a curvature that is concave upward, thus tending to depress the kernel.

In Fig. 17, it may be observed that the curvature of the flux lines reverses approximately at the line marked 100. From there down, the curvature is concave downward; hence the effect of the insulation predominates and we have but one kernel, located as shown. It is possible to obtain two kernels in the general case of a partially closed slot, when the conductor is insulated from the iron, by making the insulation thinner or by

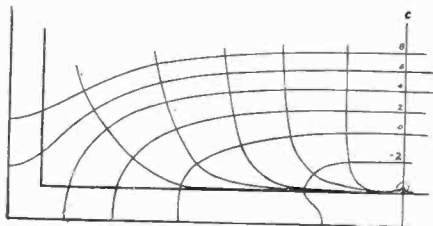

FIG. 19

making the depth of the slot smaller in comparison with the width.

In locating the kernel from a plot made by the mathematical formula, where the flux lines close to the kernel are very flat, two considerations may be followed. First, the general location of the kernel will be clearly indicated, as it is known to be in the region of lowest flux density, the density at the kernel being zero. Secondly, the flux lines surround the kernel, and the rate of change of flux, along any line passing through the kernel will change from positive to negative as the kernel is passed. Hence, by taking  $\partial r / \partial x = 0$  for a value of  $(y)$  known to lie near the kernel, the  $(x)$  coordinate of the kernel will be obtained to a high degree of approximation. Then, taking  $\partial R / \partial y = 0$  along this  $(x)$  coordinate will be determined to good accuracy. The accuracy can be made as great as desired by repeating this process.

**Th. Lehmann** (communicated after adjournment): By their ingenious extension of Professor Rogowski's method of calculation to interpolar fields, Messrs. Stevenson and Park have shown that in certain cases the Fourier method has some advantages over the method of conformal representation, even though the latter

method can be used to solve Poisson's equation, as has already been shown by E. B. Christoffel<sup>1</sup>.

But I maintain that Messrs. Stevenson and Park have furnished by their work a very welcome check on the graphical method of determining lines of force. The result of this comparison is satisfactory, and the same is true of the very cleverly arranged experimental check by Messrs. Johnson and Green, which corroborates perfectly the sketches of the lines of force plotted by Messrs. Wieseman and Shildneck.

The fact that it was possible for Mr. Wieseman to obtain by the graphical method values which check within 1 per cent with Mr. Carter's equation for air-gap reluctance of infinite teeth, shows eloquently the great accuracy which can be obtained by the graphical method if it is used methodically and with judgment.

Further, the charts and functional curves given in these papers for air-gap reluctance, tooth harmonics, reactances, etc., will be of service to practical engineers, and will save them a great deal of work, for which much credit should be given to the authors.

One might perhaps think that the assumption of infinite permeability in the iron would reduce somewhat the practical use of the sketches of lines of force given by the authors.

I am of the opinion that, in spite of this, these sketches are still interesting and valuable, even in the case where the poles are saturated, for the following two reasons. First, the saturation of the poles does not seem to have more than a slight influence on the interpolar flux for a given useful armature flux, even though the body of the pole absorbs as much as 30 per cent of the total ampere-turns. Further, even if one desires to take account of the influence of saturation, the sketches of the lines of force for  $\mu = \infty$  can still be used as a basis.

I will later show how, with the aid of a sketch of lines of force obtained on the assumption of infinite permeability, one can deduce rigorously the actual distribution of the field when the circuit is saturated.

The sketches of lines of force given by the authors are, therefore, still of actual practical interest, even when there is considerable saturation in the iron, and it has seemed worth while to me to emphasize this fact.

**J. F. H. Douglas:** In one of the three papers a preference is expressed for graphical methods and I wish to say that with this new development of a means of treating the interior of copper, locating the flux and lines of zero work in that way, we have perhaps the most valuable contribution that has been made to the subject for many years.

The test methods which I have used—namely, the use of high-resistance templates—are inadequate for such cases. Nevertheless, I cannot quite pass the matter without protesting that the difficulty attached to making tests with templates is somewhat exaggerated. It is a very speedy method, both for determining total reactance and also for determining flux densities to any point of the boundary.

I have used all three methods and templates, and I find the labor with templates somewhat less than in the case of using graphical distribution, and decidedly less than that using the functions of complex variable.

I do not think that the possibilities of the functions of complex variable, however, have been fully appreciated. Generally the writers feel it incumbent to evaluate the whole field of force. Where problems of boundary densities are concerned, which alone would be of interest in loss calculations, and where problems of the total reactance or permeance of the field is in question, then there is a very neat way of handling Schwartz's and Christophel's theorem, which I don't recall having seen in print. That is a method of graphical integration around the boundary.

1. E. B. Christoffel, *Annali di Matematica*, 1867, ser. II, Vol. I, fasc. 1°, p. 89.

Schwartz's and Christophel's theorem is a very simple matter of formulating, provided the boundaries are straight line boundaries, but extremely difficult to integrate, except for the simplest cases. Nevertheless, on the boundary, the functions are wholly real and a graphical integration is easily possible.

I ask Mr. Wieseman one or two specific questions. I should like, either now or in the written closure, information as to whether Fig. 2 checks my 1915 work<sup>2</sup> and whether Fig. 3 checks<sup>2</sup> my 1924 work.<sup>3</sup>

I should like also to make one or two detailed comments. In Mr. Wieseman's paper is the statement: "If the number of teeth spanned by a pole varies, a certain amount of flux pulsation is necessary."

There is one shape of pole which will avoid all pulsations when used with armatures of any amount of slotting and every amount of slotting; namely that pole shape which gives a perfect sine wave on the equivalent armature circuit. Such a punching could be used with any amount of slotting opposite, without pulsation. The proof of this proposition was given in the appendix of the paper read by Douglas and Kane in Chicago two years this coming June.

A rough calculation of Mr. Wieseman's coefficient as  $A q 1$  and as  $A D 1$  for complete range of pole pitches, air-gaps and pole-face curvatures used seems to lie within the range of 40 to 60 per cent. It seems that the problem of obtaining extremely high pull-out torque (I mean pull-out torques greatly in excess of present ratings) is not yet possible without a radical change of pole design.

It may be that there are some particular combinations of pole pitch, air-gap and pole curvature which will give smaller ratios of the transverse coefficient, but it should now be clear that in order to develop extremely sturdy synchronous motors, it is needful that the ratios of  $A q 1$  to  $A d 1$  should be brought very much less.

**Vladimir Karapetoff:** (communicated after adjournment): The mathematical treatment in Appendix C may be given also in the language of vector analysis. While the authors are justified in using ordinary partial derivatives, so as to make the theory comprehensible to a larger circle of engineers, yet, with an ever increasing interest in vector analysis among younger engineers and physicists, the alternative abbreviated treatment, added below, may not, for the sake of completeness, be out of place. Several elementary works on vector analysis are now available, so that the exposition is given without proofs or definitions. The great advantage of this new "short-hand" language is that no axes of coordinates are used (crutches or scaffolding, as some vector analysis enthusiasts call them), and the quantities concerned are dealt with directly in their magnitude and direction in space, thus bringing out more clearly the physical relationships.

By the definition of vector potential

$$\mathbf{H} = -\nabla \times \mathbf{R} \quad (1)$$

According to the magnetic-circulation law

$$4 \pi \mathbf{i} = \nabla \times \mathbf{H} \quad (2)$$

Substituting  $\mathbf{H}$  from (1) in (2), gives

$$-4 \pi \mathbf{i} = \nabla \times (\nabla \times \mathbf{R}) \quad (3)$$

Since the vector potential is defined through its curl only, an additional condition may be imposed; namely, that  $\mathbf{R}$  is a solenoidal vector ( $\nabla \cdot \mathbf{R} = 0$ ).

Hence

$$\nabla \times (\nabla \times \mathbf{R}) = \nabla (\nabla \cdot \mathbf{R}) - \mathbf{R} (\nabla \cdot \nabla) = -\nabla^2 \mathbf{R} \quad (4)$$

Consequently, Eq. (3) becomes

$$4 \pi \mathbf{i} = \nabla^2 \mathbf{R} \quad (5)$$

which is identical with Eq. (30) in the paper,  $\nabla^2$  being the Laplacian operator. If, in Eq. (2),  $H$  were expressed in

rational units, the factor  $4 \pi$  would be entirely absent from the equations, thus still further simplifying the result.

In a two-dimensional field, according to Eq. (1), if the component of  $\mathbf{H}$  in a certain direction is zero,  $\mathbf{R}$  must be constant in the perpendicular direction. This follows directly from the definition of the curl as a line integral. Consequently, the equation of a line of force is  $\mathbf{R} = \text{const.}$

At a point in the two-dimensional field, consider the direction  $n$  in which  $R$  varies most rapidly. We then have from Eq. (1), for the absolute value of  $H$ :

$$H = \partial R / \partial n \quad (6)$$

so that

$$d R = H d n \quad (7)$$

This result indicates that an increment of  $R$  is equal to the flux between two lines of force to which the two values of  $R$  refer; Eq. (33) in the paper.

**R. W. Wieseman:** Perhaps the most interesting, as well as the most important, application of graphical flux plotting at the present time is the calculation of the quadrature synchronous reactance of a salient-pole machine. As a matter of fact, the value of the quadrature synchronous reactance can be pre-determined only by a field plot. This quadrature synchronous reactance is one of the several coefficients which appear in the paper *Synchronous Machines*. Part II, 1926, by Messrs. Doherty and Nickle.

In a polyphase machine, the armature currents produce a sine wave of flux which travels in synchronism with the poles. When the armature m. m. f. axis coincides with the pole axis (for example, at zero power factor), the flux which the armature currents tend to produce is much more than the armature flux when the armature m. m. f. axis is in quadrature with the pole. Thus, the direct synchronous reactance is more than quadrature synchronous reactance.

Let the normal fundamental flux per pole =  $\phi$  and let the normal armature currents produce a flux  $\phi_q$  in the quadrature axis.

Let the fundamental of this armature flux =  $\phi_{q1}$

Let  $X_{lq}$  equal the armature leakage reactance (expressed as a decimal fraction) in the quadrature axis.

Then the quadrature synchronous reactance  $X_q = \frac{\phi_{q1}}{\phi} + X_{lq}$ .

The values of  $\phi_{q1}$ , as well as many other coefficients, are given in this paper.

With reference to the Laffoon and Calvert discussion: I note that they also prefer the graphical method of obtaining the flux distribution and the flux distribution coefficients for design calculations.

Mr. Douglas stated that the templet method is very speedy, and that the labor involved with templets is somewhat less than in the case of using the graphical method. There are a few simple cases of magnetic-flux distribution where the templet method can be used to advantage, especially in illustrating flux fringing to students. When, however, the flux distribution is to be obtained in the many different magnetic parts of dynamo machinery, I prefer the graphical method, and I have found that the results obtained by this method are quite accurate.

Mr. Douglas requested information as to whether Figs. 2 and 3 checked his work. In Mr. Douglas' 1915 paper, the ratio of the slot width to the tooth width is very much larger than is used in Fig. 2 of my paper. Consequently, no check can be made. Fig. 6 in the article by Messrs. Douglas and Kane, in 1924, practically checks my Fig. 3.

Mr. Douglas stated that the flux pulsations can be avoided with armatures having any number of teeth, if the pole gives a perfect sine wave of flux on the equivalent armature circuit.

Salient-pole machines practically never have perfect sine flux waves and, therefore, this method of eliminating flux pulsations cannot be used.

2. *Potential Gradient and Flux Density*, by J. F. H. Douglas and E. W. Kane, *TRANS. A. I. E. E.*, 1924, p. 982.

3. *The Reluctance of Some Irregular Magnetic Fields*, by J. F. H. Douglas, *TRANS. A. I. E. E.*, 1915, p. 1067.

**A. R. Stevenson:** Messrs. Laffoon and Calvert are right in saying that the graphical method is the most convenient one for use in the everyday designing of electrical machinery, but the mathematical method is of importance in the preparation of the 20 or 30 typical flux plots which Mr. Calvert mentioned as being of great assistance in sketching similar fields. Although these typical flux plots can be determined to any degree of accuracy by the graphical method, in some cases it takes a great deal of experimental sketching before the general outline of the distribution can be determined; whereas, in such cases, the mathematical method will sometimes give a more accurate answer with less work, in less time.

The best articles on graphical plotting are contained in the long series of articles by Lehmann, mentioned in the bibliography of our paper. He carried the graphical method of plotting much farther than we did, including in the problem the saturation in the iron. If anyone desires to study the graphical method further, he could not do better than to refer to Lehmann's work.

Mr. Calvert, in his discussion, has submitted six pictures of flux distributions sketched by the graphical method. The two showing the flux distribution in a square bar in a square slot did not look quite right to us. They are sufficiently accurate for all practical purposes; but we do not agree with the location of the kernels, and Mr. Woodward has submitting a discussion in which he shows the flux distribution in these same square bars in square slots, as determined by the mathematical method described in our paper.

Professor Douglas' discussion is of special interest because of the articles he has already published on this subject, especially with regard to the templet method of determining flux distribution and also because of his remarks about the use of the theory of functions of a complex variable in connection with these problems. The valuable work of Dr. Carter in this connection is well known, and is especially interesting because of the recent publication of another paper in which he applies the method to many new distributions which had not been attempted before.<sup>4</sup> The application of the Schwarz and Christoffel transformation is very difficult when it is necessary to integrate around more than four angles, and the suggestion by Professor Douglas of a graphical method of integration should be of great assistance in the application of the theory of functions of a complex variable to these problems.

The authors are very grateful to Dr. Lehmann for emphasizing that their sketches of magnetic lines of force are of actual practical value, in spite of the fact that saturation was neglected. The article by E. B. Christoffel, which he mentions, we think will be a valuable addition to the bibliography, although his discussion came in so late that we have not had a chance yet to look it up. The use of conformal representation for the solution of Poisson's equation has been done by St. Venat in the solution of the torsion of rods; see, for example, Love's "Theory of Elasticity." Herr M. Strutt, in the *Archiv fur Elektrotechnik*, April 7, 1927, has applied this method to the approximate solution of the case of a current-carrying rectangular iron conductor of constant (high) permeability.

**Mr. E. E. Johnson:** While the iron-filing method gives excellent indications of the form of the magnetic field, the field plots so determined must not be interpreted too strictly as regards field intensities. When making the iron-filing distributions, the filings, which are preferably of cast iron, are first distributed on some suitable plain surface, such as white paper. The m. m. fs. are then applied and the whole structure is gently tapped to allow the filings to take their proper conformations.

In the process of tapping, the iron filings in the near vicinity of highly magnetized iron surfaces have a tendency to skip along the paper and gather in clusters on those surfaces. Also, even in uniform magnetic fields of high intensity the filings cluster

together in strings. This clustering leaves free open spaces, from which it might be inferred, on superficial examination, that the flux density is low at these points.

Mr. Green and I are very grateful for the comments of Mr. Laffoon and Mr. Calvert. The experimental method which we have used for determining the field distribution inside of current-carrying regions is not always convenient although there may be cases where it might with profit, be employed. The method was used in the particular case of the alternator field poles as a check upon the work which Mr. Stevenson and Mr. Park did in their paper.

## TESTS ON OIL CIRCUIT BREAKERS

(SPORN AND ST. CLAIR)

NEW YORK, N. Y., FEBRUARY 10, 1927

**J. D. Hilliard:** The management of the American Gas and Electric Company, and other companies allied in making the tests, showed real courage in permitting repeated and severe short circuits to be thrown on the system,—short circuits of greater magnitude than any to which high-voltage system had hitherto been intentionally subjected,—and they deserve the thanks of the electrical profession. The operating and construction departments also deserve credit for their efforts in carrying out the testing program in an efficient and expeditious manner.

In consenting to the publication of the full details without reserve of the Canton tests made by Messrs. Sporn and St. Clair, the General Electric Company has taken the stand that it believes that the engineers of the power companies of the country should be fully informed regarding circuit-breaker operation. The General Electric Company's engineers realize the value of field tests as supplementing the tests made in its testing laboratory; they realize that the only test which absolutely determines the interrupting capacity of an oil circuit breaker is the test made repeatedly at the full rated capacity, both in current and voltage, and they realize also that the only thing proved by such a test is the interrupting capacity of the breaker upon that particular system and under the particular conditions existing at the time the test was made; that if the test had been made upon another system at the same voltage and current interrupted, results might have been entirely different. The latter remark is not "theorizing," but is based upon years of experience in circuit-breaker testing and is a fact.

In their paper, the authors have drawn certain conclusions which seemed logical to them; they have assumed that because to them, a breaker performed satisfactorily, at part rated current or part rated voltage, it would perform satisfactorily at its full rating. Such a conclusion is illogical and is, in a large number of cases, contrary to the facts. A breaker may interrupt more than its rated kv-a. at a voltage below its maximum rating, and be blown to pieces at a small part of its kv-a. rating at its maximum voltage rating. Many tests have proved the truth of this latter statement and have repeatedly proved it at the first shot of the higher voltage. The explanation is simple. The excessive current at the lower voltage produces a strong electromagnetic blowout effect which instantly ruptures the circuit, while at the higher voltage and much smaller current, the blowout effect is weak, the arc hangs, producing a continuous generation of gas which almost instantly blows off the tank. It is my belief that in reporting tests upon oil circuit breakers, all authors should stick to observed facts in the tests, that speculation is almost sure to mislead and may do a great deal of harm by giving confidence in apparatus which is in fact not the reliable piece it is assumed to be. The immediately proceeding remarks are general and not intended to apply to any particular breaker or make of breaker. It is a statement based on conclusions drawn from observing many tests.

It is not thought necessary to make extended explanations on the happenings in the case of the K-136-B breaker, except to say that the causes of the trouble are known, the remedy has been

4. "The Magnetic Field of the Dynamo-Electric Machine," *The Institution of Electrical Engineers*, Vol. 64, No. 359, November, 1926.

applied to our full satisfaction and the tests have proved that the explosion-chamber breaker is all we ever claimed it to be.

The tests upon General Electric Company's breakers confirmed the empirical formula upon which the interrupting-capacity rating is based, they confirmed our observations as to the burning of the arcing contacts in our own testing laboratory and it was this latter experience which influenced us to consent to the making of the full number of shots, (26 and 30 respectively), without an examination of contacts until the end of the tests. The tests confirmed also our laboratory tests for oil throw, as not a drop of oil was thrown from any tank during any shot on the K-39-B breaker and the final test on the K-136-B breaker. In short, except for the very slight burning of the arcing contacts, there was nothing to indicate that the breakers had undergone a test.

Evidently, through an oversight, a misstatement of fact appears in the test of the Reyrolle breaker. I refer to the statement "For some unknown reason the short circuit lasted only 2½ cycles, etc." As a matter of fact the reason was known at the time of testing and is previously explained as being due to the latch on the breaker not holding. The same thing had happened at previous shots. I believe it is due to the General Electric Company, whose generator and testing organization was used to make the tests that this statement of fact be made.

Since the data are given for the Brown Boveri and General Electric K-39-B and K-136-B breakers, it is possible to make in a way a comparison between them and since Prof. Dycke recorded the Brown Boveri tests, we shall take his records on the K-39-B and K-136-B breakers.

laboratory on a breaker of similar design. I believe it should be stated that the observations and conclusions in reference to the General Electric Company breakers as stated in the paper are those of the authors, and do not necessarily express the opinions of the General Electric engineers.

Electrical engineers should understand that in testing oil circuit breakers they are dealing with very erratic phenomena and because of this fact should be slow in drawing conclusions from any series of tests or generally applying such conclusions.

The information gained by means of its present testing generator has been so valuable to the General Electric Company that it is building, and will have in operation in early summer, the largest testing generator in existence; a generator that will have a sustained short-circuit capacity for circuit-breaker interrupting tests of over 500,000 kv-a., three-phase, with provision for the addition of units of equal or larger capacity as they may be required. The new laboratory will be equipped to test breakers of all voltages and currents and to observe and record phenomena taking place during interruption.

The interruption of a given number of volt-amperes by the breaker—for example 100,000 kv-a.—does not necessarily impose the same stresses as result from the interruption of the same kv-a. at other times at the same point on the system, at other points on the system or on different systems. In other words, volt-amperes are not equally "hot" at all times and places, due to a number of causes. It seems probable that this difference in the difficulty of interruption depends largely upon the magnitude of the voltage "kick" at the end of each half wave of arc, and upon the speed at which each half wave of this transient voltage is built up. The need for making many tests on a device and making them under the most severe operating conditions is clearly indicated.

To give a concrete illustration of what may be expected, I shall cite one particular test in which the length of arc drawn in the same breaker operating with the same kind of oil, at the same speed, on the same system—but a different part thereof,—at the same voltage and current interrupted, consistently gave an arc nearly three times as long in one case as obtained in the other. In one case, the breaker was safe; in the other, it was severely stressed and if the break distance had not been large, it would have been blown up.

The Canton tests were very valuable in determining interrupting constants on that particular system and upon the existing conditions, but the "duty" was light as measured by other tests under other conditions. Certainly there are few, if any, other places in the world where so much power is available at 132,000 volts. In concluding my discussion, however, I wish to emphasize again the importance of conservation in drawing conclusions from one set of tests on a given breaker. Until experience is gained under conditions giving a vicious recovery voltage "kick," one is very likely to label a breaker safe which, as a matter of fact, is far from being so.

**J. B. MacNeill:** Looking over the data on the several makes of breakers given for the 132,000-volt tests, the thing that strikes one is that the duration of arcing time is comparable for all designs. For instance, with the 150-kv. Brown Boveri breaker, the average test voltage, (so-called, in the paper),—that is, the system voltage prior to the short circuit,—for all the tests is 134,700 volts; the average duration of arcing in the breaker is 14½ half-cycles or 7¼ cycles on a 60-cycle circuit. In other words, the breaker handled approximately 18,600 volts per cycle of arcing.

Now, turning to the final set of tests on the General Electric K-136-B breaker, (135-kv.), the average test voltage of 139,000 volts was somewhat higher, the average time of arcing was 16½ half-cycles on 60 cycles, or, the breaker handled 16,800 volts per cycle of arcing.

On the KO 39-B, rated at 132,000 volts, the average test voltage was 132,000 volts and the average time of arcing 13.3

	Brown Boveri	General Electric	
		K-39-B	K-136-B
Rating of breaker.....	1,500,000 kv-a. at 150,000-volt	1,250,000 kv-a. at 132,000-volt	750,000 kv-a. at 132,000-volt
Break in series.....	10	2-explosion chamber	2-explosion chamber
Total number of shots made.....	26	26	30
Maximum load interrupted.....	70,000 kv-a. (est)	826,000 kv-a.	617,000 kv-a.
Percentage of rated interrupting capacity interrupted.....	46.6	65.8	81
Ratio max. line voltage before shot, to rated voltage (per cent)...	89.5	100	104.5
Half cycles of arc at 2800 to 2900 amperes	13 min. to 17 max.		
Half cycles of arc at 3380 to 3610 amperes		11 min. to 15 max.	
Half cycles of arc at 2280 to 2600 amperes			12.5 min. to 17 max.
Oil throw.....	some	none	none
Contacts inspected and dressed during tests...	yes	no	no
New oil used during tests	yes	no	no
Signs of burning of any part of breaker other than arcing contacts.	yes	no	no

While no statement is made as to the speed of operation or arc lengths in the Brown Boveri breaker, it is believed from the arc duration that each of the ten arcs was not substantially shorter than each of the two arcs in the General Electric K-39-B breaker and in any event each of the two arcs of the General Electric K-39-B breaker had a shorter arc duration than each of the ten arcs of the Brown Boveri breaker. No conclusions are drawn from the above facts. I shall state, however, that the above observations agree with test results obtained in our testing

half-cycles. This breaker handled voltage at the average rate of 20,000 volts per cycle of arcing.

So we have those three values for comparison; 18,600 volts per cycle, 16,800 volts per cycle, and 20,000 volts per cycle. They are all of the same order of magnitude. What are the relative dissipations of energy in the two types of breaker? Personally, until I saw the paper, I had expected to see considerably less duration of arcing on the 10-break breaker. While the data on volts handled per cycle are not conclusive regarding the operation of the breaker; in fact, the breaker with 10 breaks made a very successful test, but, looking forward to higher powers, the question naturally arises whether the dissipation of energy on 10 breaks isn't considerably greater than on 2 breaks. The indication from these tests is that 2 breaks will handle voltage about as fast as 10 breaks. Possibly these comparisons don't represent the ultimate development to which the two types may lead, but that is the conclusion that I draw from the data submitted here.

The length of the arcs in the breakers may vary and the dissipation of energy may not be five times in one case what it is in the other. The length of arc, I believe, was given for the General Electric tests but not for the Brown Boveri tests.

Another thing to which I invite attention is this: These tests are quite interesting from the point of view of the type of short circuit placed on the system. Some of the short circuits were grounded and some were made with the short circuit ungrounded. Most data that have been accumulated on previous tests on other voltages has indicated that ungrounded short circuits hang on longer. You get instantaneous conditions in the breaker when one pole has come to a zero of current whereby that pole may be subjected to as high as 87 per cent of line voltage. If the short circuit and the source of power are grounded, that particular pole that is open first cannot be subjected regularly to more than 58 per cent of line voltage. Consequently, we have been led to expect longer durations of arcing, with short circuits ungrounded than with short circuits grounded. This is the first series of tests of any magnitude that I have seen in which the indications seem to be that an ungrounded short circuit is no more severe than a grounded short circuit.

Referring to Table V, we see that certain of the tests. (56 to 65), were made with the system ungrounded, and that they were made with different kv-a's ranging from 460,000 to 625,000 arc kv-a. The average duration of arcing on these tests is 16.7 cycles. Referring, now, to similar tests made on grounded short circuits, tests (52 to 55), the duration of arc is 15.4 on the same voltages, 134,000 kv-a.

The conclusion I should draw from this would be that at this voltage there is not much difference between a grounded and an ungrounded short circuit. This is of particular interest to the operating people at this time because of the discussions that have arisen as to the application of breakers on grounded-neutral systems. Several of the large systems have installed great quantities of apparatus for 220-kv. service, using 187-kv. apparatus. So far they have gotten away with it but there has been a great deal of discussion as to whether they were justified in buying under-rated apparatus. This is the first actual test information brought forward that indicates practically no difference between the two types of short circuit. If this data can be substantiated by further data, it would seem that the operator's practise of using undervoltage apparatus would be pretty well justified and that special apparatus was hardly necessary.

**G. A. Burnham:** It is possible to draw an entirely erroneous conclusion from witnessing the moving picture of an oil circuit breaker test.

The film of the 6600-volt test on one of our competitor's breakers showed a breaker tested to destruction. In making a judgment on this breaker's ability, one should bear in mind that this picture showed the oil circuit breaker undergoing a test at a value far above its rating.

With reference to Mr. Hilliard's comments on testing, we feel very much as he does. Apparently their vast experience in testing has led them to the conclusion that the variables in circuit-breaker operation are so great that a test on a particular circuit breaker at one place perhaps does not lead to a general conclusion as to how well that breaker may operate under other conditions. From this, we are led to believe that when comparison tests are to be made, (particularly on oil circuit breakers in which so much difficulty is encountered in arriving at analytical results), the test should be made in the same place; as near at the same time as possible; with the same system setup; and, if possible, the tests be run under what might be called a "master supervisor." It is obvious that exactly the same instruments should be used to record the results.

In making comparison between the Brown Boveri breaker and the General Electric Co.'s breaker in the 132,000-volt class, it is perhaps, as Mr. Hilliard has said, impossible to draw a conclusion without giving the most careful analytical study. The Brown Boveri breaker I believe handled all energy that could be imposed upon it at the time by the American Gas & Electric Co.'s system. It may have had slightly less duty, according to records, than the General Electric Co.'s breaker; nevertheless, we do not know how much more the Brown Boveri breaker would have handled had it been given the opportunity to display its ability. It apparently operated without sign of distress, and no doubt would have handled considerably more energy. Both Mr. MacNeill and Mr. Hilliard have referred to the fact that the duration of arcing was about the same in both breakers. Both gentlemen have therefore concluded that the arc length per arc in the Brown Boveri breaker was as great as the arc length per arc in the General Electric Co.'s breaker. From these statements, it would be a logical deduction to assume that the Brown Boveri breaker would have five times the total length of arc and for that reason would probably generate greater destructive forces. Such a conclusion would be incorrect as it rests upon the false premise that the speed of the moving elements was the same. The fact is that the moving element of the Brown Boveri breaker is slower and calculation shows that the total sum or actual arc length for the Brown Boveri 10 breaks is almost exactly equal to the total sum or actual arc length in the General Electric Co.'s 2 breaks. Furthermore, were Mr. Hilliard's assumptions correct, it is evident that the 10-break breaker would have to be built enormously stronger than the 2-break breaker. Analysis of facts will show that this older design of Brown Boveri breaker, successful as it was, was not of so heavy construction as the General Electric Co.'s breaker.

We believe this special test confirms the very satisfactory actual service results which have been had for some years in the United States with these multiple-break oil circuit breakers. It is our opinion that the multiple-break principle gives a more efficient handling of the arc resulting in less gas evolution, and less evolution results in lower pressures or destructive effects.

**Philip Sporn:** Mr. Hilliard stated in his discussion that a breaker performing satisfactorily at a low value of current may not perform satisfactorily at the maximum rating. There could be, of course, no argument on this point. What we should like to point out is that the engineer who tests his breaker and finds that it is satisfactory even at half rating is on safer ground than the one who makes no test at all.

Mr. Hilliard further stated that it is dangerous to speculate regarding the ability of a breaker to perform on the higher voltage from results obtained on a lower voltage. With this, again, we are in agreement. On the other hand, if a breaker is going to be used at other than its rated voltage, it should be tested at that voltage as that is the only way of finding out whether it can actually perform satisfactorily under those conditions.

Another statement made by Mr. Hilliard was that the test showed that the explosion chamber is all that it was claimed

to be. Here, again, we agree. The explosion-chamber assembly is now all that it was claimed to be.

In connection with the table in which were shown comparisons between Brown Boveri and General Electric Company breakers, statement was made that the Brown Boveri breaker had the oil in it changed whereas the General Electric Company had no change. We should like to point out that this change in the case of the Brown Boveri breaker was made on one pole only, no changes whatever having been made on the other two poles. There was also a statement made to the effect that some burning occurred on the Brown Boveri breaker. Here, again, we should like to point out in fairness to the Brown Boveri Company that the burning in question was a slight amount of charring on a barrier that was made up in the field, out of micaite bought in a local shop. No trouble of any kind was experienced on any of the material that originally was supplied with the breaker.

Mr. MacNeill has raised the question as to whether, in view of the time of arcing being practically the same in the case of the General Electric as in the Brown Boveri breaker, this would not indicate that the relative rate of dissipation of energy was five times as great in the General Electric breaker as in the Brown Boveri breaker. We do not see that the tests have shown this. The fact of the matter is that the Brown Boveri breaker was physically lighter than the General Electric breaker. The above carefully considered may not lead to Mr. MacNeill's conclusions.

Another point brought out by Mr. MacNeill was the fact that previous to our tests it had been generally believed that ungrounded short circuits lasted considerably longer than grounded short circuits, whereas apparently in our tests this was not the case. It seems to us that there were not enough data obtained on this point to warrant any conclusions, nor do we see that this throws any conclusive light on the application of what we term 147-kv. breakers on 220,000-volt systems. For one thing, in a good many cases the breakers that were actually applied had clearances and length of stroke equivalent to 220,000-volt service, but bushings for 147,000-volt service. Such a piece of apparatus is, of course, underrated, but it certainly is not a straight 147-kv. piece of apparatus and the data which we have presented do not, we believe, throw very much light on the advisability or inadvisability of such practice.

Mr. Burnham has brought up a fact in regard to the Reynolds breaker and motion pictures of the tests which were shown. It will be recalled that considerable fire and smoke ensued when the breaker exploded. We believe it was definitely pointed out in Table II that in the test where the breaker exploded, contacts of the breaker actually opened a short circuit of 122,000-kv-a. or a short circuit 63 per cent in excess of its guaranteed rating. The resulting pressure was enough to wreck the breaker tank. It would appear that little else could be expected under such conditions.

One more point in connection with the Canton tests we should like to bring out further and that is that, in all, we placed something like 50 short circuits on the system without apparently in order to test the system to seek short circuits definitely, at the same time it is well to know that the system is so designed and assembled that it can withstand these trials when it may be called upon to withstand them without danger of everything breaking loose. So long as short circuits may occur on a power system it is essential that the system be so built that it can stand up under them and can come out of the short circuit unharmed except for the particular minor portion that can be affected by it. It seems to us that such a knowledge is bound to help the morale of an operating organization, that the less these things are feared the more likely it is that they will be handled properly when they do occur.

## ADDITIONAL LOSSES OF SYNCHRONOUS MACHINES<sup>1</sup>

(LAFFOON AND CALVERT)

NEW YORK, N. Y., FEBRUARY 8, 1927

**J. H. Summers:** Referring to Fig. 3, in which data are given for a 600-volt winding, one bar per slot, the load loss at 100 per cent kv-a. is slightly more than 20 per cent of the full-load loss. Referring to Fig. 4, in which data are given for a 2100-volt winding, 2-coil sides per slot, the load loss at 100 per cent kv-a. is approximately 3 per cent of the full-load loss.

**W. F. Dawson:** I wish to comment on the method of measuring losses by the calorimetric method. I published an article on this subject in the *General Electric Review*, February 1920. Messrs. Laffoon and Calvert have laid particular stress on the stack method. It is one means of measuring the volume of air discharge, but if one refers to the paper published by Barclay and Smith, (*Journal I. E. S. London*, Vol. 37, April 1919), he will find that they also experimented with the stack method and found that the distribution of air velocity across the section was very uneven, varying from 1050 ft. per minute to 1480 ft. per minute. It was necessary to insert several trays of expanded metal as baffles before even approximate distribution was secured. They selected the anemometer for measuring the velocity.

My experiments were commenced over eight years ago. We divided the discharge area into 100 or more rectangular sections and measured the velocity of each section with a manometer or hook gage. These results (see Fig. 3 *G. E. Review*, article) were very discouraging, as the readings varied from 0.05 in. of water to a maximum of 0.154 in., corresponding to velocities of 15 ft. per second and 26.3 ft. per second. We found also that all sorts of whirls and distortions occurred in the discharge pipes, even to an occasional indication of negative flow. These were corrected by placing a large wooden cross near the inlet end of the pipe, having an axial length of about twice the pipe diameter.

Another great difficulty was in averaging the temperatures of the inlet and outlet air. The temperatures of the inlet air were often influenced by the presence of adjacent steam pipes and turbine parts, and at times the variation of temperature across the inlet was greater than the difference between the average inlet and outlet temperatures. Special electrical resistance thermometers were used to average the temperatures of inlet and outlet air, the resistance wires being wound on wooden crossarms, so distributed and spaced as to give a true average of the air temperature. An improvement over the method of attempting to measure at the ordinary generator outlet was to place thereon a long straight pipe of suitable section, on the end of which was a specially shaped, calibrated orifice, similar to that described by Mr. Laffoon. This reduced the area of the outlet sufficiently to bring the discharge velocity up to about 4000 or 5000 ft. per min., corresponding to an air pressure of from 1 to 1.5 in. of water. Properly arranged, these orifices give, by a single reading, observed at the center, the actual accurate air velocity to within 1 per cent.

By using electric resistance thermometers giving true average temperatures, and by inserting electric heaters, and a third resistance thermometer beyond the electric heater, very satisfactory results were obtained, but the hook-gage readings were found unsatisfactory. When this method is used, it is not necessary to make allowance for the varying barometric pressure of the air. It is particularly adaptable to turbine alternators, usually there are two inlets and one discharge and the air stream is con-

I should like to ask the authors whether or not, in their opinion, this discrepancy can be materially attributed to either the eddy-current loss in the armature windings or the pole-face loss, or both?

<sup>1</sup> I. A. I. E. R. JOURNAL, June 1927, p. 575.

fined and guided in such a way that all the air that goes into the machine can be measured.

I show in the accompanying Fig. 1, a generator frame having two inlets and one discharge. The original suggestion for this arrangement is due to Mr. H. M. Hobart.

- $T_1$  = Average temperature (deg. cent.) of inlet air  
 $T_2$  = Average temperature (deg. cent.) of outlet air  
 $H$  = Watts energy supplied to electric heater  
 $T_3$  = Average temperature (deg. cent.) of air after leaving heater

$$\text{Watts Loss} = H \frac{T_2 - T_1}{T_3 - T_2}$$

$$\text{Cu. ft. air per min.}^* = \frac{\text{Watts loss}}{0.585 (T_2 - T_1)} = \frac{H}{0.585 (T_3 - T_2)}$$

**Caution.** From three to four hours are usually necessary for all parts to attain steady temperature. Only about 30 min. are necessary to produce steady temperatures in the electric heater. If readings are recorded three or four times per hour, it will be observed that  $T_2$  increases rapidly when current is applied to the heater. This is due to radiant energy and demands certain precautions and corrections. The heater should be placed 4 to 5 ft. from  $T_2$  and exactly midway between  $T_2$  and  $T_3$ . In writing the expression  $T_2 - T_1$  use the last reading before heater is

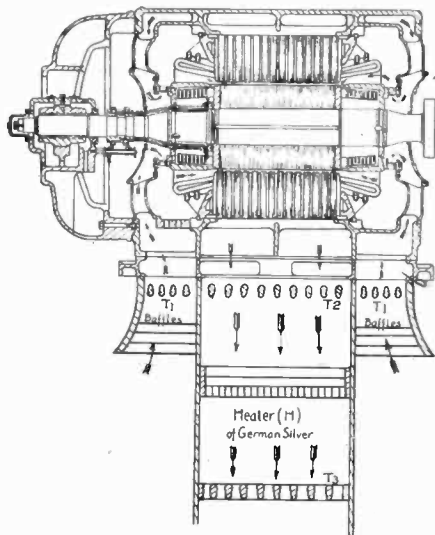

FIG. 1

energized. In writing  $T_3 - T_2$  use the last reading with heater applied. Measurable convection losses should be allowed for.

If the loss of the machine be calculated by these equations, we are rid of all such disputes as correct barometric pressure, specific heat and effect of moisture. My experience with two-pole machines of note more than 6000-kw. rating is that the radiation or convection losses amount to probably 3 or 4 per cent of the total losses, which for machines of 1500 to 2000-kw. rating, never exceeds 5 per cent of the rating of the machine, nor 4 per cent for machines of 5000-kw. rating.

Mr. Laffoon's paper has made a comparison between the losses, particularly the additional losses observed when a machine is being operated on short circuit and those observed when it is being operated over-excited at zero power factor. It seems, after all, that while that comparison is interesting, it doesn't tell us what we want to know. What the manufacturer wishes to know and what his customers wish to know is what is the ratio of the load losses measured on short circuit to those measured while the

machine is operating at normal voltage and power factor in accordance with its rating? The few data that I have gathered indicate that at times at least the losses under normal operating conditions are less than they are on short circuit. I have not, however, confirmed that sufficiently to lay it down as a rule.

**E. E. Johnson:** Refer to Fig. 20 of the paper by Messrs. Laffoon and Calvert. The distribution of the end-bolt leakage flux is three-dimensional, and I raise the question as to whether a field plot made on the basis of a two-dimensional distribution, as was done in Fig. 20, holds strictly. It may be that the results obtained from this field plot made on the basis of a two-dimensional distribution are sufficiently accurate for the particular case in question, although, in general, this is not necessarily true. It will be noted that all the areas in the plot of Fig. 20 are curvilinear squares; whereas, on the outer boundaries, they should perhaps not be so, considering that the actual flux distribution there is three-dimensional.

**P. L. Alger:** The two conclusions that I draw from the paper are: (1) That the method of measuring the total losses by means of the rise of air through the machine is not yet developed to the point where it can be called convenient; and (2) that the extra losses due to the armature leakage flux are not large in machines of the type described. This latter conclusion is not general, as it is evident that very markedly different losses will be obtained with different types of end construction. For example, if a chain-type armature winding had been used, the end losses would have been very much greater.

The most interesting thing about the paper to me is the temperature-rise method used by the authors to determine the separate losses in different parts of the machine. It seems to be quite feasible to determine the initial rate of temperature rise of each part separately, and, from this and the known heat capacity of that part, to determine the segregated losses. We have made some experiments along this line, and have found one of the principal difficulties to be the variation in the rate of heat generation in different parts of the same element of the machine. For instance, the losses in the clamping fingers are localized near the end, and the rate of rise of the tip of the finger is, therefore, much greater than that of the back. It requires considerable care to decide on what is the average rate of rise of each part from a relatively small number of temperature readings.

I should like to ask the authors whether they consider that the average rate of temperature rise of one tooth in the end packet of laminations, for example, can be determined with reasonable accuracy by using only two thermocouples.

**E. H. Freiburghouse:** The authors of the paper have favored the stack method for determining the stray-load losses of the generator. It has also been our practise at Schenectady to use that method in measuring the stray-load losses of large turbo-generators.

I should like to ask the authors whether they have ever applied a baffle-type mixer in the discharge air to get uniformity of temperatures?

I am somewhat surprised to notice the comparison for generators 2 and 3, as to stray-load losses. Generator No. 2 (see Table I) had stator end plates of magnetic material, whereas in generator No. 3, which I assume is the same generator or one of the same rating at least, they used a non-magnetic ring for clamping the core. By Table II and by the curves in Figs. 4 and 5, I find that the load loss is even higher for the machine which had the non-magnetic end ring. This is somewhat of a surprise to me. We have made many experiments on model generators of the turbine type, in which we applied different materials for the end rings, even using wood to determine what the limit would be in the elimination of the loss. Based on our investigation I believe that the load loss ought to be less in the case of the generator which has the non-magnetic end ring.

Mr. Alger referred to the influence of the rings on the rotor. We have found by the application of non-magnetic end rings

\*Standard air at 29.92 in. Hg., 15.5 deg. cent. (60 deg. Fahr.)





velocities for at least three sections in the air stream, or (2) a very complicated system for obtaining the mean temperatures of the intake and discharge sections of the heat sources (both the machine and the volume meter); while the use of the stack with the calorimeter test requires uniform air velocities at one less section in the air stream than does the heater or calorimeter-type volume meter. On the basis of results from a large number of tests, it is our conclusion that uniform velocities at several sections in the air stream are inherent requirements in calorimeter tests of this sort, and that the stack rather than increasing the difficulty, simplifies it. Reference to Fig. 2 herewith will show that sufficiently uniform velocities were established over the outlet of the stack. The maximum variation in velocity pressure head from the average value is 12 per cent; hence the maximum variation in velocity from the mean value is approximately 6 per cent, (neglecting the one low point in the corner).

In the tests described in the paper, care was taken to avoid the convection of heat to the inlet air from transformers, steam pipes, leads, and other sources, so that practically uniform intake air temperatures were maintained. The possible errors due to the existing variations in temperatures and velocities in the intakes were checked on generator No. 5, and found to be a small fraction of one per cent.

The measurements of barometric pressures is a comparatively simple matter, and introduces no serious difficulty in the use of the stack volume meter. Since the variations in the specific heat of air with changes in temperature, pressure, and moisture content are known, corrections can be made if desired; but it did not appear that this difference was of sufficient importance to consider.

The fact that the calorimeter tests and electrical input readings were in agreement for a number of "no-load" 100 per cent power-factor tests at different voltages, is a satisfactory confirmation of both the volume-meter and air-rise measurements, because both these latter two readings could not be in error by just the right amount in each case, and because the electrical readings of input at 100 per cent power factor can be taken as quite reliable.

In reply to the discussion by Mr. E. E. Johnson: The determination of the end-bell flux field on the basis of a two-dimensional distribution as shown in Fig. 20 of the paper, does not hold strictly, but to consider it as a three-dimensional field, tremendously complicates the already difficult problem of field mapping. Fig. 20 checked the filing photograph very closely in the parts of the field where the flux density is greatest, but deviated somewhat where the density was small. Since the density decreased very rapidly toward the outer edge of the end winding, the errors introduced in either loss or reactance calculations on the basis of the two-dimensional field must be small with this type of winding and end bell.

In reply to the discussion by Mr. P. L. Alger: While the additional losses are not a large percentage of the total losses in many machines, yet in large machines they represent a direct loss to the customer and a limitation to the manufacturer of very considerable importance. Unfortunately, sufficient data were not obtained to tell how many temperature detectors would be necessary to determine the losses from time-temperature curves for the various parts of the machine. It appears, however, that flux mapping can be used to indicate the best location for these detectors, and the safest method would be to locate a rather large number on various radial lines throughout the machine. Then, if it could be shown during the first tests that some couples need not be read, they could be abandoned for later readings.

In reply to discussion by Mr. E. H. Freiburghouse: Before the air discharge stack was built, a model stack was tested under conditions which were intended to give distributions of both temperature and pressure with wider variations than those which would be found at the outlet from the machine. In the tests with models, two types of baffles, as well as a screen, were used in the air stream just preceding the entrance to the stack. The

baffles, or air mixers, did not give sufficient improvement to warrant their application. The screen gave considerable improvement in extreme cases, but was not used, because of the undesirable loss of head, and consequent change in air volume from that existing under normal operating conditions. Had the tests on the actual machine shown the desirability of better distributions, undoubtedly, it would have been necessary to introduce a screen, and perhaps some form of baffle in the air stream at the entrance to the stack.

The tests on generators Nos. 2 and 3 were made to determine the effect of stator end-plate material on the magnitude of the additional losses. The same machine was used in both cases; magnetic plates were used on No. 2 and non-magnetic plates were used on generator No. 3. The total values of the additional losses of these two generators were very small and it appears evident from the end-plate temperatures that only a very small portion of the additional losses actually occurred in the end plates. Hence, it is impossible to draw any definite conclusions from the tests on these two machines in regard to the influence of magnetic and non-magnetic stator end plates on the additional losses of the machines.

### CONSTANT-CURRENT REGULATING TRANSFORMER CHARACTERISTICS<sup>1</sup>

(LOUIS AND ALBAUGH)

NEW YORK, N. Y., FEBRUARY 8, 1927

**E. D. Treanor:** The authors' criticism of the conventional method of stating the characteristics of constant-current transformers is possibly justified in that this method was indefinite and allowed the possibility of misinterpretation by the purchaser and of neglect by the manufacturer. The assumption that the losses remain essentially constant at all loads was of course known to be not strictly accurate, but the method was of long standing and thought to be satisfactory for transformers which were usually operated near full load or on taps which approximate full-load conditions. It was a convenient assumption because it simplified and reduced the costs of tests and gave accurate results at the point of usual loading.

It seems to me that the most important point in the paper is the viewpoint that there is sufficient use of such transformers at quite low loads to justify more attention to light-load losses, as it is suggested that better characteristics may even justify increased cost if they cannot be obtained without it. On this basis the suggestions for improvement made by the authors and other possible methods should of course be studied to determine whether they are feasible economically on transformers which are now in somewhat limited use. It would seem quite difficult to prove that it is economical to operate constant-current transformer at half load or less even at the assumption that the losses remain constant.

Where the general data of the company with which I am affiliated have been made on the so-called theoretical basis, this has been very plainly stated, but in order to avoid any possibility of confusion such data will in the future be placed on the basis of input-output measurements and it will be shown where the data is based on normal windings and where on taps.

One other point is suggested as a possible danger from increasing light-load losses, that is, high temperature in coils or core structure. These transformers have not as yet been specifically covered by standardization rules of the Institute. Temperature limits, of course, should be considered with reference to the particular apparatus involved and the location of the heated portions with respect to insulation. Until such rules are laid down, the best guides would seem to be general information on other apparatus and experience on particular transformers. The maximum temperature reported at extremely low loads, while

1. A. I. E. E. JOURNAL, May, 1927, p. 421.

undesirably high, should not be injurious to the transformers which have been carefully designed to keep organic material from exposure to points of maximum temperature on metallic parts. The temperatures shown are not generally representative of modern designs.

There should be no difficulty in covering desired characteristics in losses and temperature by specifications so definite that no confusion can arise. However, when operating conditions compel the use of constant-current transformers at so much less than their normal load that the taps provided will not give reasonable characteristics, it would seem that the economical thing would be to provide transformers of a proper rating even if the larger transformer has the same losses at all loads.

**J. B. Gibbs:** It is well known that constant-current regulating transformers depend for their operation on the leakage flux between coils. This knowledge has enabled us to design and build regulators which operate satisfactorily and even to predict with good accuracy the reluctance of the average path which the magnetic leakage flux must follow. It has remained, however, for the authors of this paper to make a detailed study of the path of the leakage flux and of its effect on the regulator operation.

The ampere-turns in the winding of a constant-current regulator, or of any other transformer for that matter, cause a difference in magnetic potential between different parts of the iron circuit. This in turn causes a leakage flux to pass from one part to the other through the air space between the coils. The amount of this leakage flux depends upon the ampere-turns which produce it and on the length and area of the average path which it must traverse. If a constant-current regulator is to go to short circuit without an increase in secondary current, the designer must make the total leakage flux when the coils are at their position of maximum separation as great as the total flux induced in the regulator. The leakage leaves from the central core of the regulator in every direction, and quite a large part of it leaves in a direction perpendicular to the plane of the laminations. This part, of course, must pass directly through the outer laminations and it sets up considerable losses. The losses naturally depend upon the amount of iron affected, that is, upon the distance between the primary and secondary coil, and they are greater, as the authors have pointed out, under no-load condition. Under certain conditions, the temperature of the iron may be relatively high, especially under the no-load condition. The highest temperatures are usually confined to small parts of the iron, though, and it should be pointed out that the coils of this type of transformer are not wound on the iron, they are wound on a heavy insulating tube, and this is further separated from the iron by an air space. I never have heard of a case of damage to the coils on account of the temperature of the iron. In fact, all our tests seem to indicate that although the iron at certain points may become hot, the wire nearest to that iron is relatively cool. As to the coils themselves, the temperature test on such regulators is usually made with the secondary coil short-circuited and full voltage applied to the primary, which is the worst condition, as this paper shows. So that if the temperature test shows the coils at a safe temperature, you may be reasonably sure that the operating condition will show them at a still lower temperature. The authors' remarks about temperature as applied to commercial constant-current regulators seem to me rather unduly alarming.

The most desirable operating condition, as every one recognizes, is with full load on the regulator. This results in the highest efficiency and the highest power factor. The present paper shows also that it results in the lowest temperature. All these three factors operate in the same direction. Sometimes the condition of the circuits demands that the regulator be operated at less than full load. If this is done, efficiency and power factor are sacrificed to a certain extent and the temperature is increased above what it might be, but it is not increased to a point where

a good commercial regulator will be endangered either in operation or in life.

**W. B. Kouwenhoven:** As Messrs. Louis and Albaugh show, the losses are mainly caused by the leakage flux. This leakage flux will naturally produce a high temperature in the iron, but it is a surprise to me that the temperature of the secondary winding should be as high as shown by the authors. I should like to know how the temperature of this winding was measured. Owing to the small current in the secondary, the size of the conductor is relatively small and I should expect that the eddy currents set up in this conductor by the leakage flux would be small.

**A. F. Hamdi:** During the summer of 1925 we were testing some constant-current transformers and it had been our habit to use the overall method for getting efficiency. We did not use the accepted A. I. E. E. method, which means calculating the efficiency from the losses. The A. I. E. E. rules apply specifically to constant-potential transformers and were not suited for this purpose; and the paper and also the previous speakers have pointed out why those rules do not cover constant-current transformers. We hope that in the future revision of the standards, this thing will be taken care of.

In our tests the errors in efficiency were not quite as much as

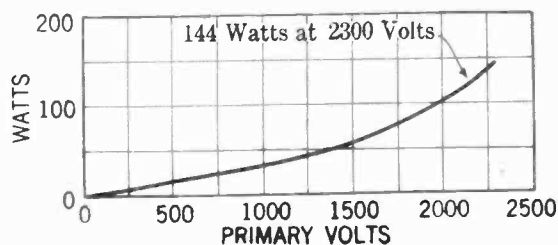

FIG. 1

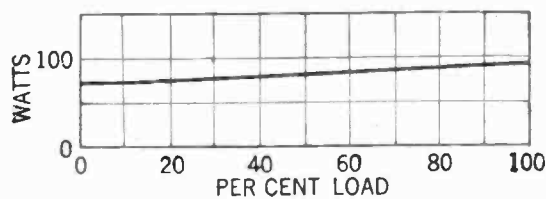

FIG. 2

pointed out by the authors, namely, in Fig. 1 of the paper we find about a 10 per cent difference at 25 per cent load. In our tests we found discrepancies of about  $1\frac{1}{2}$  to 5 per cent in various transformers. The transformers we tested were oil-cooled, 10-kv-a. modern transformers.

I should like to ask the actual magnitude of the stray-load losses. In our case we found that the total losses varied by less than 20 per cent, whereas the stray-load losses themselves varied by over 100 per cent; in other words, they were about 100 watts at full load and went up to about 225 watts at light load.

I should like to discuss an empirical method which we have used for efficiency calculations, which apparently gives very good results. On a test of six transformers, we have been able to come within better than 1 per cent of the overall method.

One thing, of course, to be kept in mind is that the entire core of the constant-current transformer is not excited to the same flux density.

In the new method we have assumed, arbitrarily, that one-half of the core is excited to a flux density corresponding to the primary voltage, while the other half is excited to a flux density corresponding to the secondary voltage. The total core loss at any load can therefore be obtained from the accompanying Fig. 1, which represents core losses at various voltages with open circuited secondary. Fig. 2 represents the total core losses obtained from Fig. 1, following the above assumption.

Taking for instance the case of full load, the core loss is 95 watts, made up of 72 watts (half the core loss occurring at primary voltage—2300 volts) and 23 watts (half the core loss occurring at full load secondary voltage—1335 volts). Similarly at no load, the core loss is taken to be only 72 watts, as there is practically no voltage across the short-circuited secondary.

The next thing to calculate is the stray-load loss. This can be obtained from the short-circuited impedance test made with the two extreme positions of the coils: first with the coils locked close together and second with the coils away from each other as far as possible, corresponding to the full-load and the no-load positions respectively.

From the two values of losses so measured we obtain the stray-load losses by subtracting the d-c.  $I^2 R$  losses involved and also

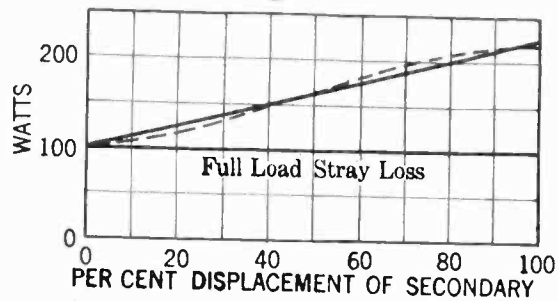

FIG. 3

the core losses which are obtained from Fig. 1. This last step is essential because contrary to the case of constant-potential transformers considerable voltage is necessary to perform a short-circuit test on constant-current transformers.

The two values of stray-load losses so obtained are plotted in Fig. 3. The straight line joining them gives the stray-load losses at various loads, if we assume that the coil displacement is a straight-line function of the load. This assumption is really fair, because the stray-load losses actually vary as the curve in dotted line superimposed on the straight line in Fig. 3.

The total losses of the transformer can therefore be obtained by adding to the d-c.  $I^2 R$  losses (constant for all loads) the core losses as obtained from Fig. 2 and the stray-load losses as obtained from Fig. 3.

The efficiency is then calculated in the usual manner.

**H. C. Louis and A. Albaugh:** The question of loading constant-current transformers is a very serious one, especially when circuits are growing. In this case, it is necessary to provide certain spare capacity in the transformers. This capacity, of course, will vary with the assumed ultimate size of the circuit. So that to prepare for the final condition, transformers of apparently excessive size are often used.

Another reason is that when station-type transformers are used, it is highly advantageous to have them all of the same size thereby providing the greatest standardization and flexibility. Some of the circuits for these transformers will, therefore, be more heavily loaded than others.

Regardless of the loading of these transformers, it is important that their characteristics be thoroughly understood by operators and designers and the main object of this paper is to present the most important of these characteristics.

Mr. Treanor mentioned that the temperatures shown in the curves are not generally representative of modern designs. The temperatures shown are fairly representative of the latest design station-type air-cooled constant-current transformers. However, oil-cooled transformers have lower temperature due to the presence of the cooling oil.

The advantage of taps on constant-current transformers is questionable. Some of our tests show that although operating on a lower capacity tap, the transformers do not have a higher efficiency than when operating at the same load on the full-

capacity tap. At light loads on the low-capacity tap, losses were found to be actually higher than on the full-rating connection. The main advantage of the tap is the slightly higher power factor obtained.

Mr. Gibbs mentions that temperature tests are usually made with the secondary coils short-circuited and full primary voltage applied. Under these conditions, the temperature rise will be a maximum, but considerable care must be taken in these tests to locate the hottest parts, especially in oil-cooled transformers. The hot-spot temperatures of these transformers may be sufficiently high to cause sludging and for this reason, should be located.

Dr. Kouwenhoven's question about the temperature rise in the coils, is an interesting one. Undoubtedly, the great amount of leakage flux causes eddy-current losses in the copper conductors which will vary somewhat with the load and thus affect the temperatures. However, the copper temperature variation noted was mainly due to radiation and convection of heat from the iron core. The temperature of the coils on the transformers tested were measured by means of thermometers and thermocouples applied directly to the coils. Temperatures by rise of resistance measurements were taken but as these gave only the average temperatures and not the maximum temperatures, they were not used in the paper.

In reference to the losses, we have made some attempts to segregate them but the results were not very satisfactory. The stray-load losses at full load on 50-kw. air-cooled station-type transformers amount to approximately 400 watts out of a total loss of about 1800 watts, while at short circuit, the stray-load losses amount to 2400 watts out of a total of 3500 watts. Of course, we are not certain of these values and do not put much dependence in them. They were worked up only in order that we might reach some conclusion for the apparent increase in losses of the transformer with decreased load.

## Discussion at Kansas City Meeting

### ELECTRIC WELDING OF PIPES<sup>1</sup>

(LINCOLN)

KANSAS CITY, MO., MARCH 18, 1927

**H. R. Park:** I should like to supplement Mr. Lincoln's paper by outlining the field for electric arc welded pipe in the petroleum industry with special regard to oil and gas transmission lines and mention some of the factors which must be considered when arc-welded pipe is used for this duty.

Mr. Lincoln's paper discusses arc-welded pipe in competition with riveted and lock-bar pipe. The pipe manufactured by these processes is usually 20 in. in diameter and larger, while the majority of pipe used by the petroleum industry for cross-country lines varies from 6 in. up to 20 in. Inasmuch as the pipe in the smaller sizes is not handled in the same way as the larger sizes in the field, the problems involved in its use will be somewhat different. There are several factors which must be considered in laying an oil or gas transmission line. These factors are pipe delivery, tightness, strength, difficulties met in laying the line and in repairing leaks and cost.

Usually speed is a big factor in laying an oil or gas transmission line and it follows that early deliveries of pipe are very necessary. At the present time there are comparatively few manufacturing concerns which are in a position to manufacture arc-welded pipe and deliveries of any large quantity are somewhat uncertain. As the use of arc-welded pipe becomes more general, however, more plants will be equipped to manufacture it and this difficulty will be overcome.

1. A. I. E. E. JOURNAL, June 1927, p. 593.

It is very important that an oil or gas transmission line have as low a leakage rate as is possible. It is surprising how much gas can leak through a small hole; for instance, a vessel having a shell thickness of 1.4 in. maintained at a pressure of 100 lb., will leak through a 1/16-in. diameter hole about 3,000,000 cu. ft. of gas per year. It is evident from this that pin holes in the longitudinal seam of arc-welded pipe can cause an enormous leakage in 50 or 100 mi. of line. We now have gas pipe lines in service with acetylene-welded joints; that is, ordinary mill pipe with acetylene-welded girth seams which show a loss of 50,000 cu. ft. per year per mile of 3-in. line. If arc-welded pipe is to compete with mill pipe laid with acetylene-welded girth joints, the leakage rate must be as good as that with the acetylene joints.

It is not the practise to use expansion joints in oil or gas lines but to take care of the expansion and contraction by laying the line in the ditch in loops which give considerable slack. It is also the practise to make the pipe conform to the topography of the ground traversed which means that the pipe must be bent. These bends are made cold. It is essential in making bends that they be made between the girth welds in order that an emergency sleeve can be placed on the weld in case it develops a leak while in service. Arc-welded pipe is now being made in joints varying from 5 ft. to 14 ft. which are welded into longer sections and shipped to the field and with these short joints it becomes difficult to make the field bends between the welds. This difficulty can be overcome somewhat by devising a different method of rolling the sheets which will permit the manufacture of longer joints. It is my understanding that an organization in the Mid-Continent field, which is contemplating the manufacture of arc-welded pipe, is working on this problem and expects to be able to manufacture arc-welded pipe in 30-ft. joints.

Among the lines laid last year by the Empire Companies was a 22½-mi. section of 16-in. gas line. Mill pipe with a 45-deg. bevel on the ends of the joints for acetylene girth welds in the field, was used. It was decided to weld 7 mi. of this line by the electric arc method as an experiment and in order to check the work done in the field we cut approximately 100 welds from the line and had them tested. The electric welds showed approximately 5000 lb. higher in tensile strength than the acetylene welds and also showed better elongation and ductility. In direct contrast to this, we found a great many broken welds made by the electric arc method while none of the acetylene welds failed. After testing the line carefully and removing all of the defective welds, the line was put into operation and has given very satisfactory service. From our own experience and the experience of others who have electric arc-welded pipe lines, we have decided that an electric-arc butt-welded girth joint made in the field is not entirely satisfactory for an oil and gas transmission line. Although satisfactory welds can be made as indicated by the fact that the section of line welded by the electric arc method is now operating satisfactorily, it is also evident from the fact that we found so many broken welds when the line was tested that the possibility of getting poor welds is too great and the number of replacements is excessive. From all the information which we are able to gather, it appears that a satisfactory arc-welded girth joint can be made if a slip joint is used. The slip joint may be made by having alternate joints of such size that they will slip one within the other or they can be made by belling one end of each joint of pipe. While either of these joints is the same insofar as the welding operation itself is concerned, it appears that the bell joint has the advantage in that it is easier to put an emergency sleeve on this joint than on the straight slip joint. Either of these joints will present some difficulties in assembling the line in the field for welding in that it will be more or less difficult to slip one joint within the other after the pipe has been handled roughly and the ends have been battered or dented even slightly; however, I believe that these difficulties can be overcome and this type of joint can be used satisfactorily.

Mr. Lincoln's paper mentions using a lighter weight pipe in larger sizes and with reduced pressures. This is satisfactory

within certain limits; however, when a light weight pipe is made in diameters of 18 in. or over, it becomes very difficult to bend the pipe in the field.

In regard to the cost of arc-welded pipe, we had occasion to estimate a line of considerable length made from mill pipe and also from arc-welded pipe and we anticipated the arc-welded pipe to be cheaper by approximately 45 per cent. I have talked to several men in California who have had some experience in the manufacture and laying of lines fabricated by the electric arc method and they have found the arc-welded pipe to be approximately 30 per cent cheaper than mill pipe.

There is no doubt that arc-welded pipe has a great field in the petroleum industry. It is making considerable headway in California and has recently drawn considerable attention in the Mid-Continent. I have mentioned some of the difficulties which will be met when arc-welded pipe is used for oil and gas transmission lines, and no doubt additional difficulties will be met when more lines are put into service. I believe, however, that with the proper amount of thought and study the difficulties can be overcome and the use of arc-welded pipe for oil and gas transmission lines will become widespread.

**W. L. Warner:** Welding of pipe lines has been practised extensively for a number of years in the petroleum and gas fields of this country. Welding for this work has consisted of joining the ends of pipe sections in the field where the diameter of the pipe did not generally exceed 18 in. The pipe sections joined have been of the seamless or roll-welded type from 20 to 40 ft. in length.

The welding of penstocks and hydraulic pipe lines is a recent development as riveting has been exclusively used for this work in the past. About a year ago a 22-mi. hydraulic pipe line was completed by the Western Pipe and Steel Company for the city of Vallejo, California. This pipe was 22 and 24 in. in diameter and was fabricated from flat plate in the shop in 20-ft. lengths two of which were joined together to make a 40-ft. length. The field joints were made by a butt weld using the electric arc. The longitudinal joints were automatically arc-welded in the shop and gas-engine-driven welding sets were used for welding the field joints. The plate thickness was 3/16 and ¼ in.

The pipe line discussed by Mr. Lincoln is probably the largest built so far on which arc welding has been used for making the side seams and Mr. Lincoln certainly deserves credit for his promotion of the welding art in this field of application. There is indeed nothing impossible in the application of welding to steel work of this kind provided the necessary machinery for handling the pipe efficiently is available. With present practises there is evidently a limit to the diameter and length of pipe sections which can be successfully fabricated and safely handled after fabrication. Undoubtedly, however, continued use of the welding process for this work will develop new machinery, new methods and new technique, which will revolutionize the pipe industry. As is indicated in the paper under discussion the specifications for the Mokelumne project were written to cover a certain type of welding machine to the exclusion of any other type. Such a specification does not appear fair to the welding industry.

If specifications are to be prepared for welding work it would be much better if those specifications were prepared to cover the product to be used and the acceptance tests to which that product is to be subjected rather than to discriminate against certain types of apparatus.

It is interesting to note the tests called for in the specifications given. They are evidently quite severe and sufficient for the work in question and although the test stress in the steel is slightly over two-thirds the elastic limit of the material it is evidently high enough to bring out any defects in the welded joint. The test pressure advocated by the American Welding Society for unfired pressure vessels is three times the working pressure which would put a test stress in the steel of 24,000 lb. per sq. in. There is also some opinion that this test stress should be increased to the elastic limit of the steel for final acceptance.

Under "laboratory tests" it is stated that "the test specimens cut from the sample welds shall withstand being bent cold through 90 deg. etc. . . . without serious fracture." It might be considered that serious fracture is a relative term only, at least it is very indefinite. Ordinarily any fracture at all where pressure is concerned is serious and it would appear desirable that more definite explanation of what is meant by serious fracture should be given.

The standard cold-bend test for welds as adopted by the American Welding Society is much more severe than that outlined in the paper under discussion. In the bend test as outlined by Mr. Lincoln ample opportunity is given for the bending of the specimen to take place in the steel plate instead of in the weld. With the American Welding Society test the bending is confined to the weld metal and the steel immediately adjacent to the weld. It is, therefore, more a test of the weld than of the base metal. The writer has made bending tests on automatically metal arc-welded specimens of  $\frac{1}{2}$ -in. plate welded at a speed of 5 in. per minute in the manner outlined in the specifications which we are discussing and these specimens have under those conditions been bent cold through 180 deg. without a crack. In those cases, however, the specimens have bent so that about 75 per cent of the bend occurred in the plate and 25 per cent in the weld itself.

The claim is made "that possibly no other method of manufacturing large pipe now known could pass the specifications for test as outlined in these specifications." This statement seems rather broad in view of present-day welding experience.

For making the field joints the method of expanded lapped joints as suggested will be a successful method for welding on pipes of this size. The butt type of joint on pipes over 24 in. in diameter will undoubtedly cause trouble from expansion and contraction. This bell and spigot method will also assist in lining up the pipe sections.

**J. F. Lincoln:** There is one reason and one reason only for automatic welding of pipe for pipe lines and that is that tight joints and tight pipe can be made cheaper in that way than by any other known process. Experience has already shown that the pipe itself is superior in the larger diameters to that made by lock bar and rivets, which have been the previous methods.

Experience has also shown that the result is equal (as far as tightness is concerned) to the tube-mill pipe. The addition of the welding of the field joints is merely one more step forward in reducing the cost and increasing the efficiency of pipe lines compared to the previous methods using screw joints, couplings or riveted joints. There is no manufacturing difficulty in making pipe of practically any length, diameter, of practically plate thickness and analysis. There is no manufacturing difficulty also in making this more economically than by any other method now in use. The future use of this process will depend on two things:

First: Whether the other pipe-making processes can be perfected so that the economic advantage of welded pipe will disappear.

Second: How long it will take the pipe users to take advantage of its economies.

Mr. Parks' discussion regarding difficulty in the welding of field joints by the butt-welding process is merely one of the growing pains which any new process must go through. I believe that Mr. Parks' company, if it had the same job to do again, could do it without the breaking of a single joint and it would seem to me that the trouble which they had on these 8 mi. would be a very small price to pay for the valuable experience for future work that this line gave them.

The company which Mr. Warner represents undoubtedly can and does manufacture equipment which will do this work with entire success. In fact, I believe that the Vallejo pipe line (which antedated the Mokelumne pipe line by a year or two), was made exclusively with the equipment manufactured by Mr. Warner's company, and undoubtedly Mr. Warner's com-

pany could manufacture equipment which would have successfully accomplished the making of the Mokelumne River line. Exactly the same thing could be said of hand-welded, riveted, lock-bar, and tube-mill pipe.

There was one reason and one reason only for manufacturing this pipe with the process that was used and that was the fact that it was a good deal more economical to do it in that way than in any other known way.

Mr. Warner also discusses rather fully the matter of bending and the tests which were put on this particular pipe. It is rather difficult, however, for me at this time to understand the reason for the bending of welded joints in a pipe line.

For a good many years we have been successfully using lock-bar pipe and riveted pipe with entirely satisfactory results except insofar as economy is concerned, and I am not at the present time advised as to just how a riveted or lock-bar joint can be bent through 180 deg. without sufficient deterioration so that its utility in a pipe line is largely removed. I cannot see therefore, that the bending of the joint or the making of a joint which will bend, assumes such tremendously large proportions. It is perfectly safe, however, to say that the apparatus manufactured by Mr. Warner's company will make a welded joint which will bend through 180 deg. Further, it is just as true that the welds made by any other welding equipment on the market can be so constructed that bends through 180 deg. in the metal itself can be made.

Regarding the matter of tests, Mr. Warner stresses the point that the actual tests used are up to two-thirds of the elastic limit of the plate. As a matter of fact there were a number of the joints which in the specified test went beyond the elastic limit sufficiently so that the joints themselves had to be rejected because of their expansion beyond their normal sizes. I, myself, witnessed one joint in which the diameter was increased over 3 in. because of the metal being stressed beyond the elastic limit at the time of testing.

## CURRENT ANALYSIS IN CIRCUITS CONTAINING A RESISTANCE MODULATOR<sup>1</sup>

(GRANDY)

KANSAS CITY, MO., MARCH 17, 1927

**R. M. Kerchner:** It seems to me that some of Mr. Grandy's statements, while not incorrect, may be a little misleading, while some assumptions are made that exaggerate the poor qualities of the transmitter.

The statement that the current output wave is an inverse function of the exciting wave, while I think it is true, is, however, likely to give a wrong physical conception. Physically, the qualitative results of the exciting wave are similar to those of the output wave, that is, when the exciting wave has a high value the output wave has also a high value and similarly with low values. From his statement we might get the idea that if the output wave is an inverse function of the exciting wave, the output wave is small when the exciting wave is large, and vice versa. Technically, however, Mr. Grandy's statement, I think, is correct.

I disagree, however, with the statement that distortion is due to the fact that the pressure-resistance relation of the carbon-granule transmitter is not linear. It is by assuming that this relation is linear that the results tend to magnify the distortion due the output current being an inverse function of the exciting wave. As a matter of fact, if the pressure-resistance relation were a rectangular hyperbola and there were no resistance outside of that in the transmitter, the output wave would be a true image of the exciting wave, mechanical distortion neglected. This is shown as follows.

Let  $p$  be the pressure on the diaphragm at any time.

1. A. I. E. E. JOURNAL, May, 1927, p. 426.

It  $p_o$  be the pressure about which the pressure variation occurs. According to the assumption  $r p = c$

$$r = \frac{c}{p}$$

Assuming a sinusoidal exciting wave the pressure would be  $p = P_o + p_o \sin \theta$  where  $p_o$  is the modulating pressure. Hence

$$r = \frac{C}{p} = \frac{C}{P_o + p_o \sin \theta}$$

$$I = \frac{E}{r} = \frac{E (P_o + p_o \sin \theta)}{C} = \frac{E P_o}{C} + \frac{E}{C} p_o \sin \theta$$

which shows the output wave to be of the same form as the exciting wave if the pressure-resistance relation is a rectangular hyperbola, hence not linear. That the relation is actually a curve of the same general trend as a rectangular hyperbola, namely, to curve upward, can be seen by a consideration of the limits of the resistance as the pressure is 0 and become infinite.

Actually, however, distortion will also exist with such a relation since the whole curve is shifted upward by an amount depending on the constant resistance in the circuit of the transmitter. Under these conditions it can be shown that the current wave due to a sinusoidal exciting wave would be

$$I = \frac{E (P_o + p_o \sin \theta)}{R_x P_o + R_x p_o \sin \theta + C}$$

which on account of the second term in the denominator will not give a pure sine wave.

From this it can be seen that the ideal condition would be to have the pressure-resistance relation of the transmitter follow the law of a rectangular hyperbola, with no resistance in the exterior circuit instead of a linear relation as Mr. Grandy implies. This, I believe, explains in part the fact that the distortion actually realized is not as great as might be suspected from simply an

analysis of the expression  $\frac{E}{R_x + R_o + r \cos \theta}$  given in Mr.

Grandy's paper.

The conclusion that might be inferred from this discussion is that a transmitter that varies the e. m. f. in the circuit would lend itself more readily to production of distortionless output waves. This suggests that the magneto transmitter operates on a principle that underlies distortionless reproduction of diaphragm vibrations.

**S. Grandy:** Commenting on Mr. Kerchner's discussion; the original statement, that the current wave in the output circuit is an inverse function of the exciting wave, is misleading if not wrong. It was intended to state that the current wave is an inverse function of the modulating resistance.

A linear pressure-resistance relation was assumed to be ideal because any other relation would mean the introduction of harmonics into the variations of the modulating resistance so that resistance change would not be a copy of the exciting wave. Mr. Kerchner has shown that if a rectangular hyperbolic pressure-resistance relation could be realized, an instrument, in an hypothetical case, could be made to produce an output current wave that would be a true image of the exciting wave and that such a pressure-resistance law would permit the building of instruments that would presumably materially reduce distortion.

It is thought probable that for every combination of circuit and modulator constants there exists a law of pressure-resistance change that would produce distortionless reproduction of the exciting cause or at least, permit a reproduction with a minimum distortion. Upon the linear assumption a diminution factor was defined as that factor which gives the relative magnitude of each succeeding harmonic relative to the preceding. Dis-

ortionless reproduction would be attained if the diminution factor was made zero. Referring to Fig. 4, such a situation would be approached if  $R$ , the resistance of the output circuit, was made very large in proportion to the modulating resistance  $r$ . This is the condition under which the carbon radio microphone operates as its output is impressed upon a vacuum-tube circuit of very high impedance. Thus the linear pressure-resistance relation becomes the perfect relation for that particular combination of modulator and circuit constants. As the carbon microphone gives very excellent results from the quality standpoint and as such results depend upon a linear relation it is thought that the pressure-resistance law for carbon must not depart very far from the linear form. It is true as Mr. Kerchner points out that at limiting conditions the law for carbon must depart from the linear form, but for pressures actually used, limiting conditions are not likely to be encountered. The pressures involved are of a very low order of magnitude. The writer has had other evidence that, while not at all conclusive, was strongly suggestive of the linear relation for carbon.

A magneto type, or a condenser type of modulator is very desirable from the quality standpoint. As pointed out in the first paragraph of the paper, such an instrument modulates current supplied to it by voltage changes in the circuit making the modulated product a direct function of the modulating change. However, it is impossible to get enough energy from the exciting cause into such an instrument to produce modulated currents of a magnitude that can be used in most applications. On the other hand the carbon instrument acts as a modulator and a very large amplifier at the same time.

### CARRIER-CURRENT SELECTOR SUPERVISORY EQUIPMENT<sup>1</sup>

(STEWART AND WHITNEY)

KANSAS CITY, MO., MARCH 17, 1927

**R. J. Wensley:** There are many applications for remote control of power apparatus where the distance is such that control conductors become prohibitively expensive. Such applications are usually in connection with high-voltage systems where inductive interference would be severe should control circuits be constructed along the transmission right-of-way. The Alabama Power Company solved such a problem in a very ingenious manner. They have an extensive 110-kv., "H"-type wooden-pole transmission system. Their southern loop is to be sectionalized at intervals of about 15 mi. by motor-operated disconnecting switches. As there are several hundred miles of this loop, the construction of separate control circuits would have been very expensive.

The standard practise of the Alabama Power Company is to install two ground wires on the tops of the two poles of the "H" frame. These wires serve as static guards and as return circuits for the ground relays. In addition, these wires are now used for the supervisory control of the section switches.

To enable their use, insulators were installed and all direct ground connections were removed. Transformers were installed at each section switch with center taps on the primary windings, these taps being grounded. The control is effected by impulses of 500-cycle and 650-cycle energy.

The control equipment is an adaptation of the Westinghouse audible system. Motor-generator sets provide the two frequencies. The impulses are originated by an ordinary automatic telephone dial.

Selection is obtained by dialing impulses of one frequency. Answering signals are received by audible signals originated by a buzzer at the distant point which checks both the station called and the device selected. Operation is obtained by application of the second frequency by means of the control key on the dispatcher's cabinet.

1. A. I. E. E. JOURNAL, JUNE 1927, p. 588.

The impulses of the two frequencies are received on tuned relays. These relays are tuned to resonance by condensers in series with their coils and will not operate unless the frequency is within about 50 cycles of the point of resonance. The selective equipment is operated by a local 12-volt battery. This same battery is used for the motor of the disconnecting switch.

The batteries are to be charged at certain central locations and distributed by trucks at regular intervals. An experimental installation for trickle charging from the drainage current in the ground connection of the transformer primary is now being tried. This involves a special transformer and a Rectox rectifier. If successful, this method will eliminate the handling of batteries. The receiving equipment illustrated is located in a substation, but at most of the locations there is no station and the equipment is housed in an outdoor steel switchhouse converted for the purpose.

All control connections to the ground wires are made through transformers. Spark-gaps on both primary and secondary guard against actual crosses between the ground wires and the 110-kv. lines. A series relay short circuits the transformer primary when the current exceeds its safe rating.

## ILLUMINATION ITEMS

By Committee on Production and Application of Light

### THE ROXY THEATER\*

To describe in a few words the complete electrical equipment of the Roxy Theater in New York, of which an important part lies in the lighting, borders on the impossible. The master showman—Roxy—uses electricity everywhere to make his house a real "Cathedral of the motion picture."

Four street services, two a-c. and two d-c., supply the electrical energy. Twenty-three meters are connected to record an anticipated load of 2500 kw. Two reasons make this large number of meters necessary: (1) different rates apply for lighting, signs, general power and refrigerating power, and (2) the difficulty of testing d-c. meters of over 800-ampere capacity. The d-c. service is three-wire, 240-120-volt; the a-c., 208-volt, four-wire, three-phase with 120 volts between each main and neutral. There are no ties within the building to connect the services, with the single exception of the projector booth which is connected to both d-c. services.

The stage switchboard of over 200 control units, under the direction of the conductor, controls the general lighting, the stage lighting and the organ and orchestra lift. Another switchboard, under the manager's direction, controls the exterior lighting and the interior lighting not within the sphere of influence of the stage.

The lighting equipment shows to what an extent lighting may be used to beautify a building. As one approaches the theater, the high-intensity marquee lighting, the street lighting units which have concealed floodlights directed on the building, and the advertising signs make an irresistible attraction. In the ticket lobby and in the grand foyer the lighting intensity is gradually reduced, preparing the visitor for the dark interior of the main auditorium. The type and location

of lighting equipment carry out the general Spanish architectural motive of the theater. In the foyer and the surrounding stairways the visitor encounters the last pendant fixtures, the whole auditorium being illuminated by cove lighting, with a few floodlights to get the maximum beauty from the gold decorations and to break up dark corners produced by the cove lighting.

The stage lighting equipment is of the latest type. Practically the whole load of 780 kw. is on dimmers. Ordinary resistance dimmers, which, on account of space limitations, are not regularly used to control more than 2000 watts, are used to some extent, but the majority of stage lights are controlled by a new type of reactance dimmers, each capable of handling 15,000 watts. The enormous saving of space is apparent.

All the stage circuits are remote controlled, using direct current to energize the control coils. The contactors, reactors and resistances are situated in the basement directly below the control board. Some idea of the number of circuits may be gained from the statement that the a-c. fuse panel has 600 circuits and the d-c. panel, 200. The stage control board is of the pre-set type; two absolutely independent set-ups may be made, and, for some ordinary lighting effects, three set-ups.

One of the biggest pieces of electrical equipment is the air conditioning apparatus. The apparatus consists of washers, dehumidifiers, and refrigerators which change and condition the air in the building every three minutes. The refrigerators use a total of 600 h. p., the spray pumps, 60 h. p. and the ventilating fans, 50 h. p.

Both the orchestra and the organ console platform can be raised at will by the conductor, from a pit 12 ft. below the auditorium floor level by means of electrically operated elevating screws.

Many other motors are in use for other services such as the organ, the curtain, elevators, stage props and the like. The total connected power load is 1600 h. p., distributed over 60 motors.

## LIGHTING RESEARCH PROBLEMS

The Illuminating Engineering Society Committee on Research has published a list of fifty lighting research problems suitable for investigation by Engineers or Engineering students and seventeen problems for Scientists or Science students. The list appears in the *Transactions* of the I. E. S., February 1927, pp. 190-194.<sup>1</sup> The Committee points out that work has been done on all the subjects listed. In many cases the work is satisfactory so far as it goes, but the problems are so ramified and far reaching that valuable contributions may still be made.

This list should be of great value to those who are called upon to advise students with regard to suitable these subjects.

1. Complete information may be secured from the *Transactions* referred to above, or from the Illuminating Engineering Society, 29 West 39th Street, New York City.

\*The committee is indebted to Harry Alexander, Inc., New York, for data included in this article.



# JOURNAL OF THE American Institute of Electrical Engineers

**PUBLISHED MONTHLY BY THE A. I. E. E.**  
33 West 39th Street, New York  
Under the Direction of the Publication Committee

C. C. CHESNEY, *President*  
GEORGE A. HAMILTON, *National Treasurer*      F. L. HUTCHINSON, *National Secretary*

#### PUBLICATION COMMITTEE

L. F. MOREHOUSE, *Chairman*  
F. L. HUTCHINSON, *Member*      E. B. MEYER, *Member*  
DONALD McNICOL, *Member*      I. E. MOULTROP, *Member*

GEORGE R. METCALFE, *Editor*

Subscription: \$10.00 per year to United States, Mexico, Cuba, Porto Rico, Hawaii and the Phillipines; \$10.50 to Canada and \$11.00 to all other countries. Single copies \$1.00. Volumes begin with the January issue.

Changes of advertising copy should reach this office by the 15th day of the month for the issue of the following month.

*The Institute is not responsible for the statements and opinions given in the papers and discussions published herein. These are the views of individuals to whom they are credited and are not binding on the membership as a whole.*

## Excellent Technical and Entertainment Programs for Summer Convention

An extensive and varied technical program and very enjoyable recreational features will contribute to make the coming Summer Convention one of the most successful of the Institute's history. This convention will be held in Detroit, Michigan, with headquarters at the Book-Cadillac Hotel, June 20-24.

Power stations, transmission-line operation, cable joints, relays, control circuits, television, communication, arcs, corona, dielectrics, rectifiers, electrical units and electric traction will be among the subjects covered in the technical papers. A complete schedule of events is given in the accompanying program.

Electric traction engineers will be specially interested in the papers on catenary construction which will be presented Friday morning, June 24.

"The Nature of the Electric Arc" will be the subject of an address given on Tuesday evening by Professor Karl T. Compton of Princeton University, who is president of the American Physical Society.

#### TELEVISION SYMPOSIUM AND DEMONSTRATION

A specially interesting event will be the symposium on *Television* led by Dr. Herbert E. Ives of the Bell Telephone Laboratories, Inc. Dr. Ives was instrumental in developing the equipment for the recent test by which Secretary Hoover, while speaking in Washington, was seen and heard by an audience in New York City. This event is scheduled for Thursday morning, June 23.

Following the symposium, there will be operating demonstrations of television equipment arranged at convenient hours.

#### CONFERENCE OF SECTION AND BRANCH DELEGATES

Conferences of Section delegates and Branch Counselors will be held on the first day of the meeting, Monday, June 20. This entire day will be devoted to discussions of affairs of interest to the Institute Sections and Branches. All members interested are welcome to attend.

#### INSPECTION TRIPS

Detroit is unusually well supplied with points of engineering and industrial interest as well as recreational opportunities. Its industry includes power generation, manufacturing and shipping. It is the world's largest automobile-manufacturing center. One of the most modern electrically operated railroads belonging to the Ford Motor Company, centers there. The Detroit Edison Company's plants and system are among the greatest in the country.

Trips will be made to power plants, substations, automobile plants, steel mills, brass foundries, airplane factories and other interesting places.

#### PRESIDENT'S RECEPTION AND DANCE

On Tuesday evening will come the reception of the President of the Institute and this will be followed by dancing in a ballroom of the Book-Cadillac hotel.

#### CONVENTION DINNER

On Wednesday evening, June 22, will be held the convention dinner at which a number of interesting addresses will be made. Alex Dow, President of the Detroit Edison Company, will preside as Chairman of this meeting and C. F. Hirschfeld, Chief of Research, the Detroit Edison Company, will be toastmaster. Addresses will be made by W. B. Stout, President of the Stout Metal Airplane Division of the Ford Motor Company, on some phase of commercial aviation; by C. M. Newcomb on "The Psychology of Laughter" and by an official of an automobile company on the automobile industry.

#### ENTERTAINMENT AND SPORTS

Golf and tennis tournaments will be played in competition for the Mershon cups offered for these two sports. There will be opportunities also for other sports such as boating and bathing.

A moonlight boat ride with dancing and vaudeville entertainment will be taken on Thursday evening on the steamer Tashmoo which will run up the Detroit River and into Lake Ste. Claire.

One of the world's largest municipal parks, Belle Isle, set with woods in their natural state, equipped with lakes and canals, casinos and boat clubs, is within twenty minutes of convention headquarters. Immediately across the Detroit river and reached by means of electric train through under-the-river tubes or by ferry boat, lies the Dominion of Canada. One of Ontario's points of interest, located but a few miles from Detroit, is Jack Miner's famous bird paradise, where flock wild birds of every sort. Windsor, also, has two of North America's greatest horse-racing tracks, Kenilworth and the Jockey Club.

#### LADIES ENTERTAINMENT

Complete plans have been made for the entertainment of the ladies. On Monday afternoon, June 20, there will be a reception, entertainment and tea for the ladies, at the Women's City Club. On Tuesday, there will be touring of the Grosse Pointe and Belle Isle districts and drives, with lunch at the Detroit Yacht Club, swimming for those who wish it in the club's outdoor lagoons, and tables of bridge.

Wednesday morning will be open for shopping and other tours, and in the afternoon the ladies may accompany the members of the Institute on their railroad ride and inspection of the beautiful Trenton Channel district and the Trenton Channel station of the Detroit Edison Company.

The ladies will visit the Bloomfield Hills Country Club and the famous park-like Booth estates Thursday morning, with luncheon at the Detroit Golf Club and a matinee at the Jessie Bonstelle

playhouse, a most unique theatre. Friday will be open, all day, for touring, picnicking, shopping and the like.

**STEAMER TRIP FOLLOWING CONVENTION**

An event which may be enjoyed by those who attend the convention is the lake steamer trip which may be taken starting on Saturday, June 25, the day after the convention closes. This will be a three-day trip starting from Detroit, June 25, touching at Mackinac Island and at Parry Sound in Georgian Bay, and returning to Detroit, Tuesday, June 28.

All members who are interested in this trip are requested to write to Institute headquarters, New York.

The trip will be made on two of the larger steamers traveling the Great Lakes. From Detroit to Mackinac, a steamer of the Detroit and Cleveland Navigation Company will be used. From Mackinac through Georgian Bay and back to Detroit the trip will be made on a steamer of the Chicago, Duluth and Georgian Bay Transit Company. The following is the schedule of this trip:

Lv. Detroit	Sat.	1:30 p. m.	D. & C.
Ar. Mackinac	Sun.	8:15 a. m.	
Lv. Mackinac	Sun.	4:30 p. m.	C. D. & G. B.
Ar. Parry Sound	Mon.	10:00 a. m.	
Lv. Parry Sound	Mon.	11:30 a. m.	
Ar. Detroit	Tues.	9:30 a. m.	

The cost of this round trip will be \$42.50 or \$45.50, including meals and berth. Two passengers must share each stateroom. The lower rate includes transportation on Deck C of the C. D. and G. B. Steamer, while the higher rate includes transportation on Deck D-E.

Those who desire may continue on a steamer from Detroit to Cleveland or Buffalo; also, it will be possible to go from Detroit through Mackinac to Chicago, omitting the return trip from Mackinac through Georgian Bay to Detroit.

**REGISTER IN ADVANCE**

All who plan to attend the convention are requested to register in advance by means of the registration card which accompanied the announcement sent to members by mail.

Immediately on arriving in Detroit members and guests should visit the registration desk to obtain badges and to register for the dinner, sports and entertainment events in which they will participate.

**HOTEL RESERVATIONS**

Requests for hotel accommodations should be made in advance on the "Information Collector Card" also mailed to members. Requests should be sent to J. W. Bishop, chairman of the hotel subcommittee, at the Detroit Edison Company, 2000 Second Avenue, Detroit, Mich. Hotel preferences, room requirements, etc. should be indicated.

This subcommittee will make the reservations with the hotels and members will be notified of the arrangements made. In case all rooms have been taken at the hotel of prior choice, reservations will be made according to the second choice or third choice. Hotel rates are given in the following table.

**DETROIT HOTELS**

Showing room rates per day without meals

	No. of Rooms	Single		Double	
		Without Bath	With Bath	Without Bath	With Bath
Book-Cadillac Hotel.....	1200	..	\$3.50	..	\$6.00
			4.00		7.00
Barlum Hotel.....	810	..	2.50	..	4.00
Detroit Leland Hotel.....	700	..	3.00	..	4.50
Fort Shelby Hotel.....	393	\$2.50	3.00	\$3.50	4.50
Fort Wayne Hotel.....	300	..	2.50	..	3.50
Hotel Statler.....	1000	..	3.00	..	5.00
Hotel Tuller.....	800	..	2.50	..	5.00
Savoy Hotel.....	750	..	2.50	..	4.00
Webster Hall (Stag).....	766	2.00	3.00	4.00	5.00
Wolverine Hotel.....	500	..	2.50	..	5.00

**SPECIAL RAILROAD RATES**

Special railroad rates under the certificate plan will be available to members and guests who attend the convention. Under this plan each person must get a certificate from his local ticket agent when purchasing a one-way ticket to Detroit. Presentation of this certificate at convention headquarters will entitle the passenger to half-rate fare for the return trip by the same route *providing 250 certificates are presented at the convention.*

Members should advise their local ticket agents of their intention to attend the A. I. E. E. convention and should ask for certificates. Tickets must be purchased not more than a fixed number of days prior to the convention and the return trip must be started from Detroit not later than Wednesday, June 29. Return tickets purchased at reduced rates may not be used on certain limited trains. Details relative to dates and other matters should be obtained from ticket agents.

Immediately on arriving at Detroit certificates should be presented to the endorsing officer at convention headquarters.

**ALL VISITORS SHOULD GET CERTIFICATES**

Everyone should obtain a certificate except those who come from the extreme West who can take advantage of the Summer tourist rates as mentioned in the following paragraph. Failure to get certificate may deprive others coming long distances of considerable saving.

**TOURIST RATES FOR WESTERN MEMBERS**

Summer tourist tickets on a lower basis than regular certificate-plan fares will be in effect from Arizona, British Columbia, California, Idaho, Nevada, Oregon and Washington. These tickets will be on sale from May 22 with a return limit of October 31, 1927.

**COMMITTEES**

A large group of committee members is working very effectively to make this meeting a success. They are headed by the following general committee:

**GENERAL CONVENTION COMMITTEE**

- |                                                  |                              |
|--------------------------------------------------|------------------------------|
| Alex Dow, Chairman, G. B. McCabe, Vice-Chairman, |                              |
| <i>Entertainment:</i>                            | <i>Publicity:</i>            |
| G. H. Roosevelt, Chairman                        | A. MacLachlan, Chairman      |
| L. Braisted, Vice-Chairman                       | Harold Cole, Vice-Chairman   |
| <i>Finance:</i>                                  | <i>Registration:</i>         |
| A. C. Marshall, Chairman                         | F. H. Riddle, Chairman       |
| A. A. Meyer, Vice-Chairman                       | T. N. Lacy, Vice-Chairman    |
| <i>Hotel:</i>                                    | <i>Transportation:</i>       |
| J. W. Bishop, Chairman                           | C. Kittredge, Chairman       |
| F. R. Jennings, Vice-Chairman                    | C. G. Winslow, Vice-Chairman |
| <i>Local Trips:</i>                              | <i>Sections:</i>             |
| E. L. Bailey, Chairman                           | H. B. Smith                  |
| F. L. Snyder, Vice-Chairman                      |                              |
| <i>Meetings and Papers:</i>                      | <i>Student Branches:</i>     |
| E. B. Meyer, Chairman                            | C. E. Magnusson              |
| A. H. Lovell, Vice-Chairman                      |                              |
| <i>Out-of-Detroit Members</i>                    |                              |
| J. H. Foote                                      | B. G. Jamieson G. E. Lewis   |

**PROGRAM FOR SUMMER CONVENTION DETROIT JUNE 20-24\***

**MONDAY, JUNE 20**

- 9:00 a. m. Registration
- 10:00 a. m. and 2:00 p. m. Section and Branch Delegates Conference
- 8:30 p. m. Informal Dancing

**TUESDAY, JUNE 21**

- 9:00 a. m. Registration
- 10:00 a. m. Mayor's Address
- President's Address

\*Copies of the papers on this program may be obtained by requesting them from Institute headquarters.

June 1927

## TECHNICAL SESSION

- 10:30 a. m. *Holtwood Steam Plant, Design and Operation in Coordination with Water Power*, F. A. Allner, Penn. Water and Power Co.  
*Auxiliary Power at Richmond Station*, J. W. Anderson, Philadelphia Electric Co., and A. C. Monteith, Westinghouse Electric & Mfg. Co.  
*Recent Investigations of Transmission-Line Operation*, J. G. Hemstreet, Consumers Power Co.  
*Ground-Relay Protection for Transmission Systems*, B. M. Jones and G. B. Dodds, Duquesne Light Co.  
*Directional Ground-Relay Protection*, J. B. Breisky, Westinghouse Electric & Mfg. Co., G. W. King, Consumers Power Co., and J. R. North, Commonwealth Power Corp.
- 2:00 p. m. Golf and Tennis Tournaments  
 Inspection Trips
- 8:00 p. m. Lecture—"The Physical Nature of the Electric Arc," by Dr. K. T. Compton, Princeton University, President American Physical Society
- 9:30 p. m. President's Reception and Dance

## WEDNESDAY, JUNE 22

- 9:30 a. m. Presentation of Technical Committee Reports in two sessions, A and B

## SESSION A

- Research . . . . . J. B. Whitehead, Chairman  
 Electrophysics . . . . . Vladimir Karapetoff, Chairman
- Education . . . . . P. M. Lincoln, Chairman  
 Standards . . . . . J. F. Meyer, Chairman  
 Instruments and Measurements . . . . . A. E. Knowlton, Chairman  
 Communication . . . . . H. P. Charlesworth, Chairman
- Production and Application of  
 Light . . . . . P. S. Millar, Chairman  
 Electrical Machinery . . . . . H. M. Hobart, Chairman

## SESSION B

- Power Generation . . . . . W. S. Gorsuch, Chairman  
 Power Transmission and Distribution . . . . . Philip Torchio, Chairman  
 Protective Devices . . . . . F. L. Hunt
- Applications to Iron and Steel  
 Production . . . . . A. G. Pierce, Chairman  
 Applications to Mining Work . . . . . W. H. Lesser, Chairman  
 Applications to Marine Work . . . . . G. A. Pierce, Chairman  
 Transportation . . . . . J. V. B. Duer, Chairman  
 Electric Welding . . . . . J. C. Lincoln, Chairman  
 Electrochemistry and Electrometallurgy . . . . . G. W. Vinal, Chairman
- 1:30 p. m. Trip to Trenton Channel Power Station
- 2:00 p. m. Golf and Tennis Tournaments  
 Trips
- 6:45 p. m. Convention Dinner  
 Addresses as follows:  
 W. B. Stout, President of the Stout Metal Airplane Division, Ford Motor Co., will speak on Commercial Aviation  
 C. M. Newcomb,—"The Psychology of Laughter"  
 An official of an automobile company will speak on the automobile industry

## THURSDAY, JUNE 23

- 10:00 a. m. Two Technical Sessions A and B

## SESSION A

- Printing Telegraphs on Non-Loaded Ocean Cables*, Herbert Angel, Western Union Telegraph Co.

- A Non-Rotary Regenerative Telegraph Repeater*, A. F. Connery, Postal Telegraph Co.  
*Electrical Reproduction from Phonograph Records*, E. W. Kellogg, General Electric Co.  
*Symposium on Television*, led by Dr. Herbert E. Ives, Bell Telephone Laboratories, Inc.  
 Operating demonstrations of television equipment will be made following the symposium at convenient hours.

## SESSION B

- (This session will be adjourned in time to allow those who desire to attend the symposium on Television scheduled under Session A.)  
*High-Voltage Multiple-Conductor Joints*, Thomas F. Peterson, Brooklyn Edison Co.  
*Use of High-Frequency Currents for Control*, C. A. Boddie, Westinghouse Electric & Mfg. Co.  
*Electromagnetic Waves Guided by Parallel Wires*, S. A. Levin, National Electric Light Association  
*The International Electrical Units*, E. C. Crittenden, Bureau of Standards
- 2:00 p. m. Golf and Tennis Tournaments  
 Inspection Trips
- 8:30 p. m. Boat Ride and Dance

## FRIDAY, JUNE 24

- 10:00 a. m. Two Technical Sessions A and B

## SESSION A

- An Investigation of Corona Loss*, E. C. Starr and W. L. Lloyd, General Electric Co.  
*Law of Corona and Dielectric Strength*, F. W. Peek, Jr., General Electric Co.  
*Puncture Voltage as a Precision Measurement*, V. Bush and P. H. Moon, Massachusetts Institute of Technology  
*The Electrical Resistivity of Insulating Materials*, H. L. Curtis, Bureau of Standards  
*Electric Strength of Solid and Liquid Dielectrics*, Wm. A. Del Mar, Habirshaw Cable and Wire Corp., W. F. Davidson, Brooklyn Edison Co., R. H. Marvin, Johns Hopkins University  
*Mercury Arc Rectifier Phenomena*, D. C. Prince, General Electric Co.

## SESSION B

- Current Collection from an Overhead Contact System Applied to Railroad Operation*, S. M. Viele, Pennsylvania Railroad  
*Catenary Design for Overhead Contact Systems*, H. F. Brown, New York, New Haven and Hartford Railroad  
*Catenary Construction for Chicago Terminal Electrification of Illinois Central Railroad*, J. S. Thorp, Illinois Central Railroad Co.  
*Collection of Current from Overhead Contact Wires*, R. E. Wade and J. J. Linebaugh, General Electric Co.  
*Railway Inclined-Catenary Standardized Design*, O. M. Jorstad, Westinghouse Electric & Mfg. Co.

## SATURDAY, JUNE 24

- 1:30 p. m. Lake Trip to Mackinac Island and Georgian Bay

### Northeastern District's Fourth Meeting Proves Very Successful

A most successful regional meeting was held in Pittsfield, Mass., May 25-28, under the direction of the Northeastern District of the Institute. This fourth regional meeting of the district has not been surpassed for the quality of its program and

the perfection of its management. Approximately 550 members and guests, including many ladies, were present.

Six technical sessions comprising forty papers were held, including one session devoted to presentation of nine student papers. There was also a delightful chain of less serious events with a reception and dance, inspection and sightseeing trips, a convention dinner with several noted speakers a musical entertainment,—a piano recital and lecture,—card playing, teas and golf.

The meeting closed too late to publish a full account in this issue of the JOURNAL, but fuller details will be given in the July issue.

### Plans for Pacific Coast Convention

IN DEL MONTE, SEPTEMBER 13-16

Already a program of particular interest has been arranged rather definitely for the coming Pacific Coast Convention, which will be held in Del Monte, Cal., September 13-16.

Among the subjects which will be discussed in the technical papers are the following: 220-Kv. system design, stability of 220-kv. lines, oscillograph recording of surges, carrier-current communication on power lines, long-distance communication, trunk lines in metropolitan areas, the sphere-gap voltmeter and protection of oil tanks against lightning.

More complete information on the program will be published in later issue of the JOURNAL.

### Report of Committee of Tellers on Election of Officers

To the President,  
American Institute of Electrical Engineers

DEAR SIR:

This committee has carefully canvassed the ballots cast for officers for the year 1927-1928. The result is as follows:

Total number of ballot envelopes received	4840
Rejected on account of bearing no identifying name on outer envelope, according to Art. VI, Sec. 34, of the Constitution	53
Rejected on account of voter being in arrears for dues for year ending May 1, 1927, as provided in the Constitution and By-laws	118
Rejected on account of ballot not being enclosed in inner envelope, or being improperly marked, or on account of inner envelope or ballot bearing an identifying name according to Art. VI, Sec. 24, of the Constitution	113
Rejected on account of having reached the Secretary's office after May 1, according to Art. VI, Sec. 34, of the Constitution	18
Blank Ballots	39
Leaving as valid ballots	4499

These 4499 valid ballots were counted, and the result is shown as follows:

FOR PRESIDENT

Bancroft Gherardi	4383
Blank	116

FOR VICE-PRESIDENTS

District

No. 2. Middle Eastern	
J. L. Beaver	4367
Blank	132
No. 4. Southern	
C. O. Bickelhaupt	4357
Blank	142

No. 6. North Central	
O. J. Ferguson	4357
Blank	142
No. 8. Pacific	
E. R. Northmore	4363
Blank	136
No. 10. Canada	
A. B. Cooper	4366
Blank	133

FOR MANAGERS

F. C. Hanker	4435
H. P. Liversidge	4438
E. B. Meyer	4432
Blank	192

FOR TREASURER

George A. Hamilton	4411
Blank	88

Respectfully submitted,

ERNEST HOLCOMBE, *Chairman* J. T. WELLS  
 CHARLES D. LINDRIDGE LELAND F. STONE  
 W. E. COOVER CHARLES S. DEMAREST  
*Committee of Tellers.*

Date May 17, 1927.

### Board of Directors' Report for the Year Ending April 30, 1927

The annual report of the Board of Directors of the American Institute of Electrical Engineers was presented at the annual business meeting of the Institute held in New York Friday evening, May 20.

This report consists of a brief summary of the principal activities of the Institute during the year, including abstracts of various reports submitted by officers and committees, covering their respective branches of work. The more important matters referred to in the report have been, or will be, covered in a much more detailed form in the JOURNAL, and therefore the report will not be published in full here; but any member of the Institute may obtain a pamphlet copy upon application to the National Secretary.

The total membership of the Institute on April 30 was 18,344, a net increase of 186.

The activity of the Sections and Branches during the year and the growth in the number of these organizations, also in the number of meetings held by them and in the aggregate attendance, are shown in the following statement:

	For Fiscal Year Ending			
	April 30 1921	April 30 1923	April 30 1925	April 30 1927
SECTIONS				
Number of Sections	42	46	49	52
Number of Section meetings held	303	344	386	431
Total Attendance	37,823	46,672	49,029	60,708
BRANCHES				
Number of Branches	65	68	82	95
Number of Branch meetings held	443	503	548	842
Total Attendance	21,629	26,893	27,603	42,650

The Finance Committee's report, together with the general balance sheet and detailed financial statements of the public accountants who audited the Institute's books, is included in the report.

# Bancroft Gherardi

## President-Elect of the A. I. E. E.

Bancroft Gherardi, vice-president and chief engineer, American Telephone & Telegraph Company, New York City, has been elected President of the American Institute of Electrical Engineers for the year beginning August 1, 1927, as announced in the report of the Committee of Tellers, published elsewhere in this issue.

President-elect Gherardi was born in San Francisco, Calif., April 6, 1873. He was graduated with the degree of B. S. from the Polytechnic Institute of Brooklyn in 1891, and from Cornell University with the degree of M. E. in 1893 and degree of M. M. E. in 1894.

Mr. Gherardi entered the employ of the New York Telephone Company in 1895 and in 1899 was made traffic engineer of that Company. In 1901 he became chief engineer of the New York and New Jersey Telephone Company, serving in that capacity until 1906, when he was made assistant chief engineer of the New York Telephone Company and New York and New Jersey Telephone Company. In 1907 he was appointed equipment engineer of the American Telephone and Telegraph Company, and in 1909 engineer of plant, in which capacity he served until 1918, when he was appointed acting chief engineer and and shortly thereafter, chief engineer. In April 1920, he became vice-president and chief engineer of the American Telephone and Telegraph Company.

Mr. Gherardi's activities with the American Institute of Electrical Engineers are as follows: Associate 1895; Fellow 1912; Manager 1905-8—1914-16; Vice-President 1908-10. He has served upon various committees, including the Edison Medal, Telephony and Telegraphy, Papers, Finance, Membership, Organization of Technical Committees, Constitutional Revision, and Research. He represents the Institute on the U. S. National Committee of the International Electrotechnical Commission and the Board of Trustees of the United Engineering Society. At the present time, Mr. Gherardi is President of the United Engineering Society and a member of the Engineering Foundation Board. He is also a member of the American Society of Mechanical Engineers, New York Electrical Society, and the Franklin Institute. He is a member of the Joint General Committee of the

National Electric Light Association and Bell Telephone System and of its Engineering Subcommittee, and is chairman of the American Committee on Inductive Coordination.

### A. I. E. E. Directors' Meeting

The meeting of the Board of Directors of the Institute called for New York on Friday, May 20, 1927, was adjourned and continued in Pittsfield, Mass., on Thursday morning, May 26, during the Regional Convention of District No. 1.

Those present at one or both sessions were: President C. C. Chesney, Pittsfield, Mass.—Vice-Presidents H. M. Hobart, Schenectady, N. Y.; George L. Knight, Brooklyn, N. Y.—Managers H. C. Don Carlos, Toronto, Ont., E. B. Merriam, Schenectady, N. Y.—National Secretary F. L. Hutchinson, New York City. Present by invitation: Dr. C. H. Sharp, President, U. S. National Committee of the International Electrotechnical Commission; Dr. William McClellan, Chairman, Subcommittee on Reorganization of the U. S. National Committee of the I. E. C.

The minutes of the Directors' meeting of April 8, 1927, were approved.

A report was presented of a meeting of the Board of Examiners held May 16, 1927.

Upon the recommendation of the Board of Examiners, the following actions were taken upon pending applications: 104 Students were ordered enrolled; 201 applicants were admitted to the grade of Associate; 5 applicants were elected to the grade of Member; 22 applicants were transferred to the grade of Member; 7 applicants were transferred to the grade of Fellow.

The Board ratified the approval by the Finance Committee for payment, of monthly bills amounting to \$28,522.40.

Upon application, and as provided in Article IV, Section 22, of the Constitution, the Board voted that the following members be made "Members for Life" by exemption from future annual dues: D. L. Davis (on membership list 38 years) and Alex. B. Simpson (on membership list 36 years).

The Secretary reported 1623 members delinquent in the payment of dues for the fiscal year ending April 30, 1927 (1508

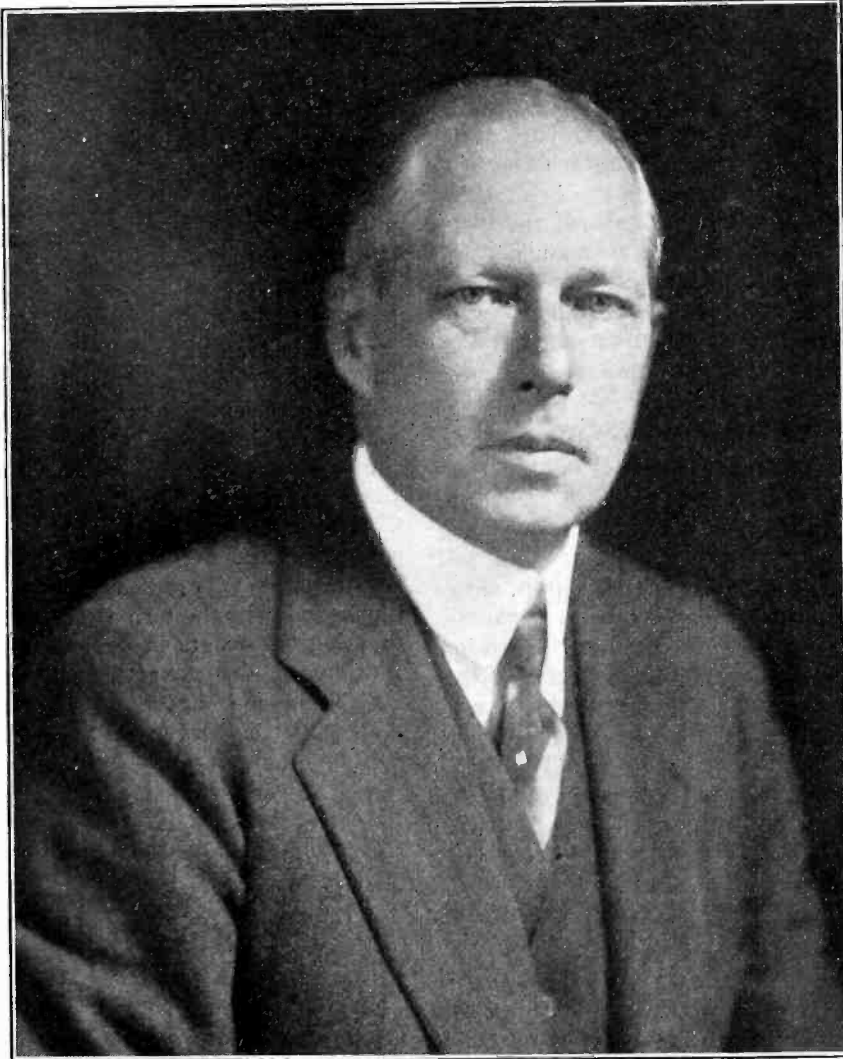

BANCROFT GHERARDI

Associates, 108 Members, and 7 Fellows), and was directed to remove these names from the mailing list, placing on a "suspended" list, and to employ the usual means of collecting the dues and restoring the members to the active membership list.

The annual report of the Board of Directors to the membership, as prepared under the direction of the National Secretary, was presented and approved.

The annual report of the National Treasurer was presented, accepted, and ordered filed.

The annual reports of the general standing committees of the Institute (exclusive of the reports of the technical committees, which will be presented at the annual Summer Convention in June) were presented and ordered filed for future reference. Abstracts of these reports were incorporated in the Board of Directors' report.

In accordance with Section 37 of the Constitution, the Board considered the appointment of the National Secretary for the administrative year beginning August 1, 1927, and National Secretary F. L. Hutchinson was reappointed.

The Committee on Award of Institute Prizes reported the awards of prizes for the year 1926. (The committee's report is published elsewhere in this issue.)

Mr. Edward D. Adams was appointed to represent the Institute, in cooperation with other engineering organizations, at the 500th anniversary of the founding of the University of Louvain, to be celebrated at Louvain, Belgium, June 28-29, 1927.

Other matters of importance were discussed, reference to which may be found in this and future issues of the JOURNAL.

### Thirtieth Annual Meeting of A. S. T. M.

The American Society for Testing Materials will hold its thirtieth annual meeting June 20-24, 1927, at French Lick, Ind. The sessions will open Monday, June 21—(the preceding day being given over to registration and committee meetings)—and will include the following subjects: Wrought iron, cast iron, magnetic testing, testing and nomenclature, petroleum products, insulating materials and preservative coatings, corrosion endurance testing and wear testing of metals, non-ferrous metals and metallography, clay and concrete products and building stone, cement, lime and gypsum, road materials and waterproofing. Tennis and golf tournaments will furnish recreation, beside the informal dance and smoker which will be a part of the convention program. The Edgar Marburg Lecture will be delivered Wednesday, June 22d, at 4 p. m.

### Annual Meeting and New York Section Meeting May 20, 1927

The annual business meeting of the Institute was held at the Engineering Societies Building, New York, on Friday evening, May 20, 1927. Vice-President H. M. Hobart presiding, called upon National Secretary Hutchinson, who presented in abstract the annual report of the Board of Directors, printed copies of which had been distributed to members in attendance. (This report is referred to elsewhere in this issue).

The report of the Committee of Tellers on the election of officers of the Institute was then presented by Mr. Hutchinson, and, in accordance therewith, Vice-President Hobart declared the election of the following officers, whose terms will begin on August 1, 1927:

PRESIDENT:	Bancroft Gherardi, New York, N. Y. Vice-President, A. T. & T. Co.
VICE-PRESIDENTS:	
District No. 2	J. L. Beaver, Bethlehem, Pa., Professor, Electrical Engineering, Lehigh University.
District No. 4	C. O. Bichelhaupt, Atlanta, Ga., Vice- President, Southern Bell Tel. & Tel. Co.
District No. 6	O. J. Ferguson, Lincoln, Nebr., Dean, College of Engineering, University of Nebraska.

District No. 8 E. R. Northmore, Los Angeles, Cal., Supt.  
Electric Distribution, Los Angeles Gas  
& Elec. Corp.

District No. 10 A. B. Cooper, Toronto, Ont., General  
Manager, Ferranti Electric Limited.

#### MANAGERS:

F. C. Hanker, E. Pittsburgh, Pa., Mgr.  
Control Station Engg., Westinghouse  
Elec. & Mfg. Co.

H. P. Liversidge, Philadelphia, Pa., Vice-  
President & General Manager, Philadel-  
phia Electric Co.

E. B. Meyer, Newark, N. J., Chief Engineer,  
Public Service Production Co.

#### NATIONAL

#### TREASURER:

George A. Hamilton, Elizabeth, N. J.  
Electrical Engineer (Retired).

These officers, together with the following hold-over officers, will constitute the Board of Directors for the next administrative year, beginning August 1: C. C. Chesney, Pittsfield, Mass.; M. I. Pupin, New York, N. Y.; H. M. Hobart, Schenectady, N. Y.; B. G. Jameson, Chicago, Ill.; G. L. Knight, Brooklyn, N. Y.; H. H. Schoolfield, Portland, Ore.; A. E. Bettis, Kansas City, Mo.; J. B. Whitehead, Baltimore, Md.; J. M. Bryant, Austin, Texas; E. B. Merriam, Schenectady, N. Y.; M. N. Fowler, Chicago, Ill.; H. A. Kidder, New York, N. Y.; E. C. Stone, Pittsburgh, Pa.; I. E. Moulthrop, Boston, Mass.; H. C. Don Carlos, Toronto, Ont.; F. J. Chesterman, Pittsburgh, Pa.;

Vice-President Hobart then called upon E. B. Meyer, Chairman of the New York Section to preside during the remainder of the meeting which was held jointly with the Institute of Radio Engineers and was under the auspices of the New York Section. Chairman Meyer after a few preliminary remarks introduced the speaker of the evening, Dr. Herbert E. Ives, Bell Telephone Laboratories, who gave a talk on "Television." The talk was illustrated with lantern slides and moving pictures, the latter covering the events in connection with the recent New York-Washington demonstration of television. By courtesy of the Bell Telephone Laboratories, arrangements had been made for interested members to visit the laboratories and see a demonstration of television. The attendance numbered about 750.

### Institute Prizes Awarded for 1926

At the May meeting of the Board of Directors of the Institute, the Committee on Award of Institute Prizes reported the following awards of national prizes for papers presented during the year 1926:

#### Best Paper Prize

Awarded to F. M. Farmer, New York, for his paper *Tests of Paper-Insulated, High-Tension Cable*, presented at the Madison Regional Meeting, May 7, 1926.

Honorable Mention given to paper by William G. Baker and Chester W. Rice, Schenectady, N. Y., entitled *Refraction of Short Radio Waves in the Upper Atmosphere*, presented at Midwinter Convention, New York, February 9, 1926.

#### First Paper Prize

Awarded to Othmar K. Marti, Camden, N. J., for his paper *Steel Enclosed Power Rectifiers*, presented at the Niagara Falls Regional Meeting, May 27, 1926.

Honorable Mention given to paper by C. F. Hanson, Yonkers, N. Y., entitled *Accuracy Required in the Measurement of Dielectric Power Factor in Impregnated Paper-Insulated Cables*, presented at the Niagara Falls Regional Meeting, May 26, 1926.

#### Best Regional Paper Prize

Awarded to F. M. Farmer, New York, for his paper *Tests of Paper-Insulated, High-Tension Cable*, presented at Madison Regional Meeting, May 7, 1926.

Honorable Mention given to paper by Lloyd Espenschied, New York, entitled *Radio Broadcast Coverage of City Areas*, presented at New York Regional Meeting, November 12, 1926.

#### Best Branch Paper Prize

Awarded to R. A. Schaefer, for his paper *A Study of Transverse Armature Reaction in Synchronous Machines by Means of a Second Machine with an Adjustable Stator*, presented at meeting of Marquette University Branch, December 30, 1926.

Honorable Mention given to paper by D. O. Bergey, E. E. Kearns, and C. W. Leihy, of the Oregon State College Branch, entitled *The Effect of Three-Phase-Transformer Connections on Induced Harmonics*, presented at Portland Section meeting, April 9, 1926.

#### Doctor Coolidge Honored

Dr. W. D. Coolidge, assistant director of the research laboratory of the General Electric Company, has been honored by the Franklin Institute and the American College of Radiology. Both honors, with gold medals, were received May 18, one in the afternoon in Philadelphia and the other in the evening at Washington.

The award by the Franklin Institute was the Louis Edward Levy gold medal, for Doctor Coolidge's paper on "The Production of High-Voltage Cathode Rays Outside the Generating Tube," read about a year ago; and the other award, by the American College of Radiology, was made "in recognition of his contribution to radiology and the science of medicine." At the time this latter medal was presented, Dr. Coolidge was made a fellow of the society. This was the first award of the gold medal by the American College of Radiology.

#### Report on Standards for Storage Batteries Available

A revision of Section 36 of the A. I. E. E. Standards for Storage Batteries has been in course of development for some time and is now available for criticism and suggestion before final adoption. Copies of this pamphlet may be obtained without charge by writing to H. E. Farrer, Secretary, A. I. E. E. Standards Committee, 33 West 39th St., New York, N. Y.

Standards in the revised section apply to storage batteries of the lead-acid and of the nickel-iron alkaline types, in large or small sizes and for either stationary or portable service. The report consists of definitions grouped under the following heads: Classification; construction; capacity; voltage; charging and discharging; efficiency; temperature; rating.

#### General Electric Appoints Engineering Council

In conformity with the action of the board of directors of the General Electric Company, an engineering council has been appointed. The council includes Messrs. E. W. Rice, Jr., honorary chairman (*ex-officio*); E. W. Allen, chairman; Elihu Thomson, A. C. Davis, W. R. Whitney, W. L. R. Emmet, C. C. Chesney and C. E. Eveleth.

The purpose of the engineering council, says the announcement by president Gerard Swope, is to advise with the vice-president in charge of engineering on the various problems that arise from time to time, and as to the direction and scope of the engineering and scientific work. The council may invite other engineers to meet with it, and at such times may give them the status of regular members.

## American Engineering Council

#### UNITED STATES PATENT OFFICE PROCEDURE

BY

L. W. WALLACE\*

In October, 1924, the Committee on Patent Office Procedure, appointed by Mr. Hubert Work, Secretary of the Department of the Interior, began to function. The Secretary, in a statement to the committee, said, "A very useful purpose may be served by this committee of prominent patent attorneys, representatives of industrial organizations and the engineering profession, in making a thorough review of the Patent Office, with a view of simplifying the methods of procedure and expediting the handling of applications for patents."

When the Patent Office was transferred to the Department of Commerce in 1925, the Secretary of Commerce added two engineers to the committee and instructed the committee to continue its work. In April, 1926, a searching, comprehensive and constructive report was submitted to Herbert Hoover, Secretary of Commerce. This report represented a great deal of painstaking work by the members of the committee and a number of engineers loaned to the committee by various agencies as staff men. A subcommittee, composed of management engineers assisted by the engineering staff, made a thorough engineering study of the equipment, layout, and internal procedure of the Patent Office. A corresponding analysis was made of the legal and legislative phases of the situation by subcommittees largely composed of attorneys. These subcommittees consulted with many attorneys in public and private life. The resulting report contained 108 specific recommendations, designed to facilitate and improve the work of the Patent Office, and to simplify and clarify the legal aspects of the patent system.

Few reports have been so widely accepted, or fallen into such sympathetic hands and immediate application. The Hon. Thomas E. Robertson, Commissioner of Patents, and his associates, as soon as the report was placed in their hands, began earnestly to apply the recommendations. As a consequence, remarkable progress has been made in many and varied directions. It is the purpose of this article to enumerate some of the major steps of progress, which are due almost entirely to the energy, enthusiasm, and farsightedness of Commissioner Robertson and his associates.

The basic and fundamental recommendation of the Committee was that the Patent Office above all things required a modern, adequate, and properly designed new building and equipment. It was realized that marked improvement in the service rendered to American agriculture, industry, and commerce would not be attained under the housing and equipment conditions now obtaining. It has been definitely decided that an entire wing of the new Department of Commerce Building will be allotted to the Patent Office. In these new quarters the Patent Office will have more square feet of floor space than now. Not only this, but the area will be much better adapted to the purpose than with the present building. Until the new building is ready, additional space will be obtained in other buildings adjacent to the Patent Office building.

By virtue of the Department of the Interior releasing some of the space it was using in the Patent Office Building, a rearrangement of the filing cases has been made possible. This rearrangement with the addition of a number of new steel filing cases, has greatly simplified the storing of patent prints. Not only this, but they are better protected from fire hazard, more easily assorted and placed in and withdrawn from the files thus facilitating the work of the office. It was recommended that the present method of filing material in the examiners rooms be replaced by

\*Executive Secretary, American Engineering Council.

vertical steel filing cases. Also in cooperation with the Bureau of Standards, the Patent Office has developed a much more suitable and satisfactory file wrapper.

In compliance with recommendations of the committee at the last session of Congress, the statutes were revised in a number of important directions. It has been said by those competent to judge that the revisions made were more constructive and helpful than any legislation passed in the last quarter of a century relating to the patent system. Among the revisions authorized by Congress were the following:

1. The filing fee has been increased by \$1.00 for each claim filed in excess of twenty and the final fee has been increased by \$1.00 for each claim allowed in excess of twenty.

The committee found that the privilege of submitting an unlimited number of claims was being grossly abused. Many applications obtained far more claims than necessary, enormously increasing the work of the office and resulting in no particular benefit to anyone. The committee endeavored to limit such abuse by charging a nominal amount for each claim applied for and each claim granted above twenty. Incidentally, this will add considerable revenue which will permit the employment of more examiners,—something badly needed.

To expedite the work, decrease the inequities and contribute to the general usefulness of the patent system, the committee made the following recommendations which have been enacted into law, that:

Applications must be amended within six months instead of one year and renewals must be made within one year instead of two.

That the length of time allowed for appeals be reduced from one year to six months. As appeals weigh heavily in point of time and cost, one appeal within the Patent Office has been abolished so that an appeal from the Examiners or from the Examiner of Interferences goes directly to a Board of Appeals consisting of the Commissioner, two Assistant Commissioners, and Examiners-in-Chief, three of whom shall constitute a quorum. A sixth member of the Examiners-in-Chief has been supplied. The foregoing makes it possible for two Boards of Appeal to sit at the same time. This, with the elimination of one appeal in the Patent Office will greatly facilitate the handling of appeal cases. Heretofore appeals outside of the Patent Office could be made to the Court of Appeals, and a Bill in equity could afterwards be filed under Section 4915 of the Revised statutes. Now either of these courses may be followed, but not both. This means that only one appeal can now be made outside of the Patent Office.

Improved service is being rendered to patentees and patent lawyers by the following rules which have been established within the office:

1. All patents in the Public Search Room are being checked, and missing patents placed in the files at a cost of about \$20,000. 2. It is now provided that claims are renumbered at the time of allowance instead of each time a change is made. 3. Photostat copies of the drawings in each application are made and placed on file at the time the application is received. 4. It is now permissible to use original drawings in re-issue applications. 5. A sufficient number of hard copies for trademarks has been provided and facilities have been increased so that orders for soft copies of patents and trade-marks are often delivered the same day received and not later than the second day. Copies are promptly supplied to the examiners and all delays avoided.

Increased appropriations have made possible (a) greatly improved service of the mail room and materially reduced delays; (b) upon the recommendation of the committee, Junior Assistant and Associate Examiners are now paid the average of their grade and an increase in salary will be available for present examiners after July first. (One of the great dif-

ficulties is the large labor turnover among the examiners, largely due to the low salaries paid for the high type of men required).

According to the Commissioner of Patents, other important improvements recommended by the Committee on Patent Office Procedure have been effected. Among them are the following: (a) The complete reorganization of the Issue Division to change the flow of work and the arrangement of files. (b) The Trade Mark Division has been wholly reorganized to carry out the recommendation with respect to the routing of the work. (c) It was found in many instances the divisions were not laid out and the equipment placed to conform to the natural and most practicable flow of the work. Several of the divisions were specially studied from this point of view and recommendations made as to the changes necessary. It is gratifying that such changes are being made insofar as present conditions will permit. It is anticipated that this feature will be adequately provided for in the new building. (d) The usual preamble of printed patents has been omitted, saving from \$8,000 to \$10,000 a year. (e) Assignments are recorded by the photostat method, saving a number of clerks and reducing the time for recording from 52 to 15 days. (f) The Card Indexes for Assignments have been completed and have proved the biggest item of saving accomplished. (g) Adequate stenographic service has been provided for all examiners, obviating the writing of decisions in long-hand. (h) The work of the Application Division has been reorganized so as to proceed with the work in small lots in a steady flow, instead of in large batches which resulted in alternately a peak and a trough of work.

It is apparent from the foregoing that many changes are taking place in the Patent Office, showing that it is now, and will continue to render an increasingly improved service. An instrument of such value to American agriculture, commerce and industry requires a continuing thoughtful, sympathetic and active support. There are many other things needing correction before the Patent Office will be able to meet the legitimate demands being made upon it. In a large degree a full measure of accomplishment cannot be realized through the devoted and intelligent efforts of the Commissioner and his staff alone. The changes required must come through the action, interest and work of those in agriculture, commerce and industry, vitally interested in, concerned with and affected by the Patent system. The Commissioner and his associates have the will to do, as exemplified by their work, and manifested by the following expression, which appeared in the Commissioner's report to the Secretary of Commerce under date of June 30, 1926.

"The Report of the Secretary's Committee is being studied to make use of various other suggestions contained in it to increase the efficiency of the office. In fact, the report will be of immense value. At this time, I desire to express the appreciation of the officers of this bureau to the committee, which was composed of men of wide experience in patent, engineering, and industrial problems. Although its members were busy men of affairs, they came again and again to Washington and gave generously of their time and made a most exhaustive study of the Patent Office and its needs. I recommend that the report be printed."

#### PAN AMERICAN CONFERENCE URGES STANDARDIZATION

Dean Dexter S. Kimball, President of American Engineering Council and Past-President of the American Society of Mechanical Engineers, opened the conference by calling attention to the simplification movement in the industries of the United States, especially the work being carried on by the Department of Commerce.

Other addresses at the opening session were delivered by Assistant Secretary of Commerce, J. Walter Drake, who declared that uniform classifications and descriptions of goods must be applied to remove the obstacles to international business. E. A. Canalizo, President of the New York Cocoa Exchange was elected permanent president.



C. E. Skinner, Chairman of the American Engineering Standards Committee, spoke on simplifications and standardization programs, pointing out that wherever they were used, they had the primary objectives of eliminating waste. Mr. Skinner said:

"It matters not whether one is buying hats, shoes, radio sets, electric motors, axle steel, machine screws, paving bricks, chinaware or incandescent lamps, a better and cheaper product is usually secured if that product is one of a simplified line made to conform to a reasonable standard and produced in large quantity.

"It would be helpful to our standardization agencies in the United States to know what classes of materials and products covered by our national recognized standard specifications would be most useful translated into Spanish for use in the South American Republics."

During the three-day conference, under the direction of the Inter American High Commission, ten resolutions embodying specific recommendations relative to Pan American standardization activities were adopted and it was decided to establish a permanent commission of standards comprising the commercial attaches of the Latin American Embassies and Legations in Washington.

The next conference will be held in Cuba in 1930.

## Bureau of Standards Year Book for 1927

The Standards Year Book represents an effort to present an adequate description of the diversification and ramification of the standardization movement that have elapsed throughout the world since the establishment of the National Bureau of Standards. It contains outlines of the activities and accomplishments of not only this bureau and other agencies of the Federal Government and the states and municipalities, but also of the American societies and associations of which standardization is an important activity. Descriptions and illustrations are presented of all the fundamental national standards of the United States, and outlines of the various foreign national and the several international standardizing agencies.

The issue is Bureau of Standards Miscellaneous Publications No. 77, and can be obtained from the Superintendent of Documents, Government Printing Office, Washington, D. C., at \$1.00 per copy.

## Electrophysics Committee

### COOPERATE WITH AMERICAN PHYSICAL SOCIETY

Upon the recommendation of Professor V. Karapetoff, chairman of the Committee on Electrophysics, the American Physical Society, was recently invited to designate two of its members to act as "liaison representatives" of that society upon the Electrophysics Committee.

The invitation has been accepted, and President Compton of the American Physical Society has designated as these representatives, Professor W. F. G. Swann, of Yale University, and Professor A. P. Wills, of Columbia University.

It is hoped that this action will result in some coordination of of the work carried on by the Institute's Committee on Electrophysics and the American Physical Society.

## National Museum of Engineering and Industry

The National Museum of Engineering and Industry held its third annual meeting at its headquarters in the Engineering Societies Building, 29 West 39th Street, New York City, on Thursday afternoon, April 28th, at 4 o'clock.

Preliminary to the meeting the members tendered a luncheon at the adjoining Engineers Club to the Presidents and Secretaries of the following Societies who were represented on its Board of Trustees: The American Society of Civil Engineers, The American Institute of Mining and Metallurgical Engineers, The

American Society of Mechanical Engineers, The American Institute of Electrical Engineers, The United Engineering Society, The Engineering Foundation, The Engineers Club, The American Engineering Council, The Society for the Promotion of Engineering Education, The American Chemical Society, and The American Association for the Advancement of Science.

The Smithsonian Institution of Washington, D. C., of which the National Museum of Engineering and Industry will be a part, and the Museum of the Peaceful Arts of New York City, were also represented. The following Trustees were elected: L. P. Alford, B. C. Batcheller, George M. Bond, Nicholas F. Brady, Ericsson F. Bushnell, Fred H. Colvin, F. A. Halsey, Thomas T. Hoopes, Prof. D. C. Jackson, Joseph Keller, Fred R. Low, H. P. Merriam, H. F. J. Porter, Dr. M. I. Pupin, Dr. Elmer A. Sperry, Kirby Thomas, F. A. Waldron.

Mr. Thomas Ewing, former Commissioner of Patents, is president, and Mr. Harrison W. Craver, Director, United Engineering Societies Library, secretary.

## French Chemical Combine Proposed

A combination representing all of the principal French chemical industries has been officially confirmed to the Department of Commerce. A permanent industrial chemical committee will act as the directing organization of this union and will control it along the lines adopted by the French steel industry. It will also be effective in tying this union in with the German and English combinations already in existence.

## PERSONAL MENTION

HERBERT G. LINDNER, transmission engineer for the Wisconsin Telephone Company, Milwaukee, Wis., has been transferred to the Bell Telephone Laboratories, New York, N. Y.

WALTER S. FINLAY, JR., who has been serving the American Water Works and Electric Company, New York, N. Y., in the capacity of vice-president, has been elected president of the West Penn Electric Company, with offices at Pittsburgh, Pa.

JACK B. SILVERMAN, formerly with the Louisville Gas and Electric Company, Louisville, Ky., has removed to Cincinnati, Ohio, where he will be connected with the Columbia Engineering and Management Corporation.

CHESTER W. RICE, who has been engaged in development work in the research laboratory of the General Electric Company, has been named assistant to E. W. Allen, vice-president in charge of engineering. Mr. Rice will give special attention to new developments.

C. C. CHESNEY has been transferred from the managership of the Pittsfield Works of the General Electric Company, and, since May 25th, pursuant to the action of Board of Directors, has been vice-president of the company and chairman of the manufacturing committee.

F. W. PEEK, who has been consulting engineer in the transformer department of the General Electric Company and in charge of the high-voltage laboratory, has been named engineer to succeed Mr. W. S. Moody, in general charge of the transformer engineering department.

W. L. HOLLADAY has been transferred from the Dallas office of the General Electric Company, where he was serving the company as refrigerator specialist, to be district representative for its newly established electric refrigeration department in Los Angeles.

ERNEST C. MORSE, has been appointed to take charge of the Section of New Uses which has been formed by the Cotton-Textile Institute, Inc., New York, N. Y. This section will work in close cooperation with the Departments of Agriculture and Commerce in Washington.

**A. K. WARREN**, who has been serving the West Lynn Works of the General Electric Company as managing engineer, has returned to Japan to continue his work of consulting engineer for the Shibaura Engineering Works, Ltd., Tsurumi Works, Tsurumimachi, Kanagawaken, Japan.

**J. P. ALEXANDER**, manager of the New Haven Office of the Westinghouse Electric & Mfg. Co., has been Boston manager in charge of all New England sales and service for the company. Mr. Alexander has worked up to his present position from enrollment in an apprentice course with the company's East Pittsburgh office after his graduation from Lafayette College in 1907.

**PALMER H. CRAIG**, former professor of physics at Mercer University, Macon, Ga., and inventor of the electromagnetic radio amplifier which recently attracted considerable attention, is now associated with the Premier Laboratory Company, New York, N. Y., in the capacity of research physicist. Doctor Craig has only recently joined the Institute.

**WILLIAM S. H. HAMILTON**, who has been in the Railway Dept. of the General Electric Company, has been transferred to the New York Office of the company, in the capacity of electrification specialist for the New York District. Mr. Hamilton was one of the General Electric Company's representatives in the field when the initial installation of the C. M. & St. P. Railway was put into operation.

**J. IRVING ELLMAN**, district engineer of the Florida Light & Power Company, Miami, Fla., entered the employ of W. N. Matthews Corporation, St. Louis, Mo., on the 1st of May, reporting to its New York district manager for Connecticut, New York State, New Jersey, Delaware and Pennsylvania east of Harrisburg. Mr. Ellman was previously special engineer on distribution and construction for the Westchester Lighting Company, and electrical engineer for the Queensboro Gas & Electric Company.

**NICHOLAS STAHL**, who has been a Fellow of the Institute since 1913, on May 1st became first vice-president in charge of operations of the United Public Service Company, with headquarters at Chicago. This company serves about 90 communities in Indiana, Ohio, Arkansas and North and South Dakota. Mr. Stahl, who has made a life study of power-plant operation and has contributed many articles and papers to the technical press, is vice-chairman of the Engineering National Section of the N. E. L. A., as well as present councilor and past chairman of its Prime Movers Committee and member of its Electric Apparatus Committee, past chairman and member of the Institute's Power Generation Committee and a member of the Committee on Fuel Specification and subcommittee on Care of Pressure Vessels in Service of the A. S. M. E. Boiler Code Committee.

## Obituary

**George Eisenhauer**, electrical engineer for the Erie Railroad Co., and an Associate of the Institute since 1912, died February 14th. Mr. Eisenhauer was a native of New York City and since his school days has been associated with the Erie Railroad Company in the varying capacities of telegrapher, signal inspector, chief electrical inspector, and acting electrical engineer. He was born December 21, 1870, and has accomplished his technical success by practical experience with only a common school education, followed by a correspondence course and home study.

**Archie L. Lewis**, electrician, Latourette-Fical, died at St. Francis Hospital in San Francisco, February 8, 1927. Mr. Lewis was born in Portland, Ore., in 1892, and his early electrical work was in the city of Spokane with local engineering companies. In 1909 he removed to Seattle, but a year later went to the Electric Construction Co., in Vancouver. He was next with the Utah Light and Power Co., Ogden, Utah, returning the following year to the Coast, where he remained until the time of his death.

**Henry H. Curtis**, late treasurer of the C. & P. Electric Works, Springfield, Mass., and Fellow of the Institute, died suddenly April 21, 1927, in the 58th year of his age. Mr. Curtis was born at Bowdoinham, Maine. Most of his early life was spent in Iowa, but he came east again in 1880 and has been associated with the electrical industry ever since. In 1891 he joined the Thomson Houston Electric Company of Lynn, Mass., but left them a year later to identify himself with the Mather Electric Company, Manchester, N. H. From 1893 to 1900 he was with the Davis Electric Mfg. Co., at Springfield, Mass. Shortly after this he became interested in the manufacture of electrical apparatus, and in 1914 organized the C. & P. Electric Works, Inc., which he owned and managed up to the time of his death.

**Abel L. Brownrigg**, patent solicitor for Fish, Richardson & Neave, New York, N. Y., and Associate of the Institute, died April 9, 1927 of appendicitis. Born in Slayton, Minnesota, April 24, 1882, Mr. Brownrigg spent two years in the engineering university of Minnesota, following it by a course in law at Georgetown University, Washington, D. C., from which he obtained his degrees of L. L. B. and M. P. L. He was the Assistant Examiner in the Electrical Division of the United States Patent Office from May 1910 to Sept. 1915 when he established his patent law practise in New York.

**George Ross Green**, engineer of station engineering for the Philadelphia Electric Company, died April 23, 1927 at Philadelphia. Mr. Green was graduated from the University of Pennsylvania, Dept. of Mechanical Engineering, with the class of 1884. He then spent two years in machine shop practise and for nearly four and a half years was engineer for the Spiral Weld Tube Co. In this work he spent a year in Germany. He was also one of the assistants in mechanical engineering for the World's Columbia Exposition, Chicago. Just prior to going with the Philadelphia Electric Company, he was secretary and treasurer for the American Electric Meter Co. for three years.

**Beverly B. Tucker**, hydraulic engineer, of the Power Corporation of New York, Watertown, N. Y., and Associate of the Institute since 1908, died suddenly May 1927. He was born in Allenburg, Ont., November 4, 1880, and won his B. A. Sc. at the University of Toronto. Two years were spent by him with the Canada Tin Plate & Sheet Steel Co. of Morrisburg and for a short time he was identified with the New York & Ontario Power Company, Waddington, N. Y.

**George L. Hedges**, of the Hedges-Lincoln Iron Works, Lincoln, Neb., died March 21, 1927. Mr. Hedges was born May 23, 1885 and was a native of Lincoln, Neb. During 1906, he taught mechanical drawing and descriptive geometry at the University of Nebraska, and from 1907 to 1909, was assistant superintendent of the grounds, building and equipment for the University. For that period he also made complete design and drawings for the 12-in. equatorial telescope finished at the University shops. For three months from February 1909 he was designer for the Cleveland Crane and Engineering Co., at Wickliffe, Ohio, but was compelled to abandon this work because of ill health. After a year's recuperative period he became engineer for the Kelman Electric & Mfg. Co., Los Angeles, Calif., in complete charge of the engineering and design work, which position he held for several years.

**Frank E. Field**, telephone engineer, Bell Telephone Laboratories, Inc., Somerville, N. J., died April 14, 1927. He was born in Somerville, N. J., and after graduating from the Somerville High School, he attended Rutgers College, New Brunswick, from which in 1913 he obtained the degree of B. S. in Electrical Engineering. From 1913 to 1914 he was Teaching Fellow at Pennsylvania State College and received a degree in Electrical Engineering. He then became an instructor in Electrical Engineering at the Pennsylvania State College and did considerable research work with Professor Markle. Mr. Field joined the Institute in 1914 as an Associate but was transferred to the grade of Member in 1921.

**Paul T. Kamerer**, Superintendent of the meter division of the West Penn Power Company, Connellsville, Pa., and an Associate of the Institute since 1909, died of pneumonia on April 20, 1927. Mr. Kamerer was born at Greensburg, Pa., April 28, 1883. He attended the Greensburg High School and followed this with a course at the Pennsylvania State College, from which he graduated in 1906 with his degree in Electrical Engineering. He then took an apprentice Course with the Westinghouse Electric & Mfg. Co., at East Pittsburgh and at the Newark Works, subsequently becoming an instrument expert in erecting work.

**Louis C. Brooks**, Chairman of Committee on Applications to Marine Work for two years, (1924-1926), and a member of that Committee since 1918—also a member of Committee on Meetings and Papers for one year—died suddenly on April 18th, at his home, Groton, Mass. Mr. Brooks' life was devoted largely to electricity as applied to Marine work. Born at Brighton, Michigan, June 4th, 1874, he was graduated from Michigan State College in 1892 with the degree of B. S., and E. E. in 1908. Until 1899, he was associated with the General Electric Company, Schenectady, N. Y. Then entered the Government employ in the Superintending Constructor's Office at Newport News in connection with construction of the Battleships "Kearsage" and "Kentucky", the first of Naval vessels to use the three-wire, two-voltage system. For one year he left Marine work, and was with the Brown Hoisting Machinery Company, Cleveland, Ohio, returning to the marine work in the Government employ as expert electrical aide at Cramp's Shipyard in Philadelphia in 1902. He was master electrician of the Boston Navy Yard, 1905-1910, then returned to the General Electric Company, Schenectady, N. Y., as commercial engineer in the Industrial Control Department. From 1918 to 1926 he was electrical engineer for Bethlehem Shipbuilding Corporation, Ltd., at Bethlehem, Pa., and Quincy, Mass., from which he resigned to take up work in the country, hoping to regain his failing health.

While at Bethlehem, Pa., Mr. Brooks was instrumental in the organization of the Lehigh Valley Branch of the A. I. E. E., of which he was the first chairman. He was active in the preparation of the volume published by the Institute, *Recommended Practice for Electrical Installations on Shipboard*, the first comprehensive set of Rules ever published for that class of electrical work.

Mr. Brooks was an exemplary character, had a fine personality, and made friends readily. Energetic in every movement with

which he was associated, conscientious in his opinions, and possessed of a determination in his conclusions which always received consideration and respect of his associates.

## Addresses Wanted

A list of members whose mail has been returned by the postal Authorities is given below, together with the addresses as they now appear on the Institute records. Any member knowing the present address of any of these members is requested to communicate with the Secretary at 33 West 39th St., New York.

All members are urged to notify the Institute Headquarters promptly of any changes in mailing or business address, thus relieving the member of needless annoyance and also assuring the prompt delivery of Institute mail, the accuracy of our mailing records, and the elimination of unnecessary expense for postage and clerical work.

J. H. Ashbaugh, 6744 Penn Ave., Pittsburgh, Pa.  
 John H. Barr, Box A. A. Stone & Webster Inc., Peoria, Ill.  
 Ransom H. Beman, 1621 Kensington Blvd., Ft. Wayne, Ind.  
 H. A. Blenden, 4559 Wichita Ave., St. Louis, Mo.  
 E. P. Bryant, 1421 Ridge Way, Los Angeles, Calif.  
 Claude Cole, 3313 5th Ave., Pittsburgh, Pa.  
 Adam C. Cook, 5842 Patterson Ave., Chicago, Ill.  
 J. E. Cowart, 55 Hanson Place, Brooklyn, N. Y.  
 A. J. Evans, 466 63rd St., Brooklyn, N. Y.  
 Wm. Farger, 1211 Harvard Ave., Seattle, Wash.  
 Cale R. Gough, Albion Elec. Co., Albion, Ill.  
 F. J. Nankivell, N. Y. & Q. Elec. Lt. & Pr. Co., Flushing, N. Y.  
 Arthur B. Newell, 315 Marlborough Rd. Brooklyn, N. Y.  
 Arnold J. Oliver, 4300 Euclid Ave., Cleveland, Ohio.  
 H. J. Olson, Western Elec. Co., 655 Planter Bldg., St. Louis, Mo.  
 Marvin D. Parks, Westinghouse Club, Wilkinsburgh, Pa.  
 Ed. G. S. Pryor, 1100 Alaska Bldg., Cleveland, Ohio.  
 M. C. Ray, 313 Illuminating Bldg., Cleveland, Ohio.  
 F. J. Rudershausen, 35 W. 34th St., Bayonne, N. J.  
 F. Scalandre, 156 Mt. Prospect St., Newark, N. J.  
 W. H. Schrank, 246-5th Ave., New York, N. Y.  
 Earl C. Snow, 1435 S. 2nd St., Louisville, Ky.  
 V. W. Villamena, 111 Roosevelt Ave., Corona, L. I., N. Y.  
 I. B. Watkins, 336 "D" St., N. W., Ardmore, Okla.  
 R. J. Wise, 119 Oglethorpe Ave., Atlanta, Ga.  
 Benj. U. Young, Cheyenne Fuel & Pr. Co. Cheyenne, Wyo.

## Past Section Meetings

### SECTION MEETINGS

#### Akron

*Power-Factor Problems*, by Frank Wallene. January 14. Attendance 35.

Inspection trip to the High-Voltage Experimental Station of the Ohio Insulator Co., where a demonstration was conducted, showing methods of preventing flashovers on transmission lines; supplemented by a lecture by A. O. Austin, Chief Engineer. Joint meeting with Cleveland Section. April 21. Attendance 450.

#### Boston

*Problems Arising from the Expansion and Interconnection of Power Systems*, by F. C. Harker, Westinghouse Electric & Mfg. Co. Illustrated with slides. April 27. Attendance 115.

#### Chicago

*Carrier Current and Other Vacuum-Tube Applications*, by T. Johnson, Jr., and T. A. E. Belt, General Electric Co. Joint meeting with Electrical Section, W. S. E. May 2. Attendance 275.

#### Cleveland

*High-Voltage Investigations*, by A. O. Austin, Ohio Insulator Co. (See April 21 meeting Akron Section). April 21. Attendance 450.

#### Connecticut

*Getting Production in Outside Plant Construction*, by T. N. Bradshaw, Southern New England Telephone Co. Illustrated by slides. April 19. Attendance 115.

#### Denver

*Lest We Forget*, by J. J. Cooper, Mountain Electric Co. The speaker brought out the history of and pioneering in public utilities in Colorado. Luncheon Meeting. January 11. Attendance 40.

*Engineering Education*, by Prof. H. S. Evans, University of Colorado. Illustrated. Luncheon Meeting. March 22. Attendance 60.

*Electrification of the Pueblo Steel Works*, by F. L. Lindemuth, Colorado Fuel and Iron Co. April 29. Attendance 52.

#### Erie

*Radio and Power Transmission by Radio*, by Dr. Phillips Thomas, Westinghouse Electric & Mfg. Co. Demonstrated. April 21. Attendance 200.

#### Fort Wayne

*Air-Craft Development*, by Brigadier-General W. E. Gillmore, Asst. Chief of U. S. Air Corps. Illustrated with slides. April 28. Attendance 85.

**Ithaca**

*Automatic Train Control*, by W. H. Reichard, General Railway Signal Co. April 22. Attendance 40.

**Kansas City**

*The Self-Starting Synchronous Motor and Its Applications*, by S. H. Mortenson, Allis-Chalmers Mfg. Co. April 18. Attendance 27.

**Lehigh Valley**

*Traveling Waves on Transmission Lines*, by A. R. Miller, Lehigh University, and

*The Principles of Mechanical Telephony*, by H. Goldsmith, N. Y. Telephone Co. Meeting preceded by a dinner. March 25. Attendance 80.

**Los Angeles**

*Modern Magnetic Materials*, by T. D. Yensen, California Institute of Technology, and

*Magnetic Analysis*, by B. W. Creim, Bureau of Power and Light. April 5. Attendance 65.

*Modern Tendencies in Distribution*, by C. A. Heinze, Bureau of Power and Light, and

*Problems of Recent Origin in Distribution*, by N. B. Hinson, So. California Edison Co. May 3. Attendance 102.

**Louisville**

*Trolley Contact Signalling for Electric Railways*, by C. P. Nachod, Nachod and U. S. Signal Co. April 13. Attendance 48.

**Lynn**

Inspection trip to Mystic Iron Works. January 15. Attendance 200.

Inspection trip to the new Ford Assembly Plant at Somerville. March 10. Attendance 200.

Annual Banquet. A talk on China was given by Tehyi Hsieh, March 26. Attendance 250.

Inspection trip to Lynn Gas and Electric Co. April 16. Attendance 50.

*Electric Drive for Automobiles*, by H. S. Baldwin, General Electric Co. Illustrated with slides. April 27. Attendance 75.

**Minnesota**

*Engineering Education—From the Standpoint of the Employer*, by W. H. Meese, Western Electric Co., and

*Engineering Education—From the Standpoint of the Educator*, by O. M. Leland, University of Minnesota. Joint meeting with A. S. M. E., A. S. C. E., N. C. E. A. and S. P. E. E. April 5. Attendance 102.

**Niagara Frontier**

Inspection trip to the Charles R. Huntley Station of the Buffalo General Electric Co. A description, illustrated by slides, was given by H. M. Cushing, Chief Engineer. April 22. Attendance 86.

**Philadelphia**

*An Electrical Combustion-Control System for Steam-Boiler Furnaces*, by I. M. Stein, Leeds and Northrup Co. Illustrated with slides. May 9. Attendance 118.

**Pittsburgh**

*Development of Executive and Administrative Ability*, by S. J. Chesterman, Bell Telephone Co. of Pa. The following officers were elected: Chairman, W. C. Goodwin; Secretary-Treasurer, H. E. Dyche. May 10. Attendance 400.

**Pittsfield**

Inspection trip to the High-Voltage Laboratory of the General Electric Co. January 29. Attendance 860.

Inspection trip to the Hartford Light Company Plant. April 19. Attendance 140.

**Portland**

*Recent Development in Oil*, by O. F. Stafford, University of Oregon. April 22. Attendance 80.

**Providence**

*The Wonders of Light*, by Prof. F. N. Tompkins, Brown University. The following officers were elected: Chairman, F. N. Tompkins; Vice-Chairman, A. E. Watson; Secretary-Treasurer, F. W. Smith. April 15. Attendance 105.

**Rochester**

*Piezo-Electric Crystals*, by Dr. August Hand, Bureau of Standards. Joint meeting with I. E. E., Optical Society of America and Rochester Engineering Society. March 4. Attendance 112.

*Telephone Traffic Problems*, by C. W. Vlekory, Rochester Telephone Corp. April 1. Attendance 24.

**St. Louis**

Business Meeting. The following officers were elected: Chairman, L. F. Woolston; Vice-Chairman, C. P. Potter; Secretary-Treasurer, L. P. Van Houten. April 20. Attendance 20.

**San Francisco**

*New Developments in A-C. Rotating Machines, and High-Voltage Underground Cable*, by J. F. Spence, General Electric Co. Illustrated with slides. A dinner preceded the meeting. March 18. Attendance 130.

*Modern Developments in Motor and Control Applications*, by H. D. James, Westinghouse Electric & Mfg. Co. April 8. Attendance 65.

**Schenectady**

*Spectroscopic Prediction*, by R. A. Millikan, California Institute of Technology. April 20. Attendance 500.

Spring Smoker. April 29. Attendance 300.

**Seattle**

*Motor and Control Applications*, by H. D. James, Westinghouse Electric & Mfg. Co. April 19. Attendance 120.

**Spokane**

Inspection Trip to Automatic Telephone Exchange of the Home Telephone & Telegraph Co. April 12. Attendance 72.

**Springfield**

*Bakelite*, by L. V. Qungley, Bakelite Corp. April 18. Attendance 44.

**Syracuse**

*Power-System Stability*, by A. P. Fugill, Westinghouse Electric & Mfg. Co. April 11. Attendance 216.

**Toledo**

Inspection trip to the Ohio Bell Telephone Co. April 15. Attendance 54.

**Toronto**

*High-Tension Underground Cables*, by D. M. Simons, Standard Underground Cable Co. April 8. Attendance 74.

*Mechanical Analogy of Transmission-Line Characteristics*, by R. C. Burgvall, Westinghouse Electric & Mfg. Co. April 22. Attendance 250.

**Utah**

*Diesel Engines from the Purchaser's Viewpoint*, by V. A. Stout, Henry R. Worthington Co., and

*Air Blast and Mechanical Inspection in Diesel Engines*, by V. L. Moleer, Western Machinery Co. April 22. Attendance 75.

*New Developments in X-Rays*, by F. J. Nicholes;

*The Vitaphone*, by N. R. Anderson;

*Super Power*, by W. S. Rigby;

*Power Factor of Flynn-Weichsel Motor*, by V. S. Thomander and O. C. Haycock, and

*Magic*, by B. S. Greval. April 28. Attendance 50.

**Vancouver**

*Hydro-Electric Developments of the East Kootenay Power Co.*, by M. L. Wade, General Supt. April 5. Attendance 90.

**Washington**

*Greenland*, by G. P. Putman. Illustrated with moving pictures. Joint meeting with Washington Society of Engineers and other affiliated engineering societies. April 6. Attendance 600.

Noonday Luncheon. A talk was given by Wm. Tyler Page, Clerk of the U. S. House of Representatives, on the proposed bi-centennial to be held in Washington, D. C., in 1932. April 12. Attendance 45.

*Electric Household Refrigeration*, by H. B. Wallace, General Motors Corp. Illustrated with slides and motion pictures. The following officers were elected: Chairman, M. G. Lloyd; Vice-Chairman, Edward Kerschner; Secretary-Treasurer, H. E. Bradley. May 10. Attendance 94.

## A. I. E. E. Student Activities

### NEBRASKA SECTION HAS STUDENT PROGRAM

The Nebraska Section entertained the juniors, seniors, and faculty members in electrical engineering at the University of Nebraska during the entire day and evening of May 10, 1927. The following program was followed, all parts being in Omaha:

Inspection, Omaha and Council Bluffs Street Railway power plant. Nebraska Power Co. plant.

Luncheon at Nebraska Power Co. plant. Guests of Nebraska Section.

Inspection, American Smelting and Refining Co. plant. Northwestern Bell Telephone Co. building.

Dinner at University Club. Guests of Nebraska Section.

Student Program:

L. H. Hobson (senior) presiding.

Piano solo and violin duets by students.

Remarks by Dean O. J. Ferguson.

*Properties of Iron Wire*, H. H. Brown (senior).

Vocal and banjo solos by students.

*Private Ownership of Public Utilities*, J. P. Gillilan (senior).

Tenor solo, H. H. Brown (senior).

*The Engineering College at the University of Nebraska*, A. A. Little (senior).

Popular numbers by student quartet.

The Section officers considered this one of the most successful meetings ever held by the Nebraska Section. The evening program was received with much enthusiasm by the local engineers, and offered an excellent opportunity to renew acquaintanceships with the faculty members and to meet the juniors and seniors. This type of meeting probably will be held each year.

### JOINT SECTION AND BRANCH MEETING AT CORVALLIS, OREGON

A joint meeting of the Portland Section and the Oregon Agricultural College Branch was held at Corvallis on May 7, 1927.

Vice-President Schoolfield presented the Best Branch Paper Prize for District No. 9 for 1926 to H. E. Rhoads and C. H. Bjorquist. An account of this award and an abridgment of the prize winning paper, entitled *The Influence of Line Voltage Upon Induction Motor Characteristics*, were published on pages 398-99 of the JOURNAL for April 1927.

The following papers were presented by students and were discussed by both students and Portland engineers:

*Effect of Insulation Resistance on the Characteristics of an Artificial Line*, by O. C. Doty, V. E. Rinehart, and W. C. Wing.

*A New Type of Rectifier*, by N. M. Mekeel.

*Alternating Current Transients in Incandescent Lamps*, by F. D. Crowther and R. L. Earnhart.

The attendance was about 100, and the meeting was considered very successful in all respects.

### JOINT SECTION AND BRANCH MEETING AT UNIVERSITY OF UTAH

The annual joint meeting of the Utah Section and University of Utah Branch was held in Salt Lake City on April 28, 1927, and the following program was presented by students:

*New Developments in X-Rays*, F. J. Nicholes.

*The Vitaphone*, R. N. Anderson.

*Super Power*, W. S. Rigby.

*Power Factor of the Fynn-Weichsel Motor*, V. S. Thomander and O. C. Haycock.

The papers were very interesting to an audience of about 50 Institute members and enrolled students.

### ELECTRICAL ENGINEERS' PARTY AT UNIVERSITY OF MINNESOTA

The Biennial Electrical Engineers' Party at the University of Minnesota was held on April 21-22. This form of entertainment was adopted in 1913 to provide a social function strictly electrical in theme and management.

The attendance of the first night was limited to guests of the faculty members and students, but for the second night, invitations were issued through the newspapers to all friends of the University and to the general public. The first parts of the evenings were devoted to demonstrations and exhibits in the laboratories, and the latter parts to dancing. Every effort was made to create the atmosphere of a reception rather than that of a show.

All regular laboratory equipment was used in the demonstration of the fundamentals of electricity, and, in addition, a large number of special exhibits were built especially for the occasion. There were 80 exhibits, including many novel and interesting stunts.

Among the outstanding features were high voltage demonstrations, radio transmission of pictures, radio controlled car, electric fountain, speech oscillograph, talking arc, illumination, high frequency-lamp, fused quartz, photoelectric cell, and an automatic telephone. 19 merchants and manufacturers assisted in the preparations, and a number of manufacturers' exhibits were secured to show recent developments in the electrical industry.

The Party aroused great interest in the whole University community and in the Twin Cities. A capacity crowd, conservatively estimated at 1000 persons, attended each night. J. H. DuBois, Secretary of the Branch was Manager.

### THE TRANSMISSION OF MOTION PICTURES BY RADIO

BY

JOSEPH I. HELLER

STUDENT, POLYTECHNIC INSTITUTE OF BROOKLYN

*An abridgment of a paper presented at the New York Student Convention on April 8, 1927 for which the author was awarded the prize of \$25.00 in gold offered by the New York Section.*

Pictures are made up of countless minute elements of different shades of light. To make a clear-cut, distinguishable picture, the individual elements need not be less than one millimeter square.

The requirements for successful picture transmission are as follows:

- a. A method of breaking up a picture into minute elements.
- b. A method of changing the variations in shade of these elements into a varying electric current.
- c. A method of propagating these current variations over the necessary distance.
- d. The receiving equipment, which must be capable of amplifying the received impulses to a very high degree.
- e. A light capable of passing from maximum brilliancy to zero brilliancy many times a second.
- f. A method of replacing the elements of the picture upon a screen, each element bearing the same relative position to the rest of the picture as in the original picture.

The present methods of meeting these requirements are as follows:

- a. and b. The picture is broken up into tiny elements by means of rotating prisms, rotating mirrors, or a combination of both. These elements are each in turn made to fall upon a light sensi-

tive cell which converts the changes in shade to changes of current.

c. The varying current controls a continuous wave oscillator, so its output varies exactly as the current changes in the light sensitive cell. The oscillator energy is then impressed upon a suitable antenna which radiates the light impulses as a modulated continuous wave.

d. The receiving equipment consists of a tuner, rectifier, and the apparatus necessary to amplify the impulses to a required degree.

e. The receiver output is impressed upon a lamp capable of following the current variations with an exact variation in light.

f. The light pulsations are fed to an exact duplicate of the prisms or mirrors used to break up the picture—with this difference: the instrument replaces the elements in their original position.

Methods of synchronizing.

- Current impulse
- Tuning fork
- "Light spots"

The different systems in use or under development

- The Michaelson Transmitter
- The Belin System
- The Jenkins Apparatus

Applications:

1. Picture transmission of public events
2. Entertainment in the home
3. Possibilities for visual as well as audible transmission of lectures, etc.

#### DIRECT-CURRENT TRANSMISSION CONSIDERATIONS<sup>1</sup>

SAMUEL W. MARSHALL, JR.<sup>2</sup>

*An abridgment of a paper for which the author was awarded the Best Branch Paper Prize in Geographical District No. 1 for 1926. A copy of the paper is on file at Institute headquarters.*

The many advances, along both mechanical and electrical lines of development, during the last five years have made an analysis of the considerations of direct current-transmission both interesting and worthy of careful thought. This paper contains some of the most important technical and economic aspects of such an investigation.

By adding one conductor to a single circuit three-phase line and changing to direct current, the capacity can be increased to 175 percent (nearly) of its former value. When a new line is constructed for direct current, the cost of conductors and insulators is about two-thirds of that for an alternating current line. The comparative cost of towers is slightly greater than two-thirds, and that of switches is about 75 per cent.

Power losses in the insulators of an alternating current line are due to: the  $I^2 R$  loss produced by leakage current; the ionization of occluded gases within the dielectric; the oscillatory movement of the particles due to alternating charges; the  $I^2 R$  loss due to charging current; and electrolysis of the dielectric. The first two and the last are encountered in direct current transmission.

Some operating engineers make the insulator strings one or more units longer than is the general practise, in order to increase the factor of safety. In direct current transmission, such additions are very beneficial because the stress per unit is uniform over the entire length, while in alternating current transmission they cause relatively small reductions in the duty of certain units in the string.

The inductive reactance of a line causes almost no detrimental effects upon its operating characteristics when direct current is

used, but performs a useful service in smoothing out the minor surges and transients. Therefore a steel-clad copper conductor is highly desirable for direct current transmission. Its inductive reactance is very high even at low frequencies, and with increase in frequency, the reactance rises rapidly until the steel becomes saturated. The increase in inductance, together with the increase in effective resistance, would cause a marked damping effect upon any surges that might occur.

In d-c. transmission, telephone interference is largely eliminated, and corona loss is less than when alternating current is used.

The protective devices on a d-c. line would be those governed by: (1) overload relays, and (2) over-voltage relays. The switching probably would be done by vacuum tubes and might be arranged to act instantaneously, or to open at such a rate that the total resistance of the circuit would be approximately equal to the surge impedance of the line.

It is assumed that a-c. generating equipment would be used. The most logical form of conversion apparatus is the two-element thermionic tube.

In sharp contrast to the comparatively simple problem of converting alternating to direct current, the problem at the receiving station presents many difficulties. The most promising types of apparatus for converting direct current at high voltage to alternating current are the "magnetron" and the "transverter."

#### CONCLUSIONS

1. D-c. transmission of powers including 60,000 kw., from source to concentrated load, may be considered economically feasible.
2. The "magnetron" offers the best possibilities for conversion.
3. Switching would be done best by tubes.
4. Voltage regulation would be excellent, and large synchronous condensers could be eliminated.
5. D-c. transmission has good possibilities for superpower projects on account of its stability and the absence of synchronizing machinery.
6. The installation of new apparatus or the conversion of an alternating current to a d-c. system would not involve radical departures from present accepted practise, except in the matter of switching, in which direct current has a distinct advantage.

The paper contains a number of curves, connection diagrams, and references.

#### ACKNOWLEDGMENTS

The author gratefully acknowledges the valuable help and suggestions given by Dr. V. Bush and Dr. H. B. Dwight, and the assistance of Mr. K. T. Bainbridge in checking the calculations.

#### NORTH EASTERN DISTRICT AWARDS BEST BRANCH PAPER PRIZE FOR 1926

The Committee on Awards of District No. 1 has awarded the Best Branch Paper Prize for 1926 to Mr. Samuel W. Marshall, Jr. for his paper entitled *Direct-Current Transmission Considerations*, which was presented at the Student Convention of the North Eastern District held at the Massachusetts Institute of Technology on May 7, 1926. Mr. Marshall was at that time a graduate student in electrical engineering at the Massachusetts Institute of Technology.

The prize consists of \$25.00 from the national treasury of the Institute and a suitable certificate of award issued by the officers of the District.

#### GENERAL ENGINEERING COUNCIL ORGANIZED AT STANFORD UNIVERSITY

Officers of the Stanford University Branches of the A. S. C. E., A. I. E. E., A. S. M. E., and A. I. M. E. organized a General Engineering Council on April 13, 1927, and A. V. Perring, Chairman of the Stanford Branch, A. I. E. E., was elected Chairman.

1. Presented at Student Convention, North Eastern District, Massachusetts Institute of Technology, May 7, 1926.

2. Graduate student in electrical engineering, Massachusetts Institute of Technology, 1925-26.

The membership of the Council is to include the chairmen, vice-chairmen, and secretaries of the four Branches and a faculty member elected by each Branch.

#### ELECTRICAL VAUDEVILLE AT LOUISIANA STATE UNIVERSITY

The Louisiana State University Branch held an Electrical Vaudeville on April 21st. The program included thirty exhibits and tricks covering a wide range of electrical and magnetic phenomena as well as some of the laws of liquids, gases, etc. Induction coils, electromagnets, and the principles of motor operation were prominent in the program. In addition to being entertained, the 380 who attended received several surprises.

#### M. I. T. BRANCH DISTRIBUTES PROBLEM SOLUTIONS

During the present academic year, the Massachusetts Institute of Technology Branch has been distributing each Friday, at cost, mimeographed solutions of the home problems assigned during the week just past to juniors and seniors in the Principles of Electrical Engineering. The solutions are distributed just in time for study before the weekly two hour examination. The plan has the full support of the Department of Electrical Engineering, and the problems are solved by members of the faculty.

#### BRANCH MEETINGS

##### Municipal University of Akron

Motion pictures, entitled respectively "The Building of New York's Newest Subway" and "Portable Electricity," were shown. Questions on last subject answered by the Cleveland representative of the Edison Storage Battery Co. April 8. Attendance 42.

##### Armour Institute of Technology

Business Meeting. April 21. Attendance 30.

##### Alabama Polytechnic Institute

Discussion by several members of some of their summer work, and of other engineering subjects. Election of temporary officers for duty at next meeting while the present officers were on Senior inspection trip. March 31. Attendance 43.

*The Relation Between the Engineer and the Pure Scientist*, by James Shirley, student;

*Automatic Train Control*, by L. C. Yancey, student;

*Life of Hugh Grant*, by Comer Pierce, student;

*How Congress Left Muscle Shoals*, by J. K. Smith, student, and *Farm Electrification*, by R. P. Morton, student. April 7. Attendance 31.

*Negro Readings*, by Mrs. Frazier, of Auburn. Questions and Answers of Engineering Interest, by the entire group present. April 14. Attendance 43.

Business Meeting. The following officers were elected: Chairman, T. S. Lynch; Vice-Chairman, S. L. Hancock; Secretary-Treasurer, P. E. Sandlin. April 21. Attendance 46.

Business Meeting. April 29. Attendance 36.

##### University of Arkansas

*The Radio Controlled Car*, by Dick Ray. March 30. Attendance 12.

*Electrical Grounds*, by Carroll Walsh, and

*The Circle Diagram*, by Joe Acker. April 13. Attendance 15.

*Batteries*, by Joe Acker. April 26. Attendance 8.

##### Bucknell University

*The Application of Electricity to Anthracite Coal Mining*, by Wilmon K. Bucknell, Estimating Engineer, Advice and Maintenance Department, Reading Coal and Coke Co. Illustrated with slides. April 13. Attendance 60.

##### California Institute of Technology

*Operation of the Edison Big Creek System*, by Carter Austin, student. April 8. Attendance 15.

##### University of California

Business Meeting. March 30. Attendance 27.

*The Engineers' Outlook*, by L. S. Ready, President, Key System Transit Co. April 14. Attendance 39.

#### Carnegie Institute of Technology

Annual Banquet. Talks were given by Profs. W. R. Work and B. C. Dennison, and R. H. Giles, Chairman-Elect. May 4. Attendance 53.

#### Case School of Applied Science

*Hazards of Static Electricity*, by E. B. Crofts, student;

*Charles Proteus Steinmetz*, by H. H. White, student;

*Recent Developments in the Electrifying of Railroads*, by J. E. Shiland, student; and

*Marconi and Wireless Telegraphy*, by F. R. Hippler, student. April 2. Attendance 54.

*Cyrus W. Field, and the Atlantic Cable*, by W. C. Petersen;

*Bell, and the Invention of the Telephone*, by J. L. Wilcox, and

*The Gas-Electric Bus*, by E. W. Drexler. Appointment of Committees. April 16. Attendance 56.

*Theory, History and Probable Future of Airplanes*, by L. C. Melburn, Chief Engineer, Glenn L. Martin Co. April 20. Attendance 25.

*Vacuum Tubes*, by W. L. Cogger, General Electric Co. April 23. Attendance 53.

Report by G. J. Currie on his experiences at the Regional Meeting and Conference of Counselors and Branch Chairmen at Bethlehem, Pa. Discussion of a farewell party for the Senior Electricals. April 30. Attendance 55.

#### Catholic University of America

Business Meeting. April 21. Attendance 23.

#### Clemson Agricultural College

*Recent Developments in Radio Photography and Television*, by M. A. Jones;

*Application of Electric Drive to Conveyors*, by J. H. Hardee, and *Current Engineering Topics of Interest*, by H. I. Sanders. April 21. Attendance 16.

#### University of Colorado

R. G. Lorraine, student, gave a demonstration of the oscillograph and explained its applications. April 13. Attendance 35.

*Some Phases of the Work at the Moffat Tunnel*, by J. F. Cohig, Chief Resident Engineer of the Moffat Tunnel. Slides. Miniature model of a part of the tunnel used to show the Lewis Cantilever beam for placing mine timbering. Motion picture, entitled "The Story of Dynamite," was also shown. April 27. Attendance 80.

#### University of Denver

*Electric Waves*, by T. R. Cuykendall;

*Principles of the Induction Motor*, by L. L. Booth;

*Phenomenal Welding*, by G. K. Baker;

*Optical Illusions*, by Richard Hays, and

*Description of Electrical Laboratories*, by H. H. Henson. Motion picture, entitled "Queen of the Waves," was shown. Demonstrations of motors, generators, and other apparatus in the laboratory. This meeting was held particularly for parents and immediate friends of the engineering students. Refreshments were served. April 22. Attendance 100.

#### Drexel Institute

*Radio Sending and Receiving Circuits*, by J. H. Broadbent;

*Relay Circuits*, by R. S. Eininger, Jr., and

*Mechanical Construction and Details*, by G. H. Melson. These talks dealt with plans for a radio controlled car for the Spring engineering show. Plans and details for the show were discussed and adopted. April 8. Attendance 28.

#### Duke University

Organization Meeting. The following officers were elected: Chairman, Oren Long; Vice-Chairman, O. T. Colclough; Secretary-Treasurer, W. C. Earnhardt, Jr. February 28. Attendance 11.

*Transatlantic Radio Telephony*, by Mr. Hardin, student. Reading and discussion of the proposed Constitution and By-laws. Discussion of future activities of the Branch. March 21. Attendance 15.

*Flat River Dam and Power Plant*, by D. M. Williams, Assistant Engineer. Nomination of Professor, W. J. Seeley as Counselor. April 4. Attendance 36.

Motion picture of the Southern Power Company's Developments was shown. May 2. Attendance 100.

**Business Meeting.** Appointment of Committee to prepare by-laws and Program Committee. Number of regular meetings to be two per month. May 7. Attendance 17.

#### University of Florida

*Construction and Design of Transformers*, by H. O. Stephens, General Electric Co. Illustrated lecture. March 17. Attendance 12.

Motion picture on Automatic Substation Operation was exhibited. March 22. Attendance 15.

**Business Meeting.** The following officers were elected: Chairman, W. H. Johnson; Secretary-Treasurer, A. C. Dean; Vice-Chairman, F. E. Wray, Counselor, Prof. J. Weil. May 2. Attendance 10.

#### Iowa State College

Motion picture, entitled "Nature's Frozen Credits," was shown. April 7. Attendance 150.

Motion picture, entitled "From Coal to Electricity," was shown. April 13. Attendance 31.

#### State University of Iowa

*Automatic Train Control*, by J. S. Beck. March 2. Attendance 28.

*Electric Heating Applications in Metal Industries*, by H. W. Franks;

*Resonance Control System for Street Lighting*, by M. B. Hurd, and *The Beam Method of Transmitting Radio Signals*, by J. T. Jones. March 9. Attendance 36.

*The Gaseous Conductor Lamp*, by E. J. Flannagan, and *A New Type of Changeable Speed Motor*, by F. L. Kline. April 6. Attendance 32.

*The Use of the Electric Furnace in Melting Gray Iron*, by K. I. Postel, and

*Progress and Development of the Electric Light*, by G. R. Parizek. April 13. Attendance 36.

*Some of the Weak Points in Radio Receivers*, by F. E. Schneider;

*A New Fire Extinguisher for Generators*, by R. Weldy; and *Modern Manufacture of Large Power Transformers*, by W. W. Wertzbauger. April 20. Attendance 36.

#### Kansas State College

*Elements of Success in Engineering*, by Prof. L. M. Jorgenson. April 25. Attendance 73.

*The Development of the Electron Theory of Matter*, by Prof. J. L. Breneman. May 9. Attendance 65.

#### University of Kansas

*Behind the Pyramids*, by Mr. Robinson, National Carbon Co. Illustrated. The following officers were elected: Chairman, Clair Williamson; Vice-Chairman, C. E. Miller; Secretary, D. M. Black; Treasurer, E. McDonald. May 5. Attendance 80.

#### Lehigh University

*Personal Reminiscences of Heaviside and Steinmetz*, by Dr. Ernst J. Berg, General Electric Co. April 22. Attendance 45.

#### Lewis Institute

**Business Meeting.** April 19. Attendance 45.

#### Louisiana State University

**Business Meeting.** Discussion of plans for Electrical Vaudeville. April 7. Attendance 16.

Electrical Vaudeville. See account in first part of Student Activities section. April 21. Attendance 381.

#### Massachusetts Institute of Technology

Inspection trip to Kenmore, Back Bay and Copley Circle offices of the New England Telephone and Telegraph Co. April 13. Attendance 60.

#### Michigan State College

*Diesel-Electric Locomotive*, by A. F. Southwick. Illustrated. March 2. Attendance 24.

*Merits of the Gas-Electric Bus*, by F. Byrne, and

*Synchronous Condensers*, by T. A. Hoffmeyer. Decided that delegate would be sent, if possible, to the joint meeting of the University of Wisconsin, Marquette University and Armour Tech. Branches, to be held in Chicago during the early part of May. April 14. Attendance 34.

#### Engineering School of Milwaukee

*Some Considerations for Determining Rates in Public Service*, by Joseph Havlick, Engineering Accountant, the Milwaukee Electric Railway & Light Co. May 10. Attendance 16.

#### Mississippi A. and M. College

*Power Transformers*, by H. O. Stephens, General Electric Co. March 25. Attendance 16.

#### Missouri School of Mines and Metallurgy

*Automatic Substations in Kansas City*, by Prof. I. H. Lovett;

*Talking Motion Pictures*, by Prof. F. H. Frame, and

*Benefits Derived from A. I. E. E. Meetings*, by Mr. Berry. Appointment of committees. The meeting of the A. I. E. E. at Kansas City, Mo., was discussed by Profs. Frame and Lovett. April 13. Attendance 20.

#### University of Missouri

*The Use of Electric Power on Farms*, by W. G. Davis. April 4. Attendance 25.

*The Design of the Electric Scrubbing Machine*, by R. C. Hase, and *Electric Rate Structures*, by V. L. Tiller. The following officers were elected: Chairman, C. E. Schooley; Vice-Chairman, G. L. Crow; Secretary, W. R. Holmes; Treasurer, E. R. Rehagen. May 2. Attendance 35.

#### Montana State College

*Electricity and the Steel Industry*, by F. W. Jordan, Westinghouse Electric and Mfg. Co. April 5. Attendance 161.

*Problems Arising from the Interconnection and Expansion of Power Systems*, E. A. Elge. April 15. Attendance 176.

*The Aurora and Radio*, by C. W. Reitsch, and

*The Gaseous Conductor Lamps*, by C. T. Oberbauer. April 22. Attendance 166.

#### University of Nebraska

Inspection trip to plant of Lincoln Tel. & Tel. Co. Refreshments. Motion pictures. Announcements regarding Engineers' Week. April 13. Attendance 40.

#### University of Nevada

**Business Meeting.** Discussion of personnel records. April 4. Attendance 19.

Motion picture, entitled "The Single Ridge—The Story of Wire and Cable," was shown by Prof. S. G. Palmer. The following officers were elected: Chairman, Kenneth Knopf; Vice-Chairman, Leslie Clover; Secretary-Treasurer, Clark Amens. April 21. Attendance 16.

#### Newark College of Engineering

*Gas-Electric Buses*, by S. Cozza, student, and

*Electricity in Mines*, by A. Becker, student. April 6. Attendance 22.

*The Electronic Theory*, by Prof. F. N. Entwisle. Branch decided to purchase a motion picture machine in cooperation with A. C. S. and A. S. M. E. Branches. May 4. Attendance 32.

#### University of New Hampshire

*Opportunities Offered by the Telephone Company*, by Mr. Appel, New England Tel. & Tel. Co. March 9. Attendance 48.

*Electrification of the Chicago, Milwaukee and St. Paul Railroad*, by M. B. Smith, student, and

*General Electric 110-Ton Gasoline-Electric Storage Battery Locomotive*, by C. L. Morreels, student. March 16. Attendance 35.

A motion picture, entitled "From Coal to Electricity," was shown. April 2. Attendance 41.

*Television*, by C. Spillaine, student, and

*The Fynn-Weichsel Motor*, by H. B. Rose, student. April 9. Attendance 31.

*Kohler Electric Light and Power Systems*, by M. B. Sargent, student, and

*Magnetic Blowouts*, by L. C. Simpson, student. April 16. Attendance 22.

*Talking Motion Pictures*, by W. P. Thurber, student;

*Lightning Arresters*, by J. F. Stevens, student, and

*New Types of Railway Cars*, by T. C. Tappan, student. April 23. Attendance 31.



**College of the City of New York**

Inspection trip to the Okonite Company Wire Plant at Passaic. April 19. Attendance 6.

Motion picture, entitled "The Wizardry of Wireless," was exhibited. April 28. Attendance 53.

Inspection trip to the U. S. S. *Colorado*. May 6. Attendance 24.

Inspection trip to the boiler works of the Babcock and Wilcox Company and Durant Motor Car Company plant. May 9. Attendance 15.

**University of North Carolina**

*The Fundamental Circuit of Radio*, by T. B. Smiley. April 14. Attendance 22.

The Branch joined the William Cain Society in attending an illustrated lecture by C. E. Waddell of Asheville, N. C. April 28. Attendance 20.

**University of North Dakota**

*Synchronous Condensers*, by Mr. Johnston;

*Gatineau Power Development Project*, by Bair, and

*Communication on Wavelengths Not in General Use*, by Mr. Houck. April 11. Attendance 24.

Business Meeting. Discussion of exhibits for Engineers' Day. May 2. Attendance 32.

Business Meeting. The following officers were elected; Chairman, Alfred Botten; Vice-Chairman, George Renaud; Secretary-Treasurer, Nels Anderson. May 9. Attendance 17.

**Ohio Northern University**

*Life of the Late B. G. Lamme*, Chief Engineer of the Westinghouse Elec. & Mfg. Co. April 21. Attendance 20.

**Ohio State University**

*Railway Signaling*, by C. R. Beall, Assistant Chief Engineer, Union Switch and Signal Co. March 11. Attendance 60.

*History of Lighting*, by Prof. F. C. Caldwell, Counselor. The following officers were elected: President, A. B. Crawford; Vice-President, J. H. Hackenberg; Junior Chairman, R. H. Spry; Secretary-Treasurer, L. G. Stewart. April 7. Attendance 85.

**Oklahoma A. and M. College**

*Water Resources of Oklahoma for Power and Irrigation*, by E. R. Page, Assoc. Prof. of Elec. Engg., University of Oklahoma, and

*Telephone Transmission and Protection*, by E. B. Jennings, Engineer. Southwestern Bell Telephone Co. Joint meeting with Oklahoma Section. May 5. Attendance 61.

**University of Oklahoma**

*What I Didn't Know When I Graduated*, by V. A. Pendleton, Asst. Distribution Manager, Oklahoma Gas and Electric Co. Discussion of plans for Branch baseball team. The following officers were elected: Chairman, Dick Mason; Vice-Chairman, LeRoy Moffett; Secretary, Sterl Harmon; Treasurer, Elwood Kaiser. April 21. Attendance 24.

**Oregon Agricultural College**

*Development and Applications of Electrical Controls*, by H. D. James, Westinghouse Elec. & Mfg. Co. April 12. Attendance 36.

**Pennsylvania State College**

Motion picture, entitled "From Coal to Electricity," was shown. April 27. Attendance 45.

**Purdue University**

*Superheterodynes—Their Practical Construction and Theory of Operation*, by A. B. McCullah, student, and

*Electricity Vs. Steam in Motive Power*, by A. L. Witbeck, student. April 19. Attendance 40.

*Automatic Telephone Systems*, by G. V. Morris, Air Brake Laboratory. A practical demonstration was given with a model system. Mr. Anderson, of the C. M. & St. P. R. R. Co., discussed the electrification of his company's road and its proved advantages. The following officers were elected: Chairman, H. L. Lindstrom; Vice-Chairman, L. R. Johnson; Secretary, H. A. Hartley; Treasurer, W. P. Place. May 3. Attendance 46.

**Rensselaer Polytechnic Institute**

*A Few Aspects of Today's Public Utility Economics*, by Samuel Ferguson, President of the Hartford Elec. Lt. Co. and Association of Edison Illuminating Companies. Dr. P. C. Ricketts, Director of the Institute, spoke on the progress of electrical engineering since his undergraduate days. April 13. Attendance 130.

**Rhode Island State College**

Business Meeting. The following officers were elected: Chairman, C. F. Easterbrooks; Vice-Chairman, W. G. Johnson; Secretary, Charles Miller. April 6. Attendance 16.

*Electrification of the Virginian Railway*, by Chas. Wales, Westinghouse Elec. & Mfg. Co. Lantern slides. April 26. Attendance 23.

Inspection trip to R. C. A. Radio Station at Marion, Mass. April 27. Attendance 12.

**Rutgers University**

Trip of Senior Class to Pittsfield, Mass., and Schenectady, N. Y. The following officers were elected: President, N. A. Kiet; Vice-President, J. Cost; Secretary-Treasurer, J. E. Conover; Recording Secretary, E. T. Wilson. May 9. Attendance 24.

**University of Santa Clara**

Business Meeting. Discussion of selection of paper to be presented by Branch at meeting at University of California on April 29. March 29. Attendance 23.

**South Dakota State School of Mines**

*Communication and Progress*, by G. M. Bickley, Northwestern Bell Telephone Co., and

*Plant Engineering*, by E. L. Yetter, Northwestern Bell Telephone Co. April 13. Attendance 28.

**University of South Dakota**

Business Meeting. April 27. Attendance 9.

**University of Southern California**

*Preparing for a Better Job by Being Active in Student Activities*, by R. E. Rowley, Los Angeles Bureau of Power and Light. March 30. Attendance 32.

**Stanford University**

Inspection trip to Marsh Radio Station of the Federal Telegraph Co. March 5. Attendance 30.

*Motors and Their Control*, by H. D. James, Westinghouse Elec. & Mfg. Co. April 6. Attendance 39.

**Swarthmore College**

*History and Development of Hot Water Heaters*, by H. L. Long, President, Kompak Water Heater Co. April 11. Attendance 25.

**Syracuse University**

*Hydraulic Development on Beaver River*, by H. E. Slone. March 17. Attendance 22.

*Electrification of Mexican Railroads*, by M. C. Waters. March 24. Attendance 24.

*Water Power Development in Canada*, by N. W. Seiter. March 31. Attendance 24.

**University of Texas**

*Transmission of Pictures by Wire*, by A. P. Lancaster, Western Electric Co. March 9. Attendance 45.

*Important Developments and Engineering Achievements of the General Electric Co.*, by John Liston, Technical Writer, Publication Bureau, General Electric Co. Slides. March 15. Attendance 15.

*Discussion of Harmonic Curves*, by L. E. Brown, student. April 13. Attendance 19.

**Virginia Military Institute**

*Fifty Years Progress in Electrical Communication*, by A. W. Griffith;

*The Use of Electricity in the Mines*, by S. C. Robinson;

*Computation of the Unbalance Factor of a Three-Phase Triangle*, by F. Barkus, and

*The Induction Lamp*, by S. H. Franklin. April 11. Attendance 48.

*Special Features of the Power System of the U. S. Government Explosives Plant "C"*, by M. L. Waring;

*The Future of the Standardization Movement*, by C. P. Bowman, and

*The Raising of the S-51*, by M. T. Docker. April 20. Attendance 45.

#### Washington State College

*Electric Welding*, by Mr. Lommanson. Joint meeting with the Idaho Branch was discussed. April 20. Attendance 25.

#### Washington University

*Report on A. I. E. E. Student Convention*, by E. B. Kempster, and *Report of Smoker Committee*, by C. C. Duncan. Discussion of the Smoker which is to be held April 14 at the Engineer's Club of St. Louis. April 7. Attendance 30.

*Changes in the Position and Character of the Engineering Profession*, by W. A. Layman. Smoker. Motion pictures were shown, including some taken on the campus and "The Queen of the Waves." Refreshments. April 14. Attendance 150.

#### University of Washington

*Research*, by B. A. Case, student, and Professor George Smith. April 6. Attendance 15.

*The Carrier Current Telephone System*, by B. O. Bach, Pacific Tel. & Tel. Co. The following officers were elected: Chairman, William Bolster; Secretary-Treasurer, Arthur Peterson. May 4. Attendance 27.

#### West Virginia University

*Stroboscopic Method of Testing Walthour Meters*, by H. P. Sparkos, Meter and Transformer Specialist, Westinghouse Elec. & Mfg. Co. April 20. Attendance 54.

*Automatic and Machine Switching Telephone Exchanges*, by E. H. Braid and C. B. Binns.

*KDKA Broadcasting Station of Pittsburgh*, by W. F. Davis and A. M. Kalo;

*National Tube Works*, by W. L. Nuhfer and James Cricchi;

*High-Tension Testing Laboratory at Trafford*, by I. L. Smith and W. W. Reed;

*The Colfax Power Plant*, by G. R. Latham and G. H. Cornell;

*Drilling Holes of a Polygon Cross-Section*, by E. R. Long and A. L. P. Schmeichel;

*Springdale Power Plant*, by G. E. Meintel and H. S. McGowan; and

*The Westinghouse Manufacturing Plant*, by K. D. Stewart and H. S. Muller. The papers presented were by seniors, the subjects pertaining to the plants and factories inspected on the recent eastern tour of graduating students. May 6. Attendance 37.

#### Worcester Polytechnic Institute

*The D-c. Side of Heavy Electrification*, by W. D. Bearse, General Electric Co. Slides. February 25. Attendance 37.

## Engineering Societies Library

The library is a cooperative activity of the American Institute of Electrical Engineers, the American Society of Civil Engineers, the American Institute of Mining and Metallurgical Engineers and the American Society of Mechanical Engineers. It is administered for these Founder Societies by the United Engineering Society, as a public reference library of engineering and the allied sciences. It contains 150,000 volumes and pamphlets and receives currently most of the important periodicals in its field. It is housed in the Engineering Societies Building, 29 West Thirty-ninth St., New York.

In order to place the resources of the Library at the disposal of those unable to visit it in person, the Library is prepared to furnish lists of references to engineering subjects, copies or translations of articles, and similar assistance. Charges sufficient to cover the cost of this work are made.

The Library maintains a collection of modern technical books which may be rented by members residing in North America. A rental of five cents a day, plus transportation, is charged.

The Director of the Library will gladly give information concerning charges for the various kinds of service to those interested. In asking for information, letters should be made as definite as possible, so that the investigator may understand clearly what is desired.

The library is open from 9 a. m. to 10 p. m. on all week days except holidays throughout the year except during July and August when the hours are 9 a. m. to 5 p. m.

#### BOOK NOTICES APRIL 1-30, 1927

Unless otherwise specified, books in this list have been presented by the publishers. The Society does not assume responsibility for any statement made; these are taken from the preface or the text of the book.

All books listed may be consulted in the Engineering Societies library.

##### DIE ALCHEMIE DES GEBER.

By Ernst Darmstaedter. Berlin, Julius Springer, 1922. 202 pp., illus., 10 x 7 in., boards. 13,25 r. m. (Gift of Author.)

At the end of the thirteenth or beginning of the fourteenth century A. D., there appeared a manual of theoretical and experimental chemistry which was so clear and concise an account of the general chemical practise of that time that it influenced chemists for several centuries. This work, by an unknown writer under the name of Geber, was long believed to be a translation of Arabian manuscripts of Gheber, an Arabian alchemist of the eighth or ninth century, but that opinion is no longer held.

Numerous editions were printed during the sixteenth century, and an English translation appeared in 1678. These are all scarce, so this translation into German will be welcome to students of the history of science. Dr. Darmstaeder has translated the four books usually ascribed to Geber, with one of more doubtful ascription, and has added a wealth of comment upon the text, and a valuable glossary of alchemistic terms. The illustrations are taken from books of the period.

##### STANDARD WIRING FOR ELECTRIC LIGHT AND POWER.

By H. C. Cushing, Jr., N. Y., H. C. Cushing, Jr. 1927. 496 pp., illus., diags., tables, 7 x 4 in., fabrikoid. \$3.00.

Although great changes cannot be expected in a work that is republished each year, the 1927 edition of this well-known handbook contains a good deal of new material, particularly with respect to house wiring and the lighting of dwellings and commercial establishments. The book remains a thoroughly satisfactory manual of correct wiring practise, comprehensive enough to meet all usual requirements, and strictly in accordance with the National Electrical Code.

##### EINFUEHRUNG IN DIE ELEKTRIZITATSLEHRE.

By R. W. Pohl. Berlin, Julius Springer, 1927. 256 pp., illus., 10 x 7 in., cloth. 13,80 r. m.

A course of lectures upon electricity, intended to form parts of an introductory course upon experimental physics for students of science and engineering. The presentation has many interesting features. The text is clear and logical, the experiments are well chosen and clearly illustrated, and the subject is covered within reasonable time.

##### ELECTRIC POWER TRANSMISSION.

By Alfred Still. 3rd edition. N. Y., McGraw-Hill Book Co., 1927. 412 pp., illus., diags., tables, 9 x 6 in., cloth. \$4.00.

A presentation "of the fundamental principles and scientific laws which determine the correct design of power lines." The author discusses economic and mechanical principles, as well as electrical ones, but does not consider practical details of con-

struction, maintenance nor operation. The work is intended primarily for the engineer in practise but is also adapted for use as a college text.

#### ELECTRIC SWITCH AND CONTROLLING GEAR.

By Charles C. Garrard. 3d edition. Lond., Ernest Benn, 1927. 783 pp., illus., diags., tables, 10 x 6 in., cloth. 63 s. (Gift of Author.)

The main objects of this handsome book are to classify electric switch and controlling gear and to state the principles underlying its design and construction.

The initial chapter is concerned with materials and methods of manufacturing. Succeeding chapters are devoted to apparatus for making and breaking circuits, for preventing a dangerous condition of the current flowing, for regulating the amount of current and for starting and controlling electrical machinery, to switchboards, and to apparatus for protection against abnormal conditions. The varieties of apparatus included in each of these groups are explained and representative commercial examples are described.

This edition has been revised in the light of new standard specifications and of recent developments in the art.

#### LECTURES ON THEORETICAL PHYSICS, v. 1.

By H. A. Lorentz. Lond. & N. Y., Macmillan Co., 1927. 195 pp., 9 x 6 in., cloth. \$4.00.

The first of a series of volumes which will present the courses of lectures which Professor Lorentz has delivered at the University of Leiden. Two of these courses, one upon "Ether theories and ether models," delivered in 1901-1902, and one upon "Kinetical problems," delivered in 1911-1912, are contained in this first volume.

The first course describes the attempts of Stokes, Maxwell, Kelvin and others to account for various phenomena, especially electromagnetic ones, by means of speculations about the structure and properties of the ether. The second discusses some questions belonging partly to the domain of the kinetic theory of gases and partly to that of the electron theory.

This translation of the lectures of the eminent physicist will be welcomed by all students of theoretical physics.

NEMA HANDBOOK OF RADIO STANDARDS. 2nd edition, March 1927. N. Y., National Electrical Manufacturers Association, 1927. 50 pp., diags., 9 x 6 in., paper. \$1.00.

The standards given here have the approval of a group of manufacturers which has considered both commercial and technical problems in formulating them. They deal with questions of the construction of radio apparatus and with methods of testing. The instructions cover a variety of matters connected with transmitters, receivers, batteries and other sources of power, and vacuum tubes.

#### PHYSICO-CHEMICAL GEOLOGY.

By R. H. Rastall. N. Y., Longmans, Green & Co., 1927. 248 pp., diags., 9 x 6 in., cloth. \$6.00.

The purpose of this book is to give in a connected form some account of the application of modern theories of physical chemistry to geological problems. It is intended for readers with a knowledge of geology and mineralogy.

The subjects treated include fusion and solidification, isomorphism and solid solutions, polymorphism and inversions, igneous rocks, mineral formation, metamorphism, rock weathering, mineral deposits and colloids. The author aims to point out a method of treatment that will prove useful in the precise study of certain branches of geology which have hitherto lacked precision in their statement.

#### PRINCIPLES OF MERCURY ARC RECTIFIERS AND THEIR CIRCUITS.

By David Chandler Prince and Francis Brooke Vogdes. N. Y., McGraw-Hill Book Co., 1927. 233 pp., illus., diags., tables, 9 x 6 in., cloth. \$3.00.

This study of rectifiers is divided into two sections, dealing respectively with rectifiers themselves, and with the circuits in which they operate. The first section opens with a chapter on kenotron rectifiers, followed by another upon the tungar rectifier. Mercury arc rectifiers are then taken up, and their construction, theory and physical properties are discussed.

The second part is devoted to presenting an accurate picture of what occurs in rectifier circuits. The fundamental wave shapes of rectifiers are discussed, together with the phenomena of regulation and allied problems. The authors are connected with the research laboratory of the General Electric Company.

#### PROBLEMS OF MODERN PHYSICS.

By H. A. Lorentz. Bost. & N. Y., Ginn & Co., 1927. 312 pp., 8 x 6 in., cloth. \$3.60.

These lectures are a scholarly discussion of many important questions confronting the physicist of today, by one of the leading workers in that science. The propagation of light in different media, the structure and mutual action of atoms, the ideas of the theory of quanta and their application to the Zeeman effect, and the theory of relativity and its effect on the fundamental laws of dynamics are among the subjects.

#### RASCHLAUFENDE OLMASCHINEN.

By Otto Kehler. Mün. u. Ber., R. Oldenbourg, 1927. 111 pp., diags., plates, tables, 11 x 8 in., paper. 10.-r. m.

Presents the results of a thorough experimental and theoretical study of a modern hot-bulb, high-speed oil engine, discusses the behavior of high-speed Diesel engines of various designs and concludes with a comparison of these with gas engines. The investigation was made at the Munich Technical High School.

#### REPORT, 1926-27, of the North Jersey Transit Commission.

Jersey City, 1927. 281 pp., illus., plates, diags., tables, 9 x 6 in., cloth. Price not quoted. (Gift of Glenn S. Reeves, Ass't Chief Engineer.)

This progress report of the Commission is chiefly devoted to two important parts of its general plan. The engineering report, which is confined to the question of commuter traffic between New Jersey and New York City, presents various plans that have been developed for connecting the rapid transit systems of New York with the various railroads serving New Jersey, to care for the three hundred thousand persons who travel back and forth each day. The second report, upon financing, is of more than local interest. It is an exhaustive study of methods for financing great public improvements, including a valuable discussion of the theory of benefit assessments. The author of this report, Mr. P. H. Cornick, recommends that the proposed rapid transit system be financed by public funds obtained through local benefit assessments.

#### S. A. E. HANDBOOK, March 1927.

Society of Automotive Engineers. N. Y., The Society, 1927. Various paging, illus., diags., tables, 8 x 5 in., fabrikoid. \$5.00.

The Handbook contains the standards and recommended practices of the Society of Automotive Engineers, including the modifications adopted since the previous publication in October, 1926. Sixteen revisions are recorded, four new standards are given, and eight former practises are cancelled.

The recommendations cover the materials entering into the construction of internal combustion engines, automobiles, motor boats and airplanes. Many of them have, of course, much wider applicability than within the field of the Society, and the book is in consequence a useful reference work to builders of machinery generally.

#### TREATISE ON THE MATHEMATICAL THEORY OF ELASTICITY.

By A. E. H. Love. 4th edition. Lond., Cambridge University Press; N. Y., Macmillan Co., 1927. 643 pp., 11 x 7 in., cloth. \$13.50.

The fourth edition of this work, the classical treatise in the English language, will be welcomed by mathematicians; for while it does not present any marked changes from the second and third editions, it has been revised and extended to cover the researches published since 1914.

The most important additions are concerned with the theory of a rectangular plate, clamped at the edges and bent by pressure applied to one face; the theory of the resistance of a very thin plate to pressure; and the process by which stress-strain relations are deduced from the molecular theory of a crystalline solid. The theory of the equilibrium of a sphere has been simplified and its application to geophysical problems made easier.

In addition to being a masterly exposition of the subject, the book is noteworthy for its very complete set of references to the original papers and memoirs dealing with the theory of elasticity.

#### TWO LECTURES ON THE DEVELOPMENT AND PRESENT POSITION OF CHEMICAL ANALYSIS BY EMISSION SPECTRA.

By F. Twyman. Lond., Adam Hilger [1927]. 43 pp., illus., 10 x 6 in., cloth. 2s. 8d.

These lectures deal with the history and development of spectrum analysis. They trace the subject from its origin, describe modern apparatus, explain the production, observation and photographing of spectra, and discuss the applications of spectrum analysis. The advantages of the method are pointed out.

# Engineering Societies Employment Service

*Under joint management of the national societies of Civil, Mining, Mechanical and Electrical Engineers cooperating with the Western Society of Engineers. The service is available only to their membership, and is maintained as a cooperative bureau by contributions from the societies and their individual members who are directly benefited.*

Offices:—33 West 39th St., New York, N. Y.,—W. V. Brown, Manager.

53 West Jackson Bl'v'de., Room 1736, Chicago, Ill., A. K. Krauser, Manager.

57 Post St., San Francisco, Calif., N. D. Cook, Manager.

**MEN AVAILABLE.**—Brief announcements will be published without charge but will not be repeated except upon requests received after an interval of one month. Names and records will remain in the active files of the bureau for a period of three months and are renewable upon request. Notices for this Department should be addressed to **EMPLOYMENT SERVICE, 33 West 39th Street, New York City**, and should be received prior to the 15th day of the month.

**OPPORTUNITIES.**—A Bulletin of engineering positions available is published weekly and is available to members of the Societies concerned at a subscription rate of \$3 per quarter, or \$10 per annum, payable in advance. Positions not filled promptly as a result of publication in the Bulletin may be announced herein, as formerly.

**VOLUNTARY CONTRIBUTIONS.**—Members obtaining positions through the medium of this service are invited to cooperate with the Societies in the financing of the work by nominal contributions made within thirty days after placement, on the basis of \$10 for all positions paying a salary of \$2000 or less per annum; \$10 plus one per cent of all amounts in excess of \$2000 per annum; temporary positions (of one month or less) three per cent of total salary received. The income contributed by the members, together with the finances appropriated by the four societies named above, will it is hoped, be sufficient not only to maintain, but to increase and extend the service.

**REPLIES TO ANNOUNCEMENTS.**—Replies to announcements published herein or in the Bulletin, should be addressed to the key number indicated in each case, with a two cent stamp attached for reforwarding, and forwarded to the Employment Service as above. Replies received by the bureau after the positions to which they refer have been filled will not be forwarded.

## POSITIONS OPEN

**ELECTRICAL DESIGNER AND ENGINEER**, for large power company. Technical graduate, five to ten years' experience laying out substations and generating stations for large utility companies. Must be good draftsman, prepared to make finished drawings in pencil. Apply by letter, giving full details, age, salary desired, references and photograph, also sample of work. Opportunity. Location, Canada. X-2544-C.

**LARGE PUBLIC UTILITY** in middle west wants young electrical engineering graduate of the class of 1923 or 1926 for investigation and research work on underground cables, transmission and distribution systems, and general central station problems. Apply by letter, giving age, education, experience, and enclose photograph. X-2021-C-S.

**PUBLIC UTILITY IN BRAZIL** requires experienced operating man as chief of hydro-electric plant. Must have at least ten years' experience in operating water power plants, a part of time in responsible charge. Plant modern and medium size. Location healthy. Married man preferred, and knowledge of Portuguese or Spanish very desirable. Apply by letter giving complete resumé of experience, references and salary required. X-2487-C-S.

**ELECTRICAL ENGINEER**, having contracting business experience wanted as partner. Reply must state business experience and amount of capital he can invest. References asked and given. Apply by letter. Location, New York City. X-2624.

**MANAGING EDITOR**, thoroughly trained, expert trade paper and merchandising man, with theoretical and practical knowledge of radio. Apply by letter giving full particulars. Location East. X-2583.

## MEN AVAILABLE

**ELECTRICAL ENGINEER**, 24, single, B. S. in E. E. 1924, with three years' industrial experience, desires permanent position with consulting firm or industrial organization. Location preferred, New York City or vicinity. B-8400.

**EXPERIENCED OPERATOR** for public utility, desires a position operating where same might lead to promotion to load dispatching. Has had practical experience along this line. Thoroughly experienced in the operating of the entire plant on shift. Can furnish best of references. Available after a reasonable notice. C-2838.

**ELECTRICAL ENGINEER**, with successful seventeen years' record here and abroad. Development and research in advanced electro-mechanical problems; automatic train control, safety devices for navigation, high voltage rectification, low voltage technique. Conscientious, good judgment, knowledge of languages and patent routine, M. E. and E. E. degrees. Location desired, New York City, unless offer is very interesting. A-165.

**GRADUATE ELECTRICAL ENGINEER**, American, single, age 30, desires position as electrical engineer in sugar factory or public utility company, preferably in the Tropics. Has had three years' experience as electrical engineer in charge of electric plants and electrical equipment in large sugar factories in Porto Rico and Santo Domingo. Speaks Spanish. At present employed, but desirous of securing better position. B-6778.

**OPERATING ENGINEER**, 30, married, fully qualified engineer, with over fifteen years' actual experience in the operation and maintenance of electric light and power plants. Specially trained in boilerhouse efficiency and fuel economy. Location, anywhere. C-2694.

**ELECTRICAL ENGINEERING GRADUATE OF M. I. T.**, with twenty months' varied utility experience and recognized initiative and executive ability, desires utility connection as assistant to executive, or in new business department. Prefers East, but will go anywhere. C-803.

**ASSISTANT TO EXECUTIVE**, executive experience, scientific mind, engineering knowledge offered executive who demands exceptional ability and exact results. Training: M. I. T. five years in chemistry, mathematical physics, mechanical engineering. Now employed as industrial engineer. Experience: reports, technical writing, design, shop, scientific, industrial and financial research, systematizing, estimates and costs on equipment, buildings, labor. Economist. B-9930.

**YOUNG MAN** desires position in the power field with opportunity for advancement assured. Graduate of school of recognized standing, and considerable general practical experience. Single, 26 years of age. Available four to six weeks after notification. Employed at present, but desires change to the above. East or Southeast preferred, though secondary consideration to opportunity. C-2940.

**GRADUATE ELECTRICAL ENGINEER**, B. S. in E. E., four years' experience with trans-

formers, mostly in design. Desires power sales in the East, or engineering development, also would teach, location being immaterial. 30 years of age married. C-2944.

**ELECTRICAL ENGINEER**, graduate of Wisconsin 1920, seven years' experience in utility engineering and operation. Will consider sales or commercial proposition in which engineering training will be advantageous. Work leading to executive in public utility preferred. C-2943.

**SUPERINTENDENT OF ELECTRICAL CONSTRUCTION**, 34, married, thoroughly competent to take complete charge of large installations. Six years' actual experience on commercial buildings, city schools, power plants and signal stations. Would also consider plant maintenance. Master License. Available immediately. Location, New York City. B-9638.

**ELECTRICAL-MECHANICAL ENGINEER**, technical graduate, 1924, 29, married, with four years' electrical maintenance experience in steel mills previous to graduating, ten months G. E. test, and two years switchboard design and control layout, desires change. Prefers industrial control or maintenance engineering, also interested in research or design. Location, North Central States. C-2902.

**ELECTRICAL ENGINEER**, 32, married, B. S. in E. E., 1920, fifteen months General Electrical test, five years' teaching experience in college and university, to complete work for M. S. in E. E. this summer, Massachusetts Institute of Technology, desires position as professor in electrical engineering, or connection with public utility or manufacturing company. Location preferred, United States. Available September 1st. C-2906.

**ELECTRICAL ENGINEER**, available as superintendent, manager or assistant, age 32. Inured to hard work and responsibility and traveling. Ten years direct practical steam, electrical and shop. Last four years in full charge, including office, all details operation, reconstruction and enlargement completed system in Tropics. Performance in isolated situation on own resources. B-5803.

**DISTRIBUTION ENGINEER**, age, 27, single, graduated in 1924, one and one half years' experience on test with Westinghouse, sixteen months with a public utility. Desires position with public utility as a distribution engineer with wider field than at present. Available in two weeks. C-790.

**PRODUCTION ENGINEER OR MANAGER**, competent engineer and executive trained

on production control, scheduling, machine operations, equipment, budgeting, valuations, costs, wage incentives, with technical and college degrees and background of electrical and mechanical engineering experience with eleven years' constructive record of development, desires position in Eastern States. Now engaged on installing production control methods in large organization. Age 32, married. B-9676.

**GRADUATE ELECTRICAL DESIGNING AND CONSTRUCTING ENGINEER**, fifteen years' experience light, power, distribution, transformation, high and low tension work in connection with railway stations and facilities, public buildings, industrial plants. Location, Central West. B-508-84.

**ELECTRICAL AND MECHANICAL ENGINEER**, technical graduate, fifteen years' experience, twelve of which have been engineering for large public utilities. Now employed in charge of electrical work for power plants and substations. Has had transmission line and steam experience. Desires responsible position requiring technical and executive ability. B-5842.

**ELECTRICAL ENGINEER**, desires supervisory position. Fifteen years electrical distribution, transmission, construction, maintenance, engineering stores and materials, engineering accounting, estimating appraisals, costs, organization, ten years electrical installations estimating, engineering power and illumination. Practical with technical training. Handle men. B-5347.

**MARINE ELECTRICAL ENGINEER**, technical graduate E. E., thoroughly competent to supervise installation of electrical equipment and circuits aboard steamer or Diesel type vessels. Able to get quick results and carry out with minimum cost electrical repair jobs on large shops. Has had a large amount of experience installing both electric and oxy-acetylene plants and operating welding departments. Able to get up price estimates on either electrical or welding jobs on short notice. Holds first assistant marine engineer's license, unlimited tonnage. A-2932.

**ENGINEERING EXECUTIVE**, ten years' experience in factory and power plant construction and installation of mechanical and electrical equipment, five years operation, maintenance and research work, four years contract and executive engineering. Age 39. Desires Eastern connection, New York or vicinity. A-2280.

**TECHNICAL GRADUATE**, B. S. (E. E.), and B. S. (M. E.), one year's teaching experience, three years in electrical maintenance, four years in A. C. and D. C. distribution work combined with high tension cable testing and insulation research on splices and compounds. Married. Available one month. B-8886.

**GRADUATE ELECTRICAL ENGINEER**, wishes to make connection with an electrical firm, nine years maintenance, installation and testing of electrical equipment. Location, New York City or New Jersey. C-3006.

**ELECTRICAL ENGINEER**, graduate of high grade technical school, sixteen years with large electrical manufacturer, including apprentice course, research and development work, materials and process engineer, design and application of control apparatus, desires operating or design position, or situation in consulting engineering firm. Location, Pacific Coast region or South preferred, but not essential. C-2986.

**ELECTRICAL ENGINEER**, 33, with broad technical education. Has had eight years of signal and communication experience in many different phases. Has had three and one-half years' experience as supervisor in this line of work. Would prefer position where ability to supervise is an important factor. C-2982.

**JUNIOR ELECTRICAL ENGINEER**, 28, single, receive B. Sc. degree in E. E. August 1, 1927. Inventive ability. Can handle men. Open to any branch of electrical engineering offering a future. Location preferred, United States. Available after August 15th. C-2862.

**SALES ENGINEER**, 32, married thorough experience operation, maintenance power and heating equipment. Exceptional record in sales and sales direction with line of heating equipment.

Desires connection as manufacturer's sales representative. B-7551.

**ELECTRICAL ENGINEER**, wishes position with aggressive organization in the East. Twelve years in all phases of utility and industrial power generation and industrial and building distribution and lighting. Reports, design, purchase, contracts, construction and test. Especially suited for organization where varied experience would be useful. C-2570.

**ASSISTANT TO TRANSMISSION LINE ENGINEER**, college graduate, 28, married, has three years' experience in design of transmission lines with regard to mechanical features and safety. Experience includes application of safety codes, design of structures, sag and tension calculations, pole spotting, estimating, etc. Employed at present. C-3033.

#### AGENTS REPRESENTATIVES

**ENGINEER**, well acquainted with important industrial and export buyers in New York Metropolitan District and environs and maintaining own sales office now distributing bituminous coal, is desirous of acquiring accounts from power equipment or supply manufacturers suitable for trade already developed. Highest class representation assured. B-6603.

**ENGINEER**, calling on master mechanics and chief electricians in industrial plants, also construction and operating departments of power companies, desires additional accounts. Office facilities in San Francisco and at present covering adjacent field with occasional visits to other points on the Pacific Coast, with the intention of developing especially California business. B-7371.

**ELECTRICAL ENGINEER**, 29, single, graduate University Washington, completed General Electric Company test course and motor sales training. Four years' experience engineer industrial installations and technical sales, three years radio. Desires to become manufacturer's agent Southern California for reputable engineering manufacturers. C-2998-5-C-29.

## MEMBERSHIP — Applications, Elections, Transfers, Etc.

### ASSOCIATES ELECTED MAY 20, 1927

- ANDERSON, OSCAR MANFORD, Junior Engineer, Cutler-Hammer Mfg. Co., 12th & St. Paul St., Milwaukee, Wis.
- ANGEL, HERBERT, Telegraph Engineer, Western Union Telegraph Co., 195 Broadway, New York, N. Y.
- ANGUS, D. GORDON, Engineer, Bell Telephone Laboratories, Inc., 463 West St., New York; res., Rockville Centre, N. Y.
- ANKENEY, FREDERICK NEWCOMER, Chief Engineer, Philadelphia Area, Bell Telephone Co. of Penn., 1835 Arch St., Philadelphia, Pa.
- APPLEGATE, GEORGE MACPHERSON, Engineering Assistant, Bell Telephone Co. of Penn., 416 7th Ave., Pittsburgh, Pa.
- ARTHUR, E. S., Estimator, New York Edison Co., 327 Rider Ave., New York, N. Y.; res., Stamford, Conn.
- AUBY, LAWRENCE C., Assistant Distribution Engineer, Illinois Power & Light Corporation, 500 Compton Bldg., St. Louis, Mo.
- BHAMAN, RAM CHANDRA, Electrical Engineer, Tata Iron & Steel Co., Ltd., 10, B Road, East, Jamshedpur, India.
- BIRNIE, JOHN, JR., Designer, Brooklyn Edison Co., Pearl & Willoughby Sts., Brooklyn, N. Y.
- \*BLINN, EARL FRANKLIN, Graduate Student, Educational Dept., Westinghouse Elec. & Mfg. Co., East Pittsburgh, Pa.; res., Woodbury, N. J.

- BORNHOLZ, FRED. JAY, Substation Assistant, Electrical Dept., Shanghai Municipal Council, Shanghai, China.
- BOYKIN, RALPH EUGENE, Tester, Brooklyn Edison Co., 360 Pearl St., Brooklyn, N. Y.
- BROWNE, VINCENT F., Electrical Instructor, Boys Vocational School, Newark, N. J.; res., Long Island City, N. Y.
- BRYDON, EARLE MCKENZIE, Field Engineer, Public Service Co. of Northern Illinois, 114 N. Oak Park Ave., Oak Park, Ill.
- \*BUCKLEY, CLIFTON L., Instructor, Dept. of Electricity, High School, Trenton, N. J.
- BUDDEKE, V. FRANK, Assistant Engineer, Public Service Co. of Northern Illinois, 72 W. Adams St., Chicago, Ill.
- BUSHBY, MERRITT, Assistant District Engineer, Public Service Co. of Northern Illinois, 484 Schorie Ave., R-5, Joliet, Ill.
- BUTTOLPH, O. D., Equipment Engineer, Western Electric Co., Kearny Works, Kearny, N. J.
- CALLAHAN, MARTIN EDWARD, JR., Sales Agent, General Electric Co., 200 S. Main St., Salt Lake City, Utah.
- CAMPBELL, REGINALD MORTIMER, Eastern District Manager, Sangamo Electric Co., 50 Church St., New York, N. Y.
- \*CANNON, MALLORY KING, JR., Engineer, 140 Appleton Ave., Pittsfield, Mass.
- CASWELL, RALPH WALDO, Field Engineer, Public Service Co. of Northern Illinois, 114 N. Oak Park Ave., Oak Park, Ill.

- CHALUPA, PAUL P., Load Inspector, Duquesne Light Co., 435 6th Ave., Pittsburgh, Pa.
- CHAMBERS, WILLIAM GREFFIS, Desk Switchman, Bell Telephone Co. of Pa., 1631 Arch St., Philadelphia, Pa.
- CHEESEMAN, JOSEPH A., Engineer, Traffic Dept., New York Telephone Co., 1060 Broad St., Newark, N. J.
- CHENEY, FREDERICK COLLINGWOOD, Electrician, Stone & Webster, Havre de Grace, Md.
- CHITTY, WILLIAM C., Electrical Engineer, Tidewater Oil Co., Bayonne, N. J.; for mail, Alhambra, Calif.
- CHRISTEN, VIRGIL E., Transformer Tester, Moloney Electric Co., St. Louis; res., Ferguson, Mo.
- COOPER, JAMES REGINALD, Electrical Engineer, Metropolitan Water Supply & Sewage Board, Albert St., Brisbane, Queensland, Aust.
- CORBY, DONALD K., Field Engineer, Public Service Co. of Northern Illinois, 114 N. Oak Park Ave., Oak Park, Ill.
- CORNELIUS, HARRY ALLAN, Acting Assistant Electrical Engineer, Public Service Co. of Northern Illinois, 72 W. Adams St., Chicago, Ill.
- CORY, ABRAM ADKINS, Electrical Engineer, Russian Reconstruction Farms, Inc., Village Archangelskoye, Estate No. 4, Ter Dist Union of Socialist Soviet Republics.
- COX, ROBERT CORSON, Distribution Dept., Scranton Electric Co., Scranton, Pa.

- CREASMON, WILLIAM KENNETH, Jr.**, Telephone Plant Man, Southern Bell Tel. & Tel. Co., 17 Main St., York, S. C.
- DEACON, LIONEL OAKLEY**, Factory Engineer, Lincoln Meter Co., Ltd., 79 Stafford St., Toronto, Ont., Can.
- DELLA CORTE, JOSEPH PARQUALE**, Radio Laboratory, Sonora Phonograph Co., 16 E. 40th St., New York, N. Y.
- DENNIS, JOHN H.**, Electrical Engineering Dept., Public Service Co. of Northern Illinois, 310 Van Buren St., Joliet, Ill.
- \*DEVOE, JAY J.**, Surveyor, Board of Fire Underwriters of the Pacific, Station "C", Los Angeles, Calif.
- DE WITT, JOHN HUBBETT, Jr.**, Designing & Building, Radio Transmitting Equipment, 1812 15th Ave. S., Nashville, Tenn.
- DICKEY, ALBERT WILLIAM**, Electrical Engineer, Western Union Telegraph Co., 195 Broadway, New York, N. Y.
- DICKEY, WILLIAM EARLE**, City Electrical Superintendent, City of Revelstoke, City Hall, Revelstoke, B. C., Can.
- EARLE, RAYMOND O.**, Record Foreman, Brooklyn Edison Co., 360 Pearl St., Brooklyn, N. Y.
- EDDY, HAROLD T.**, Assistant Engineer, Public Service Co. of Northern Illinois, 72 W. Adams St., Chicago; res., Evanston, Ill.
- ENDRESS, GEORGE EDWIN**, Inspector, Public Service Co. of Northern Illinois, 310 Van Buren St., Joliet, Ill.
- EWART, WILLIAM E.**, Load Dispatcher, Puget Sound Power & Light Co., Electric Bldg., Seattle, Wash.
- EWERT, HARRY WALTER**, Northwestern Mfg. Co., 480 Clinton St., Milwaukee, Wis.
- FERNANDES, JOSEPH A.**, General Foreman, Brooklyn Edison Co., 14 Rockwell Place, Brooklyn, N. Y.
- FISHER, FRANK EMERSON**, Assistant Distribution Engineer, Puget Sound Power & Light Co., Electric Bldg., 7th & Olive Sts., Seattle, Wash.
- FLETCHER, BRIAN**, Electrical Draftsman, New York Edison Co., First Ave. & 41st St., New York; res., Astoria, N. Y.
- FLUELER, ALFRED K.**, Electrical Engineer, American Brown Boveri Electric Corporation, Camden, N. J.
- FONDA, BAYARD PINTARD**, Electrical Engineer, May Oil Burner Corporation, 3500 E. Biddle St., Baltimore, Md.
- FORT, TOMLINSON, Jr.**, Sales Engineer, Westinghouse Elec. & Mfg. Co., Home Savings Bank Bldg., Albany, N. Y.
- FOSS, HALFDAN MARCUS**, Engineer, Bell Telephone Co. of Pa., 416 7th Ave., Pittsburgh, Pa.
- FOUSER, JOHN R.**, Electrical Engineer, Public Service Co. of Northern Illinois, 310 Van Buren St., Joliet, Ill.
- \*FOX, CLAUDE ERNEST**, Testing Dept., General Electric Co., Schenectady, N. Y.
- FRANTZ, JESSE DALE**, Salesman, General Electric Co., 701 Electric Bldg., Portland, Ore.
- FRASER, DONALD GORDON**, Transmission Tester, The Southern New England Telephone Co., New Haven, Conn.
- FRISCH, RICHARD A.**, Laboratory Helper, Public Service Co. of New Jersey, 21st St. & Clinton Ave., Irvington; res., Roseland, N. J.
- GALLO, CHARLES**, Designer Engineer, Public Service Electric & Gas Co., 80 Park Place, Newark, N. J.
- GEARY, WARREN J. D.**, Division Supt. of Transmission, Pennsylvania Power & Light Co., Northampton, Pa.
- \*GIDEON, WILLARD INGELS**, Engineer, Virginia Public Service Co., Alexandria; res., Clarendon, Va.
- GIGER, WALTER A.**, Project Engineer, Traction Division, American Brown-Boveri Electric Corp., Camden, N. J.
- GILKESPIE, BERNARD FRANCIS**, Engineer, Industrial Control Dept., General Electric Co., 6 Lawrence St., Bloomfield, res. West Orange, N. J.
- GORNY, BERNARD JOSEPH**, Electrical Repairman, Service Shop, General Electric Co., Erie, Pa.
- GREY, JOHN BERTRAND**, Construction Foreman, Wairarapa Electric Power Board, Te Kuiti, New Zealand.
- GRIEB, VICTOR JOHN**, Foreman, Electrical Maintenance, General Electric Co., Erie, Pa.
- GUILDFORD, RAYMOND P.**, Tester of Electrical Apparatus, Westinghouse Elec. & Mfg. Co., East Pittsburgh, res. Turtle Creek, Pa.
- GUNKEL, HENRY R.**, Circuit Breaker Engineer, Westinghouse Elec. & Mfg. Co., East Pittsburgh; res., Wilkinsburg, Pa.
- GUZZO, LOUIS MICHAEL**, Field Engineer, New England Telephone Co., 1130 Albany Ave., Hartford, Conn.
- \*HALBACH, RALPH H.**, Electrical Testing, Northwestern Mfg. Co., 480 Clinton St., Milwaukee, Wis.
- HALL, HOWARD WESLEY**, Laboratory Fieldman, Pennsylvania Power & Light Co., Hazleton, Pa.
- HAROUS, WILMORE CUSTER**, Engineer, Pacific Telephone & Telegraph Co., 140 New Montgomery St., San Francisco, Calif.
- \*HARTAY, CLARENCE E.**, Field Tester & Inspector, Duquesne Light Co., 8th Floor, Duquesne Bldg., Pittsburgh, Pa.
- HARVEY, JAMES ORIAN**, Electrical Drafting & Design, Coast Counties Gas & Electric Co., 315 Montgomery St., San Francisco, Calif.
- HOVEY, LINDSAY MANSUR**, Junior Engineer, Winnipeg Electric Co., Electric Railway Chambers, Winnipeg, Man., Can.
- HUNTLEY, EDSON D.**, A. C. Engineering Dept., General Electric Co., Schenectady, N. Y.
- HURD, OWEN W.**, Meter Dept., Northwestern Electric Co., Portland, Ore.
- HUTMIRE, EDWARD HENRY**, Student, 403 East Broad St., Angola, Ind.
- ILES, JOHN THOMAS**, Plat Engineer, Bell Telephone Co. of Pa., 416 7th Ave., Pittsburgh, Pa.
- JACOBSEN, ROBERT CHRISTIAN**, Engineer, Edison Electric Illuminating Co. of Brockton, 42 Main St., Brockton, Mass.
- JONES, HARRY KENNETH**, Telephone Equipment Engineer, Western Electric Co., Hawthorne Station, Chicago; res., Oak Park, Ill.
- KEADY, THOMAS PAKENHAM**, Test Dept., New York & Queens Electric Light & Power Co., Central Station, Flushing, N. Y.; for mail, Paterson, N. J.
- KEOGH, RAYMOND JAMES**, Electrical Engineer, Western Electric Co., Hawthorne Station, Chicago, Ill.
- KNOBLOCH, ELMER S.**, Electrical Contractor, 250 E. 26th St., Erie, Pa.
- KOESTER, HENRY**, Foreman of Meter & Test Bureau, New York & Queens Electric Light & Power Co., 40-22 Lawrence St., Flushing, N. Y.
- KRAEHN, CLARENCE EDWIN**, Switchboard Specialist, General Electric Co., 120 Broadway, New York, N. Y.
- KUNST, WALTER EUGENE**, Substation Operator, Public Service Co. of Northern Illinois, Substation No. 57, Forest Park, Ill.
- LAKE, LEO REUBEN**, Chief Electrician, Roundout Paper Mills, Inc., Napanoch, N. Y.
- \*LARKINS, JAMES FRANCIS**, Student Engineer, New York Telephone Co., 140 West St., New York, N. Y.
- LARSEN, S. P.**, Salesman, Line Material Co., 355 Everett St., Portland, Ore.
- LAURITSEN, CLARENCE N.**, Assistant Engineer Electric Distribution, Public Service Co. of Northern Illinois, 72 W. Adams St., Chicago, Ill.
- \*LAFKI, CLARENCE J.**, Graduate Student, Mass. Institute of Technology, Cambridge, Mass. for mail, New York, N. Y.
- LONG, MARVIN**, Bell Telephone Co. of Pa., 17th & Lombard Sts., Philadelphia, Pa.
- LUNEN, EDWARD JAMES**, Substation Operator, Commonwealth Edison Co., 72 W. Adams St., Chicago, Ill.
- MASCHARKA, LOUIS ALLOY**, Student Engineer, Test Dept., General Electric Co., Erie, Pa.
- MCANDREW, JOHN SYLVESTER, Jr.**, Senior Station Tester, Brooklyn Edison Co., 14 Rockwell Place, Brooklyn, N. Y.
- \*McCANN, E. EARL**, Student, Oregon Institute of Technology, Portland, Ore.
- McCLURE, JAMES J.**, Methods Engineer, Western Electric Co., Hawthorne Station, Chicago; res., Oak Park, Ill.
- MCDONALD, IAN M.**, General Engineer, Westinghouse Elec. & Mfg. Co., East Pittsburgh; res., Wilkinsburg, Pa.
- McINTYRE, MARVIN VAUGHN**, Toll Wire Chief, Mountain States Tel. & Tel. Co., 101 N. Jackson St., Helena, Mont.
- McMASTER, DONALD ANDERSON**, Engineering Assistant, Bell Telephone Company of Pa., 416 7th Ave., Pittsburgh, Pa.
- MELARKEY, WILLIAM EDWARD**, Automatic & Switchboard Equipment Specialist, General Electric Co., Rialto Bldg., San Francisco; res., Oakland, Calif.
- MERRITT, CHARLES H.**, Engineer, Distribution & Installation Dept., New York Edison Co., 130 E. 15th St., New York, N. Y.
- MESS, CHARLES THEODORE**, Assistant Engineer, California State Railroad Commission, State Bldg., Civic Center, San Francisco, Calif.
- MEYER, JOE L. G.**, Manager, Electric Service Dept., Washington County Operative Egg & Poultry Association, Seattle, Wash.
- MOORE, CHARLES GILBERT**, Sales Engineer, General Electric Co., 201 Falls St., Niagara Falls, N. Y.
- MOORE, LYLE MERTON**, Engineering Assistant to Plant Engineer, Syracuse Lighting Co., Inc., 431 Fulton St., Syracuse, N. Y.
- MOORE, PERCY WHITTON**, Survey Tracer, Brooklyn Edison Co., 360 Pearl St., Brooklyn, N. Y.
- MORRIS, ROBERT RAPHEAL**, Estimating Bureau, New York Edison Co., 130 E. 15th St., New York; res., Brooklyn, N. Y.
- MORSE, ERNEST E.**, Student, Electrical Engineering Dept., Tri-State College, Angola, Ind.
- NANITA, MANUEL EMILIO**, Director, Radio Service, Dominion Republic, Radio Station, Santo Domingo, Dominion Republic, West Indies.
- NICHOLSON, JOHN HENRY**, Electrical Engineer, McGraw Electric Co., 1208 Harney St., Omaha, Nebr.
- NIELSEN, WALTER SOMMER**, Salesman, Trans-Lux Day Light Picture Screen, Inc., 247 Park Ave., New York; res., Locust Valley, N. Y.
- NORLING, BERT S.**, General Engineer, Westinghouse Elec. & Mfg. Co., East Pittsburgh, Pa.
- NORTON, JOSEPH CALVIN**, Assistant Chief Draftsman, Pacific Gas & Electric Co., 245 Market St., San Francisco, Calif.
- OLSEN, PETER**, Electrical Designer, Thomas E. Murray, 55 Duane St., New York; res., Brooklyn, N. Y.
- OLSON, ARNIM GILBERT**, Senior Field Engineer, Public Service Co. of Northern Illinois, 114 N. Oak Park Ave., Oak Park, Ill.
- \*OSSIN, JOSEPH SEBASTIAN**, Power Test, General Electric Co., Pittsfield, Mass.

- PAFENBACH, WILLIAM MAXWELL, Electrical Engineer, Westinghouse Elec. & Mfg. Co., 395 Liberty St., Springfield, Mass.
- PALM, ALBIN FREDERICK, Traffic Manager, Western Union Telegraph Co., 801 Clift Bldg., Salt Lake City, Utah.
- \*PARK, CHAUNCEY M., Engineer, Mutual Fire Prevention Bureau, 230 E. Ohio St., Chicago, Ill.
- PARKER, ANDREW LYDDLETON, Electrical Operating Engineer, City of Fort Worth Light Dept., City Hall, Fort Worth, Texas.
- PATISTEAS, MICHAEL J. N., Electrical Designer, Stone & Webster, Inc., 147 Milk St., Boston, Mass.
- PATTERSON, GEORGE HOWARD, Field Engineer, Public Service Co. of Northern Illinois, 114 N. Oak Park Ave., Oak Park, Ill.
- \*PAYNE, ROY BERTON, Engineer, Automatic Switchboard Dept., General Electric Co., Schenectady, N. Y.
- PERNICE, JOSEPH RODOLPH, 9401 40th Road, Elmhurst, N. Y.
- PHILLIPS, ALFRED EDWARD, Transmission Line Engineer, Tata Power Supply Co., Tata's Bungalows, Kalyau, Thana Dist., Bombay, India.
- \*PINEDA U, LUIS GUILLERMO, Electrical Engineer, Venezuela Power Co., Maracaibo, Venezuela, So. Amer.
- \*PIPPENGER, EDWARD EVERETT, Assistant Engineer, Public Service Co. of Northern Illinois, 72 W. Adams St., Chicago; res., Oak Park, Ill.
- \*PLANK, GEORGE ADDISON, Field Engineer, Contract Service Dept., General Electric Co., Schenectady, N. Y.; for mail, Independence, Mo.
- POWELL, ALBERT CECIL, Telephone Engineer, Bell Telephone Laboratories, Inc., 463 West St., New York, N. Y.
- PRADHAN, GEPINATH KRISHNA, Mains Superintendent, Baroda State's Power House, Baroda, India.
- \*PRENTISS, G. D., Engineering, Cutler-Hammer Mfg. Co., Milwaukee, Wis.
- PROVAN, JOSEPH CHAPMAN, Chemical Mixer, Eagnior Fibre Products Co., Detroit; res., Highland Park, Mich.
- RECTOR, CLINTON, Electrical Engineer, Westinghouse Elec. & Mfg. Co., East Pittsburgh; res., Pittsburgh, Pa.
- REYNOLDS, SILAS SPRAGUE, Assistant Engineer, New York Telephone Co., 140 West St., New York, N. Y.
- RICHMAN, SAMUEL L., Asst. Designing Engineer, Byllesby Engineering & Management Corporation, 10th Floor, Duquesne Bldg., Pittsburgh; res., Wilkinsburg, Pa.
- ROBINSON, CECIL AUBREY, Australian General Electric Co., Ltd., 93 Clarence St., Sydney, N. S. W., Aust.
- ROSENGREN, WALTER JOHN, Switchboard Engineer, Western Electric Co., Kearny; res., Jersey City, N. J.
- RYAN, DAVID CHARLES, Electrician & Power Repairman, United Fruit Co., Bocas del Toro, Panama.
- RYDZEWSKI, JAMES H., Electrical Repairman, General Electric Co., Erie, Pa.
- SADLER, CLARENCE H., Student, Tri-State College, Angola, Ind.
- SALAMON, MARL ALLEN, Electrical Expert; Supervisor, General Electric Co., 120 Broadway, New York, N. Y.
- SASSCHER, CLARENCE DESALES, A. C. Design, General Electric Co., 1 River Road, Schenectady, N. Y.
- SAYRE, GORDON BARTLETT, Chief Engineer, Owen Dyneto Corporation, Park & Wolf Sts., Syracuse, N. Y.
- SEELEY, EDWARD STURGIS, Cable Inspector, Purchasing Dept., Brooklyn Edison Co., 380 Pearl St., Brooklyn, N. Y.
- SEIPLE, WILLIAM M., Division Superintendent of Distribution, Pennsylvania Power & Light Co., 36 N. Main St., Wilkes-Barre, Pa.
- SHAFER, JAY EUGENE, Engineer, Bell Telephone Laboratories, Inc., 463 West St., New York, N. Y.; res., Hoboken, N. J.
- SHAMBEAU, WILLIAM ROBERT, Proprietor, Shambeau Radio Studio, 668 Algoma Blvd., Oshkosh, Wis.
- \*SHIRE, LEE E., Engineering Dept., Andian National Corporation, Ltd., Cartagena, Colombia, So. Amer.
- SHOLS, WILLIAM THEODORE, Field Engineer, Public Service Co. of Northern Illinois, 72 West Adams St., Chicago, Ill.
- SMALL, FRED I., Supt., Service Dept., Northwestern Electric Co., Pittock Block, 10th & Washington, Portland, Ore.
- \*SMITH, EARL JENNINGS, Assistant to Electrical Engineer, M. E. Dept., American Bridge Co., Ambridge, Pa.
- SMITH, HERBERT RUDOLPH, Sidney City Council, Sidney, Australia.
- SMITH, JOSEPH S., Engineering Inspector, Brooklyn Edison Co., 360 Pearl St., Brooklyn, N. Y.
- STAPLES, ELDEN IVAN, Electrical Engineer, General Engineering Dept., Westinghouse Elec. & Mfg. Co., East Pittsburgh, Pa.
- \*STARR, STANLEY C., Transformer Engg. Dept., General Electric Co., Fort Wayne, Ind.
- STAUFFER, HARRY R., Electrical Engineer, Metropolitan Edison Co., Reading, Pa.
- STECHEK, MELVILLE VOLLMER, Telegraph Supervisor, Western Union Telegraph Co., 195 Broadway, New York, N. Y.; res., Montclair, N. J.
- STERN, ARTHUR BUNTING, Machine Switching Traffic Engineer, The Pacific Tel. & Tel. Co., Seattle, Wash.
- STEWART, CLYDE EMERY, Electrical Engineer, General Electric Co., 1 River Road, Schenectady, N. Y.
- STEWART, DAVID O., Manufacturer's Agent, 619 Bank of Commerce Bldg., St. Louis, Mo.
- STONE, JOHN RAYMOND, Engineer, Bell Telephone Laboratories, Inc., 463 West St., New York, N. Y.; res., Orange, N. J.
- \*SWANK, LAWRENCE NATHAN, Assistant, Engineering Dept., Elliott Co., Ridgway, Pa.
- SYWULKA, VICTOR S., Engineer, Cutler-Hammer Mfg. Co., 12th & St. Paul Ave., Milwaukee, Wis.
- THEROUX, ADJUTOR HORMISDAS, Electrician, Salisbury Jenny, Inc., 13 S. Main St., Providence, R. I.
- THOMPSON, OSCAR BENJAMIN, Electrician, Port of Seattle, Seattle, Wash.
- THOWLESS, WALTER H., Electrical Engineer, Barnet Leather Co., Little Falls, N. Y.
- THRASHER, LAWRENCE R., Supt. of Distribution, Garden City Irrigation Power Co., Garden City, Kans.
- TODD, FRANCIS C., Electrical Engineer, M. & P. Engg. Dept., Westinghouse Elec. & Mfg. Co., East Pittsburgh; res., Wilkinsburg, Pa.
- TOWNSEND, F. LEBE, Sales Engineer, American Brown Boveri Electric Corporation, Camden, N. J.
- \*TSON, ZAU-LING, Graduate Student, Westinghouse Elec. & Mfg. Co., 417 Center St., Wilkinsburg, Pa.
- TWISS, ROBERT H., Electrical Engineer, General Electric Co., 1 River Road, Schenectady, N. Y.
- VANDERKODDE, WILLIAM FREDERICK, Engineering Dept., Public Service Co. of Northern Illinois, Joliet, Ill.
- VAN DER VOORT, FREDERIC CLARENDON, Technical Assistant, Electrical Testing Laboratories, 80th St. & East End Ave., New York; res., Brooklyn, N. Y.
- VERMILLION, LEWIS SAFFORD, Switchboard Operator, East Plant, Merchants Heat & Light Co., Indianapolis, Ind.
- WALTERS, AUGUSTUS P., Superintendent of Power Plant & Building, McCormick Co., 414 Light St., Baltimore, Md.
- WEBER, HOWARD HILL, Assistant Engineer, Rome Wire Co., Rome, N. Y.
- WEISS, ELMER F., Engineering Dept., The Cutler-Hammer Mfg. Co., 12th & St. Paul Ave., Milwaukee, Wis.
- WELLS, JOHN, Electrical Engineer, Western Electric Co., 48th & 22nd Sts., Hawthorne; res., Riverside, Ill.
- \*WENDELL, EDWARD NELSON, Assistant Engineer, Compania Telefonica Nacional de Espana, Gran Via 5, Madrid, Spain.
- WHITEHEAD, JOHN HERBERT, Transformer Engineer, Ferranti Ltd., Hollinwood; res., Bacup, Lancashire, Eng.
- \*WHITMORE, PHILIP HARVEY, Field Engineer, Public Service Co. of Northern Illinois, 911 Church St., Evanston, Ill.
- WHITTINGHAM, CHARLES JOSEPH, Assistant General Foreman, Meter Bureau, Brooklyn Edison Co., 14 Rockwell Place, Brooklyn; res., Bellmore, N. Y.
- WILLIAMS, GILBERT J., District Engineer, Connecticut Light & Power Co., 111 W. Main St., Waterbury, Conn.
- WILVERT, JACOB R., First-Class Lineman, Public Service Electric & Gas Co., 17th & Stevens Sts., Camden, N. J.
- WINCHESTER, ROY LEO, Electrical Engineer, Illinois Power & Light Corp., 500 Compton Bldg., St. Louis, Mo.
- WRIGHT, RALPH BLANCHARD, Supt., Neon Dept., Electrical Products Corporation, 950 30th St., Oakland, Calif.
- YARRILL, HERBERT GEORGE, Meter Dept. Assistant, Ontario Hydro-Electric Commission, Ontario Power Plant, Niagara Falls, Ont., Can.
- ZIMMERMAN, GERARD GEORGE, Student, Tri-State College, 201 West Park Ave., Angola, Ind.

Total 190.

\*Formerly enrolled students.

**ASSOCIATES REELECTED****MAY 20, 1927**

- BLYE, PAUL W., Dept. of Development & Research, American Tel. & Tel. Co., 195 Broadway, New York, N. Y.
- CODE, FRANCIS LESLIE, Sales Engineer, English Electric Co. of Canada, Ltd., 1210 Dominion Bank Bldg., Vancouver, B. C., Can.
- COLE, FRED H., Vice-President, Pacific Elec. Mfg. Co., 419 Chemical Bldg., St. Louis, Mo.
- CONWAY, CHARLES W., JR., General Electric Co., 1 River Road, Schenectady, N. Y.
- ELWELL, FRED, Supt. of Power Plants, British Columbia Electric Railway Co., 425 Carroll St., Vancouver, B. C.
- KELLOGG, RICHARD BELA, Assistant Engineer, Pacific Gas & Electric Co., 245 Market St., San Francisco, Calif.
- McKOWEN, FRANK LESLIE, Electrical Engineer, G. H. Langler & Co., Ltd., Consolidated Bldgs., Harrison St., Johannesburg, So. Africa.
- SLIMP, JAMES E., Sales Engineer, Lockc Insulator Corp., 120 Broadway, New York, N. Y.
- SMITH, MORRIS BYINGTON, Panel Sales Engineer, Crouse Hinds Co., Syracuse, N. Y.

**ASSOCIATES REINSTATED****MAY 20, 1927**

- BARROZO, RUBEM FERREIRA, Chief Electrician, Alto da Serra Construction, The Sao Paulo Tramway, Light & Power Co., Ltd., Caixa "a," Sao Paulo, Brazil, So. Amer.
- KRONENBERG, JOHN F., Bandon, Ore.

**MEMBERS ELECTED  
MAY 20, 1927**

- CHAMBERLIN, JOHN NELSON, Outside Plant Engineer, Pacific Tel. & Tel. Co., 140 New Montgomery St., San Francisco, Calif.  
 DUDLEY, WILLIAM ALLEN, Telegraph Engineer, Western Union Telegraph Co., 105 Broadway, New York, N. Y.  
 McCLYMONT, HERBERT ROSS, Chief Electrical Engineer, Kerry & Chase, Ltd., 650 Confederation Life Bldg., Toronto, Ont., Can.  
 OGLES, GEORGE MILTON, Consulting Power Engineer, General Engineering & Management Corporation, 165 Broadway, New York; res., Brooklyn, N. Y.  
 WOODBURY, STEPHEN E., Director of Laboratories, Mason & Hamlin, 560 Harrison Ave., Boston, Mass.

**TRANSFERRED TO GRADE OF FELLOW  
MAY 20, 1927**

- DOYLE, EDGAR D., Electrical Engineer, Leeds & Northrup Co., Philadelphia, Pa.  
 HOLCOMBE, ERNEST S., Electrical Construction Engineer, Interborough Rapid Transit Co., New York, N. Y.  
 KRUM, HOWARD L., Vice President, Morkrum-Kleinschmidt Corp., Chicago, Ill.  
 MAXFIELD, JOSEPH P., Manager of Development and Research, Victor Talking Machine Co., Camden, N. J.  
 MEYER, EDWARD B., Chief Engineer, Public Service Production Co., Newark, N. J.  
 OWENS, JAMES W., Director of Welding, Newport News Shipbuilding & Dry Dock Co., Newport News, Va.  
 WISEMAN, ROBERT J., Research Engineer, The Okonite Company and The Okonite-Callender Cable Co., Inc., Passaic, N. J.

**TRANSFERRED TO GRADE OF MEMBER  
MAY 20, 1927**

- ANDREWS, FRANCIS E., Engineer, Electrical Transmission Design, Public Service Co. of No. Illinois, Chicago, Ill.  
 BENDER, LOUIS B., Signal Officer, 9th Corps Area, U. S. Army, The Presidio of San Francisco, Calif.  
 BEUGLER, HUGH M., Consulting Engineer, 50 Market St., Poughkeepsie, N. Y.  
 BLOOMFIELD, JAMES M., Supt., Light and Power Plant, Kamsack, Sask., Canada.  
 BOOKZHINSKY, NICHOLAS P., Electrical Engineer, Transformer Engg. Dept., General Electric Co., Pittsfield, Mass.  
 CUSHING, RICHARD W., Electrical Engineer, Federal Power Commission, Washington, D. C.  
 FORMAN, ALEXANDER H., Professor and Head of Department, West Virginia University, Morgantown, W. Va.  
 FRASER, WILLIAM W., Patent Attorney, Mayer, Warfield & Watson, New York, N. Y.  
 GRAHAM, SIMON BURR, Engineering Department, American Tel. & Tel. Co., New York, N. Y.  
 GUILD, EARL S., Electrical Engineer, Carleton Mace Engg. Corp., Boston, Mass.  
 HARRISON, J. K. M., Owner, Harrison & Company, Engineers, Philadelphia, Pa.  
 HERTZ, STANTON S., Electrical Engineer, Copperweld Steel Co., New York, N. Y.  
 HOEPPNER, HENRY L., Assistant Electrical Engineer, Bylesby Engg. & Management Corp., Chicago, Ill.  
 KUHLMANN, JOHN H., Assistant Professor of Electrical Design, University of Minnesota, Minneapolis, Minn.  
 LUTHER, BENJAMIN S., Electrical Engineer, Stone & Webster, Inc., Boston, Mass.  
 MATTHEWS, THOMAS, Associate Professor of Electrical Engineering, University of Iowa, Iowa City, Iowa.  
 McNEILL, R. W., Electrical Engineer, Westinghouse E. & M. Co., East Pittsburgh, Pa.

- NATHAN, EUGENE J., Toll Facilities Supervisor, Bell Telephone Company of Pa., Philadelphia, Pa.  
 PIERCE, PAUL H., Member of Technical Staff, Bell Telephone Laboratories, New York, N. Y.  
 STEVENS, FRANK J., Superintendent, Lock Insulator Corp., Victor, N. Y.  
 WEBER, RUDOLF L., Electrical Engineer, Stone & Webster, Inc., Boston, Mass.  
 WILLIAMS, EARL C., Electrical Engineer, Public Service Co. of No. Illinois, Chicago, Ill.

**RECOMMENDED FOR TRANSFER**

The Board of Examiners, at its meeting held May 10, 1927, recommended the following members for transfer to the grade of membership indicated. Any objection to these transfers should be filed at once with the National Secretary.

**To Grade of Fellow**

- BARRON, JACOB T., General Manager, Elec. Dept., Public Service Electric & Gas Co., Newark, N. J.  
 MATTHEWS, CLAUDE L., Vice President and Treasurer, W. N. Matthews, Corp., St. Louis, Mo.  
 McCARTHY, J. B., Elec. Supt., International Nickel Co. of Canada, Ontario, Canada.  
 PEASLEE, W. D. A., General Manager, Davenport Radio Corporation, Newark, N. J.  
 TEMPLIN, JOHN R., Consulting Elec. Engg., Christchurch, N. Z.

**To Grade of Member**

- BALL, FRANCIS L., Vice President, Fitchburg Gas & Electric Co., Boston, Mass.  
 BALL, WILMOT C., Research Dept., Okonite Callender Cable Co., Inc., Paterson, N. J.  
 BEAVERS, FRANKLIN J., Distribution Engineer, Scranton Electric Co., Scranton, Pa.  
 BINNS, ARTHUR P., Electrical Engineer, Hydro Electric Dept., Hobart, Tasmania.  
 CALLAND, O. C., Chief Inspector, Ohio Insulator Co., Barberton, Ohio.  
 CAMILLI, G., Electrical Engineer, General Electric Co., Pittsfield, Mass.  
 DAVID, BRUCE W., Chief Engineer, Sterling Mfg. Co., Cleveland, Ohio.  
 DEWARS, ALLEN G., Supt. of Research, Northern States Power Co., St. Paul, Minn.  
 DOHERTY, ROBERT E., Consulting Engineer, General Electric Co., Schenectady, N. Y.  
 DONNELL, PHILIP S., Dean of College of Engg. and Professor of Elec. Engg., University of New Mexico, Albuquerque, New Mexico.  
 DOUGLASS, FORREST S., Electrical Engineer, Utilities Power & Light Corp., Chicago, Ill.  
 EARLY, RUPERT N., Development Engineer, Electric Machinery Mfg. Co., Minneapolis, Minn.  
 EMORY, FRED D., Electrical Engineer, California Oregon Power Co., Medford, Oregon.  
 FRISBY, ROGER L., Electrical Engineer of Stations, Kansas City Power & Light Co., Kansas City, Mo.  
 GOLL, WALTER SCOTT, Works Manager, General Electric Co., Fort Wayne, Indiana.  
 GRANFIELD, THOMAS H., Engineer of Costs and Practices, Northwestern Bell Telephone Co., Omaha, Nebraska.  
 GREEN, ADONIRAM J., Electrical Engineer, General Electric Co., Newark, N. J.  
 HANCOCK, ROBERT E., Civil Engineer Corps, U. S. Navy, U. S. Naval Station, Cavite, P. I.  
 HARRINGTON, J. L., Telephone Engineer, Chesapeake & Potomac Telephone Co., Washington, D. C.  
 HARTMAN, GEORGE, Supt. Hydro Electric Plant, The International Nickel Co. of Canada, Turbine, Ont., Canada.  
 KENT, WALTER, Electrical Engineer, General Electric Co., Fort Wayne, Indiana.

- LLOYD, WILL L., Asst. to Consulting Engineer, General Electric Co., Pittsfield, Mass.  
 LOCKETT, RALPH U., Electrical Engineer, Cutler-Hammer Mfg. Co., Milwaukee, Wis.  
 LUNSFORD, ROBERT L., Power Equipment Development Engineer, Bell Laboratories, New York.  
 MAITTE, OTTHMAR K., Chief Engineer in charge of Design and Construction, American Brown Boveri Elec. Corp., Camden, N. J.  
 METZ, LOUIS O., Assistant Engineer, Bell Telephone Co. of Pa., Philadelphia, Pa.  
 MCKEY, BRUCE O., D. O. Engg. Dept., General Electric Co., Schenectady, N. Y.  
 MELLEKEN, HUMPHREYS, Chief Engineer, Montreal Light Heat & Power Consolidated, Montreal, Canada.  
 MOULTON, JAMES B., Asst. to Executive Engineer, San Joaquin Light & Power Corp., Special Engineer, Great Western Power Co., Fresno, Calif.  
 NORTH, CHARLES, Electrical Supt., City of Kamloops, Kamloops, B. C., Canada.  
 PARROTT, REGINALD C., Manager for South America, (except Brazil) Metropolitan Vickers Electrical Export Co., Ltd., Buenos Aires, Argentina, So. America.  
 PUCHSTEIN, ALBERT F., Assistant Professor, Elec. Engg. Dept., Ohio State University, Columbus, Ohio.  
 PYE, HARVEY N., Assistant Chief Engineer, Southeastern Underwriters Association, Atlanta, Ga.  
 REED, EMERSON G., Asst. to Transformer Dept. Engg. Manager, Westinghouse Elec. & Mfg. Co., Sharon, Pa.  
 SCHUELLER, ALBERT A., Sales Engineer and Manager, St. Louis District, Holtzer-Cabot Electric Co., Chicago, Ill.  
 SEBAST, FREDERICK M., Associate Professor of Elec. Engg., Rensselaer Polytechnic Institute, Troy, N. Y.  
 SERVOS, FREDERICK M., Chief Electrical Engineer, The Rio de Janeiro Tramway Light and Power Co. Ltd., Rio de Janeiro, Brazil, So. America.  
 SHAW, HENRY S., Secretary and Chairman of Directors, General Radio Co., Cambridge, Mass.  
 SIMPSON, SIDNEY, Consulting Engineer, Messrs. Thomas Cook & Son, Hornby Rd., Bombay, India.  
 SMITH, IRWIN F., Distribution Engineer, Duquesne Light Co., Pittsburgh, Pa.  
 SMITH, WILLIAM F., Asst. Electrical Supt., Pacific Electrical Railway Co., Los Angeles, Calif.  
 STANSFIELD, ARTHUR, Electrical Engineer, Manchester Corporation Electric Dept., Manchester, England.  
 STOCKWELL, FRANK CLIFFORD, Professor of Electrical Engineering, Stevens Institute of Technology, Hoboken, N. J.  
 THALHEIMER, J. J., Engineer, General Electric Co., Cincinnati, Ohio.  
 THORNTON, GEORGE C., District Manager, West Virginia Engg. Co., Norton, Va.  
 TYSON, EDWIN H., Supt. of Meters, Penna. Power & Light Co., Hazleton, Pa.  
 UMANSKY, L. A., Electrical Engineer, General Electric Co., Schenectady, N. Y.  
 VILSTRUP, ASGER, Assistant Engineer, B. C. Electric Railway Co., Ltd., Vancouver, B. C., Canada.  
 WAGNER, EDWARD A., Managing Engineer, Distribution Transformer Dept., General Electric Co., Pittsfield, Mass.  
 WARRING, ROYAL C., Return Circuit Engineer, Eastern Mass. Street Railway Co., Boston, Mass.  
 WOOD, JOSEPH D., Division Engineer, Condit Electrical Mfg. Corp., Boston, Mass.  
 WOODWARD, EDWARD J. B., Power Representative, Public Service Elec. & Gas Co., Camden, N. J.



WRIGHT, CHARLES A., Electrical Engineer, Research Laboratory, National Carbon Co., Cleveland, Ohio.

ZAPP, LEON C., Engineer in charge Contract Service Dept., General Electric Co., Fort Wayne, Indiana.

#### APPLICATIONS FOR ELECTION

Applications have been received by the Secretary from the following candidates for election to membership in the Institute. Unless otherwise indicated, the applicant has applied for admission as an Associate. If the applicant has applied for direct admission to a higher grade than Associate, the grade follows immediately after the name. Any member objecting to the election of any of these candidates should so inform the Secretary before June 30, 1927.

Andrews, J. M., West Penn Power Co., Vandergrift, Pa.

Barney, H. P., Jr., Chesapeake & Potomac Telephone Co., Roanoke, Va.

Barr, R. W., Bucyrus Co., S. Milwaukee, Wis.

Bassett, A. J., (Member), Brooklyn Edison Co., Brooklyn, N. Y.

Beck, F. J., Bell Telephone Laboratories, Inc., New York, N. Y.

Beckwith, J. B., Louisville Gas & Electric Co., Louisville, Ky.

Behl, J. H., Reading Co., Philadelphia, Pa.

Bellingham, L. C., Irvington Varnish & Insulator Co., Irvington, N. J.

Bennett, R. G., General Electric Co., Boston, Mass.

Best, I. W., El Paso Electric Co., El Paso, Texas

Blake, C. D., Edison Elec. Illuminating Co. of Boston, Boston, Mass.

Boyle, G. J., Glen Alden Coal Co., Scranton, Pa.

Brady, R. W., Commonwealth Edison Co., Chicago, Ill.

Brown, C. R., General Electric Co., Schenectady, N. Y.

Byles, F. A. (Member), General Electric Co., Schenectady, N. Y.

Calliera, A., General Electric Co., Schenectady, N. Y.

Cameron, H. J., General Electric Co., Ft. Wayne, Ind.

Carroll, A. L., Brooklyn Edison Co., New York, N. Y.

Carson, T. H., Western Union Telegraph Co., Harrisburg, Pa.

Chamberlin, O. W., Public Service Electric & Gas Co., Newark, N. J.

Church, R. A., Puget Sound Power & Light Co., Seattle, Wash.

Clarke, J. A., Jr., (Member), Westinghouse Elec. & Mfg. Co., East Pittsburgh, Pa.

Coberg, K. C., 45 7th St., Weehawken, N. J.

Creighton, H. C., New York Edison Co., New York, N. Y.

Curtis, P. V., Van Rensselaer Hotel, New York, N. Y.

Davis, R. H., Westinghouse Elec. & Mfg. Co., East Pittsburgh, Pa.

Eipper, W. A., Bell Telephone Co. of Pa., Philadelphia, Pa.

Elg, E. G., Copperweld Steel Co., Chicago, Ill.

Encke, L., N. Y., N. H. & H. R. R. Co., New Haven, Conn.

Evans, H. W., Brooklyn Edison Co., Brooklyn, N. Y.

Evans, J. C., Teacher, Washington High School, Miami, Fla.

Evans, W. M., Chicago, Milwaukee & St. Paul Railway Co., Tacoma, Wash.

Fein, M. E., New York Edison Co., New York, N. Y.

Feller, E. W., Penn. Water & Power Co., Holtwood, Pa.

Fischer, L. O., 1749 Grand Concourse, New York, N. Y.

Ford, W. S., Drexel Institute, Philadelphia, Pa. (Applicant for re-election).

Gearhart, S. R., Penn. Power & Light Co., Wilkes-Barre, Pa.

Geary, E. A., Wm. Cramp & Sons S. & E. B. Co., Philadelphia, Pa.

Grissinger, G. G., Westinghouse Elec. & Mfg. Co., East Pittsburgh, Pa.

Halligan, B. J., New York Telephone Co., New York, N. Y.

Hanna, J. N., Robt. Skoen Electric Works, Portland, Ore.

Hart, H. C. (Member), Cuban Telephone Co., Havana, Cuba

Hathaway, C. B., Westinghouse Elec. & Mfg. Co., East Pittsburgh, Pa.

Hollyday, H. R., Philadelphia Electric Co., Philadelphia, Pa.

Horibe, S., International General Electric Co., Schenectady, N. Y.

Huddleston, J. L., The Ohio Power Co., Newcomerstown, Ohio

Kaufmann, F. W., Westinghouse Elec. & Mfg. Co., East Pittsburgh, Pa.

Kehoe, J. J., Jr., General Electric Co., Schenectady, N. Y.

Kelliher, T. H., Okonite-Callender Cable Co., Paterson, N. J.

Kennedy, A. R., Westinghouse Elec. & Mfg. Co., East Pittsburgh, Pa.

Kent, V., City Light Dept., Tacoma, Wash.

Kummer, M. T., Public Service Electric & Gas Co., Newark, N. J.

Kurman, N. A., (Member), Herald Electric Co., Inc., New York, N. Y.

Lake, A. F., (Fellow), Lake Manufacturing Co., Inc., Oakland, Calif.

Lamberger, E. H., Westinghouse Elec. & Mfg. Co., East Pittsburgh, Pa.

Lanning, H. R., Light Dept., City of Seattle, Nisqually Plant, Le Grande, Wash.

La Zan, D. C., (Miss), Simplex Wire & Cable Co., Cleveland, Ohio

Lee, R. E., General Electric Co., Tacoma, Wash.

Leslie, J. O., Metropolitan Edison Co., Reading, Pa.

Life, H. G., Western Union Telegraph Co., New York, N. Y.

Limperty, W. J., 55 Hanson Place, Brooklyn, N. Y.

Lorenz, A. M., Public Lighting Commission, Detroit, Mich.

Marconi, F. W., Jr., F. William Marconi Radio Service, Toronto, Ont., Can.

Marino, R., (Member), Bell Telephone Laboratories, Inc., New York, N. Y.

Marlowe, W. J., (Member), Charles H. Tenney & Co., Boston, Mass.

Marsh, H. H., Jr., Duquesne Light Co., Pittsburgh, Pa.

McGill, C. W., Edison Electric Illuminating Co., Boston, Mass.

Mellwain, H. A., Atlantic Tel. & Tel. Co., Philadelphia, Pa.

McNitt, D. P., Dept. of Public Utilities, City of St. Louis, St. Louis, Mo.

Mellett, P. M., Mountain Park Collieries, Ltd., Mountain Park, Alberta, Can.

Methfessel, H., With *Evening World*, New York, N. Y.

Miller, S. O., Mine & Smelter Supply Co., El Paso, Texas

Minor, H. H., Sam Joaquin Light & Power Corp., Fresno, Calif.

Mistersky, F. R., Detroit Municipal Plant, Detroit, Mich.

Moffitt, G. E., The Okonite-Callender Cable Co., Inc., Paterson, N. J.

Moore, R. J., Bell Telephone Co. of Pa., Philadelphia, Pa.

Morgan, J. A., Carnegie Steel Co., Braddock, Pa.

Munson, P. B., (Member), Westinghouse Elec. & Mfg. Co., Tacoma, Wash.

Murphy, E., Puget Sound Power & Light Co., Seattle, Wash.

Nason, F. L., Westinghouse Elec. & Mfg. Co., Boston, Mass.

Newcomb, C. D., British Columbia Electric Railway Co., Ltd., Vancouver, B. C.

Nierlich, G. E., Frederics, Inc., New York, N. Y.

O'Kelly, F. C., General Electric Co., Denver, Colo.

Parsons, J. S., Westinghouse Elec. & Mfg. Co., East Pittsburgh, Pa.

Peddicord, W. E., Westinghouse Elec. & Mfg. Co., East Pittsburgh, Pa.

Petee, F. H., Simplex Wire & Cable Co., Jacksonville, Fla.

Petersen, P. I., Cutler-Hammer Mfg. Co., Milwaukee, Wis.

Pickens, B. M., Westinghouse Elec. & Mfg. Co., East Pittsburgh, Pa.

Pooley, R. M., George Welderman & Co., New York, N. Y.

Reid, C., Puget Sound Power & Light Co., Seattle, Wash.

Reisig, C. F., Niagara Falls Power Co., Niagara Falls, N. Y.

Reiter, F. P., 1117 No. Commonwealth Ave., Los Angeles, Calif.

Ritter, E. A., 10728 112th St., Richmond Hill, N. Y.

Robbins, W. L., Puget Sound Power & Light Co., Seattle, Wash.

Rollins, N. A. (Member), Commonwealth Edison Co., Chicago, Ill.

Sawyer, L. A., 726 Pennington St., Elizabeth, N. J.

(Applicant for re-election.)

Schaber, R. F., Detroit Institute of Technology, Detroit, Mich.

Schwarz, E., General Electric Co., Schenectady, N. Y.

Scott, W. F., New York Telephone Co., Newark, N. J.

Seymour, C., Penn. Power & Light Co., Ashley, Pa.

Sherwood, H. B., Traffic Signal Engr., City of Seattle, Seattle, Wash.

Simmons, W. K., Missouri Power & Light Co., Clinton, Mo.

Smith, W. W., New York Telephone Co., Newark, N. J.

Stewart, D. M., Westinghouse Elec. & Mfg. Co., East Pittsburgh, Pa.

Sundius, H. W., The Southern New England Telephone Co., New Haven, Conn.

Sweeney, E. J., 372 Cleveland Ave., N., St. Paul, Minn.

Sylvester, W. V., Telephone Div., City Light, Seattle, Wash.

(Applicant for re-election.)

Taylor, J. J., Johns Hopkins University, Baltimore, Md.

Thomson, W. H., Detroit Edison Co., Detroit, Mich.

Toivonen, E. O., Wireless Specialty Co., Boston, Mass.

Trudgian, W., Westinghouse Elec. & Mfg. Co., Denver, Colo.

Urner, M. J., The Potomac Edison Co., Frederick, Md.

Valentine, C. E., Westinghouse Elec. & Mfg. Co., East Pittsburgh, Pa.

Vihbard, E. L., (Member), Bell Telephone Laboratories, Inc., New York, N. Y.

Volgovskoy, B. V., Union Gas & Electric Co., Cincinnati, Ohio

Weber, A. J., Electric Steel & Foundry Co., Portland, Ore.

Welford, O. C., Westinghouse Elec. & Mfg. Co., East Pittsburgh, Pa.

West, D. C., (Member), Westinghouse Elec. & Mfg. Co., East Pittsburgh, Pa.

Whitworth, W. E., Bell Telephone Laboratories, Inc., New York, N. Y.

Wilde, O. A., Sun Shipbuilding & Dry Dock Co., Chester, Pa.

Wilson, D., Electrical Draftsman, San Francisco, Calif.

Wilson, L. A., (Member), Ohio Brass Co., New York, N. Y.

Witt, E. T., Phoenix Utility Co., Miami, Fla.

Total 123.

#### Foreign

Barratt, S. E., Metropolitan-Vickers Australian Pty., Ltd., Auburn, N. S. W., Aust.

George, C. F., Corporation of Madras, Park Town, Madras, S. India

Lamb, E. L., Municipal Council, Sydney, N.S.W., Aust.  
 Marshall, F. K., Electrical Contractor, Fort. Bombay, India  
 Patel, N. N., (Member), Victoria Jubilee Technical Inst., Bombay, India  
 Raghavan, V. T. S., Corporation of India, Madras, India  
 Richardson, R. G., New Zealand Cooperative Dairy Ass'n., Hamilton, N. Z.  
 Wigley, F. D. H., B. B. O. I. Railway, Bombay, India  
 Yamamoto, K., Nippin Deuryoku K. K., Osaka, Japan  
 Total 9.

#### STUDENTS ENROLLED

Albach, Carl R., Rensselaer Polytechnic Institute  
 Amens, H. Clark, University of Nevada  
 Appleton, Scott S., University of New Hampshire  
 Bagnall, Vernon B., University of Wisconsin  
 Barker, Robert W., University of Washington  
 Bateman, Ivan L., University of Southern California  
 Bayles, Elmer L., University of Kansas  
 Beckwith, Raymond J., Brown University  
 Benson, Stanley E., Rensselaer Polytechnic Institute  
 Bigelow, Paul W., Rensselaer Polytechnic Institute  
 Blaney, Arthur C., Pennsylvania State College  
 Brooks, Charles E., Yale University  
 Burger, Jerome, University of Illinois  
 Campbell, George E., New York University  
 Carter, Edward H., University of Louisville  
 Castro, Francisco, University of Notre Dame  
 Coutant, Edward R., Rensselaer Polytechnic Institute  
 Crawley, Willard B., Brown University  
 Darragh, James B., Jr., University of Washington  
 Doi, Minari, University of Washington  
 Eagles, Horace W., University of North Carolina  
 Eastwood, D. Ross, University of Toronto  
 Eigelbach, Charles L., Washington and Lee University  
 Erdreich, Norbert, College of the City of New York  
 Fagan, Daniel J., University of Nebraska

Pfollott, Charles F., Rensselaer Polytechnic Institute  
 Gager, Frank M., The Pennsylvania State College  
 Galante, Quirino, College of the City of New York  
 Ginsberg, David, College of the City of New York  
 Gomez, Vicente I., University of Notre Dame  
 Green, G. Garner, Stanford University  
 Gregory, F. Anderson, Case School of Applied Science  
 Haley, Gale B., Washington & Lee University  
 Haller, George L., Pennsylvania State College  
 Hatch, Osborne E., University of Southern California  
 Hellriegel, Herman H., Washington and Lee University  
 Hill, Harold J., Case School of Applied Science  
 Hill, Leslie W., Ohio Northern University  
 Horn, Erling, University of Washington  
 Ingalls, Clyde E., Rensselaer Polytechnic Institute  
 Jones, Weston C., Missouri School of Mines & Metallurgy  
 Kelly, William T., Jr., Yale University  
 Kilheffer, Lawrence D., Ohio Northern University  
 Killoran, J. L., University of Toronto  
 King, Marion R., Lewis Institute  
 Knapp, Ralph T., Rensselaer Polytechnic Inst.  
 Knight, Benjamin P., Jr., Washington and Lee University  
 Lancken, Nicolas, University of Washington  
 Moak, Frank C., Rensselaer Polytechnic Institute  
 Moore, Wilbern T., Missouri School of Mines & Metallurgy  
 Motl, Laurence F., University of Wisconsin  
 Mott, Edward E., Mass. Institute of Technology  
 Murphy, William J., Mass. Institute of Tech.  
 Murray, C. Francis, Iowa State College  
 Myers, Burton L., University of Detroit  
 Nicholson, Rufus A., Jr., University of Texas  
 Norberg, Hans A., University of Minnesota  
 Nowack, David C., University of Wisconsin  
 Oatley, Henry C., Rhode Island State College  
 O'Dowd, James L., Mass. Institute of Technology  
 Olson, Richard P., So. Dakota State College of A. & M. Arts  
 Ostermeier, Russell L., University of Illinois  
 Owens, Herbert D., Ohio State University  
 Page, H. C., Missouri School of Mines & Metallurgy

Payne, Lester E., Mass. Institute of Technology  
 Pelkey, Edwin, University of Detroit  
 Poltras, Edward J., Mass. Institute of Technology  
 Pollock, John T., University of Michigan  
 Porter, Murrice O., Jr., University of Louisville  
 Pratt, Edward J., Mass. Institute of Technology  
 Presh, Victor N., University of Minnesota  
 Purdy, Donald, Rensselaer Polytechnic Institute  
 Reed, Clifford H., Bucknell University  
 Reilly, Vincent E., New York University  
 Rock, William P., University of Colorado  
 Rollman, William H., Missouri School of Mines & Metallurgy  
 Ross, E. Hart, California Institute of Technology  
 Russell, John B., Jr., Mass. Institute of Tech.  
 Sandore, George F., Rhode Island State College  
 Sorieri, Michael A., New York University  
 Spear, Paul B., University of Minneapolis  
 Stahl, Chester D., University of Illinois  
 Stainback, William P., North Carolina State College  
 Stoughton, George V., Rensselaer Polytechnic Institute  
 Swanker, Wilfred C., Case School of Applied Science  
 Taylor, Alton D., Rensselaer Polytechnic Institute  
 Tharpe, William H., Alabama Polytechnic Inst.  
 Tokunaga, Tadashi, University of British Columbia  
 Toriello, Joseph A., University of Notre Dame  
 Torple, John F., New York University  
 Tweet, Noel T., University of Wisconsin  
 Umlang, Emil E., Texas A. & M. College  
 Van Seiver, LeRoy F., Missouri School of Mines & Metallurgy  
 Ver Planck, Dennistoun W., Mass. Institute of Technology  
 Wagner, Dale R., Bucknell University  
 Waites, Ronald D., University of Washington  
 Wilcox, Brock B., University of Toronto  
 Williams, E. Eugene, University of Idaho  
 Willman, Richard C., University of Washington  
 Wine, Chester C., Washington and Lee University  
 Wooley, M. Claire, Ohio Northern University  
 Woolsey, Robert H., University of Illinois  
 Worthen, Charles E., Mass. Institute of Tech.  
 Wright, Frederick S., University of North Carolina  
 Total 104.

**Officers A. I. E. E. 1926-1927**

**PRESIDENT**

(Term expires July 31, 1927)  
C. C. CHESNEY

**JUNIOR PAST PRESIDENTS**

(Term expires July 31, 1927) FARLEY OSGOOD  
(Term expires July 31, 1928) M. I. PUPIN

**VICE-PRESIDENTS**

(Terms expire July 31, 1927) P. M. DOWNING (District No. 8)  
HERBERT S. SANDS (District No. 6)  
W. E. MITCHELL (District No. 4)  
ARTHUR G. PIERCE (District No. 2)  
W. P. DOBSON (District No. 10)

(Terms expire July 31, 1928) H. M. HOBART (District No. 1)  
B. G. JAMIESON (District No. 5)  
GEORGE L. KNIGHT (District No. 3)  
H. H. SCHOOLFIELD (District No. 9)  
A. E. BETTIS (District No. 7)

**MANAGERS**

(Terms expire July 31, 1927) W. M. McCONAHEY  
W. K. VANDERPOEL  
H. P. CHARLESWORTH  
(Terms expire July 31, 1928) JOHN B. WHITEHEAD  
J. M. BRYANT  
E. B. MERRIAM

(Terms expire July 31, 1929) M. M. FOWLER  
H. A. KIDDER  
E. C. STONE  
(Terms expire July 31, 1930) I. E. MOULTROP  
H. C. DON CARLOS  
F. J. CHESTERMAN

**NATIONAL TREASURER**

(Terms expire July 31, 1927)  
GEORGE A. HAMILTON

**NATIONAL SECRETARY**

F. L. HUTCHINSON  
**GENERAL COUNSEL**  
PARKER & AARON  
30 Broad Street, New York

**HONORARY SECRETARY**

RALPH W. POPE

**PAST PRESIDENTS—1884-1926**

*NORVIN GREEN, 1884-5-6.	*HENRY G. STOTT, 1907-8.
*FRANKLIN L. POPE, 1886-7.	LOUIS A. FERGUSON, 1908-9.
*T. COMMERFORD MARTIN, 1887-8.	LEWIS B. STILLWELL, 1909-10.
EDWARD WESTON, 1888-9.	DUGALD C. JACKSON, 1910-11.
ELIHU THOMSON, 1889-90.	GANO DUNN, 1911-12.
*WILLIAM A. ANTHONY, 1890-91.	RALPH D. MERSHON, 1912-13.
*ALEXANDER GRAHAM BELL, 1891-2.	C. O. MAILLOUX, 1913-14.
FRANK JULIAN SPRAGUE, 1892-3.	PAUL M. LINCOLN, 1914-15.
*EDWIN J. HOUSTON, 1893-4-5.	JOHN J. CARTY, 1915-16.
*LOUIS DUNCAN, 1895-6-7.	H. W. BUCK, 1916-17.
*FRANCIS BACON CROCKER, 1897-8.	E. W. RICE, JR., 1917-18.
A. E. KENNELLY, 1898-1900.	COMFORT A. ADAMS, 1918-19.
*CARL HERING, 1900-1.	CALVERT TOWNLEY, 1919-20.
*CHARLES P. STEINMETZ, 1901-2.	A. W. BERRESFORD, 1920-21.
CHARLES F. SCOTT, 1902-3.	WILLIAM MCCLELLAN, 1921-22.
BION J. ARNOLD, 1903-4.	FRANK B. JEWETT, 1922-23.
JOHN W. LIEB, 1904-5.	HARRIS J. RYAN, 1923-4.
*SCHUYLER SKAATS WHEELER, 1905-6.	FARLEY OSGOOD, 1924-25.
*SAMUEL SHELDON, 1906-7.	M. I. PUPIN, 1925-26.

\*Deceased.

**LOCAL HONORARY SECRETARIES**

T. J. Fleming, Calle B. Mitre 519, Buenos Aires, Argentina, S. A.  
H. W. Flashman, Aus. Westinghouse Elec. Co. Ltd., Cathcart House,  
11 Castlereagh St., Sydney, N. S. W., Australia.  
Carroll M. Mauseau, Caixa Postal No. 571, Rio de Janeiro, Brazil, S. A.  
Charles le Maistre, 28 Victoria St., London, S. W. 1, England.  
A. S. Garfield, 45 Bd. Beausejour, Paris 16 E, France.  
F. W. Willis, Tata Power Companies, Bombay House, Bombay, India.  
Guido Semenza, 39 Via Monte Napoleone, Milan, Italy.  
P. H. Powell, Canterbury College, Christchurch, New Zealand.  
Axel F. Enstrom, 24a Greftevegatan, Stockholm, Sweden.  
W. Elsdon-Dew, P. O. Box 4563, Johannesburg, Transvaal, Africa.

**A. I. E. E. Committees**

**GENERAL STANDING COMMITTEES**

**EXECUTIVE COMMITTEE**

C. C. Chesney, Chairman, General Electric Co., Pittsfield, Mass.  
H. P. Charlesworth, G. A. Hamilton, G. L. Knight,  
W. P. Dobson, H. A. Kidder, I. E. Moulthrop.

**FINANCE COMMITTEE**

H. A. Kidder, Chairman, 600 W. 59th St., New York, N. Y.  
H. P. Charlesworth, G. L. Knight.

**MEETINGS AND PAPERS COMMITTEE**

E. B. Meyer, Chairman, 80 Park Place, Newark, N. J.  
E. H. Hubert, Secretary, 33 W. 39th St., New York, N. Y.  
E. E. F. Creighton, L. W. W. Morrow, Harold B. Smith.  
J. E. Macdonald, F. D. Newbury, C. E. Skinner,  
F. W. Peek, Jr.,

Chairman of Committee on Coordination of Institute Activities, *ex-officio*.  
Chairmen of technical committees, *ex-officio*.

**PUBLICATION COMMITTEE**

L. F. Morehouse, Chairman, 195 Broadway, New York, N. Y.  
F. L. Hutchinson, Donald McNicol, I. E. Moulthrop.  
E. B. Meyer.

**COMMITTEE ON COORDINATION OF INSTITUTE ACTIVITIES**

Farley Osgood, Chairman, 31 Nassau Street, New York, N. Y.  
F. L. Hutchinson, E. B. Meyer, W. I. Slichter,  
H. A. Kidder, L. F. Morehouse, Harold B. Smith.

**BOARD OF EXAMINERS**

Erich Hausmann, Chairman, Polytechnic Institute, Brooklyn, N. Y.  
H. C. Don Carlos, Harold Goodwin, Jr., L. W. W. Morrow,  
H. W. Drake, S. P. Grace, N. L. Pollard,  
E. H. Everit, F. V. Magalhaes, W. I. Slichter,  
F. M. Farmer, A. E. Waller,

**SECTIONS COMMITTEE**

Harold B. Smith, Chairman, Worcester Polytechnic Institute, Worcester, Mass.  
H. H. Henline, W. B. Kouwenhoven, Herbert S. Sands.  
C. E. Magnusson,  
Chairmen of Sections, *ex-officio*.

**COMMITTEE ON STUDENT BRANCHES**

C. E. Magnusson, Chairman, University of Washington, Seattle, Wash.  
J. M. Bryant, Charles F. Scott, W. H. Timbie,  
Harold B. Smith,  
Student Branch Counselors, *ex-officio*

**MEMBERSHIP COMMITTEE**

L. S. O'Roark, Chairman, 463 West St., New York, N. Y.  
R. B. Bonney, J. J. Frank, L. M. Moyer  
A. B. Cooper, F. R. George, I. M. Stein  
H. E. Cox, G. S. Morris, C. V. Woolsey  
S. H. Mortensen  
Chairmen of Section Membership Committees *ex-officio*.

**HEADQUARTERS COMMITTEE**

G. L. Knight, Chairman, Pearl & Willoughby Sts., Brooklyn, N. Y.  
F. L. Hutchinson, H. A. Kidder.

**LAW COMMITTEE**

W. I. Slichter, Chairman, Columbia University, New York, N. Y.  
H. H. Barnes, Jr., E. B. Merriam, Charles A. Terry,  
R. F. Schuchardt,

**PUBLIC POLICY COMMITTEE**

Gano Dunn, Chairman, 43 Exchange Place, New York, N. Y.  
H. W. Buck, John W. Lieb, M. I. Pupin,  
F. B. Jewett, William McClellan, Harris J. Ryan.

**STANDARDS COMMITTEE**

J. Franklin Meyer, Chairman, Bureau of Standards, Washington, D. C.  
H. E. Farrer, Secretary, 33 W. 39th St., New York.  
H. A. Kidder, H. S. Osborne, C. E. Skinner,  
A. M. MacCutcheon, F. L. Rhodes, W. I. Slichter,  
F. D. Newbury, L. T. Robinson, R. H. Tapscott.  
*Ex Officio*

Chairmen of Working Committees.  
Chairmen of delegations on other standardizing bodies.  
President of U. S. National Committee of I. E. C.

**EDISON MEDAL COMMITTEE**

*Appointed by the President for term of five years.*

(Terms expire July 31, 1927)  
Gano Dunn, Chairman, F. A. Scheffler, W. R. Whitney.  
(Terms expire July 31, 1928)  
C. C. Chesney, Robert A. Millikan, M. I. Pupin.  
(Terms expire July 31, 1929)  
N. A. Carle, W. C. L. Eglin, John W. Lieb.  
(Terms expire July 31, 1930)  
George Gibbs, Samuel Insull, Ralph D. Mershon.  
(Terms expire July 31, 1931)  
John W. Howell, L. F. Morehouse, David B. Rushmore.  
*Elected by the Board of Directors from its own membership for term of two years.*

(Terms expire July 31, 1927)  
W. P. Dobson, Farley Osgood, A. G. Pierce.  
(Terms expire July 31, 1928)  
B. G. Jamieson, H. A. Kidder, G. L. Knight.

*Ex-Officio*

C. C. Chesney, President, George A. Hamilton, National Treasurer,  
F. L. Hutchinson, National Secretary.

**COMMITTEE ON CODE OF PRINCIPLES OF PROFESSIONAL CONDUCT**

John W. Lieb, Chairman, 124 E. 15th St., New York, N. Y.  
A. H. Babcock, R. D. Mershon, Harris J. Ryan,  
G. Faccioli, L. F. Morehouse, C. E. Skinner.

**COMMITTEE ON AWARD OF INSTITUTE PRIZES**

E. B. Meyer, Chairman, 80 Park Place, Newark, N. J.  
L. F. Morehouse, John B. Whitehead.

**COMMITTEE ON AWARD OF COLUMBIA UNIVERSITY SCHOLARSHIPS**

W. I. Slichter, Chairman, Columbia University, New York, N. Y.  
Francis Blossom, H. C. Carpenter.

**COMMITTEE ON SAFETY CODES**

John Price Jackson, Chairman, N. Y. Edison Co., 130 E. 15th St., New York, N. Y.  
 F. A. Barron, H. B. Gear, Farley Osgood,  
 Philander Betts, P. J. Howe, George Quinan,  
 W. J. Canada, L. C. Ilsley, Joseph Sachs,  
 R. N. Conwell, M. G. Lloyd, H. R. Sargent,  
 J. V. B. Duer, Ernest Lunn, W. H. Sawyer,  
 J. C. Forsyth, Wills MacLachlan, M. L. Sindeband,  
 R. C. Fryer, J. C. Martin, Paul Spencer,  
 D. H. Gage, J. E. Moore, H. S. Warren,  
 R. W. E. Moore,

**SPECIAL COMMITTEES****LICENSING OF ENGINEERS**

Francis Blossom, Chairman, Sanderson & Porter, 52 William St., New York, N. Y.  
 H. W. Buck, Gano Dunn, E. W. Rice, Jr.  
 L. E. Imlay,

**TECHNICAL ACTIVITIES**

A. G. Pierce, Chairman, 1239 Guardian Building, Cleveland, Ohio  
 H. P. Charlesworth, H. M. Hobart, E. C. Stone  
 H. A. Kidder, J. B. Whitehead.

**ADVISORY COMMITTEE TO THE MUSEUMS OF THE PEACEFUL ARTS**

J. P. Jackson, Chairman, 130 E. 15th St., New York, N. Y.  
 Randolph H. Nexsen, George K. Thompson.

**TECHNICAL COMMITTEES****COMMUNICATION**

H. P. Charlesworth, Chairman, 195 Broadway, New York, N. Y.  
 F. L. Baer, D. H. Gage, F. A. Raymond,  
 L. W. Chubb, S. P. Grace, Chester W. Rice,  
 J. L. Clarke, P. J. Howe, J. K. Roosevelt,  
 Charles E. Davies, F. H. Kroger, H. A. Shepard,  
 H. W. Drake, Ray H. Manson, J. F. Skirrow,  
 Major P. W. Evans, R. D. Parker, E. B. Tuttle,  
 R. D. Evans, H. S. Phelps, K. L. Wilkinson,  
 E. H. Everit, Lt. Comdr. B. B. Ralston, F. A. Wolff,  
 L. F. Fuller, C. A. Wright.

**EDUCATION**

P. M. Lincoln, Chairman, Franklin Hall, Cornell University, Ithaca, N. Y.  
 R. E. Doherty, Vice-Chairman, Schenectady, N. Y.  
 C. A. Adams, J. P. Jackson, Harold B. Smith,  
 Edward Bennett, John Mills, R. W. Sorensen,  
 Nelson J. Darling, H. H. Norris, J. B. Whitehead,  
 W. C. L. Elgin, Harold Pender, W. R. Whitney,  
 W. L. Robb, W. E. Wickenden.

**ELECTRICAL MACHINERY**

H. M. Hobart, Chairman, General Electric Co., Schenectady, N. Y.  
 J. C. Parker, Vice-Chairman, Brooklyn, N. Y.  
 E. B. Paxton, Secretary, General Electric Co., Schenectady, N. Y.  
 C. A. Adams, G. H. Garcelon, O. K. Marti,  
 P. L. Alger, C. M. Gilt, V. M. Montsinger,  
 B. F. Bailey, Harold Goodwin, C. A. Mudge,  
 B. L. Barns, J. L. Hamilton, F. D. Newbury,  
 B. A. Behrend, W. E. Haseltine, L. C. Nichols,  
 C. O. Bergstrom, R. A. Hentz, N. L. Pollard,  
 A. C. Bunker, C. F. Hirshfeld, C. H. Sanderson,  
 James Burke, B. G. Jamieson, R. F. Schuchardt,  
 W. M. Dann, J. A. Johnson, A. Still,  
 L. L. Elden, V. Karapetoff, E. C. Stone,  
 G. Faccioli, A. H. Kehoe, R. H. Tapscott,  
 C. J. Fechheimer, P. M. Lincoln, R. B. Williamson,  
 W. J. Foster, A. M. MacCutcheon, H. L. Zabriskie.

**ELECTRIC WELDING**

J. C. Lincoln, Chairman, Coit Road & Kirby Avenue, Cleveland, Ohio  
 C. A. Adams, Alexander Churchward, Ernest Lunn,  
 P. P. Alexander, O. H. Eschholz, J. W. Owens,  
 C. W. Bates, F. M. Farmer, William Spraragen,  
 Ernest Bauer, H. M. Hobart, H. W. Tobey,  
 A. M. Candy, C. J. Holslag, Ernest Wanamaker,  
 C. L. Ipsen, C. L. Ipsen.

**ELECTROCHEMISTRY AND ELECTROMETALLURGY**

G. W. Vinal, Chairman, Bureau of Standards, Washington, D. C.  
 Lawrence Addicks, Safford K. Colby, Magnus Unger,  
 A. N. Anderson, F. A. J. Fitzgerald, J. B. Whitehead,  
 T. C. Atchison, Walter E. Holland, J. L. Woodbridge,  
 Farley G. Clark, F. A. Lidbury, J. L. McK. Yardley,  
 C. G. Schluederberg,

**ELECTROPHYSICS**

V. Karapetoff, Chairman, Cornell University, Ithaca, N. Y.  
 Carl Kinsley, Secretary, 22 Lynwood Road, Scarsdale, N. Y.  
 Oliver E. Buckley, W. B. Kouwenhoven, Chester W. Rice,  
 V. Bush, K. B. McEachron, J. Slepian,  
 J. F. H. Douglas, R. A. Millikan, Harold B. Smith,  
 Charles Fortescue, J. H. Morecroft, Irving B. Smith,  
 Carl Kinsley, J. B. Whitehead.

**INSTRUMENTS AND MEASUREMENTS**

A. E. Knowlton, Chairman, Dunham Laboratory, Yale University,  
 New Haven, Conn.  
 E. D. Doyle, Vice-Chairman, New York, N. Y.  
 O. J. Bliss, C. F. Hanson,  
 Perry A. Borden, W. B. Kouwenhoven,  
 W. M. Bradshaw, P. M. Lincoln,  
 H. B. Brooks, W. M. McConahey,  
 J. R. Craighead, Wm. J. Mowbray,  
 Melville Eastham, H. A. Perkins,  
 W. M. Goodwin, Jr., R. T. Pierce,  
 L. T. Robinson,  
 E. J. Rutan,  
 B. W. St. Clair,  
 G. A. Sawin,  
 I. B. Smith,  
 H. M. Turner,  
 Roy Wilkins.

**APPLICATIONS TO IRON AND STEEL PRODUCTION**

A. G. Pierce, Chairman, 1239 Guardian Building, Cleveland, Ohio  
 A. C. Bunker, S. L. Henderson, J. W. Speer,  
 A. C. Cummins, R. H. Keil, G. E. Stoltz,  
 F. B. Crosby, W. C. Kennedy, T. S. Towle,  
 J. H. Hall, A. G. Place, J. D. Wright,  
 F. O. Schnure,

**PRODUCTION AND APPLICATION OF LIGHT**

P. S. Millar, Chairman, Electrical Testing Laboratories, 80th St. &  
 East End Ave., New York  
 W. T. Blackwell, G. C. Hall, F. H. Murphy,  
 J. M. Bryant, L. A. Hawkins, F. A. Rogers,  
 J. R. Cravath, H. H. Higbie, B. E. Shackelford,  
 W. T. Dempsey, C. L. Kinsloe, C. J. Stahl,  
 William Esty, A. S. McAllister, G. H. Stickney,  
 George S. Merrill,

**APPLICATIONS TO MARINE WORK**

G. A. Pierce, Chairman, Wm Cramp & Sons S. & E. B. Co., Philadelphia, Pa.  
 R. A. Beekman, Vice-Chairman, Schenectady, N. Y.  
 Comdr. C. S. Gillette, A. Kennedy, Jr., R. L. Witham,  
 E. M. Glasgow, Comdr. M. A. Libbey, H. M. Southgate,  
 H. F. Harvey, Jr., J. B. Lunsford, W. E. Thau,  
 Wm. Hetherington, Jr., E. B. Merriam, G. P. Turner,  
 H. L. Hibbard, I. H. Osborne, A. E. Waller,  
 J. S. Jones, William H. Reed, J. L. Wilson,

**APPLICATIONS TO MINING WORK**

W. H. Lesser, Chairman, Madeira Hill & Co., Frackville, Pa.  
 M. C. Benedict, Carl Lee, W. J. Schwedes,  
 F. N. Bosson, John A. Malady, E. D. Stewart,  
 Graham Bright, Charles H. Matthews, F. L. Stone,  
 L. C. Ilsley, F. C. Nicholson, W. A. Thomas,  
 G. M. Kennedy, H. F. Pigg, E. B. Wagner,  
 R. L. Kingsland, L. L. Quigley, J. F. Wiggert,  
 A. B. Kiser, Herbert S. Sands, C. D. Woodward.

**GENERAL POWER APPLICATIONS**

A. M. MacCutcheon, Chairman, 1088 Ivanhoe Road, Cleveland, Ohio  
 E. W. Henderson, Secretary, 1088 Ivanhoe Road, Cleveland, O.  
 A. E. Arnold, H. D. James, H. W. Price,  
 D. H. Braymer, P. C. Jones, H. L. Smith,  
 R. C. Deale, A. C. Lanier, A. H. Stebbins,  
 C. W. Drake, W. S. Maddocks, E. C. Stone,  
 J. F. Gaskill, N. L. Mortensen, W. H. Timbie,  
 Clyde D. Gray, K. A. Pauly, F. M. Weller,  
 C. Francis Harding, D. M. Petty, W. C. Yates.

**POWER GENERATION**

W. S. Gorsuch, Chairman, 600 W. 59th St., New York, N. Y.  
 J. T. Lawson, Vice-Chairman, Newark, N. J.  
 Vern E. Alden, H. A. Kidder, M. M. Samuels,  
 H. A. Barre, W. H. Lawrence, F. A. Scheffler,  
 E. T. Brandon, F. T. Leilich, R. F. Schuchardt,  
 N. E. Funk, James Lyman, Arthur R. Smith,  
 W. S. Gorsuch, W. E. Mitchell, Nicholas Stahl,  
 C. F. Hirshfeld, I. E. Moulthrop, B. Tikhonovitch,  
 Francis Hodgkinson, W. M. White.

**POWER TRANSMISSION AND DISTRIBUTION**

Philip Torchio, Chairman, 124 E. 15th St., New York, N. Y.  
 P. H. Chase, Vice-Chairman, Philadelphia, Pa.  
 R. N. Conwell, Vice-Chairman, Newark, N. J.  
 R. H. Tapscott, Vice-Chairman, New York, N. Y.  
 R. W. Atkinson, L. L. Elden, C. R. Oliver,  
 A. O. Austin, R. D. Evans, F. W. Peek, Jr.,  
 F. G. Baum, F. M. Farmer, D. W. Roper,  
 R. D. Booth, C. L. Fortescue, C. E. Schwenger,  
 J. A. Brundige, C. D. Gray, A. E. Silver,  
 V. Bush, K. A. Hawley, M. L. Sindeband,  
 George F. Chellis, J. P. Jollyman, H. C. Sutton,  
 Wallace S. Clark, A. H. Kehoe, Percy H. Thomas,  
 Edith Clarke, C. H. Kraft, W. K. Vanderpoel,  
 John C. Damon, A. H. Lawton, Theodore Varney,  
 W. A. Del Mar, E. A. Loew, H. S. Warren,  
 Herbert H. Dewey, W. E. Meyer, R. J. C. Wood,  
 W. E. Mitchell,

**PROTECTIVE DEVICES**

F. L. Hunt, Chairman, Turners Falls Power & Electric Co., Greenfield, Mass.  
 H. R. Summerhayes, Vice-Chairman, Schenectady, N. Y.  
 E. A. Hester, Secretary, 435 Sixth Ave., Pittsburgh, Pa.  
 Raymond Bailey, H. C. Louis, J. M. Oliver,  
 W. S. Edsall, W. B. Kirke, E. J. Rutan,  
 H. Halperin, K. B. McEachron, H. P. Sleeper,  
 F. C. Hanker, W. H. Millan, E. C. Stone,  
 J. Allen Johnson, L. J. Moore, A. H. Sweetnam,  
 M. G. Lloyd, A. Royal Wood.

**RESEARCH**

John B. Whitehead, Chairman, Johns Hopkins University, Baltimore, Md.  
 P. W. Peek, Jr., Vice-Chairman, Pittsfield, Mass.  
 Edward Bennett, B. Gherardi, E. W. Rice, Jr.,  
 V. Bush, V. Karapetoff, D. W. Roper,  
 E. H. Colpitts, A. E. Kennelly, Clayton H. Sharp,  
 E. E. P. Creighton, M. G. Lloyd, C. E. Skinner,  
 W. F. Davidson, C. E. Magnusson, Harold B. Smith,  
 W. A. Del Mar, Harold Pender, R. W. Sorensen.

**TRANSPORTATION**

J. V. B. Duer, Chairman, Pennsylvania Railroad, Altoona, Pa.  
 E. R. Hill, H. A. Kidder, N. W. Storer,  
 W. K. Howe, John Murphy, W. M. Vandersluis,  
 D. C. Jackson, W. S. Murray, Richard H. Wheeler,  
 W. B. Potter.

**A. I. E. E. Representatives**

**AMERICAN ASSOCIATION FOR THE ADVANCEMENT OF SCIENCE COUNCIL**

M. I. Pupin, John B. Taylor.

**AMERICAN BUREAU OF WELDING**  
 H. M. Hobart.

**AMERICAN COMMITTEE ON ELECTROLYSIS**

B. J. Arnold, N. A. Carle, F. N. Waterman.

**AMERICAN ENGINEERING COUNCIL ASSEMBLY**

H. H. Barnes, Jr., H. M. Hobart, A. G. Pierce,  
 A. W. Berresford, F. L. Hutchinson, M. I. Pupin,  
 \*C. C. Chesney, William McClellan, E. W. Rice, Jr.,  
 H. W. Eales, L. F. Morehouse, \*Charles F. Scott,  
 \*John H. Finney, I. E. Moulthrop, \*C. E. Skinner,  
 \*M. M. Fowler, \*Farley Osgood, Calvert Townley,  
 \*Members of Administrative Board

**AMERICAN ENGINEERING STANDARDS COMMITTEE**

H. M. Hobart, J. F. Meyer, C. E. Skinner,  
 H. S. Osborne, John C. Parker, L. T. Robinson, Alternates,

**AMERICAN MARINE STANDARDS COMMITTEE**  
 R. A. Beekman,

**AMERICAN YEAR BOOK, ADVISORY BOARD**  
 Edward Caldwell

**APPARATUS MAKERS AND USERS, COMMITTEE OF NATIONAL RESEARCH COUNCIL**  
 C. E. Skinner

**BOARD OF TRUSTEES, UNITED ENGINEERING SOCIETY**

Bancroft Gherardi, G. L. Knight, Calvert Townley.

**CHARLES A. COFFIN FELLOWSHIP AND RESEARCH FUND COMMITTEE**  
 C. C. Chesney

**ELIMINATION OF FATIGUE, COMMITTEE ON, SOCIETY OF INDUSTRIAL ENGINEERS**  
 C. Francis Harding

**ENGINEERING FOUNDATION BOARD**

Gano Dunn, L. B. Stillwell.

**JOHN FRITZ MEDAL BOARD OF AWARD**

C. C. Chesney, Gano Dunn, M. I. Pupin,  
 Farley Osgood.

**JOINT COMMITTEE ON WELDED RAIL JOINTS**

D. D. Ewing, A. P. Way.

**JOINT CONFERENCE COMMITTEE OF FOUNDER SOCIETIES**

The Presidents and Secretaries, *ex-officio*.

**LIBRARY BOARD OF UNITED ENGINEERING SOCIETY**

Edward D. Adams, F. L. Hutchinson, W. B. Jackson,  
 E. B. Craft, W. I. Slichter.

**NATIONAL FIRE PROTECTION ASSOCIATION, ELECTRICAL COMMITTEE**  
 J. P. Jackson

**NATIONAL FIRE WASTE COUNCIL**

John H. Finney, J. P. Jackson.

**NATIONAL MUSEUM OF ENGINEERING AND INDUSTRY BOARD OF TRUSTEES**  
 Gano Dunn

**NATIONAL RESEARCH COUNCIL, ENGINEERING DIVISION**

John B. Whitehead, Cary T. Hutchinson, E. W. Rice, Jr.,  
 F. L. Hutchinson, *ex-officio*,

**NATIONAL SAFETY COUNCIL, ELECTRICAL COMMITTEE OF A. S. S. E.—ENGINEERING SECTION**

J. P. Jackson

**THE NEWCOMEN SOCIETY**

E. B. Craft

**RADIO ADVISORY COMMITTEE, BUREAU OF STANDARDS**

A. E. Kennelly

**SOCIETY FOR THE PROMOTION OF ENGINEERING EDUCATION BOARD OF INVESTIGATION AND COORDINATION**

Gano Dunn, Frank B. Jewett.

**U. S. NATIONAL COMMITTEE OF THE INTERNATIONAL ILLUMINATION COMMISSION**

A. E. Kennelly, C. O. Mailloux, Clayton H. Sharp.

**WASHINGTON AWARD, COMMISSION OF**

L. A. Ferguson, Charles F. Scott.

**U. S. NATIONAL COMMITTEE OF THE INTERNATIONAL ELECTROTECHNICAL COMMISSION**

C. A. Adams, H. A. Kidder, (*ex-officio*) E. W. Rice, Jr.,  
 C. C. Chesney, *ex-officio*, John W. Lieb, L. T. Robinson,  
 L. W. Chubb, F. V. Magalhaes, D. W. Roper,  
 W. A. Del Mar, C. O. Mailloux, Charles F. Scott,  
 Gano Dunn, A. S. McAllister, C. H. Sharp,  
 B. Gherardi, William McClellan, C. E. Skinner,  
 H. M. Hobart, J. F. Meyer, *ex-officio*, N. W. Storer,  
 D. C. Jackson, F. D. Newbury, John B. Taylor,  
 F. B. Jewett, H. S. Osborne, Elihu Thomson,  
 A. E. Kennelly, Farley Osgood, R. B. Williamson,  
 F. W. Peek.

**LIST OF SECTIONS**

Name	Chairman	Secretary	Name	Chairman	Secretary
Akron	A. R. Holden	H. L. Steinbach, Electrical Engineering Dept., Goodyear Tire & Rubber Co., Akron, Ohio	Denver	W. H. Edmunds	R. B. Bonney, Telephone Bldg., P. O. Box 960, Denver, Colo.
Atlanta	C. E. Bennett	W. F. Oliver, Box 2211, Atlanta, Ga.	Detroit-Ann Arbor	Harold Cole	F. H. Riddle, Champion Porcelain Co., Detroit, Mich.
Baltimore	W. B. Kouwenhoven	R. T. Greer, Madison St. Building, Baltimore, Md.	Erie	F. A. Tennant	L. H. Curtis, General Electric Co., Erie, Pa.
Boston	Hartley Rowe	W. H. Colburn, 39 Boylston St., Boston, Mass.	Fort Wayne	D. W. Merchant	C. F. Beyer, General Electric Co., Fort Wayne, Ind.
Chicago	K. A. Auty	William Wurth, 1634 Peoples Gas Bldg., Michigan Ave. at Adams St., Chicago, Ill.	Indianapolis-Lafayette	J. B. Bailey	C. A. Fay, 4206 Cornelius Ave., Indianapolis, Ind.
Cincinnati	W. P. Beattie	L. J. Gregory, Union Gas & Electric Co., Cincinnati, Ohio	Ithaca	R. F. Chamberlain	G. F. Bason, Electrical Engineering Dept., Cornell University, Ithaca, N. Y.
Cleveland	H. L. Grant	W. E. McFarland, 720 Illuminating Bldg., Cleveland, Ohio	Kansas City	R. L. Baldwin	S. M. De Camp, 510 Dwight Bldg., Kansas City, Mo.
Columbus	A. W. Janowitz	E. A. Williams, 231 N. Fifth St., Columbus, Ohio	Lehigh Valley	W. E. Lloyd, Jr.	G. W. Brooks, Pennsylvania Power & Light Co., 8th & Hamilton Sts., Allentown, Pa.
Connecticut	A. E. Knowlton	R. G. Warner, Yale University, 10 Hillhouse Ave., New Haven, Conn.	Los Angeles	R. E. Cunningham	L. C. Williams, H. W. Hellman Bldg., Los Angeles, Calif.

## LIST OF SECTIONS—Continued.

Name	Chairman	Secretary	Name	Chairman	Secretary
Louisville	D. C. Jackson, Jr.	W. C. White, Southern Bell Tel. & Tel. Co., Louisville, Ky.	San Francisco	D. I. Cone	A. G. Jones, 807 Kialto Bldg., San Francisco, Calif.
Lynn	D. F. Smalley	Chas. Skoglund, River Works, General Electric Co., W. Lynn, Mass.	Saskatchewan	B. K. Parker	W. P. Brattie, Dept. of Telephones, Telephone Bldg., Regina, Sask.
Madison	R. J. Kallevang	H. J. Hunt, D. W. Mead & C. V. Seastone, State Journal Bldg., Madison, Wis.	Schenectady	R. R. Doherty	R. P. Franklin, Room 201, Bldg. No. 41, General Electric Co., Schenectady, N. Y.
Mexico	Carlos Macias	G. Solis Payan, Ave. Portales 80, General Anaya, Mexico D. F., Mexico.	Seattle	C. E. Mong	C. R. Wallis, 600 Colman Bldg., P. O. Box 1858, Seattle, Wash.
Milwaukee	H. L. Van Valkenberg	R. G. Lockett, Cutler-Hammer Mfg. Co., Milwaukee, Wis.	Sharon	H. L. Cole	L. H. Hill, Westinghouse Elec. & Mfg. Co., Sharon, Pa.
Minnesota	S. B. Hood	M. E. Todd, University of Minnesota, Minneapolis, Minn.	Southern Virginia	W. S. Rodman	J. H. Berry, 1325 Rockbridge Ave., Norfolk, Va.
Nebraska	C. W. Minard	N. W. Kingsley, 1303 Telephone Bldg., Omaha, Nebr.	Spokane	Richard McKay	James B. Piskin, Washington Water Power Co., Lincoln & Trent, Spokane, Wash.
New York	E. B. Meyer	O. B. Blackwell, American Tel. & Tel. Co., 195 Broadway, New York, N. Y.	Springfield, Mass.	L. P. Curtis	J. Frank Murray, United Electric Light Co., 251 Wilbraham Ave., Springfield, Mass.
Niagara Frontier	H. B. Alverson	A. W. Underhill, Jr., 606 Lafayette Bldg., Buffalo, N. Y.	Syracuse	C. E. Dorr	F. E. Verdin, 615 City Bank Bldg., Syracuse, N. Y.
Oklahoma	E. R. Page	C. C. Stewart, Oklahoma Gas & Electric Co., Norman, Okla.	Toledo	O. P. Rabbe	Max Neuber, 1257 Fernwood Ave., Toledo, Ohio
Panama	L. W. Parsons	I. F. McIlhenny, Box 413, Balboa Heights, C. Z.	Toronto	M. B. Hastings	P. P. Ambuhl, Toronto Hydro-Electric System, 226 Yonge St., Toronto, Ontario
Philadelphia	Louis J. Costa	R. H. Silbert, 2301 Market St., Philadelphia, Pa.	Urbana	J. T. Tykociner	L. B. Archer, 301 Electrical Engineering Lab., University of Illinois, Urbana, Ill.
Pittsburgh	D. M. Simons	W. C. Goodwin, Westinghouse Elec. & Mfg. Co., East Pittsburgh, Pa.	Utah	B. C. J. Wheatlake	D. L. Brundige, Utah Power & Light Co., Box 1700, Salt Lake City, Utah
Pittsfield	E. F. Gehrkens	C. H. Kline, General Electric Co., Pittsfield, Mass.	Vancouver	R. L. Hall	C. W. Colvin, B. C. Electric Railway Co., 425 Carrall St., Vancouver, B. C.
Portland, Ore.	J. C. Henkle	J. E. Yates, Gasco Bldg., Portland, Ore.	Washington, D. C.	C. A. Robinson	L. E. Reed, Potomac Elec. Power Co., 14th & C Sts., Washington, D. C.
Providence	Edwin E. Nelson	F. W. Smith, Blackstone Valley Gas & Electric Co., Pawtucket, P. I.	Worcester	C. P. Hood	F. C. Crosby, Morgan Construction Co., 15 Belmont St., Worcester, Mass.
Rochester	Earl C. Karker	Wade H. Reichard, General Ry. Signal Co., Rochester, N. Y.	Total 52		
St. Louis	L. F. Woolston	L. P. Van Houten, 2670 Washington Boulevard, St. Louis, Mo.			

## LIST OF BRANCHES

Name and Location	Chairman	Secretary	Counselor (Member of Faculty)
Akron, Municipal University of, Akron, Ohio	Lee J. Shaffer	S. K. Worthen	J. T. Walther
Alabama Polytechnic Institute, Auburn, Ala.	F. S. Lynch	P. E. Sandlin	W. W. Hill
Alabama, University of, University, Ala.	Sewell St. John	J. M. Cardwell, Jr.	
Arizona, University of, Tucson, Ariz.	J. W. Cruse	Audley Sharpe	J. C. Clark
Arkansas, University of, Fayetteville, Ark.	Carroll Walsh	W. H. Mann, Jr.	W. B. Stelzner
Armour Institute of Technology, 3300 Federal St., Chicago, Ill.	M. T. Goetz	C. W. Schramm	D. P. Moreton
Brooklyn Polytechnic Institute, 99 Livingston St., Brooklyn, N. Y.	William Berger	Joseph Heller	Robin Beach
Bucknell University, Lewisburg, Pa.	A. Fogelsanger	J. D. Johnson	W. K. Rhodes
California Institute of Technology, Pasadena, Calif.	Thomas L. Gottier	Allan E. Capon	R. W. Sorensen
California, University of, Berkeley, Calif.	F. H. McCune	A. G. Montin	T. C. McFarland
Carnegie Institute of Technology, Pittsburgh, Pa.	J. R. Power	R. O. Perrine	B. C. Dennison
Case School of Applied Science, Cleveland, O.	G. J. Currie	R. C. Taylor	H. B. Dates
Catholic University of America, Washington, D. C.	W. S. Sparks	C. S. Daily, Jr.	T. J. MacKavanaugh
Cincinnati, University of, Cincinnati, O.	C. W. Taylor	W. C. Osterbrock	W. C. Osterbrock
Clarkson College of Technology, Potsdam, N. Y.	H. J. Myrback	W. E. Turnbull	A. R. Powers
Clemson Agricultural College, Clemson College, S. C.	L. R. Miller	J. U. Wilson	S. R. Rhodes
Colorado State Agricultural College, Ft. Collins, Colo.	Harold Newsome	Harold Groat	
Colorado, University of, Boulder, Colo.	A. D. Thomas	J. A. Setter	W. C. DuVall
Cooper Union, New York, N. Y.	H. T. Wilhelm	E. T. Reynolds	Norman L. Towle
Denver, University of, Denver, Colo.	Harold Henson	Alex A. Ohlson	R. E. Nyswander
Drexel Institute, Philadelphia, Pa.	H. D. Baker	R. S. Eisinger, Jr.	E. O. Lange
Duke University, Durham, N. C.	Oren Long	W. C. Earnhardt	W. J. Seeley
Florida, University of, Gainesville, Fla.	W. Stanwix-Hay	R. D. Ross	J. M. Weil
Georgia School of Technology, Atlanta, Ga.	W. M. McGraw	F. L. Kaestle	E. S. Hannaford
Idaho, University of, Moscow, Idaho	J. W. Gartin	S. Blore	J. H. Johnson
Iowa State College, Ames, Iowa	A. G. Baumgartner	J. B. Cecil	F. A. Fish
Iowa, State University of, Iowa City, Iowa	Theo. VanLaw	E. J. Hartman	A. H. Ford
Kansas State College, Manhattan, Kans.	A. M. Young	John Yost	
Kansas, University of, Lawrence, Kans.	Elmer Bayles	Miss Lottie Young	G. C. Shaad
Kentucky, University of, Lexington, Ky.	R. W. Spicer	C. D. McClanahan	
Lafayette College, Easton, Pa.	Herbert Heinrich	Daniel Paul	Morland King
Lehigh University, Bethlehem, Pa.	A. W. Staller	J. Lloyd Dancy	J. L. Beaver
Lewis Institute, Chicago, Ill.	James S. Howe	O. D. Westerberg	F. A. Rogers
Louisiana State University, Baton Rouge, La.	K. J. Ozment	E. P. Athens	M. B. Voorhies
Maine, University of, Orono, Me.	P. E. Watson	R. F. Scott	W. E. Barrows, Jr.
Marquette University, 1200 Sycamore St., Milwaukee, Wis.	R. M. Franey	E. T. Baldwin	J. F. H. Douglas
Massachusetts Institute of Technology, Cambridge, Mass.	Constantine Bary	E. A. Michelman	W. H. Timbie
Michigan State College, East Lansing	W. H. Bartels	J. C. Phelps	L. S. Foltz
Michigan, University of, Ann Arbor, Mich.	M. H. Nelson	H. R. Stevenson	B. F. Bailey
Milwaukee, Engineering School of, 415 Marshall St., Milwaukee, Wis.	Joseph Havlick	W. H. Freisleben	John D. Ball
Minnesota, University of, Minneapolis, Minn.	C. H. Burmeister	J. H. DuBois	H. Kuhlmann
Mississippi Agricultural & Mechanical College, A. & M. College, Miss.	H. M. Alford	B. W. Robins	L. L. Patterson
Missouri School of Mines and Metallurgy, Rolla, Mo.	H. H. Brittingham	E. J. Gregory	I. H. Lovett
Missouri, University of, Columbia, Mo.	V. L. Tiller	J. L. Egbert	M. P. Weinbach

## LIST OF BRANCHES—Continued.

Name and Location	Chairman	Secretary	Counselor (Member of Faculty)
Montana State College, Bozeman, Mont.	W. E. Pakala	J. A. Thaler	J. A. Thaler
Nebraska, University of, Lincoln, Neb.	H. H. Brown	R. D. Reed	F. W. Norris
Nevada, University of, Reno, Nev.	Kenneth Knopf	Clark Amens	S. G. Palmer
Newark College of Engineering, 367 High St., Newark, N. J.	H. G. Patton	C. H. Clarendon, Jr.	J. C. Peet
New Hampshire, University of, Durham, N. H.	T. C. Tappan	F. W. Hussey	L. W. Hitchcock
New York, College of the City of, New York, N. Y.	Harold Wolf	A. H. Rapport	Harry Baum
New York University, University Heights, New York, N. Y.	H. U. Hefty	Henry Och	J. Loring Arnold
North Carolina State College, Raleigh, N. C.	J. W. Fagan	W. E. Mathews	G. C. Cox
North Carolina, University of, Chapel Hill	H. E. Thompson, Jr.	W. N. Michal	P. H. Daggett
North Dakota, University of, Grand Forks, N. D.	Alfred Botten	Nels Anderson	D. R. Jenkins
Northeastern University, 316 Huntington Ave., Boston, Mass.	W. P. Raffone	John L. Clark	W. L. Smith
Notre Dame, University of, Notre Dame, Ind.	W. C. Davis	C. H. Schamel	J. A. Caparo
Ohio Northern University, Ada, Ohio	M. W. Heft	P. W. Wadsworth	I. S. Campbell
Ohio State University, Columbus, O.	A. B. Crawford	L. G. Stewart	F. C. Caldwell
Ohio University, Athens, Ohio	Clarence Kelch	Glen R. Smith	A. A. Atkinson
Oklahoma A. & M. College, Stillwater, Okla.	B. Fonts	J. Robertson	Edwin Kurtz
Oklahoma, University of, Norman, Okla.	G. B. Brady	H. C. Mitschrich	F. G. Tappan
Oregon Agricultural College, Corvallis, Ore.	F. D. Crowther	E. F. Reddy	F. O. McMillan
Pennsylvania State College, State College, Pa.	F. F. Wilkins	C. C. Huggler	L. A. Doggett
Pennsylvania, University of, Philadelphia	F. H. Riordan, Jr.	W. H. Hamilton	C. D. Fawcett
Pittsburgh, University of, Pittsburgh, Pa.	M. G. Jarrett	D. P. Mitchell	H. E. Dyche
Princeton University, Princeton, N. J.	John Reine	J. M. Myers	Malcolm MacLaren
Purdue University, Lafayette, Ind.	H. L. Lindstrom	H. A. Hartley	A. N. Topping
Rensselaer Polytechnic Institute, Troy, N. Y.	F. M. Sebast	W. C. Michels	F. M. Sebast
Rhode Island State College, Kingston, R. I.	G. A. Eddy	C. F. Easterbrooks	Wm. Anderson
Rose Polytechnic Institute, Terre Haute, Ind.	D. L. Fenner	W. F. A. Hammerling	C. Knipmeyer
Rutgers University, New Brunswick, N. J.	E. C. Siddons	W. H. Bohlke	F. F. Thompson
Santa Clara, University of, Santa Clara, Calif.	Lloyd Whitwam	W. P. Fisher	D. W. Griswold
South Dakota State School of Mines, Rapid City, S. D.	D. A. White	Harold Eade	J. O. Kammerman
South Dakota, University of, Vermillion, S. D.	Stanley Boegler	L. E. Crowell	B. B. Brackett
Southern California, University of, Los Angeles, Calif.	Gilbert Dunstan	Osborne Hatch	P. S. Biegler
Stanford University, Stanford University, Calif.	A. V. Pering	J. G. Sharp	T. H. Morgan
Stevens Institute of Technology, Hoboken, N. J.	D. B. Wesstrom	G. E. Witham	Frank C. Stockwell
Swarthmore College, Swarthmore, Pa.	T. C. Lightfoot	W. F. Denkhau	Lewis Fussell
Syracuse University, Syracuse, N. Y.	G. F. Kern	T. P. Hall	C. W. Henderson
Tennessee, University of, Knoxville, Tenn.	F. N. Green	B. M. Gallaher	Charles A. Perkins
Texas, A. & M. College of, College Station, Texas	C. A. Altenbern	J. L. Pratt	C. C. Yates
Texas, University of, Austin, Tex.	A. L. Mayfield	G. E. Schade	J. A. Correll
Utah, University of, Salt Lake City, Utah	J. I. Farrell	M. L. Hoag	J. F. Merrill
Virginia Military Institute, Lexington, Va.	R. P. Williamson	M. L. Waring	S. W. Anderson
Virginia Polytechnic Institute, Blacksburg, Va.	R. M. Hutcheson	M. B. Cogbill	Claudius Lee
Virginia, University of, University, Va.	R. C. Small	H. M. Roth	W. S. Rodman
Washington, State College of, Pullman, Wash.	Earl Munson	C. E. Peterson	R. D. Sloan
Washington University, St. Louis, Mo.	R. L. Belshe	J. G. Mazanec, Jr.	H. G. Hake
Washington, University of, Seattle, Wash.	C. M. Murray, Jr.	Roy H. Crosby	George S. Smith
Washington and Lee University, Lexington, Va.	R. E. Kepler	Bernard Yoepf	R. W. Dickey
West Virginia University, Morgantown, W. Va.	I. L. Smith	P. E. Davis	A. H. Forman
Wisconsin, University of, Madison, Wis.	John Sargent	Leonard Saari	C. M. Jansky
Worcester Polytechnic Institute, Worcester, Mass.	D. A. Calder	C. H. Kauke	H. A. Maxfield
Wyoming, University of, Laramie, Wyo.	John Hicks	Edward Joslin	G. H. Sechrist
Yale University, New Haven, Conn.	W. W. Parker	J. W. Hinkley	Charles F. Scott
Total 95			

# DIGEST OF CURRENT INDUSTRIAL NEWS

## NEW CATALOGUES AND OTHER PUBLICATIONS

*Mailed to interested readers by issuing companies*

**Distribution Transformers.**—Bulletin 1688-B, 8 pp. Describes application of various forms of distribution and small power transformers. Westinghouse Electric & Manufacturing Company, East Pittsburgh, Pa.

**Porcelain Insulators.**—Catalog 27, 250 pp. A comprehensive description of a complete line of porcelain insulators for all voltages. Locke Insulator Corporation, So. Charles & Cromwell Streets, Baltimore, Md.

**Underground Cable.**—Bulletin 37, 8 pp. Describes Hazard Loxsteel cable for underground installation without conduits. This type of cable is somewhat lighter than double steel taped parkway cable. Hazard Manufacturing Company, Wilkes-Barre, Pa.

**Pyrometers.**—Bulletin 358, 40 pp., entitled "Pyrometer Instruction," is intended as a guide to users of thermo-electric pyrometers in securing the greatest efficiency and satisfaction. The Bristol Company, Waterbury, Conn.

**Air Compressors.**—Bulletin, 140 pp., entitled "100 and 1 Ways to Save Money With Portable Air Compressors." The book contains three hundred illustrations and one hundred tables of comparative cost figures. Ingersoll-Rand Company, 11 Broadway, New York.

**Instruments.**—Bulletin 1100, 12 pp. Describes new alternating movement now embodied in Jewell switchboard instruments, and several other distinctive and highly improved features of insulation, assembly and construction. Jewell Electrical Instrument Company, 1650 Walnut Street, Chicago, Ill.

**Meters.**—Bulletin 781, 24 pp., entitled "Co<sub>2</sub> Meters (Electrical)". Describes instruments used as a guide to efficient boiler operation that have been developed as a result of years of research and actual service conditions. The Leeds & Northrup Company, 4901 Stenton Avenue, Philadelphia, Pa.

## NOTES OF THE INDUSTRY

**The Electric Controller and Manufacturing Company,** Cleveland, announces the appointment of the firm of J. B. McCarthy and W. P. Robinson as representatives in Canada. Their offices are at 307 Reford Building, Toronto, and 808 Drummond Building, Montreal, Quebec. The Petroleum Electric Company, 217 East Archer Street, Tulsa, Oklahoma, have been appointed representatives in Oklahoma and the Pan Handle District of Texas.

**The W. N. Matthews Corporation, St. Louis,** manufacturers of electrical specialties and mechanical painting equipment, announce that L. B. Graves, 91 So. 11th St., Minneapolis, will represent them in certain sections of Nebraska and Iowa, and that M. P. McClure with headquarters at 305 Seventh Ave., Pittsburgh, has been appointed district representative for part of Pennsylvania, West Virginia & Ohio. A. Klement Hansen, Jr., has been added to the engineering department. Mr. Hansen was previously connected with McClellan & Junkersfeld, of New York.

**The Western Electric Company** announces that its subsidiary, Electrical Research Products, Inc., has taken over from the Vitaphone Corporation the handling of the sale and commercial relations of the equipment used in theatres for the reproduction of the Vitaphone. It will continue to operate from the Vitaphone Company's former headquarters in the Fisk Building, 57th Street and Broadway, New York.

The organization of a new manufacturing branch at its Hawthorne Works in Chicago, by the Western Electric Company, to be known as the Specialty Products Shop, is also announced. Among its many functions are the building of microphones, vitaphone parts, audiphones, telegraph and railroad signalling apparatus, test sets and telephone heating coil elements.

**Delta-Star Inaugurates Educational Plan.**—According to the Delta-Star Electric Company, Chicago, the many requests by colleges for information regarding the new Delta-Star 750,000 volt testing laboratory indicate that students desire a better knowledge of the fundamentals of electrical testing. To save time for all concerned, the company has inaugurated a way of imparting this information by group method. The colleges arrange to have the students, in charge of their professors, visit the laboratory on a given date. The Delta-Star engineers are thus enabled to give the desired information, make tests and such demonstrations as will be both interesting and informative to the students.

**New Type of Electric Locomotive.**—The Chicago, North Shore & Milwaukee Railroad Company is obtaining two 65-ton electric locomotives which will operate either from a trolley or from the storage batteries which they carry and which, while operating from the trolley, can charge their batteries through a motor generator set. The flexibility of operation of the locomotives, the first of their type, will enable them to switch cars into industrial plants equipped with tracks but not trolley connections. The absence of smoke, noise and noxious gases will permit the locomotives to run into buildings where a steam locomotive would be objectionable.

The equipment of each locomotive includes four 200-horse power motors and a storage battery of 192 cells capable of delivering 260 kilowatt-hours on one charge. Operating on the battery, the locomotive can haul 33 loaded freight cars 5¼ miles at 12 miles an hour on one charge, or run light at maximum speed of 37 miles per hour. The locomotives are being built by the General Electric Company, and will be equipped with storage batteries furnished by the Electric Storage Battery Company.

**Developments in Cramp Company, Philadelphia.**—The underlying companies of Cramp-Morris Industrials, Inc., which was formed recently to take over the six subsidiaries of the William Cramp & Sons Ship and Engine Building Company when the parent company decided to discontinue shipbuilding, have been extending their operations in the manufacture of Diesel engines, castings, hydraulic and other machinery. Several important contracts are being completed and new orders have just been booked.

Work now under construction in the Philadelphia shops of the I. P. Morris Corporation includes equipment for four large hydroelectric installations as follows: Two 29,000-horse power turbines for the Nippon Electric Power Company, Komaki Plant, Japan; two 31,100-horse power and one 25,600-horse power turbines for the Carolina Power and Light Company, Norwood, North Carolina; three 54,000-horse power turbines for the Susquehanna Power Company, Conowingo, Maryland, and two 34,000-horse power turbines for the Washington Water Power Company, Chelan Development, Washington.

New contracts awarded the I. P. Morris Corporation include two 25,000-horse power hydraulic turbines for the Upper Tallassee Development of the Alabama Power Company, and two turbines of 2580 and 2680 horse power for the Raymondville and Norwood Developments, respectively, of the Power Corporation of New York.

The Pelton Water Wheel Company, another subsidiary, has closed contracts for hydroelectric developments including two 30,000-horse power impulse wheels to operate under a head of 2350 feet for the Feather River Power Company, one 56,000-horse power impulse wheel to operate under a head of 2200 feet for the Southern California Edison Company, one 17,500-horse power Francis turbine for the Northwestern Power and Light Company, and three Francis turbines for the Pacific Gas & Electric Company.





The careful investor judges a security by the history of its performance.

# KERITE

in a half-century of continuous production, has spun out a record of performance that is unequalled in the history of insulated wires and cables.

Kerite is a seasoned security.

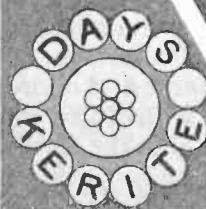
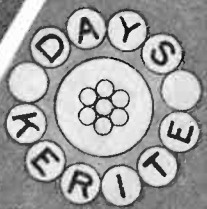

**THE KERITE INSULATED WIRE & CABLE COMPANY INC**  
NEW YORK    SAN FRANCISCO    CHICAGO



# The Linebuilder

**B**RINGING the comforts and the conveniences of modern civilization to every community—greet the Line-builder. At the head of each and every little group of these faithful pioneers of electrical progress—greet the master Line-builder, the foreman, the boss. And to this army of men ever watchful for the last word in line construction is dedicated "The Hubbard Linebuilder", carrying the monthly message of John Lineman and up-to-the-minute data pertaining to every phase of the Line-builders' work.

*THE Hardware makes The Line;  
Hubbard makes THE Hardware.*

Hubbard also issues "The Linebuilder" to show how Hubbard Pole Line Hardware and Peirce Construction Specialties can make the line better. If you are not already on our mailing list to receive "The Linebuilder," your name and address on the coupon below will insure its delivery to you monthly in the future without charge.



*Use this  
coupon*

NAME	TITLE
COMPANY	
ADDRESS	



# Hubbard and COMPANY

PITTSBURGH & OAKLAND, CAL. & CHICAGO

Please mention the JOURNAL of the A. I. E. E. when writing to advertisers.

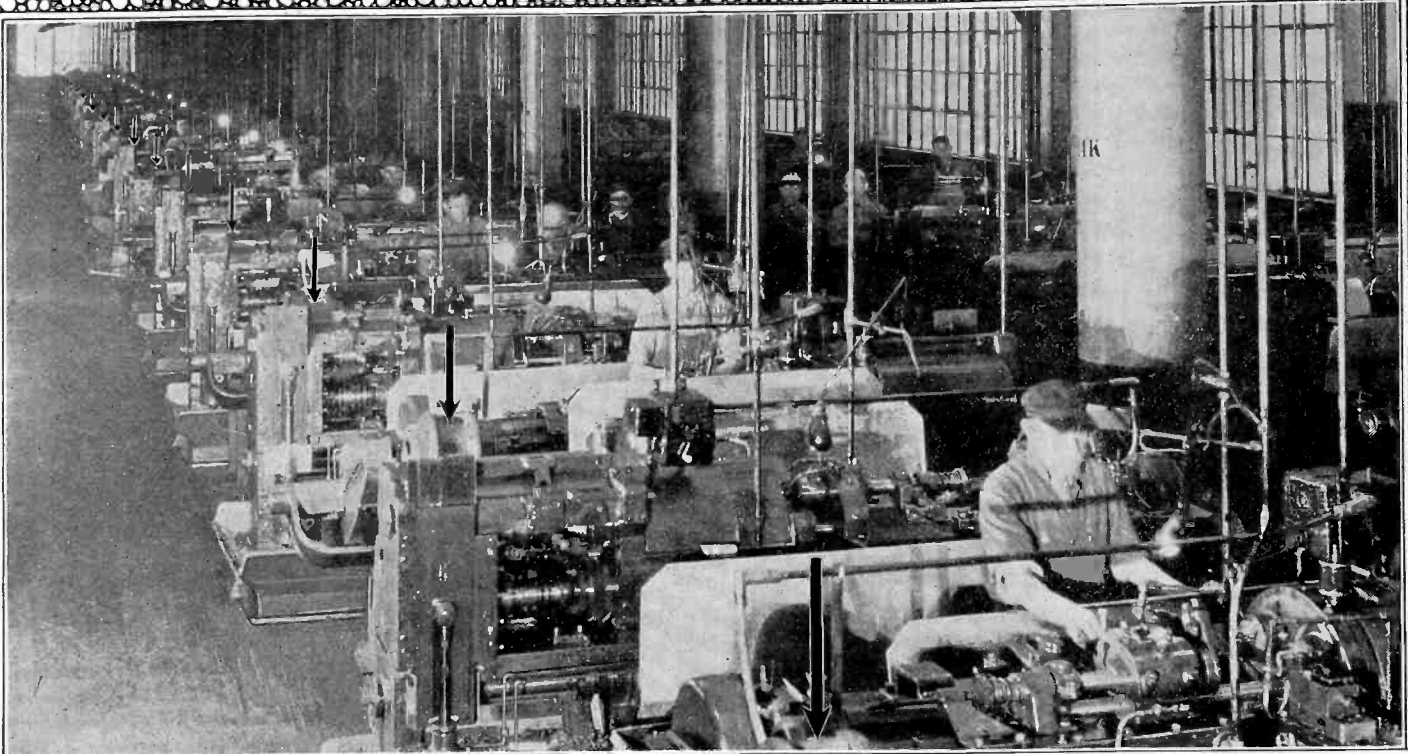

A partial view of one hundred and six "automatics" operated by as many New Departure Ball Bearing equipped General Electric motors. These have been in operation from 8 to 10 hours per day for 20 months without adding to the original lubricant placed in the bearing housings by the motor manufacturer at the time of assembly.

**T**HE advantages of New Departure Ball Bearings in electric motors are known and have been proven—no guess work about it.

New Departure Ball Bearings sustain radial and thrust loads and maintain uniform air gaps longer than any other type of anti-friction bearings.

New Departures do not wear measurably therefore never need adjustment. They consume only a minimum amount of lubricant and require relubricating only once in 9 to 12 months.

Motor rewinding and bearing replacement costs are greatly reduced, consequently there is less loss of productive time caused by idle motors, men and machines.

**The New Departure Manufacturing Company**  
 Detroit                      BRISTOL, CONNECTICUT                      Chicago

Two valuable treatises on the application of New Departure Ball Bearings to electric motors will be sent on request. They are "Cutting Your Costs" (non-technical) and "Booklet K" (technical). Write for either or both now.



# New Departure Quality Ball Bearings

537

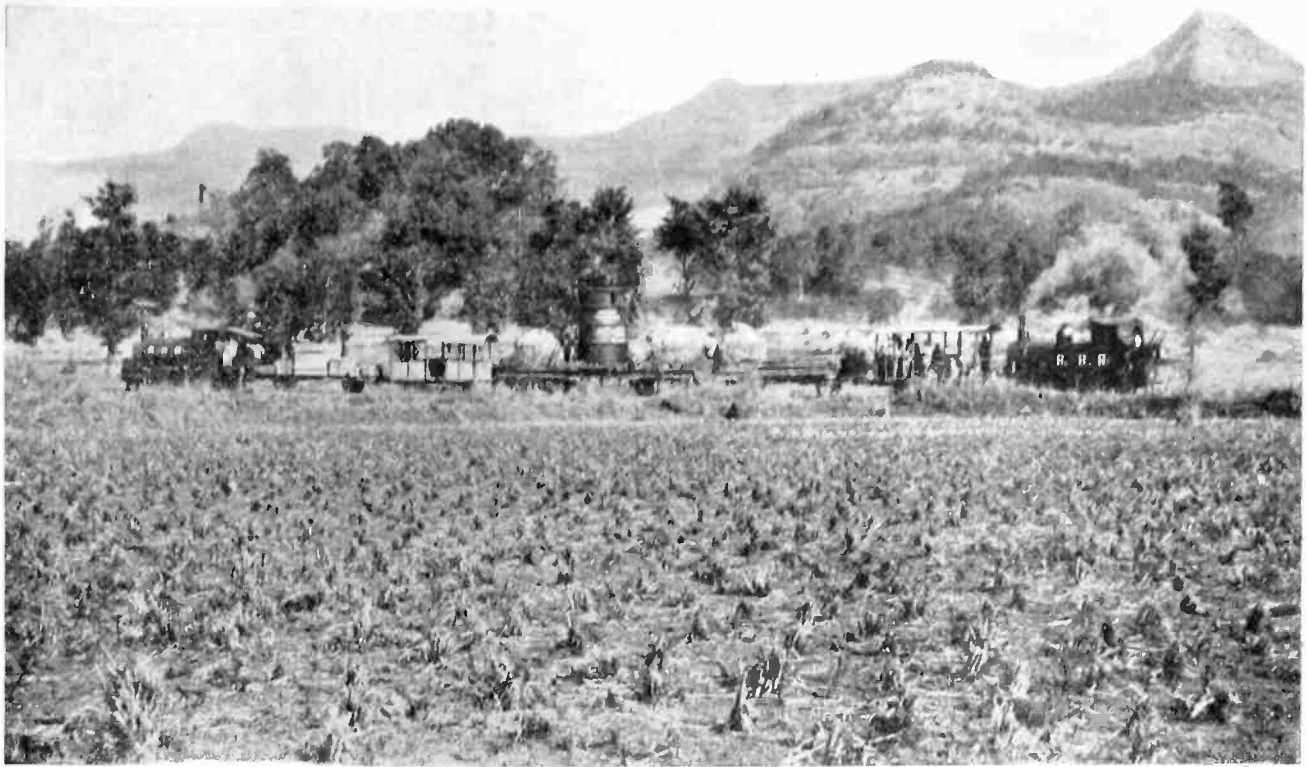

---

---

# FERRANTI TRANSFORMERS

FERRANTI, INC.  
130 W. 42ND STREET  
NEW YORK

FERRANTI, LTD.  
HOLLINWOOD  
ENGLAND

FERRANTI ELECTRIC  
LIMITED  
TORONTO, CANADA

---

---

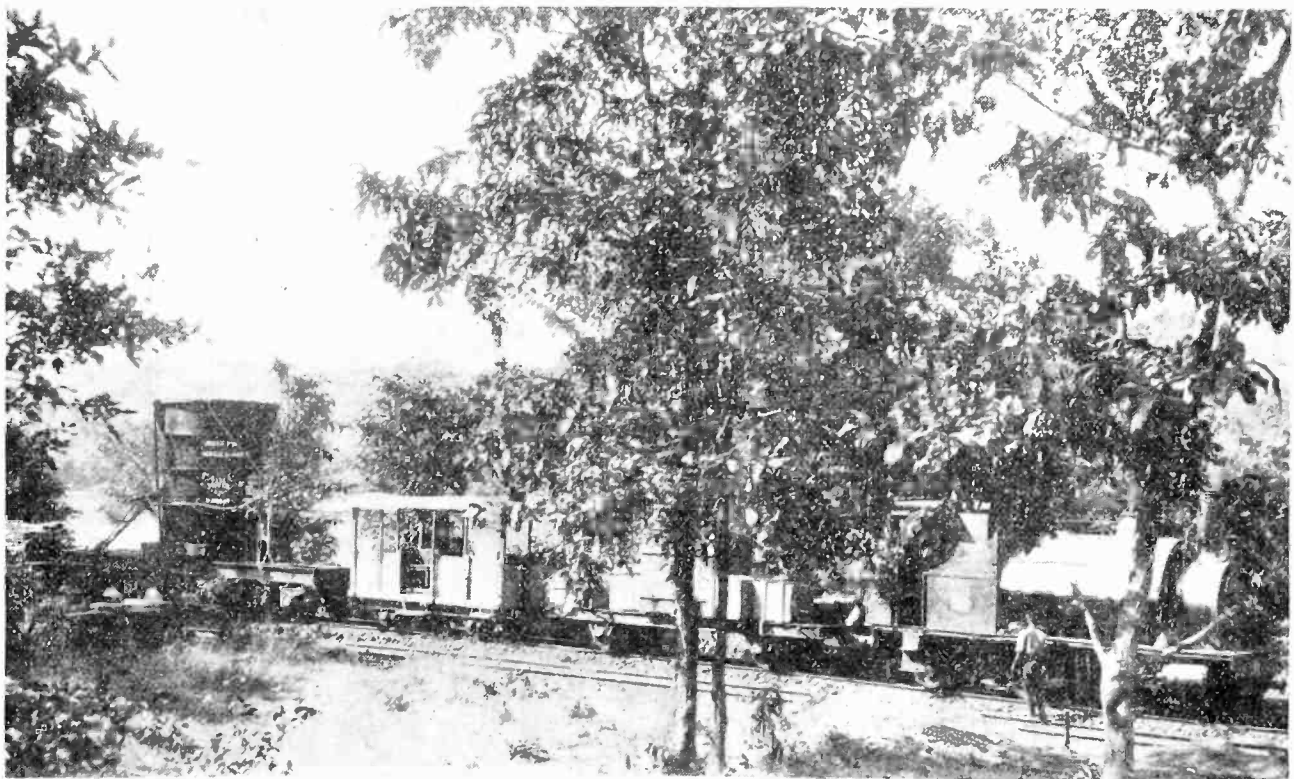

---

Please mention the JOURNAL of the A. I. E. E. when writing to advertisers.

## Thirty-Five Years of Sustained Confidence

Habirshaw success began and continues in the making of good wire. For thirty-five years the electrical industry has used Habirshaw cable and wire. Habirshaw has grown with the industry, not only meeting its needs with quality wire, but contributing to its standards and progress. Upon the sound foundation of a "quality first" policy an engineering and manufacturing organization, known for its dependability, has been solidly built.

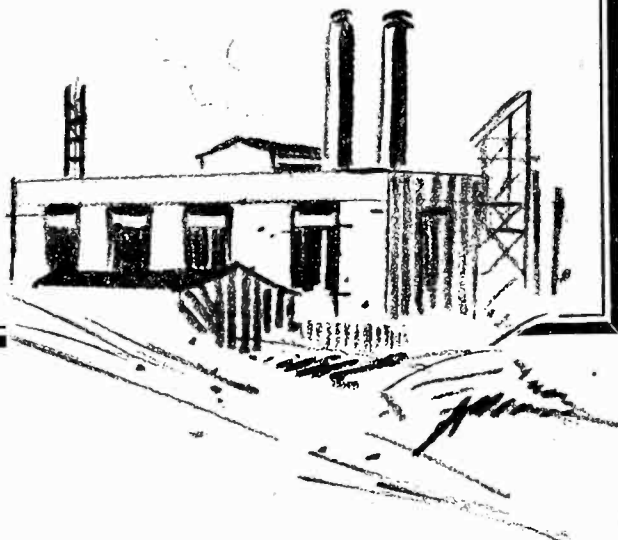

HABIRSHAW CABLE AND WIRE CORPORATION

Main Office: 10 East 43rd Street, New York City

Chicago Office: 500 South Clinton Street

Plants: Yonkers, N. Y.—Bridgeport, Conn.—Nepperhan, N. Y.

# HABIRSHAW

PROVED BY THE TEST OF TIME

Paper Insulated Cable—Varnished Cambric Insulated Cable—Armored Cable—Rubber Insulated Cable

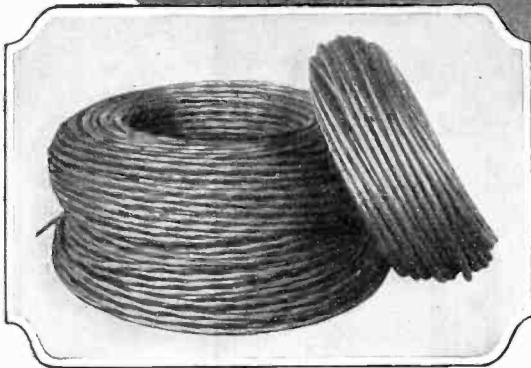
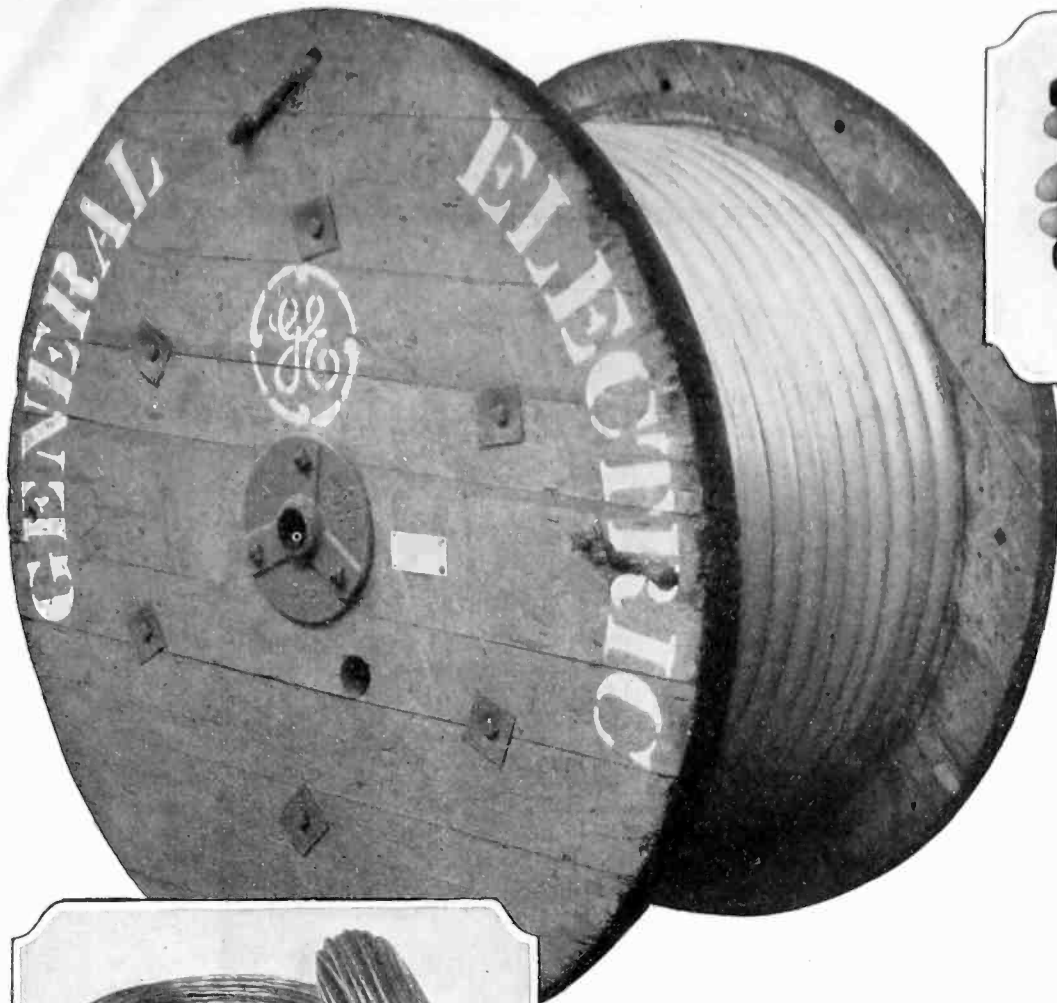

# Cable

any voltage

any capacity

any duty

But one Quality

— *unexcelled*



The quality of General Electric cable is consistent with the high standard of all products identified by this monogram.

# GENERAL ELECTRIC

GENERAL ELECTRIC COMPANY, SCHENECTADY, N. Y., SALES OFFICES IN PRINCIPAL CITIES

Please mention the JOURNAL of the A. I. E. E. when writing to advertisers.

# American Transformer

## Testing transformer with one end permanently grounded

**T**HIS 150,000-volt, 60-cycle indoor testing transformer is oil-immersed, self-cooled, with one end permanently grounded. It has an oil-filled high tension bushing on one end of the secondary winding, the other end being brought to a low tension terminal to be grounded through a meter. By this means it is possible to measure the high tension current in the secondary.

A voltmeter coil is usually provided in this transformer for indicating high tension voltage. Two types of regulators can be used, namely, auto transformer switch type and the induction regulator.

This type of transformer can be built in sizes from 5 to 500 Kva with voltages up to 300,000. It is suitable

the outside legs of the core are supported by a rugged frame. This is attached to the top portion of the core. Hence, the entire unit can be lifted out of the case without disturbing the assembly of insulation. Additional barriers are provided in the case to protect the exposed portion of the high tension winding. These barriers are well secured so that when the transformer is removed the assembly is not disturbed.

## Spherical spark gap volt meter for measuring high tension voltage

This device consists of two copper spheres rigidly mounted on a convenient framework. The upper sphere is stationary. The lower can be moved in a vertical position. The pointer on the dial shown is attached to the lower sphere shaft and its motion is proportional to that of the lower sphere. Two scales are provided, one in red, the other black. The red scale is to be used when the lower sphere is grounded, the black scale when both spheres are free. These scales are calibrated in kilovolts.

The complete device can be mounted on casters if desired. The size of sphere and range is given below. The same type of mounting is used on various size spheres listed.

Diameter of Sphere in Millimeters	Range in Kilovolts
62.5	10-90
125	30-180
250	60-320
500	80-400

In this instrument we have provided a micrometer scale for indicating distance between spheres and the reading on this scale can be used with A. I. E. E. standard tables for checking calibration of meter. This check will only be necessary occasionally, since the meter calibration will not change.

The supporting framework is built of a high grade California redwood which has high dielectric strength and does not warp or split readily.

The 62.5 and 125 millimeter sizes will be mounted on casters when required.

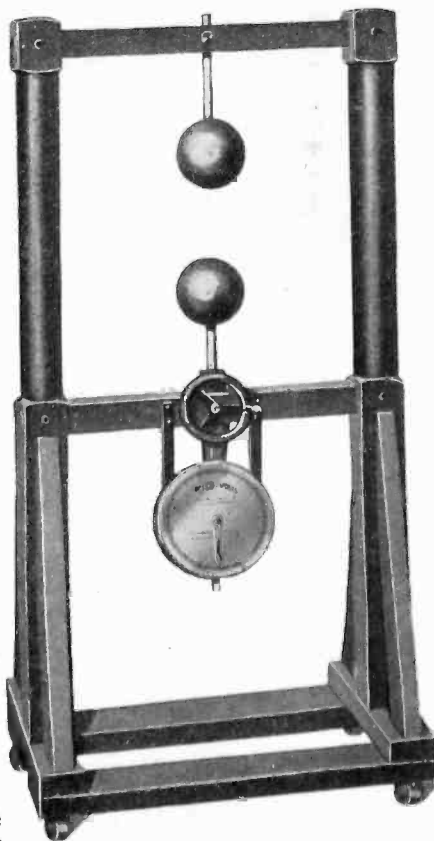

150,000 volt testing transformer with one end grounded

for making dielectric tests on cable, electrical machines, sheet insulation or for any similar uses.

Here the same transformer is shown removed from the case. The secondary winding consists of a series of disc coils, insulated from each other by press-board collars. The insulation barriers between the high tension winding and

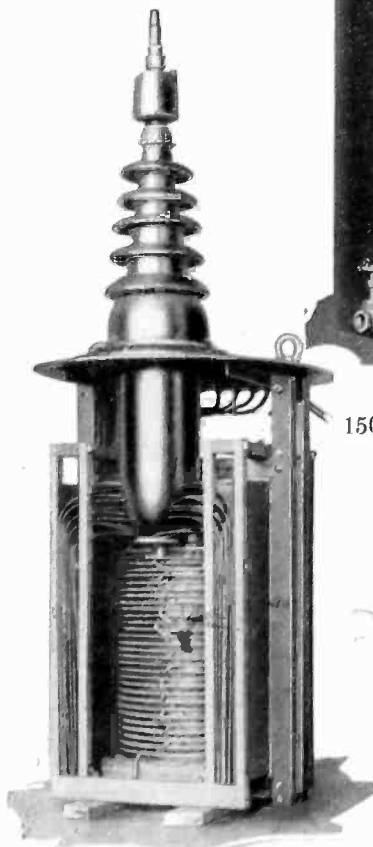

The transformer above removed from its case

Bulletins 1020.J, 1025.J, 1930.J, 1035.J, and 1040.J should be in your files. Send for them.

**AMERICAN TRANSFORMER CO., 176 Emmett Street NEWARK, NEW JERSEY**

Please mention the JOURNAL of the A. I. E. E. when writing to advertisers.

# "Puget Power"

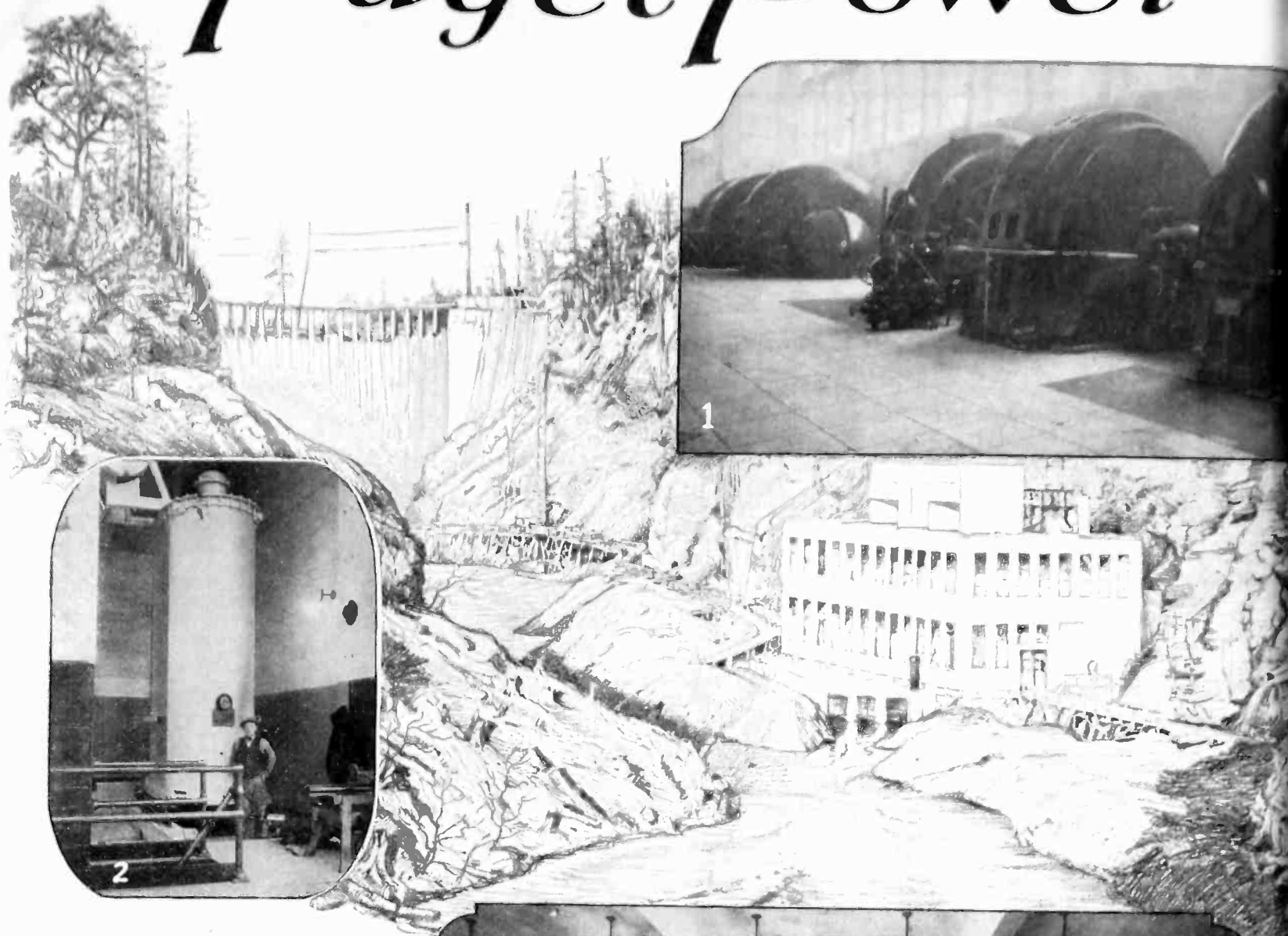

1

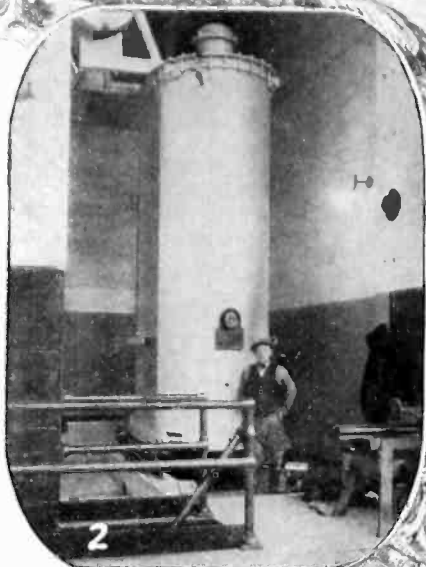

2

1 Two 19,500-kv-a. G-E horizontal Waterwheel-driven Generators

2 One of the seven 6667-kv-a. 110,000-volt G-E Transformers

3 G-E Main Switchboard, with annunciator which indicates all relay operations

4 Three of the FHKO-39 110,000-volt Breakers

5 Three of the FH-206 Breakers

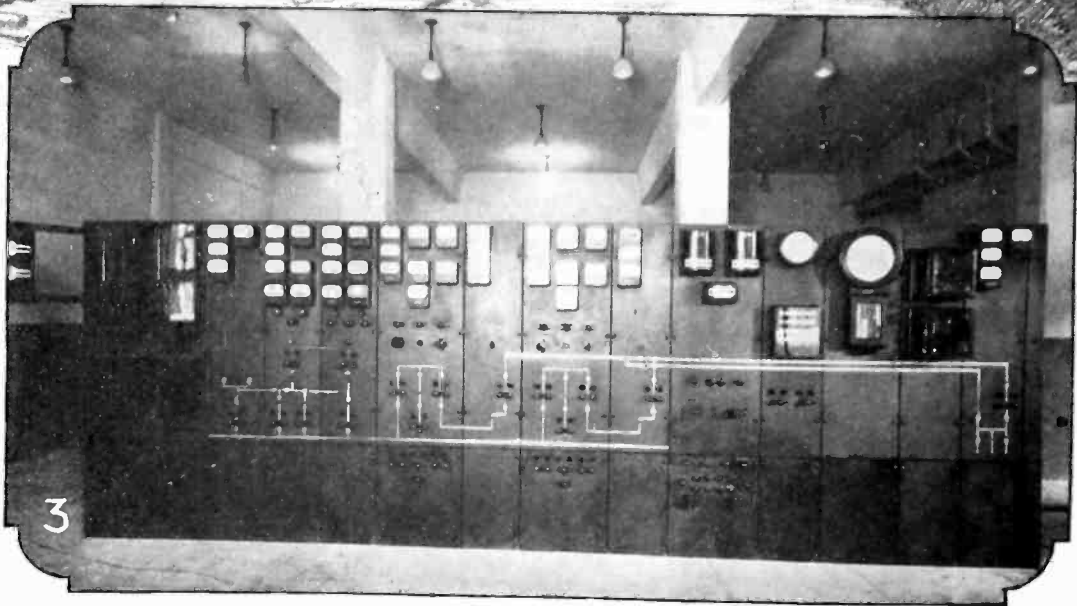

3



# GENERAL

GENERAL ELECTRIC COMPANY, SCHENECTADY, N. Y.

Please mention the JOURNAL of the A. I. E. E. when writing to advertisers.



# For the Northwest

The Baker River plant is the latest addition to the generating equipment of the Puget Sound Power & Light Company. This company supplies most of the commercial power in the Puget Sound district of the State of Washington—more than 30,000 square miles—including the cities of Seattle, Tacoma, Bellingham, and Everett.

The plant is laid out for a future addition of two units, giving an ultimate capacity of 96,000 horse power.

The General Electric Company furnished the two 19,500 kv-a. generators, seven transformers, main switchboards, both the high-tension and low-tension breakers, and lightning arresters.

G-E representation in the Baker River plant exemplifies the prominent position occupied by General Electric in the equipment selected for modern stations, both hydro-electric and steam.

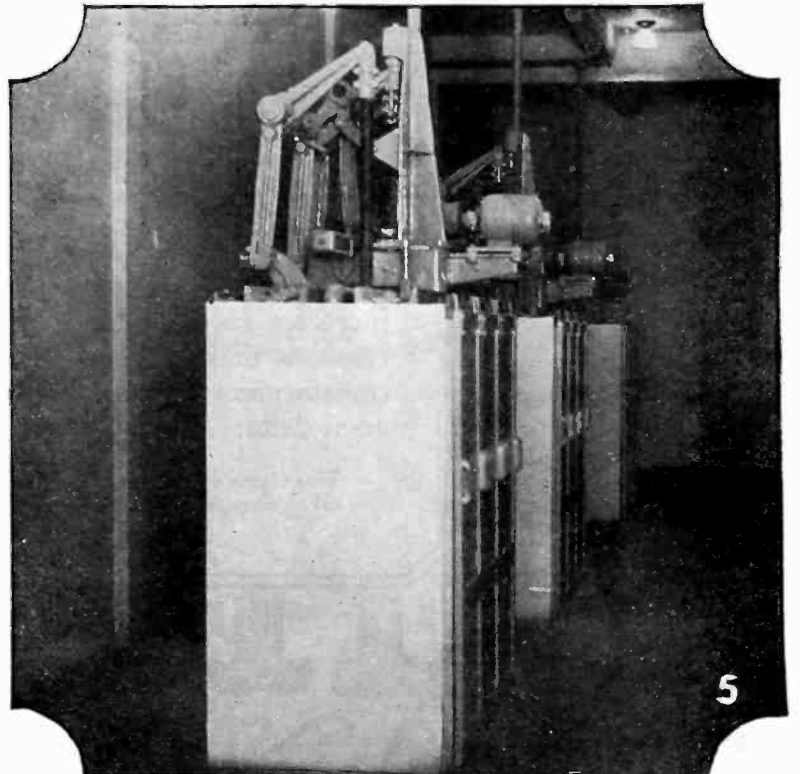
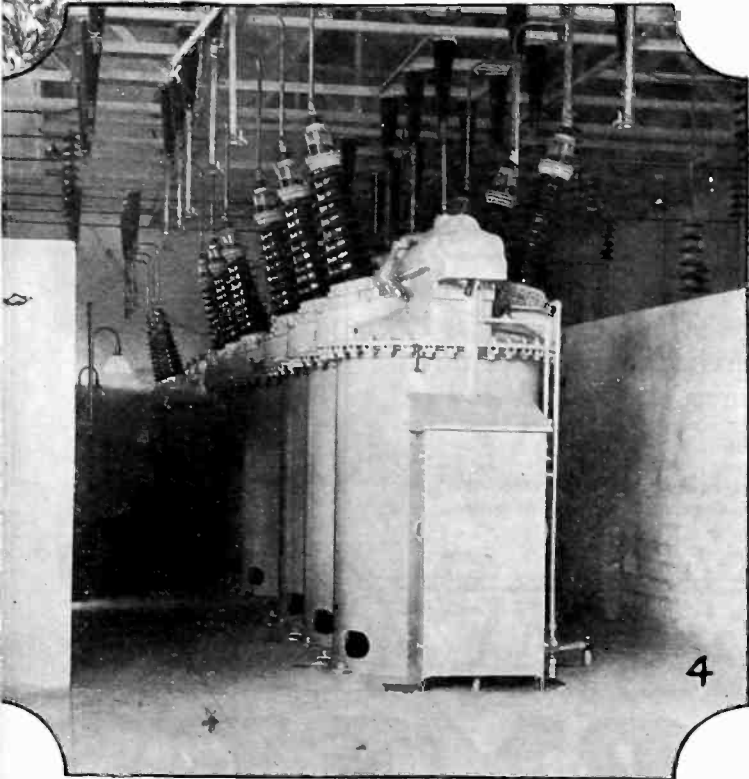

100-6

# ELECTRIC

SALES OFFICES IN PRINCIPAL CITIES

Please mention the JOURNAL of the A. I. E. E. when writing to advertisers.

# \*“What is your attitude regarding overload?”

## Replying to R.H.B.\* Re: Transformer Overloads

Prolonged heavy overloads shorten the life of a transformer because the insulation deteriorates when overheated. Overloading is also inefficient. The copper loss increases as the square of the load [see curve], and good transformer design balances the no-load and load losses for most efficient operation at from 75% to 100% rated capacity.

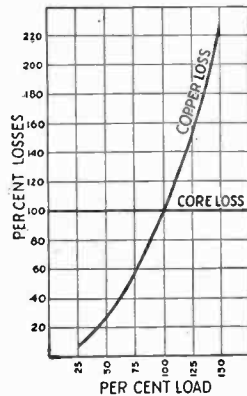

Many Kuhlman Transformers successfully carry heavy overloads for short periods of time and even continuously — but we do not recommend this as general practice. Kuhlman Transformers have liberal ratings and the coil ventilation is such that more coil surface is exposed to the oil, which keeps down the coil gradient.

It is the policy of many engineers to anticipate their load increases for a number of years. There are large utilities that make a practice of purchasing banks of three transformers large enough to carry present full load on open delta.

*This is one of a series of answers to important questions frequently asked us regarding transformer design, construction and operation.*

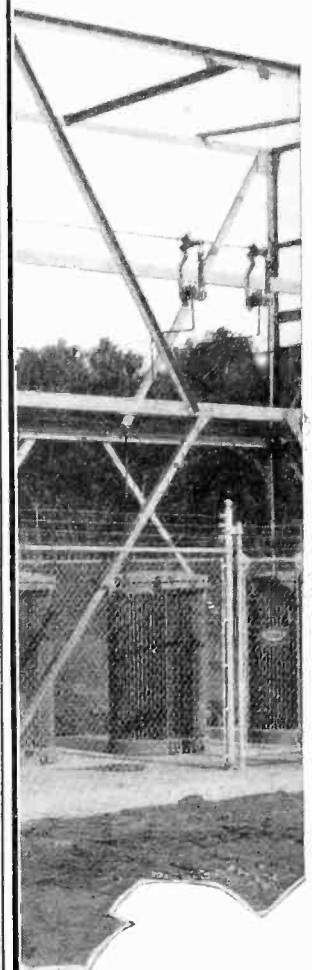

# KUHLMAN TRANSFORMERS

KUHLMAN ELECTRIC CO., Bay City, Michigan

- |                                        |                                          |                                       |                                           |
|----------------------------------------|------------------------------------------|---------------------------------------|-------------------------------------------|
| Akron..... High and Barges Sts.        | Dallas..... Unit 2, Santa Fe Bldg.       | Minneapolis..... 1004 Marquette Ave.  | Salt Lake City..... 134 West 2d South St. |
| Atlanta..... 411 Glenn Bldg.           | Denver..... 1843 Wazee St.               | New York..... 300 Madison Ave.        | San Francisco..... Call Bldg.             |
| Boston..... 69-71 High St.             | Detroit..... 3-260 Gen. Motors Bldg.     | Oklahoma City..... 1013 Braniff Bldg. | Seattle..... 314 Seneca St.               |
| Buffalo..... 280 Carolina St.          | Greensboro, N. C..... 333 S. Davie St.   | Omaha..... 727 W. O. W. Bldg.         | Toledo..... 424 Spitzer Bldg.             |
| Chicago..... 844 Rush St.              | Indianapolis..... 202 Indiana Ter. Whse. | Philadelphia..... 1700 Walnut St.     | Washington..... 1328 New York Ave.        |
| Cincinnati..... 1308 Union Trust Bldg. | Los Angeles..... 316 American Bank Bldg. | Pittsburgh..... 839 Oliver Bldg.      | N. W.                                     |
| Cleveland..... 627 Union Trust Bldg.   | Milwaukee..... 1031 Clybourn St.         | Saint Paul..... 1479 Blair St.        | York, Pa. .... 335 W. Market St.          |

Please mention the JOURNAL of the A. I. E. E. when writing to advertisers.

# TO SOLVE AN INSULATING PROBLEM

**SPECIFY**



TRADE MARK REGISTERED

## **MINERALLAC**

**High Voltage Insulating Compounds**

**NO. 104**

INSULATING COMPOUND SEMI-FLUID  
AT ORDINARY TEMPERATURE

Flash Point, - 428 deg. F.  
Fire Point, - 514 deg. F.  
Pouring Temp. - 230 deg. F.  
Note: Do not heat above 300 deg. F.

A High-Voltage Insulating Compound  
with desirable adhesive qualities

MANUFACTURED BY  
**MINERALLAC ELECTRIC COMPANY**

1045 Washington Boulevard  
CHICAGO, ILL.

**FOR  
HIGH VOLTAGE  
CABLE JOINTS**

# MINERALLAC

# Just off the press

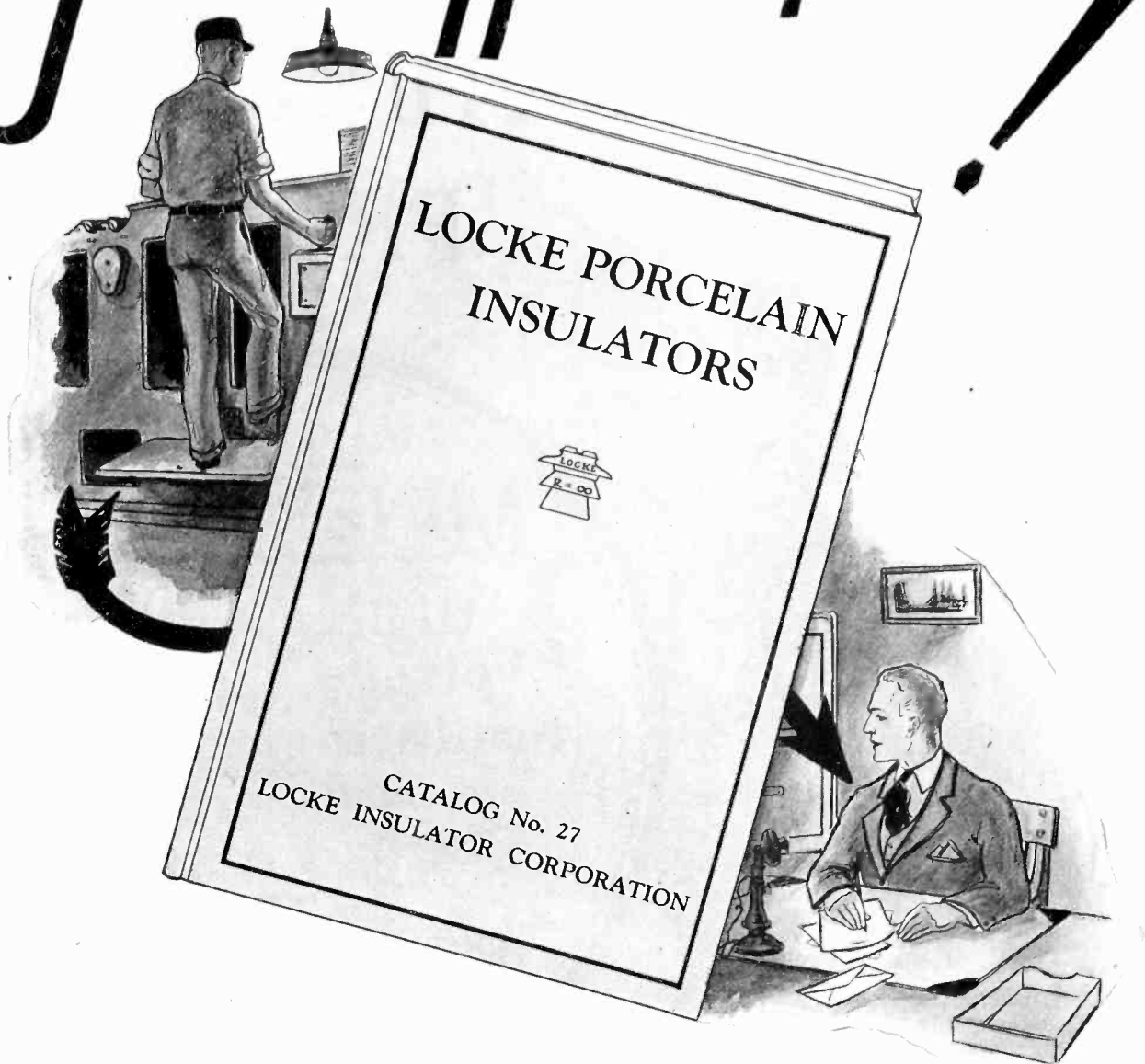

The new Locke Catalog—just off the press—contains over 250 pages of useful information for anyone who is in any way concerned with high voltage transmission.

Since 1894, when Locke produced the first wet process porcelain insulator, Locke Engineers, with every facility for research, have steadily improved both

material and design. The results of these years of experience and research are embodied in this new catalog.

Your name and address on a post card to the Locke Insulator Corporation, Baltimore, Maryland, will bring this valuable book to your desk straight from the press.

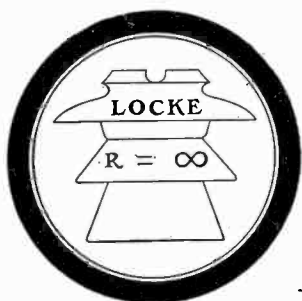

# LOCKE PORCELAIN



LOCKE QUALITY

LOCKE SERVICE

Please mention the JOURNAL of the A. I. E. E. when writing to advertisers.

## Anticipating California's Future Growth



**T**O meet the growth in California, the Southern California Edison Company added 429,000 horse power between 1921 and 1925. This increase is 114% compared with 54% for the whole country in the same five-year period.

The company's present capacity is 807,000 horse power and another five years' growth at this rate will see a demand of 920,000 horse power more.

A new plant now under construction will have the world's largest electric generators, the world's largest tandem compound turbines and the world's largest horizontal water tube boilers. It is designed for an ultimate capacity of 1,000,000 horse power.

This is the sixth time Southern California Edison Company has employed Stone & Webster construction service in its program of extension.

---

# STONE & WEBSTER

INCORPORATED

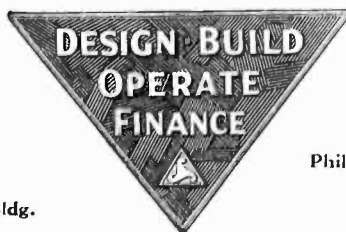

Boston, 147 Milk Street  
New York, 120 Broadway  
Chicago, First National Bank Bldg.

Philadelphia, Real Estate Trust Bldg.  
San Francisco, Holbrook Bldg.  
Pittsburgh, Union Trust Bldg.

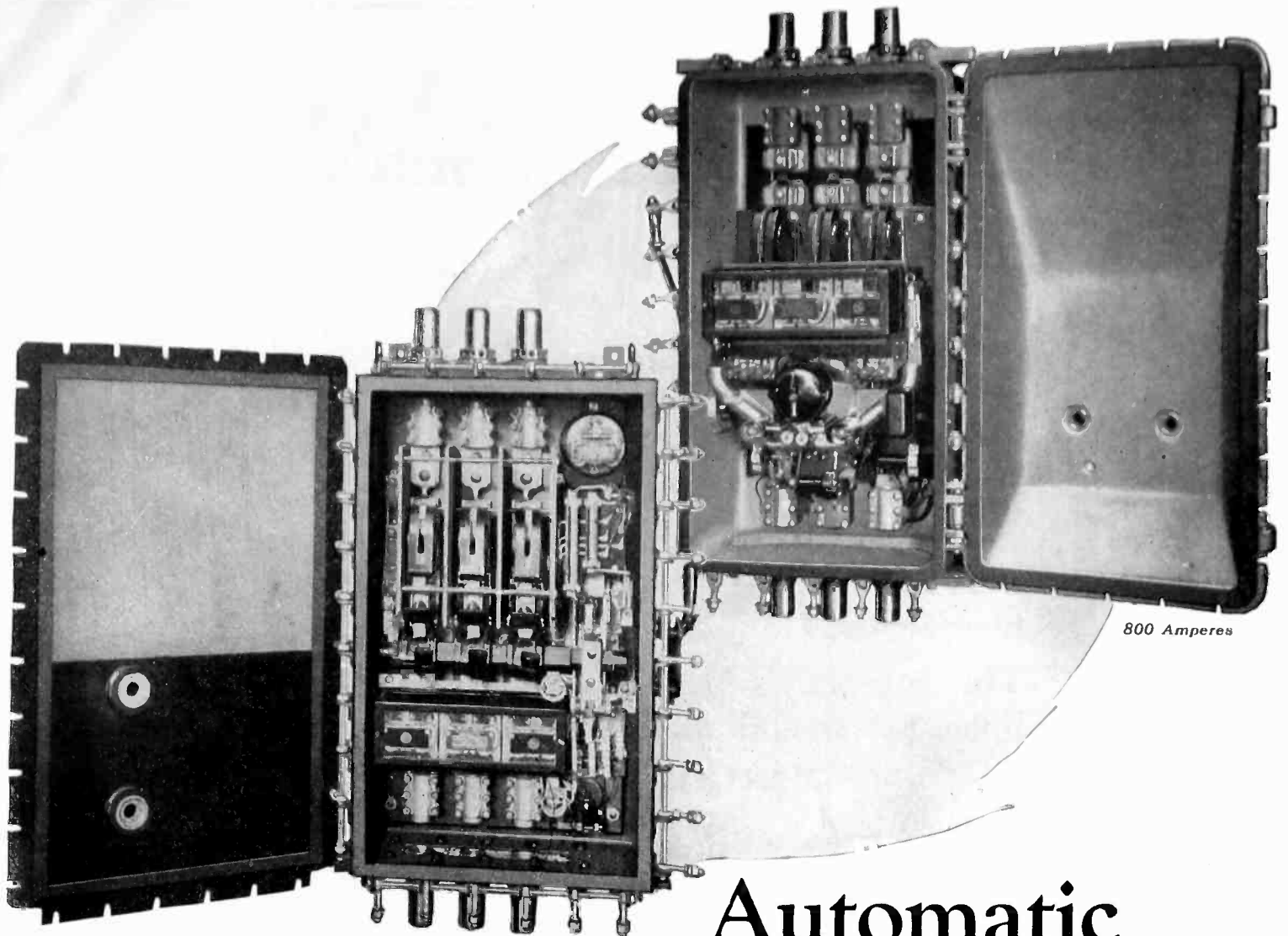

500 Amperes

800 Amperes

## Automatic A-c. Network Protectors

Provide power-directional protection between network systems and feeder transformers.

### Ratings

Motor operated—800, 1200, and 2000 amperes. Solenoid operated—500 amperes

Submersible and non-submersible  
Compact—Efficient—Reliable

The many G-E automatic network protectors now in service are proving these claims.



**Network Protectors**  
—part of the complete line of  
General Electric equipment  
to control and protect  
power generating and  
distributing apparatus

490-1

# GENERAL ELECTRIC

GENERAL ELECTRIC COMPANY, SCHENECTADY, N. Y., SALES OFFICES IN PRINCIPAL CITIES

Please mention the JOURNAL of the A. I. E. E. when writing to advertisers.

# Pole Top Space fully utilized

*Affords greater service advantages plus economy*

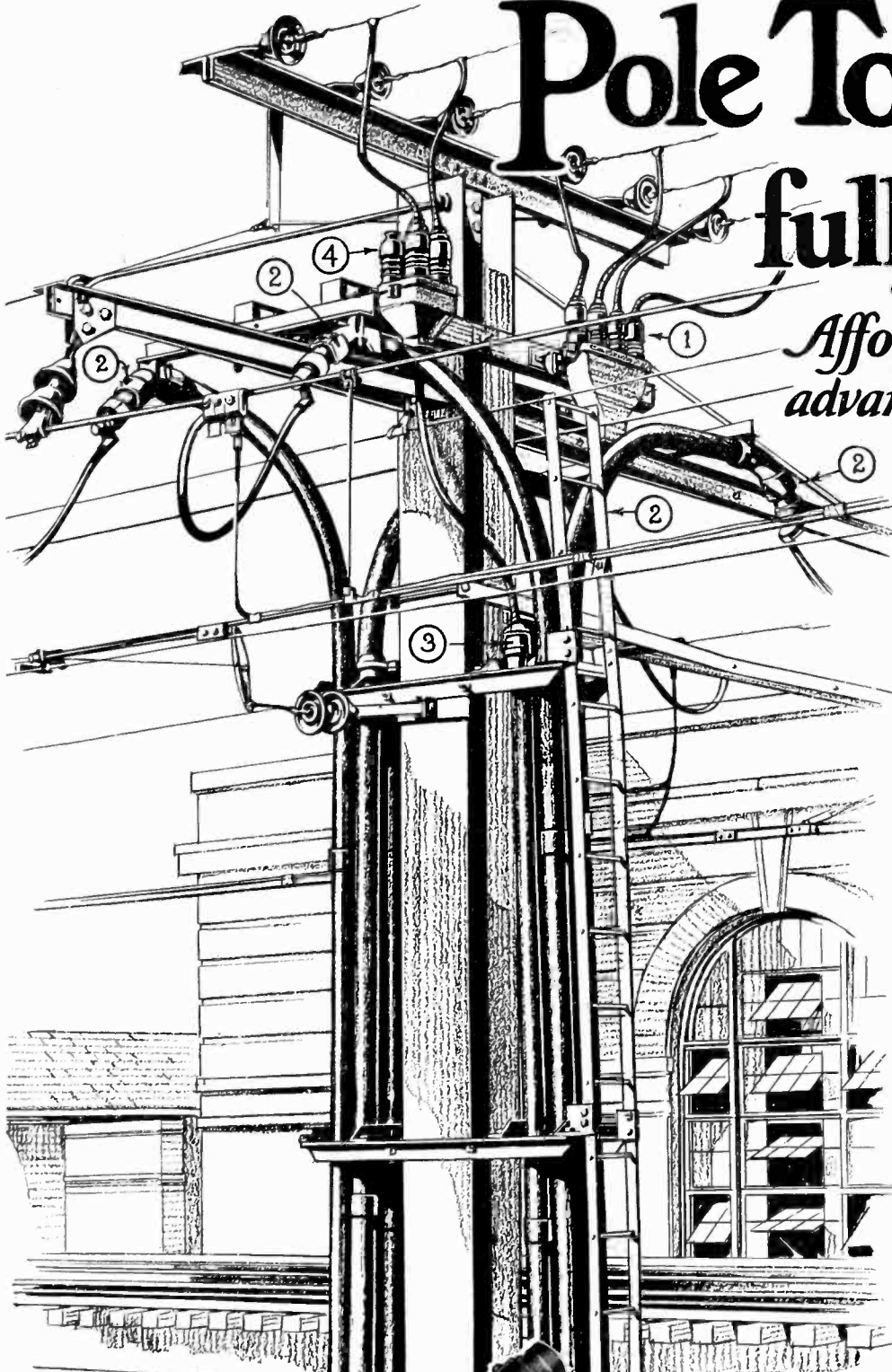

These six G & W potheads of different shapes on this pole top show the possibilities of space economy on the cross arms.

The single phase line can connect to any conductor of the four wire, Shape G, disconnecting pothead (4), without affecting the arrangement. The connection of the three phase line to the Shape C, disconnecting pothead (1), is a typical example of neatness possible with G & W potheads. Potheads (1) and (4) illustrate also the ease of pothead disconnection for phasing out trouble and killing the cable.

The single conductor potheads (2) terminating the graceful bend of the conduits assist greatly in carrying out the scheme of symmetry.

The capnuts are an easy and effective means for connecting to the catenary, in electrifying this steam-road.

The Schuster Bell (3) on the end of the conduit prevents cable creeping. Installed quickly and easily after pulling cable. Is a cable support and seals conduit.

*G & W Equipment Provides for the Emergency*

**G & W Electric Specialty Co.**  
7780 Dante Ave., Chicago

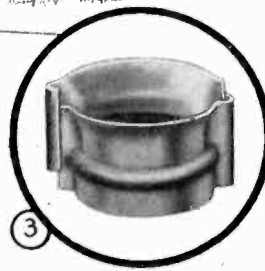
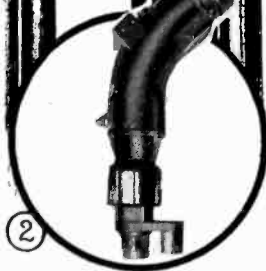
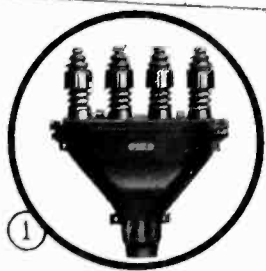

More than Protection **POTHEADS AND BOXES** for the Cable Ends

Please mention the JOURNAL of the A. I. E. E. when writing to advertisers.



## *SPANISH EDITION*

# A. I. E. E. STANDARDS



**T**HIS SERIES of pamphlets, published by the Bureau of Foreign and Domestic Commerce, consists of Spanish Translations of certain of the standards promulgated by the American Institute of Electrical Engineers. These specifications are commercially acceptable and represent good practice in the United States.

The object of their translation and publication is to develop a broader knowledge and use of the standards and to facilitate trade in electrical products between the United States and Spanish-speaking countries.

#### AVAILABLE PAMPHLETS

- |                                                                                                                                                                                                                                                                                                                                                                                                                                                                                                                                           |                                                                                                                                                                                                                                                                                                                                                                                                                                      |
|-------------------------------------------------------------------------------------------------------------------------------------------------------------------------------------------------------------------------------------------------------------------------------------------------------------------------------------------------------------------------------------------------------------------------------------------------------------------------------------------------------------------------------------------|--------------------------------------------------------------------------------------------------------------------------------------------------------------------------------------------------------------------------------------------------------------------------------------------------------------------------------------------------------------------------------------------------------------------------------------|
| <ol style="list-style-type: none"> <li>1. General principles upon which temperature limits are based in the rating of electrical machinery and apparatus.</li> <li>5. Direct-current, rotating machines, generators, and motors.</li> <li>7. Alternators, synchronous motors, and synchronous machines in general.</li> <li>8. Synchronous converters.</li> <li>9. Induction motors and induction machines in general.</li> <li>10. Direct and alternating current fractional horse-power motors.</li> <li>11. Railway motors.</li> </ol> | <ol style="list-style-type: none"> <li>13. Transformers, induction regulators, and reactors.</li> <li>14. Instrument transformers.</li> <li>15. Industrial control apparatus.</li> <li>16. Railway control and mine locomotive control apparatus.</li> <li>19. Oil circuit breakers.</li> <li>22. Disconnecting and horn gap switches.</li> <li>30. Wires and cables.</li> <li>37. Illumination.</li> <li>41. Insulators.</li> </ol> |
|-------------------------------------------------------------------------------------------------------------------------------------------------------------------------------------------------------------------------------------------------------------------------------------------------------------------------------------------------------------------------------------------------------------------------------------------------------------------------------------------------------------------------------------------|--------------------------------------------------------------------------------------------------------------------------------------------------------------------------------------------------------------------------------------------------------------------------------------------------------------------------------------------------------------------------------------------------------------------------------------|

*For convenience in filing or binding, the form and size of the English edition have been followed.*

**The price of each bulletin available is 10 cents,  
except No. 1 and No. 14, which are 5 cents.**



*For sale by the*  
**Superintendent of Documents, Government Printing Office, Washington, D. C.,  
or any district office of the Bureau of Foreign and Domestic Commerce**





## QUALITY

Quality, as embodied in G-E Portable Instruments, signifies something more than an accurately assembled unit of fine materials. It is the achievement of a generation's experience in the art of co-ordinating research and manufacturing facilities, and is reflected in terms of confidence among engineers the world over.

**GENERAL ELECTRIC** <sup>610-14</sup>



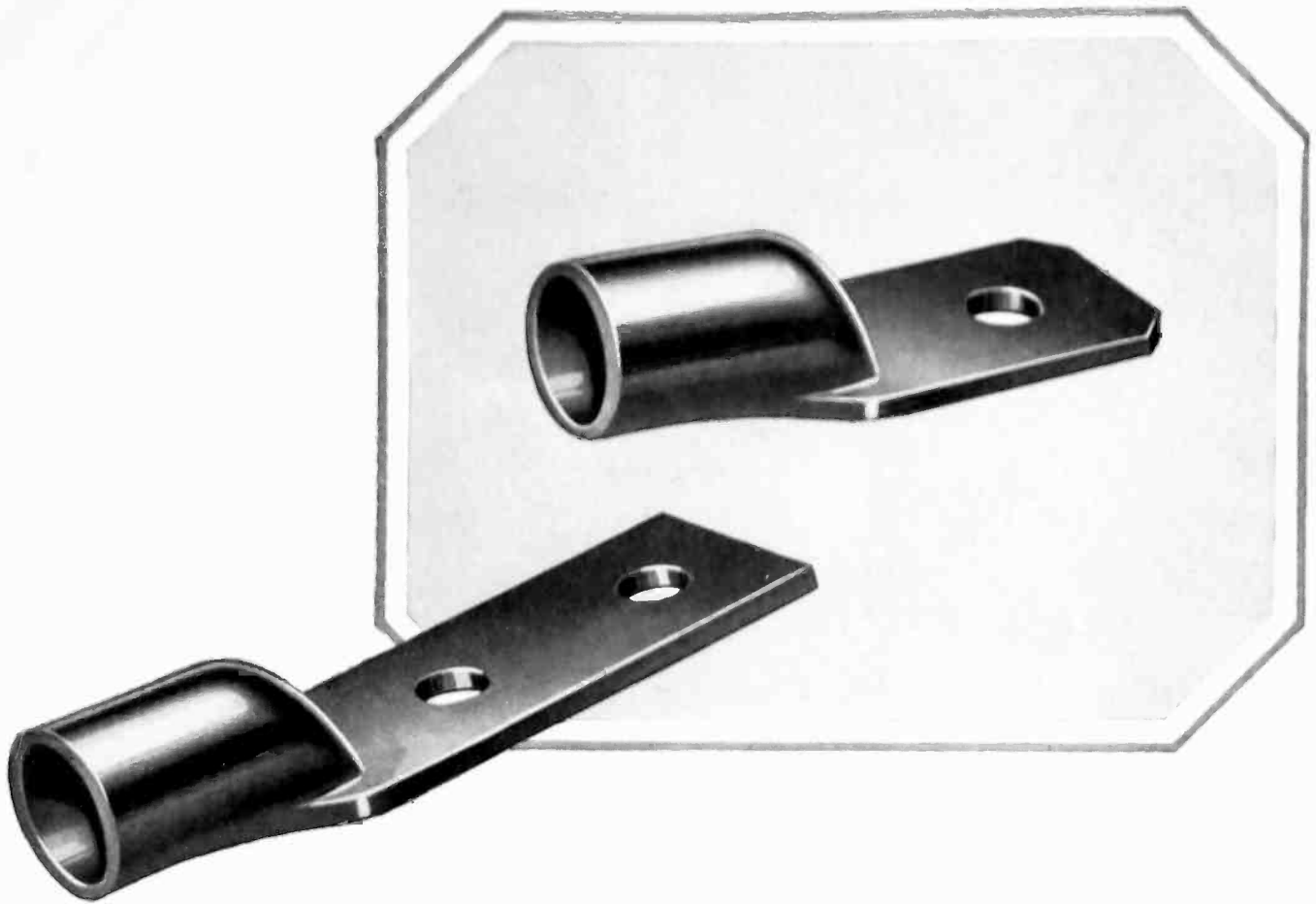

# G-E Standard Heavy-duty Pressed Copper-tube Terminals

Pressed, copper-tube terminals were originated by General Electric 20 years ago. Today, more than 100,000,000 are in use.

The experience gained through these years from the manufacture of electric equipment for every service has made possible terminals which:

- have low temperature rise
- are proved by test
- are neat in appearance



Switchboard Accessories  
—part of the complete line of  
General Electric Equipment  
to control and protect  
power generating and  
distributing apparatus

Tubes are resin-treated to prevent oxidation and to assure a reliable soldered joint.

Your nearest G-E office will supply you with information on terminals for every cable size up to 2 million cir. mils, and for one-, two-, or four-bolt fastening.

500-10

# GENERAL ELECTRIC

GENERAL ELECTRIC COMPANY, SCHENECTADY, N. Y., SALES OFFICES IN PRINCIPAL CITIES

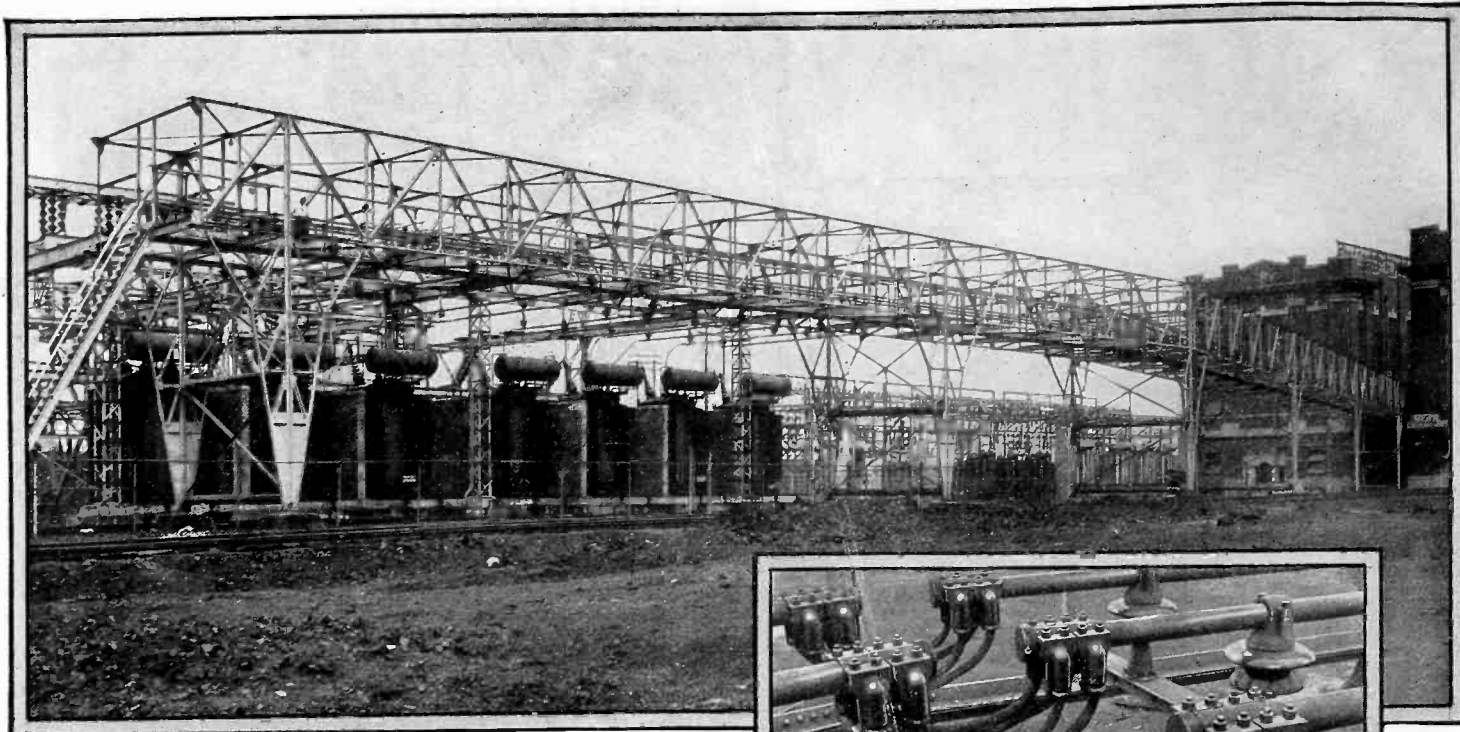

General view of the Essex 132 K. V. Outdoor Substation of Public Service Electric and Gas Company, designed and constructed by Public Service Production Company, Newark, N. J.

The secondary leads consist of three  $3\frac{1}{4}$ " O. D.,  $2\frac{3}{4}$ " I. D. Anaconda Copper Tubes per transformer bank, spaced on 2'6" centers, length of space between insulator supports, 20 feet. Anaconda Tubes supplied by Hungerford Brass & Copper Co.

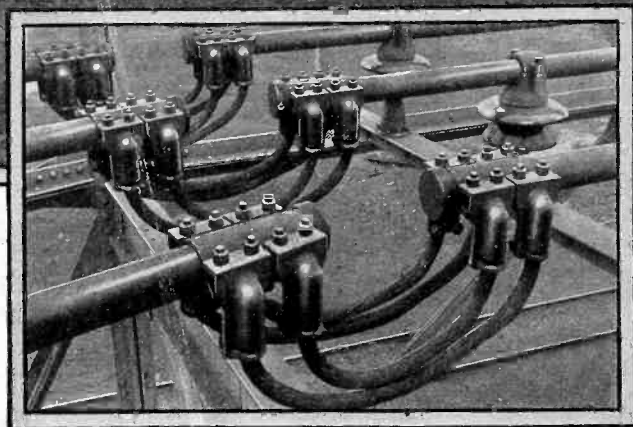

Detail of angle expansion joint

## Anaconda Bus Tubes

**For economical construction:**—The minimum conductivity of Anaconda Bus Tubes can be maintained at 98% when the tubes are hard drawn, and 99% when the tubes are soft. Anaconda Bus Tubes of high conductivity finished soft, or with a light draft, may be flattened without cracking, so that connections can be easily and quickly made on the job without the use of separate terminal lugs.

**For wide spacing:**—Deoxidized Copper Tubes are also supplied which will flatten without cracking even when hard drawn. The conductivity of such tubes, however, is not guaranteed to be in excess of 94%. The rigidity of hard drawn tubes

permits relatively long distances between insulating supports without danger of sagging or troubles from vibration.

**For large currents** tubular conductors are more efficient than solid conductors on account of the tendency of the current to crowd itself away from the center of the conductor. This advantage is particularly noticeable when the current at 60 cycles exceeds 2,000 amperes. The efficiency of tubes over flat bars increases as the current increases, and also as the frequency of alternation increases.

Electrical Engineers are invited to investigate the adaptability of Anaconda Bus Tubes to their requirements. Our Electrical Engineering Department is at your service.—THE AMERICAN BRASS COMPANY, General Offices, Waterbury, Conn., Offices and Agencies in principal cities.

# ANACONDA COPPER

# BRASS ANACONDA BRONZE

from mine to consumer

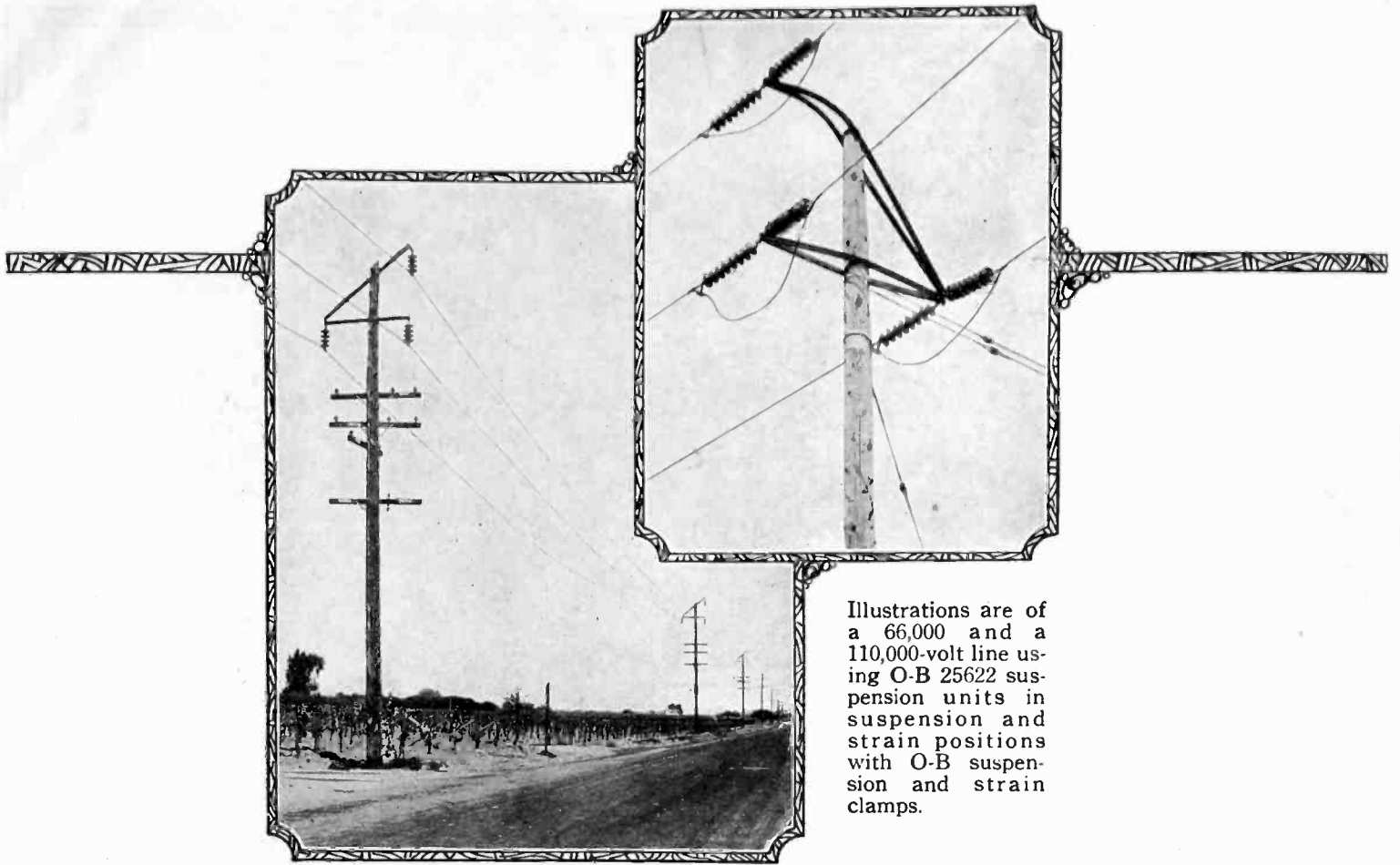

Illustrations are of a 66,000 and a 110,000-volt line using O-B 25622 suspension units in suspension and strain positions with O-B suspension and strain clamps.

## Transforming a Vast Desert into a Famously Fertile Valley—

*such is the work of the  
San Joaquin Light & Power Corp.*

OF ALL the forces and influences that have contributed to the transformation of the San Joaquin Valley from desert to virgin paradise, irrigation and electricity are foremost. Canals which carry waters of the mountain streams, and power lines which operate thousands of pumping stations, have converted vast stretches of desert into gardens.

Over 7 million acres of fertile land, dotted with 147 towns and cities—such is the San Joaquin Valley. It is said that nowhere on earth is there an area as extensive and with such productive possibilities as this

More than one-third of California's agricultural wealth lies in this great valley

and the smaller valleys of the adjacent coast country. Approximately one-third of California's oil is produced from the oil fields bordering these valleys. Thousands of these oil wells are also operated by electric motors.

Such is the scene of operation of the San Joaquin Light & Power Corp., with its 7164 miles of transmission and distribution lines, carrying 289,471 h. p. to the agricultural and industrial activities of this fertile valley. This power from 12 hydro and 3 steam electric plants, is transmitted mainly at 110,000 and 66,000 volts on lines using thousands of O-B suspension and pin type insulators with O-B hardware fittings.

Ohio Brass Company, Mansfield, Ohio  
Dominion Insulator & Mfg. Co., Limited  
Niagara Falls, Canada  
407H

# Ohio Brass Co.

SALES OFFICES: NEW YORK CHICAGO PHILADELPHIA PITTSBURGH CLEVELAND SAN FRANCISCO LOS ANGELES

PORCELAIN  
INSULATORS  
LINE MATERIALS  
RAIL BONDS  
CAR EQUIPMENT  
MINING  
MATERIALS  
VALVES

Please mention the JOURNAL of the A. I. E. E. when writing to advertisers.

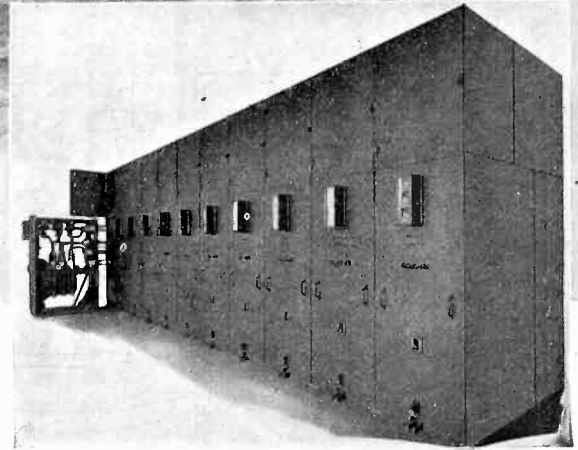
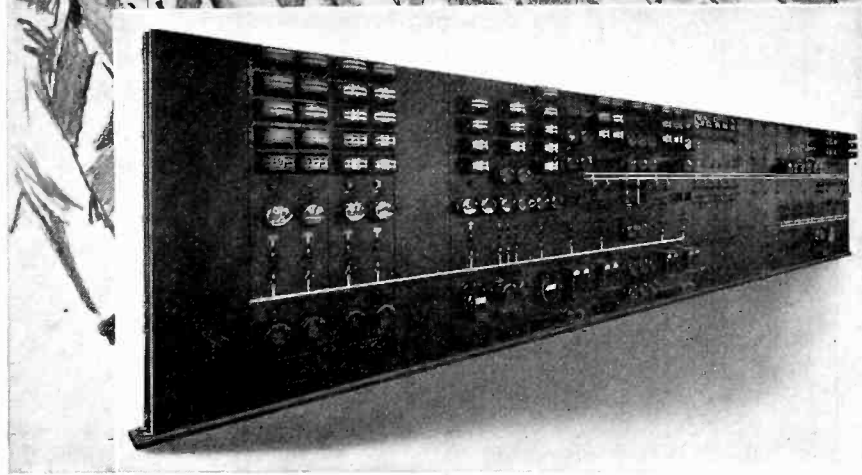
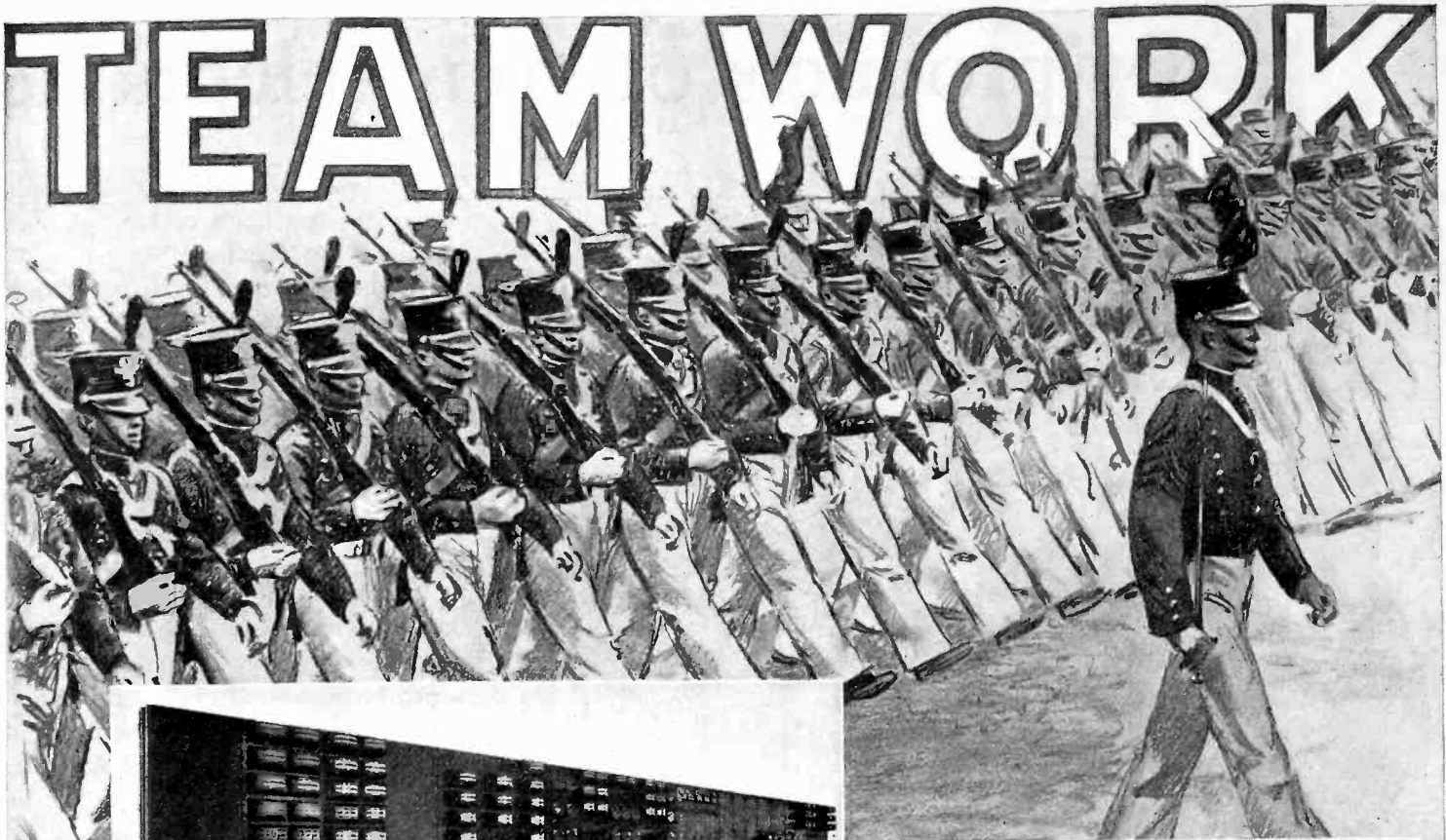

*Left!—Left!—with machine-like precision every foot and arm swings forward as one. Imagine the effect that one man out of step would have on that perfect line of march! But it never happens. Each individual does his part exactly right.*

Safety Enclosed Switchboard, Removable Truck Type

The same sort of teamwork from engineer to inspector must be developed to build switchboards that are one hundred per cent *right*. The Condit organization possesses the facilities to design and build the type and size of switchboards that will meet your exact requirements and the teamwork to make them as near perfection as humanly possible.

**CONDIT ELECTRICAL MFG. CORPORATION**

*Manufacturers of Electrical Protective Devices  
Boston, Mass.*

*Northern Electric Company  
LIMITED*

Sole Distributor for the Dominion of Canada

For safety enclosed switchboards — removable truck type — benchboards, electrical and manual controlled switchboards, get in touch with Condit.

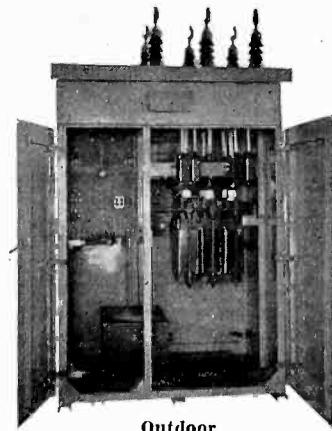

Outdoor Switch House

75

**CONDIT**

Please mention the JOURNAL of the A. I. E. E. when writing to advertisers.

# By-products of your telephone

THE microphone, familiar to the radio world, has been called "younger brother of the telephone."

It is but one of a family of products which owe their existence to the communication system engineers and to the men who made your telephone at Western Electric.

Forty-five years' experience as manufacturers for the Bell System has brought not only a telephone that is the world's standard, but also a Vitaphone to give a voice to the motion picture screen; an Audiometer to test the hearing with accuracy never before possible; an Audiphone which gives new aid to the hard of hearing; an Electrical Stethoscope to amplify the faintest heart sounds; a Public Address System to carry a speaker's voice to crowds of thousands and tens of thousands.

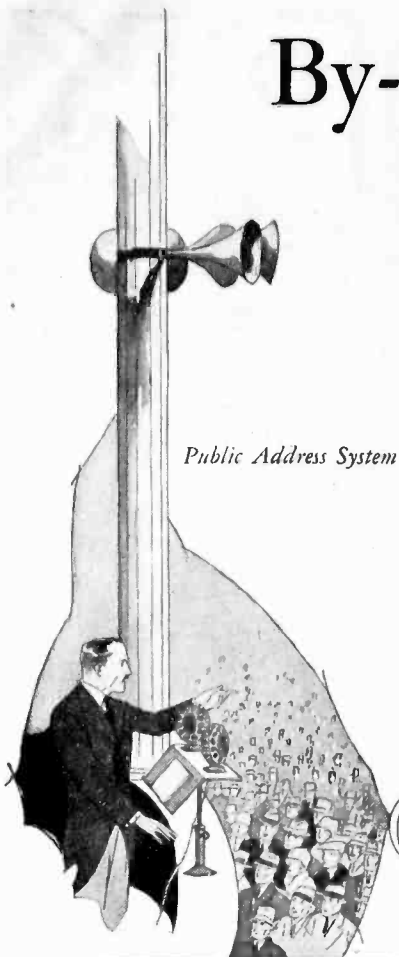

Public Address System

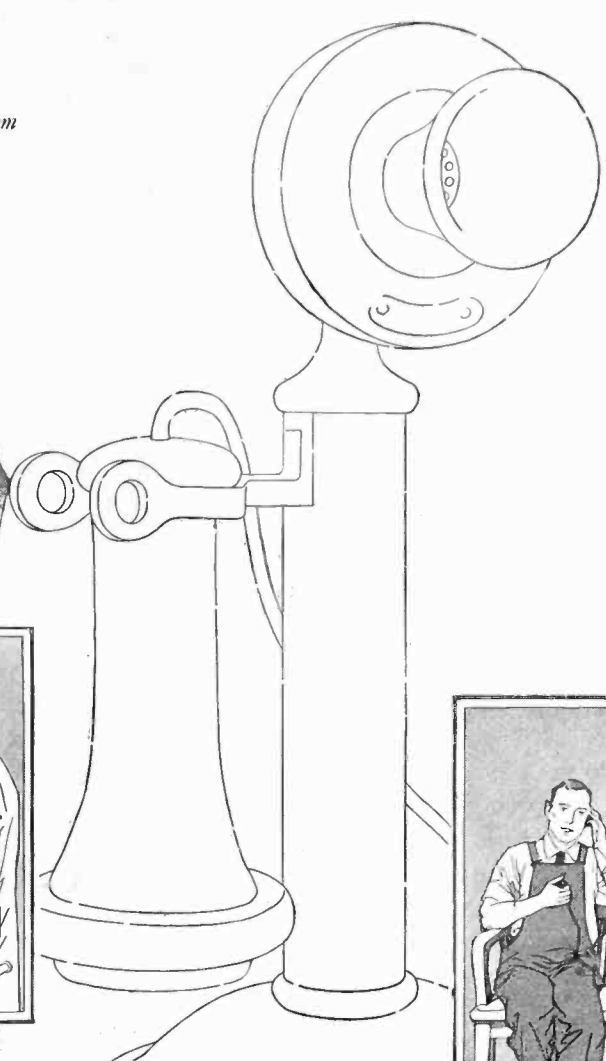

Electrical Stethoscope



Audiometer



Audiphone



Vitaphone



Radio Telephone

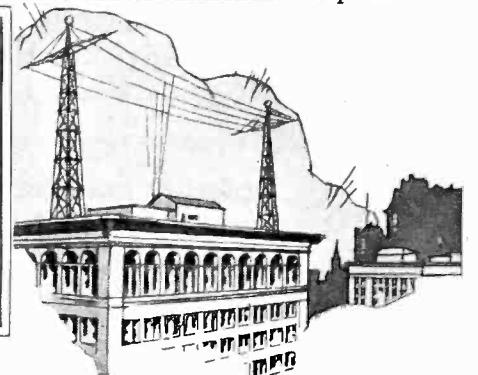

Back of your telephone

# Western Electric

SINCE 1882 MANUFACTURERS FOR THE BELL SYSTEM

Please mention the JOURNAL of the A. I. E. E. when writing to advertisers.

# A Complete Line!!

OF

## Certified Malleable Rod and Pipe Screw Type Anchors

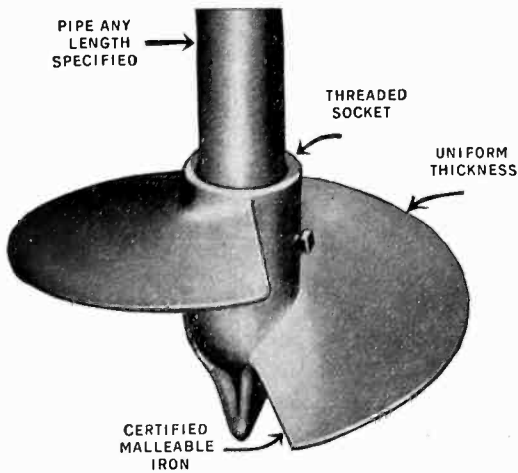
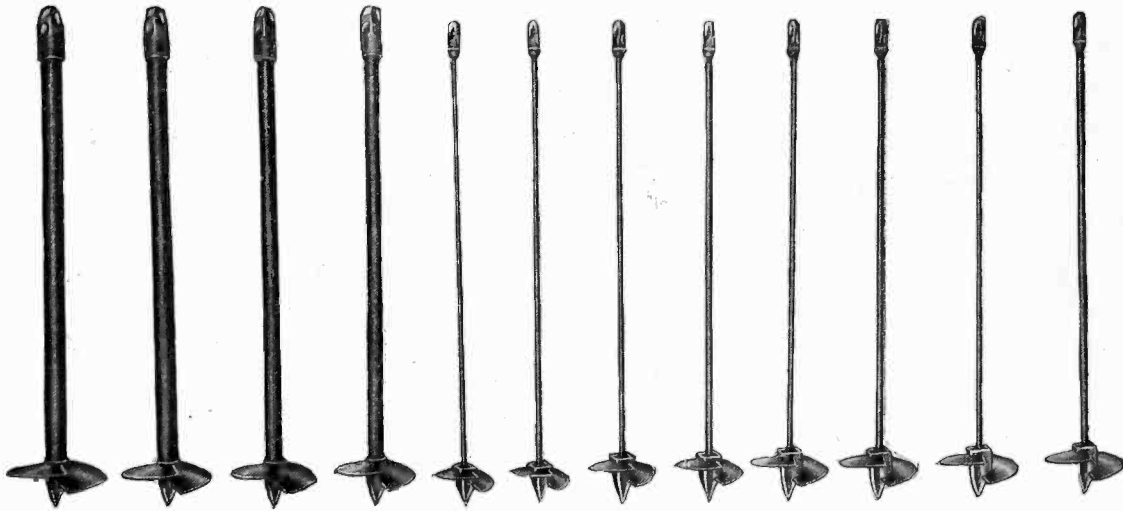
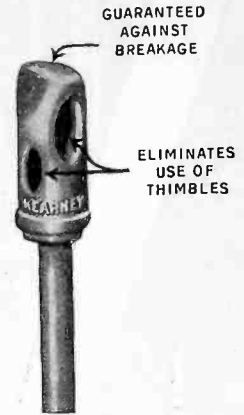
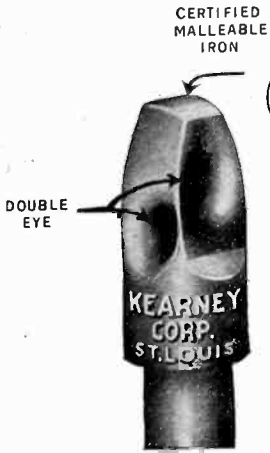

**T**WELVE sizes of Kearney pipe and steel rod screw type anchors to select from to meet your installation requirements. Note the added features of this complete line of anchors . . . all ready for immediate shipment, too.

**With This Guarantee**  
 Made of pre-heated certified malleable iron, all Kearney Screw Type Anchors are guaranteed against breakage. Either the pipe rod type or the steel rod type will conquer any soil conditions encountered in anchor installation . . . Kearney Wrenches are also guaranteed against breakage.

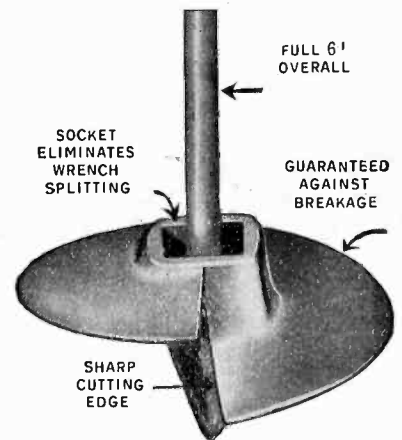

**MANUFACTURERS OF**  
 Malleable Anchors . . . Expulsion Porcelain Plug Cutouts . . . Fuse Switches . . . Disconnecting Switches . . . Choke Coils and Combinations . . . Aluminum, Galvanized iron, and Copper Guy Wire Clips . . . Extension Sleeve Twisters with Interchangeable Dies . . . Deadend Eyes . . . Solderless Service Connectors . . . Special Porcelain Mountings.

**JAMES R. KEARNEY CORPORATION**  
 4230M Clayton Avenue ST. LOUIS, MO.



**WRITE FOR BULLETIN**

Anchors . . . . .	300
Solderless Service Connectors . . . . .	310
Switching Equipment . . . . .	312
Plug Cutouts . . . . .	315
Porcelain Mountings . . . . .	316
Guy Wire Clips . . . . .	320
Extension Sleeve Twisters . . . . .	325
Deadend Eyes . . . . .	326

# KEARNEY

OVERHEAD AND UNDERGROUND UTILITY EQUIPMENT

Please mention the JOURNAL of the A. I. E. E. when writing to advertisers.

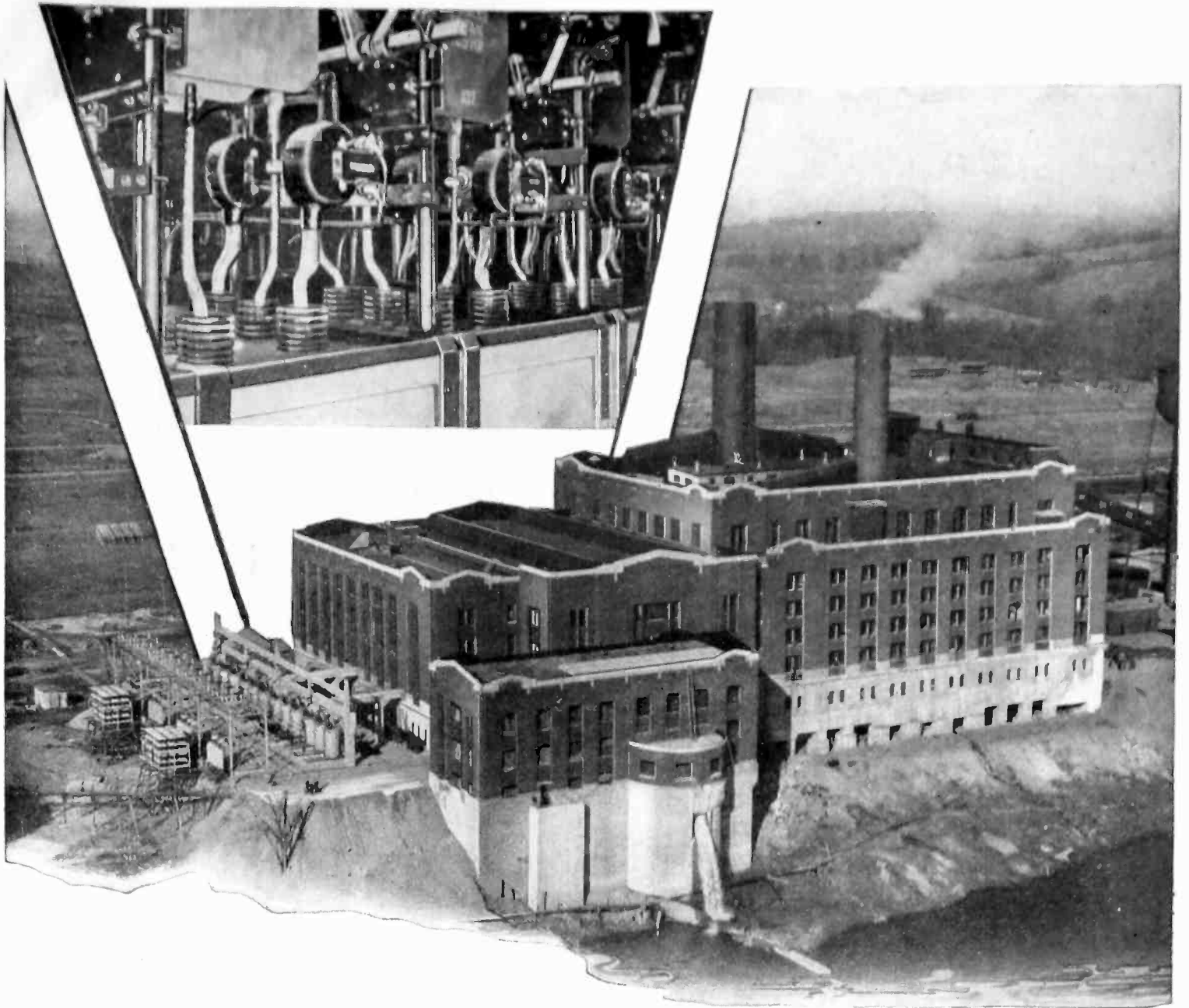

# SANGAMO HIGH HEAT-CAPACITY TRANSFORMERS

THE new Columbia Park station of the Columbia Power Company, Cincinnati, is famous for its many refinements in equipment that make for economy and reliability above ordinary good practice. SANGAMO Instrument Transformers are used in this station as well as in the substations of the affiliated operating company. Those shown in the photograph are Type SF. These transformers are designed to withstand the mechanical and thermal effects of heavy short-

circuits, and yet give the accuracy required for ordinary metering practice.

They have approximately six times the thermal capacity of the standard high accuracy Sangamo Type F as a result of which they will stand 200 per cent normal current continuously and operate satisfactorily on low power-factor circuits.

For uninterrupted safe service plus high accuracy use Sangamo transformers.



See our exhibit in Booths 359-361,  
N. E. L. A. Convention, Atlantic City

7231-3

## INSTRUMENT TRANSFORMERS

Please mention the JOURNAL of the A. I. E. E. when writing to advertisers.



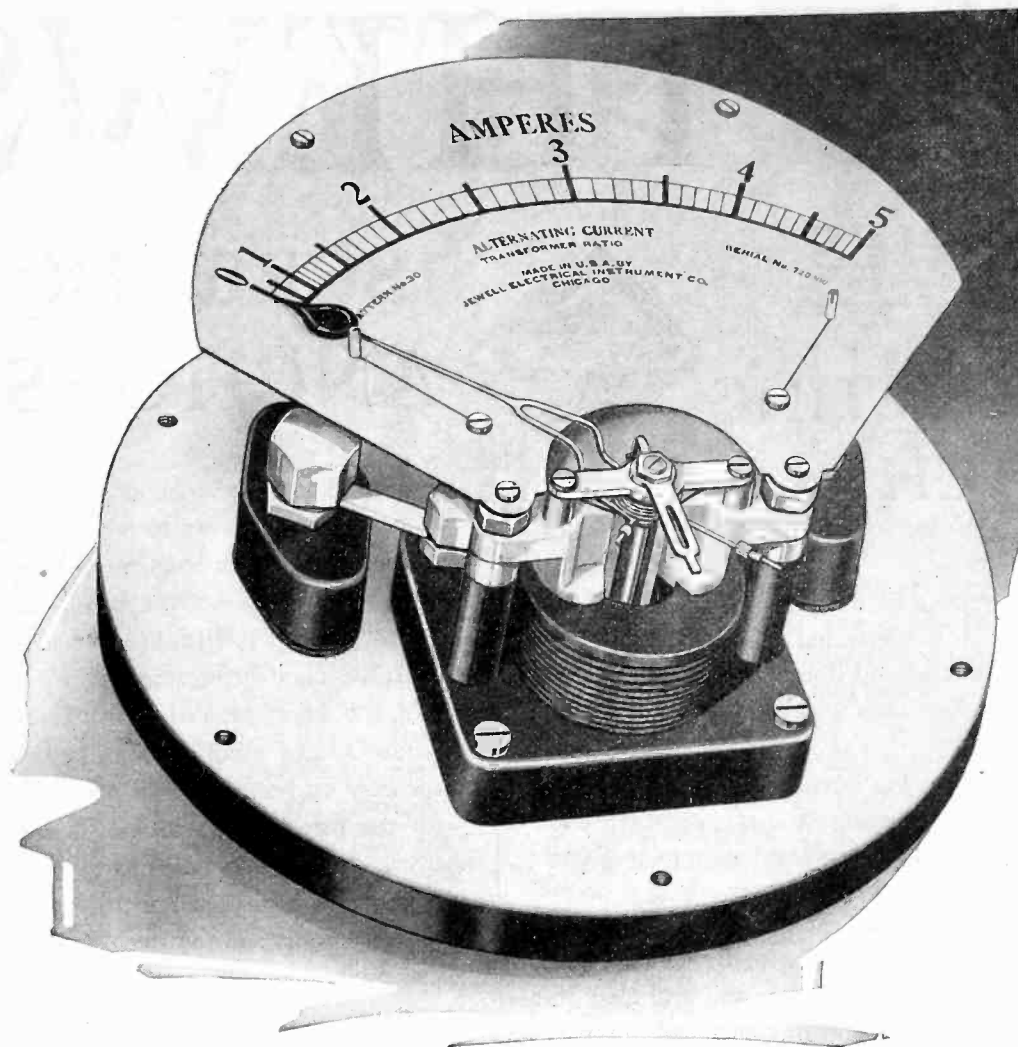

# ANNOUNCEMENT



Our new alternating current iron vane movement is the result of 27 years' experience manufacturing electrical measuring instruments. It is the finest piece of instrument design and workmanship to be found anywhere in the world, and embodies several distinctive and highly important features of insulation, assembly and construction not incorporated in other instruments.

Jewell representatives in the principal cities have samples of this instrument, and all its movement parts. We are anxious that all electrical engineers have an opportunity of making examination and comparison.

A constructional bulletin No. 1100 describing and illustrating this new movement will be mailed upon request.

**JEWELL ELECTRICAL INSTRUMENT CO.**  
**1650 WALNUT ST.**  
**CHICAGO**



Please mention the JOURNAL of the A. I. E. E. when writing to advertisers.

# MATTHEWS

## FUSWITCHES and DISCONNECTING SWITCHES (INTERCHANGEABLE)



## SCRULIX ANCHORS

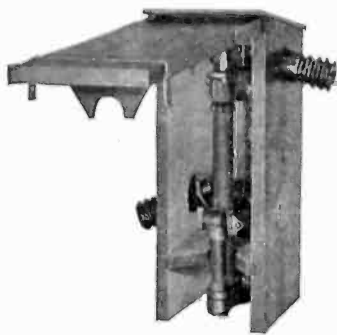

CLOSED  
TYPE

THE W. N. Matthews Corporation has perfected a complete line of Fuswitches and disconnecting switches for use on lines up to and including 15,000 volts.

These Fuswitches are capable of interrupting enormous short circuit currents, and can be depended upon to give satisfactory protection over a long period of years. When fused with Fast Blowing Matthews Fuse Links they will not overheat on 100% loads and will clear the circuit on dragging overloads in from 2 to 12 minutes when current exceeds marked rating of fuse by 15%. The disconnecting switches carry their rated current without overheating.

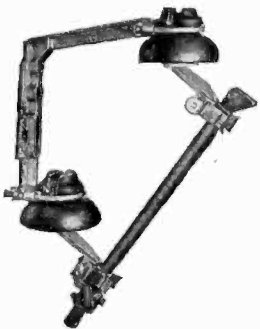

VERTICAL  
OPEN TYPE

The housings for the closed types are made of genuine Tidewater Cypress, and are guaranteed to withstand weathering for a period of ten years from date of purchase. All bushings and mountings are genuine wet process porcelain. Matthews Fuswitches have great rupturing capacity and are guaranteed to rupture twenty times their rated capacity. In a recent test the Type HQ cleared 53 and the Type OK 36 consecutive shorts through the same cartridges without the slightest damage being done to the Fuswitches or equipment. Matthews Fuswitches may be quickly converted into a disconnecting switch by substituting a solid disconnecting blade, made for this purpose, for the fuse cartridge. Used for protecting transformers and for sectionalizing over head power circuits.

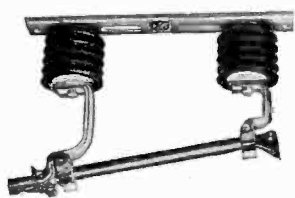

UNDERSLUNG  
OPEN TYPE

For detailed information pertaining to the various types of Matthews Fuswitches and Disconnecting Switches, send for 48 page Bulletin 502.

THESE widely used anchors are made in a variety of sizes to meet every anchoring need. Their design makes them particularly adaptable to use in sandy or swampy ground as well as in hard-pan or baked clay. They can be quickly screwed down, and when installed, cannot creep or crawl. Hard ground installation is made easy by boring a small pilot hole with the patented Matthews Hinglox Auger. Matthews Scrulix Anchors have no moving parts to adjust or that might carelessly be buried unadjusted. Nothing to assemble; they reach your men ready to install.

When screwed down they rest in solid undisturbed earth. The Ratchet Handle makes it easy to install Matthews Scrulix Anchors close to walls, fences and other obstructions, which would otherwise make the installation practically impossible. It also makes it easier to make installations at angles less than 60°.

## Breakage Guarantee

All Matthews Scrulix Anchors are absolutely guaranteed against breakage either in shipment, handling or during installation. If any customer will notify us of any broken anchors he may have, regardless of how they became broken, we will ship new helices of the size or sizes designated, all charges prepaid and without charge. This guarantee dates back to 1910. Beware of "justasgoods." They are flattering to us but dangerous to you. Look for SCRULIX on the helix.

For complete information send for Bulletin 801



# MATTHEWS

## ADJUSTABLE REEL



## SLACK PULLERS

QUICK RELEASE

for both Pay Out and Take Up

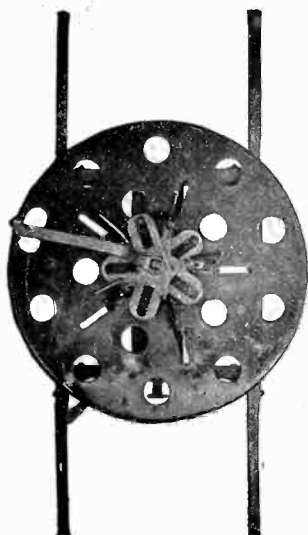

Matthews Adjustable Reel makes the handling of wire on coils very easy—much more so than wire on wooden reels. Since the wire can be purchased in coils, the cost of the wooden reels and their freight charges are saved. Fits any size coil. When stringing wire it is not necessary to pull wire down on to the road and then coil by hand as the pulling out

and coiling can be done at the same time on the Matthews Adjustable Reel. The reel table is metal and can be grounded, affording safety to operator. For complete information send for Bulletin 900.

### THE MATTHEWS STRAINOMETER

For use with the No. 730 Slack Puller. This dependable device measures the strain to which the wire or guy strand has been pulled by means of graduations on the Movable Strain Bolt. Each graduation denotes 250 pounds strain. Can be easily attached to either end of slack puller. Also for measuring strain on block and tackle.



Enable one man to do the work of four when taking the slack out of guy strand, messenger wire or changing strain insulators on high tension lines, or for splicing trolley wire, telephone or power cable under tension. Also used for pulling back underground cable. Takes the place of block and tackle. One man can easily pull 3000 pounds with the 730 or 10,000 with the 7100. No slack is lost in dead ending as strain is held to the exact point pulled. With the new Quick Release feature, when the entire take-up has been used, the wire is temporarily dead-ended and the lock released. This permits the Slack Puller to be immediately extended to its maximum or any intervening length. For additional information send for Bulletin 701.



No. 730, Capacity 3000 pounds



No. 7100, Capacity 10,000 pounds

A Complete Display of Matthews Products may be seen at Space 162-164 Million Dollar Pier

## W. N. MATTHEWS CORPORATION

3700 FOREST PARK BLVD., ST. LOUIS, U. S. A.

### Offices

ATLANTA, GA.  
138 Marietta St.  
CHICAGO, ILLINOIS  
320 S. Franklin St.  
BALTIMORE, MD.  
216 E. Lexington St.  
BOSTON, MASS.  
Statler Bldg.  
CLEVELAND, OHIO  
Rockefeller Bldg.

DALLAS, TEX.  
2425 Commerce St.  
DENVER, COLO.  
1429 18th St.  
LOUISVILLE, KY.  
88 Kenyon Bldg.  
MINNEAPOLIS, MINN.  
91 South 11th Street  
NEW ORLEANS, LA.  
3032 Fern St.

NEW YORK, N. Y.  
30 Church St.  
PITTSBURGH, PA.  
305 7th Ave.  
SAN FRANCISCO, CALIF.  
301 Rialto Bldg.  
MONTREAL, CANADA  
G. D. Peters & Co., Ltd.  
New Birks Bldg.

LONDON, ENGLAND  
F. J. Down, 90-92 Fenchurch St.  
London, E. C.  
MELBOURNE, AUSTRALIA  
(R&C) Thomas Bros. Pty. Ltd.  
201-203 Williams St.  
WELLINGTON, N. Z.  
A. C. Thomas  
19 Bank of New So. Wales  
Chambers, Lambton Quay

There is a Matthews Distributer in Every Principal City.

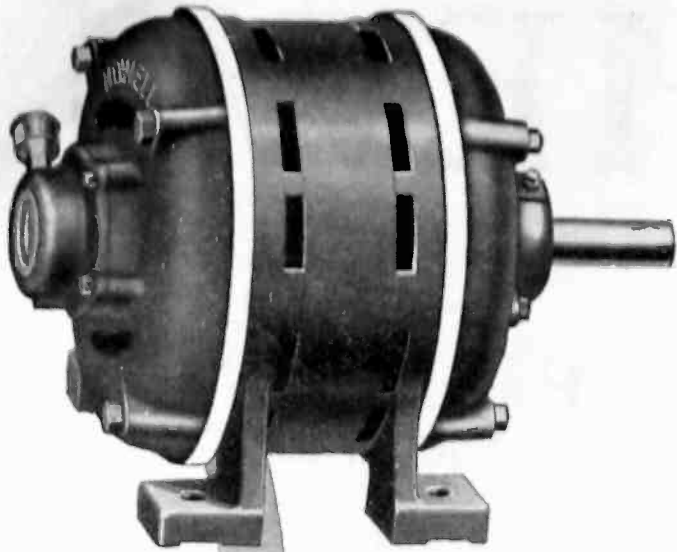

# TIMKEN

## *Tapered*

# ROLLER BEARINGS

The red bands on Howell motors have become a sign of their character. Contributing to Howell character and success are Timken Tapered Roller Bearings. *More* than a means of eliminating friction, Timken Bearings add extreme durability, high capacity for thrust, shock and radial loads, starting efficiency, lubricating economy and refinement of design.

In smaller, simple, perfectly sealed mountings—without any shaft wear or auxiliary parts—Timken Bearings scientifically carry *ALL* the load on their *POSITIVELY ALIGNED ROLLS* of Timken electric steel.

The best records in industry, for extended motor life and reduced motor cost, are being made by Timken-equipped motors.

THE TIMKEN ROLLER BEARING CO., CANTON, OHIO

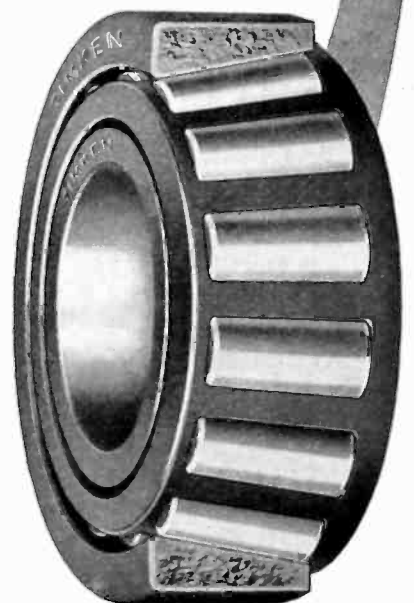

Please mention the JOURNAL of the A. I. E. E. when writing to advertisers.

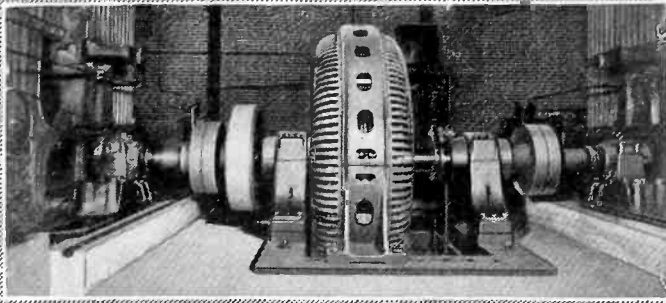

PULP GRINDER DRIVE

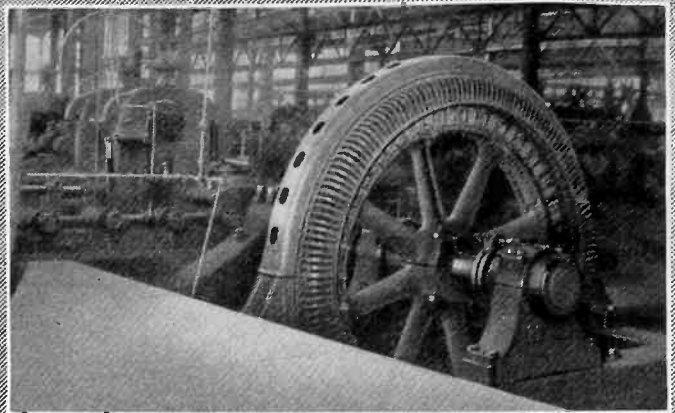

STEEL MILL DRIVE

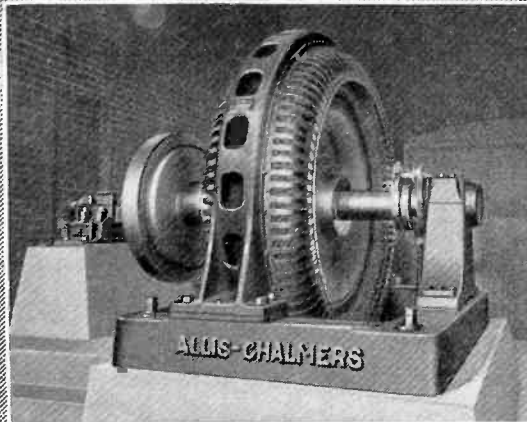

FAN DRIVE

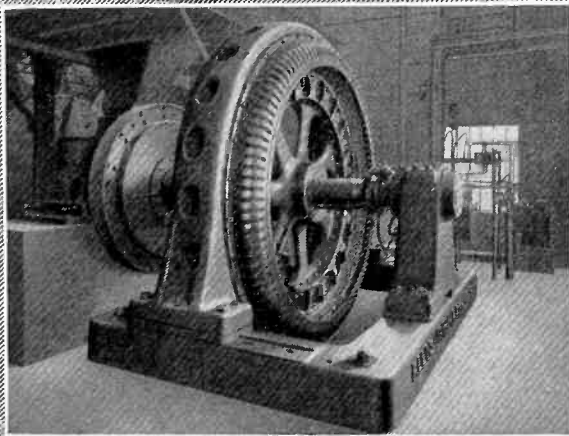

COMPER MILL DRIVE

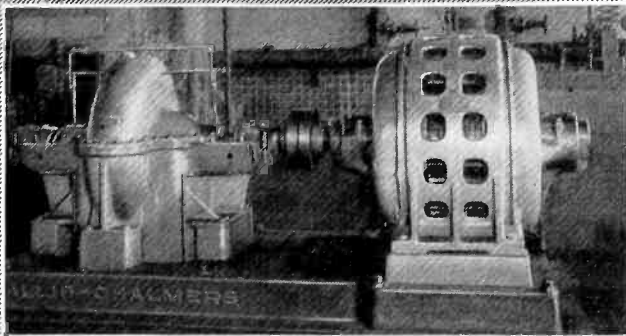

PUMP DRIVE

## Synchronous Motor Drives

Allis-Chalmers Synchronous Motors are being used in a great variety of industrial applications.

They operate at a constant speed even under varying loads, and with uniformly high efficiency at fractional loads.

The ability to operate at unity power factor regardless of the power factor of the line, together with the corrective effect on the power factor of the system, that may be obtained by increasing their excitation, are prime reasons for the increasing demand for these motors.

Some typical installations are shown in the accompanying photographs. Allis-Chalmers Synchronous Motors are built in a wide range of speeds and capacities for various service conditions.

Consult our Engineers regarding their possibilities in your plant.

**ALLIS-CHALMERS  
MANUFACTURING COMPANY**

Milwaukee, Wisconsin, U. S. A.

District Offices In All Principal Cities

# ALLIS-CHALMERS

MILWAUKEE, WIS. U. S. A.

Please mention the JOURNAL of the A. I. E. E. when writing to advertisers.

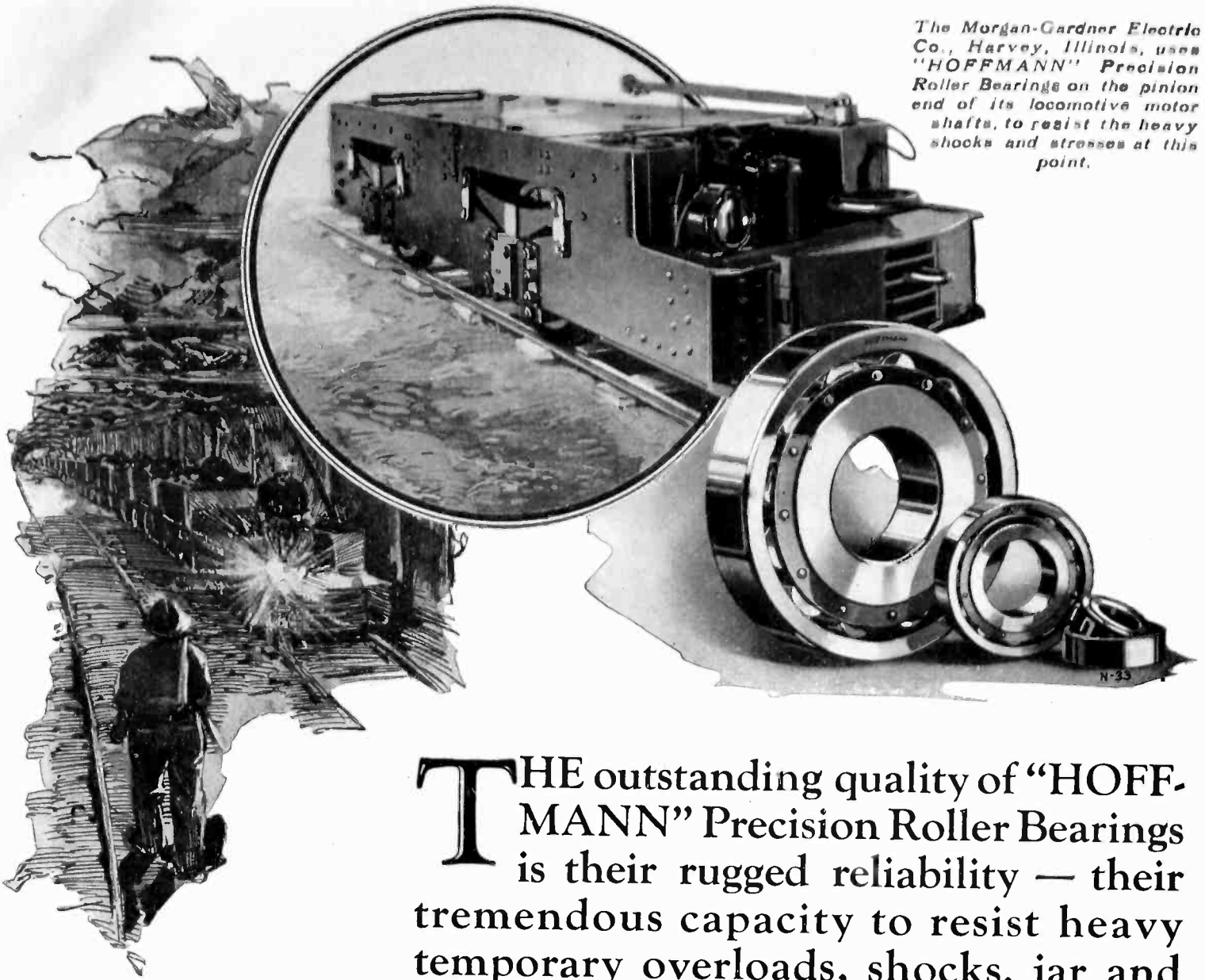

*The Morgan-Gardner Electric Co., Harvey, Illinois, uses "HOFFMANN" Precision Roller Bearings on the pinion end of its locomotive motor shafts, to resist the heavy shocks and stresses at this point.*

**T**HE outstanding quality of "HOFFMANN" Precision Roller Bearings is their rugged reliability — their tremendous capacity to resist heavy temporary overloads, shocks, jar and vibration. Yet this great load-ability is not secured at the expense of speed-ability — which is equal to that of any ball bearing. Their extreme simplicity is another factor in their favor.

**"NORMA"**  
PRECISION  
BALL BEARINGS

In both open and closed type, provide the engineer and designer with high-duty bearings of "Precision" quality for those purposes where the loads are moderate and steady, and the need for speedability and reliability imperative.

*Let us send you Catalog 904, describing "HOFFMANN" design and construction in detail.*

NORMA-HOFFMANN BEARINGS CORPORATION  
STAMFORD, CONN. . . U. S. A.

NB-872

**"HOFFMANN"**  
PRECISION  
ROLLER BEARINGS

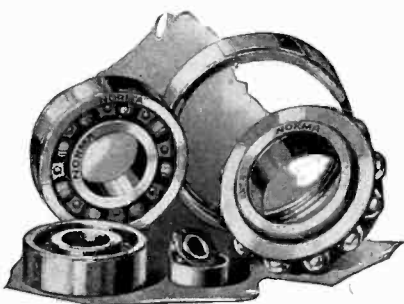

Please mention the JOURNAL of the A. I. E. E. when writing to advertisers.

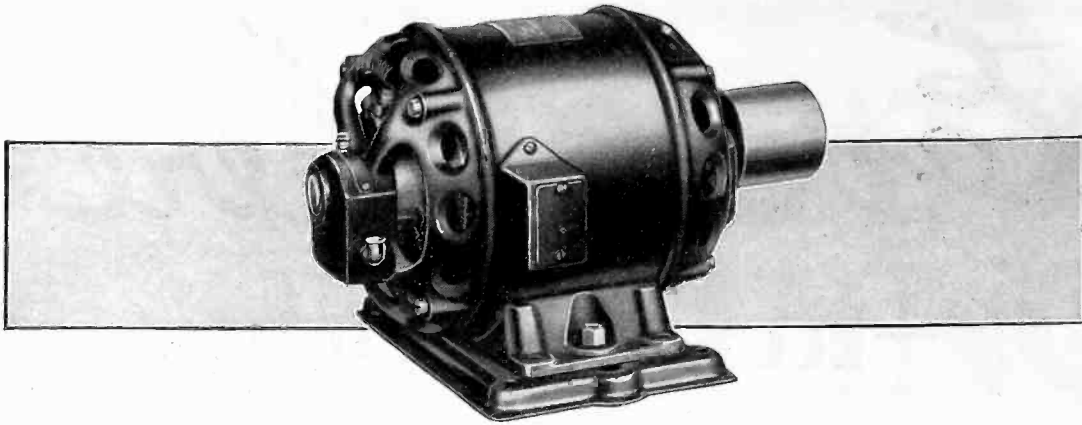

1/8 horse-power Century Type RS Repulsion-start  
Induction Single-phase Motor

## FOR ELECTRIC REFRIGERATORS

The first commercially-practical electric refrigerator was equipped with a Century Repulsion-start Induction Single-phase Motor—because the performance of Century Single-phase Motors was then, as it is now, more than adequate to meet all the service and power-supply requirements

of the installation. ∞ ∞ The pronounced popularity of the 1/8th horse power motor among the Refrigerating Industry and Central Station Operators results from the satisfaction that has accrued to all interested in their operation during the past 13 years.

- 1 . .** The 1/8th horse-power motor is particularly quiet at starting—quiet in operation—quiet at stopping.
- 2 . .** Characteristics are permanent and well balanced. The product of efficiency and power factor is high.
- 3 . .** Brushes last for years because they are in contact with the commutator only during the starting period—approximately 1/900th part of the time the motor is operating.
- 4 . .** The Century Wool-yarn System of Lubrication assures at least one year's continuous 24-hour-per-day operation—without reoiling.

Century Repulsion-start Induction Single-phase Motors are built in all standard sizes from 1/8 to 40 horse power . . . Temperature rise not more than 40° Centigrade.

*There is a decided difference!*

**CENTURY ELECTRIC CO. · 1806 Pine St. · ST. LOUIS**

*32 Stock Points in the United States and More than 50 Outside Thereof*

<i>"They Keep</i>	<b>Century</b>	<i>a-Running"</i>
<b>1/8 to 40 H. P.</b>	<b>MOTORS</b>	<b>1/8 to 40 H. P.</b>

Please mention the JOURNAL of the A. L. E. E. when writing to advertisers.

# Everywhere -in All Industries

**M**OTOR performance and motor life depend upon *many* factors—soundly developed and properly *balanced* factors. But no single development within the last quarter century has been of such outstanding importance as the Sealed Sleeve Bearing.

This is not an idle boast. Performance records, under all kinds of operating conditions, and including the most gruelling ever encountered, have *proved* the Sealed Sleeve Bearing to be both the trouble-proof bearing and the trouble-preventing bearing.

In cement mills where dust flies thick and fast; in dry grinding, where the tiny particles of metal have heretofore quickly eaten into the heart of the bearings; in mines and quarries; in lumber, textile, steel, and other mills—everywhere, in all industries, the Sealed Sleeve Bearing has demonstrated the importance of simplicity in bearing design and the further value of “sealed” simplicity.

The  
Sealed  
Sleeve  
Bearing  
*is performing*

Oiling is only a once or twice-a-year job—because the oil stays put and remains clean. And when, eventually, renewal becomes necessary, it can be done easily and quickly and economically.

These and other advantages have been proved by years of performance—proven so definitely that the Sealed Sleeve Bearing is not only the *accepted* bearing; it now is the *demand*ed bearing wherever electrical engineers and motor users have observed its advantages.

Westinghouse Electric & Manufacturing Co.  
East Pittsburgh Pennsylvania  
Sales Offices in All Principal Cities of  
the United States and Foreign Countries

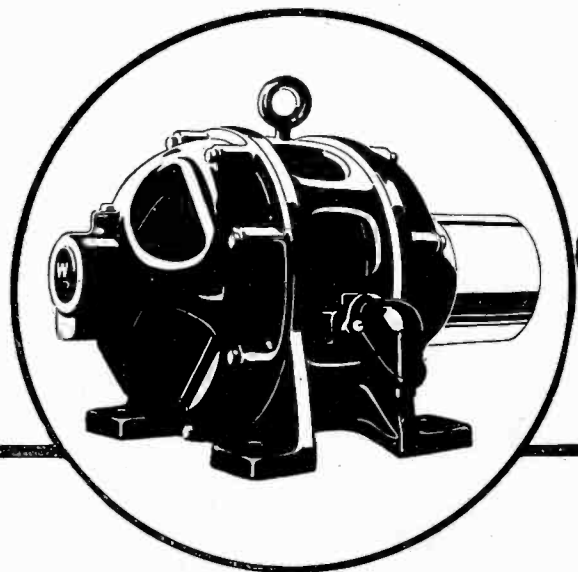

**Westinghouse**  
**Motors**  
*With*  
**Sealed Sleeve Bearings**

Please mention the JOURNAL of the A. I. E. E. when writing to advertisers.



# AUTOMATIC PUMPING

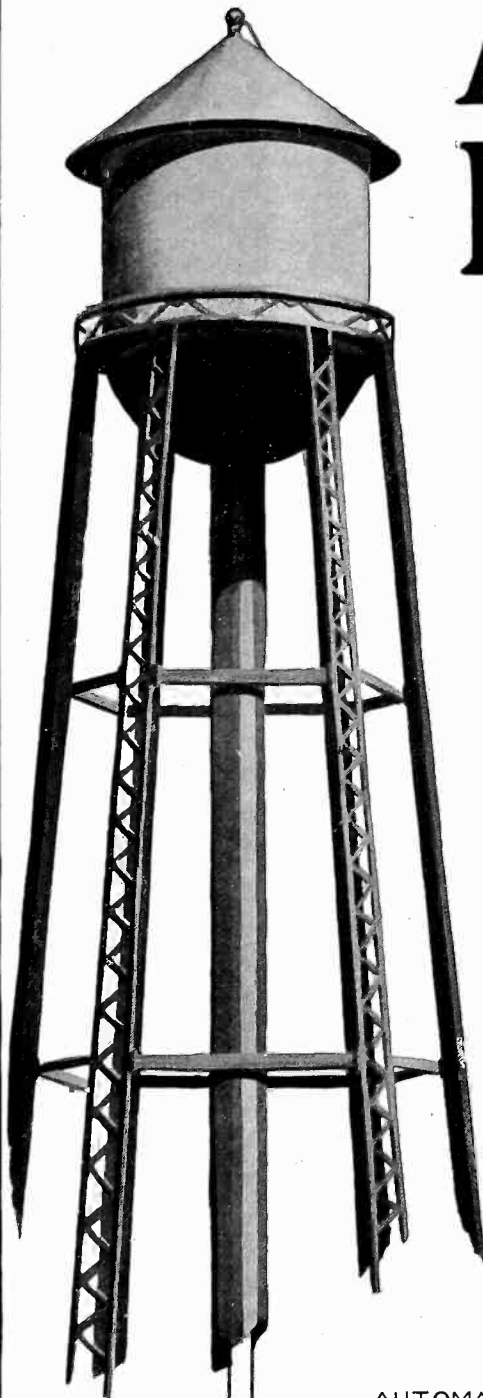

Pumps that operate automatically day after day, without an attendant on the job, are a real economy; no station attendants, no expensive boilers and standby equipment, no dependence upon the human element.

Electrically driven pumps can be started and stopped automatically as the water level in the storage tank varies and you will always be assured of a ready water supply. EC&M Automatic Pump Control Equipment is your guarantee.

Your pumping stations can be controlled by EC&M Float Switches or Altitude Gauges through EC&M Oil-immersed Automatic Compensators or Across-the-line Starters for A.C. motors and through EC&M Direct Current Starters for D.C. motors.

An EC&M Altitude Regulator will maintain the water level in a storage tank fifty feet high within limits of one foot. This is done automatically through the electrical contacts in the Regulator which are a part of the circuit that controls the starting and stopping of the pump motor.

The EC&M Cushion Tank and Valve installation, as shown in the diagram below, is designed to prevent those pulsations of the Regulator needle which result from the surging of the water in the pump discharge line. Spasmodic starting and stopping of the pump motor will not occur where this cushion tank is provided.

*Send for Specification Sheets S-21 and S-25 and Bulletins 1016-B, 1020-A, 1033-B and 1042-F.*

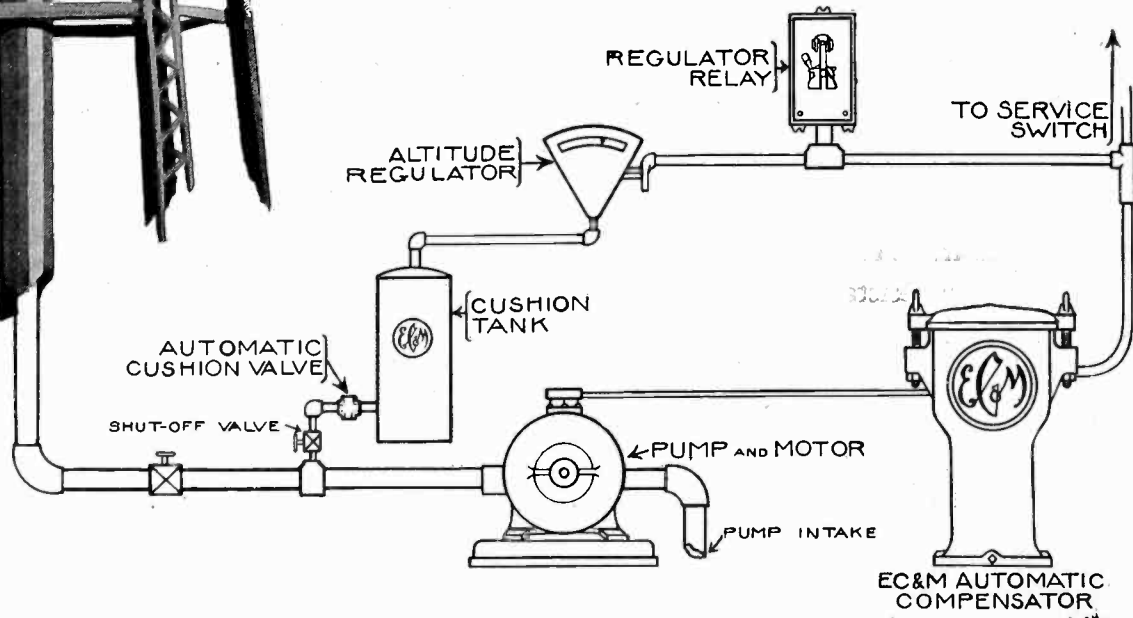

**THE ELECTRIC CONTROLLER & MFG. CO.**

BIRMINGHAM - BROWN-MARX BLDG.

CHICAGO - CONWAY BLDG.

CINCINNATI - 1<sup>ST</sup> NATIONAL BANK BLDG.

DETROIT - DIME BANK BLDG.

NEW YORK - 50 CHURCH ST.

**CLEVELAND, OHIO**

LOS ANGELES - AMERICAN BANK BLDG.

SALT LAKE CITY - 228 W. SO. TEMPLE

PHILADELPHIA - WITHERSPOON BLDG.

PITTSBURGH - OLIVER BLDG.

SAN FRANCISCO - CALL BUILDING

SEATTLE - 570 COLMAN BLDG.

TORONTO - METROPOLITAN BLDG.



# Resistance of current is the "traffic cop"

**T**HINK of living in a city where traffic regulations are poorly enforced. Accidents are frequent and expensive and the situation so dangerous to all that it is certain immediate corrective means are necessary.

Resistors are placed in a circuit as the "traffic cops" of current. Their job is to prevent shifting or variable currents by allowing only a pre-determined and definite amount of current to flow. Applying a term unusual to resistors, they must be efficient.

To be efficient resistors must have the essential characteristics of —

- 1.. Compactness.
- 2.. Harmless heat dissipation.
- 3.. Protection of resistive element against mechanical or chemical injury.
- 4.. Lack of bare hot metal surfaces to offer fire risk.
- 5.. Aged resistive element preventing erratic changes of resistance value in use.
- 6.. Low cost even compared with homemade or makeshift resistors employing bare wire, cements, shellac, or other non-permanent coating.

Vitreous enamel protected Vitrohm Resistors alone possess *all* of these characteristics. They are available — quickly — in resistance value from 1 to 1,000,000 ohms to fulfill any special space or mounting conditions met with in your resistance problems. More than 35 years of manufacture and research are at your disposal. A letter outlining your needs will bring full information on Ward Leonard Vitrohm Resistors.



## The Construction of a Vitrohm Resistor Tube

- a. Porcelain tube, unaffected by heat or atmosphere, and having an expansion coefficient similar to that of the other Resistor Components.
- b. Wire, of practically zero temperature coefficient of resistance, evenly wound on porcelain tube.
- c. Vitreous enamel entirely surrounding both resistance wire and terminal connections protects resistive element and offers a dissipating surface far in excess of the area of resistive element alone.
- d. Complete section of Vitrohm Resistor Tube. Vitreous Enamel permanently bonded to resistive element and terminal connections. A resistor capable of an indefinite useful life running continuously at its full rated load.

# Ward Leonard Electric Company

37-41 South Street Mount Vernon, N. Y.

Atlanta—G. P. Atkinson  
Baltimore—J. E. Perkins  
Boston—W. W. Gaskill  
Chicago—Westburg Eng. Co.

Cleveland—W. P. Ambros Co.  
Detroit—C. E. Wise  
Los Angeles—Bell & Slimmon  
New Orleans—Electron Eng. Co., Inc.  
Melbourne and Sydney, Australia—Warburton, Franki, Ltd.

Philadelphia—W. Miller Tompkins  
Pittsburgh—W. A. Bittner Co.  
San Francisco—Elec. Mat'l Co.  
Seattle—T. S. Wood

St. Louis—G. W. Pieksen  
Montreal—Bishop Sales Corp.  
Toronto—D. M. Fraser, Ltd.  
London, Eng.—W. Geipel & Co.

# WIRE

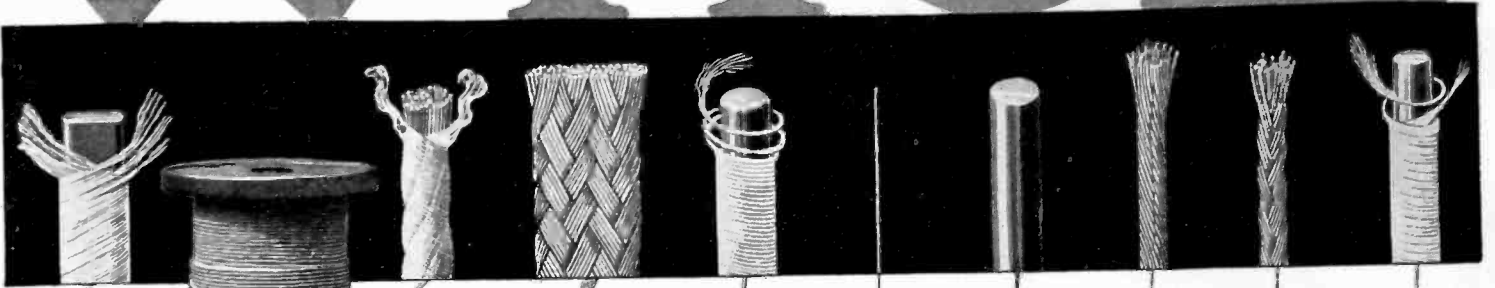

## -in Large Variety

**with one high standard of quality throughout**

Enameled  
Cotton Covered  
Silk Covered  
Cotton Enameled  
Silk Enameled  
Square Wire  
Rectangular Wire

Bare Copper  
Tinned Copper  
Litzendraht  
Stranded Cables  
Braided Cables  
Bus-Bar  
Antenna

*The recent addition of the square and rectangular shapes completes the Dudlo line of Magnet Wires from the standpoint of VARIETY as well as volume.*

**There is now a Dudlo wire to exactly fit every part of your product.**



### WINDINGS

Dudlo layer wound coils wound to your specifications. The Dudlo engineering laboratories are at your service to assist in designing coils to meet your needs—samples submitted without obligation.

### SPOOLING

The spooling of all Dudlo Wires is carefully done, with the convenience of the manufacturer who uses the wire always in mind.

### SPECIAL WIRES

Dudlo service also covers *special wires* fabricated to manufacturers' specifications.

### PROMPT DELIVERIES

Immediate delivery from large stocks at our factory and branches in Newark, St. Louis, Milwaukee and San Francisco.

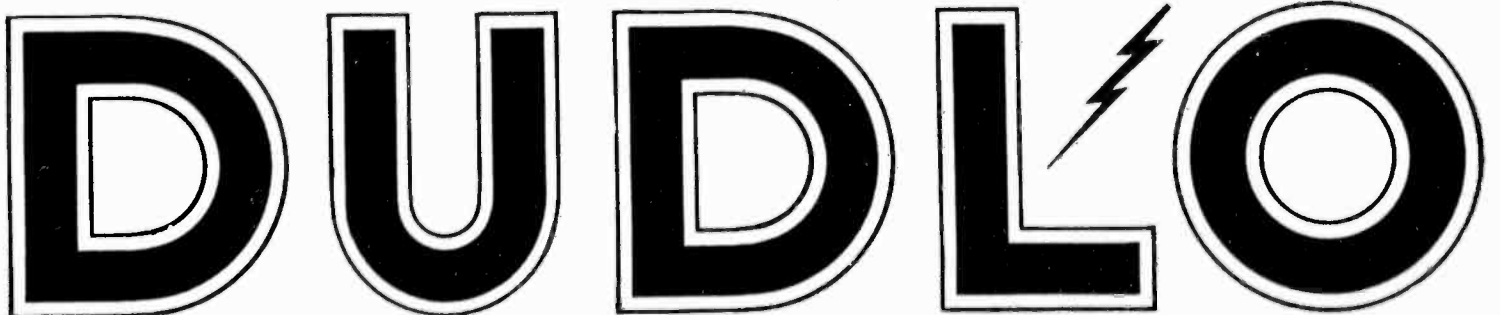

**DUDLO MANUFACTURING CORPORATION, FORT WAYNE, INDIANA**

56 EARL STREET  
NEWARK, N. J.

160 NORTH LA SALLE STREET  
CHICAGO, ILL.

4153 BINGHAM AVE.  
ST. LOUIS, MO.

274 BRANNAN ST.  
SAN FRANCISCO, CALIFORNIA

Please mention the JOURNAL of the A. I. E. E. when writing to advertisers.

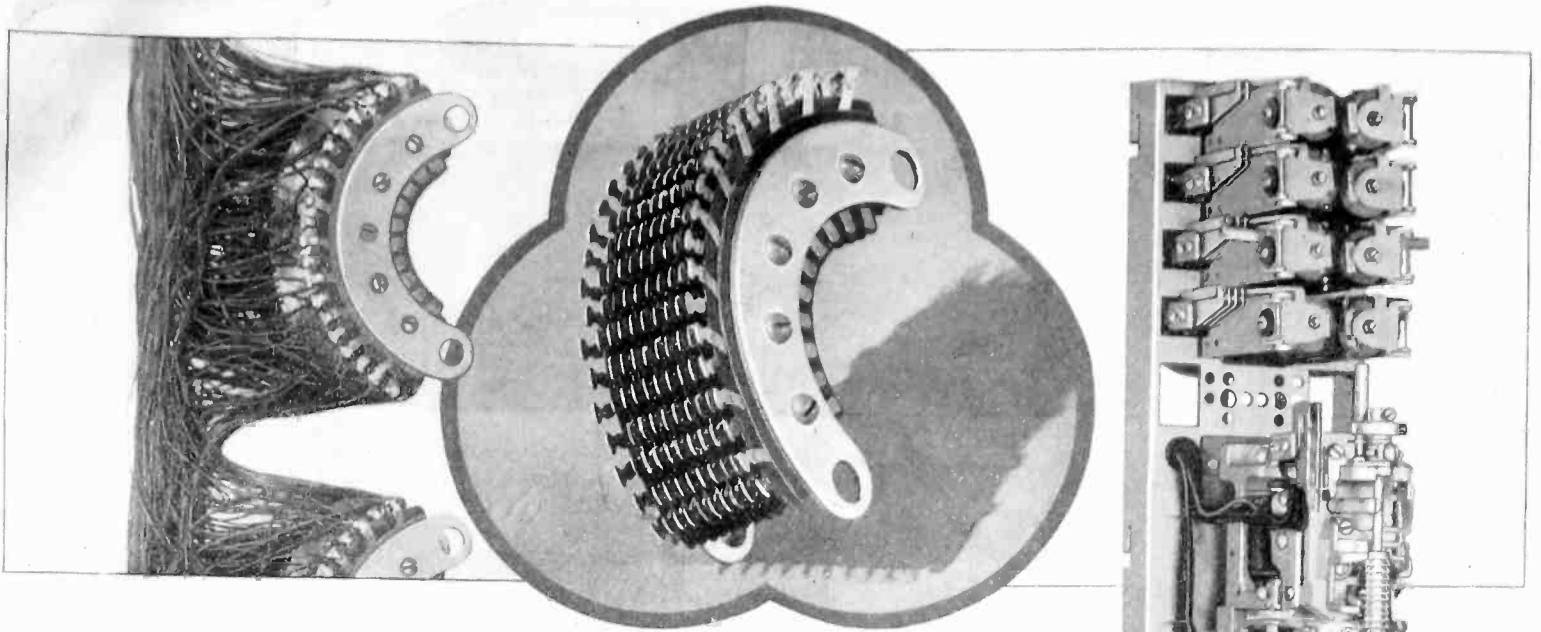

*Line terminal bank insulated with Bakelite Laminated and the Connector on which it is used. Made by Automatic Electric, Inc., Chicago, Ill.*

## *Neither age nor dampness harms Bakelite Laminated*

**E**ACH of the three-hundred contact points of the compact line terminal bank, of Strowger Automatic Telephone Equipment, must be thoroughly insulated from the others. However damp or humid the climate may be, the insulation used must retain its dielectric strength unimpaired, and hold its original dimensions and form.

For the insulation of the Strowger line terminal bank, a large number of thin punchings of Bakelite Laminated are used because, in the words of the makers of the

system, "Bakelite will stand up under all sorts of atmospheric conditions over a period of years, with no impairment of its insulating qualities."

Many manufacturers of electrical equipment have discovered that the use of Bakelite Laminated insulation promotes dependable performance under adverse operating conditions. It may be that it could be used to advantage in some part of your own product. Why not enlist the cooperation of our engineers and research laboratories in learning its possibilities?

*Write for Booklet 3*

### **BAKELITE CORPORATION**

247 Park Ave., New York, N. Y., Chicago Office: 635 West 22nd St.  
BAKELITE CORPORATION OF CANADA, LTD., 163 Dufferin St., Toronto, Ontario, Can.

# BAKELITE

REGISTERED

U. S. PAT. OFF.



THE MATERIAL OF A THOUSAND USES

"The registered Trade Mark and Symbol shown above may be used only on products made from materials manufactured by Bakelite Corporation. Under the capital 'B' is the numerical sign for infinity, or unlimited quantity. It symbolizes the infinite number of present and future uses of Bakelite Corporation's products."

Please mention the JOURNAL of the A. I. E. E. when writing to advertisers.

1-6-7—Belden heavy rectangular D. C. C. wire in transformer coils.  
 2-8—Belden heavy round D C.C. wire in transformer coils.  
 3-11—Heavy Beldenamel transformer coil.

4-5-12-13—Belden fine Silkenamel coils for high voltage transformers.  
 9—Belden D. C. C. wire medium size in relay coil.  
 10—Specially designed Belden Armored Cable.

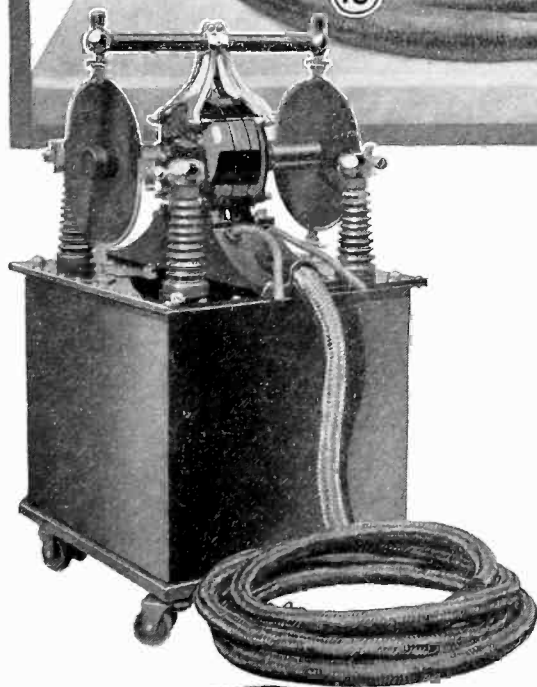
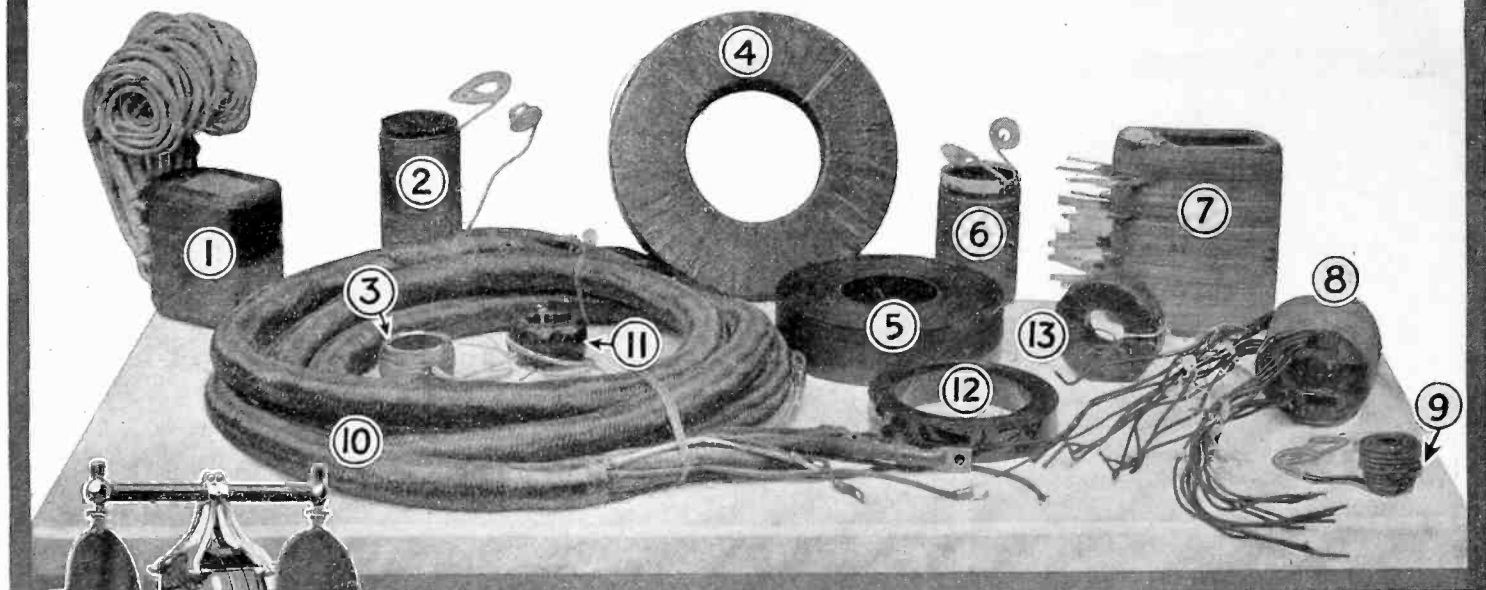

## A Complete Wire Service for Electrical Apparatus Manufacturers

In manufacturing the high grade "Keleket" X-Ray equipment, the Kelley-Koett Manufacturing Company demands wire of a great range of size, shape and kind of insulation, but of uniform quality throughout—the best that can be had. They find it very convenient to be able to meet their varied and exacting requirements from one source—the Belden Manufacturing Company.

From the fine Silkenamel wire used in the secondary coil of the 165,000 volt transformer, to the huge specially designed multiple conductor armored cable, Belden is able to supply every requirement.

No matter how varied your wire or cable requirements, Belden can supply them. Let the Belden special cable department solve your cable problems.

Write for literature and prices

**Belden Manufacturing Company**  
 2316B South Western Avenue Chicago, Illinois

### BELDEN PRODUCTS

- Beldenamel and Textile
- Magnet Wire
- Coil Windings
- Beldenmold
- (Molded Bakelite Products)
- Automotive Wires and Cables
- Airplane Assemblies
- Radio Wires, Cords and Cables
- Rubber Covered Wires
- Armored Cables
- Flexible Armature Wires
- Motor Lead Wires
- Braided and Stranded Copper Cables
- Cotton Sleaving

*Specify*  
**Belden**

# CONCENTRATED CONTROL

## DISTRIBUTION **U-RE-LITE** CENTERS

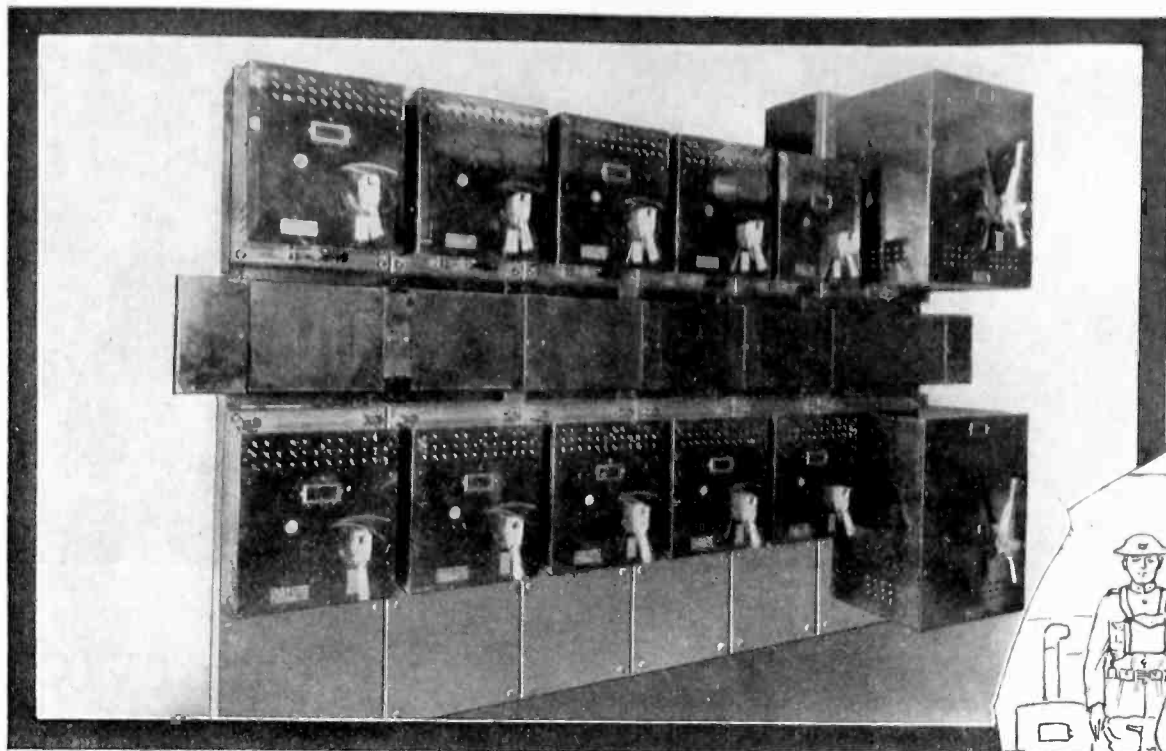

In military circles, the General Headquarters Staff directs and co-ordinates the various branches of the army. Under concentrated control, it commands at will each and every movement of the forces.

U-Re-Lite Distribution Centers—embodying this same valuable principle of CONCENTRATED CONTROL—bring within easy, arm's-length reach of the operator, full control of the electric power used throughout the building or plant.

**A**N entirely new idea of simplified power distribution—of absolute control—of perfect safety—has been realized since the introduction of U-Re-Lite Distribution Centers.

U-Re-Lite itself is the finest piece of electrical protective equipment ever devised to safeguard against “shorts,” overloading and single phasing. And placed together on one compact switchboard, a group of U-Re-Lites—controlling a group of machines or motors—becomes a “fool-proof,” trouble-free, labor-saving Distribution Center that speeds up production and cuts down overhead.

Stop—Look—Study the above illustration. It is the simplest, most convenient and economical way of protecting a group of power or lighting circuits. Rupturing capacity assured—no fuses in the line. After an overload or “short,” to restore service simply turn the handle:

*“First to the left, then to the right,  
Turn the handle, and U-RE-LITE.”*

The Hand Book of the U-Re-Lite—a 96-page book on short-circuit safety—will be mailed without charge, on request.

THE CUTTER COMPANY—Established in 1888—505 N. 19th St., PHILADELPHIA

# CUTTER

## U-RE-LITE & & & I-T-E CIRCUIT BREAKERS

Please mention the JOURNAL of the A. I. E. E. when writing to advertisers.

## Pop is just getting his bearings

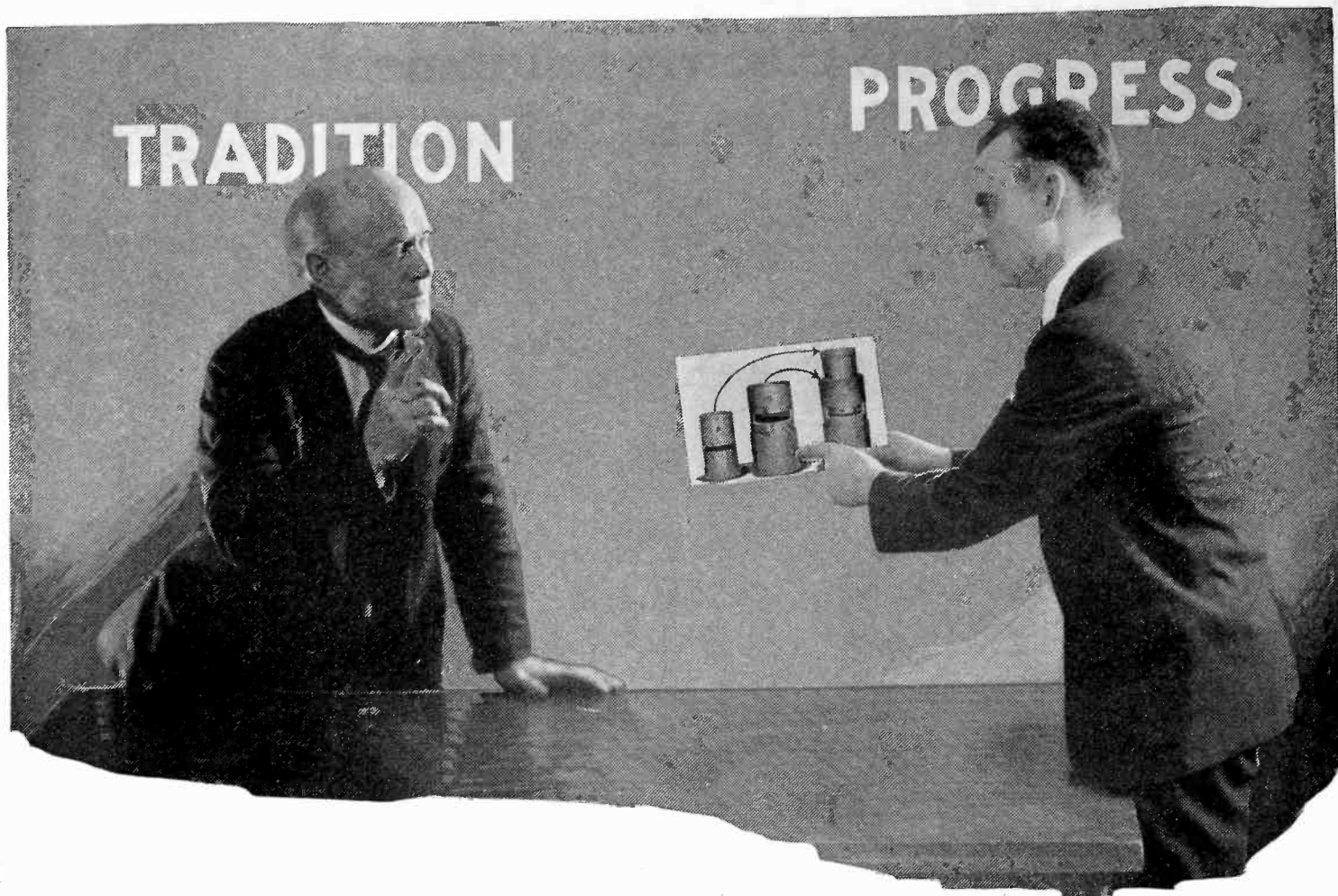

**“Say, Lad—**

they tell me out in the shop that it isn't the motors that are bad, as *you* said, but that the bearings cause all the trouble we are having. Can't you get some better bearings to save us all this repair expense?”

**“No, Pop—**

you're like the fellow who said that the egg wasn't bad—it was only the yoke that was just a lee-tle bit hatched.

Here's a picture I had taken, showing one of the bearings from the estimable motor you are standing up for.

See how nicely it fits down into the bearing from a “LINC-WELD” motor of the same rating. (Rating is a funny term . . . look into it.)

Those flapper size bearings that cause all the trouble have a bearing surface of about 4 square inches.

This amazon “LINC-WELD” bearing gives you  $7\frac{1}{4}$  square inches.

You know that the bigger the bearing, the less the trouble.

You've fallen smack against the very reason why I told you to forget your old crony motor salesman. That friendship doesn't extend as far as motor operation.

The Lincoln Electric Co., Dept. No. 21-6, Cleveland, Ohio

MA-6

*“Linc-  
Weld”*

**LINCOLN MOTOR**

Please mention the JOURNAL of the A. I. E. E. when writing to advertisers.

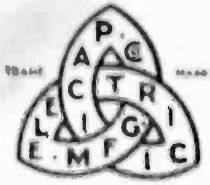

## Pacific Electric Equipment in a California Substation



Pacific Electric Type R-72, 110-kv. 400-amp. oil circuit breaker installation in the San Jose Substation, the southern terminus of the Pacific Gas and Electric Company's 110-kv. system. Each circuit breaker is equipped with a Pacific Type M.W.-2 motor wound spring actuated control mechanism provided with auxiliary hand control. This operating mechanism is so fast that on 60 cycle circuits the arc is ruptured in 4 cycles (one-fifteenth second).

The Pacific Electric Manufacturing Company manufactures complete substation structures with choke coils, switches switch controls, interlocks, motor driven controls and oil circuit breakers.

# Pacific Electric Manufacturing Co.

*"The Oldest Exclusive Manufacturers of High Voltage Switches and Circuit Breakers"*

**SAN FRANCISCO and ST. LOUIS**

5815 Third Street, San Francisco  
30 Church Street, New York  
1001 McCormick Bldg., Chicago  
Symes Bldg., Denver, Colorado  
135 High Street, Boston, Mass.  
Hoge Bldg., Seattle, Wash.

637 Michigan Trust Bldg., Grand Rapids, Mich.  
1700 Walnut Street, Philadelphia, Pa.  
Pioneer Bldg., St. Paul, Minn.  
American Trust & Savings Bldg., Birmingham, Ala.

H. W. Hellman Bldg., Los Angeles  
419 Chemical Bldg., St. Louis  
908 Allen Bldg., Dallas, Texas  
206-7 Dwight Bldg., Kansas City, Mo.  
1614 Princess Street, Pittsburgh, Pa.

Please mention the JOURNAL of the A. I. E. E. when writing to advertisers.



# 15,000 Miles of Service

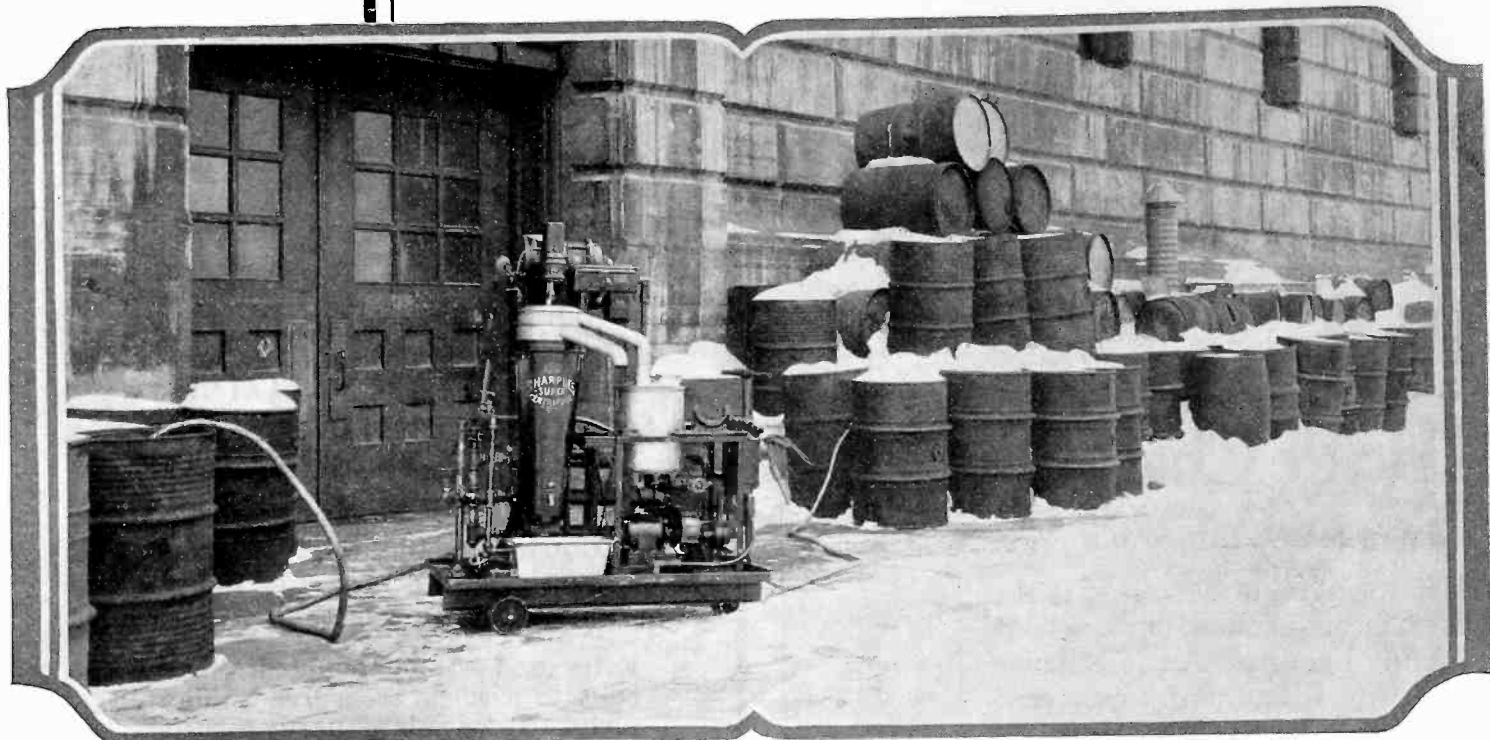

**T**HIS is the remarkable record made last year by a Sharples Portable Oil Purifier used by a large mid-western power company.

Mounted on its portable platform, this machine travelled about 15,000 miles, purifying transformer oil at the various stations and keeping the transformers at their highest operating efficiency.

Every central and sub-station—every transformer—deserves the protection of a Sharples Oil Purifier! For removing water, sludge and other dangerous impurities from Transformer and Switch Oils—and keeping them at their highest dielectric strength—no device or system can compare in actual results with the SHARPLES.

THE SHARPLES SPECIALTY COMPANY, 2324 WESTMORELAND STREET, PHILADELPHIA. Boston, New York, Pittsburgh, Chicago, Detroit, Tulsa, New Orleans, San Francisco, Los Angeles, Seattle, Toronto. London, Paris, Tokio.

Complete Sharples Bulletins on Switch and Transformer Oil Purification—with facts, figures, diagrams and illustrations—will be sent on request. Write for your copies today!

# SHARPLES

A GREAT FORCE

Please mention the JOURNAL of the A. I. E. E. when writing to advertisers.

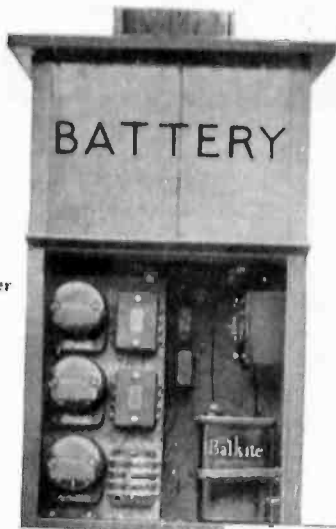

Relays and charger in box

# Balkite Trickle Charging

*for Switch Operating Batteries*

Balkite Trickle Charging is the ideal means of charging switch operating batteries. An installation made by a Southern power company is illustrated here. It consists of a relay controlled 13,200 volt motor-operated air break switch mounted on the top of the pole operated from a 12-volt storage battery charged by a Balkite Charger on trickle charge. Such an installation is very compact and economical because the entire equipment is mounted on the pole.

The Balkite Charger has unique advantages possessed by no other charger. It has no moving parts, nothing to adjust or get out of order, and requires practically no attention.

Detailed information on request.

FANSTEEL PRODUCTS CO., Inc.  
North Chicago, Illinois

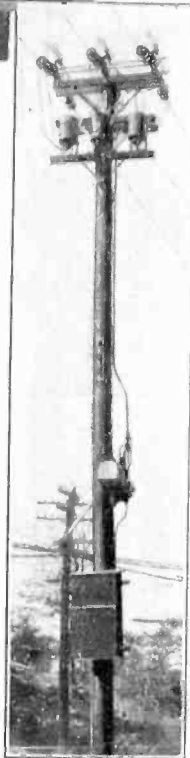

Switch-case on pole

# FANSTEEL Balkite Trickle Chargers

FANSTEEL PRODUCTS COMPANY, Inc., North Chicago, Illinois  
Gentlemen: Please send me a copy of "Balkite Trickle Charging."

Name \_\_\_\_\_

Company \_\_\_\_\_

Address \_\_\_\_\_

Position \_\_\_\_\_

A. I. E. E. - 6-27

## K-P-F POLE-TOP SWITCHES

Reduce Your Installation and Maintenance Costs

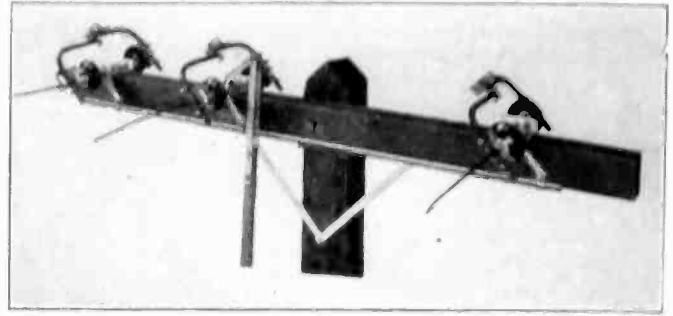

K-P-F type L-115—4500-V. Bolts to the cross-arm. Line wires can be dead-ended directly to it.

### FOR SECTIONALIZING AND DISTRIBUTING SERVICE

Manufactured For Any Voltage

K-P-F SWITCHES have established their reputation for dependability, efficiency and economy through a period of many years of actual service under varying conditions.

Extra deadends not required. Switch bolts to a single cross-arm. Shipped completely assembled—ready to install.

Bulletin #106 covers this equipment in detail

### K-P-F ELECTRIC CO.

855-859 Howard St.

San Francisco, Cal.

# DUNCAN Watthour Meters

Accurate and Dependable



Model M2.

Write for bulletins

DUNCAN ELECTRIC MFG. CO.  
Lafayette, Ind.

**Thomas Quality**  
PORCELAIN INSULATORS  
LINE HARDWARE  
WIRING PORCELAINS  
and  
Porcelain Specialties  
*An American Standard since '73*

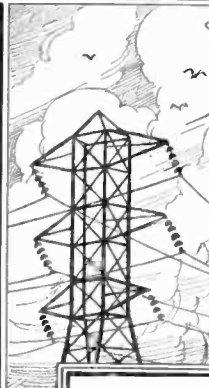

**THE R. THOMAS & SONS CO.**  
New York    East Liverpool, Ohio    Chicago  
Boston      London

Please mention the JOURNAL of the A. I. E. E. when writing to advertisers.

# RADIO TOWERS

*Designed and Erected by A B Co.*

**T**HESSE towers were designed, fabricated and erected by the American Bridge Company, for the broadcasting station of the Radio Corporation of America located at Rocky Point, Long Island, N.Y. The station consists of twelve towers 400 feet high, each having a cross-arm 150 feet long for the attachment and support of antennae cables. Towers are spaced about 1250 feet apart.

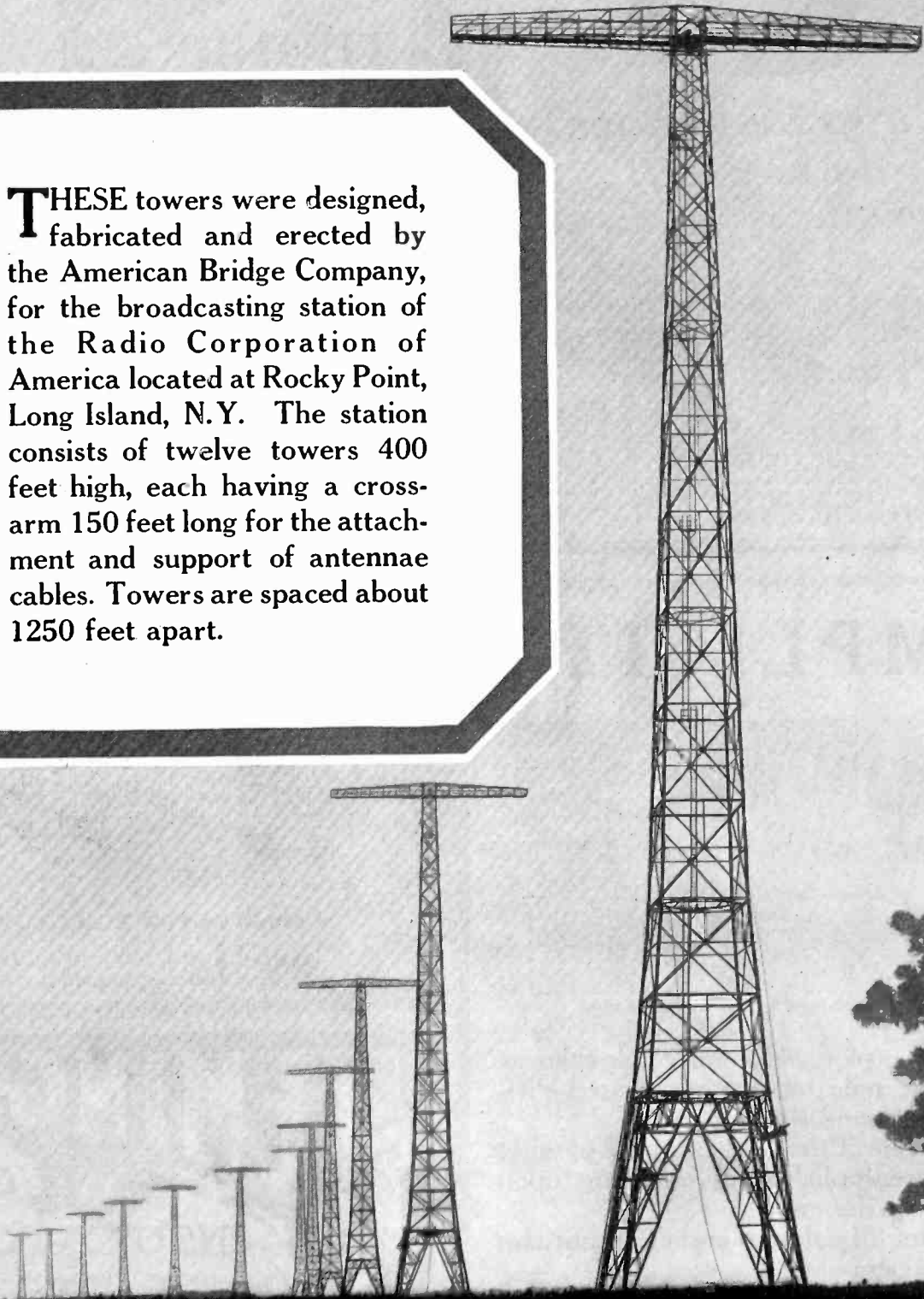

**AMERICAN BRIDGE COMPANY**  
71 BROADWAY, NEW YORK CITY  
TOWER DEPT., FRICK BLDG., PITTSBURGH, PA.



**Lapp Insulators  
do not fail!**

**LAPP INSULATOR CO., Inc.**  
LE ROY, N. Y.

*Sales Representatives*

BIRMINGHAM, ALA., Industrial Supply Co., 239 Brown-Marx Bldg.  
 BOSTON, Van Rosen Co., Statler Building  
 CHARLOTTE, N. C., J. W. Fraser & Co., Commercial Bank Bldg.  
 CHICAGO, Transelectric Co., Inc., 140 So. Dearborn St.  
 COLUMBUS, O., Engineering Merchandising Syndicate, 600 Joyce Realty Bldg.  
 DALLAS, TEX., J. K. Webb, 1521 Commerce St.  
 DENVER, The O. H. Davidson Equip. Co., 130 W. 14th Ave.  
 INDIANAPOLIS, W. D. Hamer Co., 518 Trac. Terminal Bldg.  
 KANSAS CITY, MO., Power Machinery Co., 301 Dwight Bldg.  
 LOS ANGELES, S. Herbert Lanyon, 210 Transportation Bldg.  
 MINNEAPOLIS, J. E. Sumpter Co., 515 Security Bldg.  
 NEW YORK CITY, Shield Electric Co., 149 Broadway.  
 PHILADELPHIA, Harris & Butler, Real Estate Trust Bldg.  
 PITTSBURGH, Henry N. Muller Co., 2204 First National Bank Bldg.  
 SAN ANTONIO, TEX., L. G. Bassett, 723 Navarro St.  
 SAN FRANCISCO, S. Herbert Lanyon, 509 New Call Bldg.  
 SYDNEY, AUSTRALIA, Chas. M. Terry.  
 WELLINGTON, NEW ZEALAND, A. C. Thomas.

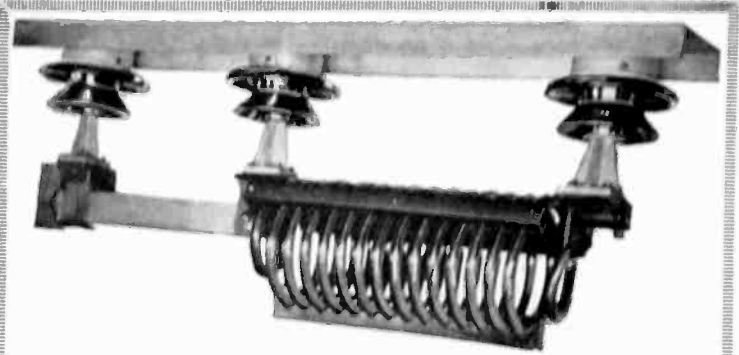

The New  
**THONER & MARTENS**

*underslung outdoor  
disconnecting switch*

THE standard T & M underslung outdoor disconnecting switch, 800 amp., is now equipped with choke coil.

Working pressure is 22,000 volts, dry flush is over 88,000 volts and wet flush over 55,000 volts.

Other T & M features are the Bolt type lock and new sleet cover.

*Write for further details*

**THONER & MARTENS**  
463 Commercial St., Boston, Mass., U. S. A.

**SIMPLICITY**

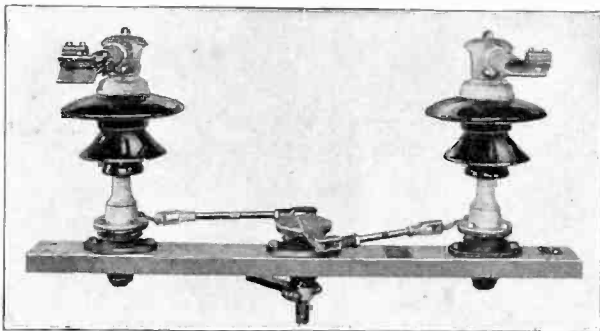

Unit Type PM-Form 2, 37 K.V., 600 Amperes

ABOVE is pictured a single pole element of our pole top gang operated PM-Form 2 disconnecting switch.

This is one of the best examples of what can be accomplished by insisting upon simplicity in design.

Made for all voltages and using but two insulators per pole.

*(Bulletins upon request.)*

**Delta-Star**  **Electric Co**

2400 Block, Fulton St. Chicago, Illinois

**MANUFACTURERS OF INSULATORS**  
For 2,200 to 220,000 Volts  
**HIGH VOLTAGE PORCELAIN**

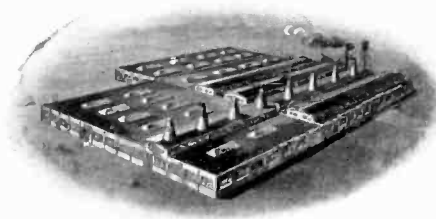

*Catalog  
on request*

**CANADIAN PORCELAIN COMPANY**  
Limited

HAMILTON — ONTARIO — CANADA  
Cable Address "PORCELAIN," Hamilton, Ontario

**HEMINGRAY**  
**GLASS**  
**INSULATORS**

The transparency of Hemingray Glass Insulators makes line inspection very simple. The lineman can tell at a glance whether the insulator is intact or not. Hemingray insulators are mechanically and dielectrically dependable, non-porous and uniform in structure. They defy moisture and age.

*Send for Bulletin No. 1.*

**HEMINGRAY GLASS COMPANY**  
Muncie, Indiana



No. 401  
Operating voltages up to  
40,000 volts

# DURABILITY

*that has stood the test of 3,500 years*

ARCHEOLOGISTS have found a glass bead whose inscription places its date around 1500 B. C. Nearly 3,500 years have in no way injured this glass! \*PYREX Power Insulators are specially developed to meet modern operating conditions. They are sturdy, acid-proof, unaffected by salt fogs or atmospheric fumes. Dept. R, Corning Glass Works, Corning, N. Y.

## PYREX

T. M. Reg. U. S. Pat. Off.

## POWER INSULATORS

*6610*

\*Trade-mark Reg. U. S. Pat. Off.

Please mention the JOURNAL of the A. I. E. E. when writing to advertisers.

# "COPPERWELD" EXHIBIT

BOOTHS 307 and 309

at the N. E. L. A. Convention in Atlantic City, June 6-10, Copperweld will have an interesting exhibit of Copperweld Messenger and Guy Wire, Overhead Ground Wire, Telephone Line Wire, Ground Rods, etc.

You are cordially invited—during your stay in Atlantic City—to visit the Copperweld Booths. Learn why Copperweld is being specified in increasing quantities for overhead line construction, by the foremost Public Utilities, who have found that

**It costs less to Prevent Rust than to endure it**

**Copperweld Steel Company**

MAIN OFFICE & MILLS—BRADDOCK P. O., RANKIN, PA.  
30 CHURCH ST., NEW YORK. 129 S. JEFFERSON ST., CHICAGO.  
403 RIALTO BLDG., SAN FRANCISCO.

In Canada: Northern Electric Co., Ltd.

# "AMERICAN BRAND"

Weatherproof Copper Wire and Cables

COST



You can buy weatherproof wire cheap, but is it worth what it costs?

"American Brand" gives you more mileage per dollar with a longer life on the line.

Get a sample and satisfy yourself.

**American Insulated Wire & Cable Co.**

954 West 21st Street, Chicago

# WIRE PRODUCTS For Varied Applications

We manufacture many types of wires, cords and cables for specific uses. Among them are:

Rubber Covered Wire—Solid Conductor, Stranded Conductor, Flexible Conductor, Extra Flexible Conductor. Lamp Cords, Reinforced Cords, Heater Cord, Brewery Cord, Canvasite Cord, Packinghouse Cord, Deck Cable, Stage Cable, Border Light Cable, Flexible Armored Cable, Elevator Lighting Cable, Elevator Operating Cable, Elevator Annunciator Cable. Switchboard Cables, Telephone Wire, Flameproof Wires and Cables, Railway Signal Wires, High Voltage Wires and Cables. Automobile Ignition Cables, Automobile Lighting Cables, Automobile Starting Cables, Automobile Charging Cables. Moving Picture Machine Cable.

**Boston Insulated Wire & Cable Co.**

Main Office and Factory:

Dorchester District Boston, Mass.  
Canadian Branch, Office and Factory, Hamilton, Ont.

# Roebbling

Electrical Wires and Cables. High in Conductivity and Reliability.

John A. Roebbling's Sons Co.  
Trenton, New Jersey



# MODELS

for

MANUFACTURING STANDARDS  
SALES DEMONSTRATION AND DISPLAY  
USE IN LITIGATION

Experimental Development under Client Supervision

**MANUFACTURERS' & INVENTORS' ELECTRIC CO.**

(Smith Building)

228 West Broadway, N. Y. City

Incorporated 1897

PATENT PEND'G

**BURNDY T-CONNECTORS**  
WILL WITHSTAND STORM AND SHOCK AND CARRY FULL CURRENT.  
INSTALLED BY SIMPLY CLAMPING BOLTS.

**BURNDY**  
IMPROVED  
**T-CONNECTOR**  
FOR TUBING AND CABLES  
**BURNDY**  
ENGINEERING CO. INC  
10 EAST 43rd STREET NEW YORK

CATALOG ON REQUEST

Please mention the JOURNAL of the A. I. E. E. when writing to advertisers.

## *Note the Dosserts*

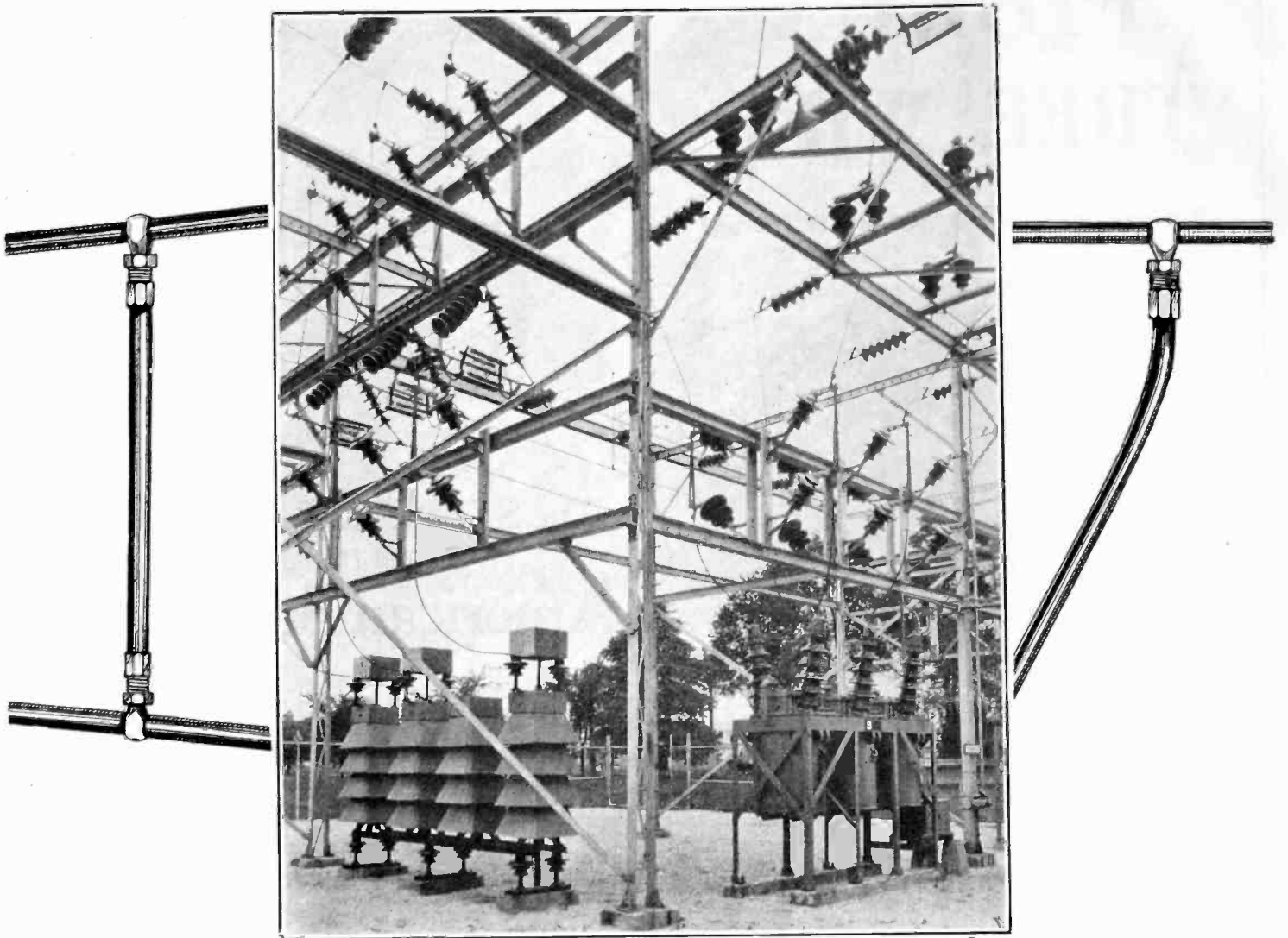

### **33,000 Volt Automatic Sub-Station of the Toledo Edison Company**

Dosserts are of course the standardized method of connections in the power plants and substations of central stations and electric railways.

The Toledo Edison Company uses Dosserts also on its 23,000 and 66,000 volt outdoor substations.

There are more than a thousand types, sizes and combinations shown in the Dossert 20th year book.

*Write for copy.*

**DOSSERT & CO. H. B. Logan, Pres. 242 West 41st St., New York**

# **DOSSERT**

## **SOLDERLESS CONNECTIONS**

Please mention the JOURNAL of the A. I. E. E. when writing to advertisers.

# FIBREX TREE WIRE

Where trees must not be trimmed



A typical Fibrex installation in New England

Where hazards are greatest - places where trees must not be trimmed and where wires are rubbed and chafed by swaying limbs - splice in a piece of Fibrex Tree Wire.

Central Stations find that Fibrex creates good will by eliminating the short circuits and swinging grounds that interfere with the maintenance of steady voltage.

Short pieces of Fibrex spliced into the line will afford ample protection where overhead lines must run through trees.

Fibrex consists of a rubber insulated copper conductor protected by successive layers of tape, tarred jute, non-metallic Fibrex armor and a wear-resisting weatherproof braid.

An immediate check-up along the line and the early installation of Fibrex at danger points will save the repair gang many annoying and expensive emergency calls.

## SIMPLEX WIRE & CABLE CO

MANUFACTURERS

201 DEVONSHIRE ST., BOSTON

CHICAGO      SAN FRANCISCO      NEW YORK  
CLEVELAND      JACKSONVILLE



Holabird & Roche, Chicago, Architects  
George A. Fuller Co., Chicago-New York, General Contractors  
J. Livingston & Co., Chicago, Electrical Contractors

## The STEVENS HOTEL, Chicago Wired Throughout with American Steel & Wire Company's Rubber Covered Wire

**T**WO million feet of rubber covered wire were used to completely wire all of the 29 floors, 3000 guest rooms, several kitchens, ballrooms, banquet and meeting rooms, hallways, reception parlors, lobbies and other parts of this magnificent new hotel recently completed on Michigan Boulevard, Chicago. Only the very finest material and the most rigid specifications were approved for this great building. The selection, therefore, of our wire to meet these demands expresses most forcefully the uniform and dependable quality of the product, and further gives striking evidence as to the standing with leading architects and contractors.

Let us send you our indexed catalog and handbook of electrical wires and cables. Estimates furnished promptly from any of our offices in all of the principal cities.

### SALES OFFICES

CHICAGO	208 So. La Salle Street	NEW YORK	20 Church Street
CLEVELAND	Rockefeller Building	BOSTON	185 Franklin Street
DETROIT	First Nat'l Bank Bldg	PITTSBURGH	First Nat'l Bank Bldg
CINCINNATI	Union Trust Building	PHILADELPHIA	Widener Building
MINNEAPOLIS-ST. PAUL		ATLANTA	101 Market Street
	Merchants Nat'l Bank Bldg	WASH. D.C.	34 Grace Street
ST. LOUIS	500 Olive Street	BALTIMORE	52 E. Charles St.
KANSAS CITY	417 Grand Avenue	BUFFALO	60 E. Canal Street
OKLAHOMA CITY	First Nat'l Bank Bldg	WILKES BARRE	Market & 4th Bldg
BIRMINGHAM	Brown Marx Bldg	SAN FRANCISCO	Market Bldg
MEMPHIS	Union and Planters Bank Bldg	LOS ANGELES	200 E. Blinnon Ave.
DALLAS	Practitioner Building	PORTLAND	6th and Alder Sts.
DENVER	First National Bank Bldg	SEATTLE	4th Ave. No. & Union St.
SALT LAKE CITY	Walker Bank Bldg		*United States Steel Products Company



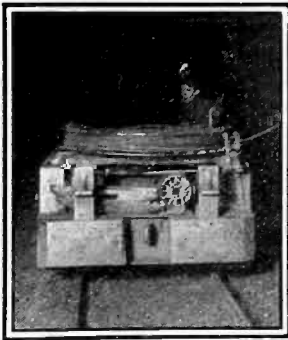

# IT PAYS

to use

## HAZARD LORECA CABLE on Mine Locomotives

The extra flexible tinned copper conductor is insulated with a generous thickness of high grade rubber compound.

Due to the patented construction, the rubber does not strip nor the braids bunch up or ravel.

Tape costs are reduced and cable life extended.

**HAZARD MFG. CO., WILKES-BARRE, PA.**

New York  
Denver

Pittsburgh  
Birmingham

Chicago  
Philadelphia

**Hazard Loreca Cable promotes efficiency**

## STANDARD

### Copper Wire — High Strength Bronze Wire — Copper Clad Steel Wire

For trolley and transmission service

Meet every service requirement, however exacting

They are rolled and drawn in our own rod and wire mills from the highest grade copper wire bars, and their superior and uniform quality is assured by a system of careful inspections and tests at different stages of manufacture. Their dependability has been demonstrated by many years of service under all sorts of operating conditions.

We have unexcelled manufacturing and shipping facilities at our several factories and, in addition, carry considerable stocks of standard materials at convenient shipping points.

*Write our nearest office about your requirements.*

### STANDARD UNDERGROUND CABLE CO.

NEW YORK	WASHINGTON	PITTSBURGH	DETROIT	SAN FRANCISCO	SEATTLE
BOSTON	PHILADELPHIA	ATLANTA	CHICAGO	ST. LOUIS	LOS ANGELES
KANSAS CITY					

FACTORIES: PERTH AMBOY, N. J.; PITTSBURGH, PA.; ST. LOUIS, MO.; EMERYVILLE, CALIF.  
FOR CANADA: STANDARD UNDERGROUND CABLE CO. OF CANADA, LIMITED, HAMILTON, ONT.



Please mention the JOURNAL of the A. I. E. E. when writing to advertisers.

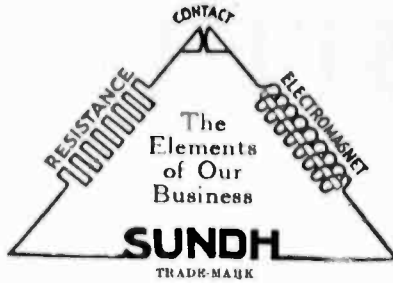

# SUNDH

Alarm, High and Low Liquid Level.....	Bulletin	Pressure Regulator Panels (See Panels, Special).	
Automatic Fire Pump Panels, Combined Hand and (See Panels, Fire Pump).....	3010-3015	Regulator, Pressure (See Pressure Regulator).	Bulletin
Automatic Starters (See Starters, Automatic).....		Regulators, Speed (See Speed Regulators).....	7250
Automatic Transfer Switches.....		Relay, Tumbler.....	7100
Brakes, Magnetic.....	5000	Remote Controlled Lighting Panels.....	
Circuit Breakers.....	9920	Remote Controlled Speed Regulators (See Speed Regulators).....	
Contactors (See Switches, Magnet).....	3800-3815	Remote Liquid Level Indicator.....	3025
Control, Machine Tool.....		Remote Switches (See Switches, Remote, also Switches, Magnet).....	
Controllers, Elevator.....	9000	Self Starters (See Starters, Automatic).....	
Elevator Controllers.....	9099	Solenoids (See Magnets).....	
Fire Pump Panels (See Panels, Fire Pump).....	9099	Solenoid Operated Valves.....	5700
Float Switches.....		Special Panels (See Panels, Special).....	
Hand and Automatic Fire Pump Panels, Combined (See Panels, Fire Pump).....	3000-3025	Speed Regulators.....	8500-8520
Hand Operated Switches.....		Starters, Automatic, A. C.....	5800-6200
Hand Starters (See Starters, Hand).....	3000	Starters, Automatic.....	5300-5350
High and Low Liquid Level Alarm Switches.....		Starters, Hand.....	8320
Indicator, Level, Liquid, Remote.....	3610-3615	Starters, Manual (See Starters, Hand).....	
Level, High and Low Liquid, Alarm Switch.....	3825	Sump Switches (See Switches, Float).....	
Level, Indicator, Remote.....	3610-3015	Switches, Float.....	3600-3620
Lighting Panels, Remote Control.....	3025	Switches, Hand Operated.....	3601
Low Levels, High and, Alarm Switches.....	7100	Switches, High and Low Liquid Level Alarm.....	3610-3615
Machine Tool Control.....	3610-3615	Switches, Magnet, A. C.....	7000
Magnetic Brakes (See Brakes, Magnetic).....	9000	Switches, Magnet, D. C.....	7500
Magnet Operated Valves.....		Switches, Remote (See also Switches, Magnet).....	7200-7250
Magnet Operated Valves.....	5700	Switches, Sump (See Switches, Float).....	
Magnet Switches, A. C.....	7000	Switches, Tank (See Switches Float).....	
Magnet Switches, D. C.....	7500	Switches, Time.....	6900
Magnets.....	6500	Switches, Transfer, Automatic.....	5000
Manual Fire Pump Panels (See Panels, Fire Pump).....		Tank Switches (See Switches, Float).....	
Manual Starters (See Starters, Hand).....		Terms.....	300
Panels, Fire Pump.....		Time Switches.....	6900
Panels, Lighting, Remote Control.....	8800-8830	Transfer Switches, Automatic.....	5600
Panels, Pressure Regulator (See Pressure Regulator, also Panels, Special).....	7100	Tumbler Relay.....	7250
Panels, Special.....		Valve Control.....	5700
Pressure Regulator, Gauge Type.....	5400-5423	Valve, Magnet Operated.....	5700
	4900-4902	Valve, Remote Controlled.....	5700

Write for Catalog

SUNDH ELECTRIC COMPANY, 4 Ave. C, NEWARK, N. J.

Branch Offices: Chicago, New York

Sales Representatives:

Boston  
Cincinnati

Cleveland  
Detroit

Minneapolis  
Los Angeles

Philadelphia  
New Orleans

St. Louis  
Pittsburgh

Baltimore  
San Francisco

Buffalo  
Toronto, Can.



## SAUTER Electric TIME SWITCHES

These "astronomic" time switches are carried in stock for circuits of  
 250 Volts: 10, 25, 40, 60, 100, 200, 300 Amps.  
 4600 Volts: 25 and 50 Amps.  
 8000 Volts: 25 and 50 Amps.

Ask for new catalog S-1.

R. W. CRAMER & COMPANY, INC.  
 136 Liberty St. New York City

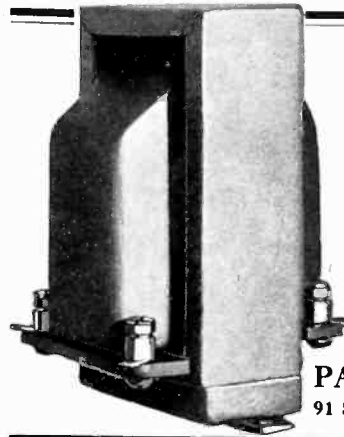

DESIGNED by audio frequency amplification specialists for present day requirements.

- flat curve without distortion over entire scale.
- designed for power amplifying circuits.

PACENT ELECTRIC CO., INC.  
 91 SEVENTH AVENUE, NEW YORK CITY

## PACENT Transformers

# Pittsburgh Transformer Company

Largest Manufacturers of Transformers exclusively in the United States

Pittsburgh, Pennsylvania

## A Needed Power Recorder For Loads of All Kinds

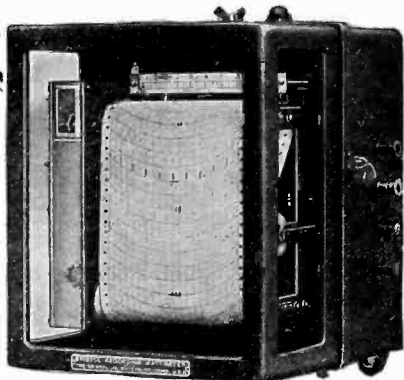

Bristol's Recording Wattmeter

is important, for it shows the load fluctuations from hour to hour and from day to day, supplying data which is of great assistance in securing uniform operating conditions.

Bristol's Recording Wattmeters are available for D. C. or A. C., and for single, two- or three-phase current. Both round and strip chart models can be furnished, in either switch-board or portable models.

A general rugged simplicity characterizes Bristol's Recording Wattmeters; with a marked absence of delicate or complicated parts, insuring long and active service with nothing but the few routine attentions.

Full information and bulletins will be sent on request.

The Bristol Company Waterbury, Connecticut  
 FOR 36 YEARS ASK ANY Technical Engineer MAKERS OF  
 BRISTOL'S RECORDING INSTRUMENTS

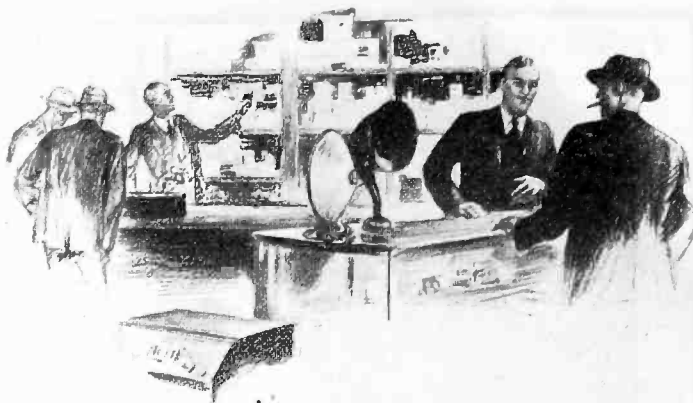

## The expert can recommend Faradon equipped sets— with confidence...

Faradon value is the result of twenty years of manufacturing to high standards.

It is logical that makers of fine equipment include Faradon Capacitors in their specifications.

Most experts know from personal experience that the equipment of Faradon quality results in satisfactory, long-lived service.

WIRELESS SPECIALTY APPARATUS CO.  
 Jamaica Plain, Boston, Mass., U. S. A.  
 Established 1907

# Faradon

951

## When You Buy Condensers

When you buy condensers—what do you demand?

Accuracy! Low Power Factor!  
 Permanent Capacity!

Dubilier condensers meet these requirements. They are used in practically all transmitting stations and U. S. Government installations.

Dubilier coupling condensers for power line telephony are supreme.

Dubilier consulting engineers are always at your service—they can help you too.

4377 Bronx Blvd., New York, N. Y.

# Dubilier

CONDENSER AND RADIO CORPORATION

## UNIQUE THIN LEAD COLORED PENCIL

"UNIQUE" THIN LEAD Colored Wooden Pencil—has the best and most usable *thinnest* lead of utmost strength and durability. Can be sharpened in a pencil sharpener to a needlepoint.

12 Colors  
 \$1.00 per dozen

Make fine lines in color for

figuring  
 checking  
 understoring  
 blueprints  
 charting, etc.

The 12 colors enable executives to have their own symbol.

- |             |                 |
|-------------|-----------------|
| No.         | No.             |
| Blue . 1206 | Orange 1214     |
| Red . 1207  | White . 1215    |
| Green 1208  | Lt. Blue . 1216 |
| Yellow 1209 | Pink . 1217     |
| Purple 1210 | Lt. Green 1218  |
| Brown 1212  | Maroon 1219     |

At all dealers, or write direct  
 AMERICAN LEAD PENCIL CO., 204 Fifth Ave., New York  
 Makers of the famous VENUS Pencils





## Here's a new starter!

Completely oil-immersed  
Dust tight—Gas tight—Weatherproof

*Write for complete details of this new across-the-line starter.*

# ROWAN CONTROL

THE ROWAN CONTROLLER CO., BALTIMORE, MD.

# VENUS PENCIL

*The largest selling Quality Pencil in the World*



EVERY VENUS PENCIL writes its own record of perfection. The 17 degrees meet every condition of superlative work, from the hair line of a dimensional projection to the careful shading of a sketch.

**17 Black Degrees—3 Copying**  
 For bold, heavy lines . . . 6B-5B-4B-3B  
 For writing, sketching . . . 2B-B-HB-F-H  
 For clean, fine lines . . . 2H-3H-4H-5H-6H  
 For delicate, thin lines . . . 7H-8H-9H

Plain Ends, per doz. . . \$1.00  
 Rubber Ends, per doz. . . 1.20

### UNIQUE THIN LEAD COLORED PENCILS

Make fine lines for figuring, checking, sketching, blueprints, etc.

Blue	Purple	Pink
Red	Brown	Lt. Blue
Green	Orange	Lt. Green
White	Yellow	Maroon

*\$1.00 per doz.*

American Lead Pencil Co.  
 204 Fifth Avenue New York

## Star Ball Bearing Motors

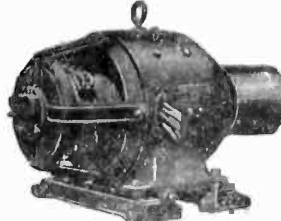

For Hard Usage

—

A. C. and D. C.

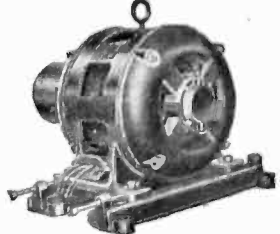

Complete line of standard motors and generators, all sizes up to 75 h. p. and 50 kw. respectively.

*Our Engineering Department at your service for all special applications*

### STAR ELECTRIC MOTOR CO.

NEWARK, NEW JERSEY

## Sturtevant Electric Motors

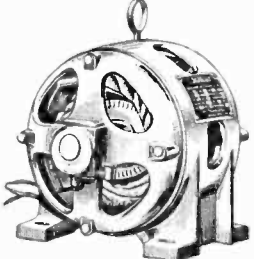

—A. C. and D. C.; single and polyphase—built in sizes from small fractional to 250 horse-power—designed to operate under a constant full load where uninterrupted service is demanded.

### B. F. STURTEVANT COMPANY

HYDE PARK, BOSTON, MASS.



### CONTROLEAD TERMINAL BLOCKS WITH INTERCHANGEABLE SWITCH PARTS

*Sample and Bulletin furnished on request*

## BURKE ELECTRIC CO., ERIE, PA.

Please mention the JOURNAL of the A. I. E. E. when writing to advertisers.

# Announcing . . . The NEW WESTON 2" and 3 1/4" Diameter

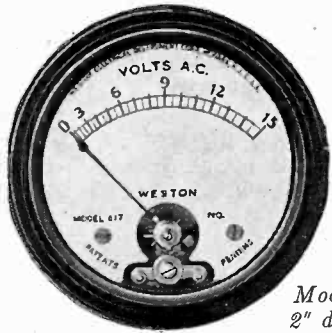

Model 517—  
2" diameter.

## A. C. Panel Instruments

IT is no longer necessary to plan your small A. C. panels in terms of large instruments in order to secure a high degree of operating economy and performance.

Miniature but reliable instruments are now available which can be used to solve your small panel problems—instruments that are accurate on any commercial frequency, that have an exceptionally high resistance with a low power consumption. Moreover they are moderately priced.

These instruments are made as Voltmeters, Ammeters and Milliammeters in both 2" and 3 1/4" sizes with flush-style cases for panel mounting.

There is no substitute for Weston quality and these new instruments meet every rigorous Weston specification.

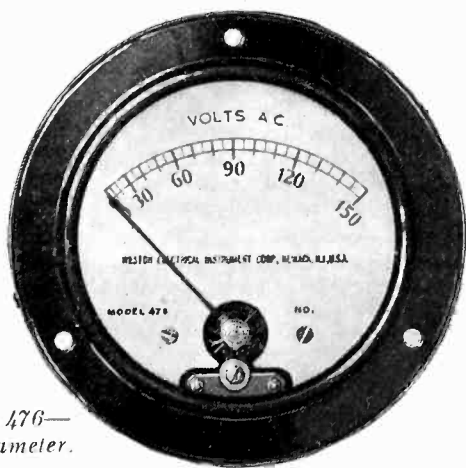

Model 476—  
3 1/4" diameter.

WESTON ELECTRICAL INSTRUMENT CORPORATION

48 Weston Avenue, Newark, N. J.



### MARTINDALE <sup>MOTOR</sup> MAINTENANCE EQUIPMENT

#### Martindale Commutator Slotting Saws

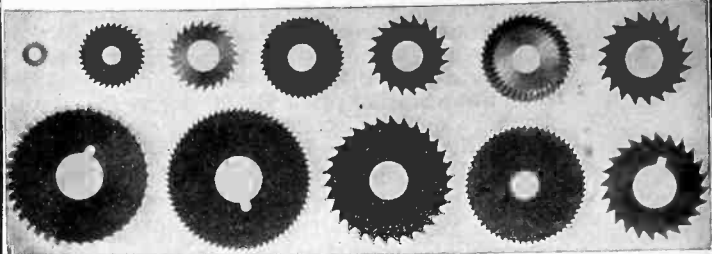

Any Size — Any Style  
For "U" Shaped Slots—  
—For "V" Shaped Slots  
Fast Clean Cutting — Long Life  
Free Samples and Prices on Application

#### Martindale Insulation Meter

Range: 200 Ohms to 100 Megohms

Low Cost—Instantaneous Readings

Fully Guaranteed

Wide Range—

Accurate Results

Price: Only \$97.50—

Shipped on Approval

(Weight: Only 11 pounds)



#### Wiggington Voltage Tester

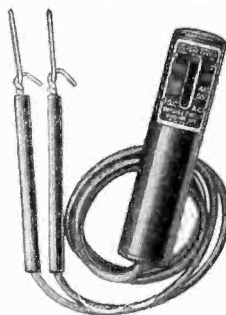

Registers Approximate Voltage and whether A.C. or D.C. A test lamp may be burned out and indicate a dead line when it is alive. A 110 volt test lamp accidentally placed across a 440 volt line may blow up in the operator's face.

Light and Small

May be conveniently carried in the pocket. *More than 60,000 in use.*

Price: \$6.00—Shipped on Approval

MARTINDALE ELECTRIC CO.  
1260 West 4th St., Cleveland, O.

Please send me your New No. 8 Catalog, containing 32 pages of Motor Maintenance Equipment.

Name and Title.....

Company.....

Street Address.....

City and State.....

26-6-27

### MARTINDALE <sup>MOTOR</sup> MAINTENANCE EQUIPMENT

Please mention the JOURNAL of the A. I. E. E. when writing to advertisers.

## A. I. E. E. PUBLICATIONS

### JOURNAL. Published monthly.

An engineering periodical containing in full or in abstract engineering and theoretical papers and discussions as presented before meetings of the Institute and its Sections and Branches; descriptions of new developments characterized by notable advances, and items relating to the activities of the Institute and other organizations.

Subscription price \$10.00 per year. Agents, publishers and dealers are allowed 20 per cent discount; a special discount of 50 per cent is allowed on single subscriptions received directly from college or public libraries. Postage to Canada on annual subscription \$0.50 additional, and to foreign countries, \$1.00. (Postage should not be included when computing discounts).

**JOURNAL BINDERS.** A loose-leaf binder, especially designed for the JOURNAL of the A. I. E. E. is now available. The new binder is attractively finished in a long-wearing, processed material, resembling brown leather. From one to six copies of the JOURNAL can be inserted. The name of the publication is embossed in gold on the front cover and backbone. The binders are sold in sets of two at \$2.25; or \$1.25 for one.

### TRANSACTIONS. Published annually.

Contains such of the technical papers and reports published by the Institute in the JOURNAL and elsewhere as are selected and authorized by the Publication Committee; also the discussions on the technical papers. The TRANSACTIONS form a permanent record of the progress of electrical engineering. Subscription price (to Institute members only) \$2.00 per year.

Current volume may be purchased by non-members at \$10.00 per year in either paper or cloth binding. (Prices for half morocco bound copies furnished on request.)

Available volumes of the TRANSACTIONS published prior to 1921 may be obtained at reduced prices. The volumes in stock and prices will be supplied upon request.

Discounts allowed on the current volume are as follows: 20 per cent to publishers and subscription agents 50 per cent to college and public libraries upon direct subscription to Institute headquarters.

**INDEX TO TRANSACTIONS.** Published every ten years. Vol. III of the TRANSACTIONS Index (Jan. 1, 1911 to Jan. 1, 1922) is a practical bibliography (168 pp.) of all A. I. E. E. papers and discussions printed during the period 1911-1922. Price to members and non-members \$2.00, with dealers' discount of 20 per cent.

### SEPARATE PAPERS AND DISCUSSIONS.

Most of the recent papers and discussions contained in the TRANSACTIONS can be furnished separately at the following prices: Single copies of any paper, usually with discussion, \$0.50. Five or more copies of any paper, each \$0.40.

A discount of 20 per cent to publishers and subscription agents; 50 per cent is allowed from the above prices to Institute members and college and public libraries.

### A. I. E. E. STANDARDS.

The work of revision of the A. I. E. E. Standards which has been in progress for several years has now reached a stage where a large number of sections of the Standards have been approved by the Board of Directors and are available in pamphlet form, as follows:

1—General Principles Upon Which Temperature Limits are Based in the Rating of Electrical Machinery, (.20); 5—Direct-Current Generators and Motors and Direct-Current Commutator Machines in General, (.40); 7—Alternators, Synchronous Motors and Synchronous Machines in General, (.40); 8—Synchronous Converters, (.40); 9—Induction Motors and Induction Machines in General, (.40); 10—Direct-Current and Alternating-Current Fractional Horse Power Motors, (.30); 11—Railway Motors, (.30); 13—Transformers, Induction Regulators and Reactors, (.40); 14—Instrument Transformers, (.30); 15—Industrial Control Apparatus, (.40); 16—Railway Control and Mine Locomotive Control Apparatus, (.40); 19—Oil Circuit Breakers, (.30); 22—Disconnecting and Horn Gap Switches, (.30); 30—Wires and Cables, (.40); 33—Electrical Measuring Instruments, (.30); 34—Telegraphy and Telephony, (.30); 36—Storage Batteries, (.20); 37—Illumination, (.30); 38—Electric Arc Welding Apparatus, (.40); 39—Electric Resistance Welding Apparatus, (.30); 41—Insulators, (.30); 42—Symbols for Electrical Equipment of Buildings, (.20).

A discount of 50% is allowed to Institute members. Numbers of the Standards Sections should be given when ordering.

**STANDARDS BINDERS.** The various sections of the Standards can be kept in bound form with the practical binder which has been designed for this purpose. Capacity of the binder is from 10 to 30 sections or pamphlets. Finished in brown fabrikoid with imprint on stiff back. Price \$1.75.

### YEAR BOOK OF THE A. I. E. E.

A directory, published annually in March, of the membership of the A. I. E. E. Gives in alphabetical order, the names, occupations and addresses of all members. The membership is also listed in geographical order. The Year Book contains general information regarding the scope and activities of the Institute, including the Constitution and By-Laws, lists of Sections and Branches, the various committees, governing body, etc. Single copies will be supplied to members without charge upon application.

**American Institute of Electrical Engineers**  
33 West Thirty-ninth Street, New York, N. Y.

**30** TIMES AS MUCH ELECTRICAL ENERGY  
IS REQUIRED TO DEPOSIT

# CHROMIUM

AS IS NECESSARY TO DEPOSIT

# NICKEL

OVER THE SAME SURFACE

TO THE SAME THICKNESS

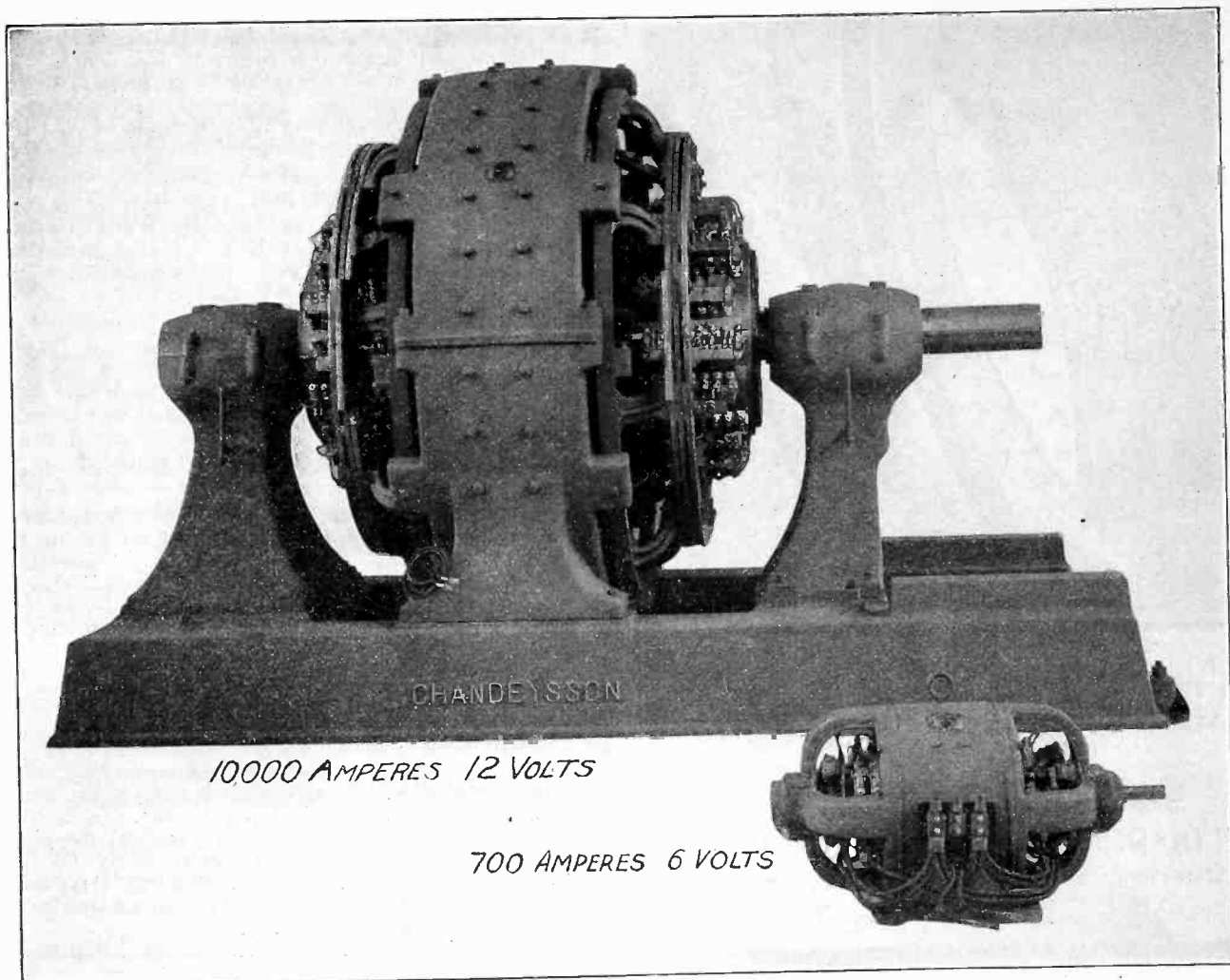

INCOMPARABLE **EFFICIENCY** ABSOLUTE **RELIABILITY**

**12 VOLTS FROM EACH** COMMUTATOR

COMPLETE **STANDARDIZED** LINE

**25 AMPERES 12 VOLTS 300 WATTS**  
TO

**25,000 AMPERES 12 VOLTS 300,000 WATTS**

CHANDEYSSON ELECTRIC CO., St. Louis, U. S. A.

Please mention the JOURNAL of the A. I. E. E. when writing to advertisers.

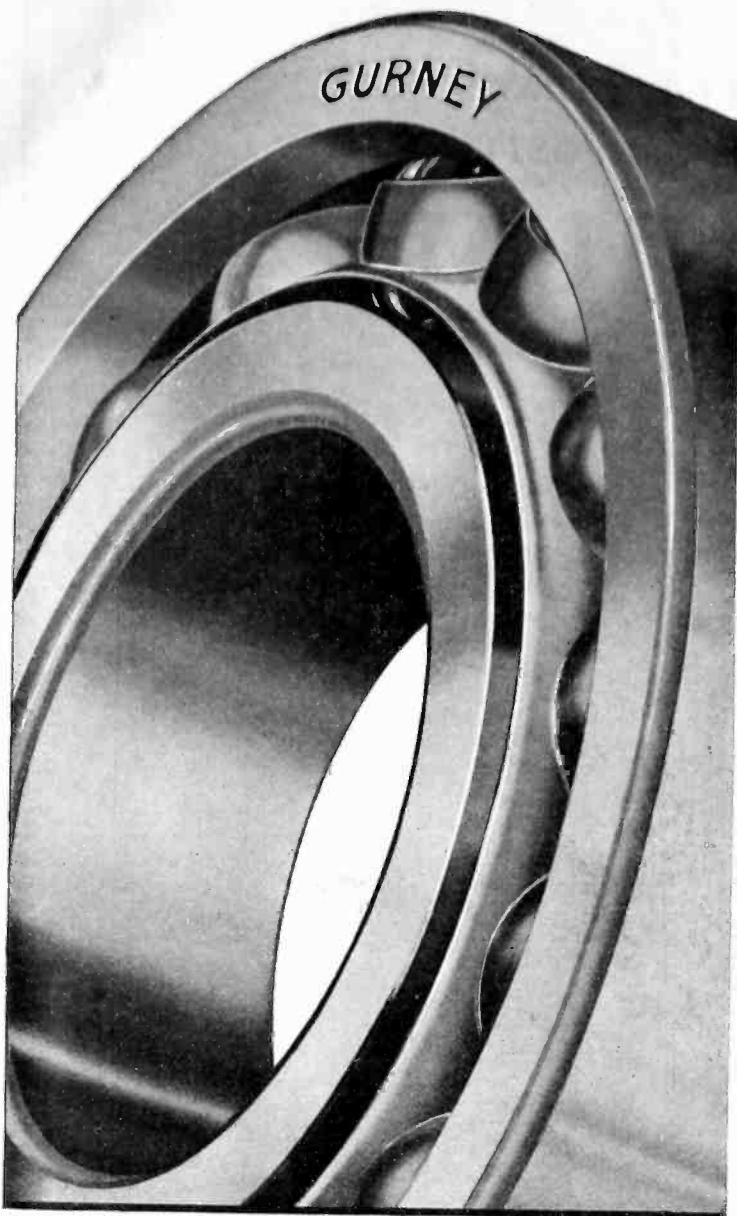

More and Larger Balls  
Greater Capacity - Longer Life

Send for Data Sheets

MARLIN-ROCKWELL CORPORATION  
Gurney Ball Bearing Division  
JAMESTOWN, N. Y. 18380

**GURNEY**  
**BALL BEARINGS**

## CLASSIFIED ADVERTISEMENTS

**RATES.** Fifty cents per line; minimum charge based on use of five lines; maximum space cannot exceed twenty lines.

Copy should be received by the 15th of the month, for insertion in the following issue.

**TECHNICAL TRANSLATIONS** by engineering graduate of American and European universities, handling highly specialized translations for largest manufacturers of electrical and mechanical equipment in the United States. Extreme accuracy and reliability are offered to manufacturers through this technical service. Adolph Luque, 150 Nassau Street, New York.

**WANTED:** Salesman to handle high grade technical product manufactured by old established firm. Field: Transmission line operating companies. Give full particulars regarding experience, personality and education. Address Box 127, JOURNAL of A. I. E. E., 33 West 39th St., New York.

**FOR SALE:** A. I. E. E. TRANSACTIONS. A member wishes to dispose of his complete set of the yearly bound volumes of the A. I. E. E. Selling price \$250.00, including shipping charges. Address the A. I. E. E., 33 West 39th Street, New York.

**WANTED:** Copies of the October and December (1926) issues of the JOURNAL of the A. I. E. E. Wrappers returning these copies should bear the sender's name and address. Twenty-five cents will be paid for each copy received. Address American Institute of Electrical Engineers, 33 West 39th Street, New York.

**BINDERS** for the JOURNAL of the A. I. E. E. A loose cover binder, especially designed for the JOURNAL, is now available. The new binder is exceptionally pleasing in appearance, durable and handy. One to six copies of the JOURNAL can be inserted. Covers of long-wearing processed material, closely resembling rich brown leather. Remittance of \$2.25 for a set of two, (or \$1.25 for one) should accompany order. A. I. E. E., 33 West 39th Street, New York.

**POPULAR RESEARCH NARRATIVES** are proving useful 'round the world in many offices, schools and laboratories. They are interesting home reading, too. Two little books, just pocket size. In each book 50 short stories of research, invention, discovery—footprints of progress. Introductions by Dr. E. E. Slosson and Prof. M. I. Pupin. Only \$1.50 for the two volumes, postpaid. Engineering Foundation, 29 West 39th Street, New York, N. Y.

### Engineering Societies Library

A reference library for engineers—contains 150,000 volumes—receives over 1,300 technical journals and periodicals on all branches of engineering.

Searches are made upon engineering subjects, translations from foreign publications, photostats made, etc.

Books may be borrowed by members of the A. I. E. E. For information address, The Engineering Societies Library, 33 West 39th St., New York.

At Your Service



**Olsen-Carwen  
Static-  
Dynamic  
Balancing  
Machine**

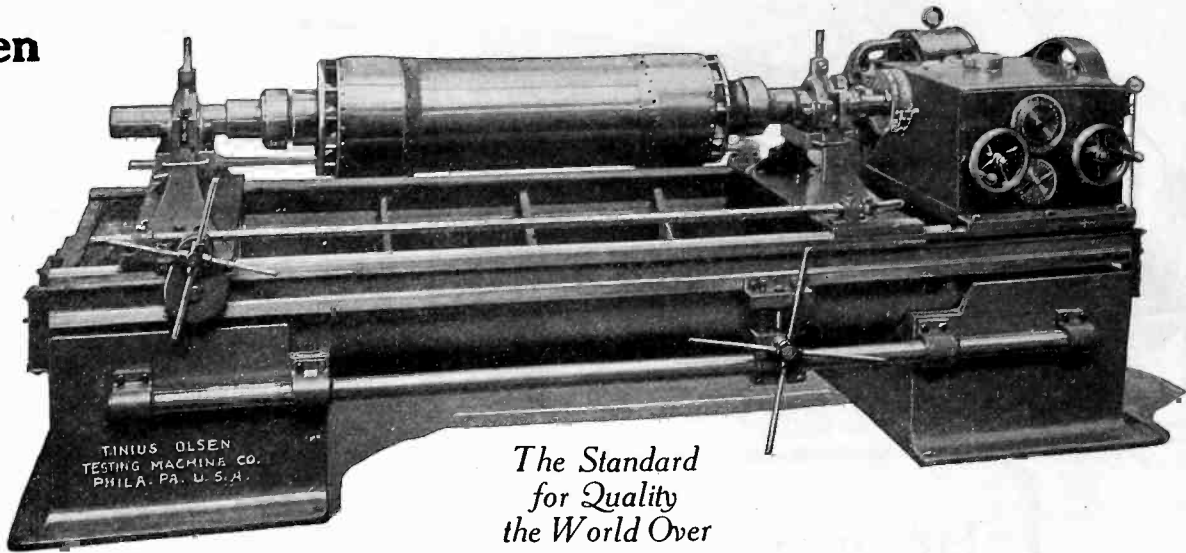

*The Standard  
for Quality  
the World Over*

The OLSEN-CARWEN indicates unbalance both statically and dynamically in ounce inches on indicating dials, together with the angle or plane of unbalance; and also indicates the axial rotation of the static unbalance along the length of the rotor.

The OLSEN-CARWEN is built in many sizes to take in all types and weights of rotors.

Special OLSEN-CARWEN machines for balancing Armatures, Turbine Rotors, Crankshafts, Flywheels, Pulleys, Propeller Shafts, Cutter-Heads, etc.

**To ELIMINATE VIBRATION and secure perfect balance with speed and economy use THE OLSEN-CARWEN.**

*Sole Manufacturers*

**TINIUS OLSEN TESTING MACHINE COMPANY**  
500 North Twelfth Street, PHILADELPHIA, PA., U. S. A.

Trade "ESCO" Mark

**ELECTRIC SPECIALTY CO.**

Engineers and Manufacturers

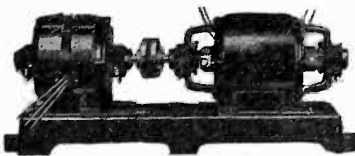

DESIGN —  
DEVELOP —  
PRODUCE —

Small Motors, Generators, Dynamotors,  
Motor Generators, Rotary Converters, Etc.

FOR SPECIAL PURPOSES—Send Us Your Problems

222 South Street, STAMFORD, CONN., U.S.A.

Prominent manufacturer is desirous of obtaining new electrical devices for manufacturing and marketing. Compensation for accepted items will be paid on a royalty basis or outright purchase arrangement if desired. Submit full particulars in strictest confidence to Box 126, JOURNAL of A. I. E. E., 33 West 39th St., New York.

**THE  
PIONEER MANUFACTURER  
OF  
Interpole & Ball Bearing  
Motors**

1/2 to 1000 H. P. D. C. and A. C.

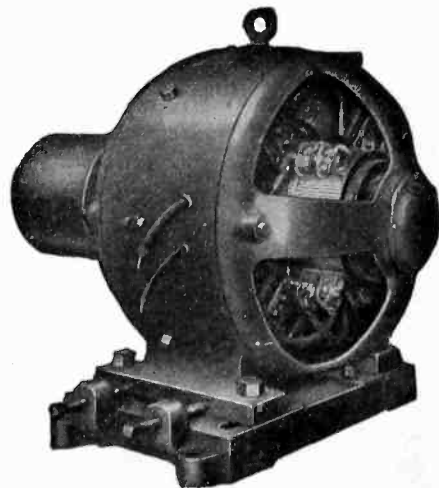

Type "S" Ball Bearing Motor  
with base and pulley

**ELECTRO DYNAMIC COMPANY**

Established 1880

BAYONNE, N. J.

Sales Offices in Principal Cities

Please mention the JOURNAL of the A. I. E. E. when writing to advertisers.



He may never need all the reserve of an extra high-powered car any more than you may need all the "25% Extra Life" of an SRB Ball Bearing, but—Important! It's there to be called upon.

*Extra SRB years of service cost no more*

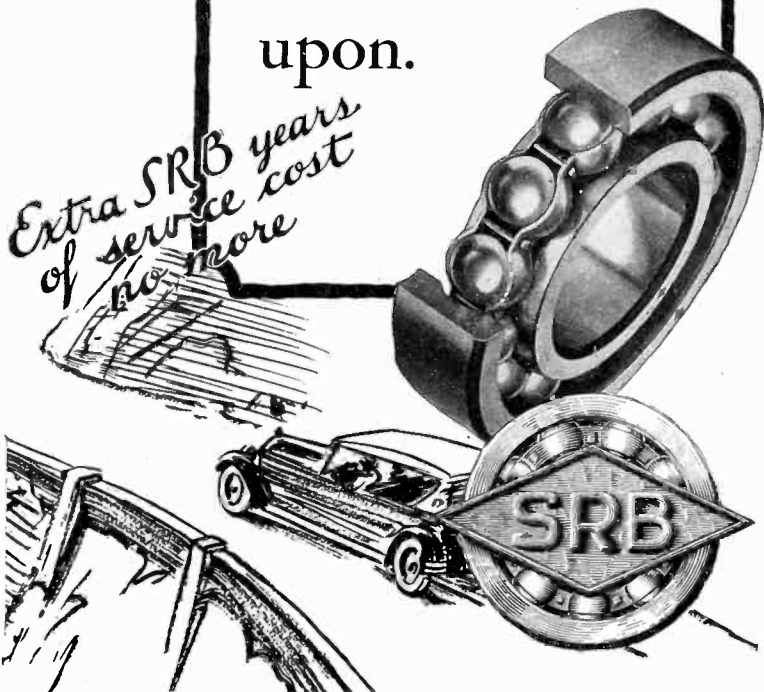

Standard Steel and Bearings Incorporated  
Plairville Connecticut

USE SRB BALL BEARINGS—*First!*  
—they'll last

Please mention the JOURNAL of the A. I. E. E. when writing to advertisers.



# LAVA INSULATORS

Lava, because of its properties, is the material best adapted for the manufacture of insulators that are required in the most intricate, electrical appliances.

AMERICAN LAVA CORPORATION  
27-67 Williamson Street  
Chattanooga Tennessee  
*Manufacturers of Heat Resistant Insulators*

NATIONAL VULCANIZED FIBRE

SHEETS  
RODS  
TUBES  
SHAPES

*Graded to your requirements*

*Paper base  
Canvas base*

PHENOLITE  
Laminated BAKELITE

SHEETS  
RODS  
TUBES  
SHAPES

PEERLESS INSULATION

NATIONAL VULCANIZED FIBRE CO.  
WILMINGTON DEL., U. S. A.  
*Offices in principal cities*

## Y-26 High-Heat Mica Plate

For High Temperature Insulation

Possesses all the advantages of natural mica for insulating heating appliances. Is more economical, particularly when used in the larger units.

Supplied in sheets up to 30" x 42", in thicknesses of ten mils or over. Can be cut or punched to any form.

Send for samples and prices.



NEW ENGLAND MICA CO.  
Waltham 54, Mass.

New York Office — 220 Broadway

ALL FORMS OF MICA FOR ELECTRICAL PURPOSES

# I-N BOARD West Virginia Fibre Board

*For Electrical Insulation*

**Tested and approved by the Underwriters' Laboratories.**

**High tensile and dielectric strength. Used successfully by many of the large electrical manufacturers.**

**A decided factor for economy.**

*Pulp Products Department*

**West Virginia  
Pulp & Paper Company**

200 Fifth Avenue, New York, N. Y.  
505 Dime Bank Bldg. Detroit, Mich. 732 Sherman Street Chicago, Ill.  
503 Market Street, San Francisco, Cal.

## "IRVINGTON" PRODUCTS

Black and Yellow

Varnished Cambric Varnished Paper  
Varnished Silk  
Flexible Varnished Tubing  
Insulating Varnishes and Compounds  
"Cellulak" Tubes and Sheets

**IRVINGTON VARNISH & INSULATOR Co.**  
Irvington, New Jersey.

*Sales Representatives*

Mitchell-Rand Mfg. Co., New York A. L. Gillies, Toronto Prenter Brothers, Inc., Chicago  
E. M. Wolcott, Rochester Consumer's Rubber Co., Cleveland White Supply Co., St. Louis  
I. W. Levine, Montreal Martin Woodard, Seattle Clapp & La Moree, Los Angeles

## TRUMBULL

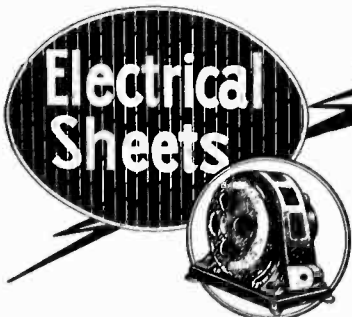

for years have stood the most exacting tests of scores of the largest motor, dynamo, generator, and radio builders in the United States.

Our Engineering Department is at your service. Write us concerning your requirements.

**THE TRUMBULL STEEL COMPANY**  
WARREN Mills, Laboratories and General Offices OHIO

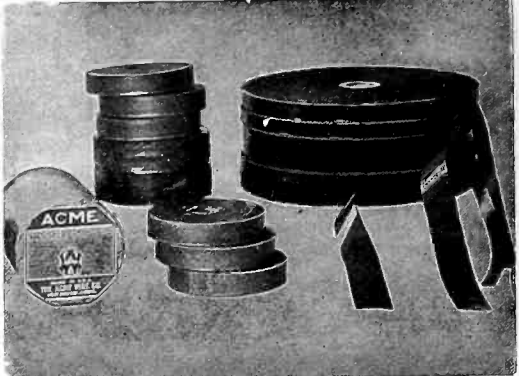
## ACME

### Varnished Insulations

### Electrically and

### Physically Tested\*

*for*

- DIELECTRIC STRENGTH
- DIELECTRIC CONSTANT
- DIELECTRIC LOSS
- INSULATION RESISTANCE
- POWER FACTOR
- FLEXIBILITY
- RESISTANCE TO TEAR
- TENSILE STRENGTH
- EFFECT OF HEAT
- RESISTANCE TO OILS
- RESISTANCE TO IMPREG-  
NATING COMPOUNDS

[\*A. S. T. M. Tests are followed in all Acme tests of raw materials and finished products.]

Acme Varnished Insulations are furnished in tape form to meet specification. Furnished in widths of 1/4 inch and wider; and in rolls of continuous lengths without splices up to 225 lineal yards. Special finishes furnished on order. Write for Catalog 3-A, telling the story of Acme Varnished Insulations.

## ACME WIRE PRODUCTS

The Acme Wire Co., New Haven, Conn.

*Branches at*

New York, 62 Vanderbilt Ave. Chicago, 427 West Erie Street  
Boston, 80 Federal Street Cleveland, Guardian Bldg.

# PROFESSIONAL ENGINEERING DIRECTORY

For Consultants in the Fields of Engineering, and Related Arts and Sciences

**AMBURSEN DAMS**  
Hydroelectric Developments  
Water Supply and Irrigation Dams  
**DAMS ON DIFFICULT FOUNDATIONS**  
**AMBURSEN CONSTRUCTION CO.**  
Incorporated  
Grand Central Terminal, New York  
Kansas City, Mo. Atlanta, Ga.

**DAY & ZIMMERMANN, Inc.**  
Engineers  
Power Plants, Sub-Stations,  
Transmission Lines, Industrial Plants  
Examinations and Reports, Valuations,  
Management of Public Utilities  
1600 WALNUT ST., PHILADELPHIA  
New York Chicago

**HOOSIER ENGINEERING CO.**  
Erectors of  
Transmission Lines and Substations  
325 South New Jersey Street  
INDIANAPOLIS INDIANA

**W. S. BARSTOW & COMPANY**  
Incorporated  
Financial and Operating  
Managers of  
Public Utilities  
50 Pine Street New York

**DAVID V. FENNESSY**  
Consulting Power Engineer  
MILLS BUILDING EL PASO, TEXAS

Dugald C. Jackson  
Edward L. Moreland  
**JACKSON & MORELAND**  
CONSULTING ENGINEERS  
31 St. James Ave. Boston, Mass.

**BATTEY & KIPP**  
Incorporated  
ENGINEERS  
Complete Industrial Plants  
Power Plants & Electrical Installations  
Engineering Reports, Analyses & Appraisals  
231 South LaSalle Street CHICAGO

**FORD, BACON & DAVIS**  
Incorporated  
ENGINEERS  
115 Broadway, New York  
Philadelphia Chicago San Francisco

**E. S. LINCOLN**  
Consulting Electrical Engineer  
Designs Investigations Reports  
Electrical Research Laboratory  
Graybar Building  
420 Lexington Avenue NEW YORK

**BLACK & VEATCH**  
Consulting Engineers  
Water, Steam and Electric Power Investiga-  
tions, Design, Supervision of Construction,  
Valuation and Tests.  
Mutual Building KANSAS CITY, MO.

**FRANK F. FOWLE & CO.**  
Electrical and Mechanical  
Engineers  
MONADNOCK BUILDING CHICAGO

**MCCLELLAN & JUNKERSFELD**  
Incorporated  
Engineering and Construction  
Power Developments—Industrial Plants  
Electrifications—Examinations  
Reports—Valuations  
NEW YORK  
68 Trinity Place  
Chicago St. Louis

**BYLLESBY**  
ENGINEERING AND MANAGEMENT  
CORPORATION  
231 S. La Salle Street  
CHICAGO  
New York San Francisco

**FREYENGINEERING COMPANY**  
Industrial Electric Power  
Generation—Application—Purchase  
Combustion Engineering  
Electric Furnace Installations  
CHICAGO PHILADELPHIA  
310 South Michigan Ave. 1600 Chestnut St.

John Minton I. G. Maloff  
**JOHN MINTON, PH. D.**  
Consulting Engineer  
For Developing, Designing & Manufacturing  
of Radio Receivers, Amplifiers, Transformers,  
Rectifiers, Sound Recording & Reproducing  
Apparatus.  
Radio & Electro-Acoustical Laboratory.  
8 Church Street White Plains, N.Y.

**WALTER G. CLARK**  
Consulting Engineer  
Electrical, Mining and Industrial  
Reports  
Supervision of Organization and Arrange-  
ments for Financing  
LOS ANGELES NEW YORK  
1211 Insurance Exch. Bldg. 40 Wall St.

**M. H. GERRY, JR.**  
Consulting Engineer  
Electrical Transmission of Power  
Hydroelectric Developments  
Steam and Diesel Plants  
Industrial Applications  
1107 Hobart Building San Francisco

**N. J. NEALL**  
Consulting Engineer  
for  
Electrical and Industrial Properties  
12 PEARL STREET BOSTON, MASS.

**EDWARD E. CLEMENT**  
Fellow A. I. E. E.  
Attorney and Expert  
in Patent Causes  
Soliciting, Consultation, Reports,  
Opinions  
McLachlen Bldg. Washington, D. C.  
700 10th St., N. W.

**A. BARNETT GREEN**  
Writing — Editing — Compiling  
Engineering Matter  
1328 BROADWAY NEW YORK

**NEILER, RICH & CO.**  
Electrical and Mechanical  
Engineers  
Consulting, Designing and  
Supervising  
431 So. Dearborn St. — — Chicago

**HAROLD A. DANNE**  
LIGHT AND POWER  
41 PARK ROW NEW YORK

**AUGUSTUS M. HENRY**  
COUNSELOR AT LAW  
(Patents and Patent Causes)  
WOOLWORTH BLDG. NEW YORK

**OPHULS & HILL, Inc.**  
Formerly Ophuls, Hill & McCreery, Inc.  
CONSULTING ENGINEERS  
112-114 WEST 42nd ST., NEW YORK CITY  
Ice Making and Refrigeration  
Investigations and Reports

# PROFESSIONAL ENGINEERING DIRECTORY

For Consultants in the Fields of Engineering and Related Arts and Sciences

## FARLEY OSGOOD

Consultant

Design, Construction, Operation  
Inter-Connection

of  
PUBLIC UTILITIES

National Bank of Commerce Building  
31 Nassau Street, New York, N. Y.  
Tel.: Rector 7878 Cable Address: Fargood

## SCOFIELD ENGINEERING CO.

Consulting Engineers

Power Stations Gas Works  
Hydraulic Developments Electric Railways  
Examinations & Reports Valuations

Philadelphia

## STONE & WEBSTER

Incorporated

DESIGN AND CONSTRUCTION

EXAMINATIONS APPRAISALS REPORTS

INDUSTRIAL AND PUBLIC SERVICE  
PROPERTIES

New York Boston Chicago

## I. S. PRENNER

Mem. A. I. E. E.

Lawyer — Engineer  
Patent Practice

Liberty Trust Bldg.  
Broad and Arch Sts. PHILADELPHIA

## J. E. SIRRINE & COMPANY

Engineers

Textile Mills; Hydro-Electric Develop-  
ments; Tobacco Products Plants; Cotton,  
Tobacco and General Warehousing; Indus-  
trial Housing; Steam Power Plants; Steam  
Utilization.

General Offices: Greenville, South Carolina  
Branches  
Chattanooga, Tenn. Birmingham, Ala.

## PERCY H. THOMAS

Consulting Engineer

ELECTRIC POWER

Generation — Transmission  
Applications

120 BROADWAY NEW YORK

## PUBLIC SERVICE PRODUCTION COMPANY

Engineers and Constructors

Design and Construct: Power Plants,  
Transmission Lines, Industrial Plants,  
Highways, Railroad Shops and Terminals,  
Gas Plants, Commercial Buildings

Make: Examinations, Reports and Valuations  
80 PARK PLACE NEWARK, N. J.

## JOHN A. STEVENS

CONSULTING POWER ENGINEER

16 Shattuck Street

LOWELL MASSACHUSETTS

## THE U. G. I. CONTRACTING CO.

Engineers & Constructors

Power Developments, Industrial Plants, Gas  
Plants, Transmission Systems, Appraisals

Broad & Arch Sts., PHILA., PA.

421 Peoples Gas Bldg., Chicago, Ill. 928 Union Trust  
Bldg., Pittsburgh, Pa.

## SANDERSON & PORTER ENGINEERS

PUBLIC UTILITIES & INDUSTRIALS

Design Construction Management  
Examinations Reports Valuations

Chicago New York San Francisco

## STEVENS & WOOD INCORPORATED

Engineers and Constructors

120 BROADWAY, NEW YORK  
Youngstown, O.

## THE J. G. WHITE ENGINEERING CORPORATION

Engineers—Constructors

Oil Refineries and Pipe Lines,  
Steam and Water Power Plants,  
Transmission Systems, Hotels, Apartments,  
Offices and Industrial Buildings, Railroads

43 EXCHANGE PLACE NEW YORK

## SARGENT & LUNDY Incorporated

Mechanical and Electrical  
Engineers

1412 Edison Bldg., 72 West Adams Street  
CHICAGO ILLINOIS

William M. Stockbridge Victor D. Borst

## STOCKBRIDGE & BORST

Patent Lawyers

41 PARK ROW NEW YORK CITY

## J. G. WRAY & CO.

Engineers

J. G. Wray, Fellow A.I.E.E. Cyrus G. Hill

Utilities and Industrial Properties

Appraisals Construction Rate Surveys  
Plans Organization Estimates

Financial Investigations Management

576 First National Bank Bldg., Chicago

**YOUR CARD** in 24,000 copies of each issue of this publication  
—12 times a year, will keep your name and specialized  
service constantly before the electrical industry.  
Qualified advertisers in the Engineering Directory are invited  
to send for rates.

## ELECTRICAL TESTING LABORATORIES

80th Street and East End Ave.  
NEW YORK

### Inspections — Tests — Research

Tests may be used by the purchaser for the following purposes:

- (1) To determine the quality of competing samples. This enables the purchase of the best quality for the money.
- (2) To make sure that shipments comply with specifications. This makes possible the assurance to the customer that shipments match buying samples.
- (3) To furnish an impartial decision in case of disputes between purchaser and manufacturer.

Testing places the whole buying problem on a sound basis.

Please mention the JOURNAL of the A. I. E. E. when writing to advertisers.

# Classified Advertiser's Index for Buyers

Manufacturers and agents for machinery and supplies used in the electrical and allied industries.

Note: For reference to the Advertisements see the Alphabetical List of Advertisers on page 68.

- AIR COMPRESSORS**  
Allis-Chalmers Mfg. Co., Milwaukee  
General Electric Co., Schenectady  
Western Electric Co., All Principal Cities
- AIR WASHERS**  
Sturtevant Company, B. F., Boston
- AMMETER COMPENSATING COILS**  
Minerallac Electric Co., Chicago
- AMMETER, VOLTMETERS**  
(See INSTRUMENTS, ELECTRICAL)
- ANCHORS, GUY**  
Hubbard & Co., Pittsburgh  
Kearney Corp., Jas. R., St. Louis  
Matthews Corp., W. N., St. Louis
- ARMS FOR STREET LIGHTING**  
Hubbard & Co., Pittsburgh
- BALANCING MACHINES, STATIC DYNAMIC**  
Olsen Testing Mach. Co., Tinius, Philadelphia
- BATTERY CHARGING APPARATUS**  
Allen-Bradley Co., Milwaukee  
Electric Specialty Co., Stamford, Conn.  
Fansteel Products Co., Inc., North Chicago  
General Electric Co., Schenectady  
Ward Leonard Electric Co., Mt. Vernon, N. Y.  
Western Electric Co., All Principal Cities  
Westinghouse Elec. & Mfg. Co., E. Pittsburgh
- BEARINGS, BALL**  
Gurney Ball Bearing Division of Marlin-Rockwell Corp., Jamestown, N. Y.  
New Departure Mfg. Co., The, Bristol, Conn.  
Norma-Hoffmann Bearings Corp., Stamford, Conn.  
Standard Steel & Bearings, Inc., Plainville, Conn.
- BEARINGS, ROLLER**  
Timken Roller Bearing Co., The, Canton, O.
- BLOWERS**  
Sturtevant Co., B. F., Boston
- BOXES, FUSE**  
General Electric Co., Schenectady  
Kearney Corp., Jas. R., St. Louis  
Metropolitan Device Corp., Brooklyn, N. Y.  
Western Electric Co., All Principal Cities  
Westinghouse Elec. & Mfg. Co., Pittsburgh
- BOXES, JUNCTION**  
G & W Elec. Specialty Co., Chicago  
Metropolitan Device Corp., Brooklyn, N. Y.  
Standard Underground Cable Co., Pittsburgh
- BRACKETS AND PINS, METAL**  
Hubbard & Co., Pittsburgh
- BRUSHES, COMMUTATOR**  
*Carbon*  
Morganite Brush Co., Inc., L. I. City, N. Y.  
National Carbon Co., Inc., Cleveland  
Westinghouse Elec. & Mfg. Co., E. Pittsburgh  
*Copper Graphite*  
Morganite Brush Co., Inc., L. I. City, N. Y.  
National Carbon Co., Inc., Cleveland  
Westinghouse Elec. & Mfg. Co., E. Pittsburgh
- BUS BAR FITTINGS**  
Burndy Engineering Co., Inc., New York  
Delta-Star Electric Co., Chicago  
General Electric Co., Schenectady  
Westinghouse Elec. & Mfg. Co., E. Pittsburgh
- CABLE ACCESSORIES**  
Delta-Star Electric Co., Chicago  
Dossert & Co., New York  
G & W Electric Specialty Co., Chicago  
General Electric Co., Schenectady  
Minerallac Electric Co., Chicago  
Standard Underground Cable Co., Pittsburgh  
Western Electric Co., All Principal Cities
- CABLE RACKS**  
Hubbard & Co., Pittsburgh  
Metropolitan Device Corp., Brooklyn, N. Y.
- CABLES**  
See WIRES AND CABLES
- CABLEWAYS**  
American Steel & Wire Co., Chicago  
Roebling's Sons Co., John A., Trenton, N. J.
- CAMBRIC, VARNISHED**  
Belden Mfg. Co., Chicago  
General Electric Co., Bridgeport, Conn.  
Irvington Varnish & Ins. Co., Irvington, N. J.  
Westinghouse Elec. & Mfg. Co., E. Pittsburgh
- CARRIER CURRENT TELEPHONE EQUIPMENT**  
Dubilier Condenser & Radio Corp., N. Y.  
Western Electric Co., All Principal Cities  
Wireless Specialty Apparatus Co., Boston
- CIRCUIT BREAKERS**  
*Air-Enclosed*  
Allen-Bradley Co., Milwaukee  
Cutter Co., The, Philadelphia  
Roller-Smith Co., New York  
Sundh Electric Co., Newark, N. J.  
Ward Leonard Electric Co., Mt. Vernon, N. Y.  
Western Electric Co., All Principal Cities  
*Oil*  
Condit Electrical Mfg. Corp., Boston  
General Electric Co., Schenectady  
Pacific Elec. Mfg. Co., San Francisco  
Westinghouse Elec. & Mfg. Co., E. Pittsburgh
- CLAMPS, GUY & CABLE**  
Burndy Engineering Co., Inc., New York  
Hubbard & Co., Pittsburgh  
Kearney Corp., Jas. R., St. Louis  
Matthews Corp., W. N., St. Louis
- CLAMPS, HOT LINE**  
Hubbard & Co., Pittsburgh  
Kearney Corp., Jas. R., St. Louis
- CLIPS, CABLE**  
Hubbard & Co., Pittsburgh  
Kearney Corp., Jas. R., St. Louis
- CLOCKS**  
Cramer & Co., Inc., R. W., New York
- COILS, CHOKE**  
Burke Electric Co., Erie, Pa.  
General Electric Co., Schenectady  
Kearney Corp., Jas. R., St. Louis  
Westinghouse Elec. & Mfg. Co., E. Pittsburgh
- COILS, MAGNET**  
Acme Wire Co., New Haven, Conn.  
Belden Mfg. Co., Chicago  
Dudlo Mfg. Corp., Ft. Wayne, Ind.  
General Electric Co., Schenectady  
Westinghouse Elec. & Mfg. Co., E. Pittsburgh
- COMMUTATOR SLOTTERS**  
Martindale Electric Co., The, Cleveland
- COMMUTATOR STONES**  
Martindale Electric Co., The, Cleveland
- CONDENSATION PRODUCTS**  
Bakelite Corporation, New York
- CONDENSERS, COUPLING**  
*For Carrier Current Telephone*  
Dubilier Condenser & Radio Corp., New York  
Wireless Specialty Apparatus Co., Boston
- CONDENSERS, RADIO**  
Dubilier Condenser & Radio Corp., New York  
General Radio Co., Cambridge, Mass.  
Pacnet Radio Corp., New York  
Wireless Specialty Apparatus Co., Boston
- CONDENSERS, STEAM**  
Allis-Chalmers Mfg. Co., Milwaukee  
General Electric Co., Schenectady  
Westinghouse Elec. & Mfg. Co., E. Pittsburgh
- CONDUIT, UNDERGROUND FIBRE**  
Western Electric Co., All Principal Cities
- CONNECTORS, SOLDERLESS**  
Dossert & Co., New York  
Kearney Corp., Jas. R., St. Louis  
Western Electric Co., All Principal Cities  
Westinghouse Elec. & Mfg. Co., E. Pittsburgh
- CONNECTORS AND TERMINALS**  
Belden Mfg. Co., Chicago  
Burke Electric Co., Erie, Pa.  
Burndy Engineering Co., Inc., New York  
Dossert & Co., New York  
G & W Electric Specialty Co., Chicago  
Western Electric Co., All Principal Cities  
Westinghouse Elec. & Mfg. Co., E. Pittsburgh
- CONTACTS, TUNGSTEN**  
Fansteel Products Co., Inc., North Chicago  
General Electric Co., Schenectady
- CONTROL SYSTEMS**  
Ward Leonard Electric Co., Mt. Vernon, N. Y.
- CONTROLLERS**  
Allen-Bradley Co., Milwaukee  
Electric Controller & Mfg. Co., Cleveland  
General Electric Co., Schenectady  
Rowan Controller Co., Baltimore  
Sundh Electric Co., Newark, N. J.  
Ward Leonard Electric Co., Mt. Vernon, N. Y.  
Western Electric Co., All Principal Cities  
Westinghouse Elec. & Mfg. Co., E. Pittsburgh
- CONVERTERS—SYNCHRONOUS**  
Allis-Chalmers Mfg. Co., Milwaukee  
Electric Specialty Co., Stamford, Conn.  
Westinghouse Elec. & Mfg. Co., E. Pittsburgh
- COPPER CLAD WIRE**  
Belden Mfg. Co., Chicago  
Copperweld Steel Co., Rankin, Pa.  
Standard Underground Cable Co., Pittsburgh  
Western Electric Co., All Principal Cities
- CROSS ARMS, STEEL**  
Hubbard & Co., Pittsburgh
- CUT-OUTS**  
Condit Electrical Mfg. Corp., S. Boston  
General Electric Co., Schenectady  
G & W Electric Specialty Co., Chicago  
Kearney Corp., Jas. R., St. Louis  
Metropolitan Device Corp., Brooklyn, N. Y.  
Western Electric Co., All Principal Cities  
Westinghouse Elec. & Mfg. Co., E. Pittsburgh
- DIMMERS, THEATRE**  
Ward Leonard Electric Co., Mt. Vernon, N. Y.
- DRAWING INSTRUMENTS**  
Cramer & Co., Inc., R. W., New York
- DYNAMOS**  
(See GENERATORS AND MOTORS)
- DYNAMOTORS**  
Burke Electric Co., Erie, Pa.  
Electric Specialty Co., Stamford, Conn.
- ELECTRIFICATION SUPPLIES, STEAM ROAD**  
General Electric Co., Schenectady  
Ohio Brass Co., Mansfield, Ohio  
Westinghouse Elec. & Mfg. Co., E. Pittsburgh
- ENGINEERS, CONSULTING AND CONTRACTING**  
(See PROFESSIONAL ENGINEERING DIRECTORY)
- ENGINES**  
*Gas & Gasoline*  
Allis-Chalmers Mfg. Co., Milwaukee  
Sturtevant Company, B. F., Boston  
*Oil*  
Allis-Chalmers Mfg. Co., Milwaukee  
Sturtevant Company, B. F., Boston  
*Steam*  
Allis-Chalmers Mfg. Co., Milwaukee  
Sturtevant Company, B. F., Boston
- FANS, MOTOR**  
Century Electric Co., St. Louis  
General Electric Co., Schenectady  
Star Electric Motor Co., Newark, N. J.  
Sturtevant Company, B. F., Boston  
Western Electric Co., All Principal Cities  
Westinghouse Elec. & Mfg. Co., E. Pittsburgh
- FARM LIGHTING GENERATORS**  
Western Electric Co., All Principal Cities  
Westinghouse Elec. & Mfg. Co., E. Pittsburgh
- FIBRE**  
Belden Mfg. Co., Chicago  
National Vulcanized Fibre Co., Wilmington, Del.
- FLOW METERS**  
General Electric Co., Schenectady
- FURNACES, ELECTRIC**  
General Electric Co., Schenectady  
Westinghouse Elec. & Mfg. Co., E. Pittsburgh



Is your name on our mailing list for bulletins and catalog?

# Morganite Brushes

Morganite Brush Co., Inc.  
3302-3320 Anable Ave.,  
Long Island City,  
N. Y.

Please mention the JOURNAL of the A. I. E. E. when writing to advertisers.

# The J. G. White Engineering Corporation

ENGINEERS and CONSTRUCTORS

Steam Power Stations	Railroads
Hydro-Electric Stations	Bridges
Sub-stations	Wharves and Sea Walls
Transmission Lines	Highways
Dams	Industrial Plants
Water Works	Industrial Housing
Irrigation Systems	Warehouses
Sewage Systems	Bank and Office Buildings
Pipe Lines	Hotels
Oil Refineries	Apartments

43 EXCHANGE PLACE



NEW YORK, N. Y.

## Classified Advertiser's Index for Buyers—Continued

### FUSES

#### Enclosed Refillable

General Electric Co., Schenectady  
Western Electric Co., All Principal Cities  
Westinghouse Elec. & Mfg. Co., E. Pitts-  
burgh

#### Enclosed Non-Refillable

General Electric Co., Schenectady  
Western Electric Co., All Principal Cities

#### Open Link

General Electric Co., Schenectady  
Metropolitan Device Corp., Brooklyn, N. Y.  
Western Electric Co., All Principal Cities

#### High Tension

Delta-Star Electric Co., Chicago  
Metropolitan Device Corp., Brooklyn, N. Y.  
Western Electric Co., All Principal Cities

### FUSE PULLERS

Kearney Corp., Jas. R., St. Louis

### GEARS, FIBRE

General Electric Co., Schenectady

### GENERATORS AND MOTORS

Allis-Chalmers Mfg. Co., Milwaukee  
Burke Electric Co., Erie, Pa.  
Century Electric Co., St. Louis  
Chandeysson Electric Co., St. Louis  
Electric Specialty Co., Stamford, Conn.  
Electro-Dynamic Co., Bayonne, N. J.  
General Electric Co., Schenectady  
Lincoln Electric Co., The, Cleveland  
Star Electric Motor Co., Newark, N. J.  
Sturtevant Company, B. F., Boston  
Western Electric Co., All Principal Cities  
Westinghouse Elec. & Mfg. Co., E. Pitts-  
burgh

### GENERATING STATION EQUIPMENT

Allis-Chalmers Mfg. Co., Milwaukee  
Burke Electric Co., Erie, Pa.  
General Electric Co., Schenectady  
Western Electric Co., All Principal Cities  
Westinghouse Elec. & Mfg. Co., E. Pitts-  
burgh

### GROUND CONNECTIONS

Hubbard & Co., Pittsburgh

### GROUND RODS

Copperweld Steel Co., Rankin, Pa.  
Hubbard & Co., Pittsburgh  
Western Electric Co., All Principal Cities

### HEADLIGHTS

Ohio Brass Co., Mansfield, O.

### HEATERS, INDUSTRIAL

General Electric Co., Schenectady  
Western Electric Co., All Principal Cities  
Westinghouse Elec. & Mfg. Co., E. Pitts-  
burgh

### INDICATORS, SPEED

Bristol Co., The, Waterbury, Conn.  
Roller-Smith Co., New York

### INDICATORS, REMOTE, WATER LEVEL

Bristol Co., The, Waterbury, Conn.  
Cramer & Co., Inc., R. W., New York

### INSTRUMENTS, ELECTRICAL

#### Graphic

Bristol Co., The, Waterbury, Conn.  
Ferranti, Ltd., Hollinwood, England  
Ferranti, Inc., New York  
Ferranti Electric, Ltd., Toronto, Ont.  
General Electric Co., Schenectady  
Westinghouse Elec. & Mfg. Co., E. Pittsburgh

#### Indicating

Bristol Co., The, Waterbury, Conn.  
Ferranti Ltd., Hollinwood, England  
Ferranti, Inc., New York  
Ferranti Electric, Ltd., Toronto, Ont.  
General Electric Co., Schenectady  
Jewell Elec. Instrument Co., Chicago  
Roller-Smith Co., New York  
Westinghouse Elec. & Mfg. Co., E. Pittsburgh  
Weston Elec. Inst. Corp., Newark, N. J.

#### Integrating

Duncan Elec. Mfg. Co., Lafayette, Ind.  
Ferranti Ltd., Hollinwood, England  
Ferranti, Inc., New York  
Ferranti Electric, Ltd., Toronto, Ont.  
General Electric Co., Schenectady  
Roller-Smith Co., New York  
Sangamo Elec. Co., Springfield, Ill.  
Western Electric Co., All Principal Cities  
Westinghouse Elec. & Mfg. Co., E. Pitts-  
burgh

#### Radio

General Radio Co., Cambridge, Mass.  
Jewell Elec. Instrument Co., Chicago

#### Repairing and Testing

Electrical Testing Laboratories, New York  
Jewell Elec. Instrument Co., Chicago

#### Scientific, Laboratory, Testing

General Electric Co., Schenectady  
Jewell Elec. Instrument Co., Chicago  
Metropolitan Device Corp., Brooklyn, N. Y.  
Roller-Smith Co., New York  
Western Electric Co., All Principal Cities  
Westinghouse Elec. & Mfg. Co., E. Pittsburgh  
Weston Elec. Inst. Corp., Newark, N. J.

#### Telegraph

Western Electric Co., All Principal Cities

### INSULATING MATERIALS

#### Board

General Electric Co., Bridgeport, Conn.  
West Va. Pulp & Paper Co., New York

#### Cloth

Acme Wire Co., New Haven, Conn.  
General Electric Co., Bridgeport, Conn.  
Irvington Varnish & Ins. Co., Irvington, N. J.  
Minerallac Electric Co., Chicago  
Westinghouse Elec. & Mfg. Co., E. Pittsburgh

#### Composition

American Lava Corp., Chattanooga  
Bakelite Corporation, New York  
Belden Mfg. Co., Chicago  
General Electric Co., Bridgeport, Conn.  
Westinghouse Elec. & Mfg. Co., E. Pittsburgh

#### Compounds

General Electric Co., Bridgeport, Conn.  
Minerallac Electric Co., Chicago  
Standard Underground Cable Co., Pittsburgh  
Western Electric Co., All Principal Cities  
Westinghouse Elec. & Mfg. Co., E. Pitts-  
burgh

#### Fibre

General Electric Co., Bridgeport, Conn.  
National Vulcanized Fibre Co., Wilmington,  
Del.  
West Va. Pulp & Paper Co., New York

#### Lava

American Lava Corp., Chattanooga, Tenn.  
Chicago Mica Co., Valparaiso, Ind.

#### Mica

Chicago Mica Co., Valparaiso, Ind.  
New England Mica Co., Waltham, Mass.  
Westinghouse Elec. & Mfg. Co., E. Pitts-  
burgh

#### Paper

Acme Wire Co., New Haven, Conn.  
General Electric Co., Bridgeport, Conn.  
Irvington Varnish & Ins. Co., Irvington, N. J.  
Westinghouse Elec. & Mfg. Co., E. Pitts-  
burgh

#### Silk

Acme Wire Co., New Haven, Conn.  
General Electric Co., Bridgeport, Conn.  
Irvington Varnish & Ins. Co., Irvington, N. J.

#### Tape

Belden Mfg. Co., Chicago  
General Electric Co., Bridgeport, Conn.  
Minerallac Electric Co., Chicago  
Okonite Co., The, Passaic, N. J.  
Western Electric Co., All Principal Cities  
Westinghouse Elec. & Mfg. Co., E. Pittsburgh

#### Varnishes

Acme Wire Co., New Haven, Conn.  
General Electric Co., Bridgeport, Conn.  
Irvington Varnish & Ins. Co., Irvington, N. J.  
Minerallac Electric Co., Chicago  
Westinghouse Elec. & Mfg. Co., E. Pitts-  
burgh

### INSULATORS, HIGH TENSION

#### Composition

General Electric Co., Schenectady

#### Glass

Hemingray Glass Co., Muncie, Ind.

#### Porcelain

Canadian Porcelain Co., Ltd., Hamilton, Ont.  
General Electric Co., Schenectady  
Hubbard & Co., Pittsburgh  
Lapp Insulator Co., Inc., LeRoy, N. Y.  
Locke Insulator Corp., Baltimore  
Ohio Brass Co., Mansfield, O.  
Thomas & Sons Co., R., East Liverpool, O.  
Western Electric Co., All Principal Cities  
Westinghouse Elec. & Mfg. Co., E. Pittsburgh

#### Post Type

Delta-Star Electric Co., Chicago

#### Pyrex

Corning Glass Works, Corning, N. Y.

### INSULATORS, TELEPHONE & TELEGRAPH

Hemingray Glass Co., Muncie, Ind.  
Western Electric Co., All Principal Cities

### INSULATOR PINS

Hubbard & Co., Pittsburgh  
Ohio Brass Co., Mansfield, O.  
Thomas & Sons Co., R., East Liverpool, O.

### LAMP GUARDS

Matthews Corp., W. N., St. Louis  
Western Electric Co., All Principal Cities

### LAVA

American Lava Corp., Chattanooga

### LIGHTNING ARRESTERS

Delta-Star Electric Co., Chicago  
General Electric Co., Schenectady  
Hubbard & Co., Pittsburgh  
Western Electric Co., All Principal Cities  
Westinghouse Elec. & Mfg. Co., E. Pittsburgh

### LOCOMOTIVES, ELECTRIC

General Electric Co., Schenectady  
Westinghouse Elec. & Mfg. Co., E. Pittsburgh

### LUBRICANTS

Texas Co., The, New York

### MAGNETIC SEPARATORS

Electric Controller & Mfg. Co., Cleveland

### METERS, ELECTRICAL

(See INSTRUMENTS ELECTRICAL)

### METER SEALS

Metropolitan Device Corp., Brooklyn, N. Y.

### MICA PRODUCTS

Chicago Mica Co., Valparaiso, Ind.  
New England Mica Co., Waltham, Mass.  
Westinghouse Elec. & Mfg. Co., E. Pitts-  
burgh

### MICA UNDERCUTTERS

Martindale Electric Co., The, Cleveland

### MOLDED INSULATION

Bakelite Corporation, New York  
Belden Mfg. Co., Chicago  
Burke Electric Co., Erie, Pa.  
Westinghouse Elec. & Mfg. Co., E. Pitts-  
burgh

### MOLYBDENUM

Faustel Products Co., Inc., North Chicago

### MOTORS

(See GENERATORS AND MOTORS)

### OHMMETERS

Jewell Elec. Instrument Co., Chicago  
Martindale Electric Co., Cleveland  
Roller-Smith Co., New York  
Weston Elec. Instr. Corp., Newark, N. J.

### OIL SEPARATORS & PURIFIERS

Sharples Specialty Co., The, Philadelphia  
Westinghouse Elec. & Mfg. Co., E. Pitts-  
burgh

### PANEL BOARDS

(See SWITCHBOARDS)

### PATENT ATTORNEYS

(See PROFESSIONAL ENGINEERING  
DIRECTORY)

### PLUGS

Delta-Star Electric Co., Chicago  
General Electric Co., Schenectady  
Western Electric Co., All Principal Cities  
Westinghouse Elec. & Mfg. Co., E. Pitts-  
burgh

### POLE LINE HARDWARE

Hubbard & Co., Pittsburgh  
Ohio Brass Co., Mansfield, O.

### POLES, STEEL

American Bridge Co., Pittsburgh  
Western Electric Co., All Principal Cities

### POLES—TIES, WOOD

Western Electric Co., All Principal Cities

### POTHEADS

G & W Electric Specialty Co., Chicago  
Standard Underground Cable Co., Pittsburgh  
Western Electric Co., All Principal Cities

### PROTECTIVE DEVICES

Metropolitan Device Corp., Brooklyn, N. Y.  
Western Electric Co., All Principal Cities

### PULERS, SLACK

Matthews Corp., W. N., St. Louis

### PUMPS

Allis-Chalmers Mfg. Co., Milwaukee

### PUMPS, SPIRAL

Morris Corporation, I. P., Philadelphia

### RADIO LABORATORY APPARATUS

General Radio Co., Cambridge, Mass.  
Westinghouse Elec. & Mfg. Co., E. Pitts-  
burgh

### RAILWAY SUPPLIES, ELECTRIC

General Electric Co., Schenectady  
Ohio Brass Co., Mansfield, O.  
Western Electric Co., All Principal Cities  
Westinghouse Elec. & Mfg. Co., E. Pitts-  
burgh

### REACTORS

General Electric Co., Schenectady  
Metropolitan Device Corp., Brooklyn, N. Y.

### RECTIFIERS

Faustel Products Co., Inc., North Chicago  
General Electric Co., Schenectady  
Western Electric Co., All Principal Cities  
Westinghouse Elec. & Mfg. Co., E. Pitts-  
burgh

### REELS, PAYOUT AND TAKEUP

Matthews Corp., W. N., St. Louis

### REGULATORS, VOLTAGE

Burke Electric Co., Erie, Pa.  
General Electric Co., Schenectady  
Western Electric Co., All Principal Cities  
Westinghouse Elec. & Mfg. Co., E. Pitts-  
burgh

### RELAYS

Cramer & Co., Inc., R. W., New York  
Electric Controller & Mfg. Co., Cleveland  
General Electric Co., Schenectady  
Westinghouse Elec. & Mfg. Co., E. Pitts-  
burgh

### RESISTOR UNITS

Allen-Bradley Co., Milwaukee  
General Electric Co., Schenectady  
Ward Leonard Electric Co., Mt. Vernon, N. Y.

### RHEOSTATS

Allen-Bradley Co., Milwaukee  
General Electric Co., Schenectady  
Sundh Electric Co., Newark, N. J.  
Ward Leonard Electric Co., Mt. Vernon, N. Y.  
Western Electric Co., All Principal Cities  
Westinghouse Elec. & Mfg. Co., E. Pitts-  
burgh

### ROPE, WIRE

American Steel & Wire Co., Chicago  
Roebing's Sons Co., John A., Trenton, N. J.

### SEARCHLIGHTS

General Electric Co., Schenectady  
Westinghouse Elec. & Mfg. Co., E. Pittsburgh

### SHEETS, ELECTRICAL

Trumbull Steel Co., The, Warren, O.

### SLEEVE TWISTERS

Kearney Corp., Jas. R., St. Louis



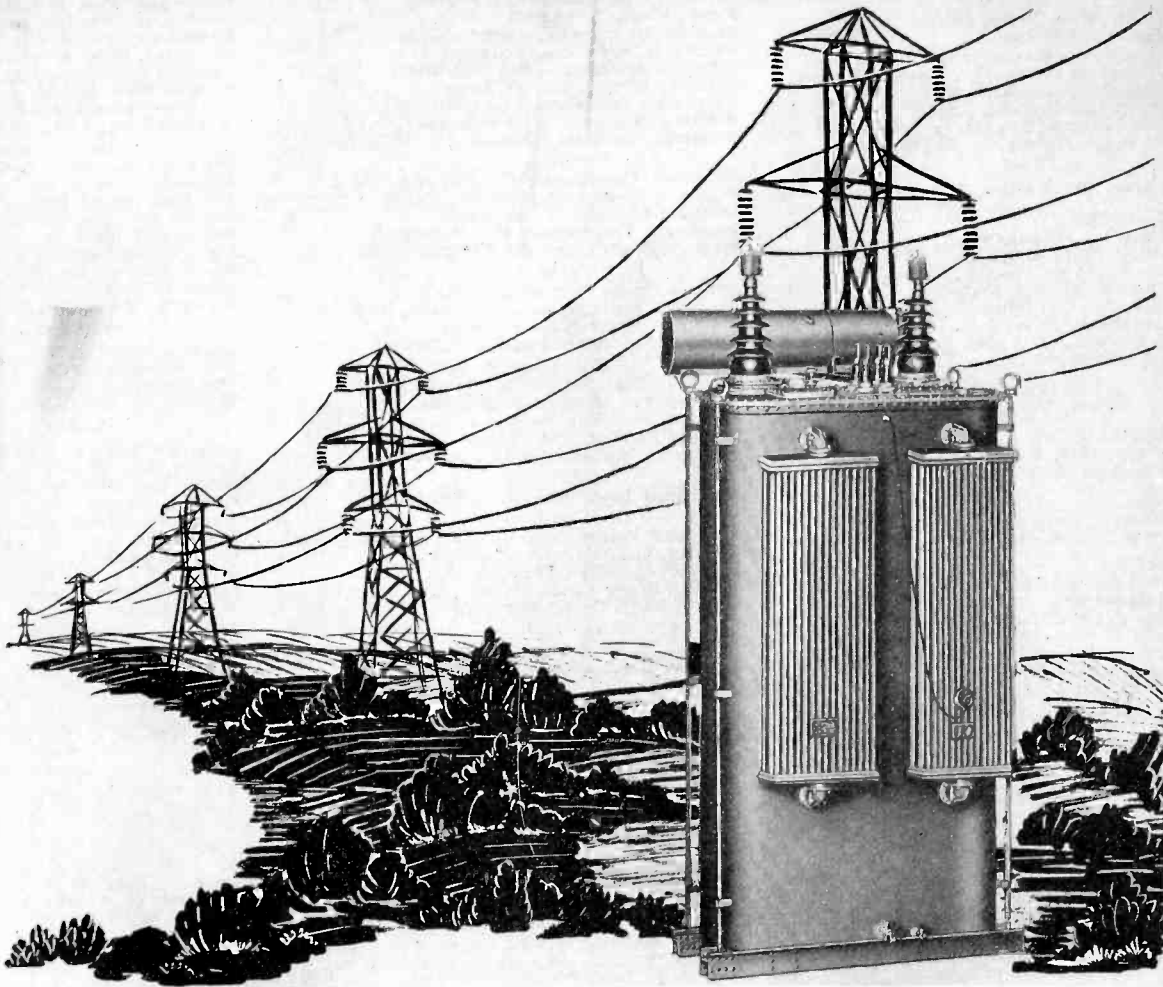

**I**NDUSTRY continues to specify Moloney Transformers in increasing numbers because the Moloney organization has always given Industry the quality of design and workmanship that made possible dependable and economical performance.

**MOLONEY ELECTRIC CO.**  
*Main Office and Factories: St. Louis, Mo.*  
*Sales Offices in Principal Cities*

**Moloney**  
**TRANSFORMERS**

## Classified Advertiser's Index for Buyers—Continued

### SOCKETS AND RECEPTACLES

General Electric Co., Schenectady  
Western Electric Co., All Principal Cities  
Westinghouse Elec. & Mfg. Co., E. Pittsburgh

### SOLENOIDS

Acme Wire Co., New Haven, Conn.  
Belden Mfg. Co., Chicago  
Dudlo Mfg. Co., Ft. Wayne, Ind.  
Electric Controller & Mfg. Co., Cleveland  
General Electric Co., Schenectady  
Sundh Electric Co., Newark, N. J.  
Ward Leonard Electric Co., Mt. Vernon, N. Y.  
Westinghouse Elec. & Mfg. Co., E. Pittsburgh

### SPRINGS

American Steel & Wire Co., Chicago

### STARTERS, MOTOR

Allen-Bradley Co., Milwaukee  
Condit Electrical Mfg. Corp., Boston  
Electric Controller & Mfg. Co., Cleveland  
General Electric Co., Schenectady  
Rowan Controller Co., Baltimore, Md.  
Sundh Electric Co., Newark, N. J.  
Ward Leonard Electric Co., Mt. Vernon, N. Y.  
Westinghouse Elec. & Mfg. Co., E. Pittsburgh

### STEEL, SHEET & STRIPS

Trumbull Steel Co., The, Warren, O.

### STOKERS, MECHANICAL

Sturtevant Company, B. F., Boston  
Westinghouse Elec. & Mfg. Co., E. Pittsburgh

### SUB-STATIONS

General Electric Co., Schenectady  
Westinghouse Elec. & Mfg. Co., E. Pittsburgh

### SWITCHBOARDS

Allis-Chalmers Mfg. Co., Milwaukee  
Condit Electrical Mfg. Corp., Boston  
General Electric Co., Schenectady  
Metropolitan Device Corp., Brooklyn, N. Y.  
Western Electric Co., All Principal Cities  
Westinghouse Elec. & Mfg. Co., E. Pittsburgh

### SWITCHES

*Automatic Time*  
Cramer & Co., Inc., R. W., New York  
General Electric Co., Schenectady  
Minerallac Electric Co., Chicago  
Sundh Electric Co., Newark, N. J.  
Westinghouse Elec. & Mfg. Co., E. Pittsburgh

*Disconnecting*  
Burke Electric Co., Erie, Pa.  
Condit Electrical Mfg. Corp., Boston  
Delta-Star Electric Co., Chicago  
General Electric Co., Schenectady  
Kearney Corp., Jas. R., St. Louis  
K-P-F Electric Co., San Francisco  
Matthews Corp., W. N., St. Louis  
Pacific Elec. Mfg. Co., San Francisco  
Thoner & Martens, Boston

*Fuse*  
General Electric Co., Schenectady  
Kearney Corp., Jas. R., St. Louis  
Matthews Corp., W. N., St. Louis  
Metropolitan Device Corp., Brooklyn, N. Y.  
Thoner & Martens, Boston

*Knife*  
Condit Electrical Mfg. Corp., Boston  
Cramer & Co., Inc., R. W., New York  
Electric Controller & Mfg. Co., Cleveland  
General Electric Co., Schenectady  
Matthews Corp., W. N., St. Louis  
Western Electric Co., All Principal Cities  
Westinghouse Elec. & Mfg. Co., E. Pittsburgh

*Magnetic*  
Allen-Bradley Co., Milwaukee  
Ward Leonard Electric Co., Mt. Vernon, N. Y.

*Oil*  
Condit Electrical Mfg. Corp., Boston  
General Electric Co., Schenectady  
Pacific Elec. Mfg. Co., San Francisco  
Western Electric Co., All Principal Cities  
Westinghouse Elec. & Mfg. Co., E. Pittsburgh

*Remote Control*  
Condit Electrical Mfg. Corp., Boston  
Cramer & Co., Inc., R. W., New York  
General Electric Co., Schenectady  
Rowan Controller Co., Baltimore  
Sundh Electric Co., Newark, N. J.  
Western Electric Co., All Principal Cities  
Westinghouse Elec. & Mfg. Co., E. Pittsburgh

### TANTALUM

Fansteel Products Co., Inc., North Chicago

### TELEGRAPH APPARATUS

Western Electric Co., All Principal Cities

### TELEPHONE CONNECTORS

Kearney Corp., Jas. R., St. Louis

### TELEPHONE EQUIPMENT

Western Electric Co., All Principal Cities

### TESTING LABORATORIES

Electrical Testing Labs., New York

### TESTING MACHINES, MATERIAL

*For Tension, Compression, Ductility, Endurance etc.*  
Olsen Testing Machine Co., Tinian, Philadelphia

### TOWERS, TRANSMISSION

American Bridge Co., Pittsburgh  
Western Electric Co., All Principal Cities

### TRANSFORMERS

Allis-Chalmers Mfg. Co., Milwaukee  
American Transformer Co., Newark, N. J.  
Duncan Elec. Mfg. Co., Lafayette, Ind.  
Ferranti, Ltd., Hollinwood, England  
Ferranti, Inc., New York  
Ferranti Electric Ltd., Toronto, Ont.  
General Electric Co., Schenectady  
Kuhlman Electric Co., Bay City, Mich.  
Moloney Electric Co., St. Louis  
Pittsburgh Transformer Co., Pittsburgh  
Western Electric Co., All Principal Cities  
Westinghouse Elec. & Mfg. Co., E. Pittsburgh

#### Factory

American Transformer Co., Newark, N. J.  
Kuhlman Electric Co., Bay City, Mich.  
Moloney Electric Co., St. Louis  
Pittsburgh Transformer Co., Pittsburgh  
Western Electric Co., All Principal Cities

#### Furnace

Allis-Chalmers Mfg. Co., Milwaukee  
American Transformer Co., Newark, N. J.  
Moloney Electric Co., St. Louis  
Pittsburgh Transformer Co., Pittsburgh

#### Metering

American Transformer Co., Newark, N. J.  
Ferranti, Ltd., Hollinwood, England  
Ferranti, Inc., New York  
Ferranti Electric Ltd., Toronto, Ont.  
Pittsburgh Transformer Co., Pittsburgh

#### Mill Type

Pittsburgh Transformer Co., Pittsburgh

#### Radio

American Transformer Co., Newark, N. J.  
Ferranti, Ltd., Hollinwood, England  
Ferranti, Inc., New York  
Ferranti Electric Ltd., Toronto, Ont.  
Pacent Radio Corp., New York

#### Street Lighting

Kuhlman Electric Co., Bay City, Mich.  
Western Electric Co., All Principal Cities

### TROLLEY LINE MATERIALS

General Electric Co., Schenectady  
Hubbard & Co., Pittsburgh  
Ohio Brass Co., Mansfield, O.  
Western Electric Co., All Principal Cities  
Westinghouse Elec. & Mfg. Co., E. Pittsburgh

### TURBINES, HYDRAULIC

Allis-Chalmers Mfg. Co., Milwaukee  
Morris Corporation, I. P., Philadelphia

### TURBINES, STEAM

Allis-Chalmers Mfg. Co., Milwaukee  
General Electric Co., Schenectady  
Sturtevant Company, B. F., Boston  
Western Electric Co., All Principal Cities  
Westinghouse Elec. & Mfg. Co., E. Pittsburgh

### TURBO-GENERATORS

Allis-Chalmers Mfg. Co., Milwaukee  
Westinghouse Elec. & Mfg. Co., E. Pittsburgh

### VALVE CONTROL, ELECTRIC

Bristol Company, The, Waterbury, Conn.

### VALVES, JOHNSON HYDRAULIC

Morris Corporation, I. P., Philadelphia

### VARNISHES, INSULATING

General Electric Co., Bridgeport, Conn.  
Irvington Varnish & Ins. Co., Irvington, N. J.  
Minerallac Electric Co., Chicago  
Westinghouse Elec. & Mfg. Co., E. Pittsburgh

### WELDING MACHINES, ELECTRIC

General Electric Co., Schenectady  
Lincoln Electric Co., The, Cleveland  
Ohio Brass Co., Mansfield, O.  
Westinghouse Elec. & Mfg. Co., E. Pittsburgh

### WELDING WIRES & RODS

American Steel & Wire Co., Chicago  
Lincoln Electric Co., Cleveland  
Ohio Brass Co., Mansfield, O.

### WIRES AND CABLES

#### Armored Cable

American Steel & Wire Co., Chicago  
Belden Mfg. Co., Chicago  
Boston Ins. Wire & Cable Co., Boston  
General Electric Co., Schenectady  
Habirshaw Cable & Wire Corp., New York  
Hazard Manufacturing Co., Wilkes-Barre, Pa.  
Kerite Ins. Wire & Cable Co., New York  
Okonite Company, The, Passaic, N. J.  
Roebing's Sons Co., John A., Trenton, N. J.  
Simplex Wire & Cable Co., Boston  
Standard Underground Cable Co., Pittsburgh  
Western Electric Co., All Principal Cities

#### Asbestos Covered

American Steel & Wire Co., Chicago  
Belden Mfg. Co., Chicago  
General Electric Co., Schenectady

### WIRES AND CABLES—Continued.

#### Automotive

American Steel & Wire Co., Chicago  
Belden Mfg. Co., Chicago  
Boston Ins. Wire & Cable Co., Boston  
General Electric Co., Schenectady  
Habirshaw Cable & Wire Corp., New York  
Kerite Ins. Wire & Cable Co., New York  
Roebing's Sons Co., John A., Trenton, N. J.  
Simplex Wire & Cable Co., Boston  
Standard Underground Cable Co., Pittsburgh  
Western Electric Co., All Principal Cities

#### Bare Copper

American Ins. Wire & Cable Co., Chicago  
American Steel & Wire Co., Chicago  
Anaconda Copper Mining Co., Chicago  
Belden Mfg. Co., Chicago  
Copperweld Steel Co., Rankin, Pa.  
Hazard Manufacturing Co., Wilkes-Barre, Pa.  
Roebing's Sons Co., John A., Trenton, N. J.  
Standard Underground Cable Co., Pittsburgh  
Western Electric Co., All Principal Cities

#### Copper Clad

American Steel & Wire Co., Chicago  
Copperweld Steel Co., Rankin, Pa.  
Standard Underground Cable Co., Pittsburgh  
Western Electric Co., All Principal Cities

#### Flexible Cord

American Steel & Wire Co., Chicago  
Belden Mfg. Co., Chicago  
Boston Ins. Wire & Cable Co., Boston  
General Electric Co., Schenectady  
Hazard Manufacturing Co., Wilkes-Barre, Pa.  
Okonite Company, The, Passaic, N. J.  
Roebing's Sons Co., John A., Trenton, N. J.  
Simplex Wire & Cable Co., Boston  
Standard Underground Cable Co., Pittsburgh  
Western Electric Co., All Principal Cities

#### Heavy Duty Cord

American Steel & Wire Co., Chicago  
Belden Mfg. Co., Chicago  
Hazard Manufacturing Co., Wilkes-Barre, Pa.  
Okonite Company, The, Passaic, N. J.  
Simplex Wire & Cable Co., Boston

#### Fuse

American Steel & Wire Co., Chicago  
General Electric Co., Schenectady  
Roebing's Sons Co., John A., Trenton, N. J.  
Western Electric Co., All Principal Cities

*Lead Covered (Paper and Varnished cambric insulated)*

American Steel & Wire Co., Chicago  
Anaconda Copper Mining Co., Chicago  
General Electric Co., Schenectady  
Habirshaw Cable & Wire Corp., New York  
Hazard Manufacturing Co., Wilkes-Barre, Pa.  
Kerite Ins. Wire & Cable Co., New York  
Okonite Company, The, Passaic, N. J.  
Okonite-Callender Cable Co., The, Inc., Passaic, N. J.  
Roebing's Sons Co., John A., Trenton, N. J.  
Simplex Wire & Cable Co., Boston  
Standard Underground Cable Co., Pittsburgh  
Western Electric Co., All Principal Cities

#### Magnet

American Steel & Wire Co., Chicago  
Belden Mfg. Co., Chicago  
Dudlo Mfg. Corp., Fort Wayne, Ind.  
General Electric Co., Schenectady  
Maring Wire Co., Muskegon, Mich.  
Roebing's Sons Co., John A., Trenton, N. J.  
Standard Underground Cable Co., Pittsburgh  
Western Electric Co., All Principal Cities

#### Rubber Insulated

American Steel & Wire Co., Chicago  
Belden Mfg. Co., Chicago  
Boston Ins. Wire & Cable Co., Boston  
General Electric Co., Schenectady  
Habirshaw Cable & Wire Corp., New York  
Hazard Manufacturing Co., Wilkes-Barre, Pa.  
Kerite Ins. Wire & Cable Co., New York  
Okonite Company, The, Passaic, N. J.  
Roebing's Sons Co., John A., Trenton, N. J.  
Simplex Wire & Cable Co., Boston  
Standard Underground Cable Co., Pittsburgh  
Western Electric Co., All Principal Cities

#### Tree Wire

Hazard Manufacturing Co., Wilkes-Barre, Pa.  
Okonite Company, The, Passaic, N. J.  
Simplex Wire & Cable Co., Boston

#### Trolley

American Steel & Wire Co., Chicago  
Anaconda Copper Mining Co., Chicago  
Copperweld Steel Co., Rankin, Pa.  
Roebing's Sons Co., John A., Trenton, N. J.  
Standard Underground Cable Co., Pittsburgh  
Western Electric Co., All Principal Cities

#### Weatherproof

American Ins. Wire & Cable Co., Chicago  
American Steel & Wire Co., Chicago  
Anaconda Copper Mining Co., Chicago  
Copperweld Steel Co., Rankin, Pa.  
General Electric Co., Schenectady  
Kerite Ins. Wire & Cable Co., New York  
Okonite Company, The, Passaic, N. J.  
Roebing's Sons Co., John A., Trenton, N. J.  
Simplex Wire & Cable Co., Boston  
Standard Underground Cable Co., Pittsburgh  
Western Electric Co., All Principal Cities

# I. P. Morris Corporation

New York Office:  
100 Broadway

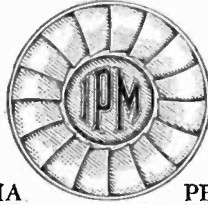

Birmingham Office:  
American Trust Building

PHILADELPHIA PENNSYLVANIA

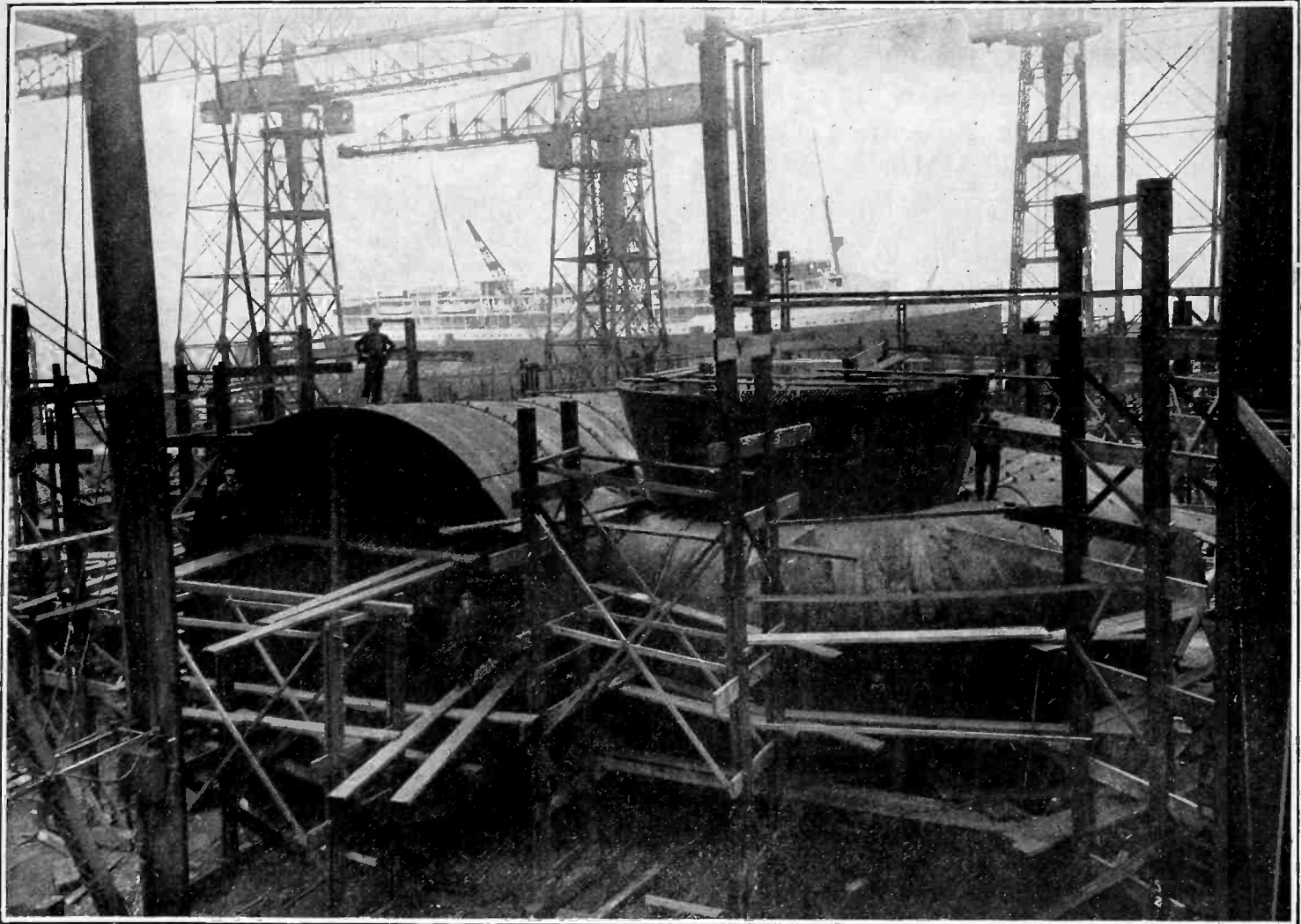

PLATE STEEL VOLUTE CASING FOR ONE OF THE 54,000 HORSEPOWER  
TURBINES TO BE INSTALLED IN THE SUSQUEHANNA POWER  
COMPANY'S CONOWINGO DEVELOPMENT  
HEAD 89 FT. SPEED 81.8 R.P.M.

Largest plate steel casing ever built.

Casing intake diameter 27 ft. 0 in.

Maximum overall width 63 ft. 0 in.

Complete assembly of entire casing prior to shipment insures accurate fitting of all plates and greatly facilitates erection at site.

*Designers and Builders of the Johnson Hydraulic Valve and the Moody Spiral Pump*

ASSOCIATED COMPANIES

THE PELTON WATER WHEEL CO., San Francisco and New York  
DOMINION ENGINEERING WORKS, LTD., Montreal, Canadian Licensees

Please mention the JOURNAL of the A. I. E. E. when writing to advertisers.

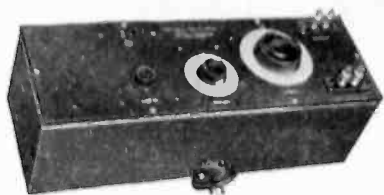

## CAPACITY METER

Type 383-A for the measurement of inter-electrode capacities of vacuum tubes, and other capacities of small magnitude up to 30 MMF.

Type 383-B for accurate measurements of capacities up to 600 MMF. Ideal for matching multiple unit condensers.

Price (either type) ..... \$80.00

Bulletin on request.

### GENERAL RADIO COMPANY

Thirty State Street  
CAMBRIDGE, MASSACHUSETTS

## MANUAL OF ENDURANCE OF METALS UNDER REPEATED STRESS

Heretofore popularly called

*Fatigue of Metals*

A little book for the practical use of Designing, Inspecting, Testing and Operating Engineers. Compiled at the request of Engineering Foundation.

By H. F. MOORE, D. Sc.

Research Professor of Engineering Materials,  
In Charge, Investigation of Fatigue of Metals,  
University of Illinois.

With the cooperation of the directors of  
other important investigations in this field.

In 60 pages of clear statements, tables and diagrams, Professor Moore has condensed much of the usable information gotten by researches occupying several years of work by a score or more of investigators and many advisers, and costing in the aggregate a few hundred thousand dollars.

Bound in cloth, with stiff boards 5x7 inches.

Price \$1.00, postpaid.

Orders and remittances should be sent to

**ENGINEERING FOUNDATION**

29 West 39th Street

New York

## ALPHABETICAL LIST OF ADVERTISERS

	PAGE		PAGE		PAGE
Acme Wire Company, The	59	Ferranti, Incorporated	4	Ohio Brass Company, The	20
Allen-Bradley Company	4th Cover	Ford, Bacon & Davis, Inc.	60	Okonite Company, The	3rd Cover
Allis-Chalmers Manufacturing Co.	29	Fowle & Company, Frank F.	60	Okonite-Callender Cable Co., Inc.	3rd Cover
Ambursen Construction Company, Inc.	60	Frey Engineering Company	60	Olsen Testing Machine Co., Tinius	57
American Bridge Company	43	G & W Electric Specialty Company	15	Ophuls & Hill, Inc.	61
American Insulated Wire & Cable Co.	46	General Electric Company	6, 8, 9, 14, 17, 18	Osgood, Farley	61
American Lava Corporation	58	General Radio Company	68	Pacent Electric Company, Inc.	50
American Lead Pencil Company	51, 52	Gerry, M. H., Jr.	60	Pacific Electric Mfg. Company	40
American Steel & Wire Company	48	Green, A. Barnett	60	Pittsburgh Transformer Company	50
American Transformer Company	7	Gurney Ball Bearing Div. M. R. Co.	56	Prenner, I. S.	61
Anaconda Copper Mining Company	19	Habirshaw Cable & Wire Corporation	5	Public Service Production Company	61
Bakelite Corporation	36	Hazard Manufacturing Company	49	Publication of A. I. E. E.	54
Barstow & Company, Inc., W. S.	60	Hemingray Glass Company	44	Roebing's Sons Company, John A.	46
Batthey & Kipp, Inc.	60	Henry, Augustus M.	60	Rowan Controller Company, The	52
Belden Manufacturing Company	37	Hoosier Engineering Company	60	Sanderson & Porter	61
Black & Veatch	60	Hubbard & Company	2	Sangamo Electric Company	24
Boston Insulated Wire & Cable Co.	46	Irvington Varnish & Insulator Company	59	Sargent & Lundy, Inc.	61
Bristol Company, The	51	Jackson & Moreland	60	Scofield Engineering Company	61
Burke Electric Company	52	Jewell Electrical Instrument Company	25	Sharples Specialty Company, The	41
Burdyn Engineering Co., Inc.	46	Kearney Corporation, James R.	23	Simplex Wire & Cable Company	48
Byllesby Engineering & Management Corp.	60	Kerite Insulated Wire & Cable Co., Inc.	1	Sirrine & Co., J. E.	61
Canadian Porcelain Company, Ltd.	44	K-P-F Electric Company	42	Standard Steel & Bearings, Inc.	58
Century Electric Company	31	Kuhlman Electric Company	10	Standard Underground Cable Company	49
Chandeysson Electric Company	55	Lapp Insulator Company, Inc.	44	Standards, A. I. E. E. (Spanish)	16
Clark, Walter G.	60	Lincoln, E. S.	60	Star Electric Motor Company	52
Classified Advertisements	56	Lincoln Electric Company, The	39	Stevens, John A.	61
Clement, Edward E.	60	Locke Insulator Corporation	12	Stevens & Wood, Inc.	61
Condit Electrical Manufacturing Corp.	21	Manufacturers' & Inventors' Elec. Co.	46	Stockbridge & Borst	61
Copperweld Steel Company	46	Marlin-Rockwell Corporation	56	Stone & Webster, Inc.	13
Corning Glass Works	45	Martindale Electric Co., The	53	Sturtevant, B. F., Company	52
Cramer & Co., Inc., R. W.	50	Mathews Corporation, W. N.	26, 27	Sundh Electric Company	50
Cutter Company, The	38	McClellan & Junkersfeld, Inc.	60	Texas Company, The	69
Danne, Harold A.	60	Metropolitan Device Corporation	70	Thomas, Percy H.	61
Day & Zimmermann, Inc.	60	Minerallac Electric Company	11	Thomas & Sons Company, The R.	42
Delta-Star Electric Company	44	Mintony, John	60	Thoner & Martens	44
Dossert & Company	47	Moloney Electric Company	65	Timken Roller Bearing Company	28
Dubilier Condenser & Radio Corp.	51	Morganite Brush Company, Inc., The	62	Trumbull Steel Company, The	59
Dudlo Manufacturing Corporation	35	Morris Corporation, I. P.	67	U. G. I. Contracting Company, The	61
Duncan Electric Manufacturing Co.	42	National Vulcanized Fibre Company	58	Ward Leonard Electric Company	34
Electric Controller & Mfg. Co., The	33	Neall, N. J.	60	West Va. Pulp & Paper Company	59
Electric Specialty Company	57	Neiler, Rich & Company	60	Western Electric Company	22
Electrical Testing Laboratories	61	New Departure Manufacturing Co., The	3	Westinghouse Elec. & Mfg. Co.	32
Electro Dynamic Company	57	New England Mica Company	58	Weston Electrical Instrument Corp.	53
Engineering Directory	60, 61	Norma-Hoffmann Bearings Corporation	30	White Engineering Corp., The J. G.	61, 63
Engineering Foundation	68			Wireless Specialty Apparatus Company	51
Fansteel Products Company, Inc., The	42			Wray & Company, J. G.	61
Fennessy, David V.	60				

(For classified list of Advertisers see pages 62, 64 and 66.)

Please mention the JOURNAL of the A. I. E. E. when writing to advertisers.

# If the Steam Turbine could be operated on "any kind of oil"—

the lubricating engineer would have little to worry about.

But the modern turbine being what it is—a machine operating under conditions quite different from other types of power units—calls for oils which are especially adapted to its lubricating requirements.

To withstand the high bearing pressures and temperatures, the oils must be of the correct viscosity.

Again, they must be of proper viscosity to be certain to function at the varying degrees of clearance.

And, in order to be sure that the prevailing high speeds will not break up the oil film, the oil must be one that will not emulsify.

The Texas Company, with its years of research and perfection of refining methods has produced a type of steam turbine lubricants which have met with remarkable success under the most unusual conditions.

So that today, to hundreds of steam turbine operators in this country and throughout the world, the selection of the adequate lubricant is no longer a problem. They have found that

## TEXACO REGAL OILS FOR STEAM TURBINES

are uniformly dependable in meeting their most exacting requirements and this is why:

1. TEXACO REGAL OILS conform to the requirements of the U. S. Navy emulsion test.
2. They are refined to the specifications of the National Electric Light Association.
3. They are obtainable in four distinct ranges of Saybolt viscosity at 100° Fahr., as follows:

TEXACO REGAL OIL "A" . . . .	145 Seconds
TEXACO REGAL OIL "B" . . . .	180 Seconds
TEXACO REGAL OIL "C" . . . .	300 Seconds
TEXACO REGAL OIL "E" . . . .	500 Seconds

We shall be glad, at all times, to cooperate with you in the matter of Steam Turbine lubrication; and we would thank you to address your inquiries to our nearest District Office.

### THE TEXAS COMPANY

*Texaco Petroleum Products*

Dept. W6, 17 Battery Place, New York City

OFFICES IN PRINCIPAL CITIES



Every month our magazine "Lubrication" publishes articles of interest to Engineers, Power Plant Executives and all others whose professional activities require an understanding of the economical selection and use of lubricants.

This magazine will be sent to you each month free, if you will just write to the address below.

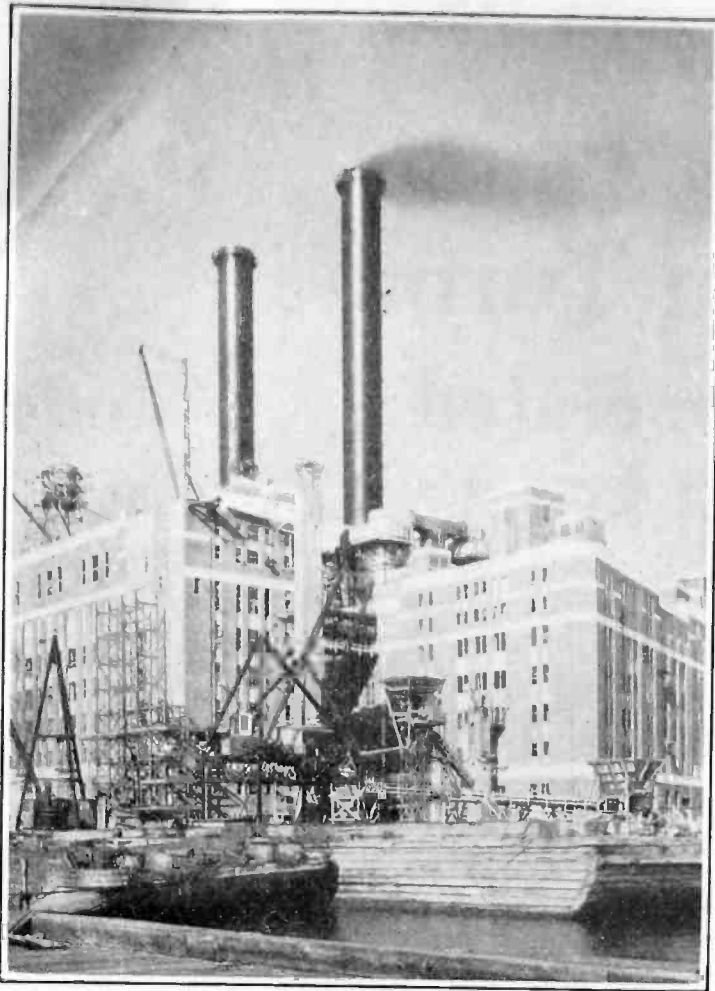

THOMAS E. MURRAY, Inc.  
 Designing and Constructing Engineers  
 New York

**East River Station  
 of the  
 New York Edison Co.  
 protected by**

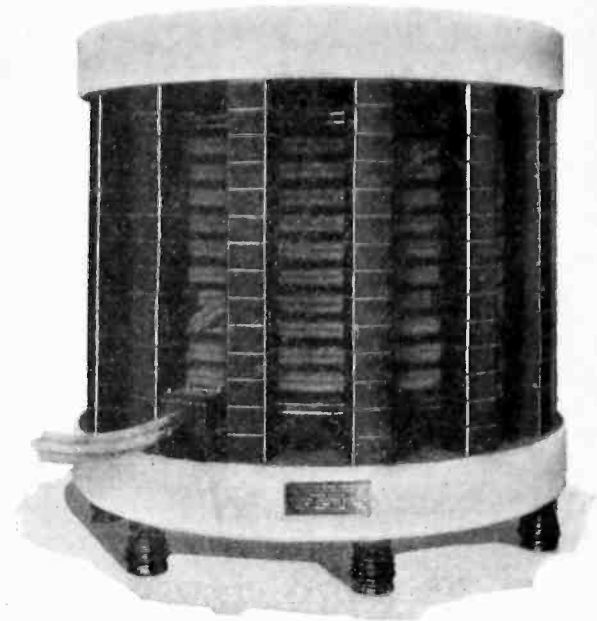

**2000 Kva. bus tie  
 METROPOLITAN Current Limiting Reactors**

Maximum short circuit protection between 60,000 kva. bus sections is provided by reactors rated at 2000 kva., 30+0 amperes, 10%, 11400 volts, 25 cycles. And the generators are protected by 1200 kva., 30+0 amperes, 5% reactors.

When you are in the market for short circuit protection, send us your inquiries.

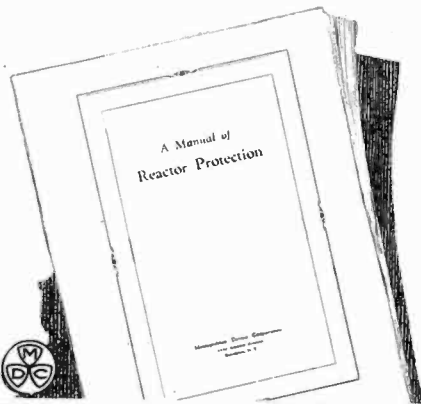

**Metropolitan Device Corporation**  
 1250 Atlantic Avenue  
 BROOKLYN, NEW YORK

**METROPOLITAN DEVICE CORPORATION**  
 1250 Atlantic Avenue, Brooklyn, N. Y.

Gentlemen: Please send me 32-page booklet describing Metropolitan Current Limiting Reactors.

Name ..... Company .....

Address ..... Title .....

Please mention the JOURNAL of the A. I. E. E. when writing to advertisers.

# Scientifically Made Impregnated Paper Cables

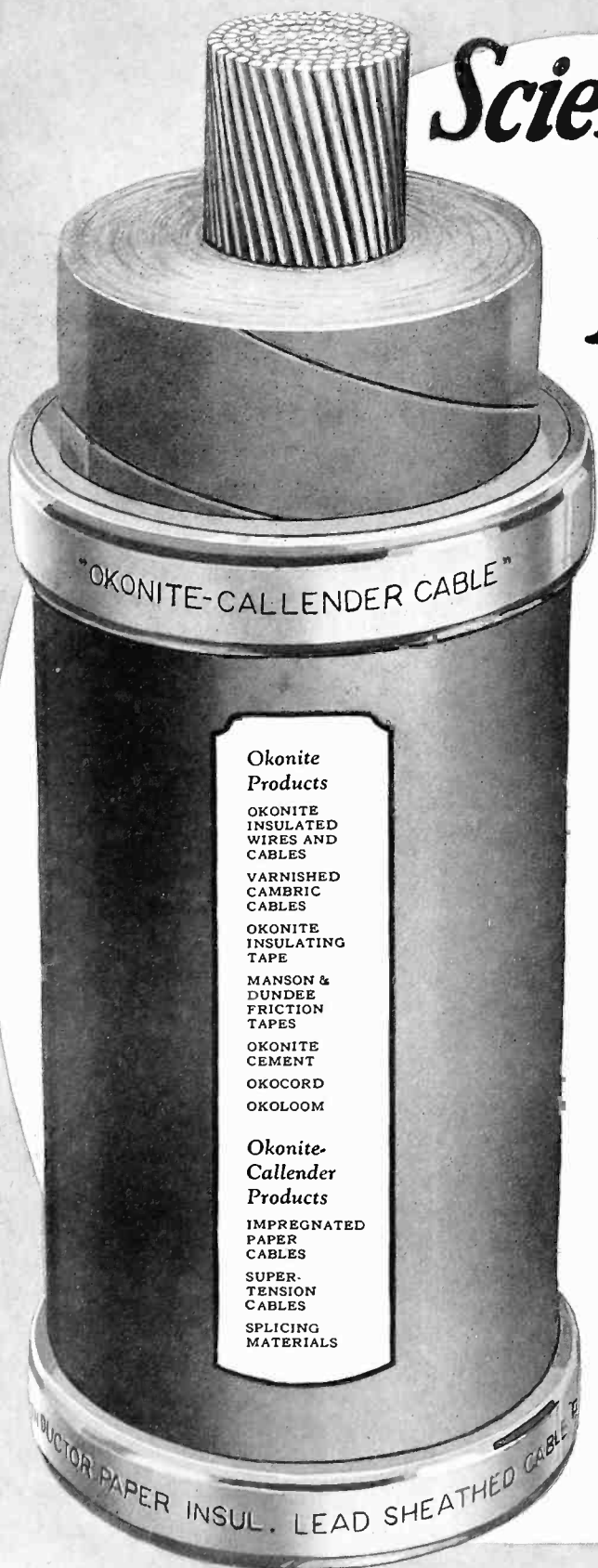

#### Okonite Products

OKONITE  
INSULATED  
WIRES AND  
CABLES  
VARNISHED  
CAMBRIC  
CABLES  
OKONITE  
INSULATING  
TAPE  
MANSON &  
DUNDEE  
FRICTION  
TAPES  
OKONITE  
CEMENT  
OKOCORD  
OKOLOOM

#### Okonite- Callender Products

IMPREGNATED  
PAPER  
CABLES  
SUPER-  
TENSION  
CABLES  
SPlicing  
MATERIALS

**O**KONITE-CALLENDER Impregnated Paper Cables are the result of many years of scientific research and experimenting together with years of practical test in the operating field.

All possible types and kinds of raw materials have been carefully studied both chemically and electrically. Even aging tests of the dielectric under electrical stress have been carried on continuously for more than twenty years.

The result is a Cable that can be depended upon to do the work for which it was designed.

Order Okonite-Callender Impregnated Paper Cables and let their performance tell their story. Our Electrical Research Laboratory and our Engineering Department are at your service to assist you in your cable problems.

## Send For Full Particulars

THE OKONITE COMPANY  
THE OKONITE-CALLENDER CABLE COMPANY, INC.

FACTORIES: PASSAIC, N. J. PATERSON, N. J.

SALES OFFICES: NEW YORK . CHICAGO . PITTSBURGH . ST. LOUIS . ATLANTA  
BIRMINGHAM . SAN FRANCISCO . LOS ANGELES . SEATTLE

Pettingell-Andrews Co., Boston, Mass. F. D. Lawrence Electric Co., Cincinnati, O.  
Novelty Electric Co., Philadelphia, Pa.

Canadian Representatives: Engineering Materials Limited, Montreal  
Cuban Representatives: Victor G. Mendoza Co., Havana



# Compression Resistance Starters Are Superior to Compensators

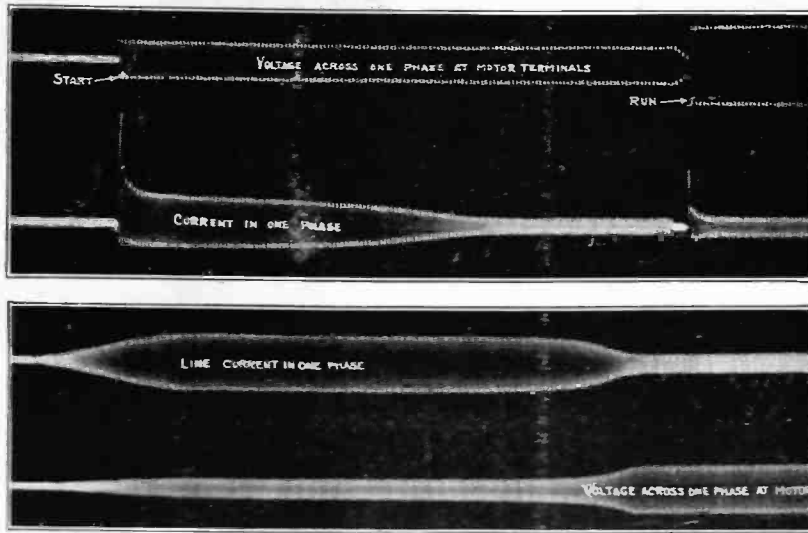

## Jerky Acceleration Is Poor Engineering *That's why the Compensator is a poor Motor Starter!*

A JOLTING start that strains belts, gears, and connected machinery, is characteristic of the induction motor. The blame, however, should be placed on the compensator. It is impractical, from a manufacturing and cost standpoint, to build a compensator with several accelerating steps, because only one speed point is feasible. The compensator must be set high enough to start the motor under all conditions. Hence, the sudden application of the high starting voltage causes a heavy current inrush and a crashing application of torque that exceeds normal requirements. Then, when the motor is switched to line voltage, another jolt occurs, accompanied by a sudden increase of torque and a second severe current inrush.

The compression resistance starter has come

into general use simply because it offers the only satisfactory solution to the problem of starting squirrel-cage motors without jerks or severe current inrushes.

The upper oscillogram of the starting current drawn by a squirrel-cage motor started with a compensator shows two severe current inrushes, one at starting and the other when the motor was switched from starting to running taps. The lower oscillogram shows the marvelously smooth increase of starting current and the total absence of periodic inrushes when the same motor was started with a Compression Resistance Starter. The jerky acceleration, characteristic of compensator starting, is eliminated by using the Allen-Bradley Starter.

Allen-Bradley Compression Resistance Starters, either hand-operated or automatic, offer stepless starting of squirrel-cage motors, up to 500 horse-power. Power companies, confronted with voltage regulation problems on power circuits, should investigate Allen-Bradley Starters.

Use the handy coupon when asking for latest technical bulletin containing oscillograms and tests.



**Allen-Bradley**  
Graphite Compression  
**RESISTANCE STARTERS**  
for Squirrel-Cage Motors

ALLEN-BRADLEY CO.,  
494 Clinton St., Milwaukee, Wis.

Please send me engineering bulletin with oscillograph test of squirrel-cage motor starters.

Name .....

Company .....

Address .....

