

TECHNOLOGY

The big picture The latest in bigscreen formats	18
Hawks, harpoons and de Havilland New choppers for Australian defence force	24
The National Science and Technology Centre Exhibits that are larger than life	32
Heat-seeking missiles Part 1 looks at the development of these deadly weapons	36
Women with the Right Stuff An update on the status of female astronauts in the USA	44
The birth of microelectronics The first integrated circuit	54

INNOVATION

Teleconferencing systems A new unit for group conferences	50
The future now Car of the future - Camry V6	56

ELECTRONICS

ETI-190 Digital diagnosis	66
ETI-1536 The electronic key	72
ETI-293 Dynamo backup	77
ETI-1620 Printer buffer — Part 2	80
Feedforward	88

DEPARTMENTS

Frequency	5
News digest	6
Kilohertz comment	14
Coming events	16
Videotex news	62
Communications news	64
New products	84
Dregs	96

SOUND INSIGHTS

Industry news	98
Sight and sound news	101
CD reviews	103
Having your video cake The Transbeam VCR mixer	104
The NAD 7600 A look at the powerful new hi-fi system from NAD	108

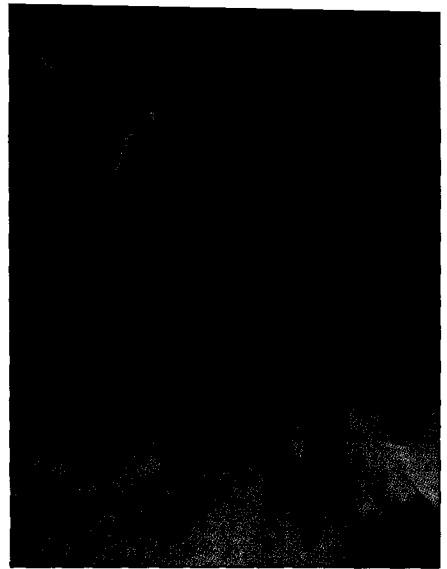

Page 32



Page 36

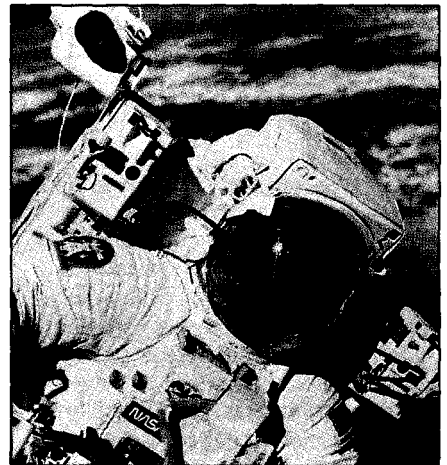

Page 44

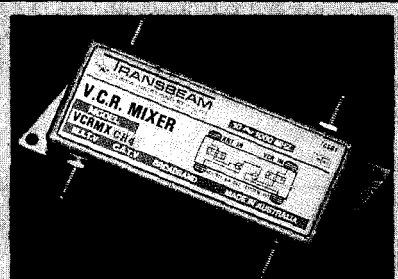

Page 104

Full
industry
standard for
about half the cost.



The BYTEK multiprogrammer makes a concerted effort to give you more for your money.

We're proud to bring you the full range of Bytek programming equipment – one of the most highly regarded brands in the USA. Bytek programmers are Data I/O compatible. You get industry standard performance and flexibility for around half the usual cost.

Yet a Bytek programmer, like the 135 shown here will support more devices than any other programmer. It's actually three programmers in one, giving you:

- a universal devices programmer
- a gang EPROM duplicator
- a set EPROM programmer.

And you can expand its capacity with many advanced

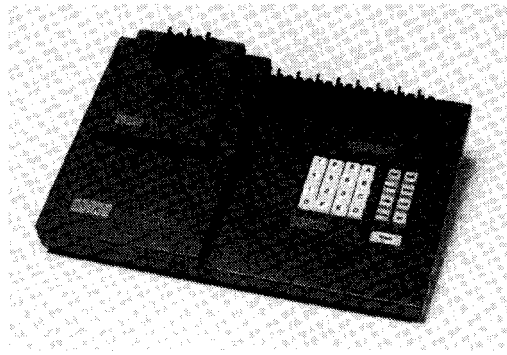

technology port options. Like LOGICel, which supports Logic Array devices or PROMCel for Bipolar PROM devices.

You'll find Bytek programmers suited to microprocessor development and the production environment. And they're backed by our 18

month warranty and Australia-wide service support. You will also receive free device updates for 12 months.

Call us now for full details – and see how much more Bytek programmers offer – for significantly less cost.

BYTEK[®]

SYDNEY:
Centrecourt 25-27 Paul Street Nth,
North Ryde 2113
Tel: (02) 888 8777
Fax: (02) 887 1283

MELBOURNE:
1064 Centre Road,
Oakleigh South 3167
Tel: (03) 575 0222
Fax: (03) 579 0622

PERTH:
106 Howe Street,
Osborne Park 6017
Tel: (09) 242 2000
Fax: (09) 242 2150

QUEENSLAND: (07) 369 1277
SOUTH AUST.: (08) 212 6235
TASMANIA (002) 34 9899

PARAMETERS
PERFECTION IN MEASUREMENT

JBA 213

READER INFO No. 2

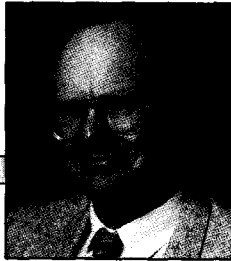

J O N F A I R A L L

The final track

Sadly, this is my last editorial for ETI. I am off to other, although not necessarily greener, pastures. So, after so many years fulminating at the idiosyncrasies of our alleged betters, I thought I might use this space to look at my own small part in the electronics industry, the electronics press.

Time was, and not all that long ago either, when there was only one magazine in the field, and that was Electronics Australia. In 1971, ETI, a totally new concept in publishing, was launched, to national acclaim. Almost overnight, ETI circulation rose to 50% of EA's, and the commercial viability of both titles, with a combined total of almost 100,000, seemed assured.

Today, the scene has changed dramatically. There are now four commercial electronics magazines sold in newsagents, competing with even more free giveaway titles, known collectively, and somewhat strangely, as the 'business press'. As well, a brief skim through the shelves of the local newsagent will show you a gaggle of specialised computer magazines, several on hi-fi and a few on radio.

The number of pages devoted to electronics in one form or another must have jumped tenfold in the last two decades. Unfortunately, the audience hasn't increased by anything like that amount. Today, a good estimate of total circulation for all the technical publications is about 150,000.

'If there is a certain sameness, indeed tameness, about our industry, it is for this reason'

How have we managed? Well, at the very least, it should surprise no one to learn that publishing an electronics magazine is no sinecure, and becoming less so as time goes by. Undoubtedly too, journalists, editors and everyone else involved have become more efficient, learned a few shortcuts or two, and, dare I say it, worked harder than they did before.

There is, obviously, an upside to this. Modern readers have a wealth of titles to choose from, incomparably more than they did twenty years ago. The downside of all that competition is perhaps less obvious. Individual magazines, with less resources to call on, less margin for error, are prepared to take fewer risks and make fewer investments in particular projects.

If there is a certain sameness, and indeed tameness, about our industry, it is for this reason, more than any other.

In this environment, it is strange, but something to be proud of, I think, that we have been able to change ETI as much as we have done over the last year. We have redefined what a popular electronics magazine should be about. In the process, I like to think we have introduced a certain excitement back into an industry that was once known for its pace. More than anything else, ETI has tried to pleasantly surprise you, and we seem to have succeeded. Although these things are difficult to know in detail, it seems that, alone among electronics magazines, our circulation is rising.

I shall miss that excitement.

EDITOR

Jon Fairall B.A.

PRODUCTION EDITOR

Anne Lawton

EDITORIAL STAFF

Terry Kee B.Sc (Hons), M. Phil

DRAUGHTING

Bill Hooker

DESIGNER

Clive Davis

ART STAFF

Ray Eirth

PRODUCTION

Mal Burgess

NATIONAL ADVERTISING

MANAGER

Mark Lewis

ADVERTISING PRODUCTION

Brett Baker

SECRETARY

Nina Stevens

ACOUSTICAL CONSULTANTS

Louis Challis and Associates

PUBLISHER

Michael Hannan

MANAGING EDITOR

Brad Boxall

HEAD OFFICE

180 Bourke Road,
Alexandria, NSW 2015,
PO Box 227, Waterloo, NSW 2017.
Ph: (02) 693 6666.
Federal Facsimile: (02) 693 9935.

ADVERTISING

New South Wales: Kim Bucknole, The
Federal Publishing Company, 180 Bourke
Road, Alexandria, NSW 2015. Ph: (02) 693
6666. Facsimile: (02) 693 9997.

Victoria and Tasmania: Valerie Newton,
The Federal Publishing Company, 221a
Bay Street, Port Melbourne, Vic 3207.
Ph: (03) 646 3111. Facsimile:
(03) 646 5494.

Queensland: John Saunders, The Federal
Publishing Company, 26 Chermiside
Street, Newstead, Qld. Ph: (07) 854 1119.
Facsimile: (07) 252 3692.

South Australia and Northern Territory:
Michael Mullins, C/- Federal Publishing, 98
Jervois Street, Torrensville, SA 5031. Ph:
(08) 352 8666. Facsimile:
(08) 352 6033.

Western Australia: Des McDonald, 48
Cliveeden Street, North Perth 6006 WA.
Ph: (09) 444 4426.

New Zealand: Rugby Press, 3rd Floor,
Communications House, 12 Heather
Street, Parnell, Auckland. Ph: 796 648.
Telex: NZ63112. "Sportby".

Britain: Peter Holloway, C/- John Fairfax &
Sons, 12 Norwich Street, London EC4A 1BH.
Ph: 353 9321.

ELECTRONICS TODAY INTERNATIONAL

is published and distributed monthly by
The Federal Publishing Company Pty
Limited, 180 Bourke Road, Alexandria,
NSW 2015, under licence from Double
Bay Newspapers Pty Limited, General
Newspapers Pty Limited and Fairfax
Community Newspapers Pty Limited.
Printed by Hannanprint, Sydney.

Distributed by Newsagents Direct
Distribution, Alexandria, NSW 2015.
*Maximum and recommended Australian
retail price only. Registered by Australia
Post. Publication No. NBPO407. ISSN No.
0013-5216. COPYRIGHT © 1985, Double
Bay Newspapers Pty Limited, General
Newspapers Pty Limited and Fairfax
Community Newspapers Pty Limited
(trading as "Eastern Suburbs
Newspapers").



Industry News



David Frazer

Australian cable and components distributor, Acme Electronics, has promoted David Frazer to the position of general manager.

Frazer, 43, has held senior sales and management positions with the company for more than 10 years. He will be responsible for the company's Australian and New Zealand operations.



Kevin Sullivan

Several other appointments have also been announced. Kevin Sullivan, 43, is Victorian sales manager. He has had more than 14 years experience in the electronics and components industry, in sales and administration positions. Michael Fabricato, Fiona O'Hehir, and Rino Cararo have been appointed as area managers, based in the Melbourne head office. David Jago and Luke Barlow have been appointed area managers and will be based in the Sydney office.

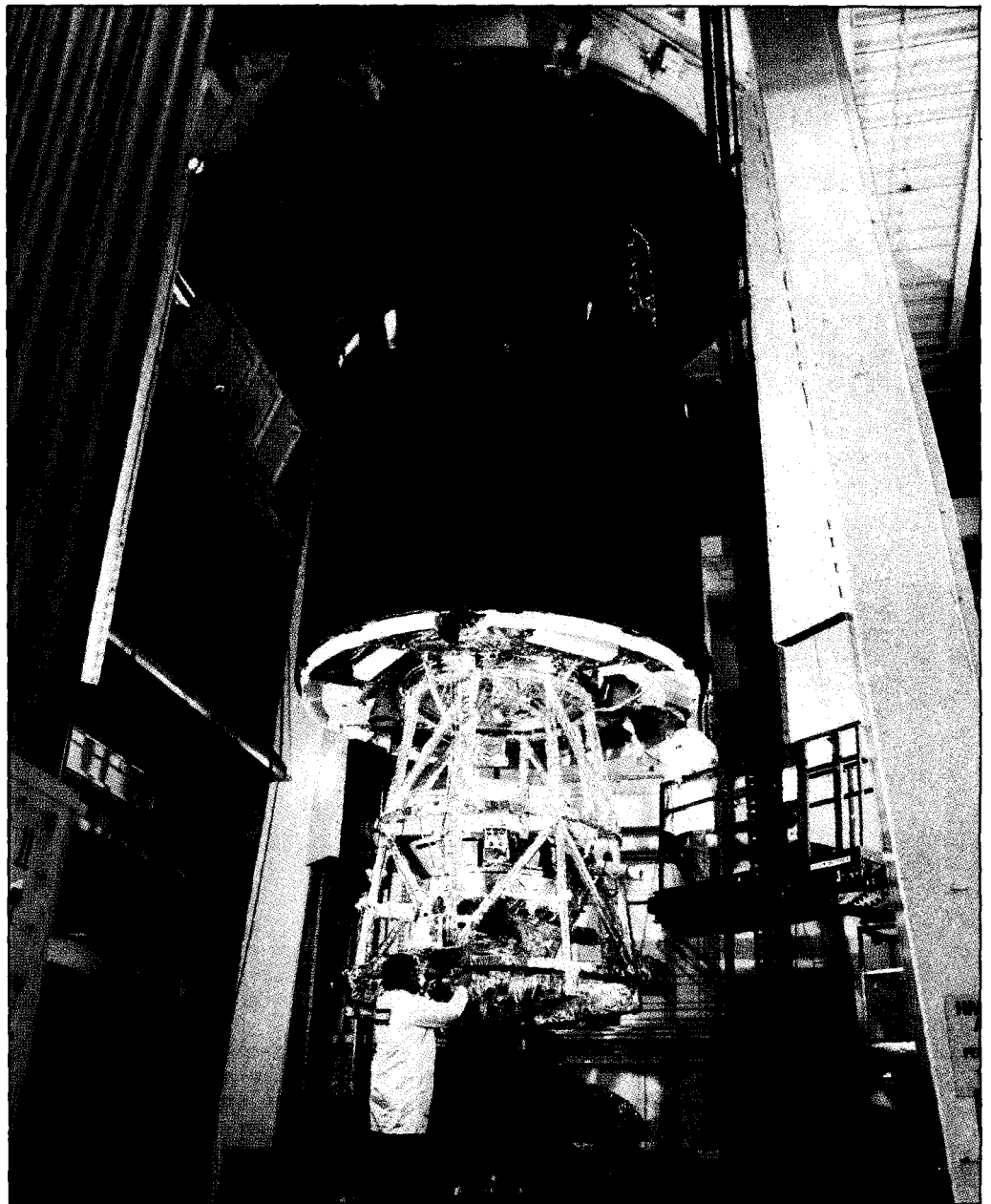

Japan's satellites tested

THE first of two JCSAT satellites – Japan's first commercial communications spacecraft – has undergone testing at Hughes Aircraft Company's simulation laboratories in Los Angeles before being shipped to Kourou, French Guyana, for launch by Ariane rocket early this year. The satellite was sealed for two weeks inside an overhead thermal vacuum chamber which duplicates the harsh environment of outer space. The JCSAT satellites are owned by Japan Communications Satellite Company.

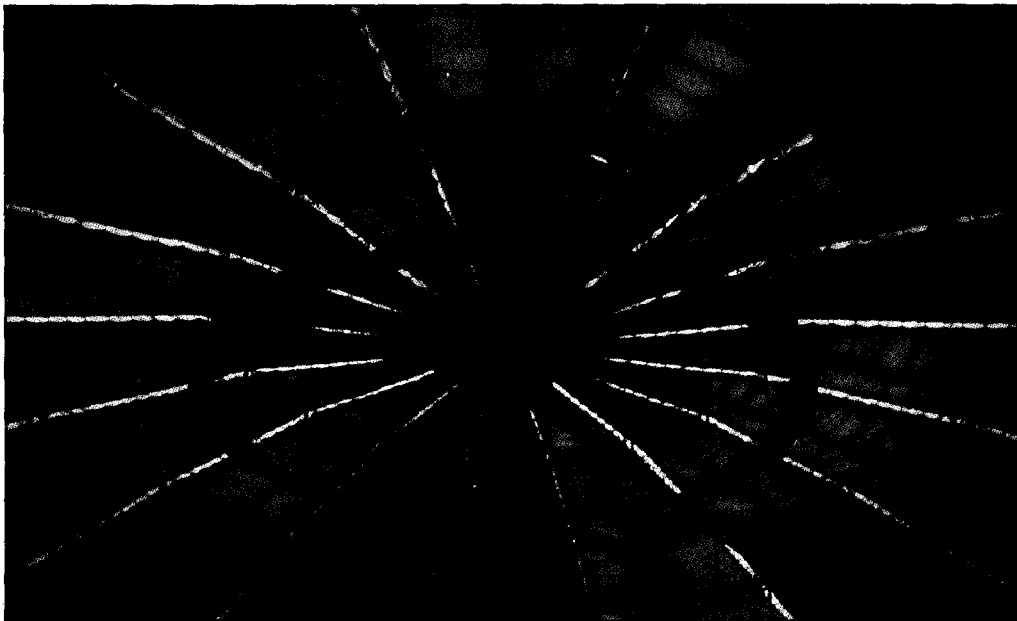

Seoul wins gold — again

The first International Awards for Technology in Architecture gathered five finalists from all over the globe. Two of the five finalists were Australian, but the winning entry was the amazing Seoul Olympics Gymnastic Hall.

The roof structure of the Seoul Gym hall is made from steel cables covered with a translucent silicone fibre glass fabric which is extremely light (and could be assembled in less than quarter of the time a conventional steel roof would have taken), self cleaning and permits light through to reduce the cost of artificial lighting.

Australia's two finalists were the new IBM headquarters in Sydney and a collection of buildings from the architectural firm of Phillip Cox, Richardson, Taylor and Partners. The collection included the Exhibition Centre at Darling Harbour, the Sydney Football Stadium and the National Tennis Centre in Melbourne.

Devine Erby Mazlin's design of

the IBM centre was singled out because of its very high-tech computer control over many of the building's operating functions. Part of the innovation evident in the building is the use of waste computer heat for water and space heating. Up to 1300kW of waste heat was available from the computers and this would have normally been vented directly to air.

A consultant ornithologist was employed during the planning and design of the building to make sure the development didn't upset bird life in the fragile French's Forest region where the building was erected. A sophisticated system of cleaning water run-off from car parks meant that the water being returned to the forest area was as close as possible to natural rain water.

The Darling Harbour Exhibition Centre uses external trusses to support the very large roof area for maximum internal space free from pillars. The enormous steel

towers and cables on the outside of the centre do actually achieve some purpose other than startling aesthetics.

The Maritime Museum also uses large spans of steel to achieve a huge interior for the display of maritime relics. One of the architects of the Maritime Museum, Ms Jenny Watt, was also a designer on the innovative Biennale building in Venice. This is the first time Australia has had a permanent exhibition there. The building was planned and made in Australia and then shipped to Italy for construction.

The interest aroused by the awards has been so great internationally that next year's event is proving to be even bigger. Apart from the kudos which accrued to architects winning — or even being mentioned in such an award — it spreads knowledge of new techniques being used for building. Australia is at the forefront of high technology architecture.

Industry News

A new advisory service dedicated exclusively to helping Australian companies to do business in the USA has been formed in California.

The Ayers Group, headquartered in Santa Monica, combines more than 100 years of business and legal experience ranging over corporate legal representation, mergers and acquisitions, civil and defence offsets and a broad range of more traditional consulting services.

The five principals of The Ayers Group are Michael Angel and Douglas Neistat, the two senior partners of the Los Angeles law firm, Angel and Neistat; John Britton, a former regional director of Hughes Aircraft Company, the satellite/defence manufacturer, and Robert Campion and Robert Grant, respectively former chairman and chief executive and former senior vice-president, corporate development of Lear Siegler, the international aerospace, automotive and commercial products manufacturer.

Angel and Neistat have acted for a number of Australian clients, including the Australian Government. Britton is well known in Australia for which he had a regional responsibility until he retired from Hughes.

★ ★ ★

MM Cables is the new cable division of Metal Manufactures Limited. The new division has been formed out of several cable companies that recently became members of the Metal Manufactures Group, Austral Standard Cables (ASC), Cable Makers Australia (CMA) and Austral Data Networks (ADN).

Phase 2 of residential optical fibre trials

TELECOM Australia has commenced Phase 2 of its residential optical fibre trials in Sydney's Centennial Park area.

Phase 2 involves multi channel video distribution, with participants in the trial receiving ABC and SBS transmissions and Telecom-produced educational videos. Provision has also been made for a fourth split-screen channel to give viewers a 'run down' on all programs available.

Transmission of these signals via an optical fibre network means a clearer picture quality and less sound distortion, even in those areas which currently experience difficulty in picking up the ABC and SBS programs because of high-rise buildings or electrical interference.

The signals are transmitted from the respective television stations to the Television Operating Centre in Telecom's City South Exchange where signal quality is closely monitored. From there the signal is transmitted to the East Exchange and on to the customer's premises.

One significant advantage of optical fibre is that no modifications are necessary to television sets or aerials. The optical fibres are connected to a decoder box placed at a convenient location and from there normal coaxial cable is run to the television set.

Phase 1 of the trial involved the provision of basic telephony to the sixty participants in the trial with the current program, available to about 10% of the participants, scheduled to run for two years. The success of the trials will bring Australia one step closer to the 'intelligent home', with interactive information videos, home video conferencing, electronic mail and the ability to electronically transfer funds for the payment of electricity, telephone, gas and many other accounts.

For more information contact John Turner on (02) 263 1840.

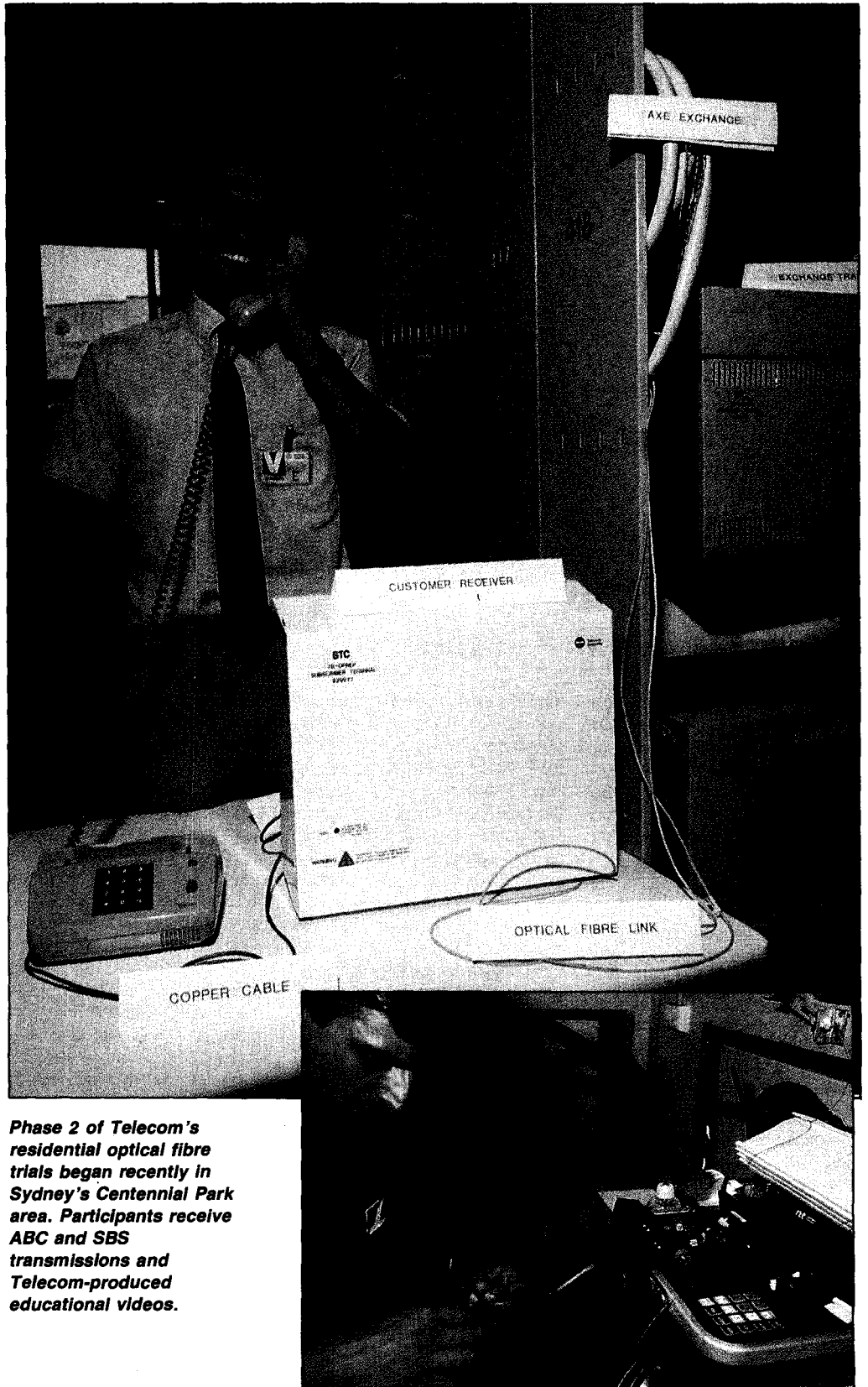

Phase 2 of Telecom's residential optical fibre trials began recently in Sydney's Centennial Park area. Participants receive ABC and SBS transmissions and Telecom-produced educational videos.

Ericsson gets bonus order

ERICSSON has won three orders, worth a total of \$55m, from Telecom Australia. The first order, a contract worth \$11.7m, is a bonus order for on-time delivery of AXE equipment during the first quarter of 1988.

The second order is for a group of contracts worth \$17.6m, covering AXE exchange equipment and technical development and support, as well as rural exchange equipment. The development of the rural exchange was a joint development between Telecom Australia and Ericsson. The exchanges now cover up to 2000 subscribers.

In July, this year, the number of AXE lines in service in the Australia public switched telephone network passed the one million mark. The installation of AXE lines has increased

dramatically during the last two years. All together, there are more than 7 million telephone lines in the Australian public network. Today, the Australian public telephone network comprises 193 AXE exchanges, 26 of them rural exchanges and 436 remote subscriber sites.

The third order, also a group of contracts, is valued at \$24.8m and covers the delivery of radio base station equipment and AXE mobile switch equipment to be used in the AXE-based cellular mobile telephony network. The network is growing rapidly and now has 55,000 subscribers in the major metropolitan areas. Ericsson manufactures the radio base station equipment for the entire network at its Broadmeadows plant.

For more information contact Chris Viviere on (03) 309 2244.

President of Terasaki inspects NHP premises



PRESIDENT of Terasaki Japan, Mr Y Terasaki, accompanied by his wife and son, inspected NHP's new premises recently in Richmond, Vic. The premises are used exclusively for housing the assembly of Terasaki circuit breakers and related support products.

Mr Terasaki, who was in

Australia to participate in NHP's 20th Anniversary celebrations, indicated his company was satisfied with NHP's marketing of Terasaki circuit breakers in Australia and pledged Terasaki Japan's continuing support in the areas of new product development and technical back-up.

COUNT ON EXIDE FOR MORE THAN BATTERIES

ASK other battery suppliers for batteries and you'll get batteries.

Ask EXIDE and you'll get total packaged power solutions.

The difference is that batteries, chargers, inverters, everything, end up performance-matched for a long trouble-free life.

So if you design or maintain standby, alarm or security systems, UPS, solar power, remote repeater stations, portable powered equipment or telecommunications, call the EXIDE HOTLINE now, toll free.

008 02 3785.



PACIFIC DUNLOP BATTERIES

Industrial Division

Home of Exide packaged power.



XT* TURBO MOTHERBOARD

- 8MHz
- 8088 Processor
- Expandable to 640K on board.
- Provisions for up to 6 x 2732 EPROMs on board
- Keyboard connector
- 8 Expansion slots

X18030 (excl. RAM) **\$135**

X18031 (incl. 640K RAM) **\$699**



10 MHz XT* TURBO MOTHERBOARD

- Increase the performance of your sluggish XT* approximately four times with this super fast motherboard.
- 8088-2 running at 10 MHz, no wait state
 - Turbo/Normal selectable
 - 640K fitted
 - 8 Expansion slots
 - 4 Channel DMA
 - Keyboard port

Excluding RAM . **\$199**

Including RAM) . **\$749**

BABY AT* MOTHERBOARD (WITHOUT MEMORY)

- 6/10 MHz system clock with zero wait state. 12 MHz, 1 wait state.
- 80286-10 Microprocessor
- Hardware and software switchable
- Socket for 80287 numeric data co-processor
- 64K ROM
- Phoenix BIOS
- 8 Expansion slots

X18200 (excl. RAM) **\$689**

X18201 (incl. 2MB RAM) **\$1,649**

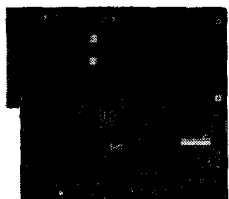

6/10 MHz AT* MAIN BOARD

- 6/10 MHz system clock with zero wait state
- Hardware and software switches for alternative system clock.
- Rechargeable battery backup for CMOS configuration table and real time clock.
- 80286-10 microprocessor
- Socket for 80287 numeric data co-processor
- 256KB, 512KB, 640KB, or 1,024KB RAM
- 64KB ROM, expandable to 128KB
- 8 Input/Output slots
- Hardware reset jumper
- Power and turbo LED connector
- Phoenix BIOS

X18100 (Excl. RAM) **\$689**

386 MAIN BOARD

- Intel 80386 CPU (16MHz)
- Socket for 80387 Math co-processor
- 32 bit BUS system, 1 M/Byte or 640K on board memory
- Built-in speaker attachment
- Battery backup for CMOS configuration table and real time clock.
- Keyboard controller and attachment
- 7 Channel DMA
- 16 Level interrupts
- 3 Programmable timers
- 8 System expansion I/O slots: 5 with a 36 pin and a 62 pin expansion slot 2 with only the 62 pin expansion slots 1 with two 62 pin expansion slots (32 bit BUS)

X18101 without RAM **\$2,390**

X18103 1 M/Byte RAM **\$2,960**

X18105 2 M/Byte RAM **\$3,500**

EXTENDED 3-5 M/BYTE CARD

- AT* compatible only
- X18056 Without RAM . **\$299**

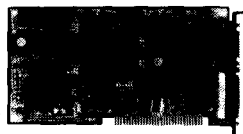

MULTI I/O & DISK CONTROLLER CARD

This card will control 2 x double sided, double density drives, and features a serial port, a parallel port, and a joystick port or games port. It also has a clock/calendar generator with battery backup.

Cat. X18040 **\$145**

HARD DISK CONTROLLER CARDS

X18060 (XT) **\$190**

X18140 (AT) **\$290**



FLOPPY DISK DRIVE CONTROLLER CARD

These cards will control up to 2 or 4 double sided 360K IBM* compatible disk drives.

X18005 (2 Drives)... **\$52**

FLOPPY DISK DRIVE CONTROLLER CARD

- Supports 1-4MB, 1-2MB, 720K, 360K
- PC*/XT*/AT* compatible
- 5 1/4" and 3 1/2" drives

X18009 **\$139**

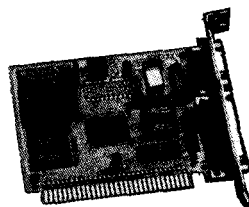

GRAPHICS CARD

- Hercules compatible
- Interface to TTL monochrome monitor
- One Centronics parallel printer port
- 2K-Static RAM, 64K Dynamic RAM
- Display Mode: 720 dots x 348 lines

Cat. X18003 **\$139**

COLOUR GRAPHICS CARD

This card plugs straight into I/O slot and gives RGB or composite video in monochrome to a monitor.

Colour graphics: 320 dots x 200 lines.

Mono graphics: 640 dots x 200 lines.

Cat. X18002 **\$99**

ENHANCED GRAPHICS ADAPTOR CARD

- Auto switch CGA, EGA, & Hercules*
- Full 256K video RAM
- Flicker free scrolling
- Standards: 320 x 200, 640 x 200, 640 x 348, and 720 x 348.
- Short slot
- XT* & AT* compatible

X18070 **\$330**

PRINTER CARD

This card features a parallel interface for Centronics printers. Included is printer data port, printer control port, and printer status port.

Cat. X18017 **\$29**

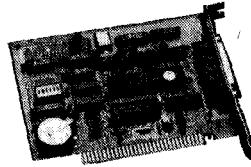

RS232 & CLOCK CARD (WITHOUT CABLE)

This RS232 card supports 1 asynchronous communication ports. Programmable baud rate generator allows operation from 50 baud to 9600 baud. Fully buffered. Clock includes battery back-up and software.

Cat. X18028 **\$65**

RS232 (SERIAL) CARD (WITHOUT CABLE)

This RS232 card supports 2 asynchronous communication ports. Programmable baud rate generator allows operation from 50 baud to 9600 baud. Fully buffered. First serial port is configured as Comm.1 Second serial port is optional and configured as Comm.2.

Cat. X18026 **\$49**

SERIAL/PARALLEL/GAMES CARD

- PC*/XT*/AT* compatible
- 1 Parallel port three port addresses selectable (378, 278, 3BC) and disable.
- Serial port: 2 serial ports available, both can be set to address comm 1, 2, 3, or 4
- Game adaptor: 2 joysticks can be connected. Paddles must be 0 - 100K range.

X18151 **\$115**

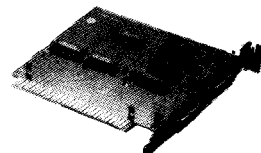

GAMES I/O CARD

Features two joystick ports. (DB15).

Cat. X18019 **\$29**

CLOCK CARD

Complete clock card including battery back-up and software.

Cat. X18024 **\$55**

I/O PLUS CARD

Provides a serial port, a parallel port and a joystick port, and even a clock/calendar with battery backup!

Cat. X18045 **\$119**

EPROM PROGRAMMER CARD

- Programs 2716, 2732, 2732A, 2764, 2764A, 27128, 27128A, 27256, 27256A, 27512, 27512A, 27C64, 27C128, 27C256, 27C512
- Software set program voltage: 12-5, 21, 25
- Software: Write, read, verify, blank, check, copy, files, process.
- Intelligent programming method: 2716 6 sec. 2732 12 sec. 2764 24 sec. 27128 48 sec. 27256 96 sec. 27512 300 sec.

X18022 **\$245**

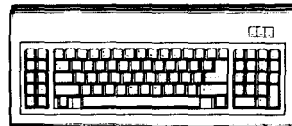

"IBM* XT* TYPE" KEYBOARD

- 100% IBM* PC*, XT* compatible,
- 84 keys, including function keys, and a numeric keypad
- low profile keyboard design,
- proper placement of shift keys with large key tops to suit professional typists
- 3 step height/angle adjustment.
- Curl lead plugs straight into IBM* PC/XT
- Status displays, Power, Cap Lock and Numeric Lock

Just like the "real McCoy" only at a fraction of the price! Why pay more?

Cat. X12020 **\$89**

IBM* COMPATIBLE EXTENDED KEYBOARD (101 KEYS)

- These new keyboards are both XT* and AT* compatible!
- 12 Dedicated function keys
- Enlarged "Return" and "Shift" key
- Positive feel keys
- Low Profile Design, DIN standard
- Separate Numeric and Cursor control keypads
- Additional Functions: Key-in-Lock, Previous Word, Next Work, Fast Repeat, Line Feed, Pause, Reset, Clear Screen

Cat. X12022. only **\$109**

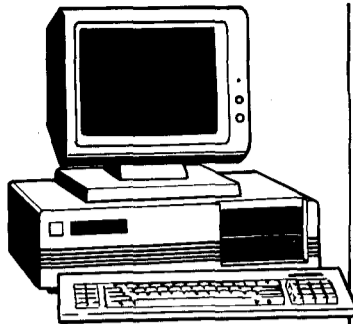

IBM* XT* COMPATIBLE COMPUTERS FROM \$995

Check these features and our prices. They're exceptional value for money!

- Final assembling and testing in Australia!
- Fast TURBO Motherboard
- AT* style keyboard
- Tested by us for 24 hours prior to delivery!
- 8 Slot motherboard
- 12 months warranty!
- 150W power supply

*** \$995 WORKSTATION COMPATIBLE COMPUTER**

256K RAM Single Drive, Graphics and Disk Controller Card. \$995

640K RAM TURBO COMPATIBLE COMPUTER

2 x 360K Disk Drives, Multifunction Card, Colour Graphics, Disk Controller, 1 Serial, Parallel Port. (Includes Timer Disk). \$1,195

WITH 20 M/BYTE HARD DISK:
& single 360K Floppy Disk Drive...\$1,495
& dual 360K Floppy Disk Drives...\$1,895

WITH 40 M/BYTE HARD DISK:
& single 360K Floppy Disk Drive...\$1,695
& dual 360K Floppy Disk Drives...\$1,895

WITH 80 M/BYTE HARD DISK:
& single 360K Floppy Disk Drive .. CALL
& dual 360K Floppy Disk Drives .. CALL



IBM* XT* COMPATIBLE CASE
XT* size and styling. Features security key switch, 8 slots, and mounting accessories. Size: 490(W) x 390(D) x 140(H)

Cat. X11090 \$69

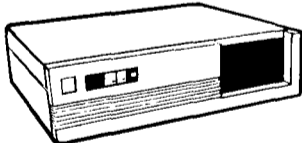

IBM* XT* COMPATIBLE CASE AT* STYLING

Now you can have the latest AT* styling in a XT* size case. Features security key switch, 8 slots, and mounting accessories. Size: 490(W) x 145(H) x 400(D)

Cat. X11091 \$99

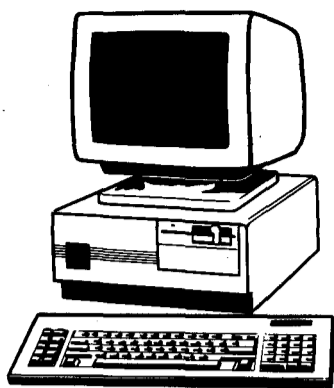

BABY AT* COMPATIBLE COMPUTER!

2 M/Byte RAM \$2,695

- Final assembling and testing in Australia!
- 4 M/Byte Main Board, 2 M/Byte fitted
- Switchable 8/10/12 MHz
- 1.2 M/Byte Floppy Disk Drive
- 80286 CPU
- Colour Graphics Display Card
- 8 Slots
- Floppy & Hard Disk Controller
- Printer Card and RS232
- Keyboard
- 200W Power Supply
- Manual
- 6 Months Warranty
- Size: 360(W) x 175(H) x 405(D)mm

WITH 20 M/BYTE HARD DISK \$2,695
WITH 40 M/BYTE HARD DISK \$2,895
WITH 80 M/BYTE HARD DISK CALL

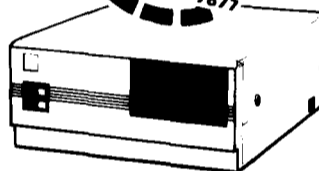

BABY AT* STYLE COMPUTER CASING

Our latest computer casing, featuring security key switch, 8 slots, and mounting accessories etc.

Size: 360(W) x 175(H) x 405(D)
Cat.X11093 **ONLY \$99**

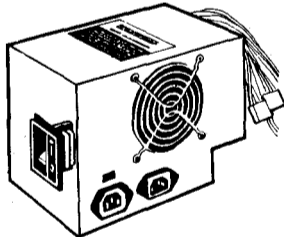

200W SWITCH MODE POWER SUPPLY FOR IBM* AT* & COMPATIBLE

DC OUTPUT: +5/16A, -5V/0.5A
+12V/5A -12V/0.5A

Cat. X11097 \$199

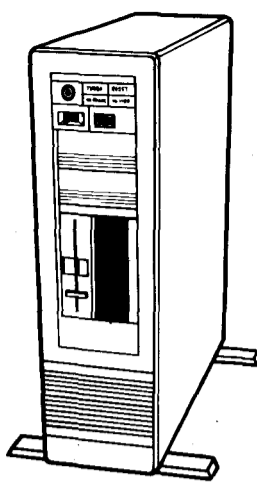

386 TOWER PC

The 386 Tower PC is a high performance system that's IBM*AT* compatible. However, the 386 Tower PC gives you 2-5 times the performance.

- FEATURES:**
- Intel 80386-16MHz microprocessor
 - Switchable 16/20 MHz
 - 2 M/Byte fitted. Total memory expandable up to 16 M/Bytes.
 - Up to 2 M/Byte or 8 M/Byte RAM modules on system board or on RAM card
 - Option for 80287 & 80387 co-processor socket
 - Operates in page mode with interleave memory subsystem
 - Shadow RAM supported to allow system BIOS to be executed on system memory instead of slower EPROM
 - Four 16-bit I/O slot. Three 8-bit I/O slot, and one 32-bit memory slot.
 - 8042 keyboard controller interface for AT* compatible keyboard
 - Seven direct memory access (DMA) channels
 - Chips and Technology chip set
 - AMI 386 BIOS / Phoenix 386 BIOS / AWARD 386 BIOS (AMI fitted)
 - 50 M/Byte Miniscribe hard disk. Fast access. Formatted to 42 M/Byte.
 - EGA card

\$5,995

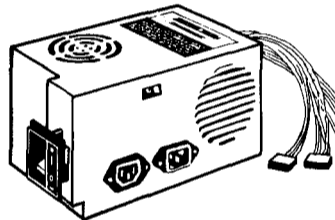

150W SWITCH MODE POWER SUPPLY FOR IBM* PC*/XT* & COMPATIBLE

DC OUTPUT: +5/13A, -5V/0.5A
+12V/4.5A -12V/0.5A

Cat. X11096 \$129

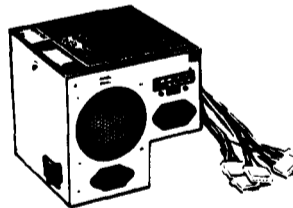

180W SWITCH MODE POWER SUPPLY FOR BABY AT* COMPATIBLES

Cat. X11098 \$199

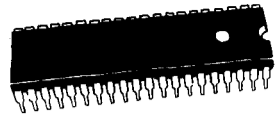

8087 CHIPS

GENUINE INTEL CHIPS WITH MANUAL AND DATA SHEETS PACKED IN BOXES

8087-3 (4.77MHz)	\$245
8087-2 (8MHz)	\$350
8087-1 (10MHz)	\$475
80287-6 (6MHz)	\$375
80287-8 (8MHz)	\$555
80287-10 (10MHz)	\$690
80387-16 (16MHz)	\$995
80387-20 (20MHz)	\$1460
80387-25 (25MHz)	\$1860



ROD IRVING ELECTRONICS

MELBOURNE: 48 A Beckett St. Phone (03) 663 6151
NORTHCOLE: 425 High St. Phone (03) 489 8866
SYDNEY: 74 Parramatta Rd, Stanmore Phone (02) 519 3134 Fax (02) 519 3868
CLAYTON: 56 Renver Rd. Phone (03) 543 7877
MAIL ORDER & CORRESPONDENCE:
P. O. Box 620, CLAYTON 3168
Mail Order Hotline:
STD Orders: 008 33 5757 Orders only
Local Orders: 543 7877
Inquiries: (03) 543 7877
Telex: AA 151938
Fax: (03) 543 2648



MAIL ORDER HOTLINE 008 335757

(TOLL FREE, STRICTLY ORDERS ONLY)

LOCAL ORDERS & INQUIRIES (03) 543 7877

POSTAGE RATES:

\$1 - \$9.99	\$2.00
\$10 - \$24.99	\$3.00
\$25 - \$49.99	\$4.00
\$50 - \$99.99	\$5.00
\$100 plus	\$7.50

The above postage rates are for basic postage only. Road Freight, bulky and fragile items will be charged at different rates.

All Wholesale and Sales Tax Exempt inquiries to:

RITRONICS WHOLESALE,
56 Renver Road, Clayton.
Phone: (03) 543 2166 (4 lines)
Fax: (03) 543 2648

Errors and omissions excepted. Prices and specifications subject to change
IBM*, PC*, XT*, AT* are registered trademarks of International Business Machines. Apple is a registered trademark.
*Denotes registered trademarks of their respective owners.



Industrial Containers' WorkCare Award

INDUSTRIAL Containers has won a WorkCare Prevention Award for design and manufacture of the Roll-Waste, a waste container which offers new safety and hygiene standards in waste storage and collection.

Presenting the award on behalf of the Minister for Labour, Steve Crabb, chairperson of the Victorian Occupational Health and Safety Commission, Barry Durham, said that Industrial Containers was the seventh company to win a WorkCare Award in 1988.

Mr Durham said the new container incorporates a range of safety features which reduce the risk of manual handling injuries and eliminate the risk of death by accidental lid closure.

"An ergonomic report commissioned by the company found the energy required to open and close the roll-top lid is far less than that required to lift the weight of the flat lid

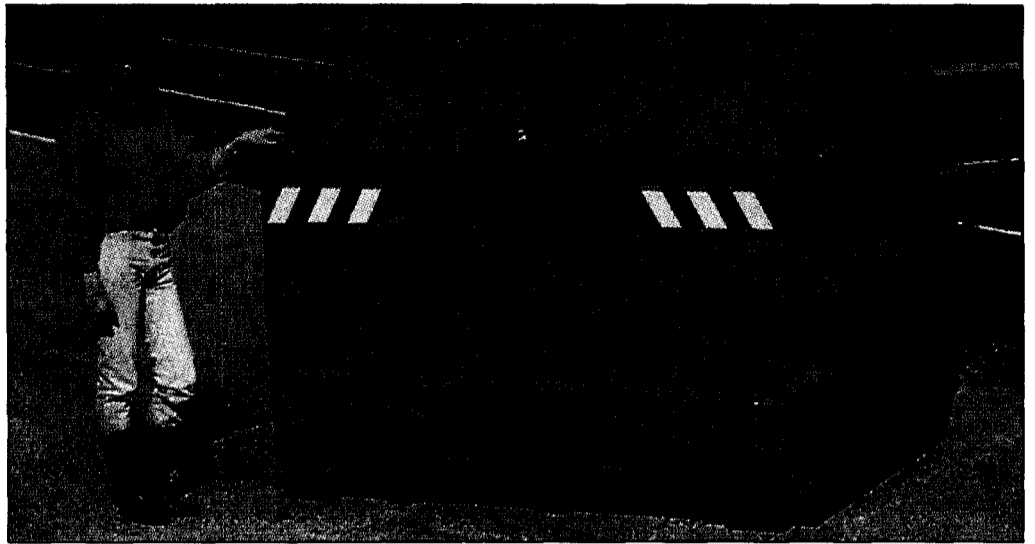

containers," he said. The "rolling action" and counterbalance spring system prevent sudden and forceful closure of the lid.

"Opening and closing of the curved lid are now done in a smooth action which can be

easily controlled. In the event of an uncontrolled closure the lid edge has a rubber flap which actually forms the final closure and seal to lessen the risk of injury."

Other features of the container

include use of metal forming to reduce the weight of the container and ease of use for contractors moving the bins.

More details from Industrial Containers, (03) 338 1753, fax (03) 338 9540.

National microwave technology facility in Sydney

AS a major step in the development and commercialisation of Australia's microwave industry, a national facility has opened in Sydney to provide expertise, education and local industry resources in this area of high technology.

The Sydney Microwave Design Resources Centre (SMDRC), established by the University of Sydney and University of Technology in Sydney, in association with Hewlett-Packard Australia, will develop Australian

expertise and technology in the applications of microwave science.

Microwave technology has been identified as a key area for sustained growth in the information industry. Some avenues of research to be undertaken at the new centre will include space- and earth-based communications, solid-state electronic devices and digital techniques, gallium arsenide integrated circuits, computer-aided design and

manufacturing of microwave circuits.

Other applications in the area of microwave technology include industrial heating, aircraft landing systems and mobile cellular radio systems.

The new centre, located at Sydney University's Department of Electrical Engineering, will provide an Australian focus for the development of this industry and help to alleviate the current critical shortage of skilled microwave engineers and

technicians in this country.

Hewlett-Packard Australia provided the centre with the most advanced equipment and microwave design software available worldwide.

Hewlett-Packard Australia's managing director, Malcolm Kerr, who opened the centre said the company's involvement in establishing the SMDRC was one of a series of strategic donation projects by HP to assist Government in fostering a solid and profitable high-tech industry.

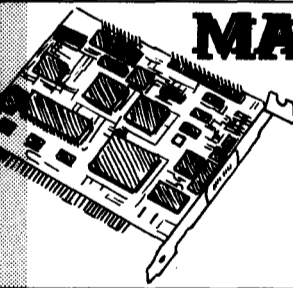
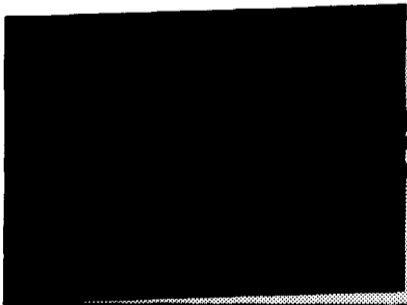

MAXIDATA

P.O. Box 2316 Brighton North 3186
Phone: (03) 698 0264

Services:

- ★ Layout
- ★ Editing
- ★ Pen plots
- ★ Checkplots
- ★ Netlists
- ★ N/C drill output
- ★ P.C.B. assembly

Professional P.C.B. layout

- ★ Single sided boards
- ★ Double sided boards
- ★ Multi-layer boards
- ★ Surface mounted devices

Specialists in:

Fast - Accurate - Quality Service

You have to hand it to Schlumberger

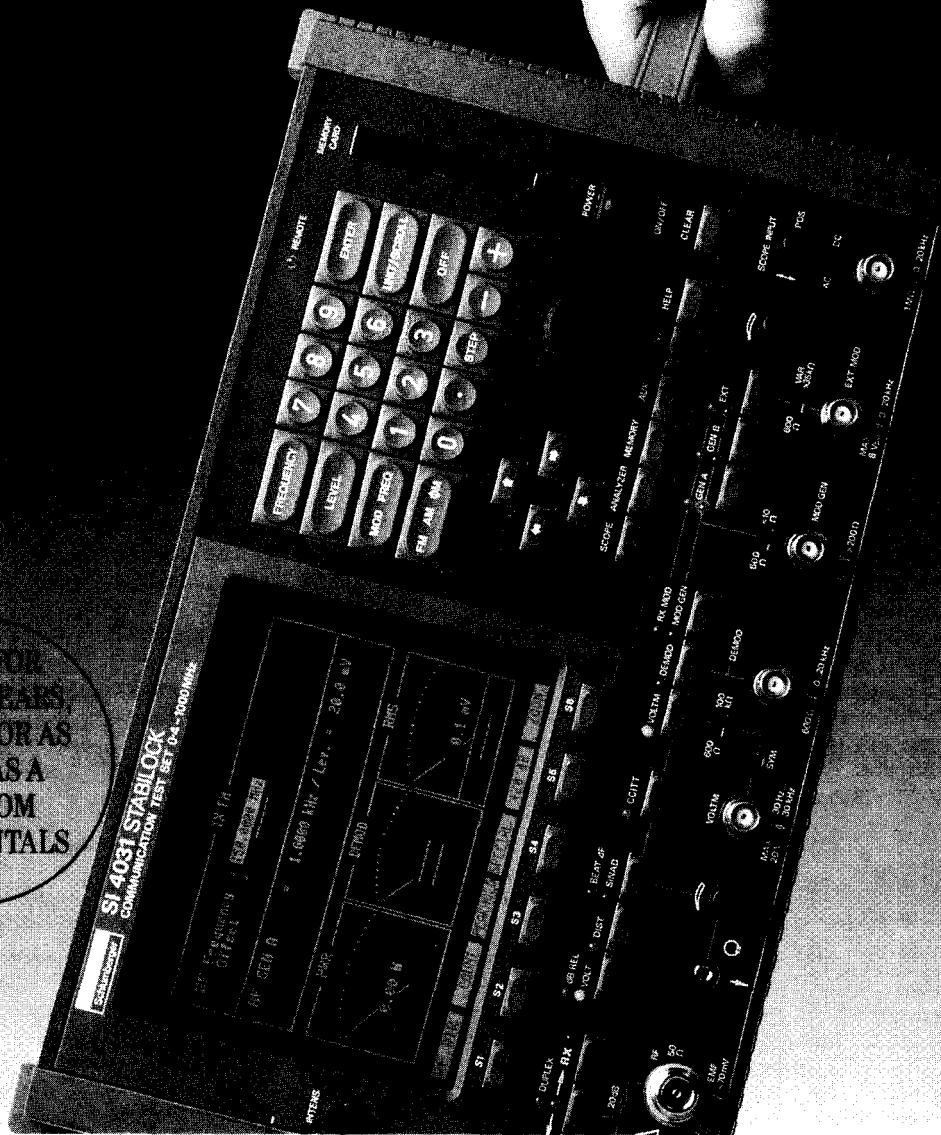

LEASE FOR
1, 2 OR 3 YEARS
OR HIRE FOR AS
SHORT AS A
DAY FROM
TECH-RENTALS

STABILOCK 4031 Portable Communication Test Set

There has never been a communication test set like the Schlumberger STABILOCK 4031. It's a go-anywhere complete radio service station suitable for the repair and maintenance of all types of receivers, transmitters and transceivers.

The time for routine tests is dramatically reduced - typically no more than 20 seconds.

There is even an IEEE-488 interface so you can print out test reports and screen hard copies.

And it's future proof too.

Expansion modules permit adaption for all present

and new testing demands - including cellular radio.

When it comes to versatility and reliability, the

STABILOCK 4031 wins - hands down.

Schlumberger

Sydney (02) 736 2888 Melbourne (03) 879 2322
Brisbane (07) 875 1444 Adelaide (08) 344 9000 Perth (09) 470 1855

ELMEASCO

Instruments Pty. Ltd.

READER INFO NO. 5

Price & Payne 2372



ARTHUR CUSHEN

ENGLISH BROADCASTS TO MIDDLE EAST

New international service

International services from the Middle East have increased in variety lately with many more English broadcasts. Arthur Cushen reports.

English broadcasts from Abu Dhabi and Jordan have recently been received adding to the variety of international services originating from the Middle East area and other countries which are well received are included in this survey.

The United Arab Emirates, in the past, has been heard through broadcasts from Radio Dubai

'The program includes a reading from the Koran with English translations'

with English transmissions, but Abu Dhabi has now commenced an international service. The broadcasts are from 2200-0200 UTC and three frequencies are announced, 6170, 9597 and 11965 kHz. The latter gives the best reception. It is noted that transmissions in Arabic are on 11965 kHz at 2130 when the national anthem is heard. The transmitter then closes, returning to the air at 2200. The sign-on is proceeded with a time signal and the national anthem, and there is a request for reception reports to PO Box 63, Abu Dhabi. The program includes a reading from the Koran with English translations, a press review at 2215,

and popular music at 2230. A news broadcast follows at 2300. Signals are best on 11965 kHz as the other two channels are either suffering from interference or too low in frequency for reception at that time.

A verification card was received in 18 days from Radio Abu Dhabi. Transmissions in Arabic are 0200-0630; 1600-2130 on 9695; 0200-0400 on 15395, 17705, 21515; 0400-0600 at 17705, 17820, 21735; 0600-1300 at 15135, 17705, 17820, 21735; 1300-2130 on 9780 and 11965.

ISRAEL: Israel has several English transmissions which are directed to Australia. The broadcasts are heard 0500-0515 on 9435, 9815, 11585, 11655, 11700 and 17630 kHz, while a further transmission is 2000-2030 on 9010, 9435, 9815, 9855, 11605, 11700 and 11960 kHz.

JORDAN: The new 500 kW transmitter at Amman has been heard on 9560 kHz with English news at 1400-1406 then a request for reception reports to PO Box 909, Amman. The station generally plays popular music and was heard again at 1700 UTC with a five minute English news broadcast. According to the announcement the transmissions are for reception in Central and Western Europe and North America. A further transmission in English is heard from 0500 weekdays and

0600 Sunday on 9560 kHz and is a relay of the mediumwave morning English broadcast in Jordan.

MOROCCO: Rabat has been heard again in English after a silence of many months and the transmission is on 17595 kHz at 1600 UTC. A news bulletin is broadcast followed by a musical program, but in the South Pacific the signal is blocked at 1620 UTC. The interference is from Brussels, Belgium which commences with its interval signal before opening transmission at 1630 UTC.

SYRIA: Damascus has an English broadcast 2005-2105 on 12085 and 15095 and repeated at 2105-2205 on 9950 and 15095 kHz.

Jamming ends

The USSR switched off its jamming transmitters on November 29, after blocking broadcasts from Western Europe for the past 40 years.

For the first time since WWII, we are able to listen to frequencies which were blocked 24 hours a day, and of course, hear many new signals which were previously not audible in the Pacific. In the 31 metre band, for instance, 9520, 9555, 9625, 9660, 9680, 9725 and 9750 were continuously jammed throughout the day. Now we can hear stations such as Radio Free Europe, Radio Liberty, Deutsche

Welle and the Voice of America operating for the first time with languages of Central Europe.

A large number of transmitters were employed as jammers, the total being estimated at 2500. The price of energy and staff to run these stations has been estimated at \$200m annually. As well as saving the Soviet Union a tremendous amount of expense the ending of jamming has opened up all the shortwave bands to many more stations. At times it was estimated that up to 40% of some of the shortwave bands were rendered useless by severe jamming, which not only disrupted the signal it was beamed at, but stations on adjacent frequencies.

As we go to press, jamming has not completely ended; some Central European languages are still being jammed such as Czechoslovak, Hungarian and Bulgarian.

SSB ends

The single side band transmissions of Radio Sweden, which have been carried out on an experimental basis for several years, have been terminated. The transmitter was 100 kW at Varberg and relayed the Radio Sweden Home Program in Swedish, except for the period 0230-0300 when it carried an English transmission to North America. Transmissions in English to Australia from Stockholm are now heard 1230-1300 UTC on 15195, 17815 and 21570 kHz.

BANGLADESH: Dhaka has been heard on 17710 with news in English at 1230, followed by commentary 1240 then music to sign off at 1300, when the next transmission is announced as commencing at 1815 on 7520 and 11510 kHz.

CHINA: Radio Beijing transmissions in English to North America are heard on relay from

Spanish National Radio on 9690 kHz between 0300-0350 UTC while there is a relay through Radio France transmitters in French Guiana, on 11695 kHz between 0400-0500 UTC. These transmissions are beamed to North America but provide fair reception in the South Pacific.

ICELAND: According to a verification, Icelandic National Broadcasting Service has the new address: Efstaleiti 1, 150 Reykjavik, Iceland. Schedule includes 1215-1245 on 13790 and 15659; 1855-1930 on 9860 and 13770/15659; 1935-2010 on 15659 and 17558; Saturday and Sundays 0700 on 13770 and 15659; all broadcasts are in Icelandic.

IRAN: Radio Tehran advises that its English broadcasts are transmitted at 1130-1225 on 7230, 9520, 9685 and 11790; 1930-2030 on 6080 and 9022 kHz.

YUGOSLAVIA: Radio Yugoslavia, Belgrade has reorganised its English transmissions and they are now 0100-0145 on 5980, 9620 and 9660; 1300-1330 on 11735, 15325 and 15380; 1930-2000 on 5980, 9620 and 9660; 2200-2245 on 5980, 7130, 9620 and 9660 kHz.

New voice

A newcomer to international broadcasting is the Voice of the Mediterranean operating from Malta and using the transmitters of Deutsche Welle. The project seems to be a combined effort from the Libyan and Maltese Governments, to provide a service for listeners in the area in English and Arabic.

Reception of the transmission 0600-0700 UTC in English on 9765 kHz has been excellent in the South Pacific, while an additional transmission on 11925 kHz 1500-1600 is received at poorer strength.

This new situation is inviting letters from listeners as it plans to run a listeners' Letter Box in the future, and is asking for suggestions and comments on the broadcasts to be sent to Voice of the Mediterranean, PO Box 143, Malta.

Operations are also carried on the mediumwave frequency of 1557 kHz, using the power of 600 kW from the transmitter at Cyclops, while the shortwave transmitters have a power of 250 kW.

Higher power

Two new 250 kW transmitters have recently been installed at Padang Cermin in north Sumatra and are carrying the Voice of Indonesia's program overseas. The shortwave transmissions continue to originate from the transmitters in Jakarta and have a VHF link to the transmitting station at Padang Cermin.

The new transmitters will cover Asia as well as Europe, the Middle East and Africa. The station is using 11788 or 11790 kHz, 15150 kHz at 0100-0200 UTC, 0800-0900, 1500-1600 in English; 0200-0300, 1200-1300 in Indonesian; 0900-1000 in Bahasa Malaysia; 1000-1100 in Chinese; 1130-1200 in Japanese; 1100-1130 in Thai; 1300-1400 in French; 1400-1500 in Arabic; 1600-1700 in German and 1700-1730 in Spanish.

The Voice of Indonesia appreciates reception reports and has a variety of QSL cards which will be sent to listeners who include two ICs with their report which should be mailed to: Voice of Indonesia, PO Box 157, Jakarta, 10001, Indonesia.

The original transmission schedule has now been extended to include a service to Europe with French 1900-2000 and English 2000-2100 UTC on 7125 kHz. On Sundays the program includes news at 2002, music at 2015 and a mailbag session at 2025 UTC.

And elsewhere

BRAZIL: Radio Bras in Brazilia as well as leasing time to Deutsche Welle is now carrying the BBC World Service 0900-1100 and then the Spanish Service 1100-1130 UTC. The broadcast is on 6185 kHz and is preceded by an opening announcement

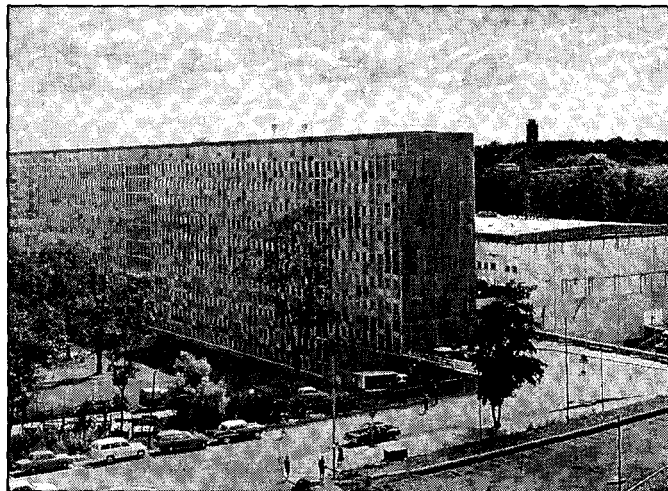

The modern studios of Radio Sweden, Stockholm, from which the domestic service and shortwave services originate.

indicating the transmission is for reception in South America.

HONG KONG: Radio TV Hong Kong is using a 30 kW shortwave transmitter to broadcast to Vietnamese "boat" people and others in the South China area with information about the new laws which restrict immigration into Hong Kong. New immigrants who arrive by boat are being screened into two classes - into economic and genuine refugees. The broadcasts in Vietnamese are to explain these new laws to possible immigrants and are transmitted 2300-0100 and 1100-1300 on 7290 kHz.

MALI: Radio Mali is broadcasting in English on Sunday 1845-1900 UTC. Two frequencies carry the shortwave service, 4783 and 4835 kHz. The news is a summary of the past week's events in Mali.

NEW ZEALAND: Radio New Zealand International has retimed its schedule and now broadcasts 1730-2015 on 12045 and 15150 kHz; 2245-0045 and 0230-0630 on 15150 and 17705 kHz; 0900-1115 on 9850 and 12045 kHz. On Saturday and Sunday the program is continuous from 0045-0230 when a sporting service is broadcast.

NORWAY: Oslo broadcasts in English on Sunday in certain transmissions. Best received in this area is from 1000 UTC on 15180, 15235, 21705 and 25730 kHz.

SAIPAN: A combined operation

on Saipan is underway with the installation of a 500 kW transmitter which will be used jointly by HCJB with its headquarters in Quito, Ecuador and the Far East Broadcasting Company which operates from Manila in the Philippines. This joint venture is part of a world wide gospel program which aims by the year 2000 to carry all the world's languages on gospel radio. The transmitter is being built in the United States, and a further 500 kW unit is being shipped to Ecuador to upgrade HCJB's facilities, which will also receive several new 100 kW transmitters - the old units have been sold to the Voice of Hope to operate as KVOH in California.

SWEDEN: Radio Sweden which now broadcasts to Australia at the later hour of 1230-1300 UTC in English, has made two frequency changes and these are received on 17810 and 21570 kHz. A service for morning reception in Australia at 2100 UTC is noted on 9566 kHz.

This item was contributed by Arthur Cushen, 212 Earn St, Invercargill, New Zealand. He would be pleased to supply additional information on medium and shortwave listening. All times are quoted in UTC (GMT) which is 10 hours behind Australian Eastern Standard Time.



MARCH

6-10: ISDN (Integrated Services Digital Network) and LAN (Local Area Network) Seminars will be held at The Crest Hotel, cnr Victoria and Darlinghurst Rd, Kings Cross, Sydney. ☎ (02) 923 1566. Interstate (008) 25 1048.

14-16: INTERNEPCON - Electronic production equipment, enclosures, connectors, components, interconnection products, packaging etc will be held at the National Exhibition Centre, Birmingham, UK. ☎ # 44 1 891 5051.

14-16: Semiconductor International - Design, processing, assembly and test equipment for semiconductor device production. The National Exhibition Centre,

Birmingham, UK. ☎ # 44 1 891 5051.

14-17: Office Technology 89 the 5th Australian International Office Technology Exhibition will be held at The Sydney Conventional Exhibition Centre, Darling Harbour, Sydney. Contact: Australian Exhibition Services Pty Ltd, 424 St Kilda Road, Melbourne, Vic. 3004 ☎ (03) 267-4500.

APRIL

17-19: Australian Symposium on Signal Processing and Applications (ASSPA) at the University of Adelaide. Information from: Symposium Organisers, Techsearch Incorporated, GPO Box 2471, Adelaide, SA 5001. ☎ (08) 267-1755. Fax (08) 267-4031.

267-1755. Fax (08) 267-4031.

26-28: A comprehensive three-day **DSP** (digital signal processing) course involving lecture sessions and hands-on exercises will be conducted by CIMA Electronics. Enquiries to Dianne Hunt ☎ (03) 563 1699.

MAY

2-4: PACEX '89, the trade exhibition for the process and control industries will be held at The Royal Hall of Industries, RAS Showgrounds, Sydney. ☎ (02) 331 5276.

16-June 2: Fifth UN course of Agrometeorological and Hydrological remote sensing. More information from COSSA. Fax: (062) 73-3958.

JUNE

6-9: PC89 The 13th Australian Personal Computer Show, Communications 89. The 5th Australian International Electronic Communications and Information Technology Exhibition and Office Technology 89. The 4th Australian International Office Technology Exhibition will be held at Royal Exhibition Building Melbourne. Contact AES or ☎ (03) 267-4500.

23-25: FM104 Queensland Electronics Show at the Exhibition Building, RNA Showgrounds, Brisbane. Contact: Robert Woodland, Queensland Exhibition Services, ☎ (07) 273-4066.

ROCKBY ELECTRONICS

244A Huntingdale Road
HUNTINGDALE

P.O. Box 189
HUNTINGDALE 3166

Phone (03) 562 8559
FAX: (03) 562 8772

CATALOGUES ARE NOW AVAILABLE

FOR YOUR COPY OF OUR FREE ILLUSTRATED CATALOGUE JUST SEND YOUR BUSINESS CARD TO THE ABOVE ADDRESS.

SONICS
MAGAZINE

For: Musicians, Road Crews, Recording Engineers, Lighting People, Managers, Promoters and anybody interested in what goes into today's music-making.

THE ALL AUSTRALIAN MUSIC MAKERS' MAGAZINE

Available bi-monthly at your newsagent or subscribe now by phoning (02) 693-9517 or 693-9515.

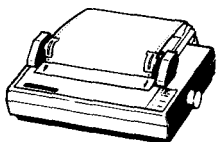

**EPSON LX-800
PRINTER**

- Dot Matrix
- Near Letter Quality Mode
- 180 C.P.S Draft mode, 25 C.P.S. N.L.Q. mode
- Tractor or friction feed
- Proportional printing
- Convenient push button control panel
- Standard Parallel interface

\$495



PRINTER LEAD

- Suits IBM® PC/XT, compatibles
- 25 pin "D" plug (computer end) to Centronics 36 pin plug

P19029 (1.8 metres) **\$14.95**
P19030 (3 metres) ... **\$19.95**
P19032 (9.5 metres) ... **\$39.95**

ROD IRVING ELECTRONICS

All sales tax exempt orders and wholesale inquiries to:
RITRONICS WHOLESALERS,
56 Renver Road, Clayton.
Phone: (03) 543 2166 (3 lines)
Fax: (03) 543 2648

SYDNEY: 74 Parramatta Rd.
Stanmore, 2048.
Phone (02) 519 3134
Fax (02) 519 3868

MELBOURNE: 48 A Beckett St.
Phone (03) 663 6151

NORTHCOLE: 425 High St.
Phone (03) 489 8866

CLAYTON: 56 Renver Rd.
Phone (03) 543 7877

MAIL ORDER & CORRESPONDENCE:
P.O. Box 620, CLAYTON 3168
Order Hotline: 008 33 5757
(Toll free, strictly orders only)
Inquiries: (03) 543 7877
Telex: AA 151938
Fax: (03) 543 2648



**ORDER HOTLINE
008 335757
(TOLL FREE)**

STRICTLY ORDERS ONLY

LOCAL ORDERS & INQUIRIES
(03) 543 7877

POSTAGE RATES:

\$1 - \$9.99	\$2.00
\$10 - \$24.99	\$3.00
\$25 - \$49.99	\$4.00
\$50 - \$99.99	\$5.00
\$100 plus	\$7.50

The above postage rates are for basic postage only. Road Freight, bulky and fragile items will be charged at different rates.

Errors and omissions excepted. Prices and specifications subject to change.

IBM®, PC®, XT®, AT®, are registered trademarks of International Business Machines. Apple is a registered trademark. Denotes registered trademarks of their respective owners.



ROD IRVING ELECTRONICS No.1 FOR DISCOUNT PERIPHERALS!



20 M/BYTE HARD DISK
Drive with controller card. IBM® compatible. 12 month warranty.
X20010 **ONLY \$449**

42 M/BYTE HARD DISK
IBM® compatible. 50 M/Byte unformatted. 12 month warranty.
Without controller ... **\$595**
With controller **\$695**

80 M/BYTE VOICE COIL HARD DISK
IBM® compatible. 25 msec access. 12 month warranty.
X20030 **\$1,595**

50 M/BYTE VOICE COIL HARD DISK
Capacity: 50.5 M/Byte unformatted
Access Time:
Track to track: 6 ms
Average 28 ms
Full span 52 ms
Size: 146(W) x 41(H) x 203(D)
C20008 **\$1,100**

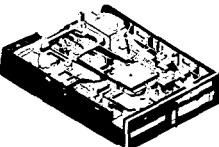

QUALITY JAPANESE DRIVES!!

5 1/4" 500K DRIVE
• 360K formatted
• IBM® XT® compatible
Cat. C11901 **\$239**

5 1/4" 1.2 M/BYTE DRIVE
• 720K formatted
• IBM® AT® compatible
Cat. C11906 **\$269**

3 1/2" 1 M/BYTE DRIVE
• 720K formatted
• Double sided, double density
• 5 1/4" mounted
Cat. C11909 **\$269**

3 1/2" 2 M/BYTE DRIVE
• 1.44 M/Byte formatted
• Double sided, double density
• 5 1/4" mounted
Cat. C11911 **\$299**

DIRECT IMPORT 5 1/4" DISK DRIVE!
Double sided, double density, 500K unformatted, 360K formatted.
Direct import price!
C11801 **Only \$139**

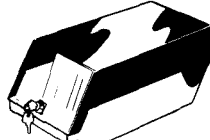

5 1/4" DISK STORAGE
• 100 x 5 1/4" disk capacity
• Smoked plastic hinged lid
• Lockable (2 keys supplied)
C16020 **only \$15.95**

50 x 5 1/4" DISK STORAGE
• 50 x 5 1/4" disk capacity
• Smoked plastic hinged lid
• Lockable (2 keys supplied)
C16025 **only \$14.95**

80 x 3 1/2" DISK STORAGE
• Holds up to 80 x 3 1/2" diskettes.
• Smoked plastic hinged lid
• Lockable (2 keys supplied)
C16038 **only \$19.95**

40 x 3 1/2" DISK STORAGE
• Holds up to 40 x 3 1/2" diskettes.
• Lockable (2 keys supplied)
• High impact plastic lid and base
C16035 **only \$14.95**



RITRON MULTISYNC VGA COLOUR MONITOR
Quality Auto VGA, EGA, CGA monitor without the high price tag!
Display Tube: 14 inch 90° deflection P22 Non-glare, tint. 0.31mm Dot pitch.
Active Display Area: 245 x 185mm
Resolution: 800 dots(H) x 600 lines(V)
Display Colour: TTL input
TTL input: 8/16/64 colours
Analog input: unlimited colours
..... **only \$945**

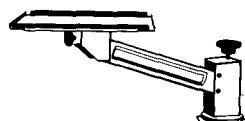

MONITOR MOVER ARM
Position your monitor exactly where you want it! Place your monitor in an ideal working position, or out of your way when you're not using it. Maximise desk space!
• Solid steel structure
• Height adjustment by knob (3cm - 27cm)
• Span 33cm
• Tray 30cm (tilting + - 15°)
• Desk clamp range 3cm - 7.5cm
• Maximum load 50kg
C21079 **\$159**

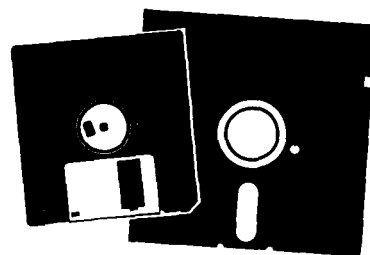

"NO BRAND" DISKS!

Now you can buy absolute top quality disks that are also the cheapest in Australia! They even come with a lifetime warranty, which indicates the quality of these disks. So why pay 2-3 times the price for the same quality?

Packs of 10, D/S D/D without boxes, or brand name, just their white paper jacket, and index labels. (5 1/4" disks includes write protects).

5 1/4" 2S/2D "NO BRAND" DISKS
10+ DISKS **\$6.95^{ea}**
100+ DISKS **\$6.75^{ea}**
1,000+ DISKS **\$6.50^{ea}**
(ALL PRICES PER 10 DISKS)

5 1/4" HIGH DENSITY DISKS (DOUBLE SIDED)
10+ DISKS **\$21^{ea}**
100+ DISKS **\$20^{ea}**
1,000+ DISKS **\$19^{ea}**
(ALL PRICES PER 10 DISKS)

3 1/2" 2S/2D "NO BRAND" DISKS
Suitable for IBM, PS/2, Macintosh, Atari, etc.
\$21
(ALL PRICES PER 10 DISKS)

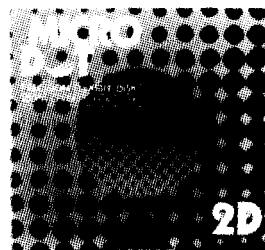

MICRODOT DISKS!

DESCRIPTION	1-9 BOXES	10+ BOXES
3 1/2" 2S/2D	\$23.95	\$22.95
5 1/4" 2S/2D	\$11.95	\$10.95
5 1/4" 2S/HD	\$21.00	\$20.00



VERBATIM DISKS!

(ALL PRICES PER BOX OF 10 DISKS)

DESCRIPTION	1-9 BOXES	10+ BOXES
3 1/2" 1S/2D	\$39.95	\$37.95
3 1/2" 2S/2D	\$46.95	\$43.95
3 1/2" 2S/HD	\$99.00	\$89.00
5 1/4" 1S/2D	\$22.00	\$21.00
5 1/4" 2S/2D	\$26.00	\$24.00
5 1/4" 2S/4D	\$75.00	\$70.00
5 1/4" 2S/HD	\$41.00	\$39.00

ROD IRVING ELECTRONICS



Derek Powell reports on the latest in big screen formats, the videowall.

THE BIG PICTURE

Video is big business. Everyone wants to show video pictures, and be it in business, advertising, entertainment or sports, everyone wants it big!

Unfortunately, while projection techniques are highly sophisticated, video projectors, like movies and slides, are only really effective in the dark. Video walls, however, which are essentially a bank of nine, 25 or more monitors working together, do produce big, bright pictures, even in daylight. They are appearing in retail outlets, discos and even Sydney's Pitt St Mall.

Video walls, though, can do far more than just produce a single, large image spread across the screen. To write them off as a piece of "stop-gap" technology while we wait for large scale liquid crystal displays, is to do them less than justice.

A well programmed videowall display is an entertainment art-form in its own right. Pictures from a number of sources can be

ETI MARCH '89



frozen, strobed, chequer-boarded and enlarged to a variety of magnifications as the program runs.

The list of applications for videowall technology is growing rapidly. Advertisers are queuing for space on walls in stores, shop windows and malls. Advertising is combined

***'Dancers at the Pattaya
Palladium in Thailand
can watch themselves
perform'***

with information display at airports, railway and bus stations.

Overseas, nightclubs and discos have been quick to take up this technology. The Empire, Leicester Square – one of London's most famous night spots, has installed a 16 screen

videowall which hangs from a monorail system high above the main stage. The wall can be split into two sections and move off into the wings and back again to form the complete wall, whilst still displaying images.

As well as displaying the inevitable video "clips", a videowall can be fed by input from video cameras. Dancers at the stunning new Pattaya Palladium, in Thailand can watch themselves perform on a 4.5 x 6 m video screen array which uses four sources, two VTRs, a laser disc player and a low light camera to capture the live action in the disco.

How it works

The first attempts at "multi-screen video" revolved around the use of a number of video recorders operating in frame sync. To do this, the recorders must be editing machines and must have some system to allow them to be accurately "cued-up". Such

This videowall, using the Electrosonic Picbloc system, was a feature at the 1988 Photokina Exhibition in Cologne. Conventional 5 x 5 and 6 x 6 format walls were combined with a novel Pyramid stack of 55 monitors.

Videowalls

The "C-Through" control software monitors the current status of each Picbloc framestore and previews the next effect to be executed.

Varying magnifications and freeze effects produce the effect of multiple sources on this promotional display.

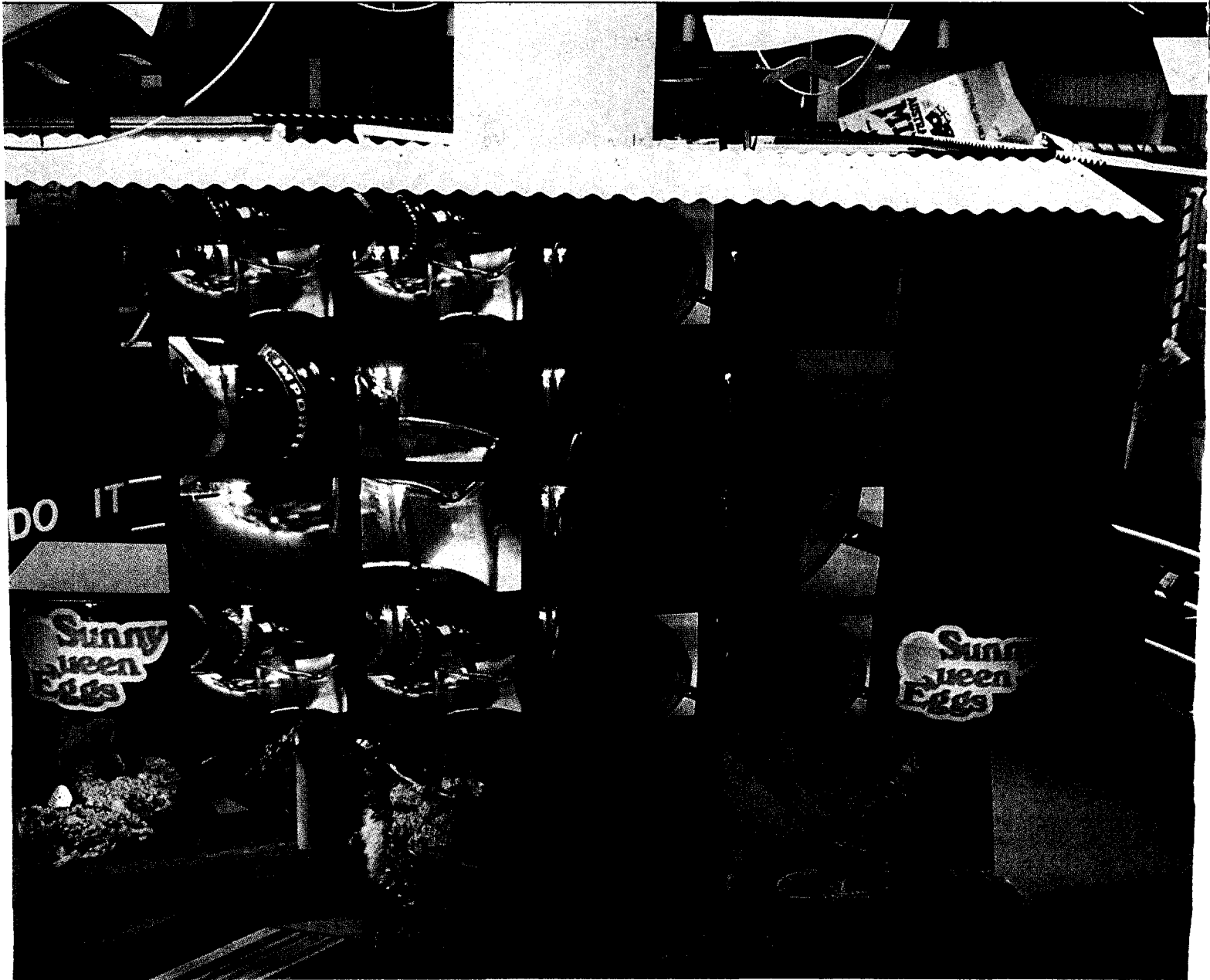

systems are unreliable in continuous operation and require very expensive production techniques.

The next improvement on the "multiple source" system was to use laser disc players, one per monitor. Such an arrangement is sometimes justified as with a four by four monitor array it is possible to have everything from 16 different moving images to one moving image covering all 16 monitors. Image quality and reliability is very high but the production methods are restricting and of course live camera inputs cannot be used.

Soon, digital systems appeared which allowed an existing video signal from tape, disc or camera to be fed into a "black box" which automatically split the image over as many monitors as required. Of the several companies operating in this field, including Delcom, the Australian company Hextronics, Meiko and Pioneer, the largest is the UK firm Electrosonic. Its PICBLOC system uses a digital framestore for each monitor.

Digital control equipment

There may be up to four video inputs to the system. Each input passes through a separate analogue to digital converter and

'Pictures can be frozen, strobed, chequer-boarded and enlarged'

the resulting seven bit data stream is multiplexed onto a bus which feeds the individual monitor framestores (Picblocs).

In the A/D converter, the incoming composite video is first decoded to YUV component form (luminance plus the two chrominance vectors). The luminance is sampled at 13.5 MHz to give 700 samples per line. The chrominance components U and V are sampled at one quarter the luminance rate (3.375 MHz) for 175 samples/line.

This 4:1:1 sampling scheme is a variant of the CCIR 601 digital video standard. The three seven-bit words are then multiplexed onto a single seven bit data bus. The data stream format is U V Y1 Y2 Y3 Y4 UV Y1...

Each of the Picbloc framestores, or, more correctly, programmable image controllers, can select between up to four incoming video data busses. One Picbloc is required for each monitor within any given videowall (ie 16 for a 4 x 4 format wall), although two outputs are available to allow two identical videowall displays to be driven from the one control system.

At the Picbloc a switcher selects one of the four data streams to feed two video field memories. The Picbloc uses a total of 14 CCD (charge coupled device) memories for video field storage. The total resolution is 700 x 574 pixels requiring 6.272 Mbits of memory.

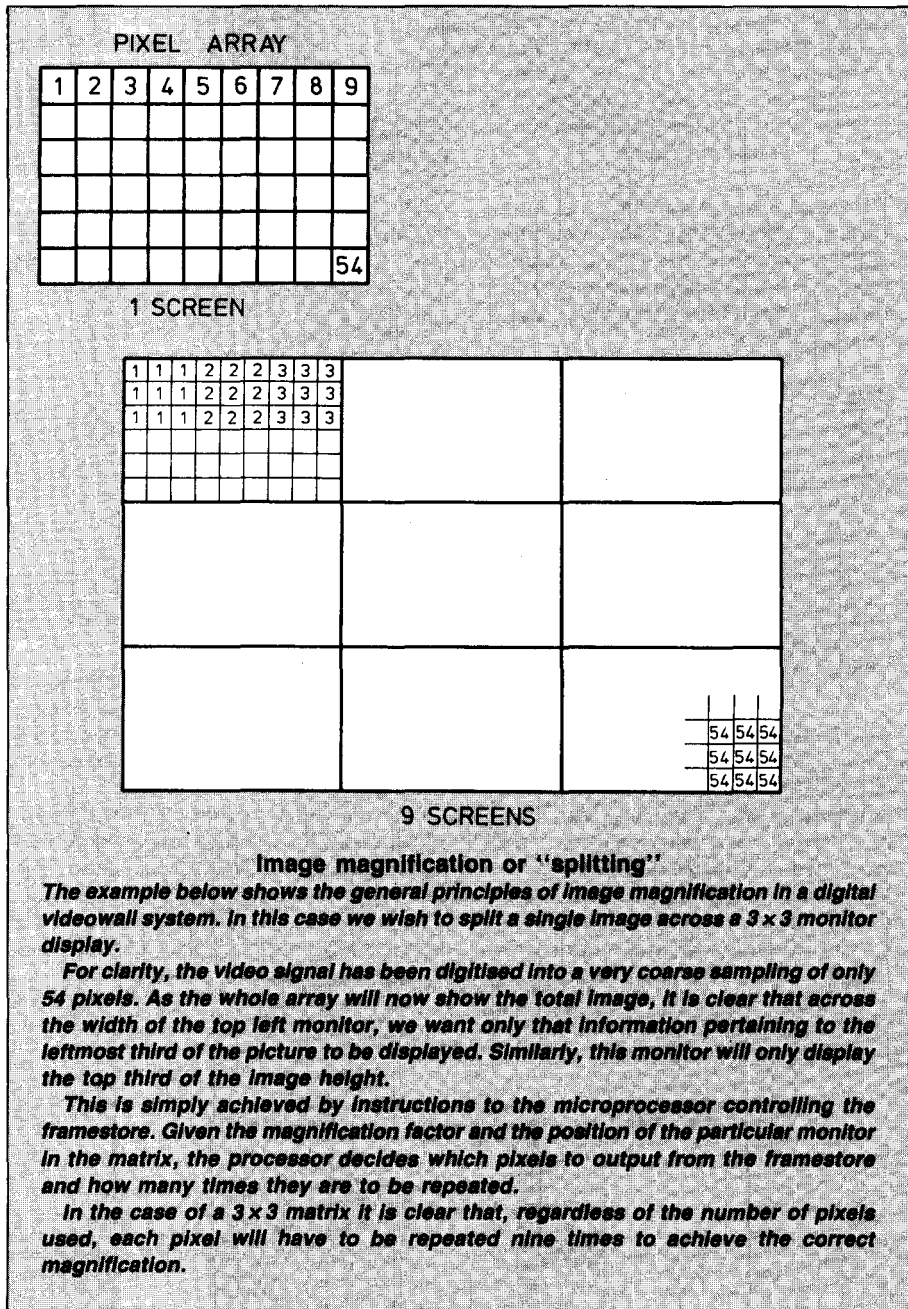

From the field memories the data passes to a demultiplexer, dual line store and D to A converter to regenerate the analogue YUV signals. A conventional matrix circuit converts the output to RGB with composite sync added to drive the wall display monitors. By keeping the display output in RGB format, high quality is maintained with an overall luminance bandwidth of 5.5 MHz.

This is quite conventional so far, but the real star of the Picbloc is a Z80 microprocessor with a 128k program EPROM which manipulates the data from the fieldstores. An RS 232 control line to the Z80 allows programmed or real time control of: input selection; magnification up to 16x; freeze at any magnification; generation of a

background colour wash instead of video.

The monitors

There are quite a few practical problems to be overcome in the design of videowall monitors. Firstly, the picture tubes must be placed very close together to produce a convincing magnified image with minimal frame divisions. Physical strength is also a factor as the monitors lock together and the frames must be capable of supporting the weight of the monitors stacked on top.

The screens need to be closely matched for brightness and colour temperature and line up of a large wall can be quite time consuming. Image size must be adjusted so

Videowalls

that the magnification factor is consistent over the entire wall and the scanning is adjusted so that the picture appears continuous with the missing space in a magnified picture taken up by the space between the monitor tubes.

Some systems have been assembled which overcome the limitations of frame divisions by using video projectors onto rear projection screens. In this way, the screen divisions can be minimised and screen sizes increased, though colour matching becomes even more critical.

Programming effects

A video wall can have any shape, indeed one of the largest "walls" so far assembled used 256 monitors in the shape of a Coke

'Whirling and zooming studio effects are usually avoided'

bottle. Usually, however, monitors are arrayed with equal numbers horizontally and vertically. This allows greater production flexibility as the image resulting from a 3x3, 4x4 or larger matrix will have the same 4:3 aspect ratio as a single video image.

There are three methods of controlling the effects possible on videowall systems. The simplest is to simply set one magnification

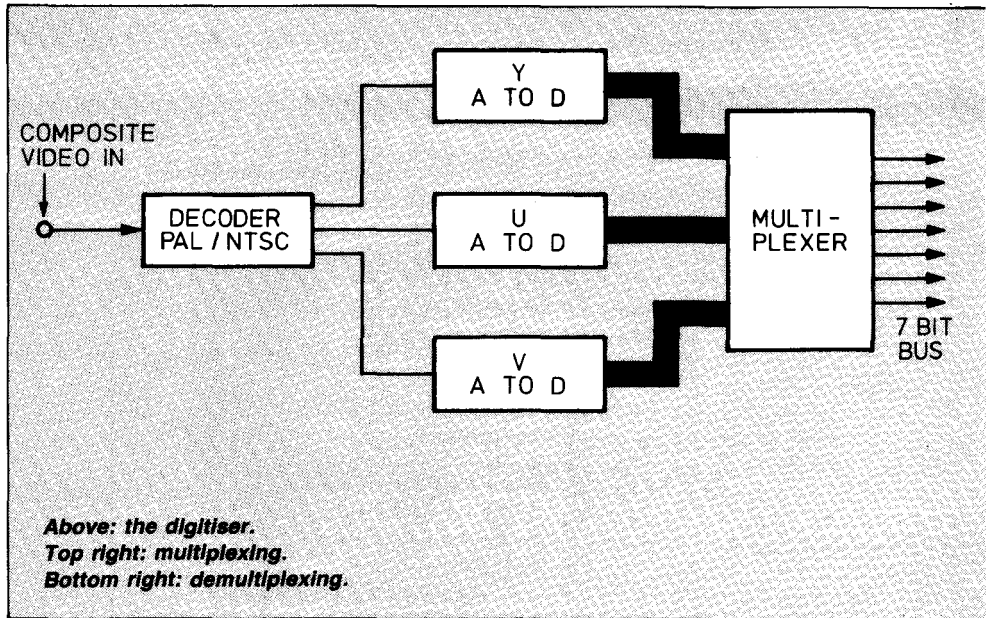

effect via dip switches on the frame stores and leave it at that. This is done in systems where there is only one video input and the main function of the wall is to provide a giant sized display.

For disco or other entertainment applications a "real time" controller is most often used. Here the "VJ" (a video jockey) chooses effects and transitions from a number of options on a push button control panel. Strobe effects, colour washes, spiral

wipes and different magnifications can be called up according to the beat and the mood of the video clip being displayed.

For applications like exhibitions, displays, advertising and the like where a set program is to be repeated, the wall effects are usually controlled by computer. The video replay sources, whether tape or video disc, are synchronised via SMPTE time code. The code is also fed to the control computer which instructs the microprocessors controlling the

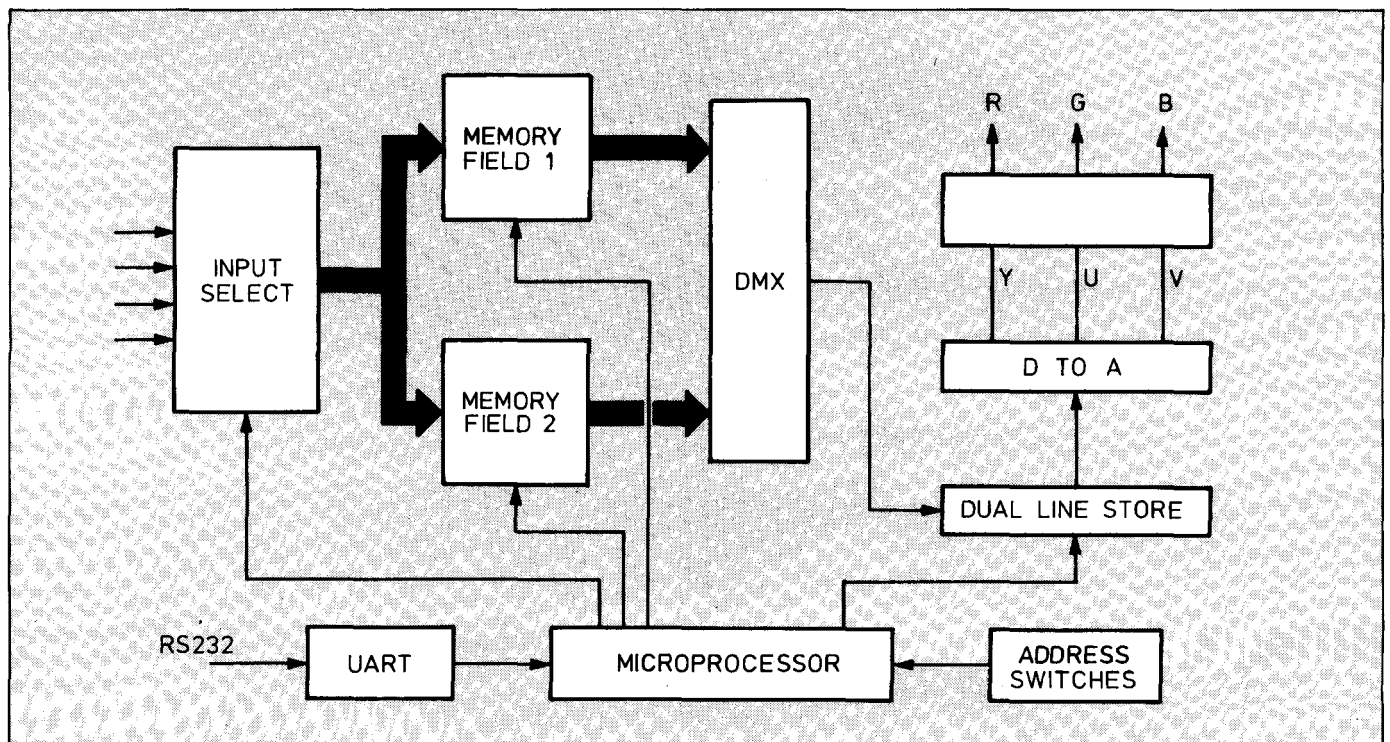

Each monitor in a videowall display is fed by a programmable frame store. This diagram shows the major components of the Picbloc system.

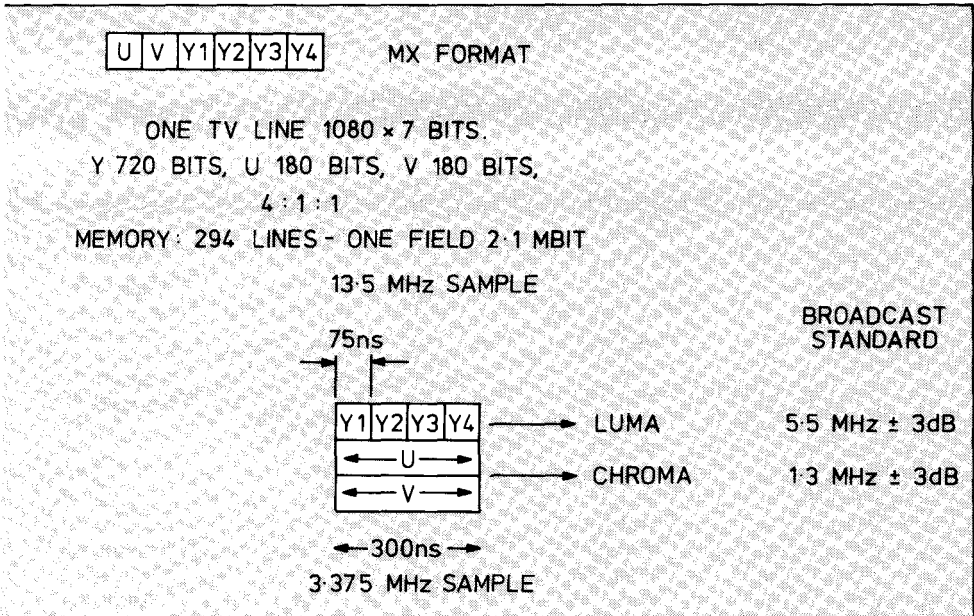

There are other, less obvious, limitations too. For example with 2×2 and 4×4 magnifications there is a vertical and horizontal gap through the centre of the enlarged picture. This can look terrible with a close up face where the vertical line goes right through the nose.

Perhaps the most surprising use of the videowall medium is as a set piece for television programs. The nationally televised "USA Today" show uses a videowall backdrop as does the popular Spanish quiz show "La Vida Sigue". As centrepiece of the prime time Spanish show, a 16 monitor wall presents the questions to the contestants, gives a visual countdown of the time they have to answer and finally displays their winnings.

For sheer overkill however, we will have to leave the last word in videowalls to the Germans. A truly enormous 12×12 screen videowall displays the 144 contestants in a television game show broadcast by ZDF from Munich. As each contestant is eliminated from their game, they disappear from the montage until finally the winner's enormous (and presumably grinning) visage is spread across all 144 monitors.

eti

Derek Powell is with Gaytone Studios in Brisbane.

individual fieldstores. The computer software executes the pre-programmed list of effects at the correct times in the video sequences by referencing to the SMPTE code.

Creating source material and programming effects on the wall demands special

care. Because the wall has a repertoire of tricks all its own, whirling and zooming studio effects are usually avoided. Viewing distance is an important consideration as too much enlargement may cause an unacceptable pixel size for very close viewing.

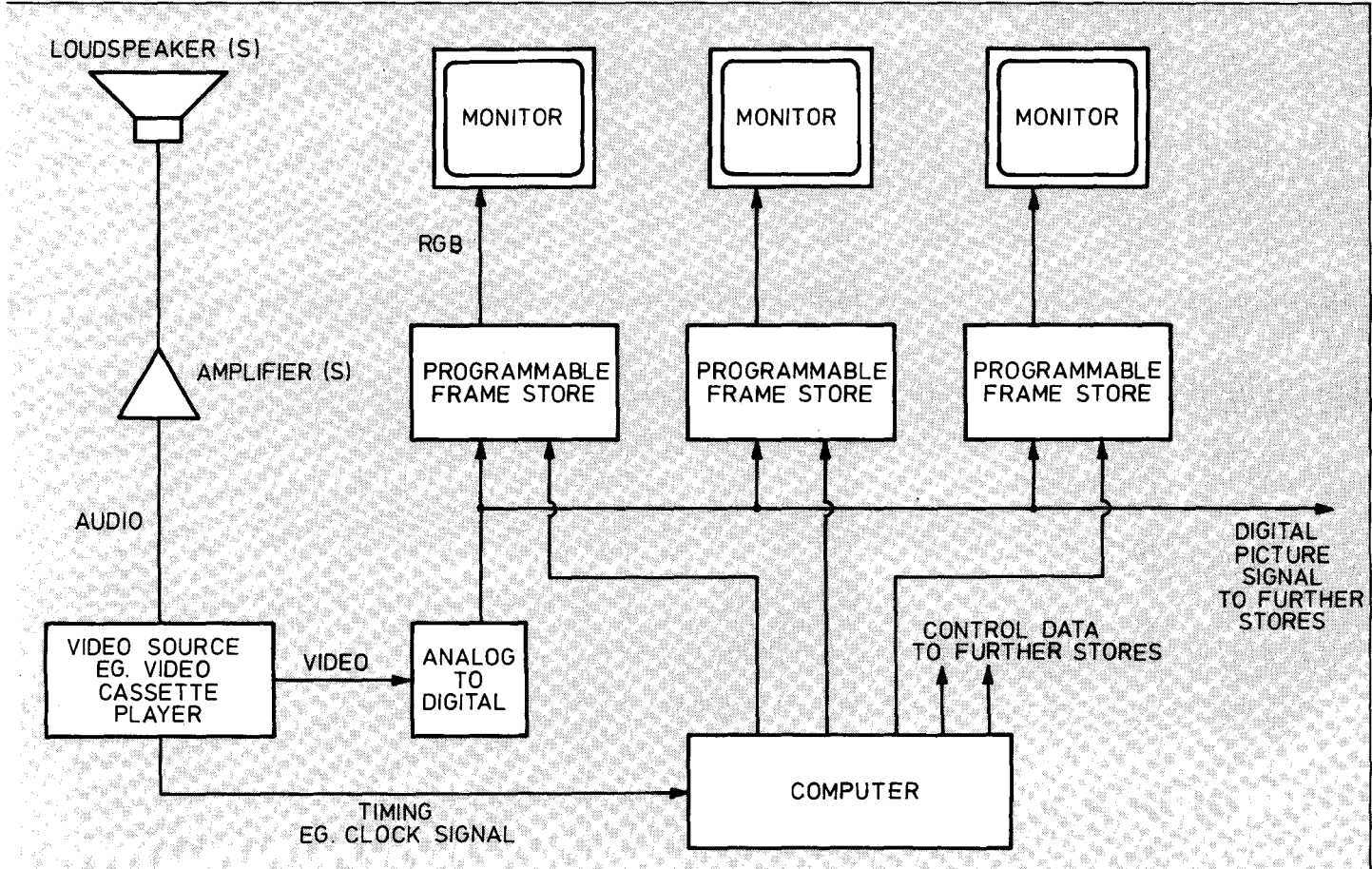

The simplest type of videowall display has only a single input source.



ANNA GRUTZNER

Sydney aircraft manufacturer Hawker de Havilland is part of the Australian defence force's expensive acquisition of new helicopters, the BlackHawk and SeaHawk, which will deploy Harpoon antisubmarine missiles. Anna Grutzner reports on progress so far.

On the two decades since the helicopter was first used extensively in a combat role in the Vietnam War, it has established its credentials as a critical component of modern warfare. Troop-carrier, submarine detector or weapons platform, its usefulness cannot be overestimated.

As a reflection of this, the Australian Defence Forces are in the process of upgrading their helicopter capability in the form of two projects costing in excess of \$1.3 billion. The Army is taking delivery of a \$750 million order for 39 Sikorsky BlackHawk S-70A-9 aircraft and the Navy is soon to acquire 16 Sikorsky SeaHawk S-70B-2s at a cost of \$610 million. The BlackHawk is the first helicopter Sikorsky has ever assembled outside the USA.

Local industry has been given a crack at the lucrative Defence Department orders via a major assembly subcontract to Sydney-based aircraft manufacturer, Hawker de Havilland. Although the Bankstown operation will get the lion's share of offsets work, the benefits to Australian industry as a whole are expected to run beyond \$100 million.

The BlackHawk project is progressing smoothly, if a little behind schedule. But the SeaHawk has run into technical and manpower problems that have resulted in

Sikorsky deciding to return assembly to the USA. The hitches well illustrate the pitfalls Australia's fledgling aerospace industry is certain to face as it attempts to gain a foothold in the highly sophisticated and competitive helicopter market.

Whether the Government can realise its hopes of establishing local facilities to repair and maintain battle-damaged helicopters and to modify software and combat systems also hinges on the success of these projects. The expertise gained in assembly could even

'With its smaller fleet, the RAN decided to develop its own avionic system'

spin off into the development of a regional major repair facility in Australia.

The acquisition of the BlackHawk for the Army will give it the capacity to lift an infantry company group of 150 personnel and equipment simultaneously to the north and north-west of the country. It will replace the Vietnam vintage UH-1H Iroquois "Huey", which can be gradually pensioned off. Fitted with ESSS (external stores support systems) for carrying extra fuel tanks, the BlackHawk will be capable of travelling more than

HAWKS, HARPOONS AND DE HAVILLAND

New helicopters with the latest in avionics



The BlackHawk's armoured bucket seats enhance pilot protection.



The Royal Australian Navy's new Sikorsky S-70B-2 SeaHawk will enable FFG-7 frigates to deploy Harpoon missiles at a range of 80 km.

Hawks, Harpoons and de Havilland

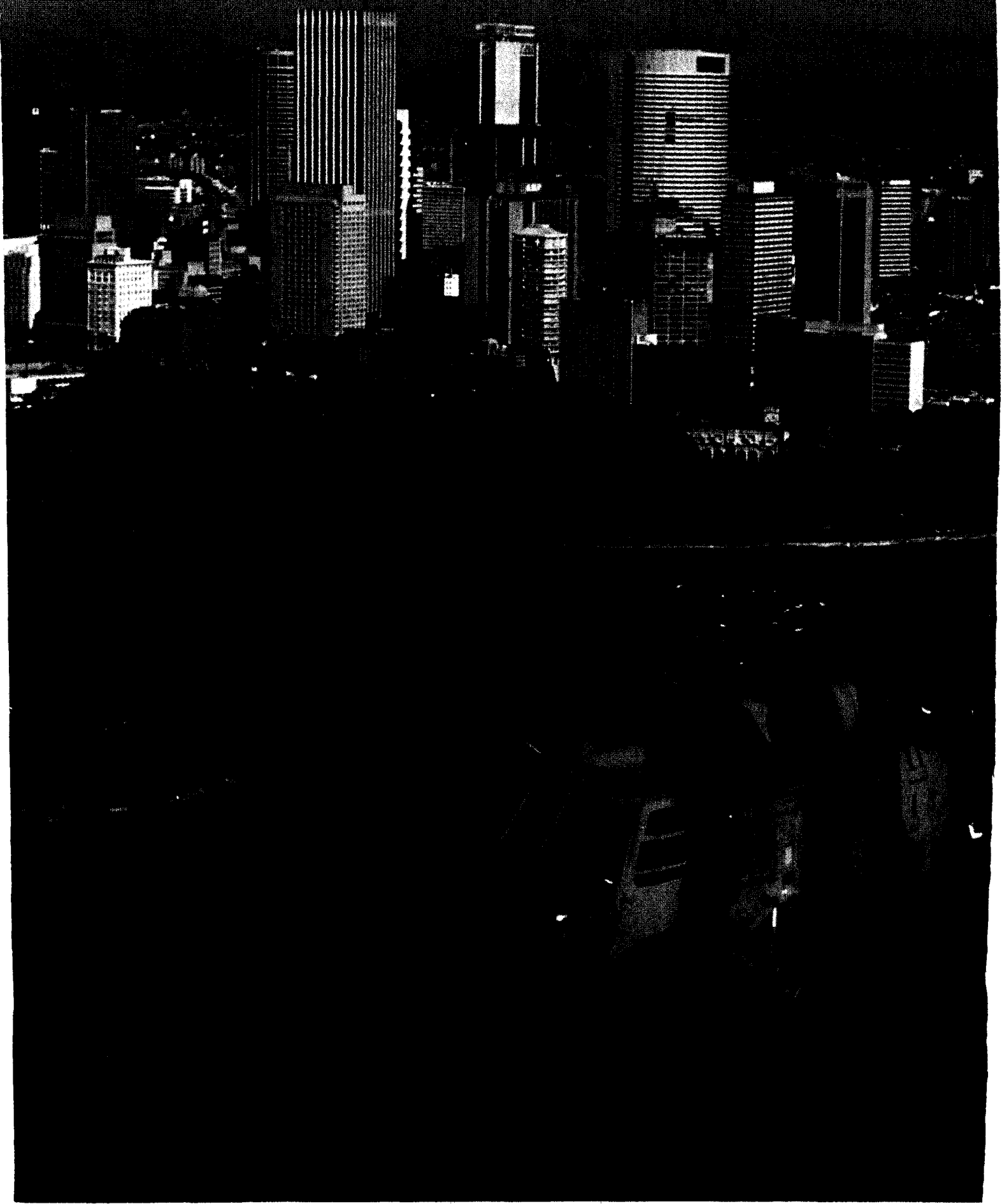

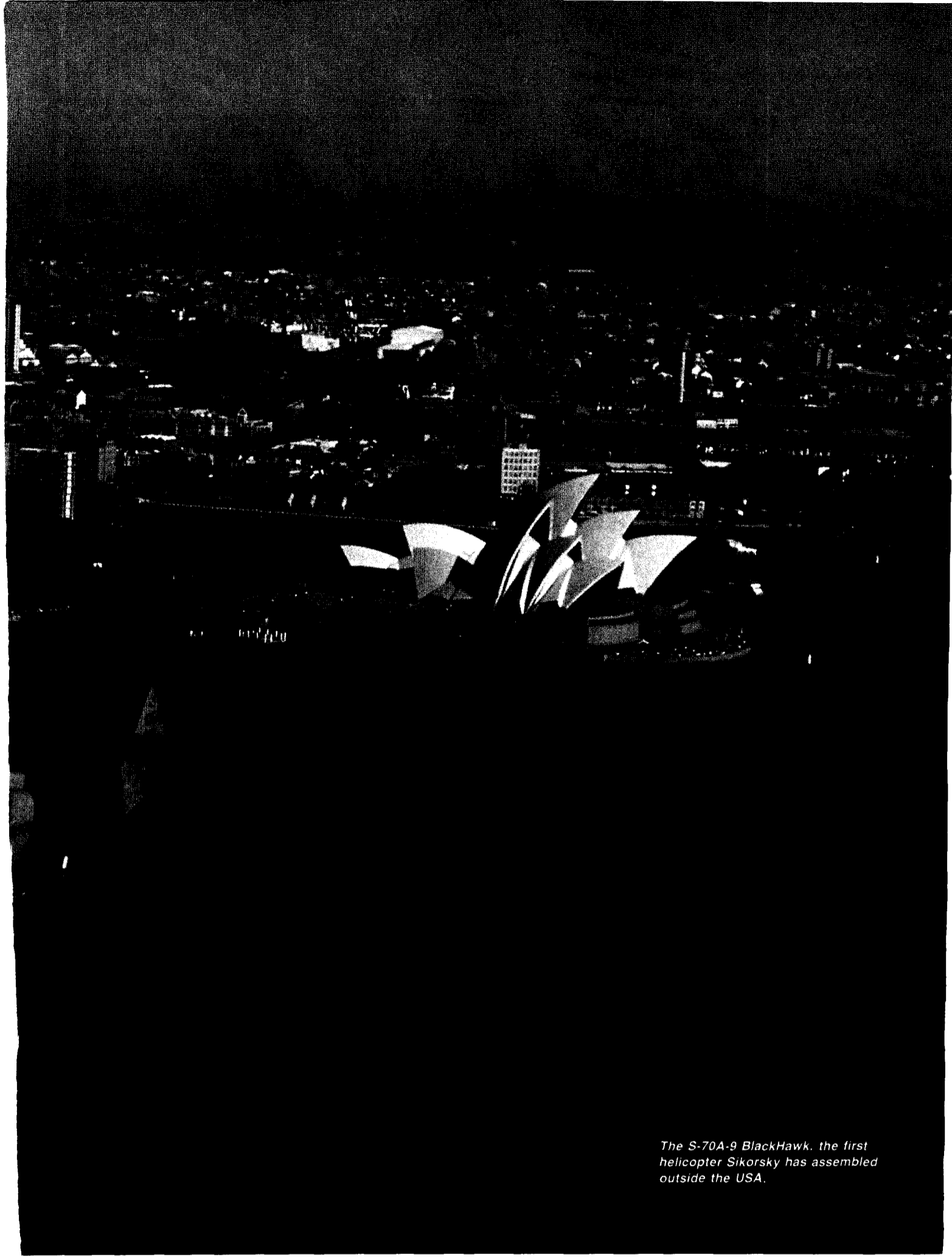

The S-70A-9 BlackHawk, the first helicopter Sikorsky has assembled outside the USA.

Hawks, Harpoons and de Havilland

2000 km in the harsh and inhospitable terrain of the outback. It is a highly manoeuvrable machine capable of hugging the landscape and of travelling at up to 160 knots just above the treetops.

While essentially a troop-carrier, the BlackHawk also could be used as a helicopter gunship for highly mobile airborne fire support operations, carrying the Army's new Hamel gun. The design is so compact that the helicopter can be airlifted in a C-130 Hercules. It has a twin turbine engine, four-blade main rotor and a light alloy structure. It is built to withstand a vertical crash of 11.5 m so that 85% of its cabin and flight deck remain intact.

Bad publicity

Soon after the Government opted for the BlackHawk rather than the French Aerospatiale AS332M1 Super Puma, it was dogged with adverse publicity in the USA.

However, the manufacturer was quick to point out that the US Army's BlackHawk UH-60A was a different model from that being bought by Australia. The latter has more powerful engines, a more durable main rotor gearbox, an advanced automatic flight control system and more sophisticated avionics.

The problem with the US version was that the aircraft's state-of-the-art "fly-by-wire" electronic control system was susceptible to electromagnetic interference from microwave towers and radio antennas. An ignition fault with the electronic probe emissions meant the device turned off at certain radio frequencies. The Australian BlackHawks are understood to have heavier shielding of the wiring looms.

The Navy ordered its SeaHawks in two batches of eight, costing \$424.43 million (April 1985 prices) and \$185.79 million (December 1985 prices). The SeaHawk is expected to

perform the full range of antisubmarine warfare (ASW) functions, a task both defence officials and the manufacturers boast it will fulfil superbly. It was chosen in preference to the smaller, cheaper Westland aircraft principally because of its ASW qualities. The SeaHawk will also permit the FFG-7 frigates to deploy Harpoon missiles at a range of 80 kms or beyond, thus enhancing considerably the navy's fire power. The Navy's SeaKing Mk 50/50A also can perform coastal ASW operations from land bases.

Submarine warfare is a low-level threat on the scale of credible contingencies. However, the Navy believes it must maintain expertise in antisubmarine warfare because of the difficulty and lead times involved in developing the technology. The author of the Government's 1984 review of Australia's defence capabilities, Dr Paul Dibb, argued: "There is little priority for further capability

ROLE-ADAPTIVE WEAPONS SYSTEM

The RAWS will make the SeaHawk like an aerial eye-in-the-sky because it will extend the ship's vision. The system offers the option of processing data aboard the helicopter or transmitting it raw back to the ship. The Minister for Defence, Kim Beazley, explained the role of RAWS to Parliament in the following terms: "The role of the role-adaptive weapons system is to process sensor data for the prime missions of antisubmarine warfare and antisurface surveillance and targetting (ASST). The RAWS is also removable to allow utility and trooplift missions to be accommodated. The Harpoon fire control system is not integrated into the tactical data system. The helicopter will relay target position to the parent or other vessel using normal tactical radio communications or the RAWS data link and related shipboard terminal."

He also defended the decision to develop it rather than purchase the standard US Navy LAMPS MkIII. "The roles of RAWS and LAMPS MkIII are similar, but operational procedures differ. The RAWS has an autonomous capability, enabling the S-70B-2 to operate without assistance, whereas the LAMPS MkIII weapons system requires that the aircraft system is constantly in radio contact, via a datalink, with the parent ship if the full capability of the system is to be utilised."

The RAN-version SeaHawk is one of the most expensive helicopters ever built for a defence force, according to leading defence analysts. On a per-machine basis, the SeaHawk will cost about \$37.5 million, compared with just \$19.6 million a piece for the LAMPS MkIII USFY89 version. As early as 1985, Federal Cabinet was having second thoughts about the project on budget grounds, given the huge price hike brought about by the worsening exchange rate. At least the BlackHawk has considerable export potential; the RAWS-equipped SeaHawk is unlikely to suit any other navy.

The delays to both the SeaHawk and BlackHawk programs differ according to whom one talks. But the Army's deliveries seem to be running about nine months late, while the Navy's are six months behind. The revised completion of delivery for the BlackHawks, which are coming off the production line at the rate of one a month, is September next year (1990). The first two SeaHawks will be received within months. Navy pilots will train initially on the new

\$48 million SeaHawk simulator under construction.

The Navy's six FFGs will be capable of each carrying two SeaHawks, although the introduction of the two new FFGs in the early 1990s will necessitate the purchase of four extra aircraft. In peacetime, the frigates will probably carry one helicopter each and the rest will be used for training at Nowra and as an attrition reserve. About \$26 million will be spent upgrading two airbases in Queensland to cater for the BlackHawks. While the RAAF initially will operate the helicopters, control is to be shifted to the Army's new 5th Aviation regiment in Townsville, hence the RAAF base there being improved. The Operational Deployment Force based in Townsville will be the big winner from the BlackHawk acquisition. Oakey army base west of Brisbane is also to get a facelift.

Despite the disappointing setback that the SeaHawk relocation represents to local industry, other new initiatives are in the pipeline. Aerospace Technologies of Australia (ASTA), the former Government Aircraft Factory, recently announced a tripartite deal with France and China to produce a new generation of light helicopters. The design would meet both civil and military needs and already is being mooted as a possible replacement for the AS350/355 Squirrel light helicopter currently in service with the RAN. The helicopter is likely to be in the 2.5 tonne class and by early next century up to 3000 machines will be manufactured.

Aerospatiale, the French helicopter manufacturer which has the biggest share of the world export market, will join the Australian company and the China Aerotechnology Import Export Corporation in a risk-sharing consortium to design, develop, manufacture and market the aircraft for production by 1995. ASTA expects to make a 20 to 30% investment in the project over a 15 to 20 year time-frame and would have commensurate sole production and marketing rights in an exclusive geographic region.

The project is particularly significant for its potential to transfer technology, to encourage local design and manufacture and to stimulate a domestic expertise in the field that Hawker de Havilland has discovered the hard way is still thin on the ground. Given the burgeoning costs of aircraft manufacture, such collaborative ventures are an obvious way to ease the capital burden, spread the risk, and sharpen the industry's competitive edge.

beyond the eight SeaHawk helicopters already on order, given the low submarine threat and that we have capable long range maritime patrol (LRMP) aircraft and are developing towed arrays."

The SeaHawk will complement other ASW functions performed by the RAN's guided-missile destroyers (DDGs) and destroyer escorts, which are equipped with the Ikara ASW missile and antisubmarine torpedos. The FFGs and submarines are also equipped with the latter. Moreover, the LRMP P-3C aircraft can lay and monitor sonobuoys, attack submarines with torpedos and lay mines.

RAN's challenge

The challenge the RAN faces with the SeaHawk is to apply the helicopter and its systems to a naval philosophy fundamentally different from that for which it was designed in the USA. The US Navy is one of vast resources, and has the capability to operate massive groups as an integrated support system. The SeaHawk's LAMPS Mk III (light airborne multipurpose system) of avionics - requiring a team of seven distributed between the helicopter and ship - was built for that environment.

With its smaller fleet and requirement that the individual components within it be more self-reliant, the RAN decided to develop its own avionic system, the RAWS - role-adaptive weapon system. Once the navy's dreams of acquiring an aircraft carrier were dashed, it favoured the use of small dispersed platforms in the form of destroyers rather than a helicopter carrier as a basis for ASW-helicopter operations at sea.

Moreover, faced with the choice of modifying its frigates at prohibitive cost to accommodate the LAMPS system or changing the system itself, the Navy sensibly opted for the latter. Modifications to the FFG-7s - HMAS Canberra, HMAS Sydney and HMAS Adelaide - to operate the SeaHawks will cost a mere \$50 million. The RAST (rapid assistance secure and traverse) system will be employed to bring the aircraft on to the frigate platform.

The SeaHawk is an adaptation of the SH-60B model Blackhawk, modified to integrate the appropriate mission equipment and to make it shipboard compatible. Such changes include installation of more powerful navalised engines, a stronger undercarriage, different cabin configuration, provision for ESM and MAD equipment, a sensor-operating station, sonobuoy launcher and modified landing gear. Even with a full load the SeaHawk, which the US Navy has been operating since 1983, can stay in the air for up to three-and-a-half hours.

Aerospace industry's future

The decision taken late last year to move assembly of the SeaHawk back to the USA

has profound implications for the future of the whole aerospace industry in Australia. Everyone involved in the project reluctantly admits that the complexity of the avionics integration and the size of the talent pool available to assemble the aircraft were grossly underestimated. The contractual penalties Sikorsky would have faced in the "flyaway"-costed deal if the helicopters had been delivered late, no doubt cast the final decision. But shortages of specialist staff have been blamed for the situation that led to the delays.

The commercial airlines are said to have lured the talent away to service the expanding civil aircraft construction industry and the booming tourism sector. Electrical tradesmen, systems engineers, electronics and communications specialists, project managers, pilots, sheet metal workers and others are in heavy demand. QANTAS is said to be the main culprit, although even the national airline says it has been forced to send its Boeing 747s for maintenance in the USA because of the labour crisis.

The Government's claims that the heavy loss of specialist personnel from the defence forces has not been all negative (because they have shifted into the industries where

'The decision to move assembly of the SeaHawk back to the USA has profound implications for the industry in Australia'

defence production is taking place) is looking somewhat shaky. Hawker de Havilland even recruited tradesmen from Britain in a bid to plug the gap, but the demands of constructing both the BlackHawks and SeaHawks proved too much. Now assembly of the first eight will be carried out in the USA and testing for the other six will be done at the Navy's Nowra base.

Integration of RAWS also has proved far more difficult than ever imagined. The head of the Defence Department's capital procurement program, Dr Malcolm Macintosh, admitted recently: "It turned out to be substantially more difficult to integrate the combat system into the aircraft than had originally been thought by either Sikorsky or the Australian industry." It is interesting to recall that after the local development of the FT11 systems in Australia, the experts vowed they never again would venture so deep into pioneer aerotechnology. 

Anna Grutzner is the Canberra-based defence correspondent for The Australian.

DO YOU WANT TO SALVAGE SOME CASH?

TURN YOUR SURPLUS STOCK INTO CASH!!!

Jaycar will purchase your surplus stocks of components and equipment. We are continually on the lookout for sources of prime quality merchandise.

Jaycar
ELECTRONICS

115 Parramatta Road
Concord 2137
or phone
(02) 747 2022
ask for Bruce Routley
or Mark Harris

INTRODUCING: THE ULTIMATE COMMUNICATIONS INTERFACE CARD

For IBM® PC, XT & AT & COMPATIBLES

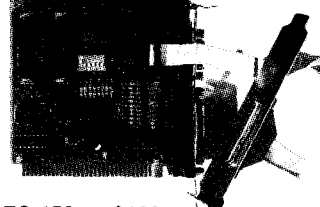

THE EC-452 — \$129 + tax
KIT EC-452-SK — \$99 + tax

**SUPPORT YOUR MOUSE,
MODEM AND PRINTER
ON ONE CARD!**

Ideal for applications requiring Multiple Printers.
Highly Reliable. Fully Socketed.
As featured in Electronics Australia May 88.
ORDER YOUR FIRST CARD TODAY

Suitable for Machines Running
up to 16 MHZ.
25 Pin SERIAL PORT
9 Pin SERIAL PORT
25 Pin PARALLEL PORT
All Mounting Hardware
Comprehensive User Manual

KEN CURRY
Managing Director



26 Boron Street,
Sumner Park, Brisbane
Qld, Australia, 4074
Fax: (07) 376 3286

BRISBANE —
(07) 376 2955
WELLINGTON — N.Z.
(04) 85 8742

enerjou
CONTROL

READER INFO No. 7

COMPLETE RANGE

MOTHERBOARDS

MB1600	10MHz XT M/Board, 0K RAM	199.00
MB286120K	Baby 286 M/Board, 12MHz/0K	645.00
MB286161M	Baby 286 M/Board, 16MHz/1M	1645.00
MB28616L1M	Baby 286 M/Board, 16MHz/1m	1495.00
MB286201M	Baby 286 M/Board, 20MHz/1M	1895.00
MB386202M	Baby 386 M/Board, 20MHz/2M	4500.00

CHIPS

IC256K12	256K RAM Chip - 120nS	23.00
IC256K15	256K RAM Chip - 150nS	19.90
IC28710	80287, 10MHz Co-processor	549.00
IC2876	80287, 6MHz Co-processor	315.00
IC2878	80287, 8MHz Co-processor	450.00
IC64K12	64K RAM Chip - 120nS	9.00
IC64K15	64K RAM Chip - 150nS	7.50
IC8087	8087-2, 8MHz Co-Processor	275.00
ICV20	NEC V20 Chip	29.00
ICV30	NEC V30 Chip - 10MHz	49.00

DISK DRIVES

DD1037A	Disk Drive, NEC 720K, 3.5in	235.00
DD1053	Disk Drive, NEC 360K	225.00
DD1157C	Disk Drive, NEC 1.2MB	245.00
DD3146H	Hard DD, NEC 40MB, 35ms	855.00
DD5126	Hard Disk Drive, NEC 20MB	495.00
DD5146H	Hard Disk Drive, NEC 40MB	895.00
DDMCASE	5.25in case - 3.5in drive	25.00

SOFTWARE

SW410	MS DOS V3.2 - (NEC)	80.00
SWCCSD	CCS Designer	179.00
SWBPRINT	CCS Paintshow	55.00
SWSL1	CCS Symbol Library No. 1	79.00
SWSL2	CCS Symbol Library No. 2	79.00
SWSL3	CCS Symbol Library No. 3	79.00
SWMM	Wordmagic, Wordprocessing	139.00

ACCESSORIES

AC2MP	Printer Cable, 2M, 25 pin	12.00
AC3MP	Printer Cable, 3M, 25 pin	15.00
AC5400	14 EGA Colour Monitor	745.00
ACDA	9 pin Designer Adaptor	10.00
ACDM	Designer Mouse (290 DPI)	99.00
ACLA	25 pin Logitech Adaptor	10.00
ACLM	Logitech Mouse	149.00
ACM2	NEC Multisync II Monitor	1249.00
ACMA	Monitor - TTL Amber	199.00
ACMG	Monitor - TTL Green	199.00

PRINTERS

PR2200	NEC P2200 Printer	695.00
PR22CSF	Cut Sheet Feeder - P2200	155.00
PR30	Printer, Olympia 9 pin	425.00
PR760	NEC P7 Printer	1355.00
PR7BT	NEC P7 Bi-directional Tr	226.00

CONSUMABLES

COD360	Diskette, box of 10, 360K	20.00
CODB360	Diskette, 360K, Bulk Pack	2.50
COMD720	Micro Disk, Box of 10, 720K	66.00

I/O CARDS

IO1005	Multi I/O Card - XT only	175.00
IO1009	Parallel Printer Card	44.00
IO1010	Serial RS232 Card, XT only	55.00
IO10102P	Serial RS232 X 2, XT only	79.00
IO1014	I/O Plus Card - XT Only	136.00
IO2210	Serial/Parallel Card - XT	125.00
IO2230	I/O Plus Card - AT only	245.00
IO2250	Multi I/O, 2S, 1P, 1G, AT	399.00
IOCHIP	Chip Set for IC1010	25.00

VIDEO CARDS

VC1623	Turbo Colour Graphics Cd	165.00
VC1625	Colour Graphics/Mono Card	195.00
VC1629C	EGA Card, W/Hercules Mode	
VC1633	Turbo Mono/Graphics Card	165.00
VC1635	Turbo/Mono Printer Card	175.00

DISK CONTROLLER CARDS

DC1004A	Floppy Disk Card, 4 Ports	65.00
DC1220	1.2M/360K/720K/1.44M FDC	145.00
DC2200	Hard Disk Controller - XT	145.00
DC2210	HDD/FDD Cont/Board - XT	199.00
DC2300	Hard Disk Controller AT	245.00
DC2310	HDD/FDD Controller AT	295.00
DC2340	2HDD/4DD Controller AT	355.00

POWER SUPPLIES

PS9150S	150W Switching PSU - XT	148.00
PS9180	180W Switch PSU - Baby AT	170.00
PS9180L	180W PSU, Baby AT, L Type	170.00
PS9200	220W Switching PSU - AT	220.00

KEYBOARDS

KB101	Keyboard, 101 Keys XT/AT	145.00
KB84	Keyboard, 84 keys XT/AT	125.00

CASES

CAAT	Case, hinged AT	153.00
CAATB	Case - Baby AT, hinged	135.00
CAXT	Case, hinged XT	95.00

INTERFACE CARDS

IF045	Serial RS-422 Adaptor	135.00
IF046	Industrial I/O Card	445.00
IF054	Universal Wire-wrap Card	125.00
IF055	Dual Serial RS-422 Card	195.00
IF1638	Facsimile Card	1249.00
IF2865	80286 Speed-up Card	595.00
IF488	IEEE 488 Interface Card	465.00
IFADDA12	A-D/D-A Conv, 1 Channel	215.00
IFADDA14	A-D/D-A Conv, 2 Channel	599.00
IFEPROM	EPROM Writer Card	245.00
IFTEGA	Orchid Turbo EGA Card	950.00

RAM CARDS

RC1015	Universal RAM Card, 0K RAM	99.00
RC2000	2MB EMS Memory Cd, 0K RAM	295.00
RC2350	3.5MB M/Funct Cd - 0K RAM	495.00

*0K RAM MEANS ZERO RAM FITTED

READER INFO NO. 35

EPROM Programmer Card

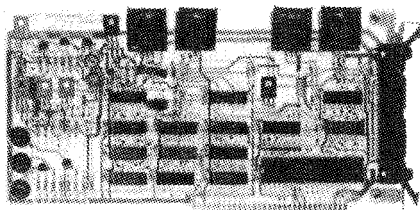

This superb EPROM burner comes with a high quality ZIF socket and cabling.

Facilities include the ability to read, write, copy, compare and erase the contents of EPROMs.

Compatible EPROMS include: 2716, 2732, 2764, 27128, 27256, 27512, 2804, 2816, 2864, 58064. It comes complete with software and user manual.

IFEPROM \$245

READER INFO NO. 36

PC Universal Card

Perfect for prototyping, with massive 4000 hole working area.

- Suits PC and AT systems
- Built-in data bus, address bus I/O line buffers
- Universal address decode chip
- D-25 connector

IF054

\$125

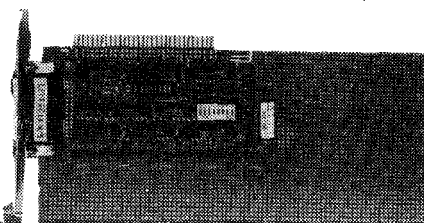

AD-DA Conversion Cards

- Input/Output voltage 0-9V (adjustable)
- Unipolar or bipolar

IFADDA12

\$215.00

READER INFO NO. 37

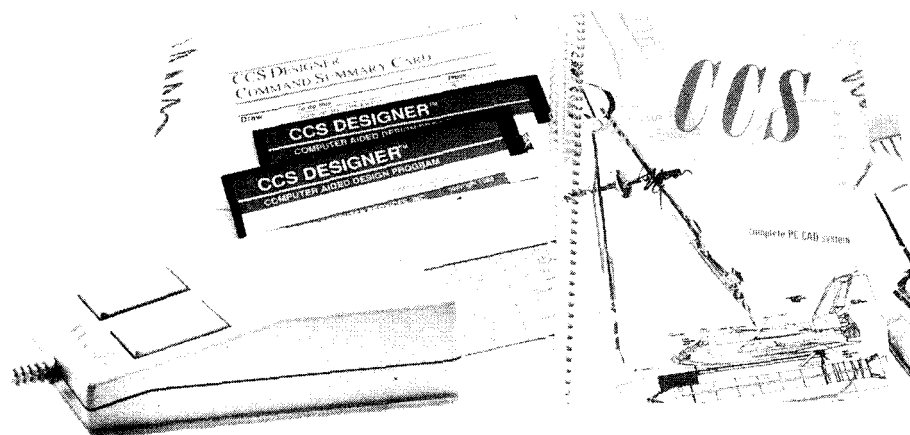

High power CAD Package only \$179

Now you can create detailed, professional quality designs and drawings quickly, easily and inexpensively.

CCS Designer comes with many of the same powerful features found in CAD systems costing thousands of dollars. All you need is an IBM PC/XT/AT or compatible computer with 512K RAM. You'll be creating designs in under 30 minutes.

Use it for dozens of applications: Architectural designs, organisational charts, mechanical designs, business graphics, electronic circuit layouts, interior designs, landscaping, flow charts, floor plans. Built in drivers support 180 mice, 52 input devices, 77 plotters, math co-processors and most display cards. An optional utility allows conversion to and from AutoCAD file format so you can exchange files with AutoCAD and read CCS Designer drawings into Desktop Publishing programs.

CCS Designer produces high quality output on matrix and laser printers - you don't need an expensive plotter for good results.

Use CCS Designer with our Symbol Libraries.

Symbol Library Volume One:

Electrical, Electronic and Plumbing symbols.

Symbol Library Volume Two:

Home design and home furnishing symbols for creating floor plans and interiors.

Symbol Library Volume Three:

Flow chart symbols for drawing professional quality flow charts.

FEATURES

- Enlarge • Rotate • Zoom in and out
- Paint/fill • Undo • Redo • Flip • Move, copy, delete and save sections
- Plot to a dot matrix printer
- Arcs and curves
- Adjustable grid and snap gravity point
- Multiple character sets
- 8 line types with adjustable thicknesses
- Clearly written manual and on-line help
- Create your own symbol libraries
- Retrieve symbols at any size, angle, or location
- 16 colour high resolution display and output
- Auto dimensioning and scaling
- Single keystroke commands
- Point XY command
- Point Polar command
- Repeat copy section
- Gravity move
- Ortho line
- Static zoom

CCS Designer \$179

Symbol Libraries \$79.00 each

Logitec Mouse \$149.00

Plus \$10.00 postage and packing

Note money back guarantee does not apply to software

Dealer Enquiries Welcome

READER INFO NO. 38

The Floppy Solution.

5.25"/3.5"/360K/1.2M/720K/1.44MB

4 of any mix, all on one card. Phew!!

Control any mix of up to four 5.25" or 3.5" inch floppies from one controller.

Total floppy compatibility is now possible with the amazing new DC1240 floppy controller from Electronic Solutions.

- Controls any mix of up to four drives including:
 - 360K 5.25", 1.2M 5.25", 720K 3.5", 1.44MB 3.5"
- Allows for 2 internal/2 external or 4 internal floppies
- Works with all PC XT's, AT's and 386 PCs
- All internal signal and power cabling included, inc. 2 daisy chain cables, power cables, both ready to plug into 5.25" and 3.5 inch drives

If you need to mount a 3.5" drive in place of a 5.25" drive, just buy the DDMCASE bracket. For external mounting, you need the CAEX case and cable.

LIMITED OFFER

If you buy any drive(s) and the controller, we offer a 5% discount off the total purchase.

Cat No.	Description	Price
Controller		
DC1240	4 x FDD Card, 2 Int./Ext/or 4 Int.	\$175

Floppy Drives

DD1157C	NEC 1.2MB, 5.25"	\$245
DD1053	Japanese 360K 5.25"	\$225
DD1037A	NEC 720K 3.5"	\$235
DD1137H	NEC 1.44M 3.5"	\$275

External Case

CAEX	5.25" Ext. Case & 37 pin cable	\$99
------	--------------------------------	------

5.25" mounting bracket

DDMCASE	5.25" Mtg. Bracket for 3.5" FDD	\$25
---------	---------------------------------	------

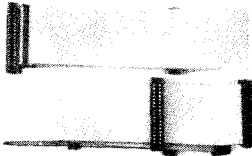
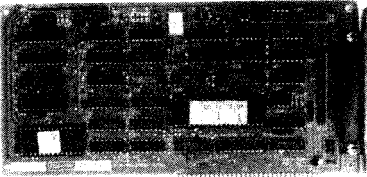

VGA Price Crash

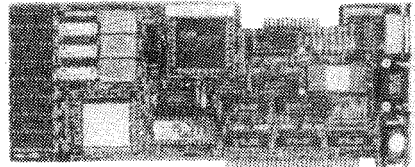

We've brought top quality VGA resolution prices down with our new VC800 Video Graphics Adaptor. Resolution to 800 x 600 x 256 colours (with suitable monitor). The VC800 is completely compatible with the IBM Video Graphics Array (VGA) standard. So all software written for IBM PS/2 systems and the VGA standard runs correctly. Interface the IBM 8503, 8512, 8513, and 8514 analogue monitors, or get even better resolution with NEC Multisync II or equivalent multisync monitors. Also compatible with EGA, CGA and MDA standards.

The following high resolution graphics modes (which are not available on IBM VGA) are also provided, with free software drivers for Ventura, Pagemaker (MS Windows), AutoCAD and other applications.

- 640 x 350, 256 colours out of palette of 256K
- 640 x 480, 256 colours out of palette of 256K
- 800 x 600, 256 colours out of palette of 256K
- Instant hardware zoom and pan
- 132 column x 25/28/44 lines text display for Lotus, Symphony, Word Perfect.

Introductory Offer

\$495 while current stocks last!!

READER INFO No. 39

READER INFO No. 40

BABY SIZE PC/AT MOTHERBOARDS WITH SPEEDS UP TO 20MHz – WOW!!

Specifications:

Cat. No.	MB286120K	MB28616L1M	MB286161M	MB286201M
Price	\$645.00	\$1495.00	\$1645.00	\$1895.00
CPU (CMOS Version)	80286-10MHz	80286-12MHz	80286-16MHz	80286-16MHz
Clock Rate	12/10/8MHz	16/12/10/8MHz	16/12/10/8MHz	20/16/12/10/8MHz
Chip Set, C&T NEAT	10 MHz	12MHz	16MHz	16MHz
On-Board Memory	OK RAM fitted exp. to 2M byte	1M byte fitted exp. to 4M byte	1M byte fitted exp. to 4M byte	1M byte fitted
RAM Speed	120nS (DIL type)	120nS (SIMM type)	120nS (SIMM type)	100nS (DIL type)
I/O Slots Speed	12/10/8MHz	16/12/10/8MHz	16/12/10/8MHz	20/16/12/10/8MHz
	Software selectable with programmable wait state to suit add-on cards of different speeds			
Co-processor	Optional 80287 (6,8,10,12Mhz selectable by DIP switch)			
BIOS	Award BIOS with built-in setup (including CMOS & extended CMOS)			
Keyboard Controller	Award version 1.3 or above			
Power Good Generator	On-board Power-good generator, jumper selectable			
DMA	7 channels			
Interrupt	16 level interrupts			
Real Time Clock	Built in			
Timers	3 programmable timers			
Battery	Off board long life battery included			
Board size	8.5" wide x 13" long			
Mounting Holes	2 sets: - PC/XT, Mini/baby AT – Standard Size AT			

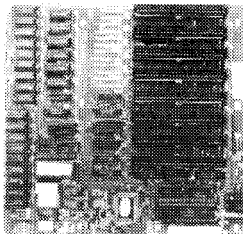

READER INFO No. 41

EGA card – unmatched resolution

Get all the standards with this superb short slot EGA card.

- Supports 132 columns in Symphony, Lotus and WordPerfect
- Automatic monitor detection
- 256K of video memory standard
- Flicker free scrolling

- Supports Monochrome, Hercules, CGA, and EGA modes. Fully auto switchable.

~~\$495~~
VC1629C
\$249

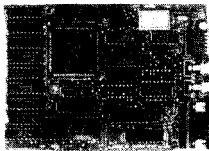

READER INFO No. 42

IEEE 488 Adaptor (GPIB interface)

Industry standard instrumentation interface. **READER INFO No. 43**

- Suits both PC and AT systems ¹¹⁻⁴⁸⁸
- Standard IEEE interface **\$465**
- 250K-1M byte transfer rate
- Manages up to 15 devices
- Basic language driver included

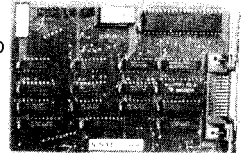

ELECTRONIC SOLUTIONS

P.O. Box 426 Gladesville 2111
Phone (02) 427 4422

We accept: Bankcard, Mastercard and Visa. Mail orders our speciality. All prices include sales tax.

Note: Products may vary in appearance from those pictured. In all cases they will perform to the same, or better standard.

- All products carry a 14 day money back guarantee
- All products carry a full 3 months warranty excludes software
- All cards come with full documentation
- Ring for quantity discounts and tax free prices.
- Freight \$7.50 for first item, then \$2.50 for each extra item.

Dealer Enquiries Welcome

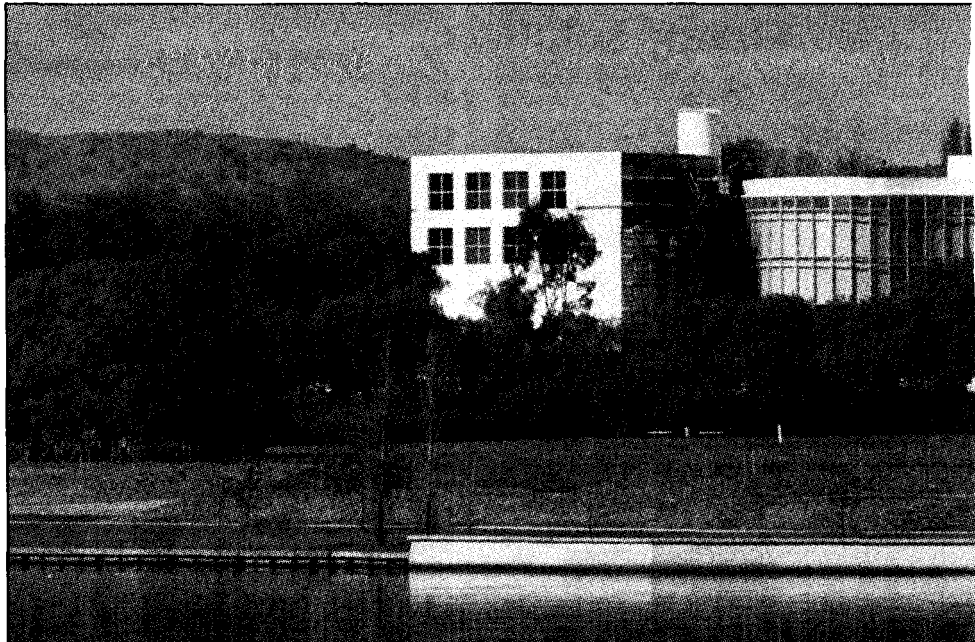
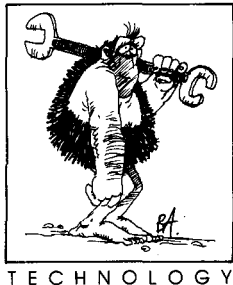

THE NATIONAL SCIENCE AND TECHNOLOGY CENTRE

Japan's Bicentennial gift to Australia came in the form of half shares in Canberra's new science playground. ETI editor Jon Fairall strolled among the exhibits.

If you were unduly young, or unduly impressionable, it's quite possible you could scare yourself witless in the dinosaur exhibit at the new National Science and Technology Centre (NSTC). Only half-scale, they nevertheless grunt, groan, chew their cud, and lunge at unsuspecting visitors with all the aplomb you would expect of the real animal. After a few seconds inspection, you realise that the limbs are driven by pneumatics and the skin is made from Laytex, but the illusion is remarkable. As a learning experience, it's unbeatable.

In fact, it's an apt comment about the whole NSTC. Five large halls surrounding a huge circular void, it is devoted to the idea that science is fascinating and fun. Each of the halls is full of hands on, interactive exhibits designed to be tumbled, turned, pushed, pulled, hit and manipulated. According to Graeme Potter, the assistant manager of

education programs, a rampaging horde of feral children does just that every day. Yet a proper understanding of the principles explained here will earn one a BSc.

History

The NSTC began back in 1982 when Mike Gore, a physics lecturer at the ANU took a holiday overseas, and came upon something called the Exploratorium in San Francisco in the US. Gore was so impressed with the idea of the Exploratorium that, home in Canberra again, he began lobbying the Federal government for funds to set up a similar scheme in Australia.

The result was Questacon, fifteen exhibits in a shed in a Canberra suburb, opened two days a week for 45 schoolchildren. It was funded by a National Innovations grant of \$50k. It was not quite what Gore had envisaged, but over the years it grew into a respectable sized exhibition.

The biggest problem was the actual construction of the exhibits. They are not, after all, the type of thing one can buy in the corner store. Assembling a team of engineers and craftsmen who could conceptualise, design and build exhibits was a long, slow job. Another part of the human resources of Questacon was the 'explainers', part-time people who could supervise a few exhibits and explain their workings to people.

Meanwhile, in 1982, the Federal government set up the bicentennial authority to consider activities for sponsorship, and the idea of a Science centre was one of the best. Gore, with several years experience in making science



NSTC

interesting, was front runner for the job of director.

Meanwhile, the Japanese government was casting around for a suitable gift to the Australian people, and when they heard about plans for a science centre, jumped on the bandwagon with both feet. In the wash-up, they agreed to pay \$10m out of the \$20m capital cost of the building.

Opening

The NSTC building was completed on schedule in the middle of 1988, and opened by Prime Minister Hawke in front of a host of invited distinguished guests. It sits on probably the best real estate in Australia, right on the shore of Lake Burley Griffin in the middle of the parliamentary triangle.

The highlight of the opening was the arrival of a motley crew of disgruntled and uninvited scientists, intent on giving new meaning to the word 'Boffin'. Hawke's record of support for science had been stupidly low in the opinion of the demonstrators. Unfortunately, most of their fury was vented on Science Minister, Barry Jones. After the formalities, Hawke swanned off into the night, leaving Jones to justify government policies he had consistently argued against since the government was elected. Hawke, apparently, was much amused by the situation. Jones was not. But the demonstration may have been more successful than was apparent on the night. The government is apparently re-thinking the wisdom of cutting research funds.

Hawke would certainly have been interested in the funding arrangement at the NSTC. Money for its exhibits has come mostly from donations by private industry. IBM has put in \$500k, Shell \$750k and ICI \$900k, to be used over the next five years.

IBM has a whole gallery of mathematical exhibits. Some demonstrate electro-mechanical methods of counting. Others show how ASCII is derived, or the importance of a Pascal triangle. Across the way, a gallery called Waves demonstrates principles and effects of wave energy. The obvious exhibits are here, waves in a spring, for instance, but there are some interesting demonstrations of resonance, and two dishes that magnify acoustic echoes, a periscope and so on.

Another exhibit called Force has the most spectacular Jacobs ladder I have ever seen. Produced by the Sydney City Council it must stand all of ten metres high and develops 15 500 V between its electrodes. There are also graphic displays of planetary orbits and black holes, conservation of momentum, moments of inertia and so on.

One of the most interesting things about the NSTC is that, as a working display, it requires a large team of technicians and a well equipped workshop to keep everything functioning properly. It also means that there is a built in ability to continually upgrade and

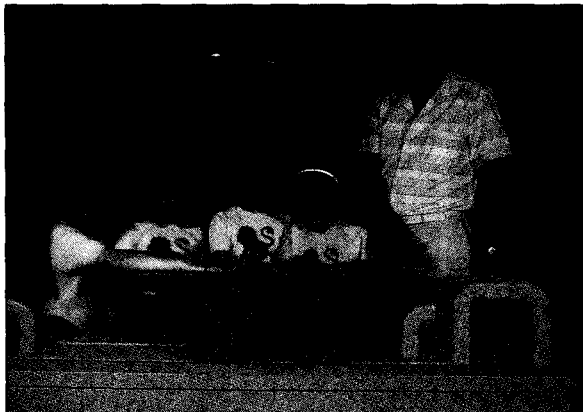

Exhibits that one can touch (or that lean over and touch you!) help make science and technology meaningful for people of all ages.

change the exhibits. Bill Burch, who manages the exhibit design and development, is full of ideas for new ones.

Telecom, for instance, has given the NSTC a grant, which will go towards the creation of a hall of communications. Exhibits will include hand held satellite tracking systems, Morse code demonstrators that will actually be used to communicate with the refurbished Overland Telegraph Station at Alice Springs, and a working Strowger Telephone Exchange.

Apart from grants from private companies, funding for the centre will come from the government, and from door sales, with the proviso that the majority share of the money, must come from users of the centre. School groups have booked up the centre for the next nine months, and this source represents the centre's bread and butter. Graeme Potter estimates that on a typical weekday, families predominate, and 60% of the visitors are adults. The NSTC can attract both groups with equal ease.

eti

R.F. DEVICES

PTY. LTD.

SUITE 1/A, 9 LYN PARADE, LURNEA, NSW 2170
PO Box 161, Miller NSW 2168

Sydney

Tel: (02) 607 8811

Telex: AA127948

Fax: (02) 607 3763

OSCILLOSCOPES

R.F. DEVICES CAN NOW OFFER A COMPLETE
RANGE OF OSCILLOSCOPES TO 60 MHz.

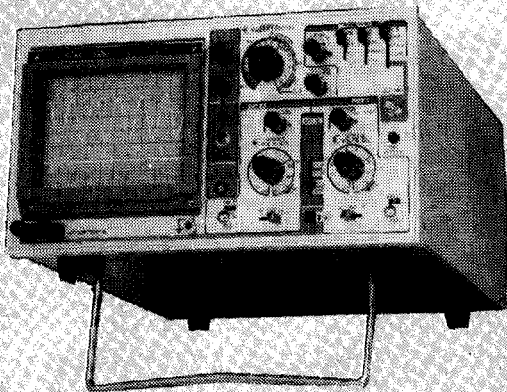

20MHz

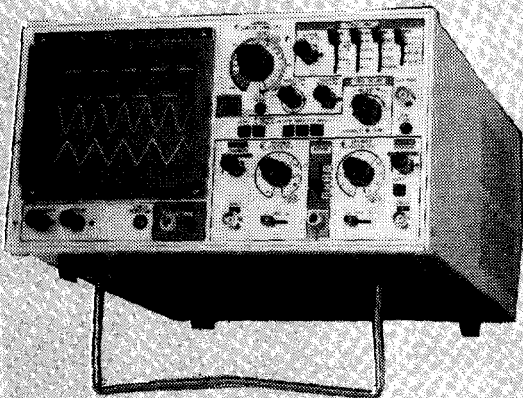

35MHz

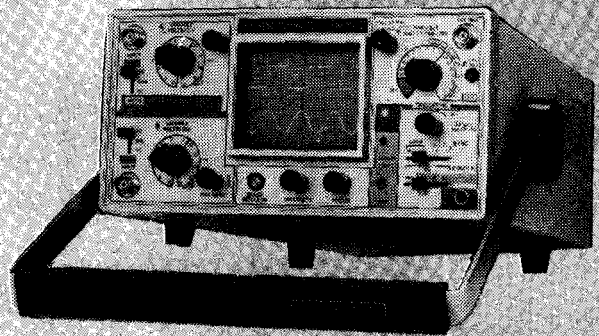

15MHz

ILLUSTRATED ARE SOME OF THE OSCILLOSCOPE RANGE

Full catalogue available on request.



READER INFO NO. 8



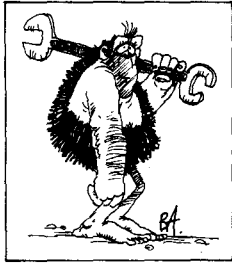

TECHNOLOGY

Over the last two decades or so numerous minor wars and conflicts have focussed attention on the guided missile as a weapon against military targets. In 1967, the Israeli destroyer Eilat sank after being hit by a Soviet-made anti-ship missile. Since then we have witnessed the use of surface-to-air (SAM) and air-to-air (AAM) missiles in the Vietnam war, the success of missiles in the Yom Kippur war of 1973, the sinking of HMS Sheffield and another vessel by the Exocet anti-ship missile in the Falklands war, the use of Chinese-made Silkworm missiles during hostilities in the Persian Gulf and the success of the Stinger missile against Soviet aircraft deployed in Afghanistan.

Modern artillery systems can accurately measure the location of a target and its motion before firing artillery shells. However, once fired, the unguided shell is likely to miss its intended target because of the vagaries of environmental factors or unforeseen movements of the target. In contrast, a guided weapon is more likely to strike its target because it monitors its position relative

to the selected target, adjusting its flight path accordingly. Typically, sustained gunfire has less than a 10% probability of destroying aircraft while a single guided missile may have a 70% chance of destroying the same target.

One type of weapon, the heat-seeking missile, has been in the weapons inventories of both Western and Eastern Bloc countries for several decades, being used with varying success in the Vietnam war, Middle East conflicts and the Falklands war. Now that these weapons are being acquired by terrorists and revolutionaries, commercial as well as military aircraft and shipping may be put at risk. (Readers may have seen a recent Four Corners Documentary about the war in Afghanistan showing how the rebels were able to mount a formidable defence against Russian aircraft by using shoulder-launched heat-seeking missiles.)

Mosquitoes detect body heat as well as using chemical signals when targeting a host animal. The guidance system of a heat-seeking missile also exploits the characteristics of the infrared spectrum. Simply put, they intercept a target by homing onto the heat emitted by it. Such targets may be aircraft, ships, land vehicles and, within certain technical bounds, any vehicle or installation – stationary or moving – which can be identified as a heat source against its natural background. The most common applications of heat-seeking missiles are for surface-to-air or air-to-air combat. In these articles we will concentrate upon the operation of heat-seeking missiles against aircraft and some of the appropriate countermeasures which can be taken to protect aircraft. The general principles of infrared technology will also be explained.

The danger to aircraft is highlighted in

HEAT-SEEKING MISSILES

The first of a two-part article by John Bell and Dr Terry Moon looks at the development of heat-seeking missiles and the way in which they operate. Part 2 will examine some of the options available for protection from these weapons.

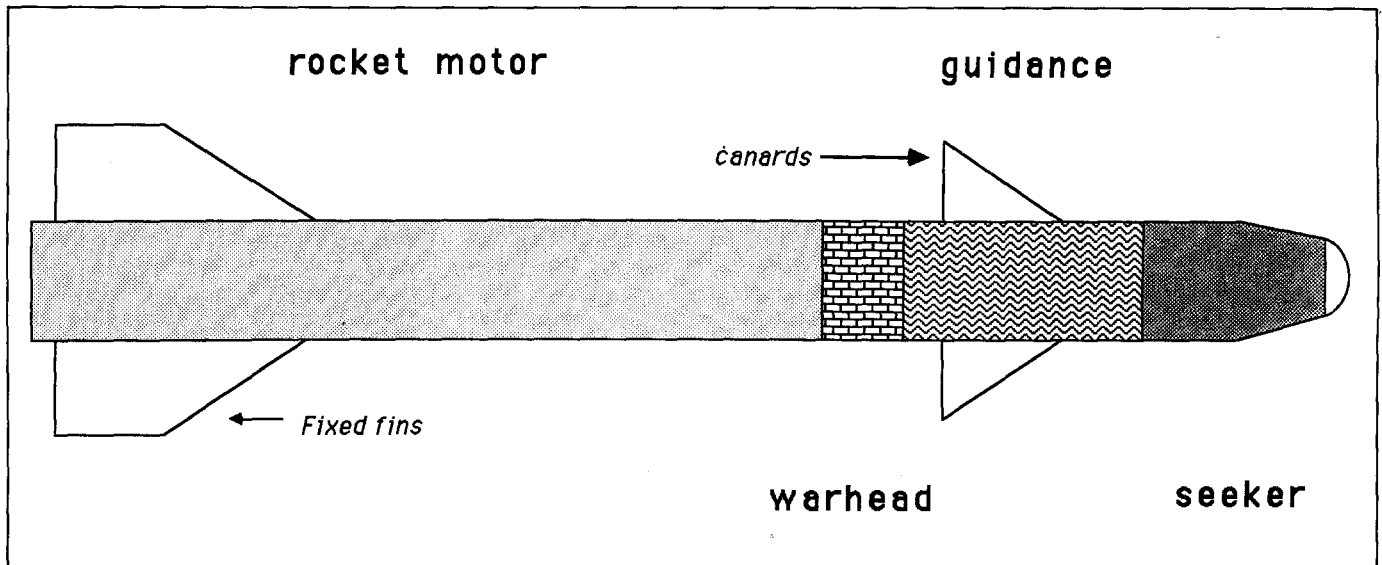

Figure 2: the main section of an infrared homing missile.

◀ Figure 1: both military and civilian aircraft are susceptible to attack by heat-seeking surface-to-air missiles. (Photo courtesy Department of Defence)

Heat-seeking missiles

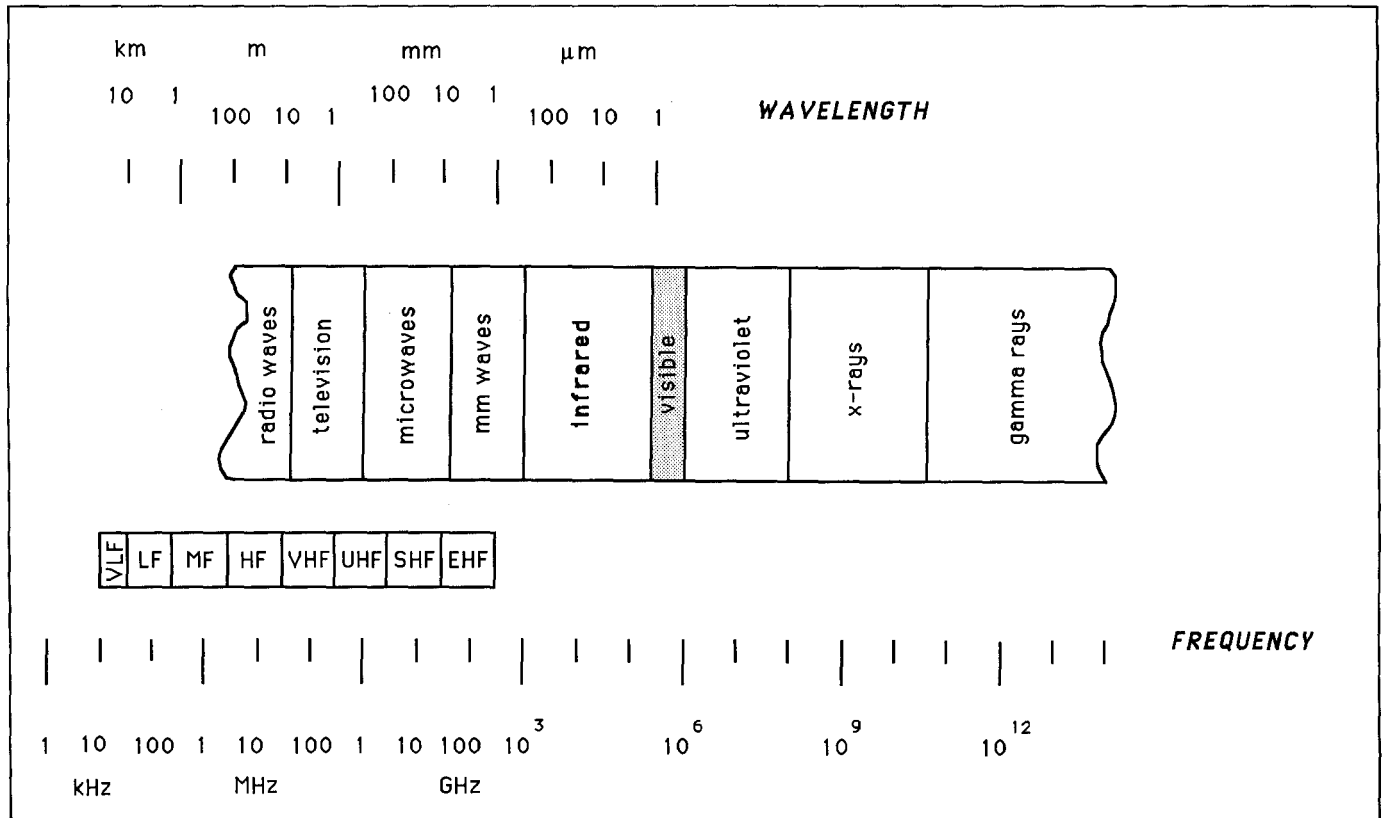

Figure 3: the electromagnetic spectrum.

Figure 1 where an aircraft is shown within range of a shoulder-launched SAM. Not only are the shoulder-launched missiles lightweight and portable but they are capable of intercepting a target aircraft at ranges up to several kilometres. Being small and portable, they can be fired from concealed positions. Unlike most radar-guided missiles, which transmit detectable microwave emissions to locate and track the target, the approach of a heat-seeking missile is 'silent' as it homes in on the heat from the engines of the target aircraft.

Developments leading to the deadly heat-seeking missile

The concept of modern guided missiles was born during World War 1. The obvious advantage of guided munitions over shells and bombs is that guided weapons dramatically increase the likelihood of hitting a target. Orville Wright, EA Sperry and Charles Kettering devised and tested the first guided missile during World War 1 though it was never used in combat. These early tests spawned new ideas, for instance using a radio link to relay steering commands to a missile in flight.

Guided missiles and bombs were first tried in World War 2 with only limited success. Some of these early types were guided using

steering commands transmitted along fine wires or over a radio link between the missile and the launching aircraft while others like the V-1 buzz bomb used a primitive type of inertial guidance. The Japanese tried an air-launched, radio-controlled, rocket-assisted glide bomb. As the control aircraft was required to drop the glide bomb from low altitudes within a range of 4 km of the intended target, the launching aircraft presented an easy target for anti-aircraft fire. The Germans were only marginally more successful with their glide bombs, the first entering service in 1942. These early Henschel glide bombs travelled at 750 kph and could reach targets 16 km away. Another advanced German weapon of this type, the Fritz X-1, achieved fame for sinking the battleship Roma. The Germans claimed to have flown their X-4 air-to-air missile which was launched by a fighter aircraft and then guided by electrical signals transmitted along a pair of thin wires. However, it was never used in combat.

The United States also initiated projects to develop guided weapons. Their glide bombs were used successfully in raids against Cologne while a glide torpedo was used in the Pacific theatre on several missions in the final days of the war.

By the end of WW2 the potential of guided weapons had been demonstrated. Also during this period major advances were

made in applying control theory and in developing the hardware which laid the basis of subsequent developments in radar, electronics and allied subjects leading to the emergence of today's modern, sophisticated missile and electronic warfare systems.

After the war, development of autonomous homing missiles commenced. One method, passive infrared homing (heat-seeking) guidance, was developed at China Lake, USA by Dr McLean and his research team. Dr McLean's research culminated in the development of the Sidewinder missile which first entered service in May 1956. The Sidewinder passive infrared air-intercept missile (also called AIM-9) has evolved through three generations and about eleven models, the various versions entering service with many nations. The Sidewinder concept and technology has been copied by others, some examples being the Israeli Shafrir, the Soviet Atoll and the French Matra Magic. While the early Sidewinders achieved only a modest success rate in the Vietnam War (only about one in seven missiles launched destroyed their intended target) the success of the modern AIM-9L in the Falklands War was outstanding. Dr Alfred Price, a Fellow of The Royal Historical Society, reported that the British launched 26 missiles to destroy 18 Argentinian aircraft and to damage another. Similarly, surface-to-air infrared homing

missiles have also become more deadly as illustrated recently by newspaper and television reports on the success of the Stinger missiles in Afghanistan.

Such heat-seeking missiles, or infrared homing missiles are often referred to as fire-and-forget (or launch-and-leave) weapons. There are two main advantages of autonomous homing guidance over other methods:

(1) After launch the missile operates independently of the attacking aircraft, or for that matter the ship or ground-based installation or terrorist, freeing the launching platform so that it may engage other targets or take evasive action.

(2) As the missile closes upon the target the absolute tracking precision improves. This occurs because a set angular tracking error will translate to a smaller linear dimension as the range shortens.

Infrared radiation

Heat-seeking missiles home in on the infrared radiation which is emitted in substantial quantities by all objects at room temperature or above. This infrared radiation is electromagnetic radiation with wavelengths longer (at lower frequencies) than light but shorter than radio waves: the part of the electromagnetic spectrum occupied by infrared radiation is shown in Figure 3.

As our sun has a surface temperature of about 6000° K the radiation from it reaches a maximum of about 0.5 micrometers (microns) being visible to us as yellow light.

On the other hand, the tailpipe of a jet aircraft is considerably cooler; for a working temperature of 900° K an aircraft tailpipe emits its maximum energy at a wavelength of about 3.2 micrometres. For objects at room temperature the maximum energy is emitted at longer wavelengths, near to 10 micrometres. This relationship between the wavelength at which radiated energy reaches a maximum and the temperature of an object is given by a simple expression called the Wien Displacement law:

$$\text{Temperature at which maximum energy is radiated (in micrometres)} = \frac{2898}{\text{temperature (in deg K)}}$$

Not all wavelengths of infrared radiation are transmitted equally through the Earth's

'Mosquitos detect body heat as well as using chemical signals'

atmosphere. Figure 4 shows the parts of the infrared spectrum blocked by the gases in the Earth's atmosphere. This absorption at certain wavelengths, caused mainly by water vapour and carbon dioxide, narrows the choice of an operating wavelength for a heat-seeking missile.

Three main regions can be used for missile guidance: the 1.5 to 2.5, the 3 to 5, and the 8 to 14 micrometre windows. (The term 'window' is used to define parts of the

spectrum where usable amounts of electromagnetic radiation are available.) A further constraint on the choice of wavelength by the missile system designer is imposed by the types of infrared detector available. Early infrared detectors were made from lead sulphide which only sensed radiation at wavelengths shorter than 3 micrometres. Modern indium antimonide and lead selenide detectors will operate at longer wavelengths but require cooling to liquid nitrogen temperatures of 77° Kelvin (i.e. -196° Celsius). Clearly, the missile designer must weigh up all the factors affecting the homing system of the missile as well as the operational requirements of its airframe.

How an infrared seeker works

Several major design considerations arise when adding an infrared seeker to the end of a missile. Firstly, the seeker must point continually at the target despite any changes in the missile's flight path or movements of its body. Secondly, the sensor within the seeker must be able to pick out the target from background infrared radiation and thirdly, there must be some means of determining the position of a target within the field of view of the seeker. (There are of course many other aspects including cooling, data processing, size, environmental conditions etc.)

Designs of such infrared missiles attempt to satisfy these requirements by mounting the optics (usually a small Cassegrain telescope and a reticle), and a sensor on a gyroscope. Typically this assembly is spun at 6000 rpm (called the spin frequency) maintaining a gyroscopically stabilised line of sight to a target irrespective of the motions of the missile body during flight. The reticle, a patterned disc of special glass, performs two functions:

- (1) The alternate transparent and opaque radial sections chop the infrared radiation collected by the viewing optics. This produces an ac signal due to the target and a dc signal due to the background radiation. The ac signal varies at the chopping frequency (the chopping frequency is the spin frequency times the number of opaque radial sections on the reticle) whilst the background infrared radiation is always present at a constant level. The modulated infrared radiation is then converted into an electrical signal by the infrared detector.
- (2) Through careful design, which usually entails adding a phasing sector to periodically stop the chopping and a more complicated pattern in the remaining chopping sector, the reticle can be used to encode the position of a target in the seeker's field of view.

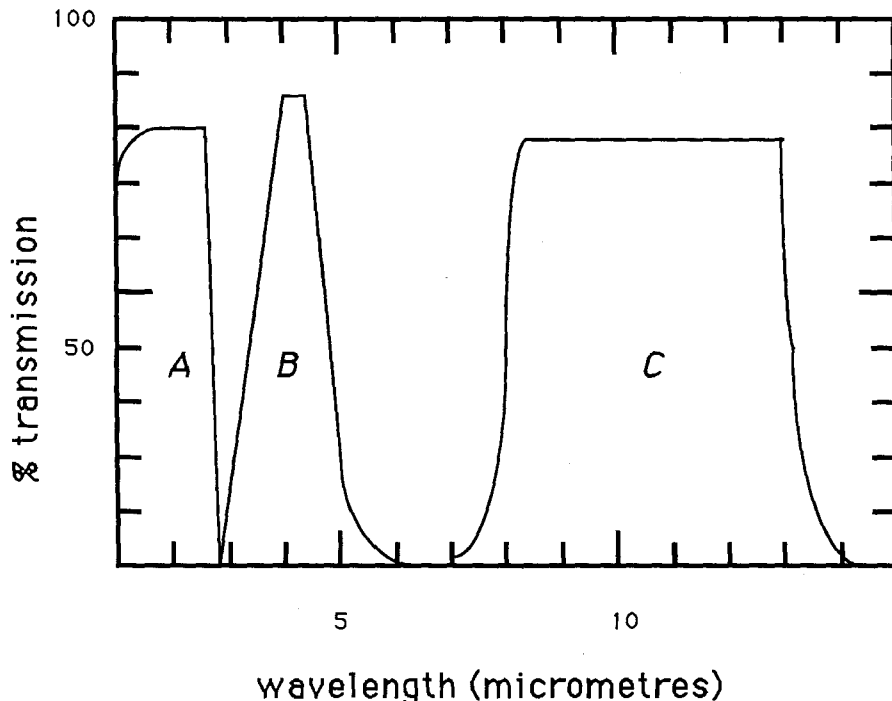

Figure 4: main wavelength regions of the infrared spectrum available for infrared homing missiles.

JOIN THE WIRELESS INSTITUTE OF AUSTRALIA

The Wireless Institute of Australia (W.I.A) represents radio amateurs in local and international matters and provides assistance, education and many other services. As a member you will receive:

AMATEUR RADIO the monthly magazine of the WIA.

OTHER SERVICES INCLUDE:

- Sole representation for amateurs at government level
- Classes for students for the Novice, Limited and Full Call Certificates
- Lessons by correspondence
- A world-wide QSL service
- Books and publications sales
- Participation in contests, seminars and field days
- Weekly news and information broadcasts



Learn more about the W.I.A. and AMATEUR RADIO

Forward this coupon, or write to:

Helen Wageningen

**MEMBERSHIP & CIRCULATION
MANAGER**

**W.I.A.
RO. BOX 300
CAULFIELD SOUTH
VICTORIA 3162**

Please send a WIA membership form to:

NAME

Address

.....

.....

..... **Postcode**

Registered Address: 3/105 Hawthorn Road, Caulfield North

BKP/88/129C

READER INFO No. 9

Heat-seeking missiles

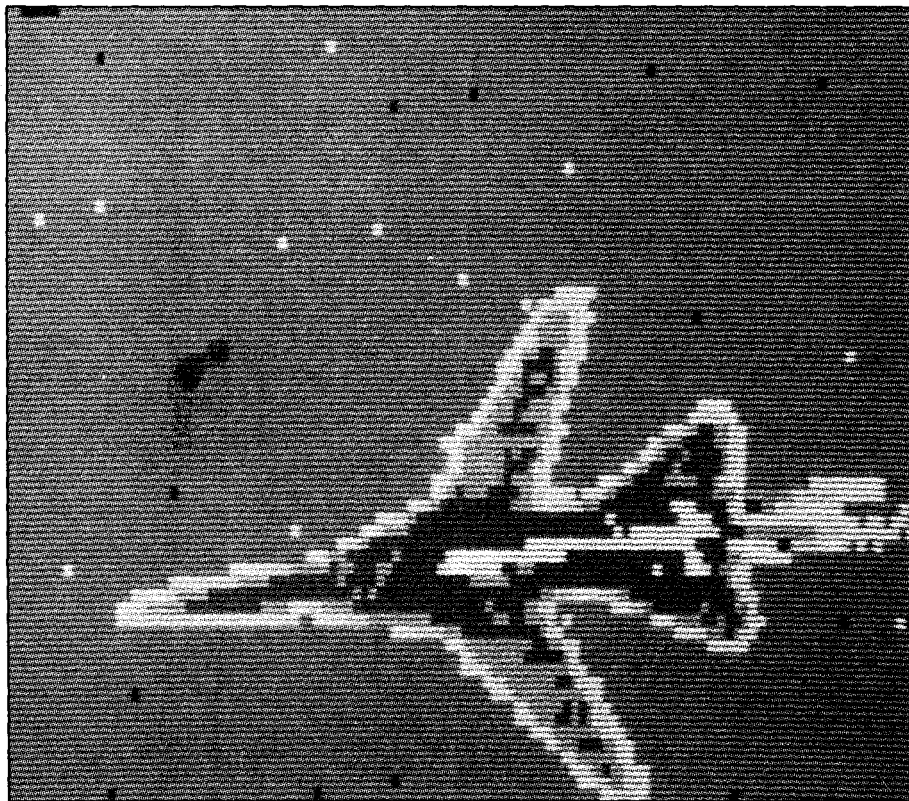

Figure 5: Infrared picture of F-111 jet aircraft. (Photo courtesy Department of Defence)

Usually the pattern on the reticle is designed to provide a measure of the magnitude and direction of a target from the boresight of the optics. The angular position in the field of view is determined by comparing the phase of the detected electrical signal to the phase of a reference ac signal obtained from the coils surrounding the spinning gyroscope and optics. The radial distance of the target from the boresight is usually determined from the amplitude of the detected signal. Figure 6 illustrates the way an infrared seeker works.

By using carefully designed optics, an infrared detector and a pre-amplifier the seeker converts the infrared radiation into a coded electrical signal. This signal is then

is shown in Figure 7. Modern infrared homing missiles may employ sophisticated signal processing techniques to improve their performance and to provide resistance or immunity to countermeasures.

The evolution of heat-seeking missiles will continue. In the future we are likely to see new imaging infrared seekers using focal plane arrays and more sophisticated signal processing to take advantage of these new detectors, using the increased signal processing power for target recognition and selection. Next month we will examine possible ways of countering the deadly heat-seeking missile. **ETI**

Further reading:
Charles T. Myers, "Guided Missiles, Operations, Design and Theory" McGraw-Hill, 1958.
MG Burns "Sidewinder 1, 2 & 3", "Armed Forces", July 1986 pp 324-328, Nov 1986 pp 510-515 and Jan 1987 pp 20-26.
Alfred Price, "The Falklands Conflict: A new look at the lessons for Air Warfare", The International Countermeasures Handbook, 4th Edition, EW Comms. Inc., California, 1978-79.
Richard D Hudson, "Infrared Systems Engineering", John Wiley & Sons, 1969.
"IR/EO in EW: An assessment of technology", The International Countermeasures Handbook, 11th Edition, EW Comms. Inc., California, 1986.

'The concept of modern guided missiles was born during World War 1.'

passed to the guidance and control section where the signal processing takes place. Finally, an error signal is fed to the fins or other control surfaces which adjust the missile's flight path so that it will continue to track, and then intercept, the target. A block diagram of the guidance system for a typical missile

John Bell and Dr Terry Moon are with The Electronics Research Laboratory, Defence Science and Technology Organisation, PO Box 1600, Salisbury, South Australia 5108.

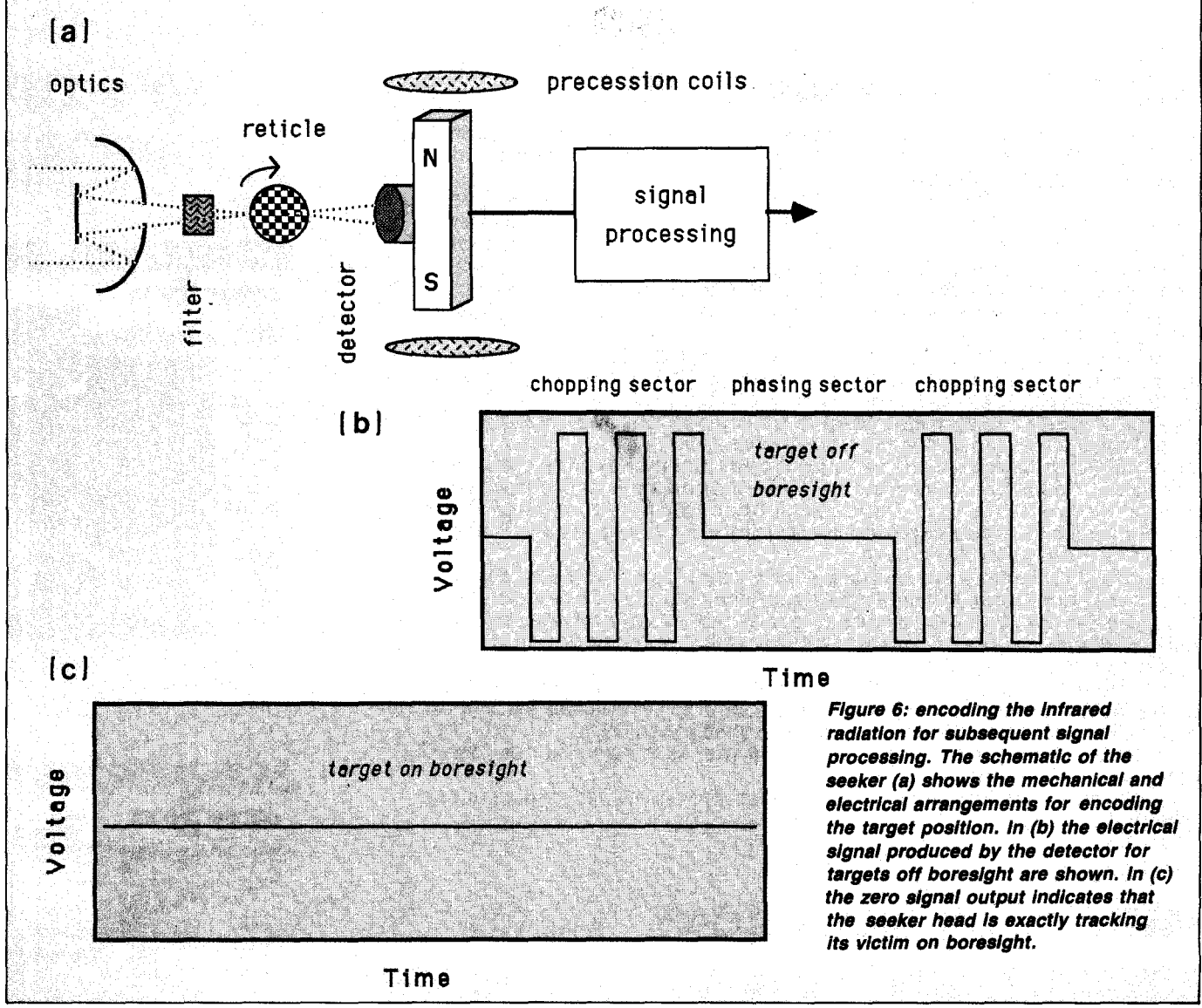

Figure 6: encoding the infrared radiation for subsequent signal processing. The schematic of the seeker (a) shows the mechanical and electrical arrangements for encoding the target position. In (b) the electrical signal produced by the detector for targets off boresight are shown. In (c) the zero signal output indicates that the seeker head is exactly tracking its victim on boresight.

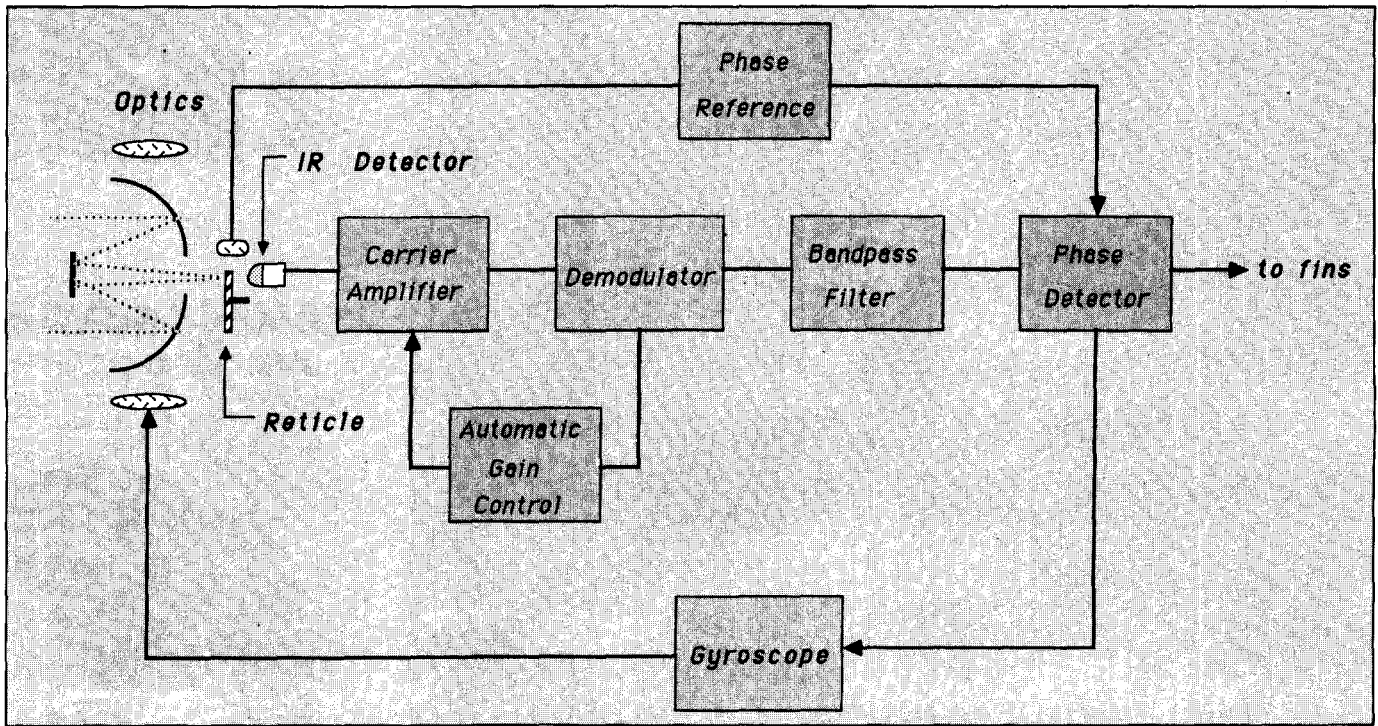

Figure 7: the guidance system of a typical infrared homing missile.

TREES! THE OZONE LAYER AND ETI

Magazine proprietors love subscriptions. Tree lovers get all sweaty palmed at the thought. Even the occasional editor has been known to spend an idle minute ruminating on the thought.

Why? Well, give a thought to how this magazine reaches you. To give you the best opportunity to buy the magazine, we must get copies into every newsagent in the country. This is, in itself, a considerable organisational task that costs a lot of money. But even worse, with a special interest title which can't even aspire to multi-million circulation figures, the number of people who are going to buy the magazine in any given newsagent is actually quite small, perhaps only one or two.

The implication is that, to keep our presence up, it might be necessary for us to supply four or five copies to a given newsagent, in the hope that we will sell one or two. Averaging across the country, publishers like ours work on the assumption that 1.7 magazines need to be supplied for every one sold. That's a lot of magazines wasted in the course of a year.

The publisher doesn't like it because it costs him money. The forests don't like it because it costs trees. Greenies don't like it because it decreases the amount of oxygen in the air. I don't like it because I hate to think of all the work that goes into this magazine being shredded. You don't like it because guess who pays in the long run?

When you become a subscriber we only have to produce one copy to supply your one copy. Ruminating on such things, we've decided rather than provide a competition and a special gift as part of your subscription we are going to begin a series of subscription drives that reflect more accurately the economics of our operation.

You can now subscribe for 12 months for only \$28, that's a huge 37½% saving on the normal subscription rate, or better still, subscribe for 24 months for only \$52 and save 40% on the normal subscription rate.

This is the inexpensive, efficient and easy way to ensure you get your magazine every month.

Protect the forests, protect the ozone layer and protect your subscription against price rises.

Regards,

JON FAIRALL

SAVE 40% ON TECHNOLOGY

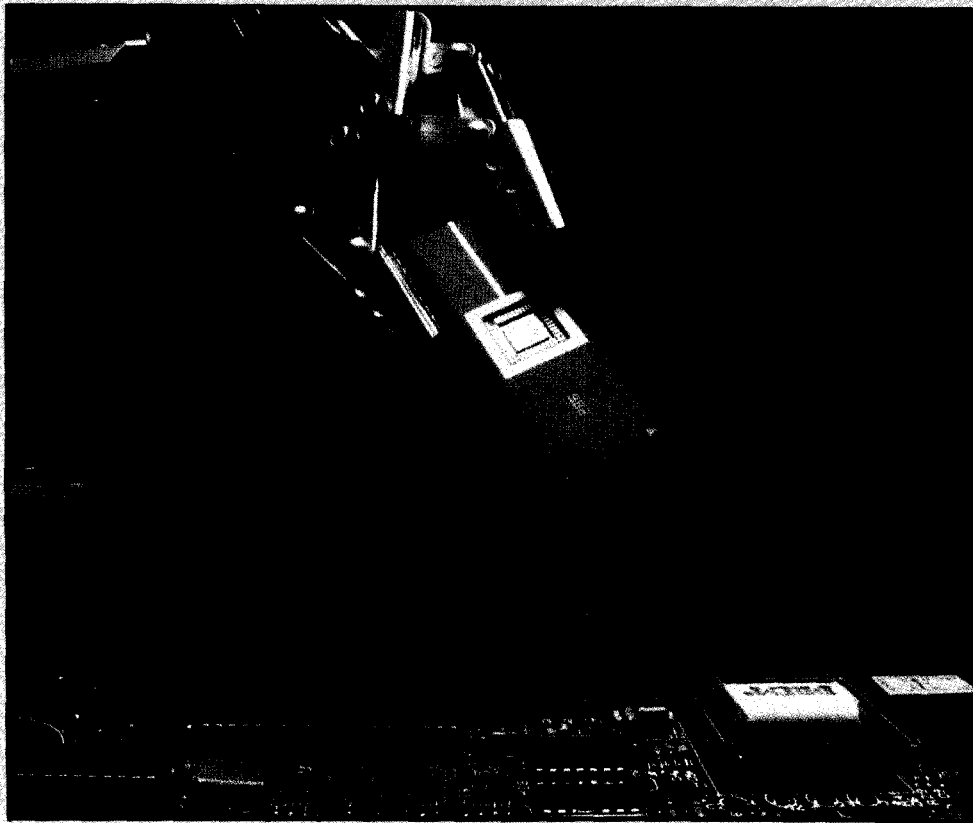

40% OFF SUBSCRIPT

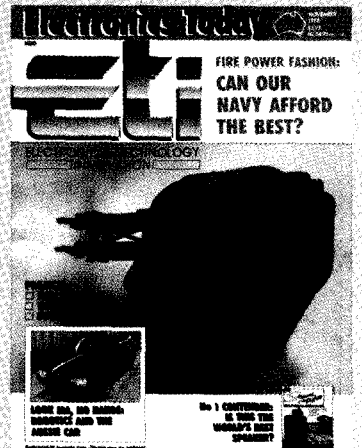

THE ETI ION RATE

SAVE 40% ON INNOVATION

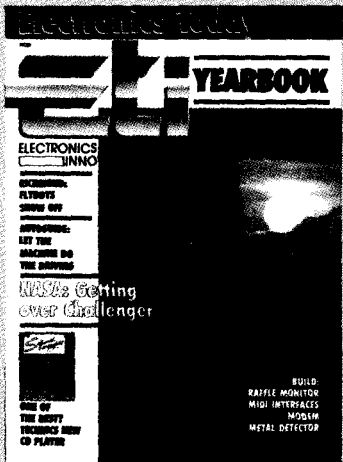
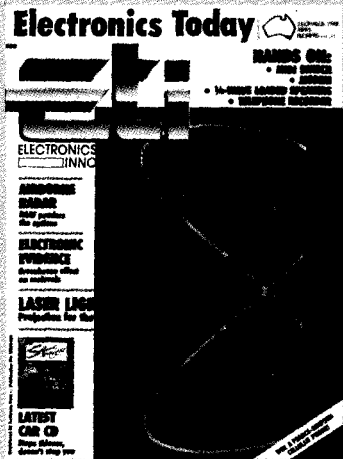

SAVE 40% ON ELECTRONICS

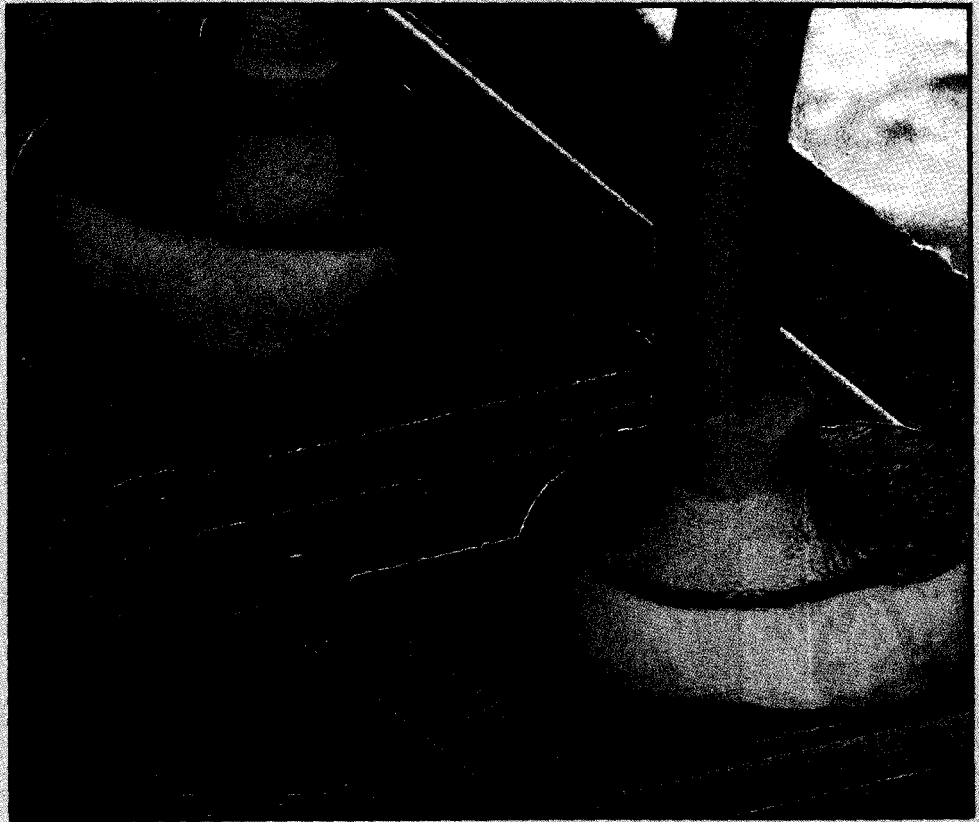

Planetwalking could conceivably be a giant step for womankind in the future.



NASA couldn't ignore forever the many well qualified space travel aspirants who happened to be women. Kathryn Doolan brings us up to date on the status of female astronauts, Stateside.

In the first 25 years of the Space Age, 1957 to 1982, some 104 men flew into space - 24 of those men flew to or landed on the Moon. In that same period of time, only two women went into space, both Soviet and both sent for dubious propaganda purposes. It was not until 1978 that women were accepted into the American space program and it was 1983 when Dr Sally K Ride became the first American woman in space. Since Ride's flight there has been a gradual acceptance of women astronauts and now women are playing prominent roles in the leadership and development of the current American space program.

The first woman to fly in space was Valentina Tereshkova in June 1963. One of the more remarkable things about her was that the year before she was just a factory worker with an interest in parachuting. In the years since her flight there have been persistent rumours that Tereshkova panicked and it was reported that her male colleagues never accepted her as an equal. After her flight, however, she was given a high profile job within the Communist Party. Her husband, fellow cosmonaut Andrian Nikolayev

commented on the prospect of Soviet women flying in to space by saying: "We love our women very much, we spare them as much as possible. In the future, however, they will surely work aboard space stations, but as specialists: doctors, geologists, astronomers and, of course, as stewardesses"!

Nineteen years after Tereshkova's flight, another Soviet women flew in to space.

John Glenn questioned whether women could withstand the same pressure in space as men'

Whether the selection of Svetlana Savitskaya was made to steal the thunder of Sally Ride, who was to go in to space in the ensuing 10 months, is not certain. Savitskaya, a former world aerobatic champion, flew in to space in August 1982 and again in July 1984, when she became the first woman to make a "spacewalk". Coincidentally Kathy Sullivan of

WOMEN WITH THE RIGHT STUFF

How the "Astronettes" won their wings



Svetlana Savitskaya, the Russian astronaut, first woman to "walk" in space.

Women with the Right Stuff

the USA made a "spacewalk" less than two months later. Another coincidence was that Sullivan's spacewalk was publicly announced in late 1983. No Soviet woman has flown since 1984 and it is unclear whether Soviet women are in training for future flights.

First moves

The American effort to put women in to space was precisely that – an effort. It was suggested to NASA that women be selected for space flight in 1958, but it was not until 25 years later that one did. During that 25 years, reactions ranged from sceptical to favourable and even after Dr Sally Ride made her flight there was controversy about "women doing men's jobs".

In 1958, NASA announced Project Mercury, which would put the first American men in space. One of the prerequisites was that candidates would have to be military test pilots, at that stage an occupation that was open to men only. Dr Randolph Lovelace, who ran most of the medical testing for NASA, proposed that a group of women be tested to see if they were suitable for spaceflight. He then recruited 26 women pilots, swore them to secrecy and commenced testing.

By February 1960, the first of the women trainees, Geraldyn (Jerrle) Cobb, had successfully passed the first stage of the physical testing. Cobb then moved on to the next stage at the Lewis Research Centre. In this series of tests Cobb was exposed to high gravity loads through centrifuge training and to the Multiple Axis Space Test Inertia Facility (MASTIF), which tested balance and sensory deprivation. During the trials the 26 women endured physical demands such as having cold water injected into their ear canals and having to swallow three feet of rubber tubing. As can be imagined it came as a major disappointment to them when James Webb, a NASA administrator, ordered the program to cease.

When it was publicly announced that NASA was testing women, the media reacted with predictable chauvinism, dubbing the trainees "astrodolls", "spacegals" and "astronettes". During this media circus, Cobb and another of the trainees, Jane Hart, travelled to Washington DC to lobby the then vice president, Lyndon Johnson. Under pressure Johnson ordered Congress to review the situation.

In July 1962, Cobb and Hart testified before the House of Representatives Space Subcommittee and accused NASA of favouritism and discrimination. One of the basic requirements for astronauts was that they should have a degree and two of the Mercury Seven, Scott Carpenter and John Glenn, did not. Glenn claimed at the hearing that if there were qualified women, NASA would put them in to the astronaut program.

Glenn queried the lack of flight training that women had and he also questioned whether women could be put under the same pressure in space as men. It was interesting to note that Cobb, with over 10,000 flying hours, had double the flying time of Glenn and almost five times as much time as Carpenter.

Also testifying at the hearing was Jacqueline Cochran, the first woman to break the sound barrier in an aircraft. Cochran did no favours for women aspiring to become astronauts when she stated that NASA would end up losing a lot of money training women who never finish the program, "because marriage is the basic

objective of all women". She suggested that Congress proceed slowly as there was insufficient evidence to compare men and women psychologically. The upshot of this was that Congress refused to consider a coed space program.

After Tereshkova's flight, there was a state of outright war between women's groups and NASA. Senator Ernest Gruening, a strong supporter of women astronauts, chastised NASA publicly and one women's group went as far as to suggest that the name of NASA should be changed from National Aeronautics and Space Administration to MASA – Male Aeronautics and Space Administration. Jerrle Cobb was eventually



Christa McAuliffe, teacher and part-time astronaut, tragically killed when Challenger exploded shortly after takeoff, in 1986.

ETI MARCH '89

appointed as a consultant to the NASA administrator, but was never called upon to give advice.

During the next 15 years, NASA started to employ more women in professional roles such as mathematicians, engineers, geologists and doctors. The first significant testing of women took place in 1973, when 12 Air Force nurses volunteered for five weeks of tests to observe the reaction of women to high gravity loads. The volunteers were spun in a centrifuge and when the women were on the verge of blacking out, the centrifuge was stopped and the women were studied to see if there were any drastic changes. The eventual findings were that women were suited to that aspect of spaceflight.

With the advent of the Space Shuttle program in 1972, NASA administrator James Fletcher announced that there would be opportunities for women and minorities to become astronauts. During several conferences of women's and minority groups, attention was paid to the fact that the Astronaut Office was an all white, all male enclave. Congress, no longer lenient towards NASA's explanations as to why the Astronaut Office was not accepting women or minorities, insisted that the next selection due to commence in the late 1970s comprise both women and minorities. NASA, which was becoming more dependent on public support, agreed to the plan.

In 1977, a newspaper advertisement requested volunteers for an experiment to determine whether women could withstand the stresses of spaceflight. Seventy women responded to the advertisement; 10 were selected to undergo testing. The 10 women would spend three weeks in a windowless

and soundproof enclosure at the Ames Research Centre, simulating orbital flight. The daily activities were conducted with 16 hours of daylight and 8 hours of darkness in timeslots of 90 minutes each 24 hours, to simulate a 90-minute orbit of the Earth.

For nine days the women were confined to bed and not allowed to get up, sit or raise their knees. They had to read through prismatic glasses and were bathed in a horizontal shower known as the "cookie oven". After the nine days, the women were

'In 1982 it was announced that Sally Ride had been assigned to STS7, to fly in June 1983. She instantly became one of the most celebrated figures in aviation history'

exposed to the centrifuge to simulate gravity forces that would be experienced during launch and re-entry of a spacecraft. The only problems that arose were boredom and occasional loss of temper and the scientists and doctors concluded that women were suited for spaceflight and should suffer no adverse effects.

Space cadets

In July 1976, NASA announced that it was recruiting astronauts to fly on the Space Shuttle. There were to be two categories to fly on the Shuttle: pilots who fly the vehicle and mission specialists to conduct

experiments, deploy satellites, undergo extra-vehicular activity ("spacewalking") and in general look after the day-to-day activity aboard the Shuttle.

An extensive recruiting effort was undertaken in search of suitable candidates. Advertisements were placed in university and college publications, technical magazines and also in women's magazines. In another break with tradition, NASA contracted actress Nichelle Nichols (Lt Uhura in Star Trek) to produce and star in a series of television commercials extolling the opportunities that women and minorities could expect from becoming astronauts, and these commercials were responsible for the large number of applications received.

During the year-long recruiting effort, which ended in June 1977, NASA received 8079 applications. Of these, 5680 were for mission specialist positions; 1251 women applied and after initial screening by selection staff at the Johnson Space Centre in Houston, medical tests and interviews took place. During the medical testing, questions about aspects that were not considered in the selection of men: marriage, pregnancy or relocating to Houston with their families if they were selected, were omitted. Realistic physical requirements such as 20/20 vision, even if corrected with glasses or contact lenses, height between 60 and 76 inches and good physical condition were also introduced.

On 16 January 1978, the selection of 35 new astronauts was announced by NASA administrator Robert Frosch. Fifteen pilots, all men, were selected and in the new category of mission specialists, there were 20 people, including six women. In later years there were rumours that NASA Headquarters in Washington DC overruled the Houston

Looking for inspiration?

THE

Lifestyle

SERIES

Look no further!

The Lifestyle Series offers you information on ways to improve your home design a new kitchen or bathroom, plan your outdoor living area, renovate or redecorate your favourite rooms.

- Restorations & Renovations
- Design & Decorating
- Pools & Spas
- Kitchens
- Pools & Outdoor Living
- Bathrooms
- Home Improvements

Look for these exciting titles at your newsagent now or subscribe by phoning (02) 693-9517 or 693-9515.



The World's leading supplier
Racal-Redac
is proud to announce an
exciting new product
CADSTAR.

CADSTAR is another
innovation from *Racal-Redac*
and a major breakthrough
in advanced high-tech
PCB design
CADSTAR gives the capability
of producing very dense
double-sided surface mount
designs.

'design right first time'

RCS CADCENTRES

A Division of RCS Design Pty. Ltd. — Incorporated in Victoria.

Unit 12, Eden Park Estate 31 Waterloo Road North Ryde NSW 2113 Tel: (02) 806 1916 Fax: (02) 806 1909	728 Heidelberg Road Alphington, Victoria 3078 Australia Tel: (03) 499 6404 Fax: (03) 499 7107
--	---

READER INFO No. 11

UV PROCESSING EQUIPMENT

KALEX LIGHT BOX

- Autoreset Timer
- 2 Level Exposure
- Timing Light
- Instant Light Up
- Safety Micro Switch
- Exposure to 22in x 11in

\$650.00

PCB PROCESSING KALEX ETCH TANK

- Two Compartment
- Heater
- Recirculation
(by Magnetic Pump)
- Two Level Rack • Ltd

\$650.00

3M Scotchal Photosensitive Riston 3400 PCB Material

All prices plus sales tax if applicable

KALEX 40 Walls Ave
East Ivanhoe 3079
(03) 497 3422
497 3034
Fax (03) 314 7400

ELECTRONIC COMPONENTS & ACCESSORIES
• SPECIALIST SCHOOL SUPPLIERS

READER INFO No. 12

Women with the Right Stuff

selections and added five more mission specialists, dropping five white pilots. Four of these five were reported to have been women.

The six women were Dr Anna Fisher, a medical doctor; Dr Shannon Lucid, a PhD in biochemistry; Dr Judy Resnik, a PhD in electrical engineering; Dr Sally Ride, a PhD in physics; Dr Rhea Seddon, a medical doctor and Dr Kathy Sullivan, a PhD in geology.

The training period began in August 1978, with survival techniques. Primarily this dealt with the problems of exiting a Space Shuttle and ejecting from the T-38 training jets that the astronauts use. Once survival training finished, the new mission specialists underwent classroom training which included spacecraft systems, astronomy, oceanography, geology, biology and psychology. In August 1979, all 35 astronauts were qualified for Space Shuttle flights and while waiting they undertook specialist training.

In the meantime NASA, which was in need of public support, sent the women and the minority members of the Astronaut Office out on extensive public tours. Although these tours were a success, the women felt that they were getting a rough deal from the NASA Media Office, which pushed them to the spotlight repeatedly. The women were subjected to the same treatment as that received by the Mercury Astronauts in the early 1960s, with the women's tastes in clothing, food and men taken as serious subject matter.

After the first flight of the Space Shuttle Columbia in 1981, opportunities opened up and in early 1982 it was announced that Sally Ride had been assigned to STS7, to fly in June 1983. With this announcement Ride instantly became one of the most celebrated figures in aviation and space history. She appeared on cover stories for most major American magazines including *Time*, *Newsweek* and *US News & World Report* and, as could be expected, appeared in every American women's magazine for the next six months.

Even though a woman had been assigned to a spaceflight small problems still cropped up. Anna Fisher, married to fellow astronaut Bill Fisher, became pregnant and was too scared to tell NASA officials. She kept flying in T-38 jets until she was six months pregnant and then told them. The male technician in charge of packing personal belongings for Sally Ride's flight packed 100 tampons for her, because he was too shy to enquire. When Rhea Seddon married fellow astronaut Robert ("Hoot") Gibson, the groom was the main feature story in bride's magazines for months to follow!

On 18 June 1983 Sally Ride was launched into space aboard the Space Shuttle Challenger. Along with her four male companions, she deployed two satellites including a German free-flying satellite which

obtained some magnificent photographs of Challenger in flight. Other activities during the six-day mission were the Continuous Flow Electrophoresis experiment which was later taken in to space three times by payload specialist Charlie Walker, observations of an ant colony in zero gravity and a series of tests determining what causes space sickness.

The next American woman in space was Judy Resnik aboard 41D. On the first attempt at launch, on 26 June 1984, one of Discovery's main engines shut down which forced the crew to abort with less than four seconds to go before launch. The flight was then delayed until 30 August. Among the payloads were three satellites, deployed without any major problems. Resnik was responsible for the deployment of the 102-foot long solar panel which was to be used in the future to provide power for the space station.

The next Shuttle flight, 41G in October 1984, saw Sally Ride making her second flight and Kathy Sullivan on her first as part of a record-breaking seven-person crew in orbit. On that flight Sullivan became the first American

**'NASA contracted
Nichelle Nichols (Star
Trek's Lt Uhura) to
make commercials
extolling the
opportunities that
women and minorities
could expect from
becoming astronauts'**

woman to "spacewalk"; along with Dave Loutema Sullivan demonstrated toxic hydrazine refuelling of a satellite.

Dr Anna Fisher went on the Space Shuttle flight which has been described as the most successful and spectacular space mission ever. In November 1984, as part of the 51A Discovery mission, Fisher assisted colleagues Dale Gardner and Joe Allen in capturing two wayward satellites and returning them to Earth. After landing, the 51A crew were awarded the Lloyds of London Silver Medal for their outstanding salvage work. Photographs of Fisher hugging her year-old daughter appeared in most American newspapers and she holds the honour as the first mother to fly in space.

When Rhea Seddon went into space in April 1985, she was accompanied by the ultimate space junketeer. Senator Jake Garn flew as an observer on the flight and was used by Seddon as a guinea pig for some medical experiments. Another unscheduled activity conducted by Seddon was the construction of a "flyswatter" device in an

ET1 MARCH '89

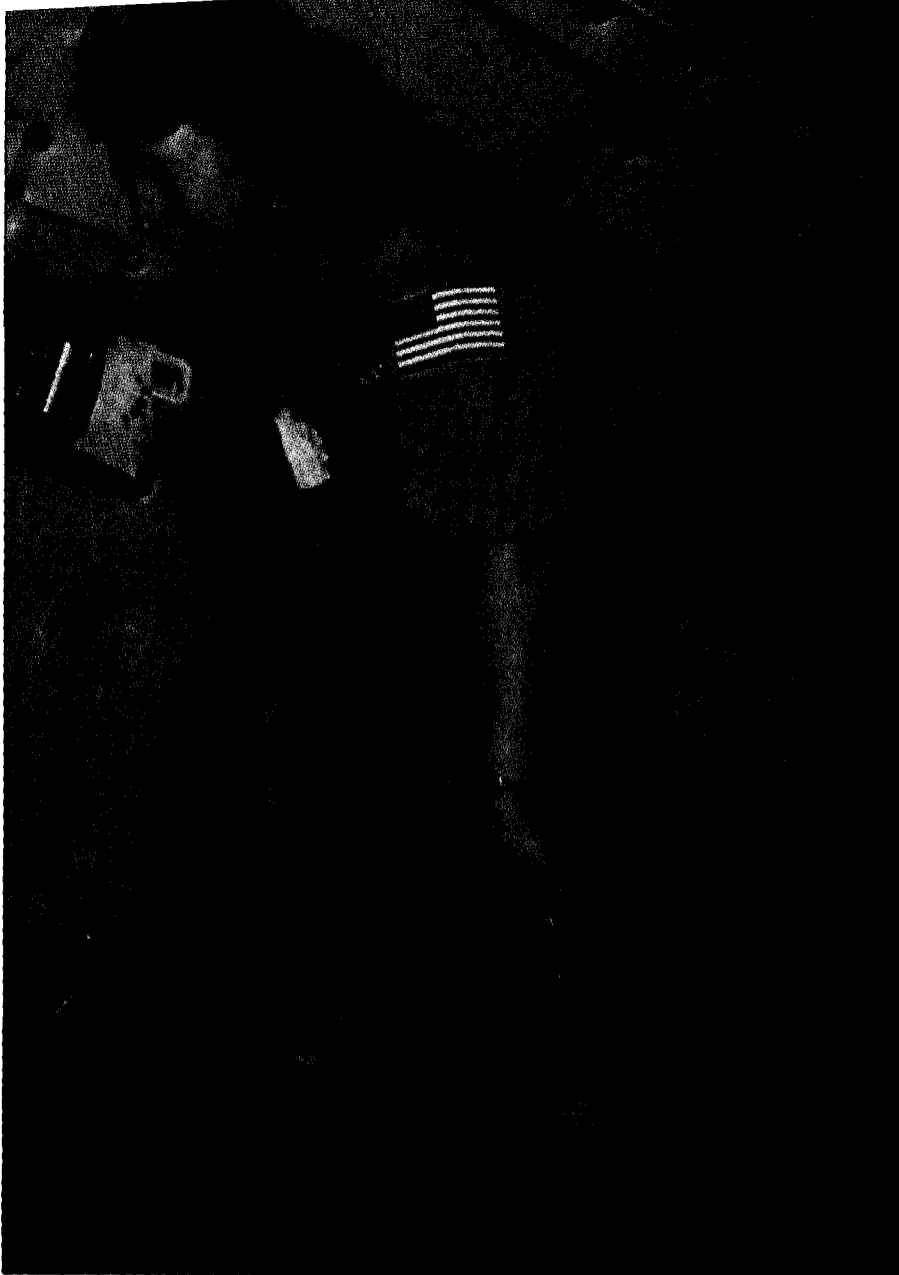

McAuliffe and Barbara Morgan practising for liftoff. Tests repeatedly showed that women were, predictably enough, equal to the rigours of spaceflight.

attempt to unsnare a switch on a satellite which did not start after deployment from Discovery's payload bay.

The last of the women to fly was Shannon Lucid, on 51G in June 1985. During the flight Lucid was responsible for the deployment of three satellites as well as a Spartan free-flying satellite which used X-ray sensors to study the Milky Way. Also on that flight was a Strategic Defence Initiative ("Star Wars") experiment. This involved bouncing a laser at Discovery, which would then be bounced back to Earth, proving that lasers can be pointed accurately at a target in space. Accompanying Lucid into space were payload specialists from France and Saudi Arabia.

The second wave

The astronaut selection in 1980 included two women: Dr Mary Cleave, an environmental

engineer, and Bonnie Dunbar, a ceramic engineer. Dunbar flew on 61A which carried Spacelab D1 in space as well as a record eight-member crew. The mission was completely funded by the German space agency DFLVR, and was the second in a series of international flights funded by overseas organisations other than NASA. The ninth Challenger flight was also the first to be controlled from outside the USA.

Cleave flew on 61B, shuttle Atlantis' second mission. Among the highlights of this flight were the launching of Aussat 2 as well as the EASE/ACCESS construction experiment, the forerunner of construction in space.

The 1986 schedule called for a record 15 missions to be flown by all four shuttles. All the Class of '78 women were all to fly again that year, with Sullivan flying on the long-awaited Hubble Space Telescope deployment mission. However, this schedule

came to an abrupt halt on 28 January 1986 when shuttle Challenger exploded 73 seconds into flight 51L. Among the seven crew members killed were Judy Resnik and teacher Christa McAuliffe.

After the stand-down of shuttle flights, Sally Ride was appointed to the presidential Rogers Commission investigating the disaster. After its completion in June 1986, Ride was appointed as a special assistant to NASA administrator James Fletcher and was given the responsibility of long term and strategic planning. This culminated in the release, in August 1987, of Leadership and America's Future in Space, better known as the Ride Report, in which is mapped out the directions for American space exploration. Included in the report are suggestions for settlements on the Moon and an eventual landing on Mars. In late 1986, Ride's acclaimed book for children, *To Space and Back*, was published. The book simply sets out the wonder of spaceflight accompanied by some excellent photography.

Kathy Sullivan was also busy after the cessation of shuttle flights. In 1985 she was appointed by President Reagan to the National Commission on Space which was to map out goals for the next 50 years in space. Although the report was overshadowed by the release of the Rogers commission report, it offers a challenging and logical blueprint.

As we go into 1989 no women have been accepted by NASA as pilots for future space missions but this is expected to change in the near future, now that women are being trained by the military to fly jets and other aircraft. It is expected that the first woman will command a spaceflight with the construction of the Space Station in the middle to late 1990s. In just over 50 years the number of women pilots has increased by 326%, so there should be abundant opportunities for women pilots at NASA, a far cry from the 1960s.

Sally Ride resigned from NASA in the middle of 1987 to take up a position at Stanford University. At the time of writing only Kathy Sullivan and Mary Cleave have been named to flights following the recommencement of the Shuttle program, but with new crew assignments expected any time we expect the Class of '78 and '80 women to be flying in the next two years. In recent astronaut selections another eight women have been chosen including Dr Mae Jemison, the first minority woman to be chosen as an astronaut. There are also plans for Department of Defence payload specialist Captain Maureen Locombe to fly aboard Starlab in 1990.

With the American program moving into full gear over the next five years, it can certainly be said that "you've come a long way baby" so don't be surprised if the first man on Mars is a woman!

ETI

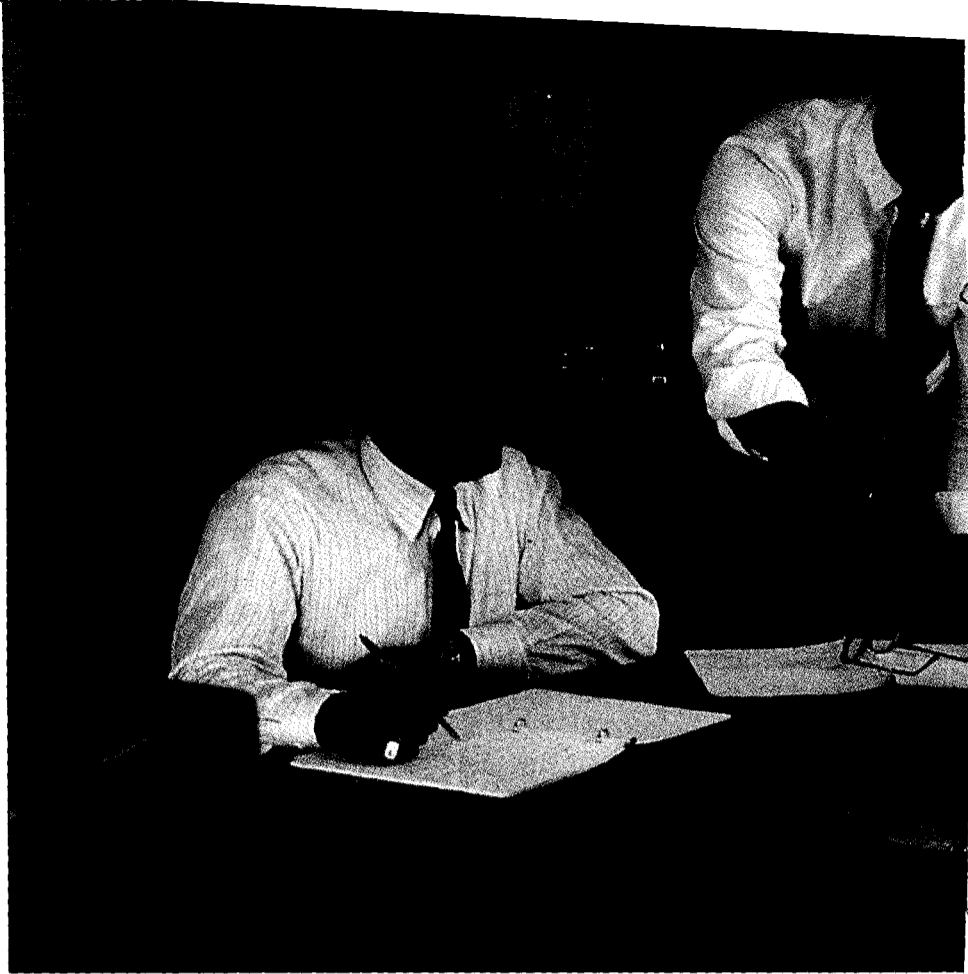

TELECONFERENCING SYSTEMS

Now more than two can tango

Teleconferencing systems, essentially, telephones that can be used by more than one person at a time, are experiencing a disproportionate growth spurt in the highly competitive telecommunications market place.

There is a range of systems available, but generally, they involve a loudspeaker, so that the signal coming down the line is available for general consumption, and a microphone, so that anything said around the unit will be audible at the other end.

It's a simple idea, but traditionally, there have been a lot of problems with implementing this type of technology. Voice levels depend dramatically on the distance between the speaker and the microphone, the room acoustics cause a distracting

boom, the signal can feedback from mic to speaker, and so on.

Now, Shure, in the USA, has produced a unit that solves most of these problems. For instance, take the question of mic to speaker distance.

*'For larger conferences,
additional modules can
be connected together'*

Moving a microphone away from a talker's mouth will reduce the level of direct speech pickup relative to room noise and reverberation. This reduces the clarity and intelligibility of the speech, and can result in

the characteristic hollow, or bottom of the barrel sound often associated with conference sets and speakerphones.

A new unit, which Shure has called the ST3000, minimises this problem through the use of an array of high-quality, electret condenser directional microphones for optimum acoustic pickup. When the module is mounted on a table surface, speech is picked up uniformly around a full 360°, yet noise and reverberation pickup is reduced, typically 3 to 5 dB relative to a surface-mounted omnidirectional microphone, and by 6 to 8 dB relative to a non-surface-mounted microphone.

For larger conferences, additional modules can be connected together to maintain closer talker-to-microphone distance for all

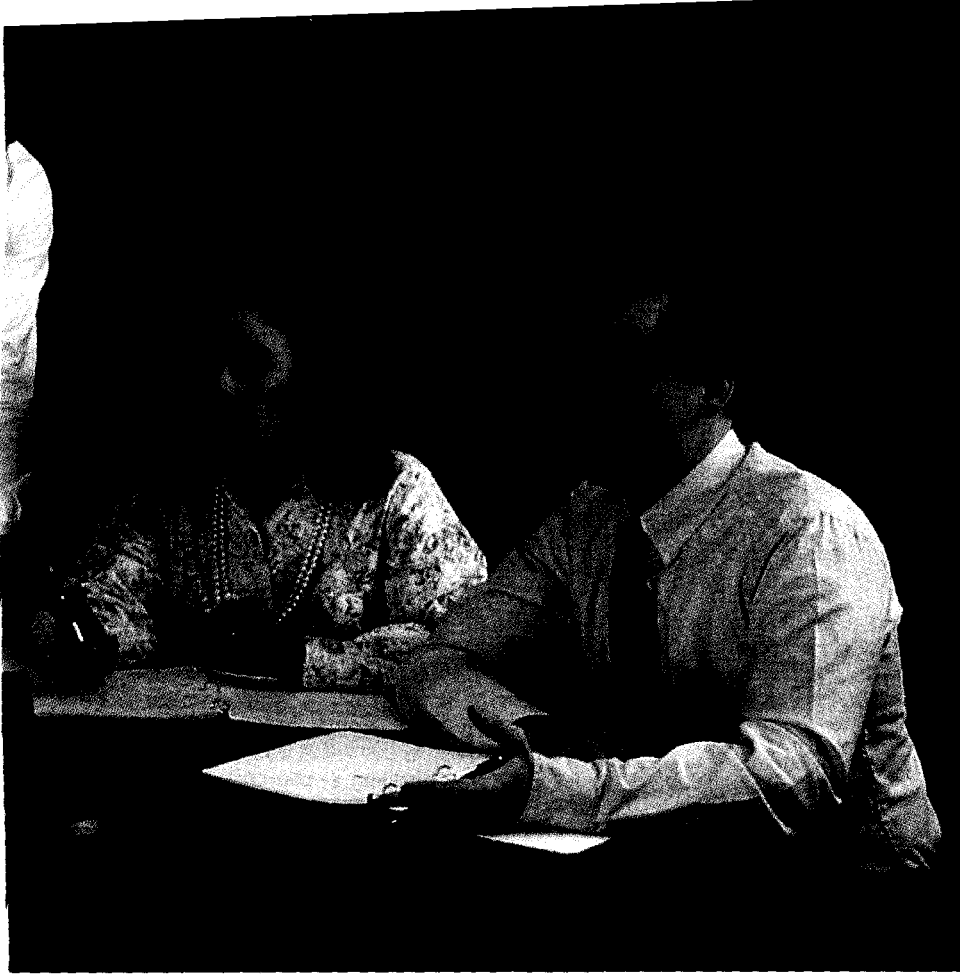

A light, portable teleconferencing setup which allows interruptible conversation with good audio performance.

Below: When video is added in the 2-wire ST3000 at downlink sites works in tandem with a 4-wire ST6000 at the uplink site, giving good lip-synchronisation.



Teleconference

participants. Unlike conventional conference microphone mixing, additional modules do not result in additional noise and reverberation pickup.

Another benefit of the means used to control the microphones is the ability to mute the microphone pickup of an individual module in a system without muting other interconnected modules. Sounds made by conference participants close to a module in the mute mode will not cause unwanted interruptions of the conference. However, these sounds may be heard at the far end of the conference if another module in the talk mode is activated by other sounds closer to that module.

The module also contains an upward-facing, surface-mounted loudspeaker which distributes received speech uniformly to the participants. The optimised surface-mounting of the microphones and loudspeaker result in wide-range sound pickup and reproduction without the frequency response aberrations commonly encountered when transducers are used near surfaces.

Room noise minimised

The same techniques which minimise room noise and reverberation pickup also help to reduce the acoustical coupling from the loudspeaker to the microphones. The

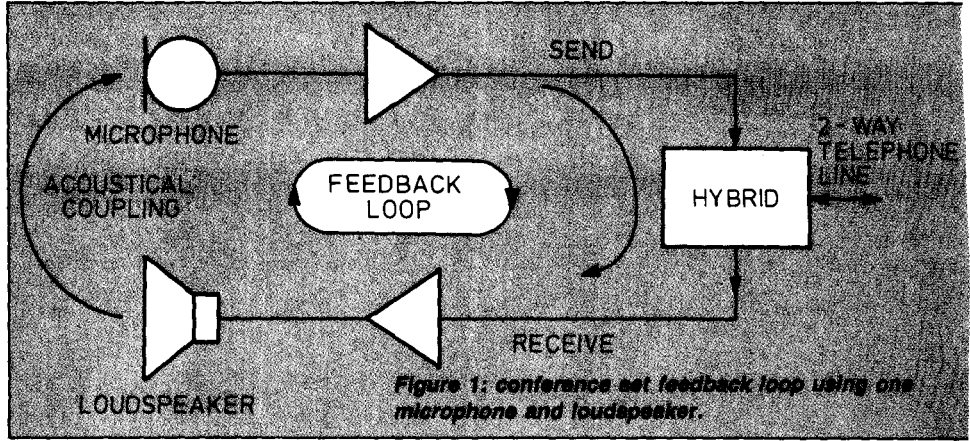

Figure 1: conference set feedback loop using one microphone and loudspeaker.

coupling is a problem because it forms a feedback path which, if not controlled, will result in howling or echo. This is not a problem in well-designed telephone handsets

'Beginning syllables and words may be lost'

because the coupling from earpiece to mouthpiece is very small.

Figure 1 is a simplified representation of a single microphone-loudspeaker conference

set. The acoustical coupling path includes all direct and reflective sound paths from loudspeaker to microphone. When connected to a standard 2-wire telephone line, a local feedback loop is completed through the hybrid circuit which becomes the dominant consideration in preventing howling. (The overall acoustic feedback loop formed with a conference set at the far end will normally be stable if the local feedback loops at each end are stable.) The hybrid's purpose is to apply the send signal to the 2-wire line while at the same time extracting the receive signal from the same line. In practice, for reasons relating to the complex and varying

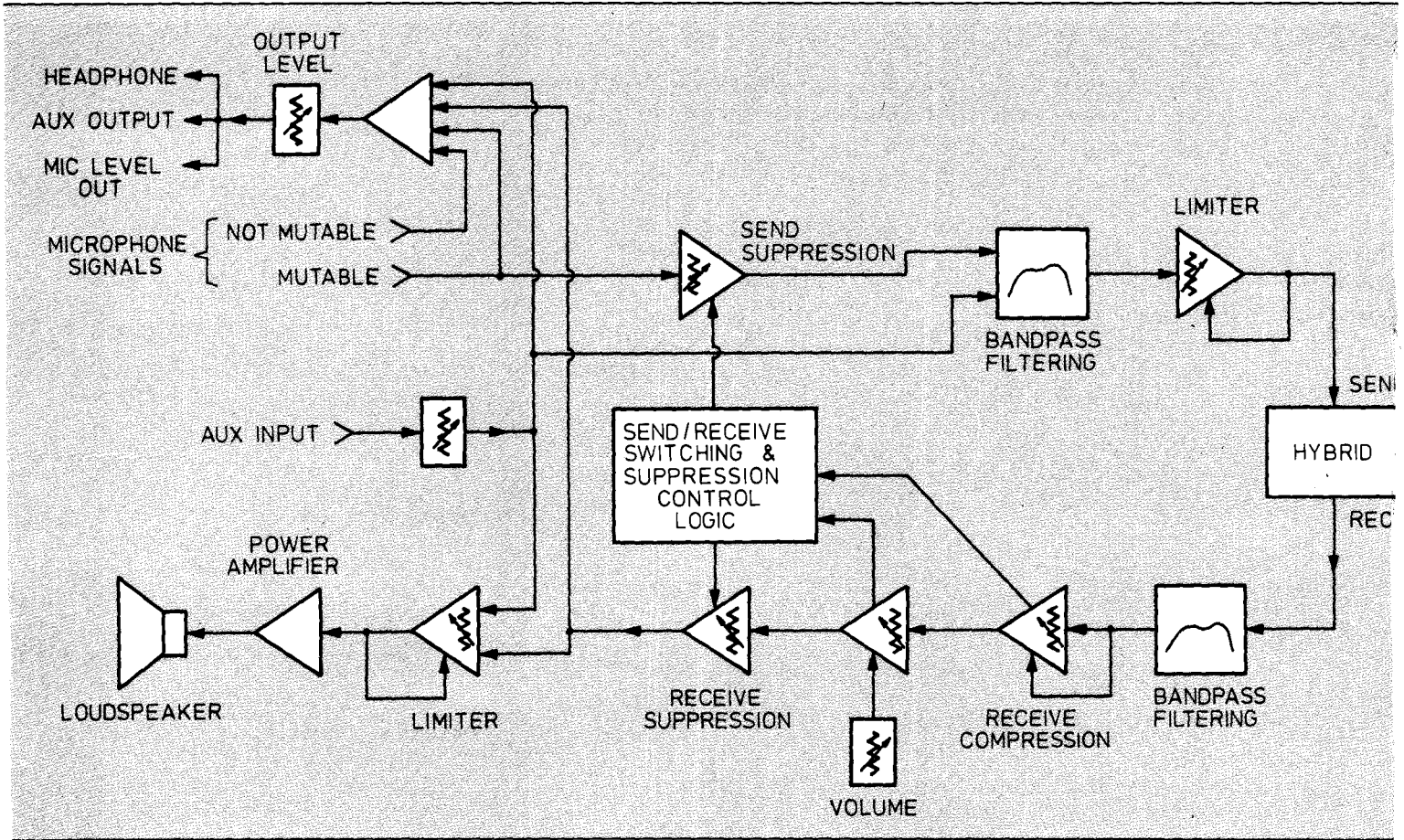

nature of telephone lines, the receive signal from the hybrid also contains a large amount of the local send signal. To avoid feedback, the acoustical coupling from the loudspeaker to the microphone must be made low enough so that the gain around this local loop is less than 0 dB at all frequencies, i.e., an acoustic input to the microphone at any frequency must return through the loudspeaker to the microphone at a lower amplitude than the original signal.

Not practical

Meeting this requirement while maintaining full-duplex operation (both loudspeaker and microphone fully active at all times) is generally not practical if adequate outgoing microphone level and loudspeaker volume are also to be maintained. This is particularly true if allowances are made for closely positioned reflective objects or for extra receive gain to bring up weak telephone connections. The near-universal solution has been half-duplex operation. Either the microphone or the loudspeaker is always attenuated depending on the assumed direction of conversation. This suppression is typically 40 dB or more. While this solves the acoustic feedback-related problems, it has often done so at the expense of interactive, natural conversation. Beginning syllables and

words may be lost, neither end of a conference may be able to interrupt the other, and both ends may be talking without hearing each other.

The Shure ST3000 attempts to solve these problems. In the absence of local speech, the microphones are automatically muted and totally break the acoustic coupling path. The green module "talk" LEDs remain lit, showing that it will respond immediately to speech, leaving the mute condition quickly without chopping syllables or words.

When local speech interrupts received speech, the loudspeaker level is suppressed to the degree necessary to maintain feedback loop stability. When local speech is interrupted by the far end, the outgoing microphone signal is suppressed and the loudspeaker heard at normal level. The receive gain may be varied freely since the actual amount of suppression is automatically compensated to maintain a constant feedback loop gain.

The received gain can vary due to volume control adjustment by or to the internal receive compressor, which automatically compensates for variations in received signal strength.

The necessary send-receive direction switching to determine which signal path is suppressed occurs in an unobtrusive, conversationally oriented manner. Switching is fast, avoiding clipped words and for the most part is transparent to the user. Interestingly, however, when using the local PABX, the lack of side tone caused by the switching was quite distinct. It took a bit of getting used to. Priority is given to the interrupting party, maintaining natural interaction. ST3000s on each end of a conference will act in a complementary manner. If one end is in "send", the other will be in "receive" and vice versa (unless the Talk- or Listen-Only functions are used). Either end can always "get through" without yelling or raising their voices.

Additional features are apparent in the block diagram of Figure 2. Limiters on the send and speaker outputs reduce gains with loud levels to prevent overloads. An auxiliary input which bypasses the suppression circuitry is provided for non-microphone signal sources such as tuners and tape players. This signal is heard in the local loudspeaker, sent to the far end, and appears at the headphones, aux and mic level outputs. These outputs contain all conference signals, including the auxiliary input signal, received signal, and local microphone signals. (The microphone signal does not mute totally in these outputs.) The Aux and Mic Level outputs are for conference recording or feeding an auditorium sound system. The same feedback considerations apply as in a conventional sound reinforcement system with respect to the auditorium loudspeakers and the module microphones. **eti**

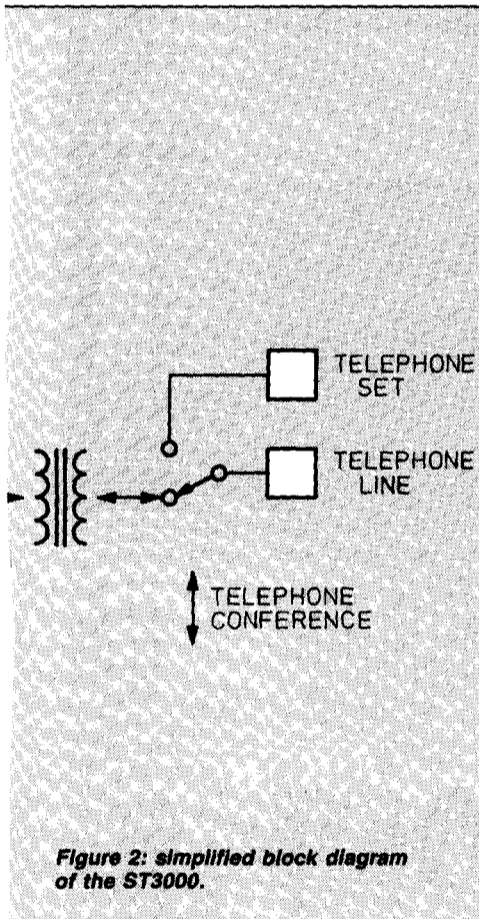

Figure 2: simplified block diagram of the ST3000.

MUSIC
SOUND RECORDING
STAGE LIGHTING

SONICS

MAGAZINE

For: Musicians,
Road Crews,
Recording Engineers,
Lighting People,
Managers, Promoters
and anybody interested
in what goes into
today's music-making.

Software and Hardware for controllers professionally made to your specification

We specialise in converting fixed logic designs to 8039, 8749 and 6805 single chip microprocessor systems with enhanced capabilities at economical prices.

Enquire about our PC based 4800 and 6805 series cross-assemblers that will assemble a 20K source file in 10 seconds.

VANDATA

Suite 8, Midway Arcade
145 Maroondah Highway
Ringwood 3134
(03) 870 6078

V262 AM1



TECHNOLOGY

Thirty years ago on September 12, TI engineer Jack Kilby demonstrated the first working integrated circuit. Since then, ICs have become ever-smaller in size, ever-greater in capability and reliability and ever-lower in cost, allowing development of systems once confined to science fiction.

Today, due in part to the invention of the IC and complementing developments, the electronics industry has grown from \$30b worldwide in 1960 to nearly \$500b today. This growth is projected to reach \$900 by the mid-1990s. To accommodate the market's changing needs, the latest ICs have reached densities in the megabit range and require geometrics of 1-micron and below.

Kilby's invention

Ever since the transistor replaced the valve, scientists had been looking for a method of connecting complex configurations of components inexpensively. Kilby's invention offered a solution to this problem.

In May of 1958, Kilby moved to Dallas, Texas, to work for Texas Instruments Semiconductor-Components Division. At that time, TI was exploring ideas in micro-miniaturisation and had a small contract from RCA to develop the micro-module concept, an approach entailing creation of discrete components of uniform size and shape, with built-in wiring. The micro-modules could then be snapped together to form circuits,

eliminating the need for wiring the connections.

In 1976, Kilby recalled in *On Electron Devices* (IEEE Transactions 1976) that: "The first electronic equipments were composed of a few dozen components and could be readily assembled by hand-soldering techniques. Each component was manufactured separately by a process optimised for the purpose. As electronic equipment became more complex, shortcomings in this

'Kilby disliked the micro-module approach because it didn't address the problem of large quantities of individual components in elaborate circuits'

procedure began to appear. The cost of the equipment increased more rapidly than component count, and equipment reliability suffered a corresponding decrease."

Kilby disliked the micro-module approach because it didn't address the problem of large quantities of individual components in elaborate circuits. As a result, he looked for an alternative.

Rather than reworking conventional



A 1958 photo of Jack Kilby's original device. This primitive working model validated Kilby's premise that both active and passive components could be composed of the same semiconducting material.

It is now thirty years since the first integrated circuit was produced. Gina de Miranda went to Dallas in the USA, to find out how it happened.

THE BIRTH OF MICROELECTRONICS

ETI MARCH '89

concepts, Kilby re-examined the problem. He later said, "I began to feel that the only thing that a semiconductor house could make in a cost-effective way was a semiconductor. Further thought led me to the conclusion that semiconductors were all that was really required - that resistors and capacitors (passive devices), in particular, could be made from the same material as the active devices (transistors).

"I also realised that, since all of the components could be made of a single material, they could also be made *in situ*, interconnected to form a complete circuit. I then quickly sketched a proposed design for a flip-flop using these components. Resistors were provided by bulk effect in the silicon, and capacitors by p-n junctions."

The breakthrough

Encouraged by the results of a preliminary test, Kilby set out to build an integrated circuit. Using a sliver of germanium mounted on a glass slide, he built a phase-shift oscillator. On September 12, 1958, he connected a power source to his device and applied 10 volts of current. A sine wave flickered across the screen of a nearby oscilloscope. The age of the integrated circuit had begun.

Kilby's breakthrough was followed by TI's introduction of the first solid state computer, a precursor to the microprocessor, in 1961. Kilby's design team won a U.S. air force contract to apply the new microelectronic ideas on a large scale, and produced a box 46 mm on a side. It weighed 1.5 kg and had fewer than 600 parts, proving that

integrated circuits were practical and that they had the potential for making a broader impact. Built conventionally, the same device weighed 88 kg, was 250 mm on a side, and consisted of 8,500 individual components.

Despite the promise this new device held for making smaller, more reliable, lighter and less expensive electronic products, it was met initially with lukewarm interest. Designers

'A sine wave flickered across the screen. The age of the integrated circuit had begun'

did not feel comfortable with the idea that their "components" were too small to see or work with. Long accustomed to hands-on design work in which components could be plugged in and pulled out freely, engineers were unsure how to work with this new invention too small to take apart.

TI's President Patrick Haggerty was convinced of the significance of integrated circuits. Persuading the rest of the industry

would require the appropriate demonstration vehicle. With this thought in mind, he challenged Kilby to assemble a team to create a calculator that would be both powerful and yet small enough to fit in a shirt pocket.

In 1967, TI demonstrated just such a choice. It was a hand-held calculator capable of executing the basic four functions provided by adding machines many times its size.

The ability to perform multiple calculations quickly, easily and at nominal cost was a popular one and one that gave the calculator an independent life of its own. Just as importantly, it advertised the possibilities of the integrated circuit.

The next 30 years would see the integrated circuit accepted by not only the electronics industry, but the world. Today every electronic product imaginable is benefiting from it.

Not only have ICs been accepted, they have become specialised. More and more functions are becoming captured in silicon.

ETI

This article first appeared in F.Y.I. We would like to thank TI.

Milestones in microelectronic innovation

TI's tradition for milestone innovations extends from the infancy of semiconductor technology into the Megachip era. Among the major highlights:

- First commercial silicon transistor (1954)
- First commercially produced transistor radio (1954)
- First integrated circuit (1958)
- First integrated circuit computer (1961)
- First hand-held calculator (1967)
- First single-chip microprocessor (1970)
- First single-chip microcomputer (1970)
- First single-chip speech synthesiser (1978)
- First advanced single-chip digital signal processor (1982)
- First video RAM (1984)
- First fully integrated trench memory cell (1985)
- First gallium arsenide (GaAs) LSI on silicon substrate (1986)
- First single-chip Artificial Intelligence microprocessor (1987)

20
EO NO. 043601
DATE Sept 12, 1958

A wafer of germanium has been prepared as shown to form a phase shift oscillator.

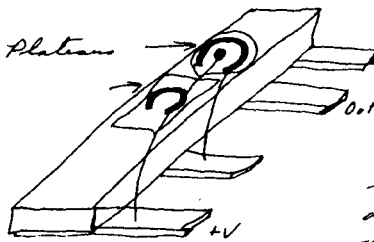

The bulk resistance of the germanium was used for resistor, and a p-n junction for a capacitor. The p-type Ge wafer was diffused by conventional techniques, and an aluminum smelter dot was evaporated, alloyed.

Solder was evaporated and alloyed to provide connections to the transistor base and to the capacitor area. Platens were formed by sputtering for the transistor and capacitor. Tapes were attached to make contact with the germanium wafer as shown. ~~with~~ The wafer was mounted on a glass slide with lacquer cement and gold wires bonded thermally to make the necessary interconnections. The unit was then given a chancey seal.

When 10 volt were applied (1000 ohm series current limiting resistor), the unit oscillated at about 1.3 Mc, amplitude about 0.2 v pp. This test was witnessed by W.D. Alcock, Paul Friteland, Mark Shepard, and others.

*Jed Kilby
September 12, 1958*

A page from the laboratory notebook kept by Kilby during 1958.



BRIAN WOODWARD

Whatever happened to the "Cars of the Future"? Some are as exciting and impractical as ever, others are harbingers — heralds of the automotive technology we'll one day call common-place. Meanwhile, one has quietly arrived. Now. Brian Woodward reports.

Apart from the excesses of the stylists, the modern car holds few surprises. Lightweight materials will be used for the car's framework in increasing quantities as the contradictory demands of economy and performance increase (and become cost effective).

Suspension, transmission and steering developments are moving quickly towards four wheel steering and active suspension which makes the car lean *into* a corner and predict bumps. Anti-lock braking will become progressively cheaper and, within a decade, only the simplest of cars will be without it.

But the area where huge changes are still possible, indeed, necessary, is engine development. Quite simply, the existing damage to the earth's ozone layer and the increasing heat of the earth's air from the so-called greenhouse effect, makes changes in this area imperative.

As you read this, teams of scientists in Antarctica are monitoring the hole which is growing daily in the ozone layer to determine its effects on the precarious food-chain which starts with simple photo-dependent water-borne plant life in the Antarctic oceans. The car is one of many offenders contributing to the ozone problem and it is only a short period of time before governments will be forced to act.

Toyota has released a working prototype which uses a gas turbine engine. It is a true "Car of the Future" and offers some hope in reducing emissions which may (or may not) be damaging the ozone layer.

But in the meantime Toyota has launched a V6 version of the Camry which heralds the short-term development of engines. It is a clear direction for engine designers.

The new engine bears Toyota's bewildering name 2VZ-FE. It is a six cylinder engine with two banks of three cylinders running at 60° to each other. Each bank of cylinders has a pair of overhead camshafts and each

cylinder has four valves — two for inlet and two for exhaust. The crankshaft of the new engine has been designed for 120° intervals between each combustion stroke for greatly increased smoothness.

There was a time when such specifications (quad-cam multivalve) would have been limited to the more exotic companies such as Alfa Romeo, Ferrari/Lancia or Maserati. But Toyota has chosen the V6 format for smoothness, a compact shape and, most importantly, for the control which can be brought to bear on it by a sophisticated engine management system.

The engine is very clever. Normally, such a highly specified engine would be very expensive to build and would involve considerable hand assembly. Toyota has created an engine which can be partly built by robots. In raw material terms it weighs only 35kg more than the 2.0 litre engine it replaces, while offering 33% more power.

'As you read this, teams of scientists are monitoring the hole in the ozone layer'

Most twin overhead cam engines have the valves set somewhere between 50 and 60° to each other. The Camry V6 has its valves set only 22.5° apart. The reason for this is to save the extra external drive needed for the second camshaft. Usually the front of each camshaft has a chain or toothed belt sprocket which is driven from the crankshaft. The V6 has drive to one camshaft only (and that is by toothed belt) while the exhaust camshaft is driven directly by a spur gear on the exhaust camshaft.

The camshaft lobe bears directly on the top of valve buckets which have shims to adjust the clearance. This makes servicing

THE FUTUR

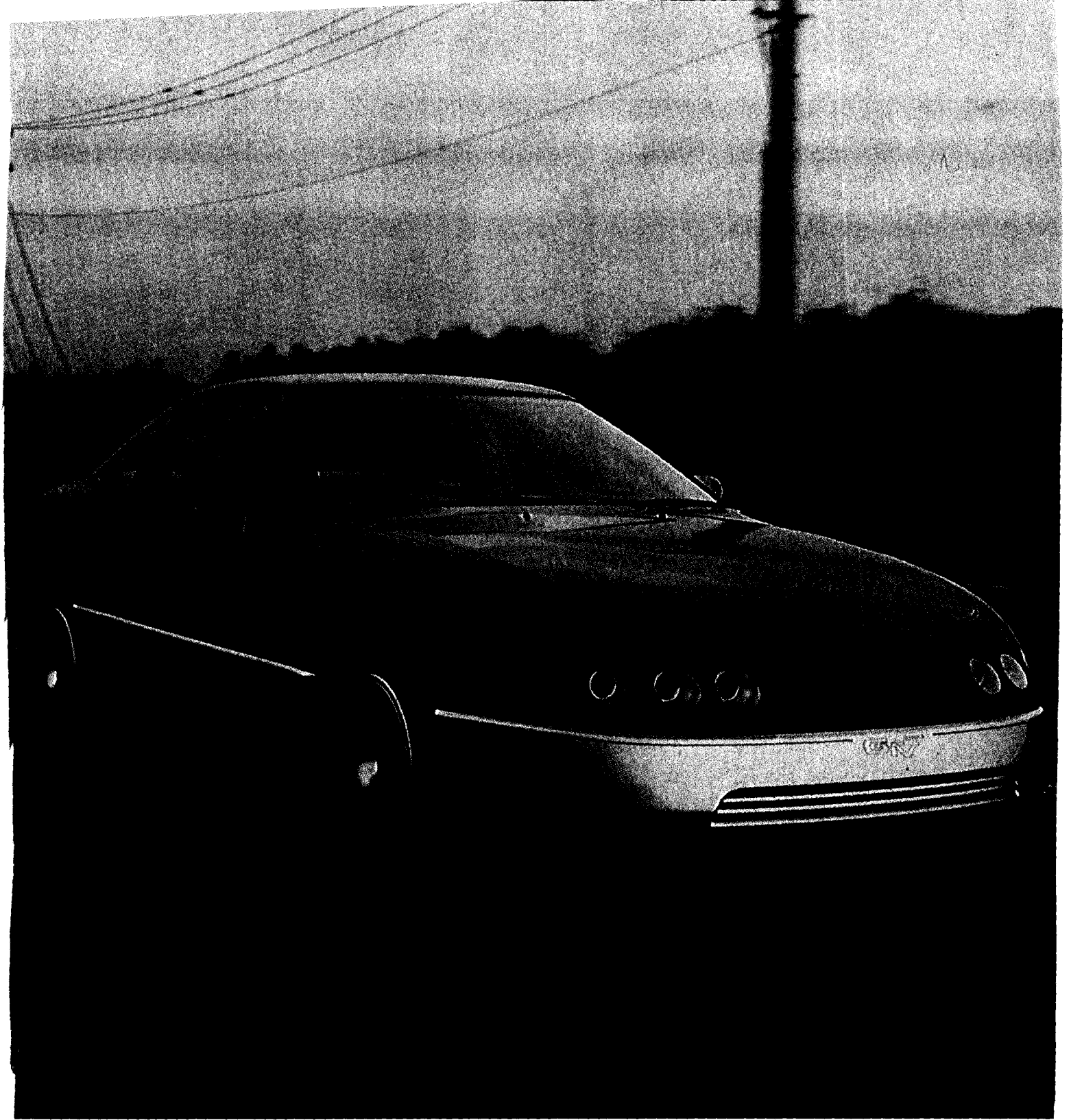

The prototype clean-air car of the future, complete with gas turbine engine.

E NOW

ETI MARCH '89
57

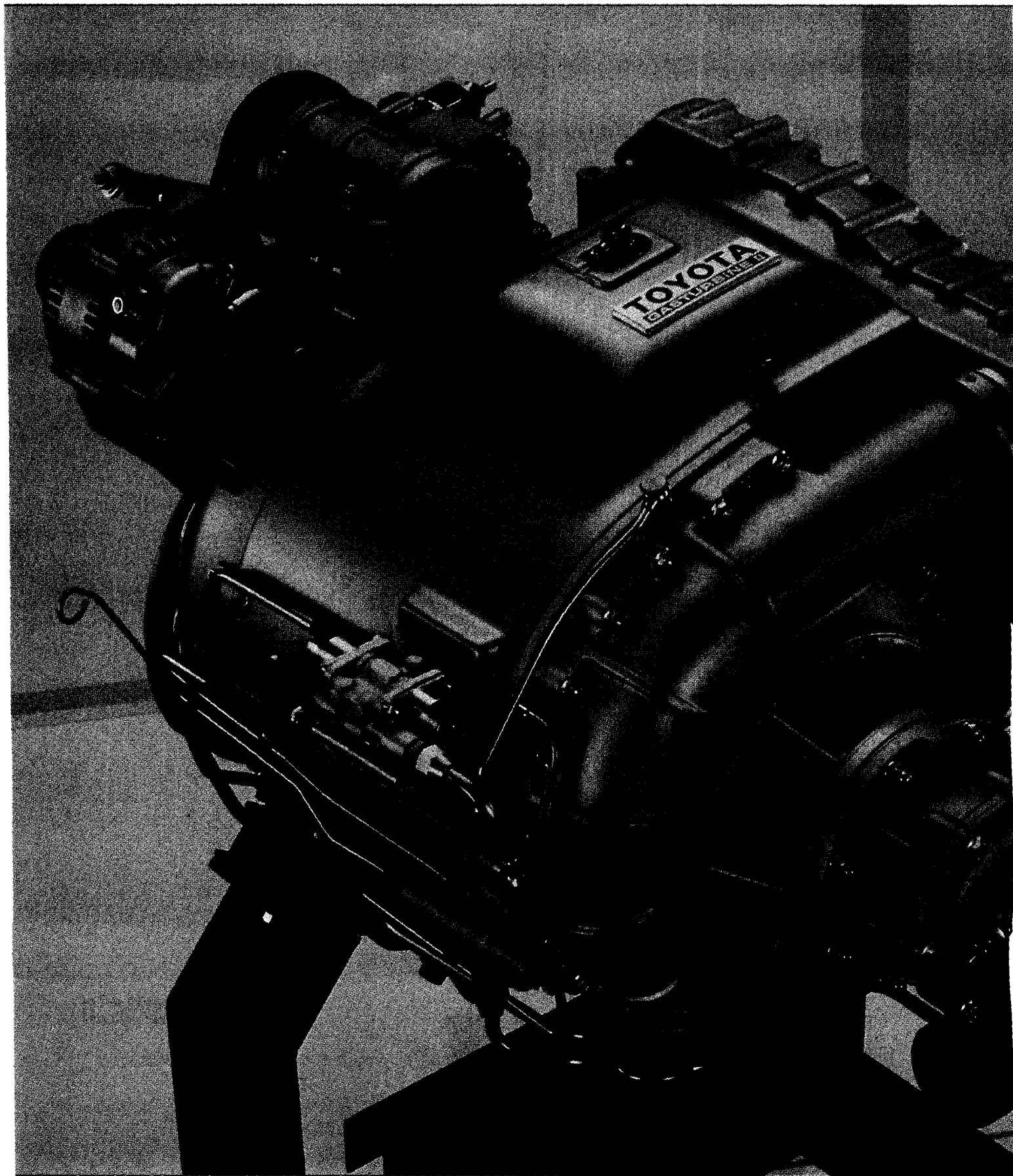

faster and cheaper than under-bucket shims or the more conventional screw and locknut method of valve adjustment. Mind you, with 24 valves, some savings would have been necessary without owners incurring huge servicing bills!

One of the clever aspects of the camshaft drive gear is a scissor gear used to reduce backlash and noise. The gears between the inlet and exhaust camshafts have the same number of teeth (the cams run at the same speed) but the gear on the inlet cam is slightly wider than that on the exhaust cam.

'The new Camry V6 incorporates many of the front-running techniques in engine and transmission technology'

Beside the exhaust camshaft gear is a thin gear the same size as the others. It engages the gear on the inlet camshaft but is free to rotate on the exhaust camshaft. A spring holds it in tension when the teeth mesh, preventing lash and noise between the two larger gears.

The inlet tracts on the V6 engine have

been shaped so that incoming air/fuel mixture swirls on entering the combustion chamber. With four valves and a centrally located spark plug the combustion chamber is almost the perfect shape for a clean and complete burn. This enables Toyota to use a leaner mixture than normal (for improved fuel economy) and a shorter inlet duration of the camshaft (226°) for improved torque in the mid-rev levels.

Careful management

Carefully managed fuel injection and ignition is controlled by a large ECU (Toyota's acronym for electronic control unit). As ECUs become increasingly more sophisticated the power output of an engine becomes more of an "on demand" operation. The idea is quite simple. First, design an engine capable of very sporting power output and then manage the fuel/ignition profiles to reduce that output significantly unless the driver's right foot demands it. This keeps economy and emissions acceptable except when the car is being driven spiritedly.

Another clever technique used in the manufacture of the engine is plastic-region tightening.

The bolts on the cylinder head, the crankshaft main bearings and the big-ends are tightened by a computer controlled air



TRONICS 2000

STEPPING MOTORS SERVO MOTORS

SANYO DENKI STEPPING MOTORS

Sanyo Denki Stepping Motors are of the efficient, latest design hybrid type. Torque outputs vary from 1 to 150 Kgcm with speeds up to 3000 rpm. Very economical drive units are available to suit all motors for interfacing to computers for programming under BASIC.

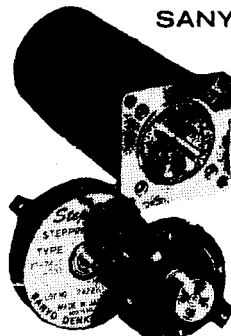

SANYO DENKI MOTOR FEATURES

- Compact, Lightweight, High out-put
- Excellent Servo Characteristics
- Well matched line-ups and options
- Controller Units available in full line up

TYPICAL APPLICATION

- Positioning Control of Conveyors
- Industrial Robotics
- Locating and Position Control
- Press Position Control
- Work Position Control
- Simplified NC Machine Retrofitting
- X-Y Table Location Control

**DRIVE UNITS AVAILABLE FOR ALL MODELS
L/R DRIVE UNIT AVAILABLE IN KIT FORM**

MELBOURNE: 18-20 Syme St., Brunswick. Ph: (03) 387 0655 Fax: 387 9062
 SYDNEY: 25 Hector St., Sefton. Ph: (02) 644 8133 Fax: 644 3550
 ADELAIDE: A.F. Hay, 116 Gilbert St., Adelaide. Ph: (03) 51 3941

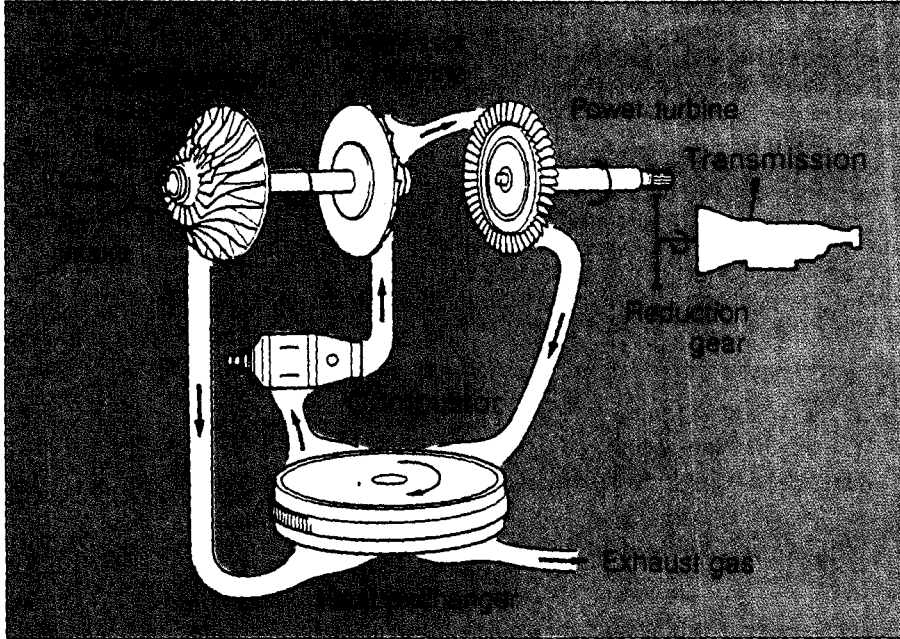

Toyota's two-shaft gas turbine engine: the company claims that it is close to developing one that is more efficient than a diesel.

spanner. The bolts are tightened until the sensor detects plastic flow of the steel which indicates that the steel's maximum tightening torque has been achieved. The bolts begin to elongate at this level of torque (still well

short of the bolt's ultimate tensile strength). This technique saves weight (and thereby reduces the reciprocating mass of the engine).

The same ECU which controls the engine

also controls the automatic transmission. The gearbox has a lock-up clutch which prevents torque converter slip in third and fourth when the car is on the move - improving fuel economy. The transmission's change points can also be altered by throwing a switch marked Economy or Power.

The new Camry V6 incorporates many of the front-running techniques in engine and transmission technology. There will be a time in the not too distant future when many cars in the sub 2.5 litre category use multiple valves and sophisticated on-board computers to give greater power, reduced emissions and acceptable economy. The Camry achieves this without entering the very expensive hand-built performance car category. It's a production line engine of bewildering complexity designed for economically acceptable mass production.

The future

Gas turbine engines have been fitted to cars before now. Rover operated a prototype vehicle named Jet 1 in the 1950s and almost every vehicle manufacturer has experimented with gas turbines for car or truck use.

The gas turbine fell from grace during the 1960s when it was discovered that no amount of improved rotor design could give the engine a response time that would suit

Turn your hobby into a profitable career in computers.

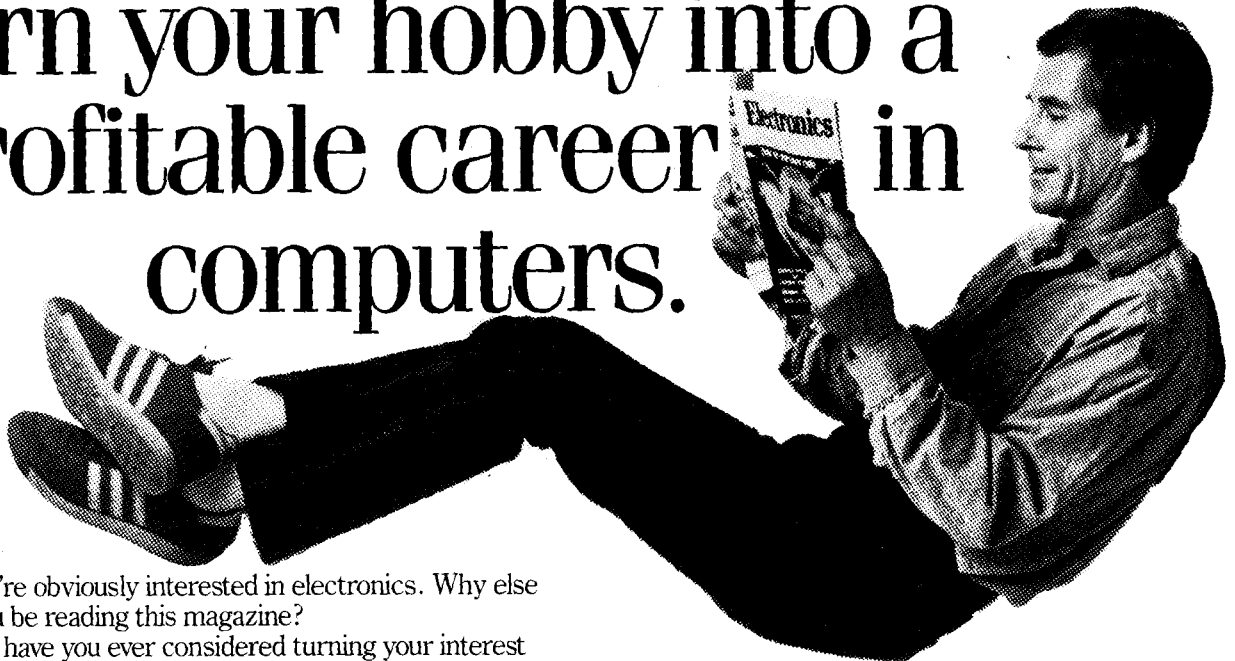

You're obviously interested in electronics. Why else would you be reading this magazine?

But have you ever considered turning your interest into a rewarding career as a computer maintenance engineer?

The Control Data Institute can help you fulfil your goal in the shortest possible time by teaching you such subjects as basic electronics, microprocessors, data communication, disk drives and machine language programming.

We then help you further by helping more than

Sanford Vick 2003

90% of our graduates get their first jobs in this exciting, expanding industry.

Don't delay, contact Control Data now. Sydney 4381300, Melbourne 2689666.

CD CONTROL DATA INSTITUTE
A computer career starts here.

driving under normal road conditions. It was a case of, "Accelerate, wait -one, two, three, pause, thrust." Hardly suitable for the cut and thrust of city driving.

Today, the gas turbine engine's further development has become critical. The main reason (apart from its low emissions) is that it is omnivorous. It can run on a wide variety of fuels. As the world begins to accept the finite nature of so-called "fossil fuels" (there is some argument about the purely fossil origin of oil) it becomes increasingly important to improve the output from refineries. The further down the scale a fuel is, the larger amount of it can be cracked from a given amount of crude.

High octane unleaded petrol and aviation gasoline, for example, require considerably more basic crude oil going into the refinery for a set output than, say, kerosene or diesel fuel.

A major breakthrough in recent years has been the two rotor gas turbine. This uses one rotor for compressing the air and burning it and a power rotor which is not connected to the compressor rotor. It 'takes' power in much the same disconnected manner as an automatic transmission's torque converter extracts power from the main rotor of the transmission.

While this partly overcomes the huge response lag which exists in a gas turbine, it doesn't overcome the problem completely. Toyota's method of overcoming the lag problem experienced by the driver is to couple the gas turbine engine with a very



Toyota's 4-valve quad cam V6 Camry (front), part of an evolutionary trail from the two-valve-per-cylinder quad cam V6 Ferrari Dino.

sophisticated automatic transmission. Using similar computers to the transmission in cars like the Camry, a throttle position sensor determines what the driver has intended by monitoring throttle position and even the speed with which the throttle is depressed. It then selects the ratio best able to achieve the driver's intentions regardless of power rotor speed in the gas turbine engine during the time the engine increases its revs.

This prestidigital relationship between the engine's output shaft speed and the gearbox output shaft speed defies human logic when the vehicle is being driven. Yet the effect is to greatly reduce lag time.

The output of the Toyota gas turbine is 112kW at an output shaft (reduced) speed of 5300 rpm and torque is a hefty 333 Nm at 1000rpm. By running the engine at an almost constant speed and using the transmission as the "accelerator" the GTV prototype car behaves almost normally.

Meanwhile the compressor shaft is turning at 68,000rpm and the power output shaft at 53,000rpm.

Toyota claims that it is well down the track on developing a gas turbine engine that is more efficient than a diesel engine. The fact that it will run on very low grade fuel offers a considerable environmental benefit as well.

eti

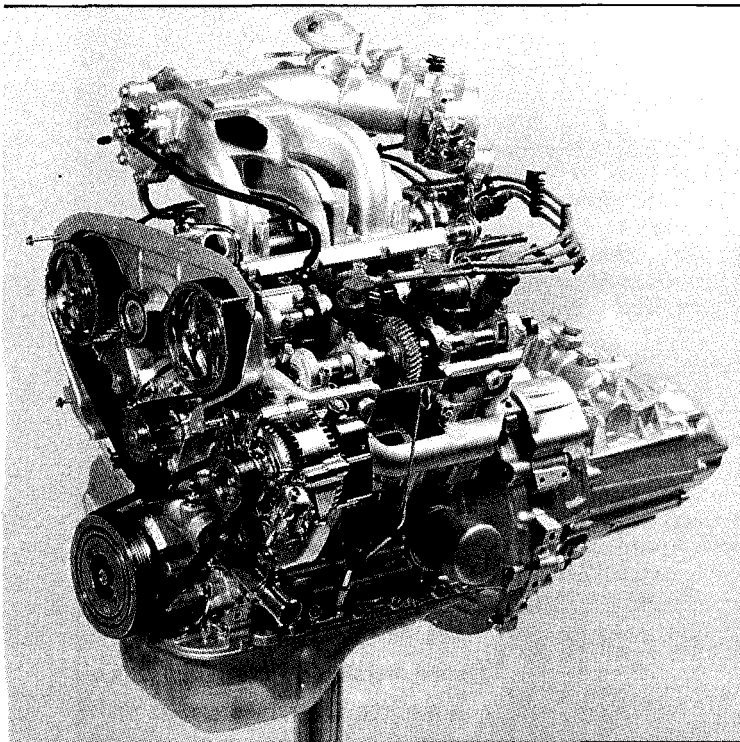

The Toyota quad cam V6 engine, said to be the first to be mass produced.

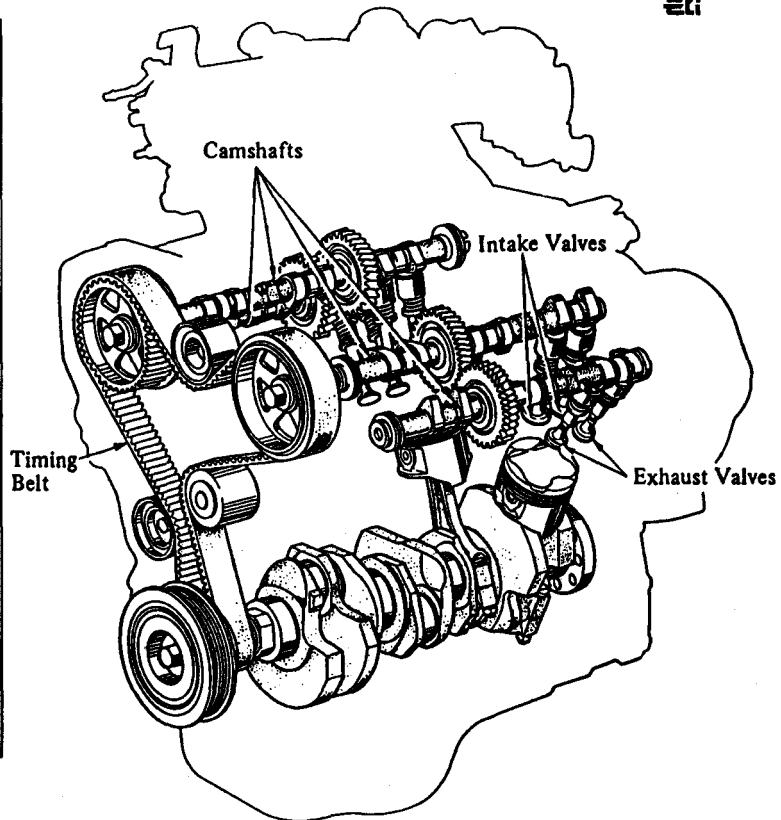



PAUL BUDDÉ

Imagineering launches Bulletin Board

After almost two years in the making, Imagineering Software Support Centre has opened the Imagineering Bulletin Board to dealers and end-users of their products. The concept of dial-up bulletin boards (sometimes called a BBS) goes back to the very early days of modems. Today the BBS is no longer just a toy for the hacker, but is a way of life in many businesses.

Imagineering is available, via electronic mail, on facilities such as MCI, Keylink, Viatel and, for dealers only, their own videotex service. The technical support centres are equipped to up- and download files as well.

EYP problems in the United States

The USA Yellow Pages Publishers Association (YPPA), a newly formed merger of two existing yellow page publishers groups, appears to be facing a problem in dealing with electronic publishing issues. YPPA faces a logistic barrier since its largest members, the Regional Bell Operating Companies, can't become actively involved in electronic information services, while smaller publishers are looking for on-line niches.

The association was created by the consolidation of the American Association of Yellow Pages Service Association (which focused on co-operative ads and local matters). Large national advertisers and the national media in general were confused as to which group spoke for the industry on which issues.

Valudata — new financial service

A Dutch data base operator recently introduced a new electronic service called Valudata. The data base holds a range of financial information on the interest and valudata markets. There is comparative information available from different countries as well as economic news and trends. The services will be updated ten times a day. Annual subscription is DFL5,000.00.

AT&T back in videotex

AT&T will re-enter the videotex business, possibly this month. The company has been largely absent from recent industry and gateway developments, although it continues to distribute some equipment, such as the low-priced ASCII video transaction terminal used in some telebanking projects.

AT&T, which spurred many of the earlier videotex projects and built a variety of frame terminal and home reception terminals, is believed to be developing directory services and/or a consumer-oriented network and information system. Not coincidentally, 1989 is the last year of the original seven-year moratorium on most AT&T information and advertising provision services following the Bell system break-up process.

Dutch PTT includes CEPT

The Dutch PTT, operator of the Dutch public videotex service, Viditel, has included the more advanced CEPT protocol as an option in its service.

The CEPT standard has been accepted by all European PTTs, but implementation is hampered by the three different standards presently in use in Europe: Prestel, Teletel and CEPT. CEPT includes 80 columns, more colours and a range of new design features. CEPT starts where Prestel stops with its block graphics. The Dutch PTT offers three CEPT products:

- a basic CEPT package;
- a more advanced Super CEPT product;
- bulk CEPT for fast update transmission.

Viditel recently started a service for ASCII users. To launch that service it offered low cost modems (\$60) to customers buying a one-year Viditel subscription.

Tax information on CD-ROM

The International Tax Information Organisation will soon publish all 9,000 worldwide tax agreements on CD-ROM. The service will also be made available through pc access. The CD-ROMs are available for DFL5,000.00 and will be updated several times per annum.

New VAN for Reuters

AAP Reuters International Headquarters is working very hard to establish a Super VAN for all its data bases. It started this VAN project soon after the acquisition of the IP Sharp network. The VAS available through this new network are Textline (Worldwide news), Country Reports, Finsbury Data and the AAP Reuters Service.

Talking Yellow Pages

To access Talking Yellow Pages, a consumer makes a local telephone call, generally at no cost, to a central number. The caller either reaches an operator or uses the touchtone keypad to request a broad variety of information and advertising messages. A system operator

The MAESTRO 2400XR

Here's a fully-featured, Hayes compatible 1200 & 2400 bps full duplex modem for just

\$369 (incl. tax).

This modem uses the LATEST in DSP chip Set Technology and microprocessor control, bringing you the future Today.



Super price on a super V.22/V.22 bis Modem!

The MAESTRO 2400 ZXR

4 Speed Version **\$399 (incl. tax).**

Don't Wait! RING NOW (043) 68 2277 or 68 2278

Maestro Distributors

Calool St. South Kincumber, NSW 2256

collects revenue from advertisers who sponsor information or provide audio ads. There are three segments in Talking Yellow Pages: Operator-Assisted Voice Services, Voice Information Services and Voice Directories. Each of these segments, their strategies and resulting degrees of advertiser and consumer acceptance will be discussed at a conference in Princeton, New Jersey, USA.

One or more of these Talking Yellow Pages services now exists in over 120 cities in the United States and Canada, more than double the number available at the time of the previous conference last February. 55 million people can access these services today, but that number could have reached 80 million by the beginning of 1989. Meanwhile, advertising revenue, which reached US\$28 million at the end of 1987, should exceed US\$83 million at the end of this year and could double by the end of 1989.

The intelligent telephone network

Data-Tel, a group of online residential and business information services created by Unique Integrated Applications Inc., USA, will reach more than a million users this year and will have up to 20 million customers by the end of 1989, according to company president, Mat Matson. Users will be able to access the range of ACSII electronic mail and information services through Data-Tel's proprietary US\$950 voice/data terminal, paying US\$10 per hour to reach any service.

Data-Tel, which bills itself as "the intelligent telephone network", has operated "secretively" since 1984, according to Matson. The company owns four satellite; earth stations and runs a fibre optics network which is being used in Unique's effort to become a "new alternative telephone company" that offers

an array of information services. In addition to operating as a data switch, the company offers three networks, featuring business information, yellow pages listings and a variety of specialty data.

12% growth information market

According to Veronis, Suhlen & Associates, the USA market for business information will grow by 12% per annum. Total sales during 1986 were US\$5.7 billion, in 1987 US\$6.6 billion. In 1992 this market will be worth US\$11.6 billion.

Marketshare information categories

Category	%
Paper	76
On-line	19.8
Microfiche	3.8
CD Rom	0.9

Marketshare application

Application	%
General business news	45
Credit info consumers	16.1
Market research	15.7
Financial information	11.5
Government information	4.6
Accounting	4.5
Legal information	1.5
Other	1.5

SeniorNet — a USA success story

SeniorNet, a USA research project designed to identify how older Americans use interactive communications facilities, will double the size of its pilot project by the end of this year, growing from its current quiet test at ten locations to twenty sites. By 1990, about 60 locations will be on-line, many of them in community centres, doctors' offices, universities and public schools.

SeniorNet users can access on-line telephone conferences,

forums and electronic mail. Each site is funded for 25 hours on-line each month. Donations of hardware, software and services such as teaching time, supplement the contribution.

At each site, the first priority is to teach the elderly how to use computers and the second is to have the facility available so the people may freely use the service at times convenient to them. Although sites are supplied with computers and modems in order to be available to all interested seniors, individual seniors with their own pcs and modems are welcome to utilise the network for a US\$6 annual membership fee.

Contrary to expectations, the seniors easily and willingly learned to operate the equipment and used the services to improve their quality of life, not just to save time. As an example of the acceptance, one site is open three days a week, offering three daily classes; it has ten computers and 400 people on the waiting list to be placed in classes.

Videotex landmark

US Videotel and Southwestern Bell Telephone Co have signed a landmark agreement calling for the two companies to work together to develop and deliver a wide range of electronic information and services to the consumer market. This unprecedented agreement between a videotex company and a major telephone service provider signals the biggest step forward in videotex commitment to date. Houston will be the site of the initial market entry, with other major USA cities to follow.

Messagerie in the United States

Le Nouvel Observateur (France) has brought its adult on-line "chat" service to the United States, the first move in the French publisher's plan to develop global services based on its Minitel experience in

France. "Aline", an on-line service aimed at "sophisticated people who want to share ideas and socialise in a new and creative way", made a debut in New York City last July, with national availability expected in November.

Initially, Aline offers live on-line conversations and messaging. Early in 1989, the service will add games, horoscopes and classified ads.

There are no sign-up or subscription fees to use Aline. Connection charges are billed to the user's regular phone statement at US\$0.96 for the first minute plus US\$0.20 per additional minute (totalling US\$12.75 per hour).

Videotex for British Navy

In 1984 a GEC Plessey Telecommunications Ltd (GPT) videotex system was fitted to the British navy ship HMS Illustrious, primarily to replace the static information display boards which were found in the operations room and to make this information instantly available in key positions throughout the ship (eg Captain's Cabin, Oops room, radar, gunnery, wardroom, medical and other areas).

It has proved to be a very flexible, "user friendly" information system, with applications which can be extended to include many other tasks such as training, personnel, records, storekeeping, to mention a few. Even a record of the vessel's rigging warrant is now held in the system.

From the central control position one operator is able to update a large number of screens of information, which can then be viewed from any number of locations simultaneously, limited only by the number of terminals fitted. It has the security capabilities to handle classified data, and their associated codewords. **ETI**

Paul Budde specialises in the marketing and management of electronic services and communications networks.



STUART CORNER

UNEASY COMPROMISE REACHED BY WATTC

New world telecommunications regulations

The recent World Administrative Telegraph and Telephone Conference (WATTC-88) faced the difficult task of producing a new set of regulations to suit both industrialised and developing nations.

Delegates from over 100 nations gathered in Melbourne in December to produce a set of regulations governing the conduct of international public telecommunication services into the next century.

The World Administrative Telegraph and Telephone Conference (WATTC-88) faced the difficult task of reaching a compromise between nations with highly deregulated domestic communications systems, such as the USA and the UK, which wanted a similarly deregulated international environment, and those nations which wanted tightly regulated international communications.

These latter were primarily the developing nations which feared that an unregulated international communications environment would lead to a host of advanced new services incompatible with the older and less sophisticated services – all their struggling economies can afford. They also feared that a *laissez-faire* approach to international regulation would see their networks exploited for economic gain, or bypassed altogether by carriers and service providers from the industrialised world.

The conference opened amid

predictions that it would end in a walkout without any new regulations being agreed to. Such an outcome could have been disastrous, particularly for the International Telecommunications Union (ITU), the 124 year old intergovernment organisation largely responsible for the high level of interconnectivity which exists today in the global telecommunications network.

After some last minute compromises, ably managed by the chairman, Australian Dr Peter Wilenski, a new set of regulations was signed by all but one of the 113 member nations present at the conference. These must now be ratified by each of the member governments and will come into force on July 1, 1990. They are likely to remain in force for the rest of this century.

The new regulations are valid for all telecommunications services available to the public, that is the traditional basic services as well as new value added information services. However, they do not attempt to draw any distinction between basic and value-added services. Instead, the regulations require each member nation to provide the ITU with a list of services available to the public.

Most importantly, the regulations permit member nations to enter into special arrangements outside other provisions of the regulations. Any such special arrangements should not cause "technical harm" to the networks of other nations. However, no mention is made of possible economic harm, so the field is open for telecommunications operators to enter into commercial agreements which might be competitive with established

'They are recommendations only – compliance is not mandatory'

national communications networks.

For example, there is reported to be an agreement between operators in the USA and UK which permits unrestricted resale to third parties of capacity on an undersea cable linking the two countries. This will enable international links to the USA to be offered to large users in France, at rates lower than the standard charge over the French international network.

The developing countries in particular fear that they will be disadvantaged by new services bypassing their international networks and have sought to modify the regulations accordingly. The conference recorded an opinion that special arrangements should only be permitted where existing arrangements "were unable satisfactorily to meet the relevant telecommunications need."

The opinion went on to say that in making special arrangements, members "should endeavour to ensure that any adverse effects of the orderly development operation and usage of the international telecommunications network by other members was minimised." This opinion does not have the power of regulation, and in any case, the USA and UK, two of the member nations most in favour of a deregulated environment, disassociated themselves from it.

Member nations who fear the activities of overseas communications entrepreneurs in their networks should, in theory, be able to institute domestic regulation to protect themselves from such abuses. However, many developing nations doubt that their domestic law will be an adequate safeguard against these powerful forces. The conference adopted a resolution, which recognised this difficulty and in such cases called upon members involved to cooperate to resolve the matter "for the improvement and rational use of telecommunications including the orderly use of the international network."

The USA however, appended a reservation to its signing of the regulations saying that it would not accept any obligation to enforce any provision of the domestic law or regulations of any other member. In other words, if practices adopted by USA based companies in another

country are perceived to be breaching the domestic telecommunications regulations of that country, the US government will accept no responsibility to restrain that company.

One of the main aims of the regulations, and of the ITU itself, is to maintain interconnectivity and compatibility between various national communications services. The CCITT recommendations provide the basis for such interconnectivity, but they are recommendations only: compliance is not mandatory.

An earlier draft of the international communications regulations prepared for WATTC put great emphasis on compliance to CCITT regulations. Opposers of these draft regulations argued that this would raise the CCITT recommendations to the level of regulations. The final draft regulations produced by WATTC require only that administrations

or recognised private operating agencies "comply to the greatest extent practicable with relevant CCITT regulations."

A further major point of disagreement over the draft regulations was their requirement that members (governments) authorise any entity established in their territory providing international telecommunications services, and endeavour to ensure that such entities comply with the international communications regulations and CCITT recommendations.

This clause would have required many nations to adopt a degree of regulation of private enterprise in conflict with their own domestic law and policy. It was vigorously opposed by the USA, the UK and other nations.

The final regulations as approved by WATTC recognise the right of each member to "subject to its own national law and should it decide to do so, to

require that administrations and recognised private operating agencies operating in its territories to provide international telecommunications services to the public are authorised to do so." Authorisation is no longer mandatory.

As newer public services such as teletex and electronic mail grow, so the use of older traditional services such as telegram and telex will decline. In the industrialised world telegrams are almost defunct and the number of telex subscribers is already falling in Australia. However, the developing world will be dependent on such services for many years to come. Those nations wish to ensure that they will continue to enjoy effective communications on a world wide basis. They did not, however, spell out what constitute traditional communications services.

The final result of the regulations will depend more on

the spirit in which they are implemented than the letter. They leave much scope for new, specialist non standard services. That a compromise was reached in very difficult circumstances testifies to the perceived importance of the ITU among its members.

For many of the most powerful member nations, the ethos of free enterprise and the law of the marketplace are also very important factors. The UK, for example, in a declaration added to its signing of the regulations, reaffirmed its government's commitment "to the development of competition in the provision of international communications infrastructure and services" as being in the best interests of users and economic development generally. On this basis, the UK said, "Every effort should be made where practicable to meet the reasonable preferences of customers." **eti**

CANNON AUDIO family has the new panel mount styles



AXR-21 and AXR-22 are suitable for limited panel space applications. They also feature common panel cutouts and can be either front or rear mounted. Designed & manufactured in Australia.

For further details contact your nearest outlet.

ALCATEL

STC-CANNON

248 Wickham Road, Moorabbin. Vic. 3189
☎ (03) 555 1566 Fax: (613) 553 3801 Telex: 30877
Sydney (02) 663 2283 Adelaide (08) 363 0055 Brisbane (07) 832 5511

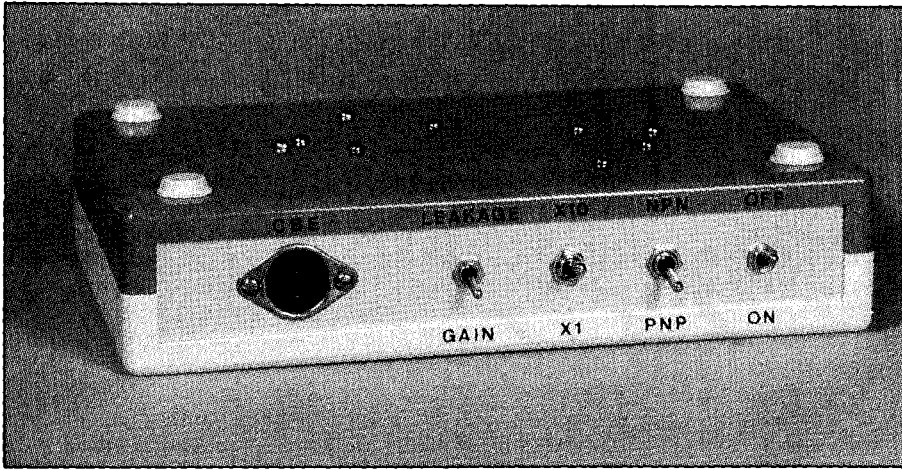

This transistor tester was developed to fulfill the need for a unit that would provide a quick and convenient means of testing DC current gain (h_{fe}) and leakage. Some other testers are inexpensive circuits based on moving coil meters but the relatively high cost of meters these days makes these designs less attractive than they once were. On the other hand, an equivalent circuit using a digital readout is substantially more complex but not necessarily much more expensive. A 2-digit display gives better accuracy than most of the moving coil meters currently on sale and certainly more than adequate accuracy for this application.

This design has proved to be quick and easy to use in practice. It can test both NPN

DIGITAL DIAGNOSIS

Building a transistor tester

Let the digits do the work and build this handy transistor tester. ETI's Robert Penfold shows you how.



ELECTRONICS
ETI-190

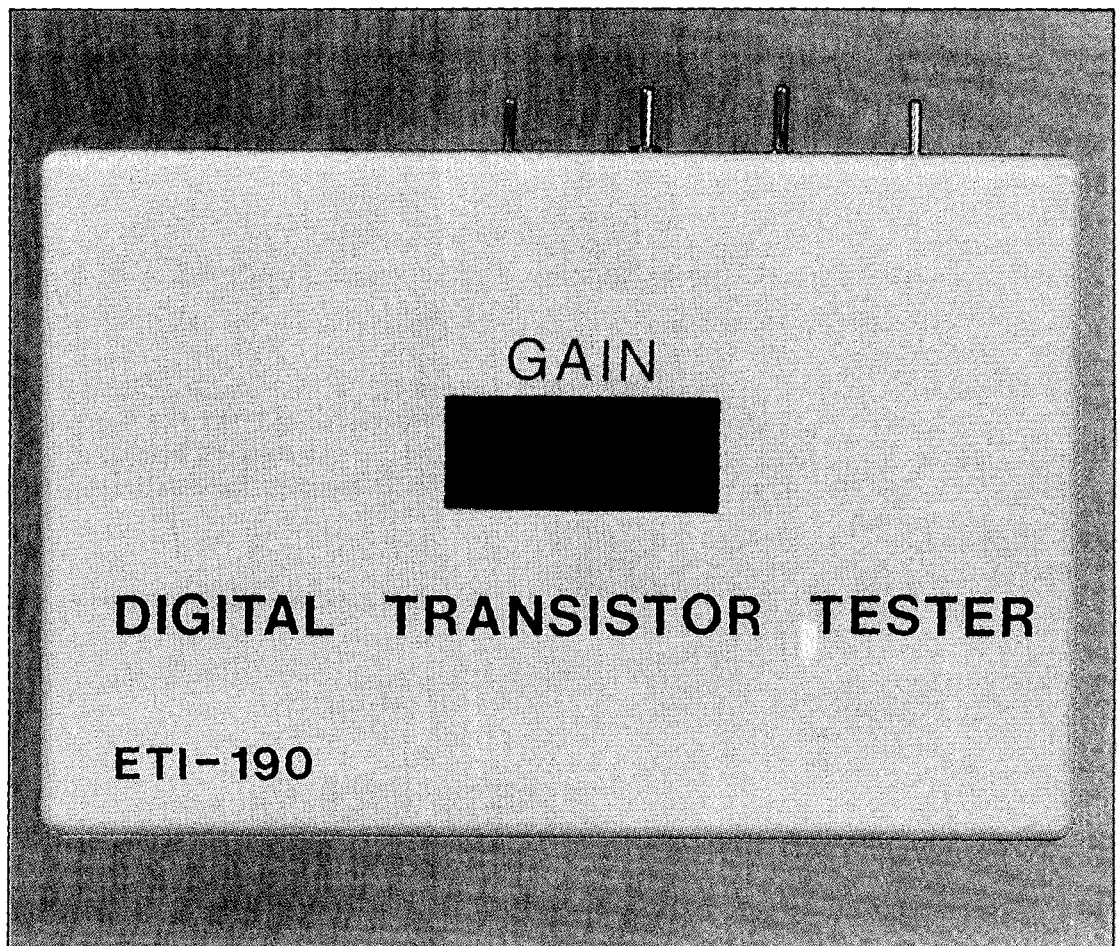

ETI MARCH '89

and PNP devices and has two gain ranges, 0-99 and 0-990. This enables reasonably accurate checks to be made on anything from low gain RF and switching devices through to very high gain audio devices.

An over-range indicator is included on the 2-digit LED display and simple leakage tests can also be made using the unit. Power is obtained from an internal 9 V battery.

Testing theory

Most simple transistor testers operate using the basic test setup of Figure 1a. Battery B1 supplies power to the test device with the correct polarity and meter M1.

A bias generator registers the flow of current in the collector circuit. The current flow from the collector to the emitter is normally very low and would typically be about one microamp or less for a silicon device. This is termed the *leakage* current. Providing a small forward bias current to the base terminal results in a much larger flow of current in the collector circuit. The current gain of the transistor is equal to the collector current divided by the base current.

In this case R1 provides a small reference current to the base of the test device. The higher the gain of the device, the greater the collector current that will be registered on M1. In fact the circuit can be arranged so that M1 provides a readout direct in current gain. For instance with the value of R chosen to give a base current of 1 μ A and M1 having a

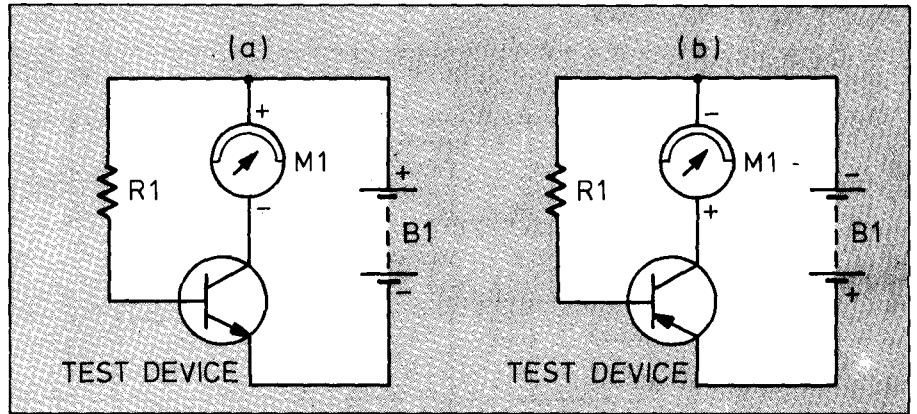

Figure 1: basic test circuits for NPN and PNP transistors.

full scale value of 1mA (1000 μ A) M1 would accommodate a current gain range of 0-1000.

This assures the leakage current is very low and is not inflating the collector current flow but as explained previously, with silicon devices the leakage current is almost invariably insignificant.

Figure 1a shows the test setup for NPN transistors but the arrangement for PNP testing is essentially the same and is shown in Figure 1b. It is just a matter of reversing the polarity of the battery and the meter.

This type of testing has a slight flaw in that it is not checking the gain at specific collector currents and voltages. These both

vary according to the gain of the test component (high gain giving increased collector current and reduced voltage). The uncertain collector voltage is not of great importance as quite large variations in this factor have a minimal effect on the gain of test components. Variations in collector current have a greater (although still fairly small) influence on current gain. Results are perfectly acceptable in practice, provided test components are not tested at very low collector currents. The use of two or more measuring ranges ensures that low gain devices can be checked at an acceptable current and also that they will give a high enough reading to provide good accuracy.

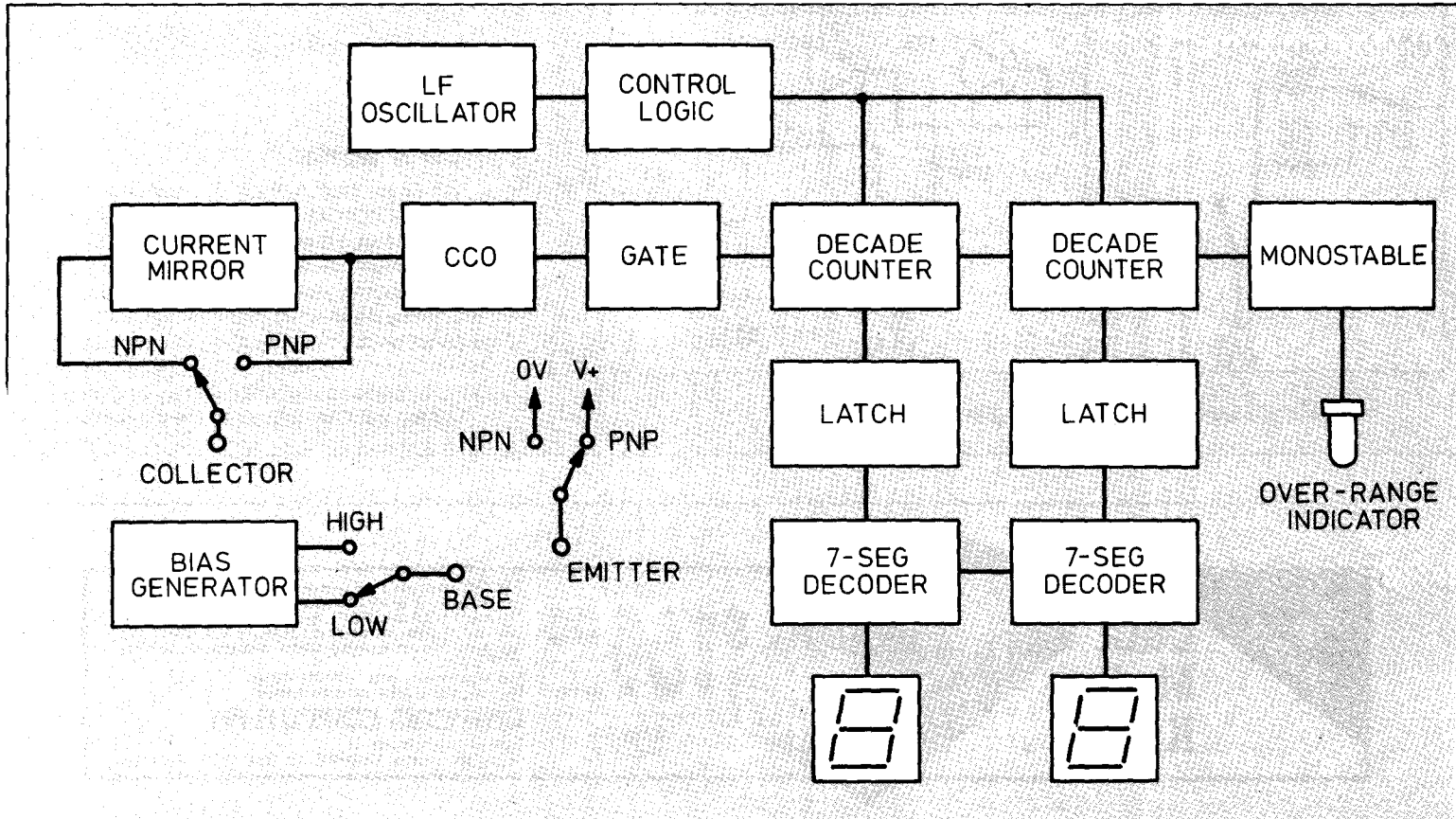

Figure 2: block diagram of the digital transistor tester.

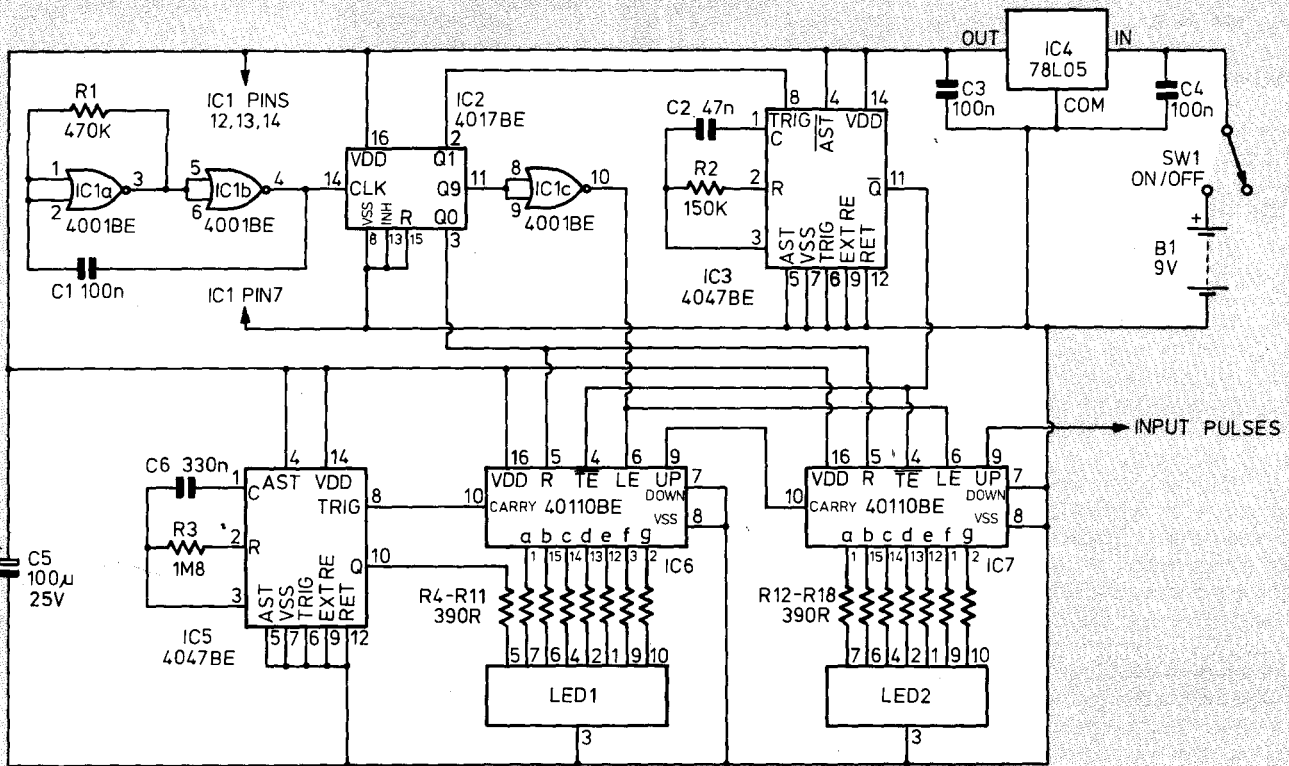

Figure 3: the circuit diagram of the display section.

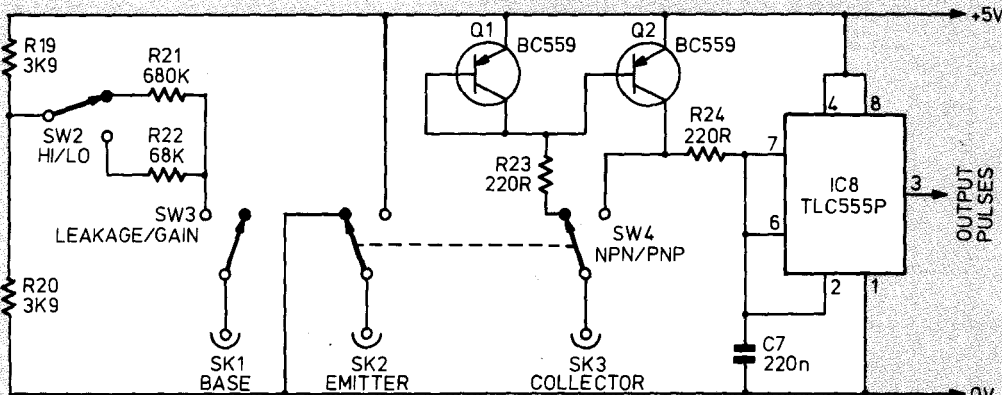

Figure 4: the circuit diagram of the input section.

How it works

The display section (Figure 3) is built around two CMOS 40110BE integrated circuits which each contain a decade counter, latch and a 7-segment decoder/driver. They also 'toggle enable' inputs that effectively give a built-in gate which avoids the need for an external gate circuit. The 40110BE is actually an up/down counter but in this application it is only used as a straightforward up counter. Unlike most CMOS devices, these have a

Ideal for Starters

Data Modem Kit . . .



ONLY **\$169⁰⁰** ex tax

\$199.00 tax paid

DATAKOM brings you a real price-crunching line up of two datamods that have to be the best value around. Featuring 300/300 and 1200/75 speeds and a constant speed converter for computers that don't run split speeds (C64, IBM PC etc). High quality PCB and pre-drilled, painted metal case. Inc. assembly and test manual.

Also available same price — M1212 V22 kit. Plug sets, cables, power packs etc available.

DATAKOM COMPUTERS
Suite 10, Midway Arcade
145 Whitehorse Road, RINGWOOD, Vic 3134. PHONE: (03) 879 5152

high output current capability and they directly drive the common cathode LED displays via current limiting resistors. The carry output of IC6 is issued to drive a positive edge triggered monostable based on IC5 and a trigger signal is only provided to IC5 if an overflow occurs. IC5 then activates the overflow indicator LED for just one second, giving clear warning that the main display reading is erroneous. The overflow indicator is the otherwise unused decimal point segment of the most significant display digit.

The low frequency oscillator uses two gates of IC1 wired as inverters and connected in the standard basis CMOS astable configuration. The oscillator operates at approximately 20 Hz but due to a divide by ten action in the control logic circuit this equates to only about two readings per second.

The control logic circuit is built around IC2, which is a CMOS 4017BE one-of-ten decoder. Output 0 (pin 3) going high resets the counters to zero and output 1 (pin 2) going high generates the gate pulse. It does so by triggering monostable multivibrator IC3. This generates a negative gate pulse of about 17 ms at its Q output which is used to drive the gate inputs of IC6 and IC7.

With this type of display circuit both gate inputs must be driven and not just the one belonging to the least significant digit. Output 9 drives the latch inputs of the counter chips and latches the new reading prior to a new cycle commencing and the counters being reset. IC1c is used to invert this signal so as to give the negative latching pulse required by IC6 and IC7. Note that outputs 2 to 8 of IC2 as well as its carry output are left unused. Also, one gate of IC1 is left unused but its inputs are tied to the positive supply rail in order to prevent spurious operation.

Power is obtained from a 9V battery but a small 5V regulator provides a well regulated 5V supply for the entire circuit. This ensures the unit provides consistent results as the battery voltage drops.

In the input circuit (Figure 4) R19 and R20

form a centre-tap on the supply lines and this drives the base terminal of the test device via one of two switched current limiting resistors (R21-R22). These provide the unit with its two measuring ranges and SW2 is used to select the desired base feed resistor. By driving these resistors from the mid-supply voltage there is no need to bother with any NPN-PNP switching in the base circuit. SW3 can be used to cut off the base bias current so that leakage checks can be made.

Q1 and Q2 form a conventional current mirror circuit, with R23 and R24 providing current limiting in the event of any accidental short circuits or closed circuit devices being checked.

There is no need to switch out the current mirror in the PNP mode and NPN/PNP switching can therefore be achieved using just a DPDT switch (SW4).

In theory, Q1 and Q2 should be a matched pair to obtain an accurate 1:1 ratio of input to output current. In practice, quite wide differences in their gain did not produce any great discrepancies between the NPN and PNP modes. One way of ensuring really accurate results is to use any two BC559s for Q1 and Q2 initially and to then use the unit to select two reasonably well-matched transistors from a batch of (say) half a dozen devices. However, this is by no means essential and unmatched devices should suffice. It is advisable to use transistors from the same gain group (say, two BC559Bs).

The CCO is just a 555 astable circuit. No resistor is used between pins 6 and 7 in order to keep C7's discharge time as short as possible. This makes the period of each cycle almost totally dependent on the charge current and ensures good linearity. A TLC555CP is specified for the IC8 position as this gives a much lower current consumption than the standard 555 and it also seems to be somewhat faster in operation (which again aids good linearity). The collector current at which the devices are tested is dependent on their current gain but is typically around one or two millamps.

then a gate at their input is activated. Input pulses then flow into the 2-digit counter circuit until the gate pulse ends. Another pulse from the control logic circuit then activates the two latches, which store the count and feed it through to two 7-segment decoder drivers. The 2-digit display therefore shows the number of pulses received during the gate period.

This cycle is then repeated, with the decade counters being reset again. Note though that resetting the counters does not affect the latches and the old count is displayed until a new one has been taken

and fed into the latches. The unit accordingly provides a continuous readout which is updated approximately twice per second. If the count goes beyond 99, it is detected by a monostable driven from the second counter, and activates a warning LED.

The display circuit requires the collector current of the test components to be converted into a proportional frequency. This is not difficult and all that is needed is a current controlled oscillator (CCO) having a reasonably linear control characteristic. This leaves a slight problem in that the CCO operates as a current sink which will operate properly with the PNP devices (which act as current sources) but is incompatible with NPN transistors which act as current sinks and must be fed from a current source. The solution to the problem is to drive the CCO direct from PNP transistors and to drive it via a current mirror for NPN transistor testing.

A current mirror is a very simple circuit which provides an output current that is equal but opposite to the input current it receives. One pole of the NPN/PNP switch connects the collector test socket to the input of the current mirror or the CCO, as appropriate. The other pole connects the emitter test socket to the appropriate supply rail. A bias generator provides two switched base bias currents and these provide the unit with its two measuring ranges.

Construction

Apart from the usual off-board components (controls, sockets, and battery) all the components fit onto the pc board, as detailed in the overlay. All the ICs are CMOS types and the usual anti-static handling precautions should be observed when dealing with these. In particular, they should be fitted in sockets but not plugged into the circuit until the unit is completed in all other respects.

It is also advisable to fit the displays in sockets. Apart from eliminating the risk of them sustaining heat damage when they are fitted to the board, this is also advantageous in that it raises them clear of other components on the board. Remember that the displays must be positioned just behind a window cut in the front panel and this will not be possible if other components protrude significantly higher above the board. 12 and 13 mm displays are compatible with the pc board layout but the larger type generally seem to offer slightly higher brightness for a given LED current. The displays must be common cathode types.

A dozen link wires are required and these can be made from the leads trimmed from the resistors. Fit single-sided pins at the points where connections to off-board components will be made.

A plastic or metal case having approximate outside dimensions of 180 x 120 x 39 mm will comfortably

System operation

The block diagram of Figure 2 shows the general arrangement used in this transistor tester. The unit breaks down into two distinct sections, one providing the display and the other converting current gain into a suitable driver signal for the display circuit. The bulk of the circuit is used to provide the display.

The display section is a simple frequency counter circuit.

That is controlled by the low frequency oscillator and a simple logic circuit. First the two decade counters are reset to zero and

Digital transistor tester

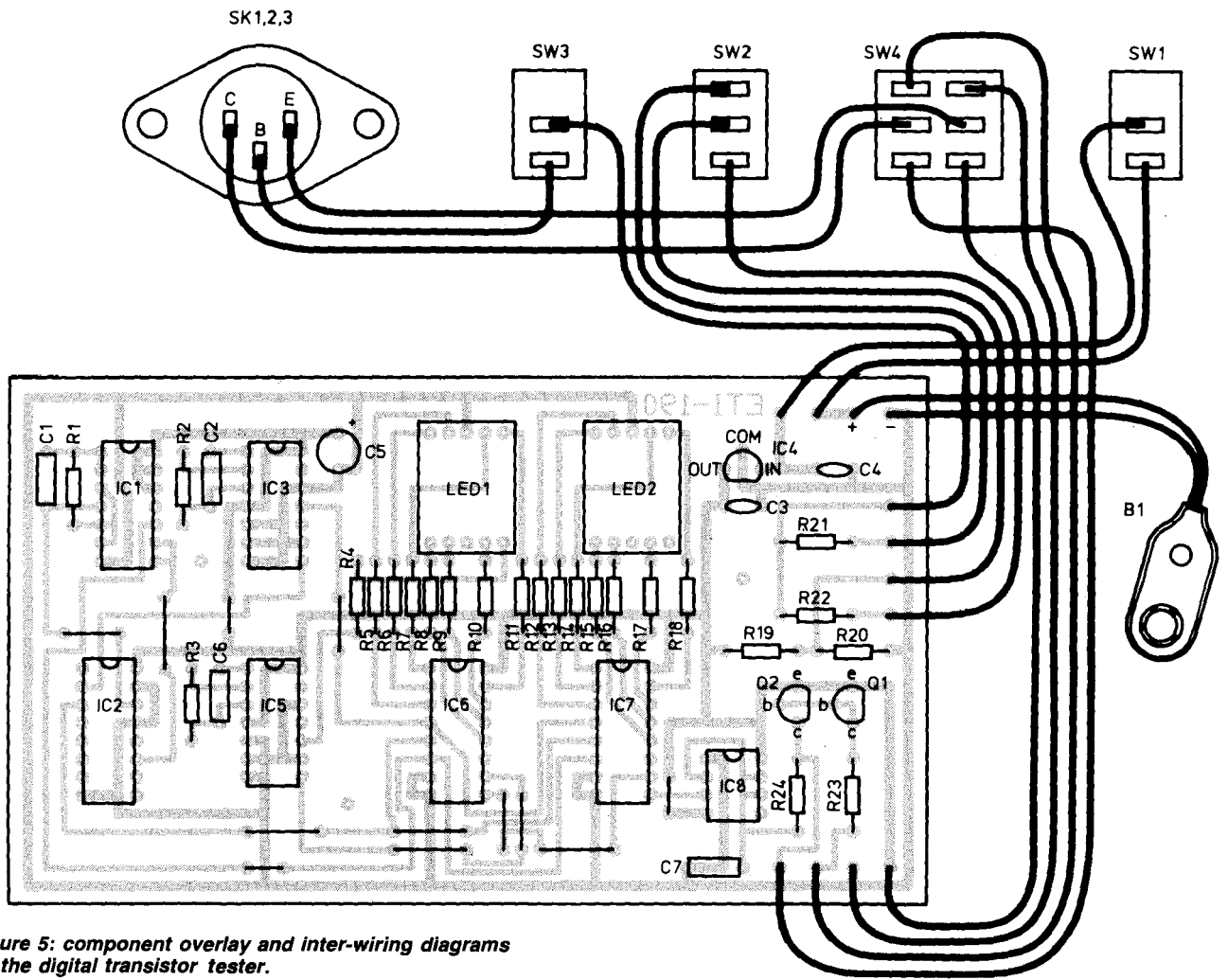
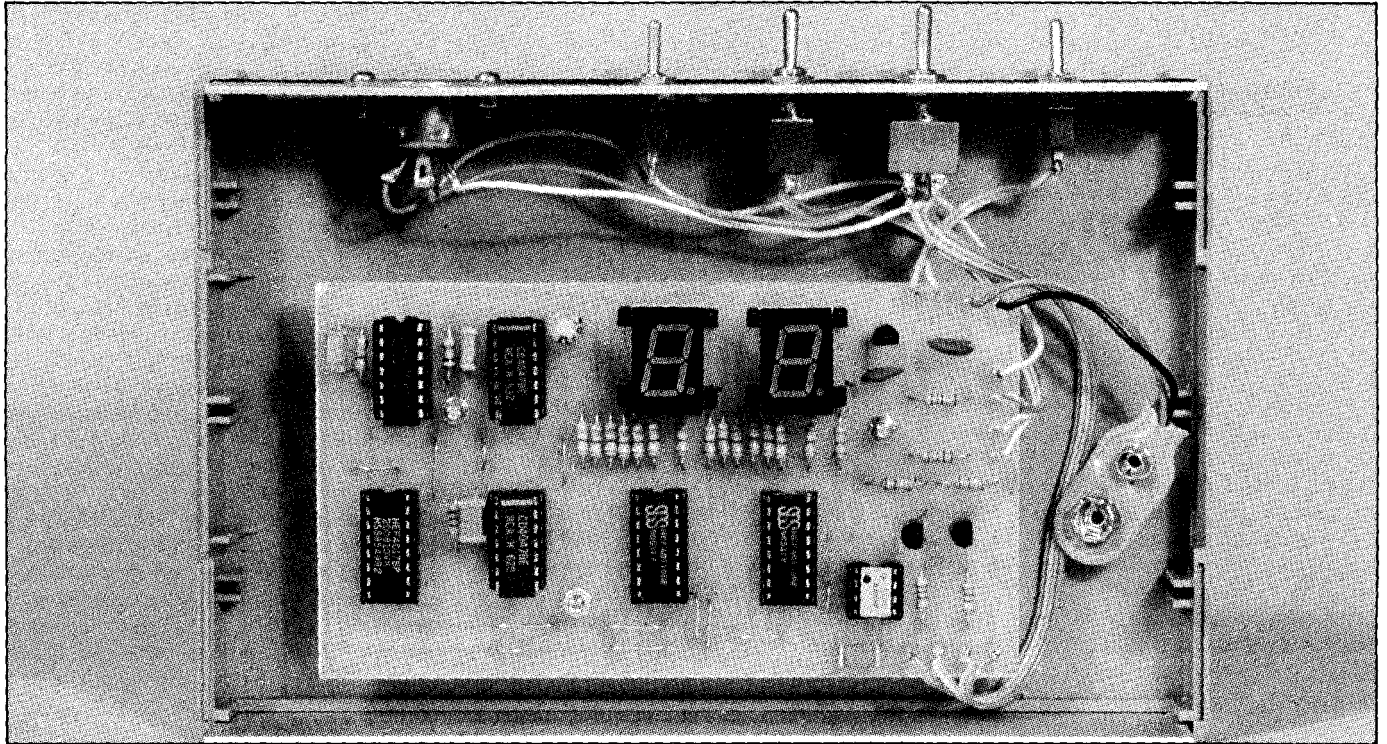

Figure 5: component overlay and inter-wiring diagrams for the digital transistor tester.

accommodate all the components. This assumes a reasonably small battery is used. The current consumption of the unit is around 65mA and if a small battery is used it must be a *high power* or nickel-cadmium rechargeable type.

The four controls and the test sockets are mounted on the front panel but the case is used vertically so that this effectively becomes the top panel. I used a 3-way DIN socket for SK1-3 and most small transistors will connect satisfactorily with one of these. An alternative would be to use three 1mm sockets mounted in the same triangular pattern. Either way, a set of test leads terminated in small crocodile clips will be needed in order to make connections to uncooperative devices.

The pc board is mounted on the rear panel (base) of the case, using 12 mm stand-offs so the fronts of the displays are brought suitably close to the front panel. A window for the displays must be cut in the front panel. This is not too difficult using a coping saw or fret saw to make a rough initial cutout and then carefully filing this out to precisely the required size. Some red display window material is then glued in place behind the cutout.

To complete the unit the hardwiring is added as detailed in the overlay. This is all pretty straightforward and should not give any difficulties.

In use

After giving the wiring the usual final check, switch the unit on and observe the display. This should be an initial random number, followed about half a second later by 00. If this does not happen, switch off at once and recheck the wiring.

Assuming all is well, try connecting a few test devices to the input sockets, remembering to select NPN or PNP, as appropriate. It is unlikely that any damage will occur to silicon devices if the wrong setting is inadvertently tried but greater care should be exercised when dealing with germanium devices. With silicon transistors the leakage currents are generally so low that a 00 display should always be obtained when making leakage tests. Any other reading almost certainly indicates that the device under test is faulty.

The situation is less straightforward with germanium transistors, where quite high leakage currents are not unusual. Leakage readings of up to about 8 are quite normal but anything much higher than this would suggest the device under test is of dubious quality. Remember that gain readings must be adjusted downwards by the appropriate amount if a significant leakage level is detected. For example, if a transistor has a leakage level of 6 and a gain of 45 is measured on the x1 range then the true gain of the component is only 39.

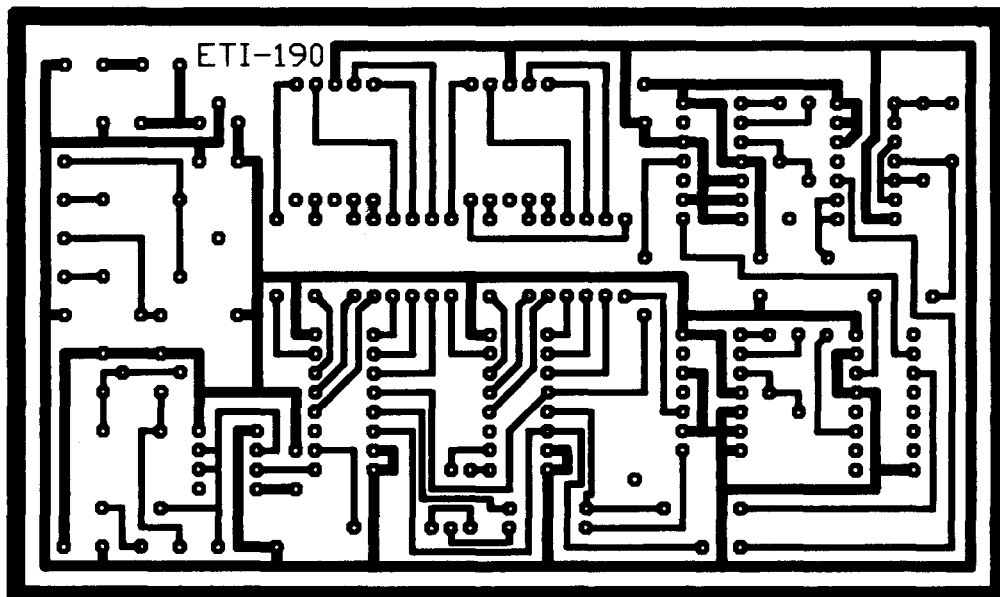

The tester can be used to check diodes. With the cathode terminal connected to the collector socket and the anode connected to the emitter socket, there should be an overflow indication with the unit set to the PNP mode. With SW4 set to the NPN position, the display should read zero for silicon diodes and a very low reading should be obtained with germanium types.

Calibration

In common with many transistor testers, this one has no means of adjusting readings for calibration purposes. Provided C2, C7, R2, R21 and R22 all have tolerances of 5% or better, the unit should give good accuracy. The vagaries of transistor gain parameters are such that there is little point in getting too pedantic about the accuracy of a simple transistor tester. Also, to calibrate the unit it would be necessary to have a reliable transistor tester or reference devices having accurately known gains.

Beware of the transistor checkers built into some multimeters. The accuracy of these ranges often seem to be unspecified and the h_{fe} range of my analogue multimeter seems to under-read by about 50%!

The best calibration source is probably a few transistors which have had their gains accurately checked by feeding them with accurate base currents, measuring the resultant collector currents and then reaching for the calculator to work out the current gains. This is the method used to derive the optimum values for the prototype. If you wish to calibrate the finished unit, despite the difficulties involved, trim the value of R2 to give the unit the correct level of sensitivity. **eti**

ETI MARCH '89

71

PARTS LIST — ETI-190

RESISTORS

R1.....	470k
R2.....	150k
R3.....	1M8
R4-R18.....	390R
R19, 20.....	3 k 9
R21.....	680k
R22.....	68k
R23, 24.....	220R

CAPACITORS

C1.....	100n greencap
C2.....	47n greencap
C3, 4.....	100n greencap
C5.....	100µ, 25 V, radial electrolytic
C6.....	330n greencap
C7.....	220n greencap

SEMICONDUCTORS

IC1.....	4001BE
IC2.....	4017BE
IC3, 5.....	4047BE
IC4.....	78L05
IC6, 7.....	40110BE
IC8.....	TLC555P
Q1, 2.....	BC559
LED 1, 2.....	0.5/0.56 inch common cathode 7-segment display

MISCELLANEOUS

B1.....	9 V (PP3) battery
SK1-3.....	3-pin DIN socket
SW1, 3.....	ON/OFF toggle
SW2.....	SPDT toggle
SW4.....	DPDT toggle
PCB Case (180 x 120 x 39 mm), Battery clip ic sockets, Connecting wire, Nuts and bolts.	



ELECTRONICS
ETI - 1536

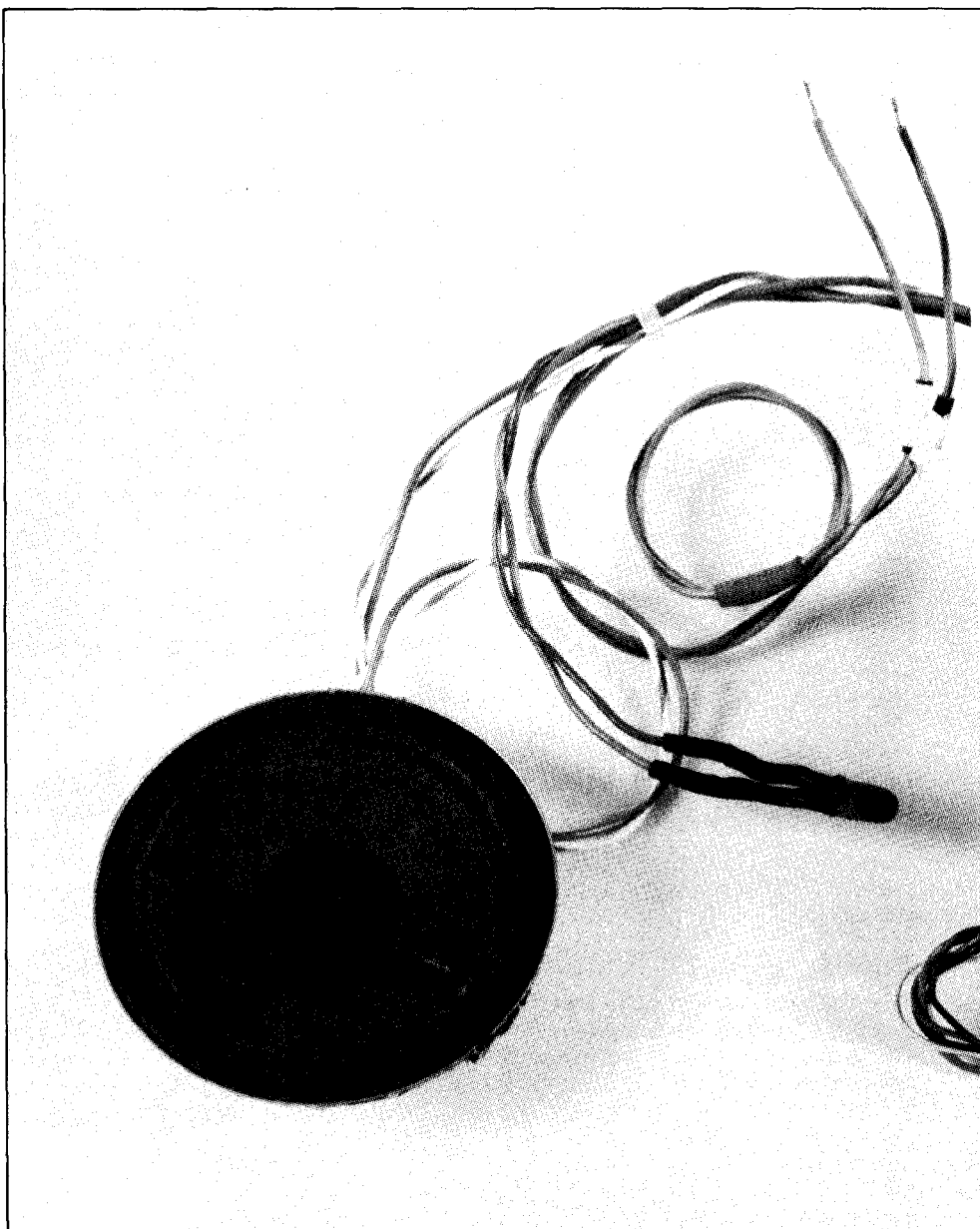

Safe behind closed contacts

Neighbourhood Watch schemes cover the land. Little stickers appear in the windows of many homes.

Security in the home has a higher profile today than ever before and a simple electronic locking device could be worth its weight in missing cufflinks.

The circuit detects correct sequence input and provides a relay output suitable to trigger an electronic lock. Its main beauty is that it uses no ICs and keeps things simple and cheap.

The correct combination is hardwired rather than programmed and the lock could be used to protect door openers, burglar alarms, car ignitions – the applications are limited only by your imagination. The circuit diagram is shown in Figure 1.

The heart of the circuit is the sequential detector which interprets the correct sequence inputs from the key switches, turns the output on and activates a relay. An indicator (LED1) shows that the correct number sequence has been entered.

THE ELECTRONIC KEY

A simple combination lock circuit designed for ETI readers.

ETI MARCH '89

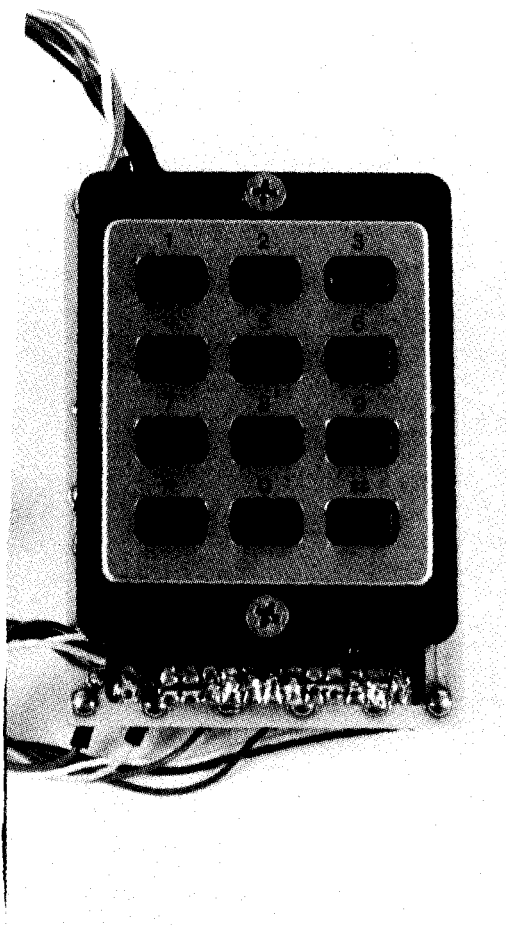

If the right numbers are entered but in the wrong order then the sequence detector is reset and the entire sequence must be repeated.

Alarm circuitry is incorporated in the design and this is activated if the digits not appearing in the combination are pushed.

Construction

The specified relay will fit directly onto the pc board. It is possible to use any relay having a 12V 300R or higher resistance coil, but it may be necessary to redesign the printed circuit layout or mount the relay off board.

The key switches are of push-to-make momentary action type and any switches of this type can be used. However a low profile keypad or keyboard is more desirable for ease of construction.

After inspection of the pc board for short

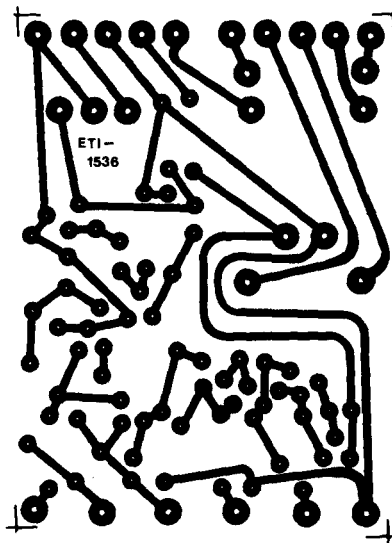

Parts List — ETI-1516

Resistors	
All 1/4W 5%	
R1, 5, 8.....	47OR
R2, 6, 9.....	15OR
R3, 7, 15.....	1k
R4.....	.82R
R10, 12.....	51OR
R11, 13, 14.....	56k
R16.....	5k
Capacitors	
C1, 2, 3.....	3µ3 25V electrolytic
C4.....	100µ 25V electrolytic
C5, 6.....	22n greencap
Semiconductors	
Q1, 3, 5.....	BC547
Q2, 4, 6, 7, 8.....	BC557
Q9.....	BD135
D1.....	1N4001
LED 1.....	red LED
Miscellaneous	
RLA1.....	12 V pc mount relay, 300R (available from Radiospares code 348-655) or similar
SWO-9.....	keypad Radiospares code 333-704 or push-to-make switches

circuits, broken tracks and any damage, the resistors should be soldered onto the board, followed by the capacitors, then the diode and transistors (care being taken with polarity of these components).

Once all the components are securely fitted onto the board, connect the switch wiring to the desired sequence.

In Figure 1 the sequence number is shown as 1-6-8. Zero is for reset and the remaining unselected invalid keys are connected in parallel to the reset/alarm warning circuitry input.

The pc board is purposely small so it can be mated back-to-back with the keypad by two spacers, and tucked away in any suitable front panel.

For door opener applications the unit can

ETI MARCH '89

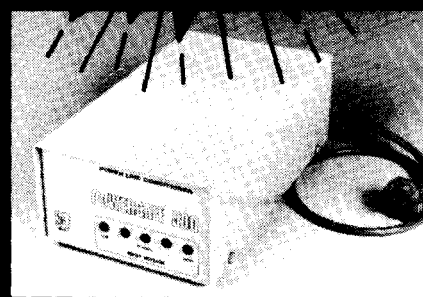
Power
Conditioning
Equipment

POWERSAFE 500

● Maintains output voltage at 240V ±5% for input voltages 189-283VAC

● Auto cut out for over and under voltage ● Maximum load rating 500W

● Built-in power line filter to protect against mains transients and noise

● VERY COMPETITIVELY PRICED!

[002] 730066

COMPONENT RESOURCES

PTY LTD

QLD (07) 391 8222 ACT (062) 51 5467
NSW (02) 688 4528 VIC (03) 555 6777
VIC (03) 419 4477 SA (08) 234 2033
WA (09) 293 2000 NT (089) 41 0322

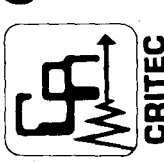

CRITEC

READER INFO No. 34

SAVE OVER 25% ON THE IF YOU O



THE COMPLETE SAILING HANDBOOK A beautiful 340 page hardcover book, filled with everything you need to know about sailing. Magnificently illustrated with more than 1000 diagrams and photographs. ~~\$29.95~~ \$21.95 (CACOM24) **SAILING YEAR 1987-1988** An excellent, informative review of the year's sailing racing. Plenty of bright action pictures bring the text alive to capture the interest of the expert and spectator alike. 256 pages beautifully presented in a hard cover. ~~\$29.95~~ \$21.95 (CASA11) **PACIFIC SAIL** The vast Pacific Ocean has been sailed by ships from the west for many centuries. All these vessels realistically depicted in superb paintings in this 192 page hardcover book. ~~\$39.95~~ \$29.95 (CAPAC1) **THE SMITHSONIAN BOOK OF FLIGHT** "I can't answer except to assure you that it will be spectacular" (Orville Wright, commenting on the future of aviation). We think you will find this beautiful 288 page history of flight book the same. ~~\$59.95~~ \$44.95 (TWSM1) **OUTBACK PUBS OF AUSTRALIA** Over 50 beautifully reproduced prints of Rex Newell's paintings. Featuring outback pubs in Australia and the tales connected to them. ~~\$26.95~~ \$19.95 (CAOUT1) **EXPLORE TROPICAL QUEENSLAND** From the Great Barrier Reef to its vast outback plains, tropical Queensland is full of amazing and colourful contrasts beautifully presented in this 160 page book. ~~\$29.95~~ \$21.95 (CAEXP2) **DINKUM AUSSIE PICTURE BOOK** Contains over 100 superb photographs which show Australia at its best. Everything from rolling wheat fields to the Sydney Opera House. ~~\$14.95~~ \$10.95 (CADIN8) **EXPLORE AUSTRALIA'S GREAT INLAND** 160 pages of suggested outback trips, beautifully depicted in full colour photography. Ideal for ideas before you get down to the real planning. ~~\$29.95~~ \$21.95 (CAEXP1) **THE ENCYCLOPEDIA OF AIRCRAFT** This meticulously researched encyclopedia presents an unrivalled record of over 500 military and civilian aircraft in Australia and New Zealand today. Each entry accompanied by a photograph. ~~\$39.95~~ \$29.95 (CAILL10) **THE AUSTRALIAN ADVENTURE** This superb 528 page book reflects the best of Australia's travel and adventure destinations. Beautifully presented with glorious colour photography. It would be a valued asset to any library. ~~\$49.95~~ \$36.95 (CA AUS61) **PRESENTING AUSTRALIA** A land of harsh beauty magically captured in over 400 photographs and engraving. For all Australians and visitors, this book brilliantly reveals the charm and appeal of Australia, past and present. ~~\$26.95~~ \$19.95 (CA PRE1) **DINKUM AUSSIE ODDITIES** A light hearted look at the weird and wonderful things, mostly man made, but some natural, which makes Australia unique. ~~\$8.95~~ \$6.70 (CA DIN3) **DINKUM AUSSIE BICENTENARY** Bob Ryan looks at the lighter side of the first fleet and early settlement. He explores the bungles and bickering, the beer and the beauties, the frolics and fun. ~~\$8.95~~ \$6.70 (CA DIN5) **DRUNK, INSANE OR AUSTRALIA** Here it is an Australian publishing first. The first detailed, factual account of the funniest and most bizarre events in recent Australian history. ~~\$8.95~~ \$6.70 (CA DRU1) **THE OUTDOOR TRAVELLER'S GUIDE TO AUSTRALIA** This is the premier guide to exploring and enjoying the landscape, wildlife, and vegetation of Australia. Superbly presented with 242 colour photographs and 15 full colour maps created especially for this book. ~~\$29.95~~ \$21.95 (WC 0000000) **ACES HIGH** Fast jet fighter, transport and trainers, all the way from the target tug to top gun itself, modern military air power captured in its element by some of the world's finest aviation photographers. ~~\$29.95~~ \$21.95 (CA ACE2) **MODERN FIGHTING AIRCRAFT SERIES** Each of these fantastic books has more than 100 full colour photographs on some of the most well known and sophisticated military aircraft. Complete with profiles, cutaway and dozens of explanatory diagrams. The series includes the Harrier, F/A-18 Hornet, F-111, AH-1 Cobra Attack Helicopter, F-16, F-14 Tomcat, F-4 Phantom II, B-1B, A-10 Thunderbolt II and the F-15 Eagle. ~~\$19.95~~ \$14.95 each (CA FAC) **MIDDLE AGE RAGE ... AND OTHER MALE INDIGNITIES** At last, an honest hilarious guide to that mysterious and terrifying phenomenon: Male Middle Age. ~~\$9.95~~ \$7.45 (CA MID1) **FOOD CHEMICAL SENSITIVITY** This book deals with the variety of additives that have been introduced to help food stay fresher longer, maintain its colour, look appealing longer, etc. Many of them can do immeasurable damage to the body. Here, is what you can do about them. ~~\$12.95~~ \$9.70 (WC 063120836) **THE DINKUM AUSSIE DICTIONARY** A list and definitions of all those words and phrases that only an Australian can understand (... and some even Australians don't know!). ~~\$8.95~~ \$6.70 (CADIN1)

SEE MAGNIFICENT BOOKS ORDER NOW!

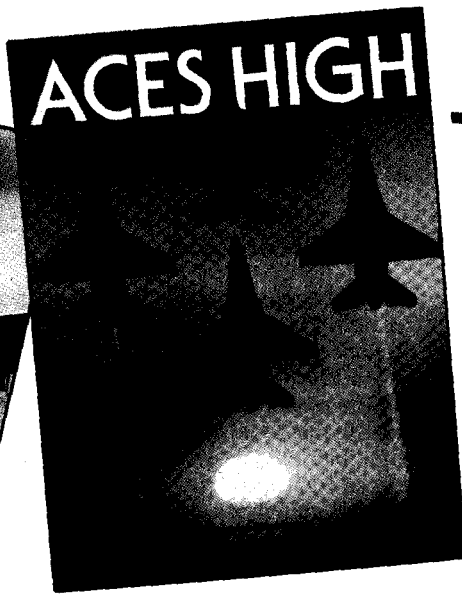
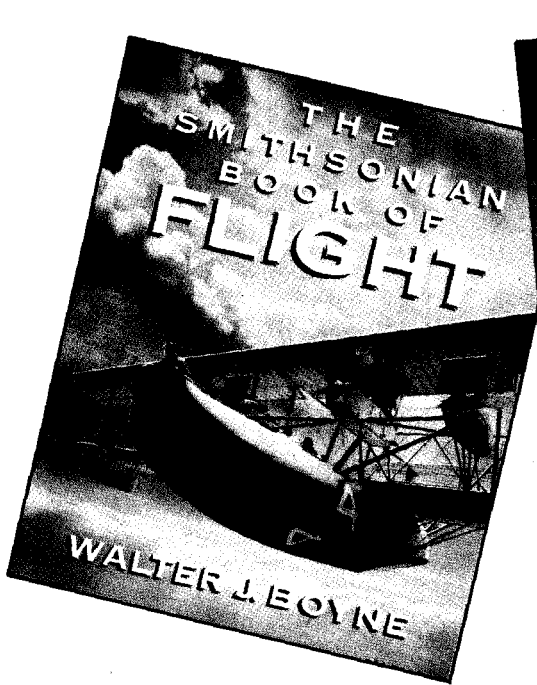

TO ORDER

Simply fill in the coupon remembering to include the code numbers and \$5 postage and handling. If the coupon is missing write down the names, code numbers and prices of the books you require. Include your name, address, telephone number, plus cheque, money order or credit card details (card type, card number, expiry date and signature) and send it all to Federal Publishing book offer, Freepost No 4, PO Box 227, Waterloo, NSW 2017. No stamp required. And don't forget to sign all orders.



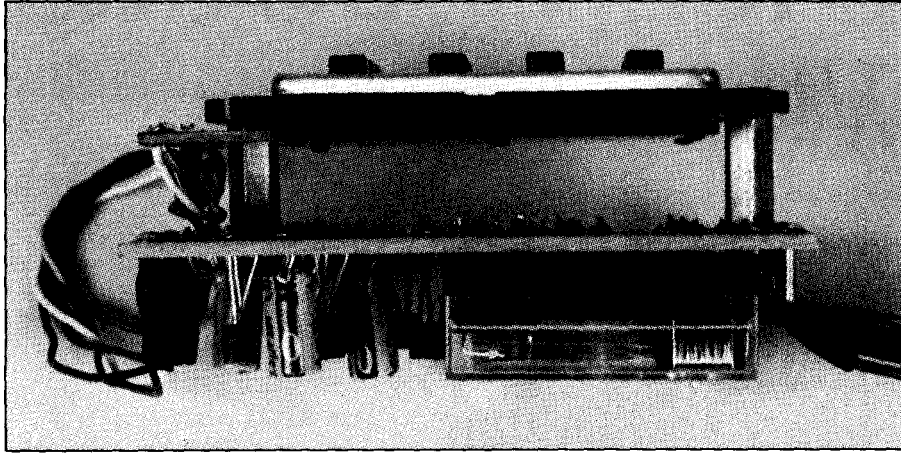

be fitted in a metal blanking plate (as used in house wiring) and mounted in the doorframe, with the speaker wired remotely indoors.

For automotive applications a small module case with metal front panel is suitable. The base of the case can be secured onto the dashboard, with the metal front panel used to mount the complete unit.

The alarm in the circuit shown is not going to wake the street and alert the local

Alsation brigade. In its present configuration it is more a loud indication that the incorrect sequence has been entered.

It would not be difficult to fit a second relay into the alarm section of the circuit which could trigger a bell alarm, or a flashing neon arrow with 'Burglar' written on it, or even to release an enormous weight from the second floor onto the burglar (please note that ETI can take no responsibility for any visitors flattened by this method).

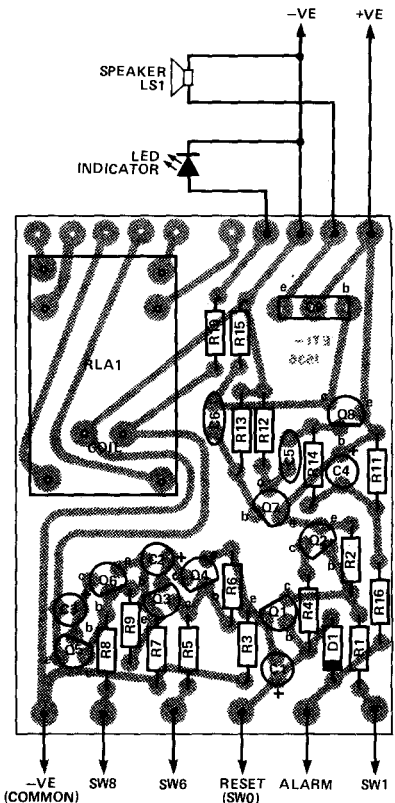

Figure 2: the component overlay for the combination lock.

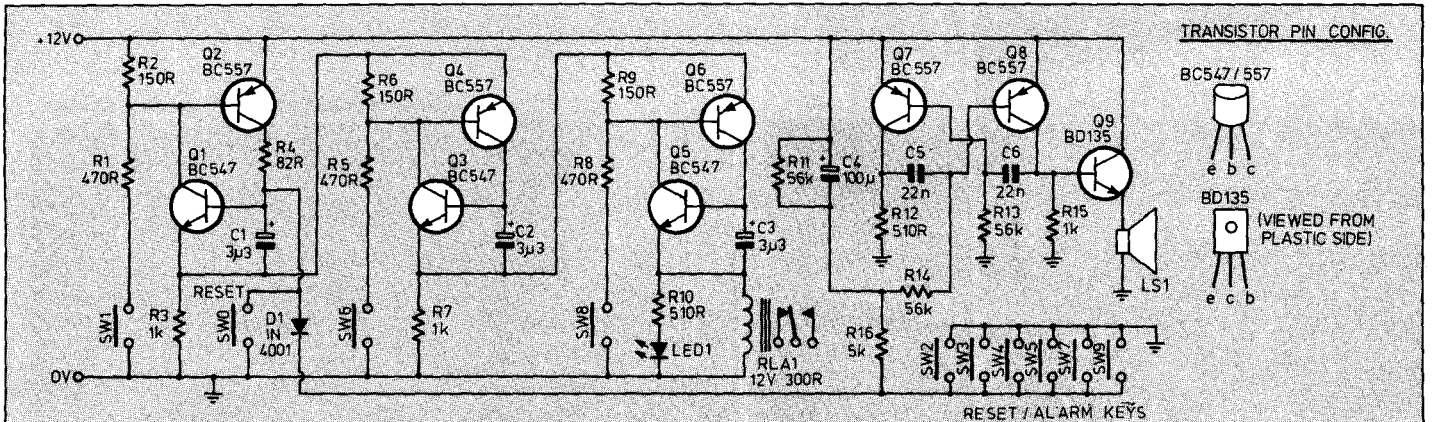

Figure 1: the circuit diagram for the combination lock.

How it works

The sequence sensing circuit is constructed around Q1 to Q6, the key switches and the relay.

Initially Q1 to Q6 are non-conducting. As soon as key 1 is keyed Q2 is forward biased, collector current flows through R4 and the base and emitter of Q1. C1 charges via R3 and R4 which provides sufficient bias to turn Q1 on. The voltage drop developed across R2 (due to Q1 collector current) briefly holds Q2 on and a constant current source is now available at the emitter of Q1, forming the power source for the remaining stages of the emitter follower.

The functions of Q3 and Q4, Q5 and Q6 are similar, except that the loading of the final stage is a relay coil and LED indicator.

Obviously the keys must be keyed in correct sequence (1, 6 then 8 as shown in

Figure 1) otherwise there will be no power source available from one stage to another and the relay will never energise.

The incorporation of the keypad or keyboard enables the user to select any three digits of any combination number chosen while the remaining keys are connected to the reset/alarm mode input.

Whenever the unselected keys are pressed the circuit is reset by pulling Q1 base negative (via D1 in alarm mode) and at the same time discharging C1. Q1 is biased off turning off Q2. At this stage the entire sequence must be repeated.

The second half of the circuit consists of the alarm warning circuitry. Whenever a reset/alarm key is keyed (except the actual reset key O) the alarm will sound for a short duration.

Q7 and Q8 form a basic astable multivibrator circuit. Initially the oscillator is inoperative, because Q8 is biased off via resistors R14 and R11 to the positive supply. As soon as a reset/alarm key is keyed, capacitor C4 charges via R16 with the polarity shown, Q8 becomes forward biased and the oscillation starts for a duration determined by the R11 and C4 network.

Gradually C4 discharges through R11 to turn Q8 off and the oscillator stops.

Q9 is a simple direct-coupling emitter-output power amplifier.

The circuit will operate well on 12V dc and draws a maximum standby current of 20mA. The maximum current is 400mA with the alarm and relay energised. This makes the device ideal for a 12V car system or a mains derived supply.

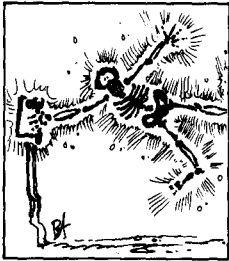

ELECTRONICS
E T I - 2 9 3

Dynamo lighting systems for bicycles suffer rather dangerously from the lack of output at standstill – when waiting at traffic lights or road junctions. Apart from this obvious disadvantage dynamos compete favourably with battery-powered lights because they:

- are lighter,
- require no costly battery replacement,
- provide higher light output (except at low speeds),
- are far more reliable than battery-powered systems.

The latter suffer from the infuriating habit of frequently needing a kick before they operate!

Because of the great similarity in the output characteristics of dynamos available on the market, the system described here will operate in conjunction with any dynamo set to provide safe lighting down to stand-still. The supply to the front and rear lamps is switched from the dynamo to the

rechargeable batteries as the bicycle speed (and so the dynamo output voltage) falls below a predetermined value.

The unit is cheap, simple to make and install, and could prove to be a lifesaver.

Features

By using rechargeable batteries in the backup unit, the need for battery replacement is eliminated. The batteries are on charge whenever the dynamo operates.

To keep losses to a minimum, no electronic devices are placed in the source/lamps circuit.

On dynamo systems, the bicycle frame is normally used for the return current by solidly connecting one terminal of the dynamo to the frame. Some commercial backup units require that the dynamo is isolated from the frame – easier said than done. The system described here does not impose such a restriction thus making it easier to install by current and future dynamo users.

DYNAMO BACKUP

ETI readers, see the light with this bicycle dynamo backup unit by Ziad Mouneimne and Nick Flowers.

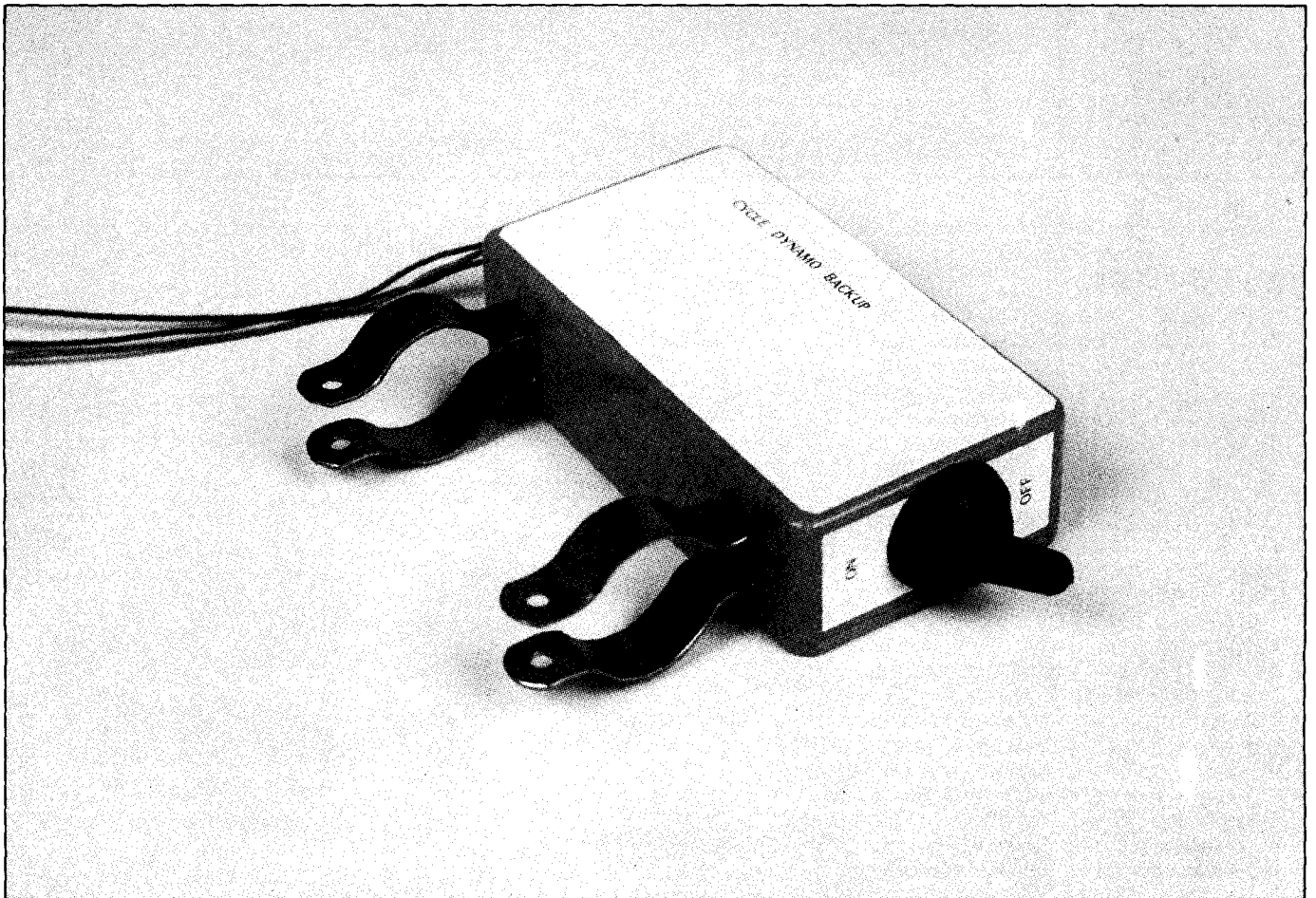

ETI MARCH '89

Dynamo backup

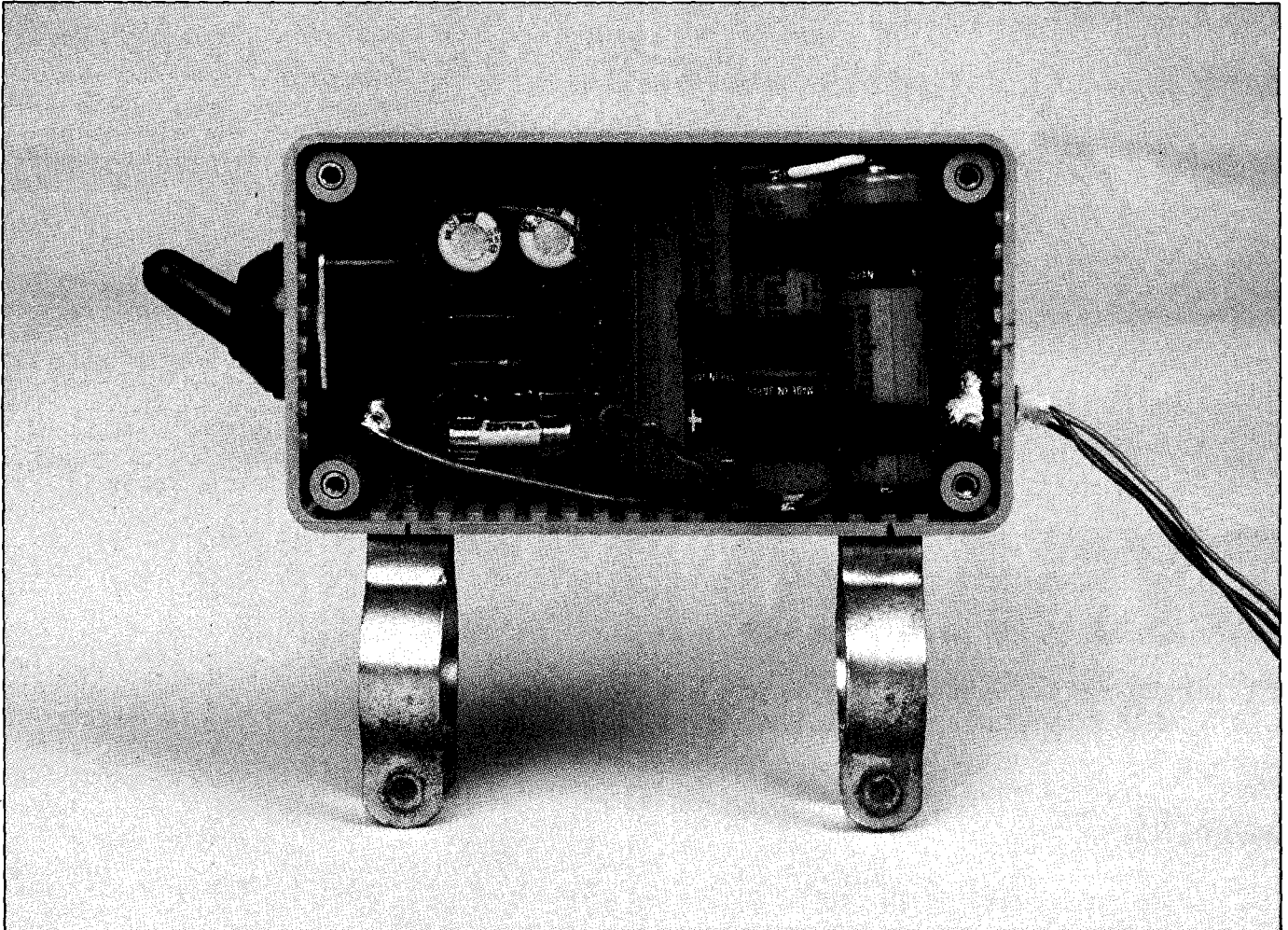

How it works

Figure 1 shows the complete circuit diagram for the unit. D1, C1 and R1 provide dc supply to the relay coil. The bicycle speed at which the supply to the lamps changes over from the battery to the dynamo is determined by R1. For the dynamo used, 120R gave a smooth changeover with the least light flicker.

D2, D3, C2 and R2 constitute the charging unit. Voltage-limiting is achieved by the back-to-back zener diodes ZD1 and ZD2. There are two modes of operation:

a) Normal, SW1 on. When the dynamo is stationary the lamps are connected to the dynamo. The peak charging current in this mode is about 50mA.

b) Fast charge, SW1 off. If the dynamo is engaged with SW1 off, the charging current increases to about 90mA. This is useful to accelerate the battery charging during daylight riding. ZD1 and ZD2 limit the voltage. Without them the charging current will reach excessive levels and damage the NiCd cells.

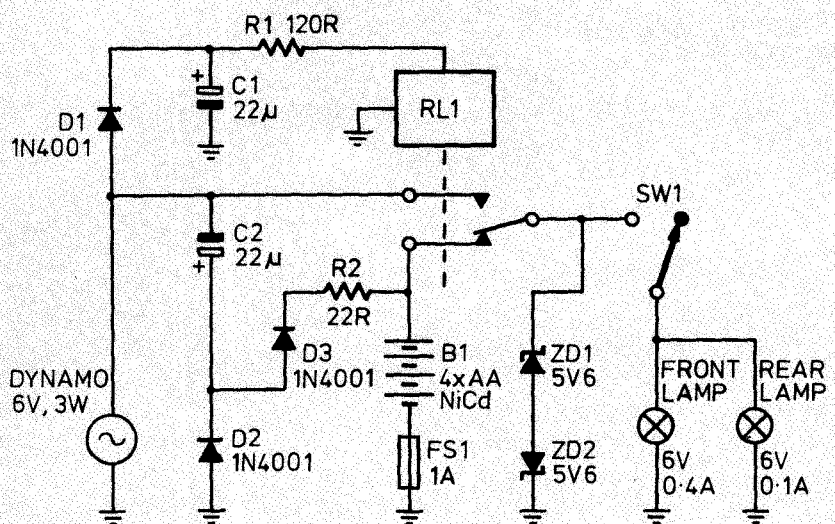

Figure 1: the circuit diagram.

The output characteristics of all dynamos are closely matched to the lamp load. On most sets a 3 W dynamo supplies a 6 V, 0.4 W front bulb and a 6 V, 0.1A, 0.6 W rear bulb. Unfortunately when the front bulb blows the rear bulb follows in seconds. When the rear blows the increase in brightness of the front bulb drastically shortens its life. In fact the authors measured the open circuit voltage of one wheel-driven dynamo and managed to read 180 V peak-to-peak on the scope by pedalling in 10th gear!

Choosing the battery

Typical AA-size NiCds have a capacity of 500mAh and recommended charging current of 50mA and 150mA for 15 and 4 hours respectively. When the bicycle is at a standstill, the total current to both lamps supplied by a battery for four NiCd cells is around 0.45A. So a fully charged battery will last for about 45 minutes without dynamo intervention. Obviously the battery will not be used like this in normal circumstances.

Where space is very tight the smaller 1/2A sized NiCds have the same capacity as the AA size but take up only about half the space.

Non-rechargeable cells can also be used if required. The charging circuit components D2, D3, R2 and C2 may then be omitted. If over-voltage protection is not required the

zener's diodes can also be eliminated. The pc board overlay is shown in figure 2.

Construction

The prototype is shown in the photographs. The pc board measures only 45x32mm so it was possible to fit all the items (pc board, battery and switch) in a compact box measuring 112x62x31mm. The unit can be neatly fitted on the bicycle tubular frame by two 25mm terry clips, chrome versions of which are available from any bicycle or hardware shop. Though less attractive (but cheaper) two capacitor clips were successfully used on the prototype.

The best position for the unit was found by the authors to be on the back of the seat down-tube just ahead of the rear mudguard. This gives the unit extra protection from rain — the seat (and rider) acting as an umbrella!

No battery holder is used. Instead, the NiCd cells are connected in series by soldered connections. This is deliberate. It eliminates the problem of bad contact which bedevils all battery systems and it is more compact. Obviously if non-rechargeable AA cells are used, a holder will be necessary and the box made larger.

At the time of writing three units had already been used for two years with excellent results.

PARTS LIST — ETI-293

RESISTORS (all 1/4W 5% unless specified)

R1 120R (see How It Works)
R2 22R 1/2W

CAPACITORS

C1, 2 22μ 25 V electrolytic

SEMICONDUCTORS

ZD1, 2 1N5339B 5 V6 5W

D1-3 1N4001

MISCELLANEOUS

B1 4x1.2 V NiCds

FS1 1A anti-surge fuse

RLA1 6 V 120R coil, SPDT ultra-miniature relay

SW1 SPST toggle switch

Pc board. Case. Waterproof cover for switch, Mounting clips. Fuse clips. Nuts and bolts.

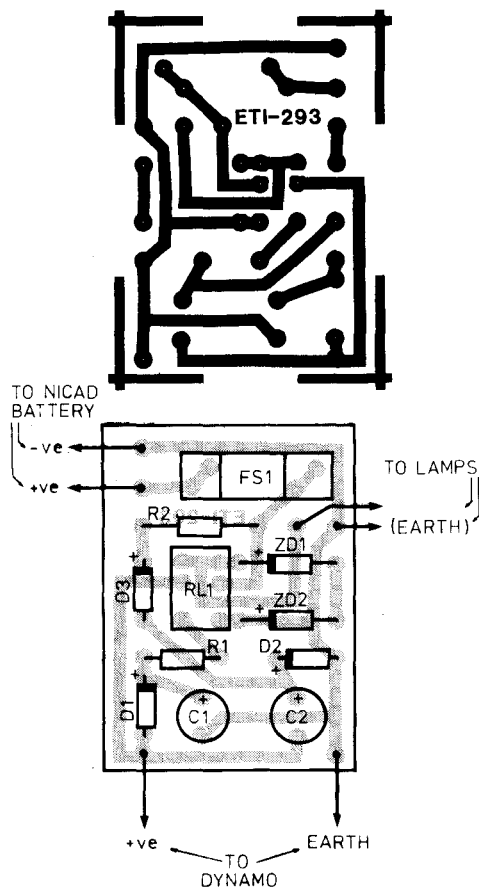

Figure 2: the component overlay diagram.

TECHNICIANS Consumer Electronics

Philips, operate Australia's largest Consumer Products manufacturers service company, providing not only warranty repairs on their own range of products but after sales service on all products.

With branches in all major cities throughout the country, and employing over 110 Consumer Electronics technicians, Philips can offer technicians with not only security but also with opportunity such as career advancement and exposure to the latest state of the art products and servicing techniques that are not always available in smaller organisations.

Due to an expansion in our activities we are seeking to engage Consumer Electronic Technicians to perform both workshop and field service. Applicants should be appropriately qualified to trades level and possess at least 3 years experience as a tradesman.

We offer above award wages and staff benefits which include immediate membership to the company superannuation fund and discounts on the company's fine range of products.

If you feel that you possess the necessary skills and are seeking a position that provides you with security, job satisfaction and excellent remuneration, then contact the Personnel Manager on 742 8361 after 9.00 am weekdays.

PHILIPS SERVICE
3 Figtree Drive,
HOMEBUSH, NSW 2140

Phillips is an equal opportunity employer.

BA4130



PHILIPS

ETI MARCH '89

79

READER INFO No. 21



ELECTRONICS
ETI - 1620

This is the final part of our printer buffer project by Andrew Conway, detailing construction and testing.

This project fits into a box quite neatly, with the input ports going out the back, the output port on the side, and the power supply out the front. The connectors can be mounted directly on the pc board and still protrude out enough to allow this. However, this means lots of wires to switches and LEDs which have to be mounted on the front panel.

If you work in a fairly safe (and dust free) environment, you may be able to avoid using a box at all. All the switches and LEDs may be mounted directly on the pc board, and all that is needed is a base to protect the bottom tracks.

Now, before you start soldering, make sure that the holes for the connectors and switches are large enough. It is a real headache enlarging some holes after you have started soldering in components.

The board is double sided, and there are many holes which require a piece of wire to be stuck through and soldered on both sides. This should be done first. A handy hint: don't cut the wire to size until after you have soldered it in place. Also remember that

several components must be soldered to on both sides of the printed circuit board. Note that soldering to sockets on the top of the pc board is fairly difficult - it is very easy to form solder bridges.

I strongly suggest that you use sockets, at least for the 68705P3 and the memory. However, ordinary sockets will not do, as some connections need to be done on the top of the board. I used the new low profile machined sockets, which stand off the circuit board by about one millimetre. This standing off is due to the pin shape (like = = - - in cross section). These sockets may be soldered to on both sides of the circuit board. They are very strong and durable, but unfortunately they are relatively expensive. If you can't find these sockets, you could always use wire wrap sockets, though these tend to be expensive.

Solder the sockets in, followed by the edge connectors and switches, though if you are doing it in a case, leave the switch wiring till as late as possible.

Next come the resistors, capacitors, LEDs, crystal and 7805, in that order. If you are not using sockets, solder in the integrated circuits now. Note that there is space to lay the crystal down on its side, as it is close to some of the pushbutton switches. Don't leave the leads on the crystal too long as it is part of an oscillator circuit and you don't want extra stray inductance.

The 7805 dissipates about two watts, so it needs a heatsink. This can usually be fairly small. However, if your air flow is not very good you should use a fairly large heatsink.

Last, put the ICs in the sockets, taking appropriate caution not to expose them to excess static electricity, and being careful not to bend any pins.

A 9Vdc plugback is required to supply power to the board. This is connected to the pc board via a five pin plug, with pin 1 as positive and any of the others as ground. This must be able to supply 400 mA. As an alternative, if you have a regulated 5V supply, you could use this and replace the 7805 with a wire link.

Testing

This should be done in separate stages. For each stage I have devoted a paragraph which tells you what to do, what should happen, and where the problem is likely to be if it doesn't happen. Don't go onto the next stage until the previous stage is working. If I say something like "check IC3", I mean check that IC3 is in the socket correctly, that

PARTS LIST — ETI-1620

SEMICONDUCTORS

IC1	programmed MC68705P3 (see "obtaining 68705P3")
IC2	74LS02
IC3	74LS157
IC4, 5	74LS374
IC6	74LS74
IC7	74LS14
IC8-15	256KX1 dynamic ram (see text for details)
IC16	74LS74
IC17	7805
D1, D2, D6	green LEDs
D3, D4, D5	red LEDs

RESISTORS

R1-2	680 ohm 5% 1/4 Watt
R3-7	1k 5% 1/4 Watt
R8-10	10k 5% 1/4 Watt

CAPACITORS

C1	1 μ 25 V electrolytic
C2	100 p ceramic
C3	470 μ electrolytic 15 V
C4-11	100 n greencap or ceramic

SWITCHES

SW1-3	SPST push button (pc board mounting)
SW4-5	miniature DPST

MISCELLANEOUS

4 MHz crystal double sided sockets (see construction)
5 pin power connector
heatsink
3x36 pin pc board mount right angle female Centronics connectors
pc board
9V plugback
Cost estimate \$150 + cost of dynamic RAMS (excluding sockets, case and cables)

PRINTER BUFFER

Large 256K storage

ETI MARCH '89

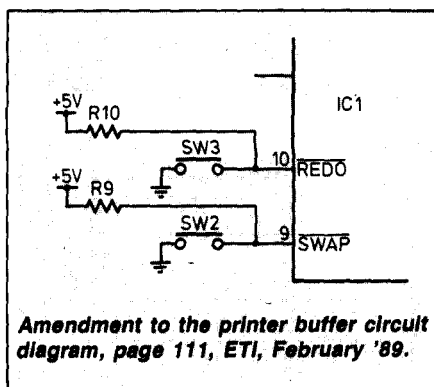
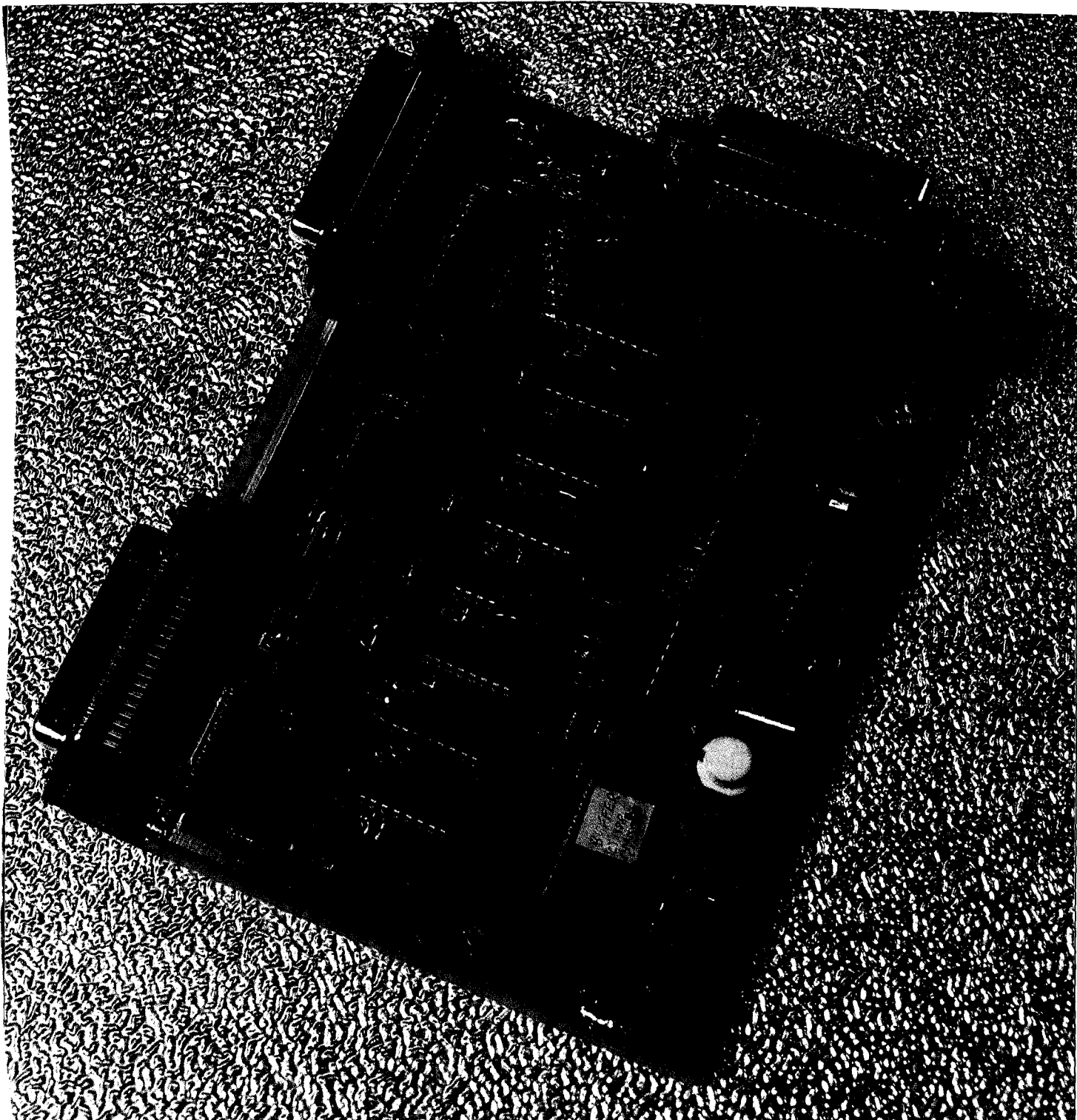

the socket is soldered in properly, that it is receiving power properly, and that there are no solder bridges nearby, and if that fails, check that the tracks leading away from IC3 are all right. It is very unlikely that there is anything wrong with the IC itself.

Start off with the computer(s) and printers disconnected, and just attach the power connector. Switch on. The port B active light should go on for about half a second (reset time), and then it will be replaced by the port A active light and the empty light. If this does not happen, switch off immediately and check for shorts, bad contacts, etc. The port B active light requires IC1 and IC3 to be

operational; the other two require IC1 and the clock, IC7.

Once you get this far, try the switches. Pressing CLEAR should cause the same effect as power-up. Pressing SWAP should change the port A active to port B active and vice versa. Pressing SWAP and REDO simultaneously (with SWAP first, as described previously) should cause both port active lights to go on, at half brightness. If any of these don't work, it is probably a fault in the clock or the switch connections.

This has verified that the 68705P3 is running its program properly, and is properly connected to the switches and LEDs.

Next, remove power and connect the computer to port A. Turn power back on. The same sequence as before should occur. If not, check for a fault around port A. Try outputting something from the computer. The data ready light for port A should go on dully, and off when the data transfer is complete. The empty LED should go off. If this does not work, check around IC3 and IC6.

Press CLEAR to get the empty light to go back on. Now try the same thing again, except first press SWAP to make the other port the active port. The data ready light and empty light should stay on. If they don't, check IC3. Then try BOTH mode, and check that the port B LED stays off while data is coming into port A. IC3 again is the probable culprit if something strange happens.

Now repeat the previous two stages, except this time connect the computer to port B. Remember to press the SWAP key to make port B the active port before you send data to it.

It is now fairly certain that the input port handshaking is working properly.

Now turn the power off again and connect the printer. Switch SW4 to the on position. Apply power to the computer, buffer and

printer. The printer should not print anything. If it does, check the output port, particularly the STROBE line.

Now, the big test. Output something from the computer. If it is printed properly, skip the next two paragraphs. If it is possible to put your printer into hex dump mode, do so (as this will allow you to see if just nulls are going to the printer.)

If nothing is printed, check the BUSY and

**Now the big test.
Output something from
the computer'**

STROBE signals on the output port. Remember of course to have the printer on line.

If something is printed, but it is gibberish, it could be due to the input latch (IC4) or the memory chips. If the printed output is totally unrelated to the input data, check the address and control lines for the dynamic RAMs, and the latching on the input port. If

some letters pass consistently through, and others don't, the problem almost certainly lies with the data path. Probably one bit is shorted to ground, Vcc or another bit.

Now repeat this test with the other port. If it does not work, the problem is probably around IC5.

Congratulations! Once you have got this far, the buffer is almost certainly in full working order.

Now try printing a large file where the buffer is actually used — that is, information is stored in the buffer for a significant time before it is sent to the printer. Also try turning the printer off line. If it doesn't work now, try the address pins of the dynamic RAMs, and the RAS generation logic (IC2 and IC16).

All that is left now is to check the fine details. You should try to fill the buffer (and check that the full light goes on). Try the REDO control, before passing more than 256K through the buffer (legal) and after (illegal — should cause both full and empty LEDs to go on). A hint for this: the null character (ascii code 0) is not printed by most printers, so can be used to send a lot of information to the buffer without too much printing. Graphics pictures also provide a lot of data.

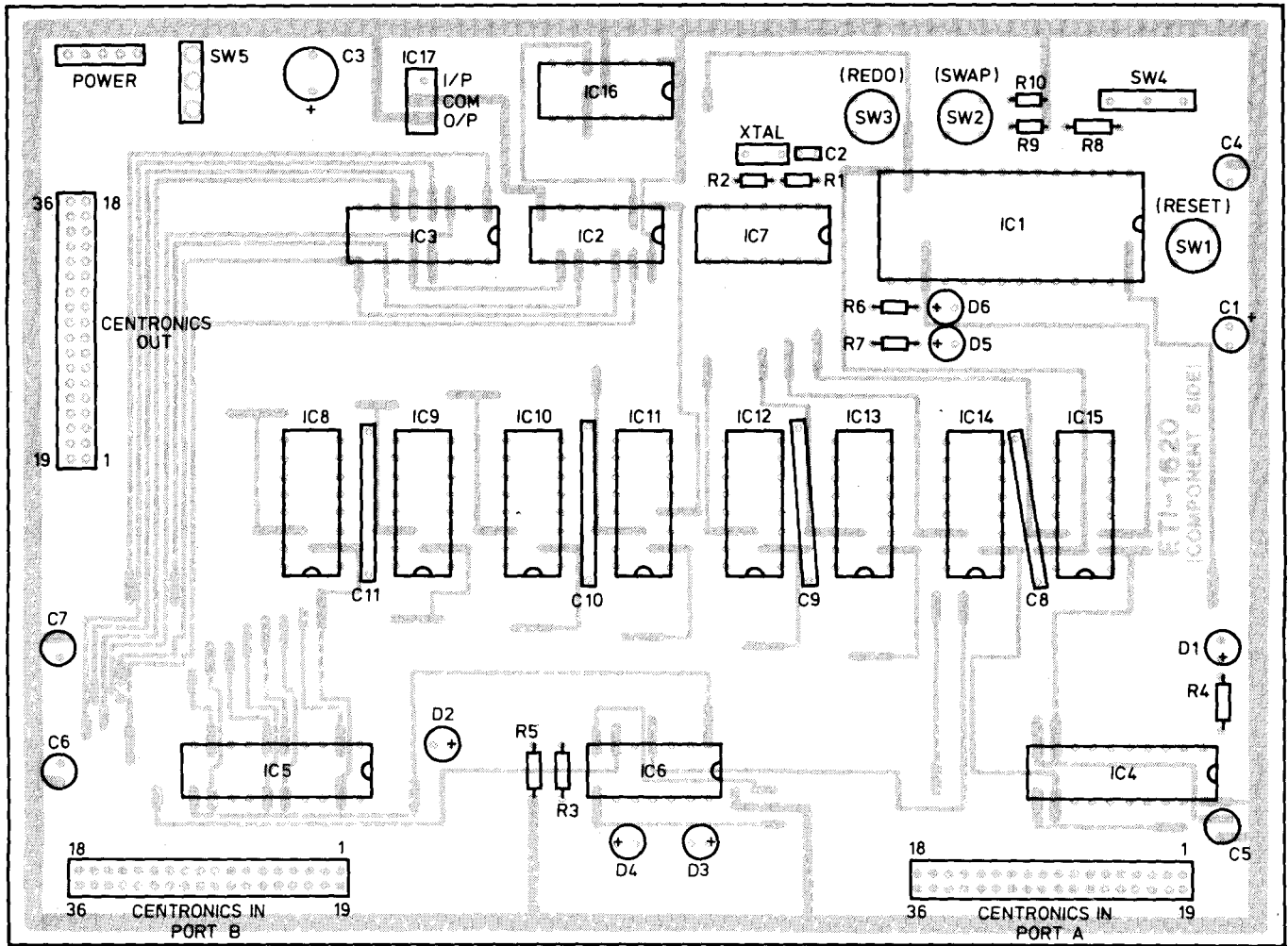

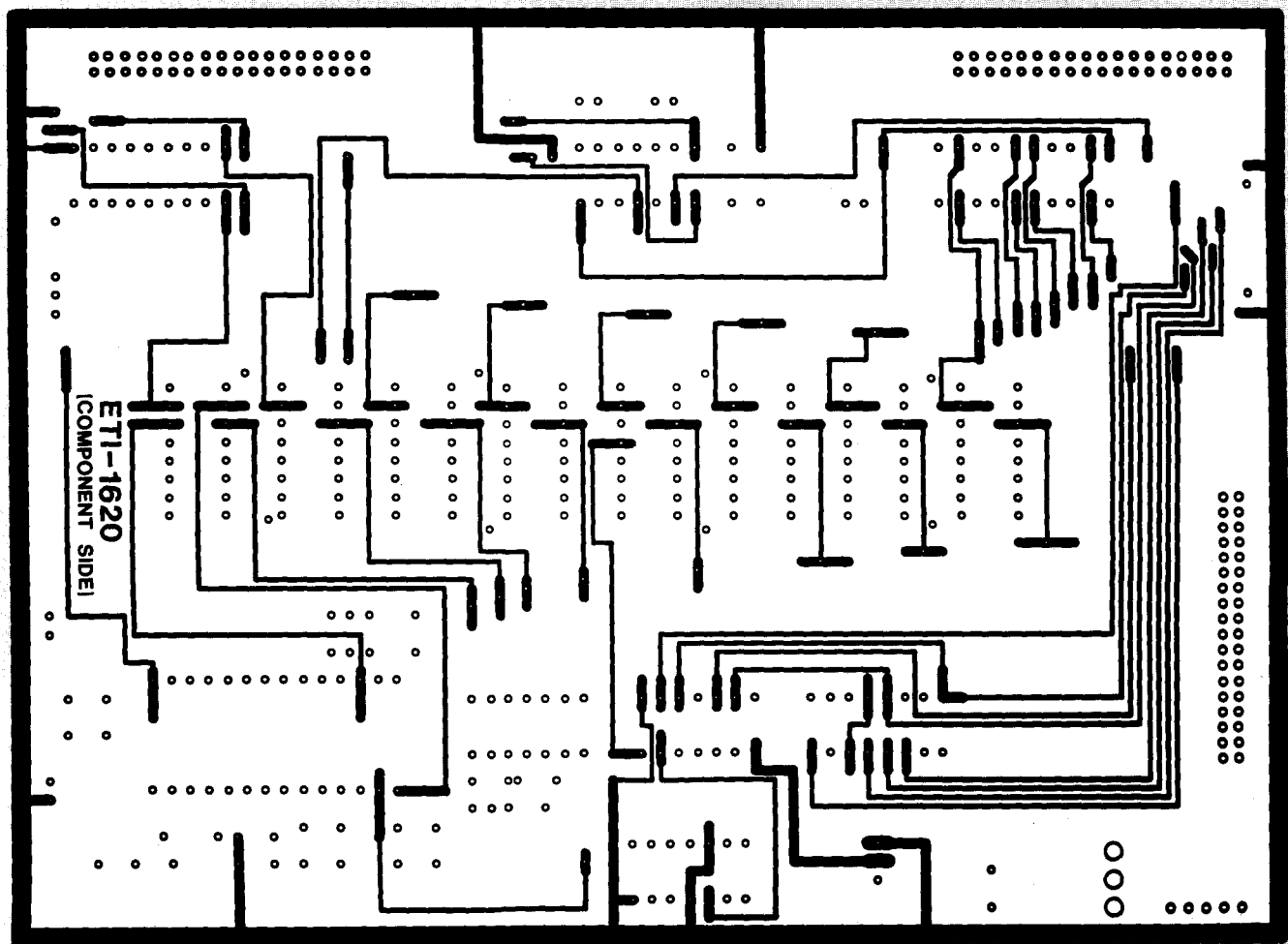
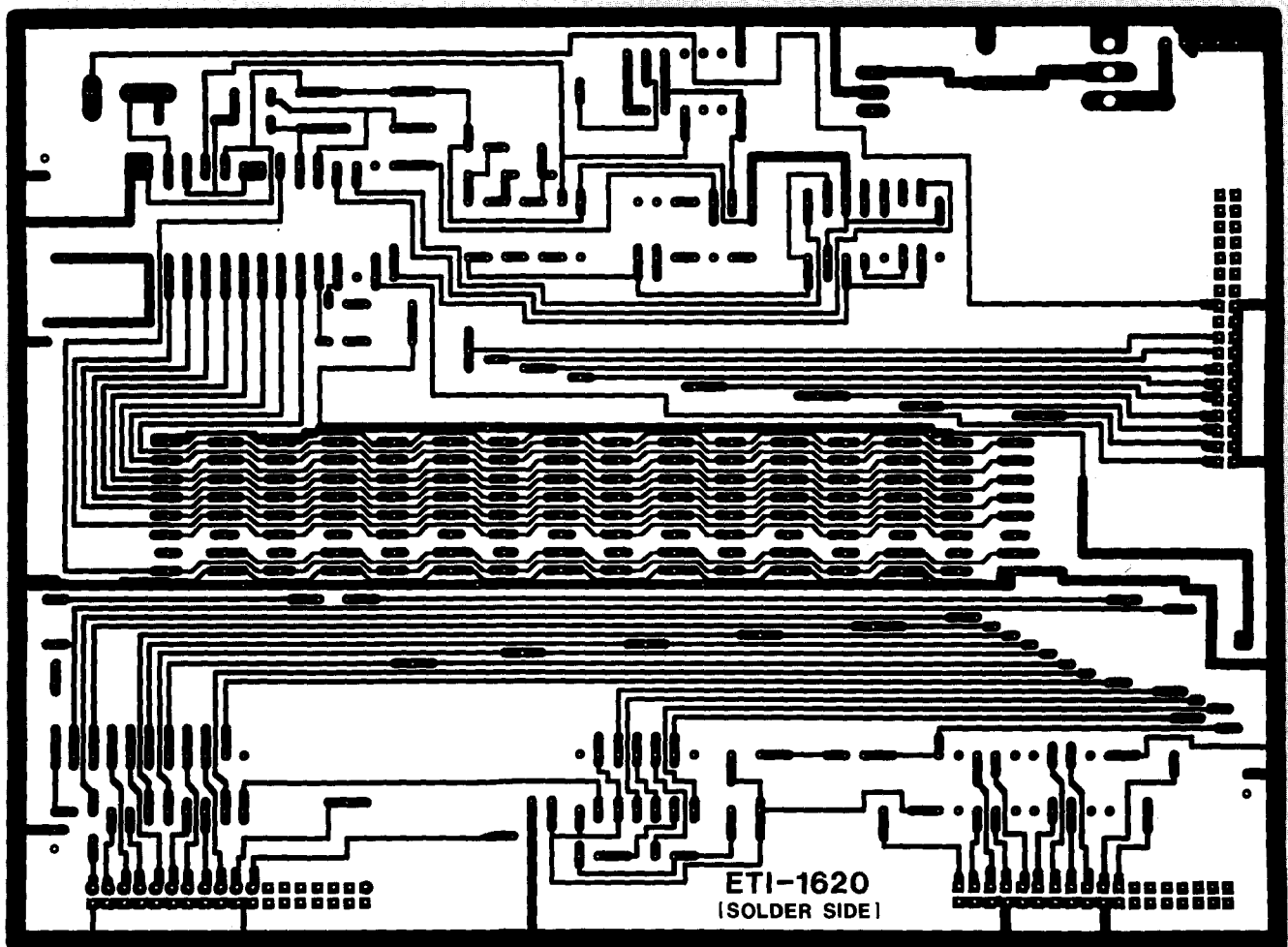

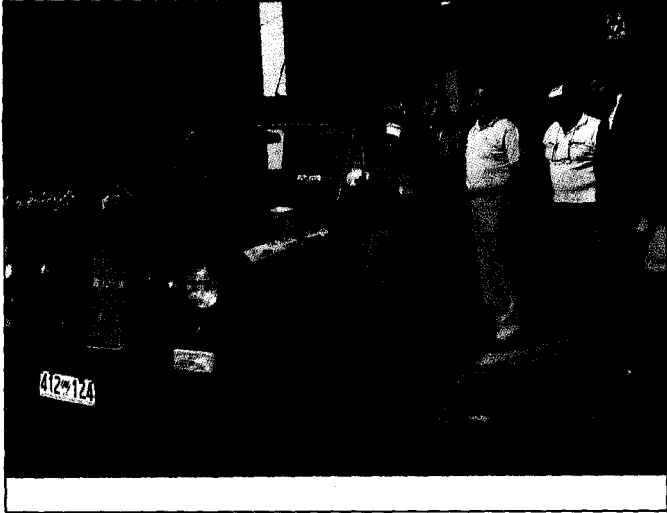
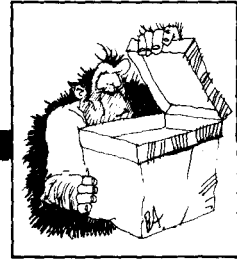

Taxi powered by soldering iron

THE great Canon taxi ride, London to Sydney, was rescued by Portasol portable soldering iron.

"We experienced vehicle break-downs in an Iranian desert, a Singaporean village, and in Australia's outback and in all these instances Portasol's instant soldering iron saved the day" said Ed "Ned" Kelly, organiser of this epic drive.

The Portasol is a powerful soldering iron for both the professional and handyman. This compact tool runs on standard household butane gas lighter fuel

and can be used anywhere.

Kelly said that the range of four replacement screw-in tips made repairs to different car parts very simple. Portasol's tip contains a patented catalytic convertor that generates extremely high heat without a flame; and this power takes only 20 seconds to reach operating temperature.

Australian distributor is DRM Industries, Mona Vale, NSW. For more information contact Don McNeill Jr on (02) 997 5522.

READER INFO No. 155

HEME 1000P power meter

WARSASH Pty Ltd of Sydney, sole Australian distributors for HEME International of England has released a powerful new multifunction diagnostic tool for the electrical and electronic design, manufacturing and maintenance engineers responsible for both ac and dc power measurements.

The HEME 1000P power meter is designed to measure almost all the parameters associated with power plant and electrically operated installations without the need to break the current circuits, to interrupt operations or processing. The true RMS measurements provide for current (dc and ac), voltage, and power readings which are accurate almost regardless of the waveform shape, to a crest factor of 7.

Through the use of Hall Effect sensors in the magnetic field of a conductor, together with a pair of sturdy probes, both dc and ac power can be measured and displayed on a large 3½ digit LCD.

Current values can be displayed on an oscilloscope,



chart recorder or other measuring instrument. Either true RMS or instantaneous value (waveform) can be selected for the analogue output.

Autorangeing for all measuring

ranges, automatic display of sinewave or polarity to indicate ac or dc, low battery indication, two ranges for surge current reading (display of maximum measured value) and an auto

switch-off all help to make the HEME 1000P a user friendly, versatile measuring tool.

Further details from Warsash on (02) 30 6815.

READER INFO No. 156

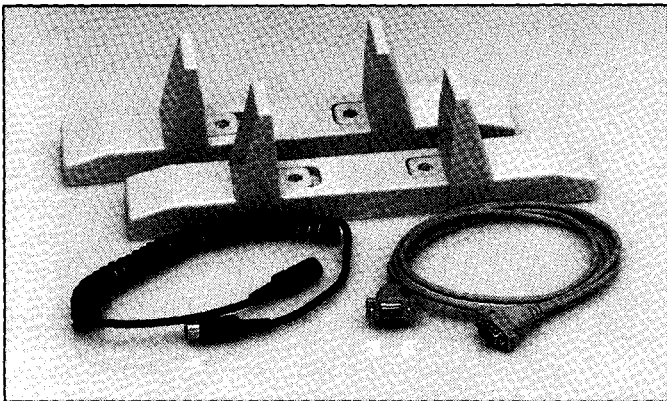

Clear your desk! ▲

ROD Irving has a handy set of add-ons for your IBM compatible so you can put your computer on the floor, reducing the noise level, and clearing your desk. The three items are a keyboard extension lead, a monitor extension lead (CGA, EGA, or TTL) and a stand

under the desk. This way your disc drive is still easily accessible and the monitor and keyboard can still be on the desk. Prices are \$6.95 for the keyboard extension, \$21.50 for the monitor extension and \$24.95 for the stand.

READER INFO No. 157

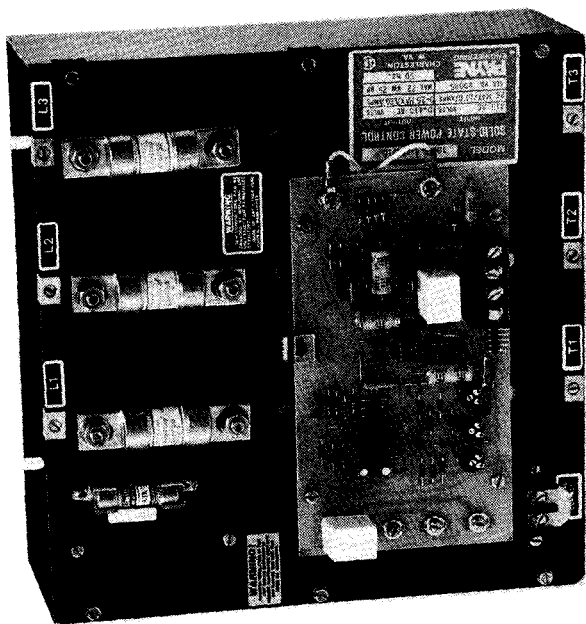

Reduced voltage motor starters ▲

NHP has announced the Payne Engineering "HPID" series of solid state reduced voltage motor starters. The "HPID" series has been designed for use with standard squirrel cage motors with 6 leads, and is intended to be connected in the Delta loop of the motor. This series employs two inverse parallel connected thyristors in each of the three phases, which allow for long ramping times, typically over 20

seconds, with reduced motor heating. This makes them ideal for use with high inertia loads and large pumping applications. All units are protected against over-current with 2 millisecond fuses and overvoltage by VBO clamping.

For more information contact NHP Electrical Engineering on (03) 429 2999.

READER INFO No. 159

Versatile RF wattmeter

THE new Thruline RF wattmeter model 4304A from Bird, provides users with versatility, ruggedness and full coverage on five power ranges, from 5 to 500 watts full scale. This portable unit measures both forward and reflected RF power levels in 50 ohm two-way communications systems.

Advantages of the 4304A include:

- performance stable to 1000 MHz,
- power ranges of 5, 15, 50, 150, 500 watts,
- supplied with one broadband, locked-in-place element, calibrated to the instrument,
- rugged, die-cast aluminium housing with shock mounted meter,
- no "off limits" on scale,
- UHF female connectors standard,

- rubber mounts on the bottom and back surfaces,
- more precise power measurements in the 800-900 MHz range;
- covers all power ranges required for measurement of all two-way communications systems,
- eliminates expense of multiple frequency-range and power-range elements,
- withstands rough service,
- no need to switch scales when reading lower powers,
- provides highest measurement accuracy with minimum insertion loss and greater mechanical stability,
- use the instrument while it is standing up or lying on its back.

READER INFO No. 158

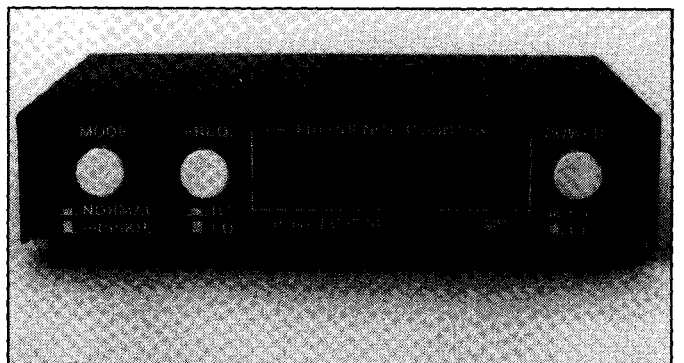

Digital frequency monitor ▲

CAPTAIN Communications of Parramatta, NSW, has released a miniature frequency monitor designed for displaying the frequency of both transmission and the frequency the receiver is tuned to. It is ideal for users of transceivers and receivers who need accurate digital readout of frequency. Many older sets can be brought up to full digital standard with this five digit frequency monitor. It is suitable for both HF and VHF operation, with coverage from 1KHz to 250MHz in two bands.

Unlike conventional frequency meters, the FC-200 can read both the frequency going out to the antenna and the frequency of the received signal. The latter is managed by a down system

based on the receiver's local oscillator and by subtracting 455KHz. The monitor comes complete with PL259 connectors for transceiver and antenna and with inputs for pickup of signal from the receiver's local oscillator.

Specifications:

- frequency range: HF: 1KHz-54MHz VHF: 50MHz-250MHz,
- standard oscillating frequency: 10MHz +/- 0.0005%,
- input impedance: 1M ohm, 20pF
- power supply: dc 13.5V
- environment: 0-40°C

For further information contact Captain Communications on (02) 633 4333.

READER INFO No. 160

Software development kit

Alfatron's new software design kit for Dallas Semiconductors' DS5000 Soft Micro-controller and the industry standard 8051 family of microcontrollers allows sophisticated real time software development and emulation from a low-cost IBM-PC or compatible computer.

The DS5000DK development kit's 12 mm thick credit card sized emulation hardware module is a self-contained system which emulates, in real time, the

operation of the DS5000 and other 8051-compatible micro-controllers. Because the kit includes cables that simply plug into the PC's COM port and the DS5000 socket on the user's target system, no special hardware is required on the PC bus. The compact system avoids the bulky enclosures of traditional emulation systems. Details ☎ (02) 720-5411.

READER INFO No. 161

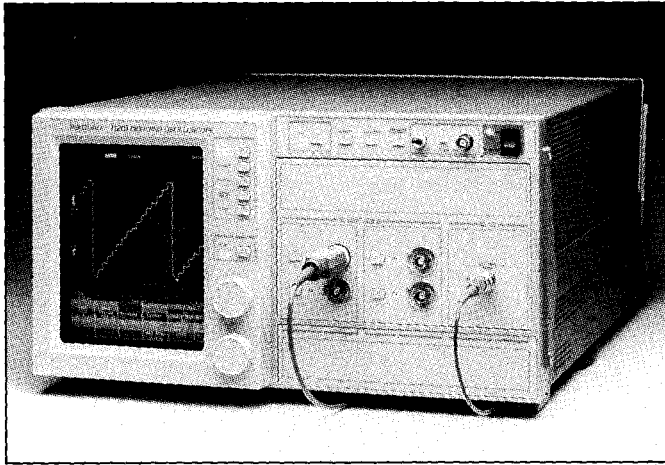
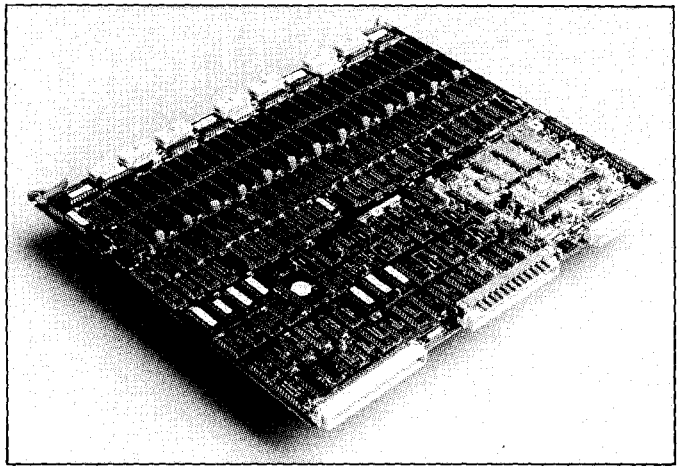

Low-cost laboratory oscilloscope

TEKTRONIX' 11201 digitising oscilloscope offers 400 MHz bandwidth, four channels and measurement automation. It combines laboratory quality measurement performance with menu-driven touch-screen controls, automatic signal and data processing and live measurement updates. The 11201 has 9-bit vertical resolution and up to 10K record length, giving it excellent accuracy for both voltage and time measurements. Vertical resolution can be augmented with signal averaging.

Digital device designing and debugging are convenient with the 11201's external trigger which enables users to focus on a specific digital event for easier device characterisation.

With a combination of up to four acquisition channels and four stored waveforms, up to

eight signals can be displayed at the same time. Windows can be used to display a detailed portion of a waveform while simultaneously showing the full waveform.

Touch-screen controls give quick access to the 11201's time, amplitude and area/energy measurements. Up to six alphanumeric measurements can be displayed simultaneously. Buttons located alongside of the screen quickly invoke waveform, trigger, measure, store recall and utility screen menus. Within these, two more levels of menus give access to all oscilloscope functions.

Measurements are continuously updated to track any changes in the input signals, giving the display a "live" look, similar to analogue oscilloscopes.

Further information from Tektronix on (02) 888 7066.

READER INFO No. 163

Resolution display controller ▲

UK company Primagraphics Ltd has introduced a new TV-resolution display controller which combines three 8-bit frame stores with real-time input capability and output look-up tables on a single card.

The combination of extensive storage capabilities and true colour display facilities makes the new controller ideally suited to applications in TV graphics, computer animation, image analysis and picture enhancement.

The controller incorporates 1664 kbyte of RAM using the latest 256 kbyte chips, and provides 24-bits-per-pixel full-colour display with additional two bit planes which allow the simple implementation of features such as text overlays and cursors.

Flexibility is provided by output look-up tables, and digital as well as analogue video input and output. The controller operates at either 15MHz or 13.5MHz sampling rates, and with 625- or 525-line

systems. Facilities are provided for 'gen-locking' the board to external sync. sources, and up to four boards may be fitted in a system with video outputs paralleled to allow mixing and switching between different images.

Multiple buffering of greyscale or false colour images is possible by the ability to reconfigure the board under software control into a 256-colour system.

The controller is compatible with other modules in the Primagraphics TOPAZ range of graphics systems, and when used in conjunction with the Primagraphics 8-bit high-resolution display controller, can provide a Unix workstation with simultaneous 24-bit colour output at a resolution of 1376 x 1072 pixels in addition to the TV standards.

For further information contact The Dindima Group on (03) 873 4455.

READER INFO No. 162

Colorscript printer

The QM ColorScript 100 printer, with flexible high performance colour Post Script graphics and test capabilities is being targeted towards graphics design and electronic publishing functions in corporate and professional environments.

Distributed by AWA, the printer includes an exclusive QMS designed external controller, with

RS-232, Centronics parallel and RS-422/Apple Talk interfacing and a 300 x 300 dot per inch Mitsubishi G650 colour thermal transfer print engine.

The printer can generate seven primary colours and can simulate an unlimited number of secondary colours. ☎ (02) 888-9000.

READER INFO No. 164

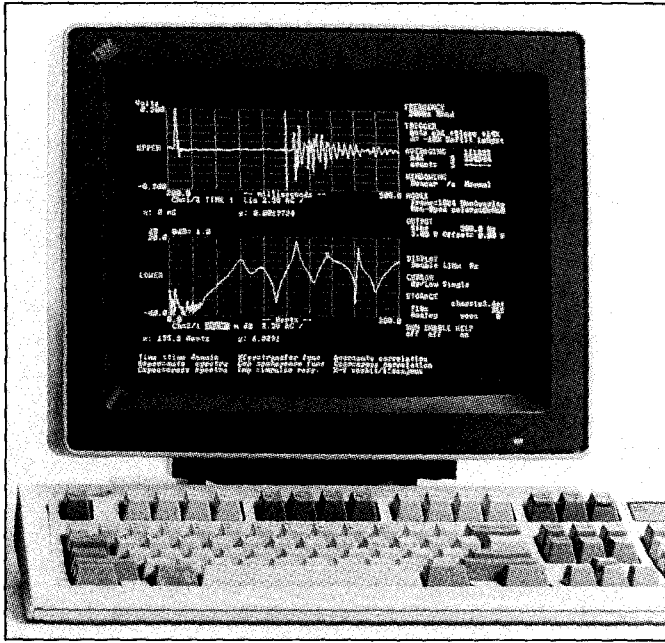

Multichannel Fourier analysis ▲

TEKTRONIX has reduced the cost of multichannel frequency-domain analysis with the 2630 Fourier Analyser. The 2630 packs complete Fourier analysis power into a surprisingly small 23-pound package. Its price, size, and capabilities make it an ideal tool for mechanical or electro-mechanical analysis in the lab, the factory, or field. Extensive application options provide even further analyser specialisation for structural analysis, control system design, and vibration and acoustics applications.

The basic two-channel 2630 Fourier Analyser provides 20 kHz bandwidth per channel, simultaneous sampling of each channel, and 75 dB of dynamic range. These same specifications apply to the four-channel option as well.

Built-in analysis capabilities include transfer function, power spectral density, coherence, impulse response, cross spectra and correlation operations. Time-critical functions are computed using special purpose hardware, allowing spectral averaging measurements to be made at a real-time rate of 10 kHz.

The 2630 is controlled from an IBM pc or compatible having an EGA card. The 2630 Fourier Analyser connects to the pc's serial port, eliminating both the cost and complexity of specialised interfaces. The

Instrument Program, included with the 2630, provides complete control of measurement and display options through simple on-screen selections. Operation is simplified further with continuously displayed context-sensitive help messages that put first-time users in control within minutes.

Screen dump capability is provided for copying text and waveform graphics to a plotter or a dot-matrix or laser printer.

Use of the 2630 in specialised applications is supported with numerous options. The input channels can be increased from two to four channels. Zoom is available for narrowband analysis to 0.006 Hz resolution, and there's an output channel option that adds built-in stimulus generation, including random and periodic functions, as well as user-defined waveforms. The TurboPac application package can be added for user programmability as well as more specific operations such as system identification, swept sine transfer function analysis, spectral maps, third octave analysis, and more. Additionally, the 2630 Fourier Analyser can be augmented by several third party software packages, such as PC-Matlab or MATRIX for control system analysis and design.

READER INFO No. 165

Link terminal for Burroughs

COMPUTERS and peripherals distributor, MPA International, has released the Link MC27 terminal for Burroughs host Poll/Select computer systems.

The new MC27 offers Burroughs T27 emulation, while offering many features and cost advantages. Compatible with Burroughs T27 and ET1100 terminals, the MC27 incorporates built-in power-off concatenation so that individual terminals can be taken off the system without the need to shut down the whole system. The MC27 includes many features including: choice of amber, green, or soft white screen text; 14-inch display; three R232 ports (modem, printer, built-in power-off concatenation); large 8 x 13 characters on an 80/132 column display; four levels of security and ergonomic design.

A choice of 80 or 132 column displays makes the MC27 ideal for complex spreadsheet applications. Display memory is eight pages in 80-column mode or six pages in 132-column mode. Pages may be separately allocated for windowing, selectable autopage, or two addresses. The 14-inch non-glare screen displays a resolution of 8 x 13 characters in a 10 x 14 cell. There are 128 ASCII characters and 32 line drawing characters in each character set.

MPA also markets a range of terminals which provide specific emulations for Data General, Honeywell, ICL and AWA computer systems.

For more information, contact Guy Goodman on (03) 894 1500.

READER INFO No. 167

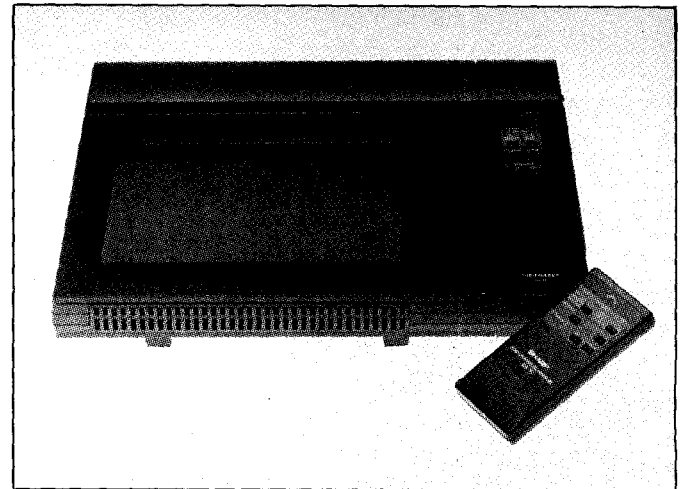

QA-50 projection panel ▲

SHARP has released a new projection panel, the QA-50. Easy to use, the panel is simply connected to a personal or business computer and placed in an overhead projector. Text, graphics and charts are all displayed onto a big screen. Presentations can be pre-programmed, or data can be updated on the spot.

Features include:

- cordless remote control,
- complete compatibility with the new IBM PS/2 and with CGA, EGA and VGA,
- double supertwist LCD screen which provides 3 times the

contrast of conventional supertwist LCDs,

- superb resolution screen with 640 dots horizontal and 480 vertical,
- 1:1 aspect ratio (giving a square image),
- eight level shading function,
- quiet cylindrical cooling fan.

The QA-50 reduces preparation time for presentations and traditional slides or overhead transparencies may never be needed again. RRP is \$2695 including tax.

For further information, contact Joe Costantino on (02) 831 9111.

READER INFO No. 168

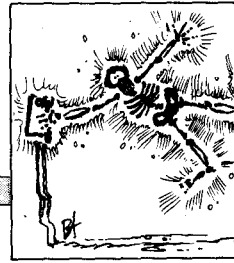

ELECTRONICS

Programs

IBM

```

10 CLS:KEY OFF:DIM P*(30):LOCATE 7,12:COLOR 0,7:PRINT"
REMEMBER CAPS
LOCK":PRINT:PRINT:COLOR 7,0
20 LOCATE 10,5:COLOR 0,7:PRINT" DO YOU WANT CD'S,VIDEO'S,CASSETTE'S,RECORD'S OR A
LL FILES":COLOR 7,0
30 AA$=INKEY$:IF AA$="" THEN 30
40 IF AA$="A" THEN AA$="ALL":GOTO 110
50 IF AA$="R" THEN AA$="RECORD":GOTO 110
60 IF AA$="V" THEN AA$="VIDEO":GOTO 110
70 IF AA$="C" THEN 80 ELSE 20
80 AA$=INKEY$:IF AA$="" THEN 80
90 IF AA$="A" THEN AA$="CASSETTE":GOTO 110
100 IF AA$="D" THEN AA$="CD" ELSE 20
110 LOCATE 25,1:PRINT"FI-F2":COLOR 0,7:PRINT"CHANGE FILE":COLOR 7,0:PRINT"F2"
:COLOR 0,7:PRINT"LIST":AA$:COLOR 7,0:PRINT"F5":COLOR 0,7:PRINT"FROM SONG":COLOR
7,0:PRINT"FF"
120 COLOR 0,7:PRINT"FROM ARTIST":COLOR 7,0:PRINT"FB":COLOR 0,7:PRINT"PRINT FIL
E":COLOR 7,0:PRINT"FI-F5":COLOR 0,7:PRINT"INSERT":COLOR 7,0:COLOR 7,0:CLS(2)
130 IF AA$="ALL" THEN 100 ELSE 280
140 OPEN "A",#1,AA$
150 P*(4)=""P*(5)=""P*(6)=""P*(7)=""P*(8)=""P*(9)=""P*(10)=""P*(11)=""P*(
12)=""P*(13)=""P*(14)=""P*(15)=""P*(16)=""P*(17)=""P*(18)=""P*(19)=""P*(
20)=""P*(21)=""P*(22)=""P*(23)=""P*(24)=""P*(25)=""P*(26)=""P*(27)=""P*(
28)=""
160 P*(29)=""P*(30)=""PRINT AA$:INPUT " TITLE ";#N$
170 IF #N$="" THEN CLOSE #1:GOTO 280
180 LINE INPUT "ARTIST ? ";#A$
190 LINE INPUT "CODE ? ";#C$
200 INPUT"HOW MANY SONG TITLES ON ALBUM";#I
210 IF #I>30 THEN PRINT "TO MANY TITLES":GOTO 200
220 FOR Q=1 TO #I
230 PRINT Q:LINE INPUT P*(Q)
240 NEXT
250 PRINT #1,#N$:PRINT #1,#A$:PRINT #1,#C$:PRINT #1,P*(1):PRINT #1,P*(2):PRINT #1,P
*(3):PRINT #1,P*(4):PRINT #1,P*(5):PRINT #1,P*(6):PRINT #1,P*(7):PRINT #1,P*(8):
PRINT #1,P*(9):PRINT #1,P*(10):PRINT #1,P*(11):PRINT #1,P*(12):PRINT #1,P*(13)
260 PRINT #1,P*(14):PRINT #1,P*(15):PRINT #1,P*(16):PRINT #1,P*(17):PRINT #1,P*(
18):PRINT #1,P*(19):PRINT #1,P*(20):PRINT #1,P*(21):PRINT #1,P*(22):PRINT #1,P*(
23):PRINT #1,P*(24)
270 PRINT #1,P*(25):PRINT #1,P*(26):PRINT #1,P*(27):PRINT #1,P*(28):PRINT #1,P*(
29):PRINT #1,P*(30):GOTO 150
280 IF #P=1 THEN LOCATE 20,31:PRINT"LINE PRINTER IS ON":LOCATE 21,28:PRINT"TO TUR
N OFF PRESS ENTER":LOCATE 22,20:PRINT"TO PRINT LAST ENTRY PRESS F9 THEN ENTER"
290 IF E=1 THEN LOCATE 23,10:COLOR 7,0:PRINT" YOU HAVE SELECTED TO SEARCH ALL FI
LES ENTER NAME ";:COLOR 7,0:INPUT ",Z$
300 IF E=0 THEN LOCATE 23,20:COLOR 0,7:PRINT " ENTER NAME OF ";AA$"; ";:COLOR 7,
0:INPUT " ",Z$
310 IF Z$="LIST RUN" THEN CLS:E=0:GOTO 20: F1 AND F2 KEY CHANGE FILE
320 IF Z$="OFF" OR Z$="END" THEN END
330 IF Z$<"KEY" THEN #N$=""
340 IF Z$="KEY" THEN #N$=Z$:Z$=X$:#P=1:CLS(2): F9 KEY LINE PRINT LAST VIEWED
350 IF Z$="" THEN #P=0:CLS(2):GOTO 280
360 IF Z$="LIST CONT" THEN 140: F1 AND F5 KEY ADD TO CURRENT FILE
370 IF Z$="TROFF" THEN #P=1:CLS(2):GOTO 280: F8 KEY TURN ON LINE PRINTER
380 CLS(2):OPEN "I",#1,AA$
390 #X=Z$
400 IF Z$="RUN" THEN Z=1:Z=1:GOTO 590: F2 KEY LIST TITLES OF CURRENT FILE
410 IF Z$="CONT" THEN Z=2: F5 KEY SEARCH FOR SONG IN CURRENT FILE
420 IF Z$="TRON" THEN Z=3: F7 KEY SEARCH FOR ARTIST IN CURRENT FILE
430 IF EOF (1) AND E=0 THEN CLOSE #1:Z=0:GOTO 280
440 IF EOF (1) AND E<>0 THEN CLOSE #1:X=0:GOTO 1010
450 GOSUB 1000
460 IF Z=2 THEN 780
470 IF Z=3 THEN 880
480 IF X=0 AND #P=1 THEN GOSUB 1130:LPRINT CHR$(27);CHR$(33);CHR$(88):X=1
490 IF X=0 THEN GOSUB 1120:X=1
500 IF #N$=Z$ THEN PRINT TAB(10);#N$,TAB(50);#C$,TAB(90);#A$:PRINT
510 IF #N$=Z$ AND #P=1 THEN LPRINT TAB(9);#N$,TAB(50);#C$,TAB(89);#A$:LPRINT;CHR$(27)
;CHR$(33);CHR$(0)
520 IF Z$=#N$ THEN PRINT #1;TAB(40);#P2$:PRINT #1;TAB(40);#P4$:PRINT #1;TAB(40);
#P6$:PRINT #1;TAB(40);#P8$:PRINT #1;TAB(40);#P10$:PRINT #1;TAB(40);#P12$:T=1
530 IF Z$=#N$ AND #P=1 THEN LPRINT #1;TAB(40);#P2$:PRINT #1;TAB(40);#P4$:LPRINT #
1;TAB(40);#P6$:LPRINT #1;TAB(40);#P8$:LPRINT #1;TAB(40);#P10$:LPRINT #1;TAB(40)
;#P12$
540 IF Z$=#N$ THEN PRINT #1;TAB(40);#P14$:PRINT #1;TAB(40);#P16$:PRINT #1;TAB
(40);#P18$:PRINT #1;TAB(40);#P20$:PRINT #1;TAB(40);#P22$:PRINT #1;TAB(40);#P24
$:T=1
550 IF Z$=#N$ AND #P=1 THEN LPRINT #1;TAB(40);#P14$:LPRINT #1;TAB(40);#P16$:LPR
INT #1;TAB(40);#P18$:LPRINT #1;TAB(40);#P20$:LPRINT #1;TAB(40);#P22$:LPRINT #1
;TAB(40);#P24$
560 IF Z$=#N$ THEN PRINT #1;TAB(40);#P26$:PRINT #1;TAB(40);#P28$:PRINT #1;TAB
(40);#P30$:T=1
570 IF Z$=#N$ AND #P=1 THEN LPRINT #1;TAB(40);#P26$:LPRINT #1;TAB(40);#P28$:LPR
INT #1;TAB(40);#P30$
580 GOTO 430
590 IF EOF (1) AND #P=1 AND E=0 THEN CLOSE #1:Z=0:GOTO 280:REM LIST TITLES
600 IF EOF (1) AND #P=1 AND E<>0 THEN CLOSE #1:D=0:GOTO 1010
610 IF #P=1 THEN GOSUB 1000
620 IF X=0 AND #P=1 THEN GOSUB 1130:LPRINT CHR$(27);CHR$(33);CHR$(0):X=1
630 IF #P=1 THEN D=D+1:WIDTH "LPT1",136:LPRINT CHR$(27);CHR$(33);CHR$(12);D;TAB
(6);#N$,TAB(56);#A$,TAB(107);CHR$(27);CHR$(33);CHR$(4);#C$;CHR$(18);WIDTH "LPT1",80
640 IF #P=1 THEN 590
650 GOSUB 1120
660 FOR A=1 TO 20
670 IF EOF (1) AND E=0 THEN CLOSE #1:Z=0:GOTO 280
680 IF EOF (1) AND E<>0 THEN CLOSE #1:D=0:GOTO 1010
690 GOSUB 1000

```

```

700 IF AA$<"VIDEO" THEN D=D+1:PRINT D;TAB(6);#N$:TAB(50);#A$
710 IF AA$="VIDEO" THEN D=D+1:PRINT D;TAB(6);#N$:TAB(50);#A$:TAB(75);LEFT$(C$,4)
720 NEXT
730 LOCATE 22,4:COLOR 0,7:PRINT"PRESS ENTER FOR NEXT PAGE,ANY KEY TO RETURN TO D
IRECTORY":COLOR 7,0
740 X$=INKEY$:IF X$="" THEN 740
750 IF X$=CHR$(13) THEN A=0:CLS(2):GOTO 590
760 IF X$<"CHR$(13) AND E<>0 THEN E=0:Z=0:D=0:CLOSE #1:GOTO 1010
770 IF X$<"CHR$(13) AND E=0 THEN Z=0:D=0:CLOSE #1:GOTO 280
780 IF S$="KEY" AND Z=2 AND X=0 THEN 800:REM FIND FROM SONG
790 IF Z=2 AND X=0 AND E<2 THEN INPUT"SONG TITLE";#N$:CLS(2)
800 IF #N$="" AND X=0 THEN GOSUB 1130:LPRINT"SONG TITLE = ";#N$:LPRINT CHR$(27);CHR$
(33);CHR$(0)
810 IF #N$="" THEN CLOSE #1:GOTO 280
820 IF X=0 THEN GOSUB 1120:PRINT TAB(2);:COLOR 0,7:PRINT"SEARCHING FOR SONG TITL
E ";#N$:TAB(50);:COLOR 7,0:PRINT:PRINT
830 X=1
840 IF #P1=#N$ OR #P2=#N$ OR #P3=#N$ OR #P4=#N$ OR #P5=#N$ OR #P6=#N$ OR #P7=#N$ OR #P8
=#N$ OR #P9=#N$ OR #P10=#N$ OR #P11=#N$ OR #P12=#N$ OR #P13=#N$ OR #P14=#N$ OR #P15=#N$
OR #P16=#N$ OR #P17=#N$ THEN PRINT #N$:TAB(40);#A$:T=1
850 IF #P18=#N$ OR #P19=#N$ OR #P20=#N$ OR #P21=#N$ OR #P22=#N$ OR #P23=#N$ OR #P24=#N$
OR #P25=#N$ OR #P26=#N$ OR #P27=#N$ OR #P28=#N$ OR #P29=#N$ OR #P30=#N$ THEN PRINT #N
$:TAB(40);#A$:T=1
860 IF #P=1 THEN 970
870 GOTO 430
880 IF S$="KEY" AND Z=3 THEN 900:REM TO FIND FROM ARTIST
890 IF Z=3 AND X=0 AND E<2 THEN INPUT"ARTIST";#N$:CLS(2)
900 IF #N$="" THEN Z=0:CLOSE #1:GOTO 280
910 IF X=0 THEN GOSUB 1120:PRINT TAB(2);:COLOR 0,7:PRINT"SEARCHING FOR ARTIST
";#N$:TAB(50);:COLOR 7,0:PRINT:PRINT
920 IF #P=1 AND X=0 THEN GOSUB 1130:LPRINT"ARTIST'S NAME = ";#N$:LPRINT CHR$(27);C
HR$(33);CHR$(0)
930 IF #N$="" THEN PRINT #N$:T=1
940 IF #N$=#N$ AND #P=1 THEN LPRINT #N$
950 X=1
960 GOTO 430
970 IF #P1=#N$ OR #P2=#N$ OR #P3=#N$ OR #P4=#N$ OR #P5=#N$ OR #P6=#N$ OR #P7=#N$ OR #P8
=#N$ OR #P9=#N$ OR #P10=#N$ OR #P11=#N$ OR #P12=#N$ OR #P13=#N$ OR #P14=#N$ OR #P15=#N$
OR #P16=#N$ OR #P17=#N$ THEN LPRINT #N$:TAB(40);#A$
980 IF #P18=#N$ OR #P19=#N$ OR #P20=#N$ OR #P21=#N$ OR #P22=#N$ OR #P23=#N$ OR #P24=#N$
OR #P25=#N$ OR #P26=#N$ OR #P27=#N$ OR #P28=#N$ OR #P29=#N$ OR #P30=#N$ THEN LPRINT #N
$:TAB(40);#A$
990 GOTO 430
1000 INPUT #1,#N$,#A$,#C$,#P1$,#P2$,#P3$,#P4$,#P5$,#P6$,#P7$,#P8$,#P9$,#P10$,#P11$,#P12$,#P13$,#P
14$,#P15$,#P16$,#P17$,#P18$,#P19$,#P20$,#P21$,#P22$,#P23$,#P24$,#P25$,#P26$,#P27$,#P28$,#P29$,#P
30$:RETURN
1010 E=E+1
1020 IF E=1 THEN AA$="CD":GOTO 280
1030 IF E=2 THEN AA$="CASSETTE"
1040 IF E=3 THEN AA$="VIDEO"
1050 IF E=4 THEN AA$="RECORD"
1060 IF E=4 THEN E=11:Z=0:X=0:T=0:GOTO 1020
1070 IF #P=1 OR #T=0 THEN 380
1080 LOCATE 22,2:COLOR 0,7:PRINT"PRESS ENTER FOR NEXT DIRECTORY AND ANY KEY TO
END SEARCH":COLOR 7,0
1090 V$=INKEY$:IF V$="" THEN 1090
1100 IF V$=CHR$(13) THEN T=0:GOTO 380
1110 E=1:Z=0:X=0:T=0:GOTO 1020
1120 PRINT TAB(2);:COLOR 0,7:PRINT TAB(20);AA$;"S";TAB(50);:COLOR 7,0:PRINT TAB
(81):RETURN
1130 LPRINT TAB(10);CHR$(27);CHR$(33);CHR$(244);AA$;"S":RETURN

```

Audio file creator

This program creates four files, one each for cd, record, cassette and video. The titles of these can then be listed either as one file or individual files. The user can search the current file or all files

for information, e.g. records that have a particular song or artist. All instructions are included in the program.

**L. Sanders,
Arncliffe,
NSW 2205.**



ADDR	CODE	LINE	LABEL	MNEM	OPERAND
		00010	ITAPE	HEADER	CRACKER
		00020	IBY	M.	MOVE 1988
		00030	ORG	3E00H	
3E00	A62F	00040	VDU	EQU	0A62FH ;VDU out & register.
D08B		00050	HLHEX	EQU	0DC8BH ;show HL in hex at (DE)
3E00	3E0C	00060	LD	A,0CH	
3E02	CD2FA6	00070	CALL	VDU	icls
3E05	219A3E	00080	LD	HL,MESG1	
3E0B	CD793E	00090	CALL	PRINT	
3E0B	3E04	00100	LD	A,4	
3E0D	32E900	00110	LD	(0E9H),A	iset for 380 Baud
3E10	CD0CAA	00120	CALL	0A0CDH	load header to 0EBH-0FFH
3E13	CD713E	00130	CALL	SETUP	
3E16	010600	00140	LD	BC,6	
3E19	1113F0	00150	LD	DE,61459	
3E1C	21F100	00160	LD	HL,0F1H	ifile name
3E1F	ED00	00170	LDIR		
3E21	3AF700	00180	LD	A,(0F7H)	ifile type
3E24	3253F0	00190	LD	(61523),A	

```

3E27 3AFE00      00      LD      A,(0FEH)      ;baud rate
3E2A B7         10      OR      A
3E2B 2         JZ20      JR      NZ,TWELVE
3E2D 21177     00230   THREE   LD      HL,THREEM
3E30 1803      00240   JR      SPDPRF
3E32 21423F    00250   TWELVE  LD      HL,TWELVM
3E35 1193F0    00260   SPDPRT  LD      DE,619B7
3E38 010900    00270   LD      BC,9
3E3B ED80      00280   LDIR
3E3D 2AF00     00290   LD      HL,(0FAH)      ;load address
3E40 11D3F0    00300   LD      DE,61651
3E41 CD8BDC    00310   CALL   HL,HL
3E43 2AF00     00320   LD      HL,(0FBH)
3E44 1113F1    00330   LD      DE,61715
3E45 CD8BDC    00340   CALL   HL,HL
3E47 3AFF00    00350   LD      A,(0FFH)
3E48 B7         00360   OR      A
3E49 2007      00370   JR      NZ,YES
3E4B 214E4F    00380   NO     LD      HL,4F4EH
3E4D 2253F1    00390   LD      HL,(61779),HL
3E4E C9         00400   RET
3E4F 214B3F    00410   YES   LD      HL,YESM
3E50 1153F1    00420   LD      DE,61779
3E51 010300    00430   LD      BC,3
3E52 ED80      00440   LDIR
3E53 2AF00     00450   LD      HL,(0FCH)
3E54 1193F1    00460   LD      DE,61943
3E55 CD8BDC    00470   CALL   HL,HL
3E56 C9         00480   RET
3E57 3E0C     00490   SETUP LD      A,0CH
3E58 CD2FA6    00500   VDU
3E59 21AD3E    00510   LD      HL,NAME
3E5A 7E         00520   PRINT LD      A,(HL)
3E5B FE40     00530   CP      '0'
3E5C 2810     00540   JR      Z,FIN
3E5D FE5C     00550   CP      '\'
3E5E 2806     00560   JR      Z,NXTLIN
3E5F CD2FA6    00570   CALL   VDU
3E60 23        00580   INC    HL

```

```

ADDR CODE LINE LABEL MNEM OPERAND

```

```

3E86 18F1      00590   JR      PRINT
3E8B CDBF3E    00600   NXTLIN CALL   CRLF
3E8C 23        00610   INC    HL
3E8D 18EB     00620   JR      PRINT
3E8E 00        00630   NOP
3E8F 3E0D     00640   CRLF  LD      A,13
3E91 CD2FA6    00650   CALL   VDU
3E94 3E0A     00660   LD      A,10
3E96 CD2FA6    00670   CALL   VDU
3E99 C9         00680   RET
3E9A 57        00690   MSG1  DEFM  'WAITING FOR HEADERS'
3E9D 4E        00700   NAME  DEFM  'NAME'
3E9E 53        00710   DEFM  'SPEED'
3E9F 46        00720   DEFM  'FILE LENGTH'
3EA0 41        00730   DEFM  'AUTO START ADDRESS'
3EA1 33        00740   THREEM DEFM  '300 BAUD'
3EA2 31        00750   TWELVM DEFM  '1200 BAUD'

```

```

3F4B 59      00760   YESM  DEFM  'YES'
0000      00770   END
00000 Total errors

```

```

CRLF 3E8F  NXTLIN 3E8B  FIN 3E8E  NAME 3EAD
YESM 3F4B  NO 3E55  YES 3E5C  TWELVM 3F42
SPDPRT 3E35  THREEM 3F39  THREE 3E2D  TWELVE 3E32
SETUP 3E71  PRINT 3E79  MSG1 3E9A  HLHEX 3E32
VDU A62F

```

Tape header cracker

For the Microbee with EDASM. This handy program deciphers information contained in the header code of all tape-based software. Although the listing was assembled at the top of the 16k memory, you can assemble it

anywhere you desire. Note that some commercial software has a dummy header with no file-name which occurs before the main one.

**M. Moye,
Drummoyne,
NSW 2047.**

C128

```

10 COLOR4,1:COLOR1,16
20 GRAPHIC1,1
30 YS=.75:YZ=199:MD=1:SP=2:XB=0:XE=319:CL=1:AD=255
100 FORI=XBTOXESTEP((XE-XB)/AD)*SP
110 D=PEEK(PS)
200 XP=XP+SP:IFXP-INT(XP)>.4THENXP=XP+1
210 PS=INT(XP):G=-D*YS+YZ:IFMD=1THEN230
220 DRAWCL,I,G:NEXTI:END
230 IFXB=1THEN250
240 DRAWCL,LX,LYTOI,G
250 LX=I:LY=G:NEXTI

```

Programmable graph routine

Here is a routine that is useful in numerous practical programs. It can draw line or dot graphs in 40

column bit map modes. The main program lines are 100 and 200 on, the rest is a demonstration

ELECTRONICS TODAY



ELECTRONICS · TECHNOLOGY
INNOVATION

Reader Information Card

On the reverse of this page you will find the Reader Information Card. This is a service ETI provides free to readers who want more information about products advertised or otherwise mentioned in the magazine. At the bottom of the article or advert you will find a RI number. Just circle that number on the card and send the card to us. We will pass on your

address to our contacts, either the advertiser or our source for the story, who will then inundate you with literature on the product of your choice. Another feature: to the right, there is a blank space. Why not use it to drop us a line, and let us know what you think of the magazine. We are particularly interested in ideas from readers on how we can improve things.

Note to the Editor:

Name:.....
Address:.....
.....
Postcode:.....

```

600 IF J=2 THEN PRINT#1, CHR$(12); J=0
605 PRINT#2; TAB(245); "*****TO FORM FRED PAPER PRESS F KEY**"
610 PRINT#TAB(4); "DO YOU WISH TO PRINT ANOTHER Y/N"
620 GET#1: IF G$="" THEN GOTO 620
630 IF G$="Y" THEN PRINT#1, CHR$(12); GOTO 620
640 IF G$="N" THEN PRINT#1; GOTO 620
650 IF G$="N" THEN PRINT#1; END
660 GOTO 620

```

READY.

SIDE 1	SIDE 2
DO YOU WANT PRINT FOR SCREEN FILE OF LIST YOUR CASSSETTE TAPE	YES NO YES NO YES NO YES NO
BROTHERS IN ARMS 1/1 NAME 1 NEW RESULTS	
NO. 1	

Audio cassette cards

This program for the C64 prints out index cards for audio cassette cases. It has been written specifically to operate with an Epson printer and a Super Graphix Jr interface. A sample printout of an index card is shown

at the bottom of the program with the printer set in the NLQ Roman mode. Instructions for use are contained in the program.

**L. Sanders,
Arncliffe,
NSW 2205.**

Circuits

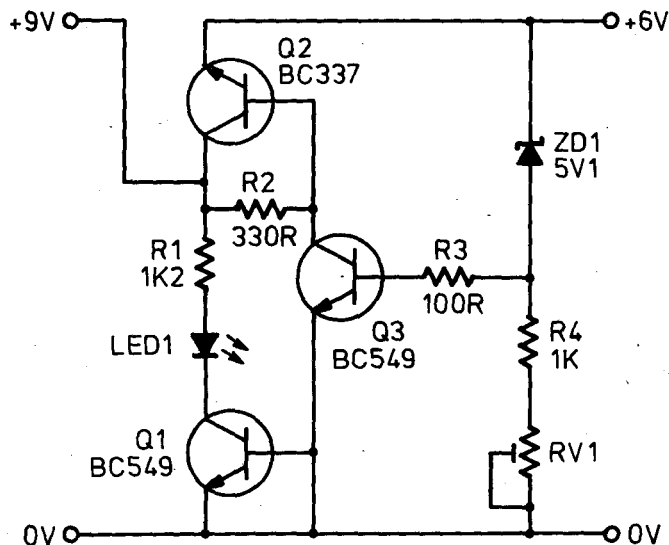

Battery regulator

This voltage regulator circuit provides a 6V output from a 9V battery input and can maintain the output with an input as low as 6.5V. Up to 180mA can be supplied.

On application of power, Q2 switches on via R2. Q3 drives Q2 to ensure the voltage across ZD1 and the base-emitter voltages of Q2 and Q3 are constant with varying supply voltages and output currents.

The output voltage can be

trimmed between 5.7V and 6.7V with RV1 as the zener voltage is dependent on the current through it.

Q1 is switched on and lights LED1 to indicate that regulated output is available. If the supply voltage drops below 6.5V then Q1 and Q3 turn off, the LED goes out and Q2 is driven hard on connecting the output to the supply with minimum power dissipated in the idle regulator.

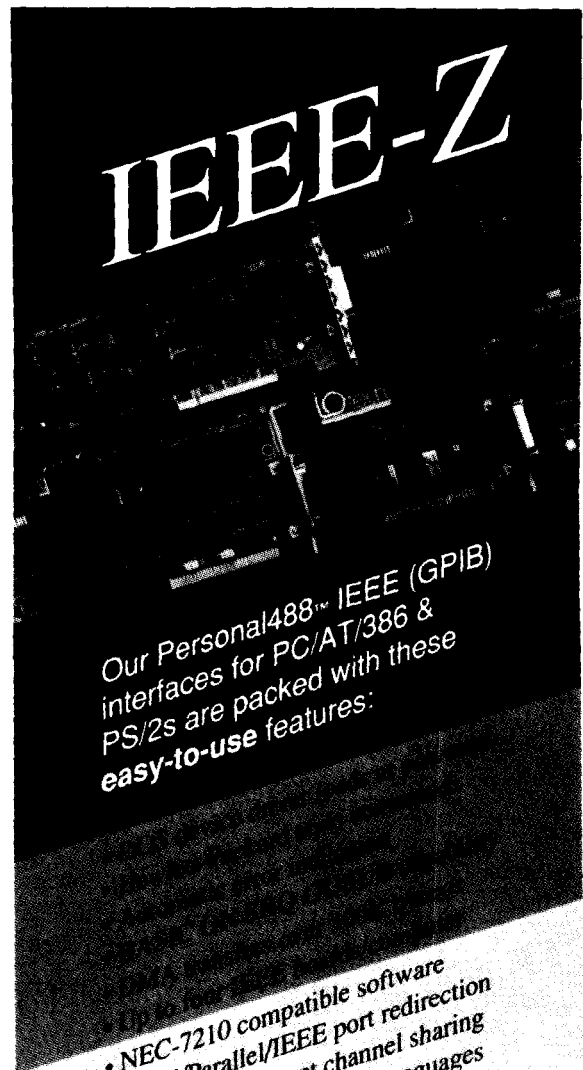

IEEE-Z

Our Personal488™ IEEE (GPiB) interfaces for PC/AT/386 & PS/2s are packed with these easy-to-use features:

- NEC-7210 compatible software
- Serial/Parallel/IEEE port redirection
- DMA and interrupt channel sharing (no extras to buy), including BASICA, GWBASIC, Quick BASIC, Compiled BASIC, Turbo BASIC, True BASIC, TBASIC, Turbo Pascal, Microsoft Pascal, Turbo C, Microsoft C, Aztec C, Lotus 1-2-3/Symphony/Measure, ASYST, DADiSP, Test Windows, AutoCAD, and many more.

LOtech



SCIENTIFIC DEVICES AUSTRALIA PTY. LTD.

Melbourne (03) 579 3622
 Fax (03) 579 0971
 Sydney (02) 958 8064
 Fax (02) 958 8890
 Adelaide (08) 281 3788
 Fax (08) 281 4194

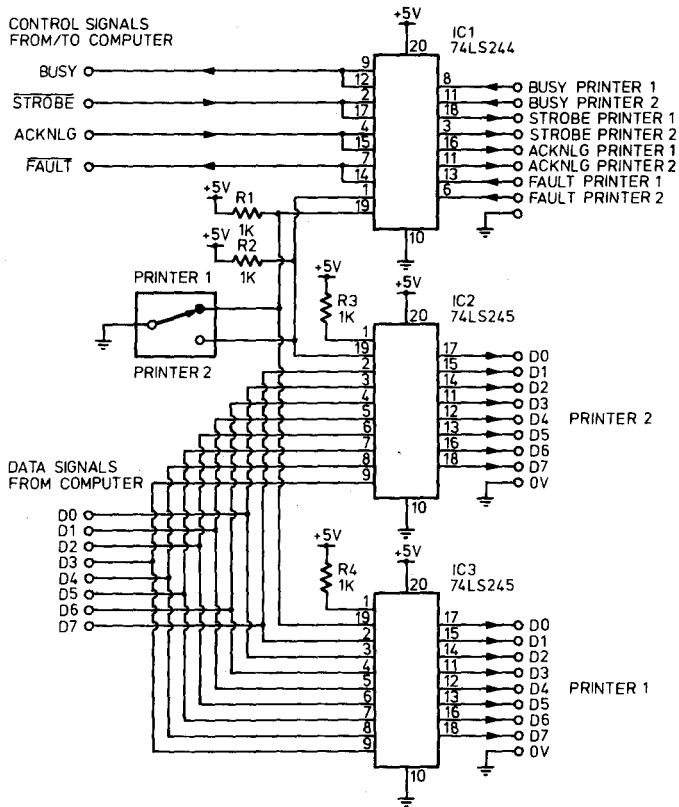

Printer switch

This design offers a convenient way of enabling two different printers or a printer and a plotter to be used with a computer which has only one parallel printer port. It uses tri-state buffers to switch the signals from the computer to the printer currently required.

Which printer is active at any one time is determined by the toggle switch connected to the 'enable' inputs of the buffers. With the switch in the position shown in the diagram Printer 1 will be active, as the buffer control pin is pulled low by the switch, activating the buffer outputs. The buffers feeding Printer 2 will conversely be open circuit due to the action of R2. The printer control lines are treated in a similar fashion to the data lines.

An added advantage of using buffers in this way is the driving capability they add to the printer port. The printer ports on most

computers tend to be unbuffered. This can lead to corruption of data when long cables are used.

The circuit will need a 5V supply in which most instances can be obtained from the computer and fed down an unused wire in the cable.

The circuit could be expanded to drive more than two printers or even reversed to allow two computers to share one printer.

Errata

ETI 1413: June 1988. One side of the resistor R21 is connected to the negative rail on the artwork. The unit will not work like this. Cut the track next to the pad for the optional connector. Also note that some readers have reported severe oscillation problems with this circuit. This is caused by excessively long tracks on the inputs to the op-amps. A small capacitor near the ic will cure this problem.

Feed Forward needs your minds. If you have ideas for circuits that you would like to enter in our idea of the month contest, programs for the computing columns or just want a word with the editor, send your thoughts to:

Feed Forward
ETI, Federal Publishing,
PO Box 227,
Waterloo, NSW 2017

Contributors can look forward to \$20 for each published idea/program which should be submitted with the declaration coupon below.

Programs MUST be in the form of a listing from a printer. You should indicate which computer the program is for. Letters should be typewritten or from a printer, preferably with lines double spaced. Circuits can be drawn roughly, because we have a draughtsman who redraws them anyway, but make sure they are clear enough for us to understand.

'Idea of the month' contest

Scope Laboratories, which manufactures and distributes soldering irons and accessory tools, is sponsoring this contest with a prize given away every month for the best item submitted for publication in the 'Ideas for Experimenters' column — one of the most consistently popular features in ETI Magazine. Each month, we will be giving away a Scope Soldering Station (model ETC60L) worth approximately \$191.

Selections will be made at the sole discretion of the editorial staff of ETI Magazine.



PRIZE WORTH \$191

RULES

The winning entry will be judged by the Editor of ETI Magazine, whose decision will be final. No correspondence can be entered into regarding the decision.

The winner will be advised by telegram. The name of the winner, together with the winning idea, will be published in the next possible issue of ETI Magazine.

Contestants must enter their names and addresses where indicated on each coupon. Photostats or clearly written copies will be accepted. You may send as many entries as your wish.

This contest is invalid in states where local laws prohibit entries. Entrants must sign the declaration on the coupon that they have read the above rules and agree to abide by their conditions.

COUPON

Cut and send to: **Scope-ETI 'Idea of the Month' Contest/ Computing Column, ETI Magazine, PO Box 227, Waterloo NSW 2017.**

"I agree to the above terms and grant *Electronics Today International* all rights to publish my idea/program in ETI Magazine or other publications produced by it. I declare that the attached idea/program is my own original material, that it has not previously been published and that its publication does not violate any other copyright."
* Breach of copyright is now a criminal offence.

Title of Idea/program

Signature Date

Name

Address

Postcode



ALL ELECTRONIC COMPONENTS

118-122 LONSDALE STREET, MELBOURNE, VIC. 3000. TEL: 662-3506

Division of DOTHAIN Pty. Ltd.
FAX (03) 663-3822

TALK ABOUT A HUGE RANGE OF KITS!

STEREO UNITS

ETI 482B Tone Control board
 ETI 480 50 watt Amplifier
 ETI 480 100 watt Amplifier
 ETI 438 Audio Level Meter
 ETI 426 Rumble Filter
 ETI 470 60 watt audio amplifier module
 ETI 4000 Series 60 watt stereo amplifier
 ETI 451 Hum Filter for Hi-Fi systems
 ETI 455 Stereo Loudspeaker Protector
 E.A. Stylus Timer
 ETI 3000 Series Amplifier 25 w/ch
 ETI 477 Mosfet power amp module inc. brackets
 ETI 457 Scratch/Rumble Filter
 ETI 458 VU Level Meter
 ETI 479 Bridging Adaptor
 ETI 494 Loudspeaker Protector
 E.A. Infrared TV Sound Control
 HE 121 Scratch & Hiss Filter
 E.A. 100W Sub Woofer Module
 E.A. Stereo Simulator
 E.A. Headphone Amp.
 AEM 6500 60W Utility Amp Module
 AEM 6500 100W Utility Amp Module
 ETI 1405 Stereo Enhancer
 ETI 442 Master Play Stereo
 E.A. Lad Bar Graph Display (Stereo)
 E.A. AM Stereo Decoder
 E.A. 1 Watt Utility Amp
 E.A. 20 Watt Utility Amp
 ETI 453 General Purpose Amp
 E.A. Bridge Adaptor
 AEM 6503 Active Cross-Over
 E.A. Filter for Add-On AM Stereo Decoder

STAGE

ETI 592 Light Show Controller (3 ch.) (1000 w ch)
 ETI 593 Colour Sequencer (for use with ETI 592)
 E.A. Twin Tremolo for Organs/Stage Amps
 ETI 499 150 w Mosfet P.A. Module
 ETI 498/499 150 w Public Address Amplifier
 E.A. Musicolor IV
 ETI 267 LED Light Chaser

PRE-AMPLIFIER AND MIXERS

ETI 445 Stereo Pre-amplifier
 ETI 449 Balance Mic Pre-amplifier
 ETI 446 Audio Limiter
 ETI 471 High Performance Stereo Pre-amplifier
 ETI 473 Moving Coil Cartridge Pre-Amp
 ETI 474 High to low Impedance Interface
 ETI 467 Input Guitar/Mic. Pre-amp suits ETI 466
 E.A. Moving Coil Pre-Amplifier (Battery)
 ETI 478 Series 5000 Pre-Amplifier
 E.A. Vocal Cancellor
 ETI 461 Balanced Pre-amplifier
 HE 112 Micromixer
 ETI 1404 4-Channel Mixer
 ETI 588 Theatrical Lighting Controller
 ETI 406 Parametric Equaliser

GUITAR UNITS

ETI 447 Audio Phaser
 ETI 452 Guitar Practice Amplifier
 ETI 466 300 watt Amp module
 ETI 454 Fuzz Sustain
 ETI 450A Bucket Brigade
 ETI 450B Mixer for above
 E.A. Guitar Pre-Amplifier
 Sonics ME 2 Wah Wah Pedal-less pedal
 E.A. Effects Unit
 ETI 1410 Bass Guitar Amp (150W)
 ETI 1424 Guitar Pre-Amplifier

AUDIO TEST UNITS

ETI 441 Audio Noise Generator
 ETI 128 Audio Millivolt Meter
 ETI 137 Audio Oscillator
 HE 105 Bench Amplifier
 E.A. Audio Test Unit
 E.A. Function Generator
 ETI 464 Audio Test Unit

TIMERS

ETI 650 STAC Timer
 ETI 540 Universal Tuner
 ETI 265 Power Down
 T6 EA 4 Digit L.C.D. Clock or Control Timer

COMMUNICATION EQUIPMENT

ETI 711 Remote Control Transmitter Switch
 ETI 711R Remote Control Receiver
 ETI 711D Remote Control Decoder
 ETI 711B Single Control

Double Control

ETI 711P Power Supply
 ETI 708 Active Antenna
 ETI 703 Antenna Matching Unit
 ETI 490 Audio Compressor
 ETI 721 Aircraft Band Converter (less XTALS)
 E.A. Masthead Pre-amplifier
 ETI 731 R.T.T.Y. Modulator
 ETI 729 UHF TV Masthead Preamp.
 ETI 735 UHF to VHF TV Converter
 HE 106 Radio Microphone
 E.A. Voice Operator Relay
 ETI 1517 Video Distribution Amp
 E.A. Video Enhancer
 E.A. VCR Sound Processor
 E.A. Motorcycle Intercom
 ETI 1405 Stereo Enhancer
 ETI 755 Computer Driven RTTY Transceiver
 E.A. Video Amplifier
 E.A. Video Effects Unit
 E.A. Telephone Hold

METAL DETECTORS

ETI 549 Induction Balance Metal Detector
 ETI 561 Metal Locator
 ETI 1500 Discriminating Metal Locator (undrilled case)
 ETI 562 Geiger Counter with ZP 1310 Tube
 E.A. Prospector Metal Locator including headphones

TEST EQUIPMENT

ETI 124 Tone Burst Generator
 ETI 120 Logic Probe
 ETI 121 Logic Pulser
 ETI 487 Real Time Audio Analyser
 ETI 483 Sound Level Meter
 ETI 489 Real Time Audio Analyser

E.A. 3 Mhz Frequency Counter

E.A. Transistor Tester incl BiPolar & F E T S
 ETI 591 Up Down Pre-settable Counter
 ETI 550 Digital dial (less case) includes ETI 591
 ETI 148 Versatile Logic Probe
 ETI 724 Microwave Oven Leak Detector

E.A. Digital Capacitance Meter

ETI 589 Digital Temp Meter
 E.A. T.V. C.R.O. Adaptor
 E.A. XTAL Locked Pattern Generator
 E.A. Decade Resistance Sub Box
 E.A. Capacitance Sub Box
 E.A. Decade Capacitance Sub Box
 E.A. Tantalum Capacitance Sub Box
 ETI 572 PH Meter

ETI 135 Panel Meter

HE 103 Transistor Tester
 HE-111 Ohm meter
 ETI 157 Crystal Marker
 ETI 161 Digital Panel Meter
 ETI 255 Analog Thermometer
 E.A. Transistor Tester
 ETI 166 Function Pulse Generator
 72 AEM 5505 Hash Harrier
 73 EA Event Counter
 74 ETI 183 OP-Amp Tester
 ETI 572 Digital pH Meter
 E.A. Megohm Meter
 E.A. Signal Tracer
 ETI 184 In-Circuit Digital I.C. Tester

MODEL TRAIN UNITS (see also "SOUND EFFECTS")

ETI 541 Model Train Control

SOUND EFFECTS

E.A. Sound Effects Generator*
 E.A. 492 Audio Sound Bender
 E.A. Electronic Sea Shell Sound Effects
 ETI 469A Percussion Synthesiser
 ETI 469B Sequencer for Synthesiser
 E.A. Effects Unit
 set as for Steam Train and Prop Plane noise

VOLTAGE/CURRENT CONTROLS

ETI 481 12 volt to \pm 40v D.C., 100 watt Inverter
 ETI 525 Drill Speed Controller
 E.A. 1976 Speed Control
 E.A. Zero-voltage switching heat controller
 ETI 1505 Fluorescent Light Inverter
 E.A. Electric Fence
 ETI 1506 Xenon Push Bike Flasher
 ETI 1509 DC-DC Inverter
 ETI 1512 Electric Fence Tester
 E.A. Fluoro Light Starter
 HE 126 Nicad Charger

ETI 578 Simple Nicad Charger

E.A. Heat Controller
 ETI 563 Fast Ni-Cad Charger
 E.A. High Voltage Insulation Tester
 E.A. Electric Fence Controller
 ETI 1532 Temp Control For Soldering Irons
 E.A. Deep Cycle Nicad Charger
 AEM 5505 Hash Harrier

WARNING SYSTEMS

ETI 583 Gas Alarm
 ETI 528 Home Burglar Alarm
 ETI 702 Radar Intruder Alarm
 ETI 313 Car Alarm
 ETI 582 House Alarm
 E.A. 1976 Car Alarm
 E.A. 10 Ghz Radar Alarm
 E.A. Light Beam Relay
 ETI 247 Soil Moisture Indicator
 ETI 570 Infrared 'Trip' Relay
 ETI 585 T&R Ultrasonic Switch
 ETI 330 Car Alarm
 ETI 1506 Xenon Bike Flasher
 ETI 340 Car Alarm
 E.A. Deluxe Car Alarm
 E.A. Ultrasonic Movement Detector
 ETI 278 Directional Door Minder
 E.A. Multisector Home Security System
 E.A. Infra-Red Light Beam Relay
 E.A. Deluxe Car Alarm
 E.A. Doorway Minder
 E.A. "Screacher" Car Alarm
 ETI 1527 4 Sector Burglar Alarm
 E.A. Driveway Sentry (MK II)
 ETI 284 VCR Theft Alarm

PHOTOGRAPHIC

ETI 514B Sound Light Flash Trigger
 ETI 532 Photo Timer
 ETI 513 Tape Slide Synchronizer
 E.A. Sync-a-Slide
 ETI 553 Tape Slide Synchronizer
 E.A. Digital Photo Timer
 ETI 594 Development Timer
 E.A. Sound Triggered Photoflash
 HE 109 Extra Flash Trigger
 E.A. Photographic Timer
 ETI 182 Lux Meter
 ETI 1521 Digital Ent Exposure Meter
 ETI 279 Exposure Meter

POWER SUPPLIES

ETI 132 Experimenters Power Supply
 ETI 581 Dual Power Supply
 ETI 131 Power Supply
 E.A. 1976 Regulated Power Supply
 E.A. C.B. Power Supply
 ETI 142 Power Supply 0-32 V 0-15 A (fully protected)
 ETI 472 Power Supply
 ETI 577 Dual 12V Supply
 E.A. Power Saver
 ETI 480 PS Power Supply for ETI 480 (100 watt Amp)
 E.A. Bench Mate Utility Amplifier Power Supply
 ETI 163 0-40 V 0-5 A
 E.A. Dual Tracking Power Supply
 ETI 162 1.3-30 Volt Fully Adjustable
 ETI 251 OP-AMP Power Supply

COMPUTER AND DIGITAL UNITS

ETI 633 Video Synch board*
 ETI 631-2 Keyboard Encoder
 ETI 637 Cuts Cassette interface
 ETI 651 Binary to Hex Number Converter
 ETI 730 Getting Going on Radio Tele Type
 ETI 760 Video RF Modulator
 E.A. Eprom Programmer
 ETI 668 Microbee Eprom Programmer
 ETI 733 RTTY Computer Decoder
 E.A. Video Amp for Computers
 ETI 675 Microbee Serial — Parallel Interface
 ETI 688 Programmer for Fusible-Link Bipolar Proms
 ETI 676 RS232 for Microbee
 all V.D.U. projects priced less connectors
 ETI 678 Rom Reader For Microbee
 ETI 659 VIC 20 Cassette Interface
 ETI 683 Mindmaster — Human Computer Link
 ETI 699 300 Band Direct-Connect Modem
 AEM 3500 Listening Post

AEM 4600 Dual Speed Modem

ETI 1601 RS 232 For Commodore
 ETI 736 Radio Fax Computer Decoder for Microbee
 AEM 3502 Signal Operated Cassette Recorder Controller
 AEM 3503 Weather Satellite Decoder
 ETI 181 "BOB" RS 232 Break-Out-Box
 E.A. Teletink Modem
 AEM 4601 Baud Rate Converter

BIO FEEDBACK

ETI 546 G.S.R. Monitor (less probes)
 ETI 544 Heart Rate Monitor
 ETI 576 Electromyogram
 AEM 5504 Electromyogram

AUTOMOTIVE UNITS

ETI 081 Tachometer
 ETI 316 Transistor Assisted Ignition
 ETI 240 High Power Emergency Flasher
 ETI 301 Vari-Wiper
 ETI 318 Digital Car Tachometer
 ETI 319A Variwiper Mk. 2 (no dynamic Braking)
 ETI 319B Variwiper Mk. 2 (for dynamic Braking)
 ETI 555 Light Activated Tacho
 ETI 320 Battery Condition Indicator
 E.A. Transistor Assisted Ignition
 ETI 324 Twin Range Tacho less case
 ETI 328 Led Oil Temp Meter less V.D.O. probe
 ETI 321 Auto Fuel Level Alarm
 ETI 332 Stethoscope
 ETI 325 Auto Probe Tests Vehicle Electricals
 ETI 333 Reversing Alarm
 E.A. Low Fuel Indicator
 ETI 326 Led Expanded Voltmeter
 ETI 329 Ammeter (expanded scale)
 ETI 327 Turn and Hazard Indicator
 ETI 159 Expanded Scale Voltmeter
 ETI 335 Wiper Controller
 E.A. Ignition Killer for Cars
 ETI 320 Low Battery Volt Indicator
 ETI 322 Over Rev Alarm
 ETI 345 Demister Timer
 ETI 287 "KITTE" Led Light Chaser
 E.A. Turbo Cool Down Timer

ELECTRONIC GAMES

ETI 043 Heads and Tails
 ETI 068 L.E.D. Dice Circuit
 E.A. Electronic Roulette Wheel
 ETI 557 Reaction Timer
 ETI 814 Dinky Die
 E.A. Selectalott
 HE 107 Electronic Dice
 E.A. Photon Torpedo
 HE 123 Alien Invaders
 E.A. Roulette Wheel
 E.A. Chase-N-Chomp (Pac Man)

MISCELLANEOUS KITS

ETI 604 Accentuated Beat Metronome
 ETI 547 Telephone Bell Extender
 ETI 044 Two Tone Doorbell
 ETI 539 Touch Switch
 E.A. Digital Metronome
 ETI 249 Combination Lock (less lock)
 E.A. Power Saver for induction motors
 E.A. Lissajous Pattern Generator
 ETI 247 Soil Moisture Alarm
 E.A. Pools Lotto Selector
 ETI 256 Humidity Meter
 ETI 257 Universal Relay Driver Board
 E.A. Simple Metronome
 ETI 1501 Neg. Ion Generator
 ETI 1516 Sure Start for Model Aeroplanes
 ETI 412 Peak Level Display
 ETI 1515 Motor Speed Controller
 ETI 1520 Wideband Amplifier
 E.A. Phone Minder
 E.A. Simple L.C.D. Clock
 E.A. Ultrasonic Rule
 AEM 1500 Simple Metronome
 AEM 5501 Negative Ion Generator
 AEM 4501 8-Channel Relay Interface
 E.A. Pest Off
 ETI 606 Electronic Tuning Fork
 ETI 184 In Circuit Digital IC Tester
 AEM 5503 Bad-Wet-Ector
 ETI 606 Tuning Fork
 ETI 287 Led Light Chaser
 ETI 569 Solar Generator

FREE KIT LIST — PLEASE SEND S.A.E.

PLUS MANY, MANY MORE KITS & PCB'S WHICH WE CANNOT LIST HERE!!!
JUST CONTACT US FOR PRICE & AVAILABILITY.

PLUS — A HUGE RANGE OF KITS AND COMPONENTS
COMPANY & SCHOOL ACCOUNTS AVAILABLE

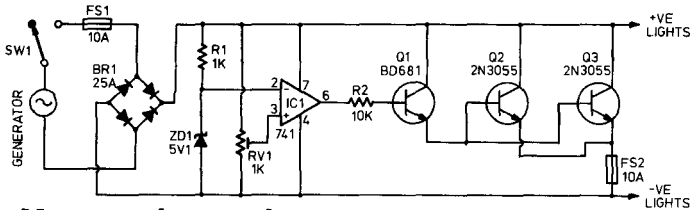

Motorcycle regulator

This circuit was devised to provide regulation for the lighting circuit added to an off-road motorcycle without lights.

The principle is straightforward. Any extra energy from the bike's generator is dumped. The 741 acts as a comparator. The output is low when the supply voltage is less than the desired value. When the supply voltage is greater than the desired output, the output of

the 741 goes high and the transistors are switched on, taking current from the generator and reducing the output voltage.

The switch on voltage is set by RV1. A bridge rectifier was chosen to provide greater power at low revs (tickover).

The transistors are mounted on a large heatsink and the whole circuit coated with a paint to keep out water.

Letters

Le Croy 9450

I enjoyed reading your article on the Le Croy 9450 (ETI, January 1989) and am particularly impressed by the overall flavour it provides. It clearly gets across the message that customers should make sure they understand the fundamental principles of a sophisticated instrument before they buy one, otherwise they are likely to purchase something which does not quite meet with expectations.

However, there were some criticisms. In reference to bandwidth you say it is "... not a particularly important criterion..." by which to categorise a DSO. Please do not undersell bandwidth as an important specification for digital scopes. It is very important, but users must understand how and when it is limited.

Most oscilloscopes do not have an algorithm like the 9450s to ensure the important information is presented to the screen. I would delete the third sentence and join para 7 and 8.

It is a little misleading (although true for our competition) to say that a practical viewing frequency might be as low as 100 kHz. At any time base setting the 9450 can still display signals up to 200MHz. How you may ask? We can expand our wave-

forms up to 1000 times (because of our long memory) to see the upper frequency components. Short record length oscilloscopes don't have this capability.

**Greg Tate,
Le Croy Corporation,
Geneva, Switzerland**

Improved presentation

Good to see the improvement in your presentation of the magazine. May I suggest that you balance up the types and levels of projects in your magazine. I was a subscriber once, but found the project consistency a bit up and down.

**Mark Coleman,
Sherwood,
QLD 4075.**

Change for the better

I like the new style of magazine, it's a change for the better. The articles and the electronics section make the magazine great. More programs should be included and the back page could or should be used for advertising user groups. Keep up the good work.

**Tim Skelton,
Caringbah,
NSW 2229.**

Errata for the Midi connection ETI-616 published in January 1989

The reference to D17 and D18 in the "How it works" section of the Mac interface should read D7 and D8. In the circuit diagram of the Mac interface the 6N138 optocoupler should read IC3 and not IC5.

Parts List for Amiga interface ETI-616b

Resistors
All resistors are 1/4 W, 5%

R1.....	10k
R2, 3, 8, 11.....	220R
R6, 7.....	50k
R12.....	22k

Capacitors

C1, 2.....	220n greencap
------------	---------------

Semiconductors

IC1.....	TLO72
IC2.....	LM78LO5
IC3.....	6N138
D1, D2.....	IN4001

Parts List for Amiga interface ETI-616a

Resistors

R1, 2, 3, 14, 15, 16, 21, 22, 24.....	220R
R4, 9, 11.....	27k
R5, 7, 10.....	47R
R6, 8, 12.....	470R
R13, 19, 20, 23.....	10k
R17, 18.....	680R

Capacitors

C1, 2.....	220u/25 V electro
C3, 4.....	10u/10 V electro
C5.....	10u/16 V electro
C6.....	2n greencap
C7.....	10n greencap
C8, 9, 10, 11.....	470p ceramic

Semiconductors

D1, 9, 10.....	IN4001
D2, 3, 5, 6, 7, 8.....	1N914
LED1, 2, 3, 4.....	3 mm or 5 mm led
Q1, 2, 3.....	BC559
Q4, 5.....	BC549
IC1.....	74LSO4
IC2.....	4049B
IC3, 4.....	6N138
IC5.....	LM78O5
IC6.....	LM79O5

Miscellaneous

X1.....	1MHz xtal
T1.....	12 Vac mains transformer rated at 300 mA

What's the greatest threat facing the computer today?

Australian and American experts agree on what it is, although their estimates of how much it costs you in downtime varies. Americans believe it accounts for more than 30% of all computer failures. Yet some Australians say their practical experience leads them to believe 70% would be a far more accurate figure.

Surprisingly enough, the greatest threat to your computer is the very power it runs on.

The way to control the power to your computer and avoid these costly breakdowns is with Clean Line Systems. Their power conditioners, uninterruptible power supplies and other products and services can eliminate all disruptive power line disturbances. They provide stable, clean electrical energy. They can combat the damaging effects of lightning and even have inbuilt safety systems to ensure the power to your computer is never cut off unexpectedly.

Clean Line Systems is a wholly Australian-owned company that designs and manufactures its own equipment. They are the people more computer companies choose to protect their corporate computers.

All Clean Line Systems equipment conform with the most stringent specifications here in Australia, America and Europe. It is so advanced that it is half the physical size and weight of most comparable competitive systems. And it outperforms them too!

Clean Line Systems equipment is not noisy, it runs cool and does not emit any damaging magnetic fields. Best of all, it can grow with your computer needs. Plus, if you ever need it, full service back-up is available 24 hours a day, seven days a week.

Clean Line Systems can eliminate the greatest threat to your computer today. You can purchase, lease or rent immediately.

Call us on the number below, or else take your chances with the power threat.



The ultimate power support systems.

Head Office: 33 Maddox Street,
Alexandria, N.S.W. 2015
Sydney: (02) 698-2277
Melbourne: (03) 565-1634
Brisbane: (07) 394-8272



BUFFOONERY

UNIDENTIFIED, UNWANTED

Trying to report a UFO

ACCUSTOMED though we are to dealing with matters practical rather than hypothetical, the Dregs Hack insists that he saw an unidentified flying object last weekend while sitting, relatively sober, in the comfort of his own back garden sharing a stubby or two with some equally almost sober friends.

Before you jump too hastily to conclusions, one of his companions saw it too. They leaped up as one, gesticulating towards the garden wall with cries of "Didyouseethat?" and "Whatthehell...?" before conducting an animated discussion which established that, yes, they had both seen a very bright, circular light, with a halo around it and trailing a silver, tapering sparkly tail as it moved very fast south to north.

Unfortunately the high garden wall caused it to vanish pretty quickly, else others might have been able to bear witness, but the earliness of the hour (it was about 8.00) and the as yet small encroachment into the case of beer were enough to spur the Dregs Hack into making some report to the supposed "interested" authorities.

So, who to contact with this great news? The telephone directory bore no fruit. The only entry under UFO is for a mobile video disco in Milperra so the information section of Telecom was the first try. Well, the Telecom

The only entry under UFO was a mobile video disco in Milperra'

lady was not impressed by the enthusiastic request for help but the weather bureau man was obviously glad of a break from calls from people complaining about the amazing inaccuracy of local forecasts and gave not only the cloud cover altitude (strange how quickly the aviation terminology springs to mind) but, helpfully, a UFO reporting number.

When tried, however, the number proved

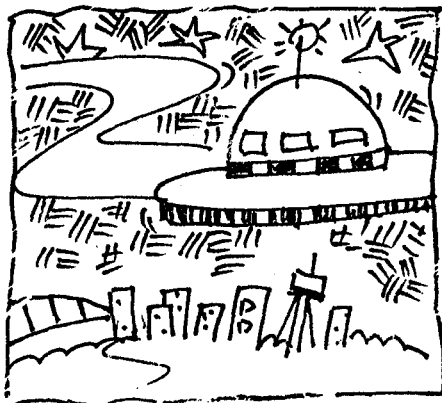

not to exist. The weatherman was having his revenge.

As a last try in the face of such indifference, Telecom services was given another chance. This time the right contact was made and a sympathetic operator recommended calling the RAAF at Glenbrook, in the Blue Mountains. They were bound to be interested, after all.

And so it proved. While the group in the garden became noisier and the pile of empties grew, the atmosphere around the telephone got more serious. Perhaps it was the effect of talking to a real live Member of the Defence Forces. Anyway, the Flight Lieutenant in the duty operations office (DOPSO) was all ears. He listened to the story, establishing a picture of the events, time, speed, direction, etc. Somewhat surprisingly he also wanted to know details of the observers' ages and occupations but was quick to say that he didn't consider them to be strange in any way. Not that strange.

Next the report was made official - a form had to be filled in. This would be submitted to the Fit Lieut's commanding officer the next morning. After more rehearsing of what was seen, the call concluded with the information that the RAAF's Intelligence section would investigate the sighting.

Satisfied, the witnesses rejoined the party,

now deep into loud speculation about the planet from which this spaceship had obviously come, looking for examples of humankind to carry off for investigation. What if a new baby should be taken, or Kylie Mole? No alien would want to invade, surely!

Imagine the Dregs Hack's dismay, then, when the following morning the friendly Fit Lieut called back to say that the RAAF's intelligence people would not, in fact, be taking the matter further and that he recommended contact with one of three civilian UFO research organisations. This was a cruel blow. A potential invasion to be dealt with by civilians? - it just didn't seem right.

The next day a copy of the nice Fit Lieut's form arrived, titled Report of Unusual Aerial Sightings, Annex A to HQOC ASI 3/A/5 A/L 42. All six pages of it. Under "additional comments" it was remarked that "the observers seemed cool, calm and collected"! He should see them when they get really excited.

That evening the Hack contacted the Australian Centre for UFO Studies at its base camp in Prospect, SA. The person there was interested in the story and requested further

'If no-one happens to be looking at the time, tough luck'

information - yes folks, another form to fill in. When asked for his opinion on why the RAAF were not going to investigate such an unusual aerial sighting he declared that "There's nothing in it for them unless something strange has been seen on radar or otherwise confirmed by their own people." So, if no-one happens to be looking at the time, tough luck. When asked how his organisation would go about checking out the sighting, he said that they would contact relevant authorities, such as local police and, surprise, surprise, the RAAF! Ah well, they did try.

It seemed, in addition, that the Dregs Hack and friend were the only two to report this free pyrotechnic that evening. Perhaps the other sighters were put off at the beginning by the unhelpful lady at Telecom or the vengeful weatherman. We'll never know.

S *opend
nights*

TRANSBEAM VCR MIXER



MARY RENNIE

THE PRICE OF PROTECTION

A high price to pay

Assiduous readers of international hi-fi magazines might have noted the remarkable difference between a product advertised in the USA and its price when it arrives in the store in Australia.

TO take an actual example, consider an amplifier which Sydney company Audio Engineers is proposing to import from America. This amplifier (which shall remain nameless) can be purchased by the Australian distributor for \$A560 at the factory gates in the USA. Transport to Australia, insurance and customs agent's fee comes to \$76. There is a 19% duty on all imported amplifiers (except those from New Zealand). Add \$106.50 and Audio Engineers' landed cost is then \$742.40.

If this product was intended for a retailer in, say, Adelaide, Audio Engineers would offer the product for \$1707.52, a mark up of 130%. This includes, apart from a contribution to overheads, promotion of the product, the freight cost and warranty, margins built in for a discount for cash, a quantity discount and a distributor discount. The retailer can then offer this product to the public for \$2885 which will include 30% sales tax and his margin of 30%.

Okay, so that's how a \$560 product comes to cost \$2885. Interestingly, when the same calculations are made without import duty or sales tax the product could be offered to the public for \$1901. If the duty alone was removed then the product could be offered for \$2472.

This month's SI cover features Perreaux's new SA 33 preamplifier and Pmf 2350 power amplifier, reviewed in ETI, February 1989.

Import duty

The import duty is imposed to protect local commercial manufacturers from competition (and to raise substantial revenue for the Government). In the case of amplifiers we have some manufacturers to protect, but what happens in a product area with no Australian manufacturer? Easy, there is no duty. But it will only take an Australian company to persuade the Industries Assistance Commission that they are making and selling a product and all hell will break loose.

Every company presently importing this product will probably be faced with a duty on it and have every cause to hate this Australian manufacturer; an interested public probably should as well. After all, they will presumably be asked to pay up to 25% more than they did before the entry of the said Aussie manufacturer.

An actual example of this occurred in the early 1970s, when duties were higher than they are now, and much higher than they will be in the future. There were no digital multimeters made in Australia (nor are there any today) and hence they incurred no import duties. When a Telecom employee sent a letter to the customs department claiming to be a manufacturer,

duty had to be paid on all DMMS coming into Australia.

Not surprisingly, the importers were furious and formed the Electronic Instrument Importers Association to fight this upstart. They held meetings, wrote letters, cajoled and lobbied until, after four or five months, they were able to establish that the person in question was not a commercial DMMS. The duty was dropped and peace returned.

On the more familiar ground of hi-fi one would assume that the same prospect faces any potential Australian CD player manufacturer. Curiously, however, a duty of 19% already

'So that's how a \$560 product comes to cost \$2885. If the duty alone was removed then the product could be offered for \$2472'

applies on the importation of CD players despite the fact that there is no Aussie manufacturer. So if you're planning to be Australia's first CD player manufacturer, you're already protected and won't incur the wrath and legal muscle of the established importers!

Perreaux trail

RECENT rumours that Perreaux New Zealand has gone into receivership have been denied by Isbee Industries spokesman David Bengé.

Bengé admitted Perreaux did hit some difficulties three years

ago when an American distributor went out of business. The situation was saved with the assistance of an Auckland-based finance bank which, in turn, went down with the 1987 stock market crash that hit New Zealand markets so savagely. As a result, Perreaux was sold off to New Zealand-based Isbee Industries, headed by Alec Isbee.

The change in ownership has meant some changes for the marketing of Perreaux products in Australia, with the aim of giving Perreaux a more upmarket, exclusive reputation. Isbee Industries has taken over the Australian distributing in place of Eurovox, and the product has been withdrawn from all the then current dealers. Bengé explained that while Eurovox was doing a good job with the professional products, the consumer products were suffering from too many dealers. "With a multiplicity of dealers, there are inevitably price wars and the better dealers don't want to touch the product." Bengé thinks this has given Perreaux a bad name and is now looking to limit the dealership to five or fewer dealers in the major cities, with others around the country.

In support of his claim about Perreaux's consolidation, Bengé has announced that Perreaux will release a new 100 W power amp and 100 W preamp early this year.

Records not dead

CBS in Australia will not be ending its sales of records, despite a recent report in *The Australian* announcing that CBS/Sony will sell only compact discs from April.

According to that report, the decision was taken because records accounted for only 10% of the Japanese maker's sales, making them unviable. However,

spokesman for CBS in Australia, Mike Edwards, has said that is definitely not the case in Australia and he knew nothing of such a change in Japan. "CBS Australia will continue to press vinyl as before, in fact, the company has increased its investment in vinyl and is doing more business than ever before."

Edwards said that CDs accounted for about 20% of CBS's product sales in Australia and vinyl about 25%-26%, "although the gap is closing". Cassettes are the big sellers accounting for more than 50% of CBS's recorded material sales.

Videos protected

While controversy has raged around the Copycode System introduced by CBS to prevent recording on Digital Audio Tape (DAT) players, a technique for protecting video cassettes from being copied which was developed in the US some years ago, is now making an impact in Europe and Australia.

The technique, called Macrovision, consists of encoding a signal onto the cassette along with the original video signal that will permit the replay of a first generation tape but make any copies unwatchable.

Macrovision works by interfering with the VCR's Automatic Gain Control (AGC) while being invisible to the television's AGC. The technique is to insert a super-white sync pulse into the vertical blanking, signalling to the VCR that the video signal is large and the AGC adjusts accordingly.

The idea is that, with Macrovision, a VCR records from a treated tape at a level too low for viewing.

The technique adds five pseudo-sync pulses to each of 10 lines of the field blanking interval which avoids the problem of a TV set possibly adjusting its black reference too far.

The success rate of the technique a couple of years ago was only 30%-40%, but according to recent reports on Macrovision, this has improved beyond 75%.

Unfortunately, like most things electronic, the technique can be overcome. A recent report which emanated originally from JVC, has stated that when the technique was first used in the US some VCR manufacturers modified their AGC circuitry to disable Macrovision. Since then an agreement has been reached between manufacturers to use the standard AGC circuitry that is "Macrovision-enabling", which makes the technique more appealing to legitimate duplicators.

According to Gerry Brooks, production manager for duplicating company RGC Magnetics, which caters for about 50% of Sydney's needs, the technique is up for consideration, but its cost-effectiveness has to be looked at. In order to make use of the technique, RGC Magnetics would have to modify its duplicating machines and parts of the overall video signal, and the fact that the system can be easily overcome with a few amplifiers is not persuasive.

Neither would the system necessarily benefit consumers. Brook's view is that with such little profit margin available for video duplicators, distributors, etc, any profit derived from beating piracy would be picked up by the industry rather than passed on to the consumer. **ETI**



Macrovision, a USA-developed technique for protecting video cassettes from being copied, is making an impact here in Australia and in Europe.

ETI MARCH '89
99



Surround is a term which crops up more and more often in circles concerned with qualified sound reproduction. It refers to a number of speakers working together to create an acoustic "room" around the listener. You can recreate the space of a large concert hall of church, the enclosed, intimate atmosphere of a small jazz club, or the spirit and closeness of a rock festival. If you have seen a recent, technically advanced film (e.g. one of Steven Spielberg's) you have probably experienced surround stereo.

The difference between ordinary stereo and surround stereo is enormous. Much greater than that between mono and stereo.

A number of hi-fi manufacturers already have surround decoders, either as separate units or built into amplifiers or receivers.

When you connect your MDS System 2000 (or System 1000 with additional lateral speakers) to one of these your record collection steps into the future.

System 1000 consists of three parts — two small, easily positioned speakers for mid-range and treble with optional (and interchangeable) attachments, and a woofer having four bass units and a built-in filter.

System 1000 is the complete hi-fi combination for those who have very high demands regarding sound quality. And it doesn't dominate the room, but blends easily into its surroundings.

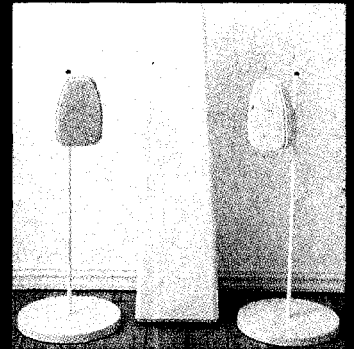

System 2000 consists of five parts — four small, easily positioned speakers for mid-range and treble with optional (and interchangeable) attachments, and a woofer having six bass units and a built-in filter with level control.

System 2000 opens up new possibilities. The four lateral speakers, when correctly positioned, give you the feeling that you are right at the centre of where the music is created. You are completely surrounded by music. Better sound dispersion through the room, more power and dynamics. 14 speaker units, perfectly controlled by a precision filter, provide you with awesome power and realism.

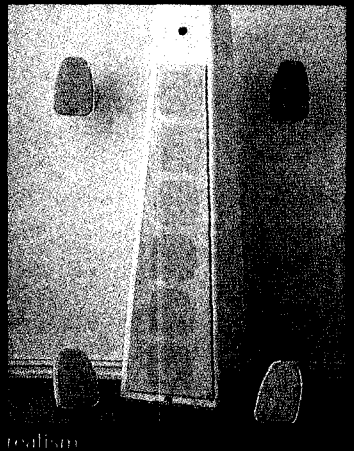

P.O. Box 199, Turrumurra, N.S.W. 2074
Telephone: (02) 44 2155

READER INFO No. 1

PERREAUX

BY
PERREAUX

UNIT 10, 21-29 CHESTER STREET, CAMPERDOWN, SYDNEY, NSW. TELEPHONE: (02) 519 3977

READER INFO No. 25



Four channel telephone voice recorder ▼

ELECTRODATA has introduced its budget model telephone voice logging recorder, the ECAT-4, which can record four conversations simultaneously. It can record continuously for 12 hours, longer when using the VOX or remote activation. This is made possible by running an ordinary C-120 cassette tape at 0.8cm/sec. The unit has been designed and manufactured in Australia and allows the automatic recording and retrieval of telephone conversations to be a one touch operation.

Incidentally, ever wondered what those pips are that you hear on talk-back radio? There is an international convention that obliges recorders of conver-

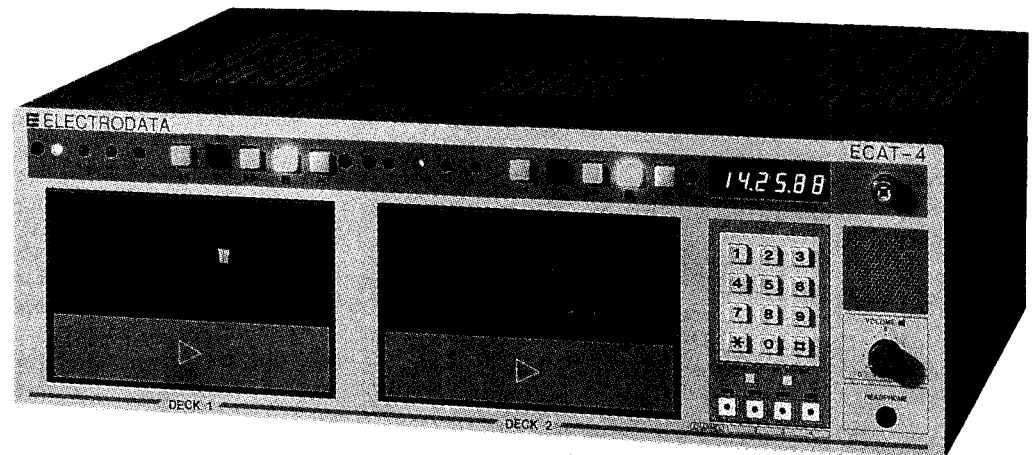

sations to tell the recorder by making that "bip" sound every 11 seconds. Taping of telephone

conversations otherwise is illegal in Australia. For further information contact Electrodata

on (02) 570 6166.

READER INFO No. 150

Video walkman ▼



IT'S finally here ... the video walkman! A complete TV/video system the size of a pocket notebook (129 x 67 x 213 mm) and powered by 6 volt batteries.

The technological key to the release of such a unit lies with both the video 8 (8 mm) tape format Sony has adopted and

with the development of high definition lcd TV screens. The breakthrough in lcds has spawned a new range of portable miniature televisions and even the prototype of a 14-inch model in Japan.

The video walkman uses a 3-inch lcd screen with a

resolution of 92,160 pixels which, Sony claims, gives a sharp picture even in clear, bright sunlight (which we are looking forward to test).

However, it is the addition of the video recording/playback facility that makes the video walkman truly remarkable. The small size of the video 8 cassettes is an obvious advantage in developing a device like this and with this format you get 5.4 MHz picture quality, AFM sound and up to 3 hours recording/playback.

Other technological feats include the use of a computer servo IC, a single video IC and high-density surface mount techniques, along with a very compact mechanical deck with a smooth and quick-loading system.

The video walkman does forego a few of the zappiest features, for example you can't

freeze frame or enhance your screen, but it certainly hasn't gone the no-frills way. Features include a 4-way ac/dc power option (battery pack, ac adapter, car battery use or dry cells), a programmable timer, sleep timer, linear tape counter, picture search and autoplay. Timer, play function and low battery warning are displayed on the screen. Total weight of the unit with batteries is 1.1 kg, which comes supplied with battery pack, adapter, headphones, cable, antenna signal separator and carry cases for \$2499 RRP.

In the ongoing battle Sony has had with VHS the GV-8 will be a new weapon. When equivalent VHS-C (for compact) players are released it is expected that their playing time will be only 60 minutes, which will deny them the market for those who wish to watch films on these portable players.

READER INFO No. 151



Bang & Olufsen Beosystem ▲

THE new Beosystem 4500 from Bang and Olufsen is a combination AM mono/FM stereo receiver, cassette recorder, turntable and compact disc player which is operated by the Beolink 1000 remote control terminal. An important difference between previous B & O Beolink systems and the new Beosystem 4500 is that, given the appropriate purchase of hardware, one can have a different sound source operating at a different volume in a different room, overcoming the previous restriction of the same sound source playing at the same volume in different locations.

The Beomaster 4500 receiver is the brain behind all functions with its interpreting of all signals received by the infrared remote

control and despatching of them to the appropriate device in the chosen room. Extra devices such as television, video recorder, satellite receiver can also be readily linked. There is provision on the remote control unit to control lighting but implementation is waiting for Australian electricity authority approval.

There is something of a Mexican standoff between B & O and Australian audio magazines over reviews of its equipment. B & O insists on its products being judged as a whole ("A car reviewer wouldn't simply review an engine"). Reviewers charge by the unit. Readers have a short attention span. So it seems interested parties will have to decide for themselves the sonic ability of this stylish new system.

READER INFO No. 153

Programmable equalisers

ELECTRO-Voice has released a family of programmable filter sets which introduce computer control and memory into sound mixing. The Altec Lansing models 8551A and 8558A are equalising filter sets with low noise and up to 12 dB of boost or 12 dB of cut in each of 28 standard one-third octave bands. They are claimed to be "tamperproof and invincible". The 1A provides one preprogrammed equalisation curve while the 8A can be preprogrammed with up to eight curves.

The programmer is a hand-held unit which draws power from the filter set itself. Cursor keys allow the user to select the filter band he or she desires to adjust and to set the band to any position over the 24 dB adjustment range in precisely resetttable 1 dB increments. An led display shows

the frequency band that has been selected and the adjustment being made is shown on another led display.

These new filter sets may also be adjusted using the 8016A computer control adaptor and Acoustagraphic software. The adaptor fits into a slot of an IBM-PC or XT. The monitor will graphically display the EQ settings, enable them to be stored on a floppy and/or print them out.

The 8051A autoprogrammer is the most sophisticated of the new devices. So sophisticated in fact that this Sound Insights hack invites you to ask Electro-Voice to give its explanation justice. For further information: Electro-Voice, Unit 24, Block C, Slough Business Park, Slough Ave, Silverwater, NSW 2141; phone (02) 648 3455.

READER INFO No. 152

New speaker range ▼



AUSTRALIAN manufacturer Aaron Loudspeakers has released the CS and DS series speakers. Designer Hume L'Estrange has used dome tweeters on all seven new speakers. In the case of the DS series they are 25 mm and made from Tetron, a new material. The CS series uses 13mm two-stage diaphragm tweeters.

Woofers and midranges are all made from paper pulp which L'Estrange states still gives the best weight, strength and damping ratio known to humankind. Enquiries: Aaron Loudspeakers 67 Alexander Avenue, Taren Point, NSW 2229.

READER INFO No. 154



ANTHONY O'GRADY

CD Reviews

PINK FLOYD LIVE: DELICATE SOUND OF THUNDER

(CBS)
Cat. No. 463161-2

EVEN those who did not see Floyd on stage in Australia in early 1988 have probably heard of the robot lasers, the huge light wheels, the audiovisual interludes and the world's largest mirror ball (which opens to become the world's largest metallic flower, emblazoned with high intensity white lights).

So what was the music like? As this double CD testifies, it was flawless. Granted, there are times when the band marks time behind prerecorded tapes (as in Another Brick In The Wall Part 2, Money and Learning To Fly). But when they flex their playing muscles live Floyd are a feast, with guitarist David Gilmour very much the maitre de.

His vocals have a raw bluesy edge and his guitar playing is about the same, except when mixed through a computer maze of techno effects to sound like the echo of a loony tune from the Twilight Zone. In musical terms, Gilmour emerges as the star of the show, validating Floyd's reputation as one of the legendary live bands of rock.

(Two other original Floyd members, drummer Nick Mason and keyboard player Rick Wright were also on tour, but their contributions are more than slightly obscured by session players Garry Wallis and Jon Carin.)

Those familiar with the intricacies of Floydian history might be surprised by this, for though Gilmour has been Floyd's

lead vocalist, guitarist and contributing songwriter for over 20 years, Floyd's brains and soul have always been thought to belong to bass player Roger Waters. Waters wrote the vast bulk of Floyd songs, supervised recording sessions and decided when and where the band would tour - which, since the late 1970s, was generally nowhere, ever.

Waters departed several years ago, in a flurry of litigation and caterwauling. (His evaluation of Floyd's stage show was: "The flying pig is mine, the burning bed is mine, the best songs are mine, the dry ice is all theirs".)

Yet, while Waters' visual/music stage spectacular based on his solo LP Radio KAOS was a box office flop, Floyd (as reassembled by Gilmour) was the world's top grossing rock tour in 1988.

Clearly it's better to be behind the wall of a legendary name of rock than to risk your own person, ego and talents on the front line. It's also testament to the fact that people want to hear hit songs sung by the original singer.

There are just enough hit songs on *Delicate Sound of Thunder* to satisfy this desire. There is also a mammoth second serving of Floyd's most recent and Waters-less album, *A Momentary Lapse Of Reason* (six of the 15 songs on *Delicate Thunder* are from *Momentary Lapse*).

The newer material retains the spacey, idiosyncratic bluesy feel that was Floyd's trademark, basically because Gilmour is still ringing the changes on guitar and vocals. But it does lack the fraught intelligence of Waters' lyrical vision.

Still, when Gilmour launches into the classic tunes (*Time*, *Money* and *Us And Them*) from Waters' 1974 saga of paranoia, *Dark Side Of The Moon*, or delivers the big hits from Waters' tortured allegorical treatise of 1979, *The Wall*, he is, as he was then, the voice of Floyd.

Without Waters, Pink Floyd may be living on borrowed time. But there's no denying that *Delicate Sound Of Thunder* sounds the genuine article.

ANITA BAKER GIVING YOU THE BEST THAT I GOT

(Elektra)
Cat. No. 960827-2

SOME of the most popular women singers are accomplished actresses who can sing. Anita Baker, on the other hand, is a polished singer who generally turns a song into a three-act play.

"A song's got to have drama," she says, "whether it's a quiet, understated melodrama, or it's a slap-you-in-the-face drama. A song's gotta have moments."

Giving You The Best is a timely follow-up to her 1986 album *Rapture*, timely because, somehow, it took some 18 months before Australian record buyers discovered the sultry charms of this singer who, even when she's hitting her most sustained notes, sounds as if she has enough reserve lung power to

simultaneously sip an exotic cocktail.

American critic Nelson George described her as "retro nuevo" ("an artful blend of graceful contemporary production with a traditional black music sensibility"). That slick phrase is true enough because Baker shares the traditional background of black singers: gospel as a child, club gigs as a teenager, solo success after meeting up with a production/writing team who could focus and showcase her vocal abilities.

Where she differs is that, instead of phoning in her vocals once the music is down (like most solo vocalists), she's involved in every aspect of the production.

The difference comes through in the final mix where Baker always sounds an essential part of the song, not just a heavenly voice on the horizon.

Whether she's reaching for the sky on a stellar pop ballad such as *Lead Me Into Love*, or loping comfortably through the samba beat of *Good Enough*, or getting moody about love on *Rules*, Anita Baker leaves an indelible impression.



Les Cardilini looks at
a new VCR mixer
from a small
Melbourne company.

Having at least a second TV set in the home has its advantages, especially if the family's preferences differ when popular programs are scheduled for the same time slot on different TV channels.

With several TV points, each set can be tuned-in independently to any of the available TV channels without affecting other sets in the system, and the TV room most appropriate for the occasion and the time of day can be used to accommodate respective family members and their guests.

The same convenience does not always extend to videomovies played on the system VCR. Depending on how the antenna is connected in a multi-point system a VCR

can be installed to playback on just one TV set or it can be set up in such a way as to serve them all.

A problem experienced with VCRs is that the reception on the regular TV channels is normally interrupted when videotapes are playing. In a system having only one TV set this is not a problem - you cannot (and probably would not wish to) watch off-air and videotaped programs simultaneously. It can, however, be decidedly inconvenient where there are two or more sets working from the same antenna. It's impossible for someone to watch a videomovie when someone else wants to watch a program off-air.

In a multi-point TV system which includes a VCR there are two main options determined by the location of the splitter in the antenna system. Ordinarily, the splitter box is used to divide the TV antenna signal between the various antenna points around the house, which is fine if you are only interested in TV programs. The location of the splitter box schematically in the system, however, will also determine which TV set or sets can or cannot view video programs, and whether regular channel viewing on any or all of the sets in the system is likely to be affected by playing the VCR.

If you are not sure which way your system works you might try playing a videotape while checking each TV set in turn to see if it picks up clearly the pictures and sound from the VCR, on the video channel. The chances are that you will be able to watch videotapes on only one TV set in the system. At the same time, the regular TV channels on the other sets in the system should be checked to see if the pictures appear snowy while the VCR is playing. This is normal, of course, and is due to the fact that the TV antenna is disconnected automatically from the TV set when the VCR is playing. (The effect can also be observed by operating the VCR/ANT switch on the VCR.)

If the splitter box connects between the antenna and the VCR then only the set connected to the VCR will play video programs. Other sets in the system will not be affected by playing the VCR.

If, on the other hand, the lead coming down from the TV antenna connects directly to the VCR/ANT socket, and the splitter box is fed from the RF OUT socket on the VCR, then all TV sets connected to that splitter box should be able to tune-in to programs on the video channel. In this instance, however, the pictures on sets tuned to the regular TV channels will appear snowy when the VCR is playing.

You cannot have it both ways, using only a splitter box.

A more practical way of connecting a VCR into a multi-point TV antenna system if you want to have your video cake and eat it, too, is to use a VCR mixer in conjunction with the splitter box. A VCR mixer permits video programs from the VCR to be played

HAVING YOUR VIDEO CAKE And eating it too!

Specifications — VCRMX201

● Impedance	75 ohms all ports		
● Bandwidth	ANT IN 10 to 1 GHZ		
● R.L.R.	Better than: 18 DB VHF		
	Better than: 12 DB UHF		
● Insertion loss		VHF	UHF
	ANT IN to SYSTEM OUT	-6DB	-7DB
	ANT IN to VCR OFF AIR	-3DB	-4DB
	VCR IN to SYSTEM OUT	-4DB	-4DB
● Rejection	RF IN out of band	-20	-40
● Isolation	RF IN to VCR OFF AIR	-30	-50
	SYSTEM OUT TO ANT IN	-40	-50

Mechanical

● Case	100mm x 51mm x 26mm — Zinc cast
● Connectors	Standard F/Type plated brass
● Mounting	2 zinc 38mm slot wood screws

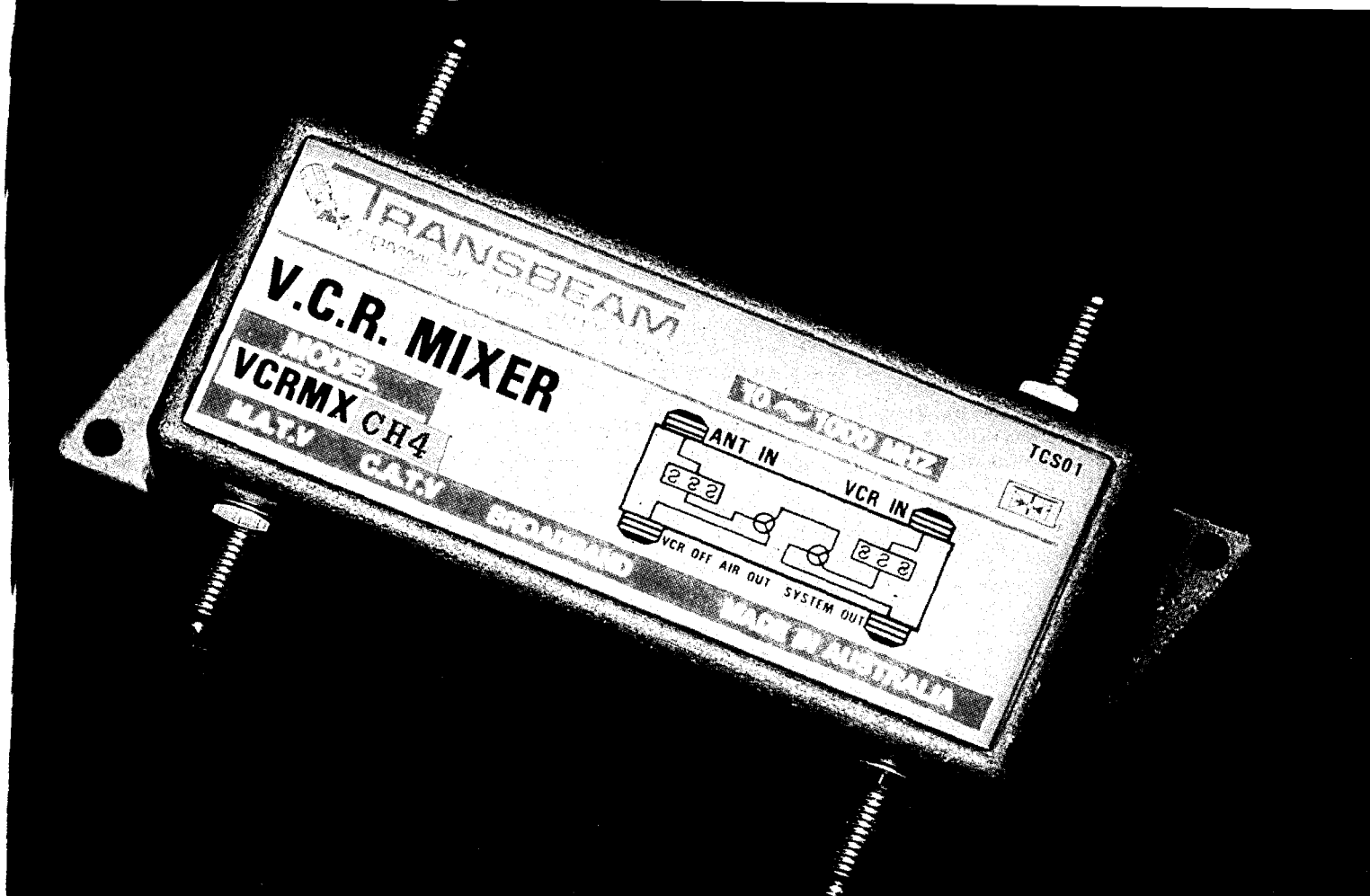

through any antenna point in the system. It also overcomes the problem of pictures on the regular channels appearing snowy on one or more sets when the VCR is playing. In other words, a videomovie can be set up to play in the system VCR and then viewed on any set connected to the system without affecting the other sets. In fact, any or all of the other TV sets connected to the same antenna system will be free to tune-in at any time to either a regular TV channel or the VCR program playing on the video channel. Now, that's one way to get Junior off to bed early!

Depending on the strength of the local TV signals, it might even be possible to go one step further and add additional mixers to

Try playing a videotape while checking each TV set in turn!

have two or more VCRs working at the same time in a multi-point system at home. Each video program could then be picked up on any TV set in the system simply by selecting the appropriate video channel number for the respective VCR output while it is playing. Typical optional video output channels available on VCRs sold locally include Channel 0 or 1, Channel 3 or 4, or a limited choice of UHF channels, depending on the make and model.

A locally made VCR mixer from Transbeam Communications, in Boronia, Victoria, requires no battery or power connections and is small

enough to hold in the palm of the hand. The mixer can be installed conveniently out of sight with the antenna system wiring and is

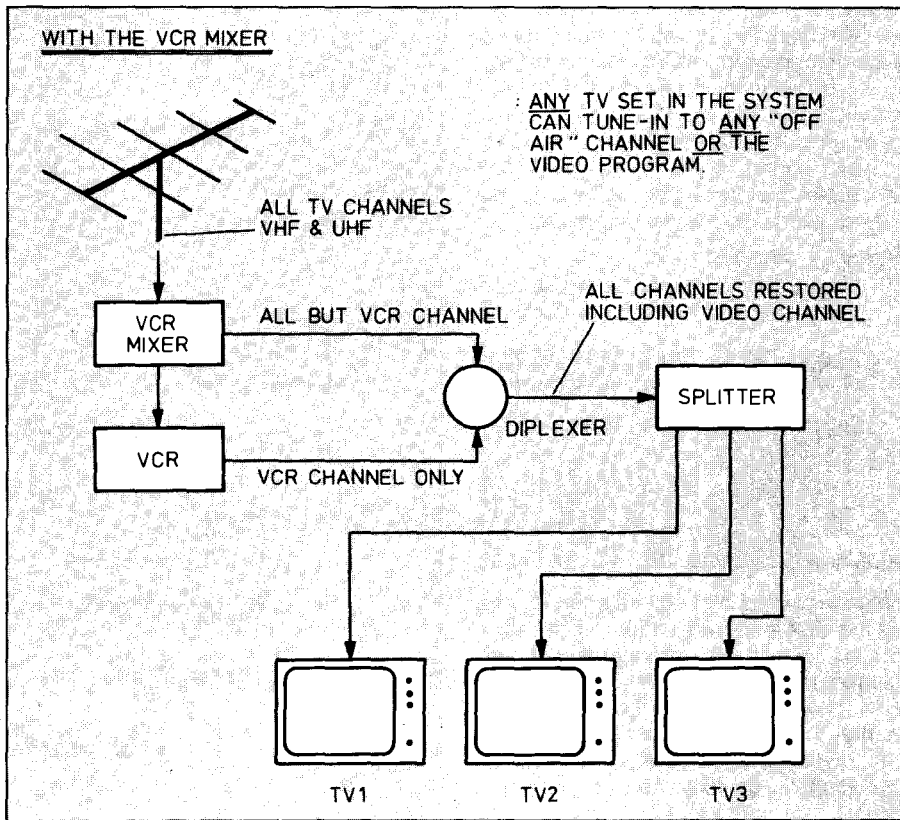

VCR mixer

designed to work over the entire VHF and UHF bands. The specification sheet for the Transbeam mixer quotes the RF bandwidth as extending out as far as 1GHz. A filter to block interference picked up in the antenna system on the video channel is also incorporated into the mixer, to improve picture clarity on VCR programs.

F-Type connectors to replace those on existing antenna leads are supplied with the Transbeam model. One additional lead and connector set is needed, however, and is not supplied with the mixer because of the uncertainty of the required length in different installations, according to Transbeam. This point would be worthwhile remembering when equipping to install a VCR mixer over a weekend. When ordering a VCR mixer such as the Transbeam model it is also necessary to specify the VCR video channel upon which it is to operate; for example Channel 0 or 1, Channel 3 or 4 - the channel you turn to to watch the videomovies on your VCR.

Connecting the VCR into the antenna system can also have advantages in terms of security as the VCR does not necessarily have to be installed in the obvious place sought by thieves, beside the main TV set.

The number of antenna points that can be added to a TV system without adversely affecting the clarity of the picture and sound will depend on the strength of the signal picked up in the antenna and will vary from one location to another. Since each splitter and mixer typically results in a relatively small loss of signal strength to each TV set, there is a limit to how many splitters and mixers can be used in a particular system without taking some compensatory action. This should not be a problem where only two or three sets are involved in the suburbs. Antenna signal amplifiers can be used to boost the signal in weak signal areas or if losses are encountered in other parts of the antenna system, such as in splitters and mixers.

How it works

The Transbeam VCR mixer takes the wideband VHF and UHF signals from the

Connecting the VCR into the antenna system can also have advantages in terms of security

antenna and notches out the channel used by the VCR for playing video into a TV set. This also has the advantage of removing interference picked up in the antenna on the video channel. All of the remaining channels in the VHF and UHF bands are passed through to the tuner in the VCR and used in the normal way for recording programs, off-air.

Playback signals in the video channel are then recombined with the rest of the VHF and UHF channels and the full complement of channels is thus reconstituted, and then fed into the antenna system where it may then be split into TV points or amplified for distribution throughout a MATV system.

Transbeam suggests that it is also possible to use the mixer as an RF diplexer for local area networking where it is also capable of two-way data transmission.

Recommended retail price for the

Transbeam VCR mixer is \$61.14. VCR mixers, splitters, antenna amplifiers and a wide range of other TV antenna gadgets and cables are, of course obtainable from TV antenna installers and accessories stores. Further information about the Transbeam VCR mixers can be obtained from MMT Australia Pty Ltd., 124 Boronia Road, Boronia, Victoria 3155, Phone (03) 762 6455, or FAX (03) 762 6818. **eti**

Les Cardilini is a lecturer at RMIT and a regular contributor to magazines and journals.

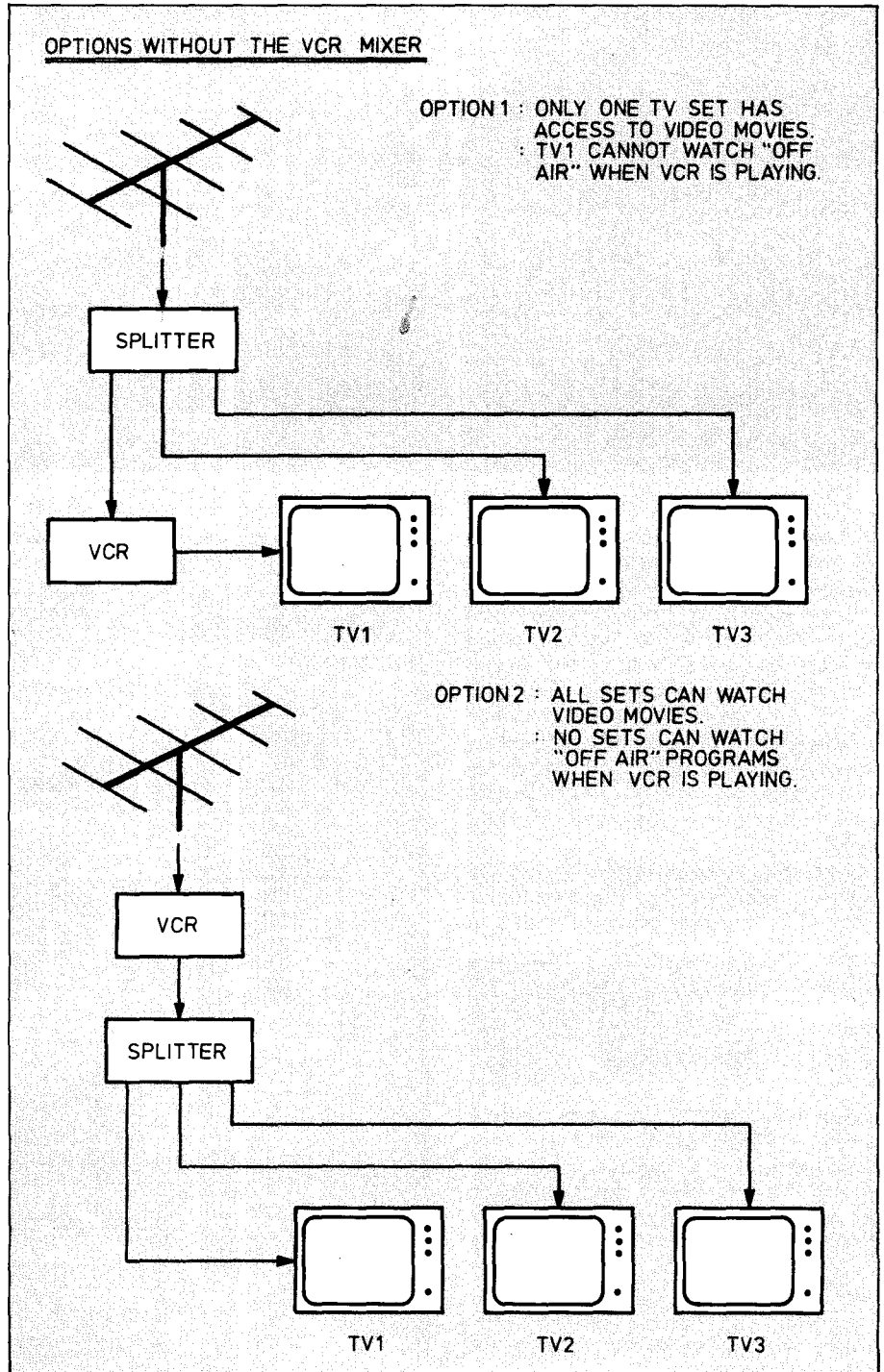

BOSE

The Bose 601™ Series III Direct/Reflecting Loudspeaker System

Bose engineers have invested more than 25 years of ongoing research seeking one goal—recreating the realism of a live performance.

The real best thing to hearing music live is hearing it through a Bose Direct/Reflecting speaker.

Drawing on the heritage of the iconic 901, the Bose 601 speaker gives you the best seat in the house—whatever you sit or stand.

The research: three dimensional sound.

Through our extensive acoustical research into live sound, we learned that focusing on only one musical parameter, such as frequency response and expecting realistic sound is like trying to create a lifelike painting by concentrating solely on colour. As with visual images, live sound has perspective, clarity and proportion.

We designed our speakers based on the natural combination of direct and reflected sound. The difference between listening to conventional speakers and Bose Direct/Reflecting speakers is like the difference between viewing a movie on a television versus experiencing it in a theatre.

The 601 system brings a three dimensional sensation to music—giving the sound depth, height and width. In short, it seems to come alive!

In a live performance, the majority of sound reaches your ears after being reflected off the walls, floors and ceiling. With conventional speakers, you mainly hear only direct sound. Bose Direct/Reflecting speakers add the missing elements of music by bringing you the natural combination of direct and reflected sound (see diagrams at right). The result is a lifelike soundstage that's practically like being there.

The performance: ideal for audio, video and digital.

With most conventional speakers, you hear stereo in one or two parts of the room. Everywhere else, you hear primarily one speaker. The 601 system allows you to hear true stereo

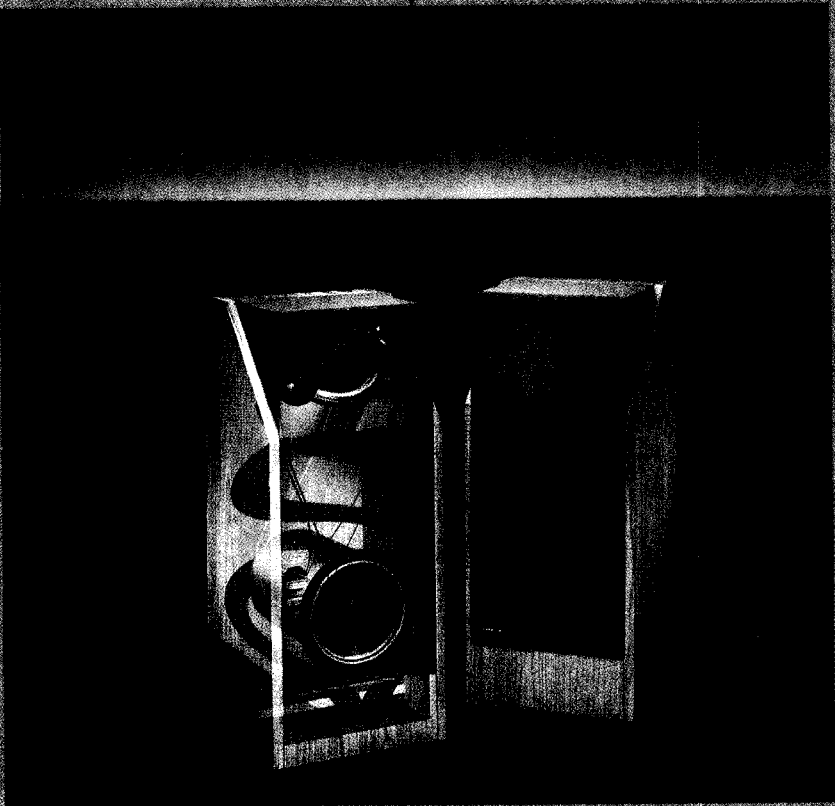

everywhere in the room—even when you are directly in front of one of the speakers.

The 601 system is the ideal cornerstone for a complete home entertainment system. It unleashes the full potential of your sound system, efficiently produces excellent sound and easily handles high power. This rare performance combination allows you to enjoy today's power-demanding sound sources such as digital audio at true-to-life volume levels.

The Bose 601 system also makes it possible to use your stereo system in a new way: as part of a total audio/video system. It is designed to produce greater realism with all video sound sources—especially stereo televisions, hi-fi VCRs and video disc players.

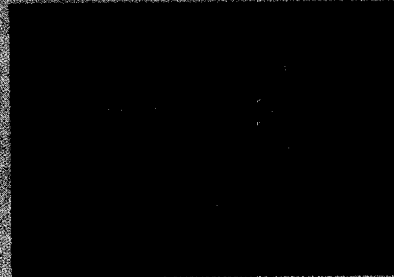

Bose 601 Direct/Reflecting® system.

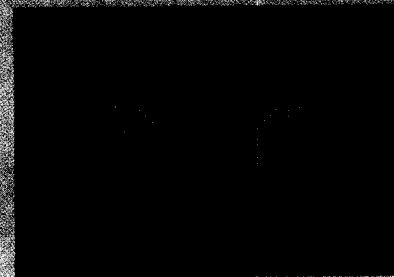

Conventional speaker system.

Bose Australia Inc., 11 Havel Avenue, Rydalmere, NSW 2116. Telephone: (02) 684 1022, 684 1255.

Bose Distributors:

NSW and VIC: Bose Australia (Reverse charge (02) 684 1022); QLD: Stereo Supplies (07) 229 7930; WA: Prosound (08) 325 1066; SA: Blackwood Sound (08) 278 1281; TAS: Chessman Distributors (003) 26 4822.

90447

READER INFO NO. 10

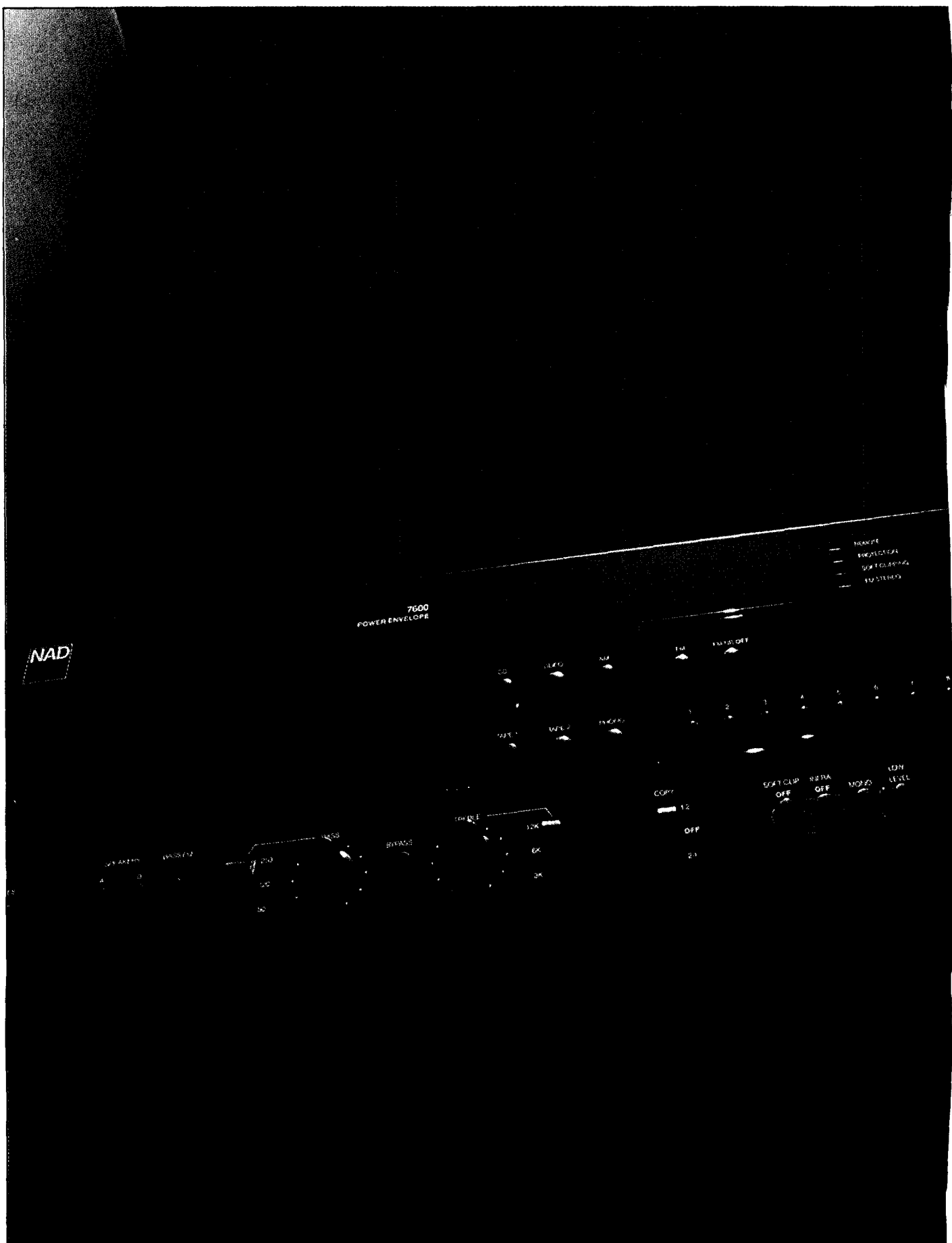

THE NAD 7600

A powerful performer

Louis Challis put this hi-fi system to the stringent test of providing entertainment for his teenage son's birthday party.

Of all of the manufacturers of high fidelity equipment, NAD seems to have developed an enigmatic approach to the issues of appearance and performance. Whilst other firms tend to produce flashy designs bordering on gaudy and tasteless, NAD invariably veers in the other direction. This 'button-down collar, suede or tweed jacket' approach seems to work well and NAD's sales and public profile have benefited enormously.

This receiver provides more (and costs more) than any of their previous receivers and amplifiers.

The NAD 7600 conforms to the company's low key profile with dark grey front panel, black central escutcheon display and white silk screen lettering for each of the major controls.

Unlike most of the European, Scandinavian, Taiwanese and Japanese high powered receivers, this unit has remarkably few front panel controls. The few controls are located in two distinct bands which are grouped at the bottom of the front panel and the centre of the black transparent display escutcheon.

The major controls are a power switch at one end, and a large tuning dial control with volume control below it, at the other. On the bottom row are two push buttons for selecting main and auxiliary speakers and a bass equalising switch immediately adjacent. The bass and treble controls are provided with selectable corner (or roll over) frequencies of 50Hz, 120Hz and 250Hz for the bass and 3kHz, 6kHz or 12kHz for the treble. Fine controls are provided by two knobs with central indent, and these sets of

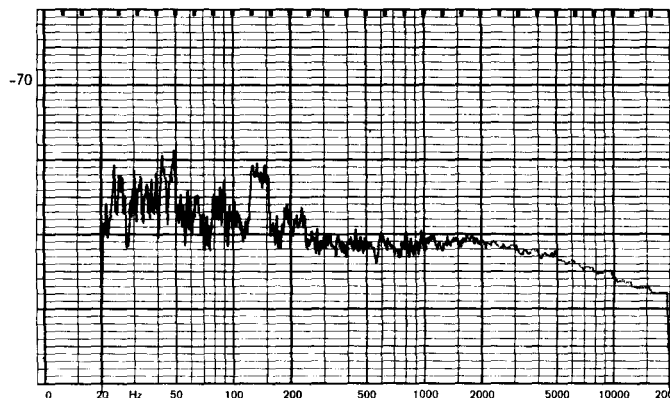

Hum and noise: one-third octave band analysis (re 1 watt in 8 ohms).

ETI MARCH '89

NAD 7600

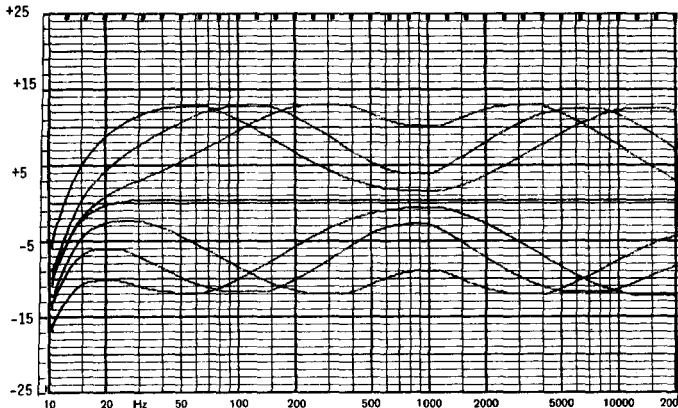

Tone controls: maximum and minimum settings, auxiliary input.

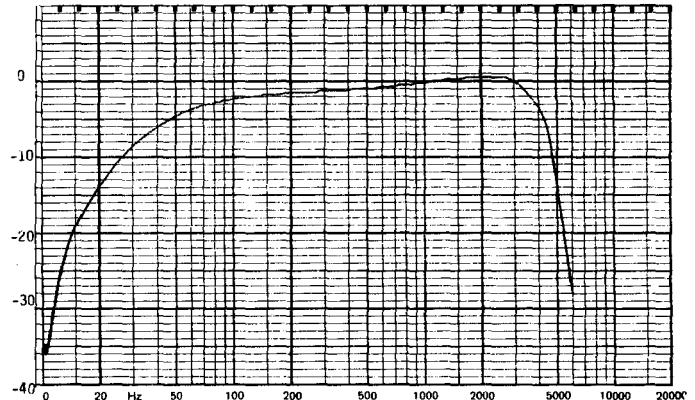

Overall response: AM receiver section.

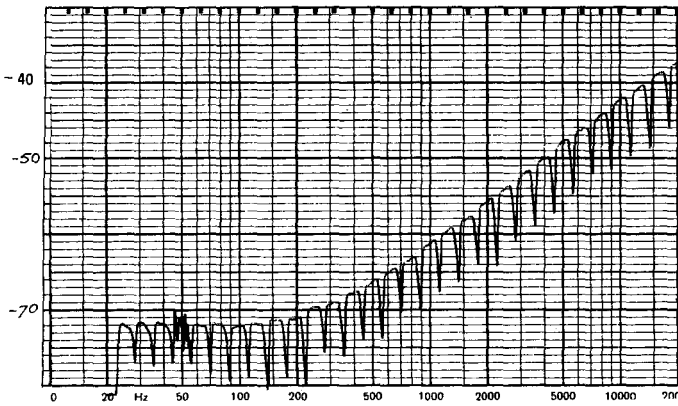

Crosstalk: one-third octave band analysis, CD input (short circuited).

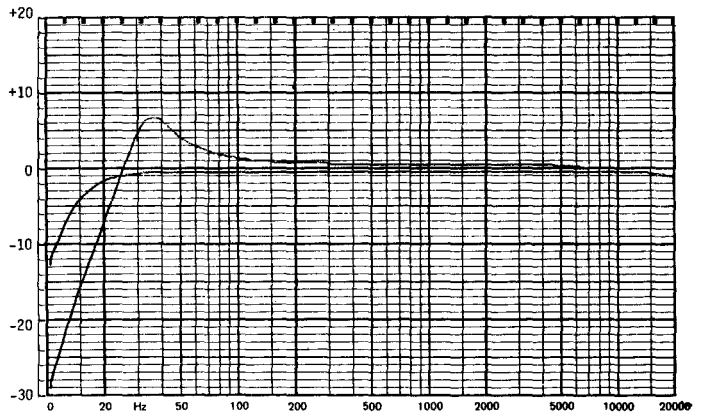

Bass EQ circuit: tone controls off. Upper curve shows EQ 'in'.

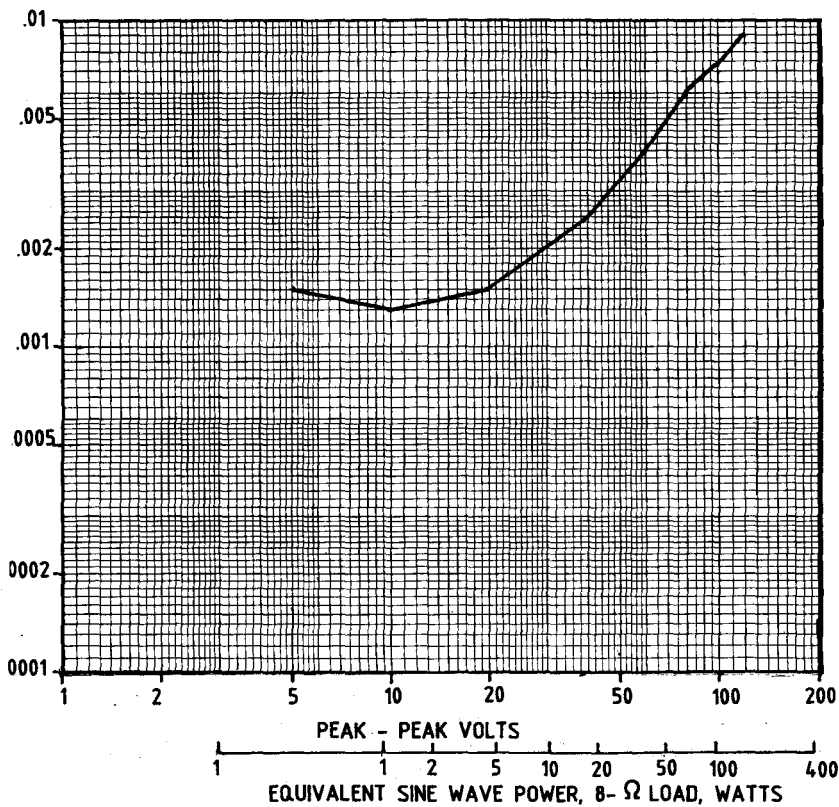

ETI MARCH '89
110

controls are supplemented by a defeat switch labelled "BYPASS".

In the centre of the bottom row a copy switch labelled "1-2 or 2-1" is provided for copying from one external tape recorder to another.

A series of 4 important controls are provided in a group. The first of these provides for the selection of soft clipping. The adjacent switch disables the infrasonic switch which has a roll over frequency of 14Hz. The next switch provides for mono selection to

The unit has remarkably few front panel controls

combine both radio and/or amplifier channels. The fourth switch in the group is labelled "LOW LEVEL" and provides a 20 decibel reduction in signal level to allow you to answer the phone or speak to a friend, while still enjoying the hi-fi sound. The balance control has two push buttons in place of the normal rotary control which operate a motorised potentiometer within the amplifier section. This unusual approach has been

IEC high frequency total difference frequency distortion.

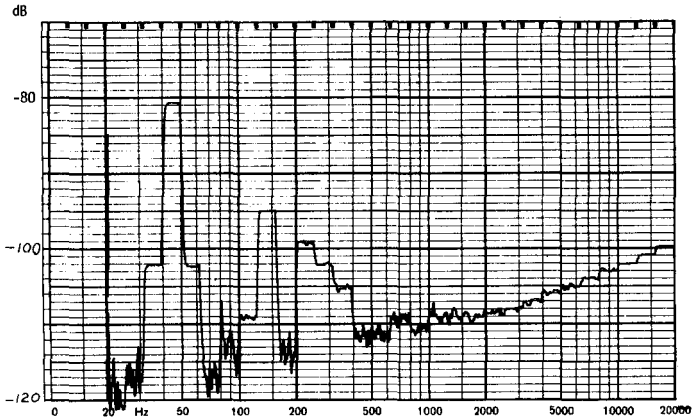

Hum and noise: one-third octave band analysis (re 1 watt in 8 ohms); CD input (short circuited).

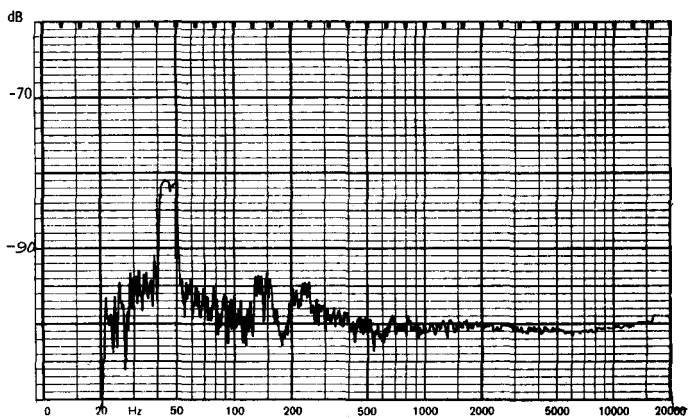

Hum and noise: one-third octave band analysis (re 1 watt in 8 ohms); phono input (short circuited).

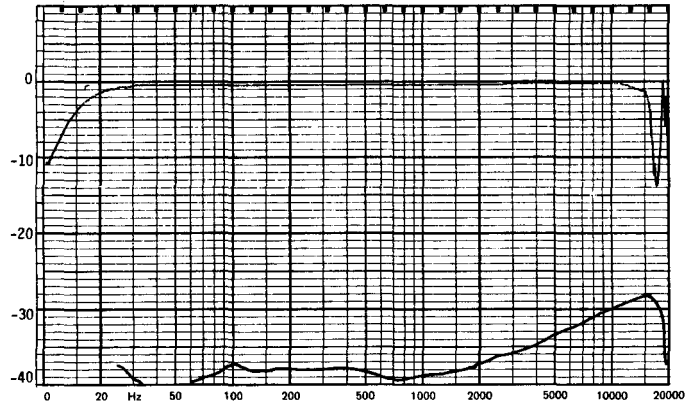

Overall response: FM receiver section, left channel. Crosstalk right channel into left channel.

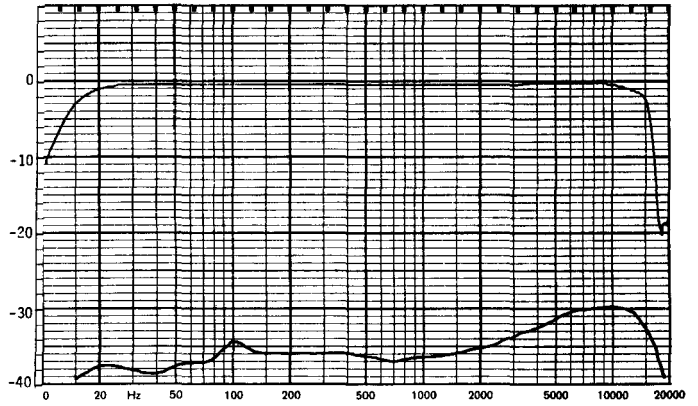

Overall response: FM receiver section, right channel. Crosstalk left channel into right channel.

adopted because the circuit designers believe it provides superior quality sound.

The central row of controls incorporates eight push buttons for selecting the input signal for the receiver. These are CD, video, AM tuner, FM tuner, tape 1, tape 2, phone and FM noise reduction disable (FM NR OFF). Eight small buttons at the bottom of the dial allow you to select eight pre-set AM and FM stations or, by using a red ENTER button adjacent, to select those eight stations as and when required.

The front of the dial has a large digital readout of station frequency, accuracy of tuning, which of the pre-set stations have been selected and which of the inputs have been selected. At the very top of the escutcheon four status displays indicate when a command is being received from the remote control, that the PROTECTION circuit is preventing overload during turn-on or when the loudspeakers or headphones are disconnected, that the SOFT CLIPPING circuit has been selected and that the FM tuner is in the FM stereo mode on the channel being received.

At the top right-hand corner is a small LED which is activated when the amplifier is overdriven and has started to produce measurable (and as we discovered) audible

Dimensions:	430 mm wide x 165 mm high x 425 mm deep
Weight:	17 kilograms
R.R.P.:	\$2,999

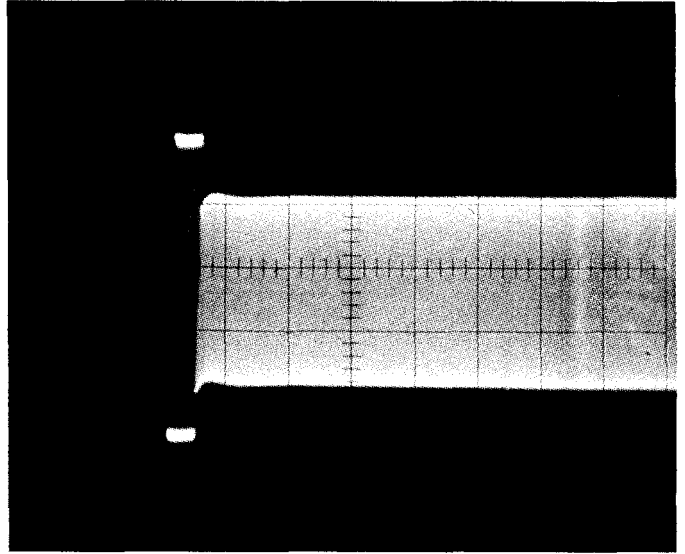
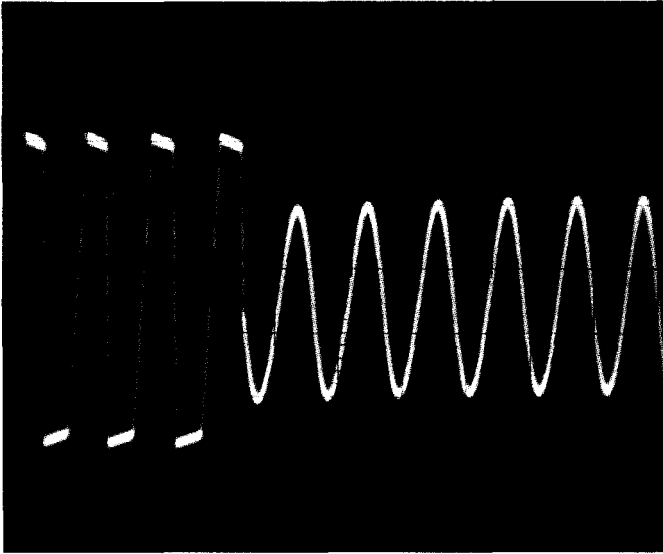

Transient overload recovery test at 1mS/div (left) and 50mS/div (right); 10dB overload re rated power into 8 ohms — both channels driven. Overload duration 20mS; repetition rate 512mS.

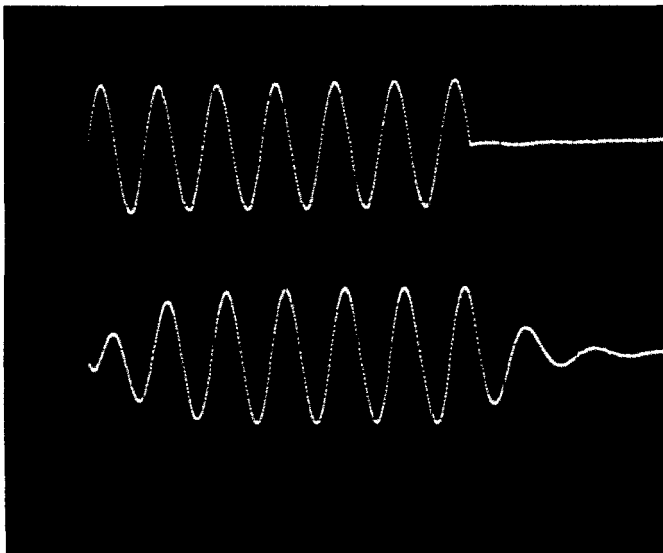

Effect of bass EQ at 35 Hz.

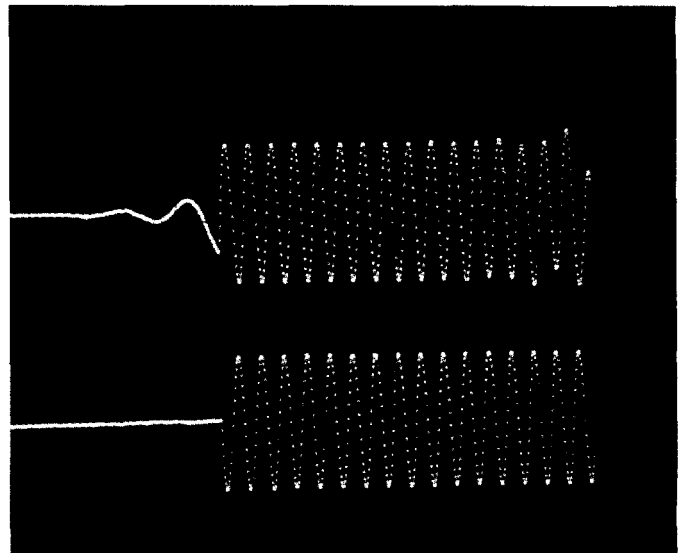

Effect of bass EQ at 90 Hz.

distortion. At the bottom left hand corner is a 6.5 mm diameter tip-ring and sleeve socket for a pair of headphones.

On the rear of the receiver are stacked arrays of pairs of phone sockets for each of the inputs listed, a neat universal rotatable antenna with locking screw for the AM tuner, a pair of spring loaded sockets for an external AM antenna and one of the newer FM coaxial sockets for the FM antenna. The rear panel has a master power switch with fuse adjacent at the top, a correctly configured shrouded unearthed socket for connecting a single external piece of equipment (most probably being intended for the record player) and four large colour-coded pairs of universal sockets for connecting speakers.

The inside of the amplifier is neatly laid out below the open, slotted top of the cabinet

with a matching, large expanse of slotted bottom panel to ensure adequate ventilation.

The evaluation of the amplifier was more troublesome than normal, as the handbook tells nothing about ratings and capabilities;

'My son had a birthday party with 50 teenagers to entertain'

nor was a data sheet or marketing blurb readily available. As I soon discovered my guesstimate of 100 watt power rating for the amplifier was way off the mark. The amplifier provides 170 watts output into 8 ohms and does so with in excess of 3dB headroom. It can put out peak powers of 528 watts into

4 ohms, and in excess of 700 watts into 2 ohms (but not for long). The frequency response is extremely flat being 1.5dB down at 20Hz and 1dB down at 20kHz. Unlike many other amplifiers on the market, the low frequency response is neatly rolled over below 20Hz to protect your speakers. The addition of the rising low frequency response between 25Hz and 100Hz is a clever concept which enables you to provide additional low frequency boost for a wide range of loudspeakers. This 7dB rise in response at 35Hz is something of a new twist, one that I can certainly recommend.

As the graph shows, the tone controls provide an unusually wide range of selectable frequency responses, and are reminiscent of the unusual flexibility pioneered by Leak in its Vari-slope range of pre-amplifiers in the late 50s and early 60s.

EUROPE'S FINEST



The new DALI-40 loudspeakers are the finest we have ever created. They incorporate technology and design features which make them technically and musically superior to virtually anything else available today.

The manner in which the bass drivers are mounted, back-to-back, gives an equalisation of vibrations caused by Newton's 3rd law. This elegant solution, whilst removing the need for concrete construction, completely eliminates front panel resonances. The duplication of the bass and mid-range drivers with the centrally mounted 1" dome tweeter ensure that the sound at all frequencies appears to originate from one central point of each loudspeaker.

Definition, imaging, and stereo separation are all outstanding as is the superlative cabinetry

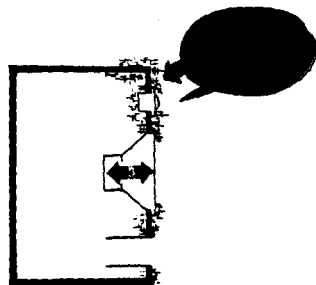

Conventional loudspeaker

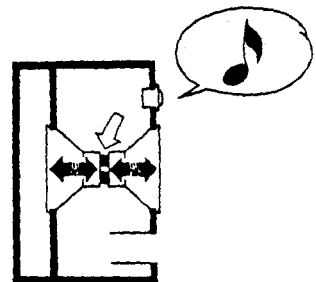

Total elimination of high- and mid-frequency distortion caused by cabinet vibrations.

finish – the combination of solid timber, anodised aluminium and glass. The new DALI-40 is a loudspeaker with truly state-of-the-art performance, worthy of the finest source and amplification equipment.



DALI-40 contains four PP-woofers with 25mm linear excursion.

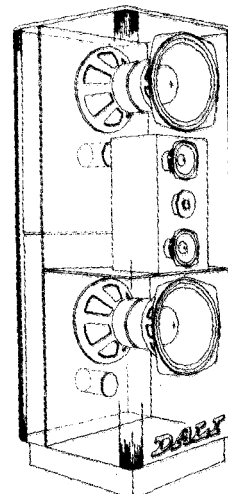

Each cabinet is divided into five separate chambers, of which two are of the band-pass bass reflex type.

Its reproduction of the musical sound stage will thrill you.

Write or telephone the sole Australian distributor Scan Audio for full information about the new DALI-40 and the entire range of DALI loudspeakers.

Scan Audio Pty. Ltd. 52 Crown Street,
Richmond, Vic., 3121
Phone: Melbourne (03) 429 2199
Adelaide (08) 278 6888
Sydney (02) 522-5697
Brisbane (07) 357 7433
Perth (09) 384 1362

READER INFO No. 28

DALI

S&T 4623

NAD 7600

The hum and noise figures for the amplifier are exemplary being -88dB down re 1 watt into 8 ohms for the phono-input (short circuited) and -94dB re 1 watt for the CD Input (short circuited). The harmonic distortion figures for the amplifier are exceptionally good with miniscule figures of less than .0095% at rated power for the 3 standard test frequencies and values of less than .0016% at the 1 watt level. The IEC high frequency - total difference frequency distortion figures are exceptionally smooth and provide no trace of the classical nasty rise in distortion that most other high powered receivers display.

The FM tuner has a smooth response of +0, -2dB from 17Hz to 15kHz and better than 30dB of separation over most of the frequency range. The AM tuner's frequency response is better than most and is 10dB at just under 5kHz, instead of the normal 3kHz. The selectivities of the AM and FM tuner are absolutely first class and this receiver offers a 24dB sensitivity for 50dB quieting, which is unusually good.

Whilst these figures may provide you with some inkling of how good the receiver is, it's not until you use it that you find out how good it really is. The night I brought it home was the night my son had a birthday party with 50 teenagers to entertain. I connected up two pairs of speakers in my carport and my son fed those speakers with all the power that he could develop till the early hours of the morning. If nothing else impressed me, that evening proved how much abuse (in terms of continuous high power operation) the receiver could handle. Although I haven't asked them, I know that my neighbours would testify as to how much power the receiver put out over a five hour period.

One of the most outstanding features of this receiver is its remote control which, once adopted into my style of living, was particularly hard to dispense with. It controls all the major functions at distances of up to 30 metres from the receiver. It's my guess that this remote control function will endear itself to a wide range of intending users.

Although the 7600 offers a power output a couple of dB below the potential of my normal system, I really couldn't detect the difference, and on high power passages, with the soft clipping selected, was convinced that the 7600 was more powerful.

When listening to FM stereo and local AM stations this receiver provides unparalleled performance, and, with a stubby aerial attached, it pulls in distant stations which my existing tuner does not capture unless a large aerial has been attached.

The NAD 7600 receiver is not the most powerful that I have ever tested, but the quality of its amplifier and tuner sections along with the simple sophistication of its front panel, puts it in a position where it 'runs rings around' most competitors. **eti**

Measured performance of the NAD 7600 Serial No: 8040191

Frequency response (-3dB re 1 watt):

Input to aux = 0.5 V

Tone controls defeated

Left 14.4 Hz to 47.4 kHz
Right 14.4 Hz to 46.7 kHz

Turnover frequencies

50 Hz - 12 kHz
250 Hz - 3 kHz
50 Hz - 12 kHz
250 Hz - 3 kHz

Tone controls centred

Left 16.0 Hz to 48 kHz
Left 16.0 Hz to 48 kHz
Right 16.0 Hz to 47 kHz
Right 16.0 Hz to 47 kHz

Sensitivity (for 1 watt in 8 ohms):

	Left	Right
C.D.	130 mV	133 mV
Video	130 mV	133 mV
Tape	130 mV	133 mV
Phono m/m	850 uV	880 uV
Phono m/c	32 uV	33 uV

OVERLOAD	Phono m/m	290 mV	300 mV
OVERLOAD	Phono m/c	11.0 mV	11.1 mV

Input impedance (@ 1kHz):

	Left	Right
C.D.	46 k ohms	46 k ohms
Video	46 k ohms	46 k ohms
Tape	48 k ohms	48 k ohms
Phono m/m	60 k ohms	56 k ohms
Phono m/c	2.5 k ohms	2.5 k ohms

Output impedance (@ 1kHz):

58 milliohms

Noise & hum levels (re 1 watt in 8 ohms):

Input 0.5 V	C.D.	-80 dB(Lin)	-94 dB(A)
Input 5 mV	Phono m/m	-79 dB(Lin)	-89 dB(A)
Input 0.5 mV	Phono m/c	-73 dB(Lin)	-80 dB(A)

Harmonic distortion:

At a power of 1 watts into 8 ohms

	100Hz	1kHz	6.3kHz
2nd	-118.2	-	-105.5 dB
3rd	-122.2	-120	-111.2 dB
4th	-123.9	-	- dB
5th	-	-117.2	- dB
T.H.D.	0.0004	0.00026	0.0016%

At rated power of 170 watts into 8 ohms:

	100Hz	1kHz	6.3kHz
2nd	-105.0	-101.4	-96.1 dB
3rd	-95.6	-93.7	-87.6 dB
4th	-121.3	-107.7	-95.7 dB
5th	-118.4	-105.8	-
T.H.D.	0.0036	0.0048	0.0095%

IEC high frequency total difference frequency distortion:

8 kHz and 11.95 kHz mixed 1.1

At rated power	0.0073%
At 1 watt	0.0014%