

AUSTRALIA'S DYNAMIC ELECTRONICS MONTHLY!

BONUS
DSE KIT
CATALOGUE INSIDE

Electronics Today

INTERNATIONAL



\$2.75*
NZ \$3.50

NOVEMBER 1985

EUROVOX'S BEST CAR
AM STEREO REVIEWED

TOP PHILIPS CD
PLAYER REVIEWED

BUILDING YOUR FIRST
SHORTWAVE ANTENNA

SATELLITES OVER
AUSTRALIA

SILICON GLEN —
SCOTLAND'S
ELECTRONICS
REVOLUTION

PROJECTS:

FAX AND RTTY FOR
YOUR CAT

**BUILD
YOUR OWN
NAVIGATING
ROBOT**

LIGHT BULB LIFESAVER PROJECT

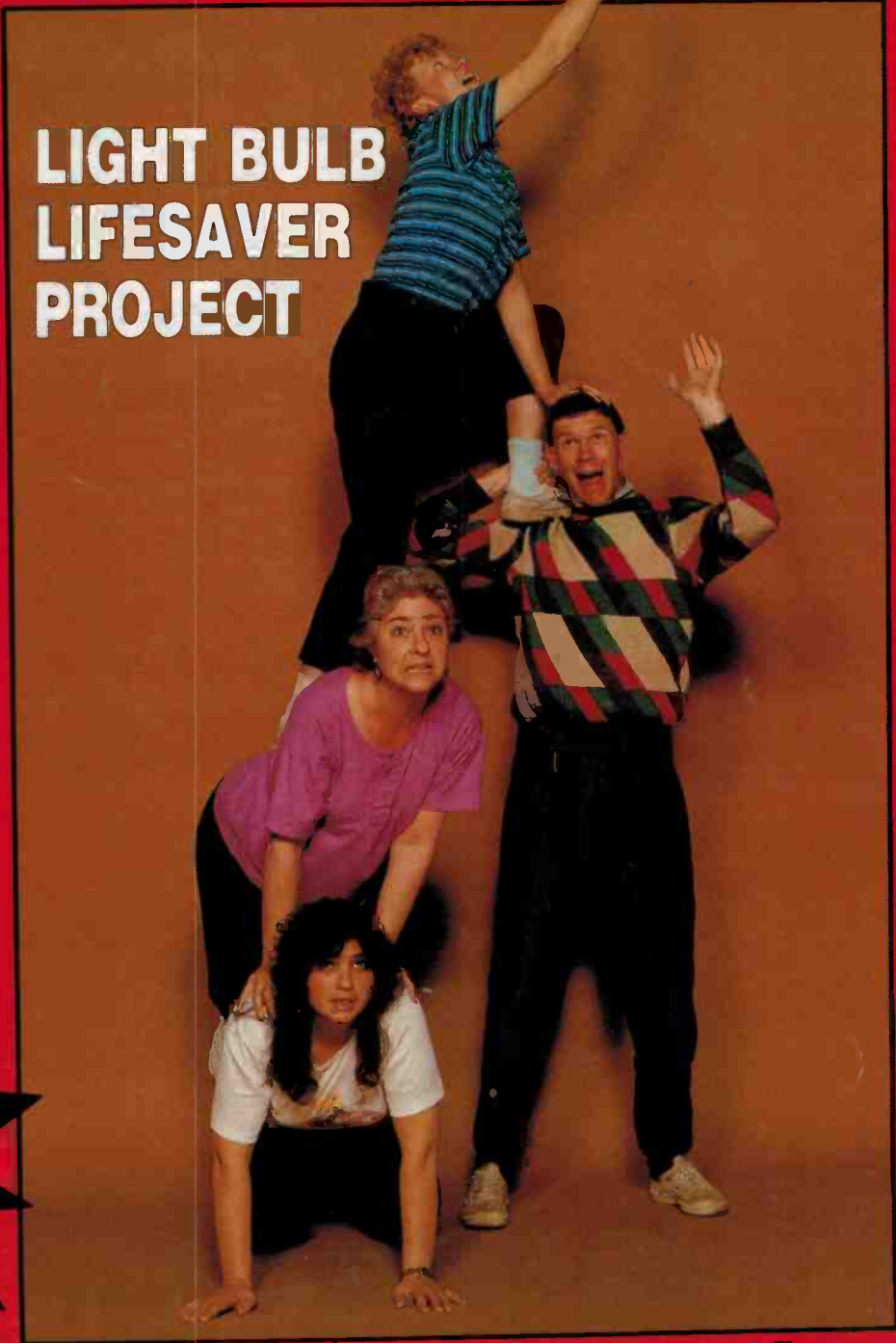

Revox B225

For those who waited.
And those who wish they had.



STUDER REVOX

All Compact Disc players are *not* created equal. This much, at least, has emerged from all the hype and hoopla.

Some CD players are built better than others. Some have more sophisticated programming features. Some are easier to use. And, yes, some *do* sound significantly better than others.

The new B225, from Revox of Switzerland, excels on all counts. For those who have postponed their purchase, patience has been rewarded. For those who didn't wait, the B225 is the logical upgrading route.

First, the B225 is designed for unexcelled CD reproduction. By using oversampling (176.4 kHz) in conjunction with digital filtering, the B225 guarantees optimum sound resolution and true phase response.

For your convenience, the B225 offers programming of nearly every conceivable combination of start, stop, pause, and loop functions, in any sequence, and using mixed combinations of track numbers and times. Cueing time is always less than 3 seconds, and a single infrared remote transmitter (optional) operates the B225 as well as all other components in the Revox 200 audio system.

Finally, the B225 is a product of refined Swiss design and meticulous craftsmanship. Behind its face-plate of functional elegance, you'll find the B225 is an audio component built in quiet defiance of planned obsolescence.

Without question, the definitive CD player has now arrived. For those who waited (and those who didn't), now is the time to see an authorized Revox dealer.

SYNTEC INTERNATIONAL PTY. LTD.

53 Victoria Ave., Chatswood, N.S.W. 2067 (02) 406-4700
Vic: (03) 819-2288. Qld: (07) 371-3999. WA: (09) 328-1200

Electronics Today

FEATURES

Satellites over Australia Looking at a sky full of satellites	12
Full level BASIC for VZ200/300 Extended BASIC program works a few tricks on the VZ	94
Catching that elusive signal With the help of an antenna	96
Ferromagnetic cores in rf circuit Taking advantage of developments to make your own toroidal cores	106
Starting electronics Electronics hardware: some words on the nuts and bolts	116
Upwards with myth Ausstat took up its place in the space age story	122
Silicon Glen Where they take the high-tech road	124

PROJECTS

ETI-1507: Light bulb saver	52
ETI-664: Hobbybot robot Part 1	60
ETI-757: RTTY/FAX decoder for the Cat computer Part 1	70
ETI-169: Low distortion audio oscillator Part 2	78

REVIEWS

Philip's CD 304 CD player	26
The Eurovox MCC 2360E	30

OFFERS

Reader information service	19
ETI mail order books	112-114
ETI-664 Allen Branch Hobbybot robot kit offer	119
Subscriptions offer	115
Dick Smith CRO competition	24

DEPARTMENTS

News Digest	6	Idea of the Month	48
Letters	8	Ideas for Experimenters	49
Sight and Sound News	36	Microbee Column	90
New Components	40	Commodore Column	92
New Equipment	44	Shoparound	127
Computing News	86	Minimart	127
Communications News	104	Dregs	130

COVER: Thanks to Pippi Storm, a community theatre and activities group, based in Sydney. For details of Pippi Storm's programme contact Barbara Malaski on (02) 692-8388.

EDITOR

David Kelly B.Com.

ASSISTANT EDITOR

Jon Fairall B.A.

EDITORIAL STAFF

Mary Rennie B.A.

Robert Irwin B.E.

S. K. Hui B.Sc. (Hons), M.Eng.Sc., MIEEE

Neale Hancock B.E.

DRAUGHTING

David Burrows

ART DIRECTOR

Vicki Jones

ART STAFF

Steven Cawthera

Nikki Byrne

ADVERTISING MANAGER

Peter Hayes B.Sc.

ADVERTISING PRODUCTION

Danny Hooper

READER SERVICES

Pam Todd

ACOUSTICAL CONSULTANTS

Louis Challis and Associates

MANAGING EDITOR

Jamieson Rowe

PUBLISHER

Michael Hannan

HEAD OFFICE

140 Joynton Avenue, (PO Box 227)

Waterloo, NSW 2017.

Phone: (02) 663-9999 Sydney.

Telex: 74488, FEDPUB.

Federal Facsimile: 663-5144.

ADVERTISING OFFICES AND AGENTS:

New South Wales: Peter Kilby, The Federal Publishing Company, 140 Joynton Avenue, Waterloo.

Victoria and Tasmania: Virginia Salmon, The Federal Publishing Company, 23rd Floor, 150 Lonsdale Street, Melbourne, Vic. 3000. Phone: (03) 662-1222 Melbourne. Telex: 34340, FEDPUB.

South Australia and Northern Territory: Steve Birbeck, The Admedia Group, 24 Kensington Road, Rose Park, SA 5067. Phone: (08) 332-8144 Adelaide. Telex: 82182, ADMEDIA.

Queensland: John Perry, The Federal Publishing Company, 25 Balaclava Street, Woolloongabba, Qld. 4102. Phone: (07) 391-8922. Telex: AA145520.

Western Australia: Tony Allen & Associates, 7 Fore St, Perth, WA 6000. Phone: (09) 328-9833.

New Zealand: Chris Horsley, 4A Symonds Court, Symonds Street, Auckland. Telex: NZ60753, TEXTURE. Phone: 39-6096. Auckland.

Britain: Peter Holloway, John Fairfax and Sons (Australia) Ltd, Associated Press House, 12 Norwich Street, London EC4A 1BH. Phone: (01) 353-9321 London. Telex: 262836, SMHLDN.

Japan: Genzo Uchida, Bancho Media Services, 5th Floor, Dai-ichi Nisawa Building, 3-1 Kanda Tacho 2-chome, Chiyoda-ku, Tokyo 101. Phone: (03) 252-2721 Tokyo. Telex: 25472, BMSINC.



ELECTRONICS TODAY INTERNATIONAL is published monthly by the Electronics Division of the Federal Publishing Company Pty Limited, 140 Joynton Avenue, Waterloo, NSW 2017 under licence from Double Bay Newspapers Pty Limited, General Newspapers Pty Limited and Suburban Publications Pty Limited. Typeset and printed by ESN-The Litho Centre, Sydney. Distributed by Gordon and Gotch Limited, Sydney. *Maximum and recommended Australian retail price only. Registered by Australia Post, Publication No NBP0407. ISSN No 0013-5216.

COPYRIGHT © 1985, Double Bay Newspapers Pty Limited, General Newspapers Pty Limited and Suburban Publications Pty Limited (trading as "Eastern Suburbs Newspapers").

Weller performance and reliability.

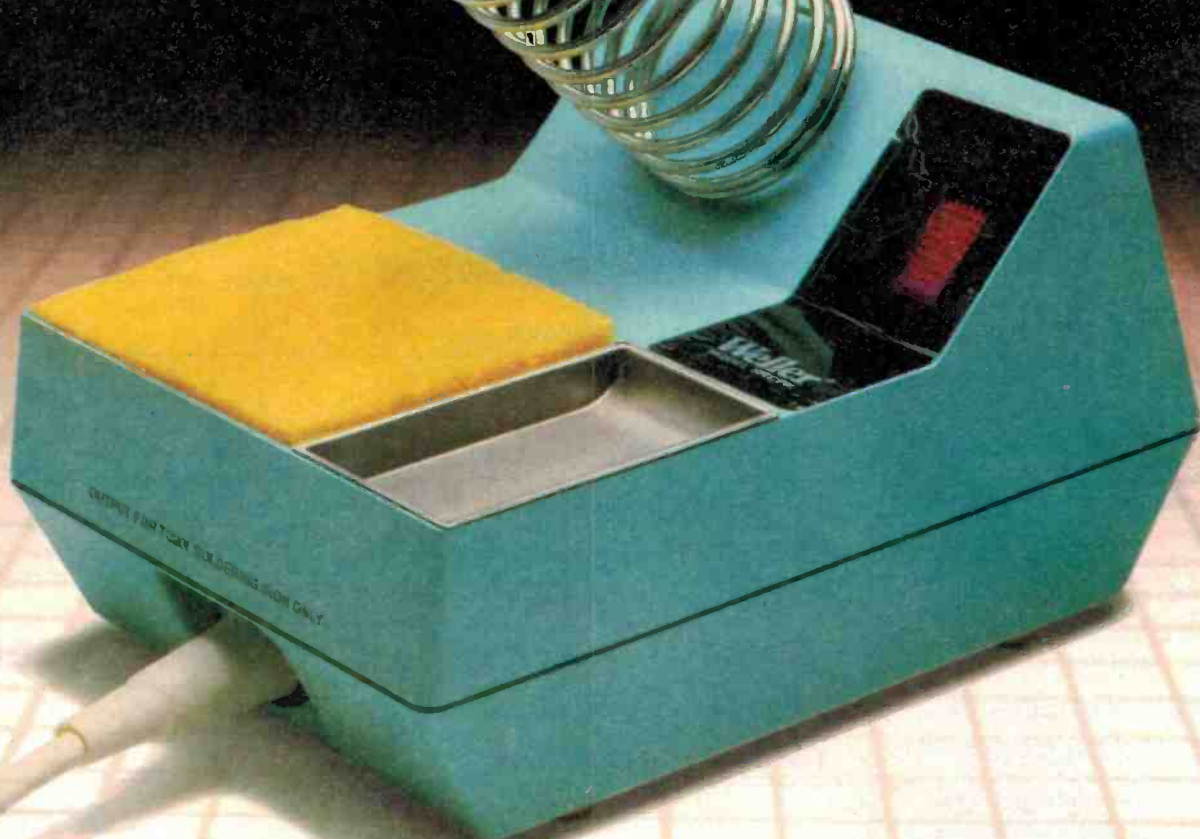

Look-alikes aren't that simple.

You could buy a lower priced soldering station that looks very similar to the Weller WTCPN. But it wouldn't perform like it.

By changing the heat sensing tips, the Weller WTCPN automatically controls output and temperature in three stages (315°C, 370°C and 430°C). Once selected, you can be assured of constant, accurate temperature control without dials to turn or settings to

watch. To make working with sensitive components that safe and simple, Weller has incorporated state-of-the-art technology into an attractive impact resistance case, that's ideally suited for assembly work.

Don't be fooled by look-alikes.

Check with your Electronics Distributor.

The Weller WTCPN



CRESCENT LUFKIN NICHOLSON PLUMB TURNER WELLER WIRE-WRAP WISS XCELITE

The Cooper Tool Group Limited, P.O. Box 366, Nurrigong Street, Albury NSW 2640, Australia, Tel: (060) 216866, Telex: AA 56995

CooperTools

SERVICES

TECHNICAL INQUIRIES: Technical inquiries by mail must be accompanied by a stamped self-addressed envelope. There is no charge, but we reserve the right to publish the inquiry and the reply in *Electronics Today* or any of its associated publications. We can only answer queries relating to projects and articles as published. We cannot advise on modifications, other than errata or addenda. Difficult questions may take some time to answer.

GENERAL INQUIRIES: For all inquiries about back issues, subscriptions, photocopies of articles, artwork or submitting articles, call (02) 663-9999 or write to: ETI Reader Services, 140 Joynton Avenue (PO Box 227), Waterloo, NSW 2017.

CONTRIBUTIONS: Submissions must be accompanied by a stamped, self-addressed envelope. The publisher accepts no responsibility for unsolicited material.

COPYRIGHT: The contents of *Electronics Today International* and associated publications is fully protected by the Commonwealth Copyright Act (1968). Copyright extends to all written material, photographs, drawings, circuit diagrams and printed-circuit boards. Although any form of reproduction is a breach of copyright, we are not concerned about individuals constructing projects for their own private use, nor by bands (for example) constructing one or more items for use in connection with their performances. Commercial organisations should note that no project or part project described in *Electronics Today International* or associated publications may be offered for sale, or sold in substantially or fully assembled form, unless a licence has been specifically obtained so to do from the publisher, The Federal Publishing Company, or from the copyright holders.

LIABILITY: Comments and test results on equipment reviewed refer to the particular item submitted for review and may not necessarily pertain to other units of the same make or model number. Whilst every effort has been made to ensure that all constructional projects referred to in this edition will operate as indicated efficiently and properly and that all necessary components to manufacture the same will be available, no responsibility is accepted in respect of the failure for any reason at all of the project to operate effectively or at all whether due to any fault in design or otherwise and no responsibility is accepted for the failure to obtain any component parts in respect of any such project. Further, no responsibility is accepted in respect of any injury or damage caused by any fault in the design of any such project as aforesaid.

WE'VE ALL DONE quite a bit of talking about high-tech industry — whether or not we would like to have one and whether we should do something about getting one.

We've all done just about enough talking now to put the whole subject to bed and forget about it. Certainly Australian industry leaders won't have much trouble forgetting about it. They didn't think much about it, or of it, in the first place if a recent study by PA Technology is any guide.

Australian companies have to compete with international ones whether they like it or not. Overseas companies usually have board members and senior managers charged with developing innovative products and keeping ahead of their competitors.

How do we compete? Well it seems that our managers, bright lads and lassies they are, can get by just "reading a few magazines". The study doesn't say what sort of magazine our leaders read!

I don't think all Australian industry lacks innovation, just most of it. There are a few, very few, companies that are innovative and face the world and its markets head on. Their trick is to produce products that people really want to buy.

Forward thinking reaps rewards. Even the banking industry, which ten years ago was very tardy, is on the move and quite a few steps ahead of most local industry.

In one example I know, Westpac, playing venture capitalist, bought \$25,000 worth of a local computer products manufacturer. Now a few years later, with its share appreciated to \$2.5 million, the bank has found it quite likes high-technology.

We all have a lot at stake in seeing Australia develop an innovative and highly competitive electronics industry.

At the most selfish level a dynamic industry will give those of us with a special interest in electronics the opportunity to spend our working life doing what we enjoy.

More importantly the development of an outward looking, world competitive industry of any type will bring Australia considerable benefits in employment and wealth.

You would think the promise of making a lot of money would have got industry moving, but the PA Technology study seems to show it hasn't, industry is not even thinking about it.

Perhaps the growth of a few bright performers, making innovative products that people really want to buy will wake our industry leaders.

Certainly there are a few performers now and they're doing very well. My prediction is that we will see a few more over the next two years particularly those making computer and telecommunications products.

The hope is that we will stumble our way into the 20th century, hopefully before the 21st arrives.

David Kelly
Editor

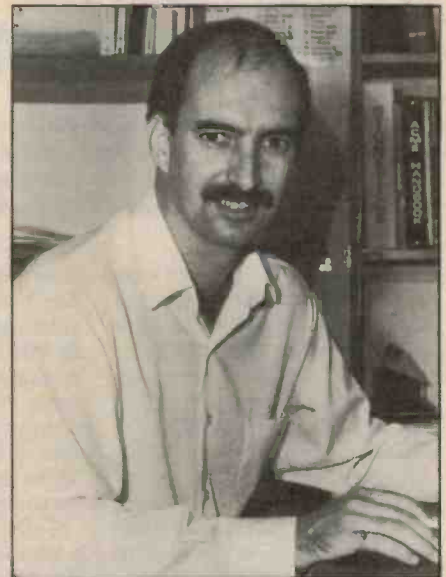

BATTERIES

The choice between longlife and the good ol' ordinary battery stumps some people; but that just hints at the range and diversity of batteries. This article elucidates some of the physical differences and looks to the future for batteries.

SCANNER SURVEY

While scanners scan the VHF and UHF airwaves, we survey the scanners. What's available on the scanner market and what does it do? These questions and more are answered next month.

MODEM

How does 1200/75, auto answer, auto dial, auto buffering sound? Be watching next month for part 1, the theory and design approach of this intelligent modem.

NEXT MONTH

CD REVIEWS

Interest in CD players is now mushrooming in Australia. People no longer regard them as some esoteric technology for only the very sophisticated or the very rich. Louis Challis reviews six of the latest middle range CD players to give a fairly comprehensive overview of what's available.

DATA REFERENCE

A special supplement which includes component characteristics, applications and useful basic circuits. It also covers the electromagnetic spectrum and broadcast bands, and gives details of forthcoming shortwave programmes.

Telephone tales

Among the more interesting products on display at the Communications '85 show in Sydney recently were the offerings of Tytel Corporation. Tytel was showing the first Australian designed and manufactured phone to be seen for more than a decade.

As a matter of fact there were three different phones on the stand. The cheapest and least sophisticated of the range is the model 701, which comes with 10-number memory and hands free operation. The model 731 can store 100 numbers and adds automatic redialling and a calculator mode. The 781 stores 272 numbers and has a time and stopwatch mode in addition to all the features of the others.

In addition Tytel has put out a version of the 731 called the 737 that is specially designed for secretaries. It has the ability to switch calls like a mini PABX and allows contact between phones in the office much like an intercom.

Currently all the models are being investigated by Telecom prior to awarding a licence to connect to the network. At the same time the company is getting itself set up to swing into

mass production. The company has been in existence for four years, apparently spending \$2m in R&D to get the products to market. Most of the money came from the family of the company founder Chris Tyree, who is connected with Amtron Tyree and other large electronics companies.

Tyree is setting out to change a situation where the entire market for telephones in this country is dominated by foreign corporations. Even Telecom standard phones are manufactured by local subsidiaries of foreign giants. He argues that with growth of VLSI and robotics, the price of expensive Australian labour can be offset to some extent by good design and marketing. The small size of local markets can also be offset by aggressive international marketing, and according to a company spokesperson, that is al-



ready taking place.

As to the bottom line, Tytel is still a bit coy as final details of marketing have still not been worked out. It appears that the 731 will sell for about \$500 and

the 701 for about \$100. The most expensive one will be the 781 at \$600. With current Telecom rental running at \$120 a year for plain old phones the price does not seem excessive.

New non-MIC

The investment and management company N&K Investments created shockwaves on the stock market recently by setting up a technology investment company without MIC status.

An MIC licence is usually regarded as the sine qua non of high technology companies, with its implication of important tax concessions and the availability of government financing. The directors of N&K, however, decided that they were in a strong enough position to do without the bureaucratic and regulatory experience that has soured some MICs.

N&K started out as an investment company with strong property interests, not all that different from a lot of other companies in Australia. In 1983, however, a decision was taken to get rid of most of the company's

property investment and put the money into high technology innovators. The rationale was probably that a lot of the shine had gone from property investment after a number of very good years, while at the same time high technology investment was starting to show some very good returns.

Through 1984 the company invested heavily in Ectron, a maker of voice synthesisers, Jacobs Radio, a telecommunications company and Laser Labs, a laser manufacturer. This year it has invested in EAI as well as carrying out some restructuring of the companies it already owns.

The float of the stock market is designed to raise \$20m, which will be invested in new companies and also used to back up existing investments.

New imaging system

A new Australian-developed satellite receiving and image processing system was launched by the Minister for Science, Mr Barry Jones, at the ANZAAS Festival of Science.

The system is expected to find a large domestic and overseas market, particularly in the Asian and Pacific region. It will enable users to produce pictures from environmental satellites such as the polar-orbiting NOAA satellites for a relatively low initial purchase price.

It consists of two separate but complementary elements: a satellite tracker and receiver developed by the CSIRO and PCM Electronics, and a hardware and software system to process the satellite pictures, developed by CSIRO and Dindima.

PCM and the Dindima Group

are cooperating to offer a complete 'turn-key' system for customers who need a ready-to-go system at a relatively low cost. This is expected to be a major advantage in selling overseas, particularly to developing countries.

The system couples 'state of the art' hardware and modular computer equipment with powerful software. The high-resolution processed images it can provide include weather maps and other meteorological data, earth resources information such as sea temperature profiles for fisheries, vegetation indices for agriculture, and areas of potential or actual mineralisation. The images can also facilitate management of natural disasters such as floods and large bushfires.

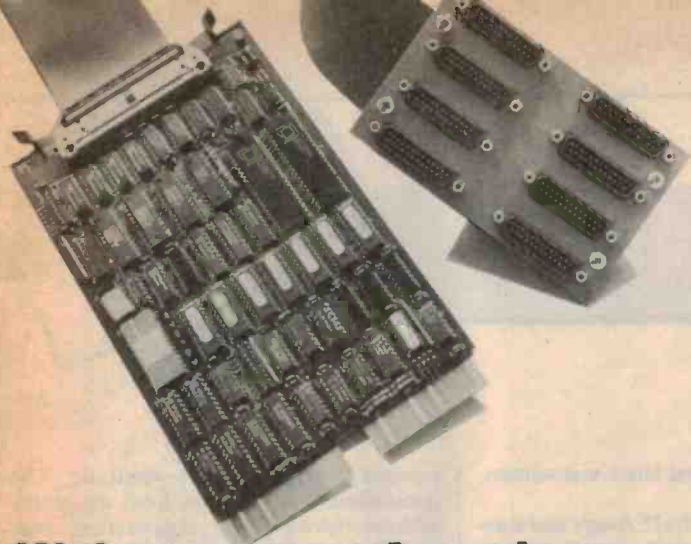

Webster goes American

Australian computer manufacturer Webster Computer Corporation has negotiated a \$US300,000 manufacturing rights contract for its SDZV11 multiplexer board. It's to be built and sold throughout the USA by a Massachusetts computer company.

Launched by Webster at a US computer show in December 1982, the board, which connects terminals and modems to DEC and Qbus computers, has already brought worldwide sales of \$2 million. Now Aviv Corporation of Woburn near Boston, has signed the technology transfer agreement under which the SDZV11 will be the first of a range of Qbus and Unibus MUXes to be developed for the company by Webster.

Webster will continue marketing the board independently in the US via its office in Sunnyvale, California, which is currently making monthly sales of \$US100,000 from the product.

Originally designed for incorporation into the Webster Spectrum and Prism minicomputer

ranges, managing director David Webster has had huge success in selling his MUX as an independent board to the enormous systems builders market throughout the US, as well as in the United Kingdom, Europe, Israel and Japan.

When the SDZV11 was introduced it was half the size and double the capacity of its competitors, yet around the same price.

"I think our success is because we are genuinely innovative," says David Webster.

"Our strategy is to seek out opportunities to redesign existing products so that they incorporate more features into a smaller board with greater market appeal."

Last December, manufacturing and marketing rights of another Webster board, the newly announced Webster ST506 disk controller, were sold to Sigma Information Systems Inc, a Californian board level manufacturer, who is now marketing the controller throughout North America and Europe.

Phone design

Telecom is presently investigating the feasibility of introducing card operated pay phones in Australia to enable customers to make local, STC and ISD calls from a pay phone without the need to insert coins.

To assist in the design, Telecom is taking submissions from interested companies on any concepts or ideas which should be considered in the development of a card operated pay phone.

Submissions should be forwarded to the Manager, Telephones Division, Telecom Australia, 7th Floor, 518 Little Bourke St, Melbourne, Vic 3000 by 11 September 1985 and be entitled: "Card Phone Design Concepts".

Further information can be obtained by ringing (03)606-7441.

BRIEFS

Eurocrays

According to a recent British report, an Anglo-French consortium led by the Royal Signals and Radar Establishment and including Thorn-EMI, its chip subsidiary Inmos, Southampton University, French hardware firm Telmat and French software firm Apsis, plans to make a parallel-processing machine built with Inmos chips. The impetus for the venture has come from winning a contract worth £3m with the EEC's Esprit programme of computer research to develop a 'super computer' over the next three years.

'Up periscope'

An extensive survey of NSW's industry is under way to help clinch the \$2.6 billion RAN submarine replacement project for the state. It is being conducted by the New South Wales Government Submarine Task Force, established to help bring the submarine project to NSW.

The submarine design will be planned around Australian industrial capacity and industries participating in the survey should have their capabilities recognised.

Companies that had not received a survey could obtain one from the Task Force Office by notifying the Industry Liaison Manager, Submarine Task Force, Telex AA23477, or Fax 02/271858.

Plessey delivers

The first milestone in the manufacture of Mulloka Sonar arrays for the Royal Australian Navy was passed last month when management plans were delivered to the RAN by Plessey Australia's Electronic Systems Division.

During the next 42 months Plessey will manufacture the Mulloka Sonar Arrays at its Meadowbank facility in New South Wales, to a contract worth over \$6m.

AWA delivers

A \$6.2 million order for 6.7 GHz 140 Mbit/digital radio relay equipment has been delivered to Telecom Australia, which will significantly upgrade the telecommunications link between Sydney and Brisbane. It uses digital transceivers, modems and protection switching equipment from two Italian companies, Telettra and GTE Telecomunicazioni. AWA assembled the equipment at its North Ryde facility and fully tested the system prior to delivery to Telecom.

More Telecom in '86

Telecom plans to invest \$1930m on new works and services during 1985/86 of which over \$50m will be spent with the building industry. Purchases of technical equipment will total \$1300m. Approximately 90% of the equipment will come from Australian factories.

Telecom chairman Robert Brack said that this, together with the other purchases such as telephone directories, motor vehicles and fuel represents a substantial boost to Australian industry and employment. Telecom itself will need to increase its own work force by about 1800 to maintain a high standard of service provision.

More Viatel

Victoria's Department of Agriculture is the latest service provider to join the national public videotex service.

Welcoming the Department of Agriculture to Viatel, Telecom's general manager, commercial services, Mr Ian Campbell, said that the Service would be called Agtex.

The services will include comprehensive stock market reports, details of the Victorian weather service, detailed pest control information including pest alerts and information and interactive routines for farm management.

Letters to the Editor

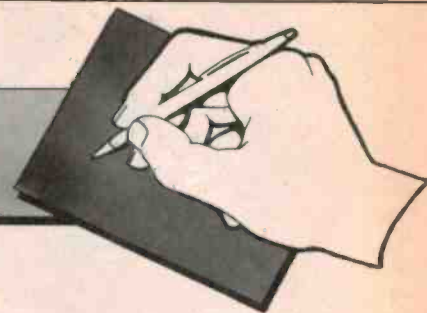

Thanks to Applied Tech

I WOULD JUST like to thank — through your magazine — Applied Technology and its staff in Gosford for assistance in sending me various manuals for the Microbee computer I purchased some time ago. I had given up hope of receiving them from the local Microbee dealer and as a last resort thought I'd try going to the top. A fortnight later I had the manuals. Once again, thank you Applied Technology.

N.R. Watts
Tom Price, WA 6751

Thanks for nothing

THIS IS A STORY about customer relations. Once upon a time there was an Australian company which manufactured and sold a computer. It was a relatively inexpensive machine, designed so it could continually be expanded, and basically the computer performed very well indeed and sold well.

But unfortunately, the company seemed to lack something in the customer relations area, for there was a computer user, and he bought one of this company's computers, and after running his computer for a while and having it upgraded by the manufacturer, he wrote to a company executive with some questions about the computer itself, and questions about software the company had available for sale.

The user had bought a copy of a computer magazine, which included a long listing of a program in the accounting area, which had been written by someone who normally sells software for the user's computer. To shorten this story a bit, the program worked well, except that it would not load data at 1200 baud. The program author suggested there was a problem with the computer, so the user wrote to the manufacturer, asking how to solve the problem.

Four weeks later, no reply had been received from the company executive. No reply about how to solve the problem, and, strangely, no reply about available software, which you would have thought the company was keen to sell.

So, the user sent the company executive a copy of the original letter, and followed this up with a phone call a week later. During that phone conversation, the executive told the user that he'd look at the letter and reply.

But, at the time of writing this, it's eight

weeks since the original letter was written, and still no reply!

How does the user feel? Angry and frustrated at a company which doesn't seem to care.

I have been told of retail companies which are fed up with 'dealing' with this manufacturer, of other users who have had less than satisfactory service from the company itself, or its retail outlets in some states. You see, it's bad customer relations which will eventually cause this company's hive of computer industry to stop buzzing.

Anyone out there want to buy a used Microbee?

Paul H. Bird,
Canberra, ACT 2601

Industry directory

THE MICROELECTRONICS industry in Australia is at a point where it needs encouragement for continued growth. At present those wishing to use microelectronics in their products for the first time are often unsure of who can assist them. There is no single record that lists facilities available in Australia be it for fabrication, computer and design service or expertise in a given area. In fact, some documents produced in recent times contain noticeable errors and omissions. Educational establishments are often spending their limited resources on writing CAD software only to discover they are duplicating work already undertaken elsewhere. There is no agreed set of design rules for many of the microelectronic processes.

To help resolve these and other difficulties it is intended to compile an 'Australian Directory of Microelectronic Facilities and Services' which will improve communications and co-operation in the industry. To this end I am seeking the assistance of educational, industrial and government establishments to compile such a directory. It is intended that the volume be widely circulated and available for a nominal charge to cover production costs.

A series of simple questionnaires has been produced covering areas of printed circuit boards, hybrid thick/thin film, silicon semi-custom, full silicon custom and special custom service. For the venture to be successful both in stimulating the microelectronics industry and assisting in the transfer of this technology to other industries the questionnaire should be completed by all in-

terested organisations in Australia. The questionnaire is available from me at the address below. Some organisations may wish to sponsor the directory and donations in excess of \$100 will be acknowledged in the publication.

Malcolm R. Haskard,
Microelectronics Centre,
School of Electronic Engineering
SA Institute of Technology
PO Box 1, Ingle Farm, SA 5098

National again

I WOULD LIKE to congratulate you for having the guts to print the letters you have received with complaints about the National company, ETI May and August 1985.

These consumers may be interested to know that authorised service agents fare no better. I have waited over six months for a part for a current model TV receiver, and an associate has reported a delay of two years for a replacement power transformer for an amplifier which is only three years old!

Part of the blame must be laid at the practice of putting out new models every two or three months, and the very short production runs of receivers and amplifiers etc which are often less than 5000 units. However other companies can supply parts: Sharp Corp, for instance, will invariably send parts to me within three days of my telephone order.

An even more upsetting part of National's policy is the non-provision of parts for video recorders unless you can quote the serial number of the machine for which the parts are required. This means that unless I can predict which machines will break down and when, I cannot stock even the most elementary spare parts such as drive belts and lamps.

It is a great shame that we do not have a strong technicians service association in Australia which could get some action on the many problems technicians face with regard to the service of National products.

Please do not print my name and address on this article as it would almost certainly mean I would get even worse service (if that is humanly possible), but I am prepared to substantiate all the claims made in this letter.

Name withheld

Eurovox Car Sound Goes the Distance



eurovox
Car Audio Systems

See your Eurovox dealer or telephone
Eurovox Toll Free (008)33 5032



LD10748200

ON/OFF

OPEN/CLOSE

MOTOR POWERED LOADING

COMPACT
disc
DIGITAL AUDIO

REM

CD304 compact disc player · LASER TRACKING · FULL REMOTE CONTROL



COMPACT
disc
DIGITAL AUDIO

PHILIPS

REMOTE CONTROL (CD304)

REPEAT



We want you
to have the best.

PHILIPS

Imagine the remote possibilities



There was a time when music played by laser was considered a remote possibility. Then Philips invented the Compact Disc. In doing so they made sure they could produce the very best Compact Disc player there is.

The CD304.

One outstanding feature of the CD304 is the Infra-Red remote control which means you can programme and operate the player from anywhere in the room. Another is the high quality headphone amplifier with separate level control – perfect for pure, private sound.

Combine those features with the unique music scan capable of up to 20 track programming and you'll see why the CD304 is Philips' top of the range Compact Disc player.

Philips imagined perfect sound and invented the Compact Disc. Now, with the CD304, you can experience the very best there is.



Philips Compact Disc.
Imagination leads the way.

COMPACT
disc
DIGITAL AUDIO

PMP V451

SATELLITES OVER AUSTRALIA

Jon Fairall

What with flying saucers, satellite dishes and pies in the sky, is the Milky Way a huge restaurant? The possibility has been explored before! For the hungry consumer we offer the ETI guide to the satellite smorgasbord.

AS AUSSAT LURCHED historically upward the nation's attention was focused on space as never before. What did it see? Aussat employees dripping with champagne? Certainly. The sheer exhilaration of a big rocket making a noise? Oh yes. And in the popular press effusive articles along the lines: "ain't science wonderful?". All over the place. But other groups had less reason to cheer.

In Telecom: a quiet beer of commiseration to all the money that could have gone into optical data links. In the offices of media magnates: thanks that they have managed to so emasculate video services on the satellite that the horrid spectre of competition has disappeared out the door (hopefully for ever). In the city: the knowledge that we have been suckered by the country cousins yet again. We all pay for it, they reap the benefit. And in the country: a belief that all is not as it should be. Why will it cost \$3000-\$4000 to set up an Aussat TVRO system (see the glossary for a compendium of the jargon), when the government predicted half that price only last year?

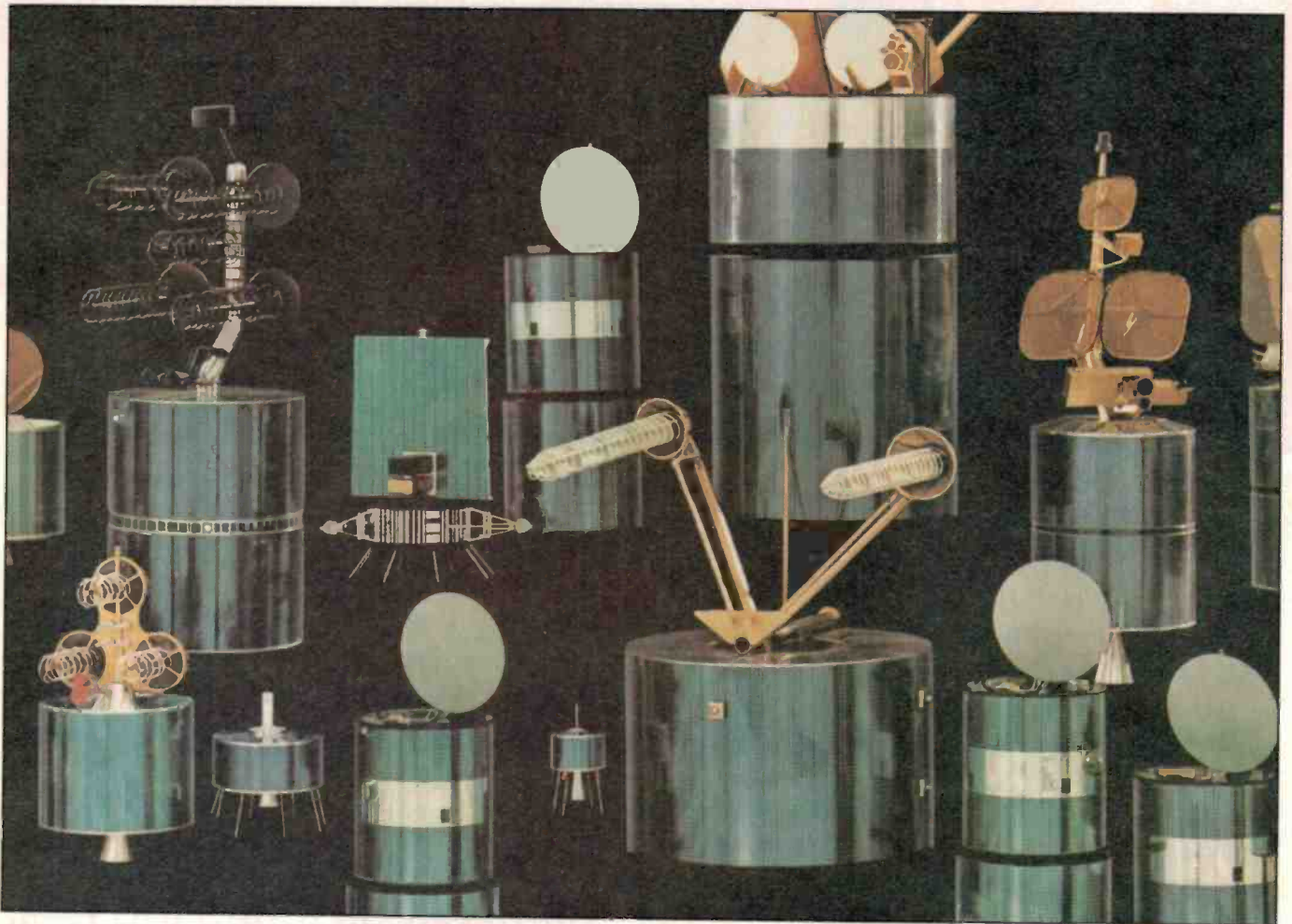

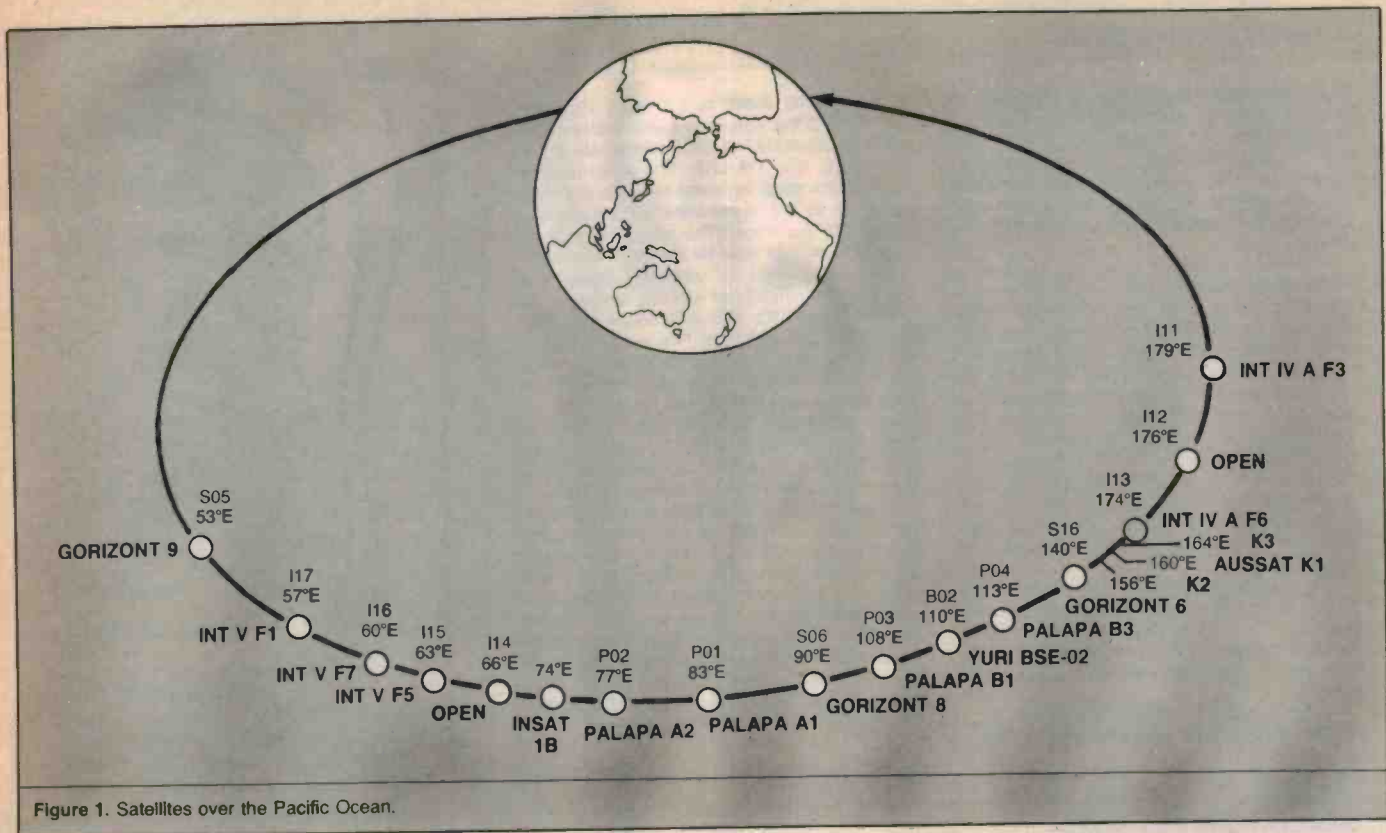

Figure 1. Satellites over the Pacific Ocean.

There has been little public controversy over the data links in Aussat, except from Telecom. But behind the screens, a considerable amount of lobbying has been taking place as potential customers try to drive the price down. It's been quite a game of poker; at launch eve, Aussat supreme Graham Gosewinckel was still unable to point to a single complete, signed, sealed and delivered contract.

Aussat TV

The TV links, on the other hand, have been talked about ad nauseam for years. It now seems certain that Aussat spot beams will carry the ABC plus one commercial channel, plus a bit of assorted radio tagged on the side. The commercial channel will be provided by consortiums of existing commercial broadcasters. For the future, Communications Minister Duffy has hung his hat on a policy of "equalisation", which means that Aussat, eventually, will provide three commercial channels. However, it's still not clear how this will be managed, especially in the face of opposition from the media proprietors.

As service providers slowly gear up to provide the pictures on Aussat, manufacturers and distributors are also moving in to provide the hardware needed on the ground. In the market place is a host of new names, as well as some old familiars. AWA, NEC, Toshiba and Mitsubishi are all there providing down stations. New faces include Satellite Systems, Acesat, Homesat and Videosat. All these companies provide a mixture of local and imported parts to provide a complete TVRO. Also coming to

EIRP LEVEL	Antenna Size	4 METRES			5 METRES			6 METRES			7,5 METRES			10 METRES			
		LNA	NT	120° 90° 60°	120° 90° 60°	120° 90° 60°	120° 90° 60°	120° 90° 60°	120° 90° 60°	120° 90° 60°							
34 dBW		+2.4	+3.4	+4.7	+4.9	+5.9	+7.2	+6.9	+7.9	+9.2	+8.8	+9.8	+11.8	+11.2	+12.2	+13.5	
33 dBW		+1.4	+2.4	+3.7	+3.9	+4.9	+6.2	+5.9	+6.9	+8.2	+7.8	+8.8	+10.1	+10.2	+11.2	+12.5	
32 dBW		+0.4	+1.4	+2.7	+2.9	+3.9	+5.2	+4.9	+5.9	+7.2	+6.8	+7.8	+9.1	+9.2	+10.2	+11.5	
31 dBW		-0.6	+0.4	+1.7	+1.9	+2.9	+4.2	+3.9	+4.9	+6.2	+5.8	+6.8	+8.1	+8.2	+9.2	+10.5	
30 dBW		-1.6	-0.4	+0.7	+0.9	+1.9	+3.2	+2.9	+3.9	+5.2	+4.8	+5.8	+7.1	+7.2	+8.2	+9.5	
29 dBW		-2.6	-1.4	-0.3	-0.1	+0.9	+2.2	+1.9	+2.9	+4.2	+3.8	+4.8	+6.1	+6.2	+7.2	+8.5	
28 dBW		-3.6	-2.4	-1.3	-1.1	-0.1	+1.2	+0.9	+1.9	+3.2	+2.8	+3.8	+5.1	+5.2	+6.2	+7.5	
27 dBW		-4.6	-3.4	-2.3	-2.1	-1.1	+0.2	-0.1	+0.9	+2.2	+1.8	+2.8	+4.1	+4.2	+5.2	+6.5	
26 dBW		-5.6	-4.4	-3.3	-3.1	-2.1	-0.8	-1.1	-0.1	+1.2	+0.8	+1.8	+3.1	+3.2	+4.2	+5.5	
25 dBW		-6.6	-5.4	-4.3	-4.1	-3.1	-1.8	-2.1	-1.1	+0.2	-0.2	+0.8	+2.1	+2.2	+3.2	+4.5	
24 dBW		-7.6	-6.4	-5.3	-5.1	-4.1	-2.8	-3.1	-2.1	-0.8	-1.2	-0.2	+1.1	+1.2	+2.2	+3.5	
23 dBW		-7.4	-6.3	-5.2	-5.1	-4.1	-3.8	-4.1	-3.1	-1.8	-2.2	-1.2	+0.1	+0.2	+1.2	+2.5	
22 dBW					-7.3	-7.1	-6.1	-4.8	-5.1	-4.1	-2.8	-3.2	-2.2	-0.9	-0.8	+0.2	+1.5
21 dBW						-7.1	-5.8	-6.1	-5.1	-3.8	-4.2	-3.2	-1.9	-1.8	-0.8	+0.5	
20 dBW							-6.8	-7.1	-6.1	-4.8	-5.2	-4.2	-2.9	-2.8	-1.8	-0.5	
19 dBW								-7.1	-5.8	-6.2	-5.2	-3.9	-3.8	-2.8	-1.5		
18 dBW									-6.8	-7.2	-6.2	-4.9	-4.8	-3.8	-2.5		
17 dBW										-7.2	-5.9	-5.8	-4.8	-3.5			

Table 1. Margin-above-threshold Chart for 4-, 5-, 6-, 7.5- and 10-metre aperture antenna earth stations

prominence are antenna companies like Andrews, Hills and Codan, providing an often exciting mix of locally produced product made to highly sophisticated specifications.

They all have in common the use of a Plessey receiver. Plessey is local licensee of the BMAC process, the only company with the legal right to provide decoding apparatus for the signal. The original deal was that Plessey would provide decoder boards to local and foreign manufacturers for inclusion in their own product, at a favourable

price and with the right timing. Not surprisingly, this hasn't happened. The only available hardware from Plessey is a BMAC receiver, but not until November, six months after the due date and only one month before the start of services. Plessey has plans to produce 1750 receivers up to the end of 1985 and 2000 a month after that, less according to many suppliers, than the market will need. A decoder board, which other manufacturers could use in their own product, will not be available until the middle of 1986, a year late. The original pricing has

GROUND STATION DESIGN

The overriding consideration in designing a satellite system is noise suppression. There are a few reasons for this. One is that the signal path is long compared to conventional transmission systems, so losses abound. Another is that it's difficult to amplify the signals and therefore they are vulnerable to corruption by noise.

In satellite systems, noise is described in terms of temperature, rather than in terms of power or voltage level. This might seem rather odd until one remembers that temperature is as much a measure of energy as watts. To quantify things, physicists have invented the idea of the black body, an idealised lossless transmitter or absorber of energy. At absolute zero (zero Kelvin) there is no energy in the box, and thus it radiates nothing. As the temperature increases so the amount of energy leaving the box goes up. (Students of physics will have sweated over a lovely lad called Stefan, whose law says energy is proportional to the fourth power of temperature.)

We can use this idea of noise temperature for any transmission system, although for most purposes it's not very useful. It comes into its own with satellite systems because we need to take such stringent steps to reduce noise in the system.

Avoiding noise constrains the design of a ground station to the extent that they all follow

essentially the same pattern (see Figure 5). The head of the system is a dish antenna. Signal is concentrated at the focus, where a feed horn ducts it to the LNA. The noise performance of this stage is critical because any noise added in to the signal here will be amplified along with the signal. The primary role of the LNA is to provide drive for the down-converter.

Down-conversion is necessary because of the inherent difficulty of handling signals in the gigahertz band. It's difficult to obtain any amplification at this frequency; it's even difficult to get the signal to pass down a coax cable without dramatic losses. As a result down-conversion occurs as close to the focus of the antenna as possible. Typically output of the converter is 70 MHz, suitable for passing along wire and easy to handle in the receiver. This is known as the satellite intermediate frequency.

The final step is the satellite receiver. The receiver is, as its name suggests, the device that decodes the satellite signal into a form and at power levels that can be accepted by a standard TV. In the Aussat system, the receiver contains the BMAC decoder set, and separates out the video, audio and data feeds. In a conventional 4 GHz system it will provide a facility for separate tuning of the audio sub-carrier. However, its most important function is to provide sufficient gain for the input of the TV.

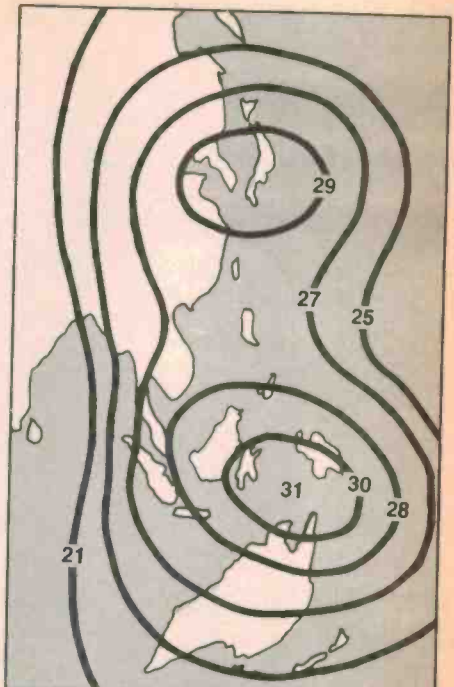

Figure 2. West hemi EIRPs include ABC and AFRTS. From Intelsat IVA — F3 at 179°W.

CALCULATIONS FOR TVROs

Somebody eminent once said that if you can't measure something you don't know much about it. Following that dictum, here is a list of the principle units and typical numbers used in satellite systems.

EIRP

Most important of all: the EIRP, (effective isotropic radiated power). This is a measure of the strength of the signal on the ground. As one would expect it's strongest at the centre of the coverage area (the bore site), and falls off towards the beam edge. Near the bore site of an Aussat transponder EIRP figures of about 51 dBW have been predicted. Intelsat IVA figures of about 16 dBW are typically observed in Sydney.

Antenna gain

Gain is measured in dBi, ie, output relative to an isotropic radiator. An isotropic radiator is a theoretical point source that radiates in all directions equally. It is thus a measure of the extent to which the antenna is able to concentrate the signal in one direction.

Some typical numbers: Andrews Antenna makes some highly regarded dishes with gain of 44 dBi. Other things being equal, the bigger the dish, the higher the gain.

LNA

As you might guess, the most important thing one asks about an LNA is its noise temperature. Ambient is 273 K, so anything below that is properly called low noise. In practical satellite systems, numbers start at about 160 K and go down to about 50. The standard in Australia seems to be shaping up to be about 55 K. Note that in large commercial down-stations figures as low as 3 or 4 K are common. However, such systems need to be physically cooled with liquid gas to achieve these figures.

The gain of a typical satellite LNA might be expected to be about 40 or 50 dB. Note, however, that the purpose of the LNA is just to provide sufficient power to drive the down-converter.

If more gain is provided than necessary for this task the net effect will be to degrade the overall noise performance of the system.

C/N

The carrier-to-noise ratio expresses the relative power of carrier and noise in dB. The measurement is made at the output of the LNA, and should be greater than 8 dB for good reception with most receivers, although usable results can be achieved down to 6 dB. Note that these figures will produce a signal-to-noise ratio of about 40 dB at the input to the TV.

G/T

Gain on temperature is often called the 'figure of merit' for a down-station. It is calculated with the formula:

$$G/T = G - \log T$$

where G is the gain of the antenna and T is the added noise of the components of the system in Kelvin. According to NEC, typical figures might look like this:

$$G \text{ (for a good 1.5 m antenna): } 44 \text{ dBi}$$

$$T \text{ (including noise from antenna, LNA and down-converter): } 300 \text{ K.}$$

So:

$$G/T = 44 - 10 \log 300$$

$$= 19.2 \text{ dB/K}$$

The relation between C/N and G/T is given by:

$$C/N = G/T + EIRP + K$$

where K is a constant which for our purposes is set equal to -50.9.

A bit of arithmetic will show you that in the presence of a typical Aussat EIRP of 47 a G/T of 19.2 results in a C/N of 15.3, more than adequate for most purposes. Incidentally, as a rule of thumb NEC advises that the difference between C/N and S/N in a BMAC decoder is 31 dB, so these figures lead to a S/N of 46.3 dB.

4 GHz FROM
SATELLITES

FM MODULATED
IF S/N > 8dB

RECEIVER

TV SIGNAL
S/N > 40dB

TV

Figure 5. Block diagram of a TVRO.

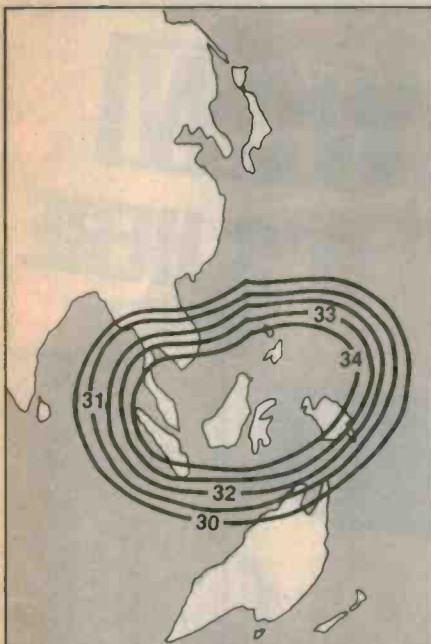

Figure 3. Spot beam contours for RPN 9 TV Manila (tr 5), Warner 2 TV Malaysia (tr 9) and QTR 7 Indonesia Television (tr 14). On board Palapa 2 at 77°E.

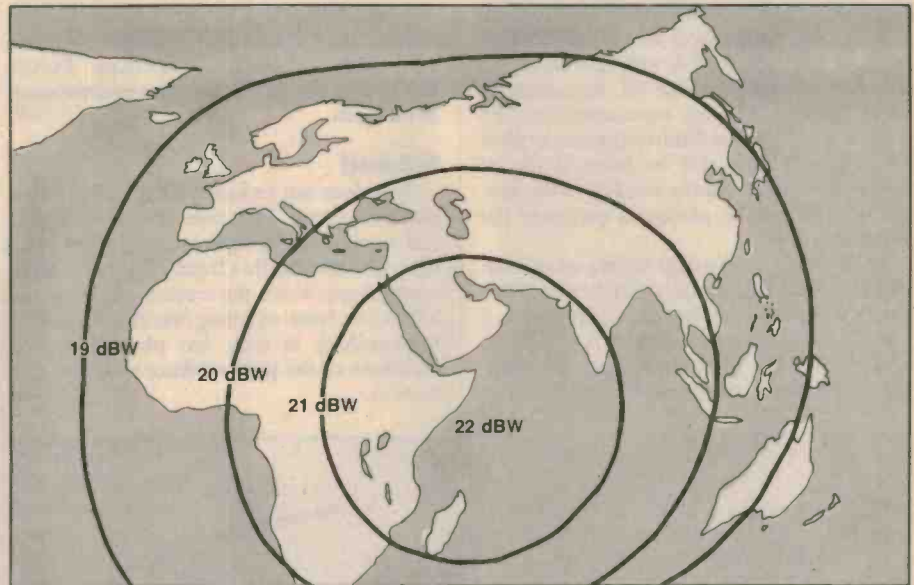
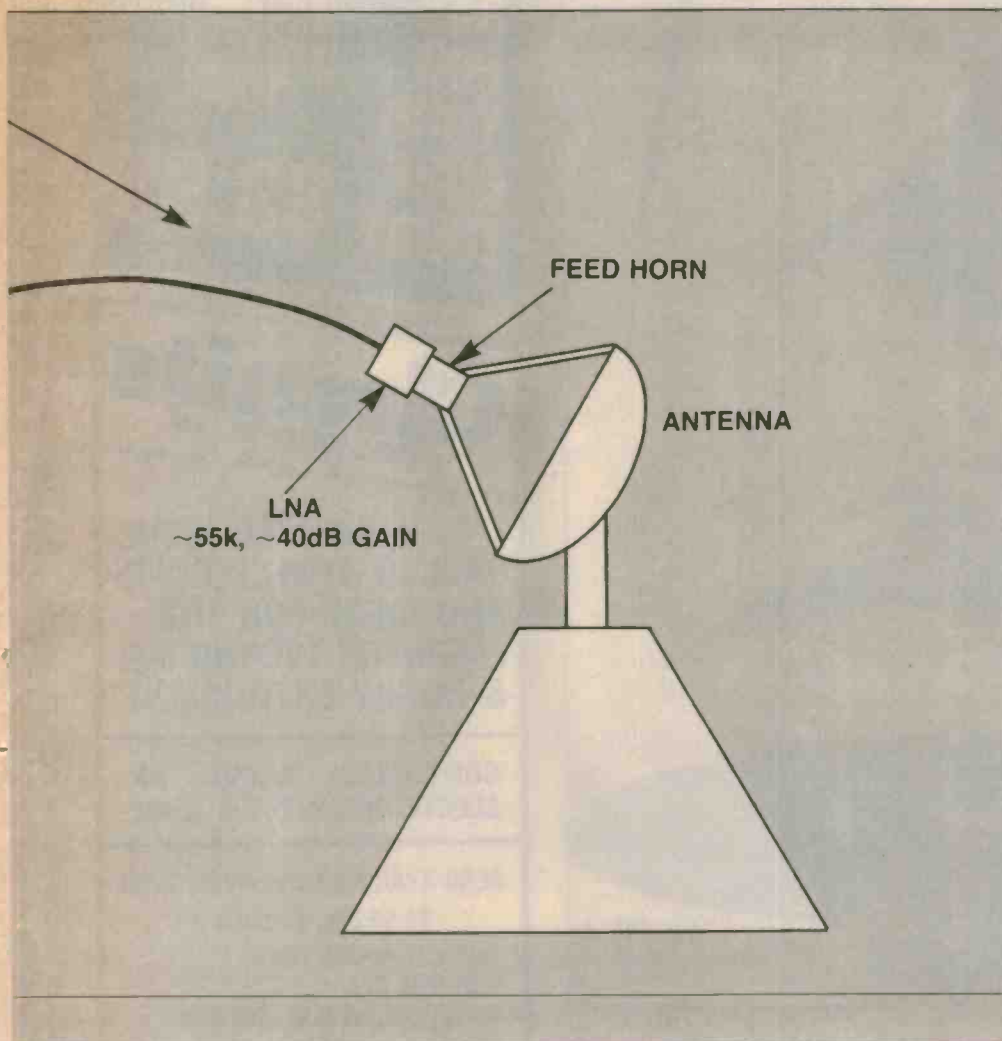

Figure 4. Global beam coverage includes Oman Television (tr 20). From Intelsat V — F1 at 57°E.



proved rubbery. Although Plessey will not reveal its prices, distributors here expect the price to be 50 per cent higher than originally planned. And this has been substantially responsible for taking the final price of a TVRO so high.

At the Department of Communications (DOC) they've been following this little saga with growing concern, although the official view is that they are "extremely happy".

The concern is not only with the role Plessey is taking, but also with the future of the BMAC format itself. There is a growing suspicion that it will turn out to be a transitional technology. The view is that BMAC will turn out to be half-way to a high definition (HDTV) and/or completely digital system that will become available about the end of the decade.

C-band birds

There is another side to the whole question of satellites. Aussat is not the only bird in the sky by any means (see Figure 1). A large number of satellites are visible above our horizon, albeit with very weak signals. Most of these are C-band transponders, as opposed to the Aussat type Ku-band.

It's been satellites of this type, notably the Intelsat IVA, F3, that have been responsible for domestic satellite transmission up to now. This has included ABC services to the outback through RATS as well as the international and domestic links of the commercial channels. The news links are often videplexed, although still worth chasing on the off-chance that they are not.

The American Forces Radio and TV Service network (AFRTS) and other news feeds will be available on F3, until Decem- ▶

FEATURE

ber 1985. Thereafter the ABC function will transfer to Aussat, and all the other functions of the ageing IVA will be transferred to a new Intelsat V called F8. According to local Hughes Aircraft representatives, F8 will be in a slightly different position from F3. The old craft will be boosted out of Earth orbit to eventually wind up in the sun, but F8 will not be placed in precisely the same slot.

In addition, and easily visible over most of the Pacific Basin, are a number of Intelsat IVs and Vs, the Russian Gorizont 6, 8 and 9, the Indonesian Palapa A1, A2, B1 and possibly B3, the Indian Insat and a couple of Japanese numbers. Programming is

diverse: Moscow TV, RPN 9 the Philippines, TBS 5 Bangkok, TV Oman, Warner TV7 Kuala Lumpur, American Forces Radio and TV (AFRTS), plus international news feeds.

S-band

This does not exhaust the list of possible targets in space. There are four meteorological satellites in geosynchronous orbit. The one over the Pacific Ocean is GMS 3 and in many respects it's the easiest target of the lot. Apart from anything else the Bureau of Meteorology is only too pleased to see members of the public taking an interest in its bird. ▶



62.5 dBi, just right for the backyard.

WOW! IT'S HERE

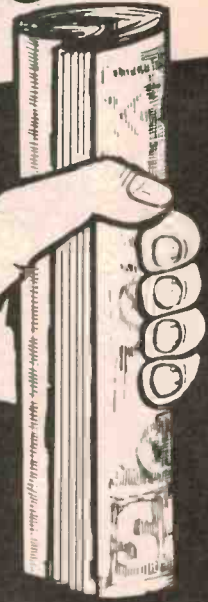

ASK
FOR
YOUR
COPY
TODAY

\$3.95

AN ELECTRONICS TODAY PUBLICATION

Circuits

COOKBOOK #5

A BUMPER ISSUE
PACKED WITH CIRCUITS
AND IDEAS FOR THE
ENGINEER TECHNICIAN
& HOBBY ENTHUSIAST

COMPUTERS + AUDIO + RF
ELECTRONIC MUSIC & MORE

ALSO AVAILABLE BY MAIL ORDER

\$3.95 plus \$1 postage

FEDERAL MARKETING

P.O. BOX 227

WATERLOO, N.S.W. 2017

YOU CAN RECEIVE TELEVISION WHEREVER YOU ARE, WITH AWA EARTH LINK.

Australia's first communications satellite, AUSSAT 1, has now been placed in orbit. For the first time television and radio reception will be available to isolated communities or homesteads anywhere in Australia via the Homestead and Community Broadcasting Satellite Service (HACBSS).

The satellite system

Known as AUSSAT, the Australian national satellite communications system will initially have two operating satellites.

The satellites will be in orbit 36,000 km above the equator at a longitude a little east of Australia.

Satellite services

A wide range of services will be provided to the entire continent and offshore islands.

Services will include HACBSS direct television and radio broadcasts to homesteads and remote communities, high quality television relays between major cities, digital data transmission for both telecommunications and business use, voice applications for urban and remote areas and centralised air traffic control services.

Earth stations

To use the satellite system you need ground equipment, known as communications earth stations, appropriate for the service required.

Earth stations use dish-type antennas of varying diameters and costs, depending on the services used.

AWA Earth Link

AWA Earth Link is a receive-only earth station for reception of HACBSS television and radio.

HACBSS signals will cover all of Australia and will, for the first time, bring programs to remote homesteads and areas where present broadcasting reception is poor.

AWA Earth Link earth stations will be distributed and guaranteed throughout Australia by AWA-Thorn.

For the location of your nearest AWA dealer, please telephone:

Sydney, 638 8444; Newcastle, 52-7088;
Melbourne, 459 1688; Brisbane, 44 7211;
Townsville, 72 2255; Canberra, 80 5314;
Adelaide, 269 1966; Perth, 277 7788;
Hobart, 72 4366; Darwin, 84 3243.

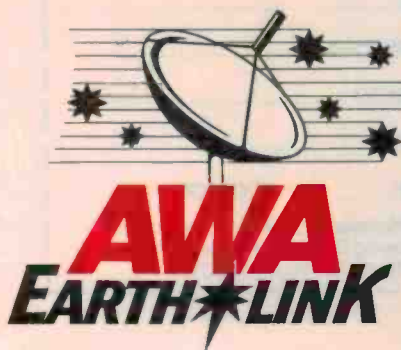

SIEMENS

VARISTORS

**Australia's widest range.
All applications. Biggest stocks.
Lowest prices. Quickest delivery.
What else?**

Siemens is now the biggest and best source of varistors in Australia with a full size range for all applications up to 70 kA. This is of special interest to the telecommunications industry.

Comprehensive stocks, plus Siemens position as one of the world's largest manufacturers of varistors underwrites our promise of quick delivery and suitability.

Siemens innovation aims at achieving substantial cost reductions across a wide spectrum in the following applications:

- Power engineering
- Electronic communications
- Power electronics
- Measuring technique
- Processing technique
- Office electronics
- RFI suppression
- Stepped protection

This wide range of varistors is available through Siemens newly strengthened national distributor network. For further information, post the coupon or phone your nearest distributor.

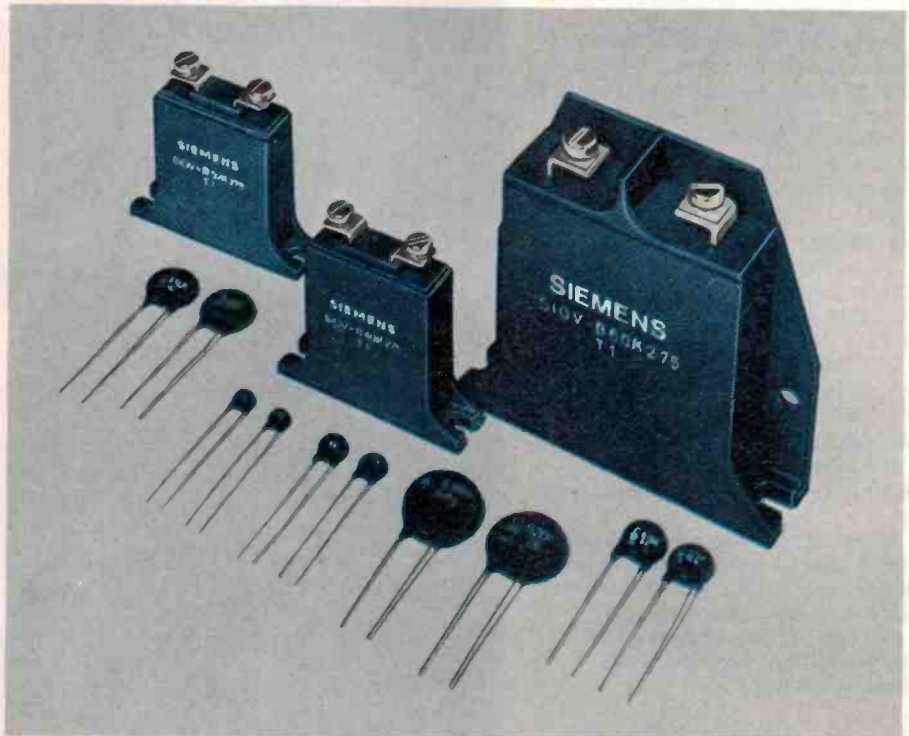

Distributors

Victoria: Promark Electronics (Vic)
(03) 878 1255

New South Wales: Nexus Electronics Pty Ltd
(02) 439 5800

New South Wales: Promark Electronics Pty Ltd
(02) 439 6477

Queensland: ECQ Electronics
(07) 376 5677

South Australia: R.G. Pank Pty Ltd
(08) 51 2411

South Australia: Protronics Pty Ltd
(08) 212 3111

Western Australia: Reserve Electronics
(09) 328 9755

New Zealand: Delphi Industries Ltd
Auckland 563 259

Siemens Ltd.

544 Church St., Richmond, Vic.
Melbourne: 420 7318 Sydney: 436 8730
Brisbane: 369 9666 Perth: 362 0123

Please mail me the new informative varistors brochure.

NAME

TITLE

COMPANY

ADDRESS

STATE..... POSTCODE.....

Post this coupon now to Siemens Ltd.
Advertising Department, Melbourne.
544 Church St., Richmond 3121.

INGENIOUS ELECTRONIC ENGINEERING

Electronics Today's FREE Reader Information Service

This service is designed to make it easy for readers to receive further information on the products and services advertised in this issue of Electronics Today.

Look up the name of the advertiser in the index at right and transfer the code number shown to a box on one of the tear-out reply-paid response cards opposite. To specify a particular product, you may need to add a code number (eg, product code number) shown in the advertisement itself. Do this for up to six products, if you wish. Then fill in the rest of the card and drop it in the mail.

We will direct your enquiries to the advertisers concerned so that they can send you the information you've requested. It's easy, avoids cutting up your magazine and saves you the time and effort of writing letters. But remember to fill in the complete card, to ensure that you get the information you want.

The cards in this issue must reach us before the end of the month of publication (ie, the month on the cover).

NOTE: This Advertiser Index and Reader Information Service are provided as an additional service to readers. The publisher cannot assume any liability for errors or omissions. The absence of a code number for any advertiser indicates that no further information is available for the products advertised.

ADVERTISERS' INDEX

Advertiser	Code	Page Number
AF Bambach	11093	29
AWA Thorn	11007	17,129
Acesat Satellite Receiver Corp	11092	21
Active Electronics	11002	121
Allan Bradley	11096	95
Allen Branch Hobbybot robot kit offer	11100	119
Altronics	11004	56,57,64, 65,102,103
Associated Controls	11099	120
Cooper Tool	11009	4
Daneva Australia	11010	88
Dick Smith Electronics	11012	38,39, 58,59,89
Disco World	11013	110
Electron Alarms	11094	37
Electronic World	11039	110
Elmeasco Instruments	11095	69,73,80
Emona Instruments	11052	99
Energy Control	11017	101
Eurovox	11091	9
Ferguson Transformers	11020	46
Geoff Wood Electronics	11044	47
Icom Australia	11022	101
Jaycar Electronics	11023	42,43,50,51
Leisure Imports	11024	29
Microtrix	11025	72
Philips	11027	IBC,10,11
Prepak Electronics	11029	25
Preston Electronic Components	11098	110
Rose Music	11032	OBC
Rod Irving Electronics	11031	22,23,35, 76,77,85
Scientific Devices	11083	100
Siemens Ltd	11035	18
Statronics	11074	123
Subscriptions offer	11088	115
Syntec	11089	IFC
Telecom Australia	11075	128
University Graham Instruments	11097	99
Wireless Institute of Australia	11041	128

RECEIVING WEATHER PIX

Meteorological Information is disseminated from GMS in two forms: as a high definition and a low definition picture. As one would expect the high definition picture has more information content and uses higher frequencies than the low definition image.

For high definition reception the carrier frequency is 1687.1 MHz, using an FM-FM modulation system. The base bandwidth is 21 kHz, which modulates a sub-carrier ($f_c = 99$ kHz) to a deviation of 29 kHz. This carrier then modulates the main carrier with 300 kHz deviation. Using this system a picture of 4562 lines is assembled in about 12 minutes.

The low resolution signal is received at 1691 MHz and down-converted to 137.5 MHz. An FM detector in the receiver detects the AM sub-carrier at 2.4 kHz. When this system is used by the bureau to generate weather pictures the AM signal directly modulates a fax machine. A typical picture is composed of about 800 lines and takes about 3.5 minutes to complete.

On low resolution signals the world view obtained from the satellite is split up into seven overlapping sectors. These are transmitted sequentially from the satellite.

```
10 CLS
20 PRINT " AUSSAT ANTENNA POINTING INFORMATION"
30 PRINT " -----"
40 PRINT " A Program developed to calculate the"
50 PRINT " Antenna Elevation and Azimuth Pointing"
60 PRINT " angles to the three AUSSAT satellites."
70 PRINT " M. JOHANNESSEN, NEC/AUSTRALIA PTY,LTD"
80 PRINT " AUGUST 1985";
90 FOR I=1 TO 5000:NEXT I
100 CLS
110 PRINT "INPUT SATELLITE LOCATION (156,160,164)"
120 INPUT LSAT
130 PRINT "Earth Station Location Information"
140 INPUT "Input Latitude, (deg,min)";TH, TM
150 INPUT "Input Longitude, (deg,min)";NH, NM
160 PRINT
170 PRINT " CALCULATING"
180 DR=3.14159#/180
190 REM Conversion from Degrées to Radians
200 RD=1/DR:NE=.43429
210 REM NE=Conversion from LOG10 to LOGE
220 LD=(LSAT-(NH+NM/60))*DR
230 REM Difference in Longitude in decimal degrees.
240 LE=(TH+TM/60)*DR
250 REM Latitude in decimal degrees.
260 H=35786!:RE=6378
270 REM H=Geostationary Orbit Height.:RE=Earth Radius.
280 X=COS(LE)*COS(LD)
290 D=(H/RE)*(H/RE)+2*((1+(H/RE))*(1-X))
300 D=RE*SQR(D)
310 Z=ATN(X/SQR(-X*X+1))+1.5708
320 AZ=SIN(LD)/SIN(Z)
330 AZ=ATN(AZ/SQR(-AZ*AZ+1))*RD
340 AD=INT(AZ)
350 Y=(RE+H)/D:Y=Y*SIN(Z)
360 EL=(-ATN(Y/SQR(-Y*Y+1))+1.5708)*RD
370 ED=INT(EL)
380 CLS
390 PRINT " ANTENNA POINTING ANGLES"
400 PRINT " -----"
405 PRINT " DEGREES"
410 PRINT "Azimuth Angle "USING "####";AD
420 PRINT "Elevation Angle "USING "####";ED
440 END
```

The general principles of its operation are easy enough: GMS is a spin stabilised satellite turning at 100 rpm. The primary instrument on board is the VISSR, or visible and infrared spin scan radiometer. The VISSR uses the spin of the satellite to derive east-west scan for the imaging system. A small stepping mirror moves the optical path in the north-south direction. A complete Earth image requires 2500 east-west scans, so it needs 25 minutes to do the whole job.

The picture is down-linked to the main control centre in Japan, where image intensification, coastlines and co-ordinates are superimposed. Then it is sent back up to the satellite for broadcast to all and sundry. It can be received as a high or low definition image, depending on the bandwidth and sensitivity of the reception system.

Constraints

So just how practical is it to receive all these signals? Clearly, the answer depends to a large extent on how much money you are prepared to spend. The weaker the signal, the more money you need. It also depends on just where you live, since as a general rule signal strength falls off the further south one goes. Most of the transmissions are aimed at places to the north of us. People in Darwin or most of Queensland should be able to receive signals with very little effort. Out in the Pacific, there is a veritable smorgasbord of signals just waiting to be devoured.

So, what are the choices that need to be made? Apart from things like making sure you have a TV and receiver compatible with the incoming signal (ie, BMAC, PAL NTSC or SECAM) the choices are actually rather small: what size aerial and what temperature LNA.

Clearly, one way to go is to get yourself a big aerial. This is the 'radio astronomy' approach used when, like designers of the Australia Telescope, you want to extract EIRPs infinitely close to zero out of a noisy sky. But this has its limitations. Firstly, neither neighbours nor councils like people who stick great wire edifices all over the neighbourhood. Secondly, it is worth remembering that doubling dish area increases gain by 3 dB, but increases cost about five times. Making the dish bigger also increases mechanical problems, and multiplies the effect of pointing errors.

The second thing to be considered is the quality of LNA required. Improving the temperature is an excellent ploy, except that it too runs up against the fact that towards, in this case decreasing noise temperature, are proportionally smaller than increasing cost. There are also limits beyond which reduction of noise within the system is irrelevant, as when there is already too much noise in the system from the sky or the antenna or the rest of the system.

There is a third way of influencing the

picture, and that is by changing the bandwidth of the intermediate frequency. The argument here is that the noise is wideband noise, spread across the entire spectrum. The picture we want is relatively concentrated. Therefore cutting down the bandwidth of the IF can improve the overall S/N. The limits of this are that if the filter cuts off too much information from the baseband signal the picture starts to fall apart, noise or no noise. It appears that bandwidths as low as 12 MHz may give useful pictures as well as an increase in C/N of 5 dB from a 36 MHz transponder. Often this feature is found inbuilt in the receiver. In other cases it's necessary to buy a separate filter unit and insert it in the IF feed.

Doing it

According to Dick Smith Electronics, at least some of these C-band signals can be received at latitudes as far south as Sydney. In fact recently DSE demonstrated a 13 foot dish with a Chapparral horn feed and a 55 K LNA. It was pulling in signals from Intelsat F3 that were noise free on the ABC transponders. AFRTS was a bit more difficult to assess because we could only see a black and white picture, due to the fact that it is broadcast using the American NTSC standard. Incidentally, a multistandard receiver, at least NTSC/PAL, is a necessity for satellite receiving. Of course, this exercise doesn't prove that all the other C-band signals are available but at least it demonstrates that efforts in this direction are worthwhile.

If you're sick and tired of playing around with computers, this might be your next hobby.

GLOSSARY

Aussat: Applied variously to the Australian domestic satellites and to the company that operates them. Properly, the satellites are called Aussat 1, 2 and 3, and the operator is Aussat Pty Ltd, owned by Telecom, OTC and the Federal Government.

BMAC: B version of the multiplexed analogue component TV transmission method advanced by the Independent Broadcast Authority in the UK, and subsequently developed by Plessey and Scientific Atlanta in the UK and Canada.

C-band: Transmit on 6 GHz; receive on 4 GHz. Satellites of this type include Palapa and Intelsats.

Geosynchronous satellite: A satellite in an orbit 36,000 km from the Earth with zero inclination with respect to the Earth's equator. Its orbital period is 23 h 56 m. If a satellite is placed in such an orbit it appears stationary in the sky. It's also known as geostationary orbit.

GMS-#: Geostationary meteorological satellites. A series of meteorological satellites launched by Japan and used by all western hemisphere nations to receive cloud pictures of the region.

Hughes Aircraft: One of the big names in satellite manufacturing. It made both Aussat and the Intelsat IVA we currently use for domestic applications.

Intelsat: An international consortium set up to run the world's communications satellites. The name is also used to refer to the satellites run by this organisation. Satellites are clustered in groups of three over the Pacific, Indian and east and west Atlantic oceans. Individual satellites are denoted by an F number. Intelsat 1, also called "early bird", was the first communications satellite in regular use. Several generations have been deployed since then. Current Intelsats are IVA, being replaced by Vs. Intelsat VIs will be on line soon.

Ku-band: Transmit on 14 GHz; receive on 12.5 GHz. This type of satellite includes all the Aussat spacecraft.

Low Earth orbit: The lowest practical path of a

satellite around the Earth. It's set by the top of the atmosphere and is usually reckoned to be about 200 miles up. Orbital period is 90 minutes.

NASA: National Aeronautics and Space Administration. Trans Pacific guys and gals big in the sat launch business.

RATS: Remote Area Television Service. A TV service relayed by the ABC via Intelsat and now Aussat for TVRO stations and then re-broadcast with UHF translators for local dissemination.

S-band: Receive on 1.6 GHz. In Australian skies this band is reserved for meteorological signals from GMS.

Spin stabilised: The satellite spins about its axis like a top. The gyroscopic forces thus created keep the axis of the satellite stationary in space and allow accurate pointing of the antenna. The antenna is mounted on a 'despun' shelf that does not share the spinning motion of the satellite. All Aussat craft are of this type.

Transponder: A black box on the satellite that receives, amplifies and retransmits signals from the ground. Its power rating is the rating of the transmitter that sends the signal back to Earth.

Three-axis stabilised: A non-spinning satellite. It uses rockets mounted in three different planes to stop tumbling. Although expensive in terms of station keeping fuel, it allows very big solar panels and antennae to be deployed in space.

TVRO: Television Receive Only. Applied to any ground station used only for receiving TV pictures from satellites.

TWTA: Travelling Wave Tube Amplifier. Standard amplifier used in satellite transponders. Also common in the LNA on the TVRO antennae.

Videplexing: A method of putting two TV signals through one transponder. Developed by the commercial stations to double the effectiveness of their satellite links. Effectively the signals are time multiplexed together.

ACESAT
SATELLITE EARTH STATIONS



LET ACESAT BRING YOU CLEAR VIBRANT COLOUR TV AND CRISP CLEAR RADIO FROM THE AUSSAT SATELLITES

ACESAT EARTH STATIONS including:

- Domestic easy-to-assemble single Earth stations
- Multi-point cable systems for Homesteads, small communities and mining settlements.
- Retransmission installations for larger communities, remote towns and mining settlements.
- Fully Guaranteed
- Government 512 compliance

Available mid-November from your nearest Retravision dealer.



ACESAT SATELLITE RECEIVER CORP. PTY. LTD.

(Incorporated in N.S.W.)
P.O. BOX 428

CARINGBAH 2229, N.S.W. AUSTRALIA
TELEX: AA 21822 PHONE: (02) 526 2411

NEW!

CHECK OUR LATEST MULTIMETERS!

METEX 3800 MULTIMETER

This instrument is a compact, rugged, battery operated, hand held 3 1/2 digit multimeter for measuring DC and AC voltage, DC and AC current, Resistance and Diode, for testing Audible continuity and transistor hFE. The Dual-slope A-D Converter uses C-MOS technology for auto-zeroing, polarity selection and over-range indication. Full overload is provided. It is an ideal instrument for use in the field, laboratory, workshop, hobby and home applications.

- Features...**
- Push-button ON/OFF power switch
 - Single 30 position easy to use rotary switch for FUNCTION and RANGE selection.
 - 1/2" high contrast LCD.
 - Automatic over-range indication with the "1" displayed.
 - Automatic polarity indication on DC ranges.
 - All ranges fully protected plus Automatic "ZERO" of all ranges without short circuit except 200 ohm Range which shows "000 or 001".
 - High Surge Voltage protection 1.5 KV-3 KV.
 - Diode testing with 1 mA fixed current.
 - Audible Continuity Test
 - Transistor hFE Test.

SPECIFICATIONS
Maximum Display: 1999 counts
3 1/2 digit type with automatic polarity indication.
Indication Method: LCD display.
Measuring Method: Dual-slope in A-D converter system.
Over-range Indication: "1" Figure only in the display.
Temperature Ranges: Operating DC to +40°C
Power Supply: one 9 volt battery (006P or FC-1 type of equivalent)
Cat. Q91530 \$79.95

AUSTRALIAN MADE

HIGH EFFICIENCY RADIAL FIN HEATSINK

Black anodized with a thick base plate, the radial fin heatsink can dissipate large amounts of heat for maximum efficiency. Designed by Rod Irving.

- 105x65mm Cat. H10524 \$2.80
- 105x75mm Cat. H10525 \$3.00
- 105x150mm Cat. H10535 \$5.50
- 105x225mm Cat. H10546 \$8.00
- 105x300mm Cat. H10549 \$12.00



MODEM PHONE

Check the features and the value for money of this stylish new modem phone...

- Speaker Phone with Built-in Amplifier for Detecting Busy Signal during communication.
- Auto/Manual Answer, Manual Originate, Auto Disconnect.
- Carrier Detect Indication, 20 Memories (each with 18 Digits Capacity) for Auto-dialing.
- BELL 103 CCITT V21 Compatible.
- 300 BPS Full Duplex.
- Last Number Redial.
- Pushbutton Keyboard.
- Volume High or Low Control.
- FCC Approved Direct Connect.
- "In-use" Dialing Indicator.

Cat. X19105 Normally \$199
Save \$251 only \$174
 (Not Telecom approved)



WELLER WTCPN SOLDERING STATION

The WTCPN Features:

- Power Unit 240 V AC
- Temperature controlled iron, 24 V AC
- Flexible silicon lead for ease of use
- Can be left on without fear of damaged tips!

The best is always worth having
 Cat. T12500
R.R.P. \$129 Our price \$99



HORN CRAZY!!

8W, 8ohm, aluminium or plastic. Normally \$9.50
 Aluminium Cat. C12015
 Plastic Cat. C12010
 1-9 \$6.50 10+ \$5.95



TKO LINE FILTERS

240 V 3A
 Cat. T12500 \$12.50



TRANSISTOR NIPPERS

Normally \$11.95
 Cat. T12070 \$9.95



MICRO NIPPERS

Normally \$11.95
 Cat. T12050 \$9.95



DESK MOUNTED LAMP MAGNIFIER

This unit magnifies any object under a clear cool fluorescent light. The magnification is the maximum obtainable lens 127mm diameter biconvex 4 Dioptres, local length 254mm) consistent with minimum distortion and eyestrain and good off-angle viewing. It is NOT cheap. But then again it will definitely last a lifetime. It is built like a Rolls Royce! Spare fluoro tubes are available from electrical outlets. If you have trouble with fine PCB work or component identification but still want both hands free, this is for you.

TECHNICAL INFORMATION
 Illumination: 22W Fluorescent
 Weight: 81.6Kg
 Lateral Extension: 254mm
 Vertical Extension: 254mm
 Fitting: Heavy table base (grey) with two chrome plated flexible arms

Cat. C92700 \$169



CANNON TYPE AUDIO CONNECTIONS

We've sold 1000's because of their great value!

- 3 Pin line male 1-9 10+
- Cat. P10960 \$2.90 \$2.80
- 3 Pin chassis male Cat. P10962 \$2.90 \$2.50
- 3 Pin line female Cat. P10964 \$3.50 \$2.90
- 3 Pin chassis female Cat. P10966 \$3.90 \$3.20



36 WAY CENTRONICS CRIMP PLUG

Cat. P12200
 1-9 \$7.95 10-99 \$7.50 100+ \$7.25



BRAND NEW FANS

Not noisy pullouts! Stacks of uses in power amps, computers, hotspot cooling etc. Anywhere you need plenty of air.

- 240V 45W Cat. T12461 \$12.95
- 115V 45W Cat. T12463 \$12.95
- 240V 3 1/2" Cat. T12465 \$12.95
- 115V 3 1/2" Cat. T12467 \$12.95

10 Fans (mixed) less 10%



LOGIC PROBE 3800A

Features 20MHz memory, TTL/CMOS operation. Normally \$29.50
 Cat. Q11272
 1-9 \$23.50 10+ \$19.50



RECHARGEABLE 12V GELL BATTERIES

Leakproof and in 3 convenient sizes, these long service life batteries are ideal for burglar systems, emergency lighting or as a computer backup power supply. Ideal for many power needs.

- Cat. S15029 12V 1.2 AH \$12.95
- Cat. S15031 12V 2.6 AH \$39.50
- Cat. S15031 12V 4.5 AH \$49.95



P.A. SPEAKERS

Low dual cone, wide range, 200mm (8in.). Ideal for public address, background music, etc. Tremendous Value at these prices!

- Cat. C12000 1-9 \$6.95 10+ \$5.95

Q: Where can you find a huge range, low prices and quality service?



METEX 3530 MULTIMETER

This instrument is a compact, rugged, battery operated, hand held 3 1/2 digit multimeter for measuring DC and AC voltage, DC and AC current, Resistance and Diode, Capacitance, Transistor hFE and Continuity Test. The Dual-slope A-D Converter uses C-MOS technology for auto-zeroing, polarity selection and over-range indication. Full overload is provided. It is an ideal instrument for use in the field, laboratory, workshop, hobby and home applications.

- Features...**
- Push-button ON/OFF power switch.
 - Single 30 position easy to use rotary switch for FUNCTION and RANGE selection.
 - 1/2" high contrast LCD.
 - Automatic over-range indication with the "1" displayed.
 - Automatic polarity indication on DC ranges.
 - All ranges fully protected plus Automatic "ZERO" of all ranges without short circuit except 200 ohm Range which shows "000 or 001".
 - High Surge Voltage protection 1.5 KV-3 KV.
 - Capacitance measurements to 1pF
 - Diode testing with 1 mA fixed current.
 - Audible Continuity Test.
 - Transistor hFE Test.

SPECIFICATIONS
Maximum Display: 1999 counts
3 1/2 digit type with automatic polarity indication.
Indication Method: LCD display.
Measuring Method: Dual-slope in A-D converter system.
Over-range Indication: "1" Figure only in the display.
Temperature Ranges: Operating DC to +40°C
Power Supply: one 9 volt battery (006P or FC-1 type of equivalent)
Cat. Q91540 \$119



10% OFF THESE PRICES THIS MONTH!

TDK AUDIO TAPE CARTRIDGES

Description	Cat. No.	1-9	10+
DC46 TDK A11305		2.75	2.10
DC60 TDK A11307		2.95	2.25
DC90 TDK A11309		3.50	2.50
DC120 TDK A11311		5.50	4.25
AD60 TDK A11315		3.75	2.95
AD90 TDK A11317		4.75	3.50
AD120 TDK A11319		6.95	5.50
AD160 TDK A11320		4.95	3.50
AD180 TDK A11322		5.95	4.50
SAG0 TDK A11325		5.35	3.95
SAG0 TDK A11327		5.95	4.50
SAX60 TDK A11329		5.25	3.95
SAX90 TDK A11332		6.95	5.95
MAC80 TDK A11335		10.95	9.35
MAC90 TDK A11337		11.50	8.75
MAR60 TDK A11340		13.50	10.95
MAR90 TDK A11342		17.20	15.35



10% OFF THESE PRICES THIS MONTH!

PANEL METERS GALORE!

We have a great range of panel meters at great prices!

Cat.No.	Description	Price
Q10500	MU45 0-1mA	12.50
Q10502	MU45 50-0.500A	12.50
Q10504	MU45 0-1000A	12.50
Q10510	MU45 0-5A	12.50
Q10518	MU45 0-1A	12.50
Q10520	MU45 0-1A	12.50
Q10525	MU45 0-20V	12.50
Q10530	MU52 0-1A	14.50
Q10533	MU52 0-5A	14.50
Q10535	MU45 VU Pmetre	14.95
Q10538	MU65 0-500A	16.95
Q10540	MU65 0-1mA	16.95
Q10550	MU65 0-100A	16.95
Q10560	MU65 0-20V	16.95



4 1/2 DIGIT LCD UNIVERSAL COUNTER - C7224

● Very Low Power
 ● High Count Rate
 A 4 1/2 digit counter offering counting to 20,000 units at rates up to 10MHz. The low current consumption makes it ideal for use in portable instruments. The counter features high contrast 10mm digits, 5V DC or 7.5V to 15V DC supply (typical consumption 1mA), and programmable decimal points. Standard controls are all TTL/CMOS compatible and include Reset, Count, Inhibit, Store, Leading Zero Blanking, 'Carry' Output. The count input is protected against accidental overload. Supplied complete with mounting kit and connectors.

SPECIFICATIONS:
 Supply Voltage: (5.5V Abs. Max.) 7.5 - 15V
 Typical Current Consumption: 1mA
 Maximum Count: 19999
 Max. Counting Rate: 10MHz
 Typical (Schmitt Trigger):
 Count Input Level: V_{IL} 2.5V V_{IH} 2V
 Min. DC Input Level: 0V
 Max. DC Input Level: 5V
 Operating Temp. Range: 0 - 50°C
 Cat. Q15530 \$79.50



DPM-200 PANEL METER

● Ultra Low Power
 ● Separately Addressable Annunciator
 ● 15mm Digits
 ● Bandgap Reference
 A low profile LCD DPM with a range of useful symbols as shown. The DPM-200 features 15mm 3 1/2 digit display, and ultra low current consumption and a bandgap reference for high stability. It also features Auto-zero, Auto-polarity, 200mV f.s.d. It may be used in single-ended, differential or ratiometric modes. The f.s.d can be easily changed by the user to indicate any other units. The decimal points and symbols can all be driven from an internal source. Wide supply and symbols can all be driven from an internal source. Wide supply rail (5-15V DC) with a variable threshold low battery warning indication. Supplied with mounting clips and comprehensive data sheet.

SPECIFICATIONS:
 Accuracy: 0.1% + -1 digit
 Linearity: + -1 digit
 Samples/sec: 3
 Temp. Stability: 50 ppm typical
 Temp. Range: 0 - 50°C
 Supply Voltage: 5 - 15V DC
 Supply Current: 50uA typical
 Max DC Input Volts: + -20V
 Cat. Q15510 \$79.95



4 1/2 DIGIT LCD DPM 60

● 200mV f.s.d.
 ● Digital Hold
 ● Bandgap Reference
 ● 10uV Resolution
 A new 4 1/2 digit LCD DPM offering levels of performance, low current consumption and compact size never previously available. The DPM-60 features Auto-zero, Auto-polarity, a logic switched 200mV or 2V f.s.d. Digital Hold, programmable decimal points and a 1mA current consumption. Automatic low battery indication and 'continuity' flags are built into the 10mm 4 1/2 digit display. The DPM 60 can be readily rescaled by user to indicate many different units, amps, volts, ohms etc. Supplied complete with fixing bezel, clips and connector, the DPM 60 will suit many applications calling for low-cost, high accuracy measurements in portable instruments or bench instruments.

SPECIFICATIONS:
 Accuracy: 0.01 m + -1 digit
 Linearity: + -1 digit
 Samples/sec: 1.6
 Temp. Stability: 50 ppm/°C typical
 Temp. Range: 0 - 35°C
 Supply Voltage: 7.5 - 15V
 Supply Current: 1mA typical
 Max DC Input Voltage: + -20V
 Cat. Q15520 \$99.95



3 1/2 DIGIT ECONOMY LCD CPM

● Ultra-low Power
 ● Bandgap Reference
 An ultra-low power, extremely stable LCD CPM suitable for a wide number of different applications. Features Auto-zero, Auto-polarity, 200mV f.s.d. User adjustable Low Battery Indication, 12.5mm digit height, programmable decimal point. The CP-5513 has an external bandgap reference for extra temperature stability, with connections brought out, allowing use in single ended, differential or ratiometric mode. The f.s.d can be easily rescaled by the user to indicate volts, amps, ohms or many other engineering units. Supplied with a bezel mounting clips, connectors and full data sheet.

SPECIFICATIONS:
 Accuracy: 0.1% + -1 count
 Linearity: + -1 count
 Samples/sec: 3
 Temp. Stability: 50 ppm typical
 Temp. Range: 0 - 50°C
 Supply Voltage: 5 - 15V DC
 Supply Current: 200uA typical
 Max. DC Input Voltage: + -20V
 Cat. Q15513 \$54.95



ECONOMY 19" RACK CASE

Tremendous Value! Dimensions W 480 x H 134 x D 250mm.
 Cat. H10415 1-9 10+ \$47.50 \$44.50



10W RMS SPEAKERS

Including boxes!! At this price you can afford to put a set of speakers in every room!
 Dimensions: H 475 x W 245 x D 200mm
 Cat. C12002 Per Pair \$59.50



10% OFF THESE PRICES THIS MONTH!

TDK VIDEO TAPES AT BARGAIN PRICES!

VHS:	£60	\$12.50
E120		\$12.50
E180		\$11.80
E240		\$22.40
BETA:	L250	\$13.50
	L500	\$14.40
	L750	\$17.50



MAGNETIC BULK ERASER

The best and by far the quickest way to erase tapes, cassettes and computer disks! Reduces noise levels below recorders own erase head level. On/Off switch located in handle. 240V AC operation.
 Cat. C14950 \$29.50



MINIATURE BUZZER

5-15V White or black.
 Cat. A15062 1-9 10+ \$1.20 \$1.00



S100 PROTCARDS

Horizontal Bus Cat. H19125 \$39.50
 Vertical Bus Cat. H19130 \$39.50
 Pad per Hole Cat. H19135 \$39.50

TRIGGER TRANSFORMERS
Cat. M10104 \$1.20



CRYSTALS SPECIALS
Prime Specs. We just have too many in stock!

Description	Cat. No.	1-9	10+
1MHz	Y11000	\$7.50	\$6.50
1.8432MHz	Y11003	\$7.50	\$6.50
4MHz	Y11020	\$2.50	\$2.00
4.194304MHz	Y11023	\$2.50	\$2.00
4.433518MHz	Y11025	\$2.50	\$2.00
4.75MHz	Y11025	\$2.50	\$2.00
4.915200MHz	Y11026	\$2.50	\$2.00
5MHz	Y11030	\$2.50	\$2.00
6MHz	Y11040	\$2.50	\$2.00
6.144MHz	Y11042	\$2.50	\$2.00
6.670MHz	Y11045	\$2.50	\$2.00
8MHz	Y11050	\$2.50	\$2.00
8.867238MHz	Y11055	\$2.50	\$2.00
10MHz	Y11060	\$2.50	\$2.00
12MHz	Y11070	\$2.50	\$2.00
14.31618MHz	Y11072	\$2.50	\$2.00
15MHz	Y11075	\$2.50	\$2.00
18MHz	Y11082	\$2.50	\$2.00
18.432MHz	Y11085	\$2.50	\$2.00
20MHz	Y11090	\$2.50	\$2.00

XENON/STROBE TUBES
As used in projects or as replacements
Cat. M14050 \$2.95

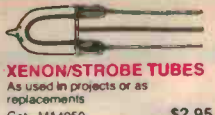

MINI JUMPERS
● Contact terminal: Phosphor bronze
● Material: P.B.T. 94V-0
● Gold plated

Qty	Cat. No.	Price
10	P12053	\$2.95
25	P12055	\$4.95
100	P12057	\$21.95

FUSE SPECIAL 3AG
Two values, 3 Amp and 1 Amp
1-9 100-999 1000+
8¢ each 6¢ each 5¢ each
STOCK UP NOW

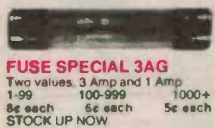

CARD EDGE GUIDES

2 1/2"	Cat. H19180	\$0.75
4 1/2"	Cat. H19182	\$0.90
6 1/2"	Cat. H19184	\$1.20
12 1/2"	Cat. H19186	\$1.40

WHAT A RANGE!



HORWOOD ALUMINIUM CASES
We have a full range of quality Horwood cases.

Cat. No.	Dimensions	Price
H10382	3x4x2"	\$5.50
H10383	3x4x3"	\$ 6.50
H10384	3x4x4"	\$ 7.50
H10385	3x4x5"	\$ 7.95
H10386	3x4x6"	\$ 8.50
H10387	3x4x7"	\$ 9.50
H10388	3x4x8"	\$10.50
H10389	3x4x9"	\$10.95
H10390	3x4x10"	\$11.95

ECONOMY TRANSFORMERS

2155	1-9 \$6.75	10+ \$5.95
Cat. M12155		
2156	\$9.50	\$8.95
Cat. M12156		
2851	\$4.50	\$3.60
Cat. M12851		
6672	\$9.95	\$9.30
Cat. M16672		

5mm PRIME SPEC LEDS!

1-9	10+	100+
Red Cat. Z10150	15¢	12¢
Green Cat. Z10151	25¢	18¢
Yellow Cat. Z10152	25¢	18¢

DIP SWITCHES

2 Way	1-9 \$1.50	10+ \$1.10
4 Way	\$1.60	\$1.20
5 Way	\$1.70	\$1.30
7 Way	\$1.80	\$1.40
8 Way	\$1.90	\$1.50

PUSH BUTTON DIALERS
Tired of old fashion dialling and re-dialling engaged numbers? These convenient push button dialers include last number redial (up to 16 digits) and instructions for an easy changeover.
Cat. H12030 \$19.95



NEW!



KEYBOARD AND CASE
A stylish, low profile case to give your system the professional look it deserves. Comes with an attached encoded, parallel output keyboard and provisions for 2 x 5 1/4" slimline disk drives.
Cat. X11080 \$249

KEYBOARD AND CASE
A stylish, low profile case to give your system the professional look it deserves. Comes with an attached encoded, parallel output keyboard and provisions for 2 x 5 1/4" slimline disk drives.
Cat. X11080 \$249

KEYBOARD AND CASE
A stylish, low profile case to give your system the professional look it deserves. Comes with an attached encoded, parallel output keyboard and provisions for 2 x 5 1/4" slimline disk drives.
Cat. X11080 \$249

RE

ROD IRVING ELECTRONICS
425 High Street, Northcote, 3070
VICTORIA, AUSTRALIA
Phone (03) 489 8866
48 A'Beckett St, MELBOURNE, 3000
VICTORIA, AUSTRALIA
Ph. (03) 663 6151
Mail Order and correspondence:
P.O. Box 920, CLAYTON 3168
T.E.L.: AA 151938

MAIL ORDER HOTLINE (03) 543 7877 (2 lines)

POSTAGE RATES

\$1-\$9.99	\$2.00
\$10-\$24.99	\$3.00
\$25-\$49.99	\$4.00
\$50-\$99.99	\$5.00
\$100-\$199	\$7.50
\$200-\$499	\$10.00
\$500 plus	\$12.50

This is for basic postage only. Comel Road freight, bulky and fragile items will be charged at different rates. Certified Post for orders over \$100 included "free". Registered Post for orders over \$200 included "free".

MasterCard VISA

Errors and Omissions Excepted.

NEW!



UV EPROM ERASER
Erase your EPROMs quickly and safely. This unit is the most effective solution to your problems. It will erase up to 9 x 24 pin devices in complete safety, in about 40 minutes (less for less chips).
Features include:
● Erase up to 9 chips at a time
● Chip drawer has conductive foam pad
● Mains powered
● High UV intensity at chip surface ensures EPROMs are thoroughly erased
● Engineered to prevent UV exposure
● Long life UV tube
● Dimensions: 217 x 80 x 68mm
● Weight 670 grams
Cat. X14950 \$89.50

A. Rod Irving Electronics, the proof is right in front of you!

NEW!



WIND SPEED/DIRECTION INDICATOR
This quality engineered European import enables you to monitor windspeed and its direction from the comfort of inside your boat cabin or home. The system comprises a fully factory made wind direction transducer which is weatherproof and has a drip seal around its moving collar. It is fitted with quality reed switches for trouble free life. An 'N' (indicating North) is shown on the outside of the body for initial compass alignment. The wind speed transducer is built into a similar high quality case but is fitted with three moulded cups on equidistant radial arms. Again high quality reed switches are employed. Both transducers are moulded thermoplastic and are supplied with 25 metres (80 feet) of factory terminated connecting cable. Each transducer is fitted with a stainless steel mounting stud with nuts. The output of each transducer is displayed on an attractive panel measuring 150(W) x 100(H)mm. A LED shows when the wind direction indicator shows main compass point (i.e. N, S, E, W) when the wind shifts between these points, two adjacent LEDs show, indicating the appropriate wind vector.
Wind speed is indicated on analogue meter with a standard Km/H scale. Scales of 0-30 metres/sec, 0-60 knots, 0-70 mph and 0-7 Beaufort (force) scale, are also provided. It must be emphasised that the meter movement must be carefully dismantled and the scale glued on the face in order to mount the other scales. Warranty is voided doing this, however, damage is unlikely if you are careful. The panel is also provided with a toggle switch to minimise power drain. (powered by 4 penlight batteries.)
Dimensions of transducers:
Main body: 40mm dia, 125mm (H)
Diameter of cup rotation is 150mm
Diameter of vane rotation is 240mm
Cat. Q96150 \$199

NEW!



MIDRANGE HORNS
Use these quality, all metal, Piezo tweeters for great top and sound in your band speakers, disco sound system, etc. Rated at 30 watts RMS, in a system they will handle over 100 watts RMS.
Two sizes to choose from:
Size: 4" x 10 1/2"
Impedance: 8 ohms
Rating: 30 watts RMS
Response: 1.5kHz - 14 kHz
Dimensions: 102 x 267 x 177mm
Cat. C92082 \$49.95

NEW!



2K OHM MULTI METER
11 Ranges, pocket size. SPECIFICATIONS
11 RANGES
DC VOLTAGE: 0-10-50-250-1000 volts 2000 ohms/volt
AC VOLTAGE: 0-10-50-250-1000 volts 2000 ohms/volt
DECIBELS: -10 to +22dB in four ranges
OHMMETER: 0-10 kohms, 0-1 mega-ohms
DC CURRENT: 1-100mA
Normally \$14.95 NOW \$9.95

RELAYS
Massive 3A connectors
1-9 10+
S.P.D.T. X14060 100+
\$1.20 \$1.10 \$0.90
D.P.D.T. X14061
\$1.50 \$1.40 \$1.20

NEW!



ULTRASONIC PEST REPELLER
The state of the art in pest control! Just think, no dead pests to dispose of, no toxic chemicals, maintenance free, economical (approx. 2c a day) and covers an area up to 2,000 sq. ft. Simply plug it in and enjoy a clean pest free environment. Perfect for the home, apartment, restaurant, school, office or any indoor area.
Effectively controls...
● Mice/Rats
● Fleas
● Mosquitoes
● Silverfish
● Cockroaches
● Ants
● Crickets
● Moths
● Waterbugs
● and many other pests
Cat. Y95510 \$55.95

NEW!



FREE STANDING, FOLD UP MAGNIFIER
An economically priced "hands free" magnifier, lets you take care of all those tricky fine detailed jobs so often encountered in electronics, or any of many other practical uses such as home, work, hobbies, etc.
Cat. T12083 \$11.95

NEW SLOPING CASES
Plastic with metal front panel, available in two sizes:
Cat. H10450 190x120mm \$11.95
Cat. H10455 256x185mm \$19.95 (measurements are approx. only)

NEW!



NICAD BATTERIES
Save on carbon batteries with these Apion Nickel cadmiums. Rechargeable up to 1000 times!
1-9 10+
Cat. S15020 AA500 MA \$2.45
Cat. S15021 C1.8 AH \$2.25
Cat. S15022 D4 AH \$3.95
Cat. S15023 \$6.95

NEW!



IC SOCKETS (LOW PROFILE)
How cheap can they go?

1-9	10+	100+	1000+
8 Pin Cat.	14c	12c	09c
14 Pin Cat.	15c	12c	10c
16c	15c	14c	10c
16 Pin Cat.	17c	16c	11c
18 Pin Cat.	18c	16c	13c
20 Pin Cat.	27c	27c	26c
24 Pin Cat.	33c	32c	28c
40 Pin Cat.	45c	40c	35c

NEW!



PROFESSIONAL SERIES RACK MOUNTING CABINETS
These beautifully crafted rack cabinet boxes will give your equipment a real 1st class appearance:
● All aluminium construction.
● Removable top and bottom panels.
● All dimensioning conforms to the International Standard.
● Natural or Black finish.
● Ventilated lid.
● Deluxe brushed finish anodised front panel.

H10401 Natural	1-4 \$4.50	5+ \$43.50
H10402 Natural	\$5.50	\$49.50
H10403 Natural	\$6.50	\$55.50
H10411 Black	\$49.50	\$43.50
H10412 Black	\$55.50	\$49.50
H10413 Black	\$62.50	\$55.50

WE HAVE THE BEST MEMORY PRICES!

SAVE

WE'RE OVERSTOCKED!

IC SPECIALS!

4116	1-9 \$1.80	10+ \$1.70	100+ \$1.60
4164	\$1.95	\$1.75	\$1.70
2715	\$5.90	\$5.50	\$5.50
2732	\$6.25	\$5.95	\$5.50
2764	\$8.25	\$7.95	\$6.00
27128	\$7.00	\$6.50	\$6.25
6116	\$2.50	\$1.95	\$1.75
41256	\$8.00	\$8.00	\$7.50
6264	\$8.00	\$7.50	\$7.00

8000 SERIES IC SPECIALS!

8085	1-9 4.50	10+ 3.50
8212	1.90	1.40
8216	1.50	1.40
8226	1.70	1.50
8243	4.50	3.90
8251	3.90	3.50
8253	3.90	3.90
8255	2.90	2.50
8257	3.90	3.10
8259	3.50	3.10
8279	3.50	3.10
2532	7.50	6.90
2764	5.50	5.10
27128	7.50	6.90
1488	.55	.45
1489	.55	.45

MSM5832 BACK IN STOCK!

1-9	\$12.50	10+ \$11.50
-----	---------	-------------

6116P-3 PRICES SLASHED!

1-9	10+
\$2.75	\$2.50

WORLD MODEM CHIP
Cat. \$49.95

BANKCARD

VISA

MASTERCARD

SIGNATURE _____ EXPIRY DATE _____

NAME _____

ADDRESS _____

PCODE _____

ETI 11/85 DATE

Win this hobbyist's CRO

Two to win!

It's easy. You could have one of these easy to use oscilloscopes on your work bench. This lightweight 6.5 MHz CRO will be great for building, testing and modifying your projects.

All you have to do is answer four simple questions. If you have any difficulty you can find clues in the Starting Electronics feature starting on page 92 in this issue. To enter use the coupon below.

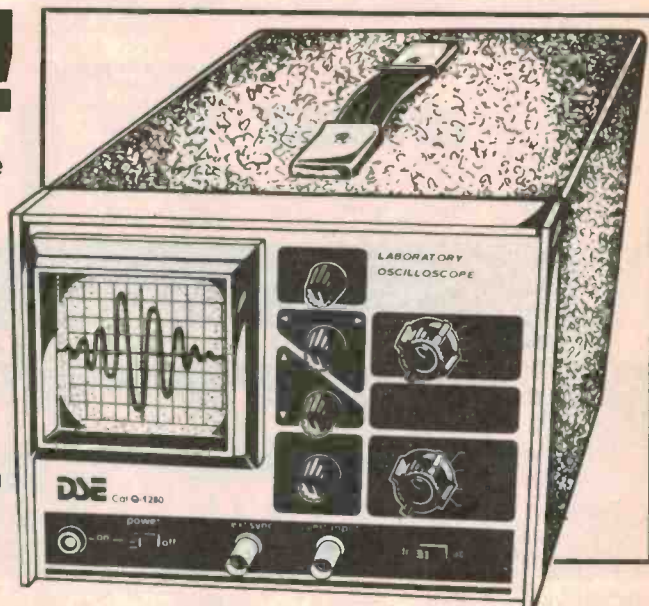

QUIZ QUESTIONS

- 1) Which of the following applications would you use single strand wire for?
 - A) Audio
 - B) Power
 - C) Breadboarding
- 2) What is a typical value for capacitance per metre for shielded cable?
 - A) 100 pF/m
 - B) 200 pF/m
 - C) 300 nF/m

- 3) How many pins does an RS-232 plug have?
 - A) 25
 - B) 36
 - C) 50
- 4) What size phono connector is commonly used in telephone switch boards?
 - A) 2.5 mm
 - B) 3.5 mm
 - C) 6.5 mm

The quiz answers are: 1) A B C
(circle the correct answer) 2) A B C

3) A B C
4) A B C



Send your entry to:

Win a CRO
Electronics Today
PO Box 227,
Waterloo,
NSW. 2017

Name

Address

Postcode

Telephone

(SA readers may enter on a separate piece of paper)

Offer closes December 1

THE MONEY SAVERS

RS-232 MINI-TESTER
 Male to female DB Connectors 25 pin
 All pins wired through
 Dual-colour LEDs
\$27.90

RS232 mini Patch Box
 Male to Female
\$21.95 ea
 Easily interface RS232 devices with 25 Jumper leads + Instructions

GENDER CHANGERS
 each **\$16.50**
 Male to Male OR Female to Female
 TAKE YOUR PICK

FULLY AUTOMATIC 12V MOTORISED CAR AERIALS
 Suits all models of car radios
 Usually \$29.50 **\$20**

NI-CAD RECHARGER
 CHARGES ALL 1.5 VOLT + 9V 216 BATTERIES
 R.R.P. \$28 Now **\$19**

WOOFERS
 4" 10w \$11.50
 6 1/2" 15w \$12.50
 8" 60w \$28.90
 10" 90w \$48.50
 All with 'Free-Edge' long-throw cone assemblies
PIEZO SUPER TWEETERS
 100w 3-30KHz
\$13.50 ea

APPLE COMPATIBLE II PLUS
 Registered trade name
\$350
 DEMO MODEL CLEAROUT!
NEW IIe \$750
 incl 80 columns and 128K RAM extended
MODELS
 SLIM-LINE DISK DRIVES
 Ready to go! **\$289 ea**

IIe COMPATIBLE WITH 2 DRIVES AND DETACHED KEYBOARD
\$1500
 WE HAVE A LARGE RANGE OF PARTS AND ACCESSORIES!
 128K Ram Card \$280
 Parallel Printer Card \$75
 RS232 Serial Card \$142
 IEEE488 Card \$179
 80 Column Card \$109
 2.80 CFM Card \$65
 Pal Colour Card \$85
 RGB Colour Card \$125
 Disk Drive Card \$65
AMBER OF GREEN MONITOR \$209
 TILT and SWIVEL BASE

IBM PC 256K COMPATIBLE
 Registered Trade mark
\$2,100
 INCL. MONITOR and 2 Disk drives
IBM ACCESSORIES
 512K Ram Board \$150
 Mono Graphics card \$350
 Color Graphics card \$395
 Mono Text card \$265
 Floppy Disk controller \$120
 Hard Disk controller \$399
 Multi-Function 384K \$289
 135W Power Supply \$199
 Detachable keyboard \$205
 Metal Case 3 slots \$119
 and lot's more!

PRINTER CABLES for-
 Apple 20 pin plug **\$19.50**
 IBM DB25 plug **\$23.95**
 to Centronics
 Standard length: 2 metres
 LIMITED STOCKS AVAILABLE!
Mini Cassette Player MOTOR \$5
 REPLACEMENT
 6V or 9V or 12V
 TAKE YOUR PICK!
 Ideal for servicemen!

NEW Replacement CERAMIC STEREO CARTRIDGES
 Now only **\$3.00**

IEC. POWER LEADS
 QTY 1-19 **\$1.50 ea**
 QTY 20+ **\$1.25 ea**
 Length: average 1.6m

ASST. POTENTIOMETERS LUCKY DIP SPECIALS
 20 for \$3 ALL NEW!
 100 for \$10
 250 for \$20

2200uf 63v ELNA Electro
 Normally \$3.95 **\$2**

LCE DC MOTORS POWERFULL 3,000 RPM 6V-12V DC
 47mm diam 60mm long
 ONLY **\$5 ea**

FM WIRELESS Microphone
 only **\$17**
 Freq. 88-108MHz
 Range to 100 metres
 Response 50-14KHz

Ex-Computer Caps
 100,000uf 10v \$3.00
 30,000uf 15v \$1.50
 25,000uf 20v \$1.00
 15,000uf 25v \$0.75
 50,000uf 25v \$2.00
 24,000uf 30v \$1.50
 22,000uf 35v \$1.20
 12,000uf 40v \$0.80
 33,000uf 40v \$1.00
 20,000uf 45v \$0.75
 10,000uf 50v \$0.50
 22,000uf 50v \$0.75
 20,000uf 55v \$0.75
 20,000uf 55v \$0.75
 All tested EA and g'feed **\$5**

JACKPOT Box No 5
 Our biggest box ever! Nearly 5Kg of parts a lot for electronic hobbyists.
 A little bit of everything - VALUED AT \$70!
\$15

Electromagnetic COUNTERS
 Non-resettable
 24v DC \$5.50
 24v DC CHASSIS \$5.50
 110v AC CHASSIS \$2.50
 220v AC CHASSIS \$4.95

Hitachi Handy Heatshrink
 4 Sizes, 4 Colours
 3.5mm diam \$1.50
 5 mm diam \$1.70
 7 mm diam \$1.90
 10 mm diam \$2.50

DPDT HI-QUALITY ROCKER SWITCH
 20¢ ea 100 for \$15
 NORMALLY 50¢ ea

SPEAKER BOX SALE!
 Sorry, Shop sales only!
\$6 ea.

DISCO STROBE
 0-12 flashes per sec!
\$25 ea
 Ideal for parties, theatre, dances etc. 240v

ALARM CONTROL PANEL
 4 INPUTS - N.O. and N.C. Instant or delay
 6 LED STATUS INDICATORS
 Entry and Reset ADJUSTABLE DEL
 Inbuilt 24MA PANIC or FIRE alarm circuit.
NEW, IMPROVED MODEL!
 Dry cell or rechargeable 12v battery operation, heavy duty lockable steel cabinet, Inbuilt siren and DC 12v power outputs. IDEAL FOR HOMES, SHOPS, OFFICES!
\$119

NEW HANDY HEATSHRINK PAK
 14x100mm p.c.s.
 Just slip over solder joint and heat - plastic shrinks to form a tight seal. Asst. sizes **\$3 ea**

HUGE REDUCTION! VIDEO ENHANCER and STABILIZER
 DETAIL ENHANCER **\$35**
\$49 THE PAIR
 IMAGE STABILIZER **\$29**
 OVER 50% OFF!

VIDEO ENHANCER and STABILIZER
 THE ENHANCER WILL BE ABLE TO RECTIFY LOSS IN PICTURE DETAIL AND QUALITY ON MOST POORLY RECORDED VCR TAPES
 Feature enhanced core and bypass controls, 12V DC operation!
 THE STABILIZER ENSURES NO VERT. ROLL OR BLACKOUT FROM COPYGUARD SIG.

INFRA-RED BURGLAR DETECTOR!
 Passive infra-red is ideal for all home, office and shop alarms - LED indicator, upto 12m range. N.O./N.C. 12vdc
\$89 ea

NEW, IMPROVED MODEL!
 Dry cell or rechargeable 12v battery operation, heavy duty lockable steel cabinet, Inbuilt siren and DC 12v power outputs. IDEAL FOR HOMES, SHOPS, OFFICES!
\$119

12v 20 AMPS Transformer
 Input: 0-240v
 Output: 8v+8v or 10v+10v
 2 WINDINGS AT 20A
 Ideal for 13.8v 60w
\$39 ea Amateur power supply

ALARM or EMERGENCY!!! STROBE FLASHER
 ORANGE, BLUE, RED
 12V WERE \$28.70 **\$21**

RADIO CONTROL REMOTE SWITCH
 CAR alarm model with 2 transmitters **\$95**
 Single OR Dual CHANNEL for home, alarms, garage doors, industrial control etc. These have Extended range to 100metres, 12,000 programmable codes.
 1CH + TRANSMITTER... \$115
 Extra Transmitters, each... \$32
 2CH + TRANSMITTER... \$125
 Extra Transmitters, each... \$40

PARTS VALUE PACKS
 LUCKY-DIP ASSORTMENTS!
 500 1W RESISTORS
 200 1W RESISTORS
 100 CERAMIC CAPS
 30 GREENCAPS
 45 ELECTROLYTICS
 20 POTENTIOMETERS
 25 PRESET POTS
 30 MICA CAPS
 40 RADIO/TV KNOBS
 20 VARIOUS FUSES
 12 SWITCHES
 50 TAG STRIPS
\$2
 EACH PACK
 BUY 10, GET 1 FREE!
 BUY 12 SWITCHES

FUJI FILM FLOPPY DISK
 SPECIAL INTRODUCTORY OFFER!
 Size Type Format Tax Free Tax Paid
 5 1/4" MD1D SDD \$32.00 \$36.00
 5 1/4" MD2D DSD \$42.00 \$48.00
 5 1/4" MD2H DSD \$73.00 \$82.00
 8" FD1S SDD \$49.00 \$56.00
 8" FD2S DSD \$51.00 \$58.00
 8" FD2D DSD \$54.00 \$61.00
 3 1/2" MF1D SDD \$66.00 \$75.00
 3 1/2" MF2D DSD \$89.00 \$99.00
 BUY 3 PACKS, receive free 5"x50 plastic disk box!

Floppy Disk cleaners
 5 1/4" Guard against data loss!
\$12.50 EACH \$19.50

FANTASTIC! CAR ALARM ULTRASONIC + RADIO KEY.
 Interior motion detector, current door sensing, panic alarm button, inbuilt siren, delay, reset!
\$159

NEON LAMP
 12v LAMP **25¢**
 40mA current EACH
 BELOW NORMAL COST.

100 ASSORTED MOSTLY DIGITAL IC'S
\$7.50
 LUCKY DIP PAK
 PACK 3 POST **\$2.00** + 5% ORDER VALUE!

2716... \$5.00
2732... \$5.50
2764... \$7.30
4164... \$2.90
555 TIMER 10... \$2.95
741 OP AMP 10... \$2.95

5 1/4" DISK CASE
\$17.50
 FLIP-TOP Holds 50 disk & dividers!

NEW STEREO MAGNETIC CARTRIDGE
 Latest model - 15KHz to 35KHz response, 2.5mv output, 0.6 diam stylus, standard mounting
\$21

NEON LAMP
 12v LAMP **25¢**
 40mA current EACH
 BELOW NORMAL COST.

100 ASSORTED MOSTLY DIGITAL IC'S
\$7.50
 LUCKY DIP PAK
 PACK 3 POST **\$2.00** + 5% ORDER VALUE!

2716... \$5.00
2732... \$5.50
2764... \$7.30
4164... \$2.90
555 TIMER 10... \$2.95
741 OP AMP 10... \$2.95

LM3900
 OR EQUIV RCA 3401
 Regular price **39¢ EA**
C106 SCR
 200V 4A **32¢**

PRE-PAK electronics p/l

1a WEST ST, LEWISHAM, NSW

569-9797
 24 HR PHONE ORDER SERVICE

Phone or mail order BANKCARD accepted

CONTRARY MOTION

— Philips CD 304 CD player

Philips has recently moved forward and backward with its more up-market player, the CD 304. It is neither cheap nor simple, rather, it incorporates a few of the sophistications we expect to be intrigued by in this satellite age with some curious design anomalies.

Louis Challis

THE YEAR of 1985 is that in which sales of CD players and CD discs have reached the commercial turning point in buyer acceptance. The public has come to realise that CD players are here to stay and that the new industry standard is finally displacing microgroove recordings as the preferred format for classical and pop music. It is anticipated that approximately 100,000 CD players will be sold in this country in 1985 and as a consequence the hardware market alone is worth somewhere between \$A30 million and \$A40 million and the software market should be of comparable or even greater value.

While the greatest number of sales will undoubtedly occur in the under \$400 bracket, the more expensive models and particularly those with remote control facilities are nevertheless attractive. The reasons for this are not hard to find; once you take the positive step and purchase a CD player, you soon learn to appreciate the convenience that a good remote control provides.

Two specific trends are evident in the

development of remote controlled CD players. The initial trend was based on the design of remote controls which provided only the normal primary functional controls. In many cases these were supplemented by the capacity for programming random track selection at a remote position. A more recent and far more exciting trend which some Japanese manufacturers have considered has been to incorporate a sound control or amplification level from that same remote position. That particular design feature has not yet reached Australia, but may well hit the market in the pre-Christmas season.

The Philips CD 304 is an excellent example of how the Philips Eindhoven research laboratories have rationalised their marketing experience with the hindsight of the millions of CD players that they have now produced for the world market.

Philips, in keeping with the other major manufacturers, has now adopted an integrated approach to its design of CD players. The most impressive aspects of that inte-

grated approach relate to the development of mechanisms incorporating an optimised laser transmitter and optical detector assembly, with new swing-arm mechanisms and disc motor drives. The particular mechanism chosen for the CD 304 is an improvement on the previous generation of players, but does not yet incorporate all the latest features of the new integrated CDM2 system which has been developed for common use in home, car or portable CD players.

Design features

The frontal appearance of the CD 304 is undoubtedly one of the most attractive that Philips has produced to date. It features a black anodised brushed satin aluminium fascia with motor powered front loading tray and an appearance that is more Japanese than European.

On the left hand side of the panel is a large, clearly labelled ON/OFF switch below which is the dark red plastic cover of the remote control optical sensor. On the top left hand side of the front panel is the



motor powered disc loading tray to the right of which is the neat OPEN/CLOSE button. On the right hand side of the escutcheon is a large fluorescent tube display which provides information on absolute time, relative time and total time available on the disc or track of the disc being played. It also provides information on how many tracks are on the disc (up to a limit of 20), which track is being played, whether the pause mode has been selected or whether the silenced output is the result of an intended pause on the disc itself; last but not least it shows an ERROR instruction in bright red.

To the right of the display is a START/REPLAY button, a STOP button and a large rocker SEARCH button which increases the rate of searching the longer you hold your finger on the button. On the panel below the display are two small silver buttons: one for time which repeated probing converts from absolute time, in terms of the period of minutes and seconds from the start of the disc, relative time from the start of the track being played and total time of

PHILIPS CD 304 COMPACT DISC PLAYER

Dimensions: 420 mm (wide) x 90 mm (high)
x 325 mm (deep)
Weight: 8.3 kg
Manufacturer: Philips, Belgium
RRP: \$799

Absolute copyright in this review and accompanying measurements is owned by Electronics Today International. Under no circumstances may any review or part thereof be reprinted or incorporated in any reprint or used in any advertising or promotion without the express written agreement of the Managing Editor.

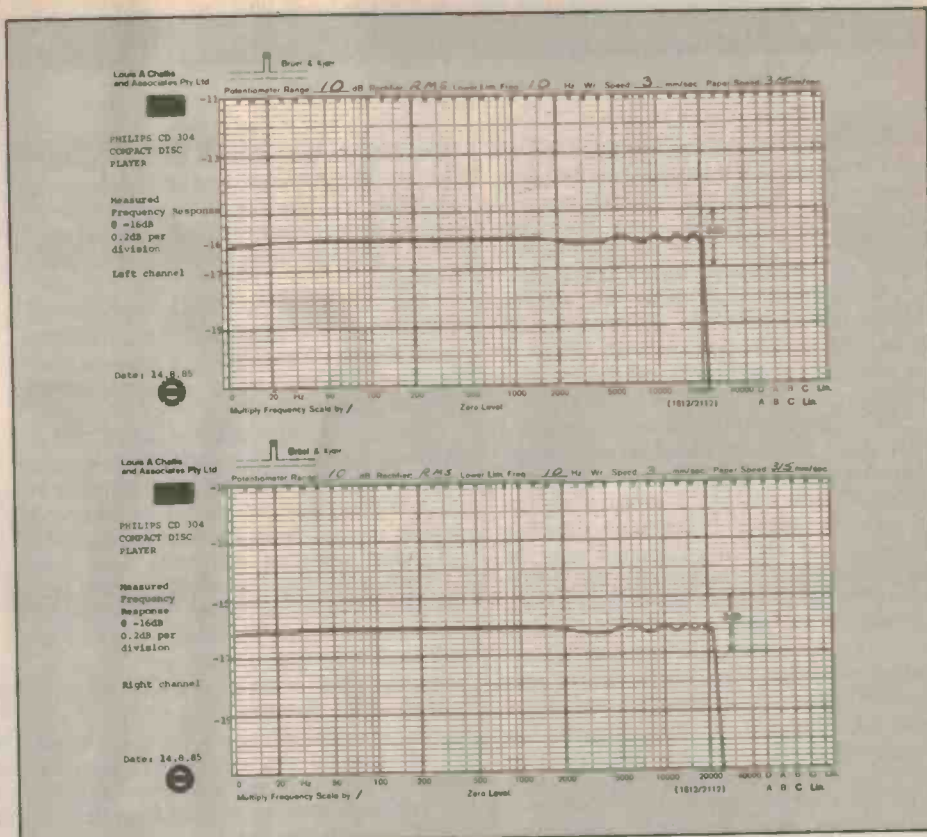

recorded content on the disc. To the right of this is the other silver pushbutton which allows you to select your track in association with the adjacent controls.

To the right of this are buttons for SCAN, which allow you to listen to the first 10 seconds of each track on the disc, the FORWARD and REVERSE SELECT buttons which allow you to select any track although only the first 20 are capable of being indicated, two other buttons of STORE and CANCEL are provided through which the random selection of tracks on the disc may be selected for subsequent play. On the right hand lower edge of the front panel are four pushbuttons for PREVIOUS track, NEXT track, REPEAT and PAUSE. Between these controls and the programming controls is a standard 6.5 mm ring tip and sleeve socket for headphones and a sensible volume control which is essential where a headphone socket is provided.

The slim remote control provides most of the programming control functions but does not provide access to the time or track buttons nor a volume control which I would like to see all remote controlled CD players incorporate in the future.

The cabinet of the CD 304 is fabricated from a strong but thin zinc diecasting with panel thicknesses a mere 1.4 mm. This die-cast chassis is only used for the sides and rear and incorporates a separate aluminium heatsink screw fixed onto the back panel. The top, sides and bottom of the player are fabricated from painted perforated steel.

The inside of the player incorporates an unusual configuration for the electronics which is contained in a pair of printed cir-

cuits located one above the other. The outer exposed surfaces of these printed circuit boards have been copper clad to provide improved electro-static screening and it is apparent that the circuitry has been manufactured to very high standards. Although Philips has recently developed a range of new large scale integrated circuits for CD players, much to my surprise virtually none of these appear to have been used in this unit.

The rear of the unit provides a separate line level volume control (which is an excellent idea), together with a permanently wired pair of signal leads (1500 mm long) terminating in RCA plugs. I have not yet reconciled myself to this approach and, like so many people, still prefer RCA sockets and separate leads, the length of which may be adjusted to suit the application. The double insulated mains lead also connected to the rear panel is terminated in a moulded two-pin plug.

Objective testing

The objective testing of the player confirmed that Philips has made significant advances and, I believe, some retrograde steps since the first generation CD player we evaluated at the end of 1982. In the intervening period, the frequency linearity, 'theoretical distortion', digital-to-analogue conversion linearity and disc trackability have all measurably improved. The frequency response of this particular player is remarkably flat with the measured deviation from 10 Hz to 20 kHz being ± 0.2 dB.

The linearity over the range 0 dB to -90 dB is excellent all the way down to -60 dB ▶

SOUND REVIEW

but exhibits modest non-linearity of 0.7 dB at -70 dB and a comparable reversed non-linearity at -80 dB and -2.7 dB reversed non-linearity at -90 dB. These figures are relatively good and have not been significantly improved on by other CD players.

The channel separations of 100 Hz, 1 kHz and 10 kHz are all exceptionally good and better than 95.8 dB while at 20 kHz this separation is still better than 90 dB.

When I came to measure the distortion, I observed a phenomenon which was strange and somewhat disconcerting: significant levels of both the 44.1 kHz sampling frequency as well as the double sampling frequency of 88.2 kHz intruded into the measured signals, particularly the 1 kHz reference signal where I would have not expected to see this occur. While totally inaudible, the presence of such components (see photos) plays 'merry hell' with the normal distortion measurement procedures as after notching out the fundamental, the equipment has to cope with high frequency components that are only -60 dB when referenced to the fundamental. The presence of such high level signals makes it almost impossible to derive completely accurate distortion figures and as a consequence the distortions quoted in the tabulation may be presumed to be equal to or less than those presented.

Notwithstanding, these distortions are still particularly low being less than 0.1% all the way down to -50 dB and only start to rise to significant levels at the -60 dB level in the order of 1.4%. At -70 dB this distortion has risen to 5.5%. By the time the -80 dB level has been reached, the distortion is up to 7.35%, while at -90 dB the distortion reaches in the order of 23.5%. These figures are probably better than the first generation Philips CD players and indicate that the latest generation of ICs providing digital-to-analogue conversion have advanced considerably in the short space of four years. The presence of the sampling

frequency in the output is still a regrettable factor; the suspicion that intermodulation products will result in the audio frequency stages of the player or in subsequent stages of the amplifier remains a matter of some concern.

The distortion levels at 100 Hz and 6.3 kHz are also excellent but my ability to measure the distortion at 6.3 kHz was once again complicated by the presence of the sampling frequency.

The signal-to-noise ratio of the CD 304 at 0 dB can be quoted in a number of different ways. While the theoretical performance is 98.2 dB(Lin) and 110 dB(A) without emphasis, the *real figure* in the presence of the 44.1 kHz sampling frequency was only -60 dB unweighted and considerably better as an A-weighted figure. The A-weighting network is not specified for 44.1 kHz but most A-weighting filters provide an attenuation of the order of -16 dB at that frequency. The frequency accuracy of the player is reasonably good being a modest 1.1 Hz low for the 19.999 kHz reference signal. The square wave response typifies the characteristics one expects from Philips' digital filtering circuitry.

The 'dirty record' test exemplifies a performance which is truly outstanding, with the player tracking all of the interruption layers including the 1.2 mm black spot. The fingerprint test provided negligible restrictions and the player's optical system and associated error correction circuitry all worked beautifully.

Subjective testing

The subjective performance of the CD 304 proved exciting. I played a number of brand new discs which I found to be outstanding and would recommend to you for your listening. The first of these is the Denon Digital Audio Check CD (33C39-7441) which offers a superb 'pot-pourri' of classical and pop music.

The second disc to which I listened and relistened at least a dozen times is a superb

CD 304 SIGNAL CHARACTERISTICS

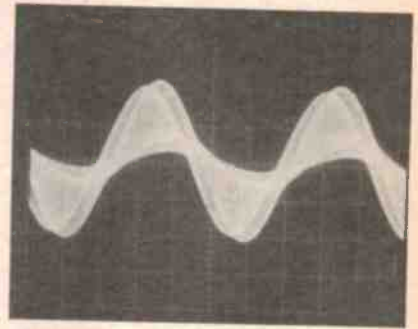

1 kHz 0 dB signal after filter attenuation with 40 dB gain in CRO.

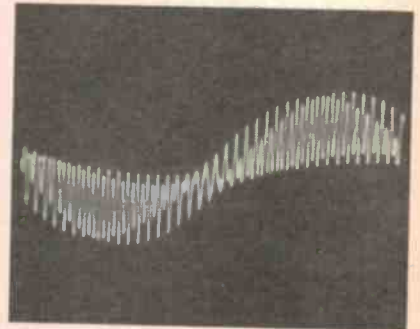

1 kHz 0 dB signal after filter attenuation with 40 dB gain in CRO. Expanded timebase scale.

rendition of W.A. Mozart's Piano Sonatas Vol 5 (Denon C73-7390) by the brilliant Portuguese pianist, Maria Joao Pires. The next disc was Tchaikovsky's Symphony No 5 with André Previn and the Royal Philharmonic Orchestra (Telarc CD 80107). The last of the discs was "Dinah Jams" by Dinah Washington (Embassy 814639-2) which features a magnificent selection of her most outstanding recordings.

With classical and pop recordings as good as these, the audible capability of the CD 304 came to the fore and provided an acoustical environment which was superb. While I am critical of one feature (or lack of it) in the CD 304, in all other respects it performs remarkably well and will provide exceptional listening quality together with outstanding user convenience.

PHILIPS CD 304 COMPACT DISC PLAYER

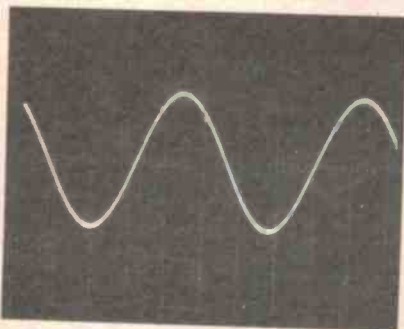

1 kHz 0 dB signal; CRO gain 0 dB no filter.

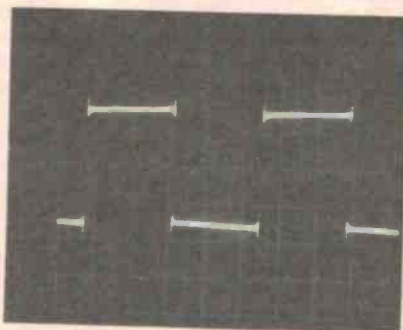

100 Hz square wave.

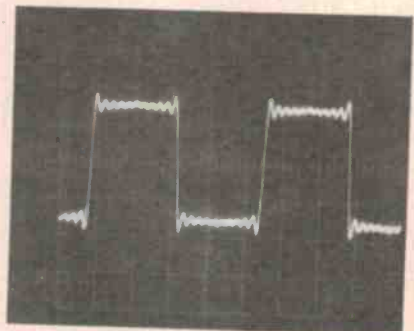

1 kHz square wave.

MEASURED PERFORMANCE OF PHILIPS COMPACT DISC PLAYER CD 304/10

SERIAL NO. AH 00503 100074

1. **FREQUENCY RESPONSE** plotted on B & K QP1 I24 Paper with 10 dB pot
Frequency Response 10 Hz to 20 kHz ± 0.2 dB

2. **LINEARITY**

NOMINAL LEVEL	L. OUTPUT	R. OUTPUT
0dB	0.0	0.0
-1.0	-1.0	-1.1
-3.0	-3.0	-3.0
-6.0	-6.0	-6.0
-10.0	-10.0	-10.0
-20.0	-20.0	-20.0
-30.0	-30.0	-30.0
-40.0	-40.0	-40.0
-50.0	-50.1	-50.1
-60.0	-60.1	-60.1
-70.0	-70.7	-70.7
-80.0	-79.8	-78.8
-90.0	-87.6	-87.3

3. **CHANNEL SEPERATION**

TEST FREQUENCY	LEFT INTO RIGHT dB	RIGHT INTO LEFT dB
100 Hz	-108.1	-107.1
1 kHz	-107.0	-106.6
10 kHz	-95.8	-100.8
20 kHz	-90.1	-93.7

4. **DISTORTION** (@ 1kHz) (See supplementary comments in Review)

Level dB	2nd	3rd	4th	5th	THD%
0	-	-97.7	-102.1	-101.5	0.0017
-1.0	-	-97.9	-102.2	-101.1	0.0018
-3.0	-88.2	-100.5	-	-94.6	0.0047
-6.0	-91.2	-95.5	-	-96.0	0.0036
-10	-92.6	-93.5	-	-95.4	0.0036
-20	-77.5	-79.6	-	-	0.017
-30	-73.9	-87.9	-	-	0.021
-40	-79.8	-	-67.3	-68.2	0.059
-50	-60.4	-59.9	-70.1	-72.2	0.14
-60	-47.3	-39.1	-45.2	-47.5	1.38
-70	-27.2	-	-29.8	-42.0	5.49
-80	-38.5	-24.4	-29.4	-33.2	7.35
-90	-21.6	-30.8	-21.6	-14.0	23.3

Distortion @ 100 Hz	0 dB	-20	-40	-60
	-98.1	-79.9	-76.0	-47.9
	-85.3	-85.0	-88.3	-39.2
	-98.6	-94.0	-74.5	-45.4
	-110.2	-101.1	-68.1	-45.4
	0.0057	0.012	0.047	1.39

Distortion @ 6.3 kHz	0 dB
	-88.2
	-89.9
	-
	-
	0.005

5. **EMPHASIS**

Frequency	Recorded Level	Output Level (L)	Output Level (R)
1 kHz	-0.37 dB	-0.4	-0.3
5 kHz	-4.53 dB	-4.7	-4.6
16 kHz	-9.04 dB	-9.4	-9.3

6. **"THEORETICAL" SIGNAL TO NOISE RATIO**

Without Emphasis	98.2 dB(Lin)	110.0 dB(A)
With Emphasis	103.2 dB(Lin)	110.6 dB(A)

7. **FREQUENCY ACCURACY**

-1.1 Hz for 19,999 kHz test signal

8. **SQUARE WAVE RESPONSE**

Frequency	Waveform	Result
100Hz	Square wave	See photo
1kHz	Square wave	See photo

DIRTY RECORD TEST

Using Philips NR4A (410-056-2)

Interruption in Information Layer

400 micrometer ;	passed
500 micrometer ;	passed
600 micrometer ;	passed
700 micrometer ;	passed
800 micrometer ;	passed
900 micrometer ;	passed

Black Dot at Read out Side

300 micrometer ;	passed
500 micrometer ;	passed
600 micrometer ;	passed
800 micrometer ;	passed
1000 micrometer ;	passed
1200 micrometer ;	passed

BLACK STRIPE TEST - Passed

SKEW TRACKING TEST - Test Disc Skew angle 2° failed.

OUTPUT IMPEDANCE - Head Phone Amplifier output impedance 120 ohms

GRUV-GLIDE

THE 15° SOLUTION TO RECORD WEAR

GRUV-GLIDES claims of complete record care and protection are now accepted by most discerning record users. Gruv-Glide replaces all other record cleaning methods in one simple application. Gruv-Glide will actually improve the sound from your records (old and new). You can make the test by taking one of your own records to your local Gruv-Glide dealer. Gruv-Glide will also remove old record cleaners that clog your stylus, and at around 15° a record is a most economical treatment.

Gruv-Glide really works.

For more information:
LEISURE IMPORTS
102 Glover Street
Cremorne 2090.
(02) 908-3944



A.F. BAMBACH PTY LTD

752 Pittwater Road,
Brookvale, NSW

(02) 938 5622

Telex AA26394

Established 50 years.
Manufacturers of Microphone
and Data Cable, Hook-up wire
and specialist cable.



Branches:

Newcastle (049) 61 5589 Brisbane (07) 44 1078 Melbourne (03) 690 5999

STEREO CASSETTE-RADIO FOR THE AUSSIE CAR

The top of the line Eurovox MCC 2360E is an auto-reverse cassette stereo player with AM and FM stereo electronic tuning. It's also expensive. However, it's been specially designed for Australian conditions and offers excellent performance.

Louis Challis

WHEN I FIRST heard of Eurovox, the name conjured up images of continental equipment imported from either Germany or Austria. That is probably what the company directors intended, though nothing could be further from the truth.

I came face to face with my first Eurovox car stereo system in a new BMW 318 in Melbourne last year. The proud owner was quick to tell me that my suppositions were completely erroneous and that Eurovox car systems are 'true-blue Aussie' and 'by far the best car stereo that money could buy'. As impressed as I was with his statements, I never did get to properly evaluate the system as the journey was only from one side of the city business district to the other.

A more comprehensive familiarisation had to wait until now, when our affable editor arranged for me to test one of the company's latest models to find out exactly how good the top of the line Eurovox system really is.

Design and appearance

The frontal appearance and size of the model MCC-2360E belies the complex capabilities of what is undoubtedly a 'wolf in sheep's clothing'. This unit contains much more 'state of the art' electronics than almost any other comparable system currently available in Australia. The designers claim that the unit is based on a totally new design concept and is consequently head and shoulders above competing systems. For the most part this statement is unquestionably true, although some of the boards used in the system are shared by the previous MCC-2301R system.

The main features of the unit are its soft touch controls for operating both the tape and radio sections. Emphasis has been placed on logical and easy operation of all the functional controls. The unit incorporates a microprocessor to control both the AM and FM stereo radio tuners, with digital readout for both radio frequency and time selection. The brightness of the display is controlled by the ambient light level so that you always have enough illumination to be able to read the frequency, time or supplementary displays. The quartz locked, synthesised radio station seeking circuit provides six AM and six FM programmable memories with the 'memory address' designated by a number for easy identification.

But the most important attribute of this receiver is its incorporation of the Motorola stereo AM decoder chip MC1302OP (C-Quam) which is sensibly coupled with a switchable wideband/narrowband IF circuit. In the wideband mode this circuit provides a quality of AM listening which is generally better than most other AM stereo car receivers on the market, including the excellent Pioneer model KE-A433, which I reviewed in September's ETI.

The unit also incorporates a number of attributes which intending purchasers will instantly perceive, together with some that take more time to appreciate. One obvious feature with which you will be immediately impressed is the 'joystick' balance control for adjusting the relative output of the four separate amplifiers provided to power the four speaker system for which the Eurovox has been designed (two at the front and two at the rear of the car). As well, there are a

number of unusual and yet very sensible design features which you may never take any notice of unless something goes wrong. In the event of a thermally distorted cassette (or an old one where the label is peeling off) jamming while being loaded or ejected, the internal microprocessor logic (MICTES — Microprocessor Controlled Tape Evaluation System) automatically moves to reject the cassette. In the unlikely event of the cassette jamming, the microprocessor de-activates the cassette function and automatically switches the unit to the radio mode so that you do not lose the total use of your 'pride and joy'. Although this function provides more effective control than is found in most other car cassette designs, if you do manage to get a cassette jammed in the player you will have to go back to your local service centre in order to retrieve your 'mal-treated' cassette.

The designers have also incorporated improved FM noise suppression circuits and AM and FM noise bandwidth adjustment circuits to improve the quality of signal in low signal strength areas, about which I will say more later.

The front panel of the unit has a beguilingly simple appearance with the controls laid out in three different sections on the front panel. On the top left hand side is the joystick balance control through which the relative levels of the four separate speakers may be conveniently adjusted. Immediately below this are three separate switches for the Dolby B noise reduction facility (which very few car radios currently provide), a loudness contour switch (LD) and the Type I (120 microseconds) or Types III and IV



EUROVOX MCC 2360E

Dimensions: Case 180 mm (wide) x 52 mm (high) x 150 mm (deep), front face 190 mm (wide) x 60 mm (high) x 10 mm (deep)

Weight: 1.8 kg
Manufacturer: Eurovox Australia
RRP: \$899

(chromium dioxide/metal, 70 microseconds), tape which are labelled METAL and are an essential feature if you wish to gain the best possible replay performance from your cassettes.

The central section of controls features a cassette loading well at the top into which you end-load your cassette, with two rows of controls below. This cassette player incorporates a fully automatic reverse play mode which is always a desirable feature, but even more so in a car.

The first control on the top row of switches is the automatic programme search (APS) which detects unrecorded blank sections of tape lasting for more than four seconds and locates the beginning of each section of the programme in either the fast forward or rewind modes. The second control is the REWIND pushbutton. The central or third control is labelled PROGRAMME and reverses the direction of tape play from forward to reverse and vice versa. The fourth button is the fast forward switch, while the fifth button is the cassette EJECT. All these pushbuttons have illuminated escutcheons immediately above to indicate their functions.

On the bottom row are three rotary knobs. The largest, on the left, is the VOLUME control which also incorporates the push mechanism to operate the power ON/OFF switch. The two smaller controls immediately to the right are the BASS and TREBLE controls respectively.

At the top of the right hand side of the front panel is the LED display which provides clear and large channel number identification on the left, AM or FM designations adjacent and a large four digit display of frequency on the right. This illumination system brightens during the daytime and uses a photosensitive diode to dim when dark (at night time).

On the extreme right of the panel is a switch labelled ME. This is the memory enable and allows a favoured station to be entered into each of the six memories for AM and FM respectively. The display also indi-

cates whether the selected station is being received as a stereo or mono signal and shows whether a narrow or wide bandwidth expansion (BX) is in operation.

The central row of controls comprises six pushbuttons for selection of a pre-set station. The bottom row of controls consists of a manual tuning rocker switch which is well conceived, a pushbutton for selecting AM or FM, a switch for selecting mono or stereo reception (MO), a bandwidth expansion (BX) switch, and a channel automatic SEEK tuning switch which searches for station carriers and locks on to the next station until reactivated. This last switch searches for stronger stations in the stereo mode and weaker in the mono mode. Unlike other receivers on the market, the AM section of this unit extends all the way up to 1629 kHz, facilitating the reception of 2RPH and 3RPH which are the Radio Print Handicap stations over which newspapers and other programmes for people with poor vision are now broadcast.

The unit comes equipped with a cable harness for connecting power and speakers, a pair of DIN male and female sockets interconnected for normal use and designed for interconnecting graphic equalisers and high powered amplifiers, and a conventional aerial socket of a 75 mm cable at the rear.

The inside of the unit features eight separate sub-boards, including those for the cassette player controls, and innumerable medium and large scale ICs to provide the complex features necessitated by the circuitry. The power output stages are particularly interesting, having a complimentary symmetry design with positive and negative supply rail requirements and consequent floating earth required by the high powered rear stage. We found that we had to be very careful when measuring these stages to avoid earthing the circuitry. The front amplifier stages present fewer problems as one side of their output is designed to be earthed.

Although the unit is well made, with sen-

sible heatsinks and reasonably rugged construction, it is not designed for servicing by amateurs and might well be labelled 'No User Serviceable Parts Inside'. Without a service manual you would be hard pressed to undertake any useful servicing. The unit has been designed in Australia by Australians, but one should note that it has been manufactured in Japan to high standards.

Objective testing

The objective testing of the unit revealed considerable information about the design characteristics of the unit as well as their implementation. The replay characteristics of the cassette player were particularly good with a frequency response that effectively extends from 90 Hz to 16 kHz ± 3 dB on Type I (gamma ferric oxide) tape and from 85 Hz to 13 kHz for Type IV (metal) tape. The low frequency performance of the cassette player is not as good as some owners might desire, but it should be remembered that very few car speaker systems provide effective outputs below 80 Hz since the size and complexity of speaker enclosures must be limited to fit within the confines of the vehicle space.

The distortion figures at maximum output level are moderately high as a result of a combination of amplifier distortion and cassette player distortion.

The wow and flutter is reasonably low at 0.15 % rms and the signal-to-noise ratio is excellent, being better than 48 dB unweighted and 55 dB(A) with the Dolby out at 1 kHz. With Dolby in, the signal-to-noise figures are considerably better but it would be hard to justify any improvement on these ▶

SOUND REVIEW

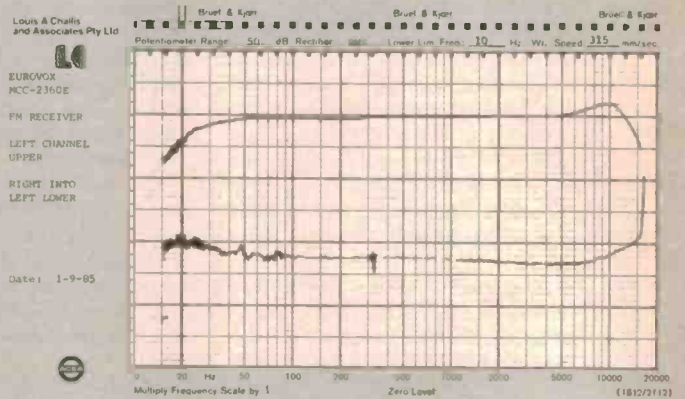
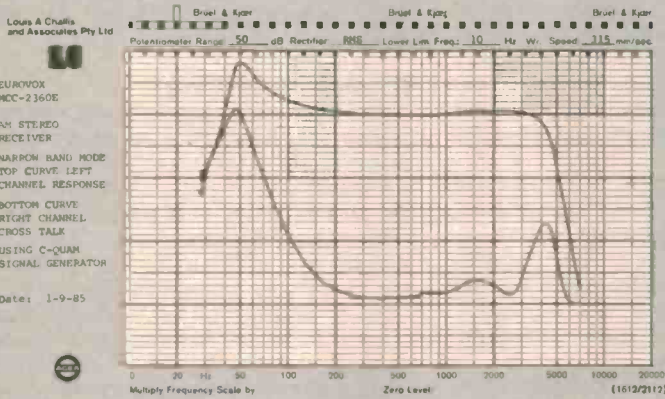
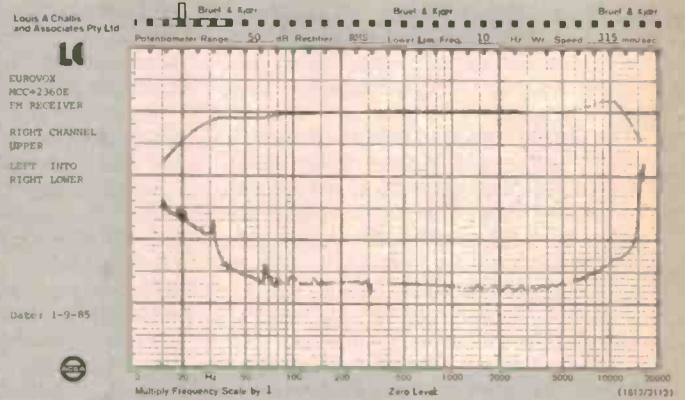
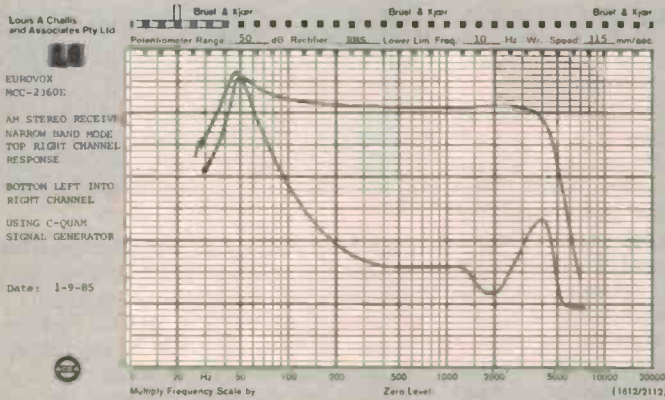
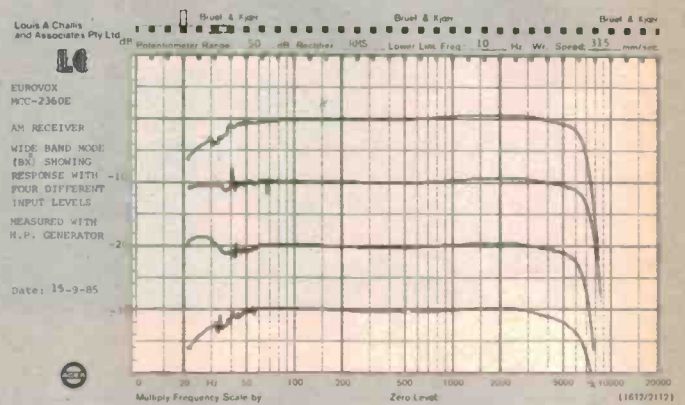
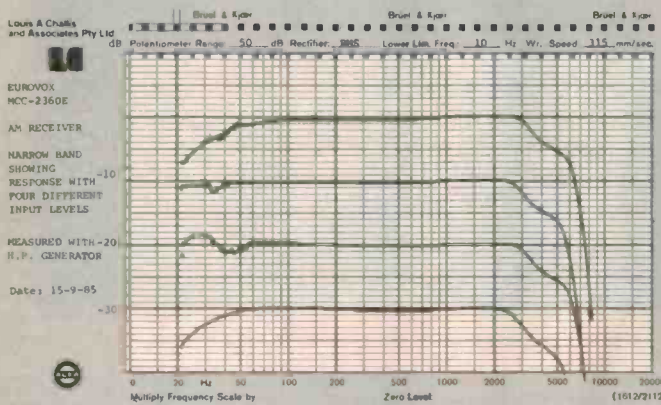

figures in a vehicle. The channel separation is 35 dB which is reasonably good and certainly good enough for a car stereo system.

The tone controls provide an excellent range of boost and cut, substantially more than most other car radios we have seen in the last few years. The power output of the amplifiers all driven in parallel is 2 x 16 watts and 2 x 4.5 watts at 3% distortion. With a single channel driven, this power increases to 20 watts or 7 watts per channel into 4 ohms respectively. The high power amplifiers are intended for connection to

the rear channel speakers while the low power amplifiers are intended for connection to the front speakers, and they provide adequate power.

The FM section provides an excellent frequency response which extends from 25 Hz to 14 kHz +3 dB with a channel separation which is better than 30 dB midband and with more than adequate separation over the range 50 Hz to 10 kHz. The FM tuner section of the unit provides excellent sensitivity, substantially better than any other car radio we have recently seen.

It is the AM section of the unit which is unquestionably the 'piece de resistance' of the unit. This is because in the narrowband mode it provides a genuine 20 Hz to 5.2 kHz ± 6 dB bandwidth in the mono mode and 28 Hz to 4.8 kHz ± 6 dB bandwidth in the stereo mode. In the wideband mode position (BX switch activated), the receiver provides a very desirable 7.0 kHz bandwidth (± 6 dB) which truly gives it an edge on virtually all the other stereo AM receivers on the market at the moment.

One characteristic which the designers

MEASURED PERFORMANCE OF EUROVOX MCC-2360E

CASSETTE CAR STEREO WITH FM/AM ELECTRONIC TUNER

Serial number : 15600004

REPLAY FREQUENCY RESPONSE AT -20VU :
(AS 2680 Clause 2.2.3.1)

Tape	Dolby	Lower - 3dB Point	Max. Point & Frequency	Upper - 3dB Point
Type I	OUT	90 Hz	+2.5 dB @ 12 kHz	16 kHz
Type IV	OUT	85 Hz	NII	13 kHz

SPEED ACCURACY : +1.25% with TDK Reference tape
(AS 2680 Clause 2.2.1)

WOW AND FLUTTER :
(AS 2680 Clause 2.2.2)

WOW : Average 0.15% peak to peak

FLUTTER : Unweighted 0.2% RMS

Weighted 0.1% RMS

HARMONIC DISTORTION : (includes AM Generator Distortion)
(at rated output 7 watts and 14 watts into 4 ohms)

		100Hz	1kHz	6.3kHz	
OVU :	2nd	-42.0	-45.4	-47.6	dB
	3rd	-45.3	-52.9	-	dB
	4th	-	-	-	dB
	5th	-	-	-	dB
	TOTAL	-40.0	-44.7	-47.6	dB
T.H.D.	1.0	0.58	0.42	%	

with 1.0 watts amplifier output

-6VU :	2nd	-48.7	-50.3	-52.6	dB
	3rd	-43.1	-52.7	-	dB
	4th	-50.2	-	-	dB
	5th	-	-	-	dB
	TOTAL	-41.4	-48.3	-52.6	dB
T.H.D.	0.85	0.38	0.23	%	

tone controls

15 dB boost and 14 dB cut at 50 Hz and
11 dB boost and 12 dB cut at 1 kHz

EQUALISATION : IS in accordance with IEC 268-3B

DYNAMIC RANGE :

Tape : Sony HF-ES 60

Dolby Out 48 dB(Lin) 55 dB(A)

FM TUNER :

Frequency Range : 87.5-108 MHz

Usable Sensitivity : (40 kHz deviation)

MONO for signal to noise 26 dB 14 dBf
STEREO for signal to noise 46 dB 21 dBf

AM TUNER :

Frequency Range : 531-1629 kHz

Usable Sensitivity : 20 microvolts for 20 dB signal to noise ratio on Mono signal

Signal to Noise Ratio @ 1mV input = 50 dB

Bandwidth : Narrow Band Mode Wide Band Mode

4.8 kHz stereo 7.0 kHz stereo
5.2 kHz mono* 7.4 kHz mono*

* using Hewlett Packard signal generator

Channel Separation Stereo better than 30 dB midband

Louis A Chellis and Associates Pty Ltd

EIRPVFX
MCC-2360E

CASSETTE PLAYER

REPLAY RESPONSE WITH TYPE "I" TAPE

Date: 1-9-85

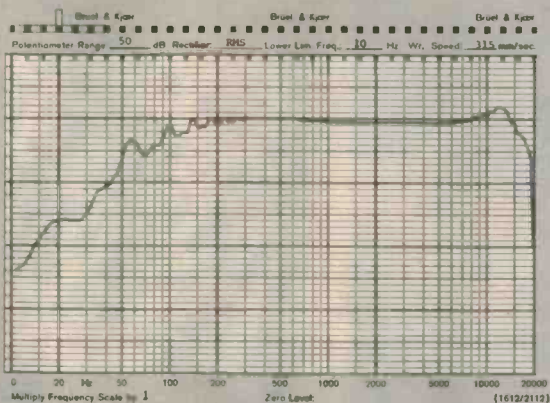

Louis A Chellis and Associates Pty Ltd

EUROVOX
MCC-2360E

CASSETTE PLAYER

REPLAY RESPONSE WITH TYPE "A" METAL TAPE

Date: 1-9-85

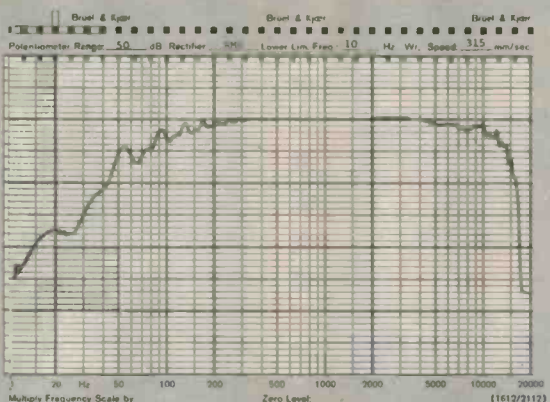

Louis A Chellis and Associates Pty Ltd

EUROVOX
MCC-2360E

tone control response showing

MAXIMUM MID-RANGE MINIMUM POSITIONS

Date: 1-9-85

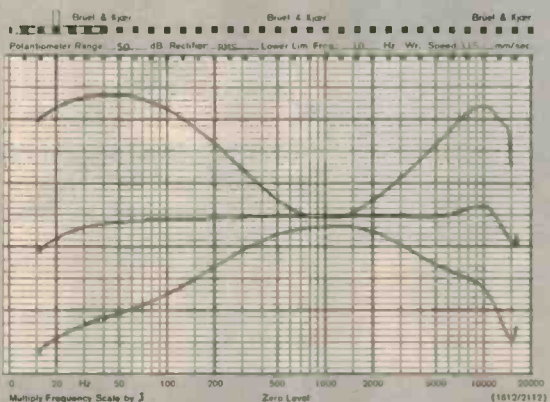

claim as a feature is associated with the variable bandwidth in both the wideband and narrowband mode for varying input signal levels. In practical terms this appears to be primarily the result of variable loading, which is a problem that has plagued most AM circuits for the last 50 years. It is nonetheless a nice touch to claim this is a "design feature" even though it is more likely that the designers had little or no control over its characteristics.

Nevertheless, the superior bandwidth capabilities on both AM and FM have been

achieved with substantially better sensitivities than those provided by most of this system's current competitors.

Subjective testing

The subjective assessment of the Eurovox MCC 2360E revealed that it has been sensibly designed to provide ergonomic features for use under the difficult operating conditions — which normally prevail in a car. The front panel design logically places the primary controls where they are required, and the shape of those controls has been se-

lected so that you can identify them by touch without taking your eyes off the road. The balance control, volume control, radio selector controls and even the tape controls are particularly easy to use.

The designers have incorporated an automatic mono circuit so that when the station signal is too weak for proper stereo reception the mono signal is automatically selected. This normally results in a change of the frequency linearity of the receiver, as noted previously, whereby some of the high frequency signal is lost and consequently

SOUND REVIEW



Testing at the House of Challs. The Eurovox MC2360E is connected to an HP AM signal generator (the big gadget on top). This device has an AM stereo modulator, transmitter exciter and low powered transmitter output. It enables measurements of AM stereo frequency response and channel separation to be taken.

turns out to be an advantage when the signal-to-noise characteristics of the background are taken into account.

The time display function, as I soon discovered, is obtained by pressing the programme switch (the central switch under the cassette well) when the radio receiver is operational and displays the time for five seconds. In the dark, all of the major panel functions are clearly indicated by rear illuminated panel designations so that you or your passenger can correctly identify the controls.

My overall impression of the Eurovox MCC 2360E is that it is a delightful and well made unit which has been 'truly designed for Australian conditions', whereas most

other imported units have not. The provision of a 'decent' AM bandwidth in lieu of the apologies to which we have grown accustomed, and about which we have complained so much is a 'ray of sunshine' in an otherwise dismal scene. When you also find that the cassette player provides Grade A2 performance and that the FM reception is equally good, you soon realise that this is no ordinary car radio. At a recommended retail price of \$899, together with another \$300-\$400 for good speakers, aerial and fitting, it is also 'no steal'. One must, however, consider the concept that 'you pay for what you get' and in the case of the MCC 2360E I believe you really do get what you have paid for. ●

Microbee HACKER'S HANDBOOK

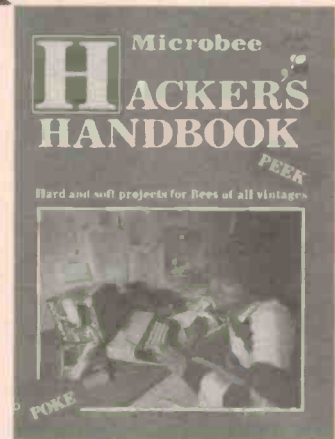

From the publishers
of 'ETI' and 'Your
Computer' magazines.

The Microbee Hackers Handbook
will tell you how to:

- Get more from the Bee's graphics capabilities.
- Set up for telecommunications on the Bee.
- Play music on the Bee.
- Build a joystick and a light pen for the Bee.
- Get hardcopy — cheaply.
- Expand your 16K Bee to 32K
- Make the Bee a better games machine.
- Turn your Bee into a facsimile decoder.
- Solve equations on the Bee . . . and much more!

★
\$6.50 at your newsagent now.

Have not you ears!

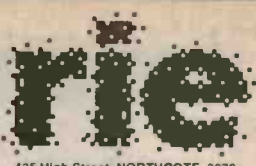

425 High Street, NORTHCOE, 3070
 VICTORIA, AUSTRALIA
 Phone (03) 489 8666
 49 A Beckett St, MELBOURNE, 3000
 VICTORIA, AUSTRALIA
 Ph. (03) 563 6151
 Mail Order and correspondence:
 P.O. Box 620, CLAYTON 3168
 TELEX: AA 15193R



MAIL ORDER HOTLINE
 (03) 543 8777
 (2 lines)

POSTAGE RATES

\$1-\$9.99	\$2.00
\$10-\$24.99	\$3.00
\$25-\$49.99	\$4.00
\$50-\$99.99	\$5.00
\$100-\$199	\$7.50
\$200-\$499	\$10.00
\$500 plus	\$12.50

This is for basic postage only. Comet Road freight, bulky and fragile items will be charged at different rates.
 Certified Post for orders over \$100 included "free"
 Registered Post for orders over \$200 included "free"



Errors and Omissions Excepted.

IC SPECIALS

		1-9	10+
6116LP-3	2.50	1.95	
4116	1.80	1.70	
4164	1.95	1.75	
2716	5.90	5.50	
2732	6.25	5.95	
27128	7.00	6.50	
6116	2.95	2.75	
41256	9.00	8.00	
27C64	19.00	17.95	
6264	8.00	7.00	

NEW IC'S

		1-9	10+
MCS2400	4.90	4.75	
41256	9.00	8.00	
27128	7.00	6.50	
74LS169	2.50	2.40	
AY-31050	12.50	11.95	
WD2791	69.00	67.00	
WD2793	69.00	67.00	
WD2795	69.00	67.00	
WD2797	69.00	67.00	
LM11CN	2.95	2.75	
LM1871	5.95	5.75	
LM1872	5.95	5.75	
Z80ADART	13.50	12.95	
LM338K	10.50	9.50	
AM53530	24.95	23.95	
AM7910	49.50	45.00	
(World Modern Chip)			
UPTC1031	19.50		
R.F. Module			
57716	64.95	59.95	
27256	69.00	59.00	

ICLT706	19.50	74C	74LS169	2.45	TL072	2.80	2N2646	1.20	MRF237	5.90	3M201	1.50	8121	5.00	74F373	4.84	DAC0086	4.50	4560	3.75
ICLT711	21.50	74C00	74LS173	90	TL073	3.20	2N2647	2.50	MRF238	29.50	25A683	1.50	8123	4.00	74F374	4.84	SX1410	9.50	4561	1.60
ICLT717	6.85	74C02	74LS174	90	TL074	4.00	2N6027	1.50	MRF245	53.50	25C208	3.95	8130	8.95	74F399	2.78	ZN414	1.95	4562	8.45
ICM7160	9.50	74C08	74LS175	1.00	TL075	1.90	2N6028	1.50	MRF246	19.50	25C209	3.95	8131	5.95	74F521	4.22		5.00	4563	3.00
ICM7171	12.50	74C10	74LS181	4.00	TL082	2.50	TRAKS		MRF247	15.50	25C216	4.95	8136	6.95	74F533	4.84	4000	5.00	4564	6.25
ICM7184	46.50	74C14	74LS190	1.50	TL083	2.90			MRF248	12.50	25C217	1.95	8303	6.95	74F534	4.84	4001	5.00	4569	2.50
ICM7216A	46.50	74C20	74LS191	1.20	TL084	3.45	AC126	1.20	MRF249	49.00	25C1969	6.30	8304	6.95			4002	5.00	4572	7.50
ICM7216B	46.50	74C30	74LS192	1.20	TL085	3.90	AC127	1.20	MRF250	56.50	25C197	3.95	8305	6.95			4006	1.90	4581	3.10
ICM7224A	44.50	74C32	74LS193	1.20	TL086	4.35	AC128	1.20	MRF251	2.00	VN86AF	3.95	852123	6.95			2101	6.90	4007	4.00
ICM7224B	44.50	74C48	74LS196	90	TL087	4.80	AC129	1.20	MRF252	1.90	25C372	1.95	8311	5.95	2102	2.50	4008	1.20	4583	1.65
ICM7227A	48.50	74C74	74LS197	1.75	TL088	5.25	AC130	1.20	MRF253	1.90	25C373	1.95	8312	5.95	2103	2.50	4010	9.00	4584	8.85
ICM7227B	48.50	74C76	74LS240	1.80	TL089	5.70	AC131	1.20	MRF254	1.90	25C374	1.95	8313	5.95	2104	2.95	4011	4.00	4585	2.10
	19.95	74C83	74LS241	1.90	TL090	6.15	AC132	1.20	MRF255	1.90	25C375	1.95	8314	5.95	2105	2.95	4012	4.00	45104	3.45
		74C85	74LS242	1.90	TL091	6.60	AC133	1.20	MRF256	1.90	25C376	1.95	8315	5.95	2106	2.95	4013	6.00	45106	7.85
74S		74C86	74LS243	1.90	TL092	7.05	AC134	1.20	MRF257	1.90	25C377	1.95	8316	5.95	2107	2.95	4014	1.80	45107	7.25
74S00	6.00	74C89	74LS244	1.50	TL093	7.50	AC135	1.20	MRF258	1.90	25C378	1.95	8317	5.95	2108	2.95	4015	1.90	45109	7.25
74S02	1.00	74C90	74LS245	1.50	TL094	8.00	AC136	1.20	MRF259	1.90	25C379	1.95	8318	5.95	2109	2.95	4016	7.50		
74S03	1.00	74C93	74LS247	1.50	TL095	8.50	AC137	1.20	MRF260	1.90	25C380	1.95	8319	5.95	2110	2.95	4017	1.50		
74S04	1.00	74C95	74LS248	1.50	TL096	9.00	AC138	1.20	MRF261	1.90	25C381	1.95	8320	5.95	2111	2.95	4018	1.80		
74S05	1.00	74C107	74LS249	1.50	TL097	9.50	AC139	1.20	MRF262	1.90	25C382	1.95	8321	5.95	2112	2.95	4019	9.00		
74S08	1.00	74C150	74LS251	1.50	TL098	10.00	AC140	1.20	MRF263	1.90	25C383	1.95	8322	5.95	2113	2.95	4020	1.50		
74S09	1.00	74C151	74LS252	1.50	TL099	10.50	AC141	1.20	MRF264	1.90	25C384	1.95	8323	5.95	2114	2.95	4021	1.50		
74S10	1.00	74C154	74LS257	1.50	TL100	11.00	AC142	1.20	MRF265	1.90	25C385	1.95	8324	5.95	2115	2.95	4022	1.50		
74S11	1.00	74C157	74LS258	1.50	TL101	11.50	AC143	1.20	MRF266	1.90	25C386	1.95	8325	5.95	2116	2.95	4023	1.50		
74S15	1.60	74C160	74LS259	1.50	TL102	12.00	AC144	1.20	MRF267	1.90	25C387	1.95	8326	5.95	2117	2.95	4024	1.50		
74S20	1.60	74C161	74LS261	2.50	TL103	12.50	AC145	1.20	MRF268	1.90	25C388	1.95	8327	5.95	2118	2.95	4025	1.50		
74S22	1.60	74C162	74LS262	2.50	TL104	13.00	AC146	1.20	MRF269	1.90	25C389	1.95	8328	5.95	2119	2.95	4026	1.50		
74S30	1.00	74C163	74LS273	1.95	TL105	13.50	AC147	1.20	MRF270	1.90	25C390	1.95	8329	5.95	2120	2.95	4027	1.50		
74S32	1.00	74C164	74LS278	6.80	TL106	14.00	AC148	1.20	MRF271	1.90	25C391	1.95	8330	5.95	2121	2.95	4028	1.50		
74S37	1.00	74C165	74LS279	6.80	TL107	14.50	AC149	1.20	MRF272	1.90	25C392	1.95	8331	5.95	2122	2.95	4029	1.50		
74S38	1.00	74C174	74LS280	2.50	TL108	15.00	AC150	1.20	MRF273	1.90	25C393	1.95	8332	5.95	2123	2.95	4030	1.50		
74S40	1.20	74C174	74LS283	1.50	TL109	15.50	AC151	1.20	MRF274	1.90	25C394	1.95	8333	5.95	2124	2.95	4031	1.50		
74S41	8.00	74C175	74LS290	1.50	TL110	16.00	AC152	1.20	MRF275	1.90	25C395	1.95	8334	5.95	2125	2.95	4032	1.50		
74S42	1.00	74C176	74LS291	1.50	TL111	16.50	AC153	1.20	MRF276	1.90	25C396	1.95	8335	5.95	2126	2.95	4033	1.50		
74S43	1.00	74C177	74LS292	1.50	TL112	17.00	AC154	1.20	MRF277	1.90	25C397	1.95	8336	5.95	2127	2.95	4034	1.50		
74S44	1.00	74C178	74LS293	1.50	TL113	17.50	AC155	1.20	MRF278	1.90	25C398	1.95	8337	5.95	2128	2.95	4035	1.50		
74S45	1.00	74C179	74LS295	1.75	TL114	18.00	AC156	1.20	MRF279	1.90	25C399	1.95	8338	5.95	2129	2.95	4036	1.50		
74S46	1.00	74C183	74LS297	6.50	TL115	18.50	AC157	1.20	MRF280	1.90	25C400	1.95	8339	5.95	2130	2.95	4037	1.50		
74S47	1.00	74C189	74LS298	1.50	TL116	19.00	AC158	1.20	MRF281	1.90	25C401	1.95	8340	5.95	2131	2.95	4038	1.50		
74S48	1.00	74C193	74LS299	1.50	TL117	19.50	AC159	1.20	MRF282	1.90	25C402	1.95	8341	5.95	2132	2.95	4039	1.50		
74S49	1.00	74C195	74LS300	1.50	TL118	20.00	AC160	1.20	MRF283	1.90	25C403	1.95	8342	5.95	2133	2.95	4040	1.50		
74S50	1.00	74C196	74LS301	1.50	TL119	20.50	AC161	1.20	MRF284	1.90	25C404	1.95	8343	5.95	2134	2.95	4041	1.50		
74S51	1.00	74C197	74LS302	1.50	TL120	21.00	AC162	1.20	MRF285	1.90	25C405	1.95	8344	5.95	2135	2.95	4042	1.50		
74S52	1.00	74C198	74LS303	1.50	TL121	21.50	AC163	1.20	MRF286	1.90	25C406	1.95	8345	5.95	2136	2.95	4043	1.50		
74S53	1.00	74C199	74LS304	1.50	TL122	22.00	AC164	1.20	MRF287	1.90	25C407	1.95	8346	5.95	2137	2.95	4044	1.50		
74S54	1.00	74C200	74LS305	1.50	TL123	22.50	AC165	1.20	MRF288	1.90	25C408	1.95	8347	5.95	2138	2.95	4045	1.50		
74S55	1.00	74C201	74LS306	1.50	TL124	23.00	AC166	1.20	MRF289	1.90	25C409	1.95	8348	5.95	2139	2.95	4046	1.50		
74S56	1.00	74C202	74LS307	1.50	TL125	23.50	AC167	1.20	MRF290	1.90	25C410	1.95	8349	5.95	2140	2.95	4047	1.50		
74S57	1.00	74C203	74LS308	1.50	TL126	24.00	AC168	1.20	MRF291	1.90	25C411	1.95	8350	5.95	2141	2.95	4048	1.50		
74S58	1.00	74C204	74LS309	1.50	TL127	24.50	AC169	1.20	MRF292	1.90	25C412	1.95	8351	5.95	2142	2.95	4049	1.50		
74S59	1.00	74C205	74LS310	1.50	TL128	25.00	AC170	1.20	MRF293	1.90	25C413	1.95	8352	5.95	2143	2.95	4050	1.50		
74S60	1.00	74C206	74LS311	1.50	TL129	25.50	AC171	1.20	MRF294	1.90	25C414	1.95	8353	5.95	2144	2.95	4051	1.50		
74S61	1.00	74C207	74LS312	1.50	TL130	26.00	AC172	1.20	MRF295	1.90	25C415	1.95	8354	5.95	2145	2.95				

VHS answers 8 mm

The Australian release of National's VHS movie camera in August this year is seen as a reply by conventional video makers to the interest shown in 8 mm technology.

The VHS camera is National's answer to the demand for a lightweight all-in-one video camera recorder which uses the standard 1/2" VHS cassette tape. It's capable of four full hours uninterrupted recording and playback.

The camera weighs 2.5 kg (without battery) and is equipped with a highly sensitive Newvicon pickup tube which makes possible available light shooting at light levels as low as 10 lux. Auto-manual iris control, x6 power zoom lens (F1.4) with macro capability and automatic white balance adjustment are other features.

To pack all these technological achievements into the compact body of the VHS movie camera while assuring complete compatibility with the standard

VHS system has called on all of Matsushita's micro-precision engineering know-how. For example, a compact direct-drive video head cylinder with a diameter of only 41 mm and a new M-shape tape loading system in which the tape is wound around the cylinder for a full 270 degrees (182° in the conventional system) are employed.

The electronic viewfinder is a 1/2" black and white TV screen which gives easy focusing and doubles as a playback monitor for immediate checking of recordings. Playback is also possible if preferred via a TV monitor or TV set.

For further information contact **National Panasonic at 99 Epping Rd, North Ryde, NSW 2113. (02)887-5315.**



Portable CD player

The new Technics SL-XP7 unit measures a mere 126 mm (w) x 31.9 mm (h) x 126 mm (d) and weighs only 520 g. It fits in the palm of a hand and incorporates a new laser pick-up system as well as 15-step random access programmability.

The SL-XP7 has been placed on the Japanese market and will be released here at a date yet to be confirmed.

The player's aluminium die-cast body comes in both black and silver and has a slimline design with a large transparent window allowing easy disc visibility. Despite its compact size the SL-XP7 has many features which give high quality sound reproduction.

It can be powered by an optional ac adaptor, or for portable use another optional accessory is a rechargeable battery built into a hard carrying case. For its portability, parent company Matsushita's engineers developed the FF1 (fine-focus one-beam), a miniaturised laser pick-up which reportedly gives



reliable performance in an ultra compact configuration. The FF1 uses an original accu-servo system for tracking error detection capability.

Engineers have incorporated a friction-free four-wire suspension system to support the focus lens. This free-floating system is designed to be especially resistant to physical shock. In addition, a spring loaded mechanism is used to assure smooth move-

ment of the laser pick-up on its guide rail.

The 15-step random access programmability means users can listen to whichever selections they want in any order they desire. Programming is performed by using the skip key to select tracks and a memory key to specify input. A program recall function can display program contents on a multi-function LCD when activated.

51 cm stereo colour TV

Sanyo Australia's CPP-2100SV is a 51 cm colour stereo television receiver which features teletext-compatibility. It also features hi-fidelity stereo/bilingual reception and a voltage synthesiser tuning system with full auto search for 32 channels.

A 30-function infrared remote control system is included with a two-way, four-speaker system (4 cm tweeters and 16 x 6 cm woofers) capable of delivering 6 watts per channel audio output.

This model features a 21-pin socket for a videotext decoder and personal computer. Other features include automatic vertical scanning selection for video disc units; three headphone mini jacks (stereo, right channel, left channel) and facilities for easy connection to a video recorder, video disc player or video camera.

The CPP-2100SV is set in a timber cabinet with woodgrain finish and is priced at around \$1099.

BRIEFS

Big TV

The new Mitsubishi VS360A projection TV system has been released in Australia. It is an example of the new projection TV technology that has been introduced by most of the large Japanese manufacturers over the last year or so.

The three guns are located in the body of the system and project up to a mirror where they are reflected onto the back of the screen. Early versions of this technology suffered from lack of definition and restricted viewing angles. However Mitsubishi claims to have solved all these problems with new screen technology. It claims 179 foot-lamberts of brightness on the screen with sharp images right out to the corners.

There are most of the features one expects on a TV these days,

stereo sound, video inputs and infrared remote control.

For more information contact **AWA Consumer Products, (02)638-8444.**



J.J. Float

Many years ago Jurg Jecklin handbuilt his own headset because he could no longer put up with the fatigue and other associated problems created by the conventional cans. The result was so good that his friends and colleagues commissioned him to make sets for them.

Some of the claimed benefits are: sound with a more 'out of the head' soundstage; use for long periods and at high levels without listener fatigue; and that unlike conventional headphones they do not deprive the human ear of its natural function by distorting the shape of the outer ear and pumping sound directly

into the ear canal, which invariably causes auditory passage distortion and unnatural brightness of sound. As well one can wear spectacles and the cans won't fall off every time one leans over the control desk.

The range of J.J. Floats consists of Model I and II, both 2-way dynamics and priced at about \$129 and \$169 respectively. The top model Float is electrostatic and is priced at around \$649.

More information is available from the Australian distributor **Audio Dynamics, Melbourne (03)813-1923.**

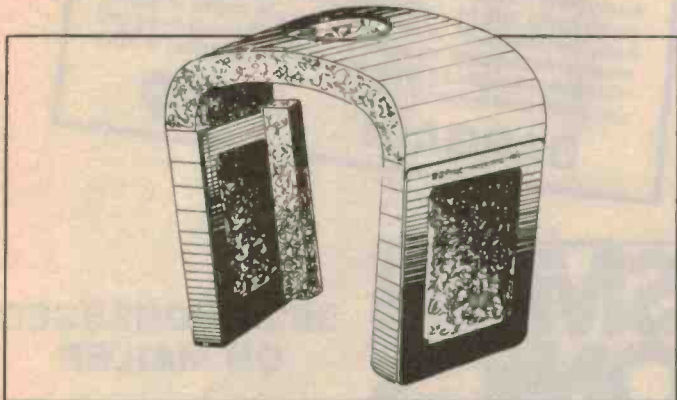

Videos for the hearing impaired

The first Australian subtitled home video library, Supertext Home Videos, has been launched at the Australian Caption Centre. They will be just like regular videos, rented at a similar cost and played through a VCR.

The library was established with a grant from the Department of Sport, Tourism and Recreation under the Assistance for Sport and Recreation for Disabled people programme. Supertext home videos will initially be distributed through the ACC with plans to extend distribution through Hearing Impaired organisations. For more information contact The Australian Caption Centre, 90 Foveaux St, Surry Hills, NSW 2010. (02)212-5277.

Home sensurround

The new Technics AV Surround System uses two speakers in the front and two in the back, for an alternative ambience effect. The reverberant sound information is extracted and reproduced mainly through the rear speakers, thus the sound field does not suffer the usual limitations of the listening room.

For more information contact National Panasonic, 99 Epping Rd, North Ryde, NSW 2113. (02)887-5315.



ELECTRON
ALARMS

WHOLESALE DISTRIBUTORS

Distributors Wanted

INSURANCE APPROVED BURGLAR ALARMS

Distributors

Manufacturers

Exclusive Importers of
GULLIVER Radio Controls
AVS Infrared Detectors
SIRIO Car Alarms
ELSA Satellite Sirens

ELECTRON ALARMS

225 Ramsay Road,
Haberfield, 2045, NSW
Phone 799-4745
Distributors Wanted

The "Star Wars" Alternative — DSE Satellite TV!

Messages From Outer Space!

Sounds like sci-fi doesn't it? With the DSE satellite system anyone can receive pictures from the heavens.

There's a large range of programs available from Intelsat IVA, in orbit over the Pacific Ocean. In fact, Australian ABC, Channel 7 and Channel 9 news feeds from America, etc via Intelsat.

While some stations will be switching to Aussat when it's ready, the Dick Smith Electronics Satlnk System will be suitable for future Intelsat satellites.

In addition many programs are beamed through the Indonesian 'Palapa' system, the Russian 'Gorizont' system and others. It is anticipated that many more will be available in the future.

The dish is one of the most important parts of the system so we've chosen what we believe to be the best compromise between room and performance. It's 3.5 metres in diameter, made from tough, lightweight fibreglass petals and has a gain approaching 40dB.

It's designed for ground mounting and special instructions have been written by our Research and Development Department so it can even be installed and aimed by the beginner.

Be the first on the block to get a message from space!
Cat D-8150



DISH

\$1800

Mounting Kit to suit:
Cat D-8151 \$320.00



ESS - 340 Satellite Receiver

Wow! We've taken a commercial design and modified it to suit our conditions. Huh! And they said it couldn't be done. We've even crystal locked the audio and modified the bandwidth circuitry to give improved signal to noise. Output is standard composite video of the type being received from the satellite. So it's the perfect partner for your DSE satellite dish!
Cat D-8100

Complete with down converter and N-N adaptor

\$599



Chapparral Feed Horn

The feed horn is pretty important to your system. Without it — you won't get a picture. That's pretty important! It's placed at the focal point of the receiving dish and acts as a 'collector' of signal ready for processing by the low noise amp. We've chosen the famous Chapparral Super Feed, regarded in the United States as the industry standard. Polarisation correction is fitted to allow reception of Intelsat signals.
Cat D-8200

VALUE \$89

Shh! It's Our Low Noise Amp.

We'll just say this softly. We don't want to disturb anyone. This is the heart of the system. If the amp isn't low noise you won't get a good picture. We've chosen the superb MSE LA-3800. Here's real quality, produced in the USA to exacting standards. There's a 40dB gain and the LNA is specifically made to cover the 4GHz 'C' band used by Intelsat IVA, V etc. 55° K noise temp Cat D-8000

\$1100



WOW

Read All About It!

The World of Satellite TV!

Everything you wanted to know about satellite TV but didn't know what to ask. This amazing book covers the lot! 224 pages tell you about the satellites, the equipment, the programming, the installation and even the legal questions. A must for the library!

Cat B-1842

\$22⁹⁵

The Complete Guide To Satellite TV.

Martin Clifford has put together 250 pages of useful information! If you've ever tried to find info on siting and installing TVRO base stations or specifications on satellite orbit — uplinks and downlinks — you've probably ended-up down yourself. Well this publication covers it all!
Cat B-1841

\$17⁵⁰

Satellite Cable Pack

Everything you need! 100 feet of highest quality siamese (twin) cable, RG-59.2 water resistant rubber booties (for baby duckies?). 'F' connectors and a 1 metre length of amalgamating tape for water proofing all those ends and connections exposed to the weather. For anything to work you need connections! Cat D-8190

BARGAIN

\$59

Home Satellite TV

By Cook and Vaughan, 326 pages of information. Can YOU set up a personal earth station? Is it a practical alternative? What about the cost? All the answers in this state-of-the-art source book.
Cat B-1840

\$19⁵⁰

**DICK SMITH
ELECTRONICS**



PTY LTD

**SEE ADDRESSES
ON MAILER**

DSE - THE LARGEST DISTRIBUTOR OF SCOPE PRODUCTS IN AUSTRALIA

WE HAVE MORE SCOPE!

SCOPE Cordless!!

It's here! Now you can take your work anywhere — outside, inside, in the field . . . it doesn't matter! With the Incredible Scope Cordless 60W Soldering Gun there's no need to be near a power outlet.

If you're a serviceman, auto electrician, technician, hobbyist: in fact any one who needs a powerful, reliable soldering tool then the new Scope is ideal!

FREE

With every Scope Cordless Soldering Iron we're giving away an AC Battery Charger . . . absolutely free! You won't find better value anywhere! Cat T-1600

Don't pay \$99 elsewhere!

Includes BONUS Charger

NEW

\$85

Spares Pack!
Spare tip and element to suit your T-1600 Scope Cordless. Keep some spares just in case!
Cat T-1601

\$510

NiCad Replacement
Spare NiCads so you've always got power!
Cat T-1602

\$1450



SUPERSCOPE!

The Scope superspeed mini-Iron is ideal when you need to get things done . . .

Fast! A massive 150W capacity and features you'd only expect in the big ones. Thumb operated

switch delivers just the right heat — at the right time.

Cat T-1660

Operates from 30 amps AC or DC.

Quality non-corrosive stainless steel barrel and comes with spare tip and element!

\$38⁵⁰

GENUINE SCOPE COPPER TIPS: \$1.15 EA

Standard 1A: T-1610 Instrument: T-1618

Spare Element T-1618 \$1.15



MINISCOPE!

When you're cramped for space you wouldn't want to cramp your style. The amazing Mini-Scope has all the advantages of bigger irons and it's easy to handle!

Fantastic for servicing PC boards, etc!

Finger tip control gives tip temperature equivalent of irons 10-70W. Comes complete with spare tip and element.

Cat T-1605

\$33⁹⁵

SPARE TIP: T-1662 SPARE ELEMENT: T-1666 EACH: ONLY \$1.15



Scope Transformer

It's made for your Scope iron! Mounts under or on the bench. Delivers 3-4 volts AC and it's completely safe!

Earthed Insulation shield prevents capacitive coupling and possible voltage leaks.

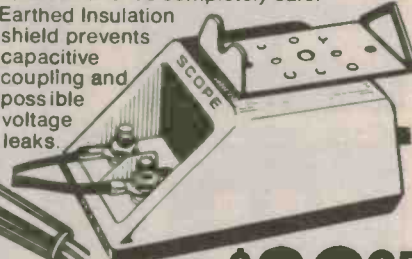

\$39⁹⁵

Suits T-1605 & T-1660

Cat T-1692

SEE ADDRESSES ON MAILER

DICK SMITH ELECTRONICS

PTY LTD

Fast GTO thyristors

Motorola has added a new series of medium-current gate turn-off thyristors (GTO) aimed at the switching power supply and motor drive markets.

The GTO family combines the turn-on/turn-off features of a bipolar power transistor with the high-current/high-voltage characteristics of the conventional SCR.

The GTO family is rated at 18 amperes and has blocking voltage ratings from 1000 to 1400 volts. It has faster switching times than conventional SCRs, with a typical turn-on delay time of only 0.6 μ s. It requires only a 300 mA trigger current, has high surge current capabilities up to 200 amps and low forward con-

duction losses at relatively high anode currents.

Compared with transistors, these asymmetric three-terminal devices can minimise drive losses because they require only a momentary pulse to turn on, unlike power transistors which need a constant drive source. They differ from standard SCRs in that the new devices can also be turned off, with a minimal reverse pulse on the gate.

For more information contact Motorola's Sydney sales office on (02)438-1955.

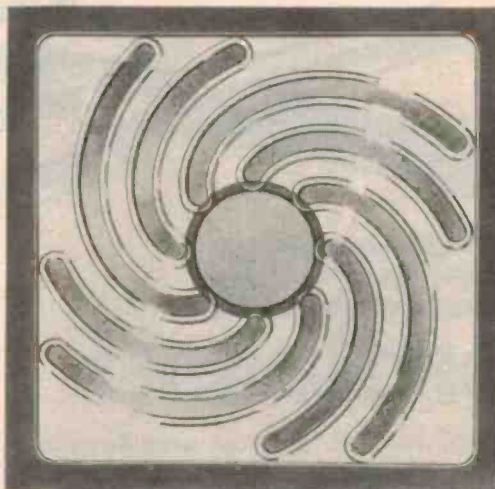

Low profile keyboards

Digitran's Series KL Minikey Low Profile Keyboards are miniature, digital entry components that provide the stroke and real tactile response previously found only in full-size, full-throw keyboards.

Designed with an 'over-centre' mechanism that provides fast, positive contact closures, the Minikey Keyboard leaves no

doubt in the operator's mind that a closure has been made. There is no artificially induced or simulated tactile feel to inhibit swift, comfortable, positive operation.

For more information contact British Merchandising, 49-51 York St, Sydney, NSW 2000. (02)291-5713.

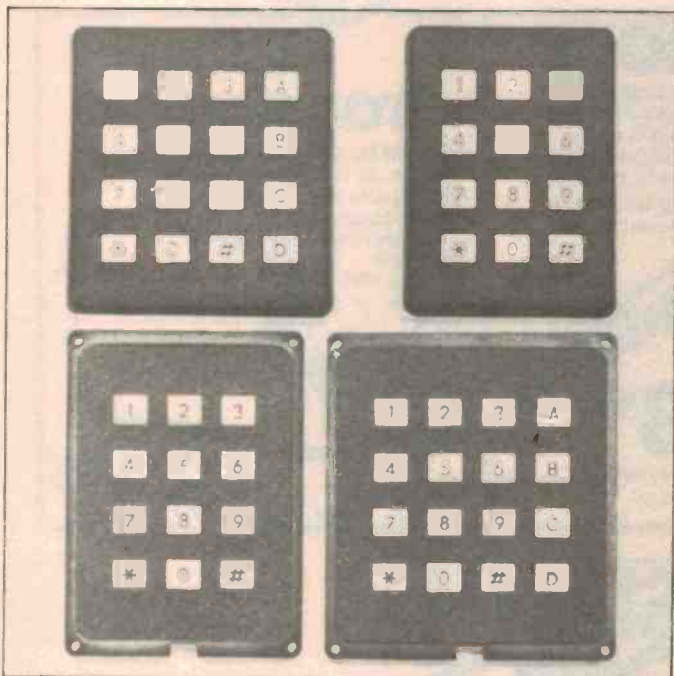

Programmable PLL

EXAR has introduced a new application note (AN-24) on a digitally programmable phase-locked loop.

The AN-24 describes the design of a digitally programmable PLL. Being digitally controlled, a microprocessor or other digital circuitry could easily tune or retune the VCO when necessary. The design uses the XR-215 monolithic PLL together with the XR9201 D-A converter, which provides the tuning function.

Most phase-locked loops re-

quire manual potentiometer adjustment if the centre frequency of the circuit is critical. Once adjusted, if ambient temperature changes cause the PLL's VCO or centre frequency to shift, the potentiometer would have to be readjusted for the accurate centre frequency to be maintained. Readjustments are, of course, an impractical solution.

For further information, contact Total Electronics, 9 Harker St, Burwood, Vic 3125. (03)288-4044.

Alpha N displays

Hewlett-Packard is now offering four-character alphanumeric 5-by-7 dot-matrix displays. With suitable contrast-enhancement filters and heatsinking, the new displays are readable in ambient sunlight up to 10,000 foot-candles.

There is a choice of three colours: yellow (HDSP-2381), high-efficiency red (HDSP-2382) and high-performance green (HDSP-2383).

For ease and flexibility in creating display arrays, the four-character cluster is in a 12-inch DIL package.

The 5-by-7 dot-matrix display

size accommodates the full ASCII set of 128 characters and symbols. With a 55-degree, off-axis viewing angle, the displays may be read from many positions.

To aid the designer, the HP data sheet for these new displays contains complete information on important design considerations including proper contrast enhancement, power dissipation and low thermal resistance.

For further information contact Hewlett-Packard, 17-23 Talavera Rd, North Ryde, NSW 2113. (02)888-4401.

BRIEFS

CMOS modems

The EF7500 series of modem chips from CSF Thomson is a new generation of communication ICs offering significant power dissipation reductions compared to older NMOS devices. The family includes asynchronous fsk and dpsk monochip units handling CCITT/V.23, V.22, Bell 202 and Bell 212A protocols. These products use the same methods as the older 7900 series but rather than having four protocols per chip there is one chip per protocol. For more information contact Promark Electronics, PO Box 381, Crows Nest, NSW 2065.

Three colours for hi-res LED arrays

The 101-element high resolution LED linear array series from HP now includes high-efficiency red and green, in addition to standard red. They all feature high-resolution precision in a 4-inch package with adjustable brightness. Interfacing the bar-graph arrays with microprocessor-based systems requires minimal additional circuitry. For details contact Hewlett-Packard Australia, 17-23 Talavera Rd, North Ryde, NSW 2113.

Connectors of all types

Coline has a range of more than 30 connectors including BNC plugs and adaptors, elbow plugs, tee adaptors, BNC jacks, panel and bulkhead sockets, UHF plugs and sockets, and type N plugs and jacks. Bodies are brass, finished in bright nickel plate. They're available from Elmeasco Instruments, 15 McDonald St, Mortlake, NSW 2137.

Universal test socket

The range of Universal test sockets marketed by Ampec accepts all devices from six through to 40 pins on 0.300, 0.400 or 0.600 centres. A normally closed contact design provides consistent normal force and prevents contact deformation from oversized leads. Further information is available from Ampec Electronics, 21 Bibby St, Chiswick, NSW 2046.

1300-nm infrared LED

Siemens' SFH 424 is an InGaAsP/Inp infrared LED. The radiation emitted by the diode should be coupled into a graded 50/125 μm index fibre. Developed especially for high-speed data transmission, the SFH 424 is available now from Siemens Ltd, 544 Church St, Richmond, Vic 3121.

16K CHMOS static RAMs

Intel has introduced a family of high-speed 16K static RAMs manufactured with CHMOS III technology. CHMOS allows access times as fast as 25 nanoseconds for the new 51C66 fast static RAM and 35 ns for the new 51C67 static RAM. Both products consume significantly less power than do similar devices. For more information contact Intel Australia Pty Ltd, Level 6, 200 Pacific Hwy, Crows Nest, NSW 2065.

1200 baud modem chip

A single-chip modem designed to meet the Bell 212A industry standard for 1200 bps full-duplex has been released. The new Fairchild $\mu\text{A}212\text{A}$ Modem performs all signal processing functions required for a Bell 212A/103-compatible modem. It incorporates an on-chip switched-capacitor modulator, digital coherent demodulator, switched-capacitor filters, 3.6864 MHz crystal oscillator and certain control and self-test functions.

Pin DIN plugs

Arista now has a wide range of pin DIN plugs, from a pola-

risied 2-pin DIN to an 8-pin DIN plug. All have plastic shielded handles, and there is both an inline socket and a chassis mount socket to match each. The 5-pin DIN is also available with a robust metal body. For more information contact Arista Electronics, 57 Vore St, Silverwater, NSW 2141.

600 ohm isolation transformer

The newly available 74/21 transformer from Transcap has a frequency response of 45 Hz–14 kHz +0 –3 dB, insertion loss of less than 1.5 dB 200 Hz–10 kHz and insulation of 4 kVac rms. More details are available from Transcap, PO Box 222, Brookvale, NSW 2100.

High-speed microcomputer ICs

A high performance 12 MHz 8-bit microcomputer from Advanced Micro Devices is now available in the 4K byte EPROM 8751H or a proprietary 12 MHz 8K byte EPROM version, the Am9761AH. The UV erasable, re-usable on-chip EPROM eases program modification. The Australian distributor is R&D Electronics, 4 Florence St, Burwood, Vic 3125.

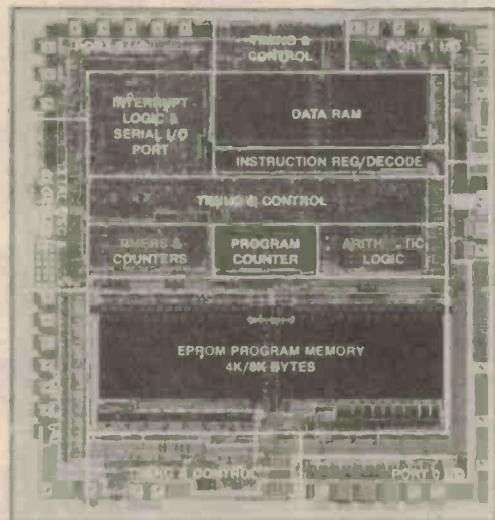

Connectors bulletin

A two-page bulletin PBC-282 describes Superfast flat-cable D-subminiature connectors. These connectors have pin and socket contact design that permits mass termination of flat cable with 0.05 inch standard pitch round conductors. The connectors may be mated with standard D-subminiature plan forms. For further information contact Total Electronics, 9 Harker St, Burwood, Vic 3125.

Efficient dc/dc converter chip

The SC 11-200-12 is a 5 Vdc output dc/dc converter packaged in a low profile 0.4 inch high module. It has operating efficiency to 70 per cent, permitting case temperature to be kept to a low 15°C to 18°C above ambient. Uses include a wide range of portable and mobile applications where primary input power is obtained from such poorly regulated dc sources as batteries and generators. The converter is available from the George Brown Electronics Group, 174 Parramatta Rd, Camperdown, NSW 2050.

Digital carrier IC

A single chip transceiver able to handle primary rate digital carrier using CEPT digital telephone formats has been introduced by Rockwell. Designed for voice/data applications, the R8070 performs synchronisation, channel monitoring and signalling extraction, and can be configured to interface to a parallel or serial bus. It is sold in Australia by Energy Control, 73 Eric St, Goodna, Qld 4300.

JAYCAR - UNIQUE PRODUCTS

VIFA SPEAKER SENSATION

European Style 2-way
Speaker Kit
Sensational NEW
design by
Dave Tillbrook

SEE AEM
JULY

Tweeter DZ5TG 8 ohm Cat. CT-2020

\$49.95 ea \$99.90 pair

Woofer PZ1WO 8 ohm Cat. CW-2132

\$135 ea \$270 pair

Crossover Network

(Not a kit now - but factory built for precision)

Cat. CX-2630

\$49.95 ea \$99.90 pair

Total price

\$469.80

Package Deal price **\$450**

(Price increase due to factory cost increases and Australian \$ devaluation).

Speaker cabinets for this system: Check with your store for details!

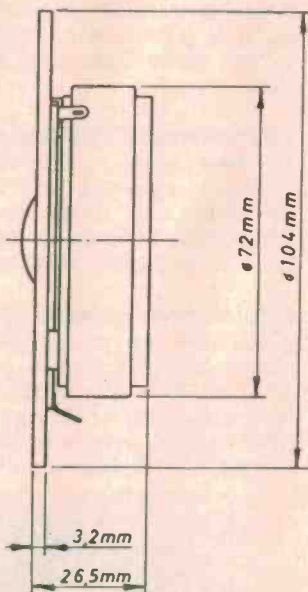

Technical Data - Tweeter

Nominal Impedance	6 ohms
Frequency Range	2 - 24kHz
Free Air Resonance	1500Hz
Operating Power	3.2 watts
Sensitivity (1W @ 1m)	90dB
Nominal Power	90 watts
Voice Coil Diameter	25mm
Voice Coil Height	1.6mm
Air Gap Height	2.0mm
Voice Coil Resistance	4.7 ohms
Effective Diaphragm Area	7cm ²
Moving Mass	0.3 grams
Weight	0.53kg

We estimate that you will be able to build the cabinets for around \$50 - \$90 (depending on finish). This means that you can end up with a superior 100 watt speaker system for under \$500!!!

UNBELIEVABLE! Technical Data - Woofer

Nominal Impedance	8 ohms
Frequency Range	26 - 4000Hz
Free Air Resonance	33Hz
Operating Power	2.5W
Sensitivity (1W @ 1m)	92dB
Nominal Power	60 watts
Voice Coil Diameter	40mm
Voice Coil Height	12mm
Air Gap Height	6mm
Voice Coil Resistance	5.8 ohms
Effective Diaphragm Area	222cm ²
Moving Mass	20 grams
Thiele/Small Parameters	
Qm	2.4
Qe	0.41
Ql	0.35
Vas	80 l
Weight	1.65kg

AT LAST! A low cost 10 Amp Digital Multimeter with transistor test facility

Digital multimeters are very popular these days but good quality ones with 10 amp scales generally cost well over \$100. We think that is too expensive so we've decided to do something about it!

Jaycar is pleased to announce a direct import digital multimeter with sensational specifications at an unheard of price!

Check the specs:

DC VOLT	0.1mV - 1000V
AC VOLT	0.1mV - 700V
DC CURRENT	1uA - 10A
AC CURRENT	1uA - 10A
RESISTANCE	0.1 - 20 Mohm
CONTINUITY	less than 30 ohm @ 1mA
hFE TEST	0-1000 10uA 2.8V NPN/PNP
DIODE TEST	1mV

Basic accuracy of Volts, Current & resistance is between 0.5 - 1.2% depending on range.

DIMENSIONS 170(H) x 90(W) x 35(D)mm

FEATURES

- ★ 0.5" high digits
- ★ High quality probe set supplied!
- ★ Vinyl carry case supplied!
- ★ Built in tilting bail!
- ★ LED & buzzer continuity test!
- ★ Precision thin film resistors used for long term accuracy!
- ★ CMOS logic 1000-2000 hours battery life!
- ★ Single function range switch
- ★ Complete with battery, spare fuse

(ZAG) and instruction manual

- ★ Protected ON/OFF switch!
- ★ Auto polarity
- ★ Protected
- ★ Floating decimal point

\$89.95

AT LAST! A low cost 10 Amp Digital Multimeter/ Transistor Tester & Capacitance Meter!

Jaycar is proud to announce a genuine low cost high performance combination Multimeter/Capacitance meter for the enthusiast! This unit is all the most commonly needed test gear rolled into one!

Similar units are on the market to sell from around \$150 to over \$200. Why pay more when you can get a Jaycar direct import for less?

DC VOLT	0.1mV - 1000V
AC VOLT	0.1mV - 700V
DC CURRENT	1uA - 10A (20A max 30 secs)
AC CURRENT	1uA - 10A (20A max 30 secs)
RESISTANCE	0.1 - 20M ohms
CAPACITANCE	1pF - 20uF (2%)
CONTINUITY	less than 30 ohms @ 1mA
hFE TEST	0-1000, 10uA 2.8V
DIODE TEST	1mA (Buzzer & LED)

FEATURES:

- ★ 0.5" high digits
- ★ High quality probes supplied!
- ★ LED and Buzzer continuity test
- ★ Precision thin film resistors for long term stability
- ★ CMOS logic 1000 - 2000 hours battery life!
- ★ Meter protection. Fused
- ★ Complete with battery, quality probes, spare fuse
- ★ Floating decimal point
- ★ Auto polarity
- ★ Impact resistant case

\$129.00



AN ECONOMICAL MAINS FILTER

250V AC @ 3A

250V AC @ 3A - insertion loss line to line 20dB 0.8 30MHz. Line to ground 30dB 0.7 - 30MHz. Ideal for computers, amps etc. Quick connect lugs. D.O.T approved.

Cat. MS-4002

ONLY \$22.50

ULTRASONIC PEST REPELLER

We were staggered by the price increases on the pest repeller we used to sell, so we found a new one at a more realistic price. Will repel mice, blowflies, birds, spiders, bats, rats, cockroaches, flies, moths and fleas. It's cosmetically appealing and is supplied with a 240 volt power adaptor. We are so sure this product works we will give you a 14 day money back guarantee (less postage costs). Power consumption only 1W watts.

**WHAT HAVE YOU GOT TO LOSE
EXCEPT THE BUGS!**

Cat. YS-5510

**MOZZIE SPECIAL
NORMALLY \$55
NOVEMBER SPECIAL
ONLY \$45.00**

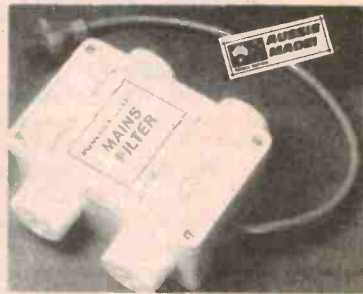

Squeaky Clean Mains Filter

Two fantastic low cost models, MS-4010 will supply up to 4 appliances. Each 240V socket is isolated from the other, i.e. Interference from disc drives is de-coupled from the CPU power supply etc. It will supply up to 4 outlets with a total load of 6 amps (unswitched).

Cat. MS-4010

**ONLY \$125.00
Single 10 amp line
socket type filter.**

(Unswitched)
Cat. MS-4012

ONLY \$34.95

Meet Roger Harrison & Dave Tillbrook!

You can meet Roger Harrison and Dave Tillbrook from Australian Electronics Monthly at our York St. store on the 3rd Saturday in November (16th) from 10.30 - 12 noon.

BE THERE!

JOIN THE JAYCAR COMPACT DISC CLUB

These are sophisticated mixers that have excellent specifications - SEE PAGE 86 of our 1985 CATALOGUE for full features and specs.

STEREO AUDIO MIXER

Cat. AM-4200

ONLY \$125.00

PRO-QUALITY CONSOLE

Cat. AM-4202

ONLY \$399.00

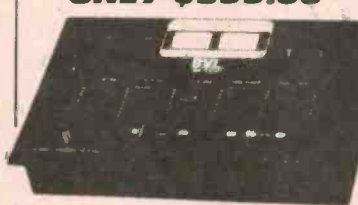

DESK MOUNTED LAMP MAGNIFIER

This unit magnifies any object under a clear cool fluorescent light. The magnification is the maximum obtainable (lens 127mm diameter biconvex 4 Dioptres, focal length 254mm) consistent with minimum distortion and eyestrain and good off-angle viewing. It is NOT cheap, but then again it will definitely last a lifetime. It is built like a Rolls Royce. (We doubt whether 20 years continuous use would wear out the German made flexible arms for example). Spare fluoro tubes are available either from us or electrical outlets. If you have trouble with fine PCB work or component identification but still want both hands free, this is for you. We thoroughly recommend this quality Australian made product.

Technical Information
Illumination 22W Fluorescent
Weight - 8.16kg
Lateral Extension 254mm
Vertical Extension 254mm
Fixing: Heavy table base (grey) with two chrome plated flexible arms.
Lens (see text)



Cat. SL-2700

**ONLY
\$169**

**NOTE: This is the GENUINE
'Maggylamp' - don't fall for cheap
substitutes.**

GREAT SPECIALS!

PIONEER 12" GUITAR SPEAKER 65W RMS

Strictly limited quantity. Crazy price. They won't last!
USUALLY \$59.50
SAVE \$20.00

Cat. CG-2381

SAVE \$20.00



★ Impedance 8 ohms ★ Power rating 65W RMS ★ Sensitivity 97dB/w 1/2 metre ★ Frequency range 80-6kHz ★ Resonance frequency 80hz

ONLY \$39.50

PIONEER HORN TWEETER

Great sounding black anodised square metal horn. Two together sound great. Limited quantity.

LESS THAN 1/2 PRICE
WAS \$13.50 SAVE \$7.00

Cat. CT-2014



★ Impedance 8 ohms ★ Power rating 12W RMS - system 60W RMS ★ Crossover frequency 2000Hz ★ Sensitivity 101 dB/w 1/2 metre ★ Frequency response 2000 - 20,000Hz

SAVE \$7.00
ONLY \$6.50

IMPORTERS DISTRESS STOCK 6" PIONEER WIDERANGE

4 ohm impedance. As used in ETI projects
USUALLY \$6.95
SAVE UP TO \$4.45

Cat. AS-3011



ONLY \$2.95
10 up \$2.50 each

12 KEY KEYPAD

This unit looks remarkably like the pushbutton keypad in the new Telecom telephones (mainly because it is). They have 12 buttons - you know the usual 0-9 plus asterisk (*) and cross hatch (#). SPST contacts are gold plated. The application MUST be endless as everytime we have advertised them before they have sold within days.

ONLY \$3.95 ea
10 plus \$3.00 each



The original ETI 3600 & 4600 Synthesiser Instructions

Brought up to date

NORMALLY \$17.50

A few left at

\$10



Cat. BM-6500 7 segment LED Display - Litronix brand DL-750

★ 15mm character height
★ Left hand decimal
★ Crazy price!
★ Brand new, but quantity limited
Cat. ZD 1892

ONLY \$1.50
10 plus \$1.00 each



Computer Controller Cookbook NOVEMBER SPECIAL

Cat. BM 0800

ONLY \$10.00!!!



IEC-320 240V Chassis Plug

Electricity Authority approved
Cat. PP-0005

ONLY \$2.95



2010 10 Band Graphic Equaliser Kit
\$29.50 OFF THIS MONTH!
NORMALLY \$149.50
NOVEMBER SPECIAL
ONLY \$120.00!!!

Cat. KJ-6535



CAR STEREO WITH AM & FM STEREO

At last, a full feature AM Stereo (Motorola CQUAM) FM - MPX Stereo and full auto reverse car cassette for only \$199!
We have made a scoop purchase of these quality JAPANESE MADE units at an unbelievable price! Act quickly! Supply is strictly limited and we will be lucky to get further supplies this side of Christmas!
Cat. AS 1000

ONLY \$189.00

2801 28 Band Graphic Equaliser Kit

★ 240V powered
★ Professional quality kit
★ Cannon in & out sockets
Cat. KJ-6531

NORMALLY \$225
NOVEMBER SPECIAL
ONLY \$199.00!!!



Sennheiser Muff Pads For HD-414

Cat. AA-2011

ONLY \$6.95/pr



Heavy Duty Speaker/Equipment Cabinet Handle

Cat. HS-8010

ONLY \$13.95



Heavy Duty DPT Footswitch

Cat. SM-1010

ONLY \$8.25 each



C&K Push button

These are quality switches which have a built-in black panel which houses the actuator and a hole for a 5mm LED (not supplied). The switches are SPDT momentary changeover
Cat. SP-0786 YELLOW ACTUATOR
Cat. SP-0785 RED ACTUATOR

ONLY \$2.95 ea
10 plus \$2.50 each

"Tex Tool" ZIF Sockets

Due to popular demand the lever type Tex Tool IC sockets are back in stock at Jaycar.

24 PIN Cat. PI-6522
\$15.95 or 10 up \$12.95
28 PIN Cat. PI-6523
\$16.95 or 10 up \$14.95



PLESSEY POT PACK BARGAINS BACK!

BRAND NEW STOCK

You get over 50 assorted pots (mostly English made by Plessey) in a pack weighing just under 1/2 a kilo. All have plain shafts, most with a flat, some are log, some are linear and some are switched. This pack is a great bargain at under 12¢ a pot how could you go wrong? The price of pots has recently risen and even if you only use 3 out of the 50 you could be in front.
Cat. RP-3900



ONLY \$5.95

Jaycar

ELECTRONICS

Incorporating ELECTRONIC AGENCIES
NUMBER 1 FOR KITS
MAIL ORDER HOTLINE (02) 747 1888

N.S.W. SHOWROOMS

SYDNEY: 117 York Street Tel. (02) 267 1614
CARLINGFORD: Cnr. Carlingford & Pennant Hills Road Tel. (02) 872 4444
CONCORD: 115/117 Parramatta Road Tel. (02) 745 3077
HURSTVILLE: 121 Forest Road Tel. (02) 570 7000
GORE HILL: 188/192 Pacific Highway (Cnr Bellevue Avenue) Tel. (02) 439 4799

QUEENSLAND BURANDA: 144 Logan Road Tel. (07) 393 0777

MAIL ORDERS: P.O. Box 185, CONCORD 2137

HEAD OFFICE: 115-117 Parramatta Road, CONCORD 2137
Tel: (02) 747 2022 Telex: 72293

SHOP HOURS

Carlingford, Hurstville
Mon-Fri: 9am - 5:30pm, Thurs 8:30pm; Sat 12pm
Sydney
Mon-Fri: 8:30am - 5:30pm, Thurs 8:30pm, Sat 12pm
Concord & C're Hill
Mon-Fri: 9am - 5:30pm, Sat 12pm

POST & PACKING

\$5 - \$9.99 \$2.00
\$10 - \$24.99 \$3.75
\$25 - \$49.99 \$4.50
\$50 - \$99.99 \$6.50
\$100 - \$198 \$8.00
Over \$199 \$10.00

COMET ROAD FREIGHT ANYWHERE IN AUSTRALIA ONLY \$13.50



MAIL ORDER VIA
YOUR PHONE

Portable digitising CRO

A new digital oscilloscope has been released by Tektronix, offering a measurement package for applied research, power conversion areas and for use in manufacturing.

The 2430 portable oscilloscope is the first digital member of the standard 2400 product family.

Tektronix, an industry leader, made its first oscilloscope 37 years ago. The company is headquartered in the USA with all products manufactured there. Tektronix has had an Australian subsidiary for 22 years.

The new scope from Tektronix has 150 MHz equivalent time bandwidth and 100 Mb/s digitising rate. It also features simultaneous acquisition of two channels with 1K record length, 8-bit vertical resolution, and enhanced glitch capture.

The 2430's ability to view complex wideband analogue or digital signals makes it suitable for many product design and troubleshooting applications. These include TTL and microprocessor-based products as well as power conversion areas such as switching power supplies and computer peripherals.

For further information contact Tektronix, 80 Waterloo Rd, North Ryde, NSW 2113. (02)888-7066.



Pulse generator

A 125 MHz pulse generator offering a wide range of features including dual normal/complementary output, error setting indicators, versatile triggering and a pre-set burst option has been introduced by Philips Test and Measuring Instruments. The PM

5786 is designed for analogue and digital circuit design, as well as for production line and maintenance work.

Features of the instrument include a wide 1 Hz to 125 MHz frequency range, rise and fall times variable from 2 ns —

equivalent to 1.4 nsd for ECL work — to 100 ms, and outputs settable from 0.2 to 5 V into 50 ohms. The unique high-speed burst option provides a presettable burst length from 0 to 9999 pulses.

A wide choice of external con-

trol is provided, including triggering, duration, gating and start of preset burst. External triggering enables the unit to be operated synchronously in phase and frequency with another clock signal. The duration facility means that the generator can function as a Schmitt trigger and pulse booster. Gating delivers pulses with set pulse-parameters during the presence of the external gate-signal, thus providing a burst-mode with 'real-time' controlled burst duration. In the preset-burst mode, a burst is generated, containing a digitally pre-settable number of pulses.

For further information contact Philips Scientific & Industrial, 25-27 Paul St, North Ryde, NSW 2113. (02)888-0403.



BRIEFS

2 MHz function generator

Emona has introduced the GFG-8016S sweep function generator from Goodwill. The generator produces sine, triangle, square, pulse TTL and ramp asymmetrical sine waves to 2 MHz. For details contact Emona, 720 George St, Sydney, NSW 2000.

Jaycar displays

Sydney retailer Jaycar has undertaken the distribution of some British-made display modules. The displays use LCDs to produce a wide range of alphanumeric and come in a wide range of packagings and configurations. One version is a 3½-digit standard 28-pin DIL socket. The largest in the range are 8-digit affairs. Contact Jaycar for more information.

Electric screwdriver

Arista Electronics has added an electric screwdriver to its range of hand tools. It is rechargeable, with both forward and reverse modes and has four tips (two flat and two Philips heads). Fully charged the "RES2" will do between 200 and 300 screws at a speed of 150 rpm. For further information contact Arista Electronics, 57 Vore St, Silverwater, NSW 2141. (02)648-3488.

Contact cleaning fluid

A new product released by Caig Laboratories is the Electronic Maintenance Kit, combining the cleaning action of Cramolin Red with the added preservative benefits of Cramolin Blue. It's packed in an easy to carry perspex case and includes 2 dram bottles of Cramolin, lint-free cloths, brushes, swabs and instructions. For further information contact Connetics Pty Ltd, PO Box 26, Gladesville, NSW 2111.

High speed drilling machine

The Oryx high speed drilling machine has been specifically designed for the production of accurate, high quality drilled holes in boards. It's manufactured in the UK and has proved to be popular and reliable in the British printed circuit industry. For further information, contact PCB Consultants & Associates, 26 Rosslyn St, Hawthorn East, Vic 3123. (03)813-1330.

20 column thermal printer

Datel's model MPP-20 offers both a serial and parallel interface in a single stand-alone, 20 column miniature thermal panel-mount printer. Selectable baud rates of 110 to 9600 baud with 9, 10 or 11-bit character lengths can be received. For more information contact Elmeasco Instruments, PO Box 30, Concord, NSW 2131. (02)736-2888.

Z8 in-circuit emulator

Microtek International has announced a MICE II in-circuit emulator for the Zilog Z8 microcontroller/microprocessor. It uses a Z8612 to emulate Z8611, Z8613 and Z8681 processors. It can also emulate the Z8601, Z8603, Z8671 and Z8682 by transferring external program memory (2K-4K bytes) from the target system on to the MICE II Z8 personality board. Contact the distributor Macro Dynamics for more information, at 80 Lewis Rd, Wantirna South, Vic 3152. (03)220-7260.

New semi from George

George Brown has released the TC34-027-48 dc/dc converter for telecommunications. It features low output noise (25 mV p-p), short circuit protection, and high frequency operation (>100 kHz). For more information contact George Brown

Electronics Group, 174 Parramatta Rd, Camperdown, NSW 2050. (02)519-5855.

Wideband analogue fibre optic modules

The IFS M1300 series of modules is intended to provide CCTV quality transmission of video and other wideband analogue signals over distances of up to 6 km using readily available low cost telecommunications 50/125 fibre. For more information contact Integral Fibre Systems, 2 Thomas St, Chatswood, NSW 2067.

Optical tests

A new, portable LED source from Fotec, for use in testing fibre optic cables, splicers and connectors, is now available from Data Cable. Called model S300, it is available in all popular wavelengths. The LEDs used are standard devices similar to those used in many fibre optic communication systems. For more information contact Data Cable, 538 Mountain Hwy, Bayswater, Vic 3153. (03)729-0044.

Boss bins

The BIM 2600 range of small and medium size desk consoles are suited to applications where meters, keyboards or switches are incorporated, with adequate space also being available on the side and rear panels for mains sockets and connectors. Sizes vary from 178 x 210 x 51 to 483 x 261 x 51 millimetres. Full information can be obtained from Crusader Electronic Components, 81 Princes Hwy, St Peters, NSW 2044. (02)519-6685.

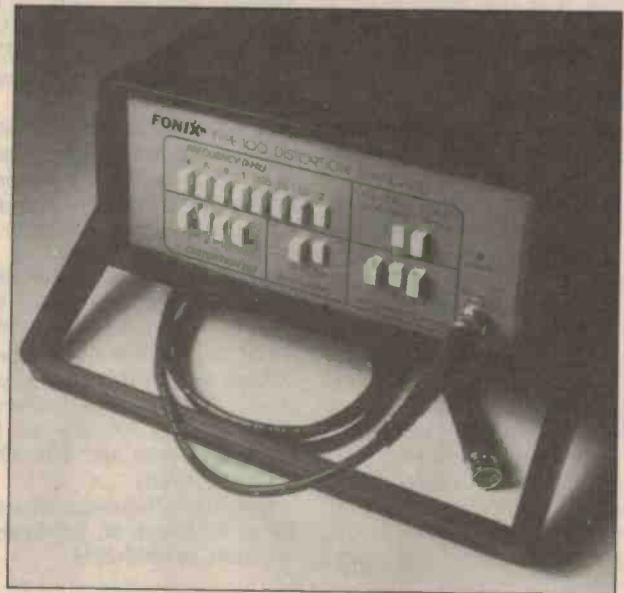

New distortion standard

ACL Special Instrument Division has released a distortion standard for use in audio measurement laboratories and studios. Manufactured by Frye Electronics, USA, the distortion standard is used to check the calibration of distortion analysers of all types. For more information contact ACL, 27 Rossella St, Doncaster East, Vic 3109. (03)892-8822.

SMDS on PC

Pro-Log has released the Single Master Development System (SMDS), a software development tool for designers of 8088-based Pro-Log STD bus systems. It consists of both hardware and software components. Software includes the Volkswriter full screen editor, Microsoft's 8088 Macro Assembler and Pro-Log's own Single Master Debugger (SMD). The hardware portion of SMDS is available in four configurations.

NEW EQUIPMENT

Low power microfan

The Redpoint Microfan gives an airflow of 15 m³/h and its 5 V motor consumes only 0.2 W of energy, making it handy for battery-powered equipment, the latest microprocessor-based computers, peripherals and instrumentation.

The fan has a wide operating temperature range of -10 to +65°C. It is made from glass reinforced flame-retardant polymer which provides a high strength low weight body of only

42 g. It is manufactured with a combination of low bearing loads, high-performance sintered bronze sleeve bearings and low rated speed of 6200 rpm.

Available in three flange variants plus a flange-free version, the fan measures some 40 mm square.

For further information contact Bowthorpe Australia Pty Ltd, 105 Cawarra Rd, Caringbah, NSW 2229.

Engineering workstations

Hewlett-Packard has expanded its HP9000 technical-computer family with the addition of a series of medium to high performance technical workstations.

Designated the Series 300, the systems are designed for instrument-control and engineering design environments.

Two different CPUs are offered with the Series 300. For use in an entry-level to mid-range system configuration, a 10 MHz Motorola 68010 is available, while a 32-bit, 16.6 MHz 68020 is available where high-speed processor performance is required.

Series 300 will run most Series 200 applications software. An integrated wordprocessing/spreadsheet/database package is available as well as electrical and mechanical engineering programs.

Integrated programming languages/operating systems available with the Series 300 include BASIC 4.0 and Pascal 3.1. HP-UX, derived from a UNIX* operating system, is also available.

A selection of input devices includes digitiser tablets and mice. Mass storage sub-systems, printers and plotters are available, allowing user flexibility in the design of the system.

As a member of the HP 9000 computer family, the Series 300 can be networked with the Series 200 and 500 systems over a high speed, 10 megabit per second, local area network (LAN). Series 300 also can be networked with the HP 3000 computer family.

For more information contact HP at 31 Joseph St, Blackburn, Vic 3130. (03)895-2895.

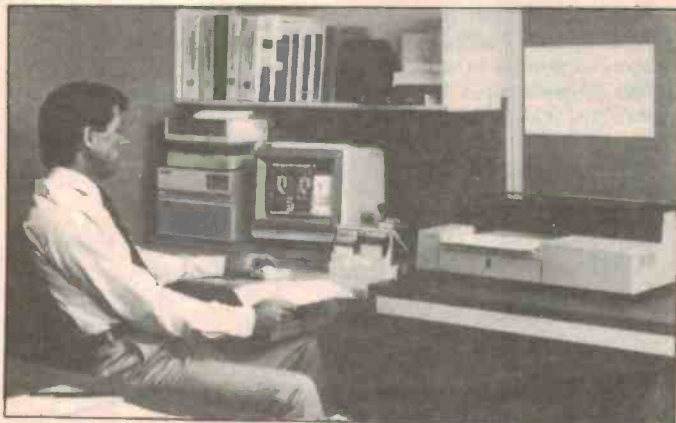

PCB TRANSFORMERS

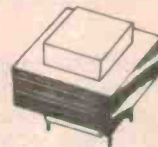

2.5/3VA

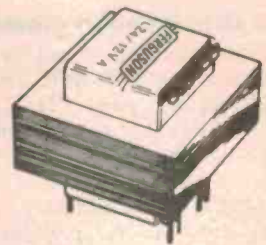

12/15VA

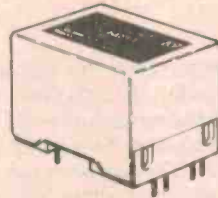

5/7 & 7.5/10VA

- Manufactured to AS3126 and Telecom approved
- Suit standard PCB grids and simplify construction

POWER TRANSFORMERS

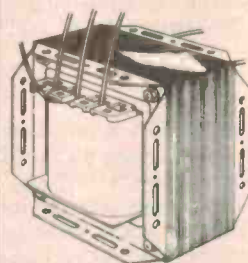

Conventional

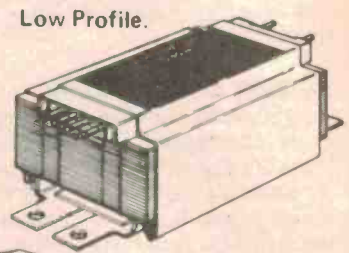

Low Profile.

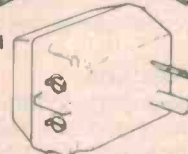

Plug Pack Adaptor



- Wide range of secondary voltages from 1.5V to 115V
- Stock range has ratings up to 1000VA
- Special types for microprocessors, 115V etc

AUDIO TRANSFORMERS

PCB mounted phone patch

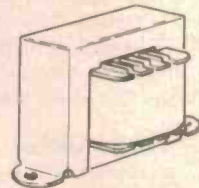
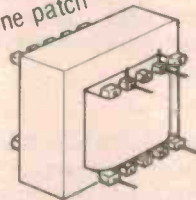

75 ohm to 300 or 600ohm matching transformer

- Line and Matching transformers up to 150W
 - Power transformers for high power amplifiers
 - Transistor drivers
 - Special 'C' core transformers
- Ask for MAL VK2BMS or DOUG VK2BPX

TALK TO FERGUSON - THE AUSTRALIAN COMPANY WITH NEARLY 50 YEARS EXPERIENCE OF MANUFACTURING IN AUSTRALIA FOR AUSTRALIAN CONDITIONS

Ferguson Transformers Pty. Ltd.
331 High Street, Chatswood 2067. Tel: (02) 407-0261.
Telex: AA25728. Melbourne: (03) 561-6699.

FERGUSON

IDEA OF THE MONTH

Car computer modification

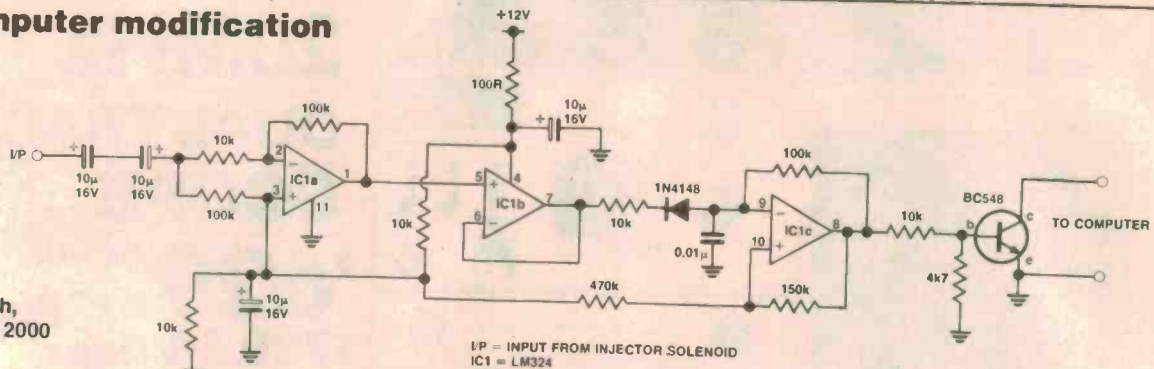

Neville Harlech,
Sydney, NSW 2000

Car buff Neville recently bought himself a Sparkrite car computer. During the course of installation he discovered that he could not use the fuel sensing functions because his car is fitted with an electronic fuel injection system.

An EFI consists of a nozzle in each cylinder which squirts a fuel air mixture into it. The fuel is delivered in pulses. The exact amount of fuel is dependent on the number and duration of these pulses. The entire procedure is under the control of a microprocessor which looks at

throttle setting, engine temperature, engine speed and so on to evaluate the number of pulses.

Fuel is delivered to each solenoid at a constant pressure. This, together with the pulsing behaviour, means that an ordinary flow meter, of the type supplied with the computer, will not work. These rely on the constant movement of the fuel in the line, which spins a small propeller. The propeller in turn causes a pulse train to be sent back to the computer, the frequency being dependent on the fuel flow rate.

So, this circuit turns the pulses

at the injector nozzles into a pulse train that will look to the computer just like one from a normal fuel sensor. Experimentation showed that the pulses at the nozzles were negative going, with repetition rates about 7 Hz at idle going up to 67 Hz at full throttle. Pulse width was approximately 3 ms at idle and 12 ms at full throttle. The standard sensor produces a pulse train with pulse width of 2 ms.

IC1a acts as a buffer and produces a positive going pulse ac coupled to the nozzle solenoid. These positive pulses are gated

again by IC1b, which is used to gate an oscillator formed around IC1c. Thus the operation of the solenoid causes the circuit to output a string of pulses to the computer. The exact number is not critical because on-board calibration allows the computer to take care of it.

Mr Harlech soldered all the bits together in a birdnest and then put the whole thing in epoxy. It fitted nicely on the back of the computer case.

'IDEA OF THE MONTH' CONTEST

Scope Laboratories, which manufactures and distributes soldering irons and accessory tools, is sponsoring this contest with a prize given away every month for the best item submitted for publication in the 'Ideas for Experimenters' column — one of the most consistently popular features in ETI Magazine. Each month we will be giving away a 60 W Portable Cordless Soldering Iron, a 240 Volt Charging Adaptor together with a Holder Bracket. The prize is worth approx. \$100.

Selections will be made at the sole discretion of the editorial staff of ETI Magazine. Apart from the prize, each person will be paid \$20 for an item published. You must submit original Ideas of circuits which have not previously been published. You may send as many entries as you wish.

COUPON

Cut and send to: Scope/ETI 'Idea of the Month' Contest, ETI Magazine, P.O. Box 227, Waterloo NSW 2017.

"I agree to the above terms and grant *Electronics Today International* all rights to publish my idea in ETI Magazine or other publications produced by it. I declare that the attached idea is my own original material, that it has not previously been published and that its publication does not violate any other copyright."
* Breach of copyright is now a criminal offence.

Title of Idea

Signature Date

Name

Address

Postcode



RULES

This contest is open to all persons normally resident in Australia, with the exception of members of the staff of Scope Laboratories, The Federal Publishing Company Pty Limited, ESN, The Litho Centre and/or associated companies.

Closing date for each issue is the last day of the month. Entries received within seven days of that date will be accepted if postmarked to and including the date of the last day of the month.

The winning entry will be judged by the editor of ETI Magazine, whose decision will be final. No correspondence can be entered into regarding the decision.

The winner will be advised by telegram the same day the result is declared. The name of the winner, together with the winning idea, will be published in the next possible issue of ETI Magazine.

Contestants must enter their names and addresses where indicated on each entry form. Photostats or clearly written copies will be accepted but if sending copies you must cut out and include with each entry the month and page number from the bottom of the page of the contest. In other words, you can send in multiple entries but you will need extra copies of the magazine so that you send an original page number with each entry.

This contest is invalid in states where local laws prohibit entries. Entrants must sign the declaration on the coupon that they have read the above rules and agree to abide by their conditions.

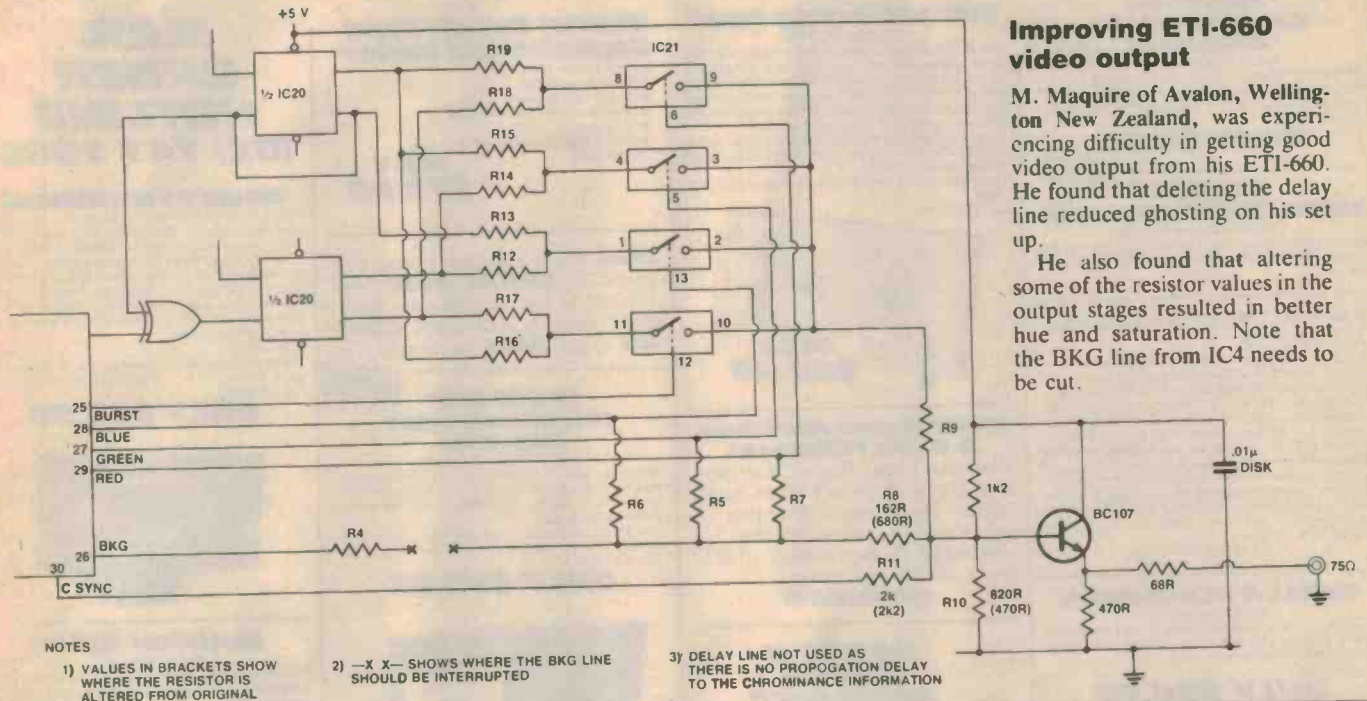

Improving ETI-660 video output

M. Maquire of Avalon, Wellington New Zealand, was experiencing difficulty in getting good video output from his ETI-660. He found that deleting the delay line reduced ghosting on his set up. He also found that altering some of the resistor values in the output stages resulted in better hue and saturation. Note that the BKG line from IC4 needs to be cut.

Giving Fluke the willies

Paul Jones of Moora WA has explained to us how to change the Fluke Model 75 into a model 77. The only difference between these two versions is that the Model 77 has a display hold function. 'Display hold' means that it's possible to freeze a

reading on the display so that you don't need to take your eyes off the probes when making difficult or delicate readings. To give a model 75 the same facility all that is required is to change the position of a single resistor. Proceed as follows:

Open the case. Below the display is a group of resistors and diodes. From the top down, there are two resistors, then two diodes, then another two resistors. Our target is the right hand one of these. Notice that there is a vacant pad between the two

resistors, so that when you have removed the resistor there are three vacant pads. Resolder the resistor on the left and centre of these. Reassemble and hey presto! A model 77.

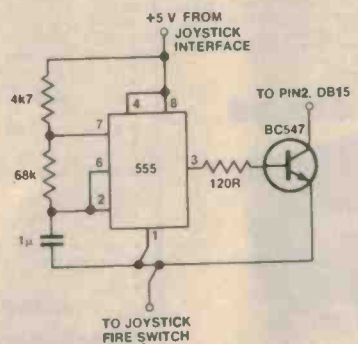

Microbee joystick auto fire

This circuit from Dean Jones of Newtown, Vic, uses a 555 timer to allow continuous fire from a joystick fire button on a Microbee. The +5 V supply is obtained by connecting a wire to the common of the pull-up resistor on the joystick interface. The orange wire on the joystick lead is cut at the interface and

reconnected to the circuit above. The switch then acts as a trigger for the timing circuit. The wire to the collector of the transistor above is then connected to where the orange wire was cut. The rate of fire can be increased by changing the value of the capacitor.

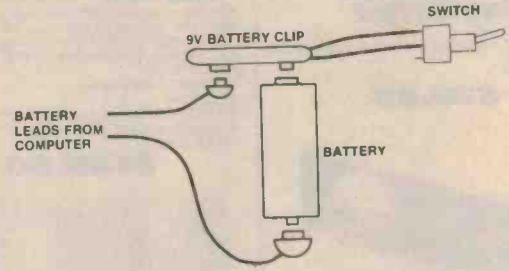

Microbee battery switch

After experiencing a number of flat batteries in the Microbee Simon Moran of Wollongong, NSW needed a method of switching the battery off when not needed which would not affect the warranty. This modification will extend the battery life without the need to cut wires or solder to the computer. To fit the switch, solder a

SPST switch between the leads from a 5 V battery clip. Unclip one lead from the battery (the positive is the most convenient) and connect the clip between the battery and the free lead. The switch could be mounted in a hole drilled in the case, but ours was mounted on a console which surrounds the computer.

KITS, KITS AND MORE KITS

AEM8500 Courtesy Light Extender **NEW**

Ref. AEM November 1985
This great little project keeps the interior light of your car 'ON' for a specified period enabling you to find your keys etc in light. Compact and inexpensive.
Cat. KM-3025

ONLY \$8.95

AEM6010 **NEW** Ultra Fidelity Preamp

Ref. AEM November 1985
Jaycar will be doing a full version of this kit in the near future. Please order in our shops - call head office for details.

SPECIAL NOTE REGARDING KIT PRICES.

It has been brought to our attention that one of our major competitors appears to be selling similar kits to Jaycar at what **APPEARS** to be much lower prices. The inference of course, is that we are expensive! The problem is, however, that the so called cheaper kit is actually a 'short form' version of some of the kits we advertise! Their cheaper kits are missing essential items which were originally specified in the magazine project. Usually the same kit supplier offers them as options - which you generally must buy to get the project going! After you add the price of the options in, you may be surprised to learn that the genuine Jaycar kit is cheaper!

PLEASE BE CAREFUL

DWELL/TACHOMETER

Ref. EA Sept. 1985
Tune up your car quickly and easily with this handy piece of gear. The Jaycar kit includes case, large meter and Scotchcal meterscale.
Cat. KA-1612

ONLY \$34.95
Suits 4-6 or 8 cylinder cars



ETI 698 Microbee Dialler - ETI July 1985.

Complete set of parts.
Cat. KE-4696

ONLY \$19.95

40 WATT DC INVERTER

Ref. EA August 1985
An upgrade of a previous design featuring a smart new ABS case.
Cat. KA-1598

\$79.95



300 WATT INVERTER

Ref. EA Sept. 1985
This totally new design is a vast improvement over the EA June 1982 project. It features a modern all plastic case, easier assembly, toroidal type inverter transformer, auto start up and double, switched power outlets.
And it's cheaper than the old model!!
The Jaycar kit contains all specified parts to enable you to complete the project in one go.
Cat. KA-1610

ONLY \$199.00



The Listening Post

Ref. AEM July 1985
This device attaches between audio output of a short wave receiver and the input port of a computer. It allows decoding and printing of Morse Code, Radioteletype (RTTY), AND radio facsimile (FAX) pictures! You can, for example, watch weather maps from the Met and dump them on to your printer!
Specific software for the Microbee is in the first article. Programs for other popular computers will be printed in later issues of AEM.
Complete set of specified components (Inc. IDC plug).
Cat. KM-3015

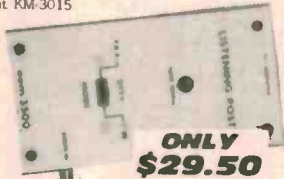

ONLY \$29.50

Meet Roger Harrison & Dave Tillbrook!

You can meet Roger Harrison and Dave Tillbrook from Australian Electronics Monthly at our York St. store on the 3rd Saturday in November (16th) from 10.30 - 12 noon.
BE THERE!

HEBOT II FULL KIT BELOW COST! WAS \$299

Cat. XR-1020
ONLY \$99.00

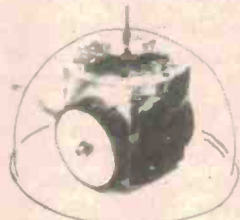

8 SECTOR BURGLAR ALARM - Ref. EA Jan/Feb 1985

Why buy a commercially made up unit for more when you can buy this kit and SAVE money! A unique feature of this kit is the fact that you can wire N/O and N/C alarm sensors ON THE SAME LINE.
★ 8 SECTORS
★ 2 delayed entry sectors
★ Steel box
★ Includes battery and siren driver in the price
★ Variable exit and entry delays
Cat. KA-1580

\$149.00



Digital Bench Type Capacitance Meter

Ref. EA August 1985
★ Easy to assemble
★ 4 digit LED readout
★ Measures from 1pF to 99.9uF
★ 3 ranges
★ Bench type mains powered
Cat. KA-1595

ONLY \$79.95

DON'T buy a speaker kit until you check our **GREAT NEW** 1986 Models of low cost Jaycar "Euro-Style" speaker system kits. **CALL US** or you **WILL** be sorry!!!

"PEST OFF" Ultrasonic Pest Repeller **NEW**

Ref. EA November 1985
Why pay up to \$150 when you can build a pest repeller yourself and save a fortune? The 'Pest Off' works on a similar principle to the expensive commercial designs.
The Jaycar kit contains all specified components including the special piezo electric transducer.
Cat. KA-1620

ONLY \$39.95



ETI 1401 DIRECT INJECT BOX

Ref. ETI Sept. 1985
This unit accepts unbalanced audio inputs (line or mic. level) and produces a line level balanced signal to drive mixers or balanced input equipment. The Jaycar kit includes die-cast box, specified push button switch bank and all other parts.
Cat. KE-4708

'SONICS' D.I. BOX

After some field experience it has been decided to replace the push bank of switches with a set of toggle switches. There are two reasons for this. (1) The push button switch bank is fairly fragile and a good kicking will destroy the bank.
(2) Constructors have had difficulty fitting the slot in the die cast box to accommodate the switch bank. The toggle switches only require a 1/8" drill hole (Incidentally we could not punch the slot in the side of the box - it's virtually impossible!)
(3) The new kit is cheaper!
Cat. KE-4708

ONLY \$29.95



Electronic Jumper Leads - ETI 341

Ref. ETI August 1985. This project enables you to charge up a car battery via the cigarette lighter plugs in each car. A small inverter boosts the battery voltage from car No.1 to charge the flat battery in car No.2 via its cigarette lighter socket.
It's amazing how quickly you can put enough charge in a flat battery to start the car!
Complete set of parts including 2 x cigarette lighter plugs.
Cat. KE-4703

\$39.95

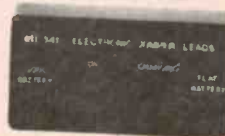

MAIL ORDER HOTLINE (02) 747 1888

DRUM SYNTHESIZER

Original design from the UK magazine 'Electronics and Music Maker' April 1981. This self-contained unit can produce a variety of fixed and falling pitch effects triggered either by tapping the unit or striking an existing drum to which the unit is attached! The Jaycar 'SYNTOM' Drum Synthesiser comes complete with a high quality pre-drilled moulded all ABS box measuring 152 x 80 x 47mm with professional silk screened front panel.
FEATURES:
Decay from less than 0.1 second to several seconds
pitch control - sweep control and volume on/off
Cat. KJ-6502

ONLY \$36.50



Ignition Killer

Ref. EA Feb 1984
This little project is cheap, easy to fit and is effective. It basically is a timer circuit that disables your ignition system a few seconds after it is activated. A would-be thief starts the car, it goes a few metres and stops. He immediately cranks the engine and it fires but it stops again moments later. This could continue indefinitely. Frustrated, the thief looks for easier "game" elsewhere. The Jaycar kit contains specified original components, instructions and two BONUS alarm stickers.
Cat. KA-1535

ONLY \$14.95

8 CHANNEL MIXER Model 8002

Balanced input 8 channel stereo mixer with features only found in units costing \$1,500 or more!

- MAIN FEATURES:
- Balanced (600 ohm) mic. Inputs/line inputs
 - Input attenuators
 - Cannon connectors included in the price
 - Bass, mid and treble equalisation on each input
 - 'Effects' (i.e. echo etc) capability
 - Foldback on all 8 inputs
 - Stereo pan on all 8 inputs
 - 60mm slide faders used throughout
 - 19" rack mount capability (or console mount)
 - Professional black front panel with format border and multicoloured knobs to assist function identification
 - Designed for quick and easy service
 - VU metering
 - Only high quality components used
 - 5534A OP amps used for low noise and very low distortion
- TECHNICAL:
- Signal to noise microphone input -75dB with ref to +4dBm
 - Signal to noise line input -90dB with ref to +4dBm
 - Line level +4dBm (0VU)
 - Distortion less than 0.005%
 - Power requirements 240V AC 50Hz 25 watts

8002 MIXER

Ref. EA April/May 1983

8002 RACK KIT This is the basic mixer. This kit gives you virtually all the electronics. Provided from panel, VU meters, 11 PCB's, all pots (rotary and slide), knobs, components for PCB's, hook-up wire etc. All Cannon X.C. chassis connectors are included as well. It is ideal for rack mount and all that is necessary is a ±15V 1A power supply.
Cat. KJ-6504

\$535.00

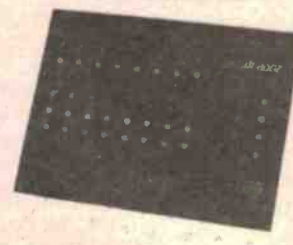

MAIL ORDER HOTLINE
(02) 747 1888

JAYCAR NO 1 IN KITS

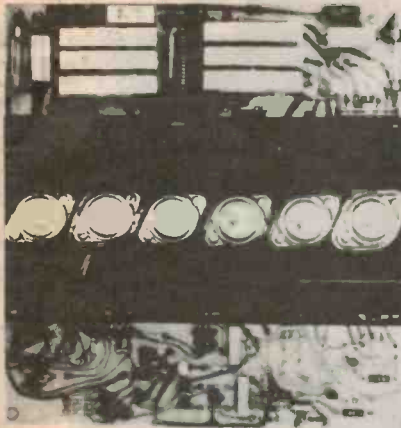

300W PLAYMASTER AMPLIFIER

Ref. EA June 1980

This rugged design provides 200W rms into 8 ohms and 300W rms into 4 ohm loads. All parts fit onto a single PCB. It also features comprehensive protection circuitry, and will even withstand short circuits for short durations without adverse effect. Unlike other high powered amps, it is unconditionally stable. It will not therefore break into supersonic oscillations, overheat and fail. The Jaycar kit of this project provides a quality roller-tinned fibreglass PCB and other quality components tuned to the heatsink compound.

ONLY \$99.95
300W AMP POWER SUPPLY KIT

This basically consists of a 300VA power transformer (PF4363), rectifier and filter capacitors. It also has 15VAC power for the speaker protector.

ONLY \$79.95
Speaker Protector for Playmaster 300W amp

This device is designed to mate with the Jaycar KA-1115 Playmaster 300W amp module. It also provides the handy facility of switch on mute. This disconnects the speakers for the first few seconds when the amp is switched on, avoiding the horrid 'thump' in the speakers. If you have expensive speakers (whether you have the EA 300W amp or not) this speaker protector is cheap insurance. The Jaycar kit provides all PCB parts including the relay.

ONLY \$14.95

Electronic Crossover

Ref. EA November 1984
NEW SHORT FORM KIT

You can NOW build this desirable project for a lot less! There have been requests for a version of this kit that can be built into other equipment. This is it! The kit contains PCB and all board components etc. The box (including front panel) and selector switches are not supplied but everything else!

ONLY \$79.00

Car Booster Amp

Ref. EA August 1985.

This project enables you to have 2 x 50 watts **REAL** power for your car sound system. In order to do this, a special high voltage power supply forms part of the system. Absolutely stunning value for money. Around half the price of inferior commercial units. The Jaycar kit is, as usual, absolutely complete.

Cat. KA-1600

AEM 6500 - 60/120 WATT UTILITY MOSFET AMP MODULES

Ref. AEM July 1985

This is a low cost high performance design using proven MOSFET technology. A single pair of (2J549/25K134) Mosfets will deliver up to 60 watts output. Another pair may be added for 120 watt performance. The module has been designed to fit into a large variety of commonly stocked instrument cases and rack boxes. It features VERY LOW distortion and impeccable transient performance. It is unconditionally stable and virtually blow-up proof. It can be powered from common transformer/rectifier/capacitor combinations. A Winner!

As usual, the Jaycar kit reflects a quality approach. All specified components for each version are included.

60 WATT MODULE Cat. KM-3010
\$49.50
120 WATT MODULE Cat. KM-3012
\$65.00



20 WATT UTILITY AMPLIFIER

Ref. EA November 1984

This is a low cost general purpose amplifier which is easy to build and gives Hi Fi performance. All components mount on the printed circuit board which is provided. Capable of up to 19 watts rms from a 35 volt supply. Note that 35V is the maximum permitted supply voltage. See the Jaycar 1985 catalogue for specs.

Cat. KA-1567

ONLY \$17.50

ETI 467 MIXER/PREAMP

Ref. ETI July 1980

The ideal companion to the Utility Amp (KA-1567). Mixes up to 4 inputs (high and low level) with individual level controls. Includes high performance 3 band tone controls making it ideal for musical instrument use. Kit comes without a case so that you can build it in with a power amplifier if you wish. Operates from 2 x 15V AC (usually available from power amp supply, or use Cat. MM-200B transformer).

Cat. KE-4014

ONLY \$29.50



BUSKER AMPLIFIER

Ref. EA Feb 1985

Fantastic, portable amplifier kit for low-level PA. Buskers or for practice.
★ Battery or mains operation
★ Full control - bass, treble and volume
★ 17 WATTS RMS output
★ Gel battery automatically recharged when mains used.

★ INTRODUCTORY PRICE ★

ONLY \$125.00

All electronics including Gel battery, 8" speaker, metal chassis etc.

Cat. KA-1592

PRE-CUT WOODEN CABINET to suit
Cat. KA-1593

ONLY \$30.00
SAVE 20%
this month and pay
ONLY \$124.00
You must buy both!

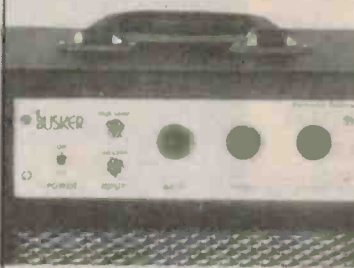

BASIC AMP

Ref. ETI 061

Teaches the basics of transistor amplifiers and builds Z useful low power amp at the same time. Amp can be used to amplify microphones or crystal radios so they they can be heard through a small loudspeaker.

Cat. KE-4001

ONLY \$5.90

ETI 499 150 watt MOSFET Amp Module

Ref. ETI March 1982

A high power amplifier with the stability and reliability of MOSFETs. Genuine 150 watts rms with power supply components on board. You only need to connect a power transformer (Cat. MM-2015) and heatsink! The Jaycar kit includes a magnificent jig drilled extruded heatsink bracket for greater thermal efficiency.

Cat. KE-4220

ONLY \$79.50 ea

ETI 480 SERIES AMPLIFIER MODULES

Ref. ETI December 1976 & ETI's 30 Audio Projects
ETI 480/100 A complete audio amp on a single board. Just add a power supply and you have a 100 watt Hi Fi musical instrument or PA amplifier! Use it with the KE-4014 mixer/preamp for instrument or PA. Kit contains metal bracket, all PCB items and instructions. Legendary performance at a modest price.
Cat. KE-4052

ONLY \$27.00
ETI 480/50 Same circuit as the 480/100 except 2 less output transistors. Half the power and a little cheaper. Great if you don't need 100 watts. All parts supplied.
cat. KE-4050

ONLY \$23.00

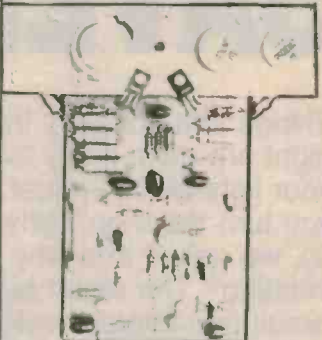

ETI 477 MOSFET AMP MODULE

Ref. ETI Jan/Feb 1981

Two 477 amp modules form the basis of the 5000 power amp. You can buy the modules (mono) individually to make your own custom MOSFET amp! For performance specifications refer to the Black Monolith amplifier in the Jaycar catalogue. Power supply extra.

Cat. KE-4210

ONLY \$59.00 ea

BENCH AMPLIFIER

Hobby Electronics Project

If you ever need to test whether a preamp is functioning correctly this is the ideal project to test it with. It can amplify signals as low as a few millivolts to an audible level.

Cat. KS-8105

ONLY \$9.75

PLAYMASTER SERIES II MOSFET AMP KIT

Ref. EA Jan/Feb/March 1985

... s stereo amplifier that will equal or better just about any integrated commercial amplifier, regardless of price". Leo Simpson, Editor of EA, February 1985.

MAIN FEATURES

- Switchable phono input for MM and MC cartridges
- Electronic signal switching
- Full facilities for dubbing between two cassette decks
- Monitor loop for either of two cassette decks or a signal processor
- Click action pushbutton switches for selection of sources, dubbing and tape monitor with LED status indicators
- Centre detents on bass, treble and balance controls, multiple detents on volume control
- Heavy duty heatsinks
- Power transformer for low hum and noise
- Easy to build - all parts except power supply mount directly on the two printed circuit boards; wiring has been kept to an absolute minimum
- 100 watts RMS per channel into 8 ohm load
- Less than 0.01% total harmonic distortion



ONLY \$179

Cat. KA-1500

ONLY \$429.00

Jaycar ELECTRONICS

Incorporating ELECTRONIC AGENCIES
NUMBER 1 FOR KITS

MAIL ORDER HOTLINE (02) 747 1888

N.S.W. SHOWROOMS
SYDNEY: 117 York Street Tel (02) 267 1614
CARLINGFORD: Cnr. Carlingford & Pennant Hills Road. Tel. (02) 872 4444
CONCORD: 115/117 Parramatta Road. Tel. (02) 745 3077
HURSTVILLE: 121 Forest Road. Tel. (02) 570 7000
GORE HILL: 188/192 Pacific Highway (Cnr Bellevue Avenue) Tel. (02) 439 4799

QUEENSLAND
BURANDA: 144 Logan Road. Tel. (07) 393 0777
MAIL ORDERS: P.O. Box 185, CONCORD 2137
HEAD OFFICE: 115-117 Parramatta Road, CONCORD 2137
Tel: (02) 747 2022 Telex: 72293

SHOP HOURS
Carlingford, Hurstville
Mon-Fri 9am - 5:30pm, Thurs 8:30pm, Sat 12pm
Sydney
Mon-Fri 8:30am - 5:30pm, Thurs 8:30pm, Sat 12pm
Concord & Gore Hill
Mon-Fri 9am - 5:30pm, Sat 12pm

POST & PACKING
\$5 - \$9.99 \$2.00
\$10 - \$24.99 \$3.75
\$25 - \$49.99 \$4.50
\$50 - \$99.99 \$6.50
\$100 - \$199 \$9.00
Over \$199 \$10.00

COMET ROAD FREIGHT ANYWHERE IN AUSTRALIA ONLY \$13.50



MAIL ORDER VIA YOUR PHONE

LIGHT BULB SAVER

Things that go 'ping' in the night are quite likely to be your light bulbs — just when you turn them on. Why is it so, we asked and why is it so irritating? The result is a circuit that avoids switch-on at those moments of peak current most hazardous to the bulb.

Robert Irwin

RETURNING HOME ONE dark and stormy night from a particularly devastating party, I encountered a situation that inspires drastic action to solve a seemingly insignificant problem. After stepping out of a taxi and weaving my way to the front door, I managed, after some struggling, to open the front door. Dripping wet and feeling delicate I searched the wall for the light switch. Flicking it, I was greeted by a quick flash, a small 'ping' and darkness. Seemed as if it were only yesterday I had replaced the bulb but here it was, blown again. Having a hall of the particularly dark, sinister, winding and decidedly unfriendly type I was tempted to sleep on the doorstep till morning but, being wet and cold drove me through unknown objects waiting to trip me in the dark and head for the shower. Negotiating the hall with only relatively minor shin scrapes and one fall I began to feel the forces of nature were not entirely against me. Ah! How wrong I was. A flick of the switch in the bathroom and 'bink', another bulb gone.

The urge to destroy eventually gave way to the creative feel which started me on a quest to extend the life of my light bulbs. After soaking in a hot, but dark, tub for an hour or so it became clear that this would be no trivial matter. Past bulb demises seemed to show that they usually go at the instant of switch on. The 'cold' resistance of a light bulb filament is far less than the resistance



Photograph taken by Greg McBean.

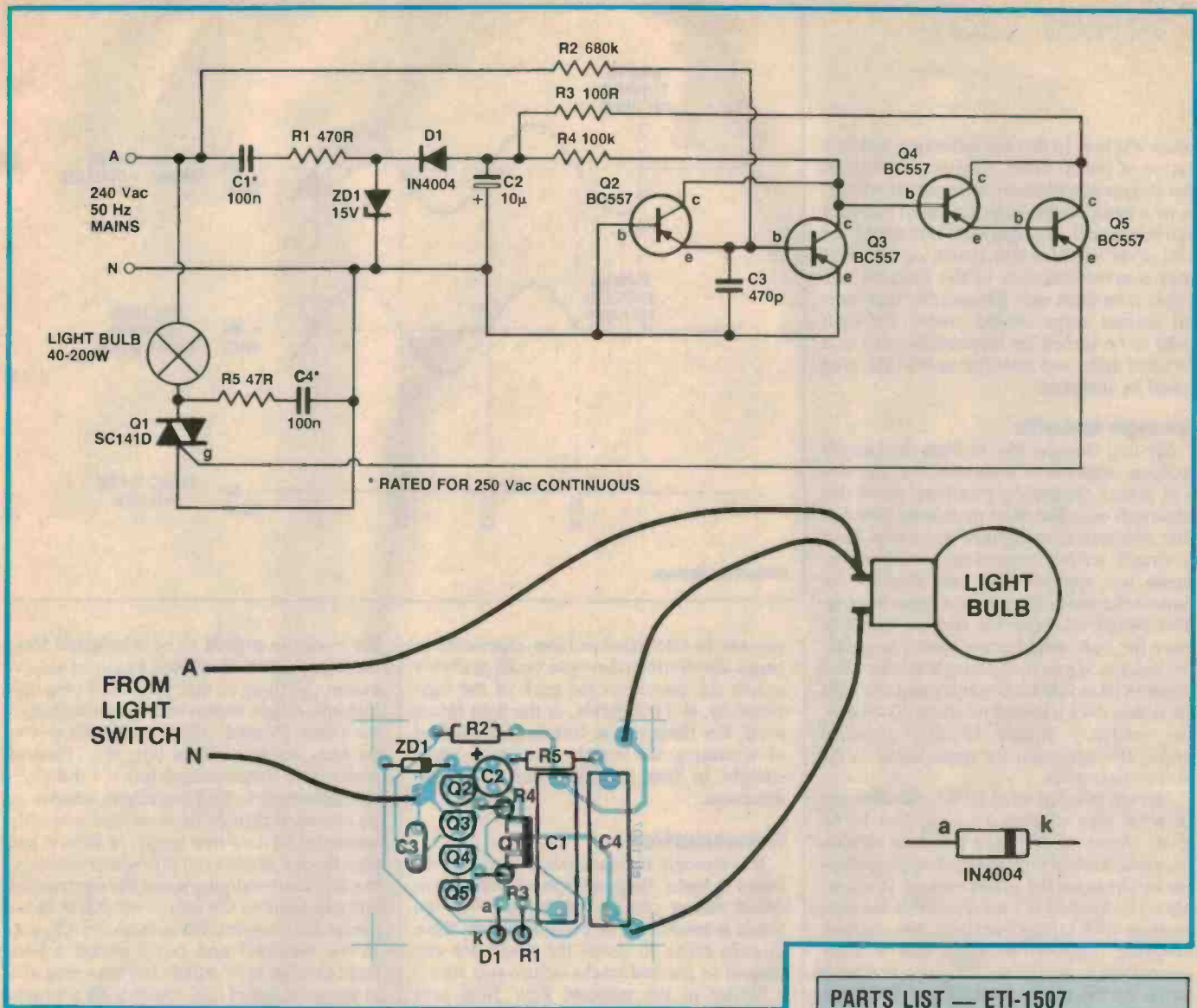

HOW IT WORKS — ETI-1507

The circuit basically consists of two parts, the power supply and the zero crossing triac drive circuitry.

The power supply consists of C1, C2, D1, ZD1 and R1. When the mains swings positive, D1 is reverse biased and C1 charges up through R1 and ZD1 to about the mains peak voltage. When the mains swings negative the stored charge in C1 is 'pumped' into C2 through D1. In this part of the cycle C1 and C2 act as a capacitive divider to divide the mains down so that large currents don't flow. The charge on C2 will build up at the end of each cycle and thus the voltage will increase (in the negative sense in this case). When the voltage reaches the zener breakdown voltage the extra charge will go to ground through the zener and thus the voltage across C2 will be constant. The voltage on the negative side of C2 will thus be about -15 Vdc. Because of the high output impedance of the charge pump, the current that can be supplied continuously is only a few milliamps.

The remainder of the circuit consists of

the zero crossing triac drive. The base of Q3 and the emitter of Q2 are connected together and to the mains via R2. We will call this point 'A' on the diagram. The emitter of Q3 and the base of Q2 are both connected to 0 V (neutral) and the collectors of both transistors are tied to -15 V. When point A goes positive (when the mains goes positive) Q2 will be biased on and the collector will be pulled low (point B on the circuit). When the mains tries to go negative Q3 will be turned on and once again the collectors (point B) will be tied low. The only time both transistors are off together is when point A is between +0.6 V and -0.6 V. At this time point B will swing to -15 V which will turn on Q4 and enable Q5 to deliver a negative gate pulse to the triac to turn it on. R3 will limit the current to the triac gate to about 100 mA.

R5 and C4 are connected across the triac to limit the rise time of the voltage when the mains is switched on. Too fast a voltage rise across the triac can cause it to turn on even when no gate pulse is present.

PARTS LIST — ETI-1507

Resistors.....all 1/4 W, 5% unless noted
 R1.....470R
 R2.....680k
 R3.....100R
 R4.....100k
 R5.....47R

Capacitors
 C1, 4.....100n 250 Vac (AEE type
 PME271M or similar)
 C2.....10μ 16 V RB electro
 C3.....470p

Semiconductors
 Q1.....SC141D triac (or similar)
 Q2, 3, 4, 5.....BC557
 D1.....1N4004 or similar
 ZD1.....15 V 400 mW zener

Miscellaneous

ETI-1507 pc board.

If mounting the board in the tube assembly described you will need the following: 45 mm length of 40 mm diameter pvc tube threaded at one end; threaded 40 mm diameter end plug; unthreaded 40 mm diameter end cap; male bayonet socket; female bayonet light socket; mains rated hookup wire.

Price estimate: \$5-\$6
 (without tube assembly)

when it is hot. In fact the difference can be a factor of ten or more. This implies that at the instant of switch-on, if the mains voltage is at a peak, quite large transient currents can be present. If a light bulb is reaching the end of its life then this switch on transient may overload sections of the filament and cause it to burn out. Eliminating this turn-on current surge should enable the light bulb to be turned on successfully even in a stressed state and thus the usable life span could be increased.

Design details

My first thought was to limit the current with an inductor of some sort but the size and power dissipation problems ruled this approach out. The most promising idea was that of a zero crossing turn-on switch. Such a circuit would, regardless of when the mains was applied to it, only connect the bulb to the mains at a point of zero crossing. This would minimise the turn-on transient since the bulb would never have a large initial voltage across it. Although not the ideal solution (it would be better to turn the light on slowly over a period of about 10 cycles), the relatively simple circuitry required makes this approach the most viable as far as a project goes.

Having decided what to do, the decision of what type of circuit to use had to be made. Most of the more common circuits use some kind of high power dropping resistor to attenuate the mains voltage to a usable level. Several ICs are available for zero crossing applications but these, too, require dropping resistors. As small size is a requirement it would be no good having a rather bulky power resistor in the circuit and anyway, the heat dissipated in such a device would present all sorts of problems of its own.

Another approach is to use a capacitive divider network. This sort of circuit could provide a stable dc rail supplying a few milliamps to run the necessary circuitry, and would not dissipate any significant amount of heat. The only disadvantage is the need of a capacitor which is rated for continuous connection across the mains. This type of cap is a little bulky but that can be lived with.

Having decided on a power supply, it was time to think about the zero crossing and triac drive circuitry. A project published in our June 1984 issue for a bathroom strip heater timer (designed by Ian Thomas) had a cunning little circuit which could be modified to do just what I wanted. This used two transistors to detect the zero crossing point of the mains and a further couple of transistors to provide a pulse to the triac gate. OK! I had a circuit. Now for the hard part!

When dealing with any circuitry which directly switches mains voltages it is important to ensure that it is mounted safely. If

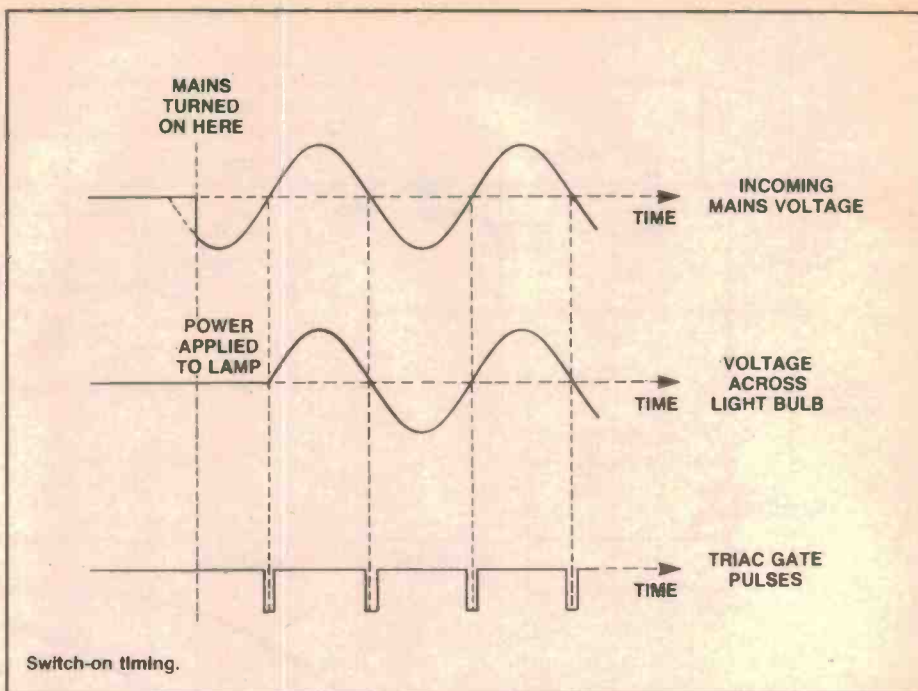

you are an electrician or have experience in mains installations then you could probably mount the circuit on the back of the light switch or, if it is suitable, in the light fitting itself. For those not so fortunate, a method of mounting the circuit so that it plugs straight in into the light socket will be discussed.

Construction

It is strongly recommended to use the pc board to build this project as any mistake in mains wiring can be dangerous. The pc board is small and the components sit close to each other so check the board for any broken or shorted tracks before you start.

Solder in the resistors first. Note that some of the resistors mount standing on end to save room. If you wish, the exposed leg of these resistors may be covered with spaghetti insulation to prevent any accidental shorts. Next solder in the capacitors. The input dropping cap and the cap across the triac are both mains rated. Be careful to get the electrolytic in the correct way round. The two diodes can go in next. Again take care to get these in right way round. Lastly, solder in the four transistors and triac.

Once the board is complete do a thorough check and make sure that all the components are in the correct positions and the right way round. Also make sure that there are no solder bridges between tracks which may cause shorts.

Installation

You are now ready to install the circuit. If you have the necessary expertise then you can mount the board behind the existing light switch or in the light fitting. If not follow the method of mounting the unit to plug into an existing light socket described below.

The search for some kind of case to put

the circuit in proved to be a long and frustrating one. What I needed was to be able to mount the thing so that you could plug one end into a light socket and a light bulb into the other. A small plastic tube with screw-on ends would be ideal but, alas, hard to come by in these modern times. I did manage, however, to find something suitable at an electrical fittings store: a tube assembly consisting of a 45 mm length of 40 mm pvc pipe tapped at one end, into which would go the threaded end plug while the unthreaded end cap went on the other end. All of these pieces are standard items made by Clipsal. In the threaded end cap I drilled a hole large enough to fit a male bayonet plug and in the unthreaded cap, a hole to fit a female bayonet light bulb socket. The end covers for the plug and socket could then be used to fasten them into the pvc caps.

The board can then be wired up as shown in the wiring diagram and put into the tube. The unthreaded end needs to be glued in place using a special pvc cement. This should be obtainable from the same place you get the tube assembly. The threaded end can then be screwed into place and you are ready to go. I would leave enough connection wire from pc board to fitting so that the board can be pulled out of the tube for servicing without having to break off the glued end. Also, you will have to make sure that the pc board does not come in contact with the mains terminals on the plug and socket when the whole assembly is mounted. This is best done by encapsulating the pc board with insulating tape before pushing it into the tube.

The completed unit can be inserted into a light socket as would a normal light bulb. The bulb then plugs into the end of the light saver. The circuit will work with any incandescent bulb from 40 to 200 watts.

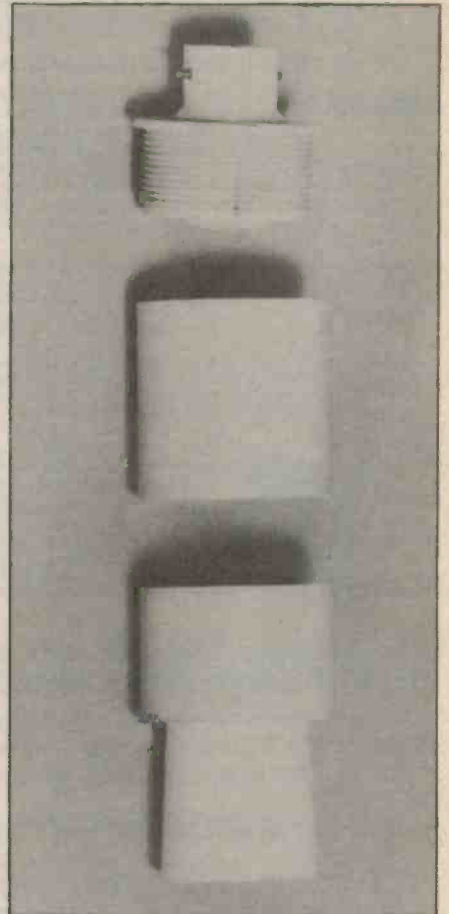
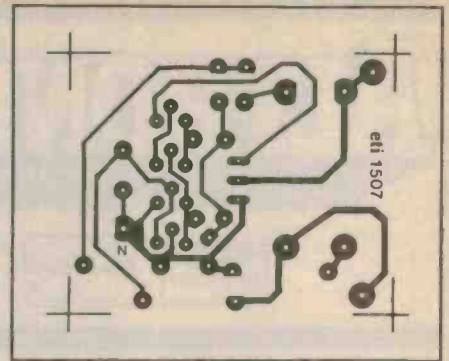
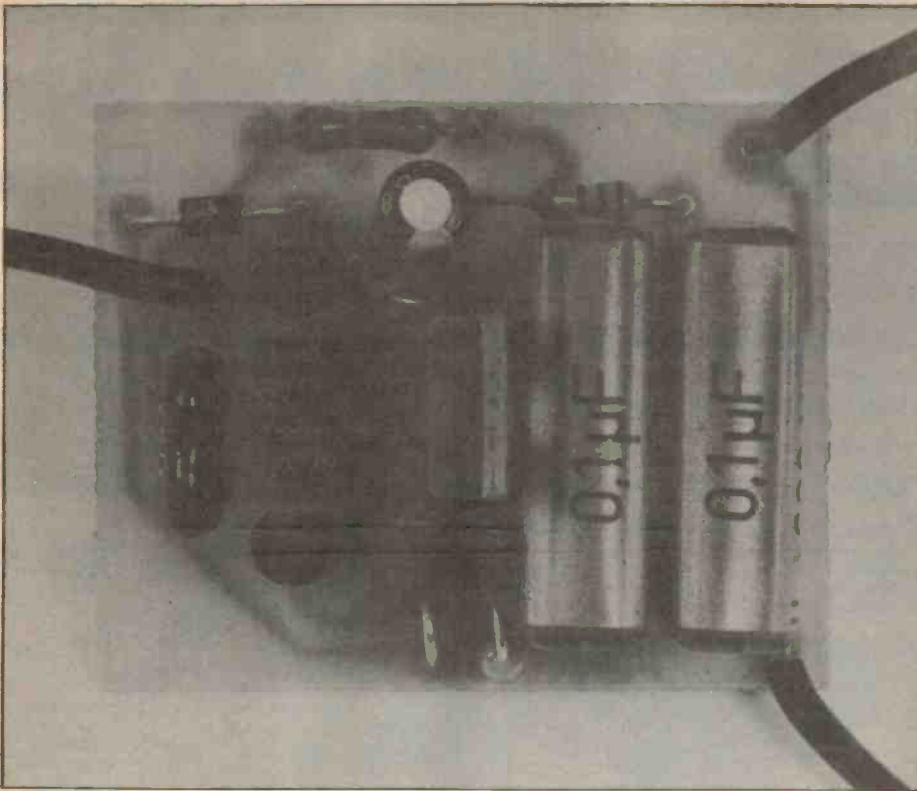

GETTING CROSS OVER LIGHT BULBS

Since the inception of this project many moons ago there have been quite a few 'friendly', lunchtime discussions down at the local between the various, humble staff members concerning the actual usefulness of a zero crossing turn-on in this situation. The usual line of argument follows that to really extend the life of a light bulb one must limit the turn-on transient to less than the thermal rise time of the filament. This 'soft turn-on' would then take place over several (about 10) mains cycles. Methods of doing this could range from very complex solid state circuits to a very simple pilot light bulb and LDR arrangement. The drawback of the former is self evident and that of the latter is low efficiency, power wise.

The zero crossing turn-on, as pointed out

in the text, was not intended to be a magical cure for blown light bulbs. (Alas! This accursed plague will be on mankind until the lights go out for the proverbial last time.) But I maintain that a significant increase in the life of a bulb that is turned on and off frequently can be achieved with this type of circuit. Some limited testing has been done in the lab and this seems to confirm my view, but the sceptics remain unconvinced!

If any of our readers has experience in this area or would just like to add two cents worth please drop us a line. Who knows? Maybe one of the alumnae reading these hallowed pages has devoted her entire life to the pursuit of longer life light bulbs and is just aching for the chance to publish. At least it would settle all the arguments down the pub!

Designers:

Got a good project idea?

ETI is paying for good designs from readers for publication in the magazine.

First step is to phone the external projects manager, Jon Fairall, at ETI on (02) 663 9999 to discuss your idea and find out what we need.

We encourage local talent.

BANKCARD HOLDERS—PHONE ALTRONICS TOLL FREE 008 • 999 • 007 FOR NEXT DAY JETSERVICE DELIVERY

ALTRONICS COMPONENTS

9th Birthday Sale

• Hundreds of Quality Electronic
Save up to 50% on
Credit Cards accepted — You don't pay a



Your on Your Way Home from the Office Party, Doing Just a Few K's Over the Limit and You'd Never Guess Just Who's Over the Hill (Unless of course you're already the proud owner of one of these Brilliant Superhet R/D's)

MICRO RADAR DETECTOR-CLIPS ONTO SUNVISOR (INVISIBLE FROM OUTSIDE THE CAR)

Now X band, K band stationary, gun or even Mobile Radar are detected up to an amazing 13Km with the all new "Space Age" Micro Computheterodyne Radar Detector. The very 1st in the world to utilize a custom microprocessor—hence enabling quite incredible sampling/checking detection of incoming signals—and what's more it's so light and compact it simply clips securely on to your sunvisor out of sight of anyone outside the vehicle.

• Detects Mobile Radar equipment even monitors the pulse which is sent to the road from the Police vehicle to enable them to accurately calibrate their own speed • Highway/City Mode switch allows monitoring of City or Highway conditions. By measuring and storing the field strength of each microwave sample taken from the source, the computheterodyne will automatically, whilst in City Mode, discriminate between Microwave Alarm Systems and Radar Traps etc. — 21 Day Money Back Guarantee Unconditionally Guaranteed to out perform any other detector you've ever tried or your money back—absolutely no quibbles whatsoever.



Cat A 0920
\$399

12 Key Keypad (Commercial Grade)

These sturdy keypads were previously standard supply on STC telecom phones — so naturally the quality speaks for itself — Brand new fully assembled with PCB and 8 way wiring harness. Just the shot for microprocessor assemblies, combination locks etc.etc. A 0495

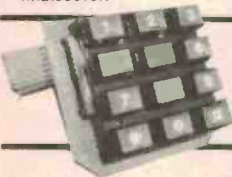

1—9 **\$3.95** 10—24 **\$3.00** 25Up **\$2.50**

Look at This!
Superb Quality Nicad Rechargeable's
From an Incredible

\$1.50



Save Up to 50%

1—9 \$2.20
10—99 \$1.80
100 Plus \$1.50 ea.

Cat S 5020

Building a Disco? Or need some Hi Fi Speakers for the Den?

Why not build your own Speaker System using these Great Dainichi Drivers. After all, equivalent imported built up systems now cost a veritable fortune!!

DAINICHI HIGH FIDELITY SPEAKERS

Custom made for Altronics by Dainichi, one of the most respected loudspeaker makers in Japan (they manufacture speakers for Pioneer) All very conservatively rated—superb for building up a low cost speaker system. Naturally they also serve as rather excellent replacement speakers.

CONE TWEETER 50 WATT

50Watt Max.Power 8 Ohm Z
Amazing performance budget price. Frequency response 2 KHZ-18 KHZ. 110mm Diam. Hole centres 79mm. Australia's best value at this price.



C 3020 **\$8.95** 4up **\$8.00**

MIDRANGE 50 WATT

Midrange clarity that has to be heard to be appreciated
Absolutely 1st class reproduction of midrange — piano, vocal, guitar, violin etc. Huge 50 watts max. input. 8 Ohm. Frequency response 700-5 KHZ. Value Plus!



C 3030 **\$22.50** 4up **\$20.00**

DOME TWEETER 60 WATT

60 Watt Max.Power
Silky smooth frequency response. 1.5 KHZ to 20 KHZ. Wide Angle dispersion. Massive power handling capacity. Diam. 94mm. High spectrum. Purity. Incredible low price!



C 3010 **\$19.50** 4up **\$18.00**

WOOFER

307mm (12 in.) 40 watts max. power 8 Ohm.
Roll edge one suspension. Resonant of 30 HZ. Frequency range 30-2 KHZ. Smooth faithful bass speaker. Ideal Hi-Fi replacement. 48mm voice coil.



C 3040 **\$42.50** 4up **\$39.95**

(Speaker enclosure design details and crossover info available on request) Regretably these prices must increase 25% on January 1st (Due to devaluation) So Order Now — Stocks are limited.

Video Tape Repair Kit



A VHS/BETA Video Tape Repair Kit. No need to throw out your damaged tapes—this nifty splicing kit can save you a fortune (If you've got small children this kit will save you several fortunes!!) All accessories included for joining tape and refixing leader ends etc. Cat.No. A 9315

BICYCLE COMPUTER

INCREDIBLE 12 FUNCTION
The brilliant BIKOMP COMPUTER that is all the rage in USA is now available in Australia. For a few dollars more than a digital speedo this superbly accurate computer provides every activity readout the enthusiast cyclist is ever likely to require.

WHY PAY
~~\$90~~
NOW
\$49

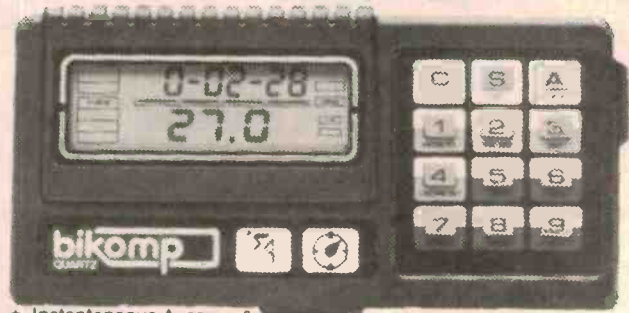

- * Instantaneous, Average & Peak Speed Readouts.
- * Measures Calories Used per Trip.
- * Measures Distance.
- * Clock, Stopwatch and journey time (whilst Mobile)
- * Miles or Kilometres
- * Pacer Tone and Performance Monitor
- * Dual Display
- * Easy Removal for Security
- * Fits to Bike in minutes

Bonanza

Components and Products —
our Competitors prices.

cent until you get your statement next month!

With Altronics Jetservice
We deliver to your Door Next Day
— Just Try Us !! —
(Capital Cities & Suburbs - Country areas allow extra 24 - 48 hours)

Compliments
of the Season
Jack O'Donnell and Staff



FOR NEXT DAY JETSERVICE DELIVERY
BANKCARD HOLDERS — PHONE ALTRONICS TOLL FREE 008 • 999 • 007

Desk Mounted Lamp Magnifier



This unit magnifies any object under a clear cool florescent light. The magnification is the maximum obtainable (lens 127mm diameter biconvex 4 Dioptres, focal length 254mm) consistent with minimum distortion and eyestrain and good off-angle viewing. It is NOT cheap, but then again it will definitely last a lifetime. It is built like a Rolls Royce. (We doubt whether 20 years continuous use would wear out the German made flexible arms for example). Spare fluoro tubes are available either from us or electrical outlets.

If you have trouble with fine PCB work or component identification but still want both hands free, this is for you. We thoroughly recommend this quality Australian made product.

TECHNICAL INFORMATION - Illumination: 22W Fluorescent Weight: 8.16kg Lateral Extension: 254mm Vertical Extension: 254mm Fixing: Heavy table base (grey & Ivory) with two chrome plated flexible arms. Lens: (see text) Cat A 0980

Only \$169

UV EPROM ERASER

Erase your EPROMS quickly and safely. This unit is the cost-effective solution to your problems. It will erase up to 9 x 24 pin devices in complete safety in about 40 minutes for 9 chips (less for less chips).

- Erase up to 9 chips at a time • Chip drawer has conductive foam pad • Mains Powered • High UV Intensity at chip surface ensures thorough erase • Engineered to prevent UV exposure • Long Life UV tube • Dimensions 217 x 80 x 68mm • Weight 670 grams

NEW \$89

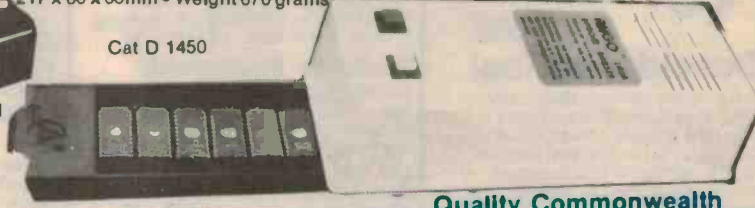

Cat D 1450

VHS VIDEO TAPE EXCELLENCE



We've tested the lot - Well how does ME stack up? — in a word superb - Forget all about paying a premium for BASF or TDK—Altronics positively guarantee our new ME Metallic is equal to the very best—and that goes for mechanical construction as well as picture quality!

Were \$12.00 Limited Stocks Cat A 9330

NOW \$9.90

10Up \$8.90

Brilliant Smoke/Fire Detector

100 Only — Great for Boat, Caravan, Home.

Every year 100's of Australian Men Women and Children perish through house fires and smoke inhalation.

Virtually none would have died had a Smoke Sentry Alarm been fitted to their home.

Cat A 0090

Be Quick 100 Only Were Selling for \$59.95 **\$14.99**



Does not include battery.

- Brilliantly Designed Dual Chamber Ionisation sensor detects particles of combustion (smoke) at earliest stages of fire e.g. smouldering etc.
- Loud, persistent 85db alarm wakes the soundest of sleepers.
- Low cost 9 volt battery lasts approx. 1 year, easily replaced.
- Low battery alarm • Test Switch.
- Dead easy to install—takes less than 10 minutes—all you need is a screw driver. Protect yourself and your whole family as of today.

Quality Commonwealth Computer Fan 80MM - 240V

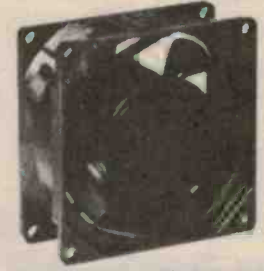

★ Super quiet ★ Sealed sleeve bearings for long life ★ Sturdy die cast frame ★ Operating range -10 deg C to +70 C Cat No. F 1020

1 - 4 \$15
5 Up \$12

BLOOD PRESSURE & HEART RATE MONITOR

Why Risk Unnecessary Heart Attack? A simple (take the reading yourself) periodic check of your blood pressure and pulse provides an "inward look" into a vital aspect of your bodily health. Heart disease strikes down many people in their early 40's (or even 30's). The tragedy remains that had such victims been alerted, remedial medical, physical and dietary action could have been prescribed to avoid illness and in many cases restore full bodily health.

A superb Gift for the dedicated fitness enthusiast Absolutely essential for those over 40 and concerned with their health, or on Fitness Therapy. Use this easy to operate Monitor, to measure your pulse (or heart rate) and Blood Pressure. Remember high blood pressure is in itself symptomless and the usual forerunner to future chronic heart disease. Features include "error" display warning of incorrect use. Handbook supplied will enable anyone in your family to be fully conversant with this monitor in minutes. Easy to read display of Systolic and Diastolic Blood Pressure and Pulse Rate. Cat X 3055



Don't Pay \$150 Now Only \$89

Treat yourself to the Greatest thing to happen to AM in 60 years

AM Stereo Sensation

★ Am Stereo ★ FM Stereo ★ Auto Reverse Tape Deck



Delightful AM Stereo is now yours for an unbelievable price. This Top Quality Roadsound RCR 760 Stereo AM and FM Receiver boasts 8 watts per channel and high grade Auto reverse tape deck (Metal Compatibility) C 9122

Amazing Price \$189.00

Runs forever without Batteries! Solar Powered

Desk Top Calculator Just released for 1985. New technology now allows powering of large desk top type display as used with our new X 1050. No more batteries to go flat. No more Batteries to leak! No more Batteries!!! Perfect for Home or Office Fantastic Value. Cat X 1060

Was \$19.95 \$15

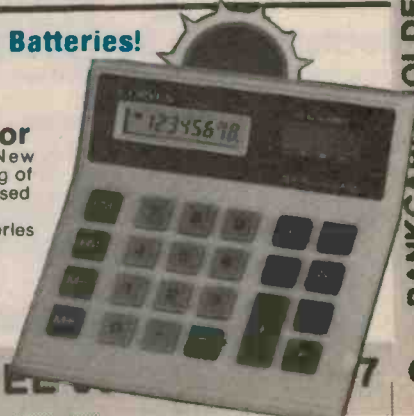

ALL THOSE BITS AND PIECES YOU'RE ALWAYS LOOKING FOR...

HOBBYIST'S BARGAINZA

TOP TOOLS!

DSE Desoldering Tool

Wow! A fully self contained 240V 30W desoldering station. And it's at a DSE bargain price! It's simple and clean to operate and features quality components and rugged construction. Ideal for home, workshop, lab, etc. Don't miss this incredible value!

\$69



Mini Drivers

This really is a miniature screw-driver! Ideal for small jobs like the magnetic cartridge in your turntable, jewellery etc. Yes they are that small! L-30mm, D-1.6mm, H-25mm X 7mm

Cat T-4C10 ... FLAT BLADE ... 50c 65c
Cat T-4020 ... PHILIPS ... 50c 75c



Pearl Catch

For reaching into awkward places. 3 pronged tweezer with syringe action. A must for small nuts, washers etc. Great for serviceman, jewellers, hobbyists, etc. Cat T-4660

\$3.95



TV Alignment Kit

A versatile four general purpose tools to cover all shapes & sizes of cores. They are made from tough plastic. Cat T-4540

\$2.99

Heatsink Clip Set

Spring loaded, piler grip clips for heat sensitive components and leads. Cat T-2620

\$2.99

ETCHING KIT

Incredible value: a pack consisting of Ferric Chloride, Dalo PC pen, resin (flux), a sample of PC board plus instructions — at less than the price of the etchant and pen on their own! And the Ferric comes in handy 500ml bottle.

\$8.95

H-5650

BEST BOOKS!

Transistor Spec. Manual

Tells you how to read specifications then gives you specifications in detail. Cat B-4508

~~\$12.50~~ **\$9.95**

Transistor Equivalents

This reference book enables the user to find substitutes for approximately 9,500 European, American and Japanese transistors.

~~\$6.85~~ **\$5.95**

Australian Amateur Callbook

Compiled by the WIA from official DOC lists, together with registered SWL's and Papua New Guinea amateurs. Cat B-2322

~~\$6.45~~ **\$5.95**

Foreign Radio

1985 Callbook WERE ~~\$32.50~~ NOW **\$29.50**

Cat B-2285

US Radio Amateur Callbook 1985 each **\$29.50**

Cat B-2185

World Radio Handbook The most thorough and complete listing of international radio and television stations. Cat B-2085

~~\$32.50~~ **\$19.95**

KITS KITS KITS KITS KITS

Beat Triggered Strobe

IDEAL FOR XMAS PARTIES

A beat triggered strobe that comes complete with case, reflector, PCB, everything! It's so simple to build and has adjustable sensitivity.

\$59

Want AM Stereo?

Don't throw out your old tuner... build an AM stereo decoder instead. Save \$\$\$ and get the latest sound. Get the latest without spending a moolah! Full fitting instructions included. Cat K-3415

\$39.95

Deluxe Car Alarm

Cheap insurance for your vehicle! Cat K-3252

\$64.95

Brake Lamp Flasher

You've seen those snazzy lamps that mount on the parcel shelf and flash when you brake? A great idea for road safety, too: you cannot avoid the flashing! Now you can build your own with this simple kit — and save \$\$\$ on the commercial units. Flashes the lamp three times before holding on. Uses our A-8520 Rear Window Brake Lamps (at extra cost!)

Cat K-3245



\$14.95

COMING SOON! 4 Channel Mixer to Build

Yes, a deluxe four channel mixer — ideal for bands, pa, churches & groups, etc. Coming next month — don't miss out on this one. Easy to build — and you'll save

Cat K-3036

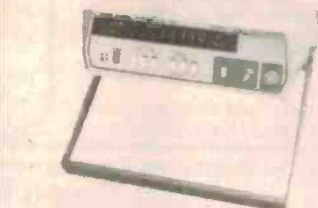

1GHz Frequency Counter

Great value for a superb 8 digit counter with an enormous range of up to 1GHz! A professional device at an affordable price. The robust, functional design make this unit ideal for the lab, technician, workshop or professional hobbyist. The large bright display and logical layout allow the job to be done quickly and efficiently.

\$499



\$89.50

Cat Q-1220

Trio CS1021 20 MHz Dual Trace CRO

Famous brand TRIO — fantastic DSE value. Top quality CRO for all general service work — and for the serious hobbyist. And even better value: we throw in two sets of top quality probes. Amazing value — call in for a test drive.

\$799

Cat Q-1255



Hand-Held RC Oscillator

A really worthwhile addition to your test gear: a hand-held oscillator that's small enough to take anywhere. About the same size as a digital multimeter, it gives you 23 ranges of sine & square waves (switchable) between 20Hz and 1.5kHz, plus a x100 range: 46 settings in all. Continuously variable amplitude and a -20dB attenuator built in gives total control. And you can sync the signal if you wish. Output is standard 600 ohms. Complete with clip test leads.

\$79.50

Shortwave Antenna Kit

Get the best reception from your receiver with this high quality short wave antenna

\$16.95

Cat K-3490

Two Great Mosfet Amps

Wow! Now you can have a 60W or 100W Mosfet module amp at a fraction of the cost of a commercially produced unit. These high performance general purpose amp kits are intended for use in a variety of applications and offer performance, reliability and versatility at an incredible price.

60 Watt Mosfet Cat K-3441 **\$49**

100 Watt Mosfet Cat K-3443

\$69



AMATEUR BARGAINS

2m Choice:

At last! Total control, total flexibility in a hand-held! That's the new FT-209 series of 2 metre transceivers from Yaesu.

Your choice of transceiver/battery combination to give the power — and the features — that you want!

FT-209R Limited Stock
(Lower power version) **\$439**
Cat D-3502

FT-209RH
(High Power version) **\$449**
Cat D-3503

FNB-3 10.8V/ 425mAh NiCad. **\$65**

Similar package to above, but containing a 10.8 volt NiCad Battery. Includes provision for charging without removal from hand-held. Instant removal & connection. Cat D-3506 **\$59**

FNB-4 12V/ 500Ah NiCad

Slightly larger to above pack, gives full 12 volts for when highest power is essential (up to 5W out on the FT-209RH!). Also includes charging provision. Cat D-3507 **\$79**
\$89



Air Band VHF Radio & AM/FM!

Operates from 4 penlight batteries (supplied), with telescopic whip antenna for aircraft band and internal ferrite rod for broadcast band.

\$29.50 Cat D-2836

• Receives both AM/FM on VHF band.

COAXIAL SWITCH

At last! A really high quality coaxial switch suitable for all HF, VHF & UHF (900MHz) uses. Made by Welz in Japan. Cat D-5208 **\$44.50**
\$39.50

Amateur Radio and Electronics Study Guide Cat B-2319 **\$12.95**
\$9.95



Linear Amplifier

Don't pay \$120 or more! This amp does a better job and will cost you less. This is an all mode, high efficiency linear amplifier for 2 metres. 30 watts output with only 3 watts in. 13.8 volt DC supply makes it perfect for mobile use. Dual time constant for SSB or FM operation. Reverse polarity protection too. Works great with our FT290R and FT208R or any 2M transceiver with up to 3 watts out. The best value in Australia. Cat D-2546 **\$95**
\$89

MW/FM/SW 6 BAND

The economic receiver with the deluxe features. Like 6 bands covering standard AM & FM broadcast PLUS 4 shortwave bands: 2.3 - 4.1MHz, 4 - 7.5MHz, 7.5 - 15MHz. And a protective 'soft feel' carry case. Slide switches and controls. And best of all, it comes complete with quality stereo headphones - at no extra charge! Cat D-2835 **\$69**

Regency HX-2000 Hand Held Scanner

At last! A hand-held, go-anywhere scanner that doesn't sacrifice any of the performance of the 'fixed' type. In fact, it does better than many other scanners. up to 525 MHz including aircraft band! and it gives you 20 memory channels! NiCad Batteries Included! Cat D-2815 **\$475**



Helical Dipole Scanner Antenna

Designed by a scanner expert especially to suit the bandwidth of today's scanners, it features performance approximately equal to a quarter wave in free space. Cat D-4432 Get the most from your scanner **\$57.50**

115V Stepdown Transformer

Input 240V AC and secondary voltage 115V AC @60VA with 7% regulation. The unit is fully enclosed and has fuse protection for the output. Heavy duty carrying handle and socket outlet. Weight 2.9kg. Cat M-1156 **\$59**
WAS \$67.50

BARGAIN CORNER

Digitran Keyboard

Get a load of this one: famous US brand keyboard and the manufacturer had to quit the stock. His loss is your gain. Not just a keyboard - the best keyboard we've ever seen. 98 keys (yes, 98!) but that's not all! Also includes decoder board with speaker and buzzer. What a bargain! Cat J-1008

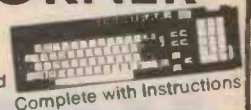

Complete with instructions **\$39.95**



Computer Flash Innards

A complete "computer flash" insides, ready to build into a case, use as a strobe, etc etc. As used in photographic kiosks - manufacturer's rejects but most work perfectly. And if they don't the fix is pretty easy (circuit supplied). Cat J-1002 **\$9.95**
~~\$14.95~~

PCB with relays

Top value. Brand new computer spare parts pcb's with dozens of resistors, capacitors, etc PLUS six ultra high quality heavy duty relays. About \$9.50 value: Look at our price. Cat J-1007 **\$1.99**
~~\$9.50~~



Philips 2-way Crossover

More bargain buying! How much would a quality crossover normally cost? \$15 or \$20?? Look again. Philips made. Ideal for most hi fi use - and they're so simple to fit (goes inside your speaker box). Cat J-1022 **\$7.50**

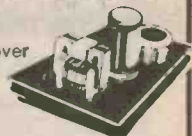

and that's not all! Buy one ... get one FREE! Perfect for stereo

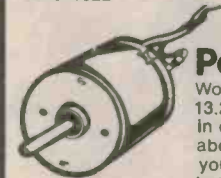

Power Plant!

Wow! Quality Matsushita brand (ie National Panasonic) 13.2 volt DC motors. With 2.5mm shaft, they're 45mm in diameter and ideal for those larger projects. Talk about torque — you can't stop these beauties with your fingers. You won't find better value! Cat J-1018 **\$1.95**

100 transistors for under ten bucks!

Value: transistors less than 10 cents each. Quality, branded small signal transistors (data available) in a handy pack so you'll have some around. Cat J-1037 **\$9.90**

The Big Guns

The incredible Molon reluctance synchronous 230 volt motors. Heavy duty cast-iron outer casting, they're quality manufactured in the USA. With an 8mm shaft they're ready for the big jobs. Cat J-1016 **\$14.95**



TARZAN FAN

Wow! This is an unprecedented price — stocks are limited so hurry! Genuine Tarzan 17cm Rotary Fans from the USA. The highest quality at this ridiculous price! Cat J-1009 **\$29.95**



Micro Switches

Quality microswitches with positive switching action! These are ideal wherever a limited switching movement is required. Don't miss this great deal! SPDT, 5A 12V or 3A 250V rating. Cat J-1004 **79¢**



Scotchlock

Genuine 3M Scotchlock brand connectors type UG. They're the ones used by Telecom! Now at a BARGAIN price! Cat J-1020 **\$1.99**



PACK OF 10 ONLY

Looking for your nearest Dick Smith Electronics store?

There's an insert in this issue with all store addresses listed ... and don't miss the bargains while you're there!

DICK SMITH ELECTRONICS



HOBBYBOT Part 1

Allan Branch

easy-to-build navigating robot

This all-Australian designed, do-it-yourself robot can be programmed to do countless navigable tasks. You can use it just for fun or teach it to do practical things like following you while you work, carrying tools or food. You can even send it around the house on its own, performing various tricks. In Part I we show you how to build your Hobbybot then in Part 2 (in next month's ETI) we'll show you how to program it.

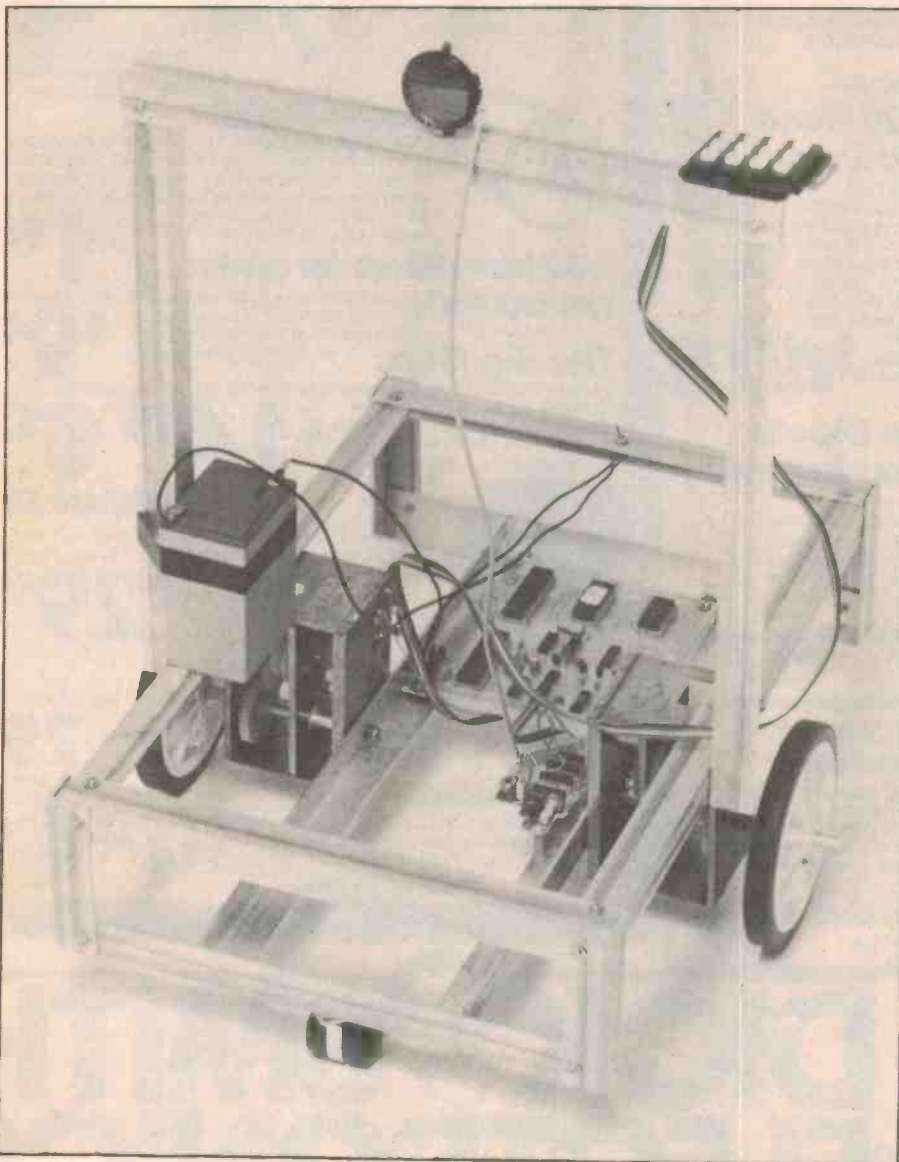

SINCE THE PUBLICATION of the Tasman Turtle (ETI, April 1982) we've experienced a dearth of robot projects in Australia to cater directly for the electronic and computing enthusiast. Sure, there have been a number of personal robots available, but they have not been able to attract the large 'enthusiasts' market because they are too expensive or they do too little. Besides they are not designed to be customised by the purchaser.

With 'Hobbybot', all of that is about to change. This is a robot designed especially for the experimenter! It's a versatile, low-cost unit, which can be easily adapted or modified to suit your needs. And to make things simple a complete kit containing all of the hardware, electromechanics, microprocessor, software in EPROM and electronic circuitry has been developed.

You will be able to send your self-contained Hobbybot around the house, performing various types of behaviour, by programming it with an easy-to-use controller included in the kit. No external computer is used and no prior knowledge of computers, programming or electronics is required.

If you're feeling innovative and have some adventurous ideas, the kit will pro-

THE DESIGNER — ALLAN BRANCH

Allan Branch, principal of Branch & Associates Pty Ltd of Glenorchy, Tasmania, has worked in Hong Kong and Japan on personal robots ('Elami' and 'Tomy's Omnibot' are adaptations of his original work) and in the USA as director of robotics for Commodore Business Machines, where he designed 'Chester'. He is a world leader in the implementation of autonomous navigation on mobile devices and has recently been granted research funds totalling \$300,000 by the State government of Tasmania and the Federal government to develop navigation and guidance for industrial and defence robot applications.

In the April 1982 issue of ETI we published a D-I-Y educational robot, the 'Tasman Turtle', designed by Allan Branch when he was with Flexible Systems. This robot proved extremely popular both for educational and general applications. It and its successor, the 'Turtle Tot', have since gone on to capture the world market in educational robots.

'Hobbybot' and a new robot called 'Blinker' demonstrate Allan Branch's on-going commitment to developing useful and enjoyable household robots for people who want to participate in this exciting new technology.

Table 1. KEYPAD COMMANDS

Manual Commands: F B L R Stop
 Program Control: REPEAT, WHILE,
 IF/ELSE DELAY
 User Control: LEARN RUN COMM
 Numerical: = > VAR RANDOM
 Digits: 0 1 2 3 4 5 6 7 8 9
 Parsing: { } , CLEAR
 Peripheral Control: PORT RANGE

vide the starting point for your own experiments in robotics. Your own specialised sensors and actuators, or even additional electronic pc boards, can be attached to the Hobbybot and interface, increasing the power of its microprocessor 'brain'. Or the control software can be replaced by your own programs to give your Hobbybot its own 'personality'. Again you can expand the artificial intelligence of your Hobbybot by connecting it to your personal computer.

The design

The Hobbybot consists of several major parts — an aluminium frame, motor/gearboxes, ultrasonic sensor and pc board, microprocessor board, and ancillary hardware. The Parts List gives a complete rundown of the components needed to build the robot. These can be purchased separately or in the ready-to-assemble kit form mentioned above, which is available from Allan Branch & Associates (see Shop-around). The only other things you'll need are the batteries and the tools.

Chassis and frame

The bulk of the kit is made up of pieces of aluminium bracket (25 x 25 x 3 mm) which when assembled form the robot chassis.

The chassis has been designed to allow the circuit boards, batteries, gearboxes and sensor to mount conveniently, leaving plenty of room for your own additions at a later time. Across the top of the chassis a single frame holds the sensor and also serves as a handle for you to move the Hobbybot around or to pick it up. A robot arm could be designed to use this frame as a 'shoulder' support for holding motors and associated electronics.

Motors, gearbox, wheels

The Hobbybot has two motors, each able to provide 20 kg force from around 200 mA. This is more than enough to move the unit around most floor surfaces and to carry additional loads. A small castor completes the classic three wheel base traditionally found on mobile devices from turtles to wheelchairs.

Sensor

The basic project uses an ultrasonic sen-

Figure 1. Block diagram.

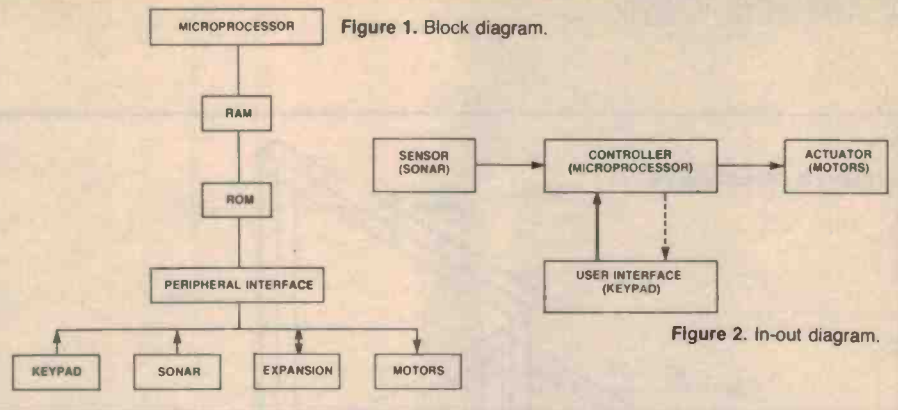
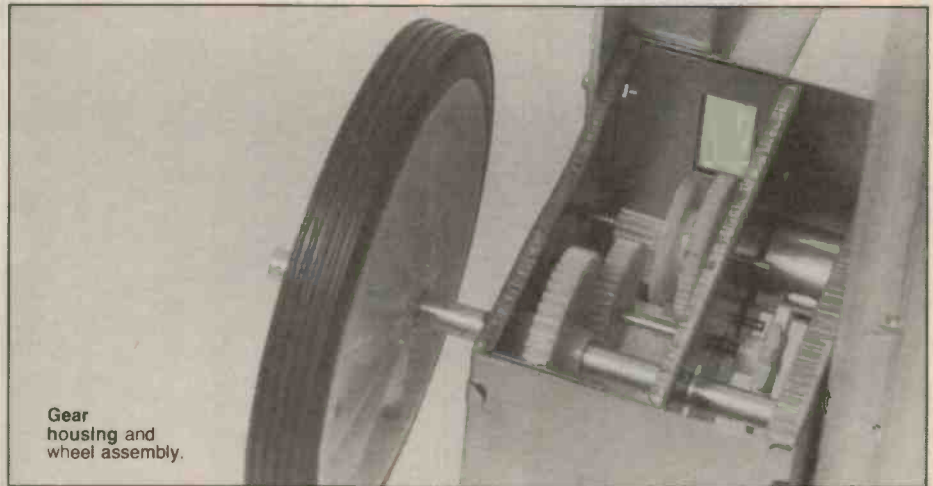

Figure 2. In-out diagram.



sor instead of touch switches, however switches can be easily added. Indeed, a depth switch mounted under the robot would make a good 'edge detector' for avoiding stairways, etc.

The sensor for this basic project is a Polaroid sonar device. We mounted ours on the top of the aluminium frame, but you can choose a different place if you prefer.

The Hobbybot's interface circuit is more suitable for microprocessor interfacing than the original Polaroid pc board. Techniques for using multiple sensors are given later, so you can place sensors all over the robot if you wish.

The controller

The controller is a 4 x 3 keypad. If further software projects are designed the keys will take on functions as required, however our first EPROM uses the keys according to Table 1.

By pressing the keys in a sequence determined by the required action, you will be able to program the Hobbybot even if you do not have any prior experience with a high level computer language. It is much like programming in the more advanced languages like 'C' and LOGO — simple programs can be written immediately and there is no limit to the eventual complexity you will be able to build into later programs.

It is possible to put an infrared link on

the controller, but in the basic project it is connected to the Hobbybot by a seven strand ribbon cable. You will need to put labels on the keypad to indicate the functions.

The main pcb

Except for the sonar interface all electronics are on the main pc board. This board holds the microprocessor, EPROM, RAM, PIA and associated logic as well as the voltage regulator and clock oscillator. The keypad, batteries, sonar interface and motors are all plugged into it.

An expansion port is provided so that you can add your own gadgets, and provision is made for a personal computer to be interfaced directly to the robot.

The complete circuit diagram can be considered in two stages. Firstly, there is the 6502 microprocessor and its associated electronics. This is a fairly conventional circuit with a 2K RAM in the form of a 6116 (IC4) and a 2764 8K EPROM (IC3) which holds the special robot language software. The highest three address lines — A15, A14 and A13 — are used to select eight different 8K blocks of the possible 64K address space of the 6502. Address decoding is done by the 74LS 138 logic chip, (IC7), however only four blocks are used in the Hobbybot. They are RAM, EPROM, EXPANSION and INTERFACE.

Figure 3. Chassis labelling.

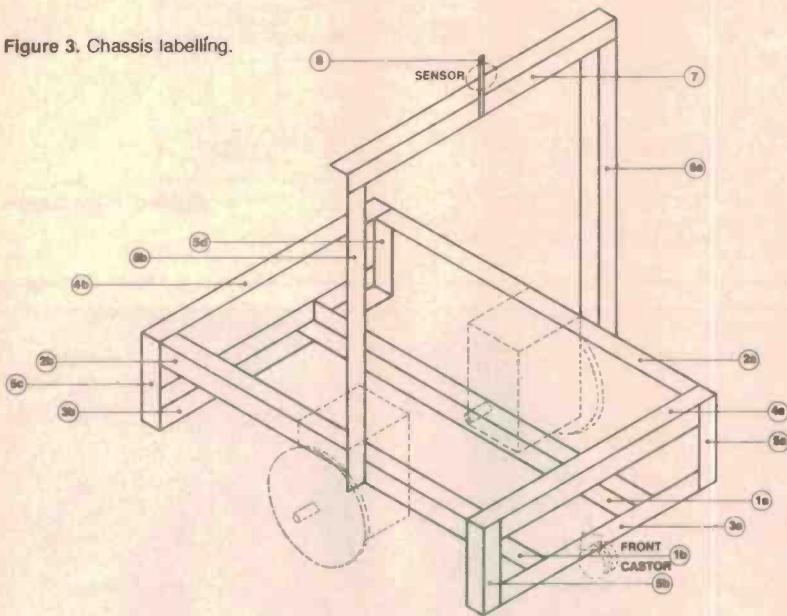

Figure 4. Wheel/gearbox assembly.

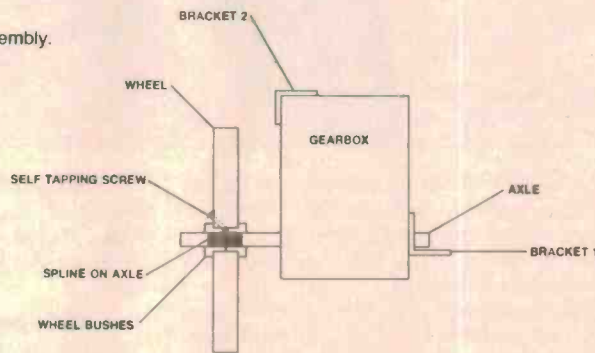

Figure 5. Castor (from under the robot).

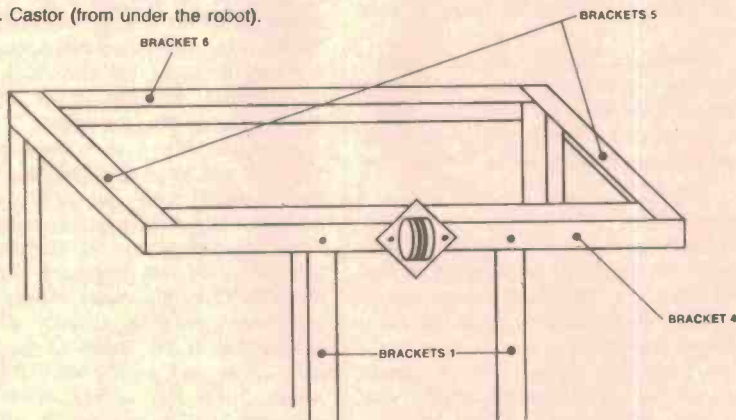
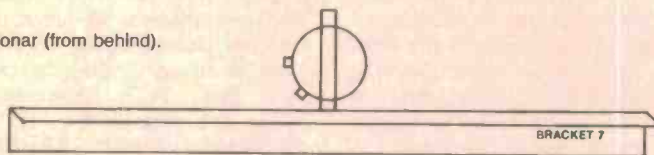

Figure 6. Sonar (from behind).



The second part of the circuit connects the microprocessor to the other robot parts. It uses a peripheral interface adaptor, called a PIA (IC1, 6821), for controlling the sonar range finder and the robot drive motors, as well as for reading the keypad.

All control functions are handled by the software in the 2764 (IC3) and hardware functions are straightforward.

Batteries

Many battery configurations can be used to power the Hobbybot. As on-board voltage regulation is provided you can choose from dry cells, NiCads or gel cells. Although reasonably expensive, gel cells are recommended because they can be used in any position — a distinct advantage considering that the Hobbybot is a mobile device! In the long run they will also be the most cost effective.

To begin with, however, the kit can be powered with D-size batteries which will give acceptable life.

When completed the robot will require 6 volts dc at approximately 500 mA.

What can the robot do?

Figure 1 shows a block diagram of the Hobbybot electronic system. To help the experimenter, circuitry has been kept as uncomplicated as possible. Basically there is a conventional microprocessor system consisting of the Hobbybot program stored in EPROM, some RAM to store your instructions as entered via the controller, a 6502 microprocessor and an interface circuit to the rest of the robot.

In this basic configuration the Hobbybot can be represented as in Figure 2, which shows an in-out diagram typical of a large number of open-loop systems.

The control software (in EPROM, IC3) is able to read the sensor and actuate the drive motors according to instructions given at the keypad. Provision is made for the controller to indicate any relevant information directly back to you via green LED2. Of course you can also verify the program by watching what the robot does — as this is an indirect method it is shown as a dashed link in Figure 2.

A complete programming language has been written especially for this project.

The source code, written by Branch & Associates' senior programmer John Colegrave, includes a set of commands and features that give you powerful tools with which to instruct Hobbybot. Taking a reading from the sonar, for example, is accomplished simply by entering the command RANGE. Moving the robot is done just as easily by entering one of the motion commands such as FORWARD. These commands can be inserted in high level instructions such as WHILE-DO, IF-THEN-ELSE, REPEAT X TIMES.

As well, you can store up to 10 separate programs in RAM and even call other programs within current programs.

The following program, which enables your Hobbybot to follow walls around your house in a clockwise fashion, gives an example of the power of control language:

```
REPEAT {LEFT 3, WHILE 35 >
RANGE {RIGHT 1}, RIGHT 2,
FORWARD 3}
```

By using the controller you can easily instruct your Hobbybot to follow people, look for doorways or repeat lists of movement commands.

Construction

To construct the Hobbybot, begin with the aluminium frame followed by the electronic pc board then the peripherals.

Frame assembly

Putting the Hobbybot frame together is not much different from playing with a mechano set.

Figure 3 and the accompanying photograph will help in assembling the gearboxes, wheels and various pieces of angle bracket that make up the chassis. Be careful that the correct mirror image pieces are used since the brackets come in right and left handed pairs. To arrange the pieces see the list of chassis parts.

Start by loosely assembling the frame using brackets 2, 3, 4 and 5.

Then attach a wheel to each gearbox, on the longer end of the axle. (See Figure 4.)

Next loosely attach the gearboxes to brackets 2a and 2b, slide brackets 1a and 1b over the short axle of the gearboxes, and attach them to brackets 3a and 3b.

Make sure all the brackets are squarely set, then tighten all the screws. *Do not tighten any of the screws until this point to ensure a tension-free structure, which is essential for long life of both the gearbox and the drive mechanism.*

Now loosely assemble the handle using brackets 6 and 7, and fix it to brackets 2a and 2b on the frame. Ensure that the handle is sitting square and tighten all screws.

Fix the castor on to bracket 3 at the front of the frame (see Figure 3) with the diagonal holes of the castor's plate sitting as in Figure 5.

Finally, fix bracket 8 to bracket 7 and slide the sonar sensor into place, making sure that it is facing in the direction of the castor (see Figure 6). If you wish to, you can bend back the free end of bracket 8 to doubly ensure the security of the sensor.

Main pcb

Now that the frame is assembled with sonar sensor, gearboxes, motors, wheels and castor all in place it is time to prepare the electronics.

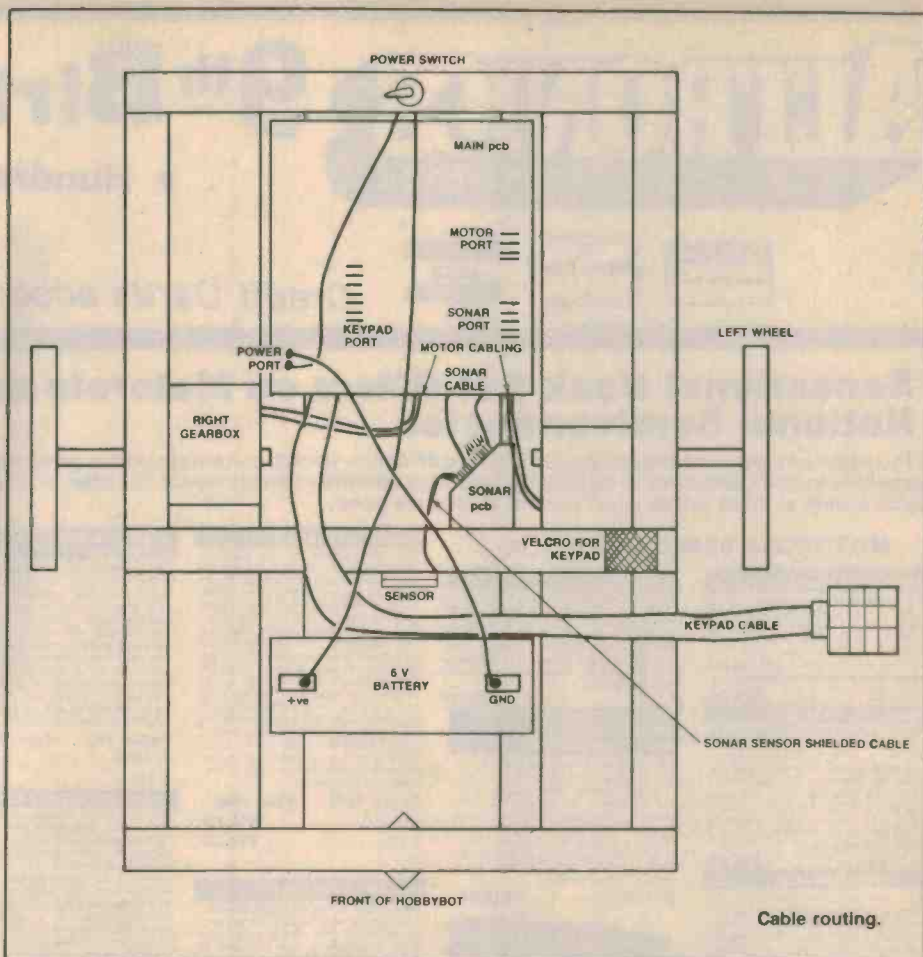

After checking that you have all of the pcb components listed in the Parts List, solder in each socket taking care to ensure correct orientation. Only sockets for IC1, IC2, IC3 and IC4 are provided since these semiconductors are expensive to replace if accidentally overheated during soldering. (Before soldering, check that all the pins are through the pcb and not bent under the socket. Check also that no tracks are shorted together when you solder the pins.)

Next cut to length the 21 short jumper links required on the pcb. The cost of the pcb is considerably reduced by keeping it single sided, but the trade-off is that these links are required. Don't try to make the links too exact since they will be difficult to position. A moderate loop is quite satisfactory.

Resistors and ceramic capacitors are next to go in. The electrolytic capacitors' leads are marked negative (-); the positive (+) leads are longer.

The two LEDs, electrolytic capacitors and transistors must be inserted the correct way round. If not, they will be permanently damaged! The component overlay shows the three leads of the transistors from the component side of the board. Be careful not to overheat the transistors when soldering them in.

Both a green and a red LED are needed — the red as a power indicator

and the green as a syntax error indicator. The red LED1, to be situated near-IC14, the 7805 voltage regulator, goes in next followed by the green LED2. The long lead of the LED is the positive one.

Refer to the component overlay for orientation of IC14 and solder it in next followed by the crystal.

Finally, solder in the integrated circuits which do not have sockets. Some of these are CMOS chips (IC5, IC6, IC8) and should be handled carefully to prevent static charges. Hold them only by the plastic body and solder in pins 8 and 16 first. If you are an inexperienced solderer you should consider buying extra sockets for your kit so that you don't damage the ICs. Again, don't overheat the chips. It's a good idea to go along each IC sequentially, soldering in only one pin on all the ICs then repeating for the other pins. This allows each chip to cool before you come back to solder the next pin.

Cables and peripherals

Now it's time to prepare the expansion cables to connect each port of the main pcb to the peripherals. These are the motors, keypad, battery and sonar pc board. Divide the rainbow cable to form a five strand length and a seven strand length, for the sonar and keypad respectively. Leave the seven strand length one metre long, but cut the sonar cable to 25

BANKCARD HOLDERS—PHONE ALTRONICS TOLL FREE 008 • 999 • 007

ALTRONICS 9th Birthday Sale

COMPONENTS

• Hundreds of Quality Electronic
Save up to 50% on
Credit Cards accepted — You don't pay a



Sensational Book Set Offers on Motorola and National Semiconductor

(The super low prices on the sets are for Nov/Dec 85 only — or until current stocks are gone. As we expect next book deliveries to be 25-30% dearer we definitely cannot repeat this offer or accept back orders at these prices when current stocks are gone.)

MOTOROLA SEMICONDUCTOR

MOTOROLA CMOS DATA

A comprehensive reference covering 40XX, 45XX CMOS family's along with specialty devices such as LCD drivers, telephone and general communication functions and industrial control. **882 pages** essential in all spheres of electronics.

B 1105 \$12.95

SCHOTTKY TTL DATA

Essential reference for the enthusiast and engineer alike. Designing, building and servicing digital circuitry is an absorbing pastime. Data for the LS, ALS and FAST families along with design considerations and circuit characteristics are logically presented in this manual, making it quick and easy to use.

B 1109 \$11.95

MOTOROLA MEMORY DATA

An absolute must for the microprocessor buff. This is the latest reprint of Motorola's famous memory data manual and includes the latest specifications and design application data on TTL RAM, TTL PROM, MECL MEMORY, MECL RAM, MECL PROM, MOS DYNAMIC RAM, MOS STATIC RAM, MOS EPROM, MOS EE PROM AND MOS ROM. Worth many dollars more.

B 1113 \$11.95

LINEAR & INTERFACE DATA

Popular data manual. At last readily available. Includes Data design procedures and equivalent listings for 1000's of devices under headings OP AMPS, VOLTAGE REGULATORS, CONSUMER CIRCUITS (e.g. TV, automotive power), HIGH FREQUENCY CIRCUITS and SPECIAL PURPOSE CIRCUITS. Gives data design procedures and equivalent listings for MEMOY, MICROPROCESSOR SUPPORT, LINE DRIVERS/RECEIVERS, TELEPHONE COMPARATORS, VOLTAGE REFERENCE AND DATA CONVERSION DEVICES. Includes comprehensive selector guide.

B 1114 \$22.95

MOTOROLA MECL DATA

Emmiter Collector Logic (ECL) is today's fastest form of digital logic providing the most direct way of improving system performance. This previously hard to get manual provides data on the 10KM, 10K and 10L families, MECL memory and PLL CHIPS.

B 1100 \$11.95

MOTOROLA POWER DATA

Motorola are the undisputed world leader in power transistors. Renowned for their low cost and reliability. Book includes a 9 page selection guide, application notes and data sheets for over 700 devices. 989 pages.

B 1101 \$19.95

MOTOROLA MASTER SELECTION GUIDE

The most useful book ever printed. Covers MOS IC's listed by function. INTERFACE IC's listed by function. LSI memory, TTL, ECL, power products, SCR's, diodes, transistors listed by application and ratings. RF, small signal and opto devices listed by application and ratings. Essential data given for all devices. Terrific value.

B 1104 \$7.95

CMOS DATA

This manual is intended to give the users of Power Mosfets basic information on the products, application ideas and data sheets of the broadest line of Mosfets. With over 225 device types in 11 package configurations currently available from Motorola.

B 1102 \$11.95

MOTOROLA 8-BIT MICROPROCESSORS AND PERIPHERALS

This manual covers all aspects of Motorola's microprocessor, microcomputer and peripheral components. A clearly written manual providing all the data necessary to design and build a working computer system from scratch. 100's of circuit examples, flow charts, truth tables and program routines.

B 1125 \$16.95



NATIONAL SEMICONDUCTOR

INTERFACE

This databook provides complete specifications for a variety of transmission line drivers/receivers, peripheral power drivers and level translators/buffers. Product selection guides list applications information and operating features. Memory, dynamic memory, microprocessor, data communications and disk support products are also covered in the data book. The interface appendices section contains cross reference guides, the programmable logic section describes the technology, design and gives application suggestions.

Pages: 1520 Year 1983

B 1005 \$13.50

5 Up \$12.00

DATA CONVERSION ACQUISITION DATABOOK

The 1984 edition of the Data Conversion/Acquisition Databook is one of the most comprehensive in the industry. It contains specifications for high technology conversion products in the analog signal path, both preceding and following the conversion process. Combining high volume production capability with leading edge technology such as thin film resistors, laser trimming and advanced micro-CMOS and bipolar processing, has helped develop products best suited to your design needs.

Pages: 1232 Year: 1984

B 1007 \$13.50

5 Up \$12.00

LINEAR DATABOOK

The 1982 edition of the National Semiconductor Linear Databook is the most comprehensive available. It presents approximately 2000 pages of specifications for our high-technology linear products. Applications, descriptions, features and diagrams in this databook include detailed sections for Voltage Regulators, Op Amps, Voltage Comparators, A to D, D to A Converters, Industrial Blocks and Audio and TV Circuits. The databook also features advanced telecommunication devices and speech synthesis (DIGITALKER), plus other non-state-of-the-art linear products offering performance, economy, quality and reliability.

Pages: 1952 Year: 1982

B 1010 \$15.00

5 Up \$14.00

LINEAR SUPPLEMENT

The 1984 Linear supplement provides the most recent information on National's new linear products. This supplement also provides a comprehensive index published in the Master Databook. New products designed are indicated by an Asterisk and in bold type. Revised data sheets are listed in bold type. National's supplement databook system allows you to make product selections of their latest product offerings.

Pages: 566 Year: 1984

B 1011 \$7.50

5 Up \$6.50

LOGIC DATABOOK

National's new Logic Databook covers five of their logic families: TTL (54/74), Schottky (54S/74S) low power, Schottky (54LS/74LS) high speed (54M/74M) and low power (54L/74L). The Logic Databook—specially organized for quick and easy referencing—offers two complete functional indices and selection guides, one for SSI and one for MSI devices. In addition, it includes over 100 connection diagrams and test waveforms to help speed the design-in cycle. All in all, it's probably the most comprehensive collection of practical information ever assembled on such a broad line of practical components.

Pages: 550 Year: 1981

B 1015 \$11.00

5 Up \$10.00

MOS MEMORY DATABOOK

The 1984 MOS Memory Databook is a comprehensive collection of information advanced, high-density memory products covering the spectrum of this mainstream semiconductor component category. National Semiconductor has an array of advanced technology processes to apply to memory design and development. These range from high-density triple-poly process used in the most advanced RAMs, the small-geometry, silicon gate, oxide-isolated micro-CMOS technology which is now being applied to high-performance memory devices for the first time.

Page: 256 Year: 1984

B 1025 \$7.50

5 Up \$6.50

HYBRID PRODUCTS DATABOOK

The Hybrid Products Databook is the only National Semiconductor publication that contains complete information on all our hybrid semiconductor products included are precision thin film and thick film products which provide the user with standard functions from operational amplifiers to converters with capabilities beyond those of current monolithic technology. Product selection guides and an application section are also included.

Pages: 792 Year: 1982

B 1045 \$9.95

5 Up \$9.25

TRANSISTOR DATABOOK

National Semiconductor has added many new transistors and product families since publication of the last databook. Many have already been widely acclaimed by users in addition to small-signal, power-bipolar and field effect transistors that have been the mainstay of our catalog, there is a section for multiple-field-effect transistors. More part numbers will be added as market needs expand. To keep current on all new National transistors, please contact your National sales representative or franchised distributor and ask to be placed on the customer mailing list.

Pages: 558 Year: 1982

B 1050 \$9.95

5 Up \$9.25

CMOS DATABOOK—1984

The CMOS Databook contains the industry's most comprehensive collection of high-performance CMOS products available. Our early commitment to micro-CMOS technology has made possible the development of a broad spectrum of advanced devices that will simplify your design and ensure state-of-the-art systems. Micro-CMOS technology describes National's array of small-geometry, silicon gate, oxide-isolated processes used to build the products in this book. Using N- or P- well substrates and multiple-layer metal or polysilicon-interconnect structures, micro CMOS processes feature sizes of 3.0, 2.0 or 1.5 microns, with submicron feature sizes in development.

Pages: 1520 Year: 1984

B 1030 \$13.50

5 Up \$12.00

VOLTAGE REGULATOR HANDBOOK

With the variety of fixed and variable regulator technology currently available, the 336 page Voltage Regulator Handbook becomes a must for the selection of three terminal and dual tracking semiconductor components that meet the system requirement while utilizing the most cost effective approach. Beginning with product selection procedure and a data sheet summary, the text continues with easily accessible information about booster circuitry, power transformer and filter specifications, test methods, manufacturer's cross reference, and extended use applications for National's regulators.

Page: 336 Year: 1982

B 1055 \$9.95

5 Up \$9.25

New PCB Mount Mains Transformers



7/9 VA Rating, Super Compact, wound on Grain Oriented Steel Core for High efficiency and low temperature rise.
Power Rating:
7VA Load Full voltage +3% - 0%
9VA Load Full voltage -6% to 8%

Call Us For Pinout PCB Spacing

Model	Prim/SEC's	1+2
M 7012	240/6+6	
M 7015	240/7.5+7.5	
M 7018	240/9+9	
M 7024	240/12+12	
M 7030	240/15+15	

Overall Height 35mm
Length 43mm
Width 36mm

1—9	\$9.80 ea
10—24	\$9.20 ea
25 Plus	\$8.40 ea

A Great Xmas Gift
Ideal for the Kids



Solar Energy Kit
Natty Solar Kit—Solar cell converts sunlight to electrical energy which in turn drives motor/propeller. Includes fantastic little booklet on Solar experimentation. Just the shot for school projects. Free energy from the sun. Educational — Great Fun.

A 0960 Only \$12.50

MOTOROLA BONUS OFFER SET OF 9 TITLES

B 9995 \$79
SAVE \$50

NATIONAL SEMI BONUS OFFER SET OF 10 TITLES

B 9996 \$79
SAVE \$32

Bonanza

Components and Products —
our Competitors prices.

cent until you get your statement next month!



Compliments
of the Season
Jack O'Donnell and Staff



Remember Altronics
Famous 14 Day Money Back
Satisfaction Guarantee



Only \$49.95

Check Appliances & Electrical Wiring

Build This 1000V Megohm Meter

(1985 Successor to the "Megger")
(See EA July '85)

There are many situations where a stringent test of insulation resistance is required. For example, whenever mains operated equipment is repaired or built, an insulation test between the active and neutral conductors and the case should be carried out. Similarly, it is a good idea to check for insulation breakdown whenever electrical wiring is installed. There are many circumstances in which a tester of this type can be used. Apart from the applications mentioned above, a megohm meter can be used to check the insulation between transformer windings and the frame. Insulation breakdowns in automotive alternators and generators can also be diagnosed. As well, rough checks of the leakage of high voltage capacitors can be made. It uses a transistor inverter to produce a regulated 1000V DC supply which is applied to the insulation under test. Insulation resistances between 2M Ohm and more than 2000 Ohm can be measured. Cat K 2550

Precision Electronic Fet Multimeter For Laboratory Or Workshop

* 10 Meg Ohm input * 12 Amp DC a- AC
Current Ranges * Centre zero Pointer
for + and - readings * Single Range
and Polarity Reversing switch * Power on
LED indicator * Transistor Tester Inbuilt * P-P
calibrated scale.

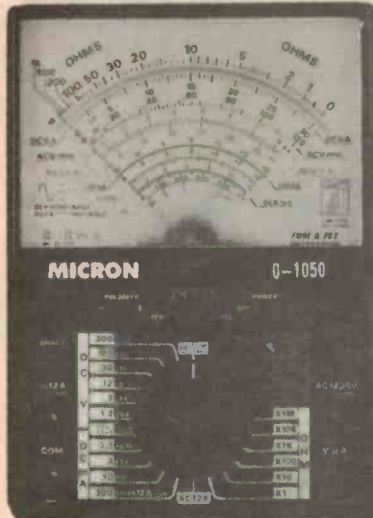

Centre Zero Pointer Setting
Allows + and - Readings
Q 1050 **\$59.50**

We're absolutely delighted with our new laboratory FET VOM. The Q 1050 breaks new ground for an advanced, precision analogue meter of this quality below \$100. The Q 1050 has the advantages of digital multimeters i.e. insignificant circuit loading, high accuracy etc. without the misleading and erroneous readings that DVM's are "famous" for.

DC VOLTS
Ranges—0-0.3, 1, 2, 12,
30, 120, 300, 1200V—0-
+0.15, 0.6, 6, 15, 60, 150,
600V at Centre 0.
Input Impedance—
Approx 10M Ohm, 3M
Ohm at 300mV range.
Rated Accuracy—2.5%
DC and 3.5% AC, full
scale on all ranges.

Rated Accuracy—50Hz
—5MHz + 3%—dB—
—10dB—+63dB at all AC
ranges.

DC CURRENT
Ranges—0-0.1 uA, 0.3, 3,
30, 300mA, 12A
Potential Drop—300mV
Rated Accuracy—Within + 2.5% full scale,
all ranges

AC CURRENT
Ranges—0-12A
DC RESISTANCE
Ranges—
Rx1 0-1K Ohm
Rx10 0-10K Ohm
Rx100 0-100K Ohm
Rx10K 0-10M Ohm
Rx1M 0-1000M Ohm

AC VOLTS
Ranges—RMS 0-3, 12,
30, 120, 300, 1200V—
Peak-peak 0-5, 4, 33, 84,
330, 840, 3300
Input Impedance—
Approx. 1M Ohm 80PF,
2.5M Ohm on 3V Range

Protect Your Family—Protect Your Home and Valuables.

MONA LISA BURGLAR ALARM ?

The Mona Lisa is recognised as a brilliant work of art. The Altronic wireless burglar alarm is too. Why? Can you imagine a burglar alarm that hangs on the wall like a painting? If not read on.

NO HASSLE HOME SECURITY

At last, A Home Security/Burglar Alarm that is comprehensive but a cinch to install!

- No Wiring!
- Virtually no extra hardware costs!
- No drilling holes through walls!
- Take it with you if you move.
- Don't pay \$500 plus in labour to install an inferior alarm when you can do it yourself for nothing!

Because the components of this system communicate by a UHF wireless link, ordinary messy wiring is eliminated. You simply place these units where they are needed. Its as simple as that.

Full Security The Altronic Security System consists of Door and Window entry detectors, Infra Red movement detector, 4 zone Main Control Box, Alarm Siren and Pocket remote controller. All detectors are battery operated and can stick to the wall with double sided tape. The system can be set for "Home" perimeter detection only (protecting door and windows) thus allowing you or the kids to move about the house or "Away" where internal movement detector is also armed. A brief description of each unit appears below.

Main Control Unit The heart of the system. Locate in laundry, pantry cupboard or anywhere convenient to a power point. Accepts signals from the various detectors. Can be operated by remote control unit. **CAT S 5210 \$299**



CAT S 5230
\$49.50

Remote Control This unit is just like the remote controller on your Video Player. You use it to turn the alarm on when leaving home and off when entering. Keep it on your bedside table to alarm the system when you retire. It also operates as a panic switch so even if you suspect a prowler you can activate the Siren even if the power is turned off. Smaller than a packet of cigarettes.



Alarm Siren It's the unit that alerts the neighbours if a breakin occurs. Automatically mutes after pre determined period.
CAT S 5250 \$99.00



Easy to Install
(Mum can do it)

Door/Window Detector

Your first line of protection: They simply stick on to the door or window frame with double sided tape. They send a signal to the control box if an unauthorised door or window is opened. (Extra Units Available).
CAT S 5220 \$49.50

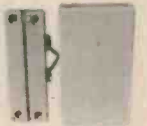

Movement Detector

This unit actually detects human body movement in daylight or dark. You position this unit on a wall, or shelving unit, say, facing your Video or Hi-Fi gear. It is your second line of defense. (Extra Units Available).
CAT S 5240 \$99.00



SPECIAL PACKAGE DEAL

(Suits Normal Dwelling or Medium Business Office)

Main Control	\$299.00
Remote Control Unit	\$49.50
Door/Window Detector	
2 of @ \$49.50	\$99.00
Movement Detector	\$99.00
Alarm Siren	\$99.00
Normally	\$646.50

Buy the
Whole System
for Only **\$599**

Battery Backup In case of Mains Power Failure

Both the Main Controller and Alarm Siren can be fitted with rechargeable batteries permitting normal operation independent of Mains Power.

CAT S 5065 **\$22.95 ea.**

Each of the detectors require standard 9V transistor battery. CAT S 5009 **.85¢ ea.**

See Detailed System Review by Roger Harrison, Editor Australian Electronics Monthly Magazine July 1985.
Excerpt "The Passive Infra Red Detector is a remarkable piece of Modern Electronic Technology"
R.Harrison A.E.M.

FOR NEXT DAY JETSERVICE DELIVERY
BANKCARD HOLDERS—PHONE ALTRONICS TOLL FREE 008 • 999 • 007

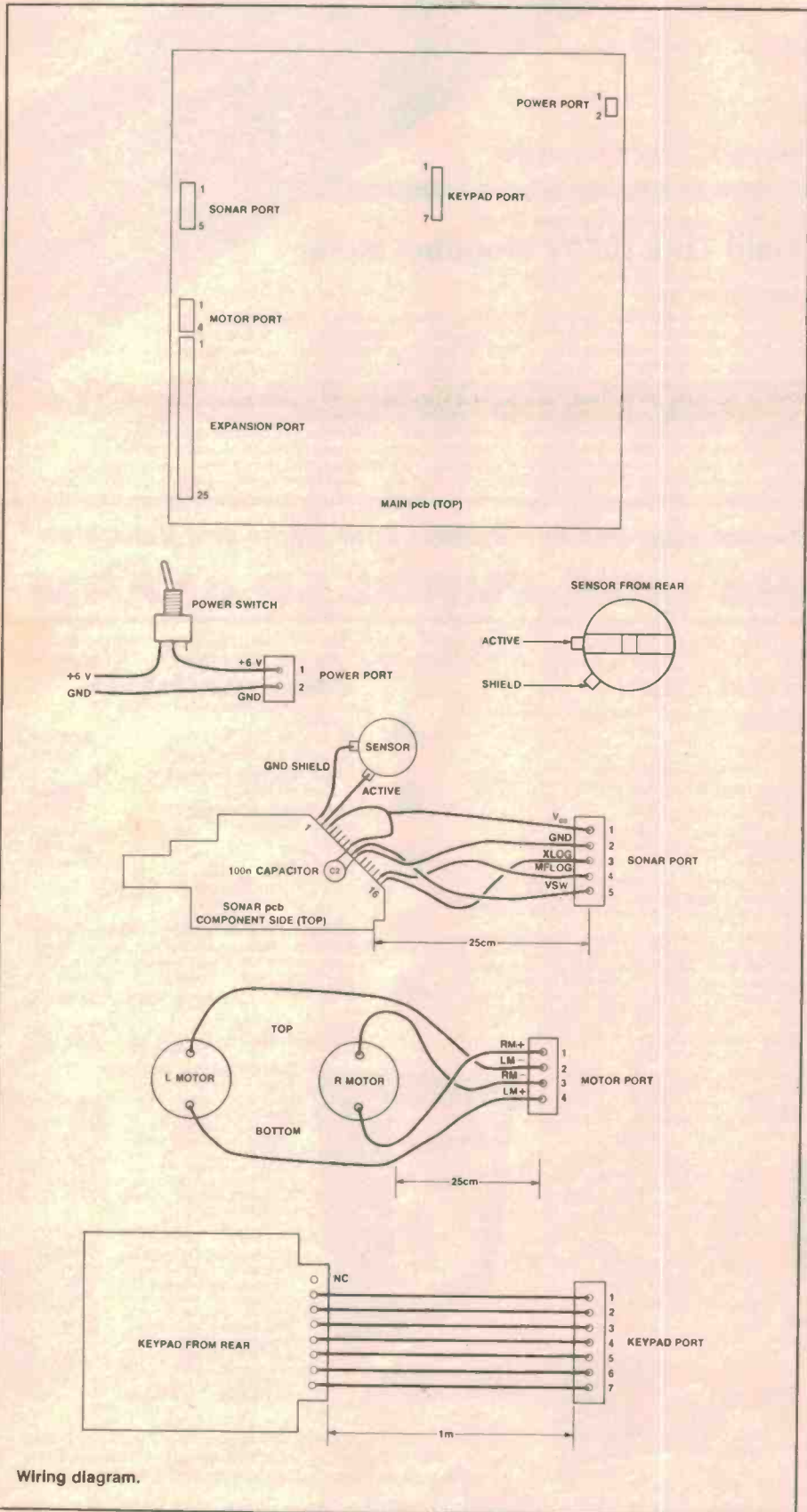

Wiring diagram.

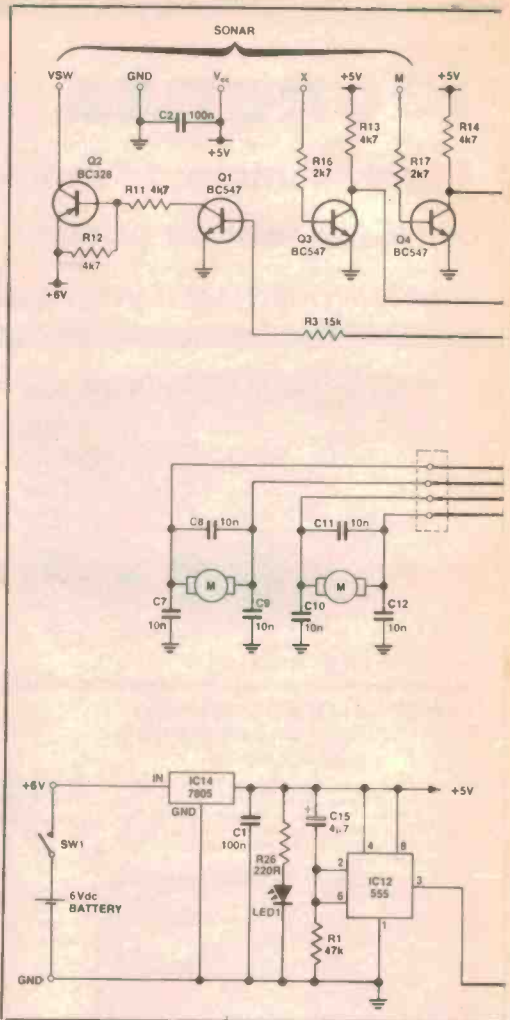

HOW IT WORKS — ETI-664

On power up capacitor C15 brings V_{cc} (5 V) to pins 2 and 6 of the '555 timer (IC12). This condition keeps the timer output pin 3 low. The low signal resets the CPU (IC2) and the PIA (IC1) on power up. As C15 gradually discharges through R1, pin 2 of IC12 goes low and a high is generated on pin 3 of IC12, allowing the CPU and the PIA to come out of the reset condition simultaneously. The CPU will output addresses FFFF, FFFE (in HEX) to fetch the reset jump vector stored in the EPROM (IC3) where the starting address of the control program is stored, allowing the controls to start to execute the instructions.

IC1, the 6821 PIA is responsible for communicating with the controller (basically IC1, IC2, IC3, IC4, IC7) and with the peripherals. Seven bits of port B (PB1-PB7) of the PIA are dedicated to the 4 x 3 matrix keypad. With the help of IC13, the two motors could be controlled by just three lines from the PIA. Six bits (PA2-PA7) from port A are used to check the output of a counter, which starts counting once a pulse is sent to enable the sonar. The reflected ultrasonic echo generates a transition to CA1 (pin 40 of IC1). The PIA is programmed to trigger an interrupt to the CPU whenever an edge is detected by CA1. The same transition also stops the counter and the value of the delay time (hence the distance) is directly available to PA2 to PA7. The interrupt routine will scan the value and react accordingly.

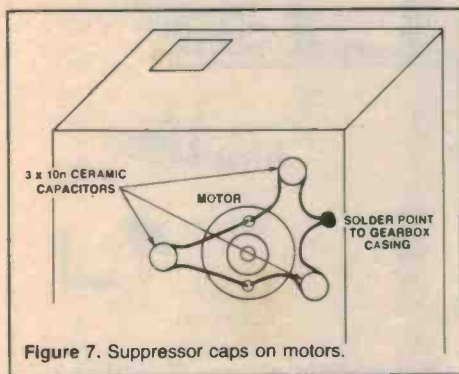
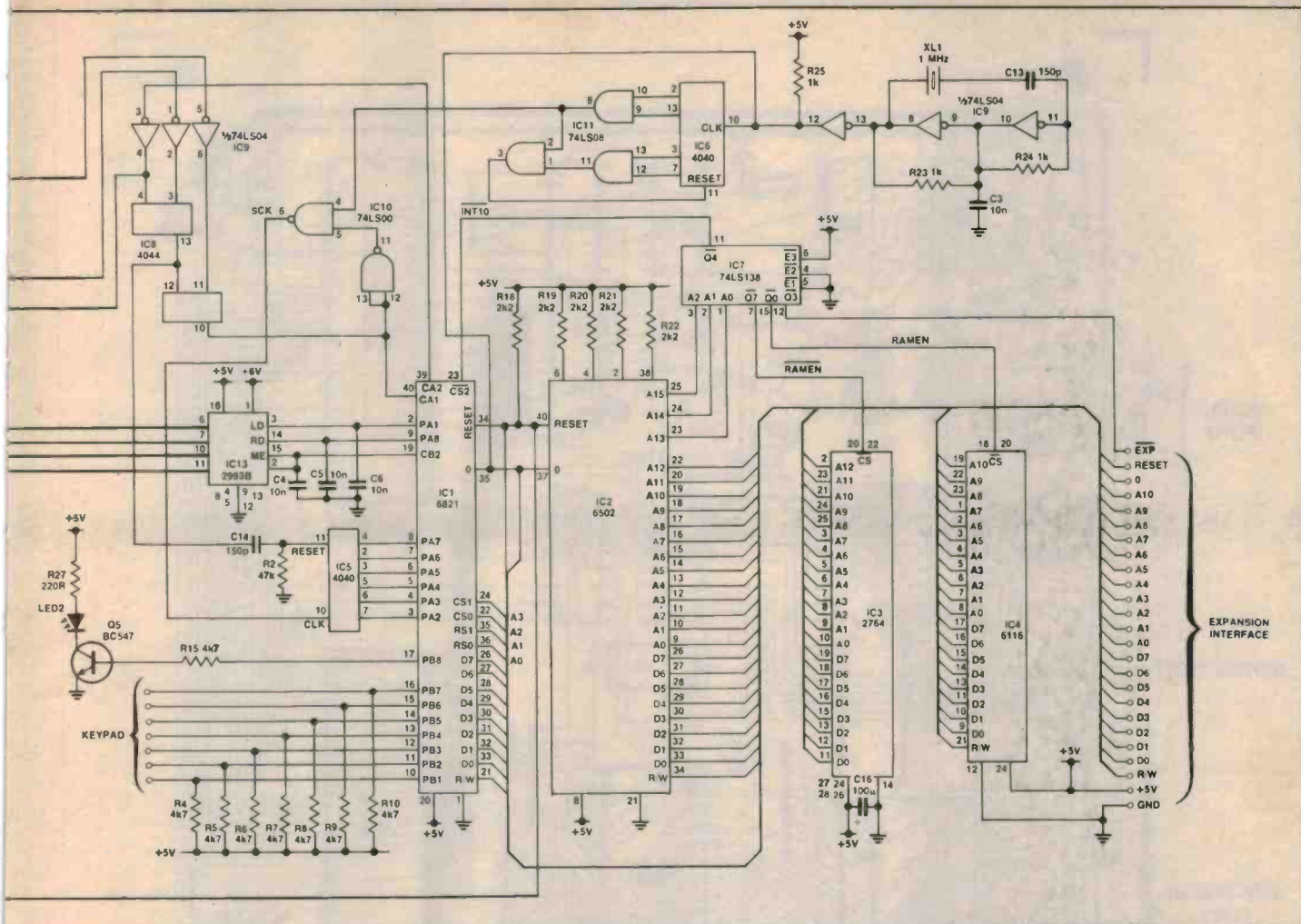
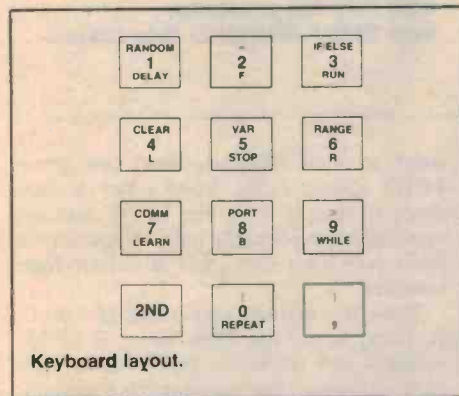

Figure 7. Suppressor caps on motors.



Keyboard layout.

cm. Strip, then tin each strand at both ends and pass them through the strain relief holes on the main pcb, from the bottom. Solder them to the corresponding donuts on the pcb. The other end of each cable will be soldered to the sonar pcb and the keypad according to the wiring diagram.

When connecting the five strand cable (25 cm long) to the sonar pcb, solder to the top of the designated pins on the angled edge of the odd-shaped sonar pcb. Pins 3 and 8 are joined with a short jumper and then a 0.1 μ F ceramic capacitor is soldered across the Vcc and ground pins on the pcb itself.

Connect the battery wires (the heavier cable) to the switch and power port of the pcb as shown (in the diagram) and then connect the motors to the motor port. Figure 7 shows how to connect the three suppressor capacitors at each motor by soldering across the motor lugs and to the gearbox.

Don't be anxious to turn on the power to the main pcb yet as it is possible to damage the sonar pcb if everything is not connected correctly. Wait until the final checklist is completed.

You should now have the main pcb ready to mount on the robot frame. The

board will fit neatly into the base between brackets 1a and 1b at the end away from the castor. Before mounting the pcb, route the cables for the power, keypad, sonar and motors as shown in the diagram.

Mount the main pcb (using three screws, washer, nuts and insulating spacer), then solder the motor wires to the motors. Place the power switch in position at the rear of the frame in the hole provided on bracket 4. Unfortunately the sonar pc board comes as a package with the transducer and has only one decent mounting hole. Enlarge the small hole near the connector on the sonar board and mount the board on plastic standoffs near the robot's left hand gearbox.

Use the Velcro to attach your keypad to a convenient place on the robot's top frame and label the keys using the keypad cut-outs. Finally, connect the sensor to the sonar pcb and the power leads to the battery.

Test and start-up

By now the main pcb should have four cables emanating from each of the power, keypad, motor and sonar ports. The main pc board and sonar pc board should be separated from the aluminium frame by

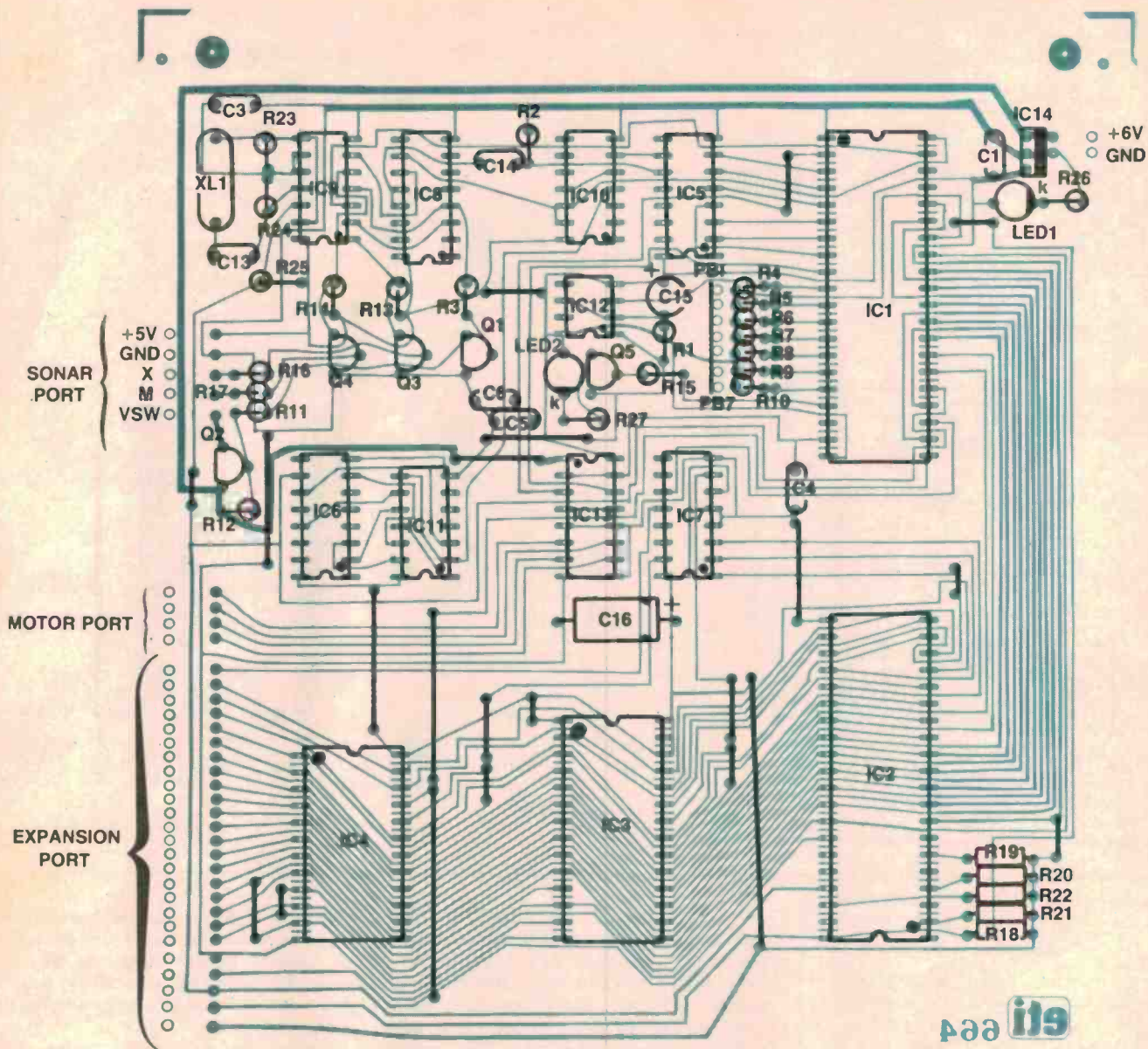

NOTES: C2 IS SOLDERED ON TO SONAR BOARD OUTPUT

C7,8,9,10,11,12 ARE SOLDERED ON TO THE MOTORS AND GEARBOXES

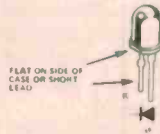

For a guide to components and kits for projects, see SHOPAROUND this issue.

four insulating spacers. The shielded cable should be connected securely between the sensor and the sonar pcb. The power leads should be correctly oriented, with the positive (+) lead going from the battery to the switch to the main pcb.

When you are sure these details are taken care of, you are ready to try it out. Remove each of the four main semi-conductors from their sockets. Turn on the

power switch — the red LED1 should glow instantly. If not, check the power leads to the board and ensure your batteries are not discharged. If the green LED2 came on, the red LED1 is probably in the wrong way.

If all is well, turn the power off and replace the semiconductors. Turn on the power again. This time after the red LED1 goes on, the robot should jump for-

ward a short distance then the green LED2 should light. Your robot is now ready to test. If the green LED2 does not come on, you probably have a fault on the main pcb since this LED is driven from software.

Press the manual commands (F, B, L, R, Stop) to see the robot move. If the directions and responses don't match, you have connected the motor wires incorrect-

hobbybot robot

CHASSIS PARTS

Brackets 1a, 1b

2 pieces x 460 mm long
To fix to gearbox:
2 short screws
2 flat washers
2 star washers
2 nuts

Brackets 2a, 2b

2 pieces x 460 mm long
To fix to gearbox:
2 long screws
4 flat washers
2 star washers
2 nuts

Brackets 3a, 3b

2 pieces x 317 mm long
To fix to brackets 1a, 1b:
4 screws
4 flat washers
4 star washers
4 nuts

To attach castor:

2 screws
2 flat washers
2 star washers
2 nuts

Bracket 4a, 4b

2 pieces x 317 mm long
To fix to brackets 5a, 5b, 5c, 5d:
4 screws
4 flat washers
4 star washers
4 nuts

To fix to brackets 2a, 2b:

4 screws
4 flat washers
4 star washers
4 nuts

Brackets 5a, 5b, 5c, 5d

4 pieces x 106 mm long
To fix to brackets 3a, 3b:
4 screws
4 flat washers
4 star washers
4 nuts

Brackets 6a, 6b

2 pieces x 382 mm long
To fix to brackets 2a, 2b:
4 screws
4 flat washers
4 star washers
4 nuts

Bracket 7

1 piece x 366 mm long
To fix to brackets 6a, 6b:
2 screws
2 flat washers
2 star washers
2 nuts

Bracket 8

1 piece x 70 mm
To fix to bracket 7:
2 screws
2 flat washers
2 star washers
2 nuts

PARTS LIST — ETI-664

Resistors.....all ¼ W, 5% unless noted

R1, 2.....47k
R3.....15k
R4-15.....4k7
R16, 17.....2k7
R18-22.....2k2
R23-25.....1k
R26, 27.....220R

Capacitors

C1, 2.....100n ceramic
C3-12.....10n ceramic
C13, 14.....150p ceramic
C15.....4µ7 electro
C16.....100µ electro

Semiconductors

LED1.....red 5 mm
LED2.....green 5 mm
Q1, 3, 4, 5.....BC547
Q2.....BC328
IC1.....6821 PIA
IC2.....6502 microprocessor
IC3.....2764 EPROM
IC4.....6116 static RAM
IC5, 6.....4040
IC7.....74LS138
IC8.....4044
IC9.....74LS04
IC10.....74LS00
IC11.....74LS08

IC12.....LM555
IC13.....UDN 2993B
IC14.....7805
XL1.....1 MHz crystal

Miscellaneous

SW1.....SPST toggle
Frame.....4 x 460 mm
 2 x 382 mm
 1 x 366 mm } aluminium
 4 x 317 mm } angle
 4 x 106 mm
 1 x 70 mm

Cable.....1 m 12 strand ribbon
 500 mm powerflex
 200 mm single shielded flex

Sockets.....2 x 40 pin sockets
 1 x 28 pin sockets
 1 x 24 pin sockets

Screws, etc.....26 x ½" x ⅛"
 8 x ¾" x ⅛"
 38 x flat washers
 34 x star washers
 4 x spacers

TI sonar pc board; ETI-664 main pc board; sonar sensor; keypad; 2 wheels; castor; 3 cm Velcro; 8 cm x 5 mm copper strip; 2 gearboxes.

Price estimate: \$337

FLUKE 70 SERIES LOW COST ANALOG/DIGITAL MULTIMETERS —

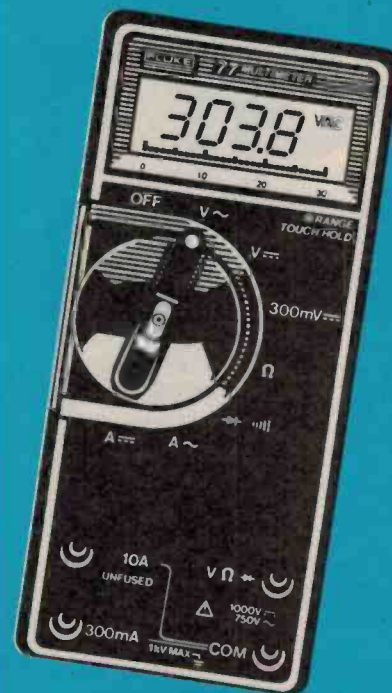

YOUR FIRST CHOICE FOR FEATURES, QUALITY & VALUE

FLUKE 73

Analog/digital display
Volts, ohms, 10A, diode test
Autorange
0.7% basic dc accuracy
2000+ hour battery life
3-year warranty

FLUKE 75

Analog/digital display
Volts, ohms, 10A, mA, diode test
Audible continuity
Autorange/range hold
0.5% basic dc accuracy
2000+ hour battery life
3-year warranty

FLUKE 77

Analog/digital display
Volts, ohms, 10A, mA, diode test
Audible continuity
"Touch Hold" ** function
Autorange/range hold
0.3% basic dc accuracy
2000+ hour battery life
3-year warranty
Multipurpose holster

FROM THE WORLD LEADER
IN DIGITAL MULTIMETERS.



See the 70 Series at leading electronics stores or contact us for data

ELMEASCO Instruments Pty. Ltd.

NEW SOUTH WALES VICTORIA

15 McDonald Street,
MORTLAKE
P.O. Box 30, CONCORD
NSW 2137
Tel: (02) 736 2888
Telex: AA25687

12 Maroondah Highway,
RINGWOOD
P.O. Box 623, RINGWOOD
VIC 3134
Tel: (03) 879 2322
Tele: AA30418, ELTENT

QUEENSLAND

Tel: (07) 369 8688
S AUSTRALIA
Tel: (08) 344 9000
W AUSTRALIA
Tel: (09) 481 1500

ly. Now press LEARN 1. The green light should go out indicating that the robot is in learn mode. Press F2, B2 then press COMM. (COMM is a 2ND key-function and you need to press the 2ND button then the COMM button. This is similar to a shift function except after the COMM button is pressed, the keypad is back to the 1ST key-functions again.)

When COMM is pressed, the green

light should come back on. Now press RUN 1. Your simple program F2, B2 should be executing.

If at any time the green LED2 starts to flash you have made a keypad error and need to press CLEAR before continuing (remember 2ND then CLEAR).

Your Hobbybot is now ready for you to program fully. Watch out for next month's ETI for complete details of the software! ●

FAX/RTTY DECODER FOR THE CAT COMPUTER

Part 1

Design by Andrew Keir, VK2XKK
Dick Smith Electronics

Development by Robert Irwin

If you own a Cat computer you can soon be listening in on the airwaves with this simple-to-construct decoder.

IT SEEMS THAT a plethora of signals crowd the airwaves these days, not all of them particularly interesting or, in fact, very accessible to the casual electromagnetic browser. Lately, though, with the advent of cheap computing power many amateurs are finding a worthwhile distraction in the reception and decoding of FAX and RTTY transmissions. Many of you will already be familiar with these terms but for those who aren't, here's a quick introduction.

The facts on FAX

Facsimile (FAX) transmission has been used for many years as a method of getting picture information from one place to an-

other by radio. The system can essentially be thought of as being like a very slow television. The picture to be transmitted is scanned by a FAX 'camera' *ver-r-r-y-y-y slo-o-o-w-w-w-ly*, one line at a time. This slow scan speed is necessary to keep the bandwidth down so that the information can be squeezed through a telephone line or radio transmitter. At the receiver end the picture is reconstituted, either photographically or by a printer, and voila! — picture perfect, or so you hope.

The above is a decidedly simplistic view of the whole affair and many problems need to be overcome to implement the system. Figure 1 shows a basic analogue FAX system which uses optical scanning and receiv-

ing elements. For a system such as this, two problems become immediately obvious. Firstly, the speed of rotation of the two drums needs to be the same otherwise the picture will be distorted. Secondly, the line scan for both the transmitter and receiver must start from the same place otherwise the picture will be a mess (like when your television loses horizontal sync).

The problem of getting both the send and receive scans to start at the same time can be overcome by using 'phasing pulses'. Before the start of a picture, a series of pulses is sent by the transmitter. One pulse is sent for each line and the end of each pulse marks the start of a new line. This enables the receiver to lock on and adjust itself to start a new line in sync with the phasing pulses. Usually about 30 seconds of phasing pulses are sent prior to a picture being sent.

The problem of getting the drums rotating at the same speed has been overcome in a number of ways. One simple method that can be used if both the transmitter and receiver are running from the same power grid is the use of synchronous motors, but this is not generally applicable. A better method is to use crystal oscillators to set the speed of rotation. With this method accuracies to 0.001% can be achieved independent of the local power supply and good FAX pictures will result.

RTTY

Radioteletype (RTTY, pronounced 'ritty' by its friends) is used to send written information over the airwaves. Traditionally, the five level Baudot code has been used for this type of transmission but an ASCII code is also occasionally used. For most people radioteletype conjures up the image of clattering mechanical-monster, typewriter-like objects sitting in the office corner spewing out reams of typed copy. Although by no means an extinct race, these old teletype machines have by and large been ousted by the quieter and more streamlined computer terminal.

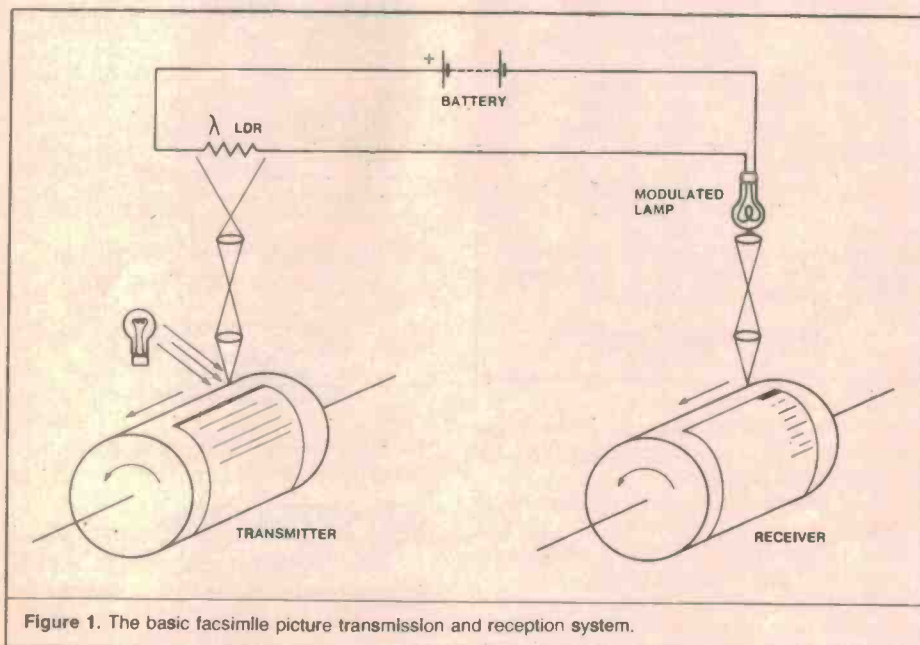
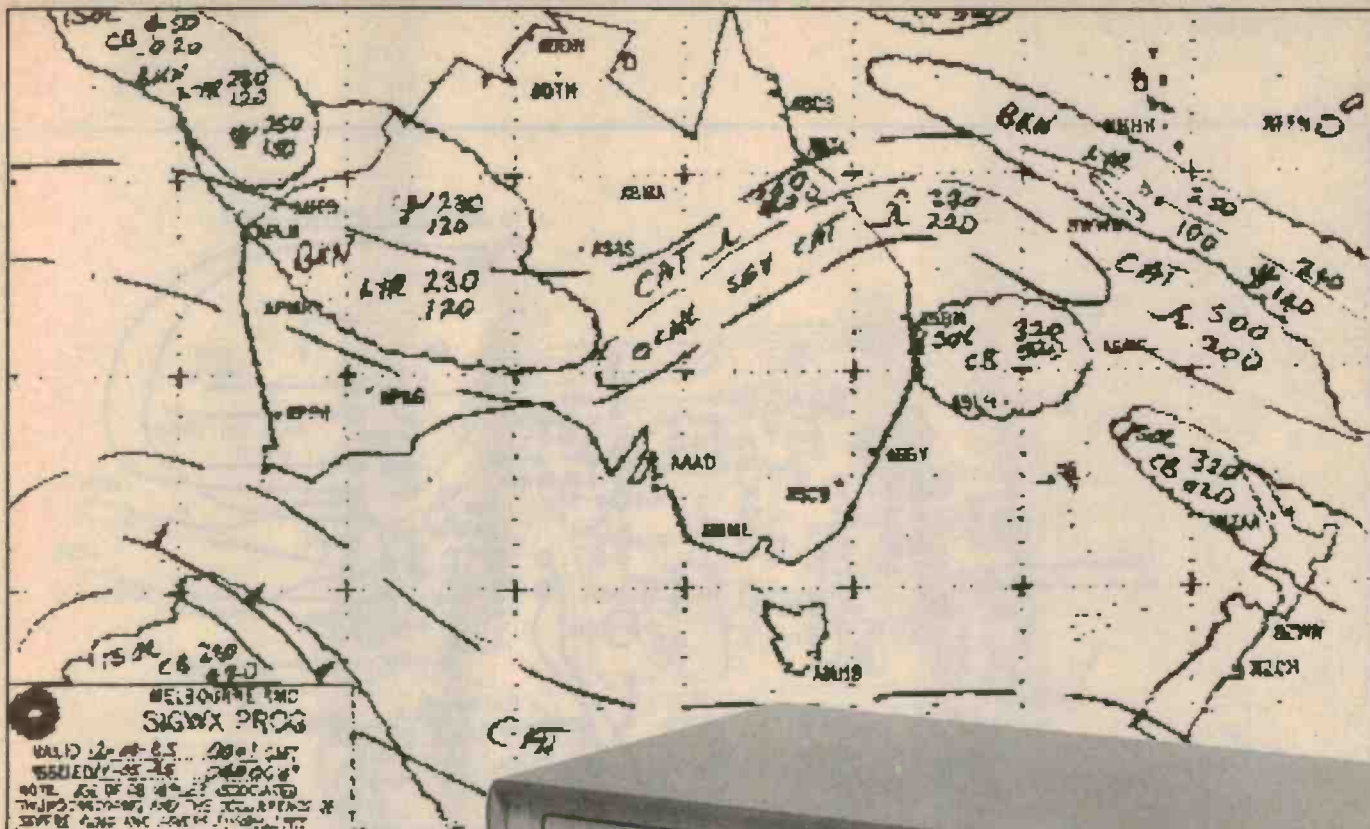

Figure 1. The basic facsimile picture transmission and reception system.



Typical aircraft weather map transmissions from AXM. (Cat here stands for 'clear air turbulence'.)

Station AXM

Now you know what FAX and RTTY are, but who uses them? In Australia one major user is station AXM. This station is run by the Bureau of Meteorology, using transmitters located in Canberra and transmitting on several frequencies, the most reliable of which is 5.1 MHz. (11.03, 13.92 and 19.69 MHz are also used.) AXM divides its transmissions into half-hour sections. From the hour to half past the hour RTTY is broadcast, and for the other half hour FAX pictures are broadcast. The FAX pictures are usually weather maps or the like, and satellite picture information is also broadcast. The RTTY will be some sort of meteorological data although other messages appear at times.

The Cat RTTY/FAX decoder

Although many RTTY and FAX projects have appeared in the past, the ETI-757 combines both decoders in the one package. In fact, only the one decoder is needed as FAX and RTTY are both transmitted using frequency shift keying (FSK). This is a method of transmitting digital signals by shifting between two frequencies, one of which represents a logic high and the other a logic low. The usual separation of frequencies is 800 Hz although many other standards are used.

The ETI-757 has been designed primarily around station AXM and so uses its transmissions as a standard. The decoder uses a crystal oscillator as a stable reference and,

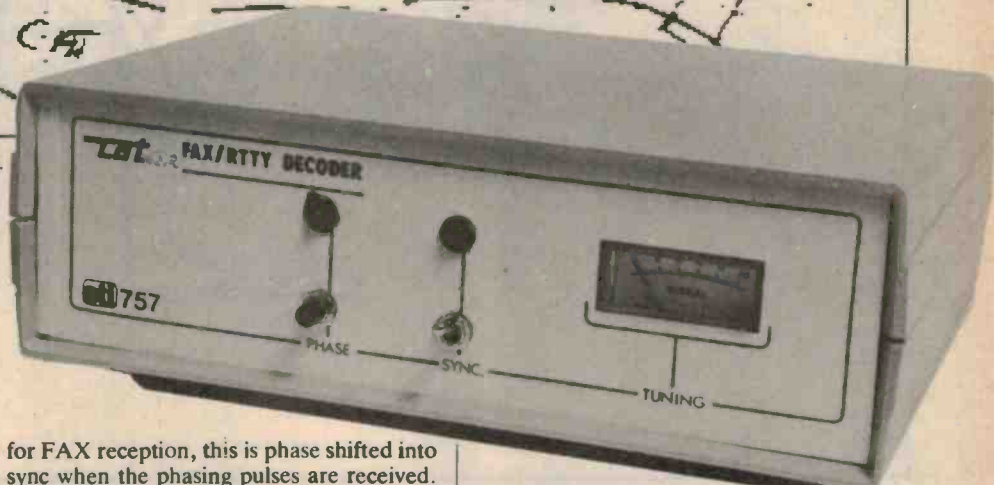

for FAX reception, this is phase shifted into sync when the phasing pulses are received. This has the advantages of simplicity and stability but means that a picture must be received right from the start. If you miss the phasing pulses then you'll have to wait for the next picture. Once synchronised, each bit is stored in consecutive memory locations in the computer from 2480 HEX to 8FFF HEX. To conserve memory and allow the printer to cope, every three lines are ANDed together and stored as one composite line. A usual picture contains about 1000 transmitted lines and, at a scan rate of 120 lines per minute and with phasing pulses, this would take about 10 minutes to transmit. Once collected the picture can be dumped to the printer or stored on a disk for later printout. When in the FAX data collection subroutine the computer won't be able to talk to the printer so you will have to wait till the whole picture is collected before you can see what you have got.

As mentioned previously RTTY is transmitted using a similar FSK method, the difference being that the information is sent in the form of binary 'words'. AXM transmits using a five level Baudot code consisting of

a start bit, five data bits and an extended stop bit which is 1.5 times the length of the other bits. The long stop bit is used to tell the computer that the next bit will be a start bit. The five data bits are decoded to an ASCII equivalent and displayed on the screen.

Construction

The construction of this project is very straightforward. Start with the pc board. Before you go soldering in components give the board a good visual check to make sure that there are no broken or shorted tracks. Once you have done that, refer to the overlay diagram and locate and solder in the 12 wire links. These can be made from any stray pieces of tinned copper wire you have lying around (the remains of trimmed component legs are ideal).

Next, solder in all the resistors and capacitors. Be careful with the electrolytic capacitors as these are polarised and need to be put in the correct way round. The four diodes should go in next, followed by the four transistors. These must also be put in ▶

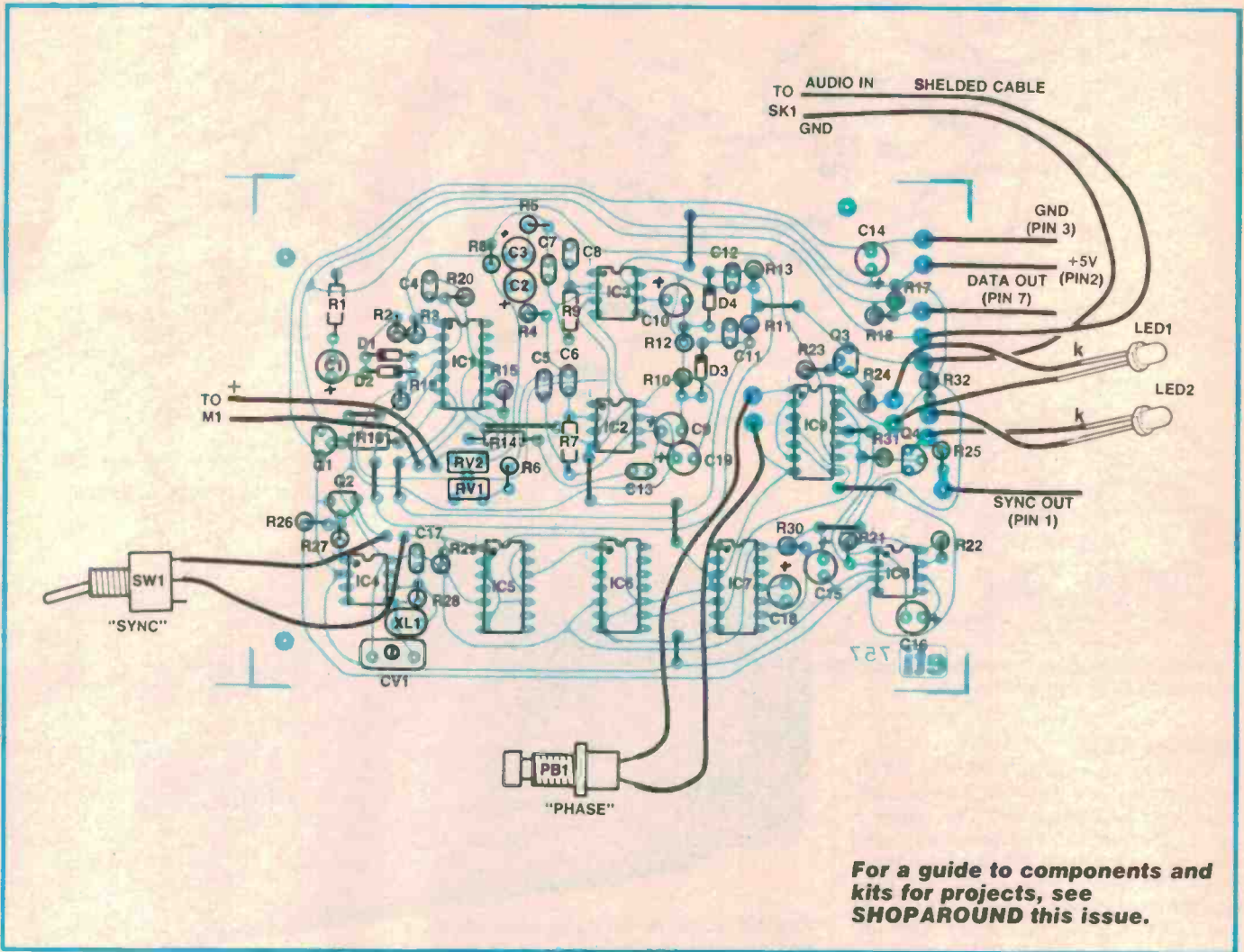

MICROMASTER—Simply Brilliant

MicroMaster is a new single board computer with more features and higher performance than previously thought possible in a board of this size. Based on the STD bus, it is possible to expand the MicroMaster into an extremely powerful multi-user system with hard disks. A friendly user interface and performance benefits are provided by a CP/M compatible operating system with MSDOS and UNIX—like features.

Features

- High performance microcoded CPU with pipelining
- Z-80 compatible but faster
- up to 512K bytes RAM with MMU
- monitor/boot PROM in 2732-27256
- two DMA channels for fast data transfers
- two 16-bit counter-timer channels
- 12 level interrupt controller
- two RS232 serial ports with on-board drivers
- Centronics parallel port
- Floppy disk controller for 3½, 5¼, 8-inch drives
- Support for new dual speed 5¼-inch drives
- Compatible with CP/M, Z-System, CP/M3, TurboDOS
- Full 12 months warranty.



\$750

(plus sales tax)

For more information or to place orders(!) contact:

Microtrix Pty. Ltd. 24 Bridge Street, Eltham, Vic., 3095. Ph. (03) 439 5155



Distributor and OEM enquiries welcome.

Microtrix

PARTS LIST — ETI-757

Resistors

R1, 10, 12, 15,	
21, 29, 30.....	10k
R2, 19, 20.....	1k
R3, 16, 17, 23,	
26, 27, 31.....	4k7
R4, 5.....	3k3
R6.....	390R
R7, 9.....	120k
R8, 24, 32.....	470R
R11, 13.....	180k
R14.....	27k
R18, 25.....	100R
R22.....	270k
R28.....	1M
RV1, 2.....	1k min trim

Capacitors

C1, 2, 3, 9, 10,	
16, 18, 19.....	1µ 25 V RB electro
C4, 7, 8, 11, 12,	
13.....	10n greencap
C5, 6.....	6n8 greencap
C14.....	220µ 25 V RB electro
C15.....	10µ 25 V RB electro
C17.....	47p ceramic
CV1.....	6p36 trimmer

Semiconductors

IC1.....	LM324
IC2, 3.....	TLC251
IC4.....	MM5369
IC5.....	74LS90
IC6.....	74LS92
IC7.....	74121
IC8.....	TLC555 CMOS timer
IC9.....	74LS00
Q1, 2, 3, 4.....	BC548
D1, 2, 3, 4.....	OA91
LED1, 2.....	5 mm red LED

Miscellaneous

XL1.....	3.579545 MHz crystal
PB1.....	SP momentary action pushbutton
SW1.....	SPDT toggle
SK1.....	3.5 mm mono socket
M1.....	signal strength panel meter

ETI-757 pc board; Scotchcal front and back panel; 2 x 5 mm LED mounting grommet; 3 self tapping screws; 1 m x 4-core insulated cable; DB9 male plug; 100 mm shielded cable; 200 x 160 x 70 mm plastic instrument case; assorted hookup wire.

Price estimate: \$65

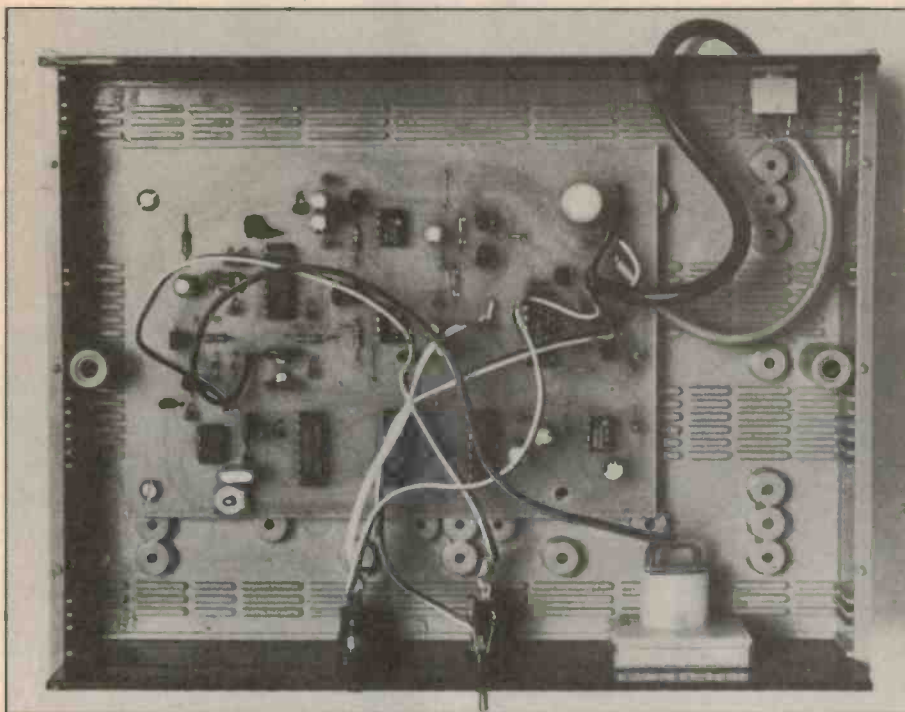

the correct way round. Solder the crystal in next and, if you haven't already done so, the trimpots and trimmer cap.

The only remaining components to put in are the ICs. If you wish you can use IC sockets, if not, be careful not to apply too much heat to the IC pins. Double check that the ICs are in the correct way round before soldering them in.

The next step is to solder about 150 mm lengths of hookup wire to the LED, switch and meter connection points on the board. A 100 mm length of shielded cable should be attached to the audio input pads. The connection to the DB9 plug for the computer interface was made on the prototype

using 4-core insulated cable. A suitable length (about a metre) should be cut and soldered to the four contact points on the pc board.

You are now ready to attack the case. The pc board has three mounting holes spaced to fit the specified plastic instrument case, so it is advisable to use this type of case. Unscrew the lid and be careful not to lose the screws. The front and back panels should slide out.

The first thing you should do is mark out and drill the holes for the two LEDs and the two switches on the front panel. The easiest way to do this is to use the front panel artwork as a template. Next cut the hole for

FLUKE 80TK CONVERTS YOUR DIGITAL MULTIMETER INTO A K-TYPE THERMOCOUPLE THERMOMETER

80TK SPECIFICATIONS

Temperature Measurement Range	
-50 to 1000°C	
-58 to 1832°F	
Battery Life: 1600 Hours (9V)	



First there was the 70 Series, which set a new standard for low-cost, high-performance, Fluke-quality multimeters.

And now, another first. The Fluke 80TK K-type Thermocouple Converter. A temperature measurement device that adds instant temperature measurement capabilities to the 70 Series DMMs.

Or any DMM, for that matter.

Feature for feature, the versatile 80TK is the most affordable unit of its kind. For quick comparison readings, it can measure °C or °F at the flick of a switch. It includes a built-in battery test. And the availability of 3 Fluke probes give you the flexibility to measure any form of temperature, from freezer to furnace, with just one base unit.

No other thermocouple converter we know of offers DMM users so much for so little.

The 80TK is just one of a range of accessories available for your multimeter including high voltage and current probes, rf and other temperature probes. A detailed catalogue is available from

ELMEASCO
Instruments Pty. Ltd.

NEW SOUTH WALES VICTORIA	QUEENSLAND
15 McDonald Street.	12 Maroonah Highway.
MORTLAKE	RINGWOOD
P.O. Box 30 CONCORD	P.O. Box 623, RINGWOOD
NSW 2137	VIC 3134
Tel: (02) 736 2888	Tel: (03) 879 2322
Telex: AA25887	Telex: AA30418 ELTENT
	S AUSTRALIA
	Tel (08) 344 9000
	W AUSTRALIA
	Tel (09) 481 1500

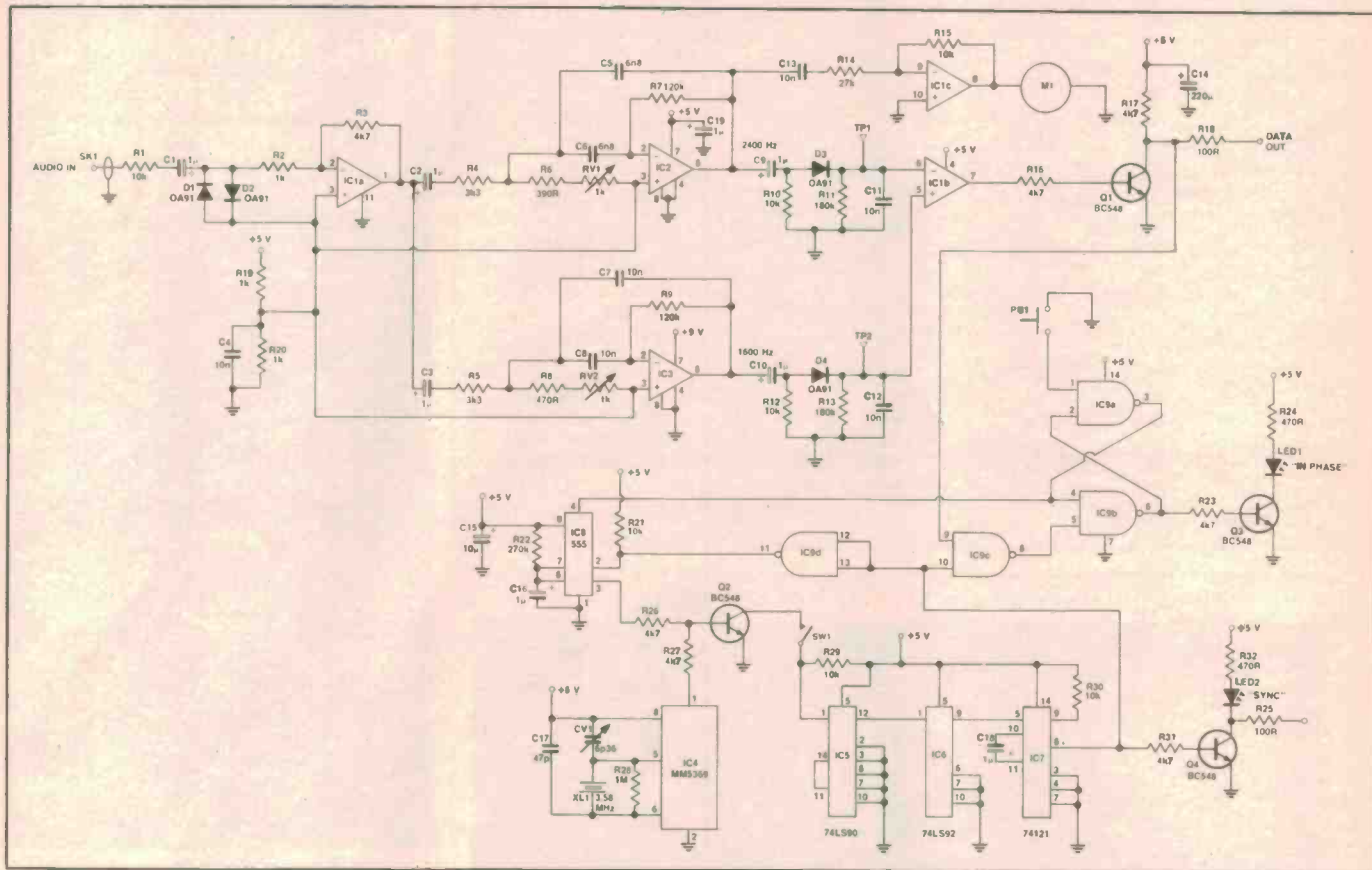

HOW IT WORKS — ETI-757

The audio input from the radio receiver ETI-757 is fed into the decoder through SK1 and is ac coupled by R1 and C1. A pair of back-to-back diodes, D1 and D2, limit the input voltage to a maximum of 0.6 V peak. The signal is then fed to a buffer amp formed by IC1a. This is connected to an inverting amplifier stage with a gain given by:

$$A_v = -R3/R2$$

which is -4.7 with the values given. Since only a single supply is used, R19 and R20 act to bias the output of IC1a to half the supply voltage with C4 filtering out any noise.

The output from the buffer is then fed to two bandpass filter stages. IC2 and the associated components form a multiple feedback bandpass filter centred on 2400 Hz with a Q of about 5. The second filter is formed by IC3 and associated components and is centred on 1600 Hz. RV1 and RV2 vary the high and low respectively over a range of about 400 Hz.

The output from each filter is rectified by D3 and D4, filtered by C11 and C12, then fed to a comparator formed by IC3b. The dc level from the 2400 Hz filter is fed to the inverting input and the dc level from the 1600 Hz filter to the non-inverting input. This means that when a 2400 Hz tone is received, for instance, the level on the inverting input will be greater than that on the non-inverting input so the output will be driven low. In a similar way, if a

1600 Hz tone is received the output will be driven high. The comparator, therefore, performs the task of transforming the FSK input signals to high or low digital pulses. The output of the comparator is buffered by Q1 which drives the computer data input terminal.

The output of the 2400 Hz filter (IC2) is also fed via C13 to IC1c which acts as a buffer to drive the signal strength meter, M1. The gain of the buffer is given by:

$$A_v = -R15/R14$$

If you wish to change the sensitivity of the meter you can vary R15 to give a proportional change in the gain of the buffer.

SYNC GENERATOR

The remaining circuitry is dedicated to synchronising the decoder with the FAX phasing pulses. IC4 is a divider chip that divides down the 3.58 MHz from the crystal, XL1, to 60 Hz. When the 'sync' switch is in, the 60 Hz signal is then divided by 10 by IC5, a 74LS90 binary counter. The 6 Hz signal is then finally divided by 3 by the 74LS93 (IC6) to obtain a 2 Hz square wave signal. IC7 is a 74121 monostable configured to give a short 5 ms pulse on the positive going edge of the 2 Hz input. The output of the monostable is buffered by Q4 before being sent to the computer via the 'sync out' line.

To bring the sync pulses into line with the incoming phasing pulses, IC8 is configured as a monostable, the output of which is fed to the base of Q2. The sync pulse from IC7 is inverted by IC9d and then sent to the trigger of IC8, therefore every time a sync pulse occurs IC8 will give a 200 ms pulse to the base of Q2 which will effectively halt the count of IC5 and IC6 for that period. This will result in the next sync pulse being delayed.

To detect when the sync pulses and the phasing pulses are in synchronisation an RS flip-flop, formed by the cross-coupled NAND gates of IC9a and IC9b, is used. When the 'phase' pushbutton is pressed, the flip-flop is reset and pin 4 of IC8 goes high enabling the mono. The data output and the sync pulses are NANDed together via IC9c. The phasing pulse sent prior to a picture consists of low tone with a short burst of high tone at the end of every line. On the data out line this will translate to a low with a short high pulse to mark the end of a line. When the sync pulse from IC7 occurs at the same time as the end of line phasing pulse, the output of IC9 will go low, which will set the flip-flop and cause its output (pin 6) to go high. This will disable IC8 and ensure that the sync pulses are not delayed any further. It will also turn on Q3 and light LED3 to indicate that the decoder is in phase with the incoming signal. Once locked, the decoder will stay in phase with the transmitter even during a complete signal loss.

the meter. You can now attach the Scotchcal label to the front panel. The best way to do this is to trim the Scotchcal to the correct size and line it up along one edge to make sure it fits well. Drill small pilot holes through the Scotchcal to mark the positions of the four holes and the corners of the meter cutout. Peel the back off the Scotchcal and lay it sticky side up on a flat table top. Carefully align the front panel above this and slowly lower it down on to the Scotchcal. Once it has stuck, press it firmly into place. You can then trim out the holes with a sharp scalpel or knife.

The next step is to drill the back panel. Artwork is supplied for this also, so if you are using a back panel Scotchcal label you can proceed as for the front panel. If not, drill the hole for the cable and audio socket. You are now ready to assemble the case.

Screw the pc board to the relevant mounting holes on the floor of the case. Mount the two LEDs with mounting grommets on to the front panel. Bolt in the two switches as well, then slide the front panel into position. The flying leads from the board can then be soldered to the LEDs and switches according to the overlay. The leads to the meter should be soldered on, and the meter can then be attached to the front panel using Araldite or Superglue.

Before positioning the back panel, thread the computer interface cable through the appropriate hole and mount the audio jack. With the back panel in position, the shielded cable can be soldered to the jack. To stop the interface cable from being pulled out tie a cable clamp on behind the back panel. To complete the construction all that is needed is to wire up a male DB9 plug to the end of the interface cable. Make sure you get the pin numbers correct. You can now screw the lid back on.

Alignment

To align the unit you need to set the two bandpass filters to 1600 Hz and 2400 Hz respectively. Since the unit is powered by the computer you will first need to plug the DB9 into the joystick port on the back of the Cat.

A 1600 Hz and 2400 Hz tone is needed for the alignment. This can be derived from a signal generator if you have one. If you don't, you should be able to record these tones off your receiver by tuning to AXM (5.1 MHz) and waiting till the end of a half hour segment. A continuous tone will then be broadcast. You will need to get a sample of both the high tone and the low tone.

Start with the 2400 Hz filter. Set RV1 to the mid position and feed a 2400 Hz signal into the audio input. You should get some deflection on the front panel meter. Set the level of the 2400 Hz input signal to give about half scale on the meter. There are two wire links on the pc board next to Q2, marked TP1 and TP2 on the overlay. These

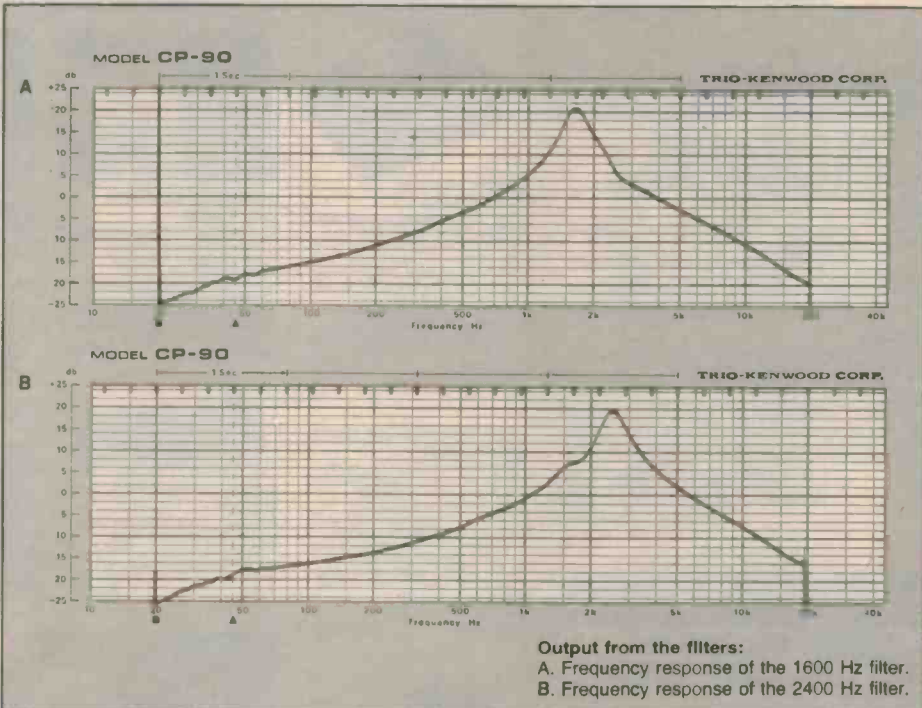
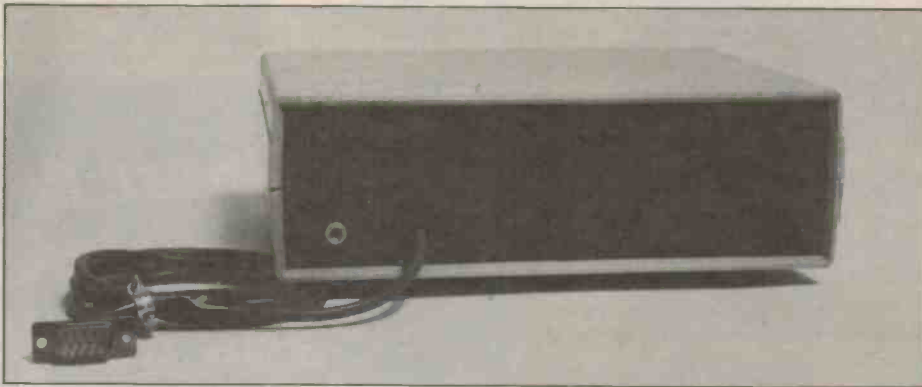
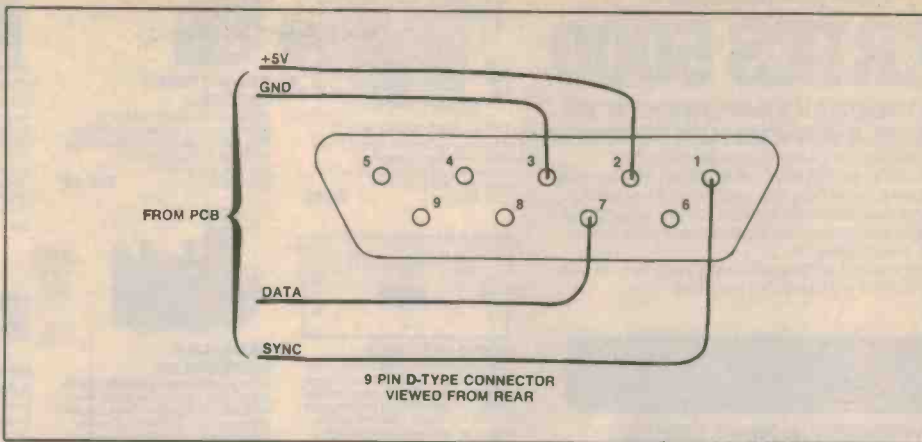

Output from the filters:
 A. Frequency response of the 1600 Hz filter.
 B. Frequency response of the 2400 Hz filter.

are used as test points for the set up procedure. Measure the dc voltage between TP1 and ground, and adjust RV1 to give a maximum reading.

Switch to the 1600 Hz tone and repeat the procedure with TP2 and RV2. (Note: the front panel meter will not show any deflection with the 1600 Hz tone.) When both test points give a maximum dc reading with

their respective tone inputs, the filters are aligned.

If you are listening to a station other than AXM which uses different FSK frequencies, you can simply align the filters in the way described above but using the two frequencies you are interested in.

Part 2 will detail the software plus show you how to use it next month.

THE BRILLIANT SERIES 5000

INDIVIDUAL COMPONENTS TO MAKE UP A SUPERB HI-FI SYSTEM!

By directly importing and a more technically orientated organisation, ROD IRVING ELECTRONICS can bring you these products at lower prices than their competitors. Enjoy the many other advantages of RIE Series 5000 kits such as "Superb Finish" front panels at no extra cost, top quality components supplied throughout. Over 1,000 sold!

For those who haven't the time and want a quality hi-fi, we also sell the Series 5000 kits assembled and tested.



POWER AMPLIFIER

WHY YOU SHOULD BUY A "ROD IRVING ELECTRONICS" SERIES 5000 POWER AMPLIFIER...

- 1% Metal Film resistors are used where possible.
 - Aluminium case as per the original article.
 - All components are top quality.
 - Over 1000 of these kits now sold.
 - Super Finish front panel supplied at no extra cost.
- Please note that the "Superb Quality" Heatsink for the Power Amplifier was designed and developed by ROD IRVING ELECTRONICS and is being supplied to other kit suppliers.

SPECIFICATIONS: 150 W RMS into 4 ohms
POWER AMPLIFIER: 100W RMS into 8 ohms (+ -55V Supply)
FREQUENCY RESPONSE: 8Hz to 20KHz +0 -0.4 dB 2.8Hz to 65KHz, +0 -3 dB. NOTE: These figures are determined solely by passive filters.
INPUT SENSITIVITY: 1 V RMS for 100W output.
HUM: 100 dB below full output (flat).
NOISE: 116 dB below full output (flat, 20KHz bandwidth)
2nd HARMONIC DISTORTION: <0.001% at 1 KHz (0.0007% on Prototypes) at 100W output using a +56V SUPPLY rated at 4A continues <0.0003% for all frequencies less than 10KHz and all powers below clipping
TOTAL HARMONIC DISTORTION: Determined by 2nd Harmonic Distortion (see above)
INTERMODULATION DISTORTION: 0.003% at 100W, (50Hz and 7KHz mixed 4:1)
STABILITY: Unconditional.

Cat. K44771 Normally \$319, now only \$299
 Assembled and tested \$499
 packing and post \$10



PREAMPLIFIER

THE ADVANTAGES OF BUYING A "ROD IRVING ELECTRONICS" SERIES 5000 PREAMPLIFIER KIT ARE:...

- 1% Metal Film Resistors are supplied.
 - 14 Metres of Low Capacitance Shielded Cable are supplied (a bit extra in case of mistakes).
 - English "Lorlin" switches are supplied (no substitutes here.)
 - Specially imported black anodised aluminium knobs.
- Available Assembled and Tested. (We believe that dollar for dollar there is not a commercial unit available that sounds as good!)

SPECIFICATIONS:
FREQUENCY RESPONSE: High-level input: 15Hz = 130KHz, +0 = 1dB
 Low-level input conforms to RIAA equalisation +0 = 0.2dB
DISTORTION: 1KHz -0.003% on all inputs (limit of resolution on measuring equipment due to noise limitation).
S/N NOISE: High-Level input, master full, with respect to 300mV input signal at full output (1.2V): 92dB flat +100dB A-weighted, MM input, master full, with respect to full output (1.2V) at 5mV input 50ohms source resistance connected: -85dB flat 92dB A-weighted MC input, master full, with respect to full output (1.2V) and 200uV input signal: -71dB flat -75dB A-weighted.

Cat. K44791 Normally \$289, now only \$269
 Assembled and tested \$599
 packing and postage \$10



THIRD OCTAVE GRAPHIC EQUALIZER

SPECIFICATIONS:
BANDS: 28 Bands from 31.5Hz to 16KHz.
NOISE: <0.008mV, sliders at 0, gain at 0 (=103dB0).
20KHz BANDWIDTH DISTORTION: 0.007% at 300mV signal, sliders at 0, gain at 0, maximum 0.01%, sliders at minimum.
FREQUENCY RESPONSE: 12Hz = 105KHz, +0 = 1dB, all controls flat.
BOOST AND CUT: 14dB

Cat. K44590 1 Unit ... \$199
 2 Units ... \$389
 packing and postage \$10

**REMEMBER! Our kits
are top quality at
very affordable prices!**



1W AUDIO AMPLIFIER
 A low-cost general-purpose, 1 watt audio amplifier, suitable for increasing your computers audio level, etc. (EA Nov '84)
 Cat. K84111 \$9.95



AUDIO TEST UNIT
 Just about everyone these days who has a stereo system also has a good cassette deck, but not many people are able to get the best performance from it. Our Audio Test Unit allows you to set your cassette recorder's bias for optimum frequency response for a given tape or alternatively, it allows you to find out which tape is best for your recorder. (81A010) (EA Oct '81)
 Cat. K81101 \$47.50



EA AM STEREO DECODER
 AM stereo is now broadcast in Australia on an experimental basis. This add-on decoder works with the Motorola C-QUAM system. (EA Oct '84) 84MS10
 Cat. K84101 \$27.50



PARABOLA MICROPHONE
 Build a low cost parabola, along with a high gain headphone amplifier to help when listening to those natural activities such as babbling brooks, singing birds or perhaps even more sinister noises. The current cost of components for this project is around \$15 including sales tax, but not the cost of batteries or headphones. (EA Nov '83) 83MA11
 Cat. K83110 \$14.95



STEREO ENHANCER
 The best thing about stereo is that it sounds good! The greatest stereo hi-fi system loses its magnificence if the effect is so narrow you can't hear it. This project lets you cheat on being cheated and creates an 'enhanced stereo effect' with a small unit which attaches to your amp. (ETI 1405, ETI, MAR '85)
 Cat. K54050 \$79.50



GENERAL PURPOSE AMPLIFIER CLASS B
 One of the handiest 'tools' for the electronics experimenter is a genuine purpose audio amp. This module will work from a wide range of supply voltages, has good sensitivity, is robust and reliable - easy to build too! (ETI 453) (ETI April '80)
 Cat. K44530 \$24.50



MOSFET POWER AMPLIFIER
 Employing Hitachi Mostets, this power amplifier features a 'no compromise' design, and is rated to deliver 150 W RMS maximum and features extremely low harmonic, transient and intermodulation distortion. ETI 477 (ETI Jan. '81) (Single module only)
 Cat. K44770 \$79.50
 Plus power supply (No trans) \$49
 Plus transformer PF4361/1 \$49.50

150W MOSFET POWER AMPLIFIER
 Here's a high power, general purpose 150W Mostel Power Amp Module! Suitable for guitar and P.A. applications and employing rugged, reliable Mostets in the output stage. (ETI 499) (ETI March '82)
 Cat. K44990 \$79
 (Heatsink not included)
 plus transformer \$49.50

Q: Where can you find a huge range, low prices and quality service?



300W "BRUTE" AMPLIFIER
 The "Brute" develops 300W into 4 ohms, 200W into 8 ohms! For many audio applications there's no substitute for sheer power - low efficiency speakers, outdoor sound systems, or maybe you like the full flavour of the dynamic range afforded by a high power amp. Whatever your requirement - this 'super power' module should fill the bill. (ETI 466) (ETI Feb '80)
 Cat. K44660 \$79.50
 (Heatsink not included)



100W SUB-WOOFER AMPLIFIER
 Capable of up to 120 watts RMS into 4 ohm loads and up to 80 watts RMS into 8 ohm loads, this power amplifier module has been specifically designed for use as a sub-woofer driver amplifier in a tri-amped hi-fi system. It uses four power Mosfets for rugged, reliable operation. (EA July '82) (82PA7)
 Cat. K82075 \$97.50



GENERAL PURPOSE PREAMPLIFIER
 A general purpose stereo preamplifier using a single LM382 IC which can be tailored for use with magnetic pickups, tape recorders or microphones by changing a few components. (ETI 445) (ETI July '76)
 Cat. K41490 \$8.95



HEADPHONE AMPLIFIER PRACTICE WITHOUT ANNOYING THE FAMILY!
 If you play any type of electronic instrument, this headphone amplifier will surely interest you. It will let you practice for hours without upsetting the household, or you can use it to monitor your own instrument in the midst of a rowdy jam session. (EA Feb '84) 83MA11
 Cat. K83011 \$29.95

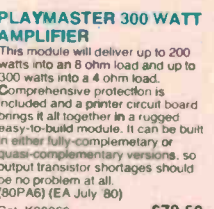

PLAYMASTER 300 WATT AMPLIFIER
 This module will deliver up to 200 watts into an 8 ohm load and up to 300 watts into a 4 ohm load. Comprehensive protection is included and a printer circuit board brings it all together in a rugged easy-to-build module. It can be built in either fully-complementary or quasi-complementary versions, so output transistor shortages should be no problem at all. (80PA6) (EA July '80)
 Cat. K80060 \$79.50



VOICE OPERATED RELAY
 EA's great Voice Operated Relay can be used to control a tape recorder, as a VOX circuit for a transmitter or to control a slide projector. (EA Apr '82) 82VX4
 Cat. \$14.95

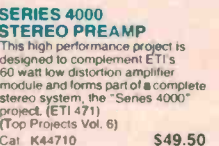

SERIES 4000 STEREO PREAMP
 This high performance project is designed to complement ETI's 60 watt low distortion amplifier module and forms part of a complete stereo system, the "Series 4000" project. (ETI 471) (Top Projects Vol. 6)
 Cat. K44710 \$49.50

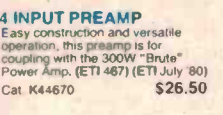

4 INPUT PREAMP
 Easy construction and versatile operation, this preamp is for coupling with the 300W "Brute" Power Amp. (ETI 467) (ETI July '80)
 Cat. K44670 \$26.50

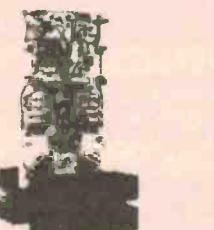

50 W AMPLIFIER MODULE (ETI 480)
 Cat. K44880 \$27.50
 (Heatsink optional extra)

100 W AMPLIFIER MODULE (ETI 480)
 Cat. K44801 \$29.95
 (Heatsink optional extra)



EFFECTS UNIT
 An "effects unit" that can create phasing, flanging, echo, reverb and vibrato effects. (EA June '83) 83GA6
 Cat. K83060 \$75.00



MUSICOLOR IV
 Add excitement to parties, card nights and discos with EAs Musicolor IV light show. This is the latest in the famous line of musicolors and it offers features such as four channel "color organ" plus four channel light chaser, front panel LED display, internal microphone, single sensitivity control plus opto-coupled switching for increased safety. (EA Aug '81) 81MC8
 Cat. K81080 \$99.00



Sensational New Microbee Kit
MICROBEE ENHANCER 1
 This brand new, totally amazing kit for the Microbee is a must for all Microbee owners/users!
 Most expansion units up to this time offered at best only one or other features; and this made it impossible to run, say, complex sound effects mingled with speech. The Enhancer 1 will do all this and much more as well. It is quite amazing how much has been shoe-horned into this compact unit. The Enhancer 1's many powerful features include:

- Two PARLOLOOM (CORE) COLECO/SEARS type joystick inputs.
- Two TRS COLOR COMPUTER type joystick inputs.
- Allows the connection of Touch Pads, Paddles, Proportional Joysticks, Trackballs, Mice, temperature sensors, lights level sensors, transducers, etc, etc!
- A 4 voice music/sound effects synthesizer.
- A real time clock.
- Unlimited vocabulary speech synthesizer (option).
- Parallel printer interface (option)
- A built in speaker with volume control.
- Listings of all necessary routines for use.
- An impressive demonstration program package.
- Compatible to all Microbees.
- Digital recording and playback of speech and sound.
- An 8 channel analog to digital converter with variable voltage or variable resistance type analog inputs and also user selectable resolution from 1 to 9 bits.
- A digital to analog converter with selectable resolution from 1-8 bits.
- Allows automatic data acquisition and logging.
- 5 digital input lines, 4 digital output lines.
- A voice input channel.
- A 40 pin experimenter socket with all 8 analog inputs, 5 digital inputs, 4 digital outputs, 3 5MHz buffered clock, sound output (so that you can play the sound effects through your Hi-Fi), 3 high resolution voltage comparators, DAC output etc.

Cat. K44990 \$149



LOW OHMS METER

How many times have you cursed your Multimeter when you had to measure a low-value resistance? Well with the "Low Ohms Meter" you can solve those old problems and in fact measure resistance from 100 Ohms down to 0.005 Ohms (ETI Nov. '81) ETI 158 Cat. K41580 \$33.50



PARALLEL PRINTER SWITCH

Tired of plug swapping when ever you want to change from one printer to another? This low-cost project should suit you down to the ground. It lets you have two Centronics-type printers connected up permanently, so that you can select one or the other at the flick of a switch (ETI 666, Feb. '85) Cat. 46660 \$69.95



MOTORCYCLE INTERCOM

OVER 300 SOLD! Motorcycling is fun, but the conversation between rider and passenger is usually just not possible. But build this intercom and you can converse with your passenger at any time while you are on the move. There are no "push-talk" buttons, adjustable volume and it's easy to build! (EA Feb. '84) 84MC2 Cat. K804020 \$45.00



ZENER TESTER

A simple low cost add-on for your multimeter. This checks zeners and reads out the zener voltage directly on your multimeter. It can also check LEDs and ordinary diodes. (ETI May '83) ETI 164 Cat. K41640 \$9.50



15V DUAL POWER SUPPLY

This simple project is suitable for most projects requiring a dual voltage. (ETI 581, June '76) Cat. \$17.50



ELECTRONIC MOUSETRAP

This clever electronic mousetrap disposes of mice instantly and mercifully, without fail, and resets itself automatically. They'll never get away with the cheese again! (ETI Aug. '84) ETI 1524 Cat. K55240 \$32.50



40-W INVERTER

This 12 240 V inverter can be used to power up mains appliances rated up to 40 W, or to vary the speed of a turntable. As a bonus, it will also work backwards as a trickle charger to top up the battery when the power is on (EA May '82) 82IV5 Cat. K82050 \$54.50



FUNCTION GENERATOR

This Function Generator with digital readout produces Sine, Triangle and Square waves over a frequency range from below 20Hz to above 160Hz with low distortion and good envelope stability. It has an inbuilt four digit frequency counter for ease and accuracy of frequency setting. (EA April '82) 82AO3(A/B) Cat. K82040 \$87.50



LOW BATTERY VOLTAGE INDICATOR

Knowing your batteries are about to give up on you could save many an embarrassing situation. This simple low cost project will give you early warning of power failure, and makes a handy beginner's project. (ETI 280, March '85) Cat. K42800 \$7.95



DUAL TRACKING POWER SUPPLY

Build around positive and negative 3-Terminal Regulators, this versatile dual tracking Power Supply can provide voltages up to 2A. In addition the Supply features a fixed +5V 0.9A output and is completely protected against short circuits, overloads and thermal runaway. (EA March '82) 82PS2 Cat. K82030 \$87.50

A: Rod Irving Electronics, the proof is right in front of you!



LOW-COST BIPOLAR MODEL TRAIN CONTROLLER

Here is a simple model train control for those enthusiasts who desire something better than the usual rheostat control. It provides much improved low speed performance and is fully overload protected, yet contains relatively few components. Best of all, you don't need to be an electronic genius to construct it. (80TC12) (EA Dec '80) Cat. K80120 \$34.50



TRANSISTOR TESTER

1000's SOLD! Have you ever desoldered a suspect transistor, only to find that it checks OK? Trouble-shooting exercises are often hindered by this type of false alarm, but many of them could be avoided with an "in-circuit" component tester, such as the EA Handy Tester. (EA Sept. '83) 83TT8 Cat. K83080 \$15.00



MICROBEE SERIAL-TO-PARALLEL INTERFACE

Most microcomputers worth owning have an "RS232" connector, or port, through which serial communications (input/output) is conducted. It is a convention that, for listing on a printer, the BASIC LLIST or LPRINT command assumes a printer is connected to the RS232 port. Problem is, serial interface printers are more expensive than parallel Centronics interface printers. Save money by building this interface. (ETI Jan. '84) ETI 675 Cat. K46750 \$59.00



ELECTRIC FENCE

Mains or battery powered, this electric fence controller is both inexpensive and versatile. Based on an automotive ignition coil, it should prove an adequate deterrent to all manner of livestock. Additionally, its operation conforms to the relevant clauses of Australian Sine 3129. (EA Sept. '82) 82EF9 Cat. K82092 \$19.50

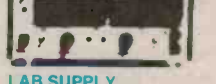

30 V/1 A FULLY PROTECTED POWER SUPPLY

The last power supply we did was the phenomenally popular ETI-131. This low cost supply features full protection, output variation from 0V to 30V and selectable current limit. Both voltage and current metering is provided. (ETI Dec. '83) ETI 162 Cat. K41620 \$52.50



EPROM PROGRAMMER EP1

No need for a Micro with EA's great Eprom Programmer suitable for 2716/2758 Eproms. (EA Jan. '82) 82EP1 Cat. K82013 \$59.95



RADIOTELETYPE CONVERTER FOR THE MICROBEE

Have your computer print the latest news from the international shortwave news service. Just hook up this project between your short wave receiver's audio output and the MicroBee parallel port. A simple bit of software does the decoding. Can be hooked up to other computers too. (ETI Apr. '83) Cat. \$19.95



COMPUTER DRIVEN RADIO-TELETYPE TRANSCIEVER

Here's what you've been asking for, a full transmit-receive system for computer driven radio teletype station. The software provides all the latest "whizz-bangs" like split-screen operation, automatically repeating text message, printer output and more. The hardware uses tried and proven techniques. While designed to learn with the popular Microbee, tips are available on interfacing the unit to other computers. (ETI Nov. '84) ETI 755 Cat. K47550 \$139.00

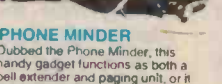

PHONE MINDER

Dubbed the Phone Minder, this handy gadget functions as both a bell extender and paging unit, or it can perform either function separately. (EA Feb. '84) 84TP2 Cat. K84020 \$27.50

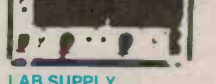

LAB SUPPLY

Fully variable 0-40V current limited 0-5A supply with both voltage and current metering (two ranges: 0-0.5A-0.5A). This employs a conventional series-pass regulator, not a switchmode type with its attendant problems, but dissipation is reduced by unique relay switching system switching between taps on the transformer secondary. (ETI May '83) ETI 163 Cat. K41630 \$175.00



TEMP PROBE

Can measure temperature from -50 to 150-c. It simply plugs into your multimeter - great for digital multimeters. Accuracy of 0.1-c resolution of 0.1-c (ETI June '83) ETI 153 Cat. K41530 \$27.50



PH METER KIT

Build this pH meter for the swimming pool season is here again! From swimming pools to fish tanks to gardening, this pH meter has many applications around the home. This unit features a large 3 1/2 digit liquid crystal display and resolution to .01 pH units, making it suitable for use in the laboratory as well. (EA Dec. '82) 82PH12 Cat. K82123 \$139

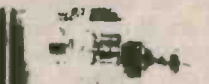

CAR IGNITION KILLER

Most car burglar alarms are easily circumvented, but not this cunning "Ignition Killer". This sneaky anti-theft device uses a 555 timer to place an intermittent short circuit across the points. Unit disabled by its hidden switch the circuit effectively makes the car undrivable - a sure deterrent to thieves! (EA Feb. '84) 84AU1 Cat. K84010 \$16.95 (Our kit includes the box)

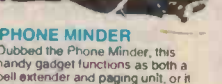

VIDEO ENHANCER

100's SOLD! Like tone controls in a hi-fi amplifier, touch up the signal with this Video Enhancer. (EA Oct. '83) 83VE10 Cat. K83100 \$35.00

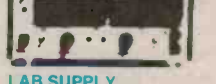

300 BAUD DIRECT CONNECT MODEM

Modem? What do I want with a modem? Think of these advantages:
• Can't afford a floppy disc? Use your telephone to access one for the cost of a call.
• Bored with your old programs? Download hundreds of free programs.
• Want to get in touch with fellow computer enthusiasts? Use "electronic mail".
• Ever used a CP/M system? CP-DOS? UNIX? Well a modem will make a your computer a remote terminal on some of the most exciting systems around. Save on ready built modems. Cat. \$99

ROD IRVING ELECTRONICS
425 High Street, NORTHCOTE, 3070 VICTORIA, AUSTRALIA
Phone (03) 489 8866
48 A Beckett St, MELBOURNE, 3000 VICTORIA, AUSTRALIA
Ph. (03) 663 6151
Mail Order and correspondence: P.O. Box 620, CLAYTON 3168
TELEX: AA 151938

MAIL ORDER HOTLINE
(03) 543 7877
(2 lines)

POSTAGE RATES
\$1-\$9.99 \$2.00
\$10-\$24.99 \$3.00
\$25-\$49.99 \$4.00
\$50-\$99.99 \$5.00
\$100-\$199 \$7.50
\$200-\$499 \$10.00
\$500 plus \$12.50
This is for basic postage only. Comet Road freight, bulky and fragile items will be charged at different rates.
Certified Post for orders over \$100 included "free"
Registered Post for orders over \$200 included "free"



Errors and Omissions Excepted.



CATHODE RAY OSCILLOSCOPE KIT

At last a CRO kit! This CRO kit has a guaranteed 5MHz bandwidth but should also go to around 6.5MHz. It also features 75mm (3") CRT Blue Phosphor with accurate graticule, separate vertical and horizontal BNC type input sockets etc. Keep in mind that a 5MHz scope is usually adequate to troubleshoot most microprocessor and other digital circuitry as well. This is a wonderful opportunity to learn electronics and end up with a valuable piece of test equipment as well. The RIE CRO kit is totally complete. The chassis is pre-punched and every component including nuts and bolts are provided, along with instructions. Cat. \$279



BIPOLAR PROM PROGRAMMER

Every digital workshop should have one! Can be used to program the popular fuse-link PROMS like the 74S188/288, 82S23 & 82S123 etc (ETI June '83) ETI 688 Cat. K46880 \$49.50

BANKCARD
VISA
MASTERCARD
SIGNATURE _____ EXPIRY DATE _____
NAME _____
ADDRESS _____
P CODE _____
ETI 11/85 DATE _____

LOW DISTORTION AUDIO OSCILLATOR

Part 2

Last month we told you the principles and compromises in designing this impressive audio oscillator. It was such a comprehensive discussion we had to split the project into two parts. Here we resume with a guide to construction, circuit details and testing advice.

Ian Thomas

SO MUCH FOR all the reasons for the eventual circuit last month. Now for how to use it.

Construction

I chose to use a plastic instrument case available from Geoff Wood, Jaycar or Altronics. I think just about every electronics store will stock one that's OK. The plastic boxes are neater but the metal ones do make the oscillator less prone to hum pickup. You pay your money and make your choice!

If you want to do your own layout and make the board fit a different case, the most important thing of all is to keep the RC parts of the oscillator *as far as possible from the power transformer*. Power transformers radiate 50 Hz fields and these are entirely too easy to get into the oscillator. If you look at the layout of the board, you'll see that they are on opposite diagonal corners of the board and I still had some trouble. For the same reason (hum pickup) I chose to use the miniature Bourns trimpots to minimise board area used by the selective components in the oscillator. These are also available from Geoff Wood and were, in fact, a lot cheaper than the normal cermet trimmers. On the subject of trimmers it's *absolutely essential* that good quality cermet trimpots be used as the cruddy old carbon film ones really aren't stable enough. All the trimpots are in frequency determining networks and if an older type is used, the output frequency would be all over the place like a dog's breakfast. Similar remarks apply to all the fixed resistors. Ideally they should be $\pm 1\%$ metal film resistors not so much for the $\pm 1\%$ as for the stability with time and temperature although in the prototype they were mainly $\pm 2\%$ and seemed to work OK.

The capacitors used in the frequency determining networks are all metallised

polyester and are encapsulated in plastic cases. The types that're suitable are ERO (Roederstein) type MKT1817 or MKT1826 or Wima type PR21 or RS21 or some fair dinkum equivalent. If you do decide to go for a rock bottom budget unit and use greencaps let me know how they work (by mail — not in person!). The point about the capacitors I specified is that they have a known temperature characteristic which only gives a $\pm 0.5\%$ change over the normal operating temperature range.

The safest way to get the board layout is to copy the one given or buy a mask from ETI (if you put any value on your time this is really far cheaper). The board is made from single sided 1/16 inch epoxy glass board. I don't recommend using paper phenolic type boards as their leakage performance is a bit sus. If you are doing your own layout take particular care to get the spacing right for the switch banks pins (they're *@#!! not on 0.1 inch centres).

Etch and drill the board normally and start assembly with the power supply. Assemble only the power transformer, rectifier, diodes, filter electrolytics and voltage regulators. I VERY strongly recommend using printed circuit terminals to get 240 volts onto the board as I have been bitten far too many times.

NEXT COVER ALL THE TRACKS THAT CARRY MAINS VOLTAGE WITH INSULATING TAPE. If you don't you'll probably kill yourself. Also there are two solder pins that carry mains that stick out from the side of the little Ferguson transformer. Tape them up too. I missed them and my CRO earth clip brushed across them on the prototype (BANG!! palpitate!).

Next create for yourself a death machine — that is a length of 2 or 3 core flex with a mains plug on one end and the other end with bare wires. Connect the wires to the

input terminals on the board then power the beast up. Check that you have plus and minus 15 volts coming out of the regulators. If all is well remove the plug from the mains, remove the bare ends from the terminals and lock the damn thing away in a safe or something. Now that you know that the voltage regulators work you can carry on with the rest of the assembly with some confidence that the whole thing won't go up in flames when you turn it on.

As always make sure that all the ICs are in the right way and also the diodes. It's particularly important that the leads be neat and short around the oscillator (mains hum again). In the prototype I used two 1M and two 200k resistors to make up the 1.2M needed for the -60 dB attenuator as this gives the exact value. There are three wire jumpers that run just behind the frequency select switch which should be as short and straight as possible — resistor leads that've been cropped off do just fine. The last components that should go in are the two switch banks.

Testing and alignment

Before you try to mount the oscillator in the box it's a good idea to do a preliminary alignment and make sure all the ranges are working. Once the board is completely assembled reconnect the death machine to the power terminals and turn the unit on. When I do this to a brand new board I normally run my hands lightly over the components for 30 seconds or so to see if anything is getting too hot too fast (that's another reason to check the power supply first). Next check that the supply rails are still sitting at ± 15 volts. If this is right then you're ready for the fun bit.

To set up the pots you really need a counter although a CRO will do in a pinch. The purpose of this adjustment is to remove the $\pm 10\%$ or so tolerances in the oscillator

components and it can't be done properly if you can only measure frequency to $\pm 20\%$. You can certainly make sure that everything is working but the frequency scale on the front panel won't be worth much.

Given that you've got, begged, borrowed or whatever a counter with a 1 second time-base at least (10 seconds is better) connect it to the output and select the 100 to 1000 Hz frequency range and the 0 dB attenuation range. Connect the frequency adjustment potentiometer temporarily to its appropriate holes and tack a piece of wire across the level adjust pot holes so you get full output. Turn all nine trimpots full clockwise and turn the beast on. If all is normal the output should go up against the rails and stay there. Set RV10 (the frequency select pot) for minimum resistance or maximum frequency then start winding RV9 anticlockwise while monitoring the output. Bring it back to about mid position then start winding RV3 counterclockwise. Somewhere around mid position oscillation should start and it should be at around 1000 Hz. If this is OK, everything is looking good and you can start checking out the level control circuitry.

First check that the squarer IC2 is working. Pin 6 of IC2 should have a square wave on it which is in opposite phase to the sine wave input. The output should show no sign of oscillation during transitions. The input to the squarer on pin 2 should show the input sine wave during positive half cycles and should be diode clamped to about -0.7 volts during negative excursions. The output from the squarer should appear on pin 10 of IC5, the CD4053. C14 and R25 should differentiate the squarer output and a very narrow negative going pulse should appear on pin 9. Finally pin 11 of IC5 should be sitting near ground. Momentarily stop the squarer by shorting its output to ground and pin 11 should rise to about 12 volts if you're using a 10M input impedance CRO probe.

Next comes the peak detector. Check that the sine wave output from the oscillator appears on pin 3 of IC3. Next check the signal on the negative input pin 2. It should be sitting at a dc voltage equal to the peak positive swing of the oscillator with a negative step occurring every time the input signal crosses zero volts going positive. If the oscillator is not being properly level controlled due to other problems then the peak detector output may not be able to get as far positive as the oscillator input but the step should still appear every time pin 9 of IC5 is pulsed negative. If this is what you get it's time to proceed to the integrator IC4.

Integrator IC4 is just a simple inverting operational amplifier with a rather messy RC network in the feedback circuit. Check that pin 3 has $+6.8$ volts on it and that pin 1 of IC5 has the peak detector output on it. As the analogue switch in IC5 is turned off when the peak detector is reset the negative

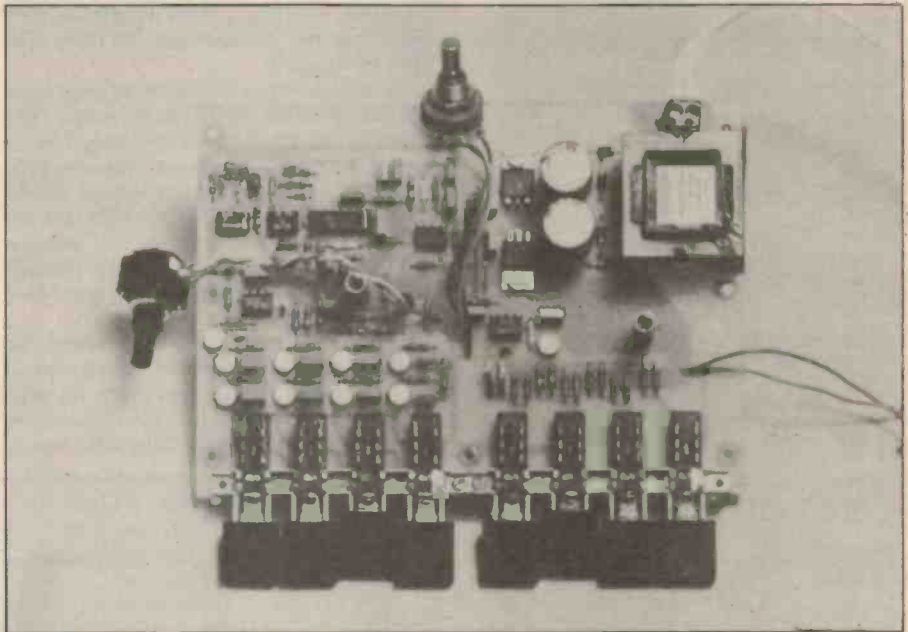
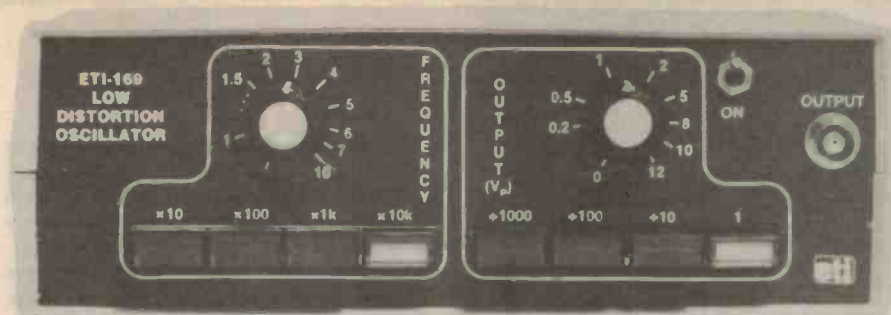

step doesn't appear on pin 1. If the oscillator output level isn't being controlled and is swinging up against the rails then the output of the integrator IC4 pin 1 should be far negative and the output of the inverting amplifier following the integrator should be hard positive. If the level control circuitry is working (that is if the oscillator has been adjusted so it has enough control range) the integrator output will probably be sitting at a few volts positive, and the output of the inverting amplifier, a few volts negative.

Last of all check that the control voltage on the gate terminal of the FET is at one half the voltage of the inverting amplifier, and the control circuitry should be OK. If the oscillator output is giving bursts of oscillation there is probably a short in the RC network around the integrator. As a final check on the level control try adjusting RV3 again until the level control circuit can take over. You should see a beautiful clean sine wave with a 6.8 volt peak swing on the oscillator output. Pretty — isn't it?

Now back to setting up the oscillator frequency. When the level control is working it's a lot easier to adjust the oscillator as monitoring the control voltage out of pin 7 of IC4 tells how the adjustment is going. Connect a voltmeter there and adjust RV9 until it reads about -4 volts. The next step is to adjust R7 until the oscillator output

frequency is 1100 Hz and the control voltage is at -3 volts. To do this, it will be necessary to adjust both RV3 and RV4 to keep the control voltage where it's wanted. You will find that rotating RV3 clockwise lowers the control voltage, and rotating RV4 clockwise raises it. Leave RV3 in the mid position and start adjusting R4 clockwise to raise the control voltage, adjusting RV9 counterclockwise to raise the output frequency until it reads 1100 Hz. Repeat until the correct frequency is obtained with a control voltage of -3 volts.

Next set the frequency pot to lowest (highest resistance). Leave RV9 alone and adjust both RV3 and RV4 until the output frequency is 90 Hz and the control voltage is steady at -2 volts. You will find that rotating RV3 counterclockwise lowers the frequency and raises the control voltage. Rotating RV4 counterclockwise raises both the voltage and frequency. It's easy to adjust one against the other to get the required result. Return now to the maximum frequency setting on RV10 and check that it is still 1100 Hz. If necessary readjust RV9 to the correct 1100 Hz. Return to the lowest frequency setting and reset RV3 and RV4 for 90 Hz. Repeat until it's perfect, but it should only take two or three tries. That's the first range setup completed and you can move on to the 900-11,000 Hz range. ▶

FOR QUALITY AND VALUE TALK TO THESE PEOPLE ABOUT FLUKE MULTIMETERS

A.C.T.

Actiec Pty Ltd
34 Geelong St Fyshwick
(062) 80 6576

N.S.W.

Ames Agency Pty Ltd
605 Elizabeth St Redfern
699 4524

George Brown & Co Pty Ltd
174 Parramatta Rd
Camperdown - 519 5855
Newcastle - 69 6399
Canberra - 80 4355

Bryan Call Industries Pty Ltd
107/59-61 Gynea Bay Rd.
Gynea
526 2222

Collier Tools (Aust) Pty Ltd
185 Parramatta Rd.
Homebush
763 1888

D G E Systems Pty Ltd
103 Broadmeadow Rd.
Broadmeadow
(049) 69 1625

Davred Electronics Pty Ltd
127 York St. Sydney
267 1385

W F Dixon & Co Pty Ltd
P O Box 42, Wickham
(049) 61 5628

Macelec Pty Ltd
99 Kenny St. Wollongong
(042) 29 1455

Paul's (Merchants) Pty Ltd
22 Canterbury R.
Bankstown
709 2311

Radio Despatch Service
869 George St Sydney
211 0291

Selectro Parts Pty Ltd
482 Hume Hwy. Yagoona
708 3244

Standard Communications
Pty Ltd
6 Frank St Gladsville
896 1755

Geoff Wood Electronics
Pty Ltd
656A Darling St Rozelle
810 6845

WESTERN AUSTRALIA

Atkins Carlyle Ltd
1 Milligan St Perth
321 0101

Dobbie Instruments (Aust)
Pty Ltd
9 Boag Rd Morley
276 8888

Cairns Instrument Services
32 Wickham St East Perth
325 3144

Willis Trading Co Pty Ltd
165 Albany Hwy
Victoria Park
470 1118

VICTORIA

Radio Parts Pty Ltd
562 Spencer St
West Melbourne
329 7888

G B Telespars Pty Ltd
504 Queensbury Rd
North Melbourne
328 3371

Browntronic Pty Ltd
93 Sackville St Collingwood
419 3986

R K B Agency
20 Council St Hawthorn
82 7704

A J Ferguson & Co Pty Ltd
558-568 Swanston St Carlton
347 6688

SIRS Sales Pty Ltd
4 Edols Pl North Geelong
(052) 78 1251

TASMANIA

George Harvey Electrics
Head Office
76 York St Launceston
(003) 31 6533
Hobart - (002) 34 2233

SOUTH AUSTRALIA

Protronics Pty Ltd
174 Wright St Adelaide
212 3111

Trio Electrix Pty Ltd
177 Gilbert St Adelaide
212 6235

Redarc Electronics
253 Main Rd Blackwood
278 7408

QUEENSLAND

L E Boughen & Co
33 Railway Tce Milton
369 1277

Colourview Wholesale
5 Commerce St Salisbury
391 6022

Fred Hoe & Sons Pty Ltd
246 Evans Rd Salisbury Nth
277 4311

Nortek
36 Punari St Townsville
(077) 79 8600

St Lucia Electronics
71-77 Brunswick St
Fortitude Valley
52 7466

Selectro Parts (Qld)
44 Esher St Ekibin
394 2422

NORTHERN TERRITORY

Thew & McCann (NT) Pty Ltd
Menmuir St Winellie Darwin
(089) 84 4999



ELMEASCO Instruments Pty. Ltd.

NEW SOUTH WALES	VICTORIA	QUEENSLAND
15 McDonald Street.	12 Maroonah Highway.	Tel (07) 369 8688
MORTLAKE	RINGWOOD	
P.O. Box 30, CONCORD	P.O. Box 623, RINGWOOD	S AUSTRALIA
NSW 2137	VIC 3134	Tel (08) 344 9000
Tel (02) 736 2888	Tel (03) 879 2322	W AUSTRALIA
Telex AA25887	Telex AA30418 ELTENT	Tel (09) 481 1500

Project 169

For starters adjust both RV5 and RV6 to mid position and select the lowest frequency setting on RV10. Adjust RV5 and RV6 until the oscillator starts; then adjust exactly as before except that you want 900 Hz. When this is right adjust RV10 to maximum frequency and check that it reads 11,000 Hz. It may not be exact and if the difference is too big for you to live with try adjusting RV9 for correct 11,000 Hz then repeating the realignment on the 100-1000 Hz range.

Exactly the same alignment process must then be done on the 9-110 Hz range. The control voltage will take a little longer to get there. The highest frequency range is a little different in that the control voltage should be adjusted for -1 volt at 9000 Hz and will go down to about -4 to -5 volts at 110,000 Hz. Once you've slogged through this lot you should have a pretty good idea of what you've built.

Finally check that the attenuators are working correctly (each step down should give an output voltage one tenth the step before) and the board is ready to go in the box. Assuming you've used the same box as

I did, proceed as follows.

First locate the board in the box and note the plastic mounting pillars that will actually support the board. Next attack the box bottom with a large pair of side cutters and remove the pillars that aren't wanted. There must be about 15 pillars there and only seven are needed. Next carefully mark off exactly where the holes are needed to allow the switch banks to come through the front panel and cut the holes. As this is the front panel it pays to take a little care: if you make a mess of it your mistake will be staring at you for years!

Mark off where you want the frequency and level pots to come through and drill the holes. The same applies to the power switch and output terminals. Assemble all the components on to the front panel then slide it into the box bottom. Solder lengths of wire into the board suitable for connecting the level and frequency pots. At this stage in the assembly of the prototype, a major problem reared its ugly head.

When the board was powered up in the box with all the mains wiring in place, I found that a *large* amount of mains hum was

PARTS LIST — ETI-169

Resistorsall 0.4 W, 2% unless noted	C9, 24.....10p ±5% ceramic plate
R1 to 9.....5k1	C10.....47p ±5% ceramic plate
R10, 13.....750R	C11.....22p ±5% ceramic plate
R11.....6k2	C12, 18.....47n ±10% 63 V met poly*
R12.....5k6	C14.....220p ±5% ceramic plate
R14.....1k5	C16.....2n2 ±10% 63 V met poly*
R15, 21, 53.....1k0	C19.....220n ±10% 63 V met poly*
R16, 17, 26, 28.....1M0	C20, 21.....470µ 25 V RB electro
R18.....220R	C22, 23, 24, 25, 27, 28, 30.....100n ceramic monolithic
R19, 20.....100k	C26.....33p ±5% ceramic plate
R22, 23.....33R	
R24.....5R1	
R25.....10k	
R27.....2M2	
R29.....220k	
R30.....330k	
R31.....470k	
R32, 33.....4k7	
R34.....100R	
R35.....3k3	
R36, 37, 48, 49.....1k2	
R38, 39.....12k	
R40.....680R	
R41.....33k	
R42, 43.....120k	
R44.....620R	
R45.....27k	
R46.....1M0	
R47.....1M5	
R50, 51, 52.....10R	
RV2, 4, 5, 8, 9, 13.....2k0 trimpot cermet*	
RV1, 3, 5, 7.....5k0 trimpot cermet*	
RV10.....100k pot freq set Allen Bradley 72J1N056S104B	
R11.....100k trimpot cermet*	
RV12.....2k linear law pot level set	
* Boums type	
Capacitors	
C1, 2.....1µ ±10% 50 V met poly*	
C3, 4, 13, 15.....100n ±10% 63 V met poly*	
C5, 6, 17, 31.....10n ±10% 63 V met poly*	
C7, 8.....1n ±10% 63 V met poly*	

* see text for types suitable

Semiconductors

IC1, 6.....NE5534
IC2.....RCA CA 3130
IC3.....LF357
IC4.....RCA CA 3240
IC5.....RCA CD4053BE
IC7.....7815 + 15 V reg
IC8.....7915 - 15 V reg
Q1.....2N5485
Q2.....BC337
Q3.....BC327
D1, 2, 3.....1N914
D4, 5, 6, 7.....1N4004
ZD1.....BZX79 C6V8

Miscellaneous

T1.....Ferguson PL30/2.5 VA
SW1.....DPDT mains toggle switch
SW2, 3.....4-way pc mount switch bank and knobs
F1.....350 mA 2AG fuse
ETI-169 pc board; 90 x 60 mm piece sheet copper; 120 x 170 mm sheet aluminium; Euro connector; 2AG fuse holder; 2 knobs for pots; 2 x 25 mm pc board spacer tapped at both ends; BNC panel mount socket; 200 x 160 x 70 mm plastic instrument case; Scotchcal front label; mains hookup wire; lght hookup wire; assorted nuts and bolts.

Price estimate: \$99.50

low distortion audio oscillator

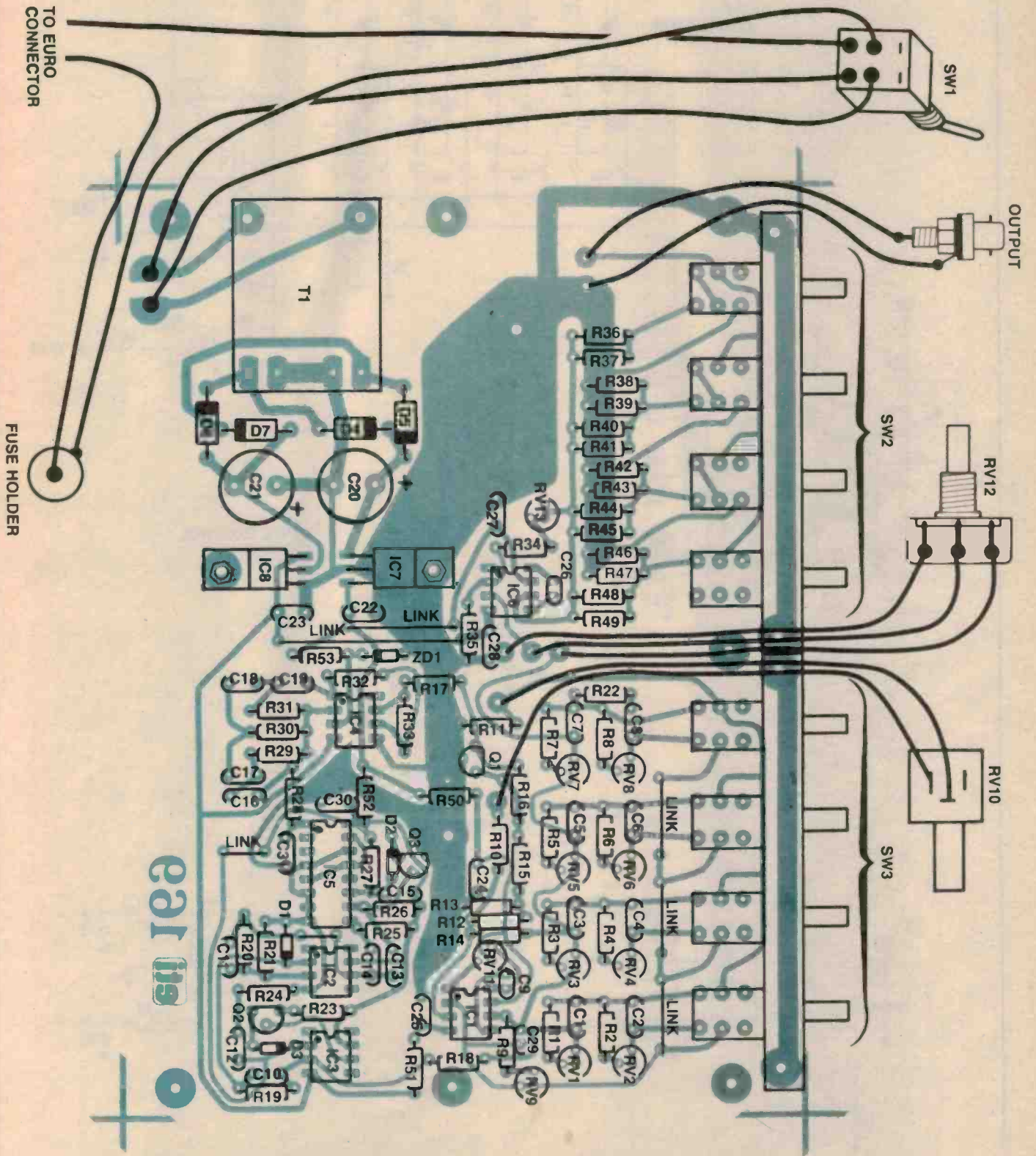

OSCILLATOR

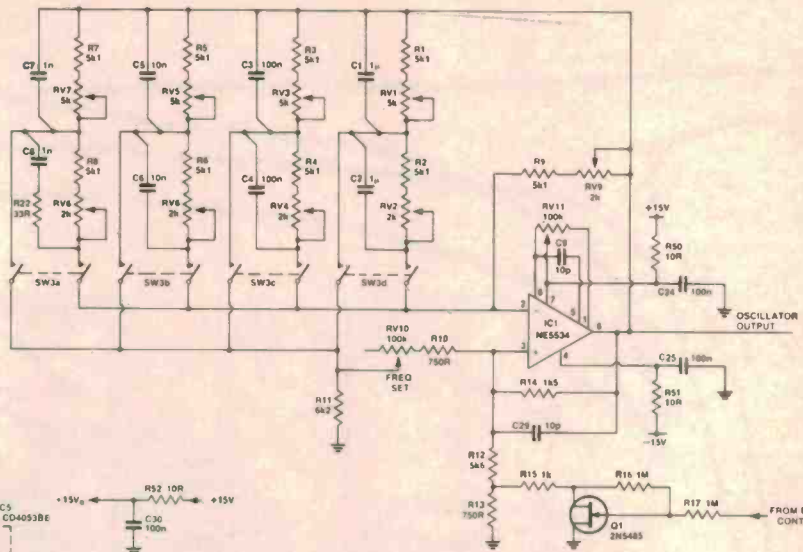

LEVEL CONTROL CIRCUITRY

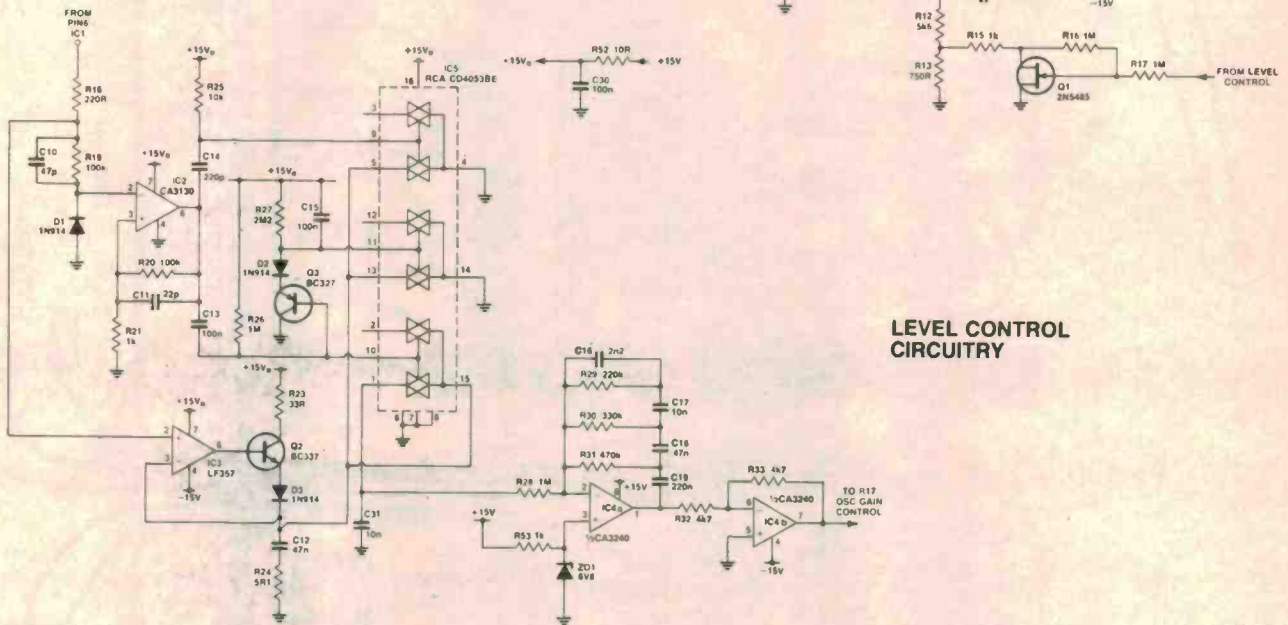

ATTENUATOR

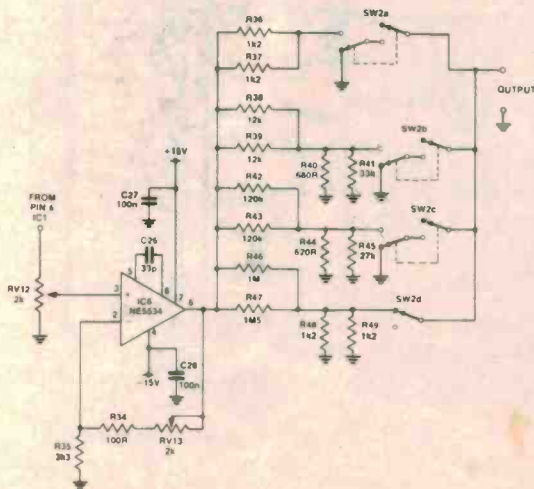

POWER SUPPLY

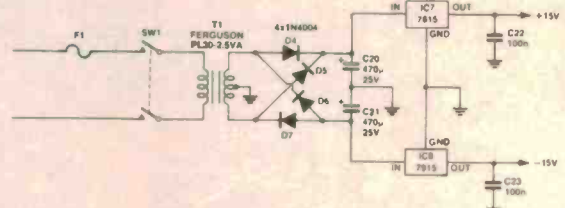

The audio oscillator can be separated into four main areas:

- (1) the power supply;
- (2) the oscillator;
- (3) the output buffer and attenuator; and
- (4) the level control circuitry which may be further broken down into
 - (a) the peak detector;
 - (b) the squarer; and
 - (c) the integrator — loop filter.

The power supply is a conventional mains operated ± 15 volt integrated regulator. The transformer TR1 is mounted on the printed circuit board and has a centre tapped secondary with outputs of ± 15 volts ac. With this brand of transformer the secondary is designed to give rated voltage under full load so in the oscillator the voltages on the two filter capacitors C20 and C21 are at about ± 24 volts. The current to charge C20 and C21 is provided from the full wave rectifier bridge D5 to D8. ICs 7 and 8 regulate the output from the filter capacitors to provide a clean ± 15 volt supply for the oscillator.

The oscillator is based on an NE5534 operational amplifier with both positive and negative feedback. SW1, the frequency band switch, selects one of four RC networks to provide frequency dependent negative feedback through two resistors and two capacitors. The two resistors associated with each of the four networks are made adjustable to make up for the fact that only 10% tolerance capacitors are used. Direct negative feedback is also provided via R9 and RV9, and RV9 allows compensation for the fact that the frequency select potentiometer, RV10, is also only $\pm 10\%$ tolerance.

Negative feedback to preserve the correct conditions for oscillation is provided via R14, R12, R13, R15 and the level control FET, Q1, also form part of the negative feedback network. R16 and R17 ensure that the voltage on the gate of the FET is exactly one half of the gate-source voltage. This minimises distortion introduced by the FET and results in predominantly third order distortion.

RV10 is the frequency adjust pot and by varying its value from 100k to 0 ohms a frequency range of 0.9 to 11 can be achieved. As this frequency variation is proportional to the square root of the resistance it is necessary to use an inverse log law pot to avoid the frequency change being bunched up at one end of the pot rotation.

Both C24 in the negative feedback path and R34 in the highest frequency band select network are to compensate for stray capacitances around the loop and ensure that the correct conditions for oscillation are maintained.

The level control circuitry is fed from the output of the oscillator via R18 which is included to provide some isolation of high frequency spikes generated in the level control circuit. The oscillator output is squared by the squarer IC2 and its associated components. R20, R21 and C11 provide positive feedback for the squarer, which is really

only an op-amp operating open loop. As IC2 and the circuitry it drives is CMOS it is necessary to only power it from +15 volts and ground. The op-amp will not tolerate large negative swings on its input under these conditions so R19 and D1 clip the negative swing at the op-amp negative input. C10 provides phase correction at high frequencies.

The output of the squarer drives a CMOS analogue switch CD4053. This switch has three sections, one of which is used to switch the error signal to the loop integrator and the other two are used to control the peak detector reset function.

The peak detector is formed by IC3 and its associated circuitry. IC3 is used as a non-inverting voltage follower with a transistor-diode in the feedback path. To understand how the peak detector works, first consider that C12 has no charge on it. This means that the voltage on the negative input of IC3 is zero volts. As the voltage on the positive input is taken positive by the oscillator output, the output of IC3 will also go positive turning on Q2 and forcing charge into C12 via diode D4. D4 is only included as the reverse bias breakdown of a transistor emitter base junction is normally only 6 or 7 volts and in theory could be left out (in practice it can't). Thus feedback is provided around the op-amp through the transistor and the negative input is held at the same voltage as the positive input. In the process C12 is charged to the same voltage as the positive input. R24 is included in series with C12 so the op-amp doesn't have to drive a purely capacitive load which makes the loop unstable.

When the input from the oscillator reaches its peak value and starts to swing negative again the transistor-diode prevents charge being removed from the capacitor and C12 is left charged to exactly the peak value of the oscillator output. The capacitor is left charged while the oscillator output swings through the complete negative part of its cycle and starts to come positive again. When it passes through zero volts positive going the squarer output IC2 pin 6 switches negative. This sharp edge is differentiated through C14 and R25 to produce a narrow negative spike on the input of one of the analogue switches. This turns on the analogue switch IC5 pins 4 and 5 and partially discharges the peak detector capacitor C12 ready for the next peak detection cycle.

The resultant voltage on the peak detector is thus a dc voltage equal to the peak ac value of the oscillator output with small negative steps every time the oscillator output crosses zero positive going.

A second section of the analogue switch is driven directly from the squarer output such that pins 1 and 15 are on during the negative half of the oscillator output and off during the positive half. Thus when the peak detector output is stable the analogue switch is on and when it is being reset it is off.

One problem that exists with this type of level control circuit is that it is possible for

the oscillator to stop running because the gain control is set too low. If the peak detector has been charged to a high voltage by a transient then, as the oscillator is not running, no reset pulse is generated from the squarer output and the oscillator cannot start. To prevent this C15 is continually discharged to ground by the squarer output if it is running by Q3 and D2.

If the squarer stops running or fails to start then R27 charges C15 to the positive rail and turns on the analogue switch pins 13 and 14. This completely discharges the peak detector. At the same time the squarer input to the analogue switch (pins 1 and 15) is ac coupled through C13 and R26 and thus under no signal conditions IC5 (pins 1 and 15) is turned hard on. This ensures that the oscillator will always get a 'kick start' if it fails to start normally.

The loop integrator is formed by one half of IC4, a MOS input op-amp. The input to the integrator is from pin 1 of the analogue switch which is at the peak detector output voltage for half the time and open circuit for the other half. The positive input of the op-amp is set to a reference voltage by the zener diode, ZD1, biased by R29.

A rather complex feedback network is formed around the op-amp by capacitors C16, C17, C18, C19 and resistors R29, R30 and R31. All these components are necessary to preserve the correct gain/phase conditions for all oscillator frequencies and conditions. The most important feature of the network is that C19 has no resistor in parallel with it and hence for low frequencies the amplifier acts as a pure integrator. This means that given sufficient time the dc voltage at the peak detector output will be adjusted by the loop to be exactly equal to the reference voltage no matter how other conditions in the loop vary.

The output of the loop integrator is inverted by the second half of IC4 with resistors R32 and R33. This is because the FET, Q1, requires an increasing dc voltage to reduce the gain and preserves the correct dc operating conditions.

The output buffer amplifier is formed by IC6 and is a simple non-inverting amplifier with adjustable gain so the correct output level can be set. RV12 is the level adjust potentiometer on the front panel which allows the oscillator output to be adjusted from maximum to nothing and RV13 in the feedback is the fine adjust to preset the amplifier gain. The output of IC6 drives three 'L' pad attenuators and a series resistor in parallel to generate four outputs, all of which have a 600 ohm output impedance and output levels of 0, -20, -40 and -60 dB referred to the output of IC6. One of these four outputs is selected by SW2 and connected to the output terminals. SW2 is connected in a 'T' configuration with the centre of the off switches connected to ground to minimise capacitive coupling of the higher level outputs to the low level output.

being coupled into the output. There were three ways that this could occur. The first was that there was hum on the power supply lines but as the crud in the output was 50 Hz this tended to rule it out. Any unfiltered and regulated grot on the rails would be at 100 Hz (full wave rectifier bridge). Also a

quick check showed the rails were as pure as the driven slush.

The next way was through some capacitive coupling from the mains area to the oscillator circuit. As the problem seemed to occur only for the lowest frequencies where the frequency set pot has its highest resis-

tance, this seemed most likely. Capacitive coupling is a high impedance effect which is, praise be, easy to stop. By holding my hands around the oscillator I found that I could snuff the coupling with ease. It appeared that I was getting capacitive hopover from the mains wiring to and from the

Project 169

switch and the high impedance oscillator circuit. Annoying but not disastrous. If it had been stray magnetic fields from the transformer it would have meant deep trouble; an electrostatic field will be stopped by almost anything but a magnetic field takes kilos of iron.

To fix it I cut a piece of sheet metal to fit in the bottom of the box so it covered the complete area under the oscillator. This must include the area under the switch bank right up to the front panel. It should extend from the centre of the box right to the left hand edge. I then completely removed what was left of the unwanted mounting pillars with a hammer and sharp wood chisel and fitted the screen to the case. I connected a piece of wire to the screen and brought it out so I could earth it and reassembled the oscillator. About a 10 dB improvement but still not nearly good enough!

I found that holding my hands over the oscillator part of the circuit still had a very marked effect so a screen above the circuit was needed too. I mounted two 1" spacers off the board in grounded areas and cut a piece of aluminium so it completely covered the top of the board, with a notch out of one corner to clear the transformer and filter capacitors. When I screwed it down there was considerable improvement but still not good enough.

If a piece of metal was held down the left hand side of the box near the oscillator frequency select elements, it helped a bit so I bent up a small bracket to protrude down 25 mm from the top screen, extending from the front edge of the screen to the centre of the side where there is a major mounting pillar. This was easily attached with two of the self tappers that hold the board down. Another test and almost good enough!

After a few more magic gestures with my hands the last culprit was found. The field was coupling into the frequency pot itself

which is visible above the screen. A bit more quick work with sheet aluminium and a little box was screwed in place around the pot. In case you have some trouble getting the sheet aluminium, I used a cheap oven baking tray that was on special for a dollar — it seemed to be pretty good stuff too! This completed the screening and got the hum down to acceptable levels. Even if you chose to use a metal instrument case it would still be necessary to do the top part of the screening as the mains wiring and the oscillator are inside the same box.

After you've gone through all the hassles of making screens as above it should be a snap to screw the board in place. Wire up the frequency select pot *using as short a wire as possible*, the output level pot and the mains wiring to the switch. The mains connection on the rear panel was through an IEC socket so if some oaf trips over the mains cord it just pulls the plug rather than ripping the cord out by the roots. Both the mains IEC connector and fuse are mounted off the rear panel and holes have to be cut for them. It's a good idea to cut the fuseholder hole just the right size and cut the locating notch in the side so it cannot rotate. *All mains wiring connections should be securely made by looping the bared end of the wire through the terminal tag then soldering it.* All connections should be completely insulated as you'll be the one to cop it if they aren't. The final result should look pretty much as shown in the photo. If this is all OK, remove the top screen and the unit's ready for final test.

More alignment and testing

Final alignment follows almost exactly the same routine as laid out in the preliminary testing except that it's a bit easier as the oscillator is working. You'll probably notice things need a bit of tweaking as the stray capacitances have changed. If the FET control voltage is allowed to go much further than -2 volts then the third harmonic distortion will start to rise. It will also be noticed that when the frequency pot is rotated from one extreme to the other a dc offset

will appear in the output. To remove this adjust RV11 next to the oscillator op-amp until there is no discernible shift over the entire range.

The only adjustment left to be made is to set the output level. To a certain extent this is a matter of choosing the units you like to work in. My choice was to terminate the output in 600 ohms then set the level pot so the maximum level out was +12 dBm or just a shade over 3 Vrms. 0 dBm is a very commonly used reference level in the audio industry and is exactly 1 mW into 600 ohms or, in volts 0.775 Vrms. The oscillator is capable of putting out up to 4 Vrms or +16 dBm.

At this stage the top screen can be screwed into place and the small cover screwed over the pot. It has to be put on afterwards but I imagine you've discovered that already! Screw on the top cover, attach knobs to the two pot shafts and the unit is ready to have the front panel marked. To calibrate the frequency pot set the knob on the pot so the knob pointer's rotation is symmetrical about the vertical axis, then set for far counterclockwise. Select the 900-11,000 Hz range and connect the output to your counter. The counter should read 900 Hz give or take. Mark this point with a pencil and label it. Then proceed up the scale in 1000 Hz increments marking and labelling each point. You will probably want finer calibration points between 1000 and about 4000 Hz but above that the scale starts to close up. The number of points you plot is largely a matter of taste and how you want the front panel to look.

Exactly the same procedure is followed for the level pot except that a level meter (or, at a pinch, an oscilloscope) is connected. If you're calibrating in dBm don't forget to terminate the output in 600 ohms. You can then permanently mark the front panel with an engraving tool or dry transfer lettering to give the unit a completed look. The switch banks also need to be labelled in some way too. When this is all done you've added another weapon to your arsenal of electronic weaponry! ●

Below. Bottom of the box showing the piece of sheet metal covering the area beneath the oscillator. Insulation tape is used to prevent shorting of tracks. Right. Aluminium completely covering the top of the board with a small bracket protruding down from the top screen stops the electrostatic field. (View from rear of box.)

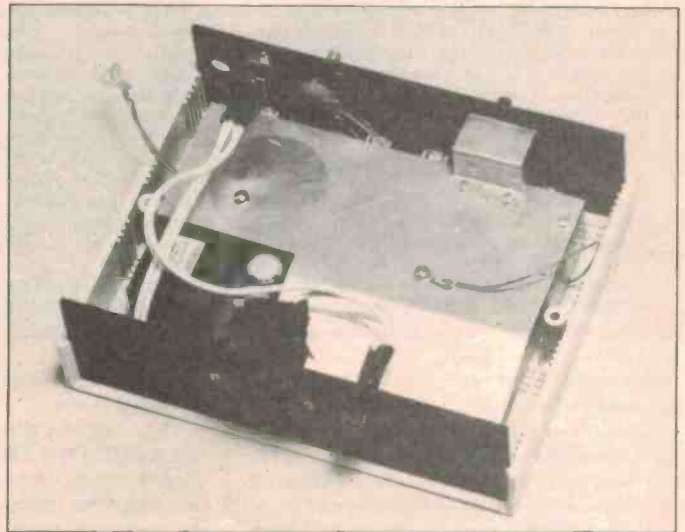
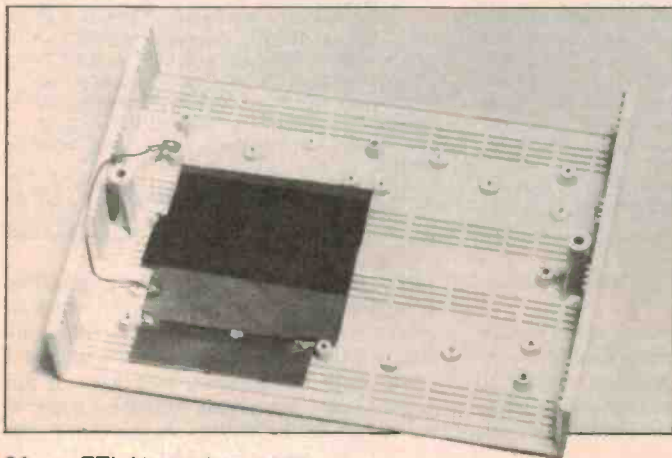



IBM COMPATIBLE CARDS

MULTIFUNCTION CARD
(384K RAM) Parallel, serial and game port. Plus battery backup clock. Cat. X18013 **\$429**

DISK CONTROLLER CARD
Controls 2 slimline drives. Cat. X18005 **\$149**

HIGH RESOLUTION MONOCHROME GRAPHICS CARD
Give your IBM real graphics capability. Cat. X18007 **\$249**

512K RAM CARD
(Includes RAM) Cat. X18015 **\$399**



KEYBOARD AND CASE
A stylish low profile case to give your system the professional look it deserves. Comes with an attached encoded, parallel output keyboard and provisions for 2 x 5 1/4" slimline disk drives. Cat. X11080 **\$249**



TELEPHONE ADAPTOR
• Australian plug to U.S. socket
• Length 10cm
• Cream colour cable. Cat. Y16026 **\$6.95**



MICROBEE ENHANCER 1

This brand new, totally amazing kit for the Microbee is a must for all Microbee owners/users!

- Most expansion units up to this time offered at best only one or other features; and this made it impossible to run, say, complex sound effects mingled with speech. The Enhancer 1 will do all this and much more as well. It is quite amazing how much has been shoe-horned into this compact unit. The Enhancer 1's many powerful features include:
- Two ATARI/COMMODORE/COLECO/SEARS type joystick inputs.
 - Two TRS COLOR COMPUTER type joystick inputs.
 - Allows the connection of Touch Pads, Paddles, Proportional Joysticks, Trackballs, Mice, temperature sensors, lights level sensors, transducers, etc. etc!
 - A 4 voice music/sound effects synthesizer.
 - A real time clock.
 - Unlimited vocabulary speech synthesizer (option).
 - Parallel printer interface (option)
 - A built-in speaker with volume control.
 - Listings of all necessary routines for use.
 - An impressive demonstration program package.
 - Compatible to all Microbees.
 - Digital recording and playback of speech and sound.
 - An 8 channel analog to digital converter with variable voltage or variable resistance type analog inputs and also user selectable resolution from 1 to 9 bits.
 - A digital to analog converter with selectable resolution from 1-8 bits.
 - Allows automatic data acquisition and logging.
 - 5 digital input lines, 4 digital output lines.
 - A voice input channel.
 - A 40 pin experimenter socket with all 8 analog inputs, 5 digital inputs, 4 digital outputs, 3.58 MHz buffered clock, sound output (so that you can play the sound effects through your HI FI), 3 high resolution voltage comparators. DAC output etc.
- The amazing Microbee Enhancer is available exclusively from Rod Irving Electronics. Cat. **\$149**

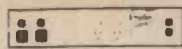

MAINS MUFFLER

Sudden mains disturbances can seriously affect your computer equipment, and stored data. Why risk it, when you can have a Mains Muffler, particularly when the cost of one failure is likely to be greater than the purchase price!

Specification:
Maximum total load: 1000w
4 AMP 250V 50Hz
First Stage: Single PI Section
Attenuation: 150KHz - 40dB
500 KHz - 65dB
10 KHz - 80dB
Second Stage: Dual T Section
Attenuation: 150KHz - 20dB
500 KHz - 60dB
10 KHz - 70dB
VDR Transient Suppression
Surge capacity 2000 AMP 8x20 uS
Cat. X110090 **\$249**



ADD ON HARD DISK DRIVE FOR IBM
Includes disk controller card. Available and installed free only at our city store.
Cat. X20010 **\$1,395**
10 M Byte **\$1,550**
20 M Byte **\$1,550**



APPLE COMPATIBLE SLIMLINE DISK DRIVE
Japanese Chiron mechanism. Normally \$225 This month \$185 (*Apple is a registered trademark)



IBM COMPATIBLE DISK DRIVE (NEW MITSUBISHI 4851)
Slimline 5 1/4" disk drive. Double sided, double density 500K unformatted, 40 tracks/side. Steel band drive system. Cat. C11901 **\$199**



MODEM PHONE
Check the features and the value for money of this stylish new modem phone.
• Speaker Phone with Built-in Amplifier for Detecting Busy Signal during communication.
• Auto/Manual Answer, Manual Original, Auto Disconnect.
• Carrier Detect Indication. 20 Memories (each with 18 Digits Capacity) for Auto-dialing.
• BELL 103 CCITT V21 Compatible.
• 300 BPS Full Duplex.
• Last Number Redial.
• Pushbutton Keyboard.
• Volume High or Low Control.
• FCC Approved Direct Connect.
• "In-use" Dialing Indicator.
Cat. X19105 **Normally \$199**
Save \$25! only \$174
(Not Telecom approved)



RITRON MULTI PURPOSE MODEM
Our New RITRON Multi Purpose Modem has arrived and has all the standards you require. Just check the Ritron's features:
• CCITT V21 300 Buad Full duplex
• CCITT V23 1200/75
• Bell 103 300 Full duplex
• Bell 202 1200 Half duplex
• Auto answer, auto disconnect.
Telecom Approval No. C84/371134 **\$379**
1200/75 BAUD RATE/BIT CONVERTER
For computers not capable of split baud rates. Buffers characters at 1200 and converts to 75 baud. Cat. X19105 **\$99**



RS232 MINI TESTER

- Male to female connections
 - All pin wired straight through
 - Dual colour LED indicates activity and direction on 7 lines
 - No batteries or power required
 - D. Transmits Data
 - D.S.R. Data Set Ready
 - R.D. Receive Data
 - C.D. Carrier Detect
 - R.T.S. Request to Send
 - D.T.R. Data Terminal Ready
 - C.T.S. Clear to Send
- Cat. X15656 **\$39.95**



GRAPHIC MOUSE SYSTEM
Now everybody can create superb computer graphics in minutes. Think of how much more professional your work could look with the 'Graphic Mouse'! An absolute must for Apple IIe users. Includes software and mouse. Cat. X17037 **only \$99**



APPLE COMPATIBLE CARDS
Printer Card Cat. X17029 **\$89**
Drive Card Cat. X17019 **\$95**
80 Column Card Cat. X17025 **\$109**
Speech Card Cat. X17009 **\$69**
Music Card X17011 **\$99**
Super Serial Cat. X17035 **\$129**
RGB Card Cat. X17039 **\$79**



PHOENIX 5
Suits Apple, Commodore, even your VCH!
• Pal and R.G.B.
• Normal Resolution
• 13" CRT Dot Pitch 0.65mm
• Horiz. Resol. 320 TV lines
• Vert. Resol. 560 TV lines
• Display Characters 1,000 Ch (40x25)
• 16 Colours (Pal)
• Green text display
Cat. X14522 **\$499**

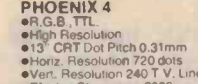

PHOENIX 4
• R.G.B. TTL
• High Resolution
• 13" CRT Dot Pitch 0.31mm
• Horiz. Resolution 720 dots
• Vert. Resolution 240 T.V. Lines
• Display Characters 2,000 Ch (80 x 25)
• 8 Display colours and intensity
• Green text display
Cat. X14520 **\$849**

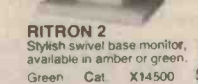

RITRON 2
Stylish swivel base monitor, available in amber or green.
Green Cat. X14500 **\$215**
Amber Cat. X14500 **\$219**



RITRON 1
Our most popular model in a steel cabinet to minimise R.F.L. interference.
Green. Cat. X14500 **\$199**
Amber Cat. X14500 **\$209**



NEW 180 CPS PRINTER!

KAITEC KAI 180 EX
Standard 80 column Dot Matrix Printer. High quality printing by NLO mode. 2K Buffer. High-speed, low-energy consumption 9 wire dot head gives: Printing speed 180 C.P.S.
Logic: seeking printing or incremental printing with high response, stepping motor. Use of fan-fold, roll or cut-sheet paper is possible with adjustable sprocket pin feed and friction feed. Both fixed and proportional character pitches are available. Emphasized and double print modes are possible. 9 graphic modes are available. 8 language international character font internalized.

SPECIFICATIONS:
Printing Type: Impact Dot Matrix
Maximum Printing Range: 203mm
Print Types: ASCII 96 Others 7 language
Character Format: Character Mode Standard 9 x 9 dots
NLO 18 x 20 dots Graphic Mode
Printer Modes: (a) Fixed pitch mode (b) Proportional pitch mode
Character Size: 2.42(H)x 1.99(W)
Printing Speed: 180 Character per sec. (pica)
Paper Feed Method: (a) Adjustable sprocket pin feed paper width 4-10 inch (pull through) (b) Friction feed paper width 4-8.5 inch
Paper Feed Pitch: (a) Standard pitch 1/6 inch (b) Min. pitch 1/216 inch
Ink Ribbon: Special ribbon cassettes
Power Requirements: 240V +10% 50 Hz
External Dimensions: 408(W) x 314(D) x 96(H)mm
Weight: Approximately 7.2kg
Ambient Environment: (a) 5-C-40C (less than 80% RH) (b) Horizontal operating surface
Reliability: (a) MTBF 3x10⁶ lines (excluding print head and ink ribbon) (b) Print head life: 100x10⁶ characters (c) Ink Ribbon life: 2.5x10⁶ characters
Interface: Parallel interface 8-bit parallel (Conforms to Centronics)
Cat. C20020 **Normally \$690**
Now only \$590



JUKI PRINTER
Professional daisy wheel printer 18CPS full incremental mode Diablo 630 emulation. Large range of daisy wheels. 8K internal buffer available. Cat. C20040 **\$785**



ENP 1091/FT 5002
• Near letter quality mode.
• 120 C.P.S.
• Down loadable character set.
• Graphics (Italics, emphasized, etc.)
Cat. C20030 **\$499**



BX RANGE OF PRINTERS!
BX 100 **\$370**
BX 130 **\$440**
BX 130W (15") **\$595**



READY MADE CABLES
Serial to serial. 2m
Cat. P19011 **\$24.95**
Parallel centronics to centronics. 2m
Cat. P19013 **\$29.95**



COMPUTER PAPER
Top quality at a very affordable price! Blank 11 x 9 1/2", 2,000 sheet, quality 60 gm bond paper. Cat. C21001 **\$34.50** **\$29.50**



XIDEX LOOK!

3 1/2" XIDEX DISKETTES!
Yes, that's right, we now have 'hard to get' 3 1/2" diskettes!
Cat. C12600 5/5 pack of 10 \$65



5 1/4" FLOPPY DISK SPECIALS!

XIDEX 1-9	10+
S/S D/D	\$31.00 \$29.00
Cat. C12401	
D/S D/D	\$38.00 \$36.50
Cat. C12410	
VERBATIM DATALIFE S/D/D/D	\$27.95 \$26.95
Cat. C12501	
D/D/D/D	\$39.95 \$37.95
Cat. C12504	
VERBATIM VALULIFE S/D/D/D	\$24.95 \$22.95
Cat. C12421	
D/D/D/D	\$31.95 \$29.95
Cat. C12425	



MINI DISK STORAGE BOX
Holds up to 30 x 5 1/4" diskettes. Cat. C16020 **\$16.95**



DISK STORAGE BOX
Holds over 50 disks! Cat. X16075 **\$34.50** **\$29.00**



COMPUTER CASSETTES
Quality 20 minute tapes
Cat. D11141
1-9 **\$1.50** **\$1.40** **\$1.20**



RITRON (ZETA) DATASETTE
For data loading and saving, this Micron Datasette suits most home computers and features tape counter, monitor function for audio verification and slide volume control for output level. Cat. C14900 **\$24.95**

TELECOMMUNICATION EXTENSION LEADS
Cat. Y16010 5m **\$12.50**
Cat. Y16012 10m **\$14.95**

IBM COMPATIBLES from \$1,495!



Incredible deals to suit everyone including our special package deals!

256K RAM: Colour Graphics, Disk Controller Card, 1 parallel port, 2 disk drives and 3 months warranty. **only \$1,495**

640K RAM: Colour graphics, Multifunction Card, Disk Controller Card, 2 serial and 1 parallel ports. 2 disk drives and 3 months warranty. **only \$2,100**

256K PACKAGE DEAL: Includes Colour Graphics Card, Multifunction Card, Disk Controller Card, 2 serial and 1 parallel ports. A 120 C.P.S. printer and a monochrome monitor and 3 months warranty! **only \$2,400**

640K PACKAGE DEAL: Includes Colour Graphics Card, Multifunction Card, Disk Controller Card, 2 serial and 1 parallel ports. A 120 C.P.S. printer, a monochrome monitor and 3 months warranty! **only \$2,500**

*IBM is a registered trademark.



REPLACEMENT KEYBOARDS

- For Apple
- 42 single key BASIC command
- One chip custom design encoder
- Made by ALPS, life time. 10 million operations
- Dimension: L340xW110xH42mm
- Cat. KC2002 **\$79.50**

- For Apple
- 45 built in function keys, BASIC and CP/M command.
- 45 user defined keys
- Built-in shift lock
- Made by ALPS, life time. 10 million operations
- Dimension: L340xW130xH42mm
- Cat. KC2002 **\$99.00**



ROD IRVING ELECTRONICS
425 High Street, NORTHCOE, 3070 VICTORIA, AUSTRALIA
Phone (03) 489 8866
48 A'Beckett St. MELBOURNE, 3000 VICTORIA, AUSTRALIA
Ph. (03) 663 6151
Mail Order and correspondence: P.O. Box 620, CLAYTON 3168
TELEX: AA 151938



MAIL ORDER HOTLINE (03) 543 7877 (2 lines)

POSTAGE RATES
\$1-\$9.99 \$2.00
\$10-\$24.99 \$3.00
\$25-\$49.99 \$4.00
\$50-\$99.99 \$5.00
\$100-\$199 \$7.50
\$200-\$499 \$10.00
\$500 plus \$12.50
This is for basic postage only. Comet Road freight, bulky and fragile items will be charged at different rates. Certified Post for orders over \$100 included "free"! Registered Post for orders over \$200 included "free"!
Errors and Omissions Excepted.

Parallelism soon

IBM's research division is designing a research tool for advanced computer science studies — an experimental, highly parallel computer.

The initial purpose is to gauge the usefulness of large-scale parallelism — many processors working on a single task — in solving a variety of complex problems. At present, most highly parallel machines work on a single class of problems.

The machine — the RP3, or Research Parallel Processor

Project — is being designed as a 64-processor unit to validate the concept and to test its ability to do a variety of tasks. By interconnecting eight of the 64-processor units, RP3 will be extendible to 512 processors, linked in parallel and connected to as many as two billion characters of main memory.

The 512 processor version of the RP3 should operate at a sustained speed of approximately one billion instructions per second in its maximum configuration and perform floating-point operations in bursts of 800 million per second.

The RP3 continues parallel processing research that began

at IBM in 1979. This work has produced special-purpose parallel machines used within IBM for basic research and for computer design automation. It is one of several current IBM projects aimed at understanding computing systems with a number of processors connected in parallel.



Viatel graphics card

Apple users can now view Viatel in full colour. Until now it has not been possible to view these systems on an Apple in their full colour set. The solution is the Interlink Viatel Graphics Terminal System, which comprises both software and hardware.

The software is dual purpose in that it decodes the Viatel information and then displays the full colour image as well as linking up with the Viatel data base via its own communication software. This software configures an Apple Superserial card or the Sercom II serial card to com-

municate in the required split baud rate mode; receiving at 1200 bps and transmitting at 75 bps. Some further features include auto ID code transmission and the ability to save-recall and print pages.

The hardware, a plug-in card, bypasses the Apple's graphics circuitry and generates its own graphics in a total of 16 colours. The card has 16K of on-board RAM.

For more information contact Interlink, 171 Dorcas St, South Melbourne, Vic 3205. (03)699-4177.

Computerised music notation

Oxford University has introduced the Oxford Music Processor (OMP), a computer program intended to provide professional and amateur musicians with an easy method of music notation. The program is claimed to be of such high standard that it will change the way in which the music publishing industry prepares music notation for printing.

The OMP carries out almost all the tasks which have traditionally required painstaking and slow manual arrangement of music notation on the page. It takes the various rules of notation design into consideration and arrives at a finished product within a tenth of the time of existing methods.

Richard Vendome of the uni-

versity's Faculty of Music developed the program while working on his post-graduate thesis, which involved the enormous job of transcribing 400 keyboard works from 17th century manuscripts into modern notation. Over several years he developed software for the encoding, editing, and printing of this music.

So far nearly 10,000 pages of music have been processed and many of them have now been published.

The OMP has been successfully used by musicians with no knowledge of computing and by young children. Vendome says the essentials can be learned in less than an hour. Music is input on a standard computer keyboard by rhythm and then by

pitch, line by line. Four-part music, for example, is input by eight successive 'sweeps' each at roughly the speed it would take to play the music. The 'Minute Waltz' might take around eight minutes to process whereas traditional methods would take hours.

An important stage in the development of the OMP has now been reached — the design of the system for economical use by home computer users. With funds from the British Technology Group and support from Oxford University Press, Vendome has been awarded a three year research appointment by the university's Faculty of Music to develop the system for this use. At the same time he is adding other facilities such as word

underlay and exploring the possibilities of using new economical laser printers.

The OMP will enable publishers, composers, arrangers, professional music copyists, academic institutions and educationists to transform musical ideas into high quality print without going to the trouble or expense of hand-copying or engraving. Additionally, separate instrumental parts may be automatically extracted and printed from a full score held in memory.

The program will be published by Oxford University Press in 1986, in the form of a case-bound user's guide and reference manual with a suite of programs on floppy disks.

BRIEFS

Printer interface

Thinking Systems has released the Champion high performance printer interface for the Apple II. The Champion's features include screen dumps and enhanced printing. For more information contact Thinking Systems at 29 Belmore St, Surry Hills, NSW 2010. (02)211-0944.

PC add on

Dindima has released the Sky Scout-PC Video Image Processor for the IBM-PC/XT. It's a video frame grabber that can digitise, process and display video signals, allow the IBM-PC or PC compatible to process the image data and display the results on a black and white monitor. For real-time image processing Sky Scout can be connected directly through auxiliary ports to the SKY320-PC fixed-point array processor. Video data is digitised and displayed at 8 bits per pixel. It has 256K of memory to handle 512 x 512 x 9 pixel resolution. For further information contact The Dindima Group Pty Ltd, PO Box 106, Vermont, Vic 3133.

Optical modem

Rockwell-Collins has released the Codenoll Fibre Optic Modem. It is compatible with all types of fibre optic cable and available with 830 nm or 1300 nm transmitters and receivers. For more information contact Rockwell-Collins, Maroondah Hwy, Lilydale, Vic 340. (03)726-0766.

Low-cost PC graphics system

A new PC-based graphics system that brings powerful CAD capabilities within the cost range of many small companies has been launched by Auto-trol Technology. Called the Advanced Personal Workstation, APW/15, it is an IBM-PC/AT-based system costing between \$A30,000 to \$A45,000. For more information contact Auto-trol at 1603 Northpoint, 100 Miller St, North Sydney, NSW 2060. (02)923-2977.

Self-powered optic modem

The IFS M232 is a small fibre optic modem designed to plug directly on to a standard 25-pin D connector RS232 interface. It transmits asynchronous signals in the range dc to 100K bps up to several kilometres of duplex optical cable. This cable can use either industrial type 100/140 fibre or low cost telecommunications type 50/125 fibre. For more information contact Integral Fibre Systems Pty Ltd, 2 Thomas St, Chatswood, NSW 2067.



Amstrad gets 128K RAM

AWA-Thorn has launched Amstrad's new model the CPC 6128, a 128K unit with a built-in 3" disk system and a number of enhancements to BASIC and CP/M PLUS operating system to make the most of the integrated disk system.

The CPC 6128 will come with a choice of monitors and will retail from around \$800 with the green screen, and from around \$1000 with the colour monitor. The unit comes complete with CP/M PLUS, GSX and LOGO,

user manual and instruction program.

Virtually all existing CPC 464 software will run on the new 6128 — plus a large proportion of the existing CPM80 software base of over 5000 programs. The new CPC 6128 has a built-in cassette interface so that existing tape based software can be loaded — although most users will obviously prefer to use the disk alternatives where available.

Queensland computer expo

The latest in computer and software products will be on show at Computer Expo '85 in Brisbane.

Visitors will be able to see products from IBM, Hewlett-Packard, Wang, Data General, NEC, Televideo, Epson, Ericsson, Apple, Tandy, Commodore, Microbee and others.

Computer Expo '85 is the one opportunity each year in Queensland for people to test

drive an array of computers, software and peripherals side by side at the one location.

The Queensland Computer Expo '85 runs from Wednesday 6 to Saturday 9 November at the Crest International Hotel, Roma St, Brisbane. Further information can be obtained from Robert Woodland on (07)372-3233.

Long distance net connects Acorns and BBCs

Acorn/BBC networks can now be extended over any distance with SuperNet, a new network bridge released in Australia by Barson Computers Australasia.

The new product enables networks to be extended beyond 1.4 kilometres and still communicate at a full 190 kilo-baud. This will be of interest to schools, the main users of Acorn/BBCs.

The first Australian network bridge has been installed at John Paul College, Frankston Victo-

ria, and has enabled the senior and junior schools' networks to be linked.

The college's junior school was previously too far away to have access to the senior school's facilities, but now both schools have instant access to the other's facilities at high speed across 2.7 kilometres of cable.

For further technical information contact Barson Computers on (03)419-3033.

Vic 20 lives on

Dear Sir,

It may interest you to know that, despite the commercial end of the very popular Commodore VIC-20 Colour Computer, there are still a great number of enthusiastic users remaining. So to support this large group of users, we have recently decided to continue publication of the Association's magazine 'VIC'.

'VIC' is now in its third year of publication with 16 bi-monthly issues under its belt. The magazine sells to subscribers and retail customers for \$2.

The Association also distributes

public domain software for a small copying fee and maintains a library of around 900 programs. Despite the end of Association meetings, we still provide services to members such as free advertising, free software consulting and special deals on books, disks/tapes and hardware.

For more information write to ACT Vic-20 Users Association, 25 Kerferd St, Watson, ACT 2602. (062)41-2316.

Yours sincerely,
Chris Groenhout,
Editor, 'VIC'

at the leading edge

NEW "SHORT SLOT" HARD DISK CONTROLLER.

Western Digital's **WD1002S-WX2** supports ST506/412 interface drives of any configuration up to **1,024 cylinders** and **16 read/write heads**. This **8" x 3.85"** form factor board is **IBM PC[®], XT[®] plug compatible** and can control up to two drives which need not be of the same capacity or configuration. **70 and 85 MByte** high performance drives from **Vertex** can now be easily accommodated to boost overall system performance. Data transfer can be either programmed **I/O or DMA**.

INTERDYNE'S 20 MBYTE TAPE BACKUP LINKS TO FLOPPY PORT.

Designed to provide cost effective and rapid archiving for **IBM's AT** range of PCs, **Interdyne's ID1020** joins their popular **ID1010**, which is becoming the de facto standard in 10 MByte streamers. storage for both drives may be either **mirror** or on a **file by file** basis. In the case of a total hard disk failure both the **ID1020** and the **ID1010** can be used in a **random access read/write mode** just like a **super capacity floppy drive**.

NEW SOFTWARE ALLOWS PCs TO ACCESS X.25 NETWORKS.

Western Digital and **TITN, Inc.** have developed, **FLEX.25**, a software package to link IBM PCs and compatibles using the X.25 network protocol. **FLEX.25**, together with the **WD4025** controller board, manages the complete communication functions of a packet data network at the PC level. The network software has already been certified for direct connection to major U.S. and European networks.

SPEECH RECOGNITION AND SYNTHESIS ADD-ON FOR IBM PC.

General Instrument Microelectronics designed the **VRSM1000** as an evaluation tool for speech recognition and synthesis using the **SP1000/VRS1000 chip set**. Software which accompanies the board allows for synthesis of several words stored in RAM, recognition of digits and phrases with voice confirmation and a graphics demonstration of the uses and parts of the **VRSM1000**. Applications will include voice dialling of telephones, robotics, assistance for the handicapped and security control.



daneva australia pty ltd

66 Bay Rd. Sandringham, Vic. 3191
P.O. Box 114, Sandringham, Vic. 3191
Telephone: 598-5622 Telex: AA34439

Suite 28, 47 Falcon Street
Crows Nest, NSW 2065
Telephone: 957-2464 Telex: AA20801

Distributors

Adelaide: DC Electronics (08) 223-6946
Brisbane: Baltec (07) 369-5900

DAN003

VZ-300 NOW ONLY \$99!!



And It Gives You So Much More!

It's unbelievable! The amazing VZ-300 colour computer is at its lowest price ever!! Whether you're a computer expert or a first-timer, the VZ-300 has plenty to offer.

Now, for under \$100 there's a computer that will expand to meet your needs. With 18K RAM memory — expandable to an amazing 32K, high resolution graphics, and optional disk drive, printer and a host of extras available: the VZ-300 is unbeatable value!

Because it uses the most popular computer language in the world, 'Microsoft Basic', there's an incredible range of software available; games, business/management, education ... there's dozens to choose from!

Look at these fantastic specifications!:

CPU. — Z80A running at 3.5MHz

Memory. — 16K Basic ROM

RAM — 18K expandable to 32K

Keyboard — 46 key full stroke with automatic repeat key.



Graphics — 32 columns x 16 lines. 128 x 64 dot (8 colour)/64 x 32 dots (9 colour) selectable colours.

With an unbelievable range of add-ons available your VZ-300 will give you years of service! When good value isn't good enough — DSE makes it even better! Cat X-7300

Dick Smith Electronics Pty Ltd

COMPUTERSTOP



Screen Dump

L. Badham,
Frenchs Forest, NSW 2086

Have you ever wanted to save a screen display on to tape so that later you can re-establish the display just by replaying the tape? This program does just that, and will save any screen display, whether ASCII characters, lo-res or hi-res graphics, or PCG characters.

The program must first be loaded into a safe part of memory (3000H for a 16K Microbee) either by using the source code listing and EDASM, or POKEing directly from BASIC. To use the program insert a USR(12288) instruction in the parent program after the instructions which produce the screen display to be saved. Start the tape recorder on RECORD and run the parent program. The cursor will indicate when saving is complete.

To re-display the screen, simply type USR(12324) and start the tape recorder on PLAY (after rewinding!). The screen will first display inverse characters and subsequently these will change one by one to the original pattern.

The program works by saving the contents of memory locations F000H to FFFFH, using the BASIC ROM routine at 8018H which sends one byte to tape. Of the above locations, F000H to

F3FFH are the screen positions, and F800H to FFFFH contain the PCG information. (It is not really necessary to save F400H to F7FFH, but it's easier!) On playback the routine at 8012H reads each byte from the tape and loads it back into its original memory location. The screen positions are first loaded with the default PCG characters, which are inverse characters, and these gradually change as they are re-programmed from the tape.

Of course, if you don't like this happening you could re-write the program to work down from FFFFH to F000H, in which case you won't see anything happen for a while, and then the correct pattern will appear, starting at the bottom right hand corner.

The Write program sends a header of 64 zero bytes, followed by a start signal of 1. The Read program looks for at least 8 zero bytes followed by a 1.

The program as listed will save and load at 1200 baud, which takes 40 seconds. For 300 baud, if using the source code listing, change LD A,1 to LD A,4 at lines 110 and 300, and if using the BASIC listing change the second byte of data in lines 130 and 160 from 1 to 4.

ADDR	CODE	LINE	LABEL	MNEM	OPERAND		
3000	00100			ORG	3000H		
	00101						
	00102			ISET FOR 1200	BAUD		
	00103						
3000	3E01	00110	WRITE	LD	A,1		
3002	32E900	00120		LD	(0E9H),A		
	00121						
	00122			ISEND 64 ZERO BYTES			
	00123						
3005	0640	00130		LD	B,64		
3007	3E00	00140	LOOP3	LD	A,0		
3009	CD1000	00150		CALL	0010H		
300C	10F9	00160		DJNZ	LOOP3		
	00161						
	00162			IIDENTIFY START			
	00163						
300E	3E01	00170		LD	A,1		
3010	CD1000	00180		CALL	0010H		
	00181						
	00182			ISAVE CONTENTS OF F000H TO FFFFH			
	00183						
3013	010010	00190		LD	BC,4096		
3016	2100F0	00200		LD	HL,0F000H		
3019	7E	00210	LOOP1	LD	A,(HL)		
301A	CD1000	00220		CALL	0010H		
301D	23	00230		INC	HL		
301E	0B	00240		DEC	BC		
301F	70	00250		LD	A,B		
3020	81	00260		OR	C		
3021	20F6	00270		JR	NZ,LOOP1		
3023	C9	00280		RET			
	00290						
	00291			ISET FOR 1200	BAUD		
	00292						
3024	3E01	00300	READ	LD	A,1		
3026	32E900	00310		LD	(0E9H),A		
	00311						
	00312			ILOOK FOR 16 ZERO BYTES			
	00313						
3029	0610	00320	FALSE	LD	B,16		
302B	CD1200	00330	LOOP4	CALL	0012H		
302E	FE00	00340		CP	0		
3030	20F7	00350		JR	NZ,FALSE		
3032	10F7	00360		DJNZ	LOOP4		
	00361						
	00362			ICHECK BYTES ARE ZERO			
	00363						
3034	CD1200	00370	LOOP5	CALL	0012H		
3037	FE00	00380		CP	0		
3039	20F9	00390		JR	Z,LOOP5		
	00391						
	00392			IFIND START			
	00393						
303B	FE01	00400		CP	1		
303D	20EA	00410		JR	NZ,FALSE		
	00411						
	00412			ILOAD F000H TO FFFFH			
	00413			IWITH ORIGINAL CONTENTS			
	00414						
303F	010010	00420		LD	BC,4096		
3042	2100F0	00430		LD	HL,0F000H		
3043	CD1200	00440	LOOP2	CALL	0012H		
3048	77	00450		LD	(HL),A		
3049	23	00460		INC	HL		
304A	0B	00470		DEC	BC		
304B	70	00480		LD	A,B		
304C	81	00490		OR	C		
304D	20F6	00500		JR	NZ,LOOP2		
304F	C9	00510		RET			
0000	00520			END			
0000	Total errors						
LOOP2	3045	LOOP5	3034	LOOP4	302B	FALSE	3029
READ	3024	LOOP1	3019	LOOP3	3007	WRITE	3000
00100	FOR A=12288 TO 12367						
00110	READ B:POKE A,B						
00120	NEXT A						
00130	DATA 62,1,50,233,0,6,64,62,0,205,24,128,16,249,62,1						
00140	DATA 205,24,128,1,0,16,33,0,240,126,205,24,128,35						
00150	DATA 11,120,177,32,246,201						
00160	DATA 62,1,50,233,0,6,16,205,18,128,254,0,32,247,16						
00170	DATA 247,205,18,128,254,0,40,249,254,1,32,234,1,0,16						
00180	DATA 33,0,240,205,18,128,119,35,11,120,177,32,246,201						
00190	END						

CONTRIBUTORS PLEASE NOTE

All contributions to this column should be accompanied by a listing of the program from a printer. Hand written or typed listings are not acceptable.

There are two reasons for this. The first is that a listing from your computer gives us some guarantee that you have the listing correct.

Secondly, if you present us with a neat final copy of your program we can use photographic techniques to reproduce it in the magazine, without risk of errors.

Contributors will be paid \$20 for each item published in this column. Submissions must be original programs which have not been previously published. You may send as many programs as you wish with the accompanying declaration.

"I agree to the above terms and grant *Electronics Today International* all rights to publish my program in ETI Magazine or other publications produced by it. I declare that it has not been previously published and that its publication does not violate any other copyright."
*Breach of copyright is now a criminal offence.

Name

Signature Date

Address

Postcode

Tennis

P. Pinches, Heathcote, NSW
2233

For tennis you will need a joystick! Tennis is for two players one using the keyboard and the other using the joystick. The keys to use on the keyboard are as follows: 'Q' up, 'A' down, 'I' left, 'J' right.

```

00090 REM TENNIS
00095 REM WRITTEN BY PAUL PINCHES
00100 LET E=0:LET F=120
00110 CLS:LORES
00120 PRINT"DEGREE OF GAME(!=EASY TO 3=HARD)"
00130 INPUT"CHOICE",K
00140 IF K=1 THEN LET M=2:N=1:O=3:GOTO 1
00150 IF K=2 THEN LET M=0:N=1:O=2:GOTO 1
00160 IF K=3 THEN LET M=0:N=0:O=1:GOTO 1
00170 GOTO 120
00180 CLS
00190 FOR X=0 TO 127:SET (X,0):SET(X,47):NEXT X
00200 FOR X=0 TO 47:SET (0,X):SET(127,X):NEXT X
00210 A=2:B=1:C=23:D=23
00220 X=INT(RND*63)*2
00230 Y=INT(RND*47)
00240 SET (X,Y):RESET(X-A,Y-B)
00250 IF(X=2) OR (X=126) THEN LET A=-A
00255 REM Z=POINT(X,Y):IF Z=0 THEN 260 ELSE 330
00260 IF X=126 THEN LET L=L+1:PLAY 9
00270 IF X=2 THEN LET R=R+1:PLAY 9
00280 IF(L=11) OR (R=11) THEN 500
00290 IF(V=1) OR (V=46) THEN LET B=-B
00300 X=X+A:Y=Y+B
00310 Z=POINT (X,Y):U=POINT (X,Y)
00320 IF Z=0 AND U=0 THEN 350
00330 PLAY 24
00340 RESET (X-A,Y-B):A=-A:X=X+A
00350 LET P=PEEK(258)
00360 IF P=1 THEN LET C=C-1
00370 IF P=17 THEN LET C=C+1
00380 IF P=29 THEN PLOT F,1 TO F,46:GOTO 44
00390 IF P=27 THEN PLOT F,1 TO F,46:GOTO 44
00395 Z=POINT(X,Y):IF Z=0 THEN 400 ELSE 330
00400 IF E>126 THEN LET E=125
00410 IF E<1 THEN LET E=2
00415 Z=POINT(X,Y):IF Z=0 THEN 420 ELSE 330
00420 OUT 1,255:U=IN(0)
00430 IF U=254 THEN LET D=D+1
00440 IF U=253 THEN LET D=D-1
00450 IF U=251 THEN PLOT F,1 TO F,46:F=F-4
00460 IF U=247 THEN PLOT F,1 TO F,46:F=F+4
00470 IF F>126 THEN LET F=125
00480 IF F<1 THEN LET F=2
00490 IF C=3 THEN LET C=4
00495 LET Z=POINT(X,Y):IF Z=0 THEN 500 ELSE 330
00500 IF C=44 THEN LET C=43
00510 IF C=3 THEN LET D=4
00520 IF C=44 THEN LET D=43
00530 SET(E,D+M):SET(E,C+M):SET(E,C+M):SET(E,C+M)
00540 SET(F,D+M):SET (F,D+M):SET(F,D-N):SET(F,D-N)
00550 RESET(F,D-O):RESET(F,D+O)
00560 RESET(E,C-O):RESET(E,C+O)
00570 CURS 25+64:PRINT L,R
00575 Z=POINT (X,Y):IF Z=0 THEN 240 ELSE 330
00580 GOTO 240
00590 CLS:GOSUB 620:INPUT"AGAIN(Y/N)";Z1
00600 IF Z1#"" THEN RUN
00610 END
00620 IF L=11 THEN PRINT "THE PERSON ON THE KEYBOARD WON" ELSE IF R=11 THEN PRINT "PERSON USING THE JOYSTICK WON"
00630 RETURN

```

Cannon

K. Doan,
Mt Lawley, WA 6050

This is a game in which you try to hit a randomly drawn target. You are required to set the angle at which a projectile is fired. The trajectory is affected by both gravity and random winds. Sound effects have been added to make the game more realistic.

```

00010 REM *** CANNON ***
00020 REM *** Khanh Doan ***
00030 REM
00040 REM *** Sound Routine ***
00050 FOR I=15000 TO 15024:READ J
00060 POKE I,J:NEXT I
00070 DATA 245,229,103,96,76,69,62,64,211,2
00080 DATA 16,254,69,62,0,211,2,16,254,13
00090 DATA 32,239,225,241,201
00100 REM Wind (W1), Initial vel of Projectile (V1)
00110 W=INT(RND*30)-15:V1=90
00120 W1=FLT(W)/50
00130 SD 4:CLS:HIRES
00140 CURS 10,5:PRINT"Wind "ABS(FLT(W))":CURS 15,6
00150 IF W<0:PRINT"---"ELSE PRINT"---"
00160 REM Target Position
00170 A=INT(RND*256)+241:B=INT(RND*247)
00180 GOSUB 380:CURS 0:INPUT"Firing Angle:"A1
00190 REM Breaks Into Vert & Horz components
00200 A1=A1*3.142/180:S1=SIN(A1)*V1:C1=COS(A1)*V1
00210 CLS:HIRES:GOSUB 380
00220 REM Plot Trajectory
00230 FOR X=0 TO A+16 STEP 3
00240 T1=FLT(X)/C1:C1=C1+1+W1
00250 Y=INT(T1*(S1-4.9*T1)):IF Y>255 THEN 300
00260 IF Y<0:NEXT*X 310
00270 REM Hit?
00280 IF X>=A AND X<A+16 AND Y>=B AND Y<B+9:NEXT*X 320
00290 SET X,Y
00300 L=USR(15000,X/3+4097):NEXT X
00310 CURS 0:PRINT"You missed!";GOTO 350
00320 FOR X=1 TO 50:L=USR(15000,INT(RND*255)+1024)
00330 NEXT X
00340 CURS 0:PRINT"You've got it! Well done!";
00350 A1$=KEY:IF A1$=""THEN 350
00360 GOTO 110
00370 REM Draw Target
00380 PLOT A,B TO A+14,B+9 TO A,B+9 TO A,B
00390 RETURN

```

Firing Angle: 45

You missed!

Wind 11.
←---

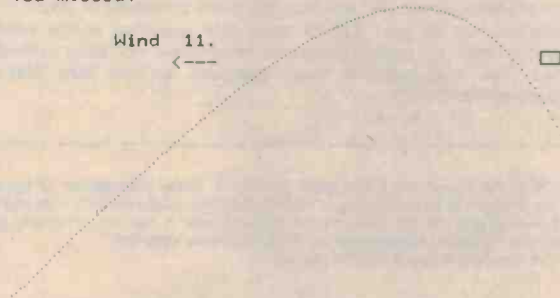

The Artistic Vic

T.J. Threlfall,
Shenton Park, WA 6008

This program uses the Commodore 1520 printer-plotter with a Vic-20 or C-64. No memory expansion is needed. There are a lot of time-consuming if...then statements, some of which could be removed if one wanted to settle for an identical picture each time the program was run. These statements are needed to prevent error conditions when a point outside the chosen picture border results from the calculations. The bulk of the drawing is composed of a set of sine waves, with the stars and 'moon' being in semi-random positions.

The major achievement for the production of this drawing is the non-drawing of lines which seem to be behind features in the foreground. This is done using the DIM statement of line 40 (using K%(x), ie an array of integer variables, which saves a lot of memory). The variables are initially set to zero (line 50), then updated as lines are drawn: for any x value, K%(x) becomes the progressive maximum y

value so far plotted for that x value, and if any succeeding y value is smaller (line 80), the pen will move to the relevant point rather than draw to it, ie line 120 is bypassed. For those without a 1520 plotter the print command using "M" results in a move with the pen off the paper; the same command using "D" instead results in the same move with the pen on the paper.

Give the thing whatever name you see fit in line 430. Whether you use this for drawing Christmas cards or nudes, don't hold your breath while you watch it. This version takes over half an hour at last check.

If it has spurred your imagination but you're impatient like the rest of us, try it on a screen graphics program (eg "Graphvics") as it's faster. Also quieter.

If any reader wants a copy I can send a cassette version for \$5, barring a jump in cassette prices, if they'll send me their details. Send SSAE to 22A Jones St, Shenton Park, WA 6008.

```

10 REM**THE ARTISTIC VIC**
20 OPEN1,6,1:OPEN2,6,2:OPEN10,6,0:PRINT#
2,0
30 PRINT#1,"D";476,0:PRINT#1,"D";476,300
:PRINT#1,"D";0,300:PRINT#1,"D";0,0
40 DIMK%(476)
50 FORX=0TO475:K%(X)=0:NEXTX
60 A=00:B=15:C=-10:S=1.3:F=065:RR=235
70 FORX=0TO475STEP02:E=(X+A+075)/476*2**
XS
80 Y=B*SIN(E)+C:IFY<K%(X)THEN130
90 IFY>300THENY=300
100 IFY<0THENY=0
110 K%(X)=Y
120 PRINT#1,"D";X,Y
130 PRINT#1,"M";X,Y:NEXTX
140 PRINT#1,"M";0,0
150 IFA<=175THEN170
160 B=B*1.6:S=S*3.3:C=C-1:A=A+2
170 IFA>RRTHEN240
180 IFA=F THENA=A+5:B=B*0.8
190 IFA>F THEN220
200 A=A+5:B=B*1.20
210 GOTO70
220 A=A+5:B=B/1.25:C=C+3
230 GOTO70
240 FORX=0TO475STEP02:K%(X+1)=K%(X):NEXT
X:Z=0
250 IFZ>20THEN340
260 Q=INT(RND(1)*450)+2
270 Y=INT(RND(1)*295)
280 IFY>K%(Q)THEN300
290 GOTO260
300 PRINT#1,"M";Q,Y:PRINT#1,"D";Q+4,Y:PR
INT#1,"D";Q+2,Y+3
310 PRINT#1,"M";Q+4,Y+2:PRINT#1,"D";Q,Y+
2:PRINT#1,"D";Q+2,Y-1
320 Z=Z+1
330 GOTO250
340 R=13:PRINT#1,"M";Q+20,Y+R:Q=Q+20:IFY
+R>=300THENPRINT#1,"M";Q,300
350 FORT=0TO2**STEP.1
360 DD=R*SIN(T)+Q:GG=R*COS(T)+Y
370 IFGG>=300THEN410
380 IFDD>=475THENPRINT#1,"M";475,GG:GOTO
410
390 IFDD<=00RGG<K%(DD)THEN410
400 PRINT#1,"D";DD,GG
410 NEXTT
420 PRINT#1,"M";0,-30
430 PRINT#10,"                UNTITLED 1984"
440 CLOSE10:CLOSE1:CLOSE2:END
    
```

CONTRIBUTORS PLEASE NOTE

All contributions to this column should be accompanied by a listing of the program from a printer. Hand written or typed listings are not acceptable.

There are two reasons for this. The first is that a listing from your computer gives us some guarantee that you have got the listing correct.

Secondly, if you present us with a neat final copy of your program we can use photographic techniques to reproduce it in the magazine, without risk of errors.

However, if you present us with a scrawl done on the back of someone's old fag packet it needs to be manually typed twice here, with consequent increase in labour on our part and increase in the probability of errors.

Contributors will be paid \$20 for each item published in this column. Submissions must be original programs which have not been previously published. You may send as many programs as you wish with the accompanying declaration.

"I agree to the above terms and grant *Electronics Today International* all rights to publish my program in ETI Magazine or other publications produced by it. I declare that the attached program is my own original material, that it has not previously been published and that its publication does not violate any other copyright."
* Breach of copyright is now a criminal offence.

Name

Signature Date

Address

Postcode

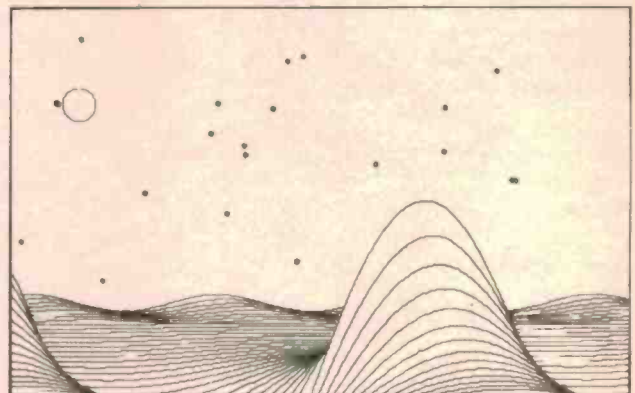

UNTITLED 1984

Lava River

D. Mason, Kilsyth Vic

All the instructions for Lava River are in the game. The idea is that you are tip toeing across a hot molten river of lava, and must use the joystick to position your feet on the floating islands of pumice.

```
100 REM* LAVA RIVER BY DAVID MASON (C)
110 POKE 36879,8 : PRINT "[CLEAR] [WHITE]
[9DOWN] [5RIGHT] LAVA RIVER" : FOR X
=1 TO 2000 : NEXT
120 POKE 36879,42 : C=30720
125 PRINT "[CLEAR] [2DOWN] [1RIGHT] YOUR
MISSION IS TO [3SPACES] [1DOWN] MAKE
DELIVERIES "
130 PRINT "[1DOWN] ACROSS THE MOLTEN
[5SPACES] [1DOWN] LAVA RIVER."
140 PRINT "[1DOWN] USE THE JOYSTICK TO
[1DOWN] TIP-TOE ON THE HOT"
145 PRINT "[1DOWN] FLOATING ROCKS OF
[1DOWN] PUMICE."
150 PRINT "[1DOWN] YOUR SKILL IS THE
[1DOWN] LIMIT."
155 PRINT"[2DOWN] PRESS FIRE TO BEGIN."
160 K=37151 : GOTO 390
170 PRINT "[CLEAR]" : H=7747 : GOSUB 340
: H=7945 : GOSUB 340 : H=8143 :
GOSUB 340
180 A(0)=32 : A(1)=160 : A(2)=128 : B$=
"[2RIGHT]" + CHR$(20)
190 P=8162-INT(RND(1)*20) : POKE P,193 :
R=9 : Q=0 : TI$="000000"
200 G=7789 : GOSUB 410 : G=7987 : GOSUB 410
210 PRINT "[HOME] [1DOWN] [5RIGHT] SCORE="SC
220 PRINT "[HOME] [3DOWN]" : GOSUB 420 :
PRINT : GOSUB 420
230 IF INT(ABS(R)/9)=0 AND R<>0 THEN P=P-1
240 GOSUB 430
250 X=0 : IF RI=119 THEN X=1
260 IF JS=4 THEN X=-22 : R=R-1
270 IF JS=8 THEN X=22 : R=R+1
280 IF JS=16 THEN X=-1
290 IF PEEK(P+X)=32 THEN 350
300 POKE P,160 : P=P+X : POKE P,193
310 IF P<7768 AND Q=0 THEN Q=1 :
SC=SC+INT(1000000/TI) : TI$="000000"
320 IF P>8142 AND Q=1 THEN Q=0 :
SC=SC+INT(1000000/TI) : TI$="000000"
330 GOTO 200
340 FOR J=H TO H+19 : POKE J,160 : POKE
J+C,5 : NEXT : RETURN
350 PRINT "[HOME] [44DOWN] [18UP] [WHITE]"
360 PRINT"SIZZLED TO A CRISP!" : PRINT
"[2DOWN] SCORE="SC : PRINT "[1DOWN]
PREVIOUS HIGH ="PH
370 IF SC>PH THEN PH=SC
380 PRINT "[3DOWN] PRESS FIRE FOR [1DOWN]
ANOTHER GO"
390 GOSUB 430: IF JS<>32 THEN 390
400 Q=0 : SC=0 : GOTO 170
410 FOR X=6 TO G+154 STEP 22 : POKE X+C,7
: POKE X,A(RND(1)*3) : NEXT : RETURN
420 FOR X=1 TO 8 : PRINT B$ : NEXT : RETURN
430 POKE K+3,127 : RI=PEEK(K+1) : JS=NOT
PEEK(K) AND 60-((RI AND 128)=0) :
POKE K+3,255 : RETURN
```

Chain

K. L. O'Rourke (VK50A),
Mount Gambier, SA 5290

A common problem is the need to append or chain two programs, ie, to put two separate programs together so that they can be called as one program. It's a particularly useful technique if you are developing a very long program and want to divide it up into smaller sections for construction and debugging.

Do it this way: Create a tape file of one program (tape 1), ie, (immediate mode) open 1,1,2: CMD1: list (return). When the file has finished loading-close 1 (return). When the data cassette has finished doing its thing, rewind the tape, and then load the second tape in the normal manner. Replace tape 1 in the cassette (making sure it's at the start) then: (immediate

mode) poke 198,1: open 1 (return). Obey the screen prompt to "press play on tape". The tape will stop after the header has been read. In immediate mode again; clear screen, press 3 cursors down. Poke 153,1; poke 198,1: poke 631,13; print "home" (return).

When this return is pressed the tape will move in blocks. At the end of the tape the computer will respond with an "out of data error" or "syntax error". This is normal and the append is now complete.

One word of caution. The two programs will align themselves in accord with their line numbers. If the programs have common line numbers things will not go smoothly!

Using the User Port

C. Groenhout,
Watson, ACT 2602

One of the interesting and powerful features of the VIC's I/O system is the 8-bit bi-directional parallel port. This port is situated in the far left hand corner of the machine (when looking from front) using a 12-way (24 track) male connector as the attachment.

As mentioned briefly in the VIC-20 manual, these carry lines such as RESET, +5 V, GND etc. All of the lines (1-12) are direct duplicates of those on other ports. The bottom connectors, marked A-N, carry eight data lines (1 bit each), two ground connections, and two other lines used with RS232 communications as IN and OUT.

This port is memory mapped in location 37136 and by PEEKing this location one can detect the bits on and off using the AND operator. For example, to check if bit 3 (value 4) is on, one would type:

```
IF (PEEK(37136)AND4)=0 THEN ...
```

To actually connect hardware to the port is very simple. To produce a bit 'on' you take whichever bit takes your fancy to the GND connection (A or N). The bits are connections C to L. With the user port one can connect a standard joystick or two extra ones to the normal one into the control port simply by wiring a 9-pin D connector (pins 1-4) to each of the data address lines (C-F) and GND (pin 8 on joystick) to GND (pin A or N on user port).

Possible applications for the user port range from the monitoring of scientific experiments in a lab using relay-driving sensors to counting the laps and lap times on a model car set!

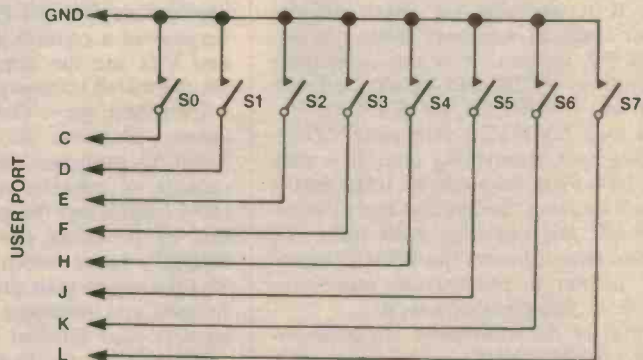

LOW COST PROGRAM GIVES VZ200/300 FULL LEVEL II BASIC

Ever wished that your little VZ200 or VZ300 would run full Microsoft Level II BASIC instead of just a stripped-down version? You needn't wish any longer thanks to an enterprising local programmer.

Jim Rowe

REMEMBER STEVE OLNEY? If you're a VZ200 or VZ300 owner and BASIC programmer, you should. We've published at least three of his articles so far, mainly on resurrecting dormant functions and statement keywords in VZ BASIC. One was in the March '84 issue, another in October '84 and the last in May '85.

Steve's a very knowledgeable guy when it comes to the VZ200/300, in terms of both software and hardware. He's spent quite a lot of time burrowing into its little secrets, and probably knows as much about it as anyone in Australia.

I know that sounds a bit like paeaning in his pocket, but I've just been trying out the latest fruit of his labours. And this time it's not just an article showing you how to restore a few more missing functions to VZ BASIC. It's a machine language utility program that restores pretty well the whole blinking lot for you — instant Level II BASIC! Hence my little paean of praise.

Steve calls his new utility Extended BASIC Version 2.2, or 'EXBSV2.2' for short. It is available on either cassette tape or disk, to suit both basic and expanded VZ systems. It is also compatible with both the VZ200 and VZ300, and with the current Disk BASIC (V1.2 DOS).

You load EXBSV2.2 into your VZ before you load in anything else. It is only about 1600 bytes long (about 1.5K) and is fully self-locating, finding the top of available RAM and installing itself there. At the same time it lowers the BASIC 'top of RAM' pointer to prevent any other programs from being loaded over it.

As part of the installation it patches itself into ROM BASIC, in much the same way that Disk BASIC does, to become

transparent to the user. All that you're aware of is that the RAM is now about 1.5K smaller than before — plus, of course, the fact that your trusty VZ now responds to no less than 25 new BASIC commands!

Of these 25 new commands, 23 are basically resurrected Level II commands that have been sleeping there all the time in the VZ's ROM, quietly waiting for EXBSV2.2 to sound the trumpet. They're listed in the table. The other two are extras — a bonus that Steve Olney has thrown in for good measure. And very handy they are too: MERGE, to allow you to combine programs and routines, and RENUM to let you rationalise and tidy up a program whose line numbers have become a mess after a lot of editing and patching (or after using MERGE).

All of the 25 new commands are fully functional, and when used in a program can be LISTed — at least on any machine with EXBSV2.2 loaded. All but two of them will even RUN on a VZ which doesn't have EXBSV2.2 loaded! The two exceptions are ON and ERROR, which arise because of a conflict in token codes (normal VZs use the normal ERROR token for the added command SOUND).

Even here Steve Olney has provided an answer, for those who really do want the Level II programs they generate to be capable of running on plain-vanilla VZs (how helpful can the guy get?). He's done this by providing the listing of a short BASIC routine which you can MERGE into the top of your programs after they're finished and debugged. You then use it to convert your finished programs

When it has finished, you DELETE the routine itself (notice that?) and CSAVE

the converted program. It won't LIST properly any more, but it will now RUN on a VZ without EXBSV2.2 installed. There's just one tiny catch: you can't use the construct 'IF <expression> THEN ERROR <n>' in any program that you want to convert in this fashion. You can only use ERROR in the 'ON ERROR GOTO' construct. Not a serious limitation, but worth remembering.

But back to EXBSV2.2 itself. Normally you'd expect to load this into your VZ every time you turn it on, which is easy enough and only takes a couple of seconds with the disk system. And with the utility installed, all of the new commands are at your disposal.

It's great to be able to use direct commands like DELETE, AUTO, TRON and TROFF, RENUM and MERGE. How did we ever get along without DELETE? It's so damn useful — not to say virtually essential when you want to scrub a whole range of program lines.

Then into the actual programming. It's really good to be able to use double-precision constants and variables again. Plus to be able to define variables as integer, single, double or string type using DEFINT, DEFNG, DEFDBL and DEFSTR. It's also much neater to be able to use ON-GOTO and ON-GOSUB, instead of a flock of IF-THENS. Not to mention being able to use ERROR, ERR and ERL. It's nice to be able to use RESUME and RANDOM, too.

Of course there's also FIX, FRE, and MEM — plus familiar old mates like CINT, CSNG and CDBL, POS and STRING\$ (handy in setting out screens, that one — I missed it). And of course the very versatile VARPTR. Wheee! Makes

you feel a bit like Uncle Scrooge let loose in the Mint (well almost).

All of the new commands and functions seem to work perfectly. I certainly couldn't find any bugs, anyway — if there are any, they're pretty well hidden. From a functional point of view, my VZ now behaves like any other Level II machine.

So thanks to EXBSV2.2, Steve Olney's little genie, you can now trundle out all those old TRS80/System80 programs and get them running on your trusty VZ. The graphics will need a few mods, of course, but the programs themselves will be fine.

And the cost of this magic ute? A mere \$15 for the tape version, or \$22 for the disk version. Both prices include packing and postage, and EXBSV2.2 comes complete with a set of driving instructions. You couldn't get much better value for money — obviously Steve Olney is not out to rip anyone off.

I've only got one complaint. Couldn't he have given it a name that's easier to pronounce and type, like 'Jeannie'? Try typing EXBSV2.2 all the way through a review, and you'll know what I mean!

Still, whatever he cares to call it, it's a utility that almost every VZ programmer

TABLE 1. WHAT EXTENDED BASIC PROVIDES

System Commands:

AUTO	automatic line numbering for program entry
DELETE	delete a line or group of lines
TRON	enable trace function (for debugging)
TROFF	disable trace function
MERGE	merge tape program with program in memory
RENUM	renumber program lines

BASIC Statements:

DEFINT	define variable as an integer
DEFSNG	define variable as single precision
DEFDBL	define variable as double precision
DEFSTR	define variable as string type
ERR	error code
ERL	line in which error was deleted
ERROR	used to simulate an error condition
ON-GOTO	branch to one of several line numbers depending upon the value of an expression
ON-GOSUB	branch to one of several subroutines depending upon the value of an expression
RANDOM	reseed random number generator
RESUME	continue program execution after error handling

BASIC Functions:

CINT	convert variable to an integer
CSNG	convert variable to single precision
CDBL	convert variable to double precision
FIX	return truncated integer part of a number
FRE	returns the amount of free memory remaining
MEM	returns the amount of free memory remaining
POS	returns the current screen cursor position
STRING\$	returns a string of specified length
VARPTR	locates a variable in memory

is going to want. And at this stage you can only get it direct from Steve Olney at 200 Terrace Road, North Richmond, NSW

2754. I only hope that his local post office is prepared for the onslaught.

Allen-Bradley Heavy Duty Resistors.

Power plus the best tradition of quality

Allen-Bradley heavy duty ceramic resistors come from the only company in the world with a proven record for consistent quality in the manufacture of resistive components.

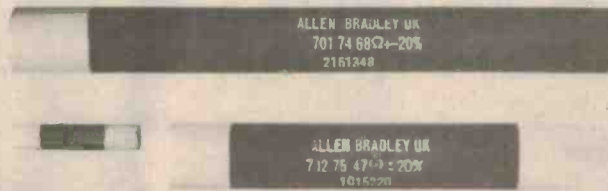

Typical applications:

- Dummy Aerial Loads.
- Overvoltage Protection of Thyristors.
- Anti-parasitic elements in the grid and anode circuits of power valves in induction heaters.

Allen-Bradley designed these heavy duty resistors with load life stability to overcome the problem of severe power loss through temperature rise, which is common to other brand resistors available to Communication Industries in Australia.

Allen-Bradley heavy duty resistors are available in 3 types with power ratings in 10W, 55W and 90W. Resistance values are to the E6 Series per decade.

Allen-Bradley resistors are available in Australia through our Electronic Components sales centres in Sydney, Brisbane, Melbourne, Adelaide and Perth.

Our oil-impregnated resistors are available to special order.

Specify Allen-Bradley - 75 years in resistive components manufacture makes our tradition of quality the best for you.



ALLEN-BRADLEY

Design excellence and quality in the best tradition.

VIC. 188 Whitehorse Road, Balwyn, 3103. Ph. 80 6171
 N.S.W. 22 Parramatta Road, Lidcombe. 2141. Ph. 648 2652
 QLD. 1925 Logan Road, Upper Mt. Gravatt, 4122. Ph. 343 7900
 W.A. P.O. Box 23, Subiaco. 6008. Ph. 387 1702
 S.A. K.D. Fisher, P.O. Box 170, St. Mary's, 5042. Ph. 277 3288

CATCHING THOSE ELUSIVE SIGNALS

An antenna is the start of your receiver's signal chain. Don't let it be the weak link.

Arthur Cushen

NOW THAT THE new listener is aware of the frequency range of the receiver and how to find the incoming signal on the radio dial, it is time to look outside in order to improve the strength of the signal, and here is where an efficient antenna is necessary.

The two main considerations in constructing or selecting an antenna are the space available to you and the frequencies you are interested in. Generally, the lower the frequency (and the longer the wavelength) the greater the space you will require. If space is the main limiting factor, the ground plane, inverted V and loop antennae are the ones to look at. Those with plenty of outdoor area can play around with the long wire antenna and its variations, the beveridge and inverted L antennae.

Long wire antenna

A long wire antenna is, as its name suggests, a long wire strung from your 'rig' to a conveniently located post or something similar. The length of the long wire should be one wavelength or more of the lowest frequency of interest. The appropriate formula is:

$$\text{metres (length)} = \frac{71.5}{f(\text{MHz})}$$

A typical long wire installation is illustrated in Figure 1. The actual height and length depend entirely on your circumstances. A piece of 50 mm by 100 mm oregon is painted (the new external wood paints such as 'Timber colour' etc are very good) and bolted to a fence post or other support, as far from your receiver installation as you can reasonably manage it. A pulley, obtainable at almost any hardware store, is fixed to the top and a loop of good quality hemp rope threaded through it, before erection.

An egg or strain insulator is attached to one end of the antenna which is also tied. The other end of the antenna is erected near the receiver installation. An insulator is also attached at this end and the lead-in taken down from it to the receiver installation. The antenna is then supported from this end by tying it off to a chimney, as illustrated, or to a screw-eye in the fascia-board of the house. Having one end of the antenna

higher than the other is of little consequence. It'll still work!

The lead-in should be taken in such that it clears the house guttering and may be fed through a ventilator opening or over a window sill — whatever is convenient. Avoid running it for any distance clamped to a wall or parallel to metal guttering, pipes or wiring. The more direct, the better.

Once your long wire is up you're ready to go! The end of the lead-in can simply be attached directly to the antenna terminal of your receiver or it can be connected to your receiver via an antenna tuner! Antenna tuning is merely a way of varying the reactance of the tuner to optimise for the particular frequency you want to receive.

Inverted L antenna

The inverted L antenna (see Figure 2) is a form of long wire that is bent at 90 degrees about half way along its length. The formula for calculating the total length of wire you need is:

$$\text{metres} = \frac{71.5}{f(\text{MHz})} \times (1.1 \text{ to } 1.3)$$

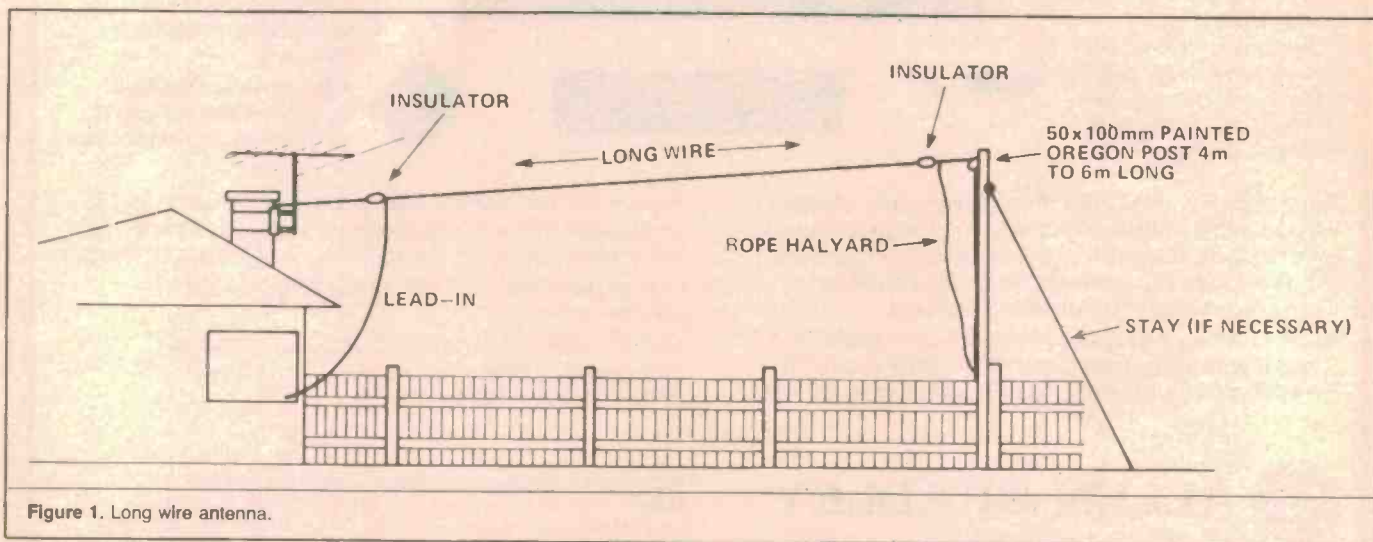

Figure 1. Long wire antenna.

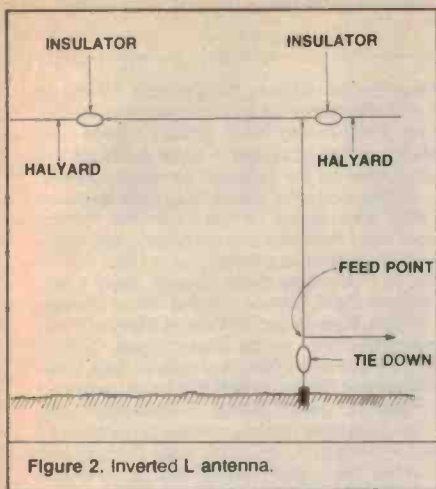

Figure 2. Inverted L antenna.

The advantage of the inverted L antenna over the long wire is that it is simpler to tune requiring only a single variable capacitor.

Beveridge antenna

For those fortunate enough to live in areas with little space limitation, another form of long wire antenna, the beveridge, has proved to be efficient especially on mediumwave.

Like the long wire this antenna is stretched horizontally, but is earthed at its end. Length is not critical, but direction is. The greater the length of antenna, the more defined is the area of reception. Thus its erection should be based on compass bearings; the antenna should be pointed towards the part of the world from which the signal of interest is received. For example, a long antenna running north-east would give best reception of signals from North America.

The beveridge antenna need not be high above the ground but it should be held in place by several short poles up to 5 metres high. Earthing the antenna at the far end relies very much on experimentation to improve reception.

Many groups in Australia and New Zealand favour this antenna for 'outdoor' listening. There have been many cases of listening in car radios at the beach with an antenna attached to broom handles and strung from the car across the beach.

Inverted V antenna

A wideband inverted V style of antenna is illustrated in Figure 3. This works extremely well across the range from about 5 MHz up to 30 MHz and uses ordinary TV ribbon for a feedline. However, an antenna tuner is necessary.

Good signals will be picked up by this antenna right down to 2 MHz, but at these low frequencies, there's no substitute for size and different antennae, designed to operate in these regions, usually provide better performance.

Beggars can't be choosers though, in many circumstances!

Construction is quite simple. Again a 4 or 6 m length of 50 x 100 mm oregon, is erected against a suitable support — shown

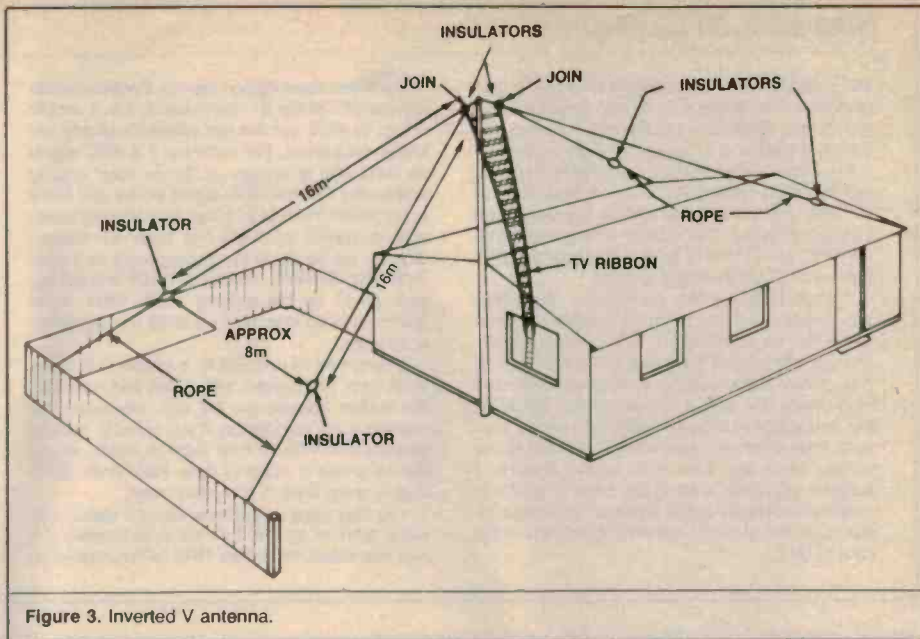

Figure 3. Inverted V antenna.

here as the side of a house. A fence or garage is just as good.

If you can attach a length of aluminium pipe to a chimney mount or to your house gable — well and good. Just get the centre up as high as you reasonably can.

Each leg of the inverted V should be 6 metres long. The legs can be shorter — whatever you can fit, but the performance at low frequencies suffers.

The TV ribbon is connected where the opposite legs of the antenna join at the apex. Support the ribbon with standard screw-in TV ribbon insulator standoffs.

Each leg should be individually tensioned with the rope strainers as indicated. Large screw-eyes, obtainable from most hardware stores, screwed into the supports as illustrated serve as excellent anchor points and allow the rope to be tightened using an appropriate slip knot (a round turn and two half-hitches is excellent).

Ground plane antenna

The ground plane antenna was originally designed as a high frequency transmitting antenna, but makes a fine receiving antenna and covers a wide frequency range. Response from 13 to 49 metres has been found better than with a long wire. Below 49 metres performance falls off but the antenna compensates by almost eliminating TV interference on 60 metres.

It is also a useful shortwave aerial for the listener who has little room available, because it can be placed on the roof of a house without extensive guy wires running everywhere. The vertical portion used is $\frac{3}{4}$ or 1-inch square aluminium tubing; 5 metres long is light and strong. The length is determined as being equivalent to quarter of the wavelength of 19 metres (5 metres approximates $\frac{1}{4}$ wavelength = 15.2 MHz).

Ground radials are copper wire 5 metres long, at right angles to each other at the base of the antenna. They do not have to be

horizontal, in fact it seems preferable that they be up to 45 degrees down from horizontal, that is 135 degrees from the vertical.

TV ribbon provides a matched lead-in for the antenna, one side linking the vertical to the antenna jack on the receiver, the other side linking the four radials to the earth of the receiver. By having the receiver earthed, performance is improved and noise level reduced. However some sets may work better without the connection to earth. Breaking strain nylon line is used to support the vertical, rather than affect the balance and performance of the antenna.

This antenna has produced some good catches already. Signals have been heard on 13 and 16 metre bands which were inaudible with a 35 metre long wire.

Tuned loop antenna

This antenna typically consists of a number of turns of insulated wire on a former about 0.75 metres in diameter. It can be tuned with a single parallel capacitor. Its particular advantages are easy construction and its portability. This aerial is highly directional so it should be mounted vertically with the edge of the loop pointed towards the station of interest.

Generally

Long wire antennae including inverted Ls and beveridges are generally more suitable for mediumwave reception. Those best suited to shortwave are the ground plane, tuned loop and dipole (which we haven't mentioned here).

In constructing an aerial, rules of thumb are to have it as high as possible and clear of any obstructions such as power lines. The wire between the two insulators can be copper or insulated; lead in should be covered wire. Most importantly, make sure the aerial touches no metal objects. One further precaution is to fit a lightning arrestor which short circuits any unwelcome current. ●

SOME MORE ON CALIBRATION

Many people listen to shortwave on an older type of receiver which has a multiband scale covering the various shortwave bands, and consequently they find it difficult to locate the right frequency.

On some of the older receivers there is often a logging scale marked 0-100 along the bottom of the dial, together with the various bands and the frequency range. The listener should note that the BBC on 9410 kHz is, for instance, on SW3 band and 32 on the logging scale.

If your receiver has no logging scale you should paste a piece of paper along the bottom of the dial or, better still, a strip of graph paper. Using a ruler, divide the paper into sections of 10 and clearly mark each one, then go back and mark every unit with a vertical stroke. By doing this you will have created a logging scale of your own, from which you can note the position of the pointer when you tune in to known stations. I suggest you keep a small log book in which to note the shortwave band, the logging number on the scale, the station's known frequency and the time in UTC.

Once you have logged several English-speaking stations in the 31 metre band, it is a simple matter to work out the dial reference of any unknown frequency. For example if a BBC signal on 9410 kHz is shown as 32 on your logging scale, and another BBC signal which you know to be on 9510 kHz is at 42 on your logging scale, then a station on 8420 kHz such as Athens, Greece, will be 33 on the logging scale as it uses 9420 kHz. Similarly, Albania on 9500 kHz will appear at 41 on the logging scale, while Israel Radio on 9440 kHz must be at 35 on your reference scale.

A third way of retuning to a station is to put a mark over the pointer, with a felt pen, showing the station position on the dial. However, this method is not satisfactory if you listen to several stations and wish to tune them in again, as the dial becomes a mass of dots. Reference notes kept in a log book is the tidiest way!

You may have an old receiver with station call signs marked on the dial, but unfortunately if it was manufactured before 1979 (when Australian

mediumwave stations moved from 10 kHz to 9 kHz separation) all this information is inaccurate. Nevertheless most stations moved only slightly in frequency and in some cases the call sign shown on the dial would be roughly correct.

On the shortwave dial you may have an old receiver which shows various transmitter sites on each band, but these also are often of little value. One of my receivers, purchased in 1939, lists on the 31 metre band Rome, Wayne, Cape Town, Moscow, Delhi, Sydney, Bombay, Paris, Zeesen, Calcutta, Pretoria and Melbourne. Many of these transmitter sites are no longer in use. Zeesan was the site of the German Radio in 1939, while Wayne was the transmitter site for an American commercial station, W2XE. Pretoria and Cape Town have been closed and replaced by the high powered Radio South Africa, while Calcutta and Bombay have been centralised for overseas broadcasting from All India Radio, Delhi.

DAYLIGHT TIME

The new listener will have noted some major time changes this month as countries in the Southern Hemisphere move to Daylight Time; those in the Northern Hemisphere have already returned to Standard Time.

Australians will be aware that NSW, Victoria and Tasmania have moved to Daylight Time; Queensland remains on Eastern Standard Time, therefore there is an hour time difference between Queensland and NSW. South Australia has moved to Daylight Time but Western Australia has not. New Zealand has moved to Daylight Time resulting in the time there being 13 hours ahead of UTC and making a '25 hour day' as New Zealand is not across the international Date Line. It is therefore possible to be in three different countries on three different days, offering further confusion to the radio listener trying to work out the local time.

New Zealand is not alone in this unusual time zone as Tonga decided some years ago to be 13 hours ahead of UTC so that it stays in the same day as New Zealand.

As the world is divided into 24 one hour time zones moving east from UTC, an hour is added on for each time zone; calculating to the west of the line of UTC one hour is deducted. UTC, formerly Greenwich Mean Time, is measured from the Greenwich Meridian in London.

For the present position concerning Daylight Time in the Southern Hemisphere the following countries have put their clocks forward by one hour:

29 September 1985-22 March 1986

Vanuatu

1 October 1985-31 March 1986

Paraguay

13 October 1985-8 March 1986

Chile, Easter Island

27 October 1985-1 March 1986

Cook Islands, New Zealand, Chatham Islands, Australia — ACT, NSW, Victoria, Tasmania, South Australia, Lord Howe Island

16 December 1985-31 March 1986

Peru

In the case of countries which have no international service and listeners are tuned to the local stations, broadcasts will be heard one hour earlier during the Daylight Time period. Radio Argentina, Radio Braz, HCJB, Radio Australia and

Radio South Africa are the only international broadcasters in the Southern Hemisphere; they remain on UTC despite the fact that local time is one hour earlier. Radio New Zealand's External Service which relays the National Programme remains with New Zealand Daylight Time and so is heard one hour earlier by listeners overseas.

Northern Hemisphere

There is some variation in commencement dates of Daylight Time in the Northern Hemisphere; some standardisation is being observed by countries in the EEC. A survey of Daylight Time during summer in the Northern Hemisphere has been compiled by Bryan Clark of Auckland, NZ and the tentative dates for 1986 are as follows:

30 March-27 September 1986

Andorra, Austria, Azores, Belgium, Bulgaria, Canary Islands, Cyprus (except northern Turkish sector), Czechoslovakia, Denmark, Faeroe Islands, Finland, France, Germany (East), Germany (West), Gibraltar, Greece, Greenland, Hungary, Italy, Luxembourg, Madeira, Malta (Spanish Morocco), Monaco, Netherlands, Norway, Poland, Portugal, Romania, Spain, Sweden, Switzerland, USSR (Moscow time zone), Yugoslavia.

30 March-25 October 1986

United Kingdom, Ireland

1 May-30 September 1986

Albania

1 April-30 September 1986

Iraq, Jordan, Mongolia

6 April-30 September 1986

Libya

14 April-14 September 1986

Israel

20 April-27 September 1986

Turkey, North Cyprus (Ercan)

1 May-15 October 1986

Lebanon

17 March — 12 October 1986

Cuba

31 March-21 September 1986

Guatemala

27 April-25 October 1986

Bahamas, Bermuda, Canada, Haiti, Mexico (Baja California), Turks and Caicos Islands, USA (including Alaska but not Hawaii).

Time conversion

With Australian Eastern Daylight Time now in operation in NSW, Victoria and Tasmania, the table below shows the equivalent time between UTC (GMT) and Australian Eastern Daylight Time.

UTC	Australian Eastern Daylight Time
0000	11.00 am Friday
0100	12.00 noon
0200	1.00 pm
0300	2.00 pm
0400	3.00 pm
0500	4.00 pm
0600	5.00 pm
0700	6.00 pm
0800	7.00 pm
0900	8.00 pm
1000	9.00 pm
1100	10.00 pm
1200	11.00 pm
1300	12.00 midnight Saturday
1400	1.00 am
1500	2.00 am
1600	3.00 am
1700	4.00 am
1800	5.00 am
1900	6.00 am
2000	7.00 am
2100	8.00 am
2200	9.00 am
2300	10.00 am
0000	11.00 am

Queensland: As Queensland remains on Australian Eastern Standard Time the table should be read 0000 equals 10.00 am, 0100 equals 11.00 am with the change of day at 1400 UTC.

South Australia: With a daylight time zone 10½ hours ahead of UTC the table should read 0000 equals 10.30 am, 0100 11.30 am and so on.

Western Australia: Time being 8 hours ahead of UTC, the table should read 0000 equals 8.00 am, 0100 9.00 am, 0200 10.00 am, with day change at 1600 UTC being 12 midnight in Perth.

New Zealand: New Zealand Daylight Time is 13 hours ahead of UTC so 0000 is 1.00 pm in New Zealand and day change is at 1100 UTC when it is 12 midnight in New Zealand.

New South Wales, Victoria, Tasmania, South Australia and New Zealand return to Standard Time on 1 March, 1986 when the clock will be put back one hour.

NEW

Electronic Circuit Analysis Software

EMONA — ENAP

Analyse complex circuits with ease on your Apple II, IBM-PC or compatible and eliminate the 'what if' questions

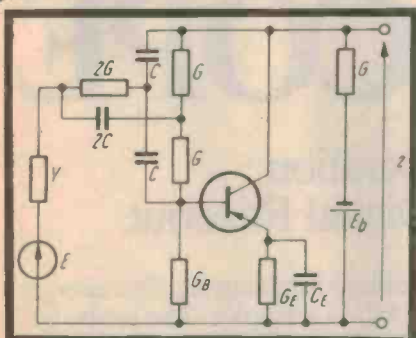

ZL				2	5
R	1.0000E+04	OHM	10		
R1A	1.6000E+05	OHM	5	2	6
R1B	1.6000E+05	OHM	5	6	1
R2	1.3000E+05	OHM	10	1	5
R3	8.0000E+04	OHM	5	4	7
RE	2.0000E+03	OHM	10	3	5
RBB	2.0500E+01	OHM	30	1	8
RPI	1.4300E+04	OHM	30	8	3
RMU	5.0600E+07	OHM	30	8	2
RCE	9.9220E+04	OHM	30	2	3
CI	4.7000E-09	F	5	2	7
C2	4.7000E-09	F	5	7	1
C3	9.4000E-09	F	5	4	6
CE	3.3000E-04	F	20	3	5
S1	3.7400E-02	S	50	8	3 3 2

ANALYSIS MODE: 5 K L

Emona-Enap, the Electronic Network Analysis Package is a collection of interactive programs that perform DC and small signal AC analysis of fully non-linear networks. ENAP provides the following:

- DC operating points
- Frequency and Phase response, the circuit is treated as a 2-port.
- Circuit stability and Temperature Effects
- Performance due to variable components
- Monte Carlo analysis

FULL LOCAL BACKUP INCLUDING AN ANNUAL UPDATE SERVICE AT A MINIMAL FEE TO REGISTERED USERS

\$249.00



EMONA INSTRUMENTS

DIVISION OF EMONA ENTERPRISES PTY LTD

1st Floor
720 George St
Sydney 2000.
Phone: (02) 212 4599

Apple II and IBM-PC are registered trademarks.

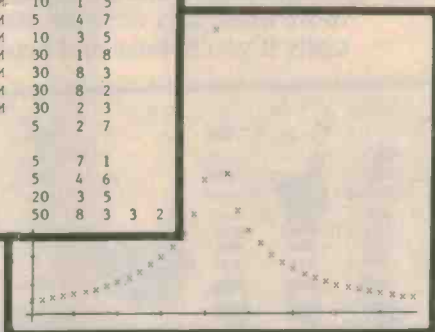

University's SPECIAL INTRODUCTORY OFFER FOR 'ETI' READERS

DROP PROOF ANALOGUE YF242

super thin 30kΩ/Volt
Normal Trade Price ~~\$45.60~~
SPECIAL \$35.80
incl. tax



Taut band movement
bench stand
reverse switch
fuse + diode prot.
DC. + AC.V to 1kV.
DC. + ACA. to 10A
Resistance to 4MΩ
continuity buzzer

NEW!! MULTIMETERS LATEST TECHNOLOGY

University for Quality

A GREAT GIFT

IDEAL for the SERVICEMAN and HOBBYIST

POCKET SIZE DIGITAL YF1060
at Analogue Prices



Normal Trade Price ~~\$57.60~~
SPECIAL \$45.80
incl. tax

3½ digit LCD Display
Basic Accuracy 0.8%
Overload Protected
Size only 120 x 67 x 27 mm
Auto Polarity.
DC Volts to 1kV ACV. to 500V.
DC current to 200mA
Resistance to 2MΩ
Diode check

These Prices apply ONLY to 15/12/1985, and must be ordered on this coupon. Please Add \$3 for Packing and Post.

GRADUATE TO

University

GRAHAM INSTRUMENTS P/L
THE AUSTRALIAN SPECIALISTS. AGENTS IN ALL STATES

106 Belmore Rd Nth,
Riverwood, NSW 2210
Phone: (02) 53 0644
Telex: AA 21398.

Name

Address

..... P/code

Qty Model Multimeter

I enclose cheque/Postal Note for above unit, or send COD Post.

100MHz COMPACT SCOPE

Extra Portability with AC/DC Operation;
Extra Features with Auto Ranging and Digital Readout.



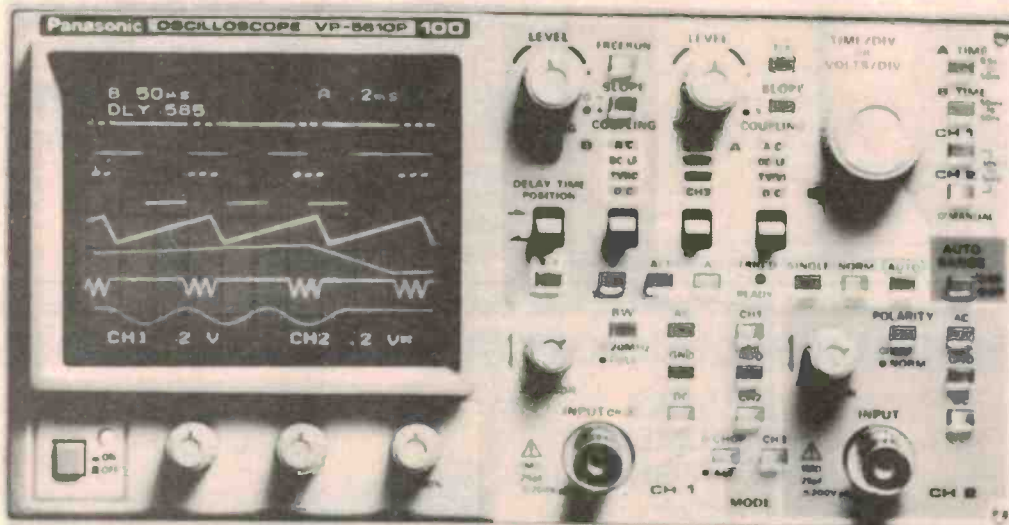

If you're looking for a really compact oscilloscope that travels anywhere and operates anywhere (AC universal input from 90 to 250V and DC), look no further. Our VP-5610P, with its advanced circuit design technology, can rest on one hand and still get the job done. For extra functions you get Auto Ranging which automatically specifies sweep range and vertical sensitivity best suited for

an unknown or indefinite input signal. You also get a handy probe with GND reference. The probe has a built-in switch right at your finger-tips for starting the auto ranging function. This plus 3-trace, an alternate sweep function, auto fix, hold-off, a drift compensation circuit, digital readout and much more make this versatile model a super scope, especially if you're busy and need something portable.



 **National
Panasonic**

* This chart compares the necessary preparatory and measuring steps of a conventional oscilloscope (11 steps) to the advanced National/Panasonic VP-5610P (only 5 steps).

Measuring Made Easy:	Conventional Oscilloscope	National/Panasonic VP-5610P
Preparations		
1. Turn on power, adjust intensity and focus		
2. Adjust V position		
3. Set V range		
4. Specify trigger mode		
5. Specify sweep range		
Measuring		
6. Connect probe and apply to measurement point		
7. Refine V range		
8. Adjust trigger slope		
9. Refine trigger		
10. Refine sweep range		
11. Read out waveform	11 steps	5 steps



SCIENTIFIC DEVICES AUSTRALIA PTY. LTD.
2 JACKS ROAD, SOUTH OAKLEIGH, VICTORIA, 3167 TELEPHONE: 579 3622
P.O. BOX 63, SOUTH OAKLEIGH, VIC. 3167 TELEX: AA32742
CABLES: DEVICES MELBOURNE
ADELAIDE — 31 HALSEY ROAD, ELIZABETH EAST, S.A. 5112
TELEPHONE 285 6975; TELEX AA88125
SYDNEY — 599A WILLOUGHBY ROAD, WILLOUGHBY, N.S.W. 2068
TELEPHONE 95 2064; TELEX AA22978

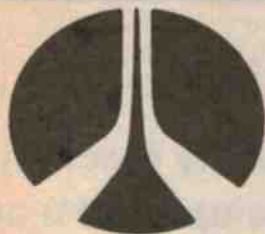

Rockwell

for semi conductor leadership
6502 now available in CMOS to 4 MHz
68000 now available up to 12 MHz

6500 SERIES

R6502P - CPU, Internal Clock	8.50
R6503AP - CPU, Internal Clock	7.24
R6504AP - CPU, Internal Clock	7.24
R6505AP - CPU, Internal Clock	7.24
R6507AP - CPU, Internal Clock	7.24
R6511Q - CPU, 192 RAM, 2 Ctrs, Comm. Port, Bus I/O, (Emulator for R6500/11,12,13)	21.26
R6520P - Peripheral Interface Adapter	5.19
R6522P - Versatile interface Adapter	6.77
R6532P - 128 RAM, I/O, Timer	9.44
R6541Q - CPU, 64 RAM, 1 CTR, BUS, I/O, (Emulator for R6500/41,42,43)	19.17
R6545-1P - CRT Controller (2.5 MHz Video Bus)	9.13
R6545AP - CRT Controller (3.7 MHz Video Bus) Pin Compatible with MC6845R	12.27
R6549P - CVDG (Colour Video Display Gen.)	60.58
R6551P - ACIA With Baud Rate Gen.	9.91
R6592P - DOT Matrix Printer Controller	18.10

CMOS DEVICES

R6502P1 - CPU, Internal Clock, 1 MHz	10.39
R65C102P1 - CPU, Quadrature Clock, Tri-State, 1 MHz	10.39
R65C21P1 - Peripheral Interface Adapter, (PIA) 1 MHz	5.82
R65C22P1 - Versatile Interface Adapter, (VIA) 1 MHz	7.71

HIGH LEVEL LANGUAGE CIRCUITS

R65C24P1 - PIA with 16 Bit Timer/Counter 1 MHz	6.61
R65C51P1 - ACIA with Baud Rate Gen.	12.27
R65C52P1 - Dual ACIA with Baud Rate Gen. 1 MHz	22.03

16 BIT 68000 SERIES I.C.'s

R68000C10 - MPU (10 MHz ceramic)	69.24
R68000Q10 - MPU (10 MHz QUIP)	33.04
R68561P - MPCC (R68000 Compatible)	58.22
R68802P - LNET	61.37

- NOTES: CMOS 2, 3 and 4 MHz parts available. Please call.
1. 6 and 8 MHz parts also available.
2. Plastic and plastic chip carrier Version processors also available.
3. QUIP, PCC available in plastic package only.

MEMORY PRICES CRASH

2114 - 1K x 4 static RAM	1.35
4116 - 16K x 1 Dynamic RAM 300 nSec	2.65
4164 - 64K x 1 Dynamic RAM 150 nSec	1.35
41256 - 256K x 1 Dynamic RAM 150 Sec	6.67
6116 (LP-3) - 2K x 8 Static RAM CMOS 300 nSec	7.18
6264 - P15 8K x 8 Static RAM 150 nSec	20.26
2716 - 2K x 8 EPROM 450 nSec	4.81
2732 - 4K x 8 EPROM 450 nSec	Call for Price
2764 - 8K x 8 EPROM 250 nSec	3.18
27128 - 16K x 8 EPROM 250 nSec	5.75

CRYSTALS

32.768 KHz - CMOS Calendar Clock	1.96
1.8432 MHz - Use with ACIA	3.08
2.000 MHz - CPU Clock	3.08

2.4576 MHz - For AMD word Modem 7910 ...	1.96
3.6864 MHz - Use with ACIA	1.96
4.000 MHz - CPU Clock	1.96
4.9152 MHz - CPU Clock	2.80
8.0000 MHz - CPU Clock	1.96
12.000 MHz - CRT Dot Clock	1.96

Contact us for 100+ prices of your desired frequency.
QUIP SOCKET for R6511Q, R68000Q, R65F12, Modem IC

PHOTOTYPING CIRCUITS

R6500/1EAB3 - 2 MHz Backpack Emulator (4K PROM) W/O PROM)	69.24
R65/11EB2 - 1 MHz Backpack Emulator (W/O PROM) 4 MHz Crystal	62.94
R65/11EAB - 2 MHz Backpack Emulator (W/O PROM)	69.24
R65/41EAB - 2 MHz Backpack Emulator (W/O PROM)	69.24

MODEMS

FULL DUPLEX DIAL MODEM FAMILY R1212M - 1200/300 BPS; Bell 212A, Bell 103, V.22	358.05
R1212DS - Device Sets from R1212M	267.51
R2424M - 2400/1200/300 BPS; V.22 bis, V.22, Bell 212A, Bell 103	590.22
R2424DS - Device Sets from R2424M	361.93

NOTE: For R2424 and R1212 a direct connect to U.S. Switched Telephone Network is available at Board Level. Contact office for price and availability.
4800-9600 BPS MODEM FAMILY
R48DP - 4800/2400 BPS; 4-Wire FDX, 2-Wire
HDX; Bell 208, V.27

R96DP - 9600/7200/4800/2400 BPS; 4-Wire FDX,
2-Wire HDX; V.29, V.27

R96FAX - 9600/7200/4800/2400 BPS; 2-Wire,
HDX; Group III and Group II Facsimile; V.29, V.27
ter, T.30, T.3

R96FT - 9600/7200/4800/2400 BPS; V.29, V.27
bis/ter, V.21 Channel 2, Fast Train

AIM65 PRODUCTS

These products are supported by Dynatem, previously Rockwell.
A65-100 - AIM 65 with 1K RAM

996.79
PRINTERS
by Creative Technology Inc.
See March, '85 E.T.I. for Review

All with Tractor/Friction Feed, Graphics, True Descenders, square pin head, solid vertical and horizontal lines, NLP, provision for 4K Buffer. P = Centronics Interface S = RS232 (Xon/Xoff) CPB has 2K Buffer fitted for IBM 130 cps CPB-136 has 2 pass ribbon and acoustic hood CPA-80 (P)	295.00
CPA-80 (S)	331.17
CPA-80 (C) for Commodore	310.00
CPB-80 (P) for IBM	323.39
Wide Carriage Dot Matrix CPB-136 (P) for IBM	497.23
CPB-136 (S)	542.97
CPA-80 Ribbons	11.90
CPB-136 Ribbons	18.68

Please phone for details on our full range of parts.



73 ERIC ST, GOODNA Q 4300
P.O. BOX 6502
GOODNA Q 4300
PHONE (07) 288 2455
TELEX AA43778 ENECON

Please include \$6.50 for packaging and freight. Prices include tax and are subject to change without notice.

ENERGY CONTROL
N.Z. P.O. BOX 12153
WELLINGTON NORTH
NEW ZEALAND
PHONE 472 6462

'WHAT CRS PORTABLE HAS 40 CHANNELS?'



... THE ANSWER IS IN THE PALM OF YOUR HAND

Now you don't have to leave your communications behind when you leave your vehicle. The ICOM IC-40 is a compact 40 channel UHF CRS field proven hand held, with optional 3 Watts output power, the same as many

mobile radios.

The IC-40 is perfect for jobs on the land, water or business.

Contact your local dealer for a demonstration of the most advanced CRS portable available in Australia.

Please post to:

ICOM AUSTRALIA PTY. LTD.
7 DUKE STREET WINDSOR 3182.
VICTORIA.

Name _____

Address _____

City _____

Postcode _____

or phone ICOM on (03) 51 2284



IC0013

FOR NEXT DAY JETSERVICE DELIVERY

ALTRONICS COMPONENTS

9th Birthday Sale

• Hundreds of Quality Electronic

Save up to 50% on

Credit Cards accepted — You don't pay a

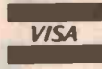

STATE OF THE ART TOROID POWER TRANSFORMERS

NEW FOR 85'



ALL WITH 240V PRIMARY

For the same price as your common garden heavy, bulky, buzzing iron (any old iron at that!) transformer you can now design in a superb Toroid Power Transformer from Altronics.

Why a Toroid?

- Smaller size and weight to meet modern "Silentline" requirements.
- Low electrically induced noise demanded by compact equipment.
- High efficiency enabling conservative rating whilst maintaining size advantages.
- Lower operating temperature.
- Simple, quick single bolt mounting.

Cat No.	Sec V	VA	Ea.	10Up
M 3050	12V + 12V	160W	45.00	43.50
M 3060	25V + 25V	160W	45.00	43.50
M 3065	30V + 30V	160W	45.00	43.50
M 3070	35V + 35V	160W	45.00	43.50
M 3075	40V + 40V	160W	45.50	43.50
M 3080	45V + 45V	160W	45.50	43.50
M 3085	12V + 12V	300W	55.00	52.50
M 3088	25V + 25V	300W	55.00	52.50
M 3090	30V + 30V	300W	55.00	52.50
M 3092	35V + 35V	300W	55.00	52.50
M 3100	40V + 40V	300W	55.00	52.50
M 3105	45V + 45V	300W	55.00	52.50

The toroidal transformer is now accepted as the standard in industry, overtaking the obsolete laminated type. Industry has been quick to recognise the advantages toroidals offer in size, weight, lower radiated field and, thanks to Altronics—Low Price.

DIMENSIONS

Diameter 110mm
Height 42mm (160VA Models)
52mm (300VA Models)
Leads 200mm length

Made in UK Quality

Highly Recommended For:

- Audio Amplifiers • Power Supplies
- Microprocessor/computer equipment

MANUFACTURERS AND BULK USERS PLEASE CONTACT OUR WHOLESALE DEPT. FOR BULK QUANTITY RATES.

Checks audio & RF circuits Signal Tracer for Trouble—Shooting

(See EA Aug. '85)

This simple signal tracer makes a valuable servicing aid and can be used to trouble-shoot both RF and audio circuits. It features an RF probe, battery operation and an in-built loudspeaker

K 2560

\$19.50

Low-Cost Unit Checks Values from 1pF to 100uF Upgraded digital Capacitance Meter

Cat K 2522

\$69.00



Digital Capacitance Meter Checks capacitor values from 1pF to 99.99uF over three ranges. Features include a nulling circuit and bright 4-digit LED display. (See EA Aug. '85)

The readout consists of a bright 4-digit LED display and the full scale readings for each range are 9999pF, 999.9nF and 99.99uF. No adjustments are necessary when taking a reading. You simply connect the capacitor to the test terminals and select the appropriate range. The circuit can accurately measure capacitance down to one picofarad (1pF). This is made possible by the internal nulling circuit which cancels any stray capacitance between the test terminals or test leads. So when you measure a 5pF capacitor, the unit will display 5pF.

EA'S LABORATORY POWER SUPPLY

3—50 Volt at up to 5 Amps

Single Printed Circuit Board construction - dead easy to build.

SPECIFICATIONS:

- Output Voltage = 3-50 volts
- Output current up to 5 amps (max. 175W)
- Floating outputs isolated from ground
- Ripple less than 90mV p.p. at Max.

K 3300

EXCLUSIVE TO ALTRONICS:

- Deluxe instrument case.
- Attractive silk screened front panel.
- Fully drilled and punched chassis—no holes to drill

\$139.50

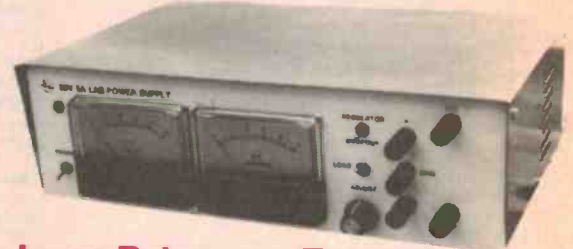

Super Low Price on Famous EA 8 Sector Alarm System Kit

(See EA Mag. Jan '85)

NOW AN INCREDIBLE

\$99

FEATURES:

- Alarm has 8 separate input circuits—8 sectors can be monitored independently.
- Each input circuit is provided with an Indicator LED and a sector On/Off switch
- Individual sector isolation allows the user to have some areas of the premises habited while others remain protected e.g. Inside Off/Outside On.
- Inputs accept both normally closed and normally open sensors
- Two inputs provided with an entry delay (between 10 - 75 seconds)
- Internal trip warning buzzer—alerts owner/occupant of pending alarm operation—great for the "forgetful" amongst us. This buzzer is pre-settable between 5 and 55 seconds prior to Alarm.
- Unique circuit detects automatically when any N/O or N/C loops are either open circuit or dead short. e.g. someone trying to bridge reed switches etc.
- Switched output can be used to send a silent alarm through an auto-dialler circuit or similar.
- Full battery back up provided via. 12V—1.2Ah battery
- Supplied in an attractive functional security case.

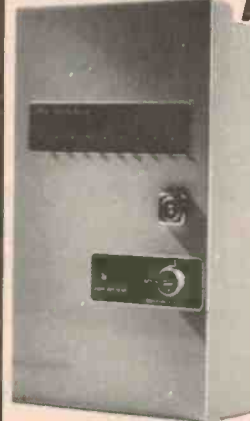

K 1900 (without Backup Battery) \$99

S 5065 12V 1.2AH Backup Battery \$22.95

240V Mains Power From Your 12V Battery 300 Watt Inverter with Auto Start

(See EA Sept. '85)

Just think how handy it would be to have 240 Volt AC Mains Power when camping, or for your Boat or Caravan — well this brilliant new design from Leo Simpson and the design team at Electronics Australia is the answer



- Super Compact - Kit is supplied in Altronics H 0482 Tough ABS Case.
- Uses High Efficiency Toroid Transformer thus keeping down heat dissipation, battery drain and weight.
- Auto Start draws power from your battery only when appliance is plugged in and "turned on" i.e. battery can be left permanently connected if desired.
- Thermal Over Load automatically shuts down if/when output stage is overheated (through high ambient temperature and high load or combination thereof — Automatic reset.
- Current Regulated Indicates inverter is being used within designed load limits.
- Current Overload unit self limits — LED Indicates overload condition. Single P.C. board construction — easy to build as there is very little internal wiring.

Complete Kit K 6752 \$199.00

Fully Built and Tested K 6754 \$249.00

BANKCARD HOLDERS—PHONE ALTRONICS TOLL FREE 008 • 999 • 007

Bonanza

Components and Products — our Competitors prices.

cent until you get your statement next month!

Just Arrived

— Ultrasonic Insect and Pest Repeller

PESTREPELLER is effective in controlling mice, rats, roaches, fleas, flies, crickets, silverfish, waterbugs, moths, ants, and most other common pests. Laboratory research has shown ultrasonic sound waves attack the auditory and nervous systems of most common pests causing them pain and discomfort. 130 decibels of sound waves are out of the range of hearing of humans and most household pets such as dogs, cats fish and birds, and farm animals.

Specifications—Dimensions: 100 x 90 x 80 Power Supply adaptor supplied 240/9V Frequency Range 30KHz to 65KHz variable Output Level 130db Cat A 0083 **\$49.50**



**Build this Fantastic New Kit
NO COMPROMISE DESIGN
Ultra Fidelity
Series 200 Mosfet
Integrated Amplifier**

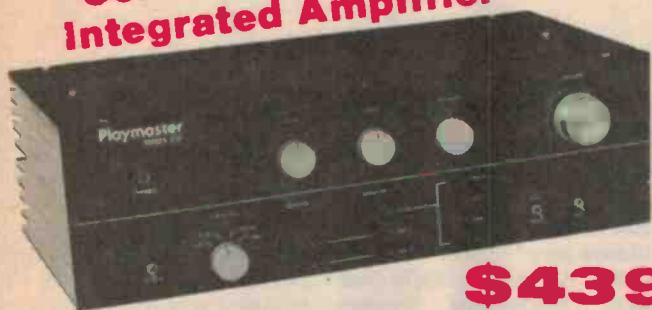

\$439

INCREDIBLE VALUE

FEATURES: — This brilliantly designed stereo amplifier will equal or better just about any integrated commercial amp regardless of price. It is a no-compromise design capable of delivering 100 watts per channel at very low distortion. Four basic stereo inputs are provided for both moving magnet and moving coil cartridges. Also three high level stereo inputs are provided for compact disc players, AM/FM tuner and auxiliary input which could be from a stereo TV tuner of Hi Fi VCR. Input facilities are also provided for two stereo cassette decks and full monitoring facilities are available for either deck plus dubbing from Deck 1 to Deck 2 or vice versa. • Full CMOS Analog switching (soft touch) • Twist Type speaker lead binding posts supplied • De-thump muting in-built • All Hi-Spec low noise IC's used.

- Incredibly accurate RIAA equalisation.
- No control wiring whatsoever
- Led indication of switch status (on/off)
- All components mount on the PCB, even pots and sockets
- Super efficient Toroidal Transformer—Low Hum
- Uses Hiltachi Mosfet Power devices
- In-built over drive protection
- Centre detents on Bass, Treble and Balance controls; multiple detents on volume control.
- Heavy Duty Heatsinks.

SPECIFICATIONS: —
Power Output: 100W RMS into 8 Ohms (per channel) Freq Response: 8Hz to 20KHz +0 -0.3db 2.8Hz to 65KHz +0 -1db Input Sensitivity: 0.775mV for full power Hum: -100db below full output S/N Ratio: 94db flat -100db A-weighted Distortion: 0.01% @ 1KHz Stability: Unconditional Cat K 5030

THE EVER POPULAR MUSICOLOUR IV

Combination Colour Organ and Light Chaser. Four channel colour organ. Internal microphone of connect to speakers for colour organ operation. (The lights connected to each channel pulse in beat to the music proportional to portion of frequency spectrum concerned). Four chaser modes forward and reverse. Output lamp load capacity a massive 2400 watts—that's 100 party globes. Full instructions and every last nut and bolt included. Great for parties, shop signs, display windows etc.



Cat K5800
\$89.00

Dear Customer
Don't forget to tell us where you saw this advertisement — we'll be delighted to send you the bonus free offer mentioned at the beginning of the ads.

Compliments of the Seasons
Jack O'Donnell and Staff



ALTRONICS

COMPONENTS

105 STIRLING STREET, PERTH
FOR INSTANT SERVICE
PHONE ORDER TOLL FREE

008 999 007

PERTH METRO AND A/HRS
(09) 328 1599

ALL MAIL ORDERS

Box 8280, Stirling St. Perth WA 6000

**PACKING & DELIVERY CHARGE
\$3.00 DELIVERY AUSTRALIA WIDE**

- We process your order the day received and despatch via Australia Post. Allow approx. 7 days from day you post order to when you receive goods. Weight limited 6Kgs.

\$5.00 OVERNIGHT JETSERVICE - We process your order the day received and despatch via Overnight Jetservice Courier for delivery next day Country areas please allow additional 24-48 hours. Weight limit 3Kgs.

\$10.00 HEAVY HEAVY SERVICE - All orders of 6Kgs. or more must travel Express Road - Please allow 7 days for delivery.

INSURANCE — As with virtually every other Australian supplier, we send goods at consignees risk. Should you require comprehensive insurance cover against loss or damage please add 1% to order value (minimum charge \$1). When phone ordering please request "Insurance".
TOLL FREE PHONE ORDER — Bankcard Holders can phone order toll free up to 6pm Eastern Standard Time. Remember with our Overnight Jetservice we deliver next day.

ALTRONICS RESELLERS
Wanted in all Areas of Australia—Phone Steve Wroblewski on (09) 381 7233 for Details.

VICTORIA

CITY

Active Electronics 602 3499

All Electronic Components 662 3506

MaGraths Electronics 347 1122

SUBURBAN

BENTLEIGH Absolute Electronics 557 3971

BOX HILL SOUTH Eastern Communications 288 3107

CHL TENHAM Talking Electronics 550 2386

DONCASTER Clipstone Electronics 84 2868

FOOTSCRAY Acron Electronics 689 1911

SOUTH CROYDEN Truacott Electronics 723 3860

COUNTRY BENDIGO K.C. Johnson 41 1411

MORWELL Morwell Electronics 34 6133

ROBINVALE John Mason Electronics 26 3643

SHEPPARTON GV Electronics 21 8866

NSW

CITY

David Reid Electronics 267 1385

Jaycar Electronics 267 1614

SUBURBAN

CARLINGFORD Jaycar Electronics 872 4444

CONCORD Jaycar Electronics 745 3077

GORE HILL Jaycar Electronics 439 4799

HURSTVILLE Jaycar Electronics 570 7000

LEWISHAM PrePak Electronics 569 9770

ORCOUNTRY ALBURY Webpa Electronics 25 4066

BATHURST The Electronics Shop 31 4421

BROKEN HILL Crystal TV 4803

COFFS HARBOUR Coffa Harbour Electronics 52 5684

GOSFORD Tomorrow Electronics 24 7246

KURRI KURRI Kum Electronics 37 2141

NEWCASTLE D.G.E. Systems 69 1625

George Brown & Company 69 6399

NOWRA Southern Communications 21 4011

ORANGE MW Electronics 626 491

PORT MACQUARIE Hall of Electronics 83 7440

RAYMOND TERRACE Albac Electronics 87 3419

RICHMOND Veng Electronics 76 4277

TAMWORTH Landlink Communications 65 4622

TENTERFIELD Nathan Ross 36 2204

NT

DARWIN

Ventronics 81 3491

ALICE SPRINGS Ascot Electronics 52 1713

Farmer Electronics 52 2967

ACT

CITY

Electronic Components 80 4654

Scientronics 54 8334

QUEENSLAND

CITY

Desound P/L 2296155

Jaycar 393 0777

SUBURBAN

FORTITUDE VALLEY McGraths Electronics 832 3944

WILLOWBONGONG S.L.Lucas Electronics 523547

PADDINGTON Jacques Electronics 369 8594

SALISBURY COLOURVIEW Wholesale 2753186

SLACKS CREEK DAVID HALL Electronics 2088808

TOOWONG ECO Technics 3710879

COUNTRY CAIRNS Thompson Instrument Services 512404

BUNDABERG PM Electronics 728 272

GLADSTONE Purley Electronics 724321

NAMBOUR Nambour Electronics 411604

PALM BEACH The Electronic Centre 341248

ROCKHAMPTON Purley Electronics 21058

TOOWOOMBA Hums Electronics 329677

TOWNSVILLE Soles Electronics 722015

SA

CITY

Force Electronic 212 2672

Protronics 2123111

Gerard & Goodman 223222

SUBURBAN

BRIGHTON Brighton Electronics 296 3531

CHRISTIES BEACH Force Electronics 382 3366

PROSPECT Jensen Electronics 269 4744

REYNELLA Force Electronics 381 2824

COUNTRY MT. GAMBIER South East Electronics 250 034

PT. LINCOLN West Coast Elect Supplies 82 5802

WHYALLA Eye Electronics 45 4764

TASMANIA

HOBART D & I Agencies 34 7877

George Harvey 342233

LAUNCESTON George Harvey 31 6533

Wills Electronics 31 5688

LEGANA Frank Beech Electronics 301379

WA

COUNTRY

ALBANY BP Electronics 41 2681

ESPERANCE Esperance Communications 71 3344

GERALDTON K.B. Electronics & Marine 21 2176

KALGOORLIE Today's Electronics 21 2777

MANOURAH Electronics 35 3227

WYALKATCHEM D & J Pesse 81 1132

FOR NEXT DAY JETSERVICE DELIVERY BANKCARD HOLDERS—PHONE ALTRONICS TOLL FREE 008 • 999 • 007

On-air radio history

The heyday of Australian radio is recaptured in a public exhibition, 'On Air', presently running at the National Film and Sound Archives' headquarters building in Canberra. 'On Air' highlights programming and personalities of Australian radio from the early 1930s through to the 1950s.

Visitors have the opportunity to hear the voices of some of Australia's most famous radio personalities such as Jack Davey, 'Mo' (Roy Rene), Bob Dyer, Neva Carr-Glynn, Queenie Ashton and Willie Fennell.

Sound extracts are the main feature of 'On Air'. Seven listening booths have been constructed for visitors to hear ex-

tracts from dramas, comedy, serials, news and documentaries, talent quests, quiz shows and children's programmes.

There is comedy — from the pure vaudeville of Roy Rene in 'McCackie Mansion' (1947-1951) to the clever verbal gags of 'Yes, What' (1936-1940), news and documentary — the 1967 broadcast of the disappearance of Harold Holt and a 1957 re-

port of atomic testing at Maralinga, talent quests like 'Australia's Amateur Hour' (1940-1960) and children's radio like the ABC's 'Argonauts' (1941-1969).

The popularity of radio serials is re-created with extracts of the longest running radio serial in the world, the ABC's 'Blue Hills' (1948-1976) and others such as 'Dr Paul', 'Life Can Be

Beautiful' and 'Portia Faces Life'. Other extracts include George Edwards in 'Dad and Dave'.

The exhibition provides visitors with a brief history of Australian radio, and covers aspects such as sports, sound effects, popular music and the operation of a radio studio. It will continue until mid-1986.

DOC News

The Minister for Communications, Mr Michael Duffy, has refused an application for a radiocommunications station licence made by Mr Brian Manning of the Australian Coalition for East Timor.

Mr Manning sought the licence on 7 June 1985 in order to establish two-way communications in Darwin with Fretilin forces in East Timor.

An annual sticker similar to a vehicle registration label may be introduced in Australia to show that operators of two-way mobile radiocommunications equipment are licensed.

"Concern about the extent of unlicensed radio operations in Australia is not new," Communications Minister Duffy said.

"Unlicensed operations interfere with licensed services through jamming, abusive calls on frequencies assigned officially to others and hoax distress calls. These can disrupt emergency services and also threaten life."

A small earth station which had been installed in Perth to watch television programs being transmitted over Intelsat's Pacific Ocean satellite will now be officially licensed for such monitoring purposes only.

A spokesperson for the Department of Communications

said today the licence would be issued to Swan Television and Radio Broadcasters Ltd.

"Special conditions will be imposed ensuring that the licensee does not retransmit or distribute the Intelsat signals in any way," the spokesperson said.

A second channel for emergency messages — channel 35 — is to be reserved for exclusive emergency use from among the 40 UHF channels available to users of citizen band (CB) radios.

In some areas, notably Melbourne, Brisbane and Adelaide, CB user groups were providing repeater stations in strategic locations such as on hilltops and buildings. Messages transmitted on channel 35 were accepted by these stations and automatically repeated on channel 5, significantly extending the area over which emergency messages could be received.

Channel 5 would remain as the primary emergency channel throughout Australia, but channel 35 (as the input channel to emergency repeaters) would also be designated as an exclusive emergency channel.

The Special Broadcasting Service's multicultural television service (SBS-TV) is now received

in Adelaide, Brisbane, Newcastle and Wollongong.

A translator service carrying SBS-TV to the Gold Coast started on 30 June, while translator services designed to fill in 'shadow areas' of poor reception in the Adelaide foothills and north Wollongong became operational in August and September 1985 respectively.

According to Communications Minister Duffy, SBS-TV is scheduled to be extended to Perth and Hobart in early 1986, thus completing the State capital city network.

All the new services would be transmitted using ultra high frequency (UHF) channels, making the SBS the first national UHF network. The SBS in Sydney and Melbourne currently broadcasts on both UHF and VHF channels, but from 6 January 1986 these services would transmit on UHF channels only.

The Minister said the introduction of additional television services in Hobart and other areas of Tasmania was made possible through UHF channels. Television viewers in East Devonport and other areas of Tasmania were already receiving television services transmitted on UHF and this trend towards using UHF channels would increase over the next few years.

The SBS-TV service would operate on UHF channel 28 and, because of congestion of the very high frequency (VHF) band, any new commercial services could also be expected to be on UHF in Hobart. Throughout the country almost all new television services, and some existing ones, would use UHF channels in the future.

The Minister said the SBS-TV service would be transmitted from Mt Wellington, with programs coming from Sydney via the Aussat satellite system.

He said the great majority of modern television sets had UHF facilities built-in, and those that didn't could use a video-cassette recorder or inexpensive down-converter to pick up the new UHF services. The only additional equipment that most householders would need to install was a UHF antenna and a UHF feeder cable.

The Department's UHF education campaign in Hobart would involve a hands-on display in November, a letterbox drop of a pamphlet on UHF reception, and a media campaign. In the meantime people could obtain more information on UHF reception from the Department's office at 162 Macquarie St, Hobart, the Minister said.

Tortoise or hare?

Six months after its introduction, it's still difficult to gauge whether AM stereo has been any sort of success. Recent reports suggest conflicting trends.

In the west, a McNair survey in Perth has shown that, while 73% of the population know of the existence of AM stereo, only 14% will buy a new receiver within the next 12 months.

According to Pioneer, the biggest supplier of AM stereo in Perth, sales started with a rush, then slowed. According to a spokesperson, the company sold 450 units to June, but since then had been selling only 40 a month.

The other main contender, Marantz, reported much the same pattern of sales. Both companies expect the next big boom to come at Christmas, although it remains to be seen just how large it will be.

Meanwhile, in Queensland, they can't get enough of it. Demand is outstripping supply and according to some surveys, over 75% of people in south-east Queensland are likely to buy a stereo set next time they buy.

The high profile of AM stereo in Queensland is being attributed to the marketing push being given by the radio stations and receiver manufacturers.

Army beefs up Samoan coms

In a two-year, \$500,000 project under the Defence Co-operation Programme, Australia has given the Western Samoan police force new-generation Philips VHF and Codan HF equipment that will help streamline criminal investigations and communication in times of emergency.

WO2 Chris Brown, who supervised the installation and is training Samoan police officers to operate and maintain the equipment, says that before he arrived, the police relied on an aged and inadequate radio system.

"Their most powerful radio in Apia could barely reach the next town, 25 kilometres down the road," he said.

"In the remote outposts, police could contact their head-

quarters only by telephone, and if it was out of order they would run down to the bus driver with the message.

"It could take up to a week for vital information to reach Apia, often severely hampering investigations."

In his first six months, WO2 Brown has installed all the new equipment including repeater stations high on the main islands of Upolu and Savaii, and nine antennae at the scattered police posts and prisons.

He has turned an empty building in the Apia police complex into a workshop and radio operations facility with VHF and HF receivers and transmitters, telephones and tape recorder.



BRIEFS

Mini time-out timer

Since 1 July 1984 the Department of Communications Quiet Base regulation has required that a 60-second transmit limit timer be fitted to all new mobiles and handheld portables. As space is very much at a premium in such units, the industry will welcome the introduction of a miniature TOT from Sigtec. Known as the T 9904 P/L, it will fit in virtually all portables. For further information, contact Signalling Technology Ptd Ltd, 2 Aspley Pl, Seaford, Vic 3198. (03)786-0077.

New rf test instruments

Vicom Australia has announced the release of a new range of rf test instruments from Fujisoku of Japan. The range includes termination power meters, wideband and narrowband power meters, through-line power meters and rf power peripherals including coaxial switches and dummy loads. Further enquiries should be directed to Vicom, PO Box 366, South Melbourne, Vic 3205. (03)62-6931.

VHF/UHF repeater

Imark has released the Sawtron KG 105 BRS repeater for use in the commercial VHF and UHF two-way radio communication bands. It provides up to 16 frequency synthesised channels with various rf power outputs from 15-50 watts on VHF and 15-40 watts on UHF frequencies, and can be configured for use as a base, repeater, trigger link or as a transponder. Further details can be obtained from Imark, 167 Roden St, West Melbourne, Vic 3003. (03)329-5433.



Privatisation a no-no

The Minister for Communications, Mr Duffy, has attacked the Federal Opposition's call for the privatisation of Telecom, saying it would lead to higher telephone charges in the country. "This ideologically blinkered commitment from the Opposition hits directly at people in rural areas, small business and ordinary domestic subscribers," said Mr Duffy. "And all in the interests of lowering telecommunications charges to big business in the Melbourne/Sydney/Canberra triangle."

New appointment to FACTS

The Federation of Australian Commercial Television Stations has appointed Mr David Morgan as its federal director. Morgan, who has been FACTS deputy federal director and general manager, joined the federation in 1977. He replaces Mr James Malone who has resigned to take up an appointment as managing director of Associated Broadcasting Services.

New appointment to ABC board

A prominent trade union official with a strong interest in technology, Mr Ken McLeod, has been appointed to the Board of the Australian Broadcasting Corporation. Mr McLeod replaces Ms Jan Marsh who resigned from the Board in March 1985 because of other pressing commitments.

FERROMAGNETIC CORES IN rf CIRCUITS

Newly available core components are making the feasibility of home constructed rf circuits a more appealing proposition than ever before. Here we present a guide to home brewed toroidal cores.

R. Sanders

MODERN COMMUNICATIONS equipment has changed a lot since the valve circuits gave way to solid-state devices. One obvious result of the 'newer technology' has been the reduction in size of the equipment.

Because of the nature of solid-state circuitry, which tends to use lower impedances and lower voltages (not to mention the absence of heat from filaments), different methods of coupling and matching between stages have come into widespread use. The old familiar large diameter coils (remember how we took great care with the shape of our coils to get the best Q?) have largely vanished, replaced by small ferromagnetic devices which seem to be stacked into odd spaces throughout the rf sections of our black-boxes. One might well wonder how 'they' get away with it, when we think how much trouble we had with unwanted coupling.

There are still plenty of problems left in producing well designed rf equipment, but some things are certainly easier now that the newer components are readily available to the home constructor. This article will cover general aspects of the ferromagnetic cores and provide the home constructor with sufficient information to select a suitable core for a particular application.

Advantages of toroidal coils

The main advantages we get from using toroids are higher Q, self-shielding and compactness. Let's consider each of these benefits in turn.

Having selected an appropriate core for the operating frequency and power (this will be clear later) we find that for a given inductance the toroidal inductor has fewer turns on it than an equivalent air cored inductor, because of the permeability of the material used in the core. This also means

that the winding resistance is lower, and since both inductors have the same inductance and therefore the same value of inductive reactance, the value of XL/R will be greater for the toroid winding. This expression is the same as that for the Q of a coil and so the Q will also be greater. An additional benefit is gained with low voltage equipment which passes dc current through the inductor, by reducing voltage drop and hence heating in the component.

Unlike normal (solenoid wound) coils which have large external magnetic fields,

the toroid winding has a field which is almost completely contained within itself. This means there is almost no magnetic coupling between toroidal coils and other circuit elements. (Try coupling a gdo [grid deposit oscillator] to a tuned circuit containing a toroid!) We are therefore free to place toroid coils fairly close to other circuit components (including ground plane) without complicated shielding. It should be noted that capacitive coupling can occur and normal precautions must be taken against this.

The two benefits mentioned above allow

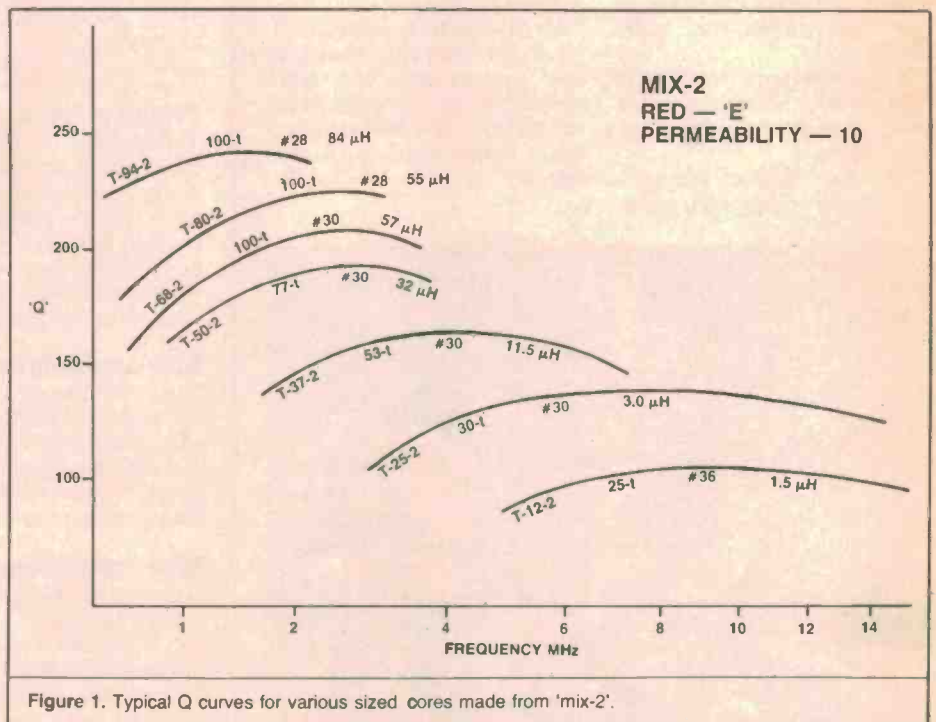

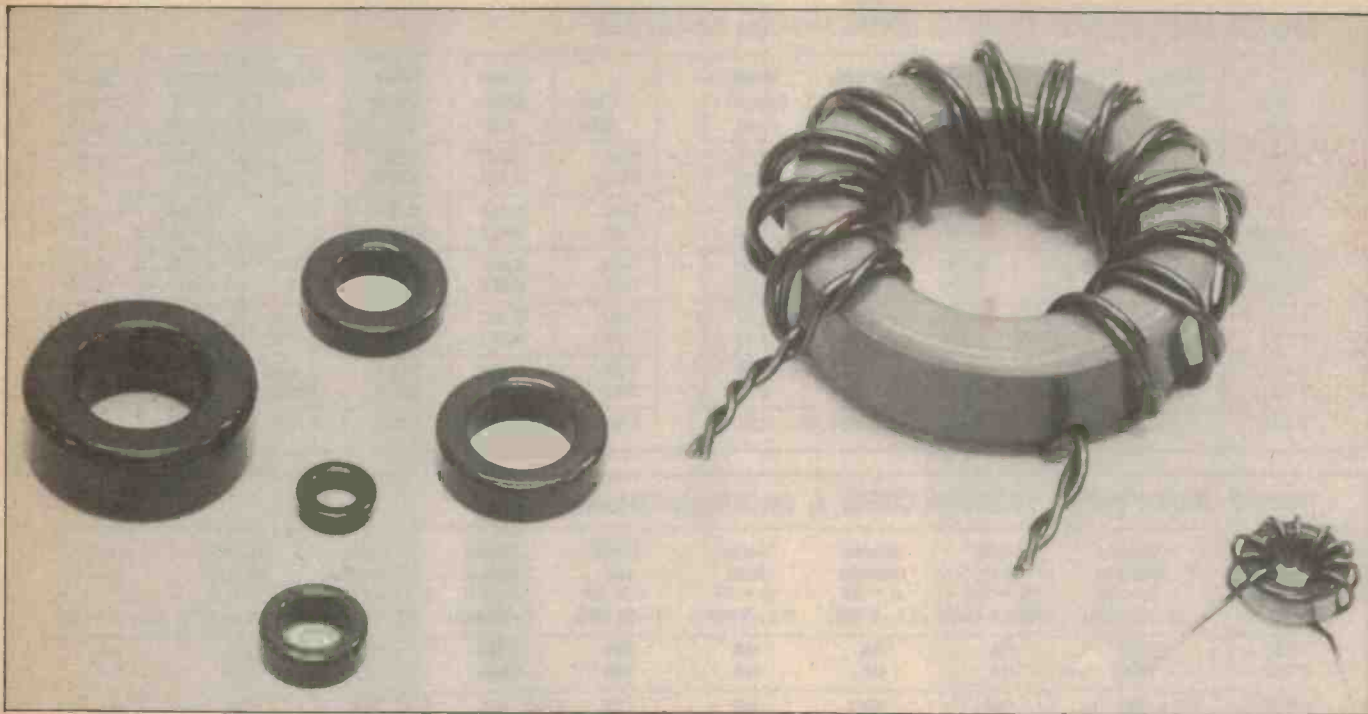

us to create a much more compact circuit layout when toroid coils are employed. This is particularly important when portable equipment is being considered or when an expensive pc board is used:

Choice of core material

Contrary to information which sometimes appears in magazines, the choice of material is of prime importance if the expected results are to be realized from any design using ferromagnetic cores. Let's look at the two most common core materials in use: ferrite and iron powder. The choice between the two is made by considering whether the core will be used in a wideband or narrowband application and how much signal power will be handled.

For a given size core, ferrite material will saturate at a much lower flux density than one made from iron powder. Permeability for ferrite materials ranges from 20 to 5000 while for iron-powder it is from 2 to 75. As a 'rule of thumb' the higher the permeability of the material the greater the temperature coefficient will be, so that it is desirable to use a material which exhibits the lowest practical temperature coefficient in a narrowband circuit. On the other hand this is not so important in wideband use.

For wideband circuits a ferrite is commonly used because it has a higher permeability and hence can provide a larger inductance for a given number of turns than is possible with an equivalent size iron powder core. The grade of ferrite chosen must exhibit low loss over the range of operating frequencies; refer to the manufacturer's data. The common rule for the design of wideband transformers is that the reactance (XL) of a winding must not be less than four times the design impedance at the lowest frequency.

'What about the effects of this at the high frequency end?' you may ask. Well luckily there is no cause for concern, as the effective permeability of the core material decreases with increasing frequency, and the core tends to 'disappear', so that the inductance of the winding is also reduced. With the proper selection of core material it is easy to make wideband transformers which cover one decade in frequency; eg 3-30 MHz.

Narrowband applications (tuned circuits) above 1.5 MHz usually use iron powder cores which can provide good Q values into the VHF frequencies. Wideband circuits by their very nature cannot have a high Q (circuit Q = centre frequency/bandwidth). The characteristics of iron powder are less temperature sensitive so with changing temperature the circuit remains more closely tuned to the design frequency than is possible with ferrite materials. When tuned circuits are used in rf amplifiers at almost any power level, we should choose an iron powder core.

Ferrite materials can be divided into two groups: those with initial permeabilities below 1000 which are nickel-zinc compounds, and those above 1000 which are made from manganese-zinc compounds. Nickel-zinc ferrites exhibit high volume resistivity, moderate stability and can offer high Q factors for the 0.5 to 100 MHz frequency range. They are well suited for low power, high inductance applications and their high permeability factors make them very useful for wideband transformer applications. The manganese-zinc group has fairly low volume resistivity and moderate saturation flux density. It can give high Q factors for the 1 kHz to 1 MHz frequency range, and some are suitable for switched-mode power conversion transformers oper-

ating between 20 and 100 kHz.

Apart from the physical dimensions of a toroid (outside and inside diameter thickness) there is a value given for each particular core size and material, which is usually called the 'A_L value', and is the manufacturer's inductance index for the core. Manufacturers' data for iron powder and ferrite cores are given in Tables 1-6 and show all the required core information. The A_L figure for powdered iron cores is normally given as μH/100 turns, but for ferrite cores it is usually quoted as mH/1000 turns. The relevant A_L value is used in many calculations involving toroids. One of the most common uses is to calculate the turns required to produce a given value of inductance on a particular core, as shown below:

iron powder:

$$\text{turns} = 100 (\text{desired } L_{\mu\text{H}}/A_L)^{0.5}$$

ferrite:

$$\text{turns} = 1000 (\text{desired } L_{\text{mH}}/A_L)^{0.5}$$

What size toroid?

Toroid cores come in sizes ranging from 3 mm up to 150 mm outside diameter, with the common sizes between 6 mm and 50 mm. The power rating of a given size core will depend upon the particular ferromagnetic material used, and the calculation of this is probably the most complex consideration of all.

Ferrite materials are basically limited by flux saturation and iron powder by temperature rise. Many ferrites can permanently change their permeability after being subjected to relatively high power (flux) levels, whereas powdered iron cores return to their original values after they cool down. In circuits up to 500 mW, saturation is not usually of any concern, but when we use a ferromagnetic core at levels above 1 W it must ▶

TABLE 1. IRON POWDER TOROIDAL CORES PHYSICAL DIMENSIONS

Core Size	Outer Diam (in)	Inner Diam (in)	Height (in)	Cross Sect (cm ²)	Mean Length (cm)	Core Size	Outer Diam (in)	Inner Diam (in)	Height (in)	Cross Sect (cm ²)	Mean Length (cm)
T-520	5.218	3.081	0.800	5.50	33.10	T-94	0.942	0.560	0.312	0.385	6.00
T-400	4.000	2.250	0.650	3.66	24.93	T-80	0.795	0.495	0.250	0.242	5.15
T-300	3.048	1.925	0.500	1.81	19.83	T-68	0.690	0.370	0.190	0.196	4.24
T-225A	2.250	1.405	1.000	2.73	14.59	T-50	0.500	0.303	0.190	0.121	3.20
T-225	2.250	1.405	0.550	1.50	14.59	T-44	0.440	0.229	0.159	0.107	2.67
T-200A	2.000	1.250	1.000	2.42	12.97	T-37	0.375	0.205	0.128	0.070	2.32
T-200	2.000	1.250	0.550	1.33	12.97	T-30	0.307	0.151	0.128	0.065	1.83
T-184	1.840	0.950	0.710	2.04	11.12	T-25	0.255	0.120	0.096	0.042	1.50
T-157	1.570	0.950	0.570	1.14	10.05	T-20	0.200	0.088	0.070	0.025	1.15
T-130	1.300	0.780	0.437	0.73	8.29	T-16	0.160	0.078	0.060	0.016	0.95
T-106	1.060	0.570	0.437	0.69	6.50	T-12	0.125	0.062	0.050	0.010	0.75

TABLE 2. IRON POWDER TOROIDAL CORES A_L VALUES (μh/100 turns)

Core Size	26-mix ylw-wht μ = 75 0-1.0 MHz	3-mix grey μ = 35 0.05-0.5 MHz	15-mix red/wht μ = 25 0.1-2 MHz	1-mix blue μ = 20 0.5-5 MHz	2-mix red μ = 10 1-30 MHz	6-mix yellow μ = 8 2-50 MHz	10-mix black μ = 6 10-100 MHz	12-mix grn/wht μ = 3 20-200 MHz	0-mix tan μ = 1 50-300 MHz
T-520 —	1500	NA	NA	NA	205	NA	NA	NA	NA
T-400 —	1320	NA	NA	NA	185	NA	NA	NA	NA
T-300 —	825	NA	NA	NA	115	NA	NA	NA	NA
T-225A —	1600	NA	NA	NA	215	NA	NA	NA	NA
T-225 —	950	425	NA	NA	120	100	NA	NA	NA
T-200A —	1550	460	NA	455	218	180	NA	NA	NA
T-200 —	895	425	NA	250	120	100	NA	NA	NA
T-184 —	1640	720	NA	500	240	195	NA	NA	NA
T-157 —	970	420	360	320	140	115	NA	NA	NA
T-130 —	785	350	250	200	110	96	NA	NA	15
T-106 —	900	450	345	325	135	116	NA	NA	19
T-94 —	590	248	200	160	84	70	58	32	10.6
T-80 —	450	180	170	115	55	45	32	22	8.5
T-68 —	420	195	180	115	57	47	32	21	7.5
T-50 —	320	175	135	100	49	40	31	18	6.4
T-44 —	360	180	160	105	52	42	33	19	6.5
T-37 —	275	120	90	80	40	30	25	15	4.9
T-30 —	325	140	93	85	43	36	25	16	6.0
T-25 —	NA	100	100	70	34	27	19	12	4.5
T-20 —	NA	90	65	52	27	22	16	10	3.5
T-16 —	NA	61	55	44	22	19	13	8	3.9
T-12 —	NA	60	50	48	20	17	12	7	3.0

μ = relative permeability

NA — not available in that size

Add mix number to core size in space provided (—) for complete part number

$$\text{Turns} = 100 \sqrt{\frac{\text{desired } L (\mu\text{h})}{A_L \text{ value } (\mu\text{h}/100 \text{ t})}}$$

be taken into account in the design. Another 'rule of thumb': when in doubt use the largest core which will conveniently fit into your layout. At high power levels considerable heat can be generated in ferromagnetic cores and the constructor must make provision for adequate ventilation and removal of heat, which can affect nearby circuit components. The surface area of the core largely determines the allowable dissipation, so once again 'use the largest core which is practical', and don't try to build a high power solid state amplifier into a closed box without ventilation.

To determine the operating flux density (Bop) of a core we must take into account the applied voltage (Erms), the equivalent area of the magnetic path in cm² (Ae), the

number of turns (N) and the operating frequency (f). These terms are used in the following formula:

$$Bop = \frac{Erms \times 10^8}{4.44 f N Ae \text{ (gauss)}}$$

and if dc is passed through the winding add the following:

$$+ \frac{N I_{dc} A_L}{10 Ae}$$

The manufacturer's data will give the saturating flux density of the core, and the calculated value of Bop should be quite a bit below this value to be on the safe side. The

formula shows that we should use the lowest operating frequency expected in our design (3 MHz in a 3-30 MHz wideband circuit) and the highest value of Erms (calculated from the required rf power and the winding impedance) to give a conservative design figure for flux density. The saturating flux density (Bsat) for iron powder materials is about 10,000 gauss, while for ferrites below 1000 μ it is 1500 gauss, and for those above 1000 μ it is about 3000 gauss.

Using the data sheets

Two principal sets of data are given in Tables 1 to 6, and cover iron powder and ferrite toroids. First, let's look in detail at Tables 1 and 2 which give all the essential information for some iron powder toroids.

Iron powder toroids

The physical dimensions are important since we must know how big the toroid is to allow sufficient space in our project. The cross sectional area and mean length (magnetic path length) are included so that flux density and magnetising force calculations can be made. You will notice that this manufacturer uses a type number which begins with 'T' for iron powder cores and is followed by a figure which denotes the outside diameter in hundredths of an inch (made in USA!).

Table 2 lists the A_L values for all the combinations of core size and mix (material types) that are available. The different materials have different values of relative permeability (μ), which also determines the useful range of frequencies for each material, and the cores are colour-coded for easy

recognition. The formula for turns calculation is also given.

Another useful table (Table 3) gives the maximum turns vs wire gauge and core size for single layer windings. This saves a lot of 'cut and try', so we can make a good 'first approximation' for our winding. Figure 1 shows typical Q curves for different sized cores made from mix-2. Notice that the larger cores are used at the lower end of the frequency range for mix-2 and they produce correspondingly larger values of Q. This principle is used generally for all core materials.

Suppose we wish to wind a toroid coil for use in a receiver front-end tuned to 7 MHz. Since there is no rf 'power' involved we do not have to worry about saturation of the core and can choose almost any size core. Without going overboard it is best to choose

the largest size consistent with our circuit layout as that will enable us to achieve a better Q, which is a common requirement in receiver front-ends. If we want to tune this coil with a 100 pF capacitor we will require an inductance of approximately 5 μ H.

With a frequency of 7 MHz we have a choice of mix-2 or mix-6, but let's decide on a (red) T-50-2 as our core. The A_L of this core is given as 49 and so we can calculate the required turns to produce 5 μ H from the formula given in section 2. This works out to 31.9 which we will round up to 32 since we cannot have fractional turns on a toroid.

Next we look up the table showing turns vs core size for different wire gauges and see that we can fit 39 turns of 24 g enamelled wire on a T-50-2 core. Our toroidal inductance would have an unloaded Q of about 200, which is quite a respectable figure for this application. If a coupling link is required on the toroid, it should be put on at the 'cold end' of the winding, and in this case, could consist of two or three turns.

Ferrite toroids

Tables 4-6 list all the data for ferrite toroids. Table 4 shows the physical dimensions of the various sized ferrite cores, which are different to the iron powder cores and are all prefixed by FT (ferrite toroid).

Table 5 lists the A_L values for all the combinations of core size and ferrite material, and also gives the formula for calculating turns. Notice that these cores are not colour coded, so be careful to keep track of the types if you acquire some ferrite cores, otherwise you will finish up with a heap of cores with unknown characteristics. A good idea is to paint coloured dots on the core to indicate the material type: eg blue and brown dots for 61 material.

Table 6 is interesting in that it gives information for narrowband (tuned circuit) and wideband use, as well as the permeability for each different ferrite mix. This enables us to select the correct mix for any particular application.

Let's work out an example. Suppose we want to design a wideband transformer for use between 3.5 MHz and 30 MHz and it has to match a 200 ohm source to a 50 ohm load. From the previous rule we know that the primary winding should have an inductive reactance of not less than 800 ohms at 3.5 MHz. Using the formula ($L\mu\text{H} = XL/2\pi f$, where f is in MHz) we see that we need a primary winding of 37 μ H. Similarly, the secondary winding would need an XL of 200 ohms which works out to be a winding of 9.2 μ H. Since these are minimum values let's round them off to 40 μ H and 10 μ H.

Now let's work out the turns required for a ferrite core of suitable material for the frequency range. Assuming that this is a low

TABLE 3. NUMBER OF TURNS v WIRE SIZE and CORE SIZE

Approximate maximum number of turns — single layer wound — enamelled wire										
Wire Size	T-200	T-130	T-106	T-94	T-80	T-68	T-50	T-37	T-25	T-12
10	33	20	12	12	10	6	4	1		
12	43	25	16	16	14	9	6	3		
14	54	32	21	21	18	13	8	5	1	
16	69	41	28	28	24	17	13	7	2	
18	88	53	37	37	32	23	18	10	4	1
20	111	67	47	47	41	29	23	14	6	1
22	140	86	60	60	53	38	30	19	9	2
24	177	109	77	77	67	49	39	25	13	4
26	223	137	97	97	85	63	50	33	17	7
28	281	173	123	123	108	80	64	42	23	9
30	355	217	154	154	136	101	81	54	29	13
32	439	272	194	194	171	127	103	68	38	17
34	557	346	247	247	218	162	132	88	49	23
36	683	424	304	304	268	199	162	108	62	30
38	875	544	389	389	344	256	209	140	80	39
40	1103	687	492	492	434	324	264	178	102	51

Actual number of turns may vary slightly according to tightness of wind

TABLE 4. FERRITE TOROIDAL CORES PHYSICAL DIMENSIONS

Core Size	Outer Diam (in)	Inner Diam (in)	Height (in)	Cross Sect (cm ²)	Mean Length (cm)	Volume (cm ³)
FT-23	0.230	0.120	0.060	0.021	1.34	0.029
FT-37	0.375	0.187	0.125	0.076	2.15	0.163
FT-50	0.500	0.281	0.188	0.133	3.02	0.401
FT-50A	0.500	0.312	0.250	0.152	3.18	0.483
FT-50B	0.500	0.312	0.500	0.303	3.18	0.964
FT-82	0.825	0.520	0.250	0.246	5.26	1.29
FT-87A	0.870	0.540	0.500	0.522	5.42	2.83
FT-114	1.142	0.750	0.295	0.375	7.42	2.79
FT-114A	1.142	0.750	0.545	0.690	7.42	5.13
FT-150	1.500	0.750	0.250	0.581	8.30	4.82
FT-150A	1.500	0.750	0.500	1.110	8.30	9.21
FT-193	1.930	1.250	0.750	1.460	12.30	18.00
FT-240	2.400	1.400	0.500	1.570	14.40	22.70

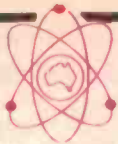

Disco World Pty, Ltd.

Showrooms:

300 Main Street, Lilydale
P.O. Box 509, Lilydale, 3140
Melb. Vic. (03) 735-0588
673 High Street, Preston
(03) 470 5822

AMPLIFIERS

ZPE Series II (500W) \$1750.00

DISCO MIXERS

Citronic SM 330 \$695.00
Arista \$350.00

JUMBO STROBE

Scanner S101 \$179.19
\$120.45

HELICOPTER

2 ARM Spinner \$238.00
4 ARM Spinner \$395.00
6 ARM Spinner \$652.00
UFO 324 \$1698.55



PINSPOT

PS 112S \$52.75
PS 112L \$70.79

MIRROR BALLS



MB 008-8" \$44.64
MB 012 \$77.49
MB 014 \$112.25
MB 018 \$130.41
MB 020 \$181.10

SMOKE MACHINE

Great for Special Effects

Hand Held 240V \$352.00

SUPER MODEL

Has remote control lead to operate off-stage. We are so excited about this that full money back guarantee will be valid for 10 days from purchase date \$1200.00

Fluid—1 litre \$15.00

MIRROR BALL MOTORS

AC 240V \$32.50

ROLLING LIGHTS

8 x 4515 lamps \$1150.74
24 lamps horizontal \$1985.45
24 lamps vertical \$1985.45



COSMOS LIGHT

24 lamps \$2376.82
Half Ball rotary light
6 lamps \$428.74

LAMPS all colours, soft glass

No Warranty on Breakages

ES 240V 60W
box of 25 \$75.00
BC 240V 40W
box of 100 \$77.00
BC 240V 25W
box of 100 \$75.00

Bankcard & Mail Orders. Power Cards not included. Trade Enquiries Welcome. Send S.A.E. with 60 cents postage for free price list

Preston Electronic Components

"The Circuit Board Specialists"

Copper Clad "Single Sided PCB Super Special".

	Single Sided Board	Was ea	Now ea
SS/50	75mm x 150mm	\$1.95	\$.95
SS/100	150mm x 150mm	\$2.75	\$1.35
SS/150	230mm x 85mm	\$3.45	\$1.75
SS/200	300mm x 150mm	\$4.95	\$2.50

Copper Clad "Double Sided PCB Super Special".

	Double Sided Board	Was ea	Now ea
DS/50	75mm x 150mm	\$2.05	\$.99
DS/100	150mm x 150mm	\$2.95	\$1.45
DS/150	230mm x 85mm	\$3.95	\$1.95
DS/200	300mm x 150mm	\$5.25	\$2.50

Preston Electronic Components

217 HIGH STREET, PRESTON
(Corner of Bell and High Streets)
Phone: 484 0191

Specialising in a wide range of
RESISTORS — CABLES — CIRCUIT BOARDS
CAPACITORS — SPRAYS — PCB ARTWORK
INSTRUMENT CASES — RELAYS — KIT SETS
SEMI CONDUCTORS (All Types) — TRIMPOTS
PHOTO SENSITIVE — TRANSFORMERS
SWITCHES — PRODUCTS, ETC.

"Mail Orders Welcome".

Ian J. Truscott's

ELECTRONIC WORLD MORE & MORE

People are discovering us each week. Both the home enthusiast through to the small manufacturer.

★ ★ ★

COMPONENTS • TOOLS • KITS

In any quantity, buy one, or one thousand, we're happy to oblige

SCHOOLS • CLUBS ETC.

Inquire about our bulk discount deals

Save yourself a trip to the city — come to

30 LACEY STREET CROYDON

OR PHONE

(03) 723 3860/
723 3094

Mail orders welcome.

TECHNIQUES

power application (eg receiver) we will decide on a ferrite toroid of 12.5 mm od and with an initial permeability of 850, which, according to Table 6 is suitable for 1-50 MHz. The A_L value for an FT-50-43 is given in Table 5 as 523. Using the formula for ferrite cores, the turns required to give 40 μ H will be 8.7 (don't forget that this formula uses mH in the A_L value calculation!). Since we require an impedance ratio of 4 to 1 in our example, the final transformer should have a turns ratio of 2 to 1. A toroid core cannot have partial turns (see "Winding hints") so we cannot have a primary with 8.7 turns and a secondary with 4.35 turns! Our original rule stated that a wideband winding should have a minimum of four times the load impedance, so we are able to increase our calculated secondary turns to 5 (instead of the 4.35) and the primary turns will then become 10, which preserves the 2 to 1 turns ratio.

Although the rule states a *minimum* of four times it should be noted that if too many turns are wound on the core, troubles can arise at the high frequency end of the wideband transformer; it would be wrong to put say, 40 turns on the primary and 20 turns on the secondary in our example.

Some winding hints

One aspect of toroidal windings which often causes newcomers some trouble is counting turns. A toroidal coil cannot have partial turns. If a straight wire passes through the centre of a core it counts as one turn, even though the ends are not brought back together. With any toroid winding it is good practice to have the winding cover 300-330 degrees of circumference. If the winding covers the whole length of the core 'end capacity' effects cause unwanted resonances which are particularly troublesome with tuned circuits, and cause a lowering of the effective Q of the winding. With tuned circuits any coupling winding should be placed over the 'cold' end of other windings on the core to prevent undesirable capacitive coupling between windings.

Broadband transformers are often made up with 'multi-winding' windings which are then joined in series to form one larger winding. This method of winding is referred to as a multifilar winding. The most common types are bifilar, trifilar and quadrifilar, which refer to two, three and four separate windings wound on the core at the same time by using two, three or four separate pieces of wire. The groups of wires are often twisted together before winding (about 3 turns per cm) by holding one set of ends in a vice and the other ends in the chuck of a hand drill which is then slowly rotated while keeping the wires taut. Since all the wires are wound together they are also wound on the core in the same sense; ie all the starts are at the same end. With the aid

TABLE 5. FERRITE TOROIDAL CORES A_L VALUES (mh/1000 turns)

Core Size	#68 $\mu = 20$	#63 $\mu = 40$	#67 $\mu = 40$	#61 $\mu = 125$	#43 $\mu = 850$	#77 $\mu = 1800$	#72 $\mu = 2000$	#F $\mu = 3000$	#75 $\mu = 5000$	#J $\mu = 5000$
FT-23 —	4.0	7.9	7.9	24.8	188	356	396	NA	990	NA
FT-37 —	8.8	17.7	17.7	55.3	420	796	884	NA	2210	NA
FT-50 —	11.0	22.0	22.0	68.0	523	990	1100	NA	2750	NA
FT-50A —	12.0	24.0	24.0	75.0	570	1080	1200	NA	2900	NA
FT-50B —	NA	48.0	48.0	150.0	1140	2160	2400	NA	NA	NA
FT-82 —	11.7	22.4	22.4	73.3	557	1060	1170	NA	2930	NA
FT-87A —	NA	NA	NA	NA	NA	NA	NA	3620	NA	6040
FT-114 —	12.7	25.4	25.4	79.3	603	1140	1270	1900	3170	3170
FT-114A —	NA	NA	NA	146.0	NA	NA	2340	NA	NA	NA
FT-150 —	NA	NA	NA	NA	NA	NA	NA	2640	NA	4400
FT-150A —	NA	NA	NA	NA	NA	NA	NA	5020	NA	8370
FT-193 —	NA	NA	NA	NA	NA	NA	NA	4460	NA	7440
FT-240 —	NA	53.0	NA	173.0	1240	NA	3130	NA	NA	NA

 μ = relative permeability

NA — not available in that size

Add mix number to core size in space provided (—) for complete part number

Turns = 1000

$$\sqrt{\frac{\text{desired } L \text{ (mh)}}{A_L \text{ (mh/1000 t)}}$$

TABLE 6. FERRITE MAGNETIC PROPERTIES

Property	#68	#63	#67	#61	#43	#77	#72	#F	#75	#J
Relative Permeability (μ)	20	40	40	125	850	1800	2000	3000	5000	5000
Saturation Flux (Gauss)	2000	1850	3000	2350	2750	4600	3500	4700	3900	4300
Curie Temp °C	500	450	500	350	130	200	150	250	160	140
Temp Coef %/°C	0.06	0.10	0.13	0.15	1.0	0.60	0.60	0.60	0.90	0.90
Tuned Circuit Frequency (MHz)	80-180	15-25	10-80	0.2-10	0.01-1	0.001-1	0.001-1	0.001-1	0.001-1	0.001-1
Wideband Frequency (MHz)	200-1000	25-200	50-500	10-200	1-50	0.5-30	0.5-30	0.5-30	0.2-15	0.2-15

of an ohm-meter the separate wires can then have their starts and finishes identified, so that it is an easy matter to join up the finish of one winding to the start of another.

If two windings are series connected in this way the winding is called a bifilar winding. The purpose of this type of winding is to reduce the stray winding capacitances which would result from a single winding of the same number of turns. This is most important at the higher frequencies. Another benefit with this type of winding is that it is easy to make up transformers with turns ratios of 1:1, 2:1 or 3:1 by joining 1, 2 or 3 windings in series for the high impedance winding and using a single winding for the low impedance. In practice it is difficult to make a good broadband transformer with a turns ratio greater than 4:1, and for greater ratios it is better to use two separate transformers which, when combined, produce the required ratio.

It is often necessary to adjust the inductance of a toroidal winding in tuned circuit applications to achieve resonance with a fixed capacitor in the circuit. Apart from adding or removing turns (a coarse adjustment) it is possible to make fine adjustments by slightly closing up or spreading apart the turns around the core. Pushing the

turns together will increase the inductance and, conversely, spreading them apart will decrease the value. Finished windings can be fixed in place with polystyrene dope, and complete toroidal inductors may be attached to a printed circuit board with silastic adhesive so that the assembly can be removed later if necessary. When fixing to an earthed base be careful of unwanted capacitive coupling to the winding itself.

Ferromagnetic materials are hard and brittle, so do not clamp cores in a vice or pliers. To prevent any sharp corners from cutting through the insulation on the wire it is good practice to wind a layer of PTFE tape (as used by plumbers for sealing threaded joints) over the entire core before laying on the winding. Always put the winding with the largest number of turns on first so that additional windings have an even base to sit on. The sealing tape can also be used as insulation between windings.

It is important to know how to measure the resonant frequency of a tuned circuit containing a toroid inductor. As mentioned earlier, toroidal coils have very little external field, so it is almost impossible to couple a gdo to such a winding. To overcome this, use a 1 or 2 turn link coupling between the gdo coil and the 'cold end' of the toroid winding.

Where ferromagnetic cores are used with transmitters quite high rf voltages can exist across windings and ordinary enamel insulation is often not sufficient to prevent breakdown between turns or breakdown between turns and the core. In these cases good spacing between turns and good HV insulation (eg PTFE insulation) must be used. Because of these restrictions, it is not usual to use ferromagnetic cores at high power levels (>200 W) where the circuit impedance exceeds 600 ohms. Fortunately, most solid state circuits operate at much lower impedances.

Suppliers

Toroidal cores are available from a number of suppliers including the following: Truscott's Electronic World, 30 Lacey St, Croydon, Vic 3136. (03)723-3094; Geoff Wood Electronics, 656A Darling St, Rozelle, NSW 2039, (02)810-6845; Electronic Components Pty Ltd, Unit 10, Fyshwick Plaza, Fyshwick, ACT 2609; Willis Trading Co, 445 Murray St, Perth, WA 6000.

I wish to acknowledge the kind permission given by Amidon Associates Inc for inclusion of the data tables.

BOOKS OF SPECIAL INTEREST

electronics textbooks

ELEMENTS OF ELECTRONICS- BOOK 1

This five book series is an introduction to modern electronics. All of the necessary mathematics is introduced and explained as required. The emphasis is on understanding concepts rather than digressing over the whole field. The author anticipates difficulties the beginner may have and explains them as they occur. BOOK 1 covers all of the fundamental theory necessary to understand simple electronic circuits and components. 209pp.

A0003B \$9.95

ELEMENTS OF ELECTRONICS- BOOK 2

See Book 1: Covers alternating current theory. 216pp.

A0004B \$9.95

ELEMENTS OF ELECTRONICS- BOOK 3

See Book 1: Covers semiconductor technology and introduces transistors and ICs. 204pp.

A0005B \$9.95

BASIC ELECTRICITY/ELECTRONICS Vol. 2

Assuming some background in overall theory and the practical aspects of electricity and electronics, this volume builds a detailed coverage of AC and DC circuits including series and parallel circuits, electro-magnetism, resistance, capacitance and inductance with explanations of the associated calculations. 318pp.

A0009H \$15.95

electronics for beginners

BEGINNER'S GUIDE TO ELECTRONIC PROJECTS

This guide enables the complete beginner to tackle the practical side of electronics so that the projects featured regularly in popular magazines can be approached with confidence. The basics are covered in detail using practical examples in the form of simple projects. 107pp.

C0030B \$6.95

RADIO CONTROL FOR BEGINNERS

Newcomers to the fascinating hobby of radio control will find this practical introduction invaluable. A number of constructional projects, many with complete board layouts, are included to help the beginner simply and successfully build up the circuits. 92pp.

C0034B \$5.95

SOLID STATE SHORTWAVE RECEIVERS FOR BEGINNERS

Details the design and construction of several solid state shortwave receivers giving a high level of performance yet utilising few components. 93pp.

C0044B \$5.95

constructional projects

HOW TO MAKE WALKIE-TALKIES

This treatise on low power transmitter-receivers (walkie-talkies) covers many aspects, from licensing requirements and bands, through practical circuitry and construction to the types of aerials that may be used. 104pp.

D0056B \$6.95

REMOTE CONTROL PROJECTS

Primarily for the enthusiast who wishes to experiment with remote control. Full explanations of the how the circuits work are given and many of the designs can be adapted to circuits that have been published elsewhere. Covers remote control by ultra-sound and infra-red as well as radio control. 164pp.

D0046B \$6.95

ELECTRONIC SECURITY DEVICES

Besides including both simple and sophisticated burglar alarm circuits using light, infra-red and ultra-sonics, this book also gives circuits for gas and smoke detectors, flood alarms, fire alarms, doorphones, etc. 102pp.

D0059B \$6.95

MINI-MATRIX BOARD PROJECTS

This selection of 20 useful projects to build is an excellent introduction to constructing electronic projects. Those without any experience in electronics will find it easy to read and simple to follow. \$6.75 RRP, 102pp.

D0062B Priced to clear \$2.00

circuit techniques and design

TO DESIGN ELECTRONIC PROJECTS

Tackles the problem of combining and integrating components into a complete working project with the minimum of trial and error and without advanced mathematics. Guides the reader through examples with circuit analysis, possible solutions and practical designs including component values. 101pp.

E0082B \$6.55

circuit techniques and design

HOW TO GET YOUR ELECTRONIC PROJECTS WORKING

Helps you to overcome the problem of a circuit that doesn't work after assembly by indicating how and where to start looking. Covers most of the common faults that occur when constructing an electronic project. 81pp.

F0114B \$6.95

TROUBLESHOOTING WITH THE OSCILLOSCOPE

Excellent for the professional service technician or serious hobbyist. It combines step by step procedures for using the 'scope with the specific nuts and bolts of television receiver troubleshooting. 92pp.

F0121P \$17.95

ELECTRONIC TROUBLESHOOTING HANDBOOK

This workbench guide shows you how to pinpoint trouble in minutes, how to test almost anything electronic and how to get the most out of low-cost test equipment. 215pp.

F0257H \$16.95

USE OF THE DUAL-TRACE OSCILLOSCOPE

This programmed text breaks down the process of operating a 'scope into a series of logical steps. It starts with the deflection of the electron beam and continues through the proper use of the triggering controls to measure the phase difference between two waveforms.

F0259H \$43.50

Postage and packing additional:
Please refer to reply card for charges.



electronic music and audio/video

AUDIO AMPLIFIER CONSTRUCTION

Provides a wide range of preamplifier and power amplifier designs including a low noise microphone, tape head and guitar preamps, and various tone controls. Written for those with limited experience in construction, but certainly useful for the more advanced hobbyist. 99pp.

G0132B \$6.55

ELECTRONIC SYNTHESIZER PROJECTS

For the electronic music enthusiast. This invaluable reference is full of circuits and information on how to build analogue delay lines, sequencers, voltage control oscillators, envelope shapers, etc. The author takes a clear and logical approach to the subject that enables even the beginning enthusiast to understand and build up what appear to be quite complex instruments. 81pp.

G0133B \$5.95

THE MUSICIAN AND THE MICRO

A straightforward and practical guide for keen musicians, teachers and those who work in the music industry. It covers the exciting world of microprocessor applications and computerised musical instruments. 192pp.

G0280D \$9.95

AUDIO

A theoretical study of sound waves and acoustical quantities which leads into a study of hearing and room acoustics. A discussion of microphones and loudspeakers is developed into sections on amplifiers and recordings, covers digital as well as magnetic and disc recording. 308pp.

G0332B \$7.55

SINGLE-CAMERA VIDEO PRODUCTION

Step by step diagrams and illustrations show you how to produce low-budget, high quality video programs using only one camera. There are chapters on audio, lighting, shooting, editing, graphics and set design. 241pp.

G0379H \$25.25

PRACTICAL TRANSISTORISED NOVELTIES FOR HI-FI ENTHUSIASTS

Covers such useful 'add-ons' as quadrophony, stereo headphone adaptor, phasing stereo loudspeaker systems, high-impedance four-channel mixer, and speaker gain control. 86pp.

G0382B Absolute Value at \$2.00

AUDIO ENTHUSIAST'S HANDBOOK

Covers the record/playback curve, stylus compliance, acoustic feedback, stereo tape track standards, compensating sideways drag, amplifier power ratings and more. \$2.75 Retail, 96pp.

G0383B Reduced to only \$2.00

CHOOSING AND USING YOUR HI-FI

Provides basic information on the technical specifications of hi-fi equipment. Offers advice on what to look for in equipment in order to obtain real high-fidelity sound and reproduction. \$4.95 Retail, 88pp.

G0385B ONLY \$3.95

ORDER TODAY — Simply return the Freepost reply card!

TO OUR READERS ...

computers for beginners

THE USER'S GUIDE TO APPLE

The editors of Consumer Guide have compiled a thorough introduction to the Apple IIe and II Plus computers, software and peripherals. With colour illustrations and a clearly written text, this reference will guide the newcomer through all phases of learning how to use the computer: From setting the system up, learning what each key does, expanding the system with peripherals, to buying new software. Specific exercises are included for each of the keys. Spiral bound, 80pp.

H0061G \$8.50

THE USER'S GUIDE TO COMMODORE 64 & VIC 20

The editors of Consumer Guide have compiled a thorough introduction to the Commodore 64 and Vic 20 computers, software and peripherals. With colour illustrations and a clearly written text, this reference will guide the newcomer through all phases of learning how to use the computer: From setting the system up, learning what each key does, expanding the system with peripherals, to buying new software. Specific exercises are included for each of the keys. Spiral bound, 80pp.

H0065G \$8.50

EASY-TO-UNDERSTAND GUIDE TO HOME COMPUTERS

Confused by all those computer terms? This clearly written book from the editors of Consumer Guide tells exactly what computers are, how they work and why they are so amazingly useful, all in plain English. Here is all of the information needed to understand and use computers, and even to start programming. A special buying section compares the most popular home computers. This book is your ticket to the computer age! Spiral bound, 96pp.

H0066G \$8.50

*Order Today!!
Don't be disappointed!*

COMPUTER TERMINOLOGY EXPLAINED

Concise explains the most common terms encountered by the home computer enthusiast as well as many of those used with mini- and mainframe computers. Includes tables of ASCII codes and BASIC control codes. 81pp.

H0143B \$5.95

SPOTLIGHT ON COMPUTER AWARENESS

An introduction to speaking confidently about how computers work, their applications, their history (from abacus to IBM) and employment prospects in computer related fields. Includes a comprehensive glossary. 84pp.

H0145P \$6.95

DON'T (OR HOW TO CARE FOR YOUR COMPUTER)

A guide to computer and peripheral preservation. Specific advice for the computer, floppy discs, hard discs, the CRT terminal, the printer, tape units, the computer room, software and documentation. 210pp.

H0153A \$14.95

YOUR FIRST COMPUTER

A beginner's guide to understanding, purchasing and applying small computers to business and personal uses. Well-written with an easy to understand style. 252pp.

H0271A \$15.25



computer hardware and techniques

THE APRICOT

This is a handy, up to date reference (more current than the latest ACT Apricot manual) covering components and upgrades, the software and a concise view of its operation. This is a first-rate bridge between the new user and the manual as it puts the hardware, software and manual into their proper perspective. One of the well-known Pitman Computer Handbooks. 117pp.

J0057P \$7.95

INTRODUCING THE APPLE IIc

This introduction to the remarkable features of the Apple IIc is also an excellent resource manual: Each chapter starts with elementary explanations, moves on to more technical descriptions and ends with detailed references. The thorough text is supplemented by exhaustive appendices and a full glossary. 400pp.

J0084P \$27.95

Z80 MICROCOMPUTER DESIGN PROJECTS

A complete look at the internal architecture of the Z80, the heart of many microcomputers, and even shows how to build a microcomputer, the EX80, using this powerful chip.

J0156P \$20.75

A PRACTICAL INTRODUCTION TO MICROPROCESSORS

Takes the reader through the construction of a simple microprocessor and experimenting with it to gain an insight into the complexities of microprocessing. The book assumes a general knowledge of electronics.

J0158B \$5.95

MICROCOMPUTING DESIGN & TROUBLESHOOTING

Explains designing microcomputer systems and making them work without expensive commercial development systems or the need for costly test instrumentation. Includes a complete description of two microprocessors - the 8085 and the 6502. 346pp.

J0161P \$26.75

STD BUS INTERFACING

Tells what the STD bus is, why it should be used and how to interface it with various peripherals. Explains addressing I/O devices, the use of different techniques to assign or decode addresses and the transfer of data and control signal timing. 286pp.

J0164P \$21.95

EASY ADD-ON PROJECTS FOR COMMODORE 64, VIC-20, BBC MICRO & ACORN ELECTRON

The simple and inexpensive projects include a pulse detector, model controller, light pen, lap sensor and more plus six projects that make up a weather station. 191pp.

J0165B \$6.95

Prices subject to change without notice.

A Z80 WORKSHOP MANUAL

Intended for those who want to progress beyond programming in BASIC to topics such as machine code and assembly language programming or who need hardware details of the Z80-based computers. 184pp.

J0283B \$8.95

SECRETS OF THE COMMODORE 64

A beginner's guide to the C64 with masses of useful information and programming tips as well as describing how to get the best from the powerful sound and graphics facilities. Includes two useful chapters on machine code. 109pp.

J0297B \$5.95

MICRO INTERFACING CIRCUITS: BOOK 1

Guides those who are unaccustomed to microprocessor techniques but have some knowledge of electronics, through a practical approach to address decoding, parallel and serial interfacing, analogue to digital and digital to analogue converters, etc. 96pp.

J0325B \$6.55

MICRO INTERFACING CIRCUITS: BOOK 2

Develops the practical side of interfacing introduced in Book 1. Discusses sound and speech generators, temperature and optical sensors, motor controllers, etc. 87pp.

J0326B \$6.55

Stock of some titles may be limited.

computing software

WILDCARDS 4

No tips, techniques or theory in this volume: It's mainly quality games with PCG graphics - games of strategy and games of fast reflexes, many of them taking full advantage of colour graphics. From simple Boxes (not so simple!) to Radio with complex scenery: This is a book that teaches the fun way. 109pp.

K0024P \$15.95

ASSEMBLY LANGUAGE FOR THE 8086 AND 8088

The Intel 8086 16-bit programming instruction set, data organization and addressing capabilities are covered in detail, but some knowledge of assembly programming language is assumed. Interrupt and I/O features are covered, while the main part of the book is a complete programming instruction glossary. One of the well-known Pitman Computer Handbooks. 105pp.

K0038P \$7.95

INTRODUCTION TO OPERATING SYSTEMS

Designed for those who want a general introduction to operating systems or for those ready to generalise their knowledge of a specific system. This concise reference covers concepts and frameworks which lead to full understanding of the specific system used, whatever it may be. One of the well-known Pitman Computer Handbooks. 88pp.

K0040P \$7.95

C LANGUAGE

Describes the C language as implemented on a diverse range of processors and operating systems. The comprehensive coverage starts with the C language definition of Kernighan and Ritchie and then covers 10 other versions including U7, CR, VAX, CC and MS; other compilers are also taken into account. One of the well-known Pitman Computer Handbooks. 120pp.

K0041P \$7.95

FEDERAL MARKETING BOOK SALES

PO Box 227, Waterloo 2017, NSW

More BOOKS follow ...

SPECIAL BOOKS OF INTEREST...

computing software

THE BIG FAT BOOK OF COMMODORE 64 GAMES

Add over 30 new games to your Commodore 64 library! The large easy to read type makes it easy to enter these wide-ranging games for all the family: Practice your management abilities in the Quest for Riemann, escape from your machines central processing unit with CPU Prisoner, rewrite history with Gettysburg Dice and learn how to get the most from your Commodore by having fun. 409pp.

K0042P \$19.95

APPLE IIe PROGRAMMER'S REFERENCE GUIDE

Has a logical approach that gives the beginner general rules and a survey of BASIC statements, commands and functions. Those with some programming experience will learn the finer points of text formatting, color graphics and advanced disk operations. The more advanced programmer will find an invaluable reference in the memory map descriptions and 6502 programming techniques. 366pp.

K0043P \$29.95

AN INTRODUCTION TO MSX BASIC

For those wanting to learn to program, Microsoft Extended (MSX) Basic offers a powerful and flexible version of the most popular computing language. This comprehensive introduction starts with the basics and progresses by stages to the more advanced programming techniques and includes coverage of advanced multicolour, sprite graphics, and the programmable sound generator. 88pp.

K0047B \$6.95

8088 ASSEMBLER LANGUAGE PROGRAMMING: THE IBM PC

This second edition includes the PC/XT and covers the new versions of DOS and the introduction of the double-sided disk drives and the complications of diskette compatibility. This is a thorough introduction to assembly language programming for the IBM PC for fast program execution and close control. Sample programs and a complete instruction set are included. 268pp.

K0050P \$24.95

INSTANT PROGRAMMING ON YOUR SEGA SC3000 COMPUTER

Spiral-bound for easy use, this is THE Sega SC3000 beginner's book! In carefully explained, easy to follow steps, it covers the function of each key and all of the commands needed for super fast mastery of BASIC programming. This is a book for do-ers: The second part of the book teaches the real art of programming with plenty of examples and subroutines. 84pp.

K0051P \$12.95

THE BEST VIC/COMMODORE SOFTWARE

Trying to find the most suitable software for personal computers can be frustrating. The editors of Consumer Guide have compiled comprehensive reviews of VIC 20 and Commodore 64 programs based on ratings by user groups; further evaluation is given by the editors and Commodore software experts Jim and Ellen Strasma. Each review describes the program's purpose and features, detailing both the good points and bad. Each program has been rated for ease of use, clarity of written and on-screen instructions, and overall performance. The program's price, publisher, format and hardware requirements are also included. The reviews are presented in sets by topic: Word Processing, Business, Home, Education, Networking, Strategy Games, Arcade Games and Programming Aids. Spiral bound, 192pp.

K0052G \$8.50

Postage and packing additional:
Please refer to reply card for charges.

WILDCARDS: VOLUME THREE

This collection of programs, tips and techniques for all models of Applied Technology's Microbee personal computer takes a 'hands-on' approach. Small business applications are given, as well as utilities and graphics, and there is a machine language game tutorial included. 122pp.

K0054P \$15.95

THE BEST APPLE SOFTWARE

Trying to find the most suitable software for personal computers can be frustrating. The editors of Consumer Guide have compiled comprehensive reviews of Apple II, II Plus and IIe programs based on ratings by user groups; further evaluation is given by the editors and Apple software expert Roe Adams. Each review describes the program's purpose and features, detailing both the good points and bad. Each program has been rated for ease of use, clarity of written and on-screen instructions, and overall performance. The program's price, publisher, format and hardware requirements are also included. The reviews are presented in sets by topic: Word Processing, Business, Home, Education, Networking, Strategy Games, Arcade Games and Programming Aids. Spiral bound, 160pp.

K0060G \$8.50

DISCOVERING KNOWLEDGEMAN

According to prestigious Byte magazine, KnowledgeMan may be the most powerful relational DBMS currently available for microprocessors- and this is a powerful introduction! After a general overview, data management and spreadsheet capabilities are examined in eight sets of detailed lessons structured to give maximum learning benefits. 342pp.

K0086P \$29.95

AN INTRODUCTION TO PROGRAMMING THE BBC MODEL B MICRO

Teaches the use of BBC BASIC by guiding the reader through BASIC instructions and functions one at a time, building programs in a logical manner with increasing complexity. 134pp.

K0174B \$5.95

THE 68000: PRINCIPLES AND PROGRAMMING

An easily read systematic approach to the 68000 advanced 16-bit microprocessor. The book guides you through the complex architecture, instruction sets, pin-outs and interfacing techniques. Written for design engineers, programmers and students. 237pp.

K0176P \$19.95

STARTING FORTH

This clear and complete guide to FORTH, covers fundamental principles and then a full set of high-level commands. It concludes with advanced techniques and style. 348pp.

K0177H \$37.95

AN INTRODUCTION TO 6502 MACHINE CODE

Starts with a general background to microprocessing and then details all of the legal 6502 instructions. Also covers the use of address modes and gives machine specific listings and sample programs. 107pp.

K0178B \$6.55

BASIC PROGRAMS FOR SCIENTISTS AND ENGINEERS

Contains over 60 of the most frequently used scientific algorithms with their program implementation in BASIC. Covers problem solving techniques with program listings and sample runs. Includes exercises and a glossary of BASIC variable names. 318pp.

K0179H \$25.95

APPLE II ASSEMBLY LANGUAGE

Teaches assembly language programming at the beginning level: No prior knowledge of 6502 assembly language is needed. Includes hands-on exercises and experiments with both software and hardware. Provides interfacing circuits and programs that can be used on the Apple II without modification. 334pp.

K0195P \$23.95

new books



LINEAR IC EQUIVALENTS AND PIN CONNECTIONS

This invaluable addition to any electronic enthusiasts' library shows the equivalents and pin connections as well as the country of origin, manufacture and functions of a user-oriented selection of linear integrated circuits. The selection has been based on usefulness and practicality to designers, hobbyists and service engineers. 247pp.

B0006B \$11.95

AN INTRODUCTION TO MSX BASIC

For those wanting to learn to program, Microsoft Extended (MSX) Basic offers a powerful and flexible version of the most popular computing language. This comprehensive introduction starts with the basics and progresses by stages to the more advanced programming techniques and includes coverage of advanced multicolour, sprite graphics, and the programmable sound generator. 88pp.

K0047B \$6.95

VISICALC

This quick and easy reference to the features of the VisiCalc spreadsheet package covers the commands and facilities of the latest available version and explains the variations with the operating features of the Commodore range, Apple II and IBM PC. VisiCalc aims, commands, and functions are all given detailed coverage in their own sections. One of the well-known Pitman Computer Handbooks. 86pp.

L0023P \$7.95

AN INTRODUCTION TO Z80 MACHINE CODE

Starts with a general background to microprocessing and then details the full set of Z80/Z80A instructions. Also covers the use of address modes and gives machine specific listings and sample programs. 107pp.

K0180B \$6.55

YOUR CALCULATOR AND YOUR MONEY

If you are interested in money and do even the simplest calculations, this book is a 'must.' It shows how to get the most practical use out of this efficient and powerful tool. The contents cover everything from simple arithmetic to compound interest, and depreciation. \$4.75 RRP, 174pp.

M0246B \$2.00

FUN & GAMES WITH YOUR ELECTRONIC CALCULATOR

Calculators might be a powerful and time saving tool, but they can also be an endless source of amusement and an excellent source of relaxation, as this book shows. What do 55 snakes in a 14 foot square pit do? (You'll have to read page 6 to find out.) \$2.50 RRP, 63pp.

M0370B \$2.00

ORDER TODAY — Simply return the Freepost reply card!

Electronics Today

Subscribe now . . .



Special Limited Offer

1/3 off 1/3 off 1/3 off 1/3 off 1/3 off

. . . at 1/3 off the normal retail price! —

save \$11.00 on a year's subscription!

Better still save \$22 on a two year subscription and guard against price increases until 1987!

Electronics Today

is Australia's dynamic electronics magazine. Keep informed and busy every month:

- ★ read informative features
- ★ assess our product reviews
- ★ projects for every level of hobbyist
- ★ update with news and ideas

Take advantage of this offer now . . .

- ★ Complete either the card opposite or the coupon below
- ★ Detach and post free from anywhere in Australia
- ★ Don't delay

Subscribe now at 1/3 off the normal price

Yes, please send me 24 issues (2 years) of Electronics Today at 1/3 off the normal newsstand price. I'll save \$22.00 and guard against price rises until 1987!!

OR Yes, please send me 12 issues (1 year) of Electronics Today at 1/3 off the normal newsstand price. I'll save \$11.00!

Name _____

Address _____

Postcode _____

Please tick payment you select: (Please do not send cash)

- Bankcard Mastercard American Express
 Cheque/money order*

*Enclose cheque/money order with this coupon in an envelope and address to: Freepost No 4, The Federal Publishing Company Pty. Ltd., PO Box 227, Waterloo, 2017. No postage stamp is required if posted in Australia.

Card No. _____
Expiry Date ____/____/198____

Signature _____
Unsigned orders cannot be accepted

Please allow up to 6 weeks for delivery of your first issue.

Coupon valid until 31/12/85.

Help us to meet your interests in ETI
Please tick the appropriate boxes.

Are you most interested in:

- New products/equipment
- Radio/communications
- Computer hardware
- Industrial Control
- Computer software
- Video/television
- Audio/hifi
- Circuit design

Which of these best describes you?

- Engineer/designer
- Interested consumer
- Technician
- Hobbyist
- Manager
- Student

ELECTRONIC HARDWARE

Peter Phillips

An exposed pc board might work but it's an awkward and vulnerable bit of electronics you're left with. Housing, clamping and decorating are the next steps which might require a bit of dexterity and patience — but the completed job should be well worth the effort.

THE SUCCESS OF any electronic project lies with the completed unit. Apart from working properly, the device needs to be able to handle the rigours of usage, be safe, and look the part. If the electronics of the device is not correctly housed, or incomplete, then only half the battle has been won. In this article hardware items such as cases, pc board mounting methods, labels, nuts and bolts, clamps and aerosol sprays are discussed. Breadboards and the techniques involved will also be looked at to give the beginner in electronics the full story on constructing a project.

Breadboarding, while not essential to the mechanics of electronics, is a means of get-

ting a design 'off the ground'. Its inclusion here is in order to give those readers who wish to design their own circuits a starting point. As this series is for the tyro reader, it is not our intention to get too involved in circuit design, but merely to present information to allow the reader to 'get started'.

Future articles in this series will look at active components and fault finding. The topic of hardware now is a natural follow on from the previous issues discussing passive components.

Breadboarding

Many circuit designs start out on a breadboard. As described in Starting Electronics

5 (June '85) the circuit, once perfected, can be transferred to a printed circuit board. The making of a pc board was the subject of this previous article, and by combining it with the presentation here, a fairly complete description of the mechanics of circuit development will be achieved.

Various breadboarding systems are used by designers but the most popular is the solderless prototyping board. Other circuit development aids include various general purpose pc board cards containing a layout of tracks to allow a miscellany of design applications. Pre-drilled phenolic boards (matrix boards) allow components to be held with press fit pins and connected either by wirewrapping or soldering with wire links. These latter systems provide a finished product that is fairly permanent, but using them is more difficult, as component changing requires either resoldering or re-wirewrapping of the new component.

Solderless breadboards are commonly available from parts suppliers, and are a very convenient method of implementing a circuit design. These boards are simply an arrangement of interconnected sockets spaced along a 0.1 inch grid format, which allows the insertion of ICs, along with all the usual components. The sockets are generally designed for lead sizes of 0.6 mm to 0.8 mm, and are made of spring steel coated with either nickel or a nickel-silver alloy, with higher priced units featuring silver or gold plating. Less expensive varieties use a phosphor-bronze contact. The contacts are held in a plastic framework, with some frames allowing the interlocking of other boards by virtue of lugs around their perimeters.

One style of breadboard provides an external connection to each line of interconnected sockets by having a solder lug for each line *beneath* the board. These would be used in conjunction with power supplies, signal generators and other support circuitry to provide a self-contained circuit development system.

Although the layout of a breadboard may vary, the general scheme is shown in Figure 1. Notice how each column is a series of five interconnected contacts, whereas a row is a



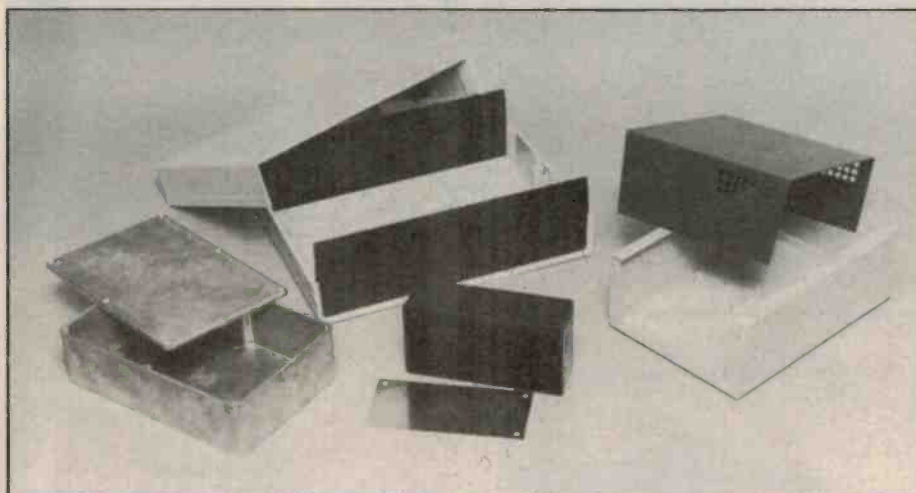

Figure 1. Internal connections of a breadboard.

line of many contacts. The rows are generally used as power supply rails and ICs are inserted across the central channel, the remainder of the circuitry being laid out using each column. Special breadboarding wire is available as are wire strippers to remove the insulation. Telephone wire is often used by experimenters, as a wide range of colours are available. The use of colours allows construction of a circuit that can be readily traced, even when it resembles the proverbial 'rat's nest'.

A breadboard is relatively expensive, but if care is taken, it will last a long time. Inserting leads or wires that exceed a diameter of 0.8 mm will force the contacts open, leaving that socket useless for future service. Also, wire that has been used many times before can often cause a bad connection, and the risk of it breaking off inside the socket increases. Insulation around the wire should be stripped using cutters that don't leave a nick in the wire, and enough insulation (around 7 mm to 8 mm) should be removed to ensure that the wire is connecting the contact properly. It is not uncommon for wires with bared lengths that are too short to end up with the insulation actually sitting in the contact, with no connection being the result, despite all appearances. Components should have lead diameters that don't exceed the capabilities of the socket, necessitating use of ¼ watt resistors and low voltage capacitors.

The layout of a design should be compact, but not so tight that it becomes impossible to remove a component should this be necessary. Avoid placing components over each other, and run the wires so that they are close to the board and formed to follow the most direct path. Cut each wire to its correct length and follow a colour coding rigidly. A procedure that often works is to lay out the circuit as it appears on paper, modifying the layout to suit as this becomes appropriate. Start by connecting the power supply wiring, and build the circuit in blocks, proceeding as each block is completed. Component leads should also be cut to length to avoid expanses of bare wire. Instances of Murphy's law abound in breadboarding, and a lot of care is necessary.



Left: diecast aluminium box. Centre top: plastic universal-mount instrument case. Centre bottom: plastic Jiffy box. Right: enamelled metal instrument case.

Housing

The choice of case is often dictated by the project itself. Where safety is essential, a plastic case should be used, but if rugged, weatherproof casing is required, then a diecast aluminium box may be more suitable. Other alternatives are aluminium boxes, fitted with a Marvplate or painted steel lid; some styles also include front panel protection handles. Further types include a range of internally ribbed plastic boxes with a flat aluminium cover, the ribs acting as possible pc board edge supports. Also available are various styles of instrument cases, generally made of plastic and often featuring carrying handles that can act as tilt feet. In general, commercial cases are designed for a multiplicity of uses, and the features in each case will vary.

A case varies in price, depending on the materials used to make it. Where heat generation is likely, a metal case may be necessary, although an abs plastic case can operate up to 85°C. Plastic has several advantages, including appearance and safety. If extreme heat conditions are likely, or if electrical screening is required, a diecast aluminium box is the best choice. However,

special plastic boxes which provide electrical screening are also available, as well as some waterproof ones. Electrical screening is necessary if the circuitry either produces radiation that can interfere with other equipment, or is sensitive to external electrical fields. Magnetic shielding requires the use of steel, although this type of shielding is best done by shielding the actual component, rather than the whole circuit.

Where a suitable case cannot be found, building your own becomes necessary. For best results, sheet metal machinery such as a bender and a guillotine are required, with 16 or 18 gauge aluminium being the easiest material to work with. A lid, formed to provide the sides and top can be made from such materials as Marvplate (available in sheet form, complete with a wide range of finishes), enamel painted steel, or even timber. Aluminium lids are not usually suitable, as a finish is difficult to apply, although the budget conscious may consider the application of adhesive contact paper.

A final touch to any case is the feet. Rubber feet are available in either self adhesive types, or those requiring attachment with a screw, usually of the self-tapping variety. Rubber feet, apart from enhancing the ap- ▶

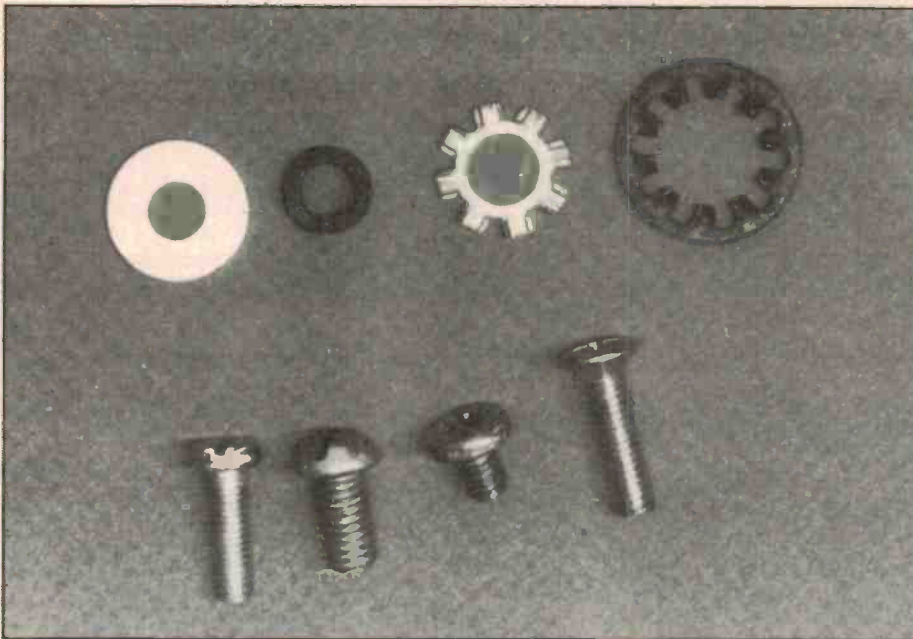

From left to right. Top row: flat washer, split spring washer, two types of star washer. Bottom row: pan head bolt, round head, half-round head, counter-sunk.

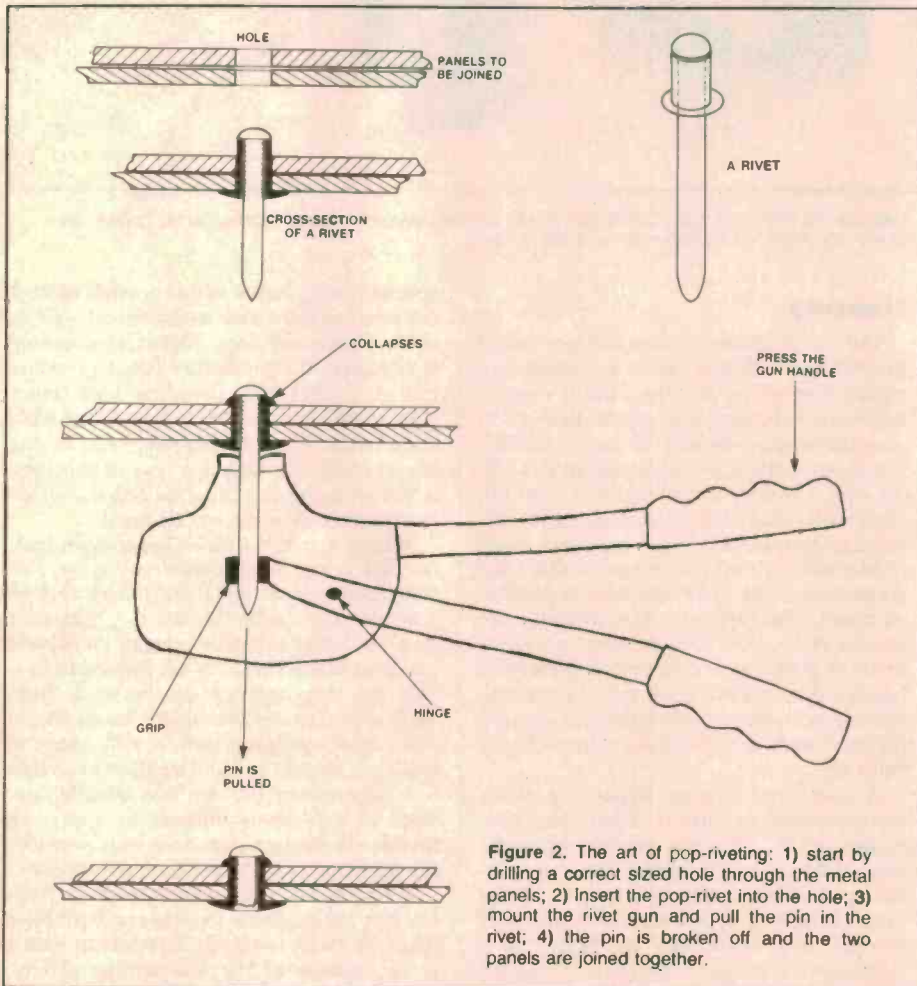

pearance, raise the case for air circulation, and prevent the case scratching the surface it is placed on.

Front panels

The appearance of the front panel can be enhanced using a variety of means. An inexpensive method of testing the bare aluminium panel associated with a metal case is to create a satin finish by dipping it in a solution of water and caustic soda. A strength of around two tablespoons to a litre of water will cause the immersed aluminium to gain this finish after about five minutes. The aluminium should be thoroughly polished with steel wool and soapy water before its immersion in the solution. A rather obnoxious gas will be generated, so allow plenty of ventilation. After treatment, remove any residue from the panel by holding it under running water and wiping with a cloth. After drying, spray the panel with a clear spray lacquer such as is available from any hardware store. When this has dried, lettering can be applied using a commercial rub on lettering set. The panel should then be resprayed with lacquer, and allowed to dry before mounting the components. A very light spray should be applied first, to prevent the lettering from crinkling due to the lacquer.

A more professional appearance will result if a photo-sensitive, self-adhesive label (eg, Scotchcal) is used. Requiring a negative of the panel design, the sensitised material needs to be exposed to a source of UV light through the negative. Special UV fluorescent tubes are required; an exposure time of around five to seven minutes is usual. After exposure, the design will appear once the material is wiped with the correct developer. This process takes around 30 seconds, during which the exposed areas will retain the colour, while the remainder should be wiped away to leave the base material.

Available in various colours, on either an aluminum or clear plastic base, the finished panel can then be applied to the case. If the label is aluminium, it should be sprayed with a lacquer. Applying the label to the case requires care, as you only get one chance; the position of the label should be determined by alignment of suitable marks (eg, aligning holes on the front panel to centre punch indents on the label). Exposure film to allow the manufacture of the negative is readily available, requiring the same UV light source and developer as for the label.

Mounting the pc board

A pc board can be held inside the case by using spacers, edge supports, and the internal ribbing or other support means that may be provided within the case. Spacers can be made of either plastic or metal, with some

types having accompanying screws fitted top and bottom. Nylon pillars of varying designs are also useful, offering several advantages over spacers. Nylon pillar supports can have a self-locking mechanism that operates when inserted into a suitable sized hole in the pc board; the base of the pillar is designed for attaching to the case with a screw, an integral self-locking device or with its own adhesive. Other varieties allow the stacking of pc boards with the top board retained by a cap inserted into the pillar. ●

Right: Circuit board stand-off spacers used to mount and secure pc boards.
Below: Several species of cable clamps used to route and secure cables inside a case.

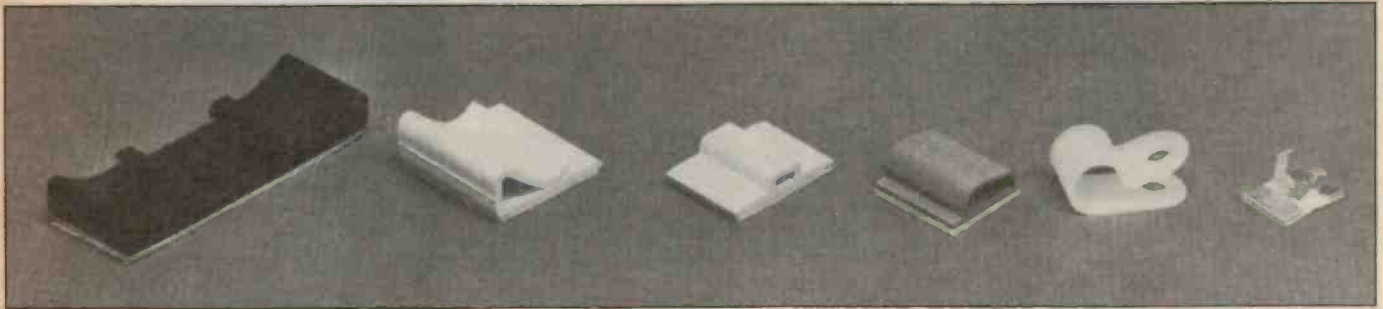
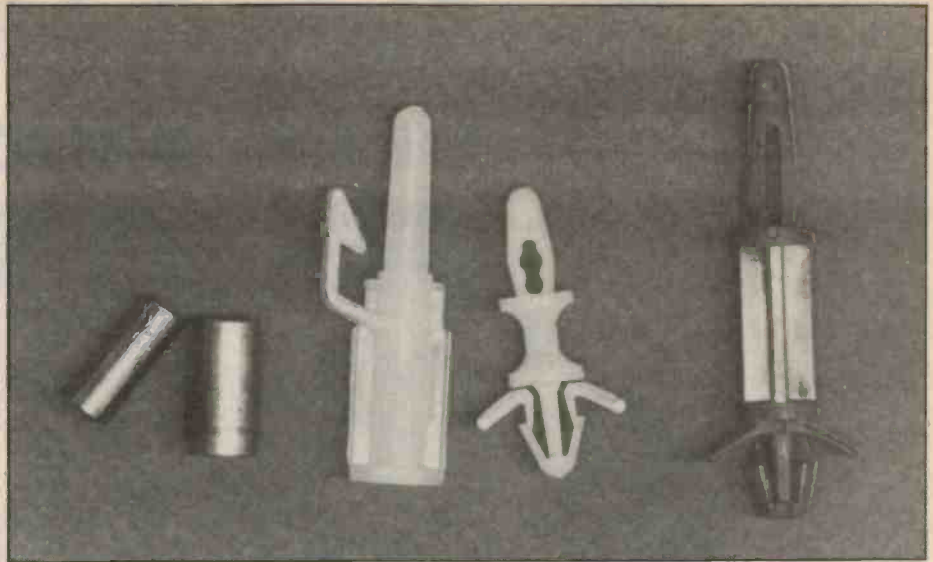

BUILD YOUR OWN PROGRAMMABLE NAVIGATING ROBOT

Order now and let your Hobbybot serve your Christmas drinks!

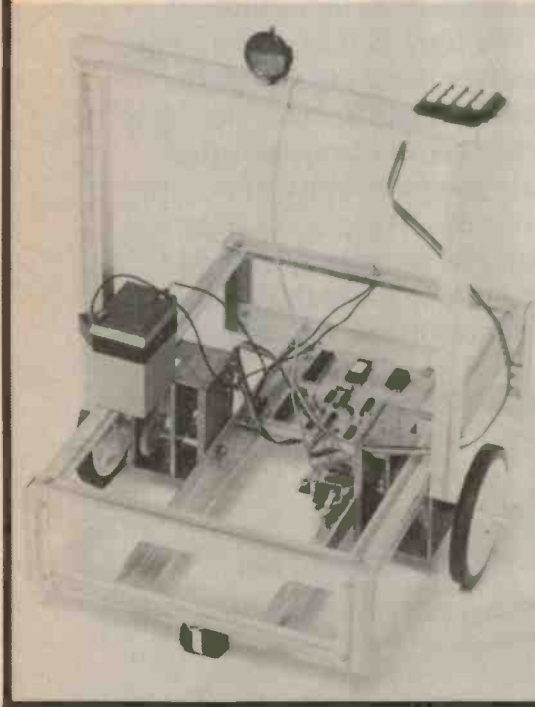

This all-Australian designed do-it-yourself robot can be programmed to do countless navigating tasks. You can use it just for fun or teach it to do practical things like following you while you work, carrying tools or food. You can even send it around the house on its own, performing various tricks. In Part 1 we show you how to build your Hobbybot and in Part 2 (next month's ETI) we'll show you how to program it.

ETI-664 HOBBYBOT KIT Order Form

Send completed coupon to: Federal Marketing Company, Mail Order Division,
PO Box 227, Waterloo 2017

Name

Address

Signature

Price: 337.00

Postage & Handling: 5.50

\$342.50

Please make cheques payable to Federal Marketing Company.
American Express — Bankcard — Cheque/Money Order

Credit Card No Expiry Date

The Right Cabinet in All Situations



ELMA's umbra brown cabinet is as stylish as it is well-finished. Its modern design is compatible with today's high standards for electronic equipment. Thanks to accessories such as the sealing set, which conforms to IP54, the cabinet is always in its element, whether in the office or in an industrial environment. The lightweight aluminium frame comes with painted steel panels. Since there are only eight screws, access is easily and quickly gained from all sides. Users appreciate the possibility of mounting recessed subracks, the easy conversion of the DIN-standard mounting frame for non-standard equipment and the chance to earth the cabinet according to VDE/SEV regulations.

As we said, the right cabinet in all situations.

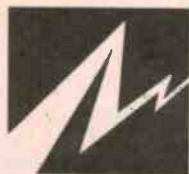
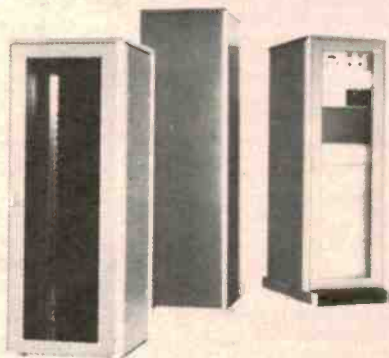

Associated Controls

Sydney (02) 709-5700
Melbourne (03) 561-2966

132/385 MK/WB



ACTIVE ELECTRONICS

289 LATROBE STREET, MELBOURNE 3000 PH. (03) 602 3499
887 SPRINGVALE ROAD, SPRINGVALE 3171 PH. (03) 547 1046

9am - 5.30pm MON-THURS

9am - 7.30pm FRIDAYS

9am - 12noon SATURDAY

ALL YOU HAVE EVER WANTED IN AN ELECTRONIC STORE - AND MORE!

\$69⁰⁰



13.8V
8 AMP PEAK

HIGH POWERED

PANTHER POWER SUPPLY

\$29⁹⁵

BOX OF 10
DSDD



VERBATIM

\$22⁹⁵

SSDD

Weller



\$89⁰⁰
WTCPN

SOLDERING STATION

PICK UP YOUR FREE COPY
FROM ANY OF OUR
ELECTRONIC SUPER STORES

COMPARE THESE PRICES!
MEMORY SPECIALS

2732	\$4 ⁹⁵	4164	\$2 ²⁵
2764	\$5 ⁸⁰	41256	\$10 ⁹⁵
27128	\$11 ⁵⁰	6116	\$2 ⁷⁵
4164	\$2 ²⁵	6264	\$15 ⁰⁰
280CPU	\$3 ⁵⁰		

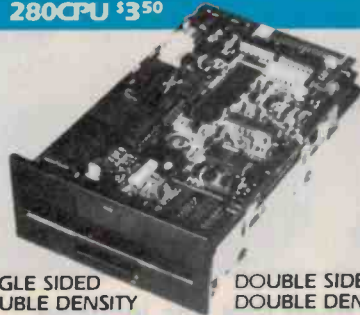

SINGLE SIDED
DOUBLE DENSITY

DOUBLE SIDED
DOUBLE DENSITY

\$149⁰⁰

\$195⁰⁰

CHINON 5 1/4" DRIVE

DISKETTES

SINGLE SIDE D/D

\$27⁵⁰

\$38⁵⁰

DOUBLE SIDED D/D

ACTIVE ELECTRONICS PRO-QUALITY KITS

TYPE	DESCRIPTION	PRICE
AE 1000	AEM 3500 Listening Post	27.50
AE 1001	AEM 6500 60/120W Utility Mosfet Amp	45.00
AE 1002	AEM 6500 Addon Parts for 120W Version	15.75
AE 1003	Logic Pulser	12.30
AE 1004	Eprom Programmer for 2716/2732 includes ZIF Socket	30.00
AE 1005	Microcomp I.A 3 Chip Z80 Computer Kit A low cost introduction into microcomputer programming	55.75
AE 1006	TEC IB Computer	98.00
AE 1007	TEC IB Computer Power Supply inc. transformer and case	44.25
AE 1008	Combination Lock	7.50
AE 1009	Counter Module	21.70
AE 1010	Seven Segment Display	11.40
AE 1011	Cube Puzzle	17.90
AE 1012	Capacitance Meter	6.25
AE 1013	Digi Chaser	17.40
AE 1014	Diode Tester	3.30
AE 1015	Dual Power Supply	11.80
AE 1016	Dual Tracking Supply	18.90
AE 1017	8 Watt Amplifier	9.70
AE 1018	FM Bug	6.80
AE 1019	Logic Designer	20.90
AE 1020	Logic Probe	11.55
AE 1021	Logic Pulser	12.30
AE 1022	Mini Frequency Counter	18.90
AE 1023	Stereo Mini Mixer	23.10
AE 1024	Square Wave Oscillator	4.70
AE 1025	Stereo VU Meter	14.00
AE 1026	Non Volatile Ram	23.20

All Active kits include full assembly instructions and the component layout is printed on each circuit board to simplify construction.

**NEW
MAIL ORDER
HOTLINE
(03) 561 2103**

ALL MAIL ORDERS TO
ACTIVE ELECTRONICS
NEW BULK STORE
797 SPRINGVALE RD.
MULGRAVE. 3170.



POSTAGE RATES

\$1 - \$9 99	\$2 00	\$50 - \$99 99	\$5 00
\$10 - \$24 99	\$3 00	\$100 - \$199	\$7 50
\$25 - \$49 99	\$4 00	\$200 plus	\$10 00

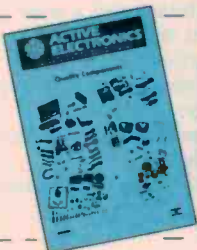

PLEASE SEND ME
ACTIVES FULL RANGE
SEMICONDUCTOR
CATALOGUE

NAME: _____

ADDRESS: _____

PLEASE ENCLOSE 50c FOR POSTAGE.

PRICES AVAILABLE FOR MONTH OF ISSUE ONLY

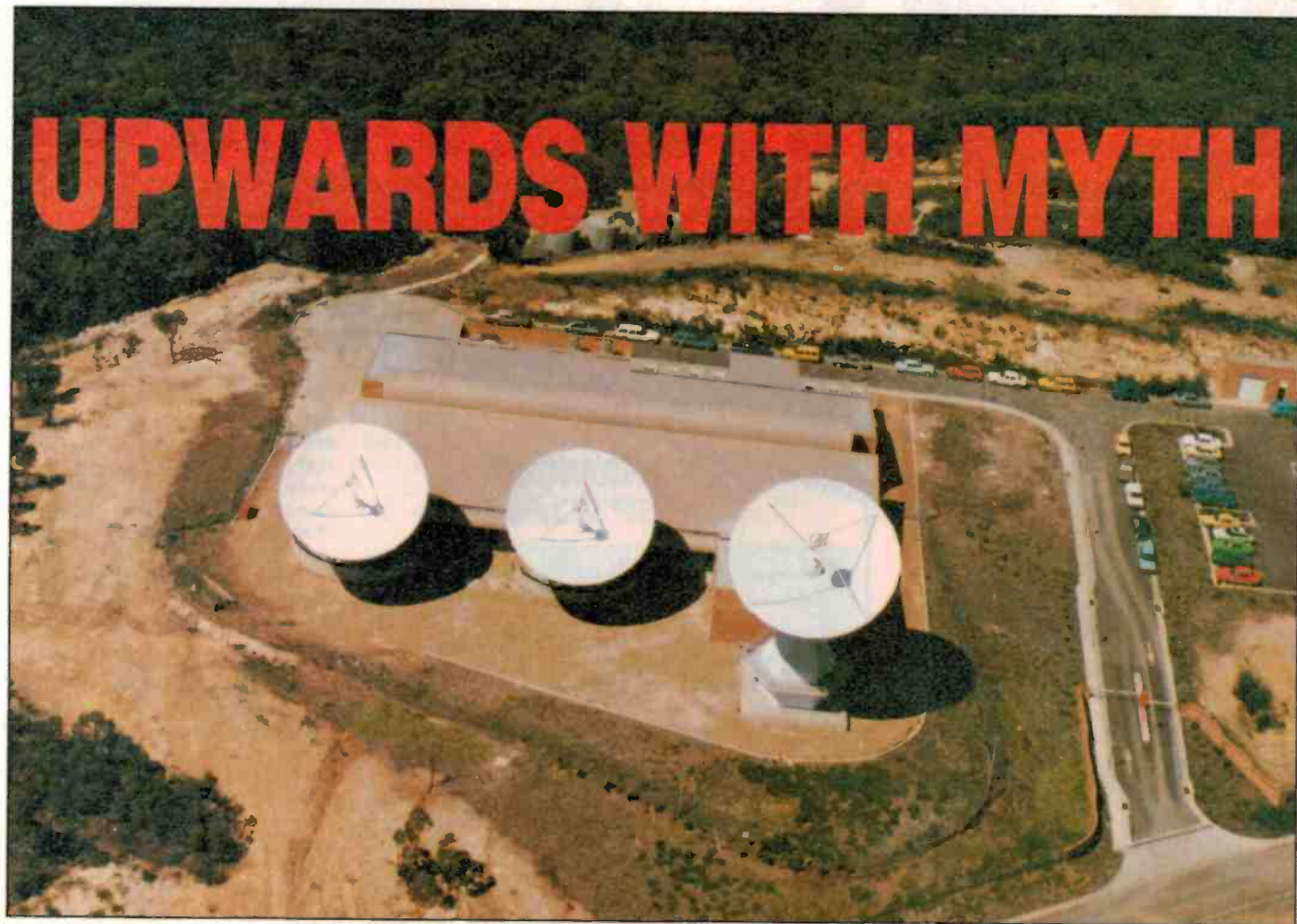

UPWARDS WITH MYTH

In its ascendancy Aussat realises a myth that has inspired and bound man over ages: due return to a sky which has provided muses for shepherds and Hollywood directors. Australia's first satellite embodies man's struggle out of himself towards the wealth of science waiting in the vastness of space.

Jon Fairall

BELROSE EARTH STATION is an unostentatious huddle of buildings set in virgin scrub half a mile to leeward of the Frenchs Forest garbage tip. Or it would be unostentatious but for three giant dishes on the roof. They stare, white and blind at the sky; totems of technology. If the four horsemen of the apocalypse ride out of the east tomorrow, this is how we will be remembered.

Such thoughts are relevant because we are not the first people to squat in this scrub and stare at the sky. Within a mile of this place you can find faint daubings on the rocks; symbols of some forgotten magic. Magic, ancient and modern, vies with smells a bit on the nose.

The press was out in force, crowded into the hospitality suite, watching the montior beaming live pictures from the Cape. At 1 minus 9 minutes, when the first attempt stalled, there was a muted cheer. At 1 minus 1 minute the tension in the room was tangible. With 10 seconds to go someone

gloomily remarked that the last shuttle launch had been stopped at 1 minus 3 seconds. Not today. The man counted down to zero, the rockets turned the screen white and mission 51-1, carrying Aussat 1, was finally on its way.

There was reason to cheer. The press was getting sick and tired of slogging through the traffic to Belrose, 30 kilometres north of Sydney and site of the main earth station in the network. The press had been out three times. On Saturday, Discovery was due to take off at 8.51 am Florida time, 10.51 pm in Sydney. With nine minutes to go the weather, testy all night, finally halted everything.

The next day NASA had another go. One of five computers on board started disagreeing with its brothers and sisters. No go. In spite of panicked attempts to reprogram it, the system stayed down. I talked to an engineer about redundant redundancy.

Forty-eight hours later they were ready to

go again. The overcast weather closed in, but NASA was even more eager than the Australian press. Discovery blasted up from the pad at 8.58 pm (Sydney), punching a hole in the cloud cover and disappeared from view within seconds of launch. It was one of the most straightforward climbs into space ever. In NASAspeak, the launch was close to nominal.

Aussat managing director Graham Gosewinkel broke open the champagne, laughed, acted like a man pleased with life. "Gonna have a barby tomorrow." Two hours later, 219 miles above the Earth Joe Engle was taking his crew through the post launch checks, which included a close look at Aussat 1, nestled inside a launch container on the cargo hold. A camera on the end of the shuttle's robot arm was to inspect the satellite closely, the container was opened and then closed again before an inspection could be carried out.

When they tried to reopen the container

the doors stuck, and horrified astronauts saw what appeared to be a big post sticking into the antennae of the \$80 million space craft. Some more manipulation with the arm ripped it open, but space controllers, now completely distrusting the container, decided to launch Aussat as soon as possible.

The first opportunity presented itself on orbit 5, almost 24 hours ahead of schedule. As Aussat emerged from the shuttle, already spinning, controllers around the world peered at the craft, looking for flaws in the blue solar cells or the delicate antennae on top. Visually none the worse for the experience, the apogee motors fired on time, and Australia's first satellite disappeared, hopefully, from the eyes of men forever.

From the eyes, but certainly not beyond the ken of its keepers. Controllers at Belrose anxiously interrogated the craft's electronics as it floated up its transfer orbit towards its final destination 36,000 kilometres away. Main suspicion centred on the antennae which, still folded up, could not be checked.

The US space shuttle has a lousy orbit for launching satellites. It can only climb out to about 200 miles, in an orbit inclined to the

Equator at an angle of 25 or so degrees. Communications satellites like Aussat, need to be placed in the Clarkian, or geostationary orbit, so called because in 1945, writing in *Wireless World*, Arthur C. Clarke proposed the idea of the communications satellite. He observed that a spacecraft in orbit around the Earth goes around in a time determined only by its distance from the centre of the Earth. At 200 miles, an orbit is completed in 90 minutes. Go further out and it takes longer. At a distance of 36,000 kilometres out, orbital time has slowed to 23 hours 56 minutes, the same as a point on the Earth. A person on the ground sees the spacecraft as stationary in the sky.

To get between these two orbits Aussat uses one rocket, its perigee rocket to speed up and enter a highly elliptical transfer orbit. When it gets to the other end of the transfer orbit another rocket fires to nudge the spacecraft into a drift orbit. This is almost circular, almost in the right direction, and almost at the right height.

Almost but not quite. Ideally the drift orbit will match the final geostationary orbit exactly. However it's not possible to fire any of the motors with sufficient precision to achieve this. When satellite director Craig Badger hit the button at Belrose he

could only guarantee the spacecraft would be in a zone roughly 300 miles above and 30 or 40 degrees east of where it should.

Aussat is equipped with station keeping rockets. These are small thrusters on the side of the craft designed to correct wobbles in the spin axis and assist in keeping the craft in the right position. They are vitally important, since the amount of fuel carried by these station keeping rockets is what finally determines the life time of the craft. When they fail, it will start to tumble through space and drift from its correct position.

It's these rockets, with their precious reserves of fuel, that are used to nudge the craft in its final orbit. It's done carefully, with absolute precision. Every bit of fuel saved extends the final life of the craft.

Aussat 1 slid quietly on to station, four days after launch. The antennae were deployed and the delicate membranes checked for any deficiency. The solar skirt was lowered into place and power applied to all the circuits for the first time. Ahead: two months of testing to see how well the craft stood up to the ordeal of launch. And then, seven years of inspecting the bald spot on top of your head. Look up occasionally, just east of north. Magic.

GET AMONGST THE ACTION!

Australian SCANNER'S WORLD is the book that will introduce you to that other world 'beyond the shortwaves'. It contains an introduction to scanning and scanners, an article on scanner antennas — including how to build and to erect antennas. The major part of this book is the "Listener's Guide"; computer-sorted listings of services throughout Australia and New Zealand, with their frequencies listed in both frequency order and alphabetical order by service. Beacons are listed also. Your copy is available by mail order direct from:

Federal Marketing
P.O. Box 227,
Waterloo, NSW 2017

Please add \$1 to the cost of the magazine to cover postage and handling. (Add \$5 to these charges for air mail postage outside Australia.)

For only \$5.95



NEW! 24V 5A SEND FOR DATA

MODULAR POWER SUPPLIES



- Current Limiting • Compact Size • Modular or Bench Versions.
- Adjustable Crowbar Overvoltage Protection (except 53/2) • Over Temp Protection • 5mV Ripple • 0.5% Line Regulation • Wide Adjustment

VOLTAGE	CURRENT	MODEL	PRICE*
12 to 15V	1A DUAL	53/2	\$88.00
12 to 15V	3A	53/3	92.00
24V	2.5A	53/4	100.00
5V	3A	53/5	88.00

*For bench version add \$20.00. All prices + Sales Tax if applicable.

Statronics 53 Series

STATRONICS POWER SUPPLIES
103 Hunter St., Hornsby, NSW. 2077
Tel: (02) 476-5714, 477-5152
Vic: Klarton Ent. (03) 61-3801
S.A.: N.S. Dist. (08) 46-8531

SILICON GLEN

A symbiosis of university and industry, fostered by the government-run Scottish Development Agency, has given birth to a new high tech Scotland. With money flowing into places like Silicon Glen, the future has never looked brighter for Scotland's educated youth. And, the Scottish experience could provide answers for some of Australia's economic woes.

Jon Fairall



New meets old. Electronic design of a tartan.

CONVENTIONAL WISDOM has it that Australia needs to restructure its economy. The argument runs that we are inheritors of a generation of easy political decisions. Our industries are inefficient and obsolete, existing only courtesy of generous tariff protection. As a result they are failing rapidly. Failing to export, failing to create jobs. Even failing to make a profit.

The answer to all our woes: modernise. Get into hi tech. Build computers and semiconductor wafers. Well, Australia is not alone in its predicament. At least one other country has done just what is proposed for our future. In the business capitals of the world the talk is of Silicon Glen.

Two nations

There are two pictures of Scotland. In one, the cranes down on Clydebank stand motionless like giant sculptures outlined against a grey sky, surrounded by ghostly shipbuilders. Against a grimy wall old newspapers and rags accumulate. Around the corner the queue shuffles forward into the dole office.

Picture two has colour in it. About eight kilometres from Clydebank as the crow flies the Motorola factory glistens in the light Scottish drizzle. A visitor is reminded that the term "Scots' mist" has a basis in reality. Inside, in the air-conditioning, managing director Barry Waite will show you, with a great deal of pride, the silicon fab clean rooms where they are ramping up for production of six inch CMOS wafers. Giant fans built on a separate concrete slab to cushion vibration, filter all the 20,000 cubic feet of air once a minute. It's only the second such facility in the world and by far and away the most advanced silicon plant outside the US.

The story can be repeated all over the lowlands of Scotland. In the 50 km valley between Glasgow and Edinburgh are all the

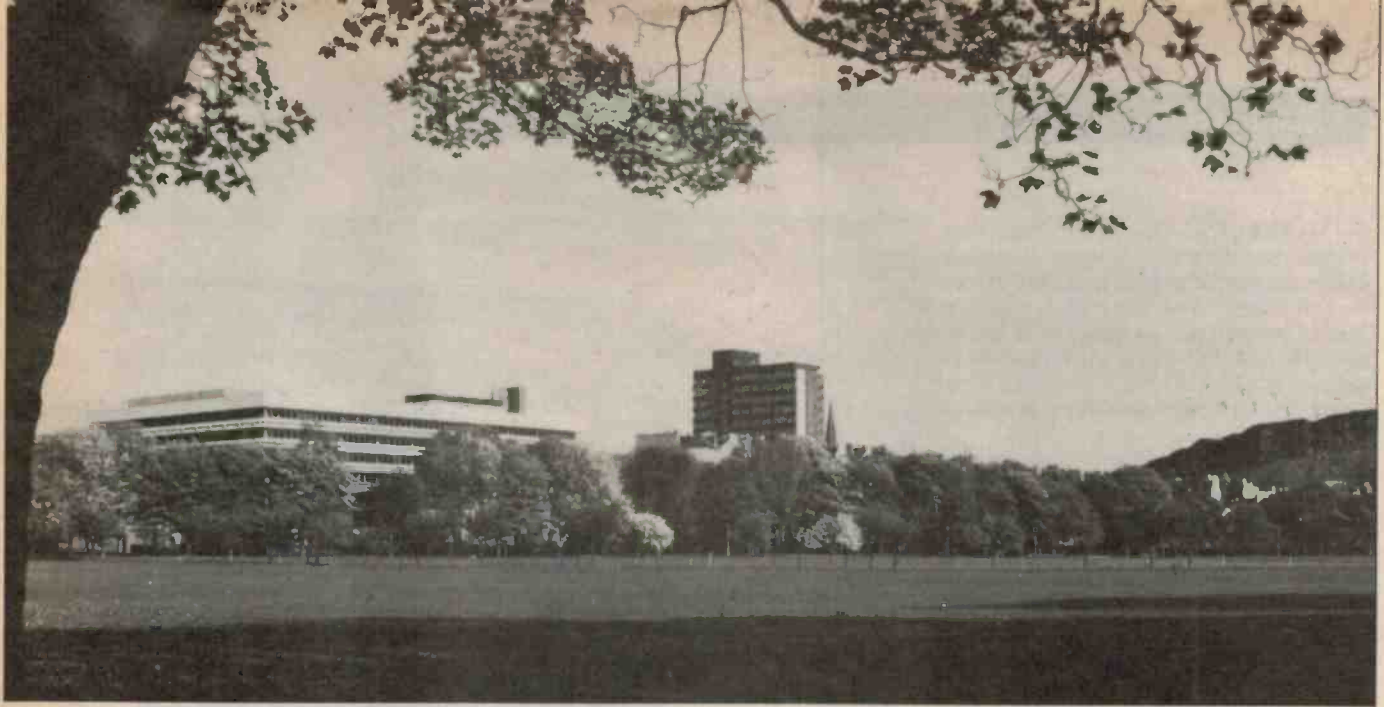

Computer company executives sit on the board and help design undergraduate courses at Edinburgh University.

big US and Japanese names: Hewlett Packard, Digital, National Semiconductor, IBM and Wang. At last count, something over 300 foreign companies. All over the place, small firms owned and run by locals are exploiting the new business climate and experimenting with the leading edge of new technology.

Two countries in one. The old country dies as a new one springs up to replace it. Whatever the agony of the old Scotland, the new version is innovative, exciting and rich.

Some parallels

The history of Scotland over the last 200 years has some interesting parallels with our own. Scotland is where the industrial revolution began. For a hundred years, up to the Great Depression, Scottish industry churned out the heavy industrial goods required by the world. The ships that carried the trade of the empire were made up here, and the engineer down in the engine room was likely as not a dour Scotsman, rubbing his hands on an ever present greasy rag.

(Incidentally, to understand anything about Scotland, you have to understand that the Scot *was* down in the engine room. The bloke up on the bridge was English. It's not an inconsequential fact if you want to know how the Scots see the world.)

The good times ended in the '30s. The Great Depression was particularly savage in Scotland, and except for war time ship building it never really recovered. During the 50s and 60s, while Britain, indeed the whole world, experienced unparalleled growth, Scotland staggered from one economic crisis to another. Its industries were old and rundown. Its brightest youth on the move, to Australia, New Zealand, the US. There was no money for investment. Around the world, other people were proving they could do the job better, cheaper, quicker.

But today the situation is very different. Money is flowing into the country. There is work, at least for some people. Everywhere, optimism abounds.

The SDA

It didn't happen by accident. The redevelopment of Scotland has been the result of a carefully contrived policy by the Scottish administration. Even today, redevelopment is being tightly controlled by the government. All the organs of the state apparatus have been integrated into a single force to get the country going again. By any

standards it has been extraordinarily successful.

The government organisation at the centre of the Scottish initiative is called the Scottish Development Agency (SDA). It has an annual budget of £100,000 (10 days worth of drilling on a typical BP oil rig in the North Sea). It also has some plush offices in Glasgow city centre with the latest chrome and glass fittings.

The SDA was set up in 1975 by the then Labour government with the express function of bringing business to Scotland. The first step was to identify areas of strength in ►

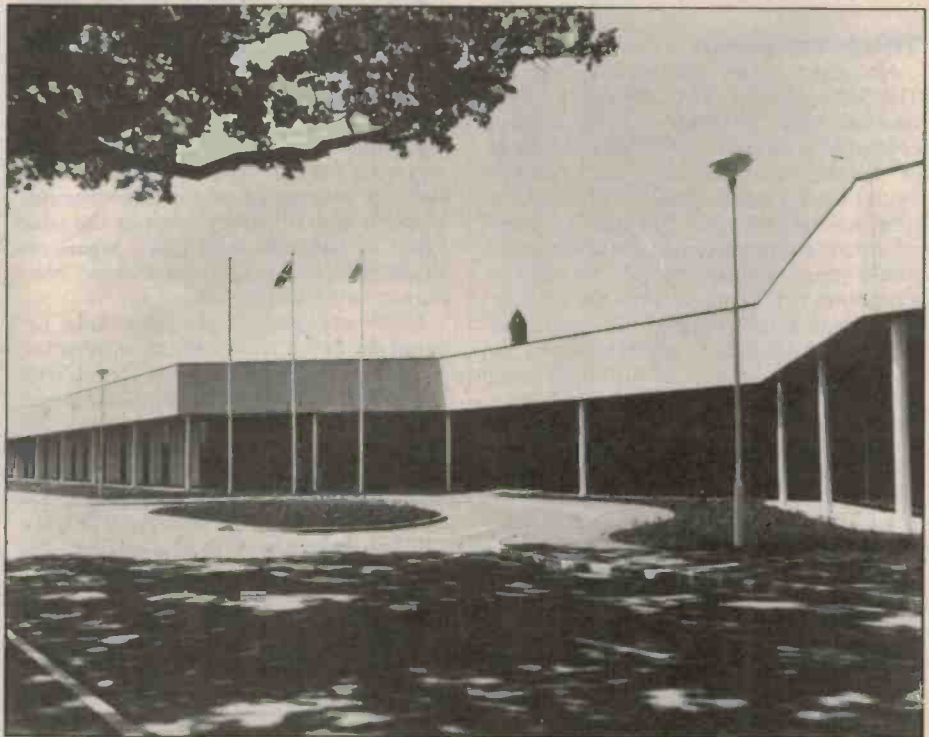

Wang Computers' on-campus factory at Stirling University.

the Scottish scene. One of these was electronics and information systems. A considerable amount of expertise already existed in universities, and there was a feeling that electronics was an industry of the future. There was also a feeling that it was an industry in which the Scots, with their reputation for technical cleverness, would do very well.

So the SDA set about getting the Scots to do electronics. They encouraged foreign companies to set up in town with a 'one stop investment shop'. The idea was that the SDA would do all the leg work; liaise with other government departments, buy land, build factories, get all the utilities supplied, supply information about work practices, skills and so on. Just as importantly, SDA would arrange all the government subsidies and incentives. These can be pretty substantial; up to 35 per cent of total set up costs.

As I say, they have been extraordinarily successful. Last year over a million computer systems were built in Scotland. The figure includes Sinclair, Honeywell, NCR and DEC, but not IBM, which is just beginning production of the PC and PC-AT. Next year will be considerably better.

Scotland now produces 20 per cent of Europe's total needs for semiconductors. In fact it produces five chips per head of population a week. The Scots have one plant producing six inch wafers, another is due on line soon. Custom chip facilities abound.

In the last three years alone the SDA has attracted over £1 billion in foreign investment and created almost 40,000 jobs.

The local touch

Not that it is open slather by any means. The Scots are very selective in the companies they help. Scotland has never been in competition with the cheap labour markets of South-East Asia. In fact, Scottish labour can no more compete with Filipinos than Australian labour. The idea has been to attract companies that use production systems requiring a great deal of skill and as a result there is plenty of scope for a young engineer in Scotland today. Of course the converse is also true, and not nearly so attractive: there is no future for the semi skilled or unskilled worker from the shipyards.

There is an obvious disadvantage for any country in attracting foreign investment: control of the economy goes overseas. One way of mitigating this effect is to ensure as much high level input into the product as possible. In other words, the Scots aim to make themselves indispensable.

Key concept for the SDA is the "science park". A science park is a place where a company can locate its offices within reach of a research institute like a university. The idea is that cross fertilisation will occur. It's easy for the company to ask the university



Will Scottish high tech reveal the Loch Ness monster?

for help in solving its production problems (at the right price). Equally, academics with the right ideas have a readily available production facility on the doorstep.

Nowhere is this symbiosis more apparent than in one of the latest start ups in Scotland. If you drive around the maze of small country lanes just north of Stirling, sooner or later you will come across a big blue sign announcing "Wang Computers". This is actually one of the entrances to Stirling University. Wang has just purchased a factory on the campus. Wang benefits from a research base it doesn't have to pay for. The university benefits from the money it can earn by contracting research assignments. With the kind of money that's on the table today in Scotland, high flown arguments about academic independence have been thrown out of the window.

Other examples of the close links between the new arrivals and the universities: NCR is funding a new chair at Heriot-Watt University in Edinburgh. Motorola senior executives sit on the committees that design undergraduate courses. Executives from Racal and Ferranti are on the board of Edinburgh University's custom chip design centre. Research at the University of Glasgow into super fast FETs is being funded to the tune of half a million dollars by industry.

It's difficult to know if they are succeeding, or will succeed. In some of the companies I visited, local expertise is there merely to sort out production problems. Of course, if you are developing processes no one has ever attempted before, production prob-

lems are of no small order. But products developed from Scottish research form a distinct minority of the total output of Scottish electronics. Still, no one involved in electronics is complaining.

The workers

Others are though. It's becoming painfully apparent that the SDA has no recipe for solving mass unemployment.

According to SDA spokesman Emrys Inker, the electronics industry will never absorb the labour force retrenched by heavy industry. In the first place, electronics simply doesn't require the same mass of humanity. Secondly, the people who come off the shop floors of Clydebank simply do not have the skills necessary to operate in the new factories. "It's like comparing apples and pears," he says.

One manager (who asked not to be identified because his company is an equal opportunity employer) told me that the lowest skilled workers he employs in any quantity are young married women with university entrance school passes. Young married women because they appreciate the highly flexible shift routine; university entrance because that is the minimum level of intelligence required to operate highly sophisticated machinery.

There may be a lesson for Australia in the Scottish experience. We face hard choices. In Scotland today, for the old, and the uneducated or stupid, there is no future. But for the bright young things with education, it's never been better.

FOR SALE: BACK ISSUES EA (1968-81), ETI (1974-81), Scientific American (1978-83) \$1 per issue. J. Rigter. (03)560-3627.

FOR SALE: HARD DISK. Shugart 604 6.66 MB 5 1/4". Brand new, with manual. \$500. Power supply to suit \$50. J. Rigter. (03)560-3627.

FOR SALE: KEYBOARD. Fully decoded serial output, 68 keys. Ideal as additional keyboard for Microbee. J. Rigter. (03)560-3627.

FOR SALE: BBC MICROCOMPUTER Model B. Choice of two — with or without disk interface. As new, never used, c/w user guide, Introductory 'Welcome' package, and some software. \$950 and \$800. T. Smith, PO Box 519, Mount Isa, Qld 4825. (077)43-8115.

FOR SALE: TOSHIBA TAPE RECORDER AM/FM stereo. Soft touch controls, stereo-wide enhancement, one touch recording. Almost new \$65. 6 Oswald Street, Cremorne, NSW (02)90-3636.

FOR SALE: MICROBEE unwanted original software. Microdefender \$8, Draughts/Othello \$6, Monkey maths \$6, Mach. code tutorial \$10. J. Arnold, 36 Victoria Street, Rooty Hill, NSW 2766.

FOR SALE: MSI MOTOROLA M6809 Computer System, 56K RAM, twin 8" floppies, VDU 80 x 24 cursor addressable, DOS, COBOL compiler, BASIC, PASCAL and other software. Will separate. \$1200 ono. John (03)390-1677.

FOR SALE: APPLE techn S100-system; DGZ80, DG640 VDU; 48K ram (64K board); Micropolis S100 control-card + disk drive (315K formatted); 9 slot motherboard Clare 70 keyboard. Micropolis MDOS, BASIC, CPM 2.2 \$950. (03) 742-1782. Chris Johanson, 1 Chandler St., Werrilbee Sth., Vic. 3030.

FOR SALE: MICROBEE 32K IC, joystick, KAGA monitor, all manuals, Wordbee and BASIC, cassette plus software \$650. Julian Bird, Kingsbury, Vic. (03)470-3010.

FOR SALE: FULL SCREEN EDITOR for Microbee BASIC programming! Send \$18 (tape), \$20 (disk), \$22 (ROM — net or pak) to Russell Crosser, Box 214, Healesville, Vic. 3777.

FOR SALE: 'PACKET RADIO the Software Approach' by Robert Richardson W4UC/2. Full Z80 source code listing. Volume 1 (Vancouver Protocol) \$24. Volume 2 (AX25 Protocol) \$34. Disks available for TRS 80 Model 1 and Model 3. \$30 each. Modem and I/O circuits included. Prices include p&p Aust and NZ. A.A. O'Brien VK2BOA, PO Box 333, Charlestown, NSW 2290. (049)43-8981.

FOR SALE: 12CH DIMMER system incl 4 preset board with instant, 2500W racks, chaser, 5ch extra board, leads. Phone (03)277-2327. Mark Shields, 67 Park Lane, Mt Waverley, Vic. 3129.

WANTED: FAX & RTTY modem and software for Microbee. Assembled and tested for use by DX/SWL. Phone Joe (059)87-1167 or write to PO Box 235, Dromana, Vic 3936.

SHOPAROUND

ETI-1507: Light Bulb Saver

The most difficult part of this project will be getting the plumbing together. You will probably have difficulty finding exactly the same bits as we used, so make an assessment of your needs and be creative. One potential source of trouble — the mains rated capacitors C1 and C4. If you get this wrong you will generate some interesting pyrotechnics. Any capacitor having the necessary values will do the trick, provided it's mains rated. The Triac SC141D features in the DSE catalogue, so if you can't get hold of it where you are, write a nasty letter! We know it's also sold by Jaycar in Sydney, and doubtless by all the other stores as well. It is unnecessary to obtain the D version of this, apparently there is a C that will do just as well.

ETI-664: Hobbybot Robot

Because the EPROM is proprietary information this project can only be purchased as a kit from Allan Branch, Corporate Research and Planning, 40 Grove Rd, Glenorchy, Tas 7010. (002) 72-0629. Price is \$337 including tax and freight.

ETI-757: FAX/RTTY Decoder for the Cat

There are no obscure parts in this project barring the MM5369 crystal divider. It can be obtained from DSE which, in any case, will be doing a kit for this one.

ETI-1401: DI Box

Jaycar has advised that it is experiencing problems with the mechanical design of this project. It intends to replace the switch bank with separate toggle switches which eliminate the need to cut a rectangular hole in the metal box. It is also using a smaller box so you can expect kits from Jaycar to look a little different.

Artwork

For those making their own pc boards or front panels from the ground up, same size positive or negative transparencies are available from our 'Artwork Sales'. Please address requests for this service to:

'ETI-xxx Artwork'

ETI Magazine

PO Box 227

Waterloo

NSW 2017.

When ordering, make sure you specify positive or negative, according to the requirements of your photoresist. Your cheque or money order should be made payable to 'ETI Artwork Sales'. Prices for this month's projects are:

ETI-1507 pc board	\$2.25
ETI-664 pc board	\$8.72
ETI-757 pc board	\$6.00
front panel	\$5.17
rear panel	\$5.17

You might also care to know that almost every pc board (and most front panels) ever published by ETI may be obtained from:

All Electronic Components

118 Lonsdale St

Melbourne, Vic 3000

RCS Radio

651 Forest Rd

Bexley, NSW 2207

For pc boards produced in recent years, the following suppliers either keep stocks on hand or can supply to order:

Acetronics

112 Robertson Rd

Bass Hill, NSW 2197

(02) 645-1241

Billco Electronics

Shop 2, 31 Pultney St

Dandenong, Vic 2175

Jaetronics

58 Appian Drive

St Albans, Vic 3021

Jaycar

117 York St

Sydney, NSW 2000

Jemal Products

PO Box 168

Victoria Park, WA 6100

Mini Tech

PO Box 9194

Auckland, NZ

Rod Irving Electronics

425 High St

Northcote, Vic 3070

WIRELESS INSTITUTE OF AUSTRALIA

FOUNDED 1910

The W.I.A. represents the Radio Amateur at Local, National and International level and offers following services:



- ★ Monthly "AMATEUR RADIO" Magazine, included in membership fee.
- ★ Most REPEATERS have their licence, power and site cost paid by the institute.
- ★ World wide QSL-service.
- ★ Assistance to members in legal problems arising out of the pursuit of their hobby.
- ★ A Weekly Sunday Broadcast to Amateurs and Short Wave Listeners.
- ★ Assistance in dealing with Interference Problems (TVI-RFI etc.)
- ★ Novice and full call courses.
- ★ Trial Novice and AOCF theory exam papers.
- ★ Advice on Radio Mast approvals
- ★ The ONLY representation of the RADIO AMATEUR in legislative matters.



Join the 8,600 Amateur members in the W.I.A. by forwarding this coupon to:
W.I.A. P.O. BOX 300,

CAULFIELD SOUTH, VIC. 3162

Please forward a membership application form and further details to:

Mr, Mrs, Miss, Ms

Address

Callsign

Postcode

Telecommunications Technician

ARE YOU LOOKING FOR A CHALLENGING
CAREER IN THE RAPIDLY DEVELOPING
TELECOMMUNICATIONS FIELD?

Telecom Australia is responsible for the planning, establishing, maintaining and operation of the rapidly developing telecommunications network throughout Australia.

Telecom is looking for skilled, motivated men and women who are capable of working on the latest technologies and who can adapt to future development.

Fields of specialisation Include:

- Digital/analogue data and voice transmission.
- PABX installation and acceptance testing.
- Installation or maintenance of subscriber equipment ranging from single service telephones to complex PABX switchboards and intercommunications systems.
- Installation or maintenance of switching equipment and transmission systems ranging from step by step and ARF Crossbar to processor controlled systems.

APPLICANTS must be Australian Citizens or permanent residents of Australia and possess one of the following qualifications:

- Tradesman's Certificate or Tradesman's Rights Certificate in the discipline of Telegraph Mechanic or Radio Tradesman.
- Electronics and Communications Certificate or Electronic Engineering Certificate plus four years' relevant experience.
- Trained as a Telecommunications Technician or Telecommunications Tradesman with Telecom Australia or the former Postmaster General's Department.
- Appropriate B or C level certificate examinations of the City and Guilds of London Institute.
- Current NSW Class 1 driver's licence.

Excellent opportunities exist for motivated persons to qualify for advancement to the Technical Officer structure and beyond by way of external Certificate studies or Telecom's training program.

BENEFITS include security of employment, a career structure, superannuation after a qualifying period, generous leave entitlement including maternity leave and a nine day working fortnight.

SALARY negotiable within the range \$17,211 to \$20,823 p.a. depending on qualifications and experience.

HOW TO APPLY: Write to the Recruitment Officer, Telecom Australia, GPO Box 5265, Sydney, NSW 2001 detailing previous work experience and copies of qualifications or call in person to the 15th Floor, 309 Kent Street, Sydney during business hours on any working day.



Telecom Australia

An Equal Opportunity Employer

PRT REC 300

The new Amstrad 6128.

A comparable 128K computer could easily cost you twice as much.

The popular Amstrad personal computers have quickly become top sellers in Europe and Australia, and have established an enviable "value for money" reputation. Now comes the remarkable Amstrad 6128 computer.

The Amstrad 6128 offers a powerful 128K memory, high definition green screen monitor, inbuilt disc drive and sophisticated CP/M PLUS* operating system from around \$800 all up. (Colour monitor package from around \$1000.) Other computers with similar capabilities can cost hundreds or even thousands of dollars more.

\$800 package offers real value for home or business.

- Powerful 128K computer
- High definition green screen monitor
- Inbuilt floppy disc drive
- CP/M PLUS* and AMSDOS operating systems
- GSX Graphics Enhancement
- Comprehensive User Manual
- Introductory program and exercises

Rapid loading, instant cataloguing.

The availability of such a low cost, disc based 128K system is a real breakthrough for both businesses and home computer enthusiasts. Programs are loaded rapidly and cataloguing is instantaneous. The CP/M PLUS* operating system is acknowledged as one

of the best and most practical in the world.

Other key features of the Amstrad 6128 system include a highly functional alpha-numerical keypad with programmable function keys and broad sound and graphics capabilities. Thus, the system offers considerable scope not only for educational and entertainment uses but also for many serious business requirements.

Wide range of programs available now.

Most of the programs developed for the Amstrad 464 and 664 computers can be used on the 6128. These cover a broad range of subjects including Business, Education, Games, Brain Power, Programming and Electronic Home.

In addition, there is an excellent range of custom CP/M PLUS* disc-based programs available.

In all, there are hundreds of titles to choose from covering all aspects of personal and business computing. Programs include Wordprocessing, Spreadsheets, Graphics, Accounting and many popular games. The Amstrad 6128 computer offers a wealth of applications for home and business.



Amstrad. Distributed and guaranteed by AWA-Thorn.

Amstrad computers are distributed and guaranteed by AWA-Thorn, one of Australia's most trusted names in home products. The new 6128 system is available at leading retailers and computer stores throughout Australia. Ask for a demonstration and you'll agree – no other system adds up to Amstrad.

For the location of your nearest Amstrad dealer, please telephone: *Sydney, 638 8444; Newcastle, 52 7088; Melbourne, 459 1688; Brisbane, 44 7211; Townsville, 72 7755; Canberra, 80 5314; Adelaide, 269 1966; Perth, 277 7788; Hobart, 72 4366; Darwin, 84 3243*

*CP/M PLUS is a registered trademark of Digital Research

AMSTRAD

Distributed and guaranteed throughout Australia by

AWA-THORN

TPB/623

GAMES by Paul Jones

HE INSERTED THE coin into the slot marked for the purpose. The instructions flashed on to the screen: a second later the mission started. First, his spaceship appeared at the end of the runway. The Alien attack started. From the sky they came, firing a hail of bullets at the small figure as it darted across the open field.

"I must get to the craft, for Aalon's sake!"

He was still fairly calm; he knew there was much more to go. A quick dodge to the left, then right and now only a pace or two to go. He got there. A sigh came from his lips. A distant crowd gave a quick cheer as he climbed aboard the sleek white craft. The throttle was pushed home and the 'Aalon Dart' sped along the damaged runway.

It took all this skill to keep the Dart on its course. High above the Alien fighter craft were grouping for the attack. His craft reached flying speed and a heave on the controls lifted him into the night sky, and on to the Battle ahead.

The Alien ships were smaller and not as well armed as the Prince's ship, but they

outnumbered him by thirty to one. This was of little concern to him: he had fought these people many times before.

He was about to say something but in his mind he knew it did not need saying, for to fail this time would mean a complete end to the war and shame and defeat to his people. He dispelled the last of the small fleet with the ease that comes with hard discipline, and then he was resting, waiting for the new danger. "Whoosh," and his quick reflexes enabled him to swerve out of the path of a meteor, then came a second, and a third.

A battlestar stood in his path, a spray of guided missiles came to meet him, shifting from one side of his screen to the other. He followed their flight and with careful timing launched his attack. "Success," he thought as the last blaze of light subsided, leaving only the huge bulk open to careful approach. Now the local defences opened fire, but moving out of danger he slowly shot away at the walls of the battlestar until the hole was large enough to fly into the hulk and blow out the main reactor.

He flew down the small corridor with only inches on each side. Ahead the green glow of the reactor grew larger as the Aalon

primed his only bomb. A quick glance at his controls confirmed that he had fuel enough for a speedy flight away from the explosion.

The complex task over, he noticed that his hand was starting to ache. He hoped he could keep up with the pressure. Would his strength let him down? His green skin quivered.

Up from the planet ahead a ship approached. It was similar to his own but for the colour; it was very, very black. Only interior lights and its rocket flare betrayed its position.

Frodges, Prince of Aalon, studied the oncoming craft carefully. This would be the climax of the fight. He braced himself. They faced each other, then without warning a spray of laserfire made him dodge wildly to the right. Fodges returned the fire, each ship dodged and swerved, advanced and retreated. Then he hesitated, his mind blank for a moment, and a blast from the foe sent his ship spinning into the void, lost forever.

The video machine made a rude noise and displayed a list of the previous best players: Frodges, Prince of Aalon, appointee of his people, the chosen champion, had failed to make the grade. The small crowd that had gathered, patted the small green man on the back and formed a 'guard-of-honour' as he slinked slowly to the door. Out of the air his real Aalon Dart appeared. He embarked and vanished. ●



Rrrrh . . . Brrr . . . Zooooom . . . Ratatatata . . . crshhhh . . . curse you Red Baron!



The smarter the villains get, the more Philips Elcoma can help you.

By the end of the decade, insurance companies will probably be demanding that all homes, offices, cars and boats are fitted with electronic alarm systems. That's the way insurance and security is going.

Electronic detection systems, electronic locks, electronic alarms: these are the security products of the future. And the future is now.

Australian manufacturers will need specific experience and resourcefulness to combat the mounting competition from overseas companies. It can be done!

Philips Electronic Components & Materials have catalogues of more than 200,000 products available to you here in Australia.

When this resource is combined with the ingenuity and skill of our own local microelectronics design service, we can deliver a customer solution to give you the edge over your competition.

Development time for a thick-film hybrid circuit can be as little as 8 weeks. More advanced custom "monolithic chip" designs will take a little longer, depending on the size of the chip and design complexity.

A full range of discrete electronic components is also available, so call Philips Electronic Components and

Materials, and discuss the improvements you have in mind for your products.

We make electronics in Australia

I'd like immediate information to help me design new generation security systems. My specific area of interest is:

ETI

- | | |
|--|---|
| <input type="checkbox"/> LDR (Light dependent resistors) | <input type="checkbox"/> Custom thick-film Hybrid Circuits & microchips |
| <input type="checkbox"/> Image Intensifiers | <input type="checkbox"/> LAN IC's |
| <input type="checkbox"/> Vidicon & Newvicon Camera Tubes | <input type="checkbox"/> Remote Control IC's |
| <input type="checkbox"/> Doppler Radar Detectors | <input type="checkbox"/> Hall Effect devices |
| <input type="checkbox"/> Solid State Image Sensors | <input type="checkbox"/> Magneto Resistive Sensors |
| <input type="checkbox"/> Infra-Red Detectors | <input type="checkbox"/> Indicator Displays |
| <input type="checkbox"/> Reed Switches | |

Name: _____

Organisation: _____

Address: _____

Postcode: _____

Phone: _____

Send to: Philips Elcoma, 11 Waltham Street, ARTARMON, N.S.W. 2064.

the UN 110



**Electronic
Components &
Materials**

Sydney (02) 439 3322
Melbourne (03) 542 3333
Adelaide (08) 243 0155

Perth (09) 277 4199
Brisbane (07) 44 0191

PHILIPS

Get all of Yamaha's latest audio equipment for only 33 cents.



Fill in this coupon and you'll get Yamaha's free catalogue featuring the latest and complete range of compact disc players, cassette decks, turntables, cartridges, integrated amps, separate amps, tuners, receivers, graphic equalizers, headphones and system components. With each component comes something you wouldn't expect. **5 YEAR WARRANTY.**

Name _____

Address _____

Postcode _____

Yamaha Consumer Electronics Division, 17-33
Market Street, South Melbourne, Victoria 3205.

*Limited warranty.

YAMAHA