

APRIL 1984

\$2.50* NZ\$2.95



ELECTRONICS TODAY INTERNATIONAL

Aust. Only.
**Yet another
DICK SMITH
CATALOGUE**

OF MICE AND...

MACINTOSH, ICONS, WINDOWS AND JOBS

**PROGRAMMABLE ROBOT
HAS EDUCATIONAL
POSSIBILITIES**

**3D PLOTTING
ON THE MICROBEE
PRECISE
TIME INTERVAL
MEASUREMENT**

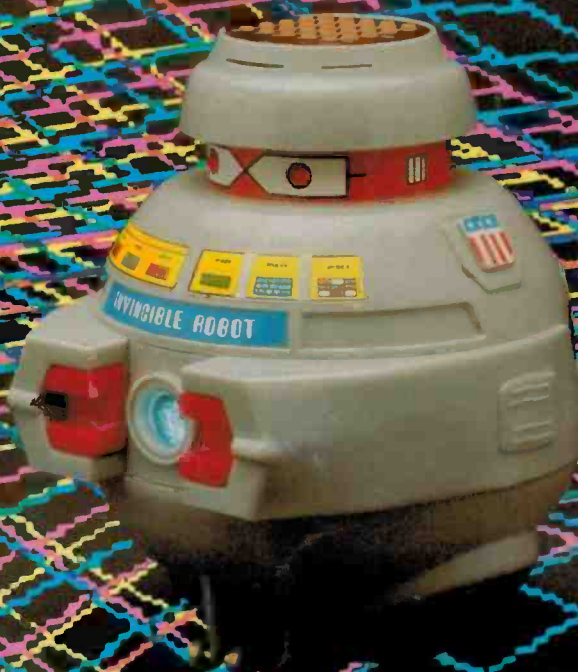

Super Car Alarm

4-Ch. Headphone Driver

Micro Timer/Controller

HI-FI: COME IN SPINNER!

Nakamichi's auto-reverse cassette deck reviewed

The audio giant scores 10 out of 10.

System 330 Hi-Fi Component System.



1

A full 35 watts RMS/channel power, drives the system's stereo units, delivering life-like sound through 3-way speakers.

2

Servo-controlled motor with belt drive assures constant, accurate speed. Cue control on turntable gently lowers tonearm into groove, preventing possible damage to the record or the stylus.

3

Built-in 5-band graphic equalizer enables you to custom contour the system's sound at 5 critical points along the audio spectrum by as much as 10dB.

4

A/B speaker switching enables you to connect two sets of speakers to your system and listen to them separately or together.

5

The tuner with its 3-segment LED signal strength indicator lets you know when you're receiving a weak or distant station.

6

Two 5-segment LED VU meters on the cassette deck provide precise, easy-to-read record levels and help to prevent distortion.

7

Dolby* noise reduction circuit minimises distracting tape hiss and allows you to record and playback crisp, clean sound.

8

3-way, 3 speaker systems each containing 25cm woofer, 10cm midrange and a 2.5cm dome tweeter.

9

Audio component rack with attractive wood-grain finish includes record storage facility. Castors for easy mobility, glass door and hinged glass turntable dust cover.

10

The tenth feature is the price and Sanyo has taken care of that too, but that's life.

*Dolby is a registered trademark of Dolby Laboratories.

 **SANYO**
That's Life!

EDITOR

Roger Harrison VK2ZTB

ASSISTANT EDITOR

Jennifer Whyte B. App. Sc.

EDITORIAL STAFF

Geoff Nicholls B.Sc./B.E.

Peter Ihnat B.E., B.Sc.

Robert Irwin

ASSOCIATES

David Tilbrook VK2YMI

Jonathan Scott

B.Sc./B.E. (Hons) VK2YBN

DRAUGHTING

David Currie

PRODUCTION

Steve Landon

Mark Davis

ADVERTISING SALES

Richard Pakalnis (Group Manager)

John Whalen (National)

Steve Collett

ART STAFF

Ali White B.A.

Bill Crump

READER SERVICES

Carmel Gatt

ACOUSTICAL CONSULTANTS

Louis Challis and Associates

HEAD OFFICE

140 Joynton Avenue, (PO Box 227)

Waterloo, NSW 2017.

Phone: (02) 663-9999 Sydney.

Telex: 74488, FEDPUB.

ADVERTISING OFFICES AND AGENTS:

Victoria and Tasmania: Virginia Salmon and Mel Godfrey, The Federal Publishing Company, 23rd Floor, 150 Lonsdale Street, Melbourne, Vic. 3000. Phone: (03) 662-1222 Melbourne. Telex: 34340, FEDPUB.

South Australia and Northern Territory: The Admedia Group, 24 Kensington Road, Rose Park, SA 5067. Phone: (08) 332-8144 Adelaide. Telex: 82182, ADMEDIA.

Queensland: Geoff Home Agencies, 16 Bellbowrie Centre, Bellbowrie, Qld 4070. Phone: (07) 202-6813 Brisbane.

Western Australia: Cliff R. Thomas, Adrep Advertising Representative, 62 Wickham Street, East Perth, WA 6000. Phone: (09) 325-6395 Perth.

New Zealand: Chris Horsley, 4A Symonds Court, Symonds Street, Auckland. Telex: NZ60753, TEXTURE. Phone: 39-6096. Auckland.

Britain: Peter Holloway, John Fairfax and Sons (Australia) Ltd, Associated Press House, 12 Norwch Street, London EC4A 1BH. Phone: (01) 353-9321 London. Telex: 262836, SMHLON.

Japan: Genzo Uchida, Bancho Media Services, 5th Floor, Dai-ichi Nisawa Building, 3-1 Kanda Tacho 2-chome, Chiyoda-ku, Tokyo 101. Phone: (03) 252-2721 Tokyo. Telex: 25472, BMSINC.



ELECTRONICS TODAY INTERNATIONAL

is published monthly by the Electronics Division of the Federal Publishing Company Pty Limited, 140 Joynton Avenue, Waterloo, NSW 2017. Managing Editor: Bob Izzard. Typeset and printed by ESN-The Litho Centre, Sydney. Distributed by Gordon and Gotch Limited, Sydney. Cover price \$2.35 (maximum and recommended Australian retail price only; recommended New Zealand price, \$2.95). Registered by Australia Post, Publication No NBP0407. ISSN No 0013-5216.

COPYRIGHT © 1984, THE FEDERAL PUBLISHING COMPANY

FEATURES

NEWS DIGEST	8
NOT THE NEWS DIGEST	10
PROGRAMMABLE ROBOT AS A TEACHING TOOL?	12
BANDWIDTH, PROBING & PRECISE TIME INTERVAL MEASUREMENTS	18
SPECIAL OFFER 6800 MICROPROCESSOR BOOKS	18
1983 INDEX & COLLECTED ERRATA	130

SIGHT & SOUND

SIGHT & SOUND NEWS	24
NAKAMICHI RX-202 CASSETTE DECK REVIEWED	30

COMPUTING TODAY

SOPHONET FOR TOTAL COMPUTER COMMUNICATIONS?	37
COMPUTING TODAY NEWS	38
3D PLOTTING ON THE MICROBEE	45
APPLE'S MACINTOSH	57
GUIDANCE FOR OWNERS OF THE '644 MODEM	80
VIC-20 COLUMN	86
SPECIAL OFFER 6800 MICROPROCESSOR BOOKS	18

TECHNICAL

EQUIPMENT NEWS	91
COMPONENT NEWS	93
GUIDANCE FOR OWNERS OF THE '644 MODEM	80
PROJECT 662A GENERAL PURPOSE MICROPROCESSOR SYSTEM	64
PROJECT 662B MICROPROCESSOR-BASED TIMER CONTROLLER	72
PROJECT 340 VEHICLE SECURITY ALARM	103
PROJECT 1522 ROOM LIGHTS CONTROLLER PART 2	116
PROJECT 462 FOUR CHANNEL HEADPHONE DRIVER	122
IDEAS FOR EXPERIMENTERS	126
IDEA OF THE MONTH	127

COMMUNICATIONS

COMMUNICATIONS NEWS	129
---------------------------	-----

GENERAL

COMMENT	5
ADVERTISERS' INDEX	5
SPECIAL OFFER 6800 MICROPROCESSOR BOOKS	69
MAIL ORDER BOOKS	97
1983 INDEX & COLLECTED ERRATA	130
LETTERS	133
MINI-MART	137
DREGS	138

COPYRIGHT: The contents of *Electronics Today International* and associated publications is fully protected by the Commonwealth Copyright Act (1968). Copyright extends to all written material, photographs, drawings, circuit diagrams and printed-circuit boards. Although any form of reproduction is a breach of copyright, we are not concerned about individuals constructing projects for their own private use, nor by bands (for example) constructing one or more items for use in connection with their performances. Commercial organisations should note that no project or part project described in *Electronics Today International* or associated publications may be offered for sale, or sold in substantially or fully assembled form, unless a licence has been specifically obtained so to do from the publisher, The Federal Publishing Company, or from the copyright holders.

LIABILITY: Comments and test results on equipment reviewed refer to the particular item submitted for review and may not necessarily pertain to other units of the same make or model number. Whilst every effort has been made to ensure that all constructional projects referred to in this edition will operate as indicated efficiently and properly and that all necessary components to manufacture the same will be available, no responsibility is accepted in respect of the failure for any reason at all of the project to operate effectively or at all whether due to any fault in design or otherwise and no responsibility is accepted for the failure to obtain any component parts in respect of any such project. Further, no responsibility is accepted in respect of any injury or damage caused by any fault in the design of any such project as aforesaid.



DISCO CONSOLE

- MASTER PARAMETRIC EQ.
- EQ. ON ALL CHANNELS
- YAMAHA P200 TURNTABLES
- SOLID PLY CABINET
- 12 MONTHS' WARRANTY
- BLACK NYLON CARPET COVERING

WRITE OR CALL FOR FURTHER INFORMATION
ON OUR EXTENSIVE RANGE OF SOUND AND LIGHTING EQUIPMENT



Hi-TECH LIGHT AND SOUND

DISCO SOUND AND LIGHTING SPECIALISTS

63 HARDGRAVE ROAD, WEST END 4101
POSTAL ADDRESS: P.O. BOX 377, WEST END, QLD. 4101
PHONE: (07) 44-4971

ADVERTISERS' INDEX

ACME	128
ADAPTIVE	42
Applied Technology	88,89
Aust. Government	26,27
Artec Soanar	121
Avtek Electronics	115
Delsound	76
Birkenhead Electronics	96
BWD	23
Datatel	113
Dick Smith	6,14,15,16
Ellstronics	70, 71, 77
Emona	90
Energy Control	87
ESD	7
GCS Computers	53
Hi-com Unitronics	121
Hi-tech Light & Sound	4
Holiday Luggage	87
Jaycar	46,47,54,55,78,79 92,94,95
K-Nar	53
Lawrence & Hansen	128
Mcgraths	62,63
Mini Tool	129
Micro 80	113
Mytek	44
Parameters	20
Powersonic	13
Prepak	52
Radio Despatch	132
Rod Irving	33,56,61,85
Rose Music	28,29,OBC
Sanyo	IFC
Scan Audio	35
Scientific Devices	90
Scope Labs	11,17
Sheridan	22
Sony (Aust)	IBC
Shere Computers	39
Tech Sales	43
Truscott Elect	84

COMMENT

WITH THE more or less successful introduction of digital audio recording and reproduction (the compact disc, etc) and digital video (in the form of the video disc), no doubt many of you have pondered, as I have, when our broadcast audio and video mediums will "go digital".

It's easy, not to mention fun, to speculate on when such a revolution might occur, considering the rapid pace of technological advancement. Fundamentally, the technology is there, along with a number of proposals for suitable system standards. We must have some sort of system standard, or standard system if you like, otherwise consumers are saddled with a variety of systems competing for the same (admittedly, huge) audience and we end up with a hotch-potch arrangement and much confusion. And the consumer pays the cost. The Beta vs VHS video systems being one recent example — the NTSC/SECAM/PAL television standards being a classic example.

Back to the speculation. Analogue and digital transmission systems are fundamentally non-compatible. Thus, there would either have to be a phase-in period where stations changed over — and consumers threw out the old receivers and bought new ones, or a period where new and old systems ran side-by-side in some manner. Just examine a real example. In HF communications, the change from AM transmission to single-sideband (SSB) transmission took *over 20 years* to complete. The two transmission modes are essentially non-compatible. The phase-out/phase-in was done service by service. From a certain date, all new services were required to use SSB only.

With the recent introduction of dual-sound (two-channel or stereo) transmission for television stations, and the imminent introduction of stereo for AM broadcast stations, shouldn't we

be considering changing to superior digital systems? It's a question worth asking, and a thorny one.

I posed it to a few colleagues around the trade and was met with what, at first, seemed a surprisingly conservative reaction: why? Er, ar... well, I blustered, digital would offer much clearer, better quality reception, free from all sorts of interference. Quite true, was the reply, but very, very few listeners/viewers complain about the existing quality and, in general, interference reports as a percentage of total audience, are extraordinarily low. If what we have is acceptable, or better than that, what would anyone gain with the disruption and confusion of such a radical and large-scale change-over? My only answer to that was, manufacturers and retailers of receivers would gain (and the attendant service industries). Perhaps apathy accounts for the lack of complaints.

Then there's the cost, I was told. Oh yes, the cost. All the stations would have to, virtually, totally re-equip. So would all the consumers. And, historically, consumers resist that — *mightily*. Going digital for Australian TV stations now has a technological limitation. The 7 MHz channel spacing on UHF, as well as VHF, prevents it. The UK digital sound system requires 8 MHz bandwidth, other systems, more. The only hope we have for digital TV transmission is cable. And that would be incompatible with current receivers — unless used strictly as a video monitor.

Give it 20 years — *then* we might start thinking about it.



Roger Harrison
Editor

Roger Harrison

NEXT MONTH

SPECIAL THEME: COMMUNICATIONS TODAY

The May issue of ETI will cover a broad variety of subjects and aspects in communications today. This issue will contain perhaps the most important and comprehensive overview of the 'communications industry' in Australia published anywhere for many years. We have commissioned articles covering such topics as: AUSSAT — a new communications era?; **Shortwave broadcasting and Australasia** — still a vital social force in our region; **Computers & Communications** — converging technologies, an overview; **Test & Measurement in Communications** — the technology, the techniques, the equipment; **Ionospheric Measurement & Prediction** — HF communications here is growing and so is the demand for frequency prediction services; **Amateur Radio & the Face of Change** — amateur radio looks set for greater growth and change in the next decade or so. Is the hobby ready?

DARKROOM TIMER

Digital readout, count-down style timer based around our 6802 Minimum Micro System, published this issue.

LOGIC GATES

Which type should be used in a particular application? Ray Marston answers.

Although these articles are in an advanced state of preparation, circumstances may affect the final content. However, we will make every attempt to include all features mentioned here.

SERVICES

TECHNICAL INQUIRIES: We can only answer readers' technical inquiries by telephone after 4.30pm Mondays to Thursdays. The technical inquiry number is (02) 662-4267. Technical inquiries by mail must be accompanied by a stamped, self-addressed envelope. There is no charge. We can only answer queries relating to projects and articles as published. We cannot advise on modifications, other than errata or addenda. We try to answer letters as soon as possible. Difficult questions may take some time to answer.

GENERAL INQUIRIES: For all inquiries about back issues, subscriptions (\$24.00 for 12 months/12 issues), photocopies of articles, artwork or submitting articles, call (02) 663-9999 or write to: ETI Reader Services, 140 Joynton Avenue (PO Box 227), Waterloo, NSW 2017.

CONTRIBUTIONS: Submissions must be accompanied by a stamped, self-addressed envelope. The publisher accepts no responsibility for unsolicited material.



**WE'RE WELL
VERSED IN
VALUE VIDEO**
(SAY THAT QUICKLY!)



DON'T BUY JUST AN ENHANCER!



**The
DICK
SMITH
Video Processor**

Far more than JUST an enhancer! This incredible processor enhances, stabilizes, amplifies and modulates as well... Latest imported design is a boon when dubbing, restoring detail normally lost in the process. But it also includes a stabiliser for tapes with 'Copyguard' eliminating the often associated annoying rolling.

Plus it has a video distribution amplifier so you can feed up to 3 other recorders or monitors AND its in-built modulator allows you to watch the enhanced picture during playback on any ordinary TV (great for A/B comparison). Incredible? Wait until you try it: it's even better!
Cat Y-8510

WHAT A BUY!

\$129⁹⁵

Fantastic stereo sound from your mono video with this kit!

**Stereo
Simulator
Mk II**

Wish those old video movies had modern stereo sound? This low-cost gadget turns almost any mono signal into amazingly good synthetic stereo!
SEE EA APRIL 1983

\$19⁹⁵

Cat K-3421

EASY TO BUILD COMPLETE WITH INSTRUCTIONS



**It's got everything!
Video to
Video Cable**

Having trouble with video leads? No more! This incredible video lead pack will match ANY video to ANY video with its unique plug & socket system. Cat W-1287



\$19⁹⁵

**Top quality,
top name
3 hour
Video
Cassettes**

Huge bulk purchase of famous name video tapes allow this ridiculous price. Not those imported 'cheapies' which can do a lot of damage to your heads - these tapes are top quality!

VHS Polaroid Cat C-3410
BETA Agfa Cat C-3415



**\$12⁵⁰
ea**

**BNC
to
BNC
Cable**

2 metres quality 75 ohm coax fitted with BNC plugs at each end. Suits many of the VCR's available. Why make one and risk shorts when it's already done for you? Cat W-1285

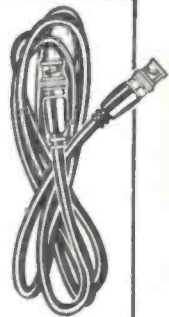

\$6⁹⁵
5 up... \$5.95

DICK SMITH Electronics
See page 16 for full address details.





Electronics & Semiconductor Distributors Pty. Ltd.

Unit 4, Cnr. Barrie Road & Adina Court, Tullamarine, Vic. 3043.
P.O. Box 144, Tullamarine, Vic. 3043. Phone: 338 8033. Telex: AA 36833.

Protect Your System from Transient Voltages

Today's complicated and expensive computer equipment employs Large Scale Integration and sophisticated MOS Microprocessors and Memory. A large percentage of failures of this equipment can be directly attributed to the damaging effects of over-voltage transients induced on AC power and data lines - which destroy these sensitive devices. Momentary loss of data, loss of memory, erroneous read-outs or print-outs, complete card or disc failure - are the direct result of these insidious over-voltage transients induced on unprotected power and data lines. These costly transient-induced failures may be immediately obvious or be such that equipment failure may occur over a prolonged period of time due to slow device degradation. Suitable protection must be provided to eliminate these costly and time consuming problems.



CPP 42 Computer Peripheral Protector Cable Assembly - Provides secondary protection to EIA STD RS-232C interconnected peripheral equipment at remote locations more than 10 metres from computer mainframe or CPU. Protects against transients caused by induced lightning, electrostatic discharge or by inductive coupling between data lines. Should be used in conjunction with CPE 80 Enclosure and CDP 42 Data Line Protector Boards.

 **General Semiconductor Industries, Inc.**



CPE 80 Enclosure - Provides a wiring interface between mainframe or CPU and interconnected peripheral equipment. Houses up to eight plug-in CDP 42 Computer Data Line Protector Boards.



CDP 42 Computer Data Line Protector Board - Previous primary transient voltage protection for EIA STD RS-232C operating interface. Plugs into CPE 80 Enclosure - or can be used with CDC 42 Connector for hard-wire application. Each board protects 4 wires per data line. Protects against transients on data lines generated from induced lightning and electrostatic discharge.



120 6K6 Transient Voltage Protector - Provides 120VAC primary power-line transient protection against induced power-line lightning transients, inductive line transients and EMI/RFI noise. Used for all 120VAC operated equipment. UL Listed to 1449 for Transient Voltage Surge Suppressors.

CDC 42 Connector - Used with CDP 42 Computer Data Line Protector Board for stand-alone, hard-wire applications

IBM SIGNS AGREEMENT WITH THE JOINT MICROELECTRONICS RESEARCH CENTRE

Australia at the forefront of research in microchip technology. Never! So why has the Very Large Scale Blue Giant (IBM) just signed an agreement, worth around \$1 million, with the Joint Microelectronics Research Centre?

According to Mr Brian Finn, Managing Director of IBM Australia, the basic reason why IBM entered the agreement with the Centre was the company's belief that it should contribute to the communities in which it does business.

"We believe this Centre can help Australian industry through improved microelectronic design skills and by innovative processes and techniques," said Mr Finn.

The agreement means that the JMRC will receive scholarships, personnel exchanges and laboratory and computer equipment over the next four years.

There will be two post-graduate research scholarships awarded each year over the duration of the agreement. The winners will work at the JMRC.

Personnel exchanges will be long and short-term between researchers at the JMRC and IBM scientists at IBM's Yorktown Heights Watson Laboratory. Yorktown Heights is IBM's leading research laboratory and is one of the most highly respected microelectronics laboratories in the world.

The equipment that will be provided by IBM is surplus to its needs but will be valuable in a research role at the Centre. According to the Director of the JMRC, the IBM agreement will mean a 30% increase in research at the Centre. The grant will help the Centre continue and expand its work in areas such as the design and fabrication of electronic chips, research into improved microelectronic materials and processes and the development of better and cheaper solar cells.

Some of the first pieces of equipment, an ultra-high vacuum system and a vacuum furnace to be used in chip devel-

opment, are now being shipped from Yorktown.

The Joint Microelectronics Research Centre is an establishment based in the University of New South Wales and the Royal Melbourne Institute of Technology. Its research program has brought its considerable international recognition. It has resulted in several important contributions to the science of microelectronics.

Some of the more significant contributions have been:

- The creation of the most efficient solar cells in the world. JMRC cells convert 19% of sunlight into electricity. The average cell costs about \$3 and would require about 5 square metres to power a heater. An epilogue to the dam issue in Tasmania is that if solar cells had been used they would have covered only a fifth of the area of the dam. This is taking into account the prevailing light conditions in Tasmania — marginal.
- The development of a transistor with two-and-a-half times more amplification than any other. Amplification is 25 000 times as opposed to 10 000.
- The discovery that the silicon used in electronic chips can be 'doped' more heavily than was thought possible. This boosts the electrical activity of the silicon and could lead to better and smaller chips.
- The development of a technique to dramatically improve the adhesion of thin metallic films to almost all materials. The process, called 'stitching', has wide application both in the microelectronics industry and in most areas using coating technology.
- Work on a method which enables people without any design experience to design a chip with the aid of a computer. The

Centre intends to use one of the two IBM XT Personal Computers being donated by IBM to assess whether a widely available microcomputer can be used for designing chips.

The IBM announcement was a real gala event. There were wall to wall professors, charcoal spray bespattered the front row and there were even the Minister for Science and Technology, the Honourable Barry Jones, MP. Many of the comments made are well worth reporting for their perception of the future of electronics in Australia and its affect on the economy as a whole.

Professor Graham Rigby pointed out that the key to making information technology work is microelectronics. "The limits and possibilities of the future lie in what we can do with chips," he said.

"But we must be in control of what happens. All the major companies are designing their own chips and are involved in research. Therefore, we must develop these skills. This can be done through first rate research, participation in world research and finding out what happens in a chip and improving its design. This grant helps us to form links and spreads the use of design tools."

The Honourable Barry Jones MP spoke of his visit to the United States when he went to the Yorktown Heights Lab.

"They do not make an arbitrary distinction between pure research and application research. If you asked them what was the economic relevance of what they were doing they couldn't tell you. They are dealing with long term possibilities, not short term perceptions of what they think is happening," he said.

Barry Jones portrayed Australia's approach to development of technology as a derivative approach born out of a parochial McEwenism. It meant you got on a plane and went overseas to secure the rights to sell the latest machine. He pointed out several areas where Australia had to improve to compete. "We need to raise our skill base, bridge academic and industrial communication, switch from low value-added to high value-added products, develop stronger and more appropriate infrastructures, develop appropriate marketing schemes through collaborative efforts such as the JMRC and IBM and overcome regional problems of over-specialisation," he said.

In concluding, Barry Jones quoted Lenin's view of industrial power. "The central question is who, whom." Who does what to whom. In thanking IBM and congratulating the JMRC he said that he hoped the agreement would not benefit one but benefit all.

DEATH OF ELECTRONICS INSTRUMENTATION PIONEER

Elmeasco Instruments Pty Ltd, the exclusive Australian representative for the John Fluke Manufacturing Co. Inc. since 1967, has been advised of the death of Mr John Fluke Snr, Founder and Chairman of the Board of that company.

Since its humble beginnings in

the basement of John Fluke's home in 1948, the company has grown under his guidance into an international organisation.

Senior management of John Fluke Manufacturing Co. have advised that the company would continue to operate on the basis of values and philosophies instilled by John Fluke.

EXPANDABLE COURSES

The Australian School of Electronics is offering an expandable training system in high technology electronics, known as the Master Builder.

Designed as a two stage trainer, stage one is a complete 'basic lab' unit with five power supplies, dual patching boards and multi-use support devices. There are seven basic 'Component Courses' that include manuals with related theory, experiments and procedures, and a components kit that contains all required components for circuit construction with emphasis on 'hands-on' training to validate circuit principles and equations.

In stage two, as the subject and circuit system become increasingly more complex, insertable, prewired panels replaced built-in circuits. These 'Insertion Panel Courses' cover instrumentation, transducers, antennas/transmission lines, microwave links, voice synthesis, biomedical instrumentation, computer and controls interface and digital/telephone communications. Included are panels and manuals.

For information on these courses contact the Australian School of Electronics, P.O. Box 108, Glen Iris, Victoria 3146. (03)523-5622.

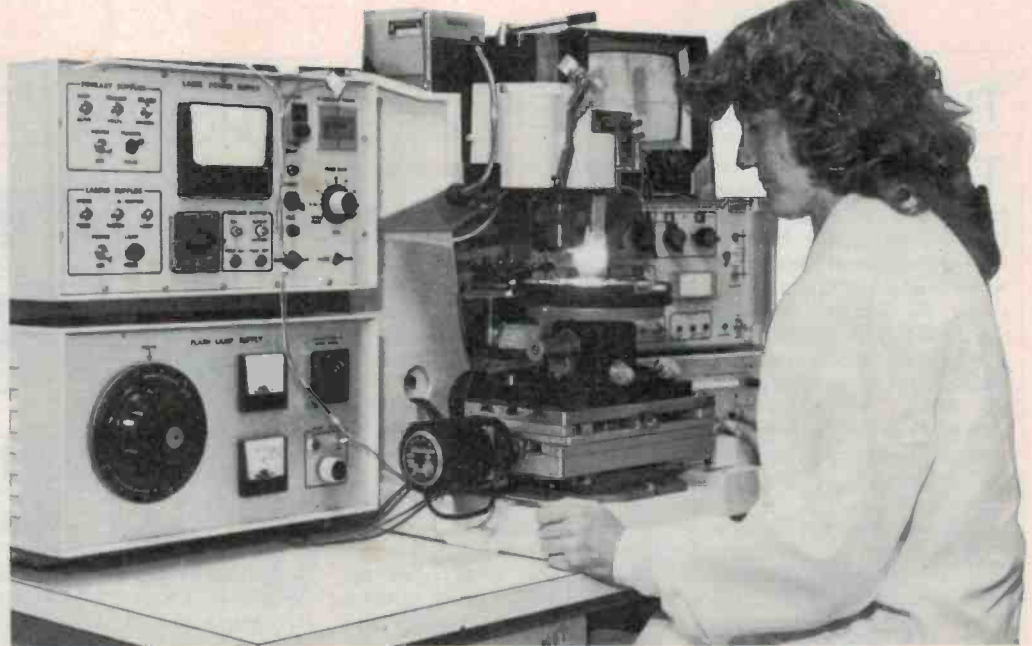

FIRST WOMAN APPRENTICE OF THE YEAR

Ms Karen Lines, 21, recently named Australian Apprentice of the Year for 1983, is now on a nine-month working study tour of Britain.

Ms Lines, from Seaview Downs in South Australia, completed a four-year radio tradesman apprenticeship at the Defence Science and Technology Organisation's Advanced Engineering Laboratory at Salisbury, near Adelaide. She is the first woman and Commonwealth employee to win the

national title and continues South Australia's unbroken success in winning the national award in the four years since its inception.

The Adelaide Junior Chamber of Commerce (JAYCEES) sponsors the overseas visit as part of the Lawrie Brownell Scholarship awarded to Ms Lines for being chosen as the SA Apprentice of the Year. The Australian Award first prize is a gold medallion and \$3000 in cash.

Concurrently with her apprenticeship, she is studying for an Associate Diploma in Electronics and hopes ultimately to gain professional engineering qualifications.

QLD SHOW

Electronic enthusiasts will be able to explore the latest advances in technology at Queensland's first Consumer Electrical Show at the Crest International Hotel, Brisbane, during May 10-13.

The Show will cover the gamut of home electrical products with an emphasis on entertainment electronics such as hi-fi, video and home computers.

Products most likely to attract interest include the video laser disc from Pioneer, Betamovie from Sony and Toshiba, compact disc players, as well as a diverse selection of home computers.

Brisbane radio station, Radio Ten, will be using the show as a launching pad for AM-Stereo in Queensland with continuous demonstrations of the new format.

For further information contact Robert Woodland Exhibitions, 50 Sherbrooke Rd, Acacia Ridge, Brisbane Qld. 4110. (07)372-3380.



DICK SMITH IN PAPATOETOE, NZ

As a convenience to customers who live in the Southern Suburbs of Auckland, the retailing centre of Papatoetoe has become the site for the latest Dick Smith Electronics store.

Now Papatoetoe's electronics

enthusiasts (and enthusiastic beginners as well) will have, at their doorstep everything from components to kits, home computers, telephone products, car sound systems, books on all facets of electronics, etc.

Located at 26 East Tamaki Road, Papatoetoe, the phone number is 278-2355. Previous manager of Dick Smith's Avondale store, Richard Row has been transferred to Papatoetoe.

THE NEW COMPUTER CURSOR DRIVER

The LOGO language came with a 'turtle' cursor, driven by keys on the computer keyboard, then Apple's Lisa came with a mechanical 'mouse' that, when driven across the desktop, drove the cursor across the screen in a similar fashion.

While the turtle cursor was graphic and appealing, you had to 'drive it blind' with orthogonally located keys — somewhat unnatural, or by typing commands — slow and cumbersome.

Apple's mouse was hailed as a great leap forward. Well, more of a roll, actually. The mouse has a little ball beneath it (only one) in contact with whatever surface it's placed on. Moving the mouse rolls the ball which activates internal circuitry that sends pulses via the mouse's tail to the computer so that the

software moves the on-screen cursor.

The mouse is great for those with good fine motor co-ordination, but for the other 90% of the population (and the original 10% after lunch) it's tedious as the user feels 'unconnected' with the cursor which never quite goes where you intended.

But, Creative Compost Artists have solved the problem! On April 1 they released *The Tortoise*. This cursor driver has no balls so won't run foul of litter on your average desk top. It has four feet to sense direction and is significantly slower than the mouse, giving you time to place your cursor with dignity and without premature overlocation. However, like the mouse, it does not work upside down. Available from all pest shops and reptile stores.

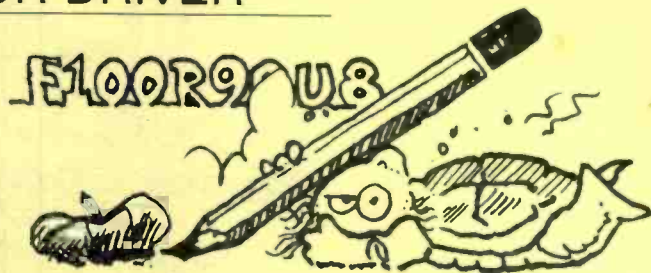

MEDIA MAGNATE MOPS UP MAGNETIC MEDIA

Multinational media magnate Mr R. ('Riptop') Murdock has purchased a controlling share in all of the world's leading chemical companies manufacturing magnetic media.

"When I bought out all the world's leading newspapers I got caught by those bushell-brained bastards who made the paper I printed my pulchritudinous propaganda on," he said.

"I ain't gonna be caught the

same way now so I'm moving into electronic media publishing," Mr Murdock said, "Nobody's gonna dickey round with my data domains before or after I've formatted the folios."

Chief executive of his newly created electronic media division, Mr G. Orwell from Cornwall UK, said through an intermediary, "My lips are sealed." I guess we take that as a 'no comment'.

GLOSSARY OF ELECTRONIC TERMS

Have you ever been a WOM? How about a CRO? Do you find the jargon used in electronics confusing?

ETI, at enormous expense (well actually no cost at all, but who's counting), present in their souvenir 13th birthday issue an informative, but concise glossary of terms for all beginners into electronics. At last, all the secrets kept from text books will be revealed.

Diode and Cathode Circuit	two members of the Ode family — Dianne and Cathy. Lady Cult's husband.
Coil	contraceptive device.
CRO	a girl I once knew.
555 timer	half of a 556 timer.
556 timer	two 555 timers.
Fission Chips	nuclear powered integrated circuits used to reduce hunger.
Henry	man's name.
Hertz	result of grabbing a soldering iron by the wrong end.
I.C.	present tense for I saw.
LED	three unrelated letters selected from the alphabet to lengthen this glossary and to waste more of your valuable time in reading the long and boring description.
Micro	short for 'my oscilloscope'.
Microfiche	baby fish.
Microphone	baby phones.
Microfarad	baby farads (strange tube-like creatures).
Open Circuit	a phrase which opens doors — like Open Sesame.
Pot	vessel kept under the bed.
Push Button	opposite of pull button.
Resistor	one who resists.
RAM	male sheep.
WOM	Write-Only-Memory: unidirectional data storage medium, better known as "students".
Semiconductor	person who collects fares from hitch-hikers on semi-trailers.
Tri-state	the third logic state. A logic gate can be in one of three states — 0, 1 or stuffed.
Woofler	a dog.
Tweeter	a canary.
Squawker	a baby.
Wocks	not really an electrical term but are used to kill wabbits.

by Peter Ihnat B.E., B.Sc.

NEW VOLTAGE STANDARD PROPOSED BY I.S.A.

The International Standards Association (I.S.A.) at its recent conference in Hobart, proposed a revision of voltage standards to bring them into line with recognized standards of resistance, capacitance and inductance.

For the past several years all measurements of these values have been expressed as a standard progression of numbers, ie: 1, 1.2, 1.5, 1.8, 2.2, ... This restriction of possible values has resulted in considerable economies to manufacturers because they now have to produce only a few types of units, instead of many.

According to the Association, restriction of voltages to standard values would result in further economies. The standard unit volt would remain the same; defined as the amount of electromotive force required to cause a current of one ampere to flow through one Ohm. It is only voltage quantities that would be restricted.

Industry sources say the new restrictions will require some minor changes to existing standards. For instance, Australia's domestic mains voltage of 240 will have to be changed to 220 to conform to the new system.

Integrated circuit manufacturers will need to redesign some of their logic series, particularly TTL, to operate on a voltage of 4.7 or 5.6 instead of the present 5 volts. It's anticipated the changes will be practically painless, much like the recent metric conversion.

The Association plans to introduce the changes on a voluntary basis from mid-1984. From 1990 onwards use of the new voltage standards will become compulsory, with heavy penalties being levied on manufacturers who supply devices operating on non-standard voltages.

Report from our Earwitness News Correspondent, on the spot in Hobart, Tom Moffat).

SCOPE

SPECIALISED TOOLS TO SUIT YOUR JOB

AUTOMATIC TEMP CONTROL PORTABLE SOLDERING STATION

- CMOS PROTECTION - FULLY EARTHED
- FAST 45 SEC. HEATING - 60W BACK UP
- $\pm 2\%$ TEMP CONTROL 200° - 400° C

Model T060
240v Iron

Model STS 2
Safety Stand & Sponge

NON TEMP CONTROL PRODUCTION QUALITY 20W IRON

NEW

Model PH20
240V Iron 370°C

- COMFORTABLE AIR COOLED FINGER GRIP
- CMOS PROTECTION - FULLY EARTHED
- LONG LIFE IRON PLATED TIP RANGE

Model STS2
Safety Stand & Sponge

SELF CLEAN TIP - METAL BODY

- CRUSH PROOF METAL BODY
- TIP SELF CLEANS EVERY CYCLE
- NEOPRENE "O" RING FOR ACCURATE SEAL

Model SR
Solder Remover

NEW MANUAL TEMP. CONTROL ADJUSTABLE 10W → 70W SOLDERING SYSTEM

- YOUR FINGER ADJUSTS WATTAGE & TEMP. 200° → 500° C
- MULTI PURPOSE ADJUSTABLE SERVICE IRON
- FAST 5 SEC HEAT FOR MAINTENANCE & REPAIR WORK

Model MS
4V Iron

Model PSU
240V-4V Power Supply Unit

NEW DISPENSER KEEPS FINGERS COOL

- POSITIONS BRAID MORE ACCURATELY
- REDUCED RISK OF BURNT FINGERS
- DISPENSER WINDS BACK SURPLUS BRAID
- 2 METRE PACK - HOLDS 30% MORE

Model SB3

Model SN
Replacement Nozzle

Model 333

BUILT LIKE PLIERS - FINE LIKE TWEEZERS

- THIN PROFILE 25mm RIGID JAWS
- SERRATED JAWS
- CUSHION PVC GRIP

Model 378

FASTER LOADING - FIRMER LOCKING

- SPRING LOADED ARMS SAVE LOADING TIME
- LOCKS FIRMLY IN 32 POSITIONS
- ACCEPTS SINGLE OR MULTIPLE BOARDS

FLUSH TYPE PCB SIDE CUTTERS RADICAL SCISSOR ACTION

- SAFETY 'OFFCUT' CATCHER OPTION
- SMALL NARROW BLADES FOR TIGHT CORNERS
- SCISSOR ACTION REDUCES CUTTING EFFORT

Model 175-1



SCOPE
(03) 338 1566

SEND FOR FREE CATALOGUE

For a
FREE CATALOGUE

send your name
and address to :

**FREEPOST No. 2
SCOPE LABORATORIES
P.O. BOX 63
NIDDRIE, VIC., 3042**

NO STAMP REQUIRED



BASIC COMMANDS

FORWARD (↑) 6 ●

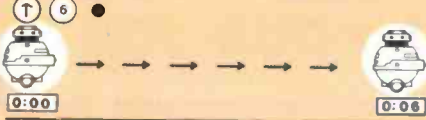

REVERSE (↓) 3 ●

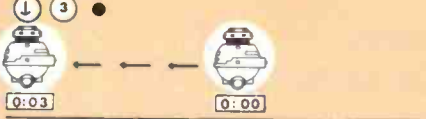

TURN LEFT (←) 9 ●



TURN RIGHT (→) 9 ●



CURVE RIGHT (↷) 9 ●



CURVE LEFT (↶) 9 ●



THIRD GEAR (⏏) 3 (↑) 4 ●



SECOND GEAR (⏏) 2 (↑) 4 ●



FIRST GEAR (⏏) 1 (↑) 4 ●



STOP (●) 3 ● 5 (↑) 2 ●



CLEAR LAST COMMAND (⊘) 3 (←) 6 ● = (↑) 3 ●



AUDIO (🔊) 1 (🔊) 5 (🔊) 3 (🔊) ●



MULTIPLY (↑) 2 (x) 3 ●



RECOLLECT (↑) 3 (⏏) ●



(↑) 3 (↷) 2 (⏏) ●



Above: Curses — a mouse! (As opposed to: Cursors! — a mouse). Inset, centre. View of the keyboard atop the Compurobot's head. Left and below. Keyboard commands and programming examples. Looks like fun!

CLEAR ALL MEMORY (○)

DEMONSTRATION (★)

COMBINATION

EXAMPLES: (⏏) 3 (↑) 2 (↓) 2 (↑) 1 (⏏) 1 (↷) 2 (→) 9 ●

0:00 ————— 0:02
0:04 ————— 0:05

0:07

ON (🔊) 2 (🔊) 2 (🔊) 1 (🔊) 2 (🔊) 2 ●

OFF (🔊) 3 (🔊) 3 (🔊) 2 (🔊) 2 ●

))))))))) (STOP)

0:00 ————— 0:15

STEEPLE CHASE (a FUN way to learn PROGRAMMING)

Low cost programmable robot has potential as a teaching tool

Roger Harrison

Teaching logic and programming concepts through computing and robotics is now an established 'methodology' in education, seen as particularly necessary with the rapid advance of high technology in our society. But the cost has always been an inhibiting factor. This newly released programmable 'toy' robot from Dick Smith Electronics might just change that.

UP UNTIL NOW, many schools have not been able to teach elementary computing and robotics concepts because of the cost of the equipment needed. Generally it has been necessary to have a 'personal' level microcomputer, a basic robot unit such as a 'turtle' or manipulator arm, an interface to connect the two together, and suitable software (such as the LOGO language). In most cases these items add up to well over \$1000, making it very difficult for a school to buy enough systems to provide pupils with any direct 'hands-on' experience.

The Dick Smith organisation hope their "Compurobot", just released, will change all that, just as low cost computers brought about a rapid rise in the use of computers as an educational tool. Priced at \$59.00 retail and providing all the fundamental features of an expensive teaching system, it seems their hopes may well be realised.

Micro drive

The Compurobot is fully self-contained, powered by batteries. It features an in-built microprocessor controller, all the robot's functions being programmed via a small keyboard located atop its head.

Traction and steering is provided by dual motors which drive rubber-tyred wheels. A built-in speaker and light, operated under control of the internal microcomputer, allow the robot to produce a variety of 'bleeps', 'buzzes' (a la R2D2) and light effects while it trundles around a pre-programmed course. Seems as if you could have a lot of fun while learning with this 'beast'!

The key to it

The 25-key programming is quite simple to use, being almost self-explanatory. To

make the robot move forward for five seconds, for example, you simply press the 'forward arrow' key followed by the '5' key. You can select three 'gears'. The lowest is selected automatically by the robot when it is turned on. To program for the second or third gears you simply press the 'gear change' key followed by either the '2' key (for second) or the '3' key (for third).

There are keys to program 'forward' or 'reverse', travel, as well as 'left' and 'right' plus 'curve left' and 'curve right'. In addition, it can be programmed to pause and make a sound — each for a programmed interval. Compurobot can also be programmed to *retrace* its steps, back to where it started.

Calculating demon

For just a little extra 'smartness', the Compurobot can be programmed to multiply two figures together to get the time-multiplier for a particular program step (i.e. 'forward' $\times \frac{1}{2}$ or $\times 3$ gives "forward 6").

You can have up to 28 steps in a program, which gives the Compurobot a very large repertoire in program possibilities, indeed. If you need any inspiration in working out programs there are two demonstration programs available at the push of a key. Just press one or other of the two 'demo' keys, and away it goes!

The plastic body of Compurobot stands 167 mm high and is 135 mm wide. It requires four AA penlite cells and a standard transistor radio 9 V (No. 216) battery to power it — thus, it is completely safe for children.

The Compurobot (D.S.E. catalogue no. Y-2000) will be available from Dick Smith Electronics stores and many dealers from this month.

POWER **PS** SONIC

AUSTRALIA
INCORPORATED IN N.S.W.

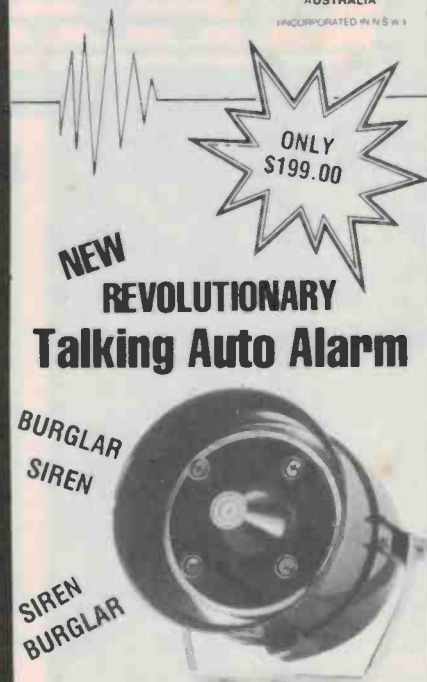

(WORLD'S FIRST VOICED SYNTHESISED SYSTEM)

U.S. & WORLD-WIDE PATENT PENDING

POWERFUL: 120DB!
COMPACT: ONLY 4" x 5"
MODEL: A-1000

- PROTECTS HOOD
- PROTECTS TRUNK
- PROTECTS DOORS

FEATURES:

- Keyless • Automatic arming
- Automatic reset • Easily installed
- custom designed microprocessor
- self contained • detects any small voltage change • tamper proof • exit and entry delay • weather resistant.

NAME
ADDRESS
POSTCODE

Bankcard Payment
BANKCARD NO.

.....

Card Expiry Date

SIGNATURE DATE

POWER **PS** SONIC

Shop 43, 61-89 Buckingham St.,
Surry Hills NSW 2010
Tel (02) 699 2722
Telex 75015

CHALLENGER

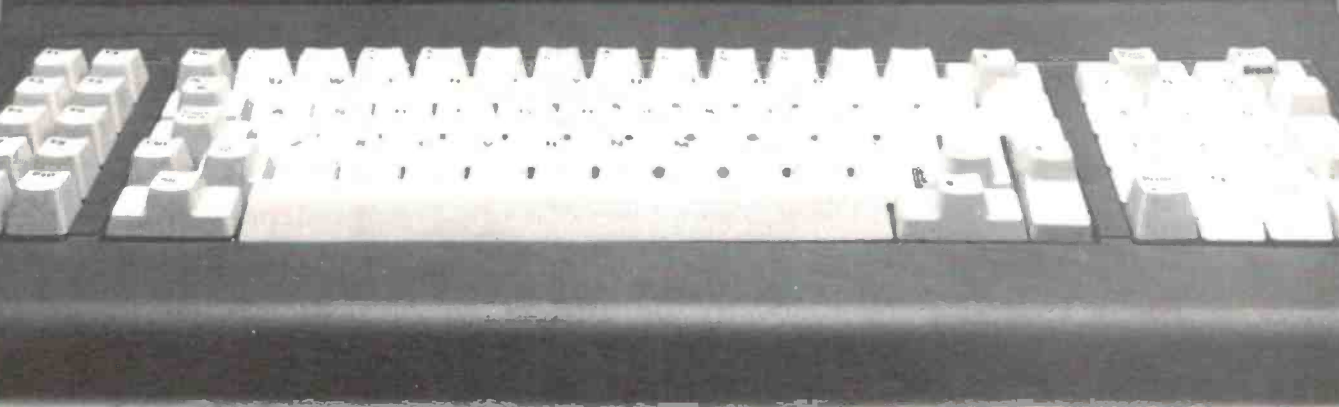
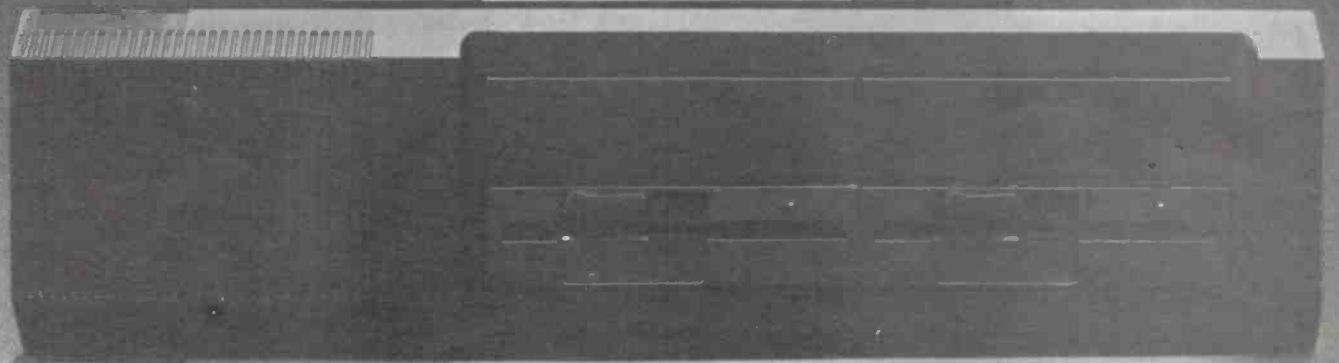
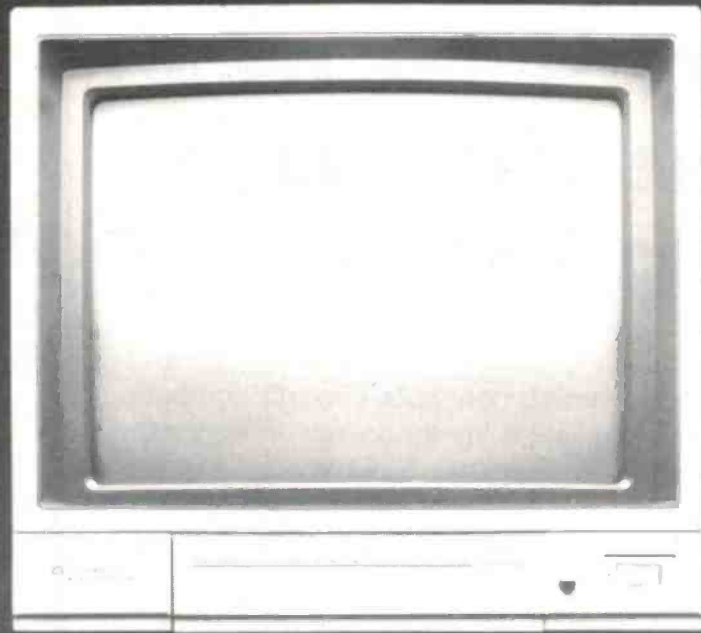

More computer for half the price!

If you're really serious about computing, you're probably looking at the IBM PC. It's a superb computer - but look at the price: way over \$6000 for a usable system, and then you have to start buying programs!

Now there's a brilliant, compatible alternative: the Dick Smith Challenger. For less than half the price of an IBM PC, it gives you much more computer. With Challenger you get 128K bytes of RAM memory, for example - not just 64K. And on the expanded machine you also get both Centronics and RS-232C serial ports as standard (IBM charges you extra for both).

And the quality is guaranteed! Each Dick Smith Challenger is individually 100% computer tested and comes complete with its own test result, confirming that it meets, or exceeds, all specifications.

Is it really IBM compatible?

Compatibility is a tricky business; some software made for the IBM PC won't even work on certain configurations of the PC itself.

The Challenger is about as compatible with the IBM PC as you can get. This means it can run just about all of the huge range of software written for the PC - just pop in the disk or cassette, load and go!

Quality - PLUS!

Apart from being manufactured in an automated factory with the consistency of quality that entails, every Dick Smith Challenger undergoes rigorous and thorough automated testing - and comes with its own test certificate! So the quality and reliability are outstanding.

Challenger total system only

\$2990

Monitor not included - shown is our optional high resolution green screen monitor. Cat X-1220 only \$249.

Keyboard slips inside case for storage!

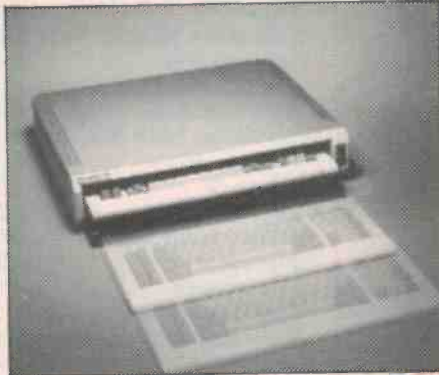

System Unit

This is the basic computer, which can be used by itself for hobby computing. It offers much more than other machines - at a very attractive price!

Specifications:
CPU: 8086 full 16-bit processor running at 4.77MHz
RAM: 128K internally expandable to 256K, 16K video RAM.
ROM: 64K including Microsoft GW BASIC, diagnostics, cassette operating system.
KEYBOARD: Separate unit with 84 keys including numeric/cursor control group, 10 function keys.
CHARACTER SET: 256 expanded ASCII, in ROM.
RESOLUTION: 320 x 200 or 640 x 200.
COLOUR GRAPHICS: 8 colours with scroll, reverse, blinking.
INPUT/OUTPUT: RF output for TV receiver; composite video and RGB outputs for video monitors; cassette I/O port; joystick port; light pen port; Centronics-type parallel printer port; inbuilt speaker.

Cat X-8600

\$995

The IBM PC with equivalent features would cost you at least \$1700 - if they'd sell you one!

YOU SAVE OVER \$700!!



Expansion Unit

Add this expansion unit, and the basic Challenger computer becomes more than equivalent to a fully expanded IBM PC - PLUS a complete set of disk software and manuals.

Specifications:
DISK DRIVES: Twin slimline, double sided double density, total storage capacity 720K bytes.
INPUT/OUTPUT: RS-232C serial communications port.
EXPANSION: Three IBM PC compatible expansion slots, two true 16-bit expansion slots.
SOFTWARE INCLUDED: Microsoft MS-DOS and GW Disk BASIC, Perfect Writer, Perfect Calc, Perfect Filer, PLUS user manuals. Cat X-8610

ONLY **\$1995** extra

An IBM PC expanded to this level would cost you well over \$7000
 Yet the expanded Challenger costs only \$2990.

YOU SAVE OVER \$4000!!



PLUS software worth over **\$1800 - Free!**

That's right - with the Challenger Expansion Unit, we give you a set of software and manuals worth over **EIGHTEEN HUNDRED DOLLARS**, absolutely **FREE!** With the IBM PC, it's all optional at extra cost!

We don't give you useless software, either. For most home and office computing you won't need anything else!

MICROSOFT MS-DOS, GW DISK BASIC - most widely used disk operating system and disk BASIC for the IBM PC itself. But with the IBM these cost you over \$60 extra!

PERFECT WRITER/SPELLER - one of the most popular word processing systems in the world. Worth at least \$790 alone!

PERFECT FILER - lets you design your own filing systems and mailing lists. Worth over \$675!

PERFECT CALC - the electronic spreadsheet to beat them all. Worth over \$330 as well!

DICK SMITH Electronics

See page 6 for full address details.

OUT NOW! 1984/5 CATALOGUE

Inside this issue you should, by now, have discovered every hobbyist's dream: the all-new, updated, latest, bright, shiny, up-to-the-minute Dick Smith Supercatalogue.

You'll have already discovered the fantastic new products for '84. You might even have seen the 32 pages of hobbyist data. And you would have found a large number of our low, low prices are actually lower, lower than 1983!

What's that? You haven't discovered any of these things yet?

Your copy is MISSING?

Shock, shock. Horror, horror. Panic, panic.

How can you possibly last the rest of 1984 without your new Dick Smith Catalogue? It's like lasting the rest of the year without eating?

Stop sobbing this minute! Fill out the coupon below. Enclose a dollar and we'll send you a copy of your very own! And we'll even include a coupon inside so you can get your dollar back!

(Your coupon can also be used at any Dick Smith Electronics store.)



**To: DICK SMITH Electronics
P.O. Box 321, North Ryde,
NSW, 2113.**

I urgently need a copy of your incredibly fantastic catalogue, as some light-fingered nard lifted the one that should have been included with my magazine purchase. I enclose payment of \$1 to cover costs.

Name

Address

.....

..... P/code

STORE LOCATIONS

NSW	Cnr. Swift & Young Sts. Parramatta Rd & Melton St T55 Terrace Level 613 Princes Hwy Oxford & Adelaide Sts 531 Pittwater Rd 147 Hume Hwy 162 Pacific Hwy 315 Mann St 4 Florence St Elizabeth Dr & Bathurst St 173 Maitland Rd Lane Cove & Waterloo Rds George & Smith Sts The Gateway, High & Henry Sts 818 George St 6 Bridge St 125 York St Tamworth Acde & Kable Ave 263 Keira St	ALBURY 21 8399 AUBURN 648 0558 BANKSTOWN SQ 707 4888 BLAKEHURST 546 7744 BONDI JCT 387 1444 BROOKVALE 93 0441 CHULLORA 642 8922 GDRE HILL 439 5311 GOSFORD 25 0235 HORNSBY 477 6633 LIVERPOOL 600 9888 NEWCASTLE 61 1896 NORTH RYDE 88 3855 PARRAMATTA 689 2188 PENRITH 32 3400 RAILWAY SQ 211 3777 SYDNEY 27 5051 SYDNEY 267 9111 TAMWORTH 66 1961 WOLLONGONG 28 3800 FYSHWICK 80 4944 BALLARAT 31 5433 BRIGHTON (EAST) 592 2677 COBURG 383 4455 FRANKSTON 783 9144 GEELONG 78 6786 MELBOURNE 67 9834 RICHMOND 428 1614 SPRINGVALE 547 0522 BRISBANE 229 9377 BURANDA 391 6233 CHERMSIDE 359 6255 SOUTHPORT 32 9863 TOOWOOMBA 38 4300 TOWNSVILLE 72 5722	ACT VIC QLD SA WA TAS NT	96 Gladstone St Creswick Rd & Webster St Cnr Hawthorn Rd & Nepean Hwy 260 Sydney Rd Nepean Hwy & Ross Smith Ave 205 Melbourne Rd 399 Lonsdale St Bridge Rd & The Boulevard Springvale & Dandenong Rds 293 Adelaide St 166 Logan Rd Gympie & Hamilton Rds Cnr Gold Coast Hwy & Welch St Bowen & Ruthven Sts Ingham Rd & Cowley St. West End Wright & Market Sts Main South & Flagstaff Rds Main North Rd & Darlington St Wharf St & Albany Hwy William St & Robinson Ave Centreway Acde, Hay St 25 Barrack St 17 Stuart Hwy	ADELAIDE 212 1962 DARLINGTON 298 8977 ENFIELD 260 6088 CANNINGTON 451 8666 PERTH 328 6944 PERTH 321 4357 HOBART 31 0800 STUART PARK TBA
------------	--	--	---	--	--

STORE HOURS

All Dick Smith stores are open for trading during the normal trading hours for their particular area (either 9-5.30 or 8.30-5). Many stores are also open for late night trading. Please ring the store concerned for their particular hours.



SPEEDY PHONE/ BANKCARD ORDER SERVICE

Just phone your order and Bankcard details - it's so simple!
(02) 888 2105

Orders only on this number.
Enquiries: (02) 888 3200

HEAD OFFICE & MAIL ORDER CENTER:

P.O. Box 321 Nth Ryde
NSW 2113.
Tel: (02) 888 3200

Post & Packing Charges

Order Value	Charge
\$5-\$9.99	\$2.00
\$10.00-\$24.99	\$3.50
\$25.00-\$49.99	\$4.50
\$50.00-\$99.99	\$6.00
\$100 or more	\$8.00

Terms available to
approved applicants
through...



Dear Customers,

Quite often, the products we advertise are so popular they run out within a few days. Or unforeseen circumstances might hold up shipments so that advertised lines are not in the stores by the time the advert appears. And very occasionally, an error might slip through our checks and appear in the advert (after all, we're human too!) Please don't blame the store manager or staff; they cannot solve a dock strike on the other side of the world, nor fix an error that's appeared in print. If you're about to drive across town to pick up an advertised line, why not play it safe and give them a call first... just in case!

Thanks.

Dick Smith Electronics

MAJOR RESELLERS

● **Atherton Qld:** Maarten's Music Centre, 55 Main St 91 1208 ● **Ballina NSW:** A. Cummings & Co., 91-93 River St 86 2285 ● **Bowral NSW:** Barry Gash Electronics, 370 Bong Bong St 61 2577 ● **Broken Hill NSW:** Hobbies & Electronics, 37 Oxide St 88 4098 ● **Bundaberg Qld:** P.M. Electronics Takalvan St 72 8272 ● **Cairns Qld:** Electronic World Shop 27 K-Mart, Westcourt Plaza, Mulgrave Rd. 51 8555 ● **Campbelltown NSW:** Fishers 'Chip' Shop, Shop 3, 274-276 Queen St. 27 1475 ● **Coffs Harbour NSW:** Coffs Harbour Electronics, 3 Coffs Plaza, Park Ave 52 5684 ● **Darwin NT:** Ventronics, 24-28 Cavanagh St 81 3491 ● **Deniliquin NSW:** Dem Electronics, 220 Cressy St 81 3672 ● **East Maitland NSW:** East Maitland Electronics 99 High St 33 7327 ● **Echuca Vic:** Webster Electronics 220 Packerham St ● **Gladstone Qld:** Purely Electronics Shop 2 Cnr Herbert & Auckland Sts 72 4321 ● **Goondiwindi Qld:** Border T.R.C. 50 Marshall St 71 2353 ● **Gosford NSW:** Tomorrow's Electronics & HiFi 68 William St 24 7246 ● **Inverell NSW:** Lyn Willing TV 22 A Evans St 22 1821 ● **Launceston Tas:** Advanced Electronics 5A The Quadrant 31 7075 ● **Lismore NSW:** Decro Electronics 3A/6-18 Carnington St 21 4137 ● **Mackay Qld:** Stevens Electronics 42 Victoria St 51 1723 ● **Maryborough Qld:** Keller Electronics 218 Adelaide St 21 4559 ● **Monwell Vic:** Monwell Electronics 95 George St 34 8133 ● **Mt Gambier SA:** Hutchesson's Comm. 5 Elizabeth St 25 6404 ● **Mildura Vic:** McWilliams Electronics 110A Langtree Ave 23 6410 ● **Port Macquarie NSW:** Horton Centre, Horton St 83 7440 ● **Nelson Bay NSW:** Oales Dynamics Cinema Mall Stockton St ● **Orange NSW:** M & W Electronics 173 Summer St 82 6491 ● **Port Lincoln S.A.:** Basshams T.V. & Computerworld 22 Liverpool St ● **Rockhampton Qld:** Purely Electronics 15 East St 21 058 ● **Shepparton Vic:** G.V. Electronics Centre 189B Cono St 21 8866 ● **Townsville Qld:** Tropical TV 49 Fulham Rd. Vincent Village 79 1421 ● **Wagga NSW:** Wagga Wholesale Electronics 89 Forsyth St ● **Whyalla SA:** Mellor Enterprises Shop 2 Forsyth St 45 4764

DICK SMITH Electronics



SCOPE PANAVISE

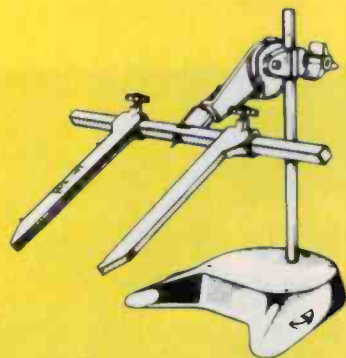
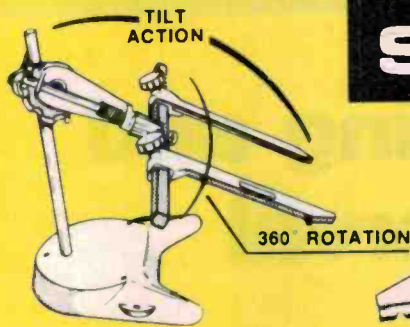

SCOPE
Model 333

NEW

INDEXING P.C.B. HOLDER LOCKS IN 32 POSITIONS

TILT AND TURN ACTION —

The New Panavise Model 333 rotates the P.C.B. and locks in any of 8 positions in 45° increments. It also Tilts and Locks at 4 angles — 0° (vertical) 45°, 90°, 120° and offers 200mm of vertical adjustment to the work height.

This design is for medium volume production of P.C. Boards and compliments the Model 315 P.C.B. Holder which is more suited to the service and repair workshop.

HEAVY BASE —

Heavy cast iron base is dedicated to this Model and provides excellent stability and has three mounting holes which permits permanent attachment to a work bench.

QUICK RELEASE ARMS —

Spring loaded arms hold boards securely, and provide rapid loading and removal of similar sized P.C.B.'s.

Cross bars are available to 750 (30") for working on large boards or multiple board work, using extra sets of arms.



(03) 338 1566

TELEX : 38318

FOR A FREE CATALOGUE

SEND YOUR NAME
AND ADDRESS TO :

FREEPOST No. 2
SCOPE LABORATORIES
P.O. BOX 63
NIDDRIE, VICTORIA, 3042
NO STAMP REQUIRED

Bandwidth, probing and precise time interval measurements

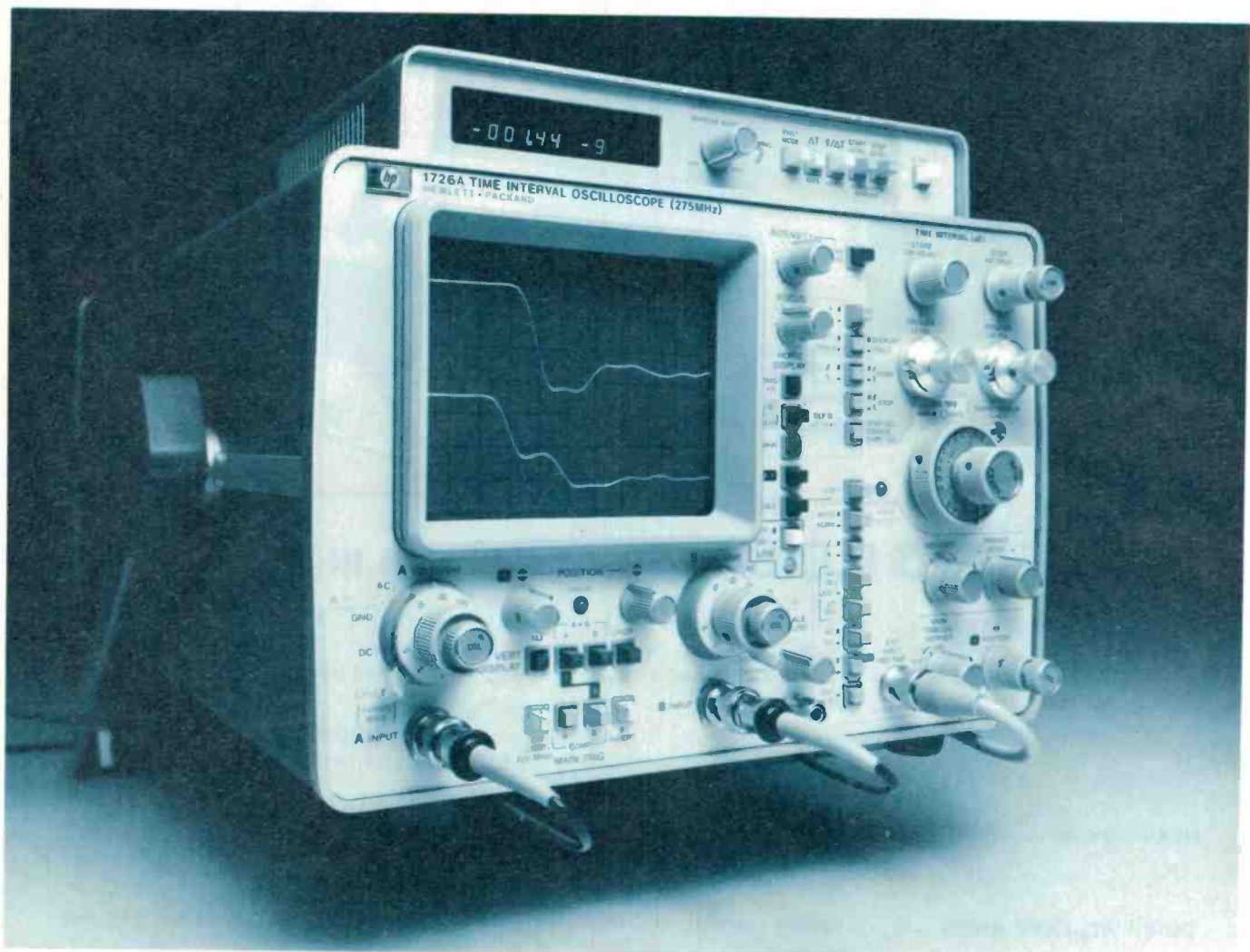

Although some oscilloscopes are designed to make precise timing measurements, such as HP's new 1726A Time Interval Oscilloscope, a system's bandwidth and the probing techniques used can reduce an oscilloscope's accuracy making timing measurements less precise than they could be. This article discusses how bandwidth and probing can cause errors when an oscilloscope is used to measure time intervals and what can be done to minimize these errors.

Michael C. Gasparian

Hewlett-Packard Company, Colorado USA.

A COMPREHENSIVE REVIEW of the variables affecting precision time interval measurements can be covered in three stages. The first step is to examine waveform distortions induced by probing or bandwidth limitations. Next, determine whether these distortions affect the measured time interval, and then discover whether measurement accuracy depends more on the time interval measurement technique or on the instrument's bandwidth.

Induced waveform distortions

Before any instrument can measure a time interval, the signal must first be accessed, usually by a probe, and then delivered to the instrument's measurement circuitry. However, a signal's fidelity can be degraded by the probing process and/or by the bandwidth limitations of the instrument before the signal even reaches the instrument's measurement circuitry.

Probing — a critical connection

The performance of a measurement system ultimately rests with the reliability and accuracy of its components. Although instrument specifications are usually considered to be extremely important, the probing system and its potential effects are often overlooked or ignored when evaluating performance. A poor probing system can degrade the performance of even the most sophisticated measurement system.

A poor probing system can degrade signal fidelity in a variety of ways. Resistive loading can attenuate pulse amplitude; excessive loading, resistive or capacitive, can change a circuit's operating point or stop circuit operation altogether; and continuous waveforms are attenuated as a function of a frequency-dependent loading equation. For precision time interval measurements in the picosecond region it is critical to understand how the source/probe input system can degrade rise time measurements and ultimately results in gross timing errors.

A basic model of a source/probe input system is outlined in Figure 1. Simplifying this model further, the source and probe resistances are combined in parallel forming an equivalent resistor that charges the input capacitance of the probe (Figure 2). The rise time (10%-90%) of this simple R-C network can be approximated by $2.2 R_{eq}C_p$. Rise times of source/probe input systems can be calculated using this formula. Table 1 provides some sample calculations.

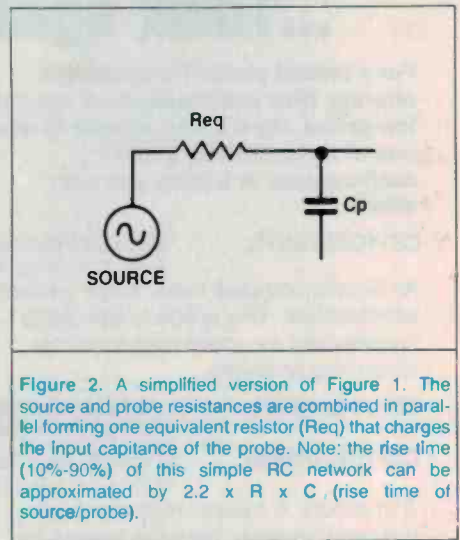
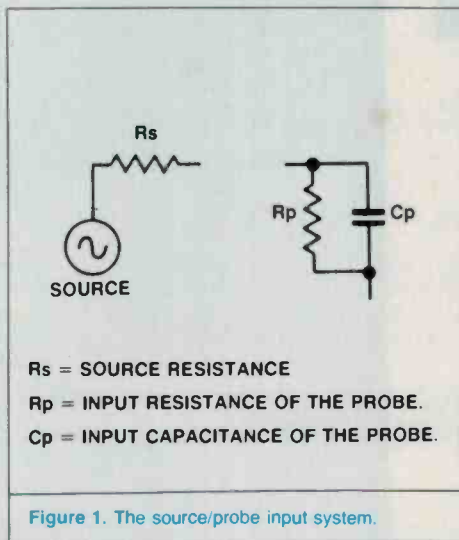

SOURCE/PROBE INPUT SYSTEM	PROBE INPUT R	PROBE INPUT C	R SOURCE	Req	2.2 RC
HP 10018A	1M	9.5 pF	50	49.99	1.05 ns
HP 10018A	1M	9.5 pF	500	514.73	10.8 ns
HP 10018A	1M	9.5 pF	2000	2015.92	42.1 ns
HP 10020A	2k5	0.7 pF	100	96.0	0.06 ns

TABLE 1.

The following example illustrates a practical application where the rise time of the source/probe input system can create a problem. A one nanosecond (1 ns) rise time signal with an amplitude of one volt (1 V) is probed at two different points in a system — check clock skewing. One point has a 50 ohm source impedance, and the other a

100 ohm source impedance. Using an HP 10018A miniature probe, Figure 3 shows how the source/probe input system distorts the rise time of the signal under two different conditions. Obviously, these time differences between waveforms translate directly into time interval measurement errors.

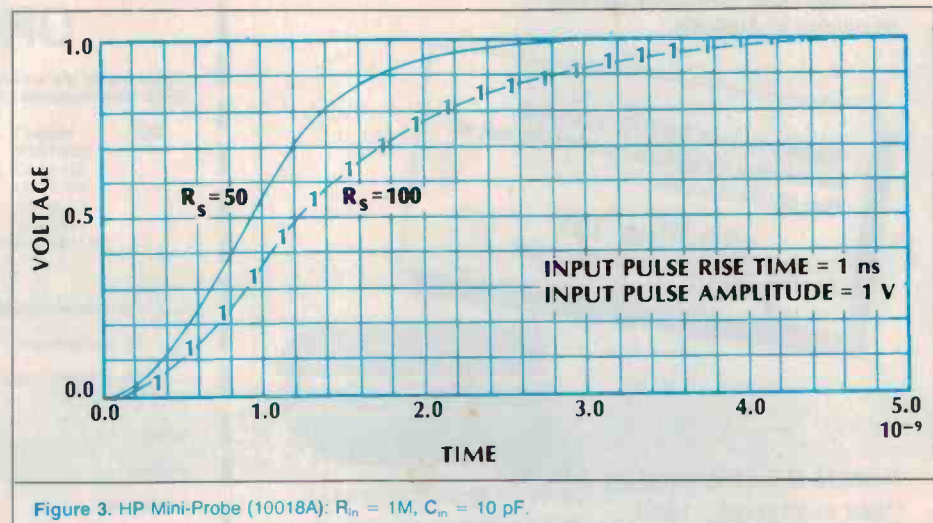

If you thought you couldn't afford the famous TRIO KENWOOD quality...

...Think again!

For a limited period Parameters is offering TRIO oscilloscopes at special low prices. Here's your chance to own one of these leading brand oscilloscopes at a price you can afford.

CS-1022 20MHz **\$649.00 Plus Tax**
 \$746.35 including tax

An economical dual trace scope packed with facilities. This scope is becoming the standard for routine work and for discerning amateurs.

CS-1040 40MHz **\$1175 Plus Tax**
 \$1351.25 including tax

CS-1060 60MHz **\$1495.00 Plus Tax**
 \$1719.25 including tax

3 channels, 6 traces. High bandwidth, high performance, portable scopes for communications and digital work. 1mV sensitivity — All new design.

CS-2075 70MHz **\$1995.00 Plus Tax**
 \$2294.25 including tax

A truly professional scope offering a 70MHz bandwidth and a thoroughly modern design at a very attractive price.

CS-2110 100MHz **\$2495.00 Plus Tax**
 \$2869.25 including tax

4 channels and 8 traces in our top of the line 100MHz scope. Offers all the sensitivity and bandwidth for practically any job.

Personal Buyers

Take advantage of our direct mail offer. If you are not completely satisfied with your oscilloscope return it to us, undamaged and in its original packaging, within 10 days for a complete refund.

* These prices all include delivery anywhere in Australia.

Probes Model 88100 100MHz switchable Greenpar probes to suit all the above scopes.

\$33 Plus Tax
\$39.60 including tax



PERFECTION IN MEASUREMENT

Sydney (02) 439 3288
Melbourne (03) 580 7444

Available at leading stockists.

* Valid to 31st July, 1984

PAR380

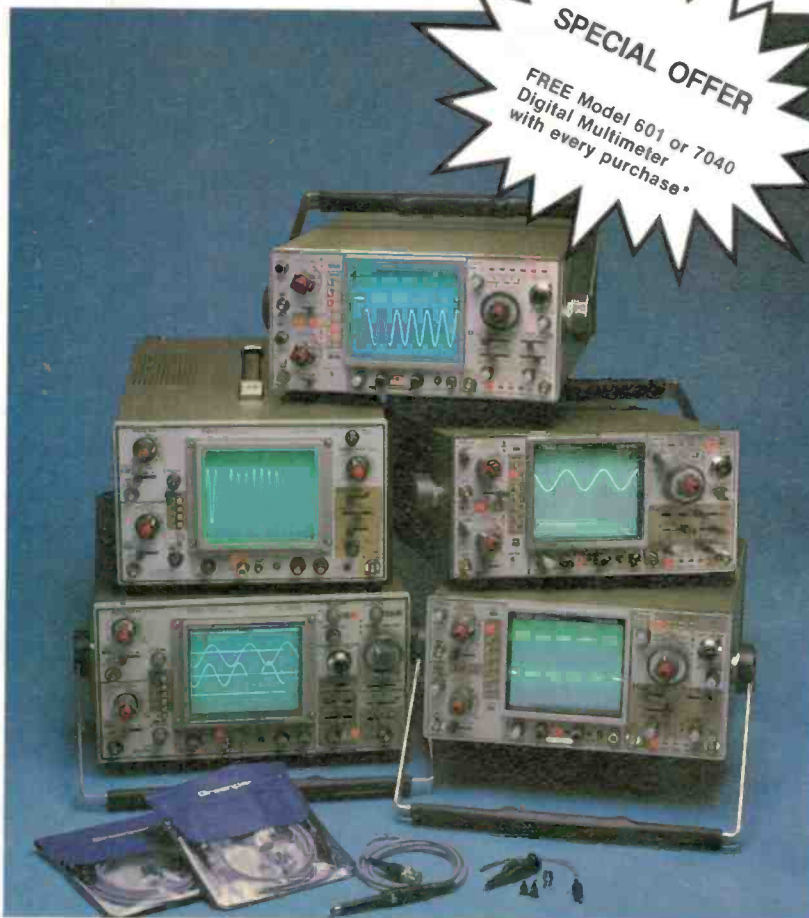

Company Purchasers

Either attach the coupon below to your purchase order and mail (credit facilities are available to current account customers). Or should you wish to arrange a demonstration please contact us direct.

Local Purchasers

We have set up a special demonstration area at our Sydney and Melbourne offices for your convenience. Come in any time and choose the model to suit your needs. Talk to our expert staff and get their free advice.

ORDER FORM

Please supply the following oscilloscope(s). I understand that I will receive a FREE digital multimeter with every scope purchased.

Qty.	Model	Price	Tax*	Amount
.....	CS-1022	\$649.00	\$97.35	
.....	CS-1040	\$1175.00	\$176.25	
.....	CS-1060	\$1495.00	\$224.25	
.....	CS-2075	\$1995.00	\$299.25	
.....	CS-2110	\$2495.00	\$374.25	
.....	88100 Probes	\$33.00	\$6.60	
			Total	_____

- My cheque is enclosed
- Bill my Bankcard** No.
- My company order is attached (credit terms available to current account customers only.).

Name:

Address:

SIGNATURE

** Bankcard purchasers must provide full street address (no P.O. Box numbers).
 *Delete if not applicable (sales tax number and office exemptions required).
 Detach and mail to Parameters Pty. Ltd., P.O. Box 573, Artamon, N.S.W. 2064.

To minimize the rise time degradation of the source/probe system in the example, the input capacitance and/or the equivalent resistance must be minimized. In Figure 4, a resistive divider probe, the HP 10020A, with a 10:1 division ratio, has been selected. It minimizes the input capacitance of the probe and eliminates most of the differential time interval measurement error.

Signal distortions and time interval measurement accuracy

The actual measurement application determines whether an instrument's rise time limitations affect time interval measurement accuracy. The following are several common measurement applications.

MEASUREMENTS BETWEEN "LIKE-EDGE" SIGNALS:

Time intervals measurements between signals with similar edges are a very common application. Examples include measurements within a logic family and propagation delay measurements on the same signal at two different points. In these measurement applications, both "like-edges" are distorted the same amount, and measurement errors do not occur. Figure 6 illustrates this case.

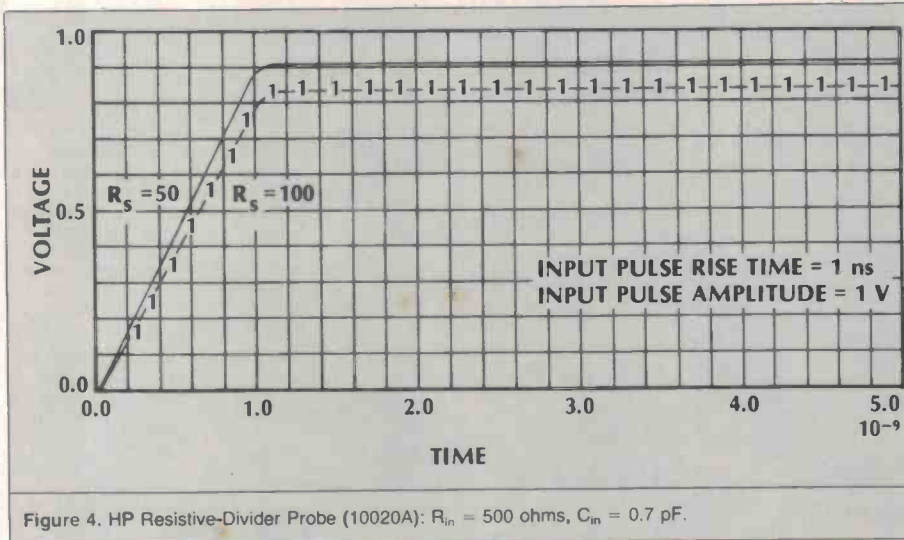

Figure 4. HP Resistive-Divider Probe (10020A): $R_{in} = 500$ ohms, $C_{in} = 0.7$ pF.

Instrument bandwidth limitations

An instrument's bandwidth can also significantly affect the fidelity of high speed signals. The easiest way to illustrate these limitations graphically, as they apply to precise time interval measurements, is to examine the rise time limitations of an instrument.

Distortion occurs as the edge speeds of a waveform approach the rise time limitations of the instrument. These distortions usually occur as shown in Figure 5. If a signal is close to the rise time of the instrument, the instrument slows down the signal. In an oscilloscope, the following formula is useful in determining the actual signal rise time based on the displayed rise time: $T_{displayed} = (Tr_{scope})^2 + (Tr_{signal})^2$. The next section covers several measurement applications where these signal distortions affect time interval measurement accuracy.

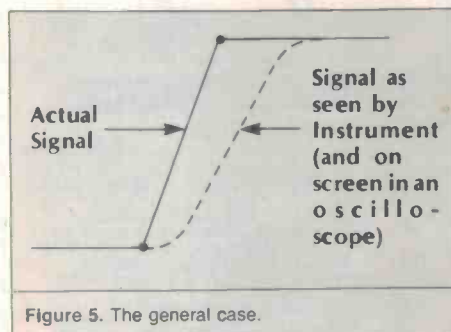

Figure 5. The general case.

RISE TIME MEASUREMENTS:

To measure a signal's rise time accurately, the measurement system must offer a system rise time at least three times faster than the input signal's rise time. For example, what bandwidth is necessary to measure the rise time of an ECL signal with a one nanosecond rise time accurately? Table 2 shows the measurement errors associated with specific bandwidths.

INSTRUMENT BANDWIDTH	INSTRUMENT RISE TIME	MEASURED RISE TIME	PER CENT ERROR
275 MHz	1.27 ns	1.61 ns	61%
400 MHz	0.875 ns	1.33 ns	33%
1 GHz	0.35 ns	1.06 ns	5.9%

TABLE 2. Errors associated with a 1 nanosecond rise time measurement.

A similar table can be developed for a 4 nanosecond rise time measurement (Table 3).

INSTRUMENT BANDWIDTH	INSTRUMENT RISE TIME	MEASURED RISE TIME	PER CENT ERROR
275 MHz	1.27 ns	4.20 ns	5.0%
100 MHz	0.875 ns	4.09 ns	2.3%
1 HGz	0.35 ns	4.015 ns	0.4%

TABLE 3. Errors associated with a 4 ns rise time measurement.

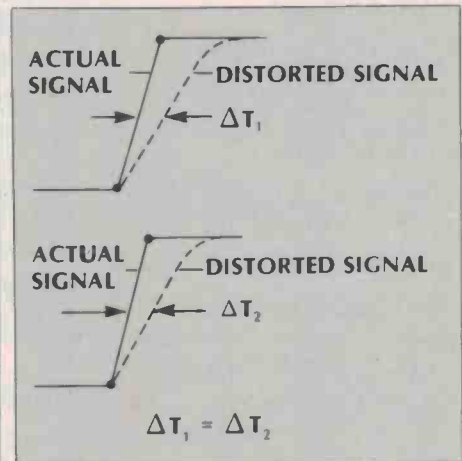

Figure 6. Time interval measurements between 'like-edge' signals will not result in errors due to instrument rise time limitations.

Grab 'em Sale

Deals so good you'll never resist them!!

Quality LEDs at Grabbable Prices!!

Super quality 3mm LEDs from Stanley at clearout prices. Only in bags of 100 at this mad price.

\$6⁰⁰ per 100



1 pole/10 position thumbwheel switches

Around 1/3 normal cost. Top quality Stolec design. Thousands of uses. Grab them while they last.

\$2.25 each
10 for \$20.00

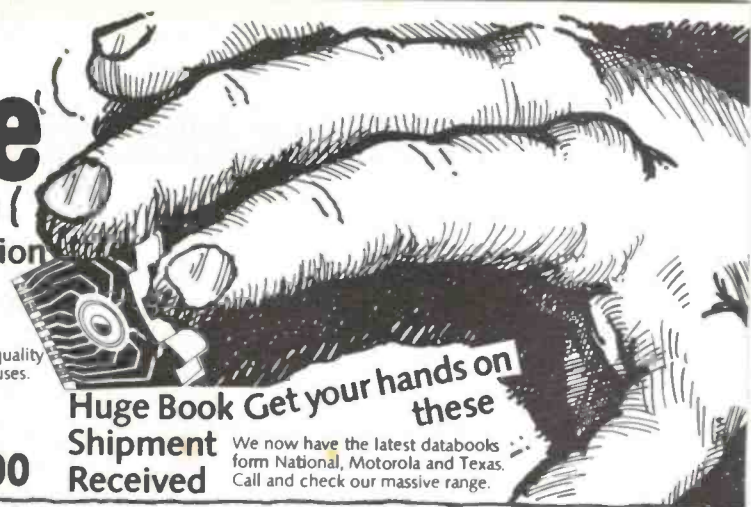

Huge Book Get your hands on these

We now have the latest databooks from National, Motorola and Texas. Call and check our massive range.

HP LEDs at Massive Savings

These incredible right angle mount HP LEDs complete with plastic holders, in red, green or yellow. For this month only a fantastic saving on our already low price!!

\$1⁰⁰ each
90¢ 10 up
normally \$1.40



12 Digit LED Display - Experimenter's Delight

These superb 7 segment displays have thousands of uses. Each digit is 7 segment with right hand decimal point. Eight inputs for segments and 12 inputs for digits (cathodes). Anodes are internally connected. They were selling for \$1.50 each now!!

only \$1⁰⁰

DATA INCLUDED



Micro Switches at Micro Prices!

Top quality Cherry Brand Microswitches at giveaway prices. 15A/250V AC rating. Normally open contact with lever.

75¢ each 10 for \$6.00



100 metre rolls of Speaker Cable Deal of a Lifetime

Grab a few rolls of speaker cable. Normally selling for \$12.00 each. Get them now and save!!

only \$8⁰⁰

Monster Tagstrip Pack

50 assorted tagstrips. Thousands of uses. Some of our opposition are selling these for \$1.00 each! They must be kidding!!

\$2⁵⁰



Quality DIP Switch at Tiny Price

These superb German DIP switches at a grab 'em price. Normal or hermetically sealed available (please specify). Limited stock so get them now!!

\$2²⁵ each,
\$2.00 10up

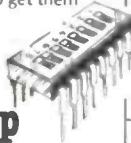

240V AC Open Frame Motors - going fast

These motors are fantastic value. Thousands of uses. Grab one while you've got the chance!!

only \$2⁰⁰

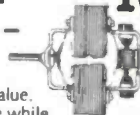

14 and 16 pin IC Sockets

Get your hands on these top quality AMP low profile IC sockets at a fraction of their normal price.

10 for \$1
100 for \$9

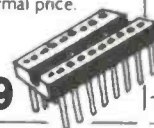

.1 ohm/7 watt Resistors

Grab these top quality resistors. Great for power supplies, amps etc. Fraction of the normal price, while they last.

10 for \$4⁰⁰



Telephone No-No's!!

Naughty Naughty!!

4 Core Telephone Cable

4 core telephone cable at a knockout price.

only 20¢ /metre



Scoop Purchase on Incredible Wallphones

Normally selling for \$26.95 (RRP \$49.95). Look at the features:

- ★ Pushbutton Keyboard
- ★ Mute Button
- ★ Last number redial
- ★ Ringer silencer
- ★ Lead and plug
- ★ Includes wall bracket

Very few left at this price
only \$14⁹⁵

Note: Not Telecom Approved.

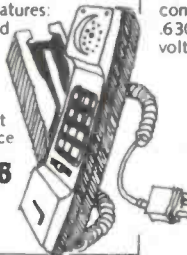

Bargain Displays

Litronix red single digit displays. Now drastically reduced to clear. Lite pipe construction, type DL-750 common cathode. Character height 6.30" 7 segment D.P. left. Forward voltage (typ) 3.4V, 20mA

70¢ each,
10 for \$5⁰⁰



Monster Trimpot Pack

100 mixed values and types. Normally selling for 30 to 50¢ each. Grab a pack or two and save!!

only \$5⁰⁰



EA and ETI Project PCB - grab 'em

We now stock the full Acetronics range of PCBs for EA and ETI projects. Phone for best prices around.

Fantastic TI TIL308 display - Amazing features

This incredible display chip has thousands of uses and at this price you can afford to use them for experiments. 27" red 7 segment display with built in counter logic and BCD input. Left hand decimal point

\$1⁷⁵ each, COMPLETE WITH DATA
\$1.50 10up



12V/4 digit Event Counter

Terrific resettable event counter. 12V/50ma operation. Thousands of uses. Up to 10cps

only \$10⁰⁰

Scoop on Pea Lamps

We are selling these amazing little lamps for only 10% of their original price. 12V/60mA and a tiny 5.5mm h. igh by 2.5mm wide. Perfect for miniature projects, modelling etc.

\$10 per 100



SHERIDAN ELECTRONICS

164-166 Redfern Street,
Redfern NSW 2106.
Phone (02) 699 5922.
Mail Orders to PO Box 229
Redfern NSW 2016

Mail Charges:
\$5.00-\$9.99 \$3.50
\$10.00-\$24.99 \$4.00
\$25.00-\$49.99 \$6.00
\$50.00-\$99.99 \$7.00
\$100.00 or over \$8.00

Trading Hours
Mon-Fri 9am-5.30pm
Thurs 9am-7pm
Saturday 9am-12noon

Note: We accept both Bankcard and American Express. However we cannot give quantity discounts on credit card purchases or account orders. Minimum for account orders is \$40.00.

Minimum order is \$6.00.
All prices include sales tax.



MEASUREMENTS BETWEEN "UNLIKE-EDGE" SIGNALS

Time interval measurements between signals with "unlike-edges" (e.g. rise time = 2 ns, fall time = 4 ns) can result in time interval measurement errors because of instrument rise time limitations. In these situations, the oscilloscope's rise time limitations affect each edge by a different amount, resulting in differential timing errors. An example of this situation is illustrated in Figure 7.

High bandwidth vs measurement technique

When evaluating precise time interval measurements, it is important to consider the accuracy of the measurement technique in light of how bandwidth limitations may affect a particular time interval measurement. Although a high bandwidth may reduce signal distortion, the errors resulting from traditional oscilloscope measurement techniques, based on analogue voltage comparisons, may add more error than the amount saved by the higher bandwidth. ●

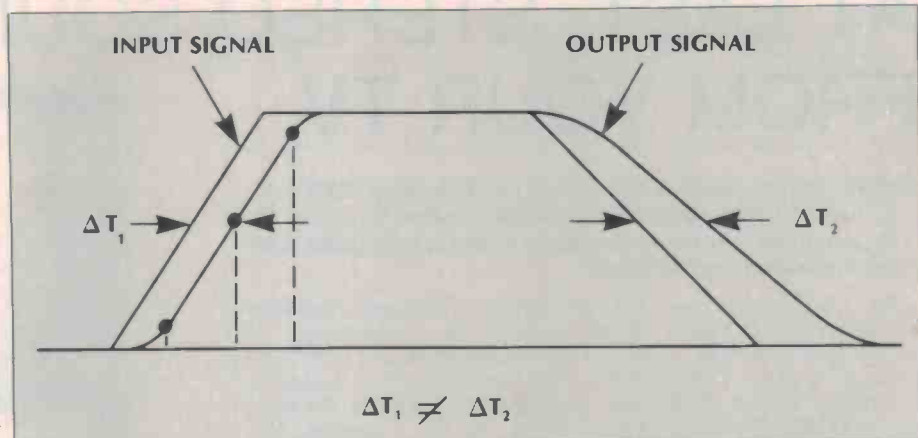

Figure 7. System bandwidth considerations; time interval measurements between 'unlike-edges' can result in differential errors due to instrument rise time limitations.

THE AUTHOR

Michael C. Gasparian is currently sales manager for Hewlett-Packard's Colorado Springs division. Mike received a degree in electrical engineering from Duke University. He is currently attending the

University of Colorado where he is studying for a Masters in Business Administration. Mike, who has been with Hewlett-Packard for three years, enjoys cross-country skiing, golf, and fly-fishing.

bwd
Instruments.

THE INNOVATIVE AUSTRALIAN

BWD's Model 821 oscilloscope is a dual-trace unit with 50 MHz bandwidth, 1 mV to 20 V per division sensitivity and a special 'mix-mag' expanded trace function

The mix-mag facility, unique to the BWD 821, enables you to get a ten times magnification of any proportion of the trace from 0% to 80% simply by pulling and turning a knob.

Normal x 10 magnification is incorporated and the trace can be expanded to x100 using the mix-mag function to provide facilities similar to a delayed sweep CRO but without the complexity.

The mix-mag facility can be used to magnify each line to examine teletext, sync pulse or video signals of VCRs, television receivers or studio equipment.

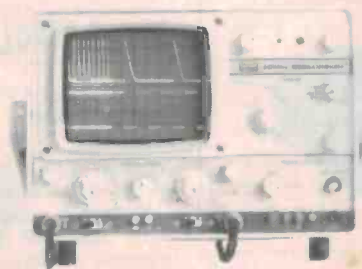

821 50 MHz MIX-MAG

Superb value...just \$850
Plus Tax

Other features of the BWD 821 include: a 7 ns rise time from 5 mV/div., 20 ns/div. maximum sweep-speed, 75 MHz triggering, TV line and frame triggering selection, bright trace with 6 kV EHT and internal tube graticule.

Two 100 MHz probes are included, a x1 and a x10. High sensitivity vertical amp inputs enable low level signals to be viewed, such as from tape recorder heads, pickups and microphones, etc.

The BWD 821 is suited to use in communications, industrial control, a research and development, video and microprocessor applications.

Designed and manufactured in Australia by
BWD Instruments Pty. Ltd.

PO Box 325, Springvale, Vic 3171
Miles Street, Mulgrave, Vic 3170 Australia
Phone National (03) 561-2888
International (613) 561-2888
Telex 35115

For further information on the BWD 821 or any instrument in the BWD range, please contact:-

Vic. (03) 561-2888 Qld. (07) 369-1277 W.A. (09) 277-7000
N.S.W. (02) 684-1822 S.A. (08) 268-2766 Tas. (002) 23-2842

*** ASK FOR OUR FREE COMPREHENSIVE CATALOGUE ***

AT LAST, STEREO SOUND FROM YOUR TV

The government's approval of the European dual sub-carrier standard as the Australian standard for stereo TV paved the way for stereophonic sound broadcasting with colour television transmissions.

The Department of Communications conducted a series of technical and field trials to evaluate systems which could potentially be introduced into Australia. The two-sound carrier system which was developed in Germany, and is now the accepted European standard, was among the systems tested.

The general feeling within the communications industry was, from the beginning, one of support for the European system as it is the only proven system which operates with PAL and gives a greatly improved channel separation between the two sound channels and almost total elimination of 'cross talk' between the channels — this characteristic permits first-class bi-lingual applications of stereo sound which has obvious benefits.

Philips Consumer Products assisted the Department of Communications and some television stations in their field trials by providing suitable receivers based on the European two sound carrier system. To further expand the field and home testing, Philips imported a small quantity of Philips stereo receivers into Australia from Europe. These European two carrier receivers have been completely modified to meet Australian Safety Standards and all applicable Broadcast and Receiver Standards.

Philips is now offering a package which includes integrated Teletext decoders, full remote control operation (including that for Teletext/Captioning and unprecedented remote control of sound), camera, VLP computer and video games via the

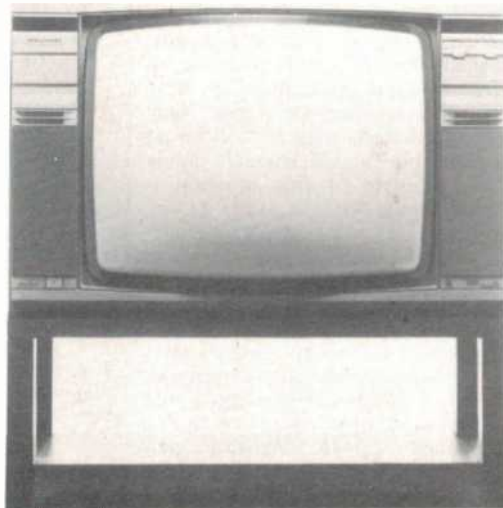

Philips' deluxe KS683 model — with stereo sound, RGB input, video in/out, Teletext, remote control and what-all!

Philips developed SCART socket. Private listening is possible using optional stereo headphones with individual control of the headphone sound volume.

For more information about the Philips products contact the Consumer Products Division, 1092 Centre Rd, Clayton Vic. 3169. (03)542-3307.

Visionhire, a video and communications equipment supply specialist, has a range of dual sound television receivers available for sale or rental.

David Peers, Technical Direc-

tor for Visionhire, said, "The market has been ready for stereo TV for some time. The technological improvements in video quality over recent years have unfortunately not been matched by the audio performance of the ordinary television receiver. A common complaint has always been the poor quality of TV transmissions".

Information about Visionhire products can be obtained by contacting Visionhire (Australia) Pty Ltd, 144 Pacific Hwy, North Sydney NSW 2060. (02)429-0902.



NEC BETAMOVIE

NEC Home Electronics Australia, formerly Rank-NEC, has produced the NEC Betamovie model BM-11 which is compatible with the NEC Beta video cassette recorder PVC 745E.

The Betamovie's self-contained video camera and recorder weighs 2.45 kg and is simple to operate — just place a Beta cassette into the unit, focus and shoot for up to 3¼ hours

with an L-750 video cassette.

Other features include a TTL optical system viewfinder, built-in electric condenser microphone and a 6x power zoom lens.

Standard accessories include an earphone, battery pack and ac power adaptor.

For more information contact NEC Home Electrics Australia Pty Ltd, (02)406-0444.

71-MINUTE COMPACT DISC

Denon has released a compact disc with a 71-minute recording of Beethoven's 9th Symphony, and you can hear all of it without interruption.

Although compact discs have been designed for up to 74 minutes of play, actual playing time comes to only 72 minutes when allowing for error tolerances. Yet up until recently, compact discs have been made with a playing time of considerably less than an hour.

One reason for this stems from the inability to achieve precision in molding the areas on the outside diameter of the disc. Even though these areas may seem perfect to the naked eye, less-than-perfect molding can cause birefringence, a double refraction phenomena that scatters the laser light sent out

by the pickup, making proper signal detection nearly impossible. This results in severe mistracking, precluding any music reproduction at all.

These areas on the outside diameter, where the last few minutes of potential playing time lie, are the hardest to mold with the precision necessary for signal recording.

Denon engineers at the Kawasaki CD production plant south of Tokyo have improved the molding precision by varying the temperature of the injection mold and the plastic, as well as designing a stamper with just the right thickness. Finally, injection speed and pressure were varied to achieve a new level of CD pressing precision, producing a longer playing compact disc.

HITACHI VIDEO SYSTEMS

The latest Hitachi products in its video range are a home video recorder, model VT-33E, a combination home/portable recorder, model VT-7E, and a video camera, model VK-C870E.

The front loading video recorder, the VT-33E, can be set to record as many as three programmes, at any time slot, up to two weeks in advance.

Playback features include a high-speed skip search function, visual search for reviewing scenes at four times normal speed and freeze picture.

In the combination recorder, the VT-7E, the lightweight portable video deck pops out of the main console. The deck itself weighs only 3.6 kg (including the battery pack) and stands only 85 mm high.

For information on these products contact Hitachi Sales Australia Pty Ltd, 153 Keys Rd, Moorabbin Vic 3189. (03)555-8722.



AWA AUDIO SYSTEMS

AWA's model S-24 audio system has a 32-function remote control unit which gives armchair control of all major functions, including a linear tracking belt drive turntable.

This unit offers the latest in microprocessor technology with soft touch logic controls including one finger operation of volume, treble, bass and balance.

Other features of the audio system include an eight-station pre-set tuning system with LED station indicator, dynamic noise

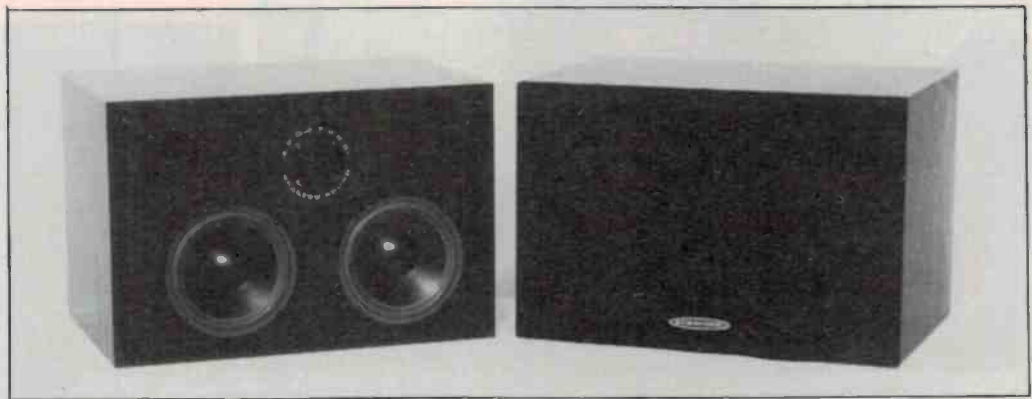

AURATONE MONITORS

Klarion has announced that Auratone Corporation, the professional audio industry's original producer of ultra-compact single driver 'recording monitors for the real world', has developed a new series of multi-driver quality sound monitors.

The five new models include the T5 ultra-compact two-way, T6 sub-compact two-way, T66 compact two-way, QC66 quality control three-way and RC66 road cube two-way.

They are claimed to have an exceptionally clean broad range

response, precise stereo imaging, durability and power handling commensurate with professional applications.

The system features polypropylene low frequency drivers, wide dispersion dome midranges, tweeters and super tweeters.

All models have six or 10-element crossover networks with precision premium quality metallised film polyester capacitors and air core inductors mounted on specially designed fibreglass/resin printed circuit boards. With the exception of the RC66 cube

two-way, all Auratone sound monitors are produced in mirror-image pairs for enhanced stereo imaging.

The enclosures are manufactured from low resonance 'Super Acoustic' wood, a high density wood-based product that is claimed to have acoustic properties that are superior to the 'particle board' used by nearly all other speaker manufacturers.

For more information contact Klarion Enterprises Pty Ltd, Kingsway, Sth Melbourne Vic. 3205. (03)61-3541.

POLY-PRO SPEAKERS

The C.I. Group, namely Cabinet Industries and C.I. Components Pty Ltd, will launch its range of Australian designed and manufactured speaker systems onto the market in 1984.

The range, known as the 'poly-pro' series, will incorporate the Foster Electric Company's range of polypropylene cone drivers, enclosed in hand crafted veneer cabinets which have been computer designed to 'Thiele-Small' parameters for optimum driver performance.

The C.I. Group employed the acoustic engineering consultants, Leembruggen and Connor, to design the crossover networks to compliment the enclosures of the four models in the poly-pro series.

The Foster polypropylene cone drivers were chosen because their reactance enables the speaker cones to move exactly as the music tells them to, without buzzing or rippling. Polypropylene is also a superb damping material which literally drinks up spurious resonances.

The result is a tighter bass, with more silence between notes.

The top of the range in the poly-pro series will be the poly-pro series 500, with a design layout incorporating two Foster 10" C250L34 translucent polypropylene woofers, two 4" C100L34 translucent polypropylene mid-range drivers and the D025N25 phenol dome tweeter. The craftsman built enclosure is of high density first grade particle board with mitrelock construction, hand lacquered in true wood veneer, unilaterally braced and constructed to exact tolerances.

C.I. Components Pty Ltd are stockist distributors of the range of Foster Speakers in Australia and not only carry stock of the hi-fi range but also stock the musical instrument, public address and high compliance professional speakers as well.

For further information contact the C.I. Group, 25 Pritchard Place, Peakhurst NSW 2210. (02)534-1746.

A degree



If you want to be a Bachelor of Science, Arts, Electrical, Mechanical or Civil Engineering, but also want a career, think of the Army. The Army is seeking university entrants to attend the Royal Military College and new Australian Defence Force Academy in Canberra to study, on excellent pay, a university degree of their choice.

If you have matriculated to a university in one of the above areas of study or are currently undertaking your matriculation, are an Australian citizen or eligible to apply for Australian citizenship, are under 19½ on the 1st January of your intended year of entry and are able to meet our selection requirements you will be offered a course that could qualify you as an Officer.

You will command soldiers while playing a key role in the defence of Australia.

So if you want more than a degree maybe the Army can give you the lead into a leading profession.



Are you good

that leads to leading.

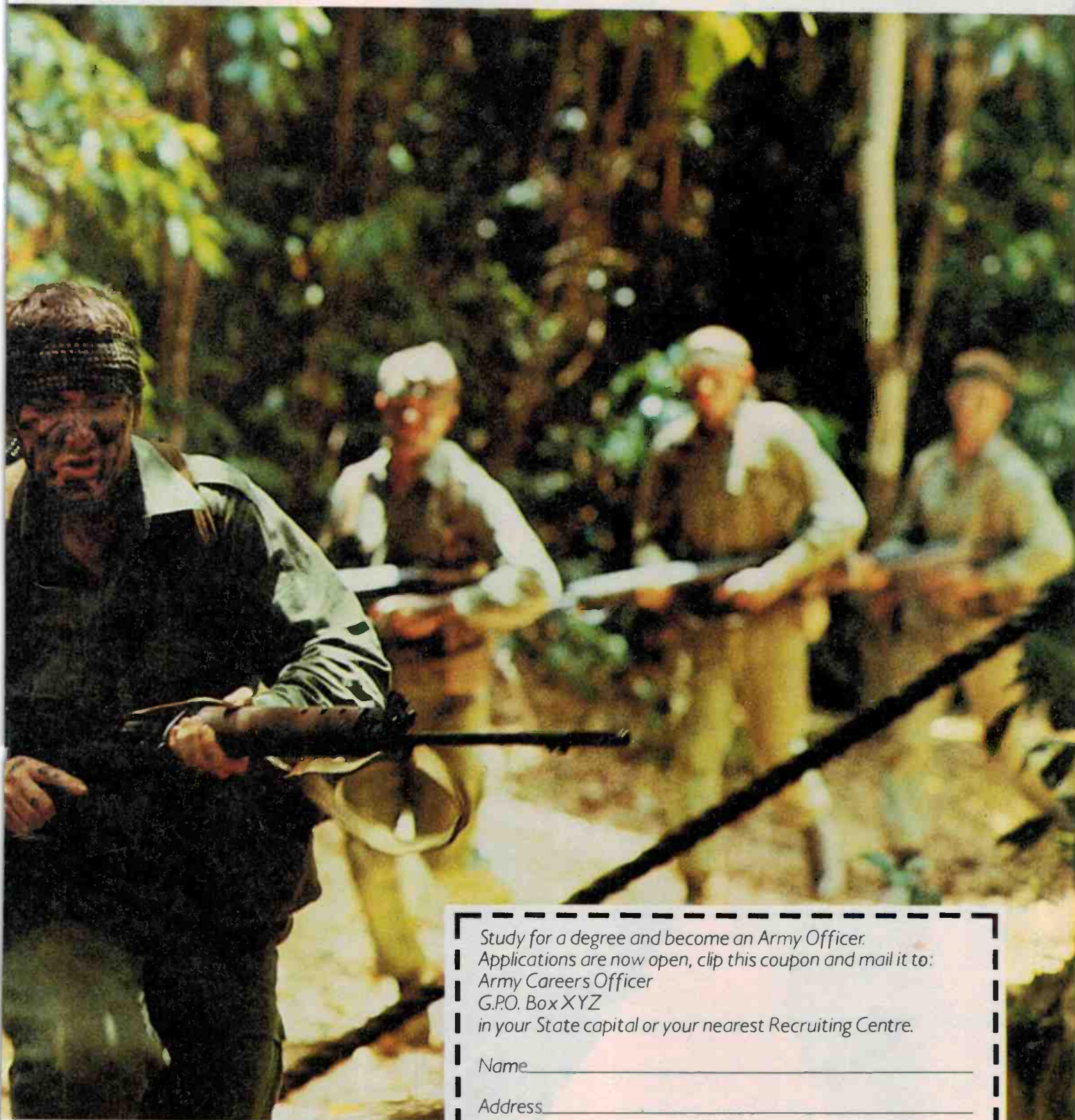

enough?

Study for a degree and become an Army Officer.
Applications are now open, clip this coupon and mail it to:
Army Careers Officer
G.P.O. Box XYZ
in your State capital or your nearest Recruiting Centre.

Name _____

Address _____

Postcode _____

Birthdate _____

Authorised by the Director General of Recruiting, Department of Defence.

RMC 67 DPS. 123



AT1551C

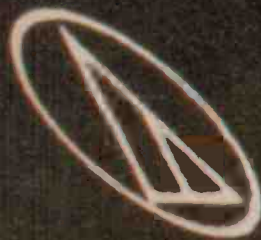

audio-technica

“We have no quality controllers, just highly critical employees.”

At Audio Technica we reject mindless, conveyer-belt operations.

Instead we encourage our employees to deal with problems on their own initiative. To be responsible for the excellence of their own work.

The result is the world's toughest quality controllers and Audio Technica's unrivalled reputation for precision and reliability in stereo cartridges, styli, microphones, headphones, tone arms and accessories.

And now Australian hi-fi enthusiasts will discover Audio Technica more readily available through an expanded dealer network.

For a free Audio Technica brochure and dealer information, simply clip the coupon below.

Please send me your free Audio Technica brochure and dealer information.

Name _____

Address _____

Postcode _____

Post to: Audio Technica brochure offer, c/- Rose Music Pty. Ltd.,
17-33 Market Street, South Melbourne, 3205.



audio-technica®

Come in spinner! Nakamichi RX-202 cassette deck



This unidirectional auto reverse cassette deck actually flips the cassette, giving outstanding reproduction quality and auto reverse through a new concept. It's a superb piece of engineering providing exceptional performance.

Louis Challis

MR NAKAMICHI is well known for his tremendous drive and his continuous quest for innovative, practical and exciting advances in cassette recorder technology which have helped to change the cassette player from a lowly 'dictation machine' to the high fidelity instrument that it is today.

The Nakamichi Corporation, over the last 15 years, has produced some exciting advances in cassette recorder technology which have helped to change the cassette player from a lowly 'dictation machine' to the high fidelity instrument that it is today.

However, not all of the products that the Nakamichi Corporation released were developed in their own laboratories. It is not well known that some of the most exciting developments are the work of the Philips research laboratories at Eindhoven.

An even more surprising fact is that some of the most exciting of Philips' research developments for the compact cassette have not been taken up by their own commercial divisions; they seem to lack confidence in this medium.

The RX-202 cassette deck is undoubtedly the most avant-garde machine to be released since 1982 when the 'Dragon' was released. Unlike the Dragon cassette deck, which was based on some of the most exciting technology that ever came out of the Philips research laboratories, the RX-202 tackles a problem that is apparently not well known.

That problem relates to auto-reverse cassette decks with bi-directional tape transport mechanisms. Mr Nakamichi tells us that they are likely to produce differing azimuth alignments, depending on the direction of tape transport. If this statement is true, then it needs obvious qualification.

NAKAMICHI RX-202 CASSETTE DECK

Dimensions: 451 mm x 136 mm x 255 mm
Weight: 9 kg
Price: Rrp \$799
Manufacturer: Nakamichi Corporation, Tokyo, Japan
Distributor: Convoy International, 400 Botany Rd, Alexandria NSW 2015. (02)698-7300.

One might well ask if this is a problem with Nakamichi auto reverse decks, other manufacturers' decks, or both?

Nakamichi claim that the problem can be, and is, overcome by incorporating an auto-reverse mechanism that literally takes out the compact cassette, spins it around and returns it to the cassette well! Obviously the mechanism required to carry out such a task is complex and adds significantly to the cost of the machine.

In this particular case the mechanism is not only complex but involves a large num-

ber of additional components which are not normally found in the conventional cassette deck. These include a series of special protective circuits designed to eliminate the problems of misoperation associated with the high speed of the motor drive mechanism, and to take care of problems such as objects obstructing the path of the cassette holder, objects getting in the way of the cassette or objects obstructing the opening or closing of the cassette well.

Naturally, to achieve the reliability and functionality of this concept, the tape transport and associated cassette reversal system require more logic and controls than a conventional auto-reverse cassette recorder. The designers have chosen to reduce the noise and complexity of the conventional solenoid activated system by use of motors and cams in lieu. The most outstanding attribute of this approach is the reduction of noise which can be so disturbing in a cassette recorder based entirely on solenoid operation.

Since Nakamichi developed the 1000 ZXL cassette deck, the principles of dif-fused resonance drive systems have been incorporated in all subsequent decks. The RX-202 goes even further than those machines did to prevent flutter by the use of a single capstan drive, in which the quality of machining is claimed to have advanced

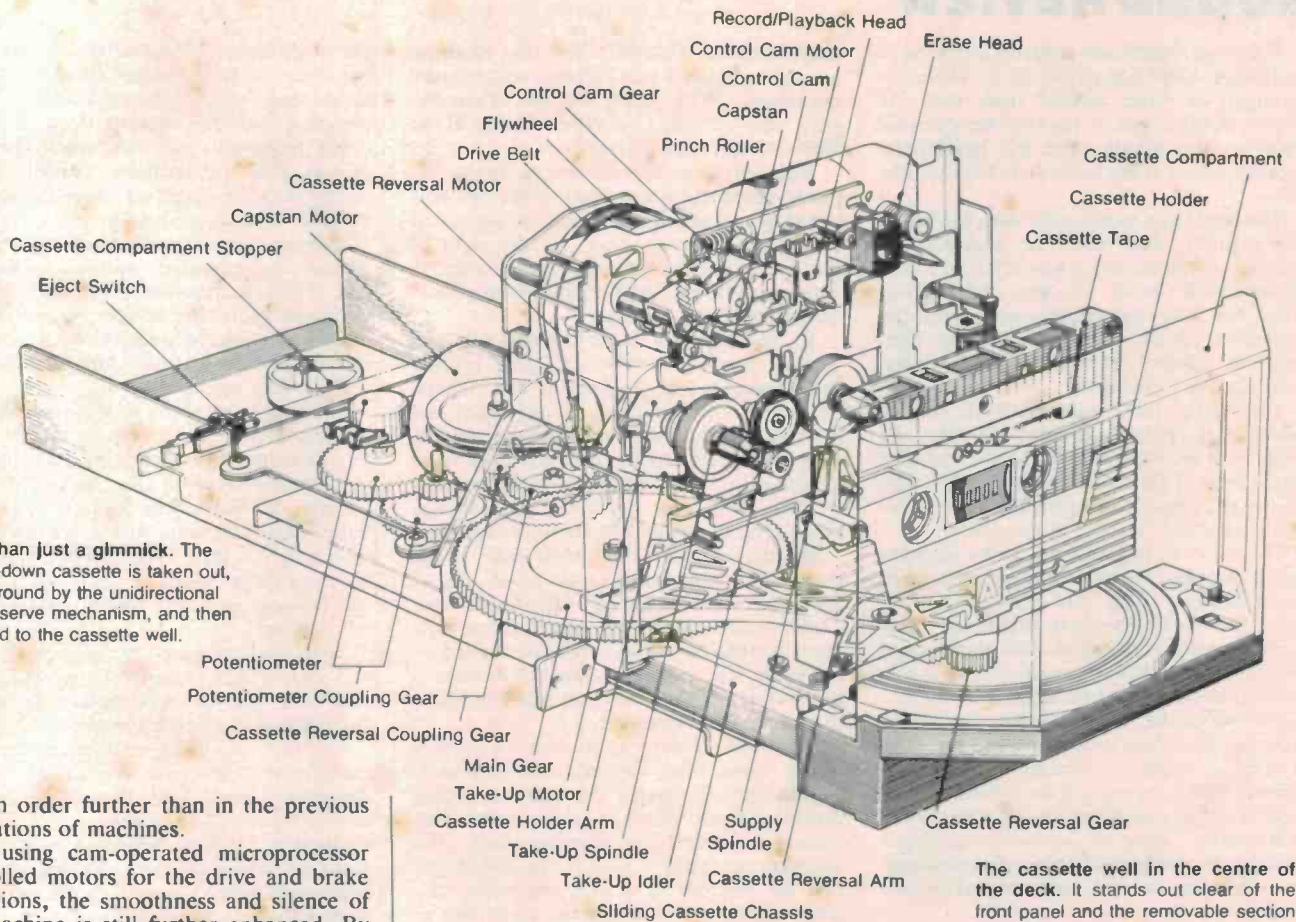

More than just a gimmick. The upside-down cassette is taken out, spun around by the unidirectional auto reserve mechanism, and then returned to the cassette well.

half an order further than in the previous generations of machines.

By using cam-operated microprocessor controlled motors for the drive and brake operations, the smoothness and silence of this machine is still further enhanced. By incorporating a single head assembly with a gap width of only 1.2 microns, Nakamichi has been able to use the same head for both 'record' and 'playback', thereby achieving a performance comparable to that provided by a three-head design which would normally be almost mandatory to achieve a full 20 kHz bandwidth capability. This particular head has been specially contoured to reduce the well known problems of tape transport modulation noise which so many cassette recorders display during playback.

Features

My initial impressions were that the appearance of the equipment belies its complexity. The front panel (in typical Nakamichi style) is all black with a series of controls and displays which are neatly labelled with particularly small letters finished in a mustard yellow coloured, silk screen printing. At the centre of the deck the cassette-well stands out clear of the front panel. This removable section has a trapezoidal-shaped, clear acrylic cover which immediately shows you that this deck is more than just slightly different from its brothers and sisters. ►

Absolute copyright in this review and accompanying measurements is owned by Electronics Today International. Under no circumstances may any review or part thereof be reprinted or incorporated in any reprint or used in any advertising or promotion without the express written agreement of the Managing Editor.

The cassette well in the centre of the deck. It stands out clear of the front panel and the removable section has a clear acrylic cover.



SOUND REVIEW

The main functional controls are located on the left-hand side of the deck. These are arranged in three vertical rows with the power on/off switch at the top, the external timer in the middle and the headphone socket located at the bottom on the extreme left.

The four large rectangular switches which are actually dual function controls are located one above the other adjacent to the power on/off switch. The first of these provides for 'fast forward/reverse' with the operation clearly indicated by the light emitting diode counter display located immediately to the right.

The second rectangular push bar control immediately below provides for 'play' or 'stop' with the function being indicated by a small green LED at each end of the bar. The next control down provides for 'pause' at one end and 'record' at the other.

The 'record' function has to be selected before pressing the 'play' button, or pressed simultaneously with the 'play' button in order to activate the recording mode. This is much more convenient than the normal simultaneous selection requirement incorporated in other cassette decks.

The last of the four controls is the master fader which allows smooth, automatic fade-in or fade-out of a recording signal over a period of four seconds. This control is only used at the beginning or end of a recording by touching it once. If you hold your finger on the button then the process is speeded up and the fade-in and fade-out takes two seconds.

The other controls on the left-hand side of the deck are the counter reset button, the 'memory stop/play' switch which will automatically stop the cassette drive when the counter reaches four zeros and the 'auto reverse' mode switch which permits continuous, uninterrupted recording of both sides sequentially, or a single pass in each direction only. The last switch on the left-hand side of the deck is a recording 'mute' switch which allows a blank section to be recorded on the tape as long as this switch is pressed.

The right-hand side of the deck contains

supplementary controls. The first of these are the twin peak level meters which cover the range -30 to -7 dB. The top of this display also indicates whether Dolby B or Dolby C has been selected.

Adjacent to these controls is a single output level control which controls the two output channels and also controls the signal fed to the headphone socket. To the right of this are two slider recording level controls which may be operated separately or conveniently operated together.

To the right of these controls are two vertical rows of switches. These include three switches for selecting the type of tape i.e: metal, chrome, chrome equivalent and low noise tapes. These are supplemented by a separate recording equalisation switch and a multiplex filter switch for removing the 19 kHz pilot tone signal on programmes being recorded from FM-stereo broadcasts.

On the extreme right-hand side of the deck are two large and three minor switches. The top switch is the 'eject/load' switch which opens the cassette compartment so that the cassette may be loaded or removed. The cassette is loaded in what is the reverse direction to most other decks as the tape points upwards.

The next control is a 'reverse' switch which opens the cassette compartment, simultaneously rotates the cassette before returning it and closes the deck. Below this control is a brand new function which is an 'auto-record standby' switch which skips the first six seconds of a tape, including the leader section then awaits the cancelling of the pause mode before starting to record. If the tape is not already rewound in the start position the machine will automatically return the tape to the 'start' position before activating the 'auto-record standby' cycle.

The last two switches are Dolby noise reduction on/off and Dolby B/C.

The rear of the deck is very plain, only providing a mains lead and two pairs of coaxial sockets for 'input' and 'output' and a mains voltage selector switch which is already locked in the 240 V position.

Inside the deck is a delightful exam-

ple of electronics integrated with mechanical systems. It has much more electronics inside than I would have expected, even in a complex two-head cassette deck. With the cover removed, you can watch the little motors and microswitches controlling the sliding deck mechanism as it responds to the external 'eject/load' button.

The tape drive is particularly smooth and, as our measurements showed, resonance free. The system produces far less noise and vibration than one would expect from a mechanism which is based on a series of motors and cam drives, instead of being activated by solenoids.

On both sides of the slide mechanism the printed circuit boards contain large quantities of transistors, integrated circuits and, much to my surprise, large scale integrated circuits of Nakamichi manufacture. The unit contains far more wiring, harnesses and ribbon cables than I would have expected. This is a direct result of the number of circuit boards connected to the cassette drive mechanism.

The unit is designed for ease of servicing and should not present any headaches or problems for a serviceman or owner equipped with a service manual.

The unit has been carefully designed to comply with the new Australian 'Wiring Approvals and Test Specifications for Mains Operated Electronic and Related Equipment for Household and Similar General Use' and is the first piece of imported equipment which I have seen that fully complies with all the latest requirements of this standard.

Objective testing

The measured replay performance of the machine is excellent with Type I tape (low noise gamma-ferric oxide) where the frequency response extends from 15 Hz to 20 kHz. With Type II tape (TDK SA) the frequency response extends from 15 Hz to beyond 20 kHz and with Type IV tape (TDK MAR) the frequency response extends from 15 Hz to well beyond 20 kHz. ▶

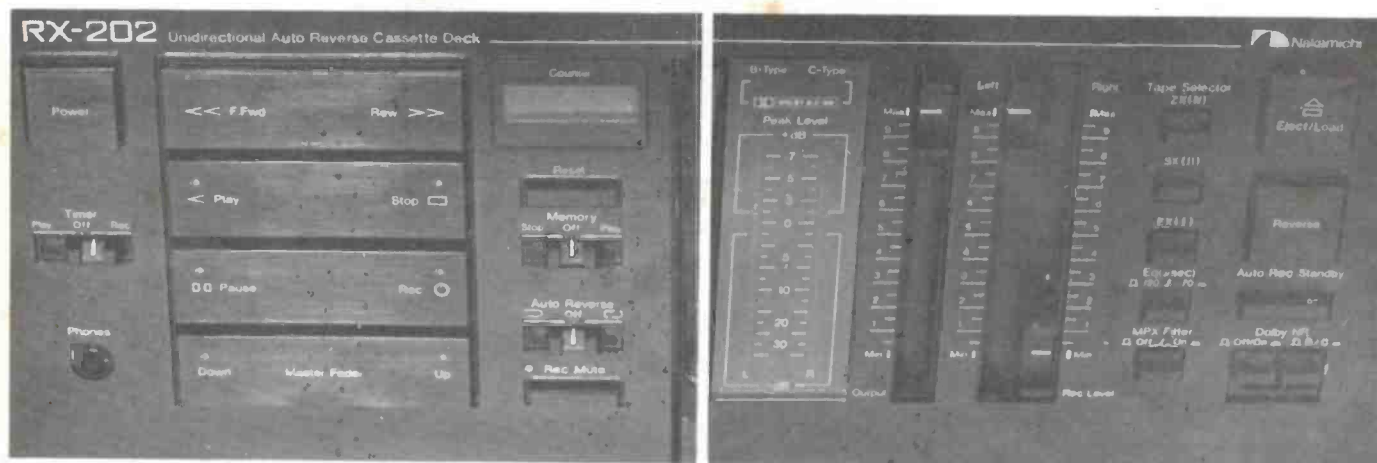

The left-hand side of the Nakamichi RX-202.

The right-hand side of the cassette deck.



SERIES 5000

PRICES SLASHED

As designed by ETI

INDIVIDUAL COMPONENTS TO MAKE UP A SUPERB HI-FI SYSTEM. BY DIRECTLY IMPORTING AND A MORE TECHNICALLY ORIENTED ORGANISATION BRING THESE PRODUCTS TO YOU AT LOWER PRICES THAN OUR COMPETITORS.

EXTRA FEATURES OF OUR KITS

POWER AMPLIFIER

KIT PRICE \$319 P&P \$12.00

- 1% Metal Film Resistors are used where possible
- Prewound Coils are supplied
- Aluminium case as per the original article
- All components are top quality
- Over 400 Kits now sold
- We have built this unit and so know what needs to go into every kit
- SUPER FINISH Front panel supplied with every kit at no extra cost to you.
- We are so confident of this kit that we can now offer it assembled and tested so that people who do not have the time can appreciate the sound that this amplifier puts out. This is done on a per order basis delivery approx. four weeks after placement.

PREAMPLIFIER

KIT PRICE \$289 P&P \$12.00

- 1% Metal Film Resistors are supplied
- 14 metres of Low Capacitance Shielded are supplied (a bit extra in case of mistakes)
- English "Lorlin" Switches are supplied no substitutes as others supply
- We have built and tested this unit and so

Only \$449

Only \$449

know what needs to go into every kit • Specially imported black anodised aluminium knobs • Again as with the power amp we are offering this kit A & T at a price which we do not believe there is a commercial unit available that sounds as good. Same delivery as the PA.

PREAMPLIFIER Kit Price \$289, P&P \$12.00
SPECIFICATIONS

Frequency response: High-level input: 15Hz-130 kHz, +0, -1 db Low-level input — conforms to RIAA equalisation, ± 0.2 db
Distortion: 1kHz < 0.003% on all inputs (limit of resolution on measuring equipment due to noise limitation).
S/N ratio: High-level input, master full, with respect to 300 mV input signal at full output (1.2V): > 92 dB flat > 100 dB A-weighted.
MM input, master full, with respect to full output (1.2V) at 5 mV input, 50 ohm source resistance connected: > 86 dB flat > 92 dB A-weighted.
MC input, master full, with respect to full output (1.2V) and 200 µV input signal: > 71 dB flat > 75 dB A-weighted.

On Special at \$259
Normally \$289

**All parts available separately for both kits.*

POWER AMPLIFIER Kit Price \$319, P&P \$12.00

SPECIFICATIONS

150W RMS into 40hms
Power output: 100W RMS into 8 ohms (± 55 V supply).
Frequency response: 8 Hz to 20 kHz, +0 -0.4 dB 2.8 Hz to 65 kHz, +0 -3 dB. NOTE: These figures are determined solely by passive filters.
Input sensitivity: 1V RMS for 100W output.
Hum: -100dB below full output (flat).
Noise: -116 dB below full output (flat, 20 kHz bandwidth).
2nd harmonic distortion: < 0.001% at 1 kHz (0.0007% on prototypes) at 100 W output using a ± 56 V supply rated at 4 A continuous. < 0.003% at 10 kHz and 100 W.
3rd harmonic distortion: < 0.0003% for all frequencies less than 10 kHz and all powers below clipping.
Total harmonic distortion: Determined by 2nd harmonic distortion (see above).
Intermodulation distortion: < 0.003% at 100 W. (50 Hz and 7 kHz mixed 4:1).
Stability: Unconditional

Please note that the "Superb Quality" Heatsink for the power amp was designed and developed by Rod Irving Electronics and is being supplied to other kit suppliers. This product cost \$1,200 to develop so that your amplifier kit would have a professional finish as well as sound.

On Special at \$299
Normally \$319

MX-1200 MICROPHONE/AUDIO MIXER



MX 1200 \$625 this month only

This unit features: 12 microphone line inputs with pan, bass, treble, effect and loud back controls for each channel • LED peak indicators for each channel • 2 turntable inputs with cross-fade and individual output controls • master equaliser for bass, midrange and treble • variable headphone output etc. etc. • complete with carrying case.

SPECIFICATIONS:
INPUTS
Level Impedance Mic: 48 db/1K
Line: 22 db/18K x 12
Phono: 52 db/50K STEREO x 2 (2 mV) at 1KHz
Effect Return (Aux): 20 db/50K x 1
OUTPUTS
Level Impedance L & R: 0 db/2K
Effect Send 0 db/2K F.B. Out 0 db/2K
Headphone Stereo: +10 db/800 (100, 1K)
EQUALISATION
Channel
Bass: ± 15db
Treble: ± 15db
Master
Bass: ± 12db
Treble: ± 10db
Middle: ± 12db

FADER & CONTROLLERS
12 channel fader: Slide, 60mm, LOG 25%
2 Master fader: Slide, 60mm, LOG 15%
12 F.B. Volume, 300, LIN
1 F.B. Master level, 300, LIN
12 Effect Send: 300, LIN
1 Effect Return: 300, LOG 15%
2 Phono, 300, LOG 18%
1 Head Phone, 300, LOG 15%
S/N, 56dB
FREQUENCY RESPONSE: 20-20 KHz
TOTAL HARMONIC DISTORTION: Less than 0.1%
METER: 2 illuminated VU Meters 0db - 0.775V
PEAK INDICATOR: 12 LED Peak Indicators
VOLTAGE: 240 VAC 50Hz
POWER CONSUMPTION: 7.2 watts
DIMENSIONS: 520 (W) x 385 (D) x 108 (H) mm (supplied complete with carrying case)

THIRD OCTAVE GRAPHIC EQUALIZER



SPECIFICATIONS E.T.I. Dec. 1982
Bands: 28 Bands from 31.5 Hz to 16 kHz
Noise: < 0.008 mV, sliders at 0, gain at 0 (-102 dB).
20 kHz bandwidth
Distortion: 0.007% at 300 mV signal, sliders at 0, gain at 0; max. 0.01%, sliders at minimum.
Frequency Response: 12 Hz-105 kHz, +0, -1 dB, all controls flat.
Boost & Cut: 14 dB

\$19500 1 Unit
\$37900 2 Units

SERIES 4000 SPEAKERS.

- 8 speakers with crossovers \$499
- Speaker boxes (assembled with grill and speaker cutout) \$299
- Crossover kits \$199
- Complete kit of parts (speakers, crossovers, screws, inner-band boxes) \$799
- Assembled, tested, ready to be hooked up to your system \$849



WE BELIEVE THAT WE ARE NOW THE ONLY ONES TO SUPPLY COMPLETE SPEAKER KITS ASSEMBLED AND TESTED FOR THOSE WHO HAVEN'T GOT TIME \$849 EX STOCK.

PLEASE WRITE FOR CONSTRUCTION NOTES, THESE COMPLIMENT THE SERIES 5000 AMP RANGE AND ADD THE FINAL TOUCH.

ROD IRVING ELECTRONICS

425 High St., Northcote, Vic. 48-50 A'Beckett St., Melb., Vic.
Phone (03) 489 8866, (03) 489 8131, Mail Order Hotline (03) 481 1436
Mail orders to P.O. Box 235 Northcote 3070 Vic.
Minimum P & P \$3.00. Errors & omissions excepted.

Please address tax exempt, school, wholesale, and dealer enquiries to:
RITRONICS WHOLESALE
1st floor 425 High St. Northcote 3070 (03) 489 7099 (03) 481 1923
Telex AA 38897

These results are amongst the best we have yet seen from any machine and are enough to make most audiophiles drool at the mouth.

The record-to-replay frequency response is not quite as good. Our results revealed significant differences between no noise reduction and Dolby B and Dolby C. Particularly in the Dolby C mode, the amount of droop in the 8 kHz to 20 kHz region was far greater than I would have expected. This problem could be improved by selecting a tape with a rising high frequency response such as the TDK AD, or BASF Super II.

With type II tapes the record-to-replay response extends basically from 15 Hz to 15 kHz. With type IV (metal) tapes the frequency response is extremely good, being almost ruler flat.

The wow figures are 0.02% peak-to-peak and the weighted flutter figures are 0.04% which are better than claimed by the manufacturer. The measured channel separation is better than 45 dB at 1 KHz and much bet-

ter than 30 dB at all frequencies, which is also substantially better than that claimed by the manufacturer.

The distortion characteristics of the machine at 0 VU are moderately high with distortions of 1.3% at 100 Hz, 0.65% at 1 kHz and 1.3% at 6.3 kHz. At -6 VU the distortion drops dramatically to 0.09% at 100 Hz, 0.24% at 1 kHz and 0.6% at 6.3 kHz.

The maximum input level for 3% third harmonic distortion is +6 VU. Consequently, the provision of a +7 VU input recording level on the peak reading meter is particularly appropriate.

The signal-to-noise figures achieved by the deck are extremely good. With Dolby out the measured performance is 53 dB(A); with Dolby B this improves to 63 dB(A) and with Dolby C it is a very healthy 68 dB(A). The 68 dB(A) figure does not provide a realistic assessment of the overall improvement in noise as between 500 Hz and 8 kHz the Dolby C provides better than a 10 dB improvement in the background

noise levels; this becomes very obvious when you play a tape where Dolby noise reduction has been used.

The last and most outstanding feature is the erasure capability which is better than 80 dB on ordinary gamma-ferric oxide tape and a healthy 81.5 dB with metallic tape.

Subjecting testing

During the active listening while recording, replaying and simply playing around with the RX-202, I quickly overcame my initial dislike for the concept of the 'spinning cassette' when I found that it resulted in no loss of functionality, convenience or performance.

The functional controls provided with the deck are delightfully easy to use and the extra features provided by the auto-record standby button, the recording mute button and the master fader controls are particularly practical features, especially if one is proposing to record one's own tapes for use in the home, in the car or as part of a school or minor theatrical production.

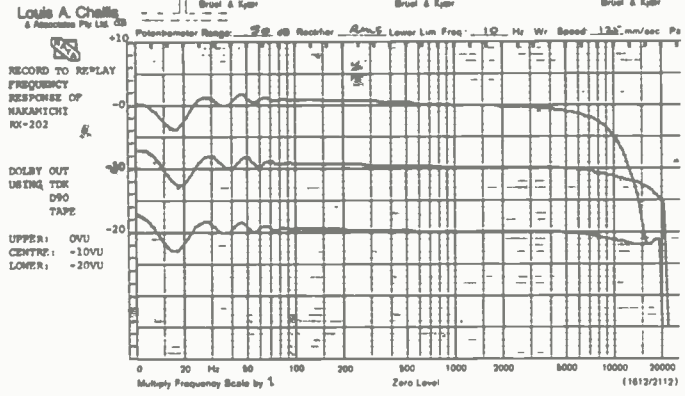
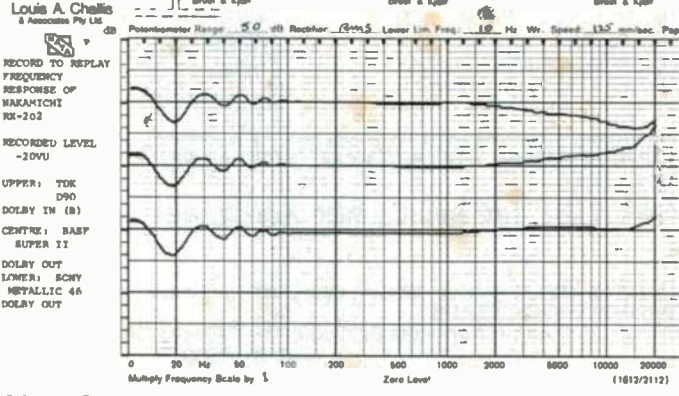
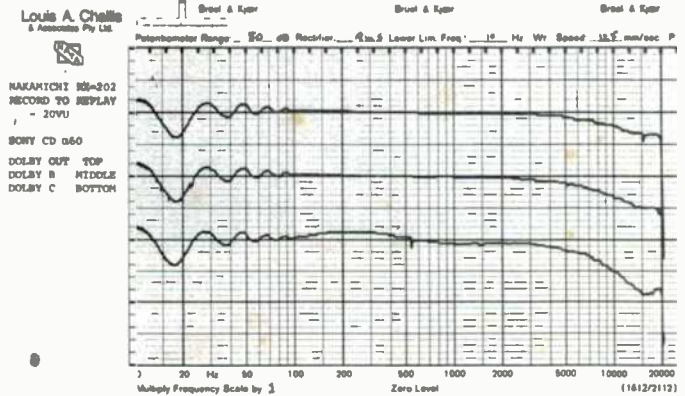
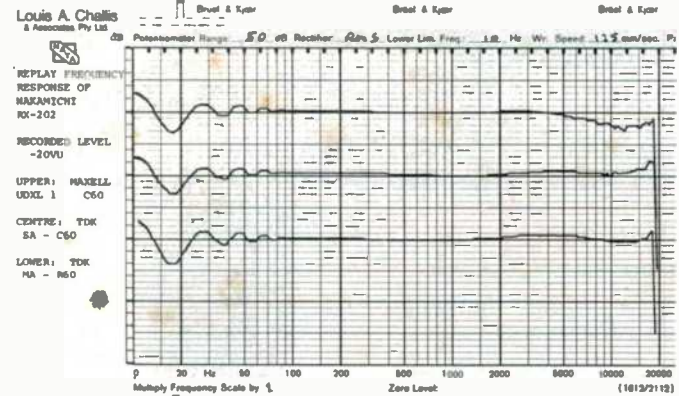
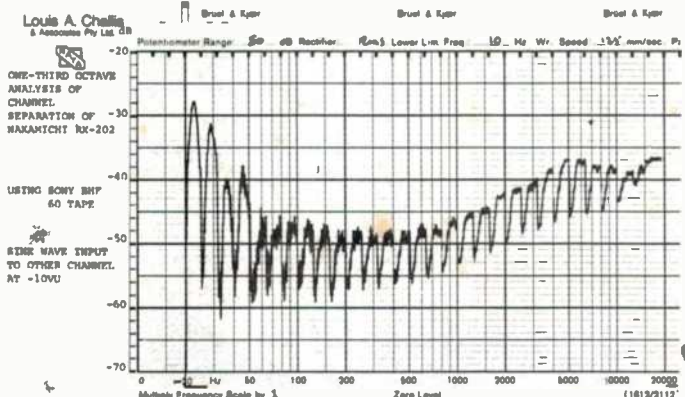
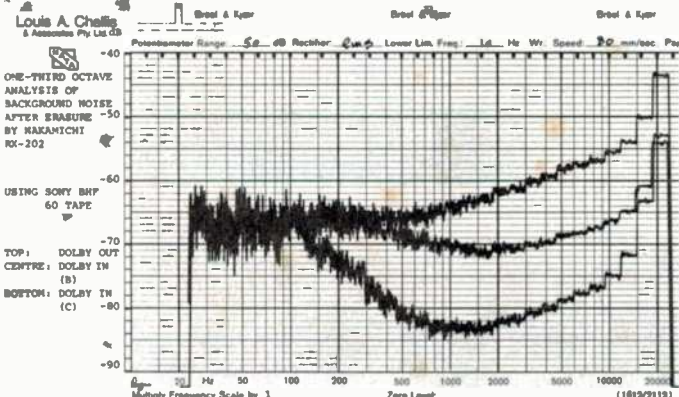

SOUND REVIEW

I listened to a large number of pre-recorded and home produced cassettes for this specific purpose. Even though I started with some degree of reticence, because of the unusual reversing mechanism, the machine soon won me over and convinced

me (as it must have convinced Mr Nakamichi) that the concept is more than just a gimmick.

The RX-202 is a superb piece of engineering. It provides exceptional performance, extremely good measured test figures

and performs as neatly and as well as you might ask.

This is one deck where the gimmickry seems to work and where the sceptics (myself included) are quickly proved to be in the wrong.

MEASURED PERFORMANCE OF NAKAMICHI RX-202 AUTO REVERSE S.N. A802 - 01477

RECORD TO REPLAY FREQUENCY RESPONSE AT -20VU:

Tape	Dolby	Lower -3 dB Point	Max. Point and Frequency	Upper -3dB Point
TDK D90	In (B)	19Hz	2dB 10Hz	10kHz
BASF Super II	Out	19Hz	6dB 20kHz	above 20kHz
Sony Metallic 46	Out	19Hz	2dB 20kHz	above 20kHz
TDK D90	Out	18Hz	2.5dB 10Hz	above 20kHz
Sony CD - X60	Out	20Hz	1.5dB 10Hz	above 20kHz

SPEED ACCURACY: +0.5%

WOW:

Average: 0.02% p-p

FLUTTER:

Unweighted: 0.1% RMS

Weighted: 0.04% RMS

ERASURE RATIO:

(for 1kHz signal recorded at OVU)

Tape: SONY BHF 60

> 80dB (Below noise)

Tape: SONY METALLIC 46

81.5 dB

HARMONIC DISTORTION: Tape: SONY BHF60

		100Hz	1kHz	6.3kHz	
OVU:	2nd	-56.6	-53.2	-50.5	dB
	3rd	-37.7	-44.3	-38.1	dB
	4th	-59.7	-	-	dB
	5th	-56.7	-	-	dB
	T.H.D.	1.3	0.65	1.28	%
-6VU:	2nd	-61.6	-53.6	-	dB
	3rd	-68.6	-57.8	-44.2	dB
	4th	-	-	-	dB
	5th	-	-	-	dB
	T.H.D.	0.09	0.24	0.62	%

MAXIMUM INPUT LEVEL:

(for 3% third harmonic distortion at 1kHz)

Tape: SONY BHF 60

+6.0 VU

DYNAMIC RANGE:

Tape: SONY BHF 60

Dolby Out	49 dB (Lin)	53 dB(A)
Dolby In (B)	58 dB (Lin)	63 dB(A)
Dolby In (C)	59 dB (Lin)	68 dB(A)

“...offer a performance bordering on the superlative.”

Louis Challis, ETI.

This statement, made by one of Australia's highly respected hi-fi critics, is no exception.

The Danish JAMO Loudspeakers are acclaimed world wide. Their unique way to solve the problems which plague ordinary speakers have made JAMO one of Europe's best speakers today.

No other speakers on the market feature all these benefits.

- Patented CBR-system (Centre Bass Reflex) which eliminates cabinet resonances and decreases distortion to an absolute minimum.
- Acoustically dead insert around tweeter and midrange ensures perfect stereo image.
- Optimum phase linearity assured by slightly curved front panel which position the drivers on axis.
- Acoustic attenuators.
- Electronic overload protection.

If you are considering spending from \$400-\$2000 on a pair of loudspeakers make sure that you arrange an audition of the incredible JAMO Professional loudspeakers.

Please contact us for brochures, reviews and your nearest dealer.

SCAN AUDIO PTY LTD
P.O. Box 242,
HAWTHORN, VIC. 3122.
Phone (03) 819 5352

Jamo HI-FI

CBR-1304
130 watt RMS
\$1095.00 incl. stands

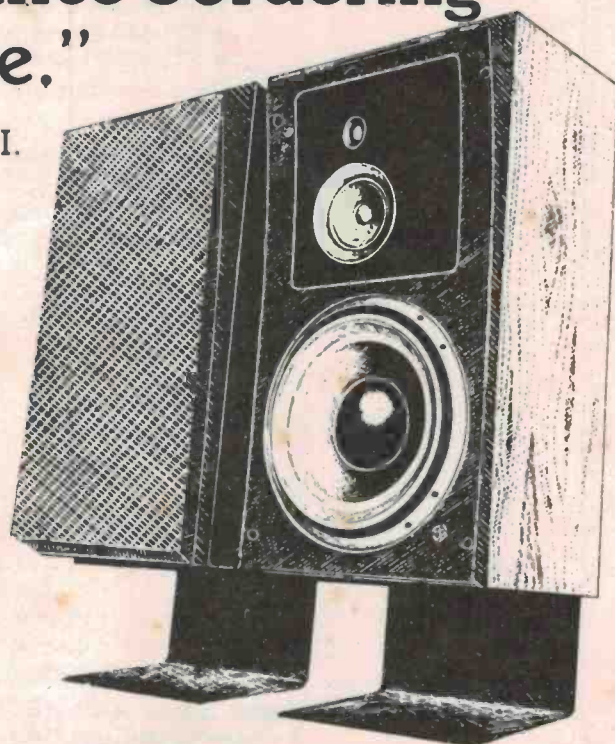

ALL ELECTRONIC COMPONENTS

118-122 LONSDALE STREET, MELBOURNE, VIC. 3000
(03) 662-3506

Kitset Specialists, here's just a few!

Worried about the ever-increasing burglary and theft figures?
Protect your property with a proven ETI or EA alarm kitset.
Kits available include:—

- **ETI 582 House Alarm (July '77)**
\$85.70, \$7.88 cert. p & p
Features: ★ Facilities for a wide variety of sensors
★ Test circuits
★ Resets automatically
★ 30 sec. silent entry
★ 7 perimeter circuits
★ 4 internal circuits
- **ETI 702 Radar Intruder Alarm (May 75)**
\$118.80, \$8.88 cert. p & p
Features: ★ 10 metre range
★ Gunn diode assembly
★ An amplified output
★ 5-pole low pass filter
★ Detector and relay driver

- **ETI 528 Home Burglar Alarm (Jan 75) \$30.10**
- **EA 10Ghz Radar Alarm (July 77) \$98.25** \$5.00 p & p
- **ETI 250 Simple House Alarm (Aug 80) \$19.25**

Concerned about leaving your car in the street overnight?

- **ETI 313 Car Alarm (Nov 74) \$18.00**
- **EA 1976 Car Alarm (Nov 76) \$23.80** \$5.00 p & p Hundreds Sold
- **ETI 330 Car Alarm (July 81) \$35.50**

Other Alarms include:

- **ETI 583 Gas Alarm (Aug 77) \$50.20**
- **ETI 247 Soil Moisture Indicator (Nov 80) \$19.40** \$5.00 p & p
- **ETI 322 Over Rev Car Alarm (include case) (Mar 80) \$24.19**

This Month's Specials:

- **ETI 340 Car Alarm/Monitor System (Apr 84) P.O.A.**
- **ETI 166 Function/Pulse Generator \$231.50**
(Modules available separately)

Fool That Burglar with an

- **ETI 585 T & R Ultrasonic Switch (Sep 77) \$34.70 or an**
- **ETI 570 Infrared 'Trip' Relay (Jan 82) \$40.95**
includes playback

OR
ETI 711 Remote Control Unit (July-Oct 76)
Transmitter Switch \$62.99
Receiver \$30.00
Decoder \$18.99
Single Control \$18.10
Double Control \$21.70
Power Supply \$13.40

- Features: ★ Many applications
★ Operates up to eight devices
★ 500m Range — Aerial up
★ 50m Range — Aerial down
★ 9V Power Supply

- Importers • General Sales • Radio Equipment • Microwave Equipment • Radar Equipment
- Pulse Techniques • Industrial Electronics • Instrumentation •

ERRORS AND OMISSIONS EXCEPTED

SOPHONET FOR TOTAL COMPUTER COMMUNICATIONS?

Sophonet, the universal digital protocol, is a wide area network that can link up more different makes of computers than any other network, it is claimed.

At its launching by Philips Australia at seminars in Sydney and Melbourne in February, Sophonet was said to break down the barriers between different makes of computers so that all pieces of digital equipment could be incorporated into an efficient and economical network.

Sophonet's multi-microprocessor 'intelligence' is distributed throughout the network in compact units called nodes which perform sophisticated protocol conversions that allow virtually all different makes of equipment to 'speak' the same language.

Major capital investment in existing data processing systems, office automation equipment

and application programs is fully protected as equipment does not need to be replaced. Existing equipment continues working as part of the greatly expanded Sophonet information sharing network, protecting customers' investments which are better utilised.

As almost any transmission resource can be used with Sophonet, an organisation using it can choose between common carrier or leased lines, public data networks or satellites as the most cost-effective transmission method.

For further information contact Peter Brownlee, Philips Industries Holdings Limited, North Sydney NSW. (02)925-3333.



COMPUTER CARE RANGE

A Danish company, AmKemi, has launched a complete computer care range which includes a specially developed antiflex, a yellow anti-glare spray that effectively softens the light from the screen.

The product comes in a 150 ml spray bottle and will have a recommended retail price of \$26.95.

A 5 1/4" and 8" disk drive cleaner is a wet-type cleaning diskette for floppy disks. The

package includes three cleaning diskettes, 100 ml cleaning fluid and three computer keyboard cleaning serviettes.

The range also includes an antistatic cleaning spray for cleaning computer screens and a computer keyboard cleaner.

For further information please contact Mr Lars Sorensen, Danish Documentation Standard, 6 Highbury Grove, Prahran Vic 3181. (03)51-7603.



COMPUTERS IN CONTROL

The Computacontrol module is an interface developed by an Australian company which gives the Dick Smith VZ200 and Commodore 64 computers the ability to control and monitor external events.

Possible applications are: computerised train controller, lap counter and timer for slot cars, home alarm system, control robots, control audio visuals, monitor school experiments,

etc. The computacontrol module is available for \$159 or \$98 in kit form.

Other products are an industrial-type interface with a large number of inputs and outputs, and a real time clock and printer interface.

For more information contact Meyertronix, P.O. Box 65, Riverstone NSW 2765. (02)627-2510.

SECURITY BASED SYSTEM CONTROLLER

All-systems Electronics has released the Handimac 512 mimic/status system controller, a powerful microprocessor-based product which has potential in the security industry.

At a central location you can have one of the Handimac 512s providing local control of 16 remote digital outputs (readily expandable to 256 outputs). The second Handimac 512 at the remote location can have its 16 digital inputs (up to 256) monitored at the central location.

A Handimac 512 consists of two basic boards, a CPU and a power supply, and one or more daisy chained digital I/O boards. Modem access is provided by an

RS232 port. A local-remote pair forming a basic system of two CPUs, two digital I/Os, two power supplies and the standard repeater software package will cost less than \$2000.

The Handimac 512 features built-in LED monitoring of all digital I/Os. All boards have the same dimensions and are easily mounted into Rittal-type enclosures.

All-Systems can provide custom co-existent software for user specified functions.

For more information contact All-Systems Electronics Pty Limited, 8 Brady Place, Kellyville NSW 2153.

FAIRCHILD D/A CONVERTER

The μ A9706 is an eight channel 12-bit D/A converter which allows a microprocessor system to interface and control analog systems.

The μ A9706 is programmed by 9-bit words, accepted in a serial format, providing conversions on all channels simultaneously and continuously as long as the oscillator signal is present.

Digital-to-analog conversion is accomplished using a pulse-width ratio technique to directly control the duty cycle of the output pulse streams. Each channel, when appropriately filtered, supplies 6-bit resolution, or 64 discrete analogue levels.

By properly summing two outputs, the resolution may be controlled up to 12 bits, or 4096 discrete levels. Each channel

output maintains 12-bit, or $\pm .01\%$ full scale, accuracy.

For further information contact Fairchild Australia Pty Ltd, P.O. Box 19, Nunawading Vic 3131. (03)877-5444.

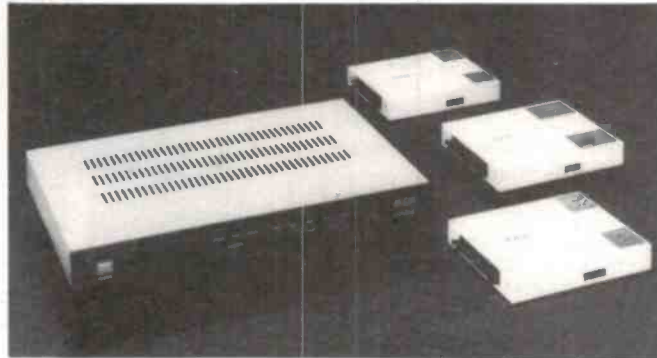

REAL TIME EMULATOR

The Ice-Engine from Alfatron is a real-time in-circuit emulator capable of being equipped with probes to handle Z80, 8085 and 6809 microprocessors.

Unlike other development emulators which must be used with a specific development system the Ice-Engine is a general purpose tool that will work with most CP/M systems. Software is provided for CP/M systems which communicates via a serial port with the Ice-Engine.

Alfatron says the Ice-Engine brings a high level of debugging power to relatively low cost systems. It has facilities for backward and forward trace and the entire memory and I/O space is

CASE REACHES FOR STARS

An agreement has been reached between Case Communication Systems and Star Micronics of Japan regarding the marketing of their new range of dot matrix printers.

Case, an exclusive Australian distributor, is now authorised to promote Star products under their original brand names of Gemini and Delta.

Effective immediately, the currently known DPX range of 120 cps printers will be promoted as the Gemini-10X (80 column) and Gemini-15x (136 column).

The even more recent Delta printers offer 160 cps for the price of a 100 cps printer, and include both a parallel and a serial interface as standard. For the home computer market, the STX-80 thermal printer is available at 60 cps for only \$295.

For further information contact Michele Cahill, Case Communications Systems, 1-3 Rodborough Rd, Frenchs Forest NSW 2086. (02)451-6655.

PRINTERS ZAPPED

Some severe disappointments are forecast for non-impact printer manufacturers in the personal computer and office automation market segments.

According to a new 200-page report from International Resource Development, a US market research firm, daisy-wheel and matrix-impact printers are becoming so inexpensive that many of the fancy new, non-impact printers currently coming onto the market are not finding buyers.

available to the user without being interfered with by the system's requirements.

The Ice-Engine utilises your existing development system for file storage and manipulation of data, and therefore avoids unnecessary duplication of equipment.

The Ice-Engine sells for about half the cost of conventional emulators and will be within the reach of many businesses that previously ruled out an emulator on a price basis, the company claims.

For further information contact Alfatron Pty Ltd, 1761 Ferntree Gully Rd, Ferntree Gully Vic 3156. (03) 758-9000.

BUSS BOX

Pulsar Electronics' new metal enclosure to house a four-way STD buss motherboard, power supply, fan and twin slimline 5 1/4 inch drives is now available.

The new enclosure comes complete with cutouts for power switch, reset button, four D connectors and 50-way port slots.

The enclosure is available from Pulsar Electronics, Lot 2 Melrose Drive, Tullamarine Vic 3043 (03)330-2555.

Club Call

The Super 80 Users Group in Melbourne is holding an open day on Saturday, March 17, from 9 am to 4 pm at the Uniting Church Hall, 83 Canterbury Rd, Heathmont Vic. For more information, write to 17 Stephen Crescent, Croydon Vic. 3136. (03)723-2713.

The Illawarra Microbee Computer Club meets on the fourth Monday of each month at 7.30 pm at the Wollongong Institute of Education, Norfields Ave, Gwynneville. For further details contact Ronald Read, 49 Beatus St, Unanderra NSW 2526. (042)71-2384.

The Macarthur Computer Association meets at 7.30 pm in the library at Airs High School, Briar Road, Campbelltown, on the first Monday of each month. The club is not orientated to any specific machine; most popular models are represented.

Further information can be obtained by phoning the President, Mr C. Wylie, on (046)26-1625 or the Secretary, Mr J. Napier on (046)25-2055. Correspondence should be addressed to the Secretary at 23 Athel Tree Crescent, Bradbury NSW 2560.

The Beebnet, BBC and Econet User Group of South Australia meets on the last Monday of each month for discussions and to collect the monthly newsletter. For information contact the president, M. A. Cowley, P.O. Box 262, Kingswood SA 5062.

The Newcastle Microbee Users Group is an enthusiastic group which has informal monthly meetings. Information can be obtained by contacting Lee Osman, 12 Cleverton Close, Warners Bay NSW 2282. (049)48-8813.

The Sorcerer Users Group of South Australia caters solely for the Sorcerer Computer. Although this computer is now no longer available, there are a large number in use throughout Australia and the owners are dependent, to a greater degree than previously, on knowledge, advice and backup from groups such as this one.

Although this group is based in South Australia, it has members in each of the States of Australia as well as New Zealand and Canada.

The contact for the group is Don Ide, Hon Sec, Sorcerer Users of South Australia, 14 Scott Rd, Newton SA 5074.

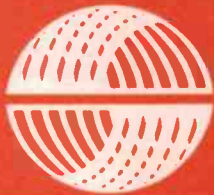

SPHERE COMPUTERS

The CCT 100 Intelligent Terminal for Intelligent decision makers.

SPECIFICATIONS

Keyboard

- Detachable, compactive, typewriter-style keyboard
- N-key rollover with auto repeat capability
- 4 LED indicators for caps lock, an line, block mode and keyboard lock/protect
- Audible keyclick enable/disable
- Auto repeat enable/disable
- Keyboard lock enable/disable
- Repeat rate 20 characters per second
- 5 cursor control keys, 10 editing function keys with 14-key numeric key-pad

Communication

- Code: 128 ASCII characters
- Baud rate: 75, 110, 150, 300, 600, 1200, 1800, 2400, 4800, 9600, 19200
- Parity: odd, even, mark, space
- Operating Mode: full duplex, half duplex or block mode
- Interface: EIA RS-232C or 20-mA Current Loop

Emulation

- LEAR SIEGLER ADM 3A ADM 5A, HAZELTINE 1500, ADDS VIEWPOINT

Screen Presentation

- Display format: 24 lines x 80 characters
- Display unit: 12-inch, non-glare CRT
- Character type: 7 x 9 dot matrix
- Refresh rate: 50/60 Hz
- Character set: 96 ASCII characters, 15 graphic symbols, 32 control character symbols.
- 5 screen attributes: blink, underline, blank, reverse, dual intensity
- Cursor type: selectable slow, fast blinking or steady cursor, block, underline or invisible cursor.

Editing Function

- Cursor: up, down, left, right, home
- Insert character, delete character, insert line, delete line, erase to end of line, page and field, field tab, field back tab, column tab, column back tab, block mode on/off, protect mode on/off, graphic mode on/off, clear unprotected.

External Control

- Power on/off
- Contrast adjustment
- Baud rate
- Parity and data format
- End of message
- Emulation mode
- Refresh rate
- Half duplex or full duplex
- Auto line feed
- Auto new line
- EIA or 20-mA Current Loop
- Reverse video or standard video



ONLY
\$799

+ S.T. if applicable F.O.B. Ex System

MAKING a powerful expandable system from the leaders in 6809 technology.

PROCESSOR

The heart of the system is the Motorola 6809 CPU considered to be the most powerful 8-bit Micro-processor available today. The CPU board is fitted with Memory Management hardware which allows it to directly address up to 1 Megabyte of memory using a 20 Bit address buss. The system is provided with a 2716 compatible 2k Monitor Rom or Eprom.

NEW FEATURE: A programmable interrupt time is fitted on the motherboard to provide multi tasking/multi user operation

MEMORY

A 64k Ram board is provided as standard. However the system may be provided with as little as 8k if desired and more added later.

INPUT/OUTPUT

8 I/O Board slots are provided, each of which may be fitted with a dual serial or dual parallel interface board using "D-TYPE" connectors. Many other types of interface boards are available.

NEW FEATURE: Led displays are provided to indicate which I/O channels are being accessed by the processor.

PERIPHERALS

Additional VDU's, DOT MATRIX PRINTERS, DAISY WHEEL PRINTERS, 8" FLOPPY DISK SYSTEMS AND A HARD DISK DRIVE OF UP TO 40MB May be connected to the system.

Interface boards and software are available to support all these devices in a SINGLE or MULTIUSER ENVIRONMENT.

NEW FEATURE: Dual 13.5 cm (5 in.) DS DD Minifloppy Disk Drives and a double density Controller.

POWER SUPPLY

Provides a nominal 8.9V, +12V, -12V Unregulated supply to the buss. All components are P.C. board mounted and fuses readily accessible.



ONLY
\$3500

+ S.T. if applicable F.O.B. Ex System

**ENQUIRIES FROM: AVAILABLE FROM OFFICES AND SHOWROOM PARIS RADIO ELECTRONICS,
SHOP 1, 165 BUNNERONG ROAD, KINGSFORD, NSW 2032. TEL. (02) 344 9111. TELEX AA22579.**

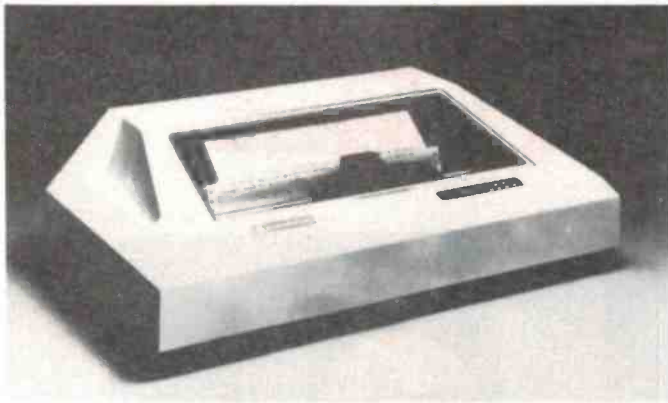

'COLOUR SCRIBE' PRINTER

Datascape has introduced a range of Anadex colour printers that provide rich colours and sharp resolutions to allow you to take full advantage of your computer's colour graphics.

The 'Colour Scribe' has sixteen discrete and simple control code sequences to identify colour shades, eliminating escape strings for colour mixing, etc. The printer also has absolute position capability.

It has the ability to back up and place the print head at any location on the paper, allowing proper merging of graphics and text via a two-pass technique.

'Colour Scribe' becomes a

high quality text printer by replacing the colour ribbon with an extended life, black only, ribbon cartridge.

'Colour Scribe' uses a nine-wire, dual-pass print head that guarantees enhanced quality control at 67 cps, high speed data processing at 240 cps, and dual density, dot addressable graphics (72 x 72/144 x 144).

Each printer will come with an emulation disk, providing full compatibility with the IBM Personal Computer and colour monitor, it is claimed.

For more information contact Datascape Int. Pty Ltd, 33 Grosvenor St, Neutral Bay Junction NSW 2089. (02) 909-1233.

LABTAM'S 32-BIT COMPUTER

Labtam, manufacturers of Series 3000 computers, has announced the availability of a new 32-bit computer system.

Based on the National Semiconductor 16032 chip set, the Labtam Series 32000 offers 8, 16 and 32-bit processing and the ability to run CP/M 2.2, CP/M 86, MP/M 86, MS/DOS and the UNIX compatible IDRIS on the same machine.

The Labtam Series 32000 features hardware floating point, demand paged virtual memory and a memory management unit. With Labtam's proprietary disk-buffering technique the user will have a very fast system which, it is claimed, will provide computational power equivalent to a Digital Equipment Corporation VAX 750 on a single pc board.

Labtam has also released a range of ergonomic packaging

for its systems.

At the basic level, a system in a floor standing enclosure is interfaced to a free-standing terminal workstation which includes a display with Regis graphics and 800 x 300 lines of screen resolution.

A company spokesman stated that they were not doing away with the popular desktop version of the Labtam but offering the user an alternative, via an enclosure that is more office oriented, that reduces the amount of required desk space.

Another Labtam product is a 15-slot printed circuit card motherboard which still uses the popular industry standard IEEE 796 multibus from Intel.

For information on these products contact Labtam International Pty Ltd, 43 Malcolm Rd, Braeside Vic 3195. (03)587-1444.

MICROPROCESSOR CENTRE

Paris Radio Electronics has introduced a remote computer information and message service.

This service will allow any computer user with a terminal/communications program and a 300 baud data modem (direct or acoustic) to access information related to the 68XXX family of microprocessors as well as the TRS-80 colour computer.

Information will be available on new products, software updates, price lists, technical updates, software and book reviews, public domain software which can be transferred to the

user's system, information on Tandy products, personal For Sale section (free to subscribers), etc.

To access Infocentre an application form must be completed and an annual subscription of \$25 per year paid.

The subscriber will be issued with a confidential authorisation code and message code number which are necessary to gain access to Infocentre.

For an Infocentre application form contact Paris Radio Electronics, 161 Bunnerong Rd, Kingsford NSW 2032. (02)344-9111.

POLAROID'S FLOPPY

Polaroid Corporation has announced its plans to enter the flexible disk market with a new line of premium-quality floppy disks to be available in the US during the first quarter of 1984.

Under agreements with Perfectdata Corporation and Permabyte Magnetics, Inc. both

of Chatsworth California, Polaroid will develop premium-quality 8", 5 1/4" and sub-4" floppies. Media supplied by Polaroid will be converted into finished disks by Permabyte Magnetics, to be distributed in the US and selected international markets by Polaroid and Perfectdata.



APPLE'S COMPUTER CLUB PLANS

As part of an international effort to assist in the organisation of computer clubs in schools, Apple Computer Australia is finalising plans for a local competition for primary and secondary students, featuring a first prize of a trip to the capital of the United States, Washington, DC.

Apple Computer Club kits, costing \$25 each, contain information for teachers on how to start a school computer club, suggestions for club activities, fundraising hints and publicity ideas. Once a school computer club is established, planned Apple support includes a bi-monthly newsletter on the

activities and achievements of club members, computer usage hint tips and technology-related articles.

Since beginning in the US a few months ago, the programme has been responsible for the formation of about 7000 computer clubs, with a year-end projection for 1984 of about 10 000 clubs.

Australian entry details for the international competition for students, launched simultaneously with the Apple Computer Clubs, will be included with each kit from Apple Computer Australia, 37 Waterloo Rd, North Ryde NSW 2113. (02)888-5888.

NEW 16-BIT CPU BOARD FOR THE S-100 BUSS

Computer Art has announced the development of a new stand-alone coprocessor CPU board for the S-100 buss called the GO-88. This board can be used either as a asynchronous coprocessor board using Intel's powerful 8088 chip on the same S-100 buss with any IEEE696 compatible 8080/85/Z80 master CPU board or as a stand-alone 8088 CPU board compatible with or exceeding IEEE696 requirements.

Changeover between these two basic hardware modes is achieved by removing one TTL chip from its socket and replacing it with a specially-wired DIP plug.

In the coprocessor mode, changeover between the existing CPU board and GO-88 is entirely under software control. Computer Art claims it has developed a fast and reliable buss exchange mechanism which, despite its asynchronous nature, meets the new IEEE696 buss exchange protocol.

GO-88 has been extensively tested at many different master and coprocessor clock frequencies and is used routinely with an

8 MHz 8088-2 and 5.5 MHz Z80B without wait states, says Computer Art.

One advantage of this capability is that each processor can operate at its maximum speed or at the maximum speed buss slaves will allow. For example, an 8088 can operate at 4.5 MHz with standard 450 ns memory, whereas a Z80 can only operate at 2 MHz.

One can also mix Z80 and 8088 code in the same program, thus bringing 16-bit processing power to an existing 8-bit computer.

GO-88 has extended (24-bit) addressing and can directly address a megabyte of memory. To enable it to be used with existing 16-bit addressed memory boards, GO-88 optionally generates Phantom to disable these boards except when they are addressed in the 64K chapter of memory to which they are allocated.

While there are several 16-bit CPU boards on the market, they require either the complete scrapping of existing 8-bit software, and most hardware as well, or as a part of the package, a different 8-bit processor which may or may not be compatible with existing Z80 software. With GO-88 your entire hardware and software investment is preserved, says Computer Art.

For further information contact Computer Art, 6 Scarborough St, Somerton Park SA 5044. (08) 295-2013.



DIGITAL OPTICAL ARCHIVE SYSTEM

Philips Data Systems has designed an electronic archive, Megadoc, which is a digital storage and retrieval system based on Digital Optical Recording (DOR).

It allows data to be entered either by optical scanning of printed documents or from Philips word processors. Pages are stored either as digitised images or as alphanumeric data.

Documents can be of any size and may have different type faces and contain handwritten notes and diagrams.

Megadoc systems can be configured with single DOR units which have a storage capacity of 1000M per disk side and the disks can be changed manually.

The system also includes a 'jukebox' which can accommodate up to 64 disks that can be changed automatically, giving on-line access to 128G of data per jukebox. The capacity of such an archive system equals that of a traditional archive containing 2.8 m high filing cabinets stretching for 60 m.

A complete Megadoc system can include a DOR drive, a high-speed image scanner, a high-speed image printer, a

high-resolution image display and a jukebox DOR disk changer.

The file server for these peripherals is a model of the P4000 series. The configuration basically includes magnetic disc storage for input and output buffering plus keyboards and VDUs for entering commands, document descriptions and keywords.

Workstations for the system can be input/retrieval or just retrieval. Per input workstation (consisting of a scanner, an image display and a keyboard with normal VDU) up to 2000 documents per day can be captured and described.

A retrieval workstation (an image display and a keyboard with VDU) allows for a page to be retrieved in under two seconds (if a disk exchange in the jukebox must be made, the time is 20 seconds).

The maximum number of workstations depends on the system work load, but is generally around 12.

For further information contact Peter Brownlee, Philips Industries Holdings Ltd, Nth Sydney NSW. (02)925-3333. ●

Solartron

NEW
ORION DELTA
DATALOGGER

Powerful BASIC type programming
Speeds up to 500 channels per second
User prompts for easy set up
Eight tasks — each with own program

200 channels (600 with slaves)
Comprehensive range of inputs
Digital and Analogue outputs
Full range of computer interfaces

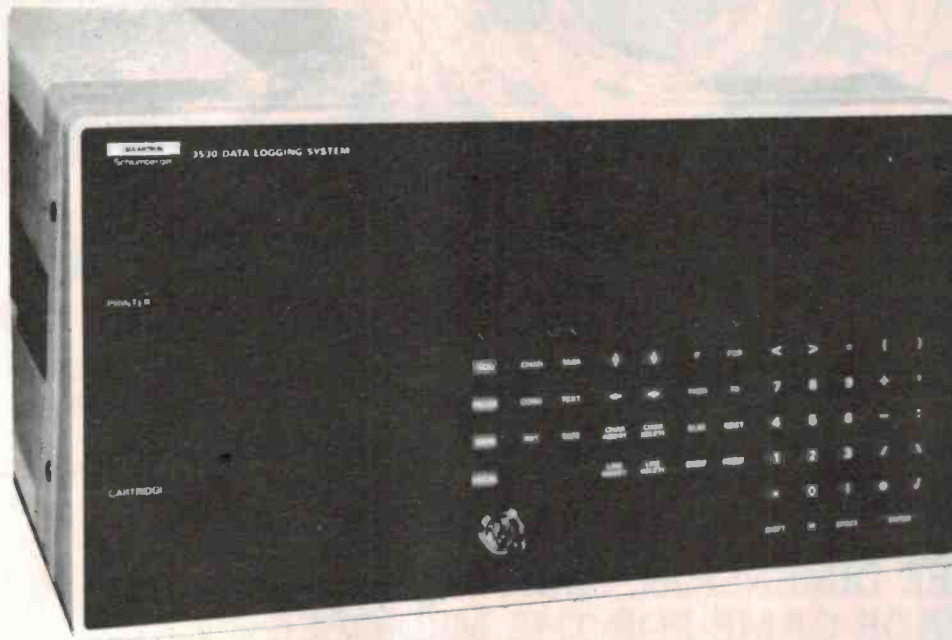

INPUTS

ORION can accept an impressive array of inputs from a wide variety of sources:

- voltage and current, both dc and ac;
- status and events;
- time periods and frequency;
- readings from remote modules;
- thermocouples and PRTs;
- strain gauges in full 1/2 and 1/4 bridge;
- magnetic and opto sensors for flow and speed;

OUTPUTS

- digital, alarms or patterns;
- analogue, voltage or current;

ORION DELTA

ORION DELTA is a natural extension of the ORION which is now accepted as the Industry standard for general purpose data logging equipment. ORION Delta has all the capabilities of the ORION, but with the addition of a powerful data processing facility. It can still handle the same wide range of 600 inputs, can run 8 different prioritized tasks, output results in engineering units and communicate with the same interfaces.

All channel results, as measured in a Task, may be manipulated by a BASIC type program which is entered at the end of a Task. The program considers the measured results as variables offering unlimited possibilities for obtaining derived results from a number of channels, reducing data output, flexible cross triggering of Tasks and sophisticated output control using both analogue and digital signals.

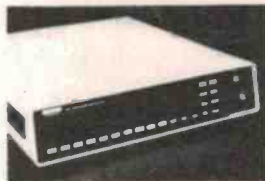

Contact your nearest Tech Sales office for a full brochure and specifications.

TECH-SALES PTY. LTD. (Inc. in Victoria)

Tech-Sales

12 Maroondah Hwy.,
Ringwood, Vic., 3134.
Telephone: (03) 879 2733
Telex: AA 30418 ELTENT

37-43 Alexander St.,
Crows Nest, N.S.W. 2065
Telephone: (02) 438 2724

Scott House,
46-48 Kings Park Rd.,
West Perth, 6005
Telephone: (09) 322 1085

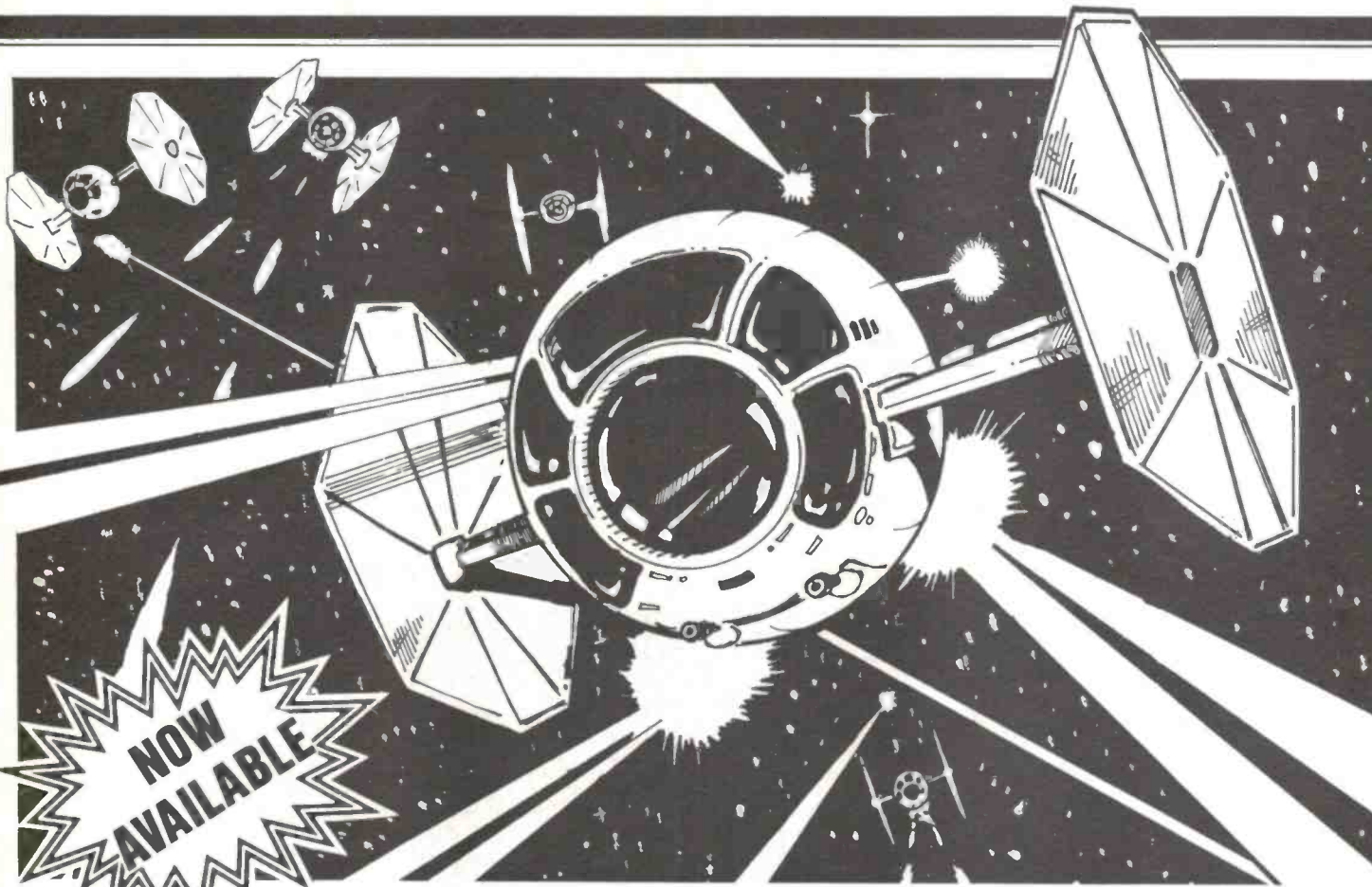

STAR STRIKER

A THREE DIMENSION, HIGH RESOLUTION
ARCADE GAME FOR THE MICROBEE

BE A JEDI !! CASSETTE \$25.00
DISK \$30.00

MYTEK DEALERS

MICROBEE IS A TRADEMARK OF APPLIED TECHNOLOGY PTY. LTD.

Altronics	Perth W A	328 1599	Microspof Computers	Fairymeadow VIC	83 5200
Aurora Data Service	Villawood N.S.W	726 5948	Mike Sanderman's	Alice Springs N T	52 2436
Ausbug	Richmond N.S.W	78 3553	TV & Computers	Darwin N.T	81 4749
Broken Hill Microbee	Broken Hill N.S.W	88 1621	Peter Kent Electronics	Tom Price W A	89 1383
Users Group	Bendigo VIC	43 7341	Pine Street Trading	Hobart TAS	31 0088
Cartridge Disk & Tape	Launceston TAS	31 7890	Quantam Computers	Melbourne VIC	347 7917
Central Data	Gorokan N.S.W	92 3021	Ritronics	Milton QLD	369 6888
Coastal Software	Coffs Harbour N.S.W	52 7530	Software 80	Salisbury S.A.	263 4456
Computed	Melbourne VIC	266 8647	Spaceland Computers	Sydney N.S.W	Erskinville
Computerland	Ballarat VIC	32 4243	Sydney Microbee	Melbourne VIC	663 3951
Computer Biz	Maroochydore QLD	43 5849	Users Group	Wauchope N.S.W	85 3311
Computer Business Aids	Lismore N.S.W	21 8180	Technical Book & Magazine Co.	Gosford N.S.W	24 7246
Compu-K	Belconnen N.S.W	51 2525	Timbertown Computers	Townsville QLD	75 4000
Computech	Nunawading VIC	878 9276	Tomorrows Electronics	Wingham N.S.W	53 5485
De Forrest Software	Cairns QLD	51 4699	Town & Country	Mount Gambier N.S.W	25 4196
Electrographic	Lindfield N.S.W	498 6556	Computer	Tawa, NEW ZEALAND	32 6999
Office Systems	Caringbah N.S.W	524 7878	The Computer Works	Vadso, NORWAY	340 8200
Flying Fox Software	Sydney N.S.W	264 6688	T & T Computing		
Hicom Unitronics Int	Carlingford N.S.W	872 4444	Checkpoint Computers		
Jaycar	Concorde N.S.W	745 3077	Schmidt Norsoft		
	Hurstville N.S.W	570 7000			
	Grenville S.A	223 7099			
	Melbourne VIC	347 1122			
Key Computer	Nunawading VIC	874 8728			
McGraths Electronics	Adelaide S.A	G.P.O. BOX 767			
Microbee Users Group					
of Australia					
Microbee Users Group of S.A.					



MYTEK COMPUTING
Suite 7, 42 Ardress St., Ardress
W.A. 6153. Tel: 364 8177

Plotting three-dimensional surfaces with your Microbee



With the advent of high-resolution graphics on computers, the construction of complex graphs and surfaces is now possible. The Microbee supports 512 x 256 graphics resolution thus giving the owner good scope for the construction of pictures that were not possible a few years ago. The following programs deal with one method to 'plot' three-dimensional surfaces on the Microbee screen and also to a printer.

Jon McCormack

TWO-DIMENSIONAL graphs are a natural for computers since most use a cartesian plane for the 'setting' (turning on) or 'resetting' (turning off) of individual pixels, the dots on the screen. However, when one wants to draw real three-dimensional objects the task becomes more difficult. No matter what method is used, all rely on the use of false perspective — the same as you use to draw 3D pictures on paper. The best method involves feeding in a three-dimensional description of the object to be drawn to the computer. After receiving this information, the computer can then draw a skeletal image of the object. This skeleton is then 'filled in' using complex techniques of shading. (The darker the area the further away it appears.) This method results in a superb illusion of reality. Examples of this can be seen in the Walt Disney film "TRON".

The one disadvantage of this method is

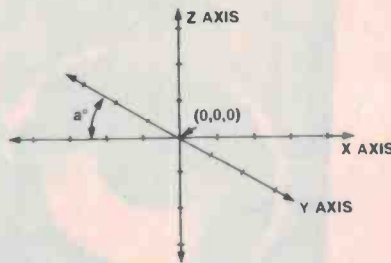

Figure 1. Representation of (X, Y, Z) axis on a 2D plane. The angle 'a' is usually set to 30°.



Figure 2. This shows the representation of the surface $Z=0$, $-100 < X < 100$, $-100 < Y < 100$. The surface is made up of square 'patches'.

that it requires *huge* amounts of memory and very high resolution graphics, both of which are not yet available to the average enthusiast!

The method used in the following programs just draws the skeletal image and even then does not account for all aspects of perspective drawing. Basically, the program fits a number of square 'patches' to the surface described by a mathematical equation. The illusion of a third dimension is achieved by placing the y axis at an angle to the x and z axes.

This is shown in Figure 1. The angle 'a' is usually set at 30 degrees. Note that the 'vanishing point' (Where all lines of perspective meet) is assumed to be infinitely far away and thus parallel lines going down the y axis are assumed to never meet. All this is best illustrated by Figure 2 which shows a graph of $z = 0$, where $-100 < x < 100$ and $-100 < y < 100$. The 'patches' can be easily seen.

JAYCAR - No.1 FOR LOW PRICES IN '84

SCOOP!

8" CEILING GRILLES

- Will they ever be this cheap again?

Once again - a massive scoop purchase with a difference. We have purchased a very large quantity of 'reject' grilles. They are rejects because they have small flaws in the mouldings. Most people however cannot pick the flaws if allowed to examine the grille. Imagine what the flaws look like *9 feet up* on the ceiling! Naturally we are offering a massive saving over normal units which we also sell. Exactly the same units (sans flaws) have been sold throughout Australia in the 10's of 000's. The perfect ones sell for around \$2.95 - at least one company sells them for well over \$3.00.
Cat AX-3560

WHAT PRICE US?

1-4 UNITS \$1.50
5-19 UNITS \$1.25
20-49 UNITS \$1.15
50 + UNITS 99¢

PRICES INCLUDE TAX

PA INSTALLERS - GO FOR IT!

TAKES STANDARD 8" SPEAKERS



FROM 99¢

SILICON SOLAR CELL

★ Size: 12 x 20mm ★ Power 45V @ 20mA (min) ★
Cat. ZM-9001

NORMALLY \$1.95
APRIL ONLY \$1.50 ea

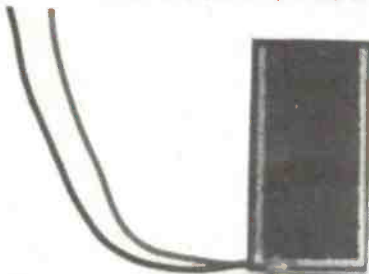

UNBELIEVABLE 'PHILIPS' SPEAKER BARGAIN

We have made a massive scoop purchase of genuine quality Philips European made Hi Fi speakers. They are so good they are used in the fabulous ETI 4000 series Hi Fi. If you thought the 4000/1 or 4000/2 systems were out of reach of your pocket - THINK AGAIN!

4th YEAR!!

GIANT EASTER SHOWBAG BACK!

This bag has become legendary in the value-for-money it provides as thousands of enthusiasts in Australia will testify. This year we are NOT SAYING what goes into the bag EXCEPT that it will have 50% MORE in it than last year - at NO extra cost!!!

HOW DO WE DO IT??

Once again, because of the tremendous amount of work in preparing the bags the quantities are strictly limited so be EARLY! Finally, we advise that not all bags are the same (like an Aussie meat pie) but each is outstanding value - we guarantee it!

Whoops sorry! Like last year p&p \$2 - we can't do anything about the enormous WEIGHT of the bag!!



\$5⁵⁰



uniden®

WORLDWIDE RADIO MODEL CR-2021



SPECIFICATIONS:

- AM/SSB/CW/FM
 - 150kHz - 29.999MHz (AM/SSB/CW)
 - FM - 108MHz
 - Triple superhet (AM/SSB/CW)
 - 3-way power AC/Batts/DC (Car)
 - Backup batteries for memory
 - Will memorise up to 6 preset frequencies
 - It's also a scanner! Will scan the HF band between pre-set limits, FM scan as well!
 - Narrow band filter
 - Facility for ext. antenna and earth
 - Size: 320 x 155 x 65mm. Weight 2.1kg
- Quite frankly we are astounded at the quality of this unit. It is one of the smartest looking modern radios around! Each unit comes with an extensive manual which includes detailed info on Short Wave Listening as well as a comprehensive list of major Short Wave stations, their frequencies and their correspondence address.
HURRY STOCKS ARE STRICTLY LIMITED - SO ACT NOW!
Cat. DR-6010

\$299 SAVE!

SAVE UP TO \$105

WOOFER AD12250/WB
NORMALLY \$99.50 SAVE \$30.00
THIS MONTH \$69.50
LOW MID AD70620/M8
NORMALLY \$32.50 SAVE \$5.00
THIS MONTH \$27.50
HIGH MID AD02161/SQB
NORMALLY \$44.95 SAVE \$5.00
THIS MONTH \$44.95
TWEETER AD0160/T8
NORMALLY \$19.95 SAVE \$4.00
THIS MONTH \$15.95
\$201.90 value for \$157.90 SAVE \$44
EVEN CHEAPER for a stereo set i.e. 2 each of the above \$315.80
SPECIAL 8 PIECE SET PRICE \$299!!
Normal price for 8 speaker set \$399!!
Crossovers 2 x 4 (ETI4000/1) \$200 Cat. CX-2637
2 x 3 (ETI4000/2) \$129.50 Cat. CX-2627

UHF AMPLIFIER SENSATION

AMATEURS PLEASE NOTE!

NORMALLY \$39.95

Jaycar has purchased a quantity of genuine Brand New MOTOROLA Brand MHW-710-1 UHF Power Amplifier modules. These units are designed for Industrial and commercial FM transmitters!
The unit (pictured) is a rugged, tuned train of RF Power Amplifier transistors featuring thin film gold metal metallization, laser trimmed Nichrome resistors and MOS capacitors. The MHW-710-1 bolts to any flat surface (metal) to assist heat dissipation.

50% OFF!!

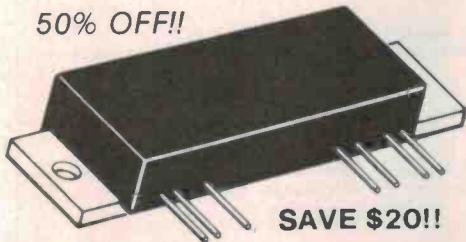

SAVE \$20!!

ONLY \$19.95

Includes FREE amateur TV transmitter circuit and full data on device!!

SOLDERING IRON TEMPERATURE METER

ENGINEERS & OTHER PROFESSIONALS PLEASE NOTE!
This compact, easy-to-read unit has a calibrated thermocouple to accurately measure the temperature of your soldering iron. Most adjustable temperature controlled irons don't have a readout so you don't know what the temperature is! Simply allow your iron to reach temperature and touch it to a point on the front of the meter. The movement is sensitive enough to be driven direct from the thermocouple junctions. No batteries are needed and the meters should last forever. The scale is easy to read, calibrated in °C and also gives coloured bands to identify correct soldering temperature. It is a must for the professional who cannot afford bad solder joints or overheated boards (especially plated-thru PCB's)
Cat. QT-2100

NORMALLY \$29.95

APRIL ONLY \$19.95

Quantities strictly limited!

EASY TO USE!

Apply solder to the tip of soldering iron and then press the temperature sensor as shown.

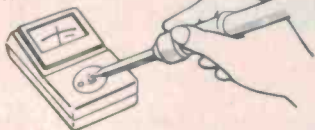

YELLOW LEDS A Jaundiced View?

We're taking a jaundiced view of round yellow LED's in April. Catch us while we're weak and you'll save!!

	3mm YELLOW LED			
Cat. No.	1-9	10-24	25-99	100+
ZD-1750	20¢(28¢)	18¢(25¢)	14¢(25¢)	13¢(25¢)
	5mm YELLOW LED			
ZD-1720	20¢(30¢)	18¢(25¢)	15¢(25¢)	14¢(25¢)

Normal prices shown in brackets - check the savings!!

AC126 - Collectors Item

Will they ever be auctioned at Christies as an antique? We don't think so but they are the genuine TO-1 case PNP Germanium device.
Cat. ZT-2040

NORMALLY \$1.20

APRIL ONLY 1/2 PRICE

60¢ each

IONISER KITS

COMPLETE KIT

- High efficiency emitter head - Fits completely inside a high quality ABS box (NOT a metal lid) - Only 2-core mains flex protrudes from the box - You can pay over \$80 for a built-up inferior unit!
Cat. KJ-6511

NORMALLY \$45 THIS MONTH ONLY

\$29 SAVE \$16

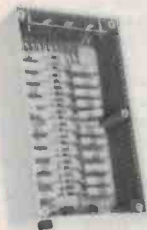

SHORTFORM KIT

- runs directly from 240V mains
- low power consumption
- produces high intensity electric field
- output around 7.5kV
- will not necessarily produce ozone in standard form
- ideal for those who wish to 'try' an ioniser at an economical price.
Cat. KJ-6510

NORMALLY \$24.50

APRIL ONLY \$15.00

AM TUNER KIT

Ref: EA Dec/Jan 1982/1983

No room for specs. but they ARE magnificent.

APRIL ONLY \$20 OFF NORMALLY \$149

APRIL \$129



30W « 30W Stereo pre-amp STEREO AMPLIFIER

- Fully built and tested
 - Separate bass, treble, balance and volume controls
 - Less than 0.1% distortion
 - Mic, phono and aux inputs (line)
 - Power supply components on board
- Back at last! No hassle amplifiers. Just connect a transformer, speakers, a signal and you're away!

ONLY \$34.95

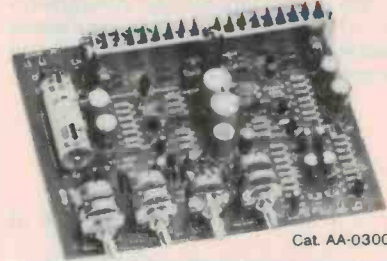

Cat. AA-0300

28 PIN IC SOCKETS

The Cheapest in the WORLD??

Well maybe, maybe not. But we think - maybe! Quality production types.

Cat. No.	1-9	10-24	25-99	100-999	1000
PI-6507	40¢(50¢)	30¢(45¢)	25¢(45¢)	20¢(45¢)	15¢

Normal prices shown in brackets - check the savings!!

TO-3 TRANSISTOR COVERS

Quality UK-made by Jerilyn. Sold in Australia by McMurdo. Normally fairly expensive but not in April!!

CHECK OUR PRICES

Cat. ZM-9902

1-9 30¢ ea SAVE 5¢
10-24 24¢ ea SAVE 6¢
25 UP 20¢ ea SAVE 10¢

CONDUCTIVE PLASTIC BAGS

Manufacturer's distress stock - you Reap the Benefit!

Jaycar has made a scoop purchase of heavy duty conductive plastic bags with inbuilt zipper closer. Each bag measures a generous 280 high x 205 wide. They will accommodate complete S-100 boards, RAM cards etc. You can store your precious ICs in them safely. (The bag would hold hundreds of ICs). Quantities strictly limited. First in first served.
Cat. ZB-9990

1-4 BAGS \$2.00
5-9 BAGS \$1.50
10 Up BAGS \$1.00 (each)

10" ELECTRIC GUITAR SPEAKER

Quality Pioneer brand - check the specs! Check the price!!
HURRY

Impedance	8 ohms
Voice Coil dia.	1 1/2"
Power Rating	60W (RMS)
Resonant Frequency	80Hz
Sensitivity	98dB/W
Response	80Hz - 7,000Hz
Total Flux	61,100 Maxwell
Flux Density	8,300 Gauss
Net Weight	1,540 grams

ONLY \$29.95

Jaycar

Incorporating ELECTRONIC AGENCIES

SYDNEY

SHOWROOMS

117 YORK STREET - PHONE: (02) 264 6688 and (02) 267 1614

TELEX: 72293

CARLINGFORD

Cnr. CARLINGFORD & PENNANT HILLS ROAD - PHONE: (02) 872 4444

CONCORD

115 - 117 PARRAMATTA ROAD - PHONE: (02) 745 3077

HURSTVILLE 121 FOREST ROAD - PHONE: (02) 570 7000

NUMBER 1 FOR KITS

POST AND PACKING CHARGES

\$5 - \$9.99 (\$1.50)	\$10 - \$24.99 (\$3.20)
\$25 - \$49.99 (\$4.50)	\$50 - \$99.99 (\$6.50)
\$100 - \$198 (\$8.00)	Over \$199 (\$10)

Free INSURANCE for Road & Registered Post over \$200

All heavy or bulky items (over 20kg.) sent Comet Road Freight \$12.00 anywhere in Australia.

SHOP HOURS CARLINGFORD, CONCORD & HURSTVILLE

Mon - Fri 9am - 5.30pm; Sat - 9am - 12pm; Thurs night 8.30pm (Not Concord)

SHOP HOURS SYDNEY

Mon - Fri 8.30am - 5.30pm; Sat - 8.30am - 12pm; Thurs night 8.30pm

MAIL ORDERS AND CORRESPONDENCE: P.O. Box 185, Concord, 2137

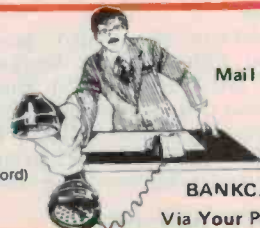

Mail Order By



BANKCARD

Via Your Phone

3D Microbee

3D using hires graphics

The first listing is a program to plot 3D surfaces using standard Microbee HIRES graphics. The equation of the surface to be plotted is put in at line 1020. The most important part of the program is the subroutine at line 2000. This subroutine converts real three-dimensional co-ordinates (x, y, z) to their perspective-corrected equivalents (u, v). The conversion relies on two simple formulae:

$$u = x - (y * \cos(a))$$

and

$$v = z + (y * \sin(a))$$

where 'a' is the angle to the horizontal of the y axis.

The angle 'a' is variable A1 in the program; this is set at line 215. The value in the listing is 30 degrees (don't forget if you wish to change the angle the value is in radians).

The two nested loops in lines 220-270 draw the horizontal lines along the x-axis, the loops in lines 280-340 draw the lines along the y-axis. Operation of the rest of the program can be seen from the comments.

Having typed in the program you are ready to go. First, run the program with the equation shown at line 1020. The program will first ask four questions. For the first two, answer eight. This means there will be eight lines describing the surface plus one end line. For the next two inputs use a domain of -80 to 80 for both. Now sit back and relax and watch your little 'Bee do its stuff. A few moments later you should have the completed surface on your screen.

Try changing the angle of perspective and the equation itself. Note how equations must be 'corrected'—the length of each dot on the screen is equal to one unit. Thus if you wanted to see $\sin(x)$ over a complete period, with a domain of -50 to 50 you would have to use $\sin(x/31.8309)$ [$100/31.8309 = \pi$, domain is 100]. Some interesting sample equations are listed later on.

Still with the original equation, try an x domain of -200 to 200 and a y domain of -100,100. All goes well until... BEEP! You have a graphics error. After the error, if you type "PRINT USED" you will see that all 128 Programmable Graphics Characters (PGC) have been used up. This is the price one must pay for such high resolution. (If the 'Bee still had 512 x 256 resolution and direct-mapped screen memory, 16K of video RAM would be required!).

Wouldn't it be nice to be able to get full 512 x 256 resolution without running out of memory? Well it is... on your printer!

Plot 3D surfaces on your printer

Most modern dot matrix printers are equipped with a feature known as BIT IMAGE GRAPHICS (BIG). This is where the printer stops printing alpha-numeric characters and, instead, will print individual dots according to the input given. Almost all dot matrix printers have this feature

3D surface plotter for standard Microbee hi-res graphics.

```
00100 rem >>> 3 DIMENSIONAL SURFACE PLOTTER FOR MICROBEE <<<
00110 rem >> by Jon McCormack, 9 Robinson St., EAST BRIGHTON <<
00120 rem
00130 cls
00140 input "How many lines resolution , x-axis ? ";N
00150 input "How many lines resolution , y-axis ? ";M
00160 input "What is the domain of x (min,max) ? ";X0,X1
00170 input "What is the domain of y (min,max) ? ";Y0,Y1
00180 cls : hires
00190 rem ** Work out values for line positions **
00200 N0 = (X1-X0) / flt(N) : M0 = (Y1-Y0) / flt(M)
00210 A = 256 : B = 128
00215 A1 = 0.52359878 : S1 = sin(A1) : C1 = cos(A1) : rem ** A1 is perspective
      angle to horizontal **
00220 for Y2 = Y0 to Y1 step M0
00230 for X2 = X0 to X1
00240 gosub [X2,Y2] 1000 : rem ** Work out equation **
00250 gosub [X2,Y2,Z2] 2000 : rem ** Convert 3D co-ordinates to 2D equivalents **
00260 set A + U , B + V / 2
00270 next X2 : next Y2
00280 rem ** Now plot lines along y axis **
00290 for X2 = X0 to X1 step N0
00300 for Y2 = Y0 to Y1
00310 gosub [X2,Y2] 1000 : rem ** Work out equation for these values of x2,y2 **
00320 gosub [X2,Y2,Z2] 2000 : rem ** Convert 3D co-ordinates to 2D equivalents **
00330 set A + U , B + V / 2
00340 next Y2 : next X2
00350 stop
01000 rem ** This subroutine has the equation to be calculated **
01010 var (X2,Y2)
01020 Z2 = 150/((X2*X2/1000)+(Y2*Y2/500)+1)
01030 return
02000 rem ** This subroutiene converts 3D co-ordinates to perspective drawn 2D
      plotting positions **
02010 rem ** Variable A1 is the value of the slope **
02020 var (X2,Y2,Z2)
02030 U1 = X2 - Y2 * C1 : rem ** C1 is cos(A1) **
02040 V1 = Z2 + Y2 * S1 : rem ** S1 is sin(A1) **
02050 U = int(U1) : V = int(V1)
02060 return
```

Listing 2a. BASIC program to print 3D surfaces to your printer.

```
00100 REM >>> 3 DIMENSIONAL SURFACE PRINTER FOR MICROBEE <<<
00110 REM >> by Jon McCormack, 9 Robinson St., EAST BRIGHTON <<
00120 REM
00130 CLS
00140 INPUT "How many lines resolution , x-axis ? ";N
00150 INPUT "How many lines resolution , y-axis ? ";M
00160 INPUT "What is the domain of x (min,max) ? ";X0,X1
00170 INPUT "What is the domain of y (min,max) ? ";Y0,Y1
00190 REM ** Work out values for line positions **
00200 N0 = (X1-X0) / FLT(N) : M0 = (Y1-Y0) / FLT(M)
00210 A = 512 : B = 256 : E = 8192 : F = B / 8 * A : GOSUB 3000
00212 C = A / 2 : D = B / 2 : REM ** position for (0,0,0) **
00215 A1 = 0.52359878 : S1 = SIN(A1) : C1 = COS(A1) : REM ** A1 is perspective
      angle to horizontal **
00220 FOR Y2 = Y0 TO Y1 STEP M0
00230 FOR X2 = X0 TO X1
00240 GOSUB [X2,Y2] 1000 : REM ** Work out equation **
00250 GOSUB [X2,Y2,Z2] 2000 : REM ** Convert 3D co-ordinates to 2D equivalents **
00260 GOSUB [C+U,D+V] 4000
00270 NEXT X2 : NEXT Y2
00280 REM ** Now plot lines along y axis **
00290 FOR X2 = X0 TO X1 STEP N0
00300 FOR Y2 = Y0 TO Y1
00310 GOSUB [X2,Y2] 1000 : REM ** Work out equation for these values of x2,y2 **
00320 GOSUB [X2,Y2,Z2] 2000 : REM ** Convert 3D co-ordinates to 2D equivalents **
00330 GOSUB [C+U,D+V] 4000
00340 NEXT Y2 : NEXT X2
00345 GOSUB 5000
00350 STOP
01000 REM ** This subroutine has the equation to be calculated **
01010 VAR (X2,Y2)
01020 Z2=1:REM Z2 = 100/((X2*X2/1000)+(Y2*Y2/500)+1)
01030 RETURN
02000 REM ** This subroutine converts 3D co-ordinates to perspective drawn 2D
      plotting positions **
02010 REM ** Variable A1 is the value of the slope **
02020 VAR (X2,Y2,Z2)
02030 U1 = X2 - Y2 * C1 : REM ** C1 is cos(A1) **
02040 V1 = Z2 + Y2 * S1 : REM ** S1 is sin(A1) **
02050 U = INT(U1) : V = INT(V1)
02060 RETURN
```

continued...

BASIC program to print 3D surfaces to your printer.

```

03000 REM ** CLEAR MEMORY VIA MACHINE LANGUAGE SUBROUTINE **
03005 PRINT "Clearing memory , please wait."
03010 USR(7680,F)
03020 DIM W(8)
03030 FOR X = 0 TO 7
03040 READ W(X) : NEXT X
03050 DATA 1,2,4,8,16,32,64,128
03060 PRINT "Ready." : RETURN
04000 REM ** This subroutine stores a given value into memory **
04010 VAR (Q,P)
04015 CURS 20,8:PRINT "co-ordinates : ";J0"; ", ";PI"
04017 IF Q<0 OR Q>A OR P<0 OR P>B THEN RETURN
04020 Z = P / 8
04030 I = P - Z * 8
04040 G = A * Z + A - Q
04050 H = PEEK(E+F-G)
04055 K = -(H AND W(I))
04060 IF K THEN RETURN : REM * If bit set then return *
04070 H = H + W(I) : POKE E+F-G,H
04080 RETURN
05000 REM ** This subroutine prints the graph to the printer **
05010 OUTLN1 : REM ** Set printer output **
05020 LPRINT "3D Surface platter by Jon McCormack."
05025 POKE 7768,B/8 : USR(7692,A)
05030 LPRINT
05035 LPRINT CHR$(27);"@";
05040 RETURN

```

although the method of getting into this mode and printing dots differs on different printers. Bit image graphics are not possible on daisy wheel printers.

The second program shows how to draw 3D surfaces on your printer. For this program to operate correctly you will need the following:

1. A 32K Microbee. It is not essential to have 32K but in order to get full 512 x 256 resolution, 32K is required. With 16K only 256 x 256 or 512 x 128 resolution can be obtained.

2. An Admate DP-80 dot matrix printer. (This is the printer sold by Applied Technology for the Microbee.) However if you have another printer don't go out and sell it yet. the DP-80 is identical to almost all the XYZ-80 printers (this includes FAX-80, BX-80, ALPHA-80, CP-80 etc., etc.) and I understand (though I haven't tested it) even the Epson MX-80. Even if you don't have any of these printers the program can be modified to accept other printers.

3. Time. Depending on the complexity of the equation the computer may take up to half an hour to come up with the goods. It is a good idea to have the kettle and a pack of cards at the ready.

Now onto the program — it is in two parts. The first is the BASIC listing which does most of the maths. The second is in machine language and performs the things that the Z-80 does best: clearing and moving memory. If you can't be bothered typing in all the listings, send \$9 to the author for a cassette of all the programs listed. (Don't forget to tell me your address!)

The BASIC part appears similar to the first listing for screen graphics — essentially the same method is used. However, instead of setting graphics dots on the screen the dot is set in the 'Bees' memory. To see how this works it is necessary to understand how the printer prints bit image graphics.

Figure 3 shows a diagram of the print head. The head has nine wires which print the dots on the paper. Normally, the head

prints a series of seven columns of these dots to form a letter or number. The sequence of printing these columns of dots is controlled by the printer's internal microprocessor. In the bit image mode the user (computer) controls the sequence in which the dots are set. According to the value sent to the printer while in the BIG mode certain dots are set. In this mode only eight of the nine dots are used. Because of this it is necessary to change the length of a form feed entering the BIG mode. The Admate printer has two different graphics modes; one with 640 x 8 dots per line (lores) and 1280 x 8 dots per line (hires). For most applications the lores mode is enough.

Before the 3D 'picture' can be printed the whole thing is stored in a huge chunk of memory (16K for 512 x 256) by a method known as *bit mapping*. Each bit represents a graphics pixel. If the pixel is on then the bit is set. Now there are eight bits in one byte — the same number as there are wires in the print head. Thus, each byte prints one eight-dot column and 512 of these make up one line. Since each byte in the memory

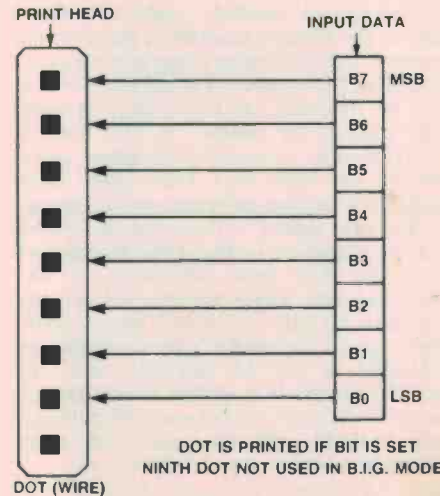

Figure 3. Diagram of the print head. Once set into the Bit Image Graphics mode ('ESC' 'K' is sent to the printer to set up this mode), the individual bits in each byte of input data control the setting of the dots on the printer.

array used to store the graph before printing is contiguous, dumping the memory in 512 byte blocks will print the 3D surface. If you are in the dark about how this all works then take a look at Figure 4.

How the program works

As mentioned earlier the basic part of the program is very similar to the first program. Instead of setting the point calculated on the video screen it is set in the 512 x 256 bit grid of Microbee memory. The subroutine at line 4000 does this. The rest of the BASIC part of the program can be understood from the comments and the first listing. The Machine code listing contains two main subroutines that are called by the BASIC program. The first, CLEAR, clears the block of memory to be used to store the surface before printing. The amount of memory to be cleared is sent to the BC registers via the BASIC 'USR' command (line 3010). The amount needed is calculated from the formula $m = (x * y) / 8$. Where x is the number of dots available on the x-axis and y is the dots on the y-axis. ▶

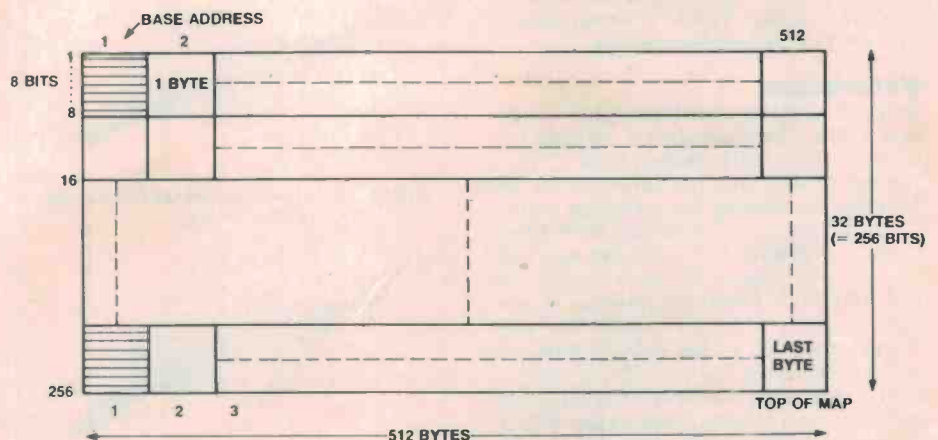

Figure 4. This diagram shows how Microbee memory is used as a bit map. Each bit represents one graphics pixel. In the diagram the size shown is 512 x 256, however, this can be changed (see text).

3D Microbee

The second machine code subroutine dumps the finished memory contents to the printer. The subroutine requires two values. The first, the number of columns, is sent to the BC registers via the USR command. The second, the number of 8-bit rows, is POKEd into a memory location called ROWS (at 1E58 hex). Once given these values the routine will print out the graph.

The plus signs (+) seen on the output are for alignment — they show the edge of the field. The other subroutines in the machine code listing are internal and are called by DUMP. To enter in the program, first type in the assembly listing (either by EDASM or the MONITOR), then the BASIC listing. It is unwise to use DATA statements to poke in the machine code part under BASIC as this uses too much memory.

How to change the parameters

There are several variables that can be changed to suit your particular amount of memory. Line 210 in the BASIC listing contains the important variables: A is the 2D x-axis length — in this case it's 512 (same as the 'Bees graphics'); B is the y-axis length. E is the BASE address for the start of storage memory. It is set at 1E00 hex (8192). However, if you have a 16K Microbee you may have to lower this value, but check that it does not overlap with the BASIC program and its storage required for variables. Also, if you change the value of E then make sure you also change the value of BASE in the machine code listing to the same value. The value of F is the total amount of memory required.

Changing the value of A and B at line 210 is accounted for in the rest of the program. Make sure that B is a multiple of 8 (eg. 64, 128, 256 etc.).

Well, that's about it. Try changing the values — many different results can be obtained. Note that, for complex equations some time is required for the computer to work out all the different values (sometimes up to 30-40 minutes!!) so when testing equations either do so on the screen version or enter a small domain and low number of lines resolution to get a vague idea what the graph looks like. Figure 5 shows various examples of the results obtained.

Extensions

To get a really high number of dots resolution requires huge amounts of memory (for example 1024 x 1024 requires 128K!!!). You can still get this resolution even with a 16K Microbee by printing the surface in parts.

Delete lines 5020, 5030 and 5035. Now, suppose you want 512 x 512 but you only have enough memory to print 512 x 256. All you have to do is run the program as normal, assuming 512 x 512 resolution, only change line 4017 in the BASIC listing to reject values in the bottom 512 x 256 part of the bit map. Now the top part of the graph will be printed. Again, changing line 4017 to reject the values in the upper 512 x 256 block will then append the bottom part to the top. ▶

Listing 2b. Machine code listing.

The subroutines are called by the BASIC program, Listing 2a. Listing 2b should be assembled first, then Listing 2a typed in.

```

ADDR  CODE  LINE  LABEL  MNEM  OPERAND
00100 ; 3 DIMENSIONAL SURFACE PLOTTER BY JON MCCORMACK .
00110 ; 9 Robinson St., EAST BRIGHTON, 3187.
00120 ;
00130 ; MACHINE LANGUAGE SUBROUTINES (CALLED FROM BASIC).
00140 ;
00150 ; SET UP VALUES FOR ASSEMBLER :
00160 ;
2000  00170  BASE    EQU    2000H    ;BASE ADDRESS FOR STORAGE
001B  00180  ESC     EQU    27
0045  00190  PRINT   EQU    0045H    ;BASIC ROM ROUTINE
00200 ;
00210 ;
00220 ;
00230 ;
00240 ;
00250 ;          CLEAR SUBROUTINE
00260 ; This subroutine clears memory from address BASE to value
00270 ; in the BC registers.
00280 ;          To use : CALL CLEAR
00290 ;
1E00  00300  ORG     1E00H
1E00  210020 00310  CLEAR  LD      HL,BASE
1E03  3600   00320  NEXT   LD      (HL),0          ;ZERO BITE IN MEMORY
1E05  23    00330  INC    HL              ;MOVE TO NEXT POSITION
1E06  0B    00335  DEC    BC
1E07  78    00340  LD     A,B
1E08  81    00350  OR     C
1E09  20F8  00360  JR     NZ,NEXT         ;CLEAR UNTIL FINISHED
1E0B  C9    00370  RET
00380 ;
00600 ;
00610 ;          DUMP SUBROUTINE
00620 ; This subroutine dumps memory to the printer. No. of rows
00630 ; is specified by memory location ROWS and collunms by BC.
00640 ;          Usage : CALL DUMP
00650 ;
1E0C  3E1B  00660  DUMP   LD      A,ESC          ;SET UP
1E0E  CD4580 00670  CALL   PRINT          ;PRINTER FOR
1E11  3E31  00680  LD     A,49           ;BIT IMAGE GRAPHICS
1E13  CD4580 00690  CALL   PRINT
1E16  C5    00700  PUSH  BC
1E17  CD4A1E 00710  CALL  CALC
1E1A  21581E 00720  LD     HL,ROWS
1E1D  46    00730  LD     B,(HL)         ;PUT NO. OF ROWS IN B
1E1E  210020 00740  LD     HL,BASE
1E21  CD391E 00750  LOOP  CALL  SETUP
1E24  D1    00760  POP   DE              ;NO. OF CHARS TO PRINT
1E25  D5    00770  PUSH  DE              ;SAVE FOR NEXT TIME ROUND
1E26  7E    00780  OLOOP LD     A,(HL)    ;PRINT BITE
1E27  CD4580 00790  CALL  PRINT
1E2A  23    00800  INC   HL

```

Figure 5. The 15 plots here and four over the page show the 'surfaces' produced by a variety of equations, illustrating the capabilities of the program.

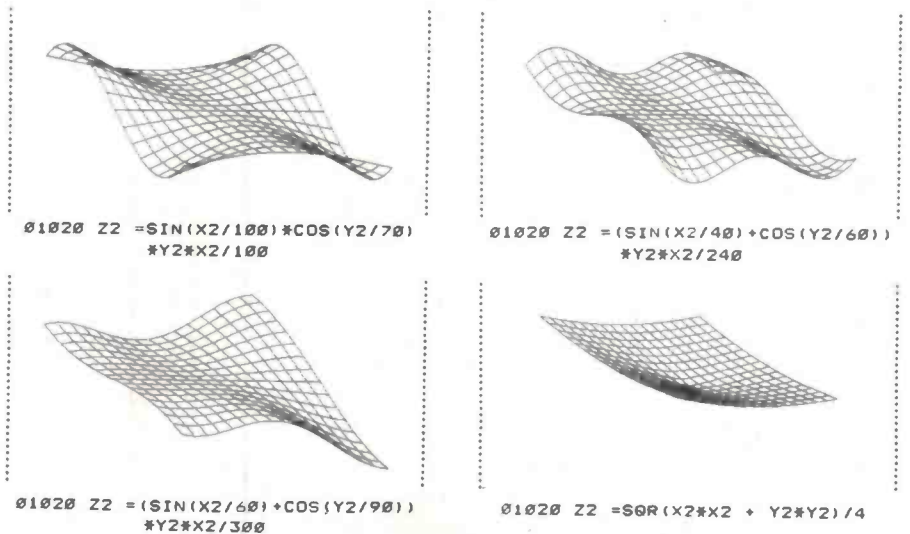



```

1E2B 1B      00010      DEC   DE
1E2C 7B      00020      LD    A,E
1E2D B2      00030      OR    D
1E2E 20F6    00040      JR    NZ,OLOOP      ;IF LINE NOT FINISHED CONTIN
UE
1E30 3E2B    00045      LD    A,'+'
1E32 CD4500  00047      CALL PRINT
1E35 10EA    00050      DJNZ LOOP           ;PRINT NEXT LINE UNTIL DONE
1E37 D1      00060      POP   DE           ;CORRECT STACK
1E38 C9      00070      RET                ;END DUMP
00080 ;
00090 ;
00090 ;      SETUP SUBROUTINE
00900 ; Sets up printer for Bit Image Graphics. Called by DUMP.
00910 ;
1E39 E5      00915 SETUP   PUSH   HL                ;SAVE HL AND BC
1E3A C5      00917      PUSH  BC
1E3B 0607    00920      LD    B,7
1E3D 21511E  00930      LD    HL,SETTBL
1E40 7E      00940 NEXTCH LD    A,(HL)      ;SET UP PRINTER
1E41 CD4500  00950      CALL PRINT        ;FOR B.I.G. MODE
1E44 23      00960      INC   HL
1E45 10F9    00970      DJNZ NEXTCH
1E47 C1      00974      POP   BC
1E48 E1      00976      POP   HL
1E49 C9      00980      RET                ;END SETUP
00990 ;
01000 ;      CALC SUBROUTINE
01010 ; This subroutine works out values for No. of Bit image
01020 ; characters to send to the printer. Called by DUMP.
01030 ;
1E4A 21561E  01040 CALC    LD    HL,VALUES
1E4D 71      01050      LD    (HL),C      ;STORE VALUES
1E4E 23      01055      INC   HL
1E4F 70      01057      LD    (HL),B
1E50 C9      01060      RET                ;END CALC
01070 ;
01080 ; Printer output table for ADMATE DP-80 Printer.
01090 ;
1E51 0A0D    01100 SETTBL  DEFW   0D0AH      ;CAR.RET. / LINE FEED
1E53 2B      01110      DEFB  '+'
1E54 1B      01120      DEFB  ESC
1E55 4B      01130      DEFB  'K'          ;SET UP BIT IMAGE MODE
1E56 0000    01140 VALUES DEFW   0000H
01150 ;
01160 ; TEMP MEMORY LOCATION USED BY DUMP
01170 ;
1E58 1F      01190 ROWS   DEFB   1FH
01200 ;
01210 ;
001F      01220      END                ;END SUBROUTINES.
00000 Total errors

VALUES 1E56 NEXTCH 1E40 SETTBL 1E51 OLOOP 1E26
SETUP 1E39 LOOP 1E21 ROWS 1E58 CALC 1E4A
DUMP 1E0C NEXT 1E03 CLEAR 1E00 PRINT 8045
ESC 001B BASE 2000

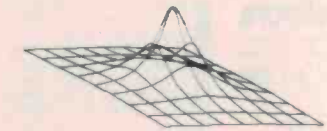
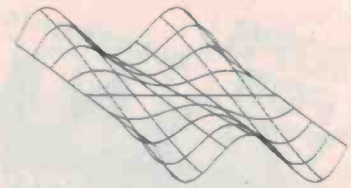
```



Plot of the equation in the listing.

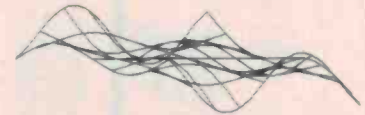
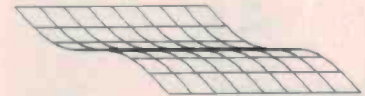

Perspective angle at 10°.

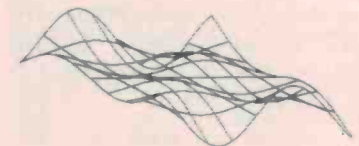

Perspective angle at 20°.



Perspective angle at 30°.

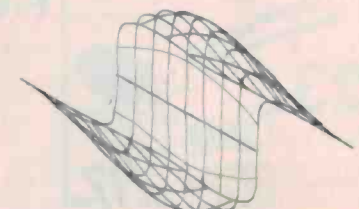

Dots in the centre area were so far apart I joined them by pen.

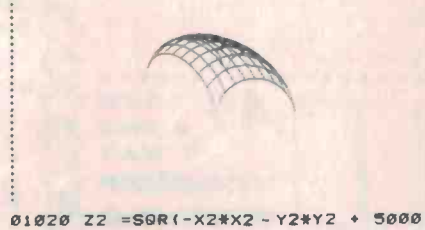
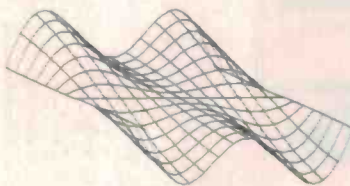

$$01020 Z2 = \text{SQR}(-X2*X2 - Y2*Y2 + 5000)$$

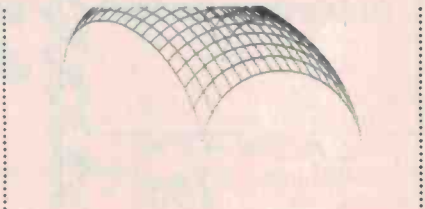
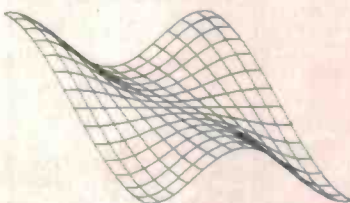

$$01020 Z2 = \text{SQR}(-X2*X2 - Y2*Y2 + 20000) * Y2*X2/100$$

$$01020 Z2 = \text{SIN}(X2/60) * \text{COS}(Y2/110) * Y2*X2/100$$

PRE-PAK

TOPS FOR VALUE
ELECTRONICS
SUPER SPECIAL OFFERS
TOO GOOD TO REFUSE!

resistors
All Wanted Values
1 ohm-10 Meg/ohm

1/2 Watt... **\$1.00**
Packs of 100 PACK ONE VALUE

PACKS OF 500 ASST. VALUES **\$2**
(Our choice)

CAPACITORS
CERAMICS
PACKS OF 100 ONE VALUE **\$4**

PACKS OF 100 ASST. VALUES **\$2**
(Our choice)

Relays

12V MINI DIL SPDT
Suits 16 pin IC SOCKET
2A contacts
NATIONAL mod. HB
10-24 \$1.75, 25-49 \$1.50

110V AC 2A cont. \$2
220V AC 2A cont. \$3
115V AC 4 pole \$3
240V AC 4 pole \$4.50
10A contacts H.O.
48V DC 3 pole \$4.50
25A contacts super Heavy Duty!

100uf 16vw, 47uf 16vw, 100uf 10vw caps ea. 3¢
4.7uf 100vw, 22uf 100vw, 47uf 25vw caps ea. 10¢
50uf 100vw, 22uf 15vw, 1uf 350vw caps ea. 15¢
2.2uf 350vw, 330uf 35vw, 10uf 315vw ea. 20¢
220uf 50vw, 400uf 40vw, 640uf 16vw caps ea. 25¢
220uf 63vw, 330uf 50vw electro caps ea. 30¢
15uf 500vw, 47uf 50vw electro caps ea. 40¢
470uf 63vw, 15uf 500vw electro caps ea. 50¢

Transistor Substitute, Jap 1981 \$3.00
12v to 6,9,12VDC 800mA car converter \$6.00
40w electronic lamp flasher 300M \$2.95
Leson power mike with compression \$14.95
30MHz CB low pass filter stops TVI \$2.50
100yd rolls multi-strand hook-up wire \$3.00
GE C37D 400v 35amp SCR's, stud mtg \$2.00
560uf + 47uf 160vw can electrolytics \$2.00
NE-2 neons, 20¢ ea or 10 for \$1 or 100 @ \$8.00
Philips NT3100, NT3101 or NT3122 EHT transformers \$4.00 ea or 5 for \$15.00

3AG in-line fuseholders, now only 5 for \$1.00
DPDT slider switches, PCB mtg. 7 for \$1.00
6.5mm stereo headphone sockets, 2 for \$1.00
3PDT rocker action switch, buy 3 for \$1.00
25C-151A only \$1.00 ea or 250-198 only \$2.00
EM-410 1000v lamp rectifiers, 8 for \$2.00
0.47uf Greencaps 100v, 10 for \$2.50, 50+ \$9.00

HEATSINKS

HUGE RANGE AVAILABLE!
3"x4" with 1xT03 TRANS. \$2.50
6"x4" with 2xT03 TRANS. \$3.00
3"x4", 3x100Piv 35A RECT. \$2

VARIETY PACK- 10 assorted sizes, all useful, only \$9.95

WANTED TO BUY...
ALL ELECTRONIC COMPONENTS, QUANTITIES LARGE OR SMALL, ALL TEST EQUIPMENT, CB RADIOS, AMATEUR EQUIPMENT, & ANY MICRO-COMPUTERS.

5 1/4" DISK DRIVES



\$199
MP1 851 SDD 250KB (Used). Fully tested, with 3 mths warranty, ex demo stock.

APPLE PRODUCTS

APPLE® 100% COMPATIBLE PRODUCTS
(®) Trade Mark of Apple

- 16K RAM CARD FOR GREATER MEMORY \$ 75
- Z-80 CP/M CARD RUNS CP/M PROGRAMS \$120
- SUPER SERIAL CARD FOR MODEMS, ETC \$190
- 80 COLUMN CARD IDEAL FOR SPREADSHEETS .. \$110
- PAL COLOUR CARD FOR GAMES, GRAPHICS ... \$100
- PARALLEL PRINTER CARD BEST AVAILABLE. \$110
- WILD COPY CARD ULTIMATE DISK BACKUP \$ 99
- SPEECH SYNTHESIZER CARD WITH SPKR ... \$ 75
- COOLING FAN ATTACHES TO SIDE OF COMPUTER \$ 55
- JOYSTICKS HEAVY DUTY, SELF-CENTERING, ADJ. \$ 49
- SLIM-LINE DISK DRIVES TEAC DRIVES .. \$365
- DISK DRIVE CARDS RUNS 1 OR 2 DRIVES ... \$ 79
- APPLE MOUSE EASY ADD-ON WITH INSTRUCTIONS. \$ 65
- GREEN-SCREEN MONITORS TILT & SWIVEL \$179
- AMBER-SCREEN MONITORS TILT & SWIVEL \$199

SPECIALS

- 200 1/2 watt assorted resistors \$1.95
- 250 mixed-up resistors \$1.95
- 25 various R1, 1/2w, bearing chokes \$1.95
- 27 various trimmer caps, range 3-120pf \$1.95
- 20 mixed trimmer pots, range 100-10k \$1.95
- 20 various non pots, sq, g, g, switched, etc. \$1.95
- 15 inst. knobs, precision, black, for use with \$1.95
- 45 assorted valve sockets, 7 pin etc \$1.95
- 10 mixed switches, rotary, toggle, slider, DPDT. \$1.95
- 1 metre desoldering iron in dispenser \$1.95
- 20 assorted zener diodes, 40w, 1/2w, etc. \$1.95
- 25 silicon diodes 1N41 and 1N4148 \$1.95
- 25 (MAD) silicon rectifiers 100 PIV 1 AMP \$1.95
- 15 assorted types, colours, 1FD's 100V gteed. \$1.95
- 3 7 core mains power leads with 3 pin plug. \$1.95
- 1 5 pin din to 5 pin din audi lead \$1.95
- 2 DPDT mini toggle switches \$1.95
- 1 1.7v nic cad pencil batteries \$1.95
- 30 metres hook up wire, 5 assist coils \$1.95
- 1 1/2m optical filter kit for CB, car stereo, etc. \$1.95
- 1 universal cable connector kit for car hi fi. \$1.95
- 3 1000uf 63v poly tail electro capacitors. \$1.95
- 1 grey foam speaker grille \$1.95
- 14 alligator clips, assist sizes, red & black. \$1.95
- 4 assist relays, various voltages, types \$1.95
- 10 in-line noise suppressor resistors for Micabs. \$1.95
- 4 50ohm 70 wu pots with knobs, vector con. \$1.95
- 3 thermal cut-out switches, approx. 70°C max. \$1.95
- 1 PCB exit assist Dial pen for making PCB's. \$1.95
- 1 set CB radio crystals, trans/rec, assist chan. \$1.95
- 1 90/700uf. #57 7 gang tuning cap. \$1.95
- 4 2uf non-polar polyester sprk over caps. \$1.95
- 4 100V 2AMP bridge rectifiers \$1.95
- 4 1000uf 25V PCB electrolytic capacitors. \$1.95
- 3 BD138 (siegler 793055) power trans. \$1.95
- 9 8 pin, 14 pin or 16 pin IC sockets \$1.95
- 100 Reles IC socket pins, make your own. \$1.95

\$1.95 *SAVE \$\$\$
PACK LOOK!

Telescopic AERIALS
170 to 875mm POPULAR TYPE
Pack of 10
for TV's pivots and swivels
* \$16
LAST FEW! BUY NOW.

TOP QUALITY AT REAL VALUE PRICES!

\$100 COMPUTER PARTS PLACE

- QT SRC2/4 Z80 SINGLE BOARD COMPUTER \$299
- COMPLETE KIT \$239, OR BARE BOARD \$ 79
- QT 64K STATIC RAM WITH 6116's & T \$395
- KIT (NO RAM) \$149, OR BARE BOARD \$ 95
- QT 256K DYNAMIC RAM (HIGH SPEED) \$695
- TELETEK HARD DISK INTERFACE \$520
- COMPURISM COLOUR VIDEO BOARD \$480
- ITHACA VIDEO DISPLAY (16LX64 DISP) \$172

USED COMPUTER BOARDS

- DG-680 APPLIED TECH. CPU BOARD \$125
- DG-640 APPLIED TECH. VIDEO DISPLAY \$125
- VECTOR GRAPHIC PROM/RAM (INCL 1K RAM) \$ 48
- VECTOR GRAPHIC BITSTREAMER I/O BOARD \$ 80
- (2 SERIAL 2 PARALLEL)
- VECTOR GRAPHIC ANALOG INTERFACE \$180
- 16K STATIC RAM BOARD \$120
- PROCESSOR TECHNOLOGY VIDEO DISPLAY \$120
- PCG CHARACTER GENERATOR FROM JADE \$180

NEW CROMEMCO BOARDS

- 4P10 4 PORT PARALLEL I/O, ISOLATED \$216
- 8P10 8 PORT PARALLEL I/O, MULTI-CHAN. \$312
- SCC CPU 4MHz Z80 SINGLE CARD COMP. \$330
- BYTESAVER 11 8K MEM/ 2708 PROGRAMMER \$180
- PRI PARALLEL PRINTER INTERFACE FOR DAISY WHEEL OR DOT MATRIX. \$180

ECONOMY FM MIC

88-108MHz
Transmits to 500 range, condenser microphone.
Normally \$14

\$10
FM wireless mikes.
De-luxe, omni-directional electret-condenser 88-108 MHz

\$23.50 EACH
New Models
SALE DUAL-PURPOSE, FM wireless or conventional
PENCIL TYPE FM WIRELESS MICROPHONE - BASIC MODEL, GOOD VALUE-FOR-MONEY. **ea. \$17.00**

BARGAIN PRICES

- SERIAL INTERFACE FOR ITOH PRINTER \$180
- 380MM TRACTOR FEED SUIT MOST PRINTERS \$180
- 4 SLOT S-100 MOTHERBOARD PCB'S \$ 17
- AXIOM THERMAL PRINTERS 120 LINE/MIN \$120

\$49 15W PAIR 8 inch 2 WAY speaker systems

at bargain prices!

famous name HI FI SPEAKERS, slightly shop soiled but there's no Al, as used in \$400 \$400 hi fi sets, or were selling these at \$79 PR, but now we need the warehouse space, o, out they go! Overall 100% 68-95% 730mm deep, weight 20 lbs. MAIL ORDERS: ADD \$25.00 FREIGHT ANYWHERE IN AUSTRALIA

5 Pin DIN → 5 Pin DIN LEAD \$1.95 1-3M LONG ea

SPEAKER BOX SALE

Walnut/Teak finish, ready-built but no front baffle. SHOP SALES ONLY
EACH **\$6**
620mm x 350mm x 225mm Deep

PACK/POST \$2 PLUS 5% OF ORDER VALUE.

LEDs

3mm Round
RED.....10¢
GREEN.....15¢
YELLOW.....15¢
5mm Round
RED.....10¢
GREEN.....15¢
YELLOW.....15¢
3x2mm Rect
RED.....20¢
GREEN.....25¢

FLASHING LED
5mm RED ONLY.....35¢
SUPER-BRIGHT LEDs
5mm GREEN.....59¢
5mm YELLOW.....59¢
DUAL-COLOR D LEDs
5mm RED/GREEN.....90¢

filter capacitors

- TESTED AND GUARANTEED
100,000uf...5v...\$2.50
150,000uf...5v...\$3.00
25,000uf...10v...\$2.00
100,000uf...10v...\$3.00
150,000uf...10v...\$3.50
15,000uf...15v...\$4.00
60,000uf...15v...\$4.50
140,000uf...15v...\$5.50
39,000uf...20v...\$4.00
10,000uf...25v...\$3.00
30,000uf...25v...\$4.50
50,000uf...25v...\$4.75
60,000uf...30v...\$5.00
3,100uf...40v...\$2.00
21,000uf...40v...\$4.50
2,000uf...50v...\$2.00
2,000uf...50v...\$3.00
23,000uf...50v...\$5.50
20,000uf...55v...\$6.00
30,000uf...60v...\$6.50
9,400uf...75v...\$4.50
4,800uf...200v...\$6.00
3,200uf...300v...\$6.00

10 FUSES for \$1

3AG
32mm x 6mm. TAKE YOUR PICK:
250mA, 500mA, 750mA, 1A,
1.5A, 2A, 3A, 5A, 7.5A, 10A,
15A, 20A, 25A, 30A, CH1AP.
PROFESSIONAL QUALITY. NEW
3AG FUSE-55c
HOLDERS 10c-15c

K-NAR APRIL SPECIALS

Start your own system with an SD Systems MPB-100, Z-80 CPU card (4MHz, 2K Eprom, front panel i/face).
Unbelievable value. **\$110**

2708/16K Eprom cards-switch selectable for 8K, full address decodable.
Unbeatable value. **\$40**

Turn your Olympia ES-100 typewriter into WP printer and full duplex terminal.
Never before value **\$160**

Steal of the year! 5 1/4" disk drives. Secondhand, in full working order.
(5 only). Full cost **\$200**

OTHER S-100 CARDS AVAILABLE AT OUR NORMAL KEEN DISCOUNTS ...

GDC-512 High-RES Graphics Card.
Unbeatable value and features **\$450**

CMC-100 Color Graphics Palette Card **\$725**

SBC-800 Single Board Computer **\$445**

FX-II Enhanced Floppy Disk Controller **\$389**

CRC-64 64K CMOS RAM card **\$593**

DRC-II 64K Dynamic Ram card **\$400**

MPU-100 10-slot bench-mount card cage **\$450**

(with boards) **\$4000**

DDU-8 Twin 8" drive unit (2MB) **\$1700**

MPC-6 Multi-channel I/O card **\$445**

ADC-32 32 channel A/D card **\$337**

All boards assembled and tested and backed with 90 day guarantee.

All unbeatable value from

K-NAR COMPUTER CARDS

PO Box 412, Dandenong 3175, Phone (03) 795 5858
Authorised distributor of SME Systems products

* Limited time offer only.
For retail prices add 20% tax.

K822

You need not own a bank to have a personal computer. Look at our prices.

48K Ram Z80 CPU with intelligent keyboard 188 function keys, 10 user define keys \$360



64K Z80 & 6502 CPU IBM look-a-like case detachable keyboard 188 function keys, 10 user define keys \$480



12" green & amber monitors high frequency, from \$110



Floppy disk drivers suitable Apple II, from \$230



Dot matrix printers using continuous and sheet paper \$275
Daisy wheel printer, letter quality \$575



Floppy Disks 5 1/4" and 8" S/S, D/S, S/D & D/D, from \$2.50



Also stepping motors
Servo motors
Synchronous motors
Digital Instruments
Presettable counters
Tachymeters &
Panel meters

Ring or send 60c postage for free catalogue.

GCS

G.C.S. Sydney — 67 Blackshaw Ave.,
Mortdale. 2223. Phone 570 1225
Wollongong — 46 Charles Road, Fairy
Meadows. Phone (042) 84-5544.
Enquiries from agents and distributors invited.

3D Microbee

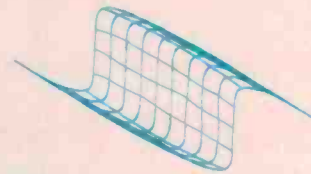

Dots in the centre joined by pen.

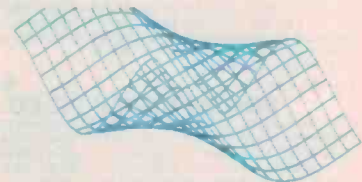

$$\theta 1020 Z Z = (\sin(X2/100) * \cos(Y2/37) + \cos(X2/60) * \sin(Y2/76)) * 60$$

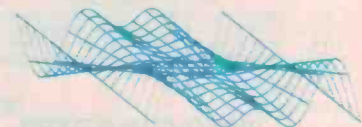

$$\theta 1020 Z Z = \sin(X2/20) * X2 * Y2 / 160$$

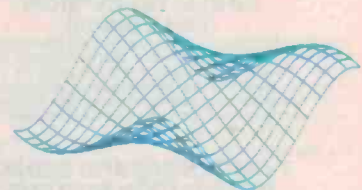

$$\theta 1020 Z Z = (\sin(X2/80) * \cos(Y2/97) + \cos(X2/40) * \sin(Y2/76)) * 60$$

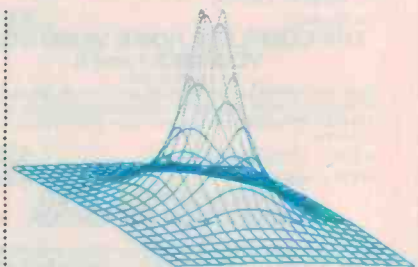

Figure 6. Full 512 x 512 dot resolution. This was obtained by printing 512 x 256 'chunks' of the complete surface (see text).

This process is illustrated in Figure 6. There is no reason why you can't break up a large resolution into more than two blocks, except that it will take a lot of time to produce very high resolution surfaces. However, this time is well worth the effort as can be seen from some of the results shown. ●

A tape listing of the programs here can be obtained for \$9.00 from the author at: 9 Robinson St, East Brighton, Vic. 3187.

JAYCAR BOOKS

VIDEO BOOKS

THE CHEAP VIDEO COOKBOOK

Complete discussion of a new, low-cost way to get words, pictures, and opcodes out of your computer and onto any ordinary TV set. Don Lancaster outlines an easy-to-build, seven-IC circuit which you can build for less than \$20. This circuit can be software-controlled to provide any alphanumeric or graphics format including a high resolution (256 x 256) and a four-colour mode.

256 Pages. 5 1/2 x 8 1/2. soft.
Cat. BS-0510 \$11.95

SON OF CHEAP VIDEO

This sequel to *The Cheap Video Cookbook* provides a complete video display system which you can build for as little as \$7. Likewise, transparency display can be created for under \$1 by using a video circuit called "The Snuffer" which is completely described in Chapter 2. This book makes cheap video even cheaper!

224 Pages. 5 1/2 x 8 1/2. soft.
Cat. BS-0604 \$15.95

VIDEO TAPE RECORDERS (2nd Edition)

In this completely revised 2nd edition of *Video Tape Recorders*, the author tells in simple language how helical VTR's work and how to operate or service them. Includes numerous examples of electronic circuits and mechanical systems.

400 Pages. 5 1/2 x 8 1/2. soft.
Cat. BS-0610 \$15.95

VIDEO/COMPUTERS

How to make full use of your home video equipment, how to transmit data over phone lines, display edited data, and more.

Cat. BS-0640 \$11.95

CABLE TELEVISION (2nd Edition)

Designed for the engineer or technician wishing to improve his knowledge of cable television. Each component of the cable system is examined separately and in relation to the system as a whole. Component testing, troubleshooting, noise reduction and system failure are discussed. Contains valuable information on the relatively new areas of fiberoptics and communications satellites.

392 Pages. 5 1/2 x 8 1/2. soft.
Cat. BS-0560 \$21.00

TV ANTENNAS AND SIGNAL DISTRIBUTION SYSTEMS

An aid in selection and installation of TV antennas and signal distribution systems, and how to implement these systems for high-quality TV reception. Includes valuable performance data based on actual measurements made by the author.

256 Pages. 5 1/2 x 8 1/2. soft.
Cat. BS-0542 \$13.95

THE COMPLETE HOME VIDEO BOOK VOLUMES I and II

Starts with elementary concepts, builds to more complex video activities, and ends with semi-professional techniques, graphics, copying a video tape, editing a video tape, planning and scripting, and more.

BOOK 1 - Cat. BS-0648 \$22.95

BOOK 2 - Cat. BS-0649 \$22.95

SINGLE-CAMERA VIDEO PRODUCTION HANDBOOK

How to produce quality video programs with tips on audio, lighting, shooting, editing, set design, graphics, putting slides and film on video tape, and more.

Cat. BS-0644 \$29.95

VIDEO FUNDAMENTALS

A practical handbook for entry-level video users. Presents • money-saving ideas on choosing the right video equipment • step-by-step instructions (with detailed diagrams) for making audio dubs, duplicating tapes, etc. • planning video programs from script development to location shooting.

Cat. BS-0646 \$22.95

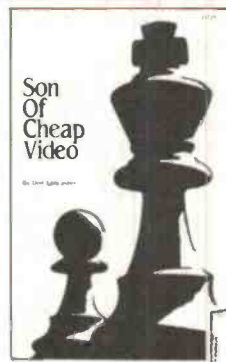

MICROBEE BOOKS

★ USERS MANUAL

Is your manual old and tattered? Or do you want a spare manual? This manual has orange coloured guide pages to find the chapter easy. Neatly bound in an attractive cover and an asset to have beside your MicroBee. Excellent value.

Cat. XB-9002 \$15.95

★ AN INTRODUCTION TO MICROBEE PERSONAL COMPUTERS AND PROGRAMMING

Just started learning BASIC? Then this is the book for you. With easy to read text and excellent examples it makes an ideal book for anyone wishing to learn to program the MicroBee.

Cat. XB-9003 \$14.95

★ WORDBEE USERS MANUAL

This manual explains fully all of the facilities available to you using WordBee. It explains everything from the basic commands through to preparing large documents and lots more. Unrivalled value.

Cat. XB-9001 \$7.95

★ EDITOR/ASSEMBLER MANUAL

This manual covers all topics needed for your MicroBee Editor/Assembler. This includes full descriptions of error messages and has a program which you are guided through by the manual for "hands-on" experience.

Cat. XB-9000 \$7.95

★ MICROSOFT BASIC

This neatly bound book contains all commands supported by Microsoft BASIC interpreter for CP/M-80. Each command is dealt with individually and commented on such as Purpose, Syntax and examples. An excellent book.

Cat. XB-9000 \$29.95

★ MICROBEE ENGINEERING NOTEBOOK

This notebook contains hardware modifications, improvements etc. Some of the modifications include printer interfaces, cassette motor control, 64K ROM pack, Joystick and lots more. Definitely value for money.

Cat. XB-9020 \$2.00

★ WILDCARDS Vol. 1

A potpourri of application notes and tips for the MicroBee. This book has received rave reviews from all computer publications. A must for all MicroBee owners.

Cat. XB-9010 \$15.00

★ WILDCARDS Vol. 2

A potpourri of more application notes. Vol. 2 continues from Vol. 1, and again is a must.

Cat. XB-9011 \$16.00

APPLE INTERFACING

Apple interfacing helps you to understand the important task of successfully interfacing your Apple computer to a variety of electronic devices. Using this book, you will be able to perform useful experiments which will provide a much clearer understanding of the fundamentals of computer interfacing and computer electronics. You will be better able to understand interactions between computer hardware and software so that you can effectively communicate with your Apple computer.

208 Pages. 5 1/2 x 8 1/2. soft.
Cat. BS-0568 \$15.95

MOSTLY BASIC: APPLICATIONS FOR YOUR APPLE II, Book 2

Provides you with 28 ready-to-use, BASIC language programs which have been completely tested and debugged for use on your Apple II. Includes a telephone dialler, digital stop watch, spelling test, a house buying guide, a gas mileage calculator, and many others useful to businessmen, hobbyists, scientists, and computer enthusiasts.

160 Pages. 8 1/2 x 11 1/2. comb.
cat. BS-0600 \$17.95

APPLESOFT LANGUAGE

Sams offers you the only complete text on Applesoft BASIC. The book is written in a self-paced, self-teaching format, using easy-to-understand, non-technical language. Apple II owners who use Applesoft BASIC are introduced to Applesoft syntax, step by step and at an easy pace. Perfect for all Applesoft programmers, including hobbyists, businessmen, and professional users. There are a number of ready-to-use programs and a section on the use of low resolution graphics.

256 Pages. 5 1/2 x 8 1/2. soft.
Cat. BS-0570 \$14.95

TRS-80 INTERFACING BOOK 1

Written for users who have a fairly good understanding of Level II BASIC. Author John Titus introduces you to the various I/O signals used by the TRS-80 and explains how these signals can be used in a number of interesting and practical circuits. Numerous hands-on experiments are included.

192 Pages. 5 1/2 x 8 1/2. soft.
cat. BS-0572 \$15.95

TRS-80 INTERFACING BOOK 2

Provides you with a number of practical and useful ways to utilize your knowledge from Book 1. Applications include how to generate voltage and current signals used in a variety of control applications, how to measure unknown voltages, how to drive high current and high voltage loads, and many more. Complete software programs are included.

256 Pages. 5 1/2 x 8 1/2. soft.
Cat. BS-0574 \$16.95

PET INTERFACING

Demonstrates how you can build numerous interfacing devices for your PET hardware. BASIC language programs are used throughout the book, so you should be familiar with this powerful programming language. The Commodore PET microcomputer has several special purpose interface connectors that ease the job of interfacing the computer to "real-world" hardware. Also includes a discussion of the microprocessor's internal architecture and general software/hardware interfacing.

264 Pages. 5 1/2 x 8 1/2. soft.
Cat. BS-0576 \$25.95



'I buy my books at Jaycar'

EXPERIMENTS IN ARTIFICIAL INTELLIGENCE FOR SMALL COMPUTERS

Conducts interesting and exciting experiments in artificial intelligence with this book, a small computer with extended BASIC, and some knowledge of the BASIC language. The author first introduces you to artificial intelligence - the capability of a device to perform functions normally associated with human intelligence, such as game playing, problem solving, reasoning, creativity, and verbal communications. Then game-playing programs, with a checkers-playing game as the main topic are explained.

112 Pages, 5 1/2 x 8 1/2, soft
Cat. BS-0512 \$12.95

CP/M PRIMER

If you are a first-time microcomputer user wanting to increase your technical knowledge or a veteran who wants to explore switching to the CP/M operating system, this book can help you find the answers. It's the only complete one-stop source available on CP/M - the very popular operating system for 8080-8085- and Z80 based microcomputers. Includes a complete list of CP/M compatible software, too!

96 Pages, 8 1/2 x 11, soft
Cat. BS-0564 \$24.95

THE COMPUTER IN YOUR LEGAL PRACTICE

by Michael Marcus & Leroy Brown

For lawyers, a book on how to computerize their practice. Applications include: law office management • data bases and research • document control • word processing • records management • accounting • electronic mail and more.

Cat. BS-0678 \$25.95
HOW TO MICROCOMPUTERIZE YOUR SMALL BUSINESS

Compiled by the staff of a major time-sharing service bureau and computer consulting firm, this book takes the technicality out of microcomputers - enabling managers to make computer decisions rationally and wisely. Case histories and step-by-step guidelines instruct readers on: data processing capabilities, equipment selection, potential pitfalls, soliciting bids, implementation and evaluation.

Cat. BS-0689 \$15.95



MS DOS: A BEGINNER'S GUIDE TO MICROSOFT DISK OPERATING SYSTEMS

by Peter Norton

An introduction to the Microsoft Disk operating system that gives the beginner a complete explanation of DOS fundamentals including DOS for the IBM-PC (over 60 computers use MS DOS or a related version). Provides handholding examples.

Cat. BS-0690 \$23.95

THE ILLUSTRATED CP/M-WORDSTAR DICTIONARY: WITH MAILMERGE AND SPELLSTAR OPERATIONS

by Russell Stultz

Saves hours retyping a letter that must be sent to an entire customer list • helps create letter-perfect correspondence • you'll be able to perform valuable work within hours.

Cat. BS-0692 \$23.95

THE ROBOTICS PRIMER: THE WHAT, AND HOW OF ROBOTS IN THE WORKPLACE

by Robert Ulrich

Designed to give managers a working knowledge of one of the fastest growing industries today. Thoroughly and accurately explains the technology of these reprogrammable, multifunctional workers and how the widespread use of robots may affect personnel.

Cat. BS-0682 \$17.95

A MANAGER'S GUIDE TO INDUSTRIAL ROBOTS

by Ken Susnjara

"A nontechnical introduction to robots. The author has installed robots in over 100 factories and guides the reader through... A down-to-earth book on an important topic." - Computerworld

This comprehensive guide includes a reference manual covering the details of installing and using an industrial robot. Also provides a glossary of robotic and technical terminology.

Cat. BS-0684 \$16.25

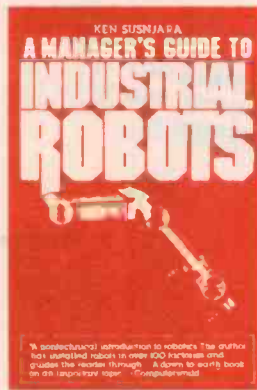

UCSD PASCAL: A BEGINNER'S GUIDE TO PROGRAMMING MICROCOMPUTERS

by J. Hume & R. Holt

Explains the UCSD Pascal system as it applies to Apple, LSH of DEC, and Z80.

Cat. BS-0704 \$19.95

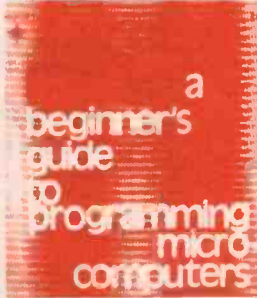

UNIX QUICK REFERENCE GUIDE

by William Wetzel

For experienced programmers, here is an easily-accessed, concise summary of the essential details of UNIX commands. This is the first 'System V Compatible' programmer's manual for UNIX.

Cat. BS-0686 \$22.95

A USER-FRIENDLY GUIDE TO CP/M 2.2

by James Perry & Robert McJunkins

For first-time users who want an easy-to-follow guide to using CP/M. Includes topics such as: built-in commands, copying a large number system files, user areas, introduction to dBASE II, altering data base contents, and more.

Cat. BS-0688 \$23.95

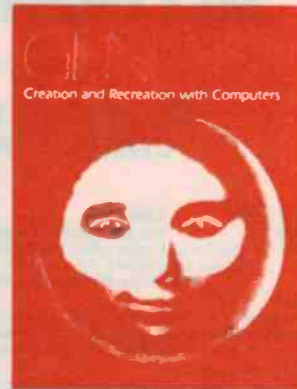

GENESIS II: CREATION AND RECREATION WITH COMPUTERS

by Dale Peterson

A full size (8 1/2 x 11) "coffee-table" book filled with computer-generated colour photographs and illustrations. Dramatically demonstrates the unique applications of computer technology in the creative arts.

Cat. BS-0694 \$33.95

THE DATA BASE GUIDE

by Charles Benton

A complete step-by-step book detailing the necessary elements for selecting, organising, and implementing data base systems for microcomputers. Provides examples of implemented data base systems.

Cat. BS-0696 \$32.00

RS232 MADE EASY: CONNECTING COMPUTERS, TERMINALS, PRINTERS, AND MODEMS

by Martin Seyer

Step-by-step demonstration of the connections between printers, CRT's, and computers employing the RS232 interface.

Cat. BS-0698 \$23.95

THE COMPUTER COOKBOOK: HOW TO CREATE SMALL COMPUTER SYSTEMS THAT WORK FOR YOU

by William Bates

Explains all components needed to create a microcomputer system. Lists over 500 hardware and software sources.

Cat. BS-0700 \$23.50

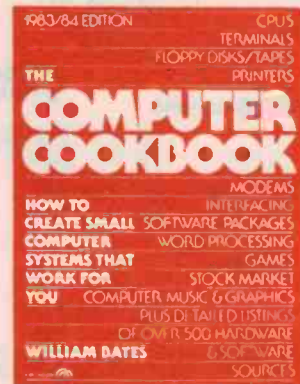

STARTING FORTH

by Leo Brodie

Over 50,000 copies already sold! Explains all standard FORTH words and commands. Describes how to write programs for simple applications.

Cat. BS-0706 \$28.75

THE VisiCalc APPLICATIONS BOOK

by Jack Grushow

Shows how to use VisiCalc for financial statement analysis, forecasting, budgeting, cash management, and more. All keystrokes and every step of using VisiCalc are provided.

Cat. BS-0642 \$25.95

Jaycar

Incorporating
ELECTRONIC AGENCIES

SYDNEY

SHOWROOMS

117 YORK STREET - PHONE: (02) 264 6688 and (02) 267 1614

TELEX 72293

CARLINGFORD

Cnr. CARLINGFORD & PENNANT HILLS ROAD - PHONE: (02) 872 4444

CONCORD

115 - 117 PARRAMATTA ROAD - PHONE: (02) 745 3077

HURSTVILLE 121 FOREST ROAD - PHONE: (02) 570 7000

NUMBER 1 FOR KITS

POST AND PACKING CHARGES

\$5 - \$9.99 (\$1.50) \$10 - \$24.99 (\$3.20)

\$25 - \$49.99 (\$4.50) \$50 - \$99.99 (\$6.50)

\$100 - \$198 (\$8.00) Over \$199 (\$10)

Free INSURANCE for Road & Registered Post over \$200

All heavy or bulky items (over 20kg.) sent Comet Road Freight \$12.00 anywhere in Australia.

SHOP HOURS CARLINGFORD, CONCORD & HURSTVILLE

Mon - Fri 9am - 5:30pm Sat - 9am - 12pm; Thurs night 8.30pm (Not Concord)

SHOP HOURS SYDNEY

Mon - Fri 8.30am - 5.30pm Sat - 8.30am - 12pm; Thurs night 8.30pm

MAIL ORDERS AND CORRESPONDENCE: P.O. Box 185, Concord, 2137



Mail Order
By



BANKCARD

Via Your Phone

MAIL ORDER

MAIL ORDER

MAIL ORDER

RITRONICS WHOLESALE PTY LTD

1st floor 425 High St. Northcote 3070 (03) 489 7099 (03) 481 1923 Telex AA 38897

**YOU WILL NEVER HAVE TO PAY FULL PRICE FOR COMPONENTS AGAIN
COMPUTER PAPER 9" x 11" 2000 SHEETS \$29.50 + TAX A BOX.**

MAIL ORDER TO P.O. BOX 235, NORTHCOTE 3070.

M4851 500K \$260 + tax.
M2896-63 THE MITSUBISHI RANGE OF DISK DRIVES
Slimline 8" Disk Drive, Double Sided, Double Density, No AC Power required, 3ms track to track, 1.6 mbytes unformatted, 77 track/side, 10⁹ bit soft error rate.
\$495 + tax. Box & Power supply to suit \$105 + tax

M2894
Standard size 8" drive, Double sides, double density, 3ms track to track access, 1.6 mbytes unformatted, 77 track/side, 10⁹ bit soft error rate.
\$475 + tax. Box & Power supply \$105 + tax

M4854
Slimline 5 1/4" disk drive, Double sides, double density, 96 track/inch, 962.1 bits/inch, 1.6 mbytes unformatted, 3ms track to track access, 77 track/side.
\$315 + tax. Box & Power supply \$75 + tax

M4853
Slimline 5 1/4" disk drive, Double sides, double density, 1 mbyte unformatted, 3ms track to track, 80 track/side, 5922 bits/inch, Steel band drive system.
\$295 + tax. Box & Power supply \$75 + tax

**10% off all Verbatim Disc prices for April
Offer ends May 15th 84.**

VERBATIM DISCS		Per Box of 10
5 YEAR DATALIFE GUARANTEE		
MD525-01	Single Sided, Double Density	soft sectored \$35.00
MD525-10	SSDD 10 Sectors 40 Tracks	43.00
MD525-16	SSDD 16 Sectors 40 Tracks	43.00
MD550-01	Double Sided, Double Density	51.00
MD550-10	DSD 10 Sectors 40 Tracks	51.00
MD550-16	DSD 16 Sectors 40 Tracks	51.00
MD577-01	SSDD Soft Sect 80 Tracks	51.00
MD577-10	SSDD 10 Sectors 80 Tracks	57.00
MD577-16	SSDD 16 Sectors 80 Tracks	57.00
MD557-01	DSD Soft Sect 80 Tracks	63.00
MD557-16	DSD 16 Sectors 80 Tracks	63.00



HI TECHNOLOGY PRODUCTS AND EXPERIENCE

LINEAR REGULATORS				
UA309KC	1.40	BU126	0.55	
UA317KC	1.95	BU326	1.40	
UA317UC	1.20	BUX80	2.00	Z80A CPU \$3.60
UA494PC	2.60	2N3771	2.30	Z80 CTC \$3.20
UA723PC	0.50	2N3772	2.50	Z80A CTC \$3.95
LM396K	15.00	2N3773	2.50	Z80 P10 \$2.90
UA7805KC	1.20	FND500	1.10	Z80A P10 \$3.40
UA7805UC	0.60	FND507	1.10	Z80 S10 \$8.00
UA7808UC	0.60	MAN74A	1.90	Z80A S10 \$10.00
UA7812KC	1.20	MAN72A	1.90	6800 \$3.90
UA7812UC	0.50	4N28	0.60	6802 \$4.90
UA7815KC	1.20	4N33	0.70	6809 \$10.60
UA7815UC	0.50	BDV64B	2.00	6821 \$2.50
UA7818UC	1.00	BDV65B	2.00	6840 \$3.50
UA7818UC	0.60	AD149	1.50	6845 \$8.90
UA7824KC	1.20	2SK134	3.50	6850 \$1.75
UA7824UC	0.60	2SJ49	3.50	8212 \$1.50
UA78L05AWC	0.27	W02	0.20	8224 \$1.70
UA78L12AWC	0.27	W04	0.25	8255 \$2.90
UA78S40DC	3.50	IN5401	0.12	8155 \$4.90
UA7905KC	1.20	IN5404	0.05	4011 \$0.20
UA7905UC	0.60	BC547	0.05	4016 \$0.45
UA7908KC	1.20	BC548	0.05	4017 \$0.50
UA7908UC	0.50	BC549	0.05	4023 \$0.40
UA7912KC	1.20	CI22D	0.65	4028 \$0.45
UA7912UC	0.60	SC141D	0.90	4040 \$0.52
UA7915KC	1.20	BU208	1.50	4051 \$0.49
UA7915UC	0.50			4066 \$0.50

HYBRID REGULATORS		MEMORY SPECIALS		
SH1605	9.50	27C16 CMOS PROM	\$9.50	74LS00 \$0.18
SH323C 3ASV	4.50	27C32 CMOS PROM	\$12.50	74LS04 \$0.18
UA78H05SC 5ASV	5.50	58725 2Kx8 RAM	\$4.50	74LS14 \$0.19
UA78H12SC 5A12V	6.00	2716 500NS	\$3.95	74LS30 \$0.20
UA78HGSC 5A variable	6.20	2732 450NS	\$4.50	74LS32 \$0.25
UA79HGSC	10.00	2764 250NS	\$7.00	74LS47 \$0.34
UA78P05SC 5A10V	12.50	4164 150NS	\$6.50	74LS90 \$0.26
		per 100 + @	\$6.00	74LS161 \$0.33
			\$28.00 + tax	74LS240 \$1.00
			\$15.00	74LS244 \$1.50
			\$25.00	74LS245 \$1.50
			\$25.00	74LS366 \$0.45
			\$3.40	74LS367 \$0.40

TRANSISTORS				
BD139	0.23	1791	\$15.00	74LS244 \$1.50
BD140	0.23	1793	\$25.00	74LS245 \$1.50
MJ802	2.40	Z80 CPU	\$3.40	74LS366 \$0.45

SCOTCHCAL RANGE OF PHOTSENSITIVE PRODUCTS.

		Per Sheet	Per Box
8001	Red on Aluminium	250mm x 300mm	\$6.50
8001	Red on Aluminium	300mm x 600mm	\$10.00
8005	Black on Aluminium	250mm x 300mm	\$6.50
8005	Black on Aluminium	300mm x 600mm	\$10.00
8009	Blue on Aluminium	250mm x 300mm	\$6.50
8009	Blue on Aluminium	300mm x 600mm	\$10.00
8007	Reversing Film	250mm x 300mm	\$ 4.00
8007	Reversing Film	300mm x 600mm	\$ 8.50
8011	Red on White Plastic	250mm x 300mm	\$48.00 (10sh)
8013	Black on Yellow Plastic	250mm x 300mm	\$48.00 (10sh)
8015	Black on White Plastic	250mm x 300mm	\$48.00 (10sh)
8016	Blue on White Plastic	250mm x 300mm	\$48.00 (10sh)
8018	Green on White Plastic	250mm x 300mm	\$48.00 (10sh)
8500	1 Litre Developer		\$9.00 per bottle
8500	250ml Developer		\$2.50 per bottle
3900	Scotch Clear Finish	368gm Aerosol	\$10.00 per can

All prices plus Sales Tax. Dealer and Trade inquiries welcome. Please note full range of products are available on order. Please contact Tim Bray on (03) 489-7099 for further information.

8" VERBATIM		
FD32-1000	Single Sided, Single Density	hard sectored 43.00
FD32-8000	Single Sided, Double Density	54.00
FD32-9000	SSDD Critically Certified	53.00
FD34-1000	Single Sided, Single Density	soft sectored 43.00
FD34-8000	Single Sided, Double Density	51.00
FD10-4008	Double Sided, Single Density	59.00
FD10-4015	Double Sided, Single Density	59.00
FD10-4026	Double Sided, Single Density	59.00
FF32-2000	SD FLIPPY FLOPPY	62.00
FF34-2000	SD FLIPPY FLOPPY	62.00
DD32-4000	Double Sided, Double Density	hard sectored 53.00
DD34-4001	Double Sided, Double Density	53.00
DD34-4008	Double Sided, Double Density	53.00
DD34-4015	Double Sided, Double Density	55.00
DD34-4026	Double Sided, Double Density	55.00

Single Disc Packs 10% Extra

ALL PRICES +20% S.T.
100MHz Probe Sets, great value @ \$23.00 + Tax

Greenpar PROBE ACCESSORIES

Standard Kit

Items 1-6 are standard accessories supplied where appropriate with probe kits.

1. Earth lead and clip 6"
2. Retractable hook.
3. I.C. test tip.
4. Tip insulator.
5. BNC adaptor.
6. Trimming tool.



TRIOS

**CS1560
ALL CROS.**

\$439.00

+ Tax

ALL PRICES PLUS 20% TAX. TRANSISTORS PLUS 32.5% TAX. MIN POST \$3.00 Heavy Items Extra

FAIRCHILD DISTRIBUTORS.

RITRONICS WHOLESALE PTY LTD

MAIL ORDER to PO Box 235, Northcote 3070 Victoria.

Minimum MAIL ORDER \$20.00

MAIL ORDER

MAIL ORDER

MAIL ORDER

MAIL ORDER

MAIL ORDER

MAIL ORDER

MAIL ORDER

MAIL ORDER

MAIL ORDER

Of mice and . . . Macintosh, icons, windows and Jobs

IN THE BEGINNING was the Word. And the Word was with Jobs. "The Macintosh", says Apple's co-founder, "was produced by a small team of great people. We simply enabled them to create their dreams."

Contrary to common belief their 'small number of great people' approach is not uncommon in the USA — both Rank and Xerox have worked like this. But few take it as far as Apple.

The team's brief was simple. To design what this small group of talented people believed a personal computer should do and be. And to produce that machine at an affordable price — defined as \$2000-\$2500.

To a large extent the starting point was Apple's Lisa — a brilliant but expensive computer in search of a market.

It was decided from the start to use the same MC68000 16-bit processor as used in Lisa in a different fashion. (Apple call the Mac a 32-bit machine, but the 68000 cannot handle multiplicands of more than 16 bits).

This decision was made primarily to enable the Mac to use the existing graphic structure and code used for the Quickdraw program in the Lisa.

The designers were also able to draw on their previous experience of using a bit-mapped display (rather than character generators), a technique developed for the Apple II. "It saves tons of chips," says Jobs.

Citing bit-mapping as an example, Jobs makes the interesting observation that, "when you first attack a problem it may seem simple because you don't understand it, then when you start to understand it you come up with complex solutions — and that's where most people stop. But if you really get into it and uncover the very basics of the problem, that's when you start producing simple elegant solutions."

The only major thing which Lisa does that Mac doesn't is that the Mac is not capable of multi-tasking (although two facilities assist). That's about the *only* limitation. In other ways the Mac is a more technically advanced product.

To start with the Mac runs faster — 7.83 MHz compared with Lisa's 5.0 MHz. It also makes more efficient use of its (smaller) memory; subroutines and programs being coded in 68000 assembly language rather than Lisa's 68000 machine-language versions (which are actually compiled from Pascal source code).

There are no add-on peripheral cards. Instead, the Macintosh's designers used a high-speed serial buss (using Zilog's SCC chip) implementing what they describe as 'virtual slots'. Using an internal clock, the buss transfers data at 230 Kbits/s. This can be speeded up to one Mbit/s with external



Design the ideal personal computer, said Apple. So a small team of brilliant people created a dream. The Macintosh sells for about a quarter of the 'Moan-a-Lisa's' original price, yet is technically a more advanced product.

Collyn Rivers went to Cupertino, California, at the behest of Apple, to bring us this story.

clocking. All the asynchronous and synchronous protocols are inside that chip.

Inherent in the 'virtual slot' concept is that peripherals must be self-powered. This concept also precludes using interface cards (such as the Microsoft CPM 'Softcard') which 'interpret' a different processor's software and, contradicting rumours, also seems to preclude the Mac from using MSDOS or IBM-PC programs.

But there's a huge plus; a totally unchanging memory map. This simplifies life for software designers. Furthermore, the system will be able to cope with any foreseeable peripheral needing less than 230 kbytes/s — and that's *fast*. Mad hardware engineer, Burrell Smith, says that the virtual slots enable people to use ports much like people used slots in the Apple II mother board.

The serial connectors (DB9s) can be used as RS232C or RS422A; the latter being a

high-speed serial-standard which enables peripherals to be interconnected via twisted pairs over distances of several hundred metres.

System software

Apple sales-staff like to imply that Mac doesn't *have* an operating system, with the inference that an operating system is the silicon equivalent of halitosis.

But the Macintosh *does* have an operating system however, unlike conventional machines which load the operating system from a disk. Mac's OS lives in about a third of the space available in the machine's 64K ROM (actually two 256K chips).

A further third of the ROM is taken up by the extraordinarily powerful graphics 'Quickdraw' package (designed by the team's Bill Atkinson).

The remaining third is occupied by what Apple call the User-Interface Toolbox. This ▶

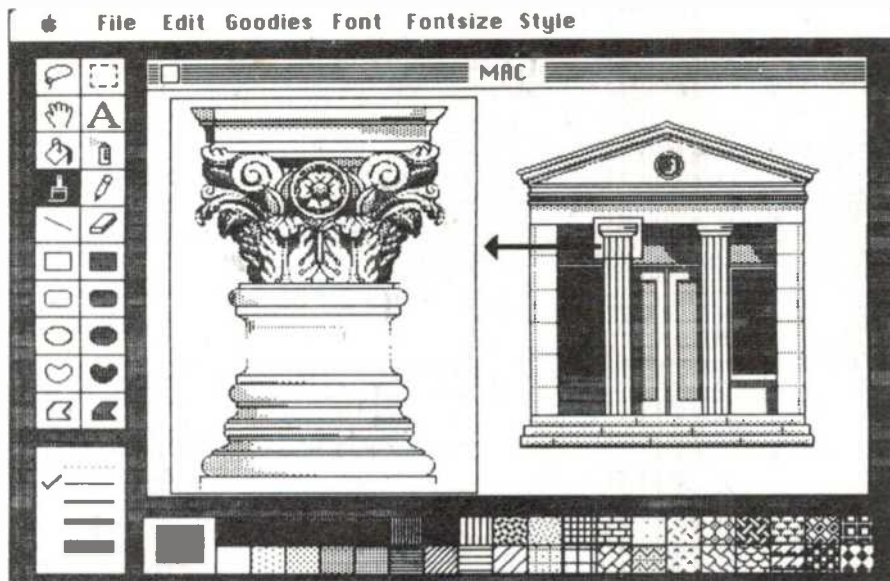

Mac Paint. Sample printout of a Mac Paint 'page', illustrating the sort of detail and resolution possible. The icons at the left show operating 'functions', palette possibilities are along the bottom. ▲

Drivers' position. The keyboard and the mouse — for driving Mac. The mouse's functions are not emulated on the keyboard. ▼



is a collection of 68000 user interface-related resources — windows, menus, controls, etc — which aid programmers to develop mouse-based and other applications. All are high-level routines.

All ROM routines are accessed indirectly via the 68000's line 1010 unimplemented instructions. These receive their addresses from a table held in RAM. Instead of the ROM routines driving the application, the applications drive the routines. What it does is totally governed by the program put into it.

Included with ROM are several programs which Apple have collectively named 'desk accessories'. The most useful of these is the so-called 'scrapbook' into which the user can 'cut and paste' data from one document to another. This facility, which is implemented as a disk file, to a minor but useful

extent overcomes the single-tasking limitation.

At present two 64K chips provide 128K of RAM. Apple says that, by the end of the year, they'll be able to replace these by a couple of 256K chips to give 512K. Although the screen requires nearly 22K, the design team has developed a technique (which to the relief of your reporter, who was rapidly getting out of his technical depth, they absolutely would not discuss) that somehow phase-locks the 68000 to the RAM without slowing everything down to a crawl.

The ROM always runs at 7.83 MHz despite the screen display accessing it most of the time. The RAM is accessed at 3.92 MHz whilst it's serving the screen, and 7.83 MHz when it's not! Eat your heart out, Peter Vogel (designer with Fairlight — Ed.).

Sound generator

Four sound channels are available, all derived from the 68000. Every 44 microseconds the 68000 looks at four 256 byte 'waveform tables' — the content (if any) is then transferred to a 370 byte sound buffer. Sound hardware moves one byte every 44 microseconds into an 8-bit digital-to-analogue converter.

Mass storage

Sony's 3½" disk drive is used, but modified to hold 400K on a single-sided disk — the Mac is designed and built to use a double-sided 800K version which they'll use if they can provide Sony with a good enough offer (like keeping the contract) to develop it for them.

The 3½" drive was chosen, not so much to save space, but for reliability in use. Unlike the larger floppies, the small Sony disk is carried within a rigid outer case, and the read/write access aperture is closed until the disk is within the drive unit. And whereas the larger disk drives simply clamp onto the Mylar disk, the hub of the Sony disk is made of thin steel.

Safeguards are included which will enable the user to recover from some (but not all) errors. For example, the file directory is duplicated, and every single block of data recorded is automatically allocated a 12-byte code corresponding to file number and sequence, date and time.

As with the Apple II the disk drive motor is controlled, essentially by the central processor, via an LSI device known as an IWM (Integrated Woz Machine) after it's concept's originator, co-founder Steve Wozniak. A pulse-width modulator enables the drive to run at any one of a possible 400 different speeds, between 390 and 6000 rpm, automatically selected so that data is recorded and read at a constant linear velocity. This enables data density to remain constant even on outside tracks.

Some clever software prevents disks being removed from the drive unless correctly updated.

Keyboard and mouse

There are 58 keys (59 on the International version), plus the mouse which is much like Lisa's. It's essential for drawing graphics but, for reasons that seem inexplicable, the designers have removed the cursor controls from the keyboard and the mouse is the only way of moving the cursor.

That's fine if you're not used to a computer keyboard (and have a large clean desk). But if you *are* used to cursor control keys — and (unlike your Editor) lack a third arm — continually moving between keyboard and mouse like a demented marionette choreographed by a windscreen wiper is frustrating, and physically tiring.

Video display

The nine-inch monitor has a 512 x 342 pixel

American-speaking countries, Apple has considered every aspect of the design, packaging, and documentation to ensure ready adaptability with the minimum of change.

Apart from the name 'Apple' on the rear panel, there's no written text on the outside of the product — nor is there any in the ROM. Plugs, etc. have pictures — where possible using IEC (International Electrotechnical Commission) icons to illustrate functions.

The software is designed so that text messages, icons etc. are stored in a resource file — separate from the program concerned, i.e. the data is factored out from the code. A resource-editor program enables programmers to change text, layout, times, date presentation, numbers, currency etc. without the necessity to change and recompile the program itself.

Joanna Hoffman, Mac's International Marketing Manager, told me that she could take a software program like 'Mac Paint' and make a German language version of it in 15 minutes!

Instead of the video-display rate being derived from the mains frequency, the Mac uses an internal oscillator (divided down to 60.15 Hz). Hence the machine can be used without change in countries using 50 Hz mains supplies.

Documentation remains the biggest problem — this must still be produced specially for each country's language.

INSIDE APPLE

In a recent report on US industry covering all US companies (1008 of them turning over more than \$450 million a year), Apple was rated the most profitable of them all averaged over the past five years. It is also first in sales growth.

I was there, early in January, for a pre-release of the Macintosh. Now, six weeks later, I still wonder at the total and absolute lack of pretention — but understand how someone like Joanna Hoffman left an all but completed Ph.D in archaeology to become International Marketing Manager for the Macintosh project. (Joanna's background also includes physics, anthropology and linguistics).

Bill Atkinson did much the same. Except he swapped an 'all-but' Ph.D in neurochemistry to write Apple's Pascal, Lisa's interfaces and then most of the brilliant software for the Mac.

Chris Espinosa's introduction to Apple was during his college days when, in exchange for a number of 4K RAM chips, he debugged Apple's BASIC. He was involved with the Mac project from the start.

Co-founder, Stephen Jobs, is like a less-frenetic version of Dick Smith. Every hour or so he'd wander into the smallish room where the Mac was being revealed, to help himself to a paper cup of coffee and a somewhat stale Danish pastry. Conservatively, 28 years old Jobs is worth \$500 million.

John Sculley, Apple's million dollar a year chief executive arrived for lunch carrying home-wrapped peanut butter sandwiches; lunch, incidentally, arrived in a large electric frying pan and was served with a few cans of Coke sans glasses.

About a hundred people like Joanna, Bill, Chris (and Stephen) designed the Mac. If ever you take the case off one, you'll see their signatures reproduced inside.

Applications software

With just two exceptions (Mac Paint and Mac BASIC) all applications programs are being produced by independent suppliers.

'Mac Paint' provides a range of shapes, patterns and tools with which the user may draw whatever is required providing it fits onto an A4 page.

There's a word processing package called 'Mac Write' (originally called Mac Author) and if you think *that* pun is bad consider that 'Mac Paint' was originally called Macel Angelo!

Which is as good a place as any to note that whilst the Macintosh is indeed named after (or 'for', as the Americans put it) a North American apple, that apple is spelt McIntosh. It's simply that the team is brilliant at design but lousy at spelling, and by the time anyone noticed it was too late to change — or they liked the maverick spelling anyway.

Pascal, BASIC, Assembler/Debugger, and Logo will shortly be available. 'Mac BASIC' is exceptionally interesting. It's been written by Donn Denman and is both interactive and multi-tasking. Multiple copies of the same program, or multiple programs, can be run at the same time — each program and each task having its own window on the screen.

'Mac Terminal' will enable the Mac to emulate the DEC VT-52 and VT-100 and teletype ASR33 terminals, and future (external) hardware will extend the emulation to the IBM 3270.

Over 100 companies are currently developing software. Microsoft Multiplan, BASIC, File, Chart, and Word should be available now; and Lotus 1, 2, 3, and Software Publishing's PFS File and Report in a month or two.

Normally no application software, beyond the graphics package held in ROM, is included with the machine — the present inclusion of a few programs is a promotional offer.

Documentation

At the time of my visit to Apple the only documentation available was in the form of final draft copies. These were well laid out, amply illustrated and appeared easy enough to follow. There's also an audio cassette/disk training combination.

The market

Most personal computers so far have been bought by what Jobs calls 'early innovators' — those prepared to spend the hundred or so hours fighting their way through the documentation that the computer industry (mistakenly) believes explains how to use their products. Indeed, as I commented in *Australian Business* last month, "it's ironic that an industry whose business is largely communications should be so amazingly bad at it."

The Macintosh is not, however, intended for this market. Rather it's for the 'early majority and majority buyers'. Apple is

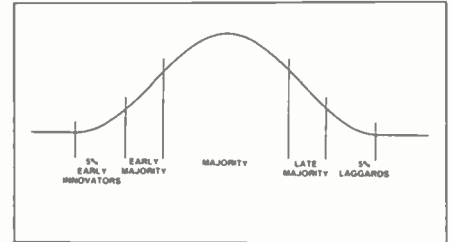

The Market. This shows the normal bell-shaped Gaussian curve. Horizontal axis is time. The Macintosh is aimed at the 'early majority and majority' buyers.

especially interested in what Americans call 'K tho 12' (from kindergarten to the end of year 12). It is also hoping to supply one to every university entrant — and has already made arrangements to do just that at Harvard, Yale, Stanford, Brown, Carnegie-Mellon just for starters.

Personal impressions

One needs some knowledge of computer circuitry and programming to realize what extraordinarily clever engineering has gone into this product. John Sculley says, "we don't think anyone else is even close to our technology."

The design team has essentially demonstrated that adage (used by mechanical engineers) that a good engineer can do for ten cents what a poor one can do for a dollar.

To quote Stephen Jobs again, "the Apple II originally had 2K of ROM with system code, the IBM has got 8K but it's as loose as a goose (equivalent to 4K by our standards). Mac has 64K of the tightest, cleverest code ever written by Apple." Or in all probability, by anyone else.

Some compromises have inevitably been made but they are very few.

While accepting the price limitation it seems unfortunate that the basic machine has only one disk drive. Backing up disks is currently tedious in the extreme, to the point where people will probably not bother. The add-on unit will partly remedy this.

The choice of a 3½" drive makes sense but what a pity that Apple and Hewlett-Packard (who've also chosen the Sony unit for their 150) could not have agreed on a standard format rather than further spreading the lunatic anarchy on non-compatible disk formats to the new small units.

While accepting totally the need for a 'mouse' or other form of analogue-like control for drawing graphics etc, I found it irritating to have to use it for normal cursor movements. And to a large extent the need for having to keep a large desk area clear for moving this malefic mammal, largely negates the benefits of the smaller than normal area occupied by the computer itself.

Lastly the price (in Australia), while remarkably low for what the buyer receives, will place the machine out of the reach of a great many otherwise prospective buyers.

But we can't blame Apple for that. ●

NEW COMPUTER DIVISION AT MAGRATHS

Magraths have done it again. We've opened a new computer division at Magraths - it is specifically established to cater for the professional and businessman - whatever your needs.

WE OFFER:

- Wide product selection
- Full support service
- Software
- Systems and peripherals
- Expert advice

SEE US NOW AT:

1st Floor, 55-59 A'Beckett St., Melbourne



BX 80 DOT MATRIX PRINTER

Printing method: Serial impact dot matrix.
 Printing format: Alpha numeric - 7 x 8 in 8 x 9 dot matrix field. Semi graphic (character graphic) 7 x 8 dot matrix. Bit image graphic - Vertical 8 dots parallel, horizontal 640 dots serial/line.
 Character set: 228 ASCII characters. Normal and italic alpha numeric fonts, symbols and semi graphic s.
 Printing Speed: 60CPS, 640 dots/line per second.
 Printing direction: Normal - Bidirectional logic seeking.

UNREAL PRICE!
\$385 00

Super script and bit image graphics - (Unidirectional, left to right)
 Dot graphics density: 1280 dots per line.
 Columns/line: Ribbon cartridge type. Normal size - 80 columns. Double width - 40 columns. Compressed print - 142 columns. Compressed double width - 71 columns. The above can be mixed in a line.
 Paper feed: Adjustable sprocket feed and friction feed.
 Paper type: Fanfold single sheet. Thickness - 0.05mm (0.002") to 0.25mm (0.01"). Paper width - 101.6mm (4") to 254mm (10").

TEXAS INSTRUMENTS PROFESSIONAL COMPUTER IS THE ANSWER

Texas Instruments has combined the most desired features and functions into one system, preplanned to easily expand as your information needs grow.

System Unit.

Compact cabinet houses the central processor, disk and diskette drives, power supply plus the optional circuit boards needed for your applications. Everything is located in one place, and option boards can be plugged in by the user. There are also additional slots for significant future expansion.

Features:

- Twin 320KB disk drives, 128 KB RAM.
- Keyboard. Attractive, low-profile keyboard with popular

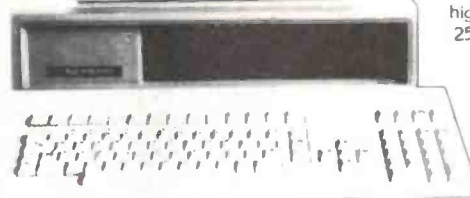
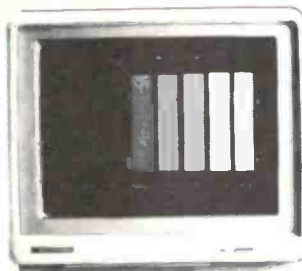

57-key typewriter layout plus separate 18-key numeric keypad, 5 cursor control keys and 12 special function keys. Features improved key "feel" - scientifically arranged for fast, easy operation. The keyboard has continuous height adjustment from 5 to 15 degrees slope.

The standard 256-character set can be expanded to 512 characters for scientific or special business use.

Display Unit.

12-inch monochrome with high resolution green screen - 25-line by 80-column format. Can use optional graphics capability and, when an application requires, scrolling which simplifies editing and reading. Colour monitors also optionally available.

Printers.

For clear, hard copies of data and graphics, TI offers the new 850 Series printers. These new 150-cps printers are the latest.

Software determines how productive your TI Professional Computer will be. In selecting your software, you need to understand the relationship between operating systems, their associated languages and application programs.

Operating systems are master programs that give your computer functional instructions. The most popular are the versatile MS™, DOS, Digital Research's CP/M-86® and Concurrent CP/M-86™. These operating systems, in turn, use specific languages such as BASIC, Pascal, FORTRAN or COBOL.

The Texas Instruments Professional Computer can use all of these popular operating systems.

AVAILABLE NOW FROM ONLY

\$4550 + S/TAX
 IF APPLICABLE



You'd expect to pay up to \$6,000 for a comparable system!



FUJITSU 8416 \$8 04 AT MAGRATHS

- PIN COMPATIBLE WITH HM 6116
- 2048 WORDS BY 8 BITS
- ACCESS TIME 200NS MAX.
- LOW POWER: 55µW MAX. STANDBY
- SINGLE +5V POWER SUPPLY +10% TOL.
- TTL COMPATIBLE INPUTS/OUTPUTS
- LOW VOLTAGE DATA RETENTION 2.0V MIN

MITSUBISHI M485 1 DISK DRIVE

- 500 KB HALF HEIGHT
- D.S.D.D.
- 40 TRACKS PER SIDE
- +5V, +12V SUPPLY
- ACCESS TIME (MILLISECONDS) TRACK TO TRACK
- AVERAGE 6
- SETTING TIME 94
- HEAD LOADING 15
- 50

SUPER BARGAINS AT MAGRATHS
VALUE!
\$345 00

TEXAS INSTRUMENTS MULTI FUNCTION PRINTER TI-855

Would have to be the best value available.

- 160 CHARACTERS PER SECOND
- DRAFT NEAR-LETTER QUALITY AND RASTER GRAPHICS MODES
- UP TO 10" PAPER WIDTH
- COMPATIBLE WITH T.I. PROFESSIONAL AND IBM™ PERSONAL COMPUTERS



BANKCARD ORDER FORM

NAME _____
 ADDRESS _____
 POSTCODE _____ Signed _____
 Please Charge my Bankcard No.

MAGRATHS ELECTRONICS Phone or Mail.
 55 A'BECKETT STREET, MELBOURNE, 3000
 Tele (03) 347 1122, Telex AA31001
 Prices subject to change without notice.



Books & Magazines.

COLOUR COMPUTER NEWS ■ COLOUR COMPUTER NEWS
SYSTEM 68—APPLICATIONS ■ 68 MICRO JOURNAL ■ MICRO
30 ■ APPLE ORCHARD ■ CREATIVE COMPUTING ■ AUSTRALIAN
PERSONAL COMPUTER

WE ALSO HAVE A RANGE OF OTHER MAGAZINES IN STOCK!

FAIRCHILD

Bipolar Memory Databook	\$8.00
CMOS Databook	\$9.00
Linear Databook	\$12.50
CMOS Memory Databook	\$8.00

MOTOROLA

CMOS Databook	\$9.00
Schottky TTL Databook	\$8.00

PHILIPS

Building Hi-Fi Speaker Systems	\$6.50
Semiconductors, Pt 2	\$10.00
Semiconductors, Pt 3	\$10.00
General Catalogue 81/82	\$10.00

DATA BOOKS

TEXAS INSTRUMENTS

Software Design for Micro Processors	\$14.95
981 Supplement—TTL Data	\$6.25
Linear Control Circuits	\$3.90
Interface Circuits	\$16.00
CMOS Memory	\$8.35
Bipolar Microcomputer Components	\$9.99
TTL Data Book	\$12.50
Understanding Solid State Electronics	\$7.95
Understanding Computer Science	\$7.95
Understanding Communications Systems	\$7.95
Understanding Optronics	\$7.95
Beginners Basic TI-99 4A	\$14.95

NATIONAL SEMICONDUCTOR

Audio Radio Handbook	\$6.50
Advanced Bipolar Logic	\$6.50
Linear Applications Handbook	\$18.00
Transistor Data Book	\$7.50
Voltage Regulator Handbook	\$8.00
Memory Data Book	\$7.00
Series 80 Board Level Computer	\$6.00
Hybrid Products Databook	\$9.00
Logic Data Book	\$9.00
MM 54HC 74HC High-Speed CMOS	\$2.50
The Reliability Handbook	\$16.00
NEW Databook 2 Vol	\$14.00



MS 503 BOOKSHELF SPEAKERS

- SPEAKERS 115 mm and 25 mm
- POWER INPUT 30 WATTS RMS
- Impedance 8 Ohms
- FREQUENCY RESPONSE 50-20 KHz
- SIZE 186(H) x 116(W) x 120(D)
- COLOUR: SILVER GREY/BLACK GRILLE
- WEIGHT: 2.7 kg EACH

ONLY **\$106⁷⁴** A PAIR

SUPER SPECIALS!

- CARBON POTS Log VCU 1/2-WATT
1 K, 5K, 10K, 25K, 50K, 100K, 250K, 500K, 1 m, 2m
60 CENTS
- LINEAR VCU 1/2-WATT
5000HM, 1K, 2.5K, 5K, 10K, 25K, 50K, 100K, 250K, 500K, 1 m, 2m, 5m
60 CENTS
- Log SWITCH POTS 1/2-WATT
5K, 10K, 50K, 100K, 500K, 1 m
\$1.09 EACH
- LINEAR SWITCHED POTS 1/2-WATT
5000HM, 1K, 2.2K, 2.5K, 5K
\$1.09 EACH
- Log GANGED POTS 1/2-WATT
500K, 1 m, 2 m
\$1.17 EACH
- LINEAR GANGED POTS 1/2-WATT
50K, 250K, 500K, 1 m, 2 m
\$1.17 EACH
- WIRE WOUND POTS 3 WATTS
5, 10, 15, 25, 30, 50, 100, 200, 250, 500, 1 K, 2K, 2.5K, 5K
\$3.01 EACH
- 10K, 15K, 25K
\$3.90 EACH



ECM 1603 LOW IMPEDANCE MICROPHONE

- UNI-DIRECTIONAL
- IMPEDANCE 600 OHMS
- FREQUENCY RESPONSE 20-20 KHz
- SENSITIVITY -72dB
- 3-METRE CORD
- ELECTRET CONDENSER

ONLY **\$17⁸⁰**

COMPUTER TAPES

1-24	25+
C20	\$1.73 \$1.43

TO CLEAR

DM8S MICROPHONE

- DUAL IMPEDANCE
- UNI-DIRECTIONAL
- IMPEDANCE 600/50K OHMS
- FREQUENCY RESPONSE 50-14KHz
- SENSITIVITY LO-78dB/HI-58dB
- 6 METRE CORD
- DIM 53 x 170MM

BUY NOW! 26⁹⁵

SENNHEISER QUALITY HEADPHONES—RUGGED, LIGHTWEIGHT

HD40 Dynamic 20 Hz-18 KHz	\$25.03
HD410 Dynamic 20 Hz-18 KHz	\$36.11
HD414 Dynamic 20 Hz-18K Hz	\$65.67
HD425 Dynamic 18 Hz-20 KHz	\$80.49

POWER TRANSISTORS

MJ4502	PNP—100 Volt—30 Amp	\$4.35
MJ802	MPN—100 Volt—30 Amp	\$5.85
2N180	NPN—400 Volt—10 Amp	\$4.63
2N126	NPN—750 Volt—3 Amp	\$2.49
BDV65B	NPN—100 Volt—10 Amp	\$3.11
BDV64B	PNP—100 Volt—10 Amp	\$3.11
MJ2955	PNP—60 Volt—11.5 Watt	\$1.62
MJ15003	NPN—140 Volt—20 Amp	\$5.10
MJ15004	PNP—140 Volt—20 Amp	\$5.10
2N3055	NPN—60 Volt—15 Amp	\$1.12

SECURITY LIGHT SWITCH



Programmable: with memory for added convenience, comfort, security and safety

- FEATURES:
- Replaces any standard wall switch in minutes
 - Sets itself
 - By memorising your normal switch use over a 24-hour period or

- Lets you set it
- You programme the times at which lights turn ON/OFF
- May be set for timed 30 minute ON/OFF periods to give your home that "LIVED-IN" look... up to 48 operators each day
- Built-in variable feature—alters ON/OFF times slightly each day to discourage burglars
- Saves energy—turns lights off even if you've forgotten
- Saves light bulbs—soft turn on lengthens bulb life
- Solid state design for silent operation— utmost reliability
- Radio frequency suppressed
- 500 watt rating
- Can be used to control one or more lights
- Standard size wall mounting plate
- Two-year guarantee

\$27⁷²

PHILLIPS SPEAKER SUPER SPECIALS

AD12650/W8	Slashed from \$106.61 to \$81.37
AD12250/W8	Slashed from \$97.74 to \$75.00

PHILLIPS AD12250/W8

8 OHM Rated Impedance	
100 WATTS RMS	
Frequency Range	40 to 1800 Hz
Recommended	80 litre sealed enclosure
Ceramic Magnet	1.15 kg

PHILLIPS AD12650/W8

8 OHM Rated Impedance	
Max Power	60 WATTS RMS
Frequency Range	35 to 2000 Hz
Recommended	80 litre sealed enclosure
Ceramic Magnet	0.53 kg

NEW RANGE OF TRIO OSCILLOSCOPES

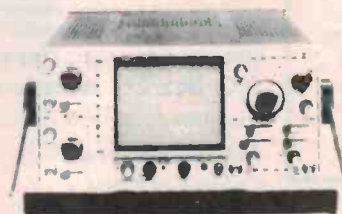

CS-1060 \$1,719²⁵ Incl. Tax

- 40/60MHz
A THOROUGHLY UPDATED DESIGN IN A 3-CHANNEL, 6-TRACE SCOPE
- 3-channel, 6-Traces using alternate delayed sweep.
 - Extremely high sensitivity of 1 mV.
 - Bright, sharp, autolocus 16kV CRT (12kV for CS-1040).
 - Maximum sweep speed 5ns/div (10ns/div for the CS-1040).
 - ±3% accuracy for precise waveform measurements
 - Eight full divisions of dynamic range.
 - Vertical axis signal output.
 - Video clamping.
 - Delayed sweep can have zero delay enabling magnification of even the leading edge of a signal

CS-2110 \$2,869²⁵ Incl. Tax

- 100MHz
A NEW STANDARD IN 100MHz SCOPE PERFORMANCE
- High sensitivity 1 mV all the way to 100MHz.
 - 2ns/div maximum sweep speed.
 - Delayed sweep for partial waveform expansion
 - 4 Channels, 8 Traces with wide range of waveform display functions
 - Dual sweep functions.
 - Accuracy ±2% for precise waveform measurements
 - Bright, sharp, 150mm rectangular CRT (20kV).
 - Push button switches with LEDs for simplicity and reliability.
 - Guaranteed channel-to-channel time accuracy
 - All position controls are on the front panel for operator convenience
 - Optimum multi-clamping of video signals

CS-1022 \$746³⁵ Inc. Tax

- 20MHz
Economy and Style in an all-new workhorse 20MHz scope.
- High sensitivity—1 mV/div.
 - 150mm rectangular CRT (6KV) with illuminated interface graticule.
 - 20ns/div maximum sweep for display of fast changing signals
 - ±3% accuracy for precise waveform measurements.
 - Video clamping for reliable synchronising.
 - Eight divisions of dynamic range.
 - Ergonomic front panel layout.
 - Observation of intensity modulated signals.
 - X-Y mode.
 - Vertical signal output

PROBES MODEL 88100 DC TO 100MHz \$39⁶⁰ Incl. Tax
(suits all scopes)

ALL ITEMS INCLUDE S/TAX UNLESS STATED OTHERWISE.

— Mail or phone orders add \$2.00 up to 1kg pack/post
Special rates for heavy items on request.

General purpose, minimum component microprocessor system

Peter Ihnat

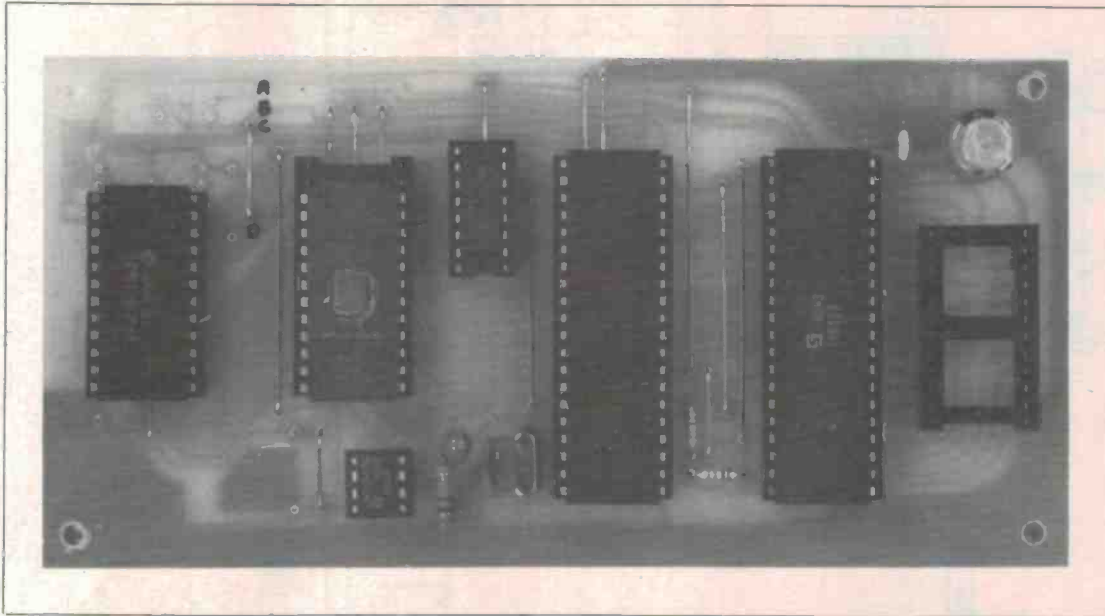

In "The 6800 microprocessor series" last issue we looked at Motorola's 6800 and 6802 microprocessors from a hardware point of view. This month we carry on with a description of the MC6802 used as the heart of a minimum component microprocessor system that will be used as the basis of a series of projects.

AS EXPLAINED in my previous article, the 6802 is an improvement over the 6800 in a number of ways. Firstly, an external clock is not required since a built-in oscillator is included on the chip. Secondly, 128 bytes of RAM have been placed on the chip and comes in very handy when only the minimal amount of user RAM is required. So for a minimum component system, only ROM is required to hold a program which will perform some dedicated task. Let's now look at the design and construction of a practical system which can be used as a general purpose microprocessor-based controller.

Background

The 6802 microprocessor connects to other

peripherals via three busses — the address, data and control busses. These lines provide data and timing information for the rest of the system. In operation, the microprocessor simply performs fetch-execute cycles — it places an address on the address buss, memory at this address responds by placing data stored there onto the data buss, the microprocessor reads and then decodes the information and performs the task specified, which may be an arithmetic or logical operation, or could involve reading or storing data.

The data buss is the principal information buss and is used to convey data between peripherals and the microprocessor. It is eight bits wide, bidirectional and has tri-

state capability. It is the simplest of the busses to connect since it runs directly (or via a buffer) to all the peripherals.

The address buss consists of 16 lines which are used by the microprocessor to select a specific memory location to be read or written to. Sixteen lines allows the microprocessor to access 65 536 different locations, but their connection to memory devices isn't as simple as the data buss. The difficulty arises since the most common, and therefore cheapest, memory ICs come in sizes of 1K, 2K, 4K, 8K and 16K bytes.

How can we configure these ICs to look like larger amounts of memory? Well, the idea is to common up the available address lines from the memory ICs, connect them to the microprocessor and use the remaining address lines to select which *one* of the memory ICs is active at any one time. This is referred to as *address decoding* and can be easily understood by examining a specific example.

Let's say we have eight, 8K memory ICs to connect up to look like 64K of memory. Each IC will have connections for 13 address lines ($2^{13} = 8192$ or 8K), eight data

lines, some control lines and the supply connections. The data buss is connected by running eight lines to each memory IC and the microprocessor. The 13 address lines are connected similarly and go to the 13 least significant address lines, A0 to A12 on the microprocessor as shown in Figure 1.

To select which of the eight memory ICs is being accessed during a memory read or write instruction, the remaining three high order address lines, A13 to A15, feed a decoder such as a 74LS138. This three-input, eight-output device produces a low on one of its selected outputs, e.g: if the input is 000, output Y0 will go low; if the input is 101 ($4 + 1 = 5$) then output Y5 will be low. Connecting each output to a memory IC just about completes the address decoding.

Only one memory IC will be selected at any time and thus 65 536 different memory locations can now be individually accessed. The first IC covers addresses 000/000000000000 to 000/111111111111 or 0000 to 1FFF in hex. The second IC covers addresses 2000 to 3FFF etc.

Only one small detail has been missed in the above address decoding scheme. When the address lines change from one address to another, there may be times when illegal addresses appear on the lines. To eliminate these false conditions the microprocessor generates a very important control signal called Valid Memory Access (VMA). When the microprocessor places an address on the address buss, it waits for the lines to settle and then places a high on the VMA line to say that the address is now valid.

To use this in our simple address decoding system we need to connect VMA to the enable input of the 74LS138 so that the only time it functions is when the lines have settled and a valid address exists.

The microprocessor's other control signals are used as required. The R/W line connects to the R/W line on the peripherals so the microprocessor can specify whether a read or write operation is to be performed. The $\overline{\text{RES}}$, $\overline{\text{NMI}}$ and $\overline{\text{IRQ}}$ inputs need to be driven externally and usually depend on the system configuration.

Armed with all this information, let's now look at the configuration of the current project.

Minimum component system

The circuit diagram shows one possible way of producing a general purpose microprocessor system. It consists of the CPU, an EPROM holding some dedicated program, I/O facilities and a spare socket which can be configured to accept either another EPROM or RAM. The board accepts either the 2732 (4K) or 2764 (8K) EPROM — the latter needing a 28-pin socket, the former a 24-pin. Socket SKT1 accepts either one of the above EPROMs or the 6116, which is 2K bytes of RAM in a 24-pin package.

In some applications, battery back-up of the RAM would be a desirable feature so provision for a 3 volt battery (or two 1.5 volt watch batteries) to be installed is provided. The only changes required are to use the 6117LP RAM instead of the 6116 and a wire link must be swapped. Details of this will follow in the section on construction.

Notice the data and address busses, which connect the four principal components, are as previously described. The data buss connects the microprocessor to both memory devices and the I/O device (called a Versatile Interface Adapter or VIA). The address buss consists of 16 lines, 13 of which go to the memory ICs and only four to the VIA since it has 16 memory locations available to the user.

The address decoding used is slightly different to that previously described. The 74LS138 decoder is used with address lines A13 and A14 connected to two of the select inputs. VMA enables the decoder but the difference lies with the other select line. When RAM is accessed by the CPU, synchronisation with the system clock is required to avoid incorrect data being transferred. This is achieved by ANDing VMA and E and using this to enable the decoder.

To avoid using an extra component, I fed the E signal into the other select line of the decoder which means that outputs Y0, Y1, Y2 and Y3 of the decoder represent invalid address conditions. The other four outputs can be used for address decoding and I have used outputs Y7 and Y5 to enable the two memory devices.

HOW IT WORKS — ETI-662A

All the hard work is performed inside the three main ICs. The CPU performs the task of fetching instructions, decoding them and then performing either an arithmetic or logical operation or moving data to and from memory or the I/O ports.

The signals which carry information travel along three busses — the address buss, data buss and the control buss. The extra ICs required for the system to function correctly have to do with power-on reset and address decoding. The 7555 timer is used in its Schmitt trigger mode and produces an active-low pulse at switch-on which lasts for about 200 ms. Address decoding is performed by the 74LS138 decoder which also synchronises with the E signal.

If battery backup for RAM is required, diodes D1 and D2 isolate the 5 V and 3 V supplies from each other so that only one supply powers the RAM at any time.

Figure 1.

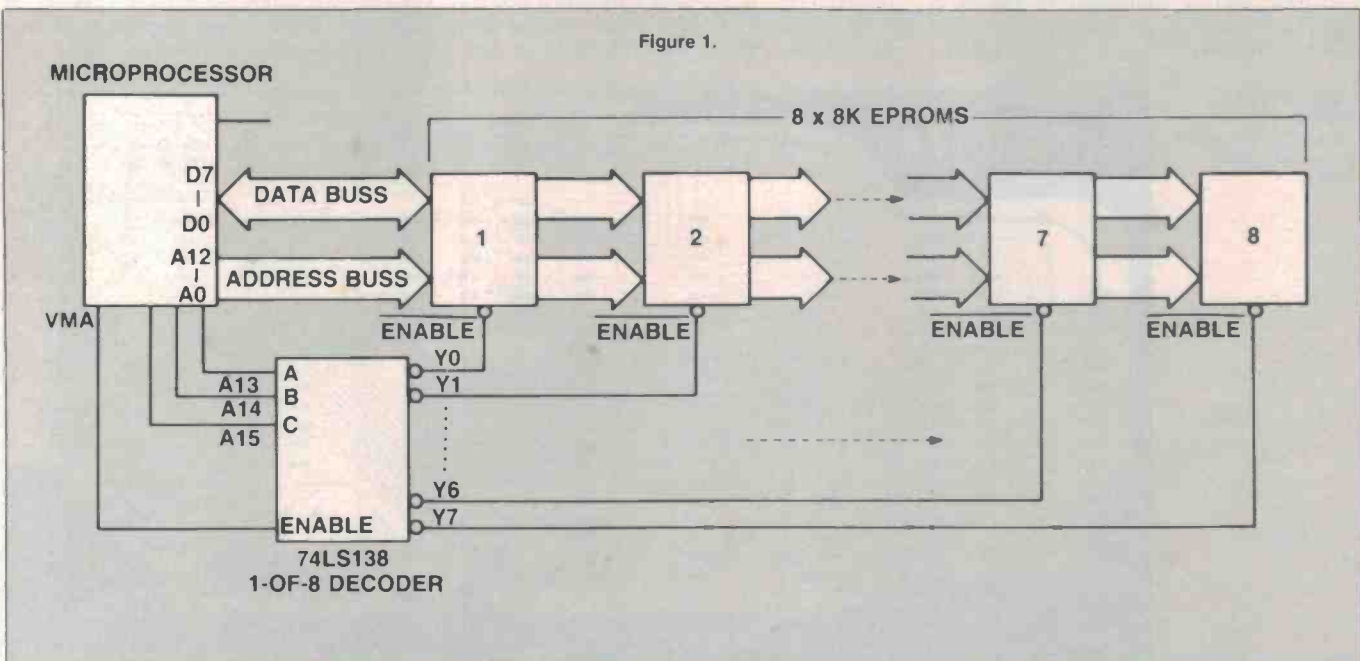

Project 662A

Peripheral	Address (hex)	
Main EPROM: 2732	6000 — 6FFF	
	2764	6000 — 7FFF
SKT1:	2732	2000 — 2FFF
	2764	2000 — 3FFF
	6116/6117	2000 — 27FF
VIA:	Register 0	4000
	1	4008
	2	4004
	3	400C
	4	4002
	5	400A
	6	4006
	7	400E
	8	4001
	9	4009
	10	4005
	11	400D
	12	4003
	13	400B
	14	4007
15	400F	
RAM in the CPU	0000 — 007F	

Table 1. Addresses of the memory ICs and VIA registers.

The decoding used for the VIA is even simpler still since it has two *enable* or *chip select* inputs — CS1 and CS2 to which I connected A14 and A13, respectively. This gives it a range of addresses which don't clash with the others. It would have been OK to run output Y6 of the decoder to the CS2 input to produce the same result in case you were wondering. Table 1 lists the addresses used to access the memory devices. Note that address line A15 is not used.

The other lines available on the CPU are connected to Vcc or 0 V as required to enable the device to run (they can be compared with the microprocessor description in the previous article). A 7555 timer is used to provide an active low reset pulse on switch-on and is connected to the RES inputs on both the CPU and the VIA. The interrupt inputs NMI and IRQ are pulled

high with 3k3 ohm pull-up resistors. An interrupt will occur if a peripheral puts a low on one of these inputs. NMI is available as an input on the I/O socket SKT2 whereas IRQ is driven by the VIA.

The only component not previously described is the VIA. As mentioned last month, components from different families can sometimes be mixed and this is one example of this. The VIA used is the 6522 made by Synertek. Versatile is certainly the operative word since the device includes two 8-bit bi-directional I/O ports, two 16-bit programmable timer/counters and a series data port. The I/O ports, timer/counters and interrupts have many modes of operation which would need several pages to describe. This will not be done here but each time the device is used in a particular project, its mode of operation will be carefully described.

Construction

It is suggested that the project be assembled on the recommended pc board. Note that it contains quite a few wire links but this was preferred to paying a much higher price for a double-sided plated-through board. Construction should commence with the wire links since some sit beneath the ICs. Then insert and solder the resistors, capacitors and IC sockets. Note that IC sockets should always be used with MOS LSI devices — a blown 40-pin IC is *very* difficult to unsolder! Care with soldering should be taken since the tracks are close together and a blob of solder can easily cover several tracks.

If RAM without battery backup is required, insert a link up to point C as shown on the overlay diagram. If battery backup is required, the link should go to point A and a "write protect" slide switch should be inserted where shown on the overlay. Note that this switch could be replaced by a toggle switch mounted on the front panel of the case used to house the electronics. When the switch is in the

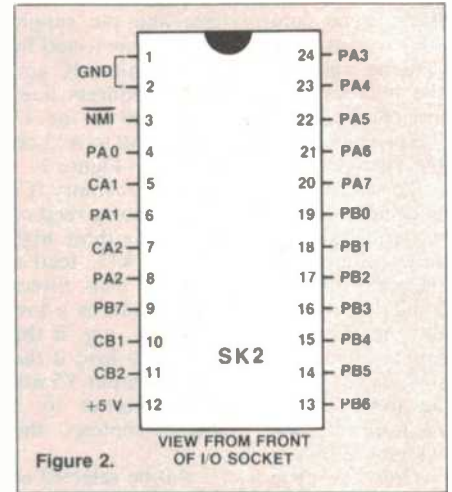

Figure 2. View from front of I/O socket.

protect position, it safeguards against accidental writes during power-up and power-down. If an extra EPROM is required instead of RAM then a link is required to point B which connects address bit A11 to it instead of the R/W line. When an extra EPROM or RAM without battery back up is used, diode D1 can be replaced with a wire link and diode D2 is not required.

IMPORTANT — if only one EPROM is being used in the system, it should be plugged into the socket nearest the microprocessor. This has to do with the way the microprocessor performs the restart sequence. Upon reset, the processor fetches the start address from the two highest memory locations which happen to be the last two locations in the EPROM nearest the microprocessor.

Operation

I/O connection to the board is accomplished via a ribbon cable and a 24-pin insulation displacement DIL plug. Figure 2 shows the I/O connections. The ribbon cable also

Printed circuit artwork. Full size reproduction of the pc board artwork.

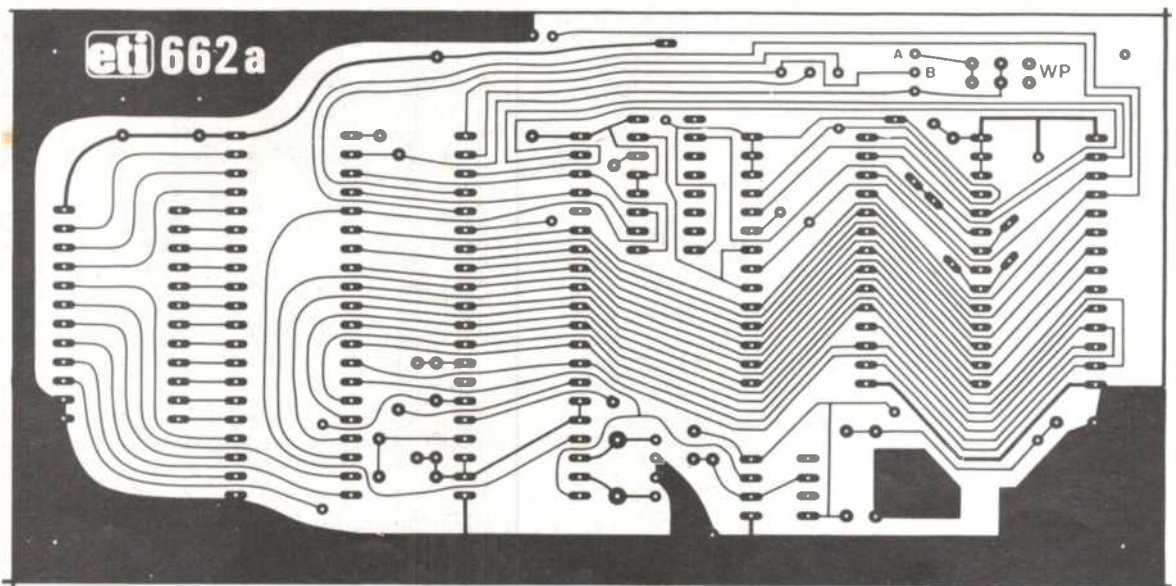

carries the power supply connections — the +5 V coming from some other circuit or from a power supply board designed specially for the dedicated application to which the microprocessor will be applied. Operation of the board can only be checked when interfaced appropriately and the necessary controller program in EPROM plugged in.

The first such project, a programmable

timer, can be found elsewhere in this issue. For those with the necessary skills and programming facilities, the board is ready to be programmed for that *special* job. We have quite a list of projects in mind for this system, but if you think of some specific application, drop us a line. Who knows, you may one day have the very system we have just discussed protecting your home as a super sophisticated alarm!

COMPARISON OF IC PIN CONNECTIONS FOR THE 2764, 2732 and 6116

6116	2732	2764			2764	2732	6116
not used	not used	Vpp or Vcc	1	28	Vcc	not used	not used
not used	not used	A12	2	27	PGM or Vcc	not used	not used
A7	A7	A7	3	26	not used	Vcc	Vcc
A6	A6	A6	4	25	A8	A8	A8
A5	A5	A5	5	24	A9	A9	A9
A4	A4	A4	6	23	A11	A11	R/W
A3	A3	A3	7	22	OE	OE	OE
A2	A2	A2	8	21	A10	A10	A10
A1	A1	A1	9	20	CE	CE	CE
A0	A0	A0	10	19	D7	D7	D7
D0	D0	D0	11	18	D6	D6	D6
D1	D1	D1	12	17	D5	D5	D5
D2	D2	D2	13	16	D4	D4	D4
GND	GND	GND	14	15	D3	D3	D3

PARTS LIST — ETI-662A

Resistors all 1/2W, 5%

R1, R2 3k3
R3, R5 # 100k
R4 47k #

Capacitors

C1, C2 27p ceramic
C3 4μ7/10 V tant.
C4 100n ceramic bypass
C5 100μ25 V pc mount electro.
C6 1μ/10 V tant. #

Semiconductors

IC1 MC6802
IC2 2732 or 2764 EPROM*
IC3 74LS138
IC4 7555 CMOS timer
IC5 6522 Synertek VIA
IC6 HM6116 **
(or HM61177LP)
D1, D2 OA90, OA91 diodes: #

Miscellaneous

XT1 4 MHz crystal
ETI-662A pc board; IC sockets — 1 x 8-pin, 1 x 16-pin, 1 x 24-pin, 1 x 24- or 28-pin (to suit 2732 or 2764, respectively), 2 x 40-pin; one 24-pin insulation displacement DIL plug; 100 mm length of 24-way ribbon cable; miniature slide switch (optional); 3 V lithium or NiCad battery (optional).

These components are only necessary where battery-backed memory is required, in which case IC6 is the HM6117LP.

* This EPROM will usually be specified in forthcoming projects using this project as a basis and will contain a specified program.

** This IC will not be required in some projects (i.e. it's an optional component) and should not be included in the basic kit.

Price estimate: \$65-\$85

(depending on battery backup or not)

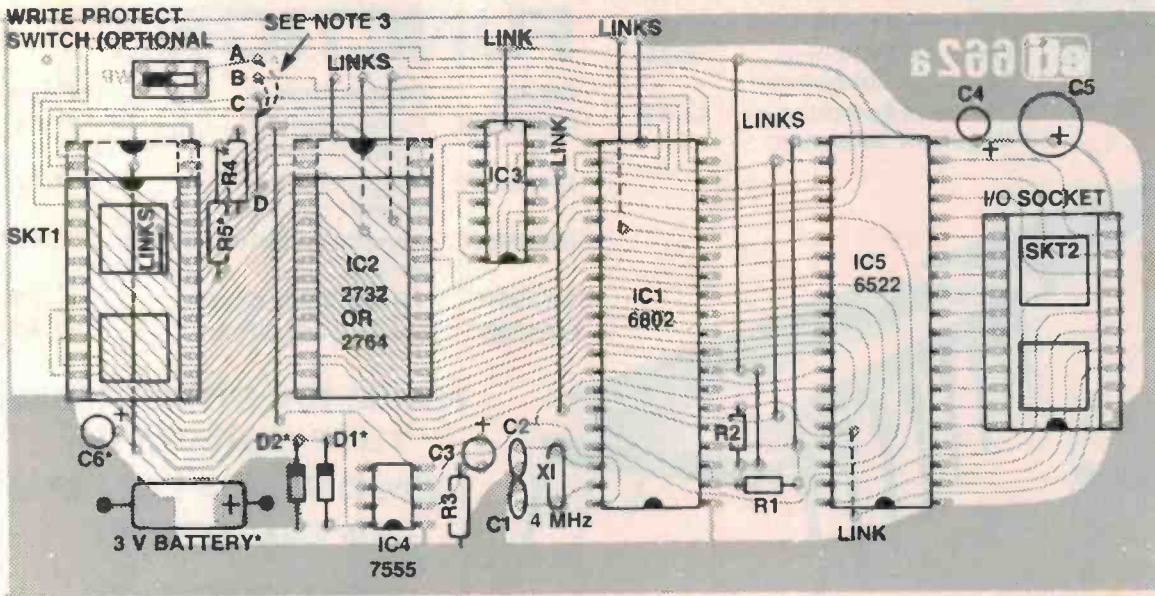

Component overlay. Note the link options at upper left and the optional components.

Capacitors

tantalum



electrolytic



BAND



A K

DIODES

NOTES:

- * COMPONENTS MARKED WITH * ARE ONLY NECESSARY WHEN USING BATTERY BACK-UP.
- WHEN NOT USING BATTERY BACK-UP REPLACE D1 WITH A WIRE LINK.
- CONNECT ONE LINK AS FOLLOWS — D TO A FOR SWITCHED WRITE PROTECT IF USING RAM OR D TO B IF USING EXTRA EPROM OR D TO C IF USING RAM WITH NO WRITE PROTECT

SPOT OR NOTCH AT THIS END

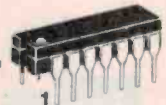

ELLISTRONICS

PROPRIETARY LIMITED

797 SPRINGVALE RD. MULGRAVE 3170. PHONE: (03) 561 5844 TELEX AA37758 LSTRON
289 Latrobe Street, Melbourne 3000. Phone: (03) 602 3499 Telex AA37758 Lstron

The BEST

REGULATORS

Device	Description	Price
UA317KC	3-Terminal Positive Adjustable	\$2.45
UA317UC	3-Terminal Positive Adjustable	.75
UA431AWC	Adjustable Precision Shunt	.56
UA494DC	Pulse Width Modulated Control Circuit	\$3.10
UA494PC	Pulse Width Modulated Control Circuit	\$2.64
UA78L62AWC	3-Terminal Positive	.36
UA78L82AWC	3-Terminal Positive	.36
UA7854ODC	Universal Switching Regulator Subsystem	\$2.55
UA78540PC	Universal Switching Regulator Subsystem	\$2.41

DATA ACQUISITION

Device	Description	Price
UA565	Digital to Analog Convertor	POA
UA571	Analog to Digital Convertor	POA
UA9708PC	6-Channel 8-Bit up compatible A/D Convertor	\$2.58

SPECIAL FUNCTIONS

Device	Description	Price
UA2240DC	Programmable Timer/Counter	\$1.56
UA2240PC	Programmable Timer/Counter	1.12
UA3086PC	General Purpose Transistor Array	.40
UA555TC	Single Timing Circuit	.29
UA556PC	Dual Timing Circuit	.85

NOTE: 10% DISCOUNT ON TUBE QUANTITIES
20% DISCOUNT ON 1000 UP QUANTITIES

PRICES PLUS SALES TAX
IF APPLICABLE

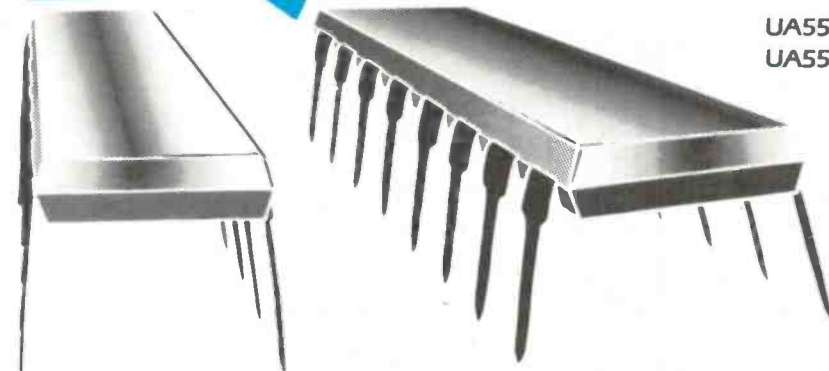

Bankcard
Mail Orders
Welcome

Please debit my Bankcard.
Bankcard No.
Expiry Date
Name
Signature

Prices subject to change without notice. Phone or write for quantity discounts.
MAIL ORDERS: To ELLISTRONICS, 289 Latrobe Street, Melbourne, Vic 3000.
Minimum pack and post \$2.00. Phone (03) 602 3499

ELUSTRONICS

PROPRIETARY LIMITED

797 SPRINGVALE RD. MULGRAVE 3170. PHONE: (03) 561 5844 TELEX AA37758 LSTRON
289 Latrobe Street, Melbourne 3000. Phone: (03) 602 3499 Telex AA37758 Lstron

of LINEAR

TELECOMMUNICATIONS

Device	Description	Price
UA3680	Telephone Relay Driver	\$3.15

OPERATIONAL AMPLIFIERS

Device	Description	Price	Device	Description	Price
UA1458HC	Dual Internally Compensated	.90	UA324PC	Quad Op Amp	.39
UA1458TC	Dual Internally Compensated	.32	UA4136PC	Quad Op Amp	.98
UA301AHC	General Purpose	1.05	UA741TC	Frequency Compensated	.29
UA301ATC	General Purpose	.69	UA759UIC	Power Op Amp	1.35
UA308TC	Super Beta	.39	UAF771TC	Single BIFET	.74
			UAF772TC	Dual BIFET	.98

INTERFACE

PRICES PLUS SALES TAX
IF APPLICABLE

Device	Description	Price
UA1488PC	Quad Line Driver	.49
75451BTC	Dual Peripheral Drivers	.59
75452BTC	Dual Peripheral Drivers	.59
75453BTC	Dual Peripheral Drivers	.59
9636ATC	Dual Programmable Slew Rate Line Driver	1.70
9637ATC	Dual Differential Line Receiver	1.70
9667PC	High Current Voltage, Darlington Driver	.98
9668PC	High Current Voltage, Darlington Driver	.98

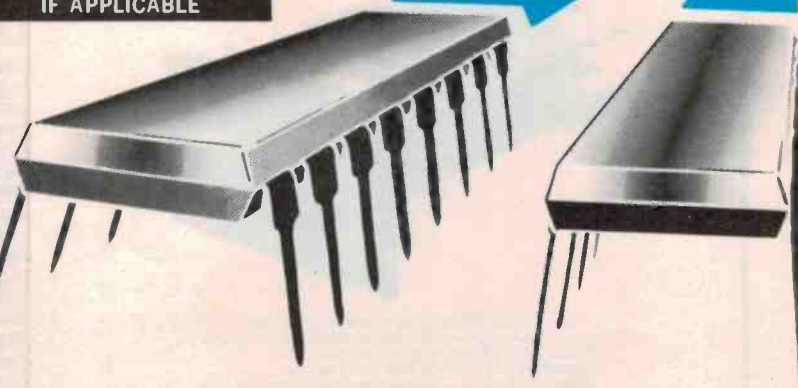

PRODUCTS MANUFACTURED BY

FAIRCHILD

A Schlumberger Company
ONE OF THE WORLDS LEADING
SEMICONDUCTOR MANUFACTURERS

**NOTE: 10% DISCOUNT ON TUBE
QUANTITIES**
**20% DISCOUNT ON 1000
UP QUANTITIES**

TANDON DISK DRIVES



TANDON NEW EIGHT-INCH THINLINE DISK DRIVES

- Direct drive.
- Proprietary, high-resolution, read-write heads patented by Tandon.
- D.C. only operation—no A.C. required.
- Industry standard interface.
- Three millisecond track-to-track access time.

TANDON MODEL TM500 SERIES WINCHESTER DISK DRIVES

Tandon's low cost 5¼" rigid disk drive features an on-board microprocessor which calculates the optimum positioning algorithm, yielding an Average Access Time of 110 milliseconds. This product family includes 1, 2, and 3 platter models with unformatted capacities of 6.4, 12.8, and 19.1 megabytes, respectively.

Up to four Tandon TM500's can be daisy-chained on a single bus, which provides a capability of up to 76 megabytes of on-line storage (unformatted) in a single system.

These drives are compatible with controllers that use an industry standard interface (ST 506).

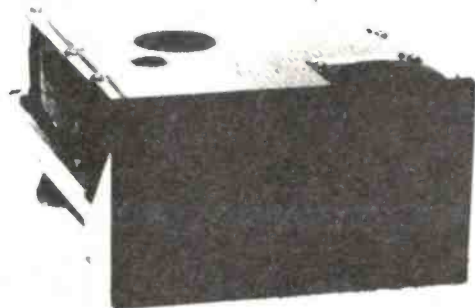

Sole Australian Agents for Tandon

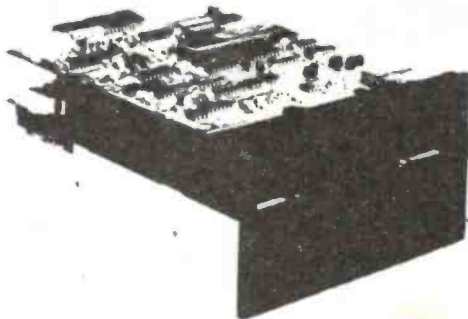

Trade-In your old disc drive on a brand new Tandon double sided, double density, 40 track, 48 tracks per inch disc drive. Trade-in offer limited to hobbyists only.
*CHANGE OVER PRICE \$250 plus sales tax.
Adaptive Electronics reserves the right to accept the trade-in.

Tandon Model TM-100 Mini-Floppy Disk Drives

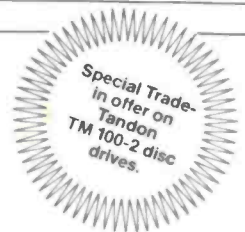

Tandon's TM-100 family of mini-floppies offer the absolute highest storage capabilities of any 5¼" high-speed, random access disk drive available in two single head and two double head models, all double density.

Unsurpassed Storage Capacity—Up to an incredible 1000K bytes information on 160 tracks. Recording density is 5877 BPI.

Advanced Dual-Head Design—Tandon Magnetics has for years been the leading designer and supplier of read/write heads to most major disk drive manufacturers.

Increased Throughput—Tandon's TM-100 have a track-to-track access time of only 5 milliseconds (an incredible 3 milliseconds double track density).

Proven Reliability—Designed for total reliability, as demonstrated by more than 50,000 production models in operation.

**AE ADAPTIVE
ELECTRONICS P/L**

418 St. Kilda Rd. Melbourne, 3004. Phone (03) 267 6800
Sydney: Phone (02) 419 5579. Newcastle: Phone (049) 23 343

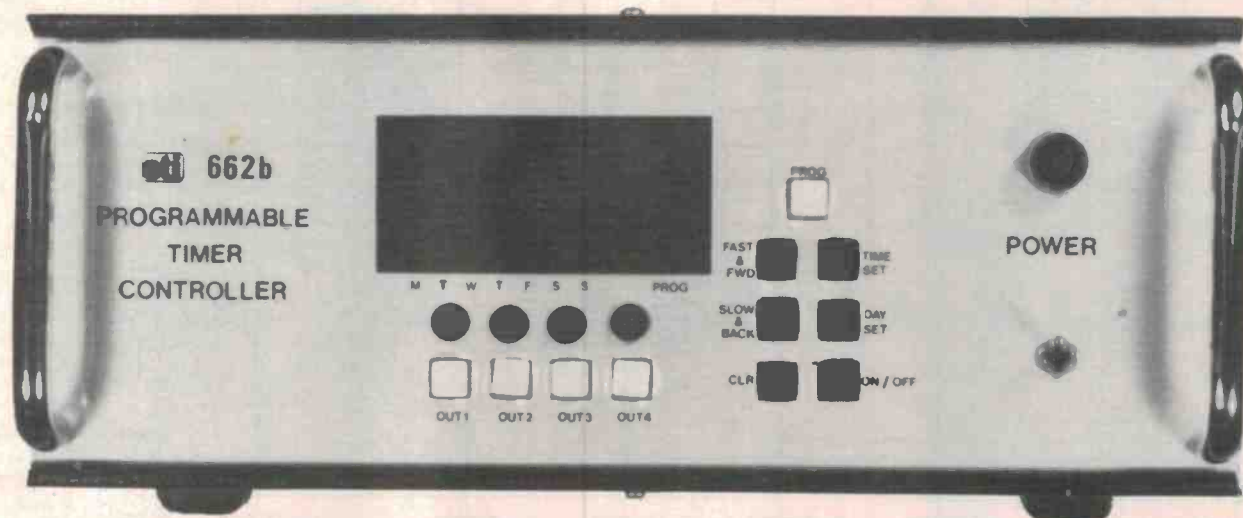

A microprocessor-based timer/controller

Here's a versatile daily/weekly timer and controller based on the ETI-662A general purpose microprocessor system. Four outputs can be switched on or off in a preprogrammed sequence during any day, during the week or weekend, or different sequences on different days. How's that for versatility!

Peter Ihnat

THE ETI-650 STAC timer which appeared in the November 1978 issue was a very successful project but, unfortunately, the main IC is *extraordinarily* scarce these days. Since there is always a demand for programmable timers, we decided that this would be an interesting application for the ETI-662A General Purpose (GP) Microprocessor System. The idea was to produce a unit with the same facilities as the original STAC timer but with a simpler programming procedure (some people found the original a little hard to program).

To apply the GP Microprocessor to a dedicated application one needs to connect the appropriate interfacing hardware and power supply to its I/O socket and place the software to make it all work in the main EPROM. Question: how do you go about

designing the interface board; where do you start? Well, let's use the current project as a

working example and go through the design step by step.

Features

- Maximum number of 85 entries per day (an entry is the storing of information specifying which output will switch on or off and at what time).
- Clock runs in 24 hour mode.
- Day-of-week indication.
- Four relay controlled outputs (capable of switching 240 volts).
- Special multi-day programming mode allows an entry to be stored for all week days only, weekend or the whole week, automatically.
- Forward and back step buttons to allow entries to be checked, modified or cleared.
- Over-ride buttons to toggle outputs manually.
- LED indication of current state of outputs (indicates whether outputs are currently on or off).

Project 662B

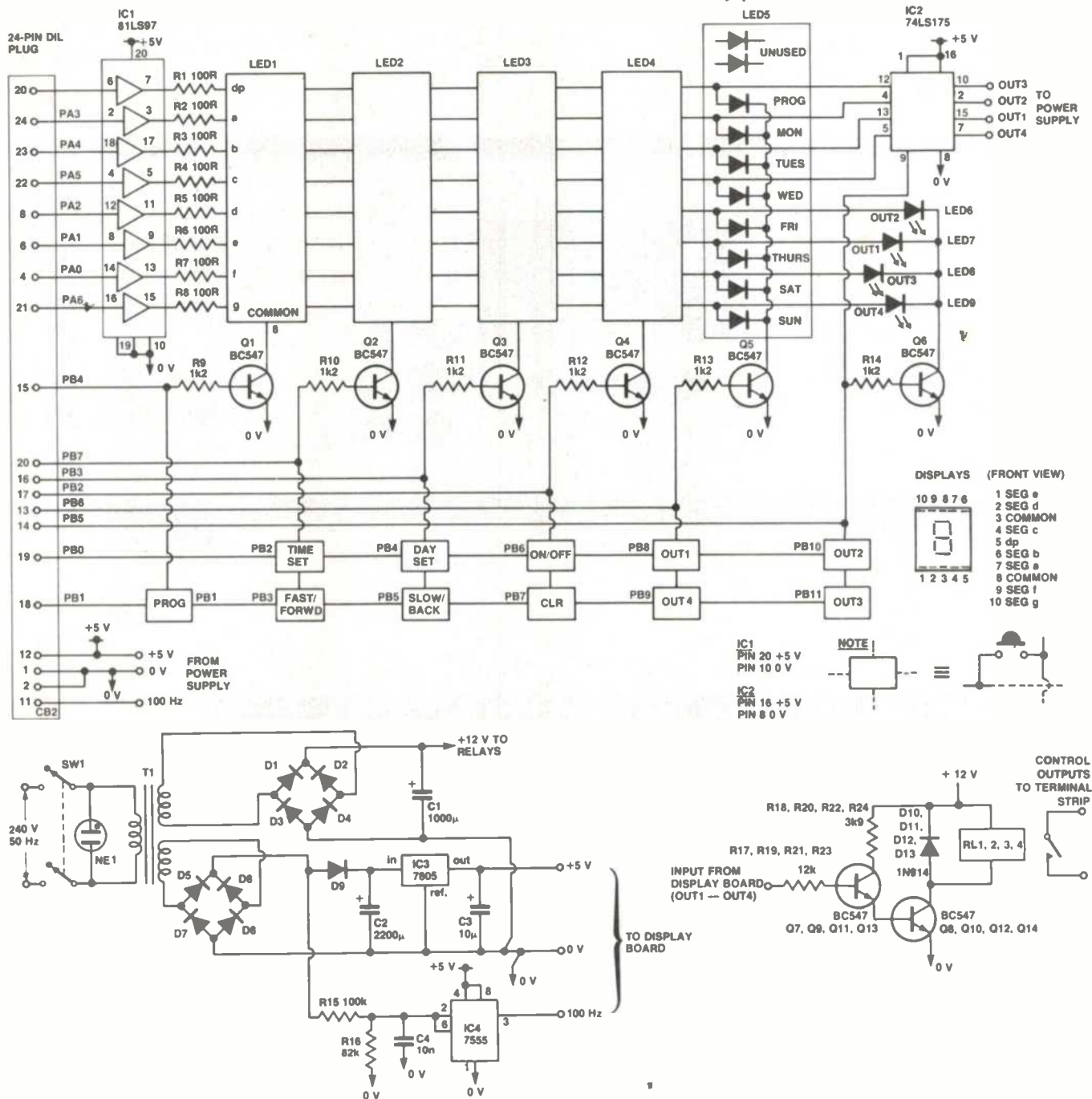

HOW IT WORKS — ETI-662B

Much of the discussion on how it works can be found in the general text. The 6522 Versatile Interface Adaptor (VIA) on the microprocessor board is used for all I/O operations but its timer/counters are not used in this application. Registers 0 and 1 of the VIA are the actual registers the microprocessor accesses to perform input or output operations (ports B and A, respectively).

To indicate to the VIA which lines are to be inputs and which are to be outputs, two registers called the "data direction" registers need to be appropriately initialised. These are registers 2 and 3 and operate as follows — each bit of data stored in the data direction

registers specifies whether the corresponding bit in the I/O registers will be an input or an output.

For example, let's configure port B so that bits PB0 and PB1 are inputs and the rest outputs. The data direction register for port B is register 2 and storing 11111100 (FC in hex) there sets it up. If we now write to register 0 (port B), only the upper six bits will be output. Reading register 0 reflects the conditions of bits PB0 and PB1.

In other words, a ONE in any bit position of a data direction register makes the corresponding bit in the I/O register an OUTPUT bit. A ZERO makes the bit an INPUT.

The 100 Hz timing signal is produced by feeding the fullwave rectified waveform from the transformer into a Schmitt trigger. It is then fed into the CB2 input line of the VIA which is set to interrupt the microprocessor each time the signal switches from LOW to HIGH. Unfortunately, a complete description of the software cannot be given in this short article, but Figure 1 shows the operation of the program in block diagram form.

The drive to the relays is quite simple — an input +5 volt signal switches on a pair of transistors connected as a Darlington Pair. The diode across the coil is to limit the reverse voltage spike during switching.

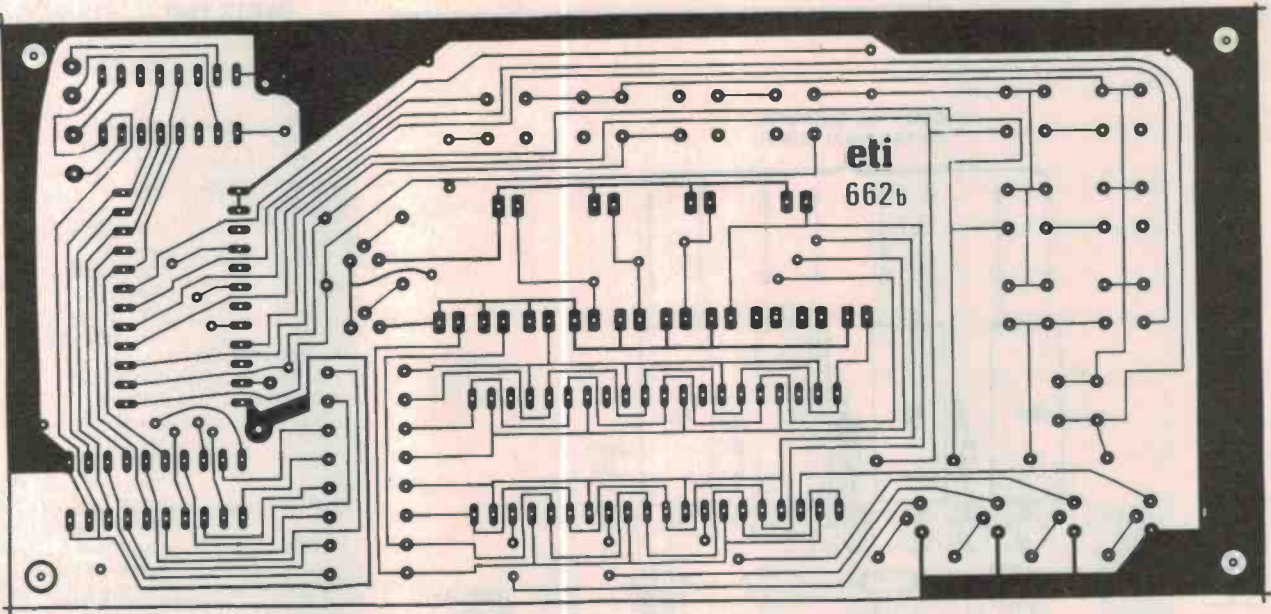

Design

What's the first step? How about the displays? Let's assume that the current time and preset times need only be accurate to the nearest minute. This requires four 7-segment displays. Outputs? Let's have the same as the STAC timer and choose four, probably driven from the VIA into a 4-bit latch which will drive the output control relays. Four LEDs would be handy to act as output status indicators. Another feature for the unit would be seven LEDs to indicate the current day of the week — that is, one LED per day.

Now let's look at the human-to-microprocessor interface — the input keyboard. To set the time, you could use a numeric keyboard, but to keep with the concept of a minimum-component system, I borrowed an idea used in digital clocks. Domestic digital clocks allow the time to be set with only three buttons — "time set", "fast" and "slow". When "time set" and "fast" are pressed (simultaneously), the displayed time increments at a rapid rate. Similarly, "time set" and "slow" increment the time at a slower rate. Easy, isn't it! What other functions would be useful?

Let's assume that the displays normally show the present time, day and output status. This is called the RUN mode. A button is needed to allow you to enter PROGRAM mode — in which times and outputs to be switched can be entered and stored. When in this mode, the following controls are needed — *four buttons* to set which output is to be switched, *one button* to set which day it will switch, *one button* to program whether it will switch on or off on the present day at the present time and, of course, the *clear button* to erase any programmed entry (I bet you thought I was going to say "to erase any MISTAKES"!).

Mistakes entered from the pushbuttons can be corrected simply by pressing the correct button to overwrite the previous entry. In total, 11 pushbuttons are needed in this design. This number could be reduced further but some other useful functions will be required when in PROGRAM mode and

some of the buttons will have double functions. More on this later.

The next part in the design is to connect all the bits and pieces to the 16 I/O lines of the VIA. ABRACADABRA — look at the circuit diagram. There it is, all connected. I'm sure electronics and magic go hand-in-hand!!

The VIA has two 8-bit ports which can be programmed to be inputs or outputs. To be more precise, any of the 16 bits can be configured to be either an input or an output. In this project, port A is configured as an 8-bit output port which, after being buffered by ICI to increase output current drive, feeds one side of the 7-segment displays and LEDs. The common side of each of these goes to 0 V through transistors Q1 to Q6. Notice that data output from port A will light a display *if and only if* its corresponding transistor is switched on. In fact, in this way we can access any display using a technique called "multiplexing" which allows all the displays to be driven with only 14 lines (for comparison, running each display from a 7-segment decoder requires a total of $(4 \times 8) + (2 \times 8) + 6 = 54$ lines!!!).

Multiplexing involves outputting segment data from port A for the first display and switching on Q1, then outputting data for the second display and switching on Q2 and so on for the other displays. If this is repeated several hundred times a second, the displays will appear to be on continuously. A special subroutine in the main program performs the multiplexing.

Notice also that six of the lines from port B must be configured as output lines to allow multiplexing to be performed — a high on any of these lines turns the corresponding transistor ON.

The pushbuttons are scanned in a similar manner. A subroutine puts a low on lines PB4, 7, 3, 2, 6 and 5 in turn and reads PB0 and PB1 (configured as inputs). If a button is pressed, the combination of outputs and inputs at port B produces a unique code for each pushbutton.

All that remains is the power supply and

relay driver board which is quite standard. The two output windings of the transformer are used to produce separate voltages — one which is regulated and runs the electronics, the other to operate the relays. The idea of using separate supplies is to avoid current surges and voltage spikes affecting the electronics when the relays switch. A 100 Hz signal generated by the power supply board is used by the microprocessor to update the time. ▶

Ian J. Truscotts

ELECTRONICS WORLD

For all your
Electronic
needs

- KITS
- COMPONENTS
- TOOLS ETC.

Resellers of Dick
Smith, Alltronics

Call in and browse around

Cnr. Bayswater & Eastfield
South Croydon

Phone
723 3860

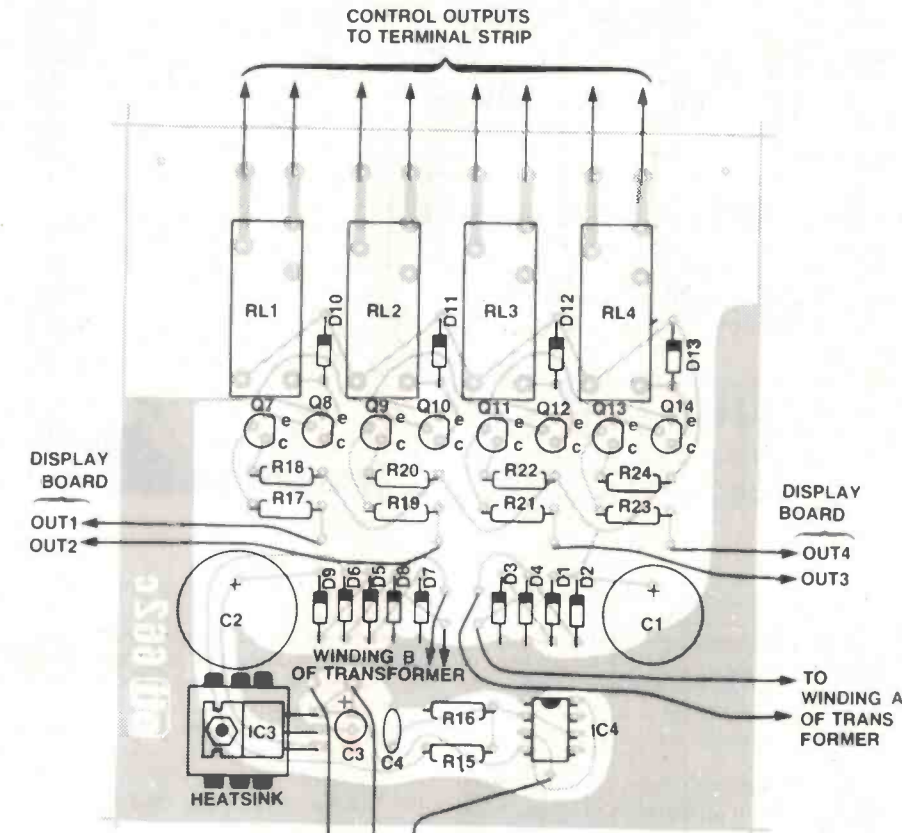

- Resistors**.....all 1/4W, 5%
- R1-R8.....100R
 - R9-R14.....1k2
 - R15.....100k
 - R16.....82k
 - R17, 19, 21, 23.....12k
 - R18, 20, 22, 24.....3k9
- Capacitors**
- C1.....1000μ/25 V pc mount electro.
 - C2.....2200μ/25 V pc mount electro.
 - C3.....10μ/16 V pc mount electro.
 - C4.....10n greencap
- Semiconductors**
- D1-D9.....1N4002 etc.
 - D10-D13.....1N914
 - IC1.....81LS97 tri-state buffer
 - IC2.....74LS175
 - IC3.....7805
 - IC4.....7555 CMOS timer
 - LED1-LED4.....HDSP-5503, FND500 or similar 7-segment displays
 - LED5.....10-LED array (Altronics Z-0180 or similar)
 - LED6-LED9.....TIL220R 5 mm red LEDs
 - Q1-Q14.....BC547, BC548 etc.
- Miscellaneous**
- RL1-RL4.....SPDT pc mount relay, 12 V coil, contacts rated to suit application.
 - T1.....Ferguson PL15/20 VA or similar, 2 x 7.5 V secondaries rated at 1.33 A each.
 - PB1-PB11.....Momentary action pushbuttons, pc mounting (Dick Smith No. S-1200 or similar).
 - NE1.....250 Vac bezel with internal resistor.
 - SW1.....DPST miniature toggle switch, 240 Vac/1.5 A

ETI-662A GP Microprocessor System kit (see text) with 2732 EPROM containing the ETI-662B Timer/Controller software; ETI-662B and C pc boards; 24-pin IDC DIL plug, four LED mounting bezels; mains terminal strip — number of terminals to suit relay contact set; red plastic filter 80 x 45 mm; Horwood case type 84/10/V (200 x 100 x 200 mm); mains cable and plug; clamp grommet or grommet and cable clamp; 9 mm and 15 mm spacers; small heatsink to suit TO-220 package; nuts, bolts, wire, etc.

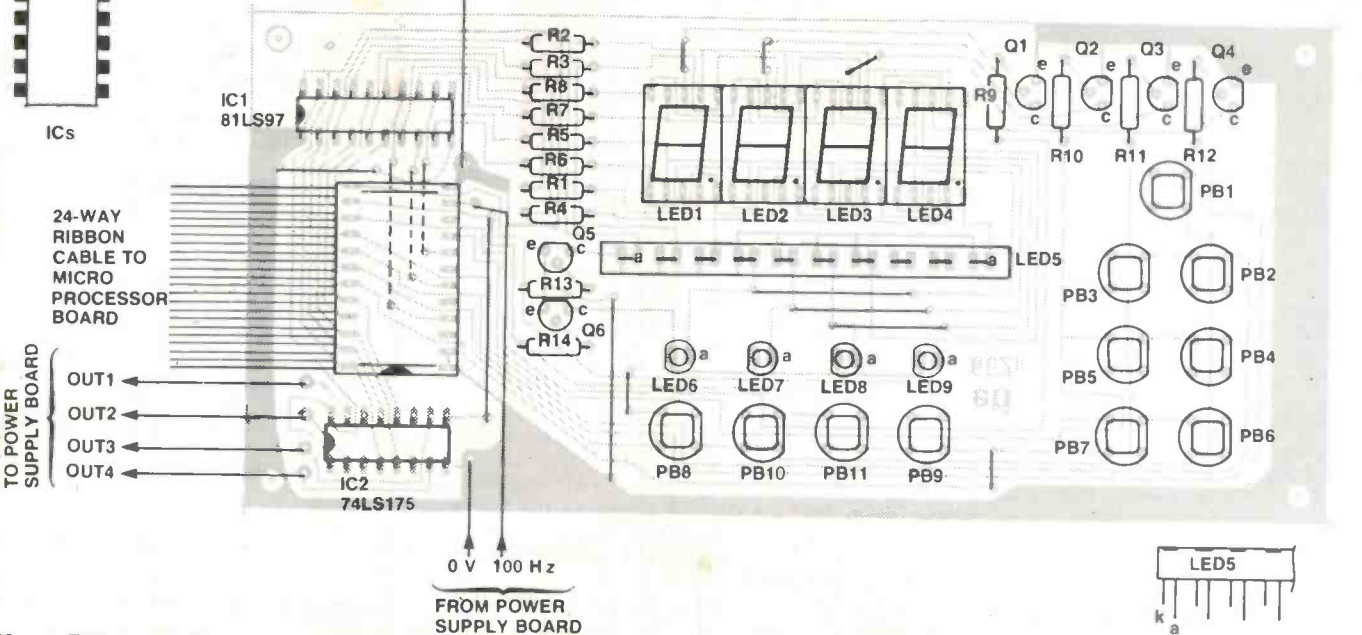
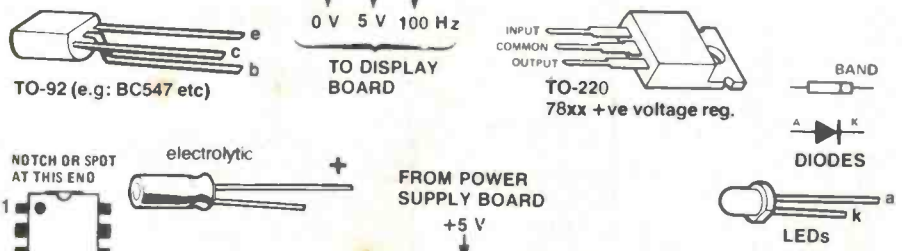

micro timer/controller

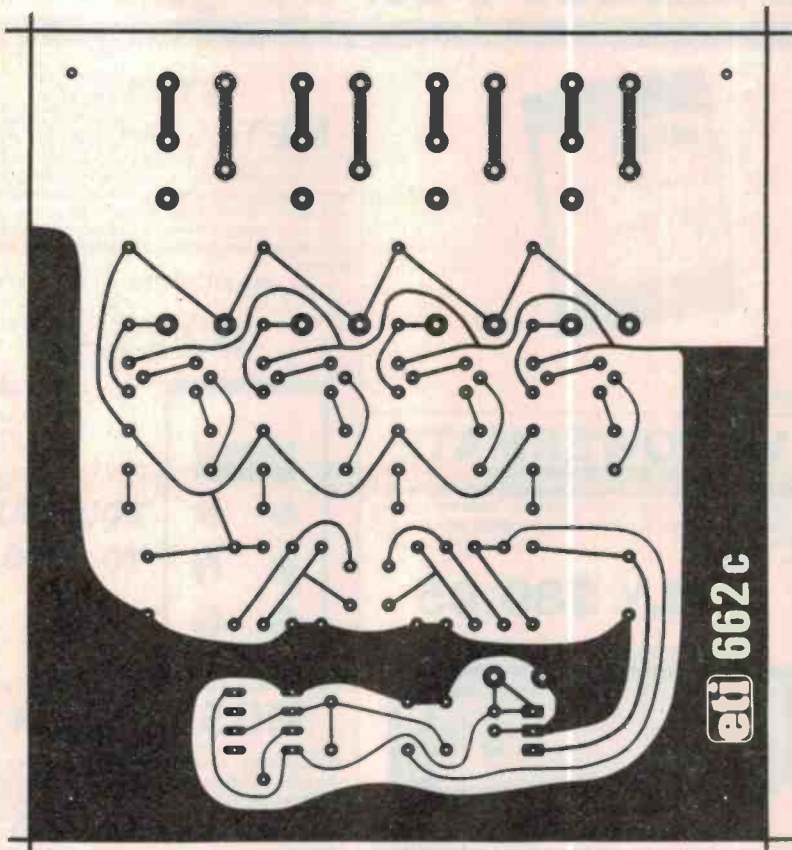

... continued next month.

Construction

Construction should present few problems if the recommended pc board is used. Start with the wire links as some lie beneath the ICs. Then insert and solder the resistors, IC sockets, transistors, push buttons and finally the displays and LEDs. Note that the push buttons should be mounted slightly proud of the board to ensure that they will protrude sufficiently through the front panel when mounted.

Connect seven, 200 mm lengths of hookup wire to the 100 Hz, output and power supply pads ready for connection to the power supply.

The ICs can be inserted next or you can wait until power is applied and the voltages checked at the IC sockets (better to be safe than sorry!!).

The I/O connections to the VIA are made using 24-way ribbon cable and a 24-pin IDC plug. DON'T mount a socket for this plug on the display board since the combined height of plug-in-socket exceeds that of the push buttons and makes it impossible to mount the board. After the IDC plug and cable are assembled, it should be soldered directly onto the board. Take care when soldering as overheating the pins may melt the insulation and cause shorts between strands of the cable.

The microprocessor board should be assembled similarly. Note that for this project, the battery backup components are not re-

quired. Insert a wire link where diode D1 (on the microprocessor board) normally goes. Also insert a link from point D to C and plug a 6116 RAM into SKT1. The display and microprocessor boards can then be mounted back to back using two 15 mm insulated spacers. The other end of the ribbon cable can be plugged into the I/O socket, SKT2, on the microprocessor board.

Next, construct the power supply and relay drivers on board ETI-662C. Insert and solder the diodes and resistors followed by the transistors, IC socket, regulator, relays and capacitors. A heatsink should be attached to the voltage regulator since it gets quite hot during operation. It is recommended that the power supply be tested WITHOUT the other boards connected. The supplies should provide +5 volts (within 5%) and +12 volts (within 25%).

Next, you can unplug the microprocessor board and connect the power supply to the display board. Measure the voltage between pins 20 and 10 of IC1, the 81LS97 buffer. It should be +5 volts. If all is well, connect the microprocessor board and power up. The displays should all light for a fraction of a second, 0000 should then appear as the time and the MONDAY LED should light. If this is the case, then congratulations. If not, then chances are that you almost certainly have either plugged an IC in the wrong way or caused a short between tracks when soldering. Trace the fault before proceeding. ●

AUSTRALIAN IMPORTERS



CLIFF
CH-1
CABINET HANDLE
102 x 48mm



SRP
PF-1
CABINET FEET
37mm



CH-2
LARGE
CABINET HANDLE
165 x 210mm



CF-1
CABINET CORNER

PCB SPACERS

12.5mm 19mm 25.4mm 31.7mm



TPI TERMINAL

4mm, SCREW, 15A, 250V.A.C.

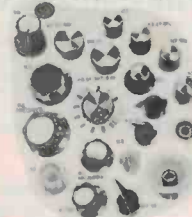

KNOBS SCREW & PUSH FIT

K9, K10, K11, K12.
ABOVE AVAILABLE IN PUSH FIT
WITH SEPARATE
COLOURED CAPS



KNOBS SLIDER

DELSOUND PTY. LTD.

1 WICKENHAM TCE., (CNR. WHARF ST.)
BRISBANE 4000
(07) 229-6155. TELEX AA44442

MOST
ELECTRONIC PARTS
& COMPONENTS

STRONGEST KIT LINEUP FOR '84 - JAYCAR!!

NEW!!
REF: ETI APRIL 1984
ETI 340
CAR ALARM/MONITOR
SYSTEM

Moving on from our very popular '330 (MkII) alarm, this system does not rely on interior lights to turn to trip the alarm, it uses low cost resonance sensors. It features three delays - entry, exit and alarm length before resetting. In addition, 'immediate-trip perimeter alarm' sounds the alarm if a thief attempts to disconnect the battery, steal tyres, lights etc. This alarm is armed in an unusual way - by pressing its 'arming' button when you turn off the ignition - which means you can leave it armed in a parking station when you have to give the keys to the attendant.

As is usual, the Jaycar kit for this project is complete and original. All parts necessary to build the standard kit are included, as well as two alarm stickers.

Cat. KE-4670 P.O.A.



ETI 1500
METAL DETECTOR

The performance of a \$500 metal detector - for \$219! This is a fully discriminating VLF T/R instrument (yes, the same principles as those expensive American ones) with ground balance. Control facilities are comprehensive - including an 'auto-tune' button. The kit includes all parts including a fully built search head and handle assembly and special meter and case.

REF: ETI DEC/1980 - JAN/FEB 1981
Cat. KE-4015

\$219.00



EQUIVALENT
TO \$500 units

"ELECTRIC FENCE"

REF: EA SEPTEMBER 1982

Mains or battery powered, this electric fence controller is both inexpensive and versatile. It should prove an adequate deterrent to all manner of livestock. Additionally, its operation conforms to the relevant clauses of Australian Standard 3129.

(Kit does not include the automotive ignition coil which is required).

Cat. KA-1109

\$15.00



VK POWERMATE

REF: EA DECEMBER 1983

This kit enables you to build a power supply that will give 13.8 volts at up to 10 Amps (8A continuous). Ideal for running mobile transceivers at home. Kit is complete with box and front panel.

Cat. KA-1120

ONLY \$89.95

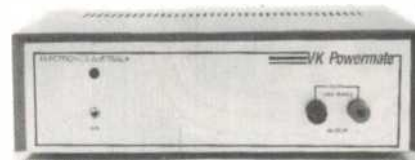

DRUM
SYNTHESISER

JOIN THE DRUM REVOLUTION

Original design from the UK magazine "Electronics and Music Maker" April 1981. This self-contained unit can produce a variety of fixed and falling pitch effects triggered either by tapping the unit itself or striking an existing drum to which the unit is attached. The Jaycar "SYNTOM" Drum Synthesiser comes complete with a high quality pre-drilled moulded all ABS box 152 x 80 x 47mm with professional silk screened front panel.

FEATURES:

Decay from less than 0.1 second to several seconds - Pitch Control - Sweep Control and Volume ON/OFF.

AS USED BY WARREN CANN OF "ULTRAVOX"

Cat. KJ-6502

\$36.50

12/230V - 300W
INVERTER

REF: EA JUNE 1982

This unit provides up to 300VA of power at 235V from an ordinary car battery. It is ideal as a standby AC power supply. The output is voltage regulated, gives a precise 50Hz and has current limiting with ultimate thermal shutdown.

The Jaycar kit features quality conservatively rated components and is complete down to the case and front panel.

Cat. KA-1114

\$195

TRANSISTOR
ASSISTED
IGNITION **\$35**

REF: EA JANUARY 1983

Latest version of this fantastically popular kit! The Jaycar kit comes COMPLETE down to the plastic TO-3 transistor covers, genuine heatsink and diecast box - as used in the original EA unit.

Beware of flimsy kits that use sheetmetal boxes!

This kit is designed to be used with contact breaker points, if you want Hall-Effect breakerless option may we suggest the KA-1505 version of this kit shown elsewhere on this page.

Cat. KA-1506

MUSICOLOR IV

REF: EA AUGUST 1981

The ultimate in lighting controllers. Combines a brand new four channel version of the famous EA Musicolor sound-to-light effect with four channel chaser. This new Musicolor has a host of features rarely seen even on expensive commercial units: ★ Front panel LED display ★ four different chaser patterns ★ auto and manual reverse chase ★ sound-triggered chase ★ inbuilt electret microphone ★ safe, opto-isolated circuitry. And just look at the price!

Cat. KA-1010

\$89.90



"SUPER SIREN"

REF: EA NOVEMBER 1982

Earsplitting sound from a CMOS that only draws 5mA on average.

NEW LOW PRICE
NORMALLY SELLS FOR \$22.00
New low price with powerful imported piezo siren

\$14.95

Cat. KA-1055

Short Form Kit (electronics only) \$5
Cat. KA-1484

DIGITAL DELAY LINE KIT



COMPLETE 400MS

VERSION

ONLY

\$449

The Digital Delay Line is designed to produce a huge variety of electronic effects. It works very well but the amazing thing is the low, low price! The effects depend on the time delay selected and some of those included are: Phasing, Flanging, Chorus, ADT (Automatic Double Tracking), Echo and Vibrato. The delay time can be varied from 0.32mS to 1.6 seconds! Because the signal is stored in digital form there is, unlike analog systems, no degeneration of the signal with time and unlimited repetition is provided by use of the freeze control. All the controls mount directly upon PCB's to eliminate wiring and to further simplify construction the main board is 'plated thru' i.e. there are no wire links or link through pins. The whole expanded 1.5 seconds model all fits on the main board as does the 400mS basic model. The cabinet which is free standing but also suitable for 19" rack mounting, is fully finished to a very high standard. The panel is deep blue whilst the cover is sprayed with a durable black enamel. The kit is available for only \$449 - compare that with inferior units that can cost over \$2,000!!
Cat. KJ-6621

JAYCAR JVE-1 VIDEO DETAIL ENHANCER

SPECIFICATIONS:

- Maximum enhancement not less than +8.3dB @ 2MHz
- Enhance disabled (Bypass) response, DC to 5MHz -0.5 +1.0dB
- Colour subcarrier 0dB notch frequency, tunable to 4.43-MHz. +/-0.5dB, all settings
- Amplifier group delay, less than 0.075µs.
- Signal handling capability not less than 1.35 volts p-p. (Sync. is clipped first)
- Power 12V AC @ 100mA
- Controls: ON/OFF, ENHANCE, ENHANCE/BYPASS SWITCH CORE/GAMMA CONTROL
- Input connector, RCA socket
- Output connector, RCA socket x 3

DESIGN FEATURES:

- A unity gain notch at the colour subcarrier frequency, whose purpose is to prevent chrominance to luminance errors at high enhance levels.
- A closed loop configuration with lead lag compensation to achieve stable, well defined gain.

- DC coupling, eliminating large capacitors in series with the video signal and achieving DC response for applications requiring it.
- Low output impedance prior to termination resistors, enabling up to three outputs to exist and be used or left unterminated.
- A level dependent closed loop response or Gamma control ("Core").
- Clip on negative going signals at -67 volts into 75 ohms to prevent sync. errors owing to overshoot.

Cat. AV-6501



\$69.95

12 Volt AC plugpack

Cat. MP-3020 \$16.95

NEW!!!

4 1/2 DIGIT LCD DPM 60

- ★ 200mV fsd ★ Digital Hold ★ Bandgap Reference ★ 10uV Resolution ★

A new 4 1/2 digit LCD DPM offering levels of performance, low current consumption and compact size never previously available. The DPM 60 features auto-zero, auto-polarity, a logic switched 200mV or 2V fsd, digital hold, programmable decimal points and a 1mA current consumption. Automatic low battery indication and 'continuity' flags are built into the 10mm 4 1/2 digit display. The DPM-60 can be readily scaled by the user to indicate many different units, amps, volts, ohms etc. Supplied complete with fixing bezel, clips and connector. The DPM 60 will suit many applications calling for low-cost, high accuracy measurements in portable or bench instruments.

Cat. QP-5520

SPECIFICATIONS:

- ★ Accuracy 0.01% ± 1 digit
- ★ Linearity ± 1 digit
- ★ Sample/Sec - 1.6
- ★ Temperature stability - 50ppm/°C typical
- ★ Temperature range - 0-35°C
- ★ Supply voltage - 7.5 to 15V
- ★ Supply current - 1mA typical
- ★ Maximum DC input voltage - ±20V

\$89.95



KAISE DIGITAL MULTIMETER

SK-6100

Check the specifications/features of this superb Digital Multimeter.

- ★ Autoranging with manual override
- ★ Auto polarity displays - sign when probes reversed
- ★ Overrange indication "Blink" and buzzer warning
- ★ Low battery warning BATT slgn shows
- ★ Sampling rate 2 times second
- ★ Power supply 2 x A penlight batteries (300 hours continuous operation)
- ★ Fuse protected, spare fuse provided
- ★ Zero adjustment, zero adjust button - a must if you change test probes
- ★ LCD display, magnificent clear readout
- ★ Inbuilt buzzer, available for continuity test, overload warning and switch warning
- ★ Ranges ±1000V DC/600V AC, AC and DC current, resistance 200 (resolution 0.1 ohm) to 2000K ohm (resolution 1K ohm) in 5 ranges autoranging
- ★ Accuracy 0.5% DC, 0.8% AC

Cat. QM-1525

\$59.95

RADAR DETECTOR

There are many different detectors on the market. We studied them all and decided there is only one to stock, the best. The fabulous Computer-Heterodyne Micro Eye. The first radar detector with on-board computer. Detectors hanging from the windscreen obstructing vision are out. The compact Micro Eye measures 95mm x 101mm x 38mm, slightly larger than a cigarette box.

It has a range of more than 3km on K band and the X band is up to 3 times that of conventional radar detectors. False alarms have been virtually eliminated since the micro-computer provides the detector with the ability to distinguish between the short pulses of mobile police radar and the constant emissions of microwave burglar alarms. The computer intelligence of the Micro Eye gives it consistently and reliably

It has a range of up to 3km on K band and the X band is up to 3 times that of conventional radar detectors. False alarms have been virtually eliminated since the micro-computer provides the detector with the ability to distinguish between the short pulses of mobile police radar and the constant emissions of microwave burglar alarms. The computer intelligence of the Micro Eye gives it the ability to be the ONLY* detector available which can consistently and reliably pick up the ground speed pulses of mobile police radar. Is your licence worth \$459?

Supplied with sunvisor or standard mounting brackets, full instructions and 12 months warranty.

*As stated in the manufacturers technical literature.

Cat. AR-0900

\$459

QUARTZ CRYSTAL CLOCK MOVEMENT

- Very compact and reliable
 - Self starting one-second stepping motor has strong torque
 - Powered by 1.5V AA battery that lasts for one year
 - Supplied with two sets of hands, one short and one long ±15 second/month accuracy
 - 56mm square, 15mm deep
- Complete with data sheet, instructions and wall hanger bracket.

Cat. XC-0100



\$14.95

NEW!!!

4 1/2 DIGIT LCD UNIVERSAL COUNTER - C7224

- ★ VERY LOW POWER ★
- ★ HIGH COUNT RATE ★

A 4 1/2 digit counter offering counting to 20,000 units at rates up to 10MHz. The low current consumption makes it ideal for use in portable instruments. The counter features high contrast 10mm digits, 5V DC or 7.5V DC supply (typical consumption 1mA), and programmable decimal points. Standard controls are all TTL/CMOS compatible and include Reset, Count, Inhibit, Store, Leading Zero Blanking, 'Carry' Output. The count input is protected against accidental overload. Supplied complete with mounting kit and connectors.

Cat. QP-5530

SPECIFICATIONS:

- ★ Supply voltage - (5.5V abs. max.) 7.5 - 15V DC unregulated 5V DC regulated
- ★ Typical current consumption - 1mA
- ★ Maximum count - 19999
- ★ Maximum counting rate - 10MHz
- ★ Typical (Schmitt Trigger) Count Input level - VTH 2.5V VTL 2.0V
- ★ Min. DC input level - 0V
- ★ Max. DC input level - 5V
- ★ Operating temperature range - 0-50°C

ONLY \$69.50



JOYSTICKS

These quality units are self centering type with heavy duty suction cups which definitely keep it in place. It has silver plated switch contacts, a pistol grip and is super responsive.

Cat. XA-5630 \$19.50

without plug

Cat. XA-5610 \$29.50
sult MicroBee

HOWLER SIREN

The old everpopular mechanical siren. 12 volt operation. Sound pressure level 116dB at 1 metre. Complete with mounting bracket.

Cat. LA-5265

\$29.95

Jaycar

Incorporating
ELECTRONIC AGENCIES

SYDNEY

SHOWROOMS

117 YORK STREET PHONE: (02) 264 6688 and (02) 267 1614

CARLINGFORD

TELEX: 72293

Cnr. CARLINGFORD & PENNANT HILLS ROAD - PHONE: (02) 872 4444

CONCORD

115 - 117 PARRAMATTA ROAD - PHONE: (02) 745 3077

HURSTVILLE 121 FOREST ROAD - PHONE: (02) 570 7000

NUMBER 1 FOR KITS

POST AND PACKING CHARGES
\$5 - \$9.99 (\$1.50) \$10 - \$24.99 (\$3.20)
\$25 - \$49.99 (\$4.50) \$50 - \$99.99 (\$6.50)
\$100 - \$199 (\$8.00) Over \$199 (\$10)

"Free INSURANCE for Road & Registered Post over \$200"

All heavy or bulky items (over 20kg.) sent Comet Road Freight \$12.00 anywhere in Australia.

SHOP HOURS CARLINGFORD, CONCORD & HURSTVILLE
Mon - Fri 9am - 5.30pm; Sat - 9am - 12pm; Thurs night 8.30pm (Not Concord)

SHOP HOURS SYDNEY
Mon - Fri 8.30am - 5.30pm; Sat - 8.30am - 12pm; Thurs night 8.30pm

MAIL ORDERS AND CORRESPONDENCE: P.O. Box 185, Concord, 2137



Mail Order
By



BANKCARD

Via Your Phone

Guidance for owner/constructors of the ETI-644 direct-connect modem

Geoff Nicholls

Here it is, all the 'gen' you need to build and operate your '644 modem, with detailed waveforms and filter responses given, frequency lists, signal levels etc.

THIS ARTICLE gives a guide to constructing and testing the ETI-644 modem and assumes that the reader is familiar with the earlier articles published in the following issues of ETI.

October 1982 pp 18-27 (original article).

December 1982 pp 100-101 (diode programming).

November 1983 pp 64-65 (notes from Marshall & White).

February 1984 pp 72-74 (revised pcb ETI-644A).

Since the modem was published we have received numerous technical enquiries from

readers having difficulty getting their project on line. The published information has been a little obscure in places so this article should tie all loose ends together and get you communicating!

Errors on ETI-644 pcbs

1. C13-D14 tracks: there was an errata in April 1983 ETI pp 132 which included a diagram showing a modification to the tracks around D14. The track from C31 goes to the junction of D4 and D14 on the pcb, whereas it should go to the other side of D14 (i.e: pin 6, IC20). The circuit diagram is correct here.

2. IC12a tracks: The circuit diagram is also correct around the squaring amplifier IC12a while the pc board is not. C18 connects to pin 2 of IC12a not pin 3.

3. R48: The circuit diagram and the ETI-644 pc boards have R48 connecting to -6 V. Trevor Marshall advised that it should go to 0 V, and this has been done on the ETI-644A. See later section on 'CARRIER RECEIVED COMPARATOR'.

All known pc board errors have been fixed on the ETI-644A version, except the R48 business.

Parts list revision

A few errors crept into the parts list on p25 of the original article and operating experience has led to changes in some component values. All changes are listed here:

R2 from 270k to 220k.

R6 from 4k7 to 10k . . . lengthen reset pulse. See text.

R7 from 3k3 to 10k . . . lengthen reset pulse. See text.

R16 from 220k to 270k.

R41 from 2k2 to 270R . . . sets line level.

R44 from 220k to 47k . . . see Ring Detect.

R46 from 10k to 100k . . . see Ring Detect.

R48 from 68k to 5k6 . . . see Carrier Received Comparator.

R90 from 12k to 2k7 . . . sets hybrid gain.

R93 from 560R to 10R . . . line resistor.

R104 from 10k to 4k7 . . . only 644A pcbs.

R105 from 10k to 4k7 . . . only 644A pcbs.

C5 from 1n5 to 1n styro or mica . . . shorten monostable.

C9 from 1n5 to 1n styro or mica . . . shorten monostable.

C19 from 22n to 2n2 ceramic.

C21 from 33p to 330p ceramic.

C24 from 4 μ 7 electro to 1 μ 5/35 VW tantalum.

IC18 from TL071 to TL081.

Q2 can be BC157 or BC557.

Construction

Check the pc board for damaged tracks — there should be no continuity between terminals 1,2 and 12 before the components are installed. Solder pc pins into the 24 terminal holes. Insert and solder all resistors, then the capacitors (except C45/C46 which are determined on the line). Solder in the

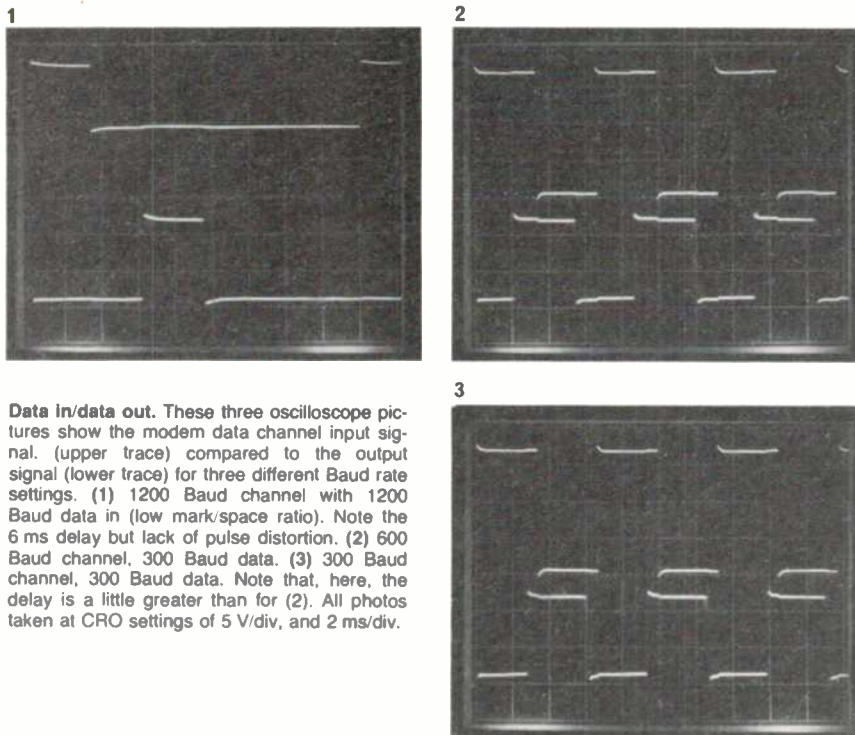

Data in/data out. These three oscilloscope pictures show the modem data channel input signal. (upper trace) compared to the output signal (lower trace) for three different Baud rate settings. (1) 1200 Baud channel with 1200 Baud data in (low mark/space ratio). Note the 6 ms delay but lack of pulse distortion. (2) 600 Baud channel, 300 Baud data. (3) 300 Baud channel, 300 Baud data. Note that, here, the delay is a little greater than for (2). All photos taken at CRO settings of 5 V/div, and 2 ms/div.

two links near the receiver diode matrix, you will need to open the left-hand link later so leave a loop. Next solder in the IC sockets, the DIL switch banks, the transistors and the diodes (see later sections for the programming diodes). Finally, solder in the relays, the line transformer, the crystal (or Ceralock resonator) and the trimpots. The unit should be powered from a 12 Vdc plug pack or other approved device, and nylon pcb standoffs or bolts and standoffs must be used when mounting it in a chassis.

Testing

In the following sections it goes without saying that the power should be switched off before an IC is inserted or removed. If you are checking a modem board that has already been assembled then remove all ICs at this point. Insert IC12 (TL074) and apply 12 Vdc between terminals 1(+) and 2(-). Measure the voltage between terminals 2 and 12. You should get 6 V. If not, then recheck the board for solder bridges etc. Next, test the relays by switching DSW2; the reed relays are very quiet in action so you may need to check the contacts with a multimeter.

Insert IC9 (4069) and look a pin 12 with a CRO. You should get a 5.07 MHz square wave swinging close to the rails — see Photo 1. Check the calibration oscillator (pin 8, IC9), it should have a frequency around 300 Hz with a 100k resistor for R19. This simulates a 600 Baud signal.

Transmitter

Insert IC1, IC2, IC6, IC7, IC16 and IC17. One of the component changes detailed earlier affects the diode programming of the transmit frequencies. Some constructors found the reset pulse to be marginally short, leading to erratic operation. To lengthen the reset pulse, I suggest on newly-built modems that you increase R7 to 10k. *Don't* make this change on an already built modem if the transmitter works properly.

The longer reset pulse adds on extra delay to each divider cycle, lowering the frequencies, with the higher ones being affected the most. I found that deleting the 'B' diodes from the transmitter matrix brought the frequencies back to normal.

There are eight 'B' diodes numbered from B0 to B7 to leave out. N.B: This means you change one component and save eight!

Solder in the other transmitter diodes and run a wire from terminal 7 to terminal 2 to transmit the '0' frequencies. Set DSW1/1, DSW1/3 and DSW1/4 to 'open', and DSW1/2 closed. Check the signal at pin 8 of IC12, you should get a clean sinewave at 1650 Hz with an amplitude of about 600 mV (as set by R41). See Photo 2.

All transmitter frequencies may be checked against Table 1 — to get the +6 V DATA IN frequencies, move the jumper wire from terminal 2 to terminal 1.

S2	DSW1 S1	DATA IN	
		+6V	-6V
		frequency	
open	open	450	390
open	closed	2100	1300
closed	open	1850	1650
closed	closed	1180	980

TABLE 1. Transmit frequencies

If your frequencies are close to these then move onto the receiver filters section, if not, then the following should help in debugging.

Look at pin 11 of IC6 (Photo 4) to see if the divider is working. There should be narrow, positive-going pulses at 16 times the selected frequency (you may need to adjust the CRO's trigger level). If the pulses are not present then remove IC7 to allow the divider to free run. Look at pin 10 of IC6 (4040B) to see if the 5.07 MHz system clock is present, then check that each output, Q0 to Q9, has the right frequency square wave present (Q0 should be 2.5 MHz; Q1 1.25 MHz etc.) and that pin 11 of IC6 is low.

To check the multiplexer, remove IC6 and insert IC7. Only one of the X0 to X7 pins of IC7 should be high as determined by the transmit frequency, the others will be floating and therefore appear to be at ground.

The programming diodes can be checked *in situ* by removing both IC6 and IC7 and testing with a multimeter.

If the divider is working (and DSW1/3 is open) but there is no sine wave at pin 8 of IC12 then look at the junction of R34 and R41 (Photo 3). There should be a stepped approximation to a sine wave. This test should isolate any faulty sections.

Receiver filters

Install the following ICs: IC1, IC2, IC5, IC8, IC9, IC12, IC13, IC16, IC21, IC22. Look at pin 9 of IC16 and verify that a 2.5 MHz square wave is present. If not, check for the system clock (5.07 MHz) at pin 3 of IC2 before replacing IC2.

Now check pins 11 to 14 of IC16 for frequencies from 1.27 MHz at pin 11 to 158 kHz at pin 14. If one or more of the outputs are stuck then remove IC13 and try again. Replace IC16 if they remain stuck (and no solder bridges are discernable), otherwise replace IC13. When the right outputs are present on IC16, insert IC15 and IC11 and recheck.

Look at pin 14 of IC13, if there are no filter diodes installed then there should be a short negative pulse (less than 0.5 μ S) every 6.3 μ S. (Photo 5). If diodes are installed then the period should remain at 6.3 μ S while the mark/space ratio will differ.

The same signal should be on pin 14 of IC11 and IC15.

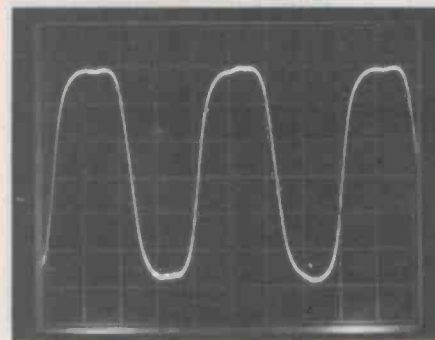

Photo 1; System clock. The 5.07 MHz clock at pin 12 of IC9. (2 V/div., 50 ns/div.). Waveform swings from rail to rail.

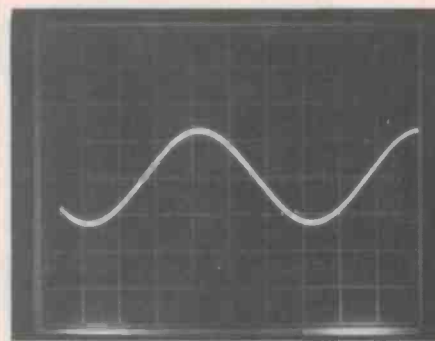

Photo 2; 1650 Hz transmit. Pin 8 of IC12. DSW1/1 open, DSW1/2 closed, DATA IN = -6 V. (200 mV/div., 100 μ s/div.). Amplitude should be about 500-600 mV p-p.

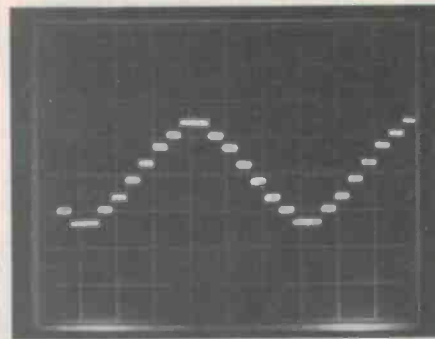

Photo 3; Transmit generator output. Waveform at the output of the Walsh Function transmit generator — taken at the junction of R34 and R41 (with R41 = 270R). DIL switch settings and DATA IN as for Photo 2. (200 mV/div., 100 μ s/div.).

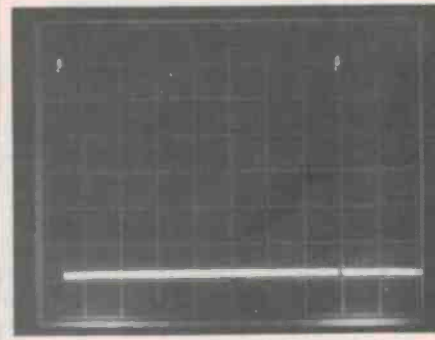

Photo 4; Divider output. Waveform at pin 11 of IC6. DIL switches and DATA IN as for Photo 2; i.e. 1650 Hz transmit frequency. (2 V/div., 5 μ s/div.).

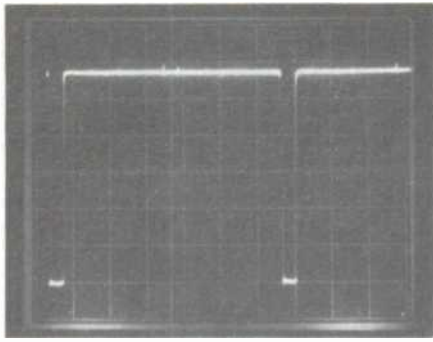

Photo 5; Filter commutation signal. This is the high pass filter commutation signal with no diodes in the programming array. Waveform taken at pin 14 of IC13. (2 V/div., 1 μ s/div.).

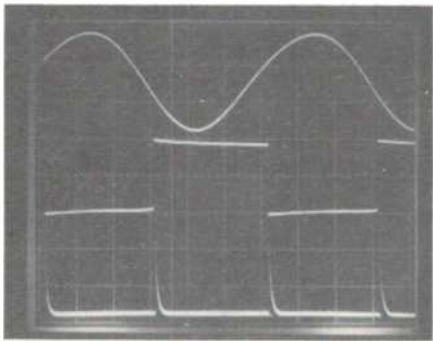

Photo 6; Frequency doubler. Outputs from the frequency doubler circuit. Upper trace — pin 2, IC12 (1 V/div.). Middle trace — pin 1, IC12 (5 V/div.). Lower trace — cathode of D3 (5 V/div.). Frequency is 1650 Hz (CRO timebase — 100 μ s/div.).

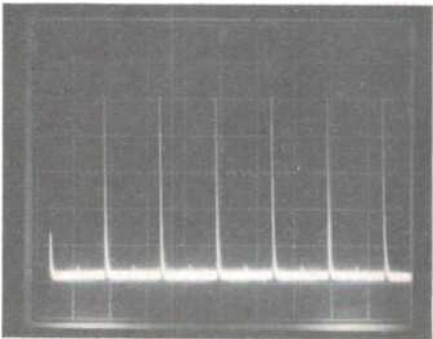
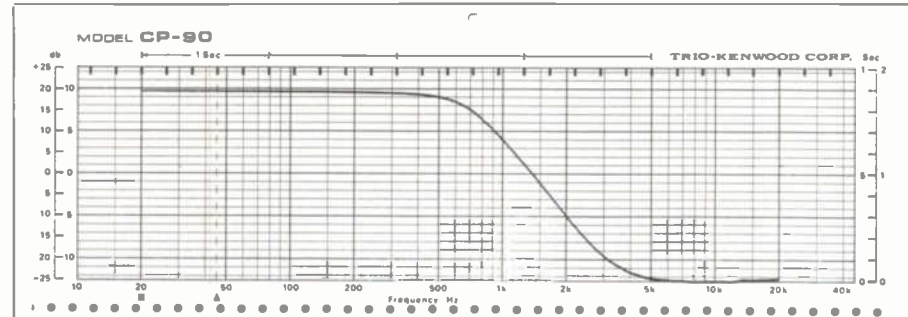

Photo 7; Frequency doubler. Another look at the cathode of D3 (or pin 4 of IC4). Frequency still 1650 Hz, as in Photo 6. (2 V/div., 200 μ s/div.).

Highpass filter

Connect a sinewave oscillator to terminal 24 (ground to terminal 12) and apply an input signal of about 12 V RMS or 3 V p-p (ensure IC20 is removed!). Monitor the highpass filter output at pin 1 of IC22. With no diodes in the matrix the -20 dB frequency of the high pass filter should be around 1.2 kHz. (At -20 dB the signal voltage will be one-tenth of its passband level, where the input and output signal amplitudes are the same.)

Frequency responses for several diode programs are reproduced to check against. If your highpass filter differs widely from



Data filter — 1200 Baud. Showing the low pass response of this stage when the modem is programmed for 1200 Baud operation. (50 dB scale). ▲

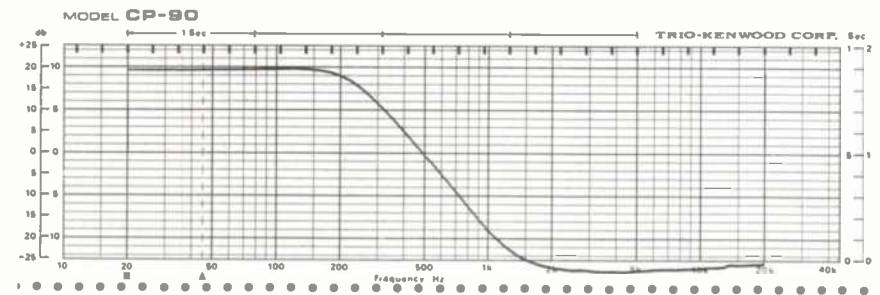

Reference filter — 1200 Baud. Showing the low pass response of this stage also for 1200 Baud operation. Note the lower cutoff frequency. (50 dB scale). ▲

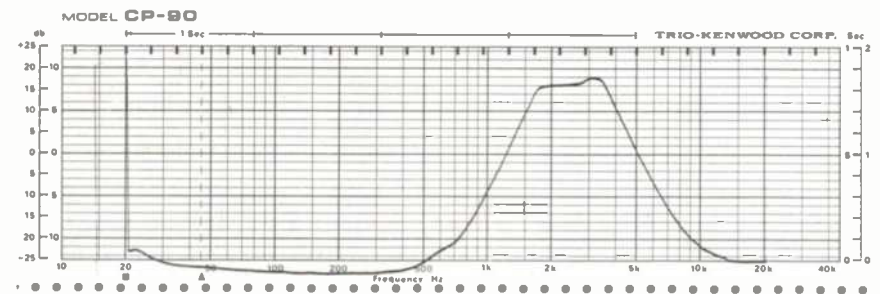

Receiver bandpass — no diodes. Overall receiver response with no diodes in the programming matrix. (25 dB scale). ▲

About the charts. All these charts were taken from our revised prototype (ETI-644A), as mentioned in the text, using ETI's Trio SE-3000 Audio Test Set. The two low pass (data and reference channel) filter responses were taken using the 50 dB scale for the sake of clarity. The receiver bandpass filter responses were taken using the 35 dB scale to 'expand' the curves, again for the sake of clarity.

Receiver bandpass — 1200 Baud. Overall response obtained when modem set for 1200 Baud receive — 1300 Hz/2100 Hz. (25 dB scale). ►►

my data then carefully check all passive components in the filter. The diodes can be changed to trim the response.

Make sure that pins 5, 6, 12 and 13 of IC21 have the same signal as pin 14 of IC13.

The diodes I am using are: A0, B0, C0, C1, D1, D2, A3.

Lowpass filter

Once the highpass section is working, insert IC23 and repeat the frequency response tests, this time monitoring the output signal at pin 8 of IC22 instead of pin 1. Without filter diodes the overall response should now be bandpass with -20 dB frequencies of around 1.2 kHz and 5.2 kHz (since the

highpass filter is also in circuit. The responses for several lowpass diode programs are reproduced (1 isolated the low-pass filter for these measurements, you need not bother!)

The diodes I am using are: G0, E1, G1, H1, H2, E3, F3, G3.

The overall bandpass response of my low and high pass filters are reproduced for each receiver channel. Note that component tolerance spreads may shift the response up or down in frequency slightly. If so, you can tune the filters via the diode matrix.

Looping back

Some of the remaining sections require an

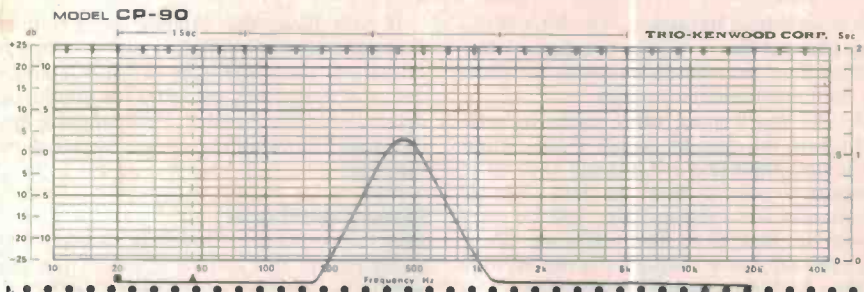

Receiver bandpass — 75 Baud. Overall receiver bandpass response when modem programmed for 75 Baud operation — 390 Hz/450 Hz. (25dB scale). ▲

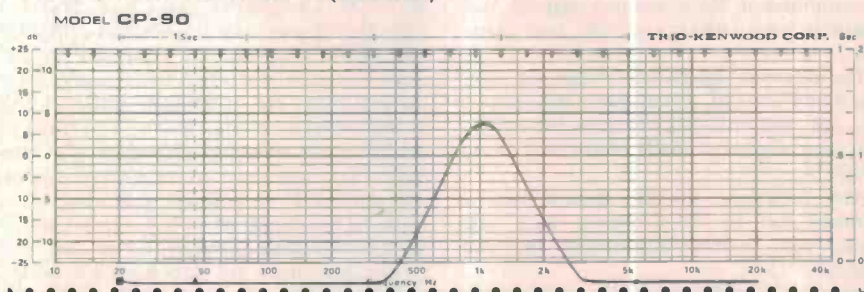

Receiver bandpass — 300 Baud. Response obtained when modem set up for 300 Baud operation — 980 Hz/1180 Hz. (25 dB scale). ▲

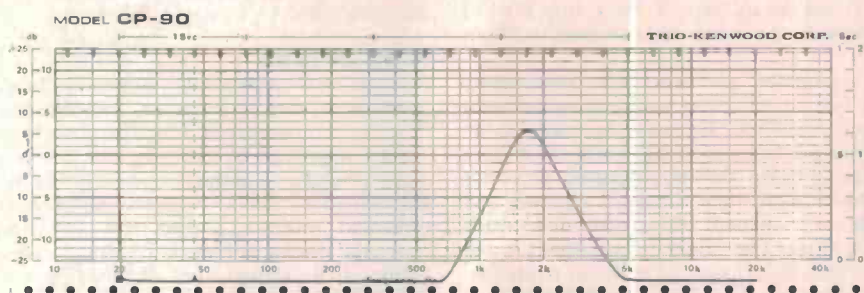

Receiver bandpass — 300/600 Baud. This shifts the response curve up, from that shown above, to accommodate the new frequencies — 1650 Hz/1850 Hz. (25 dB scale). ▲

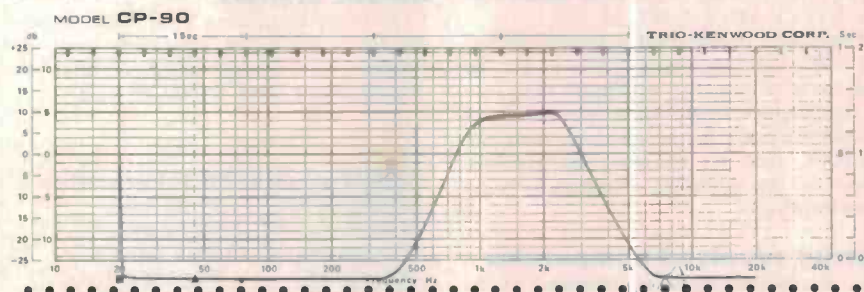

FSK signal to test circuit operation. This signal can be supplied by another modem, or the modem under test may be looped so that the transmitter generates the signal for its own receiver.

To loop back, insert IC18, IC19 and IC20 — the hybrid should be deliberately unbalanced so that the sidetone level is high. The Baud rate select input to IC8 pin 10 needs to be set opposite to the IC7 pin 10 level so that the receiver and transmitter are working the same channel. To do this, open the left-hand link of the two links near the RECEIVER DIODES matrix on the pc board. Connect a wire from the top half of the link to a 10k resistor. When DSW1/1 is

open, connect the resistor to terminal 1 (+6 V); when DSW1/1 is closed the resistor should go to terminal 2.

Remember that DSW1/3 must be 'open' to transmit and DSW1/4 has to be closed for the data test oscillator to work.

Frequency doubler

This section can be tested by either removing IC22 and injecting a signal from a generator at pin 8 of the empty IC22 socket, or looping back the modem to use the transmitter to test the receiver.

The correct signals at pins 1 and 2 of IC12 and at the cathode of D3 are shown for 1650 Hz (Photos 6 & 7).

ALC stage

Insert IC19 and IC20. With IC18 removed, apply a sinewave signal from a generator to terminal 23. Monitor the generator level and the signal at pin 8 of IC22. Use a frequency inside the filter passband. You should obtain results similar to those in Table 2:

Terminal 23	Pin 8 IC22
p-p	p-p
10 mV	0.7 V
50 mV	1.9 V
200 mV	2.3 V
500 mV	2.5 V
1.0 V	2.5 V
5.0 V	2.6 V
10.0 V	2.6 V

TABLE 2. ALC levels

Reference divider

The lengthening of the reset pulse in the reference frequency divider (R6 is 10k) only led to one change in the RECEIVER DIODE MATRIX. Diode A3 was deleted from the original table. Note that change to R6, like that of R7, may not be required on an already constructed modem, but is recommended when building up a new board.

Check the frequencies at pin 12 IC4b against my results in Table 3. This section operates like the transmit frequency divider.

Remember that the receiver channel frequencies are different to the transmit frequencies, unless you have made the changes in the LOOPING BACK section.

pin 9 —IC8— pin 10	optimum S1	measured S0	Freq. Hz.	measured Freq. Hz.
0	0	0	3400	3395
0	1	1	840	840
1	0	0	2160	2158
1	1	1	3500	3505

TABLE 3. Receiver frequencies

Data & reference channels

This section of the circuit seems to cause more problems for readers than any other, so I'll explain how it works first. Firstly, consider the reference channel operation. IC4b is a monostable that generates a train of positive-going pulses with a length determined by C5, R2 and RV1 and a period the *inverse* of the reference divider frequency. If a different reference frequency is selected (by changing channels) then the *interval* between the positive-going pulses will change, but the actual *pulse length* will remain fixed. Thus the reference frequency sets the mark/space ratio of the monostable output.

The commutated filter following the monostable removes most of the ac components in the pulse train, leaving the dc component.

The data channel operates in a similar fashion, except that the monostable IC4a is triggered by the incoming data (frequency doubled), which (unlike the reference chan-

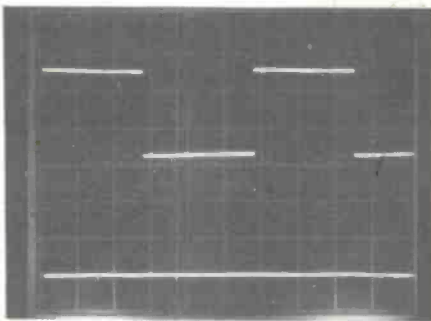

Photo 8; Reference mono. Reference mono (IC4) input and output at 3500 Hz. Upper trace — pin 10, IC4 (input). Lower trace — reset line for IC5, pin 12 of IC4. Look carefully and you'll see the very narrow pulses where the output returns high. (5 V/div., 40 μ s/div., RV1 at minimum).

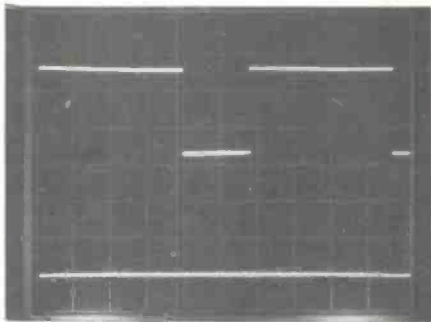

Photo 9; Reference mono. Reference mono (IC4) again, as per Photo 8, but this time with RV1 set at maximum resistance. Note that the output pulse is shorter this time.

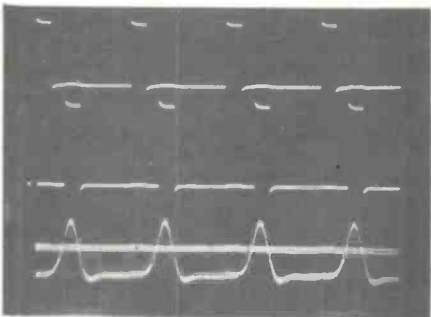

Photo 10; Frequency comparator. The data and reference channel signals are compared at the input of IC14b to recover the data. Here a 1200 Baud signal is shown. The upper trace is the data in, middle trace data out (5 V/div., 2 ms/div.). The lower two traces are taken from pins 5 and 6 of IC14. (2 V/div., 2 ms/div.).

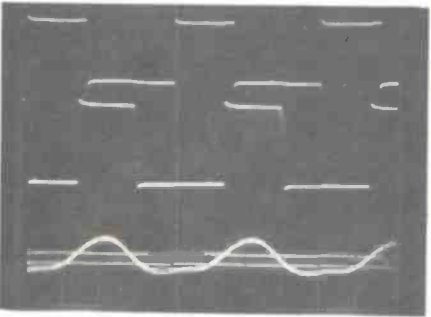

Photo 11; Frequency comparator. As per Photo 10, but this time for a 300 Baud signal. Upper trace — data in, lower trace — data out (5 V/div., 2 ms/div.). Lower two traces are pins 5 and 6 of IC14 (1 V/div., 2 ms/div.).

nel) is varying in frequency. The filter in the data channel has a higher breakpoint frequency than the reference channel to allow the data components through.

As the mark/space ratio varies in sympathy with the data the signal at the output of the data filter (pin 1 IC14) will have an ac component that follows the data. The dc component for random data will be very similar to that from the reference filter, since the reference frequency is the average of the (doubled) channel frequencies.

The data is recovered by feeding both filter outputs to a comparator IC14b. The use of commutated filters ensures that the two channels track closely over the four channels.

The relevant signals have been superimposed on Photo 10, which shows the data in, data out, and both filter outputs for 1200B. The same signals at 300B (980/1180) are in Photo 11.

Any imbalance in the monostables is trimmed out by RV1 which, once set, should not require adjustment between channels.

Insert IC4 and turn RV1 to minimum resistance. Set the receiver to the 600 Baud channel (S1=S0=1). Look at pin 10 IC4 and compare to Photo 8. Next, turn RV1 to maximum resistance and compare to Photo 9.

A common problem with constructors has been having too small an adjustment range on RV1, because the monostable period has been too long. Once the trigger pulses overlap the mono period in either IC4a or IC4b then the Data channel and Reference channel filters will fail to track each other. The original capacitors C5 and C9 (1n5) were reduced to 1n to overcome this problem. The pulse length for IC4a is 170 μ s with the 1n capacitors.

The diodes I used in the filter matrix are: M0, K1, L1, M1, L2, M2, J3, M3.

These were determined by looking at pins 1 & 2 IC14 and changing diodes to get the best signal — use the maximum data rate for the channel. If you cannot get the filters to track the four channels without readjusting RV1, then try changing the receiver diodes on the offending channels to bring them into line.

Carrier received comparator

The filtered data signal is compared to the voltage set by R48 and R49 and the carrier received indicator is true when the data signal is higher. On the original ETI-644 boards R48 goes to -6 V, so the switching point can be set anywhere in the supply voltage range by changing R48. Trevor Marshall advised that R48 should go to 0 V instead of -6 V and the change was made to the ETIO-644A board. Unfortunately, it seems that channel frequencies below about 1500 Hz drop the filtered data signal below 0 V, thus keeping the carrier received comparator off. The solution is to run R48 to -6 V and find a value that works on all channels. I found 5k6 to be satisfactory. (Murphy had to have one more in store after the change to R7 saved eight diodes!) This problem doesn't occur on Bell 103 originate, so Trevor probably never came across it.

If you have the original board, then manipulating R48 should result in correct operation, since R48 goes to -6 V. Carrier detect is really only essential for automatic operation of the modem. For manual usage the audio monitor circuit serves the same function.

Line interface

The line balance adjustment is the only tricky part of this section. To carry out the nulling, set the relays to answer a call (RL1, RL2, RL4 on; RL3 off). The loop back should be disconnected and the links intact. Set to 300B originate (DSW1/1 and DSW1/2 closed) and enable the transmitter (DSW1/3 and DSW1/4 open). To make the adjustment easier, an open line is necessary, since the dial tones etc. complicate things. Look at the signal at terminal 23 — you have to minimise the transmitter frequency at this point. You will need to try several capacitors in the C45/46 position, each time turning RV2 for minimum signal at terminal 23. Start with a value between 10 and 22nF and go up and down till you find the lowest minimum. The adjustment will need to be repeated if a different line is used. Many constructors make RV2 a remote pot for convenience.

Ring detect

Readers have reported that some lines have insufficient ring voltage to activate the detector comparator, IC12b. The sensitivity can be improved by changing the components as indicated in the Parts List Revision. Dropping R44 to 47k lowers the comparator threshold while increasing R46 to 100k raises the ringing voltage at the comparator input. C24 should be dropped to a 1 μ s/35 VW tantalum.

RS-232 signals

To connect the modem to a standard terminal (or a computer emulating one) and operate without automatic features the accompanying table should be used:

RS-232 pin no.s	ETI-644 terminal no.s
2 transmit data	7 data input
3 receive data	6 data output
7 signal ground	12 '0V' ground
8 carrier on	5 carrier detect

TABLE 4. RS-232 connection.

N.B: It is usually necessary to connect pin 4 to pin 5 on the RS-232 plug. (Connects request-to-send to clear-to-send).

Auto dialling

The ETI-644A is capable of being controlled from a computer and therefore to operate in a bulletin board type system. I have had several enquiries about the software required to control the modem, and am working on software for the Microbee computer. I cannot develop software for other machines due to lack of facilities, but welcome any reader's contributions in this area. The basic sequence is outlined in the paragraph on 'Computer control' on p23 of ETI Oct. 1982.

BARGAINS...BARGAINS...BARGAINS...BARGAINS

WE HAD SUCH GREAT RESPONSE TO OUR MARCH SPECIALS, THAT WE HAVE EXTENDED THEM TO THE END OF MAY '84

DON'T FORGET TO CHECK OUR STORE SPECIALS

WE WILL GIVE YOU THE BEST DEAL ON COMMODORE COMPUTERS PLEASE RING BERNEICE FOR THE BEST PRICE POSSIBLE ON (03) 489-8866

THIS MONTH SOMETHING FREE! FREE! FREE! WITH EACH PURCHASE.

MN3001
(SCOOP PURCHASE FOR OUR KITS)
NORMALLY \$19.95

THIS MONTH
BUCKET BRIGADE IC'S
SAVE, SAVE, SAVE,
EX1 IC EXTRACTOR

	1-9	10+
	\$14.95	\$13.95



DON'T DAMAGE YOUR IC'S WHEN YOU HAVE TO PULL THEM OUT.

1-9	10+
\$1.20	.95

2K OHM MULTIMETER
11 RANGES POCKET SIZE



SPECIFICATIONS
11 RANGES

DC VOLTAGE: 0-10-50-250-1000 volts
2000 ohms/volt

AC VOLTAGE: 0-10-50-250-1000 volts
2000 ohms/volt

DECIBELS: -10 TO +22dB in four ranges

OHMMETER: 0-10 k/ohms, 0-1 megaohms

DC CURRENT: 1-100mA

NORMALLY \$14.95

THIS MONTH \$9.95

BUTTON CELLS

FREE CHART ON WHAT THEY FIT. CHARGE YOUR FRIENDS \$4.00 TO FIT THEM INCLUDING THE BATTERY FOR FIVE MINUTES WORK.

	1-9	10+
SG13/G13	1.50	1.00
SG12/12	1.20	.80
SG10/G10	1.20	.80
SG3/G3	1.20	.80
AG13/LR44	1.00	.75
AG12/LR43	.75	.60



HI WATT BATTERIES

WE JUST LANDED A TONNE OF THESE LITTLE "HEART" STARTERS TO CHEAP THAT YOU CAN THROW THEM AWAY AFTER USING THEM ONCE IF YOU WANT TO.

	1-9	10+
AA	15c	10c
C	20c	15d
D	25c	20c
9V	40c	30c

SOLDER CENTRONICS PLUGS
(UNREAL PRICE. BUT ABSOLUTE TOP QUALITY)



	1-9	10-99	100+
	\$6.95	\$5.95	\$4.95

NORMALLY \$14.95. (OUR OPPOSITION CHARGE UP TO \$19.95. ARE YOU PAYING TOO MUCH FOR OTHER PRODUCTS FROM THEM AS WELL.)

ELECTRET MIC INSERTS
WITH PINS FOR EASY BOARD INSERTION



1-9	10-99	100+
\$1.75	\$1.65	\$1.50

DON'T PAY TOO MUCH BREADBOARD SPECIALS

CAT. No.	No. HOLES	COMP. PRICE	OUR PRICE
P11000	100	2.95	\$1.50
P11005	640	8.95	\$5.95
P11009	840	14.85	\$10.95
P11012	1680	27.95	\$19.95
P11015	2420	45.00	\$29.95



HALF HEIGHT 5" DRIVE SPECIALISTS

	BARE DRIVE	WITH BOX + P.S.
MITSUBISHI M4851 500K BYTE	\$329.00	\$369.00
M4853 1M BYTE	\$359.00	\$399.00
M4854 1.6M BYTE	\$399.00	\$439.00

MP 5" STANDARD DRIVES

B51	\$0269.00	\$299.00
B52	\$349.00	\$379.00
B91	\$349.00	\$379.00
B92	\$439.00	\$459.00

ALL DRIVE PRICES INCLUDE SALES TAX

COMPUTER CABLES



NEW PRODUCTS TO SAVE YOU HEAPS OF TIME TRYING TO CRIMP THEM IN A VICE.

P19001	SYSTEM 80 OR EARLY TRS80 2x34 WAY EDGE CONNECTORS 1 METRE 34 WAY IDC CABLE SINGLE 5 1/4" DRIVE CABLE	\$29.50
P19003	SYSTEM 80 OR EARLY TRS80 3x34 WAY EDGE CONNECTORS 1 METRE 34 WAY IDC CABLE DOUBLE 5 1/4" DRIVE CABLE	\$39.50
P19005	BIG BOARD 2 OR LATE TRS80 1x34 WAY EDGE CONNECTOR 1x34 WAY IDC CONNECTOR 1 METRE IDC CABLE SINGLE 5 1/4" DRIVE CABLE	\$26.50
P19007	BIG BOARD 2 OR LATE TRS80 2x34 WAY EDGE CONNECTORS 1x34 WAY IDC CONNECTOR 1 METRE IDC CABLE DOUBLE 5 1/4" DRIVE CABLE	\$39.50

DATA BOOKS, DATA BOOKS YOU WILL NEED THESE FOR SCHOOL

FAIRCHILD CMOS	\$9.95
NATIONAL LOGIC TTL	\$9.95
NATIONAL LINEAR I	\$9.50
NATIONAL LINEAR II	\$9.50
NATIONAL CMOS	\$9.50
NATIONAL LINEAR APPLICATIONS	\$14.50

CHASIS PUNCH SET

(WE KNOCK A HOLE IN THE OPPOSITION'S PRICES ON THIS ONE) **\$16.95**



JOYSTICKS



(AS USED IN YOUR STANDARD COIN OPERATED MACHINE'S. THESE SHOULD GIVE YEARS' OF SERVICE AS USED BY THE PROFESSIONAL OPERATORS.)

2 WAY (2 MICROSWITCHES)	1-9	10+
4 WAY (4 MICROSWITCHES)	21-50	18-50
DIP SWITCHES 4 WAY	\$1.00	
8 WAY	\$1.50	

AA NICADS 1-9 10-99 100+
1-75 1-60 1-50
NORMALLY \$2.50 EACH

BARGAIN HUNTERS CORNER

(GET YOUR BIG GAME HERE)
THE STING DISK FOR MICROBEE™ 50 only in stock WAS \$395.00 NOW \$195.00. GET IN QUICK.

5 CP-80 RIBBONS FOR \$49.50 (HOW DO WE DO IT?)

NEON TEST SCREWDRIVER
WE HAVE ZAPPED THE PRICE TO 75 CENTS

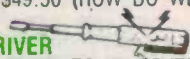

OUR NEW RANGE OF OSCILLOSCOPES ARE ON THE WAY

ASK FOR DETAILS. SHOULD ARRIVE LATE FEBRUARY

15 MHz AC-DC PORTABLE	\$695.00	Including Tax
20MHz Dual Track	\$495.00	Including Tax
45MHz Dual Track	\$995.00	Including Tax

Probes are extra at \$29.50 each

BUY IN LOTS OF 10 AND SAVE
PIC A PAK SPECIALS

10 2SJ49 for \$49.00	10 74C926 for \$59.00
10 2SK134 for \$49.00	10 2732 for \$49.00
10 2N3055 for \$7.50	10 2764 for \$79.00
10 BUX80 for \$39.00	10 74LS245 \$12.00
10 BD139 for \$3.90	10 4164 for \$69.00
10 BD140 for \$3.90	10 7400 for \$2.90
10 RED LEDS 5mm .90	10 H1044 DELUXE
10 GREEN LEDS \$1.40	METAL CASES for \$49.50

LINE FILTERS 3 AMP 240 VAC. **\$11.95**



JUST ARRIVED
NEW DIGITAL MULTIMETER

PUSH BUTTON CONTROLS BUT UNDER \$60.00	WOW!!! 10 AMP 1-9 10+ 59-95 52.50
--	---



ROD IRVING ELECTRONICS

425 High St., Northcote, Vic. 48-50 A'Beckett St., Melb., Vic.
Phone (03) 489 8866, (03) 489 8131, Mail Order Hotline (03) 481 1436
Mail orders to P.O. Box 235 Northcote 3070 Vic.

Minimum P & P \$3.00. Errors & omissions excepted.
Please address tax exempt, school, wholesale and dealer enquiries

RITRONICS WHOLESALE

1st floor 425 High St. Northcote 3070 (03) 489 7099 (03) 481 1923
Telex AA 38897

THE VIC-20 COLUMN

★ENCOURAGEMENT★

Ozi-Soft, in conjunction with Computer Technics, is offering to donate a VIC-20 expansion board for the best software item submitted to this column every month.

The board is Australian-designed and manufactured and simply plugs into the VIC-20's expansion slot. It features three sockets that can be independently switch-selected, plus an on-board reset switch. With it you can plug in up to three separate expansion units to your VIC-20 and avoid the hassle of plugging things in and out and turning the computer on and off each time.

It is distributed by Computer Technics, 123 Clarence Street, Sydney (G.P.O. Box 4936) NSW 2000. (02)29-7244. The board costs \$59.95.

All submissions must be accompanied by a signed letter from you stating that it's your original work. The winning submission will be judged by the Editor and no correspondence will be entered into. All published submissions will be paid for.

Send entries to: **The Editor, VIC-20 Column, ETI Magazine, P.O. Box 227, Waterloo NSW 2017.**

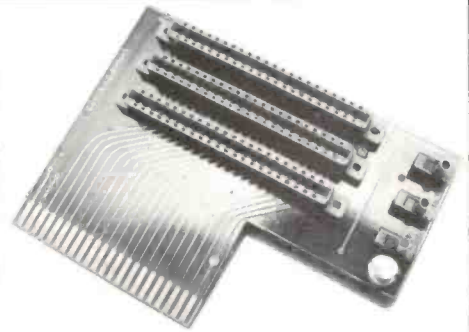

April's winner of the VIC-20 expansion board for the best program has been won by J. Ennis of East Malvern, Victoria, for the program 'Error Trapping'. Instead of halting the execution of the program when an error is found, this routine directs the program to a specified line.

ERROR TRAPPING

J. Ennis, East Malvern, Vic.

Normally an error in a BASIC program will stop the running of it and produce infuriating messages such as "SYNTAX ERROR IN ...". The following routine intercepts the error and instead of halting the execution of the program will go to a specified line in the program. Its function is the same as "TRAP 3000" on an Atari or "ON ERROR GOTO 200" on BBC micro.

The effect is produced on the Vic by changing the vector for errors, which are at 768 and 769 decimal, to point to this routine. The routine itself is entirely in machine code, so it must be poked into memory from BASIC. The program listed here pokes the routine into a given area of memory and then saves it on tape. It should be typed in as listed and without unnecessary spaces between words.

The program should be saved on tape before it is RUN; line 90 alters pointers in memory which normally point to the beginning and end of the User BASIC area. On an unexpanded Vic these can be reset by entering POKE43, 1: POKE44,16: POKE46,18: POKE45,130.

Line 100 saves onto tape, under the name of "ERR", the section of memory containing the machine code routine. To use error trapping in another program, first load ERR with the command load "ERR" 1,1; this puts it back to where it was originally in memory. Change the pointer at 768-769 so it points to the beginning of the routine and put the line number you want the routine to go to in locations 3 and 4. (Both these things are done in line 40 of the program).

Now, if in "direct" mode you make a mistake, such as typing "RUM" instead of "RUN", the usual error message will appear. If, however, an error occurs while a program is running, the program will jump to the line specified in locations 3 and 4. (If the specified line does not exist the program will stop and an error message will be printed).

Once an error has been intercepted, the BASIC program can find out where it happened and what it was; this is illustrated in lines 200-220. If we typed in the program as listed and then added: "95 AAA", an error would occur when it was run. At line 200 would then be printed the error number (stored in location 0) and the line at which the error occurred (stored in loc. 57-58). Lines 200-220 then find the normal error message and print it out.

There are some limitations: If you enter "RUN 100" and line 100 does not exist, the program is considered to be running and execution then begins at the error handling routine. If string data is entered instead of numeric data you will still get the message "?REDO FROM START", and the STOP key still

works. Also, if you made an error in the error handling routine you would set up an endless loop which could only be broken by the STOP key.

The main machine language routine is relocatable; for 6502 programmers the assembly language listing is also given here.

ERROR TRAPPING

```

10 DEF FNA(X)=PEEK(X)+256*PEEK(X+1)
20 INPUT"ADDRESS";A$:A=VAL(A$):IFA<1024ORA<FNA(49)AND
  A>FNA(43)THEN20
30 FORI=ATO A+64:READB:POKEI,B:CH=CH+B:NEXT:IFCH<>_6817
  THENPRINT"ERROR":END
40 POKE769,A/256:POKE768,A-INT(A/256)*256:POKE3,200:POKE4,0
50 DATA 165,157,208,40,134,0,165,43,133,1,165,44,133,2,160,2
60 DATA 177,1,197,3,208,7,200,177,1,197,4,240,18,160,1,177
70 DATA 1,72,136,177,1,133,1,104,133,2,208,226,76,58,196,72
80 DATA 152,24,101,1,208,2,230,2,133,122,165,2,133,123,76
  228,199
90 POKE44,A/256:POKE43,PEEK(768):A=A+65:POKE0,A/256:POKE1,
  A-INT(A/256)*256
100 POKE46,PEEK(0):POKE45,PEEK(1):SAVE"ERR":END
200 PRINT"ERROR"PEEK(0)"IN LINE"FNA(57):AD=FNA(49958+
  2*PEEK(0)):A$=""
210 A$=A$+CHR$(PEEK(AD)AND127):AD=AD+1:IFPEEK(AD-1)<128
  THEN210
220 PRINT$PC(24)A$" ERROR":END
  
```

Assembly Language Routine

BEGIN	LDA \$9D ;Run/Direct	STA \$02
	BNE ERROR	BNE LINE
	STX \$00	JMP \$C43A;Vic error sub.
	LDA \$2B ;Pointer to	PHA
	STA \$01 ;beginning	TYA
	LDA \$2C ;of Basic	CLC ;Calculate
	STA \$02 ;	ADC \$01;first byte
LINE	LDY \$02	BNE ADD;of line.
	LDA (\$01),Y;Low byte	INC \$02;
	CMP \$03 ;of line no.	STA \$7A;Store byte
	BNE CONT	LDA \$02;address in
	INY	STA \$7B;CHRGET routine.
	LDA (\$01),Y;High byte	JMP \$C7E4;Vic routine
	CMP \$04 ;of l.n.	;to start
	BEQ FOUND	;next Basic
CONT	LDY \$01	;token.
	LDA (\$01),Y;Get next	
	PHA ;link	
	DEY ;address	
	LDA (\$01),Y; and	
	STA \$01 ; store	
	PLA	

(N.B. For VICMON users, £ is the same as *.)

ELLISTRONICS

PROPRIETARY LIMITED

797 SPRINGVALE RD. MULGRAVE 3170. PHONE: (03) 561 5844 TELEX AA37758 LSTRON
 289 Latrobe Street, Melbourne 3000. Phone: (03) 502 3499-Telex AA37758 Lstron

S.G.S. & Ellistronics Have some new numbers in Telecommunications

We are building up stocks of Telecommunication Devices, maximum lead time for items not in stock at present would be 6-8 weeks from receipt of order. (Minimum order for non-stocked items \$50 per line.)

Type	Function
L146/C	High precision high voltage regulator
L200	Adjustable voltage and current regulator
L296	High current switching regulator
L387	Very low drop 5V voltage regulator
L4700 series	Very low drop voltage regulators
L4800 series	Very low drop voltage regulators
LS159	High reliability transistor array
LS188	Microphone preamplifier
LS204/A/C	High performance dual operational amplifiers
LS285/A	Telephone speech circuits
LS288	Programmable telephone speech circuit
LS388	Low consumption speech circuit
LS404/C	High performance quad operational amplifiers
LS496	Quad relay driver

Type	Function
LS76/e	Programmable operational amplifiers
LS1240	Electronic type tone ringer
LS5016/60/120	Transient voltage suppressors
M079	2x2x2 crosspoint matrix
M088	Digital switching matrix
M089/99	2x8 crosspoint matrix
M751	Dual tone multifrequency generator
M761/A	Dual tone multifrequency generator
M764/A	Tone ringer
M774	Tone ringer
M2560A	Pulse dialer
M5116	μ -225 law companding codec
M5156	A law companding codec
M5912	PCM transmit receive filters
M22110	4x4 crosspoint switch with control memory



DO WE KNOW YOU?

Ellistronics gives service to all areas of the Industrial market, you could be purchasing your goods at high prices from someone who originally bought them from Ellistronics. Ellistronics wants to know you. Send us the following information so we can mail you our latest technical data, and pricing on Semiconductors etc...

Company Name		O.E.M.	<input type="checkbox"/>
Address		Wholesaler	<input type="checkbox"/>
Postcode		Retailer	<input type="checkbox"/>
Phone No.		Government or Semi Govt. Dept.	<input type="checkbox"/>
Company Contact	Position		
Do you have Credit Account with Ellistronics at present?		YES	<input type="checkbox"/>
		NO	<input type="checkbox"/>
For further inquiries contact our Sales Manager Bill Gibson.			

**TOP SELLING
AUSTRALIAN COMPUTER**

Coming to terms with the future



microbee

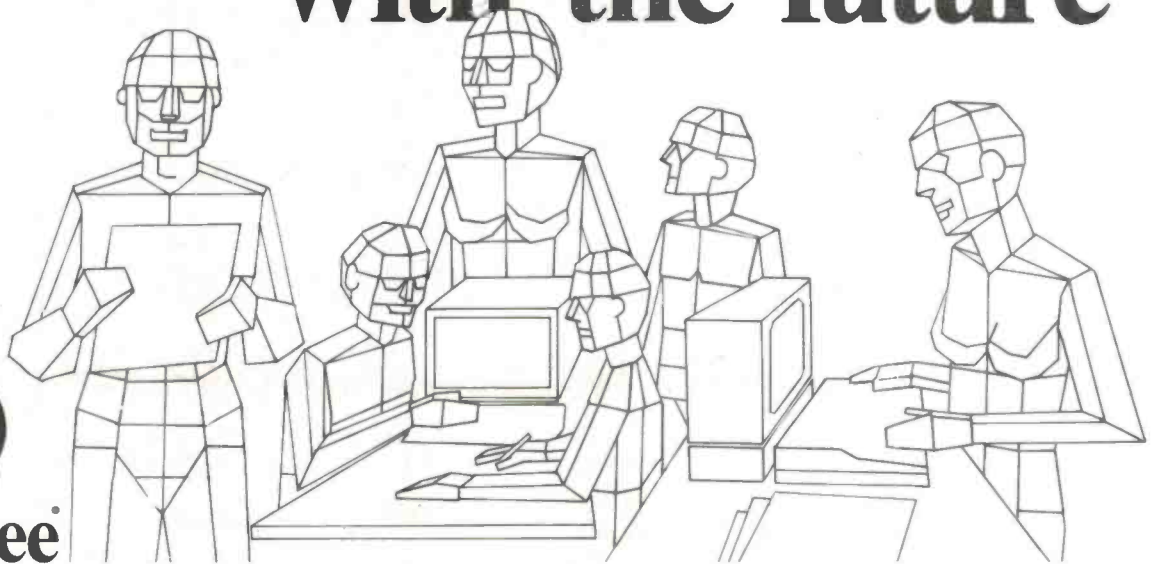

Education

microbee is now officially recognized as Australia's Educational Home Computer. With the release of BEENET 2 it is now possible to NETWORK 16 or more microbees in a classroom with each student station linked to the teacher's file server to produce the ideal classroom system sharing printers, disk drives and rapidly transferring information as required.

Personal Business Use

People don't only want to just use a personal computer. Computers are

for doing something useful in the world. Man uses TOOLS to achieve his goals. microbee recognises this and provides Wordprocessing, Communications, BASIC and a host of utilities inside each unit. In all cases microbee is being used as a TOOL in the service of mankind.

Family Entertainment

Not all applications need to be so serious. microbee is ideal as a basis for exciting and stimulating games for all the family. Fast moving graphics, sound effects and over 200 top quality popular games mean your microbee is ideal for family fun as well.

Why not try your hand at Micro Space Invaders, Robotman, or play Bee Monopoly the 1984 way. Think you know a lot about chess? Try your skills against microbee . . . it can also show how to improve your game . . .

Personal Finance

microbee is a powerful calculator and can be used to improve your personal financial planning, start a data base or even schedule your appointments. microbee is indeed a modern tool for today's times, enabling young and old to come to terms with the future in a constructive, informative and entertaining way.

SERIES 2

EXPERIMENTER

By popular request, the low cost microbee Series 2 Experimenter has been designed for those who are starting out in the fascinating world of computers or those who want to share the fascination of exploring the exciting developments in the fast moving MICROWORLD. All microbees can be expanded at any time.

microbee Experimenter\$399

SERIES 2

EDUCATOR

The microbee Series 2 Educator was specifically designed to serve the needs of the education market. This is recognised by the fact that the microbee has been chosen by the NSW, WA, Queensland and the Australian Schools Commission as a recommended computer for use in schools. With the exceptional performance at a realistic price, powerful software designed for Australian curriculum needs, microbee is now in wide use throughout primary, secondary schools, technical colleges and universities.

microbee Educator\$449



SERIES 2

ADVANCED PERSONAL COMPUTER

The microbee Series 2 APC with 500K Disk Drive is the most powerful and best priced/performance computer in its class. The APC is now supplied 'bundled' with WORDSTAR, MULTIPLAN, microbee BASIC, CP/M 2.2 plus MICROWORLD packages such as disk WORDBEE, EDASM, BASIC as well as vital utilities such as CONFIG, FORMAT, COMPARE. Comprehensive Microworld User Manual also supplied.

microbee APC (Single Disk Drive)\$1495
microbee APC (Dual Disk Drive)\$1795

The Solution: microbee Personal Communicator

Our top selling portable microbee, the Personal Communicator now features Telcom1 firmware, WORDBEE, Microworld BASIC, machine code MONITOR, ADM-3A terminal emulation, self-test in 28K of ROM with 32K of CMOS battery backed user memory, high resolution PCG GRAPHICS, SERIAL AND PARALLEL I/O ports, programmable cassette interface, and direct monochrome video output.

Add the low cost BEEMODEM and your Personal Communicator uses the home telephone line to become a complete home terminal ready, willing and able to communicate with other computers worldwide.

Microworld BASIC has long been a powerful feature of the microbee. A vast library of educational, entertainment and utility software is now widely available on the market. Microworld BASIC supports full high resolution graphics, colour if required, music, I/O data can be directed at will and, best of all, MW BASIC is a breeze to learn to program yourself.

microbee
Personal Communicator . . . \$499



microbee computer shops

1 Pattison Ave,
Waitara 2077.
Phone (02) 487 2711

729 Glenferrie Rd,
Hawthorn 3122.
Phone (03) 819 5288

141 Stirling Highway,
Nedlands, Perth.
Phone (09) 386 8250

Coolman Court,
Weston A.C.T. 2611.
Phone (062) 88 6384

151 Unley Road, Unley.
S.A. (Opening Soon).

457 Logan Road,
Stones Corner QLD.
(Opening Soon).

Koala Crescent,
West Gosford 2250.
(043) 24 2711

Authorised Dealers in—
NSW:

Carlingford,
Coffs Harbour, Concord,
Hurstville, Lismore,
Sydney, Waterloo,
Wauchope

VICTORIA:
Glen Waverley,
Melbourne.

QUEENSLAND:
Aitkenvale, Cairns.

SOUTH AUSTRALIA:
Adelaide, Edwardstown,
Port Lincoln.

WESTERN AUSTRALIA:
Mount Tom Price.

TASMANIA:
Launceston
ACT:
Belconnen, Weston.

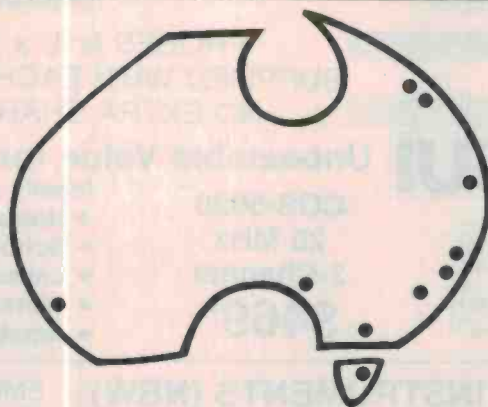

Shops and Dealers
Australia wide

bankcard

welcome here

DIRECT ORDERS
PHONE (02) 487 2711
TELEX AA72767

APPLIED
TECHNOLOGY
RETAIL PTY LTD



microbee

MODEL 175 AUTORANGING BENCH/PORTABLE DMM

KEITHLEY INSTRUMENTS



The new Model 175 Autoranging Bench Digital Multimeter, from Keithley Instruments, Inc., combines the measurement capabilities of much higher-priced system DMMs with several new features to extend its utility, yet retain simplicity of use. Ideal for use as a bench meter in production or lab work, this 4-1/2 digit autoranging DMM also has a field-installable battery option, making it fully portable. Fast autoranging (up to 200ms per range change on DCV) enables the user to concentrate on getting the reading without worrying about choosing the appropriate range.

The Model 175 features digital calibration for reduced cost of ownership, as many users can now calibrate the meter in-house. With the Model 1753 IEEE-488 (GPIB) option, the 175 is the lowest-priced IEEE-interfaceable DMM available. Model 175's 100-point data logger monitors drifts, determines rates of change, and collects response curve data without a printer, output cables, or complicated hook-ups. The data logger has six different store rates from one reading/400ms to one reading/hour, and data recall is "push-button" easy.

For more information on the Model 175 Autoranging DMM, or on a variety of other industrial electronic testing and measurement equipment, contact:



SCIENTIFIC DEVICES AUSTRALIA PTY. LTD.
 VIC. 2 JACKS RD., SOUTH OAKLEIGH. 3167
 PHONE (03) 579 3622 TELEX AA 32742
 N.S.W. OFFICE 2, 35-37 HUME ST., CROWS NEST, 2065
 PHONE (02) 43 5015 TELEX AA 22978
 S.A. 31 HALSEY RD., ELIZABETH EAST, 5112
 PHONE (08) 255 6575 TELEX AA 88125

Other features of the Model 175 include:

- 4-1/2 digit LCD display with annunciators for function, range, and feature indication
- 10µV/10mΩ/10nA sensitivity
- 0.03% basic DCV accuracy
- True RMS AC
- 10A capability
- 100kHz bandwidth in AC
- dBm/relative function
- Relative reference
- Max/Min reading hold
- Safety input jacks
- Front panel accessible amps fuse

meguro

OSCILLOSCOPES From Japan

Worldwide Recognition for Quality and Reliability

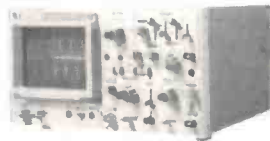

MO-1252
35 MHz
2-Channel
\$749*

Sensitivity: 5mV/div-10V/div; 1mV/div at x5 Mag.
 Bandwidth: DC or 10 Hz-35 MHz.
 Sweep Mode: NORMAL, AUTO, SINGLE, DELAY.
 Trigger Delay: INTEN'D, DELAY'D; 1µs-100mS.
 Trigger Source: INT, LINE, EXT, EXT/10.
 X-Y Operation & Z-Axis modulation.

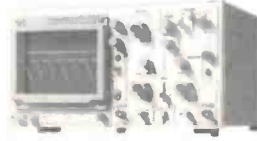

MO-1251
 (with component tester)
20 MHz
2-channel
\$525

Sensitivity: 5mV/div-20V/div; 1mV/div at x5 MAG.
 Bandwidth: DC or 10Hz-20MHz.
 Sweep Mode: NORMAL, AUTO.
 Trigger Source: INT, CH2, LINE, EXT.
 X-Y Operation & X-Axis modulation.
 Component Tester: for R.L.C. & diodes.

PROBES (x 1 / x 10)
SUPPLIED WITH EACH CRO AT
NO EXTRA CHARGE!

KIKUSUI

Unbeatable Value for a 2-Channel Cro



COS-5020
20 MHz
2-Channel
\$469*

Ideally priced for:

- Hobbyist
- Schools
- Laboratories
- Workshops
- Amateurs

Sensitivity: 5mV/div-5V/div;
 1mV/div at x5 MAG.
 Bandwidth: DC or 10 Hz-20 MHz.
 Sweep Mode: AUTO, NORM, SINGLE.
 Trigger Source: CH1, CH2, LINE, EXT.
 X-Y Operation, CHOP and TV.

* Add 20% Sales Tax if applicable



EMONA INSTRUMENTS (NSW)

Showroom & Sales:
 National Australia Bank Bldg., 2nd Floor,
 661 George Street,
 Sydney NSW 2000

Tel: (02) 212-4815, 212-3463

EMONA CATALOGUE '84 — INSTRUMENTS & COMPUTERS AS AVAILABLE ON REQUEST.

RADIO PARTS GROUP (VIC.)
 562 Spencer Street, West Melbourne, Vic 3003. Tel: (03) 329-7888
 1097-1103 Dandenong Road, East Malvern, Vic. 3145. Tel: (03) 211-8122

NEOTRONICS SCOPE TESTS COMPONENTS

The low cost high performance Neotronics oscilloscope model OS-620, offers 20 MHz bandwidth with a rise time of less than 17 ns.

The high brightness, flat faced CRT works on an acceleration voltage of 2 kV and has an effective display area of 8 x 10 divisions (1 div = 10 mm). The graticule is internal thus there are no parallax errors.

There are 11 sensitivity settings from 5 mV/div to 10 V/div in a 1-2-5 step sequence. A fine control is also incorporated. The maximum input is 600 V p-p or 300 V p-p (dc+ac peak). The timebase has 19 ranges from 0.5 μ s/div to 0.5 s/div, again in a 1-2-5 sequence. The timebase switch will automatically select either chop or alternate depending on the speed.

An unusual feature of the OS-620 is the component test facility. This unique facility checks components connected to the special test connectors on the front panel. A voltage of 9 V ac(max) is applied to the terminals when the component test switch is enabled and the screen will show the X versus Y response of the component.

A capacitor and an inductor shows an ellipse, a resistor shows a straight line, the angle of which depends on the value, and transistors, zeners and integrated circuits show knee voltage curves etc. No external power is required to perform this

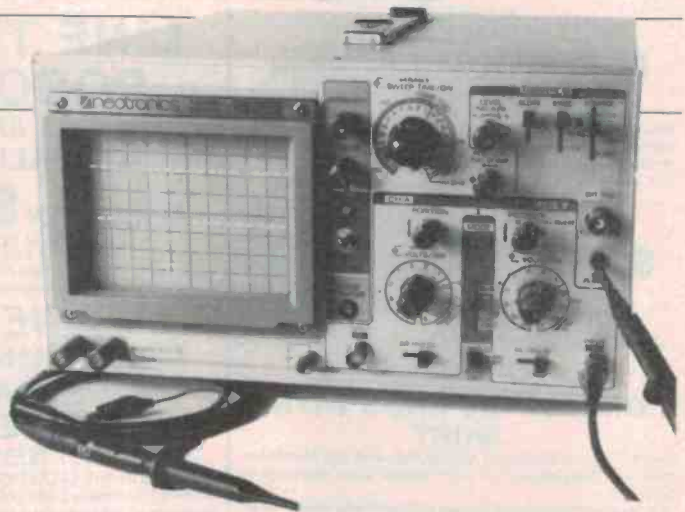

measurement.

Other features include a trace rotation from the front panel, calibration voltage on the front panel, intensity modulation on the rear of the instrument and TV synch, both line and frame.

The scope comes complete with two high quality X1,ref,X10 probes.

For further information contact Neotronics Pty Ltd, P.O. Box 289, Newport NSW 2106. (02)918-8220.

LOW COST PRECISION PULSE GENERATOR



A new low-cost precision pulse generator, offering a comprehensive range of independently variable controls, has been introduced by Global Specialties Corporation.

Offering rise and fall times of less than 30 ns, the Model 4001 covers a frequency range from 0.5 Hz to 5 MHz. Pulse width and pulse spacing are each independently variable from 100 ns to 1 s to give a 10^7 : 1 duty-cycle range.

Six modes of operation are available on the Model 4001: run frequency-settable from 0.5 to 5 MHz via the normal controls; trigger accepts dc to 10 MHz signals from an external source; gate starts the generator synchronously with the leading

edge of a gate signal; single shot produces a pulse each time a pushbutton is pressed; square wave producing a signal up to 2.5 MHz; and complement which inverts the output signal.

A single-turn vernier adjusts the output amplitude over a 1-10 V range, and the output exhibits a maximum 400 Ω impedance at full amplitude.

The Model 4001 measures only 254 mm x 76 mm x 178 mm and weighs 1 kg. It will operate over a temperature range of 0°C to 50°C, and power consumption is 6 W at 240 V ac, 50 Hz.

Global Specialties equipment is available from Vicom International Pty Ltd, 57 City Road, South Melbourne and 118 Alfred Street, Milsons Point NSW.

HIGH VOLTAGE PROBE

The Leader Model LHM-80A high voltage meter probe, recently released by Benelec Pty Ltd, provides safe measurement of extra-high voltages to 40 kV with a sensitivity of 20 kohms/volt and an accuracy of 3% full-scale.



Designed for virtually any EHT measurement application, the Leader LHM-80A would

typically have application in television repair or design and maintenance of computer video display units, etc. EHT voltages in such equipment ranges from 10 kV to 35 kV, for example.

The unit is entirely self-contained. The meter is mounted in the probe handle, behind an arc-over shield at the end of the integral high voltage tapered probe. A sturdy 50 mm long probe spike permits easy contact with the EHT point being measured.

A ground clip-lead comes from the end of the handle for connection to chassis or dc ground return. The meter scale is calibrated 0-40 kV in 2 kV increments with the 25 kV point specially marked with an arrow indicator.

The LHM-80A measures 390 mm long by 73 mm overall diameter. A screwdriver adjustable calibration potentiometer, at the ground return end of the metering circuit, is provided for periodic calibration. Overall impedance is just over 800 megohms.

Further details on the Leader LHM-80A can be obtained from Benelec Pty Ltd, P.O. Box 21, Bondi Beach 2026 NSW. (02)665-8211.

JAYCAR No.1 AGAIN FOR COMPONENTS

NEW!!

PCB MOUNT 6.5mm HEADPHONE JACK

Stereo phone jack with moulded and extended non threaded collar. As used in high quality Japanese amps. Also has a thread for bush mounting as well. Very attractive.
Cat. PS-0180

\$1.95



SPECIAL!! GRADUATED KNOB WITH SKIRT

Similar to knob illustrated except that skirt has aluminium skirt with graduations 0-9 with smaller scale markings in between.

The supplier Boo-Boo'ed and we got them! Will take 1/4" shaft and has retaining grub screw.

TOYA TYPE TK 167B

Cat. HK-7597

1-9 50¢ ea 10+ 40¢ ea
(Normally \$1.50 value)



NEW!! 16 WAY RCA INPUT JACK PANEL

Fantastic. PCB terminals, panel mount.

FEATURES: ★ Right and left input jacks are different colours to assist identification ★ Earth binding post included ★ 2 rows of eight. Can be snapped apart (vertically) for smaller configuration.

Cat. PS-0280

\$3.95



NEW MICROBEE SOFTWARE BEE BUG

A very well written utility program. It locates, disassembles single steps with break point, watch point and displays the registers. It's a definite must for M/C language programmers.
Cat. XS-8406

\$17.95

LINE TRACER ROBOT KIT

SPECIAL APRIL PRICE
NORMALLY \$39.95

APRIL ONLY **\$29.95**

HURRY!

Cat. KJ-6684



NEW!! PCB MOUNT SAFETY SPEAKER CONNECTORS

BRILLIANT NEW COMPONENT

AS USED IN THE LATEST PERREAUX & YAMAHA AMPS
Modern high-power amps produce voltages at the speaker terminals which can give a nasty shock. The new PT-3010 efficiently connects and insulates the exposed speaker wire. The bare wire is simply inserted and the plastic shroud twisted.

The connector is capable of panel mounting and is ideal for PCB termination with panel fixing. The PT-3010 is supplied as two rows of alternate black and red twist terminals.
Cat. PT-3010

\$3.95

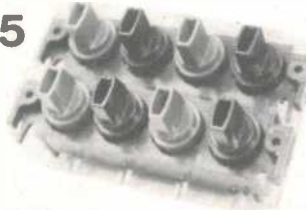

MINI BREADBOARD

Just the right thing for many small projects. This board has the same features as our larger breadboards but measures a compact 80 x 60mm. It has 420 holes. Perfect for the occasional project.
Cat. PB-8806

ONLY \$6.95

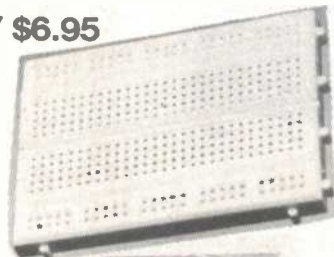

BARGAIN 4700 CAN CAPS

4700uF/40V quality Philips upright chassis mount caps. Screw terminals.
Cat. RU-6707

ONLY \$2.95 each

NEW!!

UHF TUNER MODULE EXCLUSIVE TO JAYCAR

This unit enables you to continuously tune over the entire Australian UHF band. The output from the tuner is on channel 1. Simply plugs into the antenna socket of any VHF-only TV!

USES:

- Converts VHF (only) TV's to VHF/UHF
- Enables you to watch UHF output VCR's on VHF TV
- Ditto for home computers & video games

SIMPLE TO USE You only have to connect power and a TV signal and you're away. (Instructions supplied)

DON'T PAY HUNDREDS OF DOLLARS TO UPGRADE YOUR PERFECTLY GOOD VHF TV TO AN EXPENSIVE UHF SET!

Cat. DM-9000

UHF Tuner Module \$34.50

Cat. DM-9002 Knob and backlit dial to suit **\$5.45**

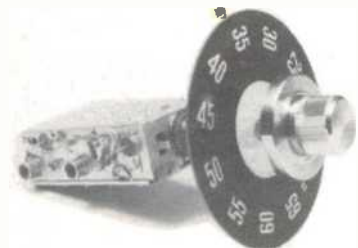

FANS - Keep your computer or power amplifier cool, or just about whatever you like with our fans.

Cat. YX-2510 ... 80mm (3 1/2") square 240V ... **\$24.95**

Cat. YX-2514 ... 119mm (4 3/4") square 240V ... **\$27.50**

Cat. YX-2506 ... 80mm (3 1/2") square 115V ... **\$14.95**

Capacitor to allow 240V operation

Cat. RG-5259 **\$4.95**

Jaycar Incorporating
ELECTRONIC AGENCIES

SYDNEY

SHOWROOMS

117 YORK STREET PHONE: (02) 264 6688 and (02) 267 1614

CARLINGFORD

TELEX: 72293

Cnr CARLINGFORD & PENNANT HILLS ROAD - PHONE: (02) 872 4444

CONCORD

115 - 117 PARRAMATTA ROAD PHONE: (02) 745 3077

HURSTVILLE 121 FOREST ROAD PHONE: (02) 570 7000

NUMBER 1 FOR KITS

POST AND PACKING CHARGES

\$5 - \$9.99 (\$1.50) \$10 - \$24.99 (\$3.20)

\$25 - \$49.99 (\$4.50) \$50 - \$99.99 (\$6.50)

\$100 - \$199 (\$8.00) Over \$199 (\$10)

"Free INSURANCE for Road & Registered Post over \$200"

All heavy or bulky items (over 20kg.) sent Comet Road Freight \$12.00 anywhere in Australia

SHOP HOURS CARLINGFORD, CONCORD & HURSTVILLE

Mon - Fri 9am - 5:30pm Sat - 9am - 12pm: Thurs night 8:30pm (Not Concord)

SHOP HOURS SYDNEY

Mon - Fri 8:30am - 5:30pm. Sat - 8:30am - 12pm: Thurs night 8:30pm

MAIL ORDERS AND CORRESPONDENCE: P.O. Box 185, Concord, 2137



Mail Order
By



BANKCARD

Via Your Phone

HP EXPANDS RESISTOR-LED FAMILY

Hewlett-Packard has introduced a new series of resistor-LED (RLED) lamps. Colours include high efficiency red and yellow, high-performance green and standard red. They are available in 5 V and 12 V versions, and both T-1 and T-1 $\frac{3}{4}$ package styles.

These lamps are claimed to provide space savings and cost savings because external current-limiting resistors are no longer needed, thus saving component insertion costs and pc board space. The resistor is an integral part of the lamp.

TTL and battery-operated circuits are well-served by HP's new resistor lamps available in HLMP Series 1100, 1600, 3100 and 3600.

For additional information contact Hewlett-Packard Australia Ltd, 31-41 Joseph St, Blackburn Vic. 3130. (03)895-2895.



SINGLE CHIP DUAL AMPS

The ua739 and ua749 dual audio operational amplifier/preamplifier ICs consist of two identical high-gain operational amplifiers constructed on a single silicon chip using the Fairchild planar epitaxial process.

These three-stage amplifiers use Class A PNP transistor output stages with uncommitted collectors. This enables a variety of loads to be employed for general purpose applications from dc to 10 MHz, where two high

performance operational amplifiers are required.

In addition, the outputs may be wired-OR for use as a dual comparator or they may function as diodes in low threshold rectifying circuits such as absolute value amplifiers, peak detectors, etc.

For more information contact Fairchild Australia Pty Ltd, 366 Whitehorse Rd, Nunawading Vic. 3131. (03)877-5444.

IT'S A COMFET

A new device has entered the power MOSFET field which combines a power MOSFET device with bipolar transistors on a single chip to enable the 'on' resistance of the device to be less than one-tenth of that of comparable power MOSFETs.

This new Conductivity Modulated FET from RCA is known as a COMFET and has an 'on' resistance of less than 100 milliohm when measured with the full drain current of 20 A flowing through the device.

The COMFET is a relatively high voltage device, since it is able to block 400 V applied in the forward direction and 100 V in the reverse direction.

The low forward resistance points to high power applications for the new device for which earlier power MOSFETs are unsuitable owing to the excessive power dissipation which would be caused by their high 'on' resistance at high currents.

COMFETs are said to be similar to bipolar power transistors in their output circuit capability, but they provide the high input impedance of a power MOSFET device. Thus they can be driven from relatively low-power, low-voltage devices such as logic ICs. Power transistors require more complex driving circuitry.

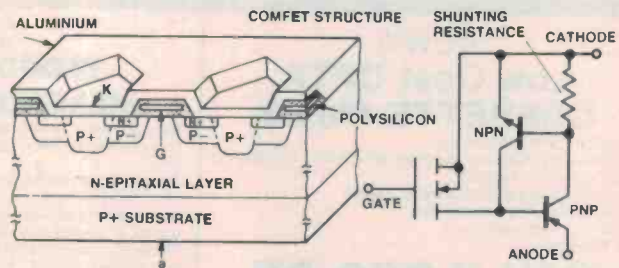

The switching speeds of COMFET devices are somewhat slower than those of conventional power MOSFET products and are about the same as those of bipolar devices. Typical turn-on times are about 100 ns with turn-off times ranging from five to 20 μ s.

RCA has already characterised and packaged several hundred COMFETs with experimental lots showing yields nearly equal to those required for production runs. Samples distributed to equipment manufacturers early in 1983 indicate the main interest is in the fields such as switched mode power supply units, stepping motor control and automotive control for battery powered vehicles.



ANALOGUE PANEL METERS

Bowmar/ALI Inc. has developed a low power, liquid crystal bargraph meter with a built-in microprocessor which performs calculations on the data displayed.

Features include wide-viewing angle and immunity to shock and vibration. Available options include differential input voltmeter, reduced response time and single and dual setpoints.

The LCM 100 offers setpoint controls on the face of the meter

plus auto polarity and increased damping as well.

LCM bargraph backlighting also affords high visibility in any lighting environment.

Also available is a range of VU/audio meters which are for use in applications where an analogue display of RMS or peak is required. In audio recording studios these meters indicate volume units and with broadcast equipment they indicate percent modulation.

Displays of 75 mm, 125 mm and 250 mm lengths with 1%, 2% or 5% resolutions are available.

The VU/audio meters are easy to read in the dark, immune to vibration sticking and overtravel problems normally associated with needle meters and are easy to mount and adjust.

Bowmar/ALI are represented in Australia by Paton Electronics, 90 Victoria St, Ashfield NSW 2131.

ZILOG DATA BOOK

Zilog has released its 1984 general catalogue which includes data on the latest generations of microprocessors from Zilog, e.g. Z80, Z80L and Z800.

The data books are available from the George Brown Electronics Group in Sydney, Melbourne, Canberra and Newcastle; also from Protronics Pty Ltd in Adelaide and Perth.

JAYCAR - No.1 AGAIN FOR NEW PRODUCTS IN '84

NEW!!! Low Cost DATA CASSETTE Player

- Mains or battery operated
 - Special Instructions for loading instructions into computer
 - Tape counter - A MUST!
 - Works as audio recorder/player as well
 - Inbuilt condenser microphone
 - LED recording indicator!
- Cat. XC-4905

ONLY \$39.95
STAGGERING VALUE!!

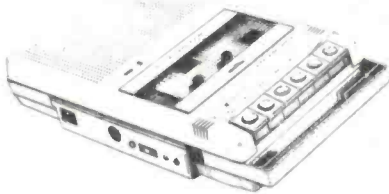

MUSICAL INSTRUMENT KEYBOARDS

Full range back in stock for the first time in ages.
4 popular keyboard sizes

Cat. No.	Size/Description	Price
HM-3010	49 Note organ keys C-C	\$85.00
HM-3011	61 Note organ keys C-C	\$95.00
HM-3012	73 Note piano keys F-F	\$125.00
HM-3013	88 Note piano keys A-C	\$149.00
	Contact Springs (each)	
HM-3015		95¢
	Gold plated 3mm x 500mm contact rod	
HM-3016		\$18.00
	Rod support blocks (each)	
HM-3017		\$0.95

The keyboards are made in Italy, feature a steel frame with white keys and black sharps. Under normal conditions they should last a lifetime.

FM TRANSMITTER MODULE

We have been working on this one for years!! Basically we wanted something akin to the \$6.50 kit "wireless microphone" transmitter but with greater signal strength and far, far greater frequency stability. WE NOW HAVE IT! Basically the (potted) unit measures a small 90 x 22 x 15mm and has connections for power, antenna and input. An AC signal between 20 and 15kHz will modulate the transmitter. The signal can be coded single or multiple frequency tone bursts etc.

FEATURES:

- Ultra low noise output (-60dB or better attainable with suitable tuner)
- Excellent frequency stability
- Not a kit - ready for immediate use
- Connections required
 - (a) Power supply or battery
 - (b) Antenna
 - (c) Audio Input
- Full instructions supplied
- Suits any application where a stable low noise FM link is required

SPECIFICATIONS:

- Frequency: 88-108MHz adjustable
 - Useable range - 50 metres
 - Supply - 6 to 9V at 20mA
 - Input sensitivity - adjustable - max. 30mV
 - Pre-emphasis - 50u/second standard
- Cat. DT-5450



NEW!!! BLOOD-PRESSURE MEASURING MACHINE

Not a kit, tested and guaranteed. One of the best presented items that we have seen for a long time. This high quality SPHYGMOMANOMETER (to use the technical term) enables you to perform accurate blood pressure measurements at home without a doctor. (You should consult a doctor, of course, to interpret the readings). The unit includes inflatable cuff, pressure gauge, hand pump and inbuilt pressure transducer which eliminates the need for a stethoscope. Included is a comprehensive instruction booklet, blood pressure record keeping charts (plenty of spares), handsome vinyl case and even a 9V battery. All that you need to supply is an arm and blood pressure!!
Cat. QM-6100

only
\$79.95



NEW!!! HEART RATE MONITOR

Not a kit. Built, tested and guaranteed. This fully self-contained unit enables you to monitor your pulse rate - anywhere!! The unit features large, easy to read LED display and comfortable finger grip pulse sensor. An exclusive feature is the bracket that enables you to mount the unit to tubular objects such as a bike (of exercise bike), weight training equipment etc. NOW you can monitor your heartbeat accurately and easily while in the middle of exercise!! The comprehensive booklet gives you explicit instructions on use of the monitor as well as mounting guidelines. Once again this is a beautifully presented piece of equipment. Included, are mounting bracket, vinyl case, instructions and 9V battery.
Cat. QM-6110



ONLY \$99.50

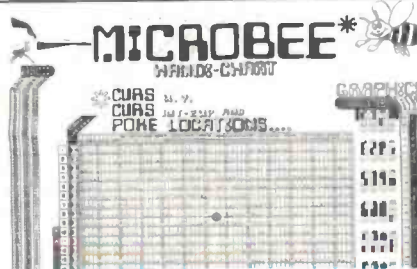

MICROBEE HANDY CHART

This great new wall chart is a must for every MicroBee owner. It measures 600mm x 740mm. It gives:

- ★ Screen Poke locations
 - ★ Graphic codes
 - ★ ASCII equivalents
 - ★ Memory map
 - ★ Expansion socket pinouts
- Cat. XB-9400

ONLY
\$6.95

MICROBEE KEYBOARD

Full 60 key QWERTY Computer keyboard exactly the same type as has been used up to now with the famous MicroBee Computer. SPST keys. Complete with mounting plate, all key caps etc. Fully assembled - incredible value.
Cat. XA-5500

ONLY \$29.95



COMPUTER CASSETTES

Exceptionally good quality, leaderless blank cassettes in the usual plastic cases.

Cat. XC-4710	C10	1-9 \$1.20	10 up \$1.20
	C20		
Cat. XC-4715	C30	1-9 \$1.30	10 up \$1.20
	C30		
Cat. XC-4720	C30	1-9 \$1.50	10 up \$1.40

MICRON SUPER 80

Your "Super 80" printer will enable you to print letters, reports, graphics generated pictures, etc. and importantly for the programmer Hard copy of program listings. Operating under software control from any general purpose micro-computer the Super 80 features 13 different print types including emphasized (LETTER QUALITY). Bidirectional print action ensures smooth, quiet operation. 228 ASCII CHARACTERS, HANDLES 4" to 10" PAPER - STANDARD CENTRONICS INTERFACE
Cat. XP-4600

ONLY \$499

NEW!!! "SPARKRITE" LOW COST CAR ALARM KIT

This low cost alarm is ideal for the budget conscious motorist. It has many features:

- ★ 10 amp output relay
- ★ Optional door, bonnet switch input
- ★ Accessory loop
- ★ Horn relay and headlamp output
- ★ Optional entry delay i.e. external disarm switch can be fitted obviating need for entry delay
- ★ Exit delay
- ★ Auto alarm disable. (To meet local noise/environmental rules)

Staggering fully imported from the UK
Cat. KJ-6662

ONLY \$39.95



NEW!!! ULTRASONIC INTRUDER DETECTOR

This fantastic little kit attaches to virtually any car alarm (as a sensor). It sets up an ultrasonic field inside the car that is virtually immune to false triggering. A special transmitter and receiver unit is supplied that can be unobtrusively fitted inside the cabin. Any movement inside the cabin will be detected and a trip signal sent to your car alarm. Complete kit and instructions.
Cat. KJ-6650

ONLY \$49.50

VOCAL CANCELLER

REF: EA APRIL 1982

Do you think you can sing? How would you like to be the lead singer in a famous rock (or any) band? You can cancel out the lead singer from almost any stereo record and substitute your own voice or musical instrument. Complete with case. Cat. KA-1430

\$19.50

GUITAR BOOSTER

REF: EA JUNE 1982

This inexpensive preamplifier enables you to use your guitar at home with the lounge room HI FI. It has treble and gain controls and runs from an inexpensive 9V battery. Super performance specs. All parts supplied including box, controls etc. Cat. KA-1450

\$17.50

MICROWAVE LEAK DETECTOR

If you own a microwave oven, your peace of mind is worth the price of this kit. Extremely simple and foolproof to build and use. Gives a positive indication of the security of your oven's seal.

REF: ETI 724

Cat. KE-4013

\$14.95

IT HAD TO HAPPEN

A professionally engineered electronic ("breakerless") contact breaker system. Yes, only Jaycar has a complete Hall effect triggerhead assembly designed to adapt to an extensive number of cars. Each kit contains the following:

- HALL EFFECT TRIGGER HEAD
- MAGNETIC ROTORS FOR BOTH 4 & 6 CYLINDER CARS
- OVER 6 CAM LOBE ADAPTORS
- OVER A DOZEN DIFFERENT ADAPTOR PLATES FOR YOUR PARTICULAR DISTRIBUTOR
- OTHER HARDWARE (i.e. SCREWS etc)
- YOU CAN REMOVE THIS SYSTEM AND RE-EQUIP YOUR CAR WITH THE ORIGINAL BREAKER POINTS WHEN YOU SELL THE CAR!
- AS EASY TO INSTALL AS A SET OF POINTS!
- INSTRUCTIONS (SIMPLE TO FOLLOW) INCLUDED!

This set is designed to fit most European and Japanese cars. In fact it will also fit many Australian cars fitted with Lucas, Bosch, Motorcraft, AC Delco or Autolite electrics. If you wish to check first, please send SAE for car distributor list.

Because we have no way of knowing, you get the fitting set for ALL of the distributors available. Basically you end up with a jar full of parts that you don't need to use! (Perhaps for your next car?) Quite frankly, we are amazed that we can supply such a comprehensive kit for this price. To produce a kit that will adapt to the dozens of different distributors around is amazing!

Remember, once you have installed a breakerless system it will never wear out and that part of your system will remain in tune FOR EVER.

We expect this kit to sell well. To ensure that you receive one, check with us early!

ONLY \$29.95

SEE EA Dec '83

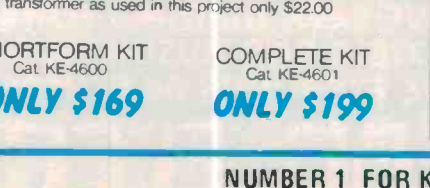
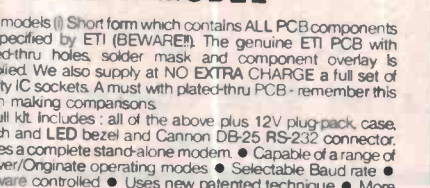
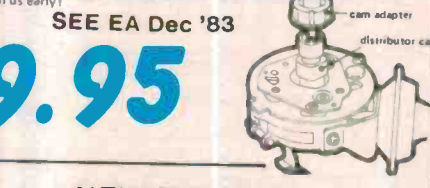
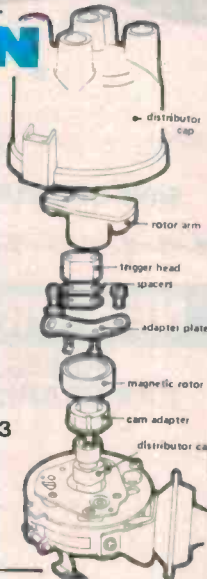

BBD EFFECTS BOX

Fantastic low-cost instrument using the versatile MN3001 Bucket Brigade Delay Line to achieve brilliant sonic effects. Now you can emulate the commercial rock groups with Phasing, Flanging, Reverb and Echo. The Jaycar kit includes all components INCLUDING IC sockets and the TU-04 box. (Not cut down but this is easily done). Jaycar has a specially built cabinet for this kit with all holes pre-punched etc. at only \$10 extra but only if you buy the original kit from us. Available as a separate item for \$29.50. When the kit is purchased with the de-luxe case the TU-04 case will not be supplied. Cat. KE-1522

COMPLETE KIT

\$79

Special cabinet to suit
Cat. HB-6445

\$10.00

STEREO SYNTHESISER

REF: EA SEPTEMBER 1982

This unit basically is the same as the KA-1510 simulator, but does a better job with more sophisticated circuitry. By employing a "Bucket Brigade" IC and Comb filtering, very realistic stereo sound spatial effect is evident. Ideal for VCR's and other mono sources that would benefit from stereo.

The circuit, though sophisticated is easy to build. Two versions of this kit are available, a shortform for people who want to build into equipment and a full kit which includes box, power supply and case.

SHORTFORM
Cat. KA-1476

\$39.50

FULL KIT
Cat. KA-1478

\$57.50



150W MOSFET AMP MODULE

REF: ETI MARCH 1982

At last, a high power amplifier with the stability and reliability of MOSFETs. Genuine 150 watts r.m.s. with power supply components on board. You only need to connect a power transformer (4361 type Cat. MM-2015) and heatsink. The Jaycar kit includes a magnificent jig drilled EXTRUDED heatsink bracket for greater thermal efficiency. Cat. KE-4220

\$79.50

TRANSISTOR ASSISTED IGNITION HALL-EFFECT "BREAKERLESS" VERSION

REF: EA DECEMBER 1983

This kit is virtually identical to the KA-1506 except that it contains the interface electronics for the KJ-6655 Hall-Effect triggerhead.

Cat. KA-1505

\$36.95

VIDEO AMPLIFIER/BUFFER

REF: EA AUGUST 1983

The answer to a maidens prayer?

This device can be made to fit inside a TV set (or in a separate box if necessary). It basically enables you to connect straight into the video drive of your TV turning it into a colour monitor. This means that the video signal from your computer, VCR, TV game etc., does not need to be converted to RF and go through the TV IF strip. You will be amazed by the clearer, sharper signal that has less interference! Notes on how to fit to various TV sets are included.

Cat. KA-1527

\$14.95

ETI644A See ETI Jan '83!

DIRECT CONNECT MODEM

Ref ETI October 1982



NEW MODEL

Two models (i) Short form which contains ALL PCB components as specified by ETI (BEWARE!). The genuine ETI PCB with plated-thru holes, solder mask and component overlay is supplied. We also supply at NO EXTRA CHARGE a full set of quality IC sockets. A must with plated-thru PCB - remember this when making comparisons.

(ii) Full kit includes: all of the above plus 12V plug-pack, case, switch and LED bezel and Cannon DB-25 RS-232 connector. Makes a complete stand-alone modem. ● Capable of a range of Answer/Orginate operating modes ● Selectable Baud rate ● Software controlled ● Uses new patented technique ● More reliable and faster than most acoustic modems. Arlec transformer as used in this project only \$22.00

SHORTFORM KIT
Cat. KE-4600

ONLY \$169

COMPLETE KIT
Cat. KE-4601

ONLY \$199

Jaycar Incorporating
ELECTRONIC AGENCIES

SYDNEY SHOWROOMS

117 YORK STREET - PHONE: (02) 264 6688 and (02) 267 1614

CARLINGFORD TELEX: 72293

Cnr. CARLINGFORD & PENNANT HILLS ROAD - PHONE: (02) 872 4444

CONCORD

115 - 117 PARRAMATTA ROAD - PHONE: (02) 745 3077

HURSTVILLE 121 FOREST ROAD - PHONE: (02) 570 7000

NUMBER 1 FOR KITS

POST AND PACKING CHARGES
\$5 - \$9.99 (\$1.50) \$10 - \$24.99 (\$3.20)
\$25 - \$49.99 (\$4.50) \$50 - \$99.99 (\$6.50)
\$100 - \$198 (\$8.00) Over \$199 (\$10)

"Free INSURANCE for Road & Registered Post over \$200"
All heavy or bulky items (over 20kg.) sent Comet Road Freight \$12.00 anywhere in Australia.

SHOP HOURS CARLINGFORD, CONCORD & HURSTVILLE

Mon - Fri 9am - 5:30pm; Sat - 9am - 12pm; Thurs night 8:30pm (Not Concord)

SHOP HOURS SYDNEY

Mon - Fri 8:30am - 5:30pm; Sat - 8:30am - 12pm; Thurs night 8:30pm

MAIL ORDERS AND CORRESPONDENCE: P.O. Box 185, Concord, 2137



BIRKENHEAD ELECTRONICS

THE MOST comprehensive range of Altronics Products outside of Western Australia.

VINYL BINDER

Holds 12 magazines, each on a spring out wire rod. Just the shot for each year's set of Electronics Australia, ETI or any of your favourite magazine.

Suits all A4 size publications (275 x 210). Very smart Royal Blue colour with beautiful gold embossing.

B 9999 \$5.50 THIS MONTH

\$5.00 each

4 or more \$4.50 each

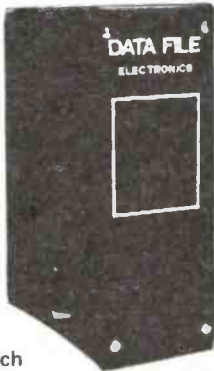

DUAL CONE WIDE RANGE

200 mm (8 in.) 10 Watts Max. power input. Public Address, Background Music, Ideal Hi Fi extension speaker. Includes transformer holes at 51 mm.

Over 50,000 sold in Australia! Mounting holes 140 x 140 mm

C2000 NOW \$6.50 WAS \$9.50 \$6.00 10 UP



Powerful 6000 RPM Mini Drill for PC Work

Tons of Torque. Just the shot for PCB work. 12V DC operated from external Power Pack 1.2mm chuck capacity. Supplied c/w 1mm drill bit.

T2302 Incredible value now only..... \$10.00



VELOSTAT

Non static sheeting for storing CMOS IC's, LSI's etc 1000 times better than aluminium foil. will store up to 150 IC's on one 225 x 150mm sheet.

H 0600..... \$2.50 per sheet

Premium Quality Genuine Philips IN914/IN4148 Signal Diodes — Out they go at never to be repeated prices.

1's \$2.50 per 100
Z0101..... 4c \$20.00 per 1,000

SAVE ON BULK QUANTITIES

NEW PRODUCT

10 SEG. RED BAR GRAPH MODULE

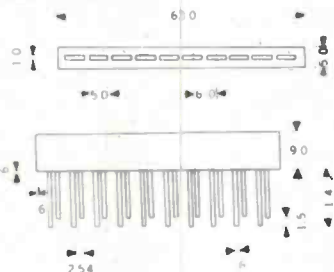

Z 0180 \$2.50 10 up \$2.20 ea.
100 UP \$1.80

CEILING SPEAKER GRILL



Suits 200 mm (8 In.) speaker. Ideal for PA/Background music systems, extension speakers etc. Colour: White.

C 0800..... ~~\$2.75~~

Now incredible \$1.50 ea

SOLDERING IRON STAND UNIVERSAL TYPE

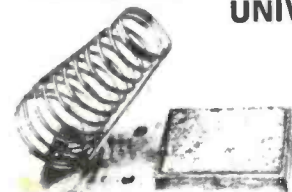

T 1302 NOW

~~\$8.50~~
\$5.00

MICRON 30 WATT

This brilliant little 30 watt iron is just the "bee's knees" for the electronics hobbyist, electrician or home handyman. We searched the world for a low cost yet quality iron which met the criteria of • light-weight • screw in interchangeable tips • efficient thermal transfer from element to tip • tip temperature maintains within the limits suitable for electronic work and also small household jobs • and of course, fully S.E.C. tested and approved.

Comes fitted with T 2435 Tip

WAS \$12.95

REPLACEMENT TIPS

T 2430 \$9.50

T 2434 Flat Tip95
T 2435 Conical Tip95
T 2436 Instrument Tip95



THE COMPUTER YOU HAVE BEEN WAITING FOR HAS FINALLY ARRIVED
THE MOST POWERFUL, FLEXIBLE AND BUSINESSLIKE MACHINE IN ITS CLASS

★★★★★★ THE EXCALIBUR 64 IS HERE ★★★★★★

BIRKENHEAD ELECTRONICS

SHOP 71 QUAY WEST ARCADE
BIRKENHEAD POINT
PHONE: 81-4077
OPEN 7 DAYS

ETI Book Sales

electronics textbooks

ELECTRONICS: IT'S EASY — VOL 1

A0001E \$5.95
Meters, resistance, capacitance and inductance, emitter followers, op-amps, power supplies, electronic filters.

ELECTRONICS: IT'S EASY — VOL 2

A0002E \$5.95
Digital sub-systems, counters and shift registers, A-D and D-A conversion, digital instruments and test equipment, computers, transmission links, oscilloscopes.

ELEMENTS OF ELECTRONICS — BOOK 1

A0003B \$9.95
This five-book series is an introduction to modern electronics. All the maths is taught as the reader progresses. The course concentrates on the understanding of concepts central to electronics, rather than digressing over the whole field. The author anticipates where difficulties lie and guides the reader. Book 1 covers all fundamental theory necessary to full understanding of simple electronic circuits and components.

ELEMENTS OF ELECTRONICS — BOOK 2

A0004B \$9.95
Alternating current theory — see Book 1.

ELEMENTS OF ELECTRONICS — BOOK 3

A0005B \$9.95
Semiconductors technology leading to transistors and ICs — see Book 1.

ELEMENTS OF ELECTRONICS — BOOK 4

A0006B \$9.95
Microprocessing systems — see Book 1.

ELEMENTS OF ELECTRONICS — BOOK 5

A0007B \$9.95
Communications — see Book 1.

BASIC ELECTRICITY/ELECTRONICS — VOL 1

A0008P \$15.95
Thorough theoretical and practical background to the overall subject of electricity and electronics.

BASIC ELECTRICITY/ELECTRONICS — VOL 2

A0009P \$15.95
Builds on the basic information in Volume 1 by giving detailed information on AC and DC circuits — covering series and parallel circuits, electro-magnetism, resistance, capacitors and inductance plus associated calculations.

BASIC ELECTRICITY/ELECTRONICS — VOL 3

A0010P \$15.95
Valves and transistors, from an introduction to vacuum tube — through multi-element tubes, semiconductor devices, power supplies, amplifiers, oscillators, pulse circuits — to special semiconductor devices.

BASIC ELECTRICITY/ELECTRONICS — VOL 4

A0011P \$15.95
Construction, operation and usage of electronic test instruments. Included are analogue and digital multimeters, vacuum-tube voltmeters, oscilloscopes, tube testers, bridge instruments and signal generators.

BASIC ELECTRICITY/ELECTRONICS — VOL 5

A0012P \$15.95
The principles of motors and generators, three-phase systems and power converters. The final chapter covers servo control systems.

ESSENTIAL THEORY FOR THE ELECTRONICS HOBBYIST

A0013B \$5.95
Supplies the electronics hobbyist with the background knowledge which will exactly suit his specific requirements. Minimum maths.

INTRODUCTION TO AUTOMOTIVE SOLID-STATE ELECTRONICS

A0015P \$14.95
For the professional as well as the home mechanic — explains the functions of most on-board automotive black boxes and logic systems, including anti-skid braking, electronic spark control and diagnostic systems.

ELECTRONICS: IT'S EASY — VOL 1

A0016E \$12.95
Meters, resistance, capacitance and inductance, emitter followers, op-amps, power supplies and electronic filters. Hardcover.

ELECTRONICS: IT'S EASY — VOL 2

A0017E \$12.95
Digital sub-systems, counters and shift registers, A-D and D-A conversion, digital instruments and test equipment, computers, transmission links and oscilloscopes. Hardcover.

DIGITAL COUNTER HANDBOOK

A0332P \$17.25
Covers general principles and explains concepts such as accuracy, precision and stability. The emphasis is on digital-counter test and measuring equipment, but also deals with elementary counters, both electronic and mechanical.

reference and data handbooks

INTERNATIONAL TRANSISTOR EQUIVALENTS GUIDE

B0018B \$9.95
Contains a huge amount of information on modern transistors produced by more than 100 manufacturers. Wherever possible, equivalents are subdivided into European, American and Japanese types.

WALL CHART — HOW TO IDENTIFY UNMARKED ICs

B0019B \$2.95
This chart shows the reader how, with just a test-meter, to go about recording the particular 'signature' of an unmarked IC which should enable the IC to be identified with reference to manufacturers or other data.

WALL CHART — RADIO, ELECTRONICS, SEMI-CONDUCTORS AND LOGIC SYMBOLS

B0020B \$2.95
Identify those symbols at a glance. A must for beginners and advanced enthusiasts alike. Professionals can always hide it in their desks!

WALL CHART — RADIO AND ELECTRONIC COLOUR CODES AND DATA

B0021B \$2.95
This chart covers all colour codes in use throughout the world. For all radio and electronic components made in Britain, United States, Europe and Japan.

REFERENCE DATA FOR RADIO ENGINEERS

B0023P \$54.50
Largest and most comprehensive collection of equations, graphs, tables, and other reference data needed in radio engineering and design.

CONTEMPORARY MATHEMATICS FOR ELECTRONICS

B0024P \$35.95
This book is split into three sections. Direct current maths introduces the student to the calculator, fractions and dimensional analysis. Alternating current maths covers phasors, quadratics and RMS in both sine and digital waveforms. Active device maths introduces number systems and boolean.

FIRST BOOK OF TRANSISTOR EQUIVALENTS AND SUBSTITUTES

B0025B \$5.95
This guide covers many thousands of transistors showing possible alternatives and equivalents. Covers transistors made in Britain, Japan, United States, Europe and Hong Kong, and includes types produced by more than 120 different manufacturers.

SECOND BOOK OF TRANSISTOR EQUIVALENTS AND SUBSTITUTES

B0026B \$6.25
Interchangeability data covers semi-conductors manufactured all over the world. Immediate equivalents are shown and possible substitutes are included.

PRACTICAL ELECTRONIC CALCULATIONS AND FORMULAE

B0027B \$9.95
For the practical person's workbench. Bridges the gap between technical theory and cut-and-dried methods which work but leave the experimenter unfulfilled. There's a strong practical bias. High maths avoided where possible.

HANDBOOK OF ICs EQUIVALENTS AND SUBSTITUTES

B0281B \$6.95
Contains full interchangeability data on more than 9500 ICs with possible alternatives and equivalents shown. Covers many types of digital and linear ICs. Recently reprinted.

WIND/SOLAR ENERGY

B0324P \$19.95
Covers solar energy and photovoltaic converters, wind energy, batteries and inverters. Also includes practical solar power supplies with applications for radio communications and low-power electrical systems.

ARRL ELECTRONICS DATA BOOK

B0335R \$5.75
Covers maths aids and tables, times and frequency, rf circuit data, LCR networks, transformers, filter design, antennas and feed systems, solid state circuits, constructions and testing data. Limited supplies.

INTERNATIONAL DIODE EQUIVALENTS GUIDE

B0339B \$6.95
Includes zener diodes, LEDs, diacs, triacs, thyristors, OCIs, photo diodes, display diodes and simple rectifier diodes.

RESISTOR SELECTION HANDBOOK

B0348B \$2.95
Shows how to combine two preferred values of resistor to obtain virtually any required value of resistance. Includes information about fixed resistors, standard ranges, colour codes and markings, power ratings and resistor calculations.

COIL DESIGN AND CONSTRUCTION MANUAL

B0413B \$6.85
How to make RF, IF, audio and power coils, chokes and transformers. Covers AM and FM radio, and TV. An essential addition to the library of all interested in electronics.

Save time and trouble with mail order — simply fill out the reply-paid coupon!

140 Joynton Avenue, Waterloo, NSW 2017, Australia. Phone (02) 663-9999 Sydney. Telex 74488.

Postal Address: ETI Book Sales, PO Box 227, Waterloo, NSW 2017.

electronics for beginners

HI-FI LOUDSPEAKER ENCLOSURES

C0028B \$4.95
Data for building corner reflex, bass reflex, exponential horn, folded horn, tuned port, Klipschorn labyrinth, tuned column, loaded port and multi speaker panoramics. Clear dimensioned diagrams included.

BEGINNER'S GUIDE TO DIGITAL ELECTRONICS

C0029B \$4.95
Covers all essential areas including number systems, codes, constructional and sequential logic, analogue/digital/analogue conversion.

BEGINNER'S GUIDE TO BUILDING ELECTRONIC PROJECTS

C0030B \$6.95
Enables total beginners to tackle electronic projects. Includes component identification, tools, soldering, building methods, cases, legends, etc. Practical basic projects are included.

HOBBY ELECTRONICS PROJECT BOOK

C0031E \$4.95
Fifty projects, ranging from very simple ones for complete beginners to more elaborate ones for those with more experience.

RADIO CONTROL FOR BEGINNERS

C0034B \$5.95
How complete systems work with constructional details of solid-state transmitters and receivers. Also included — antennas, field strength meter, crystal controlled superhet, electro-mechanical controls. Section dealing with licensing, etc. is not applicable to Australia.

FIRST BOOK OF PRACTICAL ELECTRONIC PROJECTS

C0035B \$4.95
Full constructional data, circuits, components lists for many practical projects including audio distortion meter, guitar amp, metronome, etc.

HOW TO BUILD YOUR OWN METAL AND TREASURE LOCATORS

C0036B \$6.95
Electronic and practical details on the simple and inexpensive construction of heterodyne metal locators.

BEGINNERS'S HANDBOOK OF IC PROJECTS

C0037P \$19.25
The novice is guided in mastering the fundamentals of building, troubleshooting and testing electronic projects. In addition to many elementary projects, more advanced ones are included concerning bipolar integrated circuits and medium and large-scale integrated circuits.

ELECTRONIC PROJECTS FOR BEGINNERS

C0038B \$6.95
This book gives the newcomer to electronics a wide range of easily built projects. Actual components and wiring layouts aid the beginner. Some of the projects may be built without using soldering techniques.

POPULAR ELECTRONIC PROJECTS — BOOK 1

C0039B \$6.95
A collection of the most popular types of circuits and projects to interest most electronics constructors. The projects cover a wide range and are divided into four basic types: radio, audio, household and test equipment.

EASY ELECTRONICS: CRYSTAL SET CONSTRUCTION

C0041B \$6.75
For those who wish to participate in the intricacies of electronics more through practical construction than by theoretical study. The circuits are based on those from earlier publications but have been modified to use modern components and home-wound coils.

IC PROJECTS FOR BEGINNERS

C0042B \$6.75
Especially written for the less experienced hobbyist, and offers a range of fairly simple projects based around a number of popular and inexpensive linear and digital ICs. Complete layout and point-to-point wiring diagrams.

SOLID-STATE NOVELTY PROJECTS

C0043B \$4.95
A number of novelty projects using modern ICs and transistors. Includes a musical instrument played by reflecting a light beam with your hand, water warbler for pot plants, music tone generator, LEDs and ladders game, touch switch, electronic roulette wheel, etc.

ETI PROJECT ELECTRONICS

C0269E \$4.95
Twenty-six projects for beginners, including battery saver, electronic siren, Morse practice set, FM antenna, etc. Fifth edition.

BASIC ELECTRICITY AND AN INTRODUCTION TO ELECTRONICS

C0311P \$16.95
Simply worded explanations of electrical symbols, basic electrical laws, direct current, cells and batteries, magnetism, alternating current, distribution, radiation, etc. with many diagrams and illustrations.

HOW TO READ SCHEMATIC DIAGRAMS

C0367P \$10.95
Covers the various types of electronic diagrams and explains resistors, capacitors, coils, transformers, electron tubes, semi-conductors, switches and relays. An invaluable aid for reading and interpreting the schematic.

constructional projects

ELECTRONICS PROJECTS FOR YOUNG SCIENTISTS

D0045E \$3.95
PH meter, gelger counter, helium-neon laser, sound-level meter, solar cells, negative ion generator and more.

ELECTRONIC PROJECTS USING SOLAR CELLS

D0049B \$6.75
Includes a number of projects that benefit from solar power and obviate the problems encountered with batteries, such as weight and bulk, frequency of replacement, and failure when batteries are exhausted.

DIGITAL IC PROJECTS

D0050B \$6.75
The projects included in this book range from simple to more advanced projects — some board layouts and wiring diagrams included.

MODEL RAILWAY PROJECTS

D0054B \$6.75
Projects include such things as controllers, signals and sound-effects units. Construction stripboard layouts provided for projects.

CB PROJECTS

D0055B \$6.75
A number of useful designs include a speech processor, interference filters and a simple CB radio receiver. Stripboard layouts, wiring diagrams and notes on construction are provided.

HOW TO MAKE WALKIE-TALKIES

D0056B \$6.95
This treatise on low-power transmitter-receivers (walkie-talkies) covers many aspects, from licensing requirements and bands, through practical circuitry and construction to the types of aerials that may be used.

POPULAR ELECTRONIC CIRCUITS — BOOK 1

D0060B \$6.75
Includes audio, radio, test gear, music projects, household projects and many more. An extremely useful book for all hobbyists, offering remarkable value.

POPULAR ELECTRONIC CIRCUITS — BOOK 2

D0061B \$7.75
A wide range of designs for electronics enthusiasts who are capable of producing working projects from just a circuit diagram without the aid of detailed information.

MINI-MATRIX BOARD PROJECTS

D0062B \$6.75
This book provides a selection of 20 useful circuits which can all be built on a mini-matrix board which is just 24 holes by 10 copper strips in size. Simple and easy for those with not much experience in electronics.

MULTI-CIRCUIT BOARD PROJECTS

D0063B \$6.75
All circuits are based on one specially designed pc board. Recommended to the less experienced hobbyist.

AERIAL PROJECTS

D0064B \$6.75
Practical aerial designs including active, loop and ferrite which are relatively simple and inexpensive to build. The complex theory and mathematics are avoided.

MODERN OP-AMP CIRCUITS

D0065B \$6.75
A collection of widely varying circuits and projects based on the op-amp ICs.

ELECTRONIC TIMER PROJECTS

D0066B \$6.75
These may have a high degree of accuracy with quartz control or they may be quite simple designs, using only a few components. A number of specialist timer projects are car windscreen-wiper delay unit, darkroom timer, metronome, etc.

ELECTRONIC PROJECTS FOR CARS AND BOATS

D0067B \$6.75
Fifteen fairly simple projects designed for use with 12V electrical systems but in some cases can also be employed with 6V and/or positive earth systems.

ELECTRONIC PROJECTS FOR CARS

D0261E \$4.95
Projects include car alarm, reversing alarm, over-rev alarm, twin-range tachometer, break-down beacon, intelligent battery charger, etc.

ETI TOP PROJECTS — VOL 5

D0263E \$10.00
Includes photographic strobe, bucket brigade audio delay line, white line follower, house alarm, etc. etc.

ETI TOP PROJECTS — VOL 6

D0264E \$4.95
Revised second edition. Projects include theatrical lighting controller, simple intercom, electromyogram for biofeedback use, Series 4000 four-way load-speaker, etc. etc.

ETI TOP PROJECTS — VOL 7

D0265E \$5.95
Includes geiger counter, AM tuner, laser, simple metal detector, discriminating metal detector, dc power supply, etc. etc.

ETI TOP PROJECTS — VOL 8

D0266E \$4.95
Includes UHF to VHF television converter, universal process timer, sound bender, percussion synthesiser, etc. etc.

ETI TOP PROJECTS — VOL 9

D0267E \$4.95
Includes a radioteletype-computer decoder, model railway points controller, universal dc-dc converter, MicroBee EPROM programmer, etc.

EXPERIMENTER'S GUIDE TO SOLID-STATE ELECTRONICS PROJECTS

D0323P \$9.75
A large collection of easy-to-follow electronics projects and tests, including experiments with solid-state devices such as solar cells, fibre optics, LEDs and linear and digital ICs. Projects include a transistor checker, a series regulated power supply and a solar cell battery for a portable radio.

THE COMPLETE GUIDE TO SECURITY

D0343P \$22.30
This comprehensive non-technical guide covers locks and alarm systems, security for the home, office, car and travel. Includes practical hints on telephone security, closed-circuit television, ultrasonic and photoelectric burglar alarms and rf bug detectors.

BUILD YOUR OWN ELECTRONIC EXPERIMENTER'S LABORATORY USING ICs

D0384B \$2.75
Projects include a simple audio frequency oscillator, a TTL pulse detector, a simple square wave generator and a high impedance voltmeter. Limited supplies.

52 PROJECTS USING IC741

D0386B \$3.95
Projects include remote thermometer, servodriven, rev counter for petrol and diesel engines, voltage amplifier and a record amplifier with bass boost.

circuit techniques and design

50 PROJECTS USING RELAYS, SCRs AND TRIACS

E0068B \$6.95

Practical working circuits using silicon controlled rectifiers, relays and bi-directional triodes. With a minimum of difficulty you can use them in motor control, dimming and heating control, timing and light sensitive circuits, warning devices and many others.

50 FET PROJECTS

E0069B \$5.95

Projects include amplifiers and converters, test equipment, tuners, receivers and receiver aids, mixers and tone controls, etc. The FET used is not critical. This book is of interest and value to SW listeners, radio amateurs, hi-fi enthusiasts and general experimenters.

ETI CIRCUITS — BOOK 1

E0070E \$2.95

Many of these circuits have been published in the 'Ideas for Experimenters' Section of ETI.

ETI CIRCUITS — BOOK 2

E0071E \$2.95

See Book 1.

ETI CIRCUITS — BOOK 3

E0072E \$2.95

See Book 1.

ETI CIRCUITS — BOOK 4

E0073E \$2.95

See Book 1.

PRACTICAL TRANSFORMER DESIGN HANDBOOK

E0075P \$38.95

An easy to understand, illustration-filled guide to designing and constructing transformers. Reviews the fundamentals of electricity, magnetism and algebra needed to understand transformer theory, and covers general design considerations, transformer types, power losses and transformer use in converters and inverters.

ETI CIRCUIT TECHNIQUES — VOL 1

E0076E \$4.95

The how, what, which, where, why and how much anthology of components, circuits and techniques. Second printing.

ETI CIRCUIT TECHNIQUES — VOL 2

E0077E \$4.75

See Volume 1.

ETI CIRCUIT TECHNIQUES — VOL 3

E0078E \$4.95

See Volume 1.

RF CIRCUIT DESIGN

E0079P \$36.95

A practical approach to the design of RF amplifiers, impedance-matching networks and filters. Uses a minimum of complex maths.

ACTIVE-FILTER COOKBOOK

E0084P \$24.25

Learn to construct filters of all kinds — highpass, lowpass, bandpass. The book is easy to understand — no advanced maths or obscure theory is used.

UNDERSTANDING IC OPERATIONAL AMPLIFIERS

E0085P \$12.25

Latest edition of this book covers theoretical and practical aspects of operational amplifiers and associated circuits. Includes material on BIFET and BIMOS and CMOS op-amps.

CMOS COOKBOOK

E0086P \$21.00

This book explains CMOS technology and its application to 'real world' circuitry. A mini-catalogue is included, which lists more than 100 devices, giving pinouts and application notes.

IC OP-AMP COOKBOOK

E0088P \$25.75

Basic op-amp theory in detail, with 200 practical, illustrated circuit applications: JFET and MOSFET units are featured, plus manufacturers' data sheets and company addresses.

DESIGN OF OP-AMP CIRCUITS, WITH EXPERIMENTS

E0089P \$17.50

The design of the fundamental circuits that are the basic building blocks of more sophisticated systems. A series of 35 experiments illustrates the design and operation of linear amps, differentiators and integrators, voltage and current converters, active filters, and lots more.

555 TIMER APPLICATIONS SOURCE BOOK, WITH EXPERIMENTS

E0090P \$11.25

The construction of the 555 timer and numerous practical examples of its applications in all areas of electrical and computer engineering, including 17 simple experiments.

ELECTRONIC DESIGN WITH OFF-THE-SHELF ICs

E0099P \$15.70

It contains virtually all the information you need to design and build electronic circuits, systems and subsystems with readily available ICs. Shows how to interface them into highly complex systems.

MODERN FILTER DESIGN

E0100P \$65.00

This book details the advances in active RC filters, both from a practical standpoint and from a state-of-the-art point of view. Gives detailed analysis and design procedures for switched capacitor filters.

50 PROJECTS USING CA3130 ICs

E0101B \$4.50

The CA3130 is an advanced operational amplifier capable of higher performance than many others: circuits often need ancillary components. Audio projects, RF projects, test equipment, household projects.

PRACTICAL INTRO TO DIGITAL ICs

E0102B \$5.95

Introduction to digital ICs (mainly TTL 7400). Besides simple projects, includes logic test set to identify and test digital ICs. Also includes digital counter-timer.

50 CIRCUITS USING GERMANIUM, SILICON AND ZENER DIODES

E0103B \$5.95

Fifty interesting and useful circuits and applications using the germanium and silicon signal diodes, silicon rectifier diodes and zener diodes, etc.

DESIGN OF VMOS CIRCUITS, WITH EXPERIMENTS

E0104P \$17.75

The authors look at the technology which makes dramatic advancements possible with VMOS, and show how these components can easily be integrated into common circuit designs to enhance their responses.

ELECTRONIC CIRCUITS

E0288P \$15.95

Includes fundamentals of transistor theory, bias circuits, equivalent circuits, transistor data sheets, gain considerations in amplifiers, frequency characteristics of amplifiers, multistage and feedback amplifiers and FETs, with many examples and illustrations.

MODERN CONTROL THEORY

E0289P \$16.95

Includes fundamentals of matrix algebra, vectors and linear vector spaces, transformations, eigenvalues and eigenvectors, nonlinear equations and perturbation theory, with many examples and solved problems.

DIGITAL ELECTRONICS

E0292P \$15.95

Includes device theory, basic passive logic and basic active logic, advanced active logic gates, flip-flops and monostables and astables with many examples and illustrations.

DIGITAL LOGIC CIRCUITS — TESTS AND ANALYSIS

E0374P \$25.95

This working handbook covers the theory of digital logic circuits, starting with simple gates, illustrations of IC pinouts and an introduction to truth tables. Includes tests and analysis.

DESIGN OF ACTIVE FILTERS WITH EXPERIMENTS

E0405P \$15.95

Introduction to the theory, implementation and design of active filters using the 741 op-amp.

test equipment and fault-finding

HOW TO GET YOUR ELECTRONIC PROJECTS WORKING

F0114B \$6.95

Helps you to overcome the problems of a circuit that doesn't work by indicating how and where to start looking for many of the common faults that can occur when building up a project.

WALL CHART — TRANSISTOR RADIO FAULT-FINDING

F0115B \$2.95

Used properly, this chart should enable the reader to trace most common faults quickly. Across the top of the chart are four rectangles containing brief descriptions of the faults. Selecting the appropriate fault, the reader simply follows the arrows and carries out the suggested checks until the fault is cleared.

PRACTICAL REPAIR AND RENOVATION OF COLOUR TELEVISIONS

F0116B \$6.55

This book shows how to obtain a working colour television for very little outlay by repairing and renovating a set that has been 'written off' by a dealer. Includes practical details of how to construct your own CRT tester/rejuvenator and cross-hatch generator.

TEST GEAR — VOL 2

F0119E \$4.95

Projects include audio oscillator, transistor tester, true RMS voltmeter, RF signal generator, versatile logic test probe, microwave oven leak detector, etc.

AUTOMOTIVE TUNE-UP AND EMISSION-CONTROL SERVICE

F0120P \$22.75

Car owners who wish to save money and maintain their cars at peak performance will learn how to adjust, repair and maintain the systems that ensure best operation.

TROUBLE SHOOTING WITH THE OSCILLOSCOPE

F0121P \$16.95

Excellent for the professional service technician or the serious hobbyist, as it combines step-by-step procedures for using the scope with the specific nuts and bolts of television receiver trouble-shooting.

ELECTRONIC TEST EQUIPMENT CONSTRUCTION

F0122B \$5.95

Describes construction of wide range test gear, including FET amplified voltmeter, resistance bridge, field strength indicator, heterodyne frequency meter, etc.

TEST GEAR — VOL 3

F0255E \$4.95

Projects include RF attenuator, op-amp tester, tachometer, transistor tester, mains cable seeker, electric fence tester, portable core-balance relay, etc.

ELECTRONIC TROUBLESHOOTING HANDBOOK

F0257P \$10.50

This workbook guide shows you how to pinpoint transistor troubles in minutes, how to test almost everything electronic and how to get the most out of low-cost test equipment.

EFFECTIVELY USING THE OSCILLOSCOPE

F0258P \$16.95

Describes the potential uses of the scope, ranging from audio and television tests and measurements to performance tests.

HOW TO BUILD YOUR OWN SOLID-STATE OSCILLOSCOPE

F0282B \$6.95

This book comprises a project divided into sections for builder to individually construct and test — then assemble into complete instrument. Includes short section on scope usage.

electronic music and audio/video

AN INTRODUCTION TO VIDEO

G0124B \$6.95
This book is written in layman's language and is for anyone who is thinking about buying or renting or who has just bought or rented a video recorder and wants to get the best out of the machine.

MODERN RECORDING TECHNIQUES

G0128P \$21.95
Explains the equipment controls and techniques found in a modern recording studio and how to use them creatively and correctly to produce a desired result. Numerous photographs, diagrams and charts.

ELECTRONIC SYNTHESIZER PROJECTS

G0133B \$5.95
For the electronic music enthusiast, an invaluable reference. This book is full of circuits and information on how to build analogue delay lines, sequencers, VCOs, envelope shapers, etc. The author takes a clear and logical approach to the subject that should enable the average enthusiast to understand and build up what appears to be a quite complex instrument.

AUDIO PROJECTS

G0134B \$6.95
Covers a wide range of audio projects, including preamplifiers and mixers, power amplifiers, tone controls and matching, etc. Board layouts and wiring diagrams included.

ELECTRONIC MUSIC PROJECTS

G0135B \$5.95
Provides constructors with practical circuits for the less complex music equipment including fuzz box, waa-waa pedal, sustain unit, reverb and phaser, tremolo generator, etc. Text covers guitar effects, general effects, sound generators, accessories.

SINGLE-CAMERA VIDEO PRODUCTION

G0379P \$25.75
Step-by-step diagrams and illustrations show you how to produce low-budget, high-quality video programs. Chapters on audio, lighting, shooting, editing, graphics and set design.

computers for beginners

COBOL FOR BEGINNERS

H0140P \$33.95
It is a solid text for introductory programming courses in Cobol, using a format that is easy to understand, yet comprehensive enough to make supplementary readings unnecessary.

THE PET PERSONAL COMPUTER FOR BEGINNERS

H0141P \$20.95
This handy guide is written for use with all varieties of PET computer, from the original 2001 to the 8032 Super PET. It is suited to novices with no practical experience and provides advice and practical examples.

AN INTRODUCTION TO BASIC PROGRAMMING TECHNIQUES

H0145B \$6.75
Ideal for beginners seeking to understand and program in BASIC. Includes program library for biorhythms, graphing Y against X, standard deviations, regressions, generating musical note sequences, and a card game.

BEGINNING BASIC

H0146A \$24.95
Intended for beginners with no computing experience, one should be able to intelligently program in BASIC in a short time.

NAILING JELLY TO A TREE

H0149A \$25.50
This guide to software teaches you about machine language, assembly language programming and BASIC. The emphasis is not on learning to write programs but on learning to use the thousands of available programs that have already been written.

FROM CHIPS TO SYSTEMS: AN INTRODUCTION TO MICROPROCESSORS

H0152A \$29.75
Explains exactly what a microcomputer system is and how it works. Introduces fundamental concepts and covers all aspects of microprocessors and related components: internal operation, memories, interfacing and system development, etc.

DON'T (OR, HOW TO CARE FOR YOUR COMPUTER)

H0153A \$19.95
A guide to computer and peripheral preservation. Specific advice for the computer, floppy disks, hard disks, the CRT terminal, the printer, tape units, the computer room, software and documentation.

MICROCOMPUTERS: A PARENTS' GUIDE

H0275J \$13.75
In clear, non-technical language, the authors explain what micros are, what they can do and what to expect in the future.

COMPUTERS FOR EVERYBODY

H0270A \$8.95
In this easy-to-understand book it is explained how a computer can be used at home, in the office or at school. Includes a consumer's guide to computer equipment that will help the reader decide what to buy and who to buy it from. Second edition.

ATARI PILOT FOR BEGINNERS

H0308P \$21.95
Shows how to make the Atari 400 and 800 home computers play music, display colourful moving pictures and do mathematics. Shows how to use the Pilot computer language.

THE APPLE PERSONAL COMPUTER FOR BEGINNERS

H0344P \$17.75
Comprehensive introduction to the Apple II and Apple II Plus computers written for beginners. Provides step-by-step illustrations with sample programs and responses, concentrating on Applesoft BASIC, with an appendix on integer BASIC. Includes chapters devoted to disk systems, graphics, colour and music.

THE ILLUSTRATED WORD-PROCESSING DICTIONARY

H0387P \$15.95
Includes 54 different word-processing functions described and illustrated, descriptions of equipment types, software and magnetic media, word-processing terminology and exercises.

computer hardware and techniques

Z80 MICROCOMPUTER DESIGN PROJECTS

J0156P \$20.75
A complete look at the internal architecture of the Z80, the heart of many microcomputers, and even shows how to build a microcomputer, the EX80, using this powerful chip.

MICROPROCESSOR CIRCUITS

J0157P \$14.75
Presents basic microprocessor concepts in simple language for beginners and teaches you to construct a useful microcontroller system. Offers 30 demo circuits which take you through assembly, operation and programming of a microcontroller.

DON LANCASTER'S MICRO COOKBOOK

J0159P \$22.20
This 'cookbook' starts with the very fundamentals of microprocessors and microcomputers and takes you through number systems, codes, etc. till you can work intelligently with micros.

USING THE 6800 MICROPROCESSOR

J0163P \$13.25
Guides the reader through the conception, configuration, writing and running of a variety of programs that demonstrate practical use of a 6800 system.

STD BUS INTERFACING

J0164P \$21.75
Explains what the STD bus is, in easy-to-understand language.

MICROPROCESSING INTERFACING TECHNIQUES

J0167A \$29.95
Teaches you how to interconnect a complete microprocessor system and interface it to the usual peripherals. The hardware and software skills needed to effectively interface peripheral devices are covered along with various buss standards and A/D conversion. Third edition.

EXPERIMENTS IN ARTIFICIAL INTELLIGENCE FOR SMALL COMPUTERS

J0168P \$14.25
Artificial intelligence is the capability of a device to perform functions normally associated with human intelligence. With this book, a small computer with extended BASIC and some knowledge of BASIC language, you can conduct experiments in artificial intelligence.

Z80 MICROCOMPUTER HANDBOOK

J0171P \$20.50
This handbook covers hardware, software and microcomputers built around the Z80.

PET INTERFACING

J0169P \$25.25
Demonstrates how to build numerous interfacing devices for PET hardware. BASIC language programs are used throughout, and the book includes a discussion of the microprocessor's internal architecture and general hardware/software interfacing.

6809 MICROCOMPUTER PROGRAMMING AND INTERFACING, WITH EXPERIMENTS

J0170P \$21.95
Gives a solid understanding of how to program and interface the high-performance 6809 microprocessor. The author completely explores internal structure, addressing modes, data movement instructions, registers, arithmetic logic and test instructions for the 6809.

THE SINCLAIR SPECTRUM IN FOCUS

J0277J \$16.45
The reader is taken on a programming course in ZX Spectrum BASIC which progresses toward some of the most advanced techniques that may be used on the ZX Spectrum. Numerous examples and more than 50 programs are included.

PC DOS: USING THE IBM-PC OPERATING SYSTEM

J0278J \$24.50
This self-paced guide teaches you how to become an accomplished user of all the major disk-operating system functions and utilities, no matter how much or how little computer experience you have.

MICROSOFT FORTRAN

J0291A \$24.95
Various techniques involved in MicroSoft programming are explained, including structural programming and top down programming. Compiler, editor and linker are discussed, along with the various uses of the printer, disk and video terminal.

8085A COOKBOOK

J0304P \$21.75
Beginning with basic concepts, shows how to design a microcomputer using the 8085A microprocessor chip. Includes discussions of system control, memory systems, interfacing and 8085A-family-compatible chips.

USING THE IBM PERSONAL COMPUTER

J0319P \$21.50
This all-purpose beginner's book is a complete guide to the IBM-PC.

USING THE OSBORNE 1 COMPUTER

J0327P \$21.50
How to get the most out of the Osborne 1 portable computer.

CAI SOURCEBOOK

J0333P \$19.75
Explains computer-assisted instruction (CAI) in education and industrial training and how and why to become a CAI author.

MICROCOMPUTER: ANALOG CONVERTER SOFTWARE AND HARDWARE INTERFACING

J0334P \$15.95
An introduction to the concepts and techniques of interfacing digital computers to analog devices. Applicable to all 8080-type computers, including the 8080A, 8085, Z80, etc.

16-BIT MICROPROCESSORS

J0342P 22.20

A guide to the most popular of the 16-bit microprocessors, including the Intel 8086, the Zilog Z8001 and 8002 chips, the DEC LSI-11, Texas Instruments 9900, the Motorola 68000 and the National Semiconductor 16000 family.

WORD-PROCESSING SKILLS AND APPLICATIONS USING WANG SYSTEMS

J0347P \$26.25

A training book for the Wang CRT word-processor, covering three levels of instruction: Level I BASIC, Level II Advanced and Level III Glossary. Many exercises included.

THE 8080A BUGBOOK: MICROCOMPUTER INTERFACING AND PROGRAMMING

J0349P \$21.75

Covers the four fundamental tasks of microcomputer interfacing — device pulse generation, microcomputer output, microcomputer input and interrupt servicing — for 8080-based microcomputers.

Z80 MICROPROCESSOR PROGRAMMING AND INTERFACING — BOOK 1

J0350P \$17.90

Covers Z80 software, assembly-language and machine-language programming. Requires no background in computer science, programming or digital electronics.

Z80 MICROPROCESSOR PROGRAMMING AND INTERFACING — BOOK 2

J0351P \$23.95

Covers Interfacing digital circuits with the Z80 CPU, P10 and CTC chips. Assumes familiarity with the topics covered in the first volume. Strong emphasis on learning through experimentation.

6801, 68701 and 6803 MICROCOMPUTER PROGRAMMING AND INTERFACING

J0355P \$19.95

Covers software, various I/O configurations and operating modes, Internal R/W memory and serial communications Interface for the 6801, 68701 and 6803 microprocessors.

INTERFACING AND SCIENTIFIC DATA COMMUNICATIONS EXPERIMENTS

J0366P \$10.25

An introduction to the principles involved in the transfer of data using the asynchronous serial data-transfer technique. Emphasis is on the use of the UART chip.

PROGRAMMING MICROPROCESSOR INTERFACES FOR CONTROL AND INSTRUMENTATION

J0377P \$39.95

A beginner's guide to interfacing principles. Includes discussions of practical applications for microprocessors, the 6809 signal set, hardware and software architecture and modular programming. Many examples and programs. Limited supplies.

MICROCOMPUTER DATACOMMUNICATION SYSTEMS

J0391P \$16.75

A guide to the operations of modems, terminals, electronic bulletin boards and Information utilities for users of the TRS-80, Apple II and other systems.

VIC-20 PROGRAMMER'S REFERENCE GUIDE

J0393P \$22.95

An all-purpose reference guide for first-time users and experienced programmers. Includes a BASIC vocabulary guide, programming tips, machine-language programming guide and a section on input/output operations.

PROTOCOLS AND TECHNIQUES FOR DATA COMMUNICATION NETWORKS

J0396P \$60.95

Coverage includes the packet-switching concept, file transfer, coding for reliable data transmission, network security, remote job entry, routing and flow control techniques for packet-switched computer networks and end-to-end communications between network users.

COMPUTERS AND PROGRAMMING GUIDE FOR SCIENTISTS AND ENGINEERS

J0400P \$21.95

An excellent introduction or refresher for practicing engineers and scientists. Includes BASIC and Fortran languages, problem-solving with computers, batch processing and structural programming.

PROGRAMMING AND INTERFACING THE 6502, WITH EXPERIMENTS

J0402P \$24.35

Includes simple input/output techniques, logical operations, branches and loops, register-shift instructions, subroutines, data bus, and control signals. Limited supplies.

MICROSOFT BASIC

J0406A \$24.50

Presents a complete introduction and tutorial on programming in BASIC using Microsoft BASIC, Release 5.0. Covers branching and loops, strings, editing, arrays and files, and arithmetic in BASIC.

computing software

THE CP/M HANDBOOK (WITH MP/M)

K0173A \$24.95

Contains a step-by-step description of all the CP/M command features. Designed for the beginner, the book progresses to detailed explanations of the file transfer, debugging and CP/M text-editing programs.

THE 68000: PRINCIPLES AND PROGRAMMING

K0176P \$19.95

An easy-to-read, systematic approach to the 68000 advanced 16-bit microprocessor. The book guides you through the complex architecture, instruction set, pinouts and interfacing techniques. Written for design engineers, programmers and students.

STARTING FORTH

K0177P \$25.00

A clear and complete guide to Forth, this book covers fundamental principles and then a full set of high-level Forth commands. It concludes with advanced techniques and style.

BASIC PROGRAMS FOR SCIENTISTS AND ENGINEERS

K0179A \$19.95

Contains scientific and engineering application programs written in BASIC.

COMPUTER GRAPHICS PRIMER

K0180P \$21.95

Almost every page has a colour drawing, photograph, picture or a schematic to help you learn computer graphics quickly and easily. Programming concepts apply to all microcomputers, and examples are given in BASIC for the Apple II.

PASCAL PROGRAMS FOR SCIENTISTS AND ENGINEERS

K0181A \$23.50

More than 60 of the most frequently used scientific algorithms, with program implementation in Pascal.

HOW TO WRITE AN APPLE PROGRAM

K0182P \$23.25

Very much a 'how-to' book. Author assumes only a minimal familiarity with computer and BASIC. The book covers every aspect of simple program writing from initial concepts to final debugging — wittily illustrated.

HOW TO WRITE A TRS-80 PROGRAM

K0183P \$23.25

Virtually identical to *How to Write an Apple Program*. Changes have been made to allow for differences in the two machines and variations in BASIC.

HOW TO WRITE AN IBM-PC PROGRAM

K0184P \$23.25

Virtually identical to *How to Write an Apple/TRS-80 Program*. Changes have been made to allow for differences in the two machines and variations in BASIC.

USING THE UNIX SYSTEM

K0185P \$24.95

This book by Richard Gauthier, of RGL, has been written for people with some knowledge of computers, but with no specific knowledge of Unix. It is also of value to current Unix users.

FIFTY BASIC EXERCISES

K0188A \$17.95

Designed to teach BASIC through actual practice, this book contains graduated exercises in math, business, operations research, games and statistics. The programs were designed to run directly on a TRS-80 but will run on any system with MicroSoft BASIC.

APPLE FILES

K0190P \$21.95

This book is for people who know some BASIC and would like to expand and apply this knowledge by using the capabilities of the Apple. Includes programs for the stock market, inventories, grades and medical records.

CP/M PRIMER

K0191P \$26.95

A complete one-stop course on CP/M, the very popular operating system for 8080, 8085 and Z80-based microcomputers. Complete terminology, hardware and software concepts, startup of a CP/M system, and a complete list of CP/M-compatible software.

COMPUTER PROGRAMS IN BASIC

K0192P \$18.25

Fully indexed guide to more than 1600 BASIC computer programs published in personal computer magazines for microcomputers, mini-computers and mainframe computers. Compiled by Paul Friedmann, first published in 1981.

INTRODUCTION TO PASCAL

K0198P \$22.95

The design and construction of Pascal programs, involving a wide range of basic computer algorithms in a practical context. Second edition.

PROGRAMMING THE Z80

K0231A \$26.95

This book will enable every reader to write complete application programs for Z80-based computer systems. Includes exercises to measure progress and comprehension at each level of programming.

START WITH BASIC ON COMMODORE VIC-20

K0233P \$14.75

Helpful exercises and step-by-step instructions show you how to program in BASIC utilising all the graphic functions on the VIC-20.

THE C PROGRAMMING LANGUAGE

K0272P \$24.95

C is a general purpose 'low-level' programming language. It is not specialised to any particular area of application, but its absence of restrictions make it convenient and effective for many tasks.

FORTH PROGRAMMING

K0298P \$24.25

Describes both Forth-79 and fig-Forth and shows how to write software using these languages, add new operations (words) and manipulate the stack. Includes more than 50 useful programs.

COMAL HANDBOOK

K0299P \$25.95

A structured form of BASIC, Comal can be used on the Commodore PET, 8096 and 8032 computers. A reference book with more than 100 example programs and procedures.

APPLE FORTRAN

K0317P \$19.95

A detailed language manual for Apple Fortran 77. Contains a wide range of example programs that demonstrate the various details of the Apple Fortran language.

6502 SOFTWARE DESIGN

K0354P \$18.95

Includes an introduction to the 6502 microprocessor and instruction set, subroutines, lists and look-up tables, number-base conversion, interrupts and resets and general-purpose input/output devices.

THE WORD-PROCESSING HANDBOOK

K0373P \$13.50

Includes descriptions of office automation systems, checklists for system evaluation, techniques for cost justification and payback analysis and handy tables and diagrams.

THE POWER OF VISIPILOT

K0380P \$19.35

VisiPlot enables the user to display data graphically: with line graphs, bar graphs, area and circle graphs and even two graphs on the same page for comparison.

INSIDE ATARI BASIC

K0390P \$16.50

Takes the confusion out of learning to operate a home computer. Avoiding unnecessary technical details and flow charts, it explains in plain language (and witty illustrations) how to start with BASIC on the Atari.

INTIMATE INSTRUCTIONS IN INTEGER BASIC
K0394P \$11.95

Written in a lesson-type format, this book provides definitions, the fundamentals of a programming technique and self-testing lesson exercises. Programs written in Integer BASIC.

AN END-USER'S GUIDE TO DATA-BASE
K0401P \$42.95

An introduction to data-base, including productivity and flexibility, data modelling, design tools, data-base languages for end-users and separate end-user systems. A James Martin book.

INTRODUCTION TO FORTH
K0404P \$16.95

The MMS FORTH version of FORTH is completely covered, as well as fundamental approaches to programming in all versions of FORTH. Provides many programming examples, with direct comparisons to the Microsoft Level II BASIC version of these programs.

computing for business

BASIC FOR ACCOUNTANTS
L0234P \$11.95

Shows accountancy students and accountants how to use a computer to perform the repetitive tasks associated with record keeping, calculating and report writing. Using the BASIC language attention is concentrated on debtors, inventory and general ledger systems.

COMPUTER-BASED BUSINESS SYSTEMS
L0235P \$10.95

A short introduction to the sorts of systems used by a typical business to handle its typical activities. The book aims at providing a general understanding, and, therefore, avoids technological detail.

THE COMPUTER SOLUTION
L0236P \$13.50

This should be of interest to business people contemplating implementing or already using computer data processing or to any non-technical person curious to know why and how computers are used in Australian businesses and organisations.

THE SMALL-BUSINESS COMPUTER GUIDE
L0237P \$14.95

Ideal for the inexperienced user, this text emphasises management considerations in determining the feasibility, economics, evaluation, selection, contracts and practicality of installing a computer.

SMALL-BUSINESS COMPUTER SYSTEMS
L0238P \$14.95

Provides a bridge between the accountant and the data-processing professional by explaining every step of the trading and reporting process in data-processing terms. It is especially useful to people engaged in the specification process or in auditing dataprocessing accounting systems.

THE VISICALC BOOK — APPLE EDITION
L0239P \$22.25

If you are using VisiCalc on your Apple II and want to learn more about its expanded uses then this book will show you how to build a model, enter your data and solve problems about profit/loss projections, pricing costing estimates, etc.

FROM THE COUNTER TO THE BOTTOM LINE
L0243A \$24.95

Guide to basic accounting needs and computer use. Includes inventory and purchasing, billing, accounts receivable, accounts payable and general ledger.

THE OFFICE AUTOMATION PRIMER
L0244P \$15.50

Guides the user step by step through all aspects of planning, evaluating and installing stages. Lively vignettes illustrate how automation increases productivity in word and data processing, electronic mail, photocomposition, telecommunications, scheduling and message switching. Probably the most comprehensive guide of its kind for every manager seeking to maximise productivity and profitability.

MICROCOMPUTERS FOR BUSINESS APPLICATIONS
L0301P \$12.95

An invaluable aid for the potential buyer of a business microcomputer system. Limited supplies.

INVENTORY MANAGEMENT FOR SMALL COMPUTERS
L0241A \$27.95

Owners of retail businesses and their employees need this book. The program provides an inventory control system, what stock is on hand, where it is located, what price was paid for it and the selling price.

THE POWER OF VISICALC
L0316P \$13.35

Exercises designed especially for users of the VisiCalc program.

MICROCOMPUTER DATA-BASE MANAGEMENT
L0322P \$16.75

Information on file handling, sorting, searching, linking, hashing, accessing data from BASIC and data files, to help tap the full potential of the micro-computer.

THE POWER OF VISICALC: REAL ESTATE
L0330P \$19.35

Step-by-step applications designed especially for realtors, commercial brokers, developers, contractors and property owners and managers using VisiCalc. Limited supplies.

SIMPLE BASIC PROGRAMS FOR BUSINESS APPLICATIONS
L0358P \$23.50

Program listings and sample outputs for more than 50 applications, a primer on BASIC programming, BASIC compounds and statements for popular microcomputers and BASIC-FORTRAN conversion tables.

DEVELOPING MICROCOMPUTER-BASED BUSINESS SYSTEMS
L0369P \$16.50

Directed specifically at intending developers of small computer-based business systems who are not data-processing professionals.

BUYING YOUR COMPUTER
L0372E \$4.25

Contractual details for the first-time purchaser.

DEVELOPING COMPUTER SOLUTIONS FOR YOUR BUSINESS PROBLEMS
L0376P \$19.25

A manager's guide to effective planning, implementation and evaluation of automation alternatives.

UNDERSTANDING AND BUYING A SMALL-BUSINESS COMPUTER
L0388P \$13.95

An introduction to computers for small-business owners, presenting basic concepts of computer technology and information on software and hardware.

electronic calculators

ELECTRONIC CALCULATOR USER'S HANDBOOK
M0245B \$5.50

Presents formulae, data, methods of calculation, conversion factors, etc, for use with the simplest of most sophisticated calculators. Includes the way to calculate using only a simple four-function calculator, trigonometric function, hyperbolic functions, logarithms, square roots and powers.

YOUR ELECTRONIC CALCULATOR AND YOUR MONEY
M0246B \$4.75

Starts with a basic revision of percentages and decimals, then deals with mortgages, cars, insurance, fuel, shopping, tax, etc. There's a section on investment and one on the calculator in a small business.

TAKE A CHANCE WITH YOUR CALCULATOR
M0248A \$14.95

An introduction to modern mathematics, this book deals with programming of programmable calculators and includes probability problems. Limited supplies.

FUN AND GAMES WITH YOUR ELECTRONIC CALCULATOR
M0370B \$2.50

A collection of 101 jokes and riddles, several mind-boggling games for two or more players, and a dictionary of words with their corresponding numbers.

amateur radio, dx communications

COMPUTERS AND THE RADIO AMATEUR
N0249P \$31.25

For the radio operator who wants to know how computers function and how they can be used with other equipment.

LONG-DISTANCE TELEVISION RECEPTION (TV-DX)
N0250B \$6.95

Written by the British authority, the book includes many units and devices made by active enthusiasts. A practical and authoritative introduction to this unusual aspect of electronics.

HANDBOOK OF RADIO, TELEVISION, INDUSTRIAL AND TRANSMITTING TUBE AND VALVE EQUIVALENTS
N0251B \$3.95

The equivalents books for amateurs and servicemen. More than 18,000 old and new valves from United States, Britain, Europe, Japan. CV (military) listings with commercial equivalents included.

RADIO STATIONS GUIDE
N0252B \$5.95

An aid for all those who have a radio receiver. Shows the station site, country, frequency and/or wavelength, as well as Effective Radiation Power of the transmitter and, in some cases, the station's call sign as well.

AN INTRODUCTION TO RADIO DXING
N0253B \$6.75

One section is devoted to amateur brand reception and the other section covers broadcast band reception, with advice on suitable equipment and the techniques employed when using that equipment. The construction of a number of useful accessories is described.

TELEMARKET SOCIETY
N0254P \$20.00

Demonstrates how developments in telecommunications will affect the way we live.

25 SIMPLE AMATEUR BAND AERIALS
N0286B \$6.95

How to build 25 amateur-band aerials that are simple and inexpensive to construct and perform well. From the simple dipole up to a mini-rhombic.

THE BASIC BOOK OF HAM RADIO
N0287R \$5.75

A comprehensive guide to the world of amateur radio.

SOLID-STATE BASICS FOR THE RADIO AMATEUR
N0290R \$5.95

Thorough treatment of the use of solid-state devices. Provides a wealth of tried and proven circuitry, plus practical application data.

FIBER OPTICS
N0295P \$31.75

Gives the electronics technician a practical foundation for the challenge of fibre optics. No prior knowledge of optics is necessary.

FIBER OPTICS: COMMUNICATIONS, EXPERIMENTS AND PROJECTS
N0296P \$24.35

An introduction to fibre optics for the hobbyist, student, experimenter, computer buff, radio amateur, technician or engineer.

HOW TO BUILD ADVANCED SHORTWAVE RECEIVERS
N0340B \$6.95

Contains full practical construction details of a number of receivers.

AMATEUR RADIO MAP OF THE WORLD
N0362R \$4.95

Published by the American Radio Relay League, this giant wall map is fully indexed.

ANTENNA ANTHOLOGY
N0364R \$5.75

Theoretical explanation and complete instructions for building different types of antennas for amateur work.

All prices of publications in this catalogue listing are subject to change without notice.

Versatile vehicle security alarm provides full protection for almost any vehicle

Jonathan Scott

This unit will protect your valuable vehicle from virtually any sort of interference — from hub-cap stealing to being towed away! It does not rely on voltage or current sensing to trip the alarm, but 'resonance microphones'. It can also protect 'perimeter accessories' like driving lights and racks. The project meets the major requirements of car alarms set down by the National Roads and Motorists Association (NRMA).

CAR BURGLAR ALARMS are plentiful on the shelves of electronic and automotive stores, and designs for build-it-yourself ones abound in the archives of every electronics magazine. In fact the range is so perplexing that choosing one becomes as involved a process as buying the vehicle in the first place! Which thought brings me to an interesting question — what does one unit, a car or an alarm, or any item, have over its apparent peers? Often it is merely that some recent technical development has become available at a reasonable price. A new car may come today with a turbo-charging system, electronic braking or gear control, or intelligent suspension. Perhaps a new product has just brought together a number of discreetly-developed good design ideas, much as today's 'food processors' incorporate the functions of blenders, ordinary mixers and mincers in one appliance with reliable electronic speed control. Finally, the improvement in a product may merely be the sum total of a lot of refining effort, as is the case in computers where the operating systems are more friendly and easier to use every time a new model comes out, or in a typewriter, which appears the same as ever, but feels a little better in the push of a key, and makes a little less noise than last year's model.

ETI's new car burglar alarm which we call a Vehicle Security Alarm, for the same reasons that food processors changed their names from 'mixmasters', has some of each of the three plusses above. It uses new alarm technology which we have not seen in a home construction design before, has certain additional incorporations beyond the functions of straight burglar protection, and has some facilities to make its use convenient and foolproof.

What are the features and advantages of this new design?



1). It uses inexpensive resonance microphones to detect interference with the car to which it is fitted. This means firstly that it does not rely on interior light switches or any other electrical system being disturbed as do switch closure sensing or voltage/current sensing alarms. It will not therefore miss detecting intrusion via a door with no light switch; it will also detect interference with luggage bays or hatchbacks which have no light connected, or the rear of a utility or panel van which is not enclosed. It can protect a convertible or targa body vehicle, or a truck with an open load area. Voltage and current types cannot satisfactorily do this.

Secondly, it will detect a sideswipe or minor impact such as so often occurs while your car is in the car park — the kind of dent which is not worth claiming on the insurance but which surely reduces the value of a vehicle and ruins its appearance. Even children interfering with the mirrors or similar can be detected, as actual inva-

THE NRMA'S TEN COMMANDMENTS FOR VEHICLE PROTECTION

In the February 1983 issue of *Open Road*, the NRMA's journal for members, the Association reported on tests they had carried out on some 24 car alarms, 14 fitted by suppliers or agents and 10 bought in kit form. As the report said, "The extensive tests and checks revealed deficiencies in design or performance of all 24 alarms, though most of them could have been improved by minor modifications or — in the case of the supplier-fitted types — by more care in fitting."

The report identified the key areas that need protection in a car. "When it comes to theft risk, 10 vulnerable points on a car are front doors, rear doors, bonnet, boot, ignition, accessories, wheels, glass and accessibility to towing and jacking," the report stated. It went on to say, "None of the alarms attempted to cover all 10 points, and some were unsuccessful in attempts to cover particular points because of poor components or poor fitting."

Based on police figures for reported thefts, you have a 1-in-50 chance of your car being stolen; if your car is a model in demand, the odds shorten considerably. The NRMA say that the fitting of a car alarm can reduce the risk of theft by deterring at least joy riders and petty thieves. Even a professional thief, seeing that the vehicle has a car alarm fitted, may move on in search of an easier mark.

The NRMA gives "10 Commandments" for buying protection:

1. The alarm should protect all the doors, bonnet and boot, at least.
2. It should operate instantly when the bonnet or boot is opened, or when the bonnet lock is released.
3. Air horns or a siren should be used, rather than the car's horn.
4. The alarm should be set from inside the vehicle, not by a key or other device from the outside.
5. Entry delay should be no more than five seconds.
6. The alarm should cut out the ignition system.
7. If the alarm obtains its power from the battery, wiring should be direct and should be positioned so that it cannot be reached from under the vehicle.
8. Horns or sirens and their wiring should be placed so they cannot be tampered with from behind the grille or from under the car.
9. The alarm duration should be about two minutes, with automatic cutout and reset.
10. Window stickers should indicate that the car is carrying an alarm system, but not the make and type.

It was this report that set in motion our quest for a car alarm project that would be versatile yet afford complete protection. We think this project can be installed so as to obey the Ten Commandments; although we disagree with No. 6. Artwork to comply with No. 10 is reproduced elsewhere in the article.

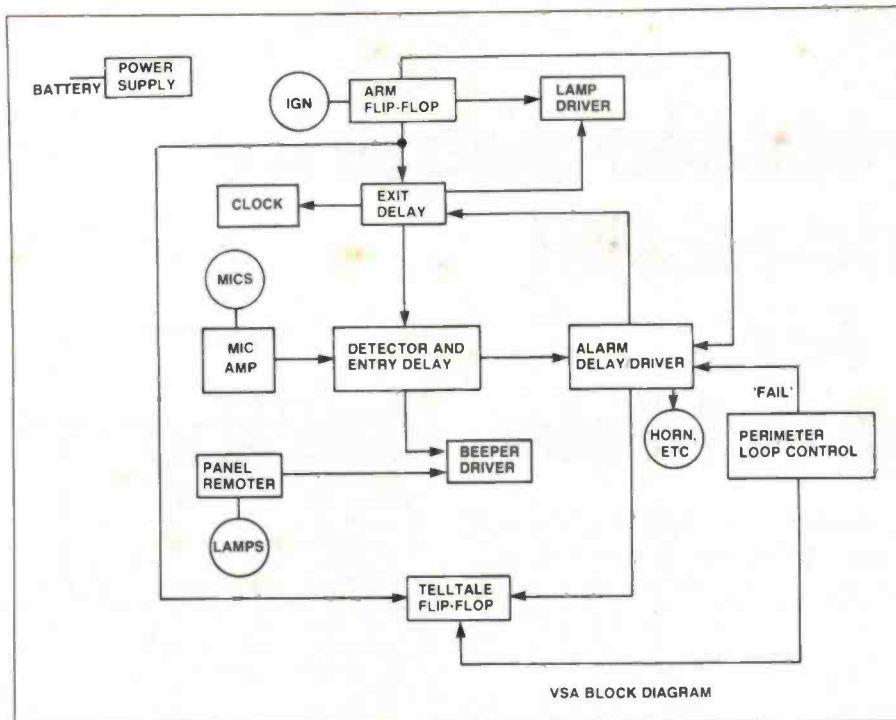

sion of the body or cabin is not necessary for detection to occur. Neither is the electronic state of the vehicle able to upset the alarm, thus eliminating false alarms due to random battery voltage variations or dash clocks drawing irregular currents.

2). The alarm is of the sensible three-delay design, but incorporates a failsafe against you forgetting it or missing one delay. By three-delay, I mean that it allows a period of time between activation and arming; a period of time between detecting possibly legal entry and sounding the alarm; and a period of time for which the alarm is sounded before resetting. Each of these is separately variable. Once activated, the warning lamp illuminates constantly; when the exit delay is over, the lamp flashes, indicating full arming. Once fully armed, a possibly legal entry/interference detection starts the second, or entry, delay. During this delay a beeping sound is emitted to quietly warn you that you have tripped the alarm (and the *thief* also that *he* has tripped it). This helps to prevent false and embarrassing blasts of the alarm noisemaker.

The final delay shuts off the alarm after a period of time, in accordance with the law of the land, not to mention the law of flat batteries! Once shut off, the system commences re-arming. This relatively 'friendly' arrangement permits full protection with minimum chance of false alarm and *no* drilling, etc of the body for installation of external switches or locks.

3). Immediate-trip perimeter inputs are provided. This facility, often missing from three-delay designs, allows the fitting of a mercury or tilt switch to the part of the car containing the battery. Without this it is relatively easy to disconnect the battery lead, killing the alarm, within the entry delay time period.

With such a mechanism connected an attempt to kill the power does at least attract a lot of attention.

In addition, connections to external driving or fog lights can be monitored and the alarm will go immediately if their earth connections are broken. These immediate loops (one normally closed, the other normally open) need not be used if not required, and if one is broken or shorted at arming time the remaining protection functions are not impaired. In addition, warning is given of a failed loop circuit, as indicated below.

4). While the state of the alarm (arming, armed, tripped, etc) is always made clear by the main lamp and the beeper, other statuses are reported by a second indicator, a 'tell-tale' LED. This glows to indicate that the alarm has gone off in your absence, and if it remains glowing after turning off the alarm by turning on the ignition, this indicates a failure in the loop circuits. Hence you are always informed as to what is going on inside the alarm circuits. The automatic rearming does not cancel the Tell-tale.

5). Alarms with automatic arming when the ignition is removed are a nuisance; conversely, an alarm which requires you to press a button to initiate arming are too open to forgetfulness. Having a concealed toggle or keyswitch is also inconvenient.

This alarm overcomes these problems by employing the usual illuminated pressbutton in an unusual mode. Turning off the ignition commences the arming cycle, *unless* the button is simultaneously pressed. Hence, normal behaviour automatically arms the system, overcoming forgetfulness, while the arming is simply overridden should you desire it by use of the button and the ignition key at once. Thus, disarming for service, etc, is facilitated. In addition, if the technique is deliberately not told to a bor-

PARTS LIST — ETI-340

Resistors.....all 1/4W, 5% unless noted

R1, R38560R
R233k
R3, 5, 6, 81k
R4680R
R75k6
R9, R32330k
R10, 11, 20, 34, 50,100k
53, 55, 561M
R121M
R13, 17, 27-30, 51,10k
5210k
R14, 22, 25, 581k5
R1556R, 1W
R16390R
R181k8
R19, 47, 494k7
R21, 48270R
R23, 26150k
R24390k
R31680k
R332k2
R3568k
R36100R
R371k2
R39, R416k8
R42180k
R43, 45, 46, 543k9
R44180R (see text)
R571M2
RV1(R40)10k vert. mount trimpot

Capacitors

C147µ/16 V pc mount tant. or LL electro.
C6, 14, 24, 25100n/6 V tant.
C3, 8, 9, 10, 12, 13,10µ/6 V tant.
16, 17, 22, 23, 3010µ/6 V tant.
C4150n ceramic or greencap
C7, 11, 20, 2847µ/6 V tant. or LL electro
C5, C151n ceramic or greencap
C18, 19, 27, 2910n ceramic
C2, 21, C26100n ceramic or greencap

Semiconductors

D1, D3EM401, 1N4001, 1N4002 etc.
D2(LED1)TIL220R red LED
D4, 5, 7, 8, 91N914, 1N4148, 1N4001, 1N4002 etc.
D610 V/400 mW or 1 W zener
D10(LED2)TIL220G green LED or colour choice
IC1, 3, 64001
IC2, 4, 5555
Q1BD139
Q2, 6, 8BC549
Q3, 4, 10BC547/8/9
Q5BC639 or BD139
Q7BC559
Q9, 11BC547

Miscellaneous

PB1.....Push-to-make switch. This can have the lamp indicator mounted internally if you wish (6 V globe).

ETI-340a and b pc boards; RL1 — relay with 12 V coil and contacts rated to suit horn or siren used; LED mounting bezel for Tell-Tale LED; Panel mount lamp, 6 V globe (but see PB1); Piezoelectric 'sounder' or buzzer (e.g. Altronics S5062 or D.S.E. L-7009, etc.); Up to four resonance microphones (see text); Mercury switch (e.g. glass type, Altronics S3070); Multiway male and female automotive connector — 6-pin and 9-pin or contact sets to suit (e.g. Tandy 274-226/274-236, 274-229/274-239 or similar); In-line RCA male and female connectors — number to suit number of microphones; Superglue or double-sided sticky pads; 5-minute epoxy; 4BA nuts, bolts and washers to suit; 12 mm spacers, Diecast box — 120 x 95 x 55 mm or similar; Scotchcal labels; Cable ties or insulation tape (ties preferred); Hookup wire — various colours, some 10 x 0.2 mm, some heavy duty 24 x 0.2 mm; Additional siren or horn, if needed.

Price estimate: \$65-\$80

(depending on optional parts)

vehicle security alarm

Overlay and wiring diagram. The two pc boards are assembled and wired as indicated here. The wires marked A, B, C, D, E, are joined between the two boards. These lines, plus those marked G and H are indicated also on the circuit diagram. Note that the lamp may actually be inside the 'Hold Off Button' assembly, rather than being a separate unit. I used the Dick Smith one, cat. no. S-1078.

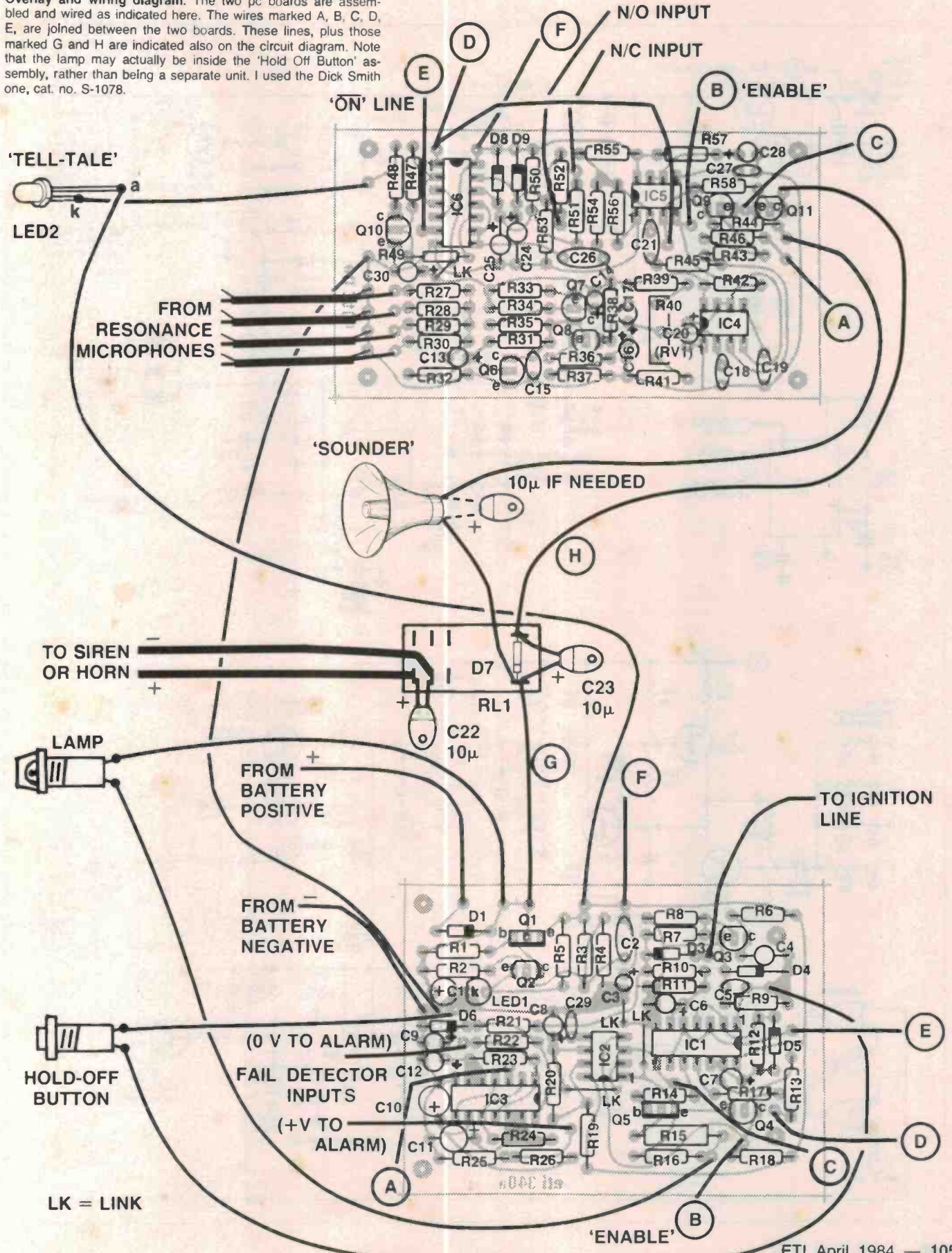

Project 340

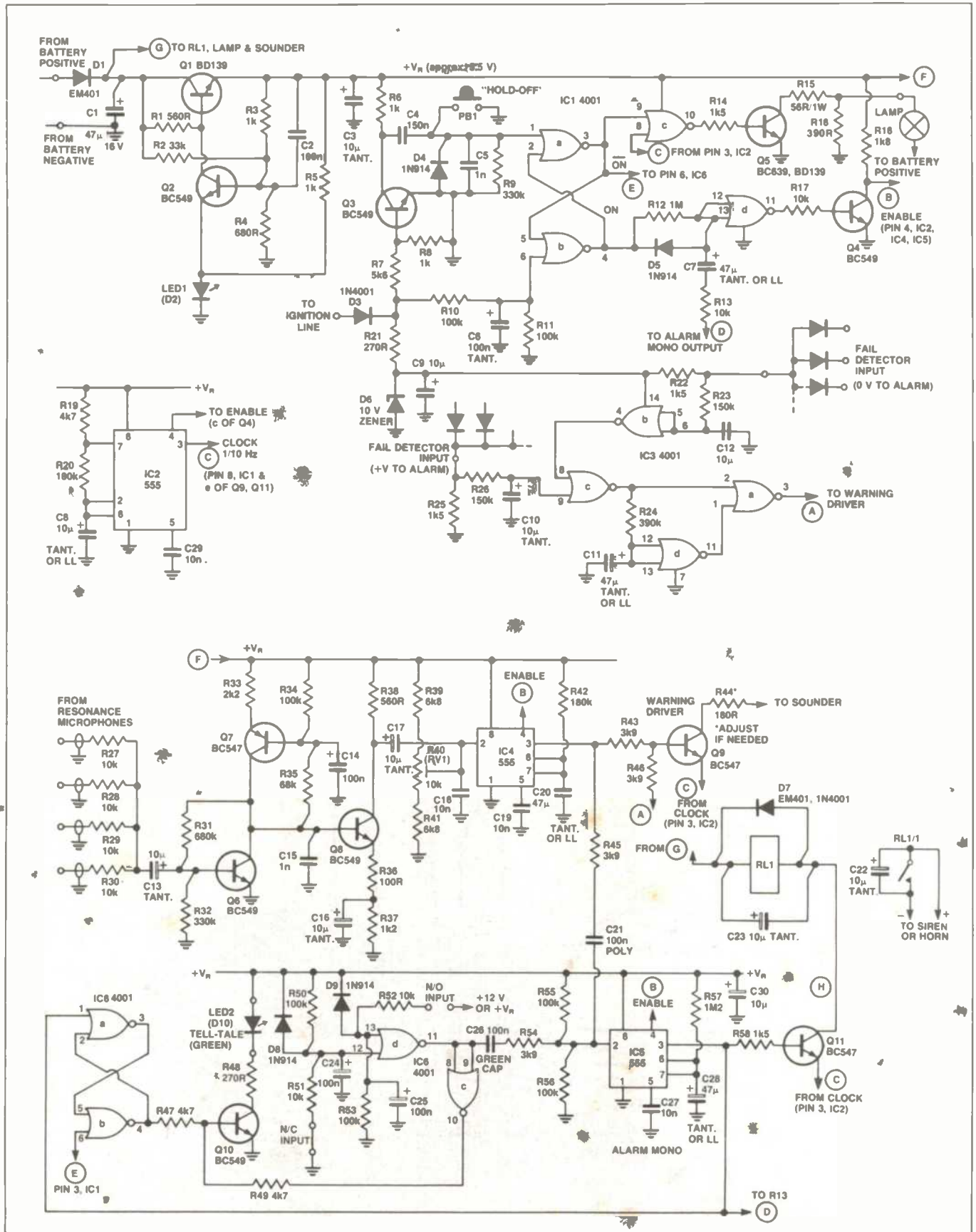

HOW IT WORKS — ETI-340

Though an apparently complex circuit, it can be broken down into 12 simple blocks. Referring to the block diagram first, these are Power Supply, Clock, Arming Flip-Flop, Lamp Driver, Exit Delay, Mic. Amplifier, Detector/Entry Delay, Alarm Delay/Driver, Panel Remoter, Beeper Driver, Perimeter Loop Control and Tell-tale Flip-flop. Referring now to both the circuit and the block diagram, we can discuss the function of each part discreetly.

The power supply provides approximately 5.5 volts for the electronics. Using so low a rail voltage permits the regulator to work with a large overhead, giving increased immunity to fluctuations in the battery voltage as are commonly encountered in the automotive environment. The supply consists of D1, the reverse polarity protection diode, which also serves to isolate C1 in the event that a spike on the supply drops the supply voltage below about 9 V. The supply reference consists of LED1 plus Q1 and Q2, the series pass and comparator elements, respectively, in a conventional series pass feedback regulator. Resistor R2 provides feedback to give nearly perfect line regulation despite the low loop gain. Capacitors C2 and C3 ensure good ac load regulation (dc load regulation is not important here).

The first two gates in IC1 form the 'ARM' RS flip-flop. Initially, consider that the ignition line is high, that is about +12 volts. R10 limits the current delivered into the protection diodes on the gate input, which is held near the 5.5 volt supply. Hence the gate output (ON) is low, and the system is disarmed. Because R9 holds the other gate's second input low also, its output ($\overline{\text{ON}}$) is high. Q3 is held on by current through R7. When the ignition line goes low (the car's ignition is turned off) the input of the first gate is pulled low by R11.

Two responses are possible, depending upon whether the pushbutton, PB1, is pressed or not.

If the button is not pressed, Q3 turns off and delivers a momentary positive-going pulse to the second input of the second gate, toggling the RS flip-flop. In this condition, which corresponds to the arming state of the alarm, the output of the second gate ($\overline{\text{ON}}$) goes low and is held low, while the other output is sent, and held, high.

If the button is pressed, the brief pulse is shorted out, and no change in the state of the flip-flop occurs. Hence, whenever a negative-going edge occurs on the ignition line (the ignition is turned off) the button is read to see if arming is required, the default being to arm.

Whenever the ignition line goes high, the level is conveyed to the first input of the first gate, resetting the flip-flop, irrespective of the button. The flip flop provides both the ON signal and its complement.

The Exit Delay is provided by R12, D5, C7 and the third gate in IC1. When the ON line goes high, C7 proceeds to charge toward the 5.5 volt rail via R12. For the time being consider that the output of IC5 is low. When the voltage on C7 passes about half the rail voltage, the gate output goes low, turning off Q4. The collector of Q4 is the 'enable' line, which is used to activate other blocks. This line going high signals the arrival of the armed condition, which follows the exit delay.

If the ON line goes back to 0 V, as is the case when the ignition is restored, C7 discharges via D5 and R13. Q4 is immediately turned on and the enable line pulled low. If the low on the ON line is soon returned to a high, before C7 has half discharged via R13, rearming occurs at once.

In addition to the above mechanisms, if the output of IC5 goes high, corresponding to the alarm going off, C7 will be discharged, though the enable signal is not removed because it is discharged until both of the terminals are held at about 5.5 volts. However, when the output of IC5 goes low again, when the alarm ceases, the circuit goes through its normal arming procedure re-arming the unit to detect further interference.

The fourth gate in IC1, in conjunction with Q5 and surrounding components, forms the Lamp Driver. When disarmed, the $\overline{\text{ON}}$ line is high, and the gate holds Q5 off. R16 keeps a small current flowing through the lamp (about 30 mA) to keep the filament warm. This greatly prolongs the lamp's life. When the exit delay commences, the $\overline{\text{ON}}$ line goes low and Q5 is turned on by the gate. R15 limits the current into the globe. The value shown is suitable for a 6 V/100 mA globe, as is commonly fitted to the illuminated push buttons sold for the very purpose of car alarms in the suppliers around Sydney. Lamp life is also greatly enhanced by using a globe of lower voltage along with a series resistor, and this is what I elected to do. If you use a 12 V globe, you should substitute a 10 R, 1/2 W resistor for R15.

The Clock signal is provided by IC2, a 555 timer. When the enable line goes high the clock line is released from 0 V and oscillates between 0 and 5.5 volts at around 0.7 Hz. That gives one lamp flash or horn blast about every second and a half. This speed may be altered by varying C8.

The power supply for IC3, the Dash Panel Remoter, is derived from the ignition line by R21, zener ZD1 and C9. Thus, this subsection of the alarm is powered up only when the ignition line is on. When on, the supply is held near 10 V.

Initially, C11 will be discharged, holding the output to the warning driver low. Thirteen seconds or so are required for C11 to reach half the supply, freeing the circuit to respond to its inputs. This ensures that no indications are given during the initial starting period.

After a few moments, C11 will have charged up to 10 volts. C12 will be held near 10 volts also, and C10 will be still discharged. The output to the warning beeper will be low. If any of the connections to the diodes joining R22 and R23 go low or any connections to the diodes meeting R25 and R26 go high for sufficient time to charge their respective filter capacitors (about one second) the output is sent high and the warning beeper sounds. After another twelve seconds, C11 will discharge and again turn off the beeper, in order not to annoy if the indication is continuous.

After that interval the unit will have drawn the driver's attention to the problem anyway.

Clearly, the circuit need not be employed if not desired as it is not interlocked to the rest of the circuit. Conversely, it could be installed in a car without the rest of the alarm. (Apart, of course, from the addition of some beeping circuit.)

The microphone preamplifier consists of Q6 to Q8 and surrounding components. Q6 and Q7 form a high gain amplifier with voltage-sample, current-sum feedback. This arrangement provides a stable gain with no crosstalk between adjacent inputs. Q7 is acting as a current source load for Q6, which is a common emitter stage. Q8 is another common emitter stage with an emitter degeneration resistor to provide current sample voltage sum feedback.

These stages give gains of around 68 and 5, or a total gain of 340. The gain must be relatively stable and constant as the trip sensitivity of the alarm is dependant upon it.

The microphone amp output is applied to the trigger input of IC4, the Entry Delay monostable. When the voltage on pin 2 falls below one-third of the supply voltage, the monostable will trigger. The dc level on this pin is set by RV40 and accompanying resistors. C18 filters any spurious spikes while C17 couples the ac signal from the resonance microphones to the trigger input. Varying the dc level changes the amount of additional signal which must be supplied by the amplifier output to initiate the entry delay. This effectively sets the sensitivity of the alarm.

When the monostable triggers, pin 3 goes high. This applies a positive voltage to the base of Q9. Whenever the clock line is low Q9 saturates, turning on the beeper. Thus the beeper pulses during the entry period, warning the driver (or thief) that the system is active.

If the positive voltage is applied to the base of Q9 by the remoter, Q9 will turn on and emit a constant beep, as the clock line will be low (disabled or 'not enabled') whenever the ignition, and hence remoter, is on. R44 is provided in case you are using a beeper rated for less than 12 volts nominal (actually about 15 volts!), or in case you find the beeper is excessively loud. It may be shorted out if you have a normal 20 volt piezo type sounder.

When the ignition line is taken high, IC4 is reset, as well as IC5, cancelling all delays, etc. If, however, the monostable times out before this happens, as is hopefully the case if some naughty thief is tampering with your pride and joy, a negative going pulse is applied to the trigger pin of IC5, yet another 555 timer. The output of this circuit is fed to the Relay Driver and the Tell-tale Flip-Flop.

For the alarm period, the relay is pulsed by Q11 in a similar fashion to how the beeper is pulsed by Q9. At this time the effectiveness of the power supply is tested as there are typically very severe electromagnetic and voltage pulses emitted by the high power circuits.

If you are using a noisemaker which is self pulsing, or some sort of sonic defence system is connected, connecting the emitter of Q11 to ground will produce a constant output for the duration of the alarm period. Once the timer times out, the re-arming cycle initiates as outlined earlier. The duration of the alarm period is set by C28; the values specified give about one minute. This is less than is often the case, but the alarm will have done its work by then anyway. In fact, 40 seconds is probably plenty. (For this use 33 μ or so.)

The alarm can be triggered also by a pulse from the perimeter loop control logic via C26. Two gates from IC6 comprise the loop sensor. The normally closed (NC) connection in series with R51 keeps C24 discharged. The normally open (NO) link in series with R52 leaves C25 discharged. If the NC link opens or the NO link closes a positive voltage is applied to one input of the first gate and its output falls, triggering IC5 immediately. The second gate turns on Q10 if the fault condition occurs, even if the reset line is low and the Tell-tale Flip-Flop is not driving the LED. This indicates the condition where one of the loops has failed. The diodes D8 and D9 provide protection in addition to the internal protection diodes of the IC to ensure that even significant voltages applied to the loop connections cannot harm the IC. C24 and C25 provide filtering to prevent extraneous pulses from upsetting the sensor.

The second two gates of IC6 form a flip-flop to remember if the alarm has been tripped in the driver's absence. It is set by the output of the alarm monostable, and drives the LED D10. It is reset by the $\overline{\text{ON}}$ line, and hence the restoring of the ignition.

Project 340

rower of the car he is effectively not given the option of inhibition! (Particularly useful if you are forced to leave your keys with an attendant in a car parking station.)

6). The power supply for the alarm circuitry is a particularly 'robust' design, in order to eliminate problems which can arise if the noisemaker draws large currents or develops strong interference signals. Hence the system can handle large and fast changes in supply without complaint. This allows the use of air horns and/or backup batteries should you wish. Performance is not compromised with a sick or flattish battery.

7). A dashboard failure warning indicator remoter is also incorporated. This is a circuit which emits a constant tone from the beeper if any crucial dash systems come on and remain on for more than 1.5 seconds. Hence, if an oil pressure warning light goes unnoticed, or the globe fails at a crucial point, a backup warning system is present.

If you ever have the fear that someone who has borrowed your car will not respond promptly to a glow in a warning panel, this is the system to relieve your nerves. Those who care to, can wire the 'low petrol' indicator to this, so that there is even more strong a warning just before you run out completely.

The remoter system waits about 20 seconds after the ignition is turned on and then starts to search the power supplies to the various connected dash indicators. If one goes active (either plus or ground as appropriate) and remains active for more than 1.5 seconds the beeper goes on for 15 seconds. Hence, in the case of the low petrol indicator, the sound only occurs when the lamp is pretty continuously on. If the alarm can protect the car when it is left alone, why shouldn't it do the same when it is being driven?

8). When installed as described, and with a main alarm noisemaker which is not accessible without violating the alarm (either a horn well concealed or a separate mechanism well away from prying hands) this alarm meets all NRMA recommendations for a vehicle alarm.

9). Finally, disarming occurs immediately when the ignition is applied, but immediate re-arming occurs if the ignition line does not remain on for at least three seconds. This means that a brief pulse may reset a trip but will leave the alarm armed. This can be

handy in setting up, and makes it harder for inept fooling to bypass the system, or spurious glitches to cause disarming.

If the above points have not sold you on this project yet, you just don't love your car enough!

Construction

Before proceeding with details of the assembly and installation of this project let me say that a lot of care should be exercised here for three reasons: Firstly, the electronics will be stowed in some less accessible location in the vehicle making it tricky to access, even if you have the recommended connectors installed, and the sensors will be bonded solidly in various places around the body, so later corrections of errors will be painful. Secondly this is not a simple project, having two separate pc boards and a lot of interconnecting wiring in a small box, so mistakes are easier to make than normal. Lastly, sloppy or careless installation procedure can degrade the effectiveness of the whole project, possibly defeating its very purpose, so the moral is DON'T RUSH IT!

Two decisions are required before you leave the shop with the parts. The first is, namely, whether you intend to use the connectors in the cabling to permit quicker disconnection of the electronics from the fixed parts of the system. If you are dealing with a less accessible sort of car, or you cannot get a soldering iron to it easily, I *thoroughly recommend them*. Do not use the sort of connector that will work loose or corrode as these will surely cause more trouble than they save, but either go the 'whole hog', or wire directly. It will not affect operation — it is purely for your convenience. I will proceed assuming that you are going to use them, so just skip relevant parts if this is not the case.

Once you have have collected the electronic parts, unless you have bought a complete kit, you will have to go to a special supplier for the resonance microphones. The 'Microphone pickup' item on p.111 discusses places you are likely to be able to get these, though you may have to order them. They may cost from \$5 to \$15 each, or thereabouts, depending where you go to get them. If you have a small car, two microphones will most likely be enough. If you have a large vehicle or you wish to have 'hair trigger' sensitivity, four will be re-

quired. It is perhaps wise to get four if they are not too expensive to save another trip later, but it is also quite acceptable to get two or even only one and add more later.

Armed with all the parts, the next step is to retire to the workroom and assemble the control box. The first phase consists of preparing the box. Preferably using the blank pc boards as templates, position the two sets of mounting holes to hold the boards. I placed the smaller board against the lid and the other on the bottom of the box such that they swing apart when the lid is removed, almost using the flying leads as hinges. This makes for a neat and compact arrangement when assembled.

Only one further hole is required, being the access point for all the wires to the various parts of the car. This should be about 10mm in diameter, and preferably fitted with a grommet.

This done, assemble the boards according to the overlay diagrams. Remember, the resistors and some of the capacitors are the only parts which can be put in either way around — every other component will at least not function properly and probably cause damage if inserted in any other way around than the correct way! It is best to insert and solder a few components at a time. Leave the ICs till last, but beyond this the order is irrelevant.

There are several links and flying leads involved, and it is perhaps best to do the links first, and flying leads last. You may like to insert each part in a logical sequence, following the circuit as you go to check the board. (The boards were fine when I last did it, but further checks cannot hurt!) Once soldered, trim the leads with side cutters, about 2 mm beyond the board surface.

If you are using connectors as recommended, leave about 250 mm of wire attached to each connection which is going to the outside of the box. Otherwise you had better leap ahead and figure out how long the wire is going to have to be!

The relay is best attached to the inside of the box with double-sided adhesive tape, such as obtained from hardware shops. This method of mounting is remarkably vibration-proof, and overcomes the fact that relays do not often have mounting holes. Gluing it to the case with silastic is also effective.

The cables running from the relay to out-

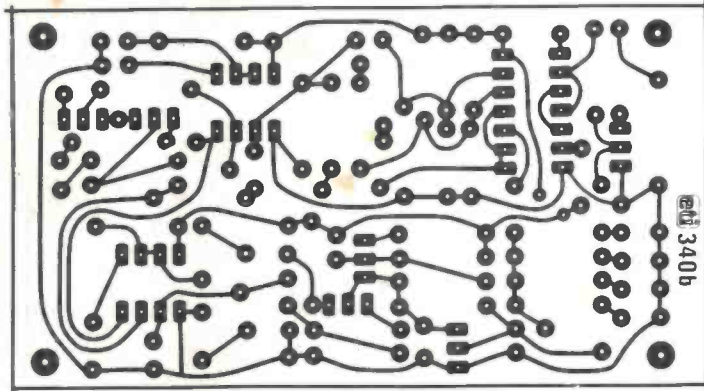
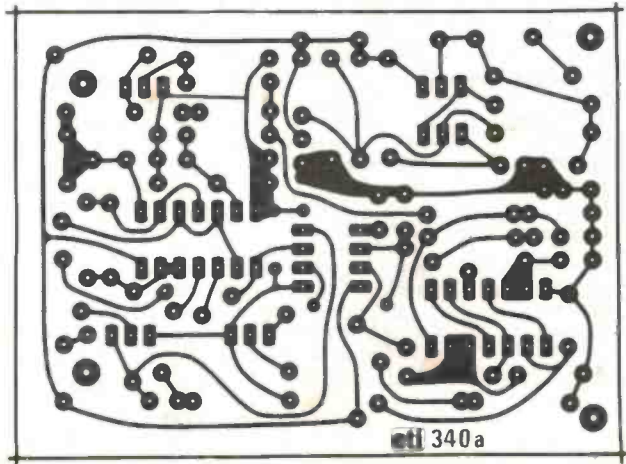

Printed circuit artwork. Reproduced full-size.

side the box should be heavy duty ones (known as '24 x 0.2 mm'), preferably of the 'automotive' sort. This merely means that both the conductor and the insulation are rather thick. Do not forget that C23 must be soldered *directly* to the relay terminals along with D7. These components prevent the relay generating any interference.

If the box is to be mounted in the dashboard (see a little later) it is convenient to mount the noisemaker on the outside of the box, again with double-sided tape or with silastic (unless screw lugs are provided). If you are not sure, leave the mounting of this part until later. In any case, you will need to select the series resistor, R44, to match the noisemaker you have chosen. You will need to know how much current it draws if it is rated for operation below 12 volts maximum. I used a 5-9 volt type, and the resistor value marked on the circuit diagram was most satisfactory.

The value of the resistor is given by subtracting the working voltage from 13 volts and dividing the result by the current the thing draws at its working voltage ($R = (13 - V_w) / I$).

Certain of the small noisemakers will act up if their supply impedance is not low. If you find it works on a supply of its working voltage but does little or erratic squawks when run with a resistor in series, place a 4-to-10 μF capacitor in parallel with it, at the noisemaker ends of the leads. This guarantees low supply impedance.

If it is not to be mounted in the dash, you will have to run the leads out, via a connector if it is to be installed permanently in the vehicle, or the leads must travel through a wall of the car.

INSTALLATION

With the basic electronic assembly finished, it is time to turn your attention to the vehicle. If you have a good service manual, the next step will be easy. It is necessary to determine certain connections within the vehicle's existent wiring.

The first line to identify is one which remains connected permanently to the vehicle's +12 V supply. If you cannot locate this in the paperwork which goes with the car you will have to do a lot of trial and error poking. If there is a dash clock it is likely that it will have an earth and +12 V continuous connection, as well as a line to light a globe when the car lights are on. This may narrow the field a bit, as will any appliance which remains operational when the ignition key is removed. The second line required is the ignition. This may be found near the key switch if accessible, or near an appliance which goes off with the ignition.

Horn connections

Next, the horn connections must be found. Some cars have a pair of wires leading to the horn switch, while others have only one, which is grounded when the horn is to be turned on. It does not matter whether you get into the circuit before or after the relay, if there is one, though before is clearly the desirable option. Some cars (e.g. VW) turn

the horn off with the ignition. In these cars you must connect after the relay or directly to the horn. (More will be said later.)

Indicators

The above are the only necessary connections for the alarm part to be able to work by itself, but the remoter circuit will require one connection for each indicator to be monitored. I recommend that the 'charge' and 'oil pressure' lamps at least be remoted. You may wish to include 'temperature' if this is a lamp, not a gauge, or 'low petrol' or 'low oil' or 'low windscreen washer water' if you really want to cover every possibility. I think that such paranoia is unnecessary if you are not forced to let your pet out alone with other people on a regular basis. (I connected the 'low petrol' warning to annoy a lady friend sufficiently to prevent the car being returned near empty. Such measures are strong, but *eminently effective!*)

Anyway, back to the task at hand. A wire must be located (for each lamp to be remoted) which swings to rail or ground when the warning lamp illuminates. This is not hard, especially if you have the ETI-325 Auto Probe. It is best to write down each of the connections you determine. If you have a manual, write this information there, as it will be where you first look next time.

If you are in the habit of placing a circuit

diagram of a project in the box along with the boards, this is also not a bad place to scribble the notes.

It may come to pass that all the lines you need to monitor with the remoter go either to ground or rail. That is, they all go to only one; in this case the part of the circuit which monitors the other option can be ignored, reducing the count of wires leaving the box by one. This will be mentioned when it comes to the wiring up.

Control box

Having located all these connections, the location of the control box can be sensibly decided. In most cases it will be more convenient for it to be located in the dashboard, but it can be in the boot or the engine bay for that matter, if it is convenient. It should be out of easy sight and away from where it might be interfered with quickly. A spot near access to the wiring harness is good, as cables will lead to various other parts of the car including the battery storage compartment, etc, and these can follow the wiring harness through the holes in the panels. Do not attach the box yet; merely sort out the location.

Given the location of the box, decide how long the wires between the box and the connectors need be. In case of failure, or the need to check wire continuity, etc, the con-

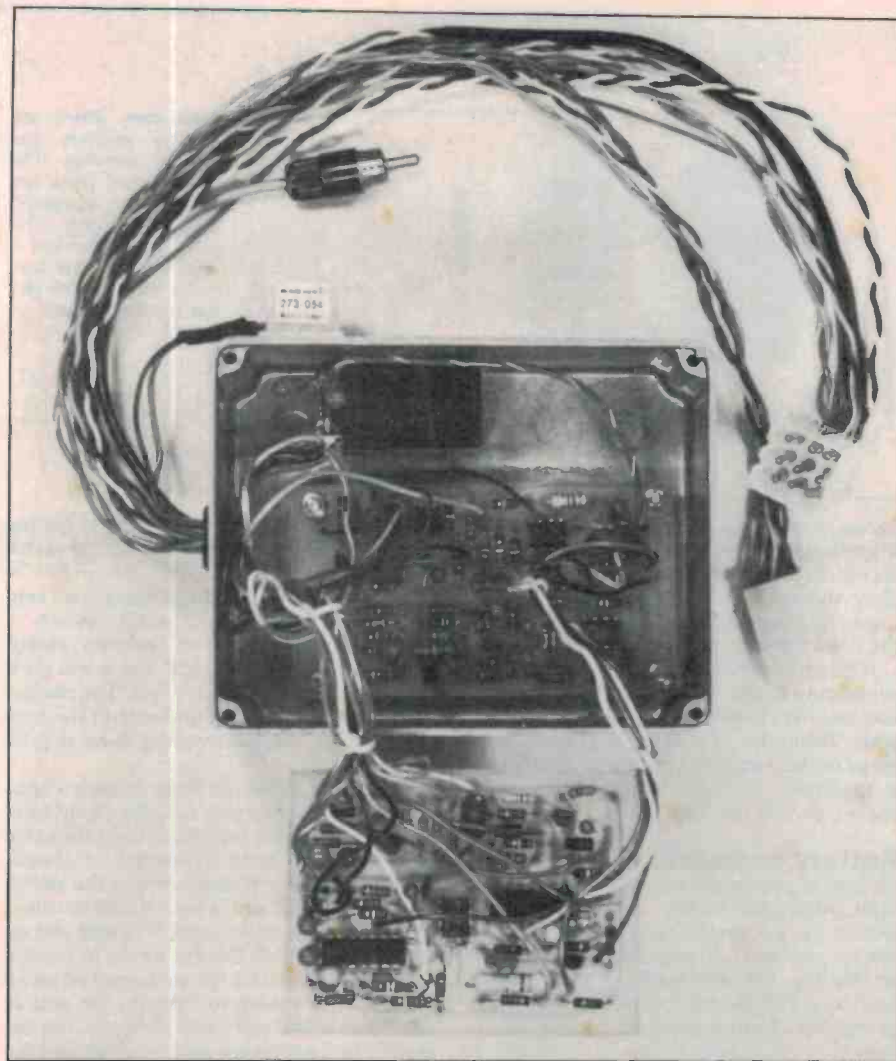

Project 340



Take care. There are mercury switches and mercury switches. The two common types are shown here, compared to a 9 V battery. The glass type on the right is the one to get, the type in the middle of the picture proved unreliable.

connector should be a little easier to get at than the box. If the box is to be in a location not accessible without tools, it is a good idea to place the connectors where they are easily reached (once you know where to look). Fit the connectors now.

Next, run cables from the car side of the connectors to the +12 volt line, the ignition line and the chassis (ground). Run a pair of wires from the connector to the nearest hinge of the compartment where the battery is mounted, leaving about 400 mm extra cable free, for the time being.

Battery protection

Clearly, if you have a car such as a Skoda or Mini, where the battery is stowed under a seat in the passenger compartment, it may not be necessary to put special protection on this bay, but in general it is necessary to connect a switch to the compartment cover to trip the alarm immediately if the bay is opened.

If you do not do this, it is possible to simply defeat the alarm by entering the car nor-

mally, opening the bonnet, say, and cutting the battery connection before the entry delay is over.

Such protection is most easily and reliably provided with a mercury switch. I recommend the kind of mercury switch which is glass encapsulated. These will most likely cost from \$1 to \$2, or so. The plastic-cased ones tend to be unreliable in the long run, so I recommend avoiding these if at all possible.

Run the cable to the hinge in such a fashion that you will be able to leave a loop free, so as not to unduly tension or twist the cable each time the hood is opened or closed. Locate a suitable position where the switch can be attached and where it will be tilted off when the compartment is closed and on when it is opened. Do not forget to leave a safety margin in case the car is parked on an incline! If this were to happen, the rest of the alarm would still work perfectly, but the loop failure warning would be given and the loop protection circuits would be disarmed.

Cut the wire to the correct length, and

carefully solder on the mercury switch. Insulate the connections with small lengths of spaghetti heatshrink tubing, or insulating tape. Next attach the switch. This is best done either using tape to bind the switch to the end of the hinge bracket or perhaps using the very strong double-sided adhesive tape to stick it to the flat surface of the cover.

Another method involves connecting the switch to a small aluminium bracket by means of binding tape or heatshrink tubing, then screwing the bracket on with a small self tapping screw. This can be tapped into one of the structural ribs of the metalwork of the cover panel. Check that it goes open when the cover is closed, and closed when it is opened. Connect the second wire of the pair to the +12 V rail at the connector.

Accessories

Next, if you intend to protect driving lights, or some other electrical appliance using the normally grounded connection to the alarm, run a cable from the connector to the appliance. The cable can be connected immediately to the chassis at the connector if you do not need this option. At the light or whatever, connect the wire to a normally grounded point.

On a radio or similar, this is the case of the unit; on a lamp, connect to the centre (active) conductor.

When off, this cable is at earth potential, by virtue of the low cold resistance of the lamp filament. If you use the above technique to protect a lamp, you will avoid the necessity to make a separate connection to the metallic body of the lamp housing, which can be quite tricky. The only thing to note is that the loop failure indication will be given whenever the lamp is on, because the active connection will not be at ground potential.

Run the wires from the connector to the point where you intend to tap into the horn circuit, if you are using the horn. If the horn in the car is accessible from outside, or without opening the compartment previously protected on account of the battery, you may choose to use a separate noisemaker, such as a siren, rather than the car horn.

Presumably for reasons of potential tampering, the NRMA recommends that a separate siren always be employed. This is sensible, but unnecessary if you have effectively rendered the car horn tamperproof by the above measures for protecting the battery compartment. At any rate, do not actually connect the noisemaker at this stage, as there is a lot of testing to be done later, and there is no sense in crying wolf or giving yourself an earache unnecessarily.

Microphones

Now the microphones must be fitted. Each one must be glued carefully in place after the surface has been carefully prepared. The selection of the locations requires some careful consideration, and the gluing some time, so leave yourself with plenty of time for the chore.

The locations you choose should have



Front panel artwork. Full-size reproduction — covers the box used.

two properties; between them you should achieve good coverage — that is, there should be an even distribution of them all over the body. Secondly, each microphone should be secured to a fairly large piece of the body or chassis in order to get good solid sound connection to the nearby body panels. Remember that sound travels much better in solids than it does in air, and much better in rigid and hard solids than it does in soft ones. Hence, it is good to place a microphone on to a solid piece of the body framework, such as the part where the door hinges are attached, or the front wing panels just in front of the door hinges. It is unwise to secure a microphone to plastic or flimsy plates of thin metal.

While glass would otherwise be a very good choice, it is also not wise to attach to windows, because the rubber mounts which hold the glass tend to insulate the glass from vibration, and hence sound.

If you have a small car, two microphones will probably be sufficient. They may be best deployed one on either side, or perhaps one front right and one left rear will be best. It is dependent upon how the car is constructed and where solid panels are accessible.

A larger car might be dealt with by having one microphone in front of each front door, and one at the rear where the bumper bars are attached. A very large or long car might have four, one near each corner panel. A utility will need four, two near the cabin, and two at the end of the load area.

It is a wise idea to cover the driver's door more carefully as the sound of the latch being opened is less than the sound of someone scraping the front paintwork. Thus, you need to be closer to the latch than you do to the front extremity. Though it is unlikely that a thief will take time to try and unlatch the door very quietly, this also suggests the need to have microphones near the doors.

If you have access to an oscilloscope, you can employ one microphone, before attaching it permanently, as a stethoscope. Connect the microphone to the CRO and set the screen up where you can observe it while walking around the car. Get an assistant to hold the microphone against small flat sections of the body at various potentially permanent locations. Tap the car at various locations with a coin, say. (Don't scratch it!). You will observe ringing waveforms at around one kilohertz. The location which gives the biggest waveforms when the car is tapped in the area you want to protect is the best one to choose.

Having settled on the locations, clean each one carefully. Acrylic thinners proved the best solvent, but Prepsol or even methylated spirits will do at a pinch. If the area is covered with a thick antirust covering, this should be scraped back in the immediate vicinity. If the paint is gloss, not matt, this should be rubbed rough with a small piece of emery paper of 400 grade or so, in order that the glue will adhere.

For the gluing, use only an epoxy adhesive. Do not use a contact adhesive, a cyanoacrylate glue (such as 'Superglue') or

Microphone pickup. This shows a ceramic 'vibration microphone' that may be used with this alarm, compared to an IC for size. This model is available from Creative Electronics, PO Box 240, Matraville, NSW 2036. (02) 666-4000. If you use this type, reduce C13 to 100n (tant) and increase R27-30 to 47k (this may need adjusting to set correct sensitivity).

Other types of pickup, the 'resonance microphone' type, are available from Tandy Electronics as accessories for their 49-762 alarm. ▽

any silicon rubber glues. I strongly recommend Araldite, but any epoxy type glue that sets rigid should do.

Coat the surface to be used with the glue, and press the microphone, flat face down, against the glue patch. Squeeze out any bubbles. Wedge the microphone in place and allow it to dry completely. If you move the body of the sensor just before setting, you may destroy the close mating of the microphone to the panel, reducing the effectiveness of the job quite considerably, so be sure to allow plenty of setting time. This will be longer than advertised on the packet if the weather is cold, so leave a safety margin.

When the glue is set, run the cable back to the control box and then attach the plug to the cable, if you are using it. The connection is made now rather than right at the start, because the connector would make the job of running the cable through any small openings much more difficult.

Lamps

Next, the connections to the lamps to be remoted must be made. You will require one diode, a 1N914 or EM401 or similar, for each lamp. If the active line of a lamp goes to ground when it is illuminated, it should be connected to the cathode of the diode, and vice versa. Then all the anodes of diodes to lamps which swing their lines to ground should be joined, and this common line run to the appropriate pin on the connector to the control box.

Similarly, all cathodes of diodes to lamps which are wired the other way should be joined, and the common connection run to the other remoter input, which should be labelled 'normally low' or 'high to alarm', or similar. If all lamps go one way, as is often the case, the other input may be ignored.

Button and tell-tale

Finally, the illuminated pushbutton and the Tell-tale LED should be installed. The location of these is up to you of course, but it is recommended that the lamp be prominent, as the flashing light does more than half of the protection involved with a car alarm. The LED should be either close to the lamp for convenience, or in some less significant location so as not to be intrusive.

Where fitted to a motor bike, the considerably smaller battery may present problems. In this case, where the bright lamp is less of a vital concern, because it will be easier to see, certain power reduction measures can be taken. The lamp may be replaced by an LED. In this case the 390R

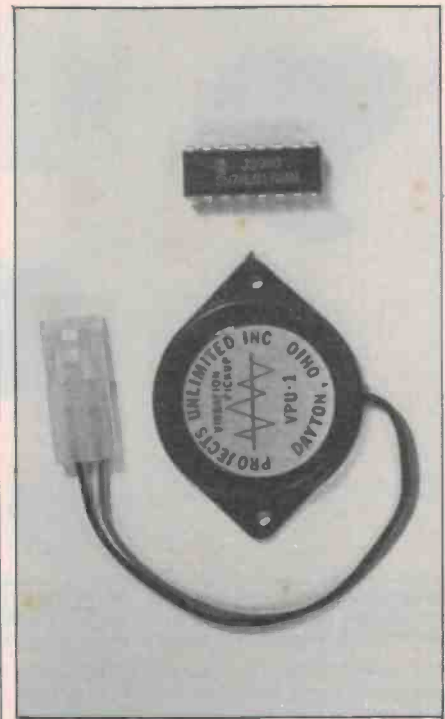

resistor (R16) should be placed in series with the LED, rather than in parallel with the lamp it replaces. Current drain is then reduced to approximately 30 mA, or 40 mA (armed) at most. On the other hand, motor bikes can usually be kick-started, circumventing flat battery problems, whereas a car is typically not provided with a crank, as all once were!

An interesting side effect here is that the usage which the alarm makes on the battery can prolong its life. Batteries like to be used. If your car is one that regularly starts on the first turn, the battery is getting almost no use at all.

A previous ETI project — the Expanded Scale Ammeter (ETI-329) — clearly evidences the fact that the car's alternator can replenish the energy used to start the engine in 15 to 30 seconds. In fact, the more sophisticated car electrical systems coming out of Europe these days are actually organised to use the battery, permitting its partial discharge under some circumstances, such as night driving. This deliberate forcing of the battery to deliver power over a period of time improves its chances of being able to do it when needed at short notice, or so the theory goes.

Special protection techniques

The main complaint levelled at car burglar alarms is that they merely make a little noise, of which no-one takes any notice. This is generally not the case, as people love to see whose alarm has gone off, although they have little intention of acting on the information. In itself, this is good protection because thieves rely upon being inconspicuous. In addition, many people are rarely out of earshot of their own cars, and ▶

Project 340

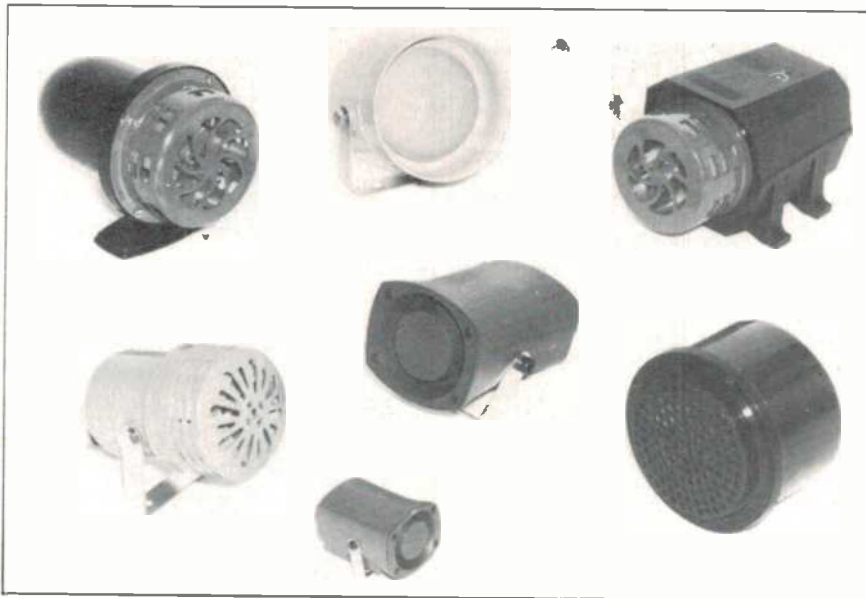

Noisemakers. This picture shows the variety of noise makers you can use if you decide not to use the vehicle's own horn. And all of these are available from one firm! This range (30-XXXX series) is distributed by Benelec, PO Box 21, Bondi Beach, NSW 2026. (02) 665-8211.

you quickly learn to respond to the horn you know to be yours! However, it is true that the alarm does not render the car unstealable.

Several tacks can be taken to enhance effectiveness, even strictly within the law. The first consists of installing a latching relay which isolates the ignition or starter relay supplies.

In some cars it is easier to hotwire the ignition by placing a patchcord directly from the battery to the coil. In this case interrupting the ignition wires is *hopeless*, as they are all bypassed immediately anyway. Where

the battery is in the engine compartment this technique is so easy as to make the effort wasted, if another jump is tried, so turn your attention from the ignition to the starter system.

The wire running to the starter solenoid is the best to interrupt, as few thieves bother push-starting. The circuit modifications required to implement such a system are shown in the adjacent circuit diagram. It is necessary either to remove and replace the battery connection with the ignition on, or to have a concealed reset switch, in order to reset the interlock, but then that is not a

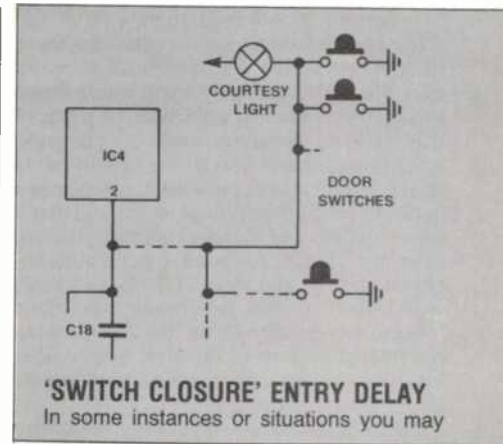

large price to pay and is unlikely to be tried by a thief endeavouring to quickly and quietly slip away with the car.

It is necessary to have a relay with two contact pairs in the alarm itself if you are using this circuit, as well as the additional relay.

Mount the isolator relay in a concealed area, so as not to make its presence too obvious. Try to cut the appropriate wire where it is not plainly visible, in case the thief notices this and bypasses it at once. The relay you use need not be rated to switch more than two amps or so, even if the solenoid is rated much higher, as the relay will probably never actually interrupt the supply while it is on.

These methods are, however, a bit messy, and do not stop the thief pinching things from the cabin. They are merely a hindrance to taking the whole car, and also represent a lot of fiddling with the car's electrics, with possible reliability problems. A favoured idea in certain foreign climes consists of putting a *very loud* noisemaker actually inside the cabin. The idea behind this is simply to drive the thief out by sheer sonic power.

Air-type sirens can be purchased which deliver sound levels of 120 dB at one metre. These are ideal for the job. The rear parcel shelf of a sedan is a suitable place to mount such a mechanism. It can be connected in place of the horn as the central sound generator, because sufficient noise leaks out of the cabin to attract attention, even with closed windows and doors.

If you need it to run continuously, rather than in a pulsed fashion, a small modification is needed to the alarm circuitry. Return the emitter of Q11 to the 0 V line, rather than the clock line. This will cause the alarm relay to remain latched rather than pulse for the alarm duration. This modification is details in the accompanying circuit.

If you do not mind the warning buzzer set for continuous rather than pulsed operation as well, the modification is quickly implemented by changing the flying lead from the emitters of Q9 and Q11 from the other pcb to the 0 V line (ground).

If thieves get away with your car after all this — wish them good luck and go see your insurance firm!

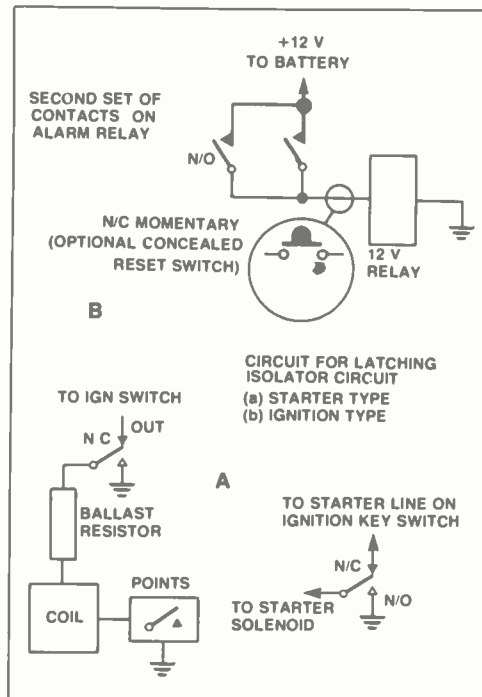
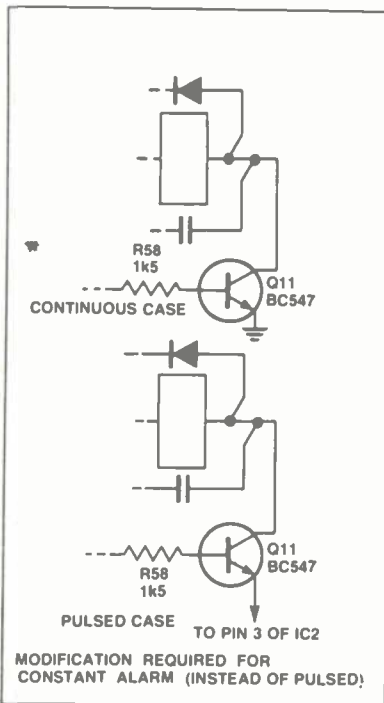

consider it desirable to have a switch closure activate the entry delay, rather than trip the alarm immediately. An example would be using the 'courtesy' light switch in a door. Some cars have door catches which don't make much noise (a noisy catch tripping the alarm) or have doors which are heavily sound-damped, such as is the case with Rovers, Mercedes', Rolls Royces (. . . we like to cover *all* our readers!) and some Peugots, etc.

Using the courtesy light switch to set off the normal entry delay is illustrated in the circuit here. All you need to do is link pin 2 of the 555 entry delay timer (IC4) to the 'lamp' side of the door switches via a diode.

ALARM SYSTEM FITTED

TO THIS VEHICLE



A QUALITY PRINTER PACKED WITH FEATURES

- Automatic paper insertion
- Variety of print modes with Pica and Elite pitch
- User font registry command
- 96 ASCII char with descenders
- 8 international char sets
- 48 semi graphics chars
- Friction and tractor feed
- Superb quality and appearance
- 96 CPS in Elite
- Compressed/expanded print
- Apple® interface option

LOGITEC MODEL 5000

**\$545 Parallel \$642 Serial
Plus Sales Tax**

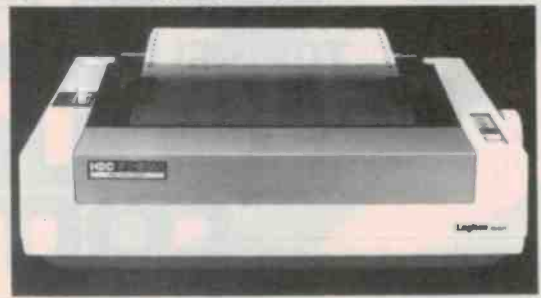

datatel

datatel pty. ltd.

19 Raglan St., South Melbourne 3205 Tel: (03) 690 4000
 80 Chandos Street., St. Leonards 2065 Tel: (02) 439 4211
 S.A.: Applied Data Control (08) 79 9211
 W.A.: W.J. Moncrieff P/L (09) 325 5722
 W.A.: Computer Communications (09) 458 9752
 Tas.: Technimark (002) 72 8622
 Qld.: Z-Systems (07) 44 3715

For System 80™, TRS-80™ Model I/III and Colour Computer owners:

ONE BIG ISSUE OF MICRO-80 MAGAZINE FREE!

If you own one of these computers, you should be reading MICRO-80 magazine, the magazine not only written by enthusiasts, but actual owners and operators of the same computers you use.

MICRO-80 understands your needs, is vital reading from cover to cover and features six new programs in each issue with full operating instructions.

An analysis of each program's structure and operation is included to help you improve your own programming capabilities.

Instructional articles on programming techniques, hardware improvements and answers to readers' problems are also published each month.

ANOTHER MICRO-80 PLUS

Readers can purchase a wide range of software and hardware for their systems at keen prices.

DON'T DELAY, ACT TODAY

Either telephone your order on (08) 211 7244 (4 lines) or send in the coupon today.

12 months
 6 months

Commence my MICRO-80 subscription for 12 months
 (a) Please debit my Bankcard
 (b) I enclose a cheque for \$26.00

My computer is a: System 80 Model I Model III Colour

Name _____ Address _____ Bankcard No. _____
 Exp. End _____ Signature _____ P/code _____

To: Micro-80
 P.O. Box 213,
 Goodwood,
 S.A. 5034

ETI

How do I decide which personal computer to buy?

- Which personal computer best suits my needs? Does it give value for money? Will my computer be out-dated and out-performed next year or is it true 'state of the art' technology? Which computers have great back-up service when the system goes down? What software should I buy?
- Where can I find up-to-date info on personal computing?

**FIND OUT FROM AUSTRALIA'S
TOP-SELLING COMPUTER MAGAZINE**

**your
computer**

*The April issue – on sale at your newsagent now –
reveals the computer industry's most prestigious awards*

**THE PERSONAL COMPUTER OF THE YEAR
THE SOFTWARE PRODUCT OF THE YEAR**

your computer, the magazine for business and pleasure,
beginners and experts

AVTEK MULTI MODEM



The AVTEK MULTI MODEM is a completely Australian Designed and Manufactured Multi Standard Modem. It has been designed to meet current Telecom specifications (approval pending) and will be available in 4 different styles.

KIT FORM

This is for the hobbyist and is not approved for connection to Telecom lines. It is ideal for private line use and for the Amateur Radio operators for Packet Radio (See review Electronics Australia January 1984). Complete kit to the last nut and bolt including pre-punched and silk screened front and back panels.

ONLY

\$249.00

MODEL MM2

This is a completely assembled and tested unit with a telephone hard wired into the Modem. It can be plugged legally into any phone socket to replace your standard phone.

INTRODUCTORY PRICE

\$329.00

SCOOP PURCHASE QUALITY ERSIN MULTICORE SOLDER

22g in 500 gram rolls (that's 1/2 kilo!). Note that most other people sell 200 gram rolls for about \$5.00.

SAVE 500 gram for
\$8.95

PERSONAL SHOPPERS ONLY

WIRE

We have just purchased a bulk lot of hookup wire in various sizes. From 2 amp to 15 amp in various colours - supplied in 200 yard rolls only.

COME IN AND LOOK FOR YOURSELF
PERSONAL SHOPPERS ONLY

FROM \$5.00 A ROLL

QUALITY AUSTRALIAN (MSP) TUNING GANG

Dual gang - same type as you used to find in the Radiola Portable(?) radios of the late '60's.

IDEAL FOR CRYSTAL SETS
WORTH A FORTUNE

ONLY **\$1.50** each

SUPER MEMORY SPECIALS

2532 EPROMS - WERE \$9.95 SAVE \$4
NOW \$5.95

2764 EPROMS WERE \$19.95 SAVE \$10
NOW \$9.95

4864 DYNAMIC RAM (as 4164)
WERE \$10.95 SAVE \$3.00

NOW \$7.95

MODEL MM3

This is basically the same as model MM2 but does not include the telephone but comes fitted with a data Telecom plug which means a dedicated socket must be installed by Telecom.

CONTACT AVTEK FOR PRICE

MODEL MM4

This unit is basically the same as model MM3 but does not have externally selectable Baud rate. The mode of operation is factory set. This is ideal for dedicated dial-up lines. This model also has hardware Auto Answer included.

CONTACT AVTEK FOR PRICE

SPECIFICATIONS FOR KIT, MM2, MM3 and MM4
 Data Standards CCITT V.21 & V.23, Bell 103 & 202 Data Rates 300, 600 and 1200BPS Backward Channel 75 BPS in conjunction with 1200 BPS Computer Interface CCITT V.24 (RS232C) Power Requirements 240V AC 3 watts Front Panel Controls Mode Switch (12 position rotary - not MM4), Connect switch (3 position toggle), Test Switch (3 position toggle) Front Panel Indications Connect LED, DCD Data Carrier Detect, RXD Received Data, RTS Request to Send, CTS Clear to Send, TXD Transmit Data, RING Ring Detect, TEST Test switch off normal, POWER.

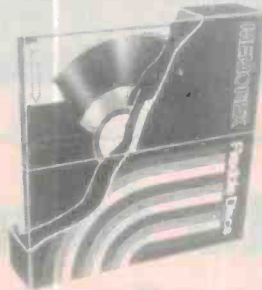

NOTE: Models MM2, MM3 and MM4 will not be available until Telecom approval has been obtained.

COMING SOON MINI MODEM

Possibly the smallest Telecom approved (pending) Modem on the Australian market - Includes phone. 300 Baud CCITT answer or originate (switchable), plugs into standard telephone socket and replaces standard phone. So small it can be mounted on your skirting board near phone socket.

SPECIFICATIONS:

- 300 Baud CCITT answer or originate
- Power 12V AC plug pack supplied
- Includes telephone with last number re-dial.

\$189.00

NEW PRODUCT MEMOREX DISCS

We have just received shipments of TOP QUALITY MEMOREX diskettes into stock.

EVERY DISC HAS EVERY SECTOR OF EVERY TRACK CERTIFIED
100% ERROR FREE!

5 1/4" Note double density can be used as single density.

Single sided/double density **\$4.95**

Double sided/double density **\$5.50**

8" Single sided/double density **\$5.95**

Double sided/double density **\$6.50**

NOTE: That these prices are cheaper than some people charge for inferior discs.

DATA BOOKS - JUST ARRIVED

UPDATE YOUR LIBRARY WITH THESE SPECIALS!

Texas Instruments TTL DATA BOOK Vol.1

Over 1,100 pages of information and specs for all TI TTL, LS

chips, with plasticised cover for longer life. **\$32.95**

Texas Instruments MOS MEMORY DATA BOOK

This covers all static ROM, Dynamic RAM, EEPROMS, EPROMS; also contains application notes. Over 300 super pages!

ONLY **\$14.95**

Texas Instruments LINEAR CIRCUIT DATA BOOK

Has everything you need to know about OP-amps to regulators

etc. Over 700 pages on high quality paper! **\$25.95**

SPECIAL OFFER

PURCHASE ALL THE TI BOOKS NORMALLY

\$73.85 - THIS MONTH ONLY \$65.00 SAVE \$8.85

HURRY WHILE STOCKS LAST

DUE TO WEIGHT P&P \$8.00

MOTOROLA BASICS OF INTEGRATED

CIRCUITS & ENGINEERING

Ever wondered how IC's are designed and made? This book tells you, from theory development and manufacture, over 500 pages with hard cover. **\$25.00**

CALL IN AND SEE OUR RANGE OF HAYDEN
COMPUTER PUBLICATIONS

OTHER MOTOROLA BOOKS

CMOS 800 pages	\$9.95
TTL 400 pages	\$9.95
Microprocessors over 1000 pages	\$14.95
Linear Interface 250 pages	\$9.95
Power Data 1,100 pages	\$12.95
Small Signal Data approx. 1000 pages	\$15.95
Memory 200 pages	\$8.95
RF Data Book 1000 pages	\$13.50

NEW PRODUCT - NEC SUPER CAPACITORS

NOW A FULL RANGE IN STOCK
Use in place of batteries for memory back-up and realtime clocks. Vertical PCB mount style.

0.022uF - \$4.50

0.047uF - \$5.95

0.1uF - \$8.95

0.22uF - \$9.95

MASSIVE 1 FARAD! - \$17.95

AVTEK

(ELECTRONICS) Pty. Ltd.

TWO GREAT LOCATIONS

119 YORK STREET, SYDNEY 2000

PHONE: (02) 267 8777

(Above Charlie Browns Place)

172 LIVERPOOL ROAD (HUME HIGHWAY), ENFIELD

PHONE: (02) 745 2122

All Correspondence to:

P.O. BOX Q302, QUEEN VICTORIA BUILDING,

SYDNEY 2000

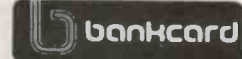

POST AND PACKING

Divide the value of your order by 20 (5%) to get post and packing value and then add \$2.00 - it's that simple!

All Bankcard orders can only be sent to a normal address (NOT a P.O. Box). All Bankcard orders will be sent by registered mail (add \$3 to P&P charges).

ENFIELD OPEN ON SUNDAY

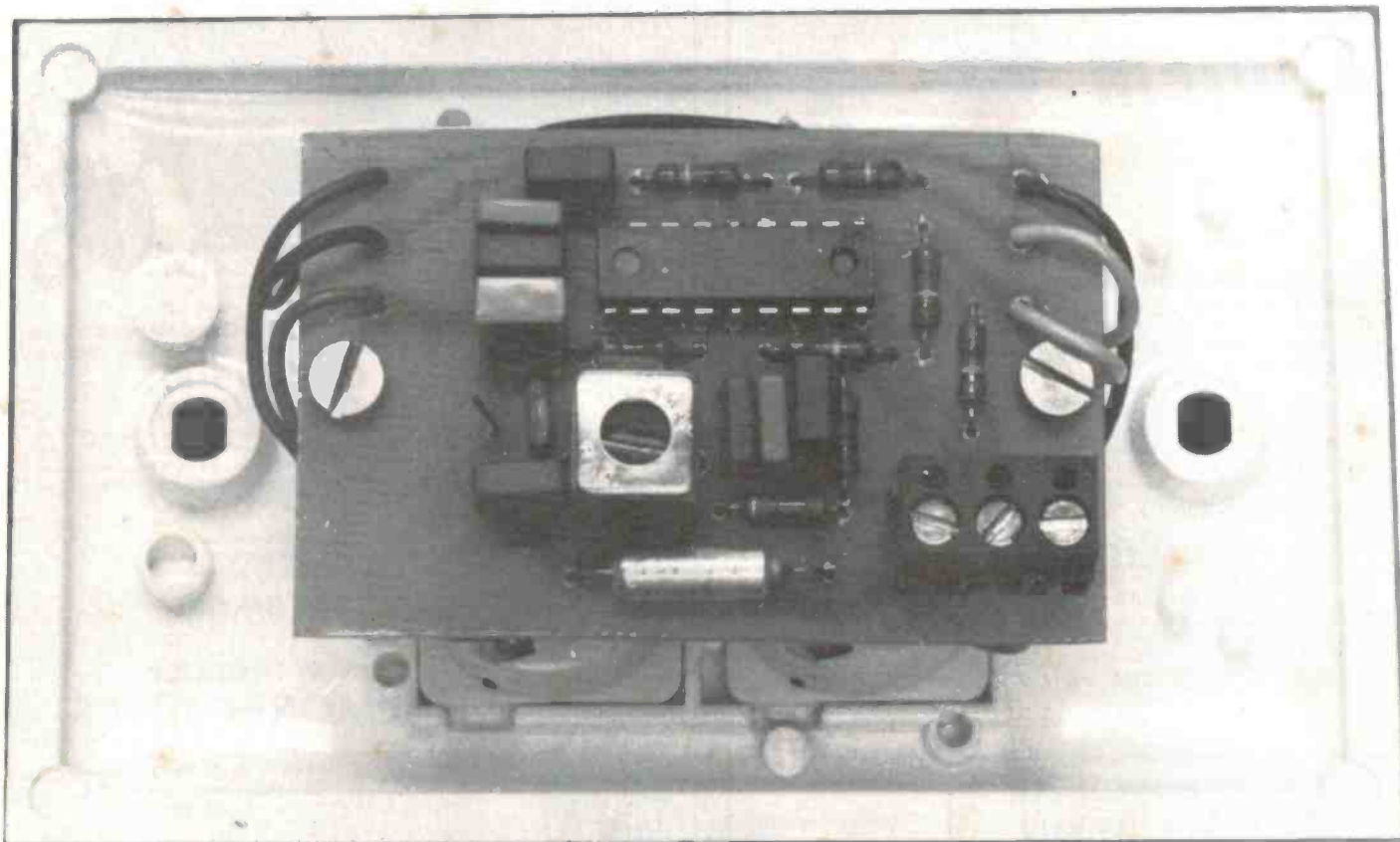

Control up to four room lights over a twin-wire cable

Here are the full construction and setup details for our room lights controller.

Part 2

THE SIMPLEST AND EASIEST part to build is the transmitter end which is finally the actual light switch on the wall. The printed circuit board itself is quite straightforward. You need only take care that the integrated circuit is in the right way and that the power supply filter capacitor, C1, has the correct polarity. The correct transformer to use in the oscillator from the pack supplied by Dick Smith (and others) is the one marked "OSC" and has a red tuning slug.

Before mounting any switches on the four-way "HPM" mounting plate it is a good idea to use the printed circuit board as a template to mark where the two mounting screw holes should go. Drill the two mounting holes in the plate to 5/64" (to clear

4 BA) and, if necessary, drill out the printed circuit board itself to the same size. Before mounting any spacers on the printed board or front panel it is necessary to assemble the front panel itself.

The first step is to completely strip down the two "HPM Cat. No. 500 VA" light dimmers. The two switches may be directly inserted in the four way panel as shown in the photo. In order to remove the dimmers from the two-way mounting panel in which they came, first pull off the knob (they're a straight pull with no clamping screws). The dimmers can then be removed from their front panels (once again, there's no magic — just muscle). The next step is to remove the rear cover of the dimmer body itself. Here it is easy to slip a small screwdriver

under where the tongue catches in the slot and lever off the rear cover. The whole works of the light dimmer can then be slid from the outer plastic case by pressing on the potentiometer shaft.

Discard all the small bits of grey insulating material around the aluminium triac heatsink. Next, unsolder the three potentiometer leads from the printed circuit board and remove the pot. The plastic main body of the dimmer must next be prepared by cutting it off about 1-2 mm from the step in the body where it locks into the front panel.

Finally, Araldite the potentiometer into the cut-down plastic body so it is located exactly as it was in the original dimmer. *Take exquisite care not to get any Araldite on the pot shaft or in the pot itself.*

Ian Thomas

room lights controller

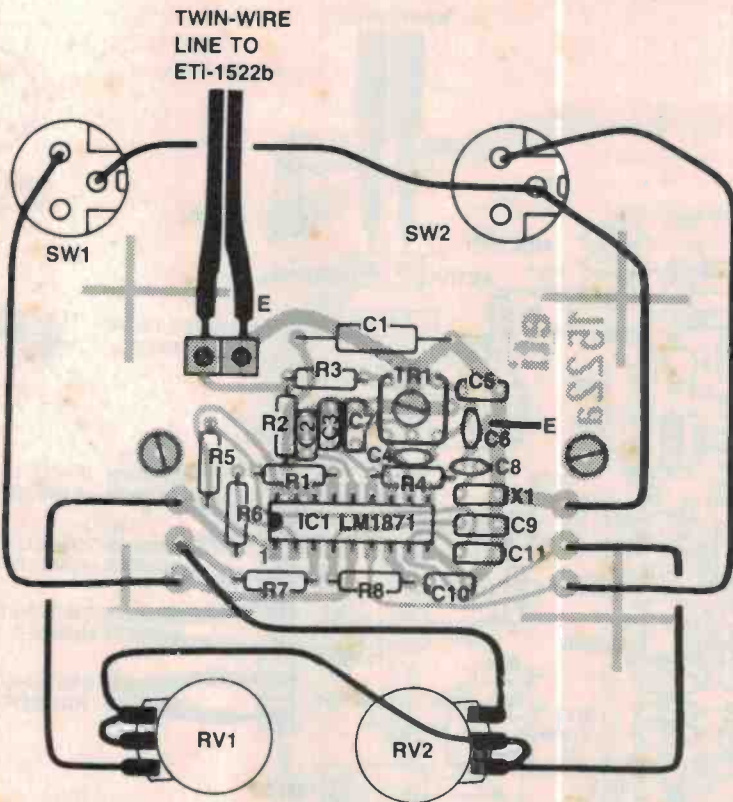

PARTS LIST — ETI-1522A

Resistors	all 1/4W, 5% unless noted
R1	150k, 2% metal film
R2	100R
R3	470R
R4	47k
R5	150k, 2% metal film
R6, R7	220k
R8	120k, 2% metal film
RV1, RV2	500k, see text
Capacitors	
C1	22μ/16 V radial lead electro.
C2, 5, 9, 10	100n/63 V Wima type RS21 or equiv.
C3	2n2/100 V Wima type PR2 or equiv.
C4	390p ERO type KP1835 or equiv.
C6	1n ERO type KP1835 or equiv.
C7	10n/63 V Wima type RS21 or equiv.
C8	100p ceramic (NP0)
C11	.3n3 100 V Wima type PR2 or equiv.
Semiconductors	
IC1	LM1871
Miscellaneous	
SW1, SW2	from HPM switch/dimmer module, see text.
TR1	local oscillator coil from 455 kHz IF set, DSE cat. no. L-0260, or equivalent.
X1	Murata CSB455E Ceralock ceramic resonator, or Tandy cat. no. 272-1303.

ETI-1522A pc board: HPM dual switch dimmer module wall plate Series P.774 VH (see text); 3-way pc mount terminal strip: 2 x 25 mm fibre standoffs with 2 x c/s bolts and 2 x cheesehead bolts; hookup wire, etc.

Price estimate: \$38-\$42

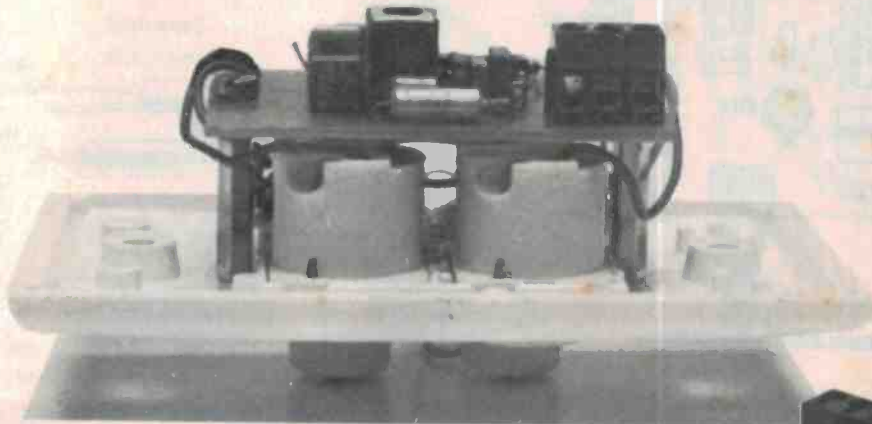

Encoder/transmitter. At top is the overlay and wiring diagram, beneath it a view of the switch plate assembly. Note that the twin-wire line to the receiver/triac driver board is polarised. The cable already in the wall will likely have a red and a black wire — use the black one for the line marked 'E' on each board.

You can now assemble the complete four way panel and wire it up as shown in the photo. Finally, mount the printed circuit board on 1" (25 mm) spacers and the control unit is complete.

The receiver and triac driver is the larger part of the project and I found it easiest (and safest) to assemble and test it in sections.

First, assemble the power supply starting from the mains input connector, mains transformer, TR4, diode bridge D2 to D5, filter capacitors C19, 20 and 21, and finally, the 5 V regulator, IC8. ▶

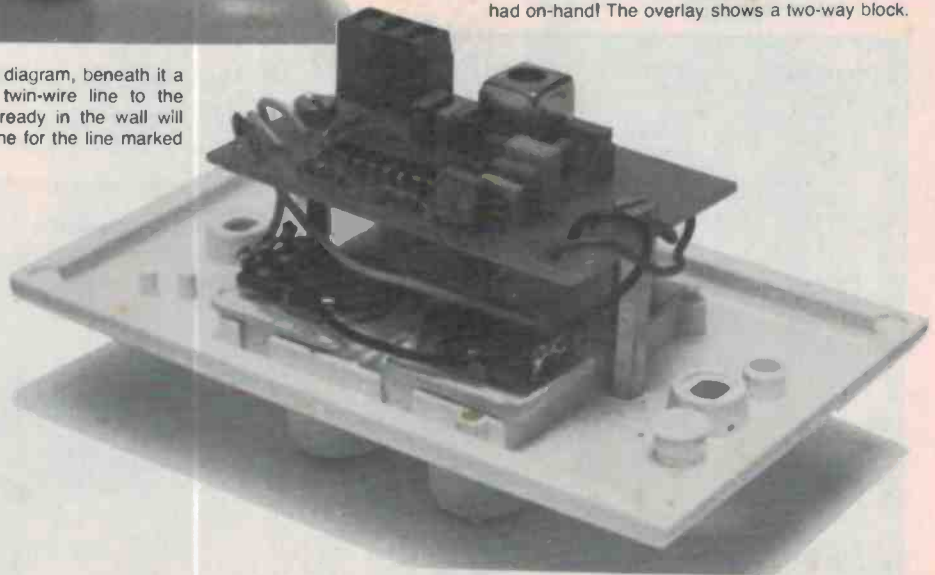

Below. Angled view of the switch plate showing the pots and the board mounting more clearly. Note that the board mounting pillars may be epoxied in place to avoid drilling screw holes through the front of the switch plate. The three-way terminal block was used only because that's what I had on-hand! The overlay shows a two-way block.

Project 1522

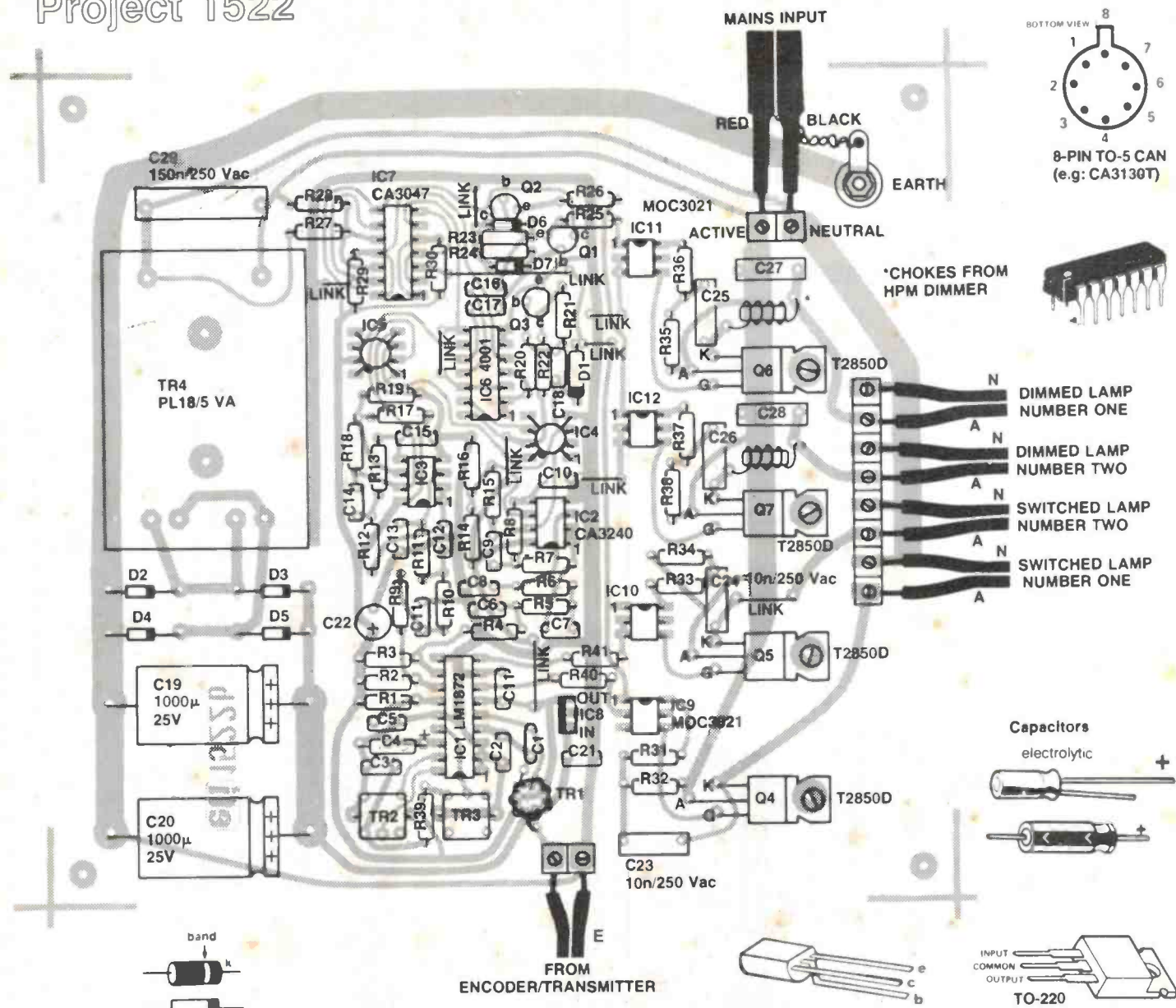

PARTS LIST — ETI-1522B

Resistors	all 1/4W, 5% unless noted
R1.....	100k
R2, R3.....	18k
R4, R9.....	390k, 2%
R5, 6, 10, 11.....	180k, 2%
R7, R12.....	160k, 2%
R8, R13.....	100k, 2%
R14, R17.....	10k, 2%
R15, R18.....	7k5, 2%
R16, R19.....	1k1, 2%
R20.....	300k, 2%
R21.....	1k
R22.....	56k
R23, R24.....	10k
R25, R26.....	150R
R27, 28, 29.....	220k
R30.....	56R
R31, 33, 36, 37.....	330R
R32, 34, 35, 38.....	470R
R39, 40, 41.....	100R
Capacitors	
C1.....	390p poly. ERO type KP1835 or sim.
Price estimate: \$90-\$100	

C2, 3, 6, 7, 10, 11, 12, 15, 21.....	100n/63 V, 5% Wima RS21 or equiv.
C4.....	1µ 6 V axial lead electro.
C5, C18.....	47n/63 V, 5% Wima RS21 or equiv.
C8, 13, 16, 17.....	10n/63 V, 5% Wima RS21 or equiv.
C9, C14.....	22n 63 V, 5% Wima RS21
C19, C20.....	1000µ/25 V axial lead electros
C22.....	100µ 10 V radial lead electro.
C23, 24, 25, 26, 27, 28.....	10n/250 Vac mains suppression caps
C29.....	150n 250 Vac mains supp. cap.
Semiconductors	
D1, 6, 7.....	1N914, 1N4148
D2, 3, 4, 5.....	1N4001, 1N4002 etc
IC1.....	LM1872
IC2, IC3.....	CA3240E
IC4, IC5.....	CA3130T

IC6.....	4001B
IC7.....	CA3046
IC8.....	7805
IC9, 10, 11, 12.....	MOC3021
Q1, 2, 3.....	BC549, BC109 etc
Q4, 5, 6, 7.....	T2850D RCA triacs
Miscellaneous	
TR1.....	Phillips toroid, 9 mm O.D. by 3 mm thick, 3H1 material; or Neosid toroid 6.35 mm O.D. by 1.52 mm thick, F9 material.
TR2, TR3.....	IF/DET. transformers from 455 kHz IF set, DSE cat. no. L-0260, or equivalent.
TR4.....	Ferguson PL18/5VA or equiv.
ETI-1522B pc board; housing to suit (see text); four 12 mm standoffs with bolts and washers; pc mount screw terminal strips (1 x 8-way, 2 x 2-way); 0.4 mm enamelled copper wire; tinned copper wire for links; 4 BA bolt, nuts & solder lug (earth terminal); 4 x 4 BA bolts and nuts; six clamp-type grommets or similar, etc.	

Next, cover all tracks that carry mains voltages with insulating tape so that when the printed circuit board is being tested your good health and longevity is not at risk (joking aside this is a very good idea as if you try to build the board up and get it running without taking any precautions you will get bitten at the very least!)

Power-up the board with only the power supply assembled and check that the output from the voltage regulator is $5\text{ V} \pm 0.4\text{ V}$. (It is exasperating beyond belief to assemble a large board only to see it all destroyed because the voltage regulator was faulty or, more likely, there was a solder short).

If all is well, turn off the power and pull out the plug as the bloke who wired up your house wouldn't be the first to get active and neutral reversed.

CONSTRUCTION OF TR1



Core: 9 mm O.D. Phillips toroid, about 3 mm thick, of 3H1 material ($A_L = 800$), or 6.35 x 1.52 mm, F9 Neosid toroid (28-501-36).

Wire: Light duty hookup wire.

Primary: One turn.

Secondary: 20 turns (Phillips toroid) or 21 turns (Neosid toroid).

Now proceed to assemble all parts of the receiver section. The transformer that recovers the 455 kHz data from the transmitter power supply line has to be wound but is only 20 turns of about 22-26 gauge wire evenly distributed around a Phillips 9 mm (O.D.) toroid of 3H1 ferrite. (These toroids are painted orange with one side of the toroid painted various other colours to indicate the permeability of the ferrite material — it doesn't matter what the permeability is). The secondary winding of TR1 is even easier; just one turn, which carries the +12 V to the transmitter section (and also holds down the toroid). Make sure that TR2 is the IF transformer with the yellow-painted tuning slug and TR3 has the white one. It is important that C22 be assembled at this stage.

After the receiver is assembled the transmitter and receiver can be tested and aligned to the same frequency. It is not all that important that the transmitter run at exactly 455.000 kHz, but merely that the receiver be tuned to the same frequency as that sent.

The first thing to do is set up the transmitter. Connect the transmitter to the receiver via the two printed circuit mounting terminals making sure you have the correct polarity (+12 V on the transmitter is nearest the corner and is nearest the IF transformers on the receiver). Then, disable the data transmission from the LM1871 by shorting pins 4 and 12 (I found it easiest to temporarily solder a short piece of wire between the two pins). Power up the combination and check that there is a continuous signal on the +12 V line. If you have a counter, measure the frequency of this sig-

nal and adjust TR1 of the transmitter until it is 455 kHz. If you don't have a counter then wind the adjusting slug all in (but gently! these things are not unbreakable) then come out about 1-1/2 turns. The oscillator showed the characteristic that it could not be pulled much below 455 kHz but could be pulled until the ceramic resonator lost control completely on the high side. Adjusting this way will put you slightly below 455 kHz but not too far.

The receiver can now be aligned to the transmitter frequency by monitoring the age voltage that appears on pin 16 of the LM1872. With the data still disabled on the transmitter, adjust first TR2 and TR3 so that the age voltage is a *minimum*. This should set the passband of the receiver correctly as both transformers are only single tuned. If you have an oscilloscope then the tuning procedure is to monitor pin 17 and adjust TR2 for a maximum then monitor pin 15 and adjust TR3 for a maximum. If your oscilloscope does not have $\div 10$ low input capacitance probes, it is necessary to monitor the voltages through a 4.7 pF capacitor so probe loading does not pull the centre frequency.

Now that the transmitter and receiver are aligned, the short between pins 4 and 12 of the LM1871 can be removed and the two switches should work. Also if the pullup resistors R2 and R3 are in, pulses containing the analogue info should be visible on pins 11 and 12.

The rest of the analogue circuitry can now be assembled starting with the two active filters. Insert ICs 2 and 3 and all the resistors and capacitors associated with them. It will be necessary to insert the jumper near the 5 V regulator (see photo), but don't put in any of the other jumpers yet.

When the two active filters have been completely assembled that section of the receiver can be tested. Power up the system and monitor pin 7 of either IC2 or IC3. When the dimmer controls on the transmitter are varied (trial and error will show which control affects which output) the appropriate output should vary between 0 (actually about 50 mV — this is why it is essential to use an RCA CA3240E for ICs 2 & 3) and 3 volts. There should be no interaction whatsoever between the two controls or between the controls and the two switches. If there is, then there's something wrong.

The next part to do is the 50 Hz zero crossing detector and ramp generator with its associated comparators and gating. Assemble the rest of the circuit up to the optocouplers. When the circuit is powered up pulses about 50 μ s wide and negative-going should be on IC6 pin 4, and positive-going on pin 3. The pulses are impedance transformed through three transistors in IC7 to give high current, positive-going pulses out of pin 3 of IC7. There should be a negative-sloping ramp of about 2 1/2 V peak at pins 3 of ICs 5 and 6, which are the two comparators that compare the dc signals out of the filters with the mains synchronised ramp (see "How It Works"). Looking at IC6 pins 11 and 12, you should see square waves whose mark-space ratio is varied by

the transmitter controls.

Finally, assemble the optocouplers, *noting that pin 1 for the optocouplers is rotated 180° from all the other ICs*. Also, assemble all the dV/dt protection circuitry and the triacs themselves. The RCA T2850 triacs that I used have the wonderful advantage that the mounting tab is electrically isolated from the pins so you can do as you like with them. If the triacs are simply screwed down to the board it can handle up to about an amp or so without getting too hot.

If you want one circuit to carry more than this it is quite easy to make up a right angle bracket to act as a heatsink. As the two on-off circuits are being switched on zero crossings they do not tend to generate RFI but the two that act as dimmers do and some form of filtering is necessary to suppress the edges if you don't want to drive your neighbours (and yourself) crazy with buzzing radios.

Fortunately, the filter inductors could be saved from the triac dimmers that were originally cannibalised to get the control pots. Unfortunately, HPM chose to use 1/32" thick printed circuit board material for the dimmers so most of the other components could not be salvaged, but by unwinding one turn from each end of the toroid winding, they can still be used. After soldering in the toroidal inductors, glue them down with a generous dab of Silastic or somesuch. Solder-in the output 8-way connector and your controller is ready for final test. The output terminals alternate between neutral and switched, with the two pairs nearest the receiver and away from the mains input being the on-off lines and the two pairs nearest the mains input being the 'dimmed' lines.

Connect a light bulb to each output in turn and ensure that the appropriate control works (at the same time you can establish which control operates which output).

Finally, the whole receiver board can be mounted in an insulated box. As the receiver is (presumably) to be left in the ceiling the size of the box doesn't matter so, as I always find it infuriating to have to work with tweezers and magnifying glass I chose a container of most generous proportions namely, a "Clipsal" adaptable box 300 mm x 200 mm x 150 mm, which gives plenty of space all around the receiver board.

Mount the board towards one end of the box with the 8-way terminal block away from the end of the box. This gives plenty of space for the four-wire pairs from the lights to connect to the board. Finally, cut holes with a hole saw opposite the three terminal blocks to allow cables into the box and you are ready to start having fun crawling around in the ceiling connecting everything up. Note that the wire pair to the wall switch is polarised. The line in the wall will likely have a black and a red wire. Connect the black to 'E' on each board. It only has the isolated 12 V on it now. By the time you cut and reconnect all the wires in the ceiling (or have a licensed electrician do it if you are not qualified to do so yourself), you will probably find that you need a few junction boxes and some spare lighting cable, so it's a good idea to plan things out carefully first.

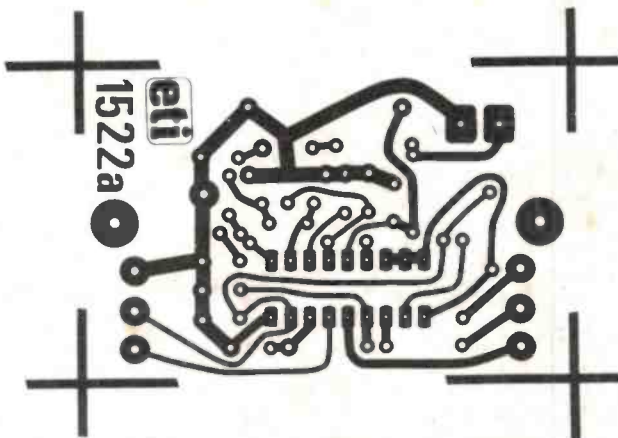
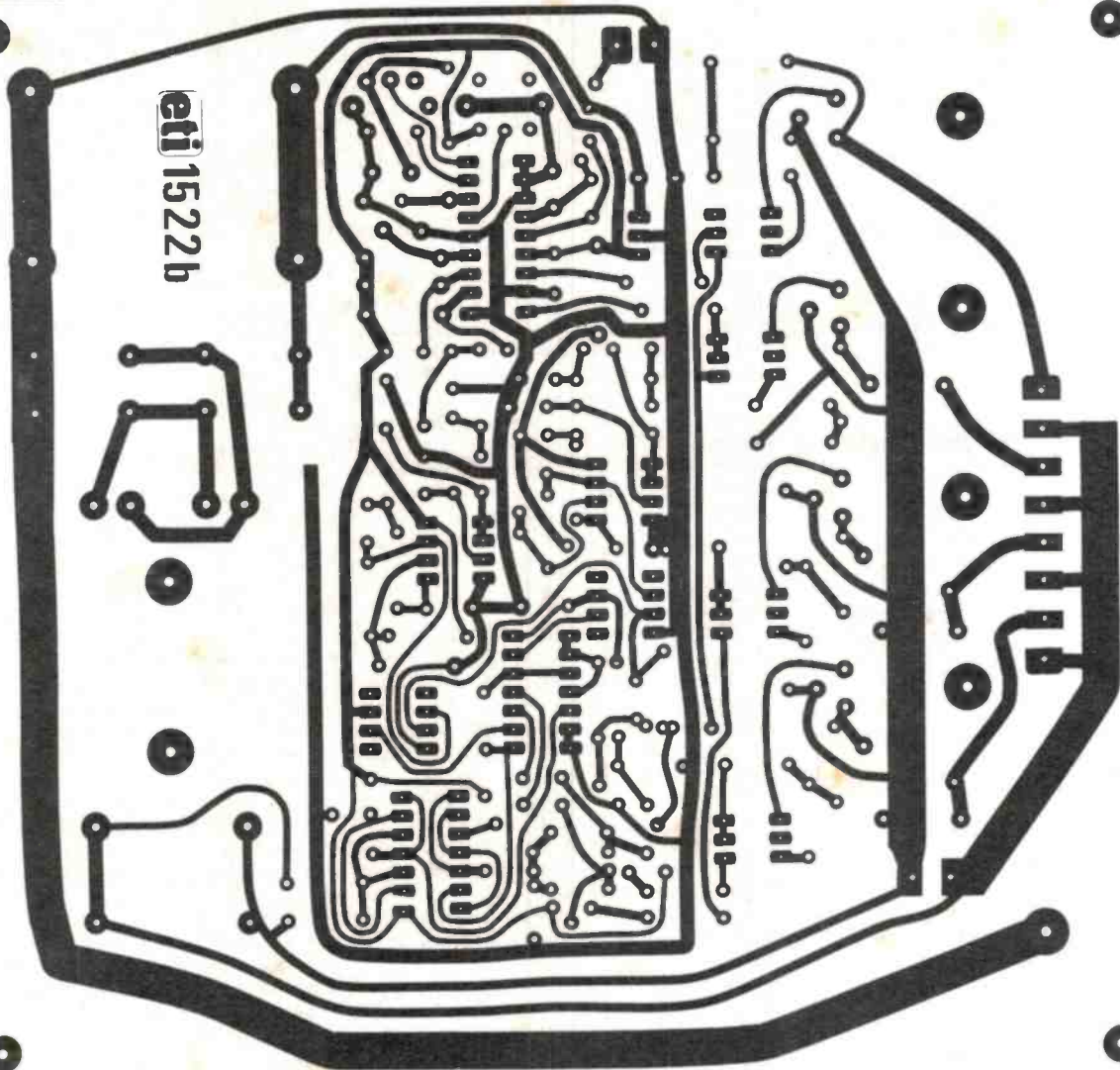

RADIO INTERFERENCE?

As the 'carrier' for this system is on 455 kHz, the standard intermediate frequency (I.F.) for broadcast receivers, readers may be worried that some interference may be caused to radios in the room or house where this system is installed. Don't worry. We tried putting a sensitive portable transistor radio right next to the switch plate and the twin-wire cable. Very weak heterodynes ('whistles') can be heard on weak carriers between stations, but not on signals which can be clearly heard, though weak. On local stations there's *no effect whatever*. Once the receiver is moved a few centimetres away, no heterodynes at all can be detected.

The twin-wire cable between the encoder/transmitter and the receiver/triac driver acts as a low impedance transmission line, so radiation from it is very low in any case. The transmitter in the LM1871 is operated at a very low level, deliberately, because high levels are unnecessary, greatly reducing the possibility of interference — as our test showed.

As the line between the encoder/transmitter and receiver/triac driver boards is isolated from the mains by the power supply, mains-borne interference should not occur.

NEW JAPANESE SP1000 PRINTER

High density 9X11 dot matrix printer with everything built-in!!! Selectable parallel/serial interface, baud rate, 96ASCII English, French, German and Japanese characters; 100 CPS bi-directional; Tractor or friction feed; includ. tax **ONLY \$499.00**



COMX 35 COMPUTER

35K RAM, 24K ROM, 16 colors, built-in joystick, 8 octave sound and noises, VHF output (add \$15 for monitor output) plus 11 programs **ONLY \$239**



12" GREEN MONITOR \$199
Printer Card w/cable \$110
(connect directly to SP1000 printer)

COMPUTER DATA RECORDER 2.5V p/p:
240VAC and counter \$55.00

CONTROL DATA 5 1/4" DISKETTES: S Side
Double density w/ plastic case for 10: \$38

COMPUTER TAPE

R/R type C-15 10 for \$15
Micron C-20 10 for \$13

32 Channel INFRA-RED REMOTE CONTROL IC's

SL490 transmitter IC \$8.50
SL480 infra-red pre-amp \$7.80
ML927/8 16 channel decoder \$8.00
Infra-red Emitter LED \$1.80
BP104 IR Receiver \$3.00
LM1035 DC Voltage Control for Vol., Balance, Base & Treble
LM1038 Low Distortion Audio Switch

FIGARO GAS SENSOR TGS812, 813 \$19.50

(For Alcohol and Toxic Gases as used in ETI & ELECTOR KIT)

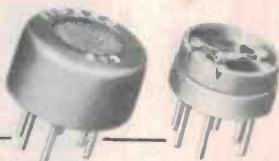

MOSFET 120W/8R MONO POWER AMP W/ HEATSINK (only 5 wires to connect; THD 0.005% Damp. F 400 @ 100Hz, full replacement guarantee.

Normal RP \$139.90. First 50 units this month **ONLY \$99.90**

STEREO HEADPHONE AMP MODULE $\pm 15 \sim 24V$.
No external components
\$59.00 This month \$46.00

NEW BLACK PLASTIC BEZELS for MEMBRANE KEYBOARDS
4 keys \$2.70; 12 keys \$3.30; 16 keys \$3.90.

TOROIDAL TRANSFORMERS full range 15 VA ~ 1625VA, 6VX2 ~ 55VX2.

ETI, EA CIRCUIT BOARDS & KITS

POST & PACK
under \$25 \$2
\$25-\$49 \$3
\$50-\$100 \$6
over \$100 \$8

HI-COM UNITRONICS Int. P/L
7 PRESIDENT LANE, CARINGBAH NSW 2229
TEL. (02)524-7878 (next to McDonalds)

NEW FROM SOANAR

ROGERS MICRO/Q
An entirely new concept in decoupling capacitors

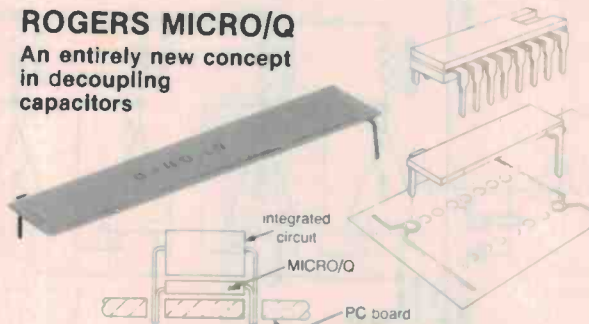

ROGERS MICRO/Q™ is a high performance decoupling capacitor designed to reduce transient noise up to ten times better than conventional decoupling methods. It requires absolutely no redesign nor does it take up any board space due to its unique construction. Just slip Micro/Q under a DIP, then forget it, and your noise problems. Micro/Q is available for all standard IC packages from 14 pin DIPs to 40 pin DIPs in capacitances from .03 μ F to .1 μ F. 50V DCW.

RESISTOR MODULES

DRM8 PIHER

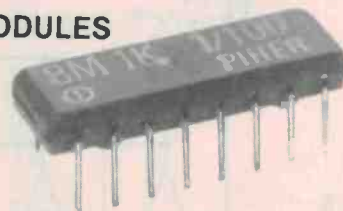

The Piher Resistor Module is a transfer-moulded dual-in-line package (DIP) containing eight individual metal-film resistors or 'zero-ohm' links (Rmax. 0.5E) of the same value.

Piher Modules are designed for either manual or automatic insertion in printed circuits with standard drillings of 7.62 mm.

STOCK RANGE

Values in OHMS						
470 Ω	1K	1.5K	2.2K	4.7K	10K	zero

These modules contain eight identical resistors each being the same as the face value of the module.

TECHNICAL INFORMATION AVAILABLE ON REQUEST.

SOANAR

SOANAR ELECTRONICS PTY. LTD.
INCORPORATED IN VICTORIA
30-32 Lexton Road, Box Hill, Vic., 3128, Australia.

VICTORIA: 895 0222
N. S. W.: 789 6744
Sth. AUST.: 42 8918

QUEENSLAND: 52 1131
WEST. AUST.: 381 9522
TASMANIA: 31 6533

Project 462

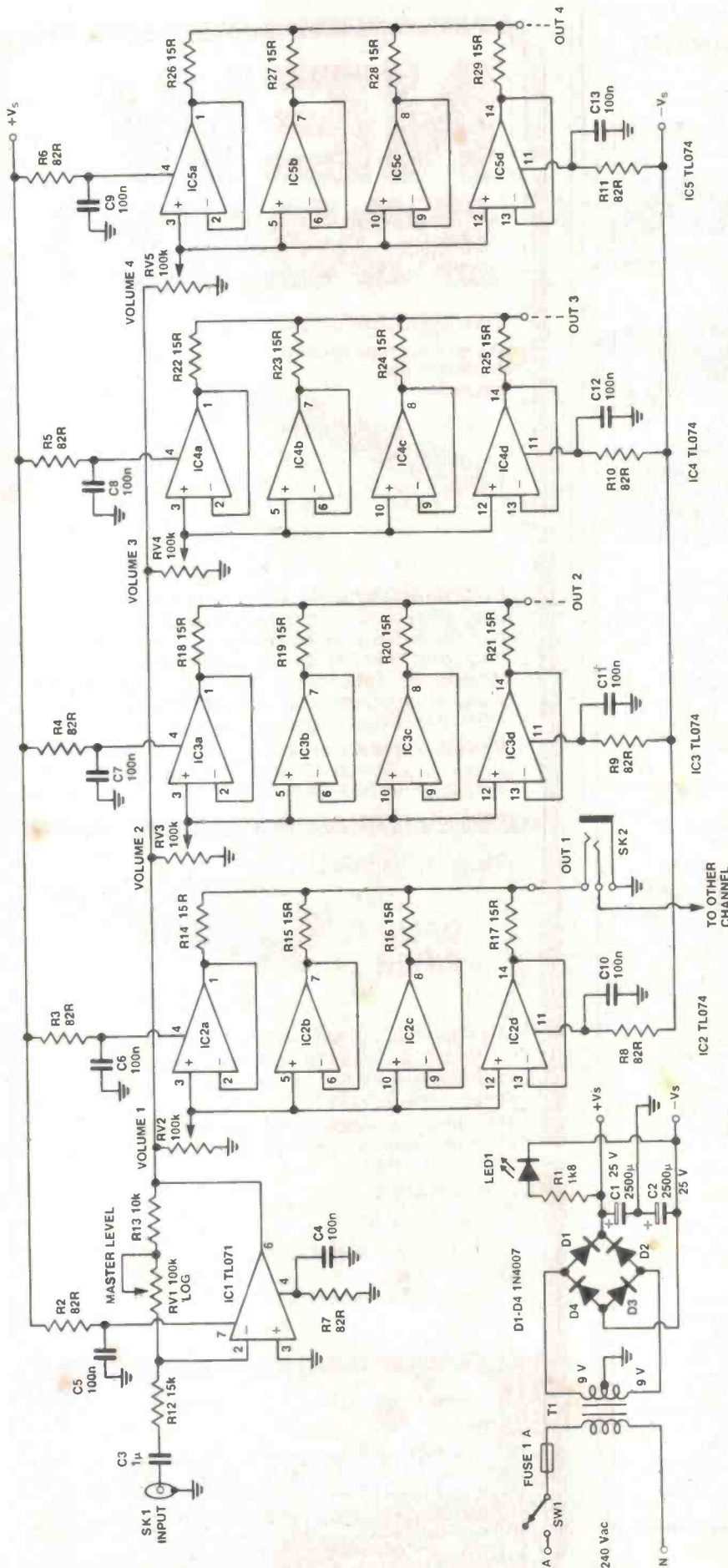

IF YOU'RE INTO home recording studios but have those "lack of monitoring facility blues" or if you like listening to loud music late at night with a few friends but have the kind of neighbour that even your pet doberman is scared of, then here is the solution. This project allows up to four sets of headphones to be driven from the one source and provides separate volume control for each.

Design details

The circuit consists basically of an input gain stage which drives four voltage follower output stages. Both of the stages use op-amps from the TL07X series. The input uses a TL071 single op-amp and the output stages each use a TL074 quad op-amp package. Both of these ICs have the low noise and distortion figures and high slew rate necessary for audio work. Each headphone output has its own volume control which allows adjustment to suit individual users. An overall gain control allows the gain of the unit to be adjusted from -6 dB to +14 dB. This should provide enough control to be able to get a good headphone level from the headphone outlet of any cassette deck or amp.

The range of headphone impedances varies from around 8 ohms up to a few thousand ohms and there seems to be no real preference amongst manufacturers. This circuit will provide enough drive for any common impedance value headphone to be used.

HOW IT WORKS — ETI-462

Referring to the circuit diagram it can be seen that all of the output stages are identical, therefore only one will be described.

IC1 is a TL071 single op-amp configured as an inverting amplifier stage. Potentiometer RV1 and resistor R13 form a variable gain control by changing the amount of negative feedback applied to the op amp. When RV1 is set to minimum, the gain is given by $R13/R12$. When RV1 is set to maximum the gain is $(R13+RV1)/R12$. This gives a -6 dB to +14 dB range with the specified components. Resistor R12 also sets the input resistance of the unit to 15k. This will provide negligible loading of the headphone outlet being used to drive the unit and allows units to be connected in parallel to provide more than four headphone outputs if needed.

The output of IC1 drives into the four parallel pots (RV2, RV3, RV4, RV5) which control the level of the signal fed to each of the driver stages. Looking at output stage 1, you can see that it consists of a TL074 quad op-amp package with all of the op-amps configured as voltage followers and connected in parallel. This acts as a voltage follower with four times the drive capability of the individual op-amps. Resistors R14, R15, R16 and R17 make sure that the current is summed evenly from each op-amp.

The power supply is derived from an 18V, centre-tapped transformer and is full wave rectified by D1-D4 and filtered by capacitors C1 and C2. This provides +ve and -ve 12 Vdc rails. The supply rails are coupled to each op-amp via an 82R resistor and a 100nF bypass capacitor which isolates each stage and provides additional supply filtering.

The output stage uses a TL074 quad op-amp with all four op-amps configured as voltage followers and connected in parallel. This increases the drive capability of the op-amps to a point where it can drive the headphones directly without the need for a transistor output stage.

Construction

Start construction with the pc boards. Two identical boards are used except that the power supply components are omitted on one board. For the remainder of this article the board with the power supply components will be referred to as BOARD 1 and the board without these components will be referred to as BOARD 2.

Begin with Board 1. Give it a thorough visual inspection, checking tracks and holes to see that all's correct. Assemble the components as per the overlay diagram. Solder in all the resistors and capacitors first, followed by the diodes and then the ICs. Make sure that all polarised components (ICs, diodes, electrolytic capacitors, etc.) are positioned in the right orientation. Finally, solder into place the solder pegs or 'pc stakes' for attaching the wiring.

The construction of Board 2 is the same as Board 1 *except* that components D1 to D4, C1, C2 and R1 are omitted. Also, the three solder pegs which connect to the main transformer can be omitted as Board 2 derives its supply from the rails of Board 1 via connecting wires.

Once the pc boards are complete, the metalwork can be tackled. Disassemble the case and drill the front panel using the panel artwork below as a template. Remove all burrs from the holes after drilling.

Small pilot holes should now be drilled in the Scotchcal front panel label. See that you can line up the label using one edge being very careful to ensure that the pilot holes are approximately in the centre of the front panel holes. Remove the backing from the Scotchcal, attach it along the line-up edge you chose and smooth it down in place working from that edge. Once the Scotchcal label has been lined up and attached, the holes can be carefully cut out using a scalpel or a very sharp pointed knife. Take care not to rip the Scotchcal when doing this.

Four channel stereo headphone driver

Robert Irwin



Received a noise abatement order lately for having the volume on the hi-fi too loud while you played Roxy Music's latest compact disc or the 1812 Overture? Maybe you've got your 'home studio' together but it lacks the monitoring facilities you need. This unit should fix all that.

Next, the back panel can be drilled. Take the mains transformer and centre it on the back panel. Make sure that there is enough room on one side for the mains grommet and fuse holder and on the other side for the input jack. Mark the position of the transformer mounting holes and the hole centres for the mains grommet, fuse holder and input jack. These can now be drilled to the appropriate sizes.

The pc boards should now be located. Take one board and position it on the floor on the box so that it is about 20 mm from the right hand side (looking from the front) and equidistant from the front and back panels. This will allow ample room for the mains wiring on the left hand side and also for the transformer on the back panel and pots on the front panel. Mark and drill the pc board mounting holes. Also on the floor

MASTER LEVEL

VOLUME

+

POWER **eti 462** HEADPHONE DRIVER

+

ON

+



of the box, holes should be drilled to mount a mains terminal block and earth lug. If a clamping type mains grommet isn't to be used then provision should be made for a mains cord clamp to be bolted to the floor as well. This is all done on the left hand side.

This completes the drilling. The case should now be reassembled but with the lid left off. You are now ready to mount the components. Firstly, take the four output jacks. Before mounting these you should attach 50 mm of hookup wire to each of the output terminals of the jacks (do not attach wires to the earth terminals yet). There is quite a bit of interwiring in this project so it is advisable to use a consistent colour code when attaching these wires. Once the jacks are mounted, the earth terminals should all be connected together and two wires soldered on to connect to the boards.

Next, 100 mm of wire should be attached to the four volume control pots. Once again a colour code should be used. Using a different colour for each of the three terminals on the pot and consistently wiring each pot the same way will greatly help when you come to wire the pc board. Once the wires have been attached, the pots can be mounted on the front panel. Make sure that none of the terminals are shorting out to the pot next to them. The master gain pot should be mounted and wired in the same way except that 200 mm lengths of wire are needed and only two of the terminals are used (see the wiring diagram).

Attach 100 mm of wire to the terminals of the LED and mount this in the front panel. It is advisable to insulate the terminals of the LED from each other with heatshrink tubing to prevent accidental shorts.

The mains switch should have 200 mm of heavy duty hookup wire attached to its terminals and be mounted on the front panel. Once again, heatshrink tubing should be used to cover the exposed parts of the terminals. Remember that mains voltages are lethal and any mains wiring should be double checked and any exposed terminals should be insulated with heatshrink tubing to prevent anyone (especially you — we'd like you to remain a reader) from accidentally touching a live terminal.

The front panel should now be complete. The back panel component can be mounted next. Start with the transformer. This should be securely mounted to the back panel with mounting bolts. The fuse holder and input jack can be mounted next. As with the front panel jacks the rear panel jack should have 50 mm lengths of hookup wire attached to its terminals before mounting.

The next step is to mount the mains terminal block on the floor of the box. Once this is done the power cord can be inserted and attached to the terminal block. The earth wire should be soldered to a lug and securely bolted to the floor of the box. Make sure that the position and length of the earth wire is such that it will be the last of the three wires to break if the mains cord is accidentally pulled out of the case. The mains grommet is now inserted to clamp the cord in place. The rest of the mains wiring

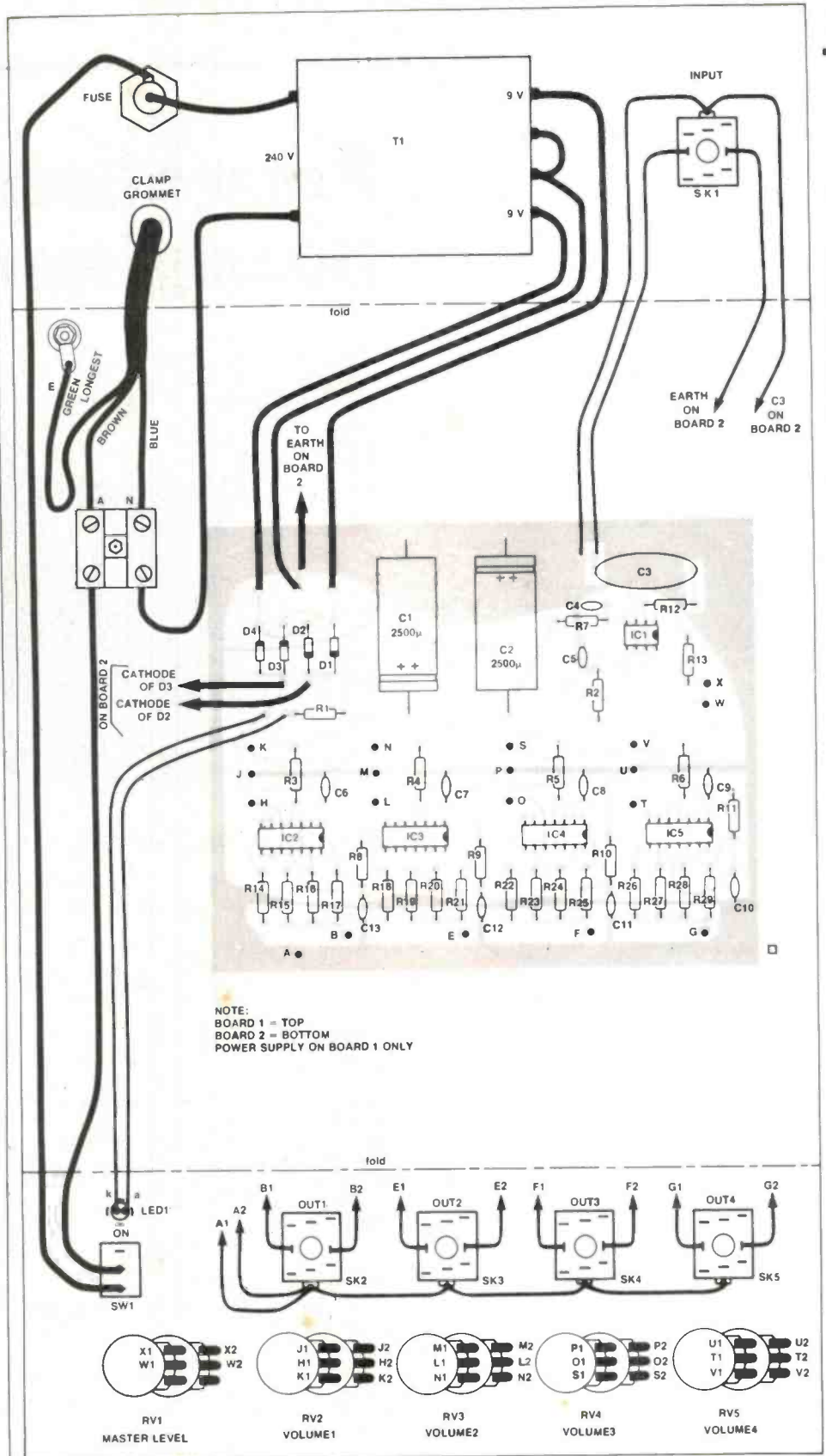

should be completed as per the wiring diagram.

The remaining task is to mount the pc boards and wire them up. Board 2 must be mounted first. Long bolts are used so that the two boards can mount one above the other.

Once Board 2 is in position, the wires can

be attached. This should be done carefully and systematically to avoid mistakes. Start with the input and output jacks and then the pots. Finally, attach 100 mm of hookup wire to the +ve rail, -ve rail and earth pegs. These will attach to the identical pegs on Board 1.

Once Board 2 has been wired, Board 1

should be mounted on top using 12 mm spacers as shown in the drawing here. Wiring up Board 1 is the same as for Board 2 except that the LED and transformer are connected on this board. Note that the two outside terminals of the secondary of the transformer are connected to the diode bridge and the two middle terminals are connected together and then to the earth peg.

This completes the construction and all that's left to do is push on the knobs, install a 1A fuse, plug it in, power it up and check that all's well. A simple voltage check with a multimeter will quickly show if you're ready to roll or not.

Using it

The first thing to do is to plug the unit into the headphone outlet of your cassette deck or amplifier. For this you will need a stereo cord with a 6.5 mm stereo plug on each end. If you can't buy one from your local stereo shop then you can easily make one. Get a suitable length of balanced microphone cable (which contains two cores plus an earth wire) and solder a 6.5 mm stereo plug on each end. This cord will plug from the headphone outlet on the cassette or amp to the input jack on the back of the Headphone Driver.

All you need to do now is plug your headphones into one of the outputs and turn the volume up to the desired level. The master gain control should initially be set to about half way and then adjusted to give a good overall maximum volume.

OK buddies — rock on (or waltz, if you prefer)!

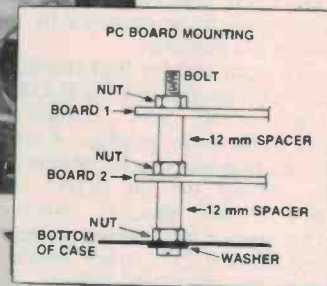
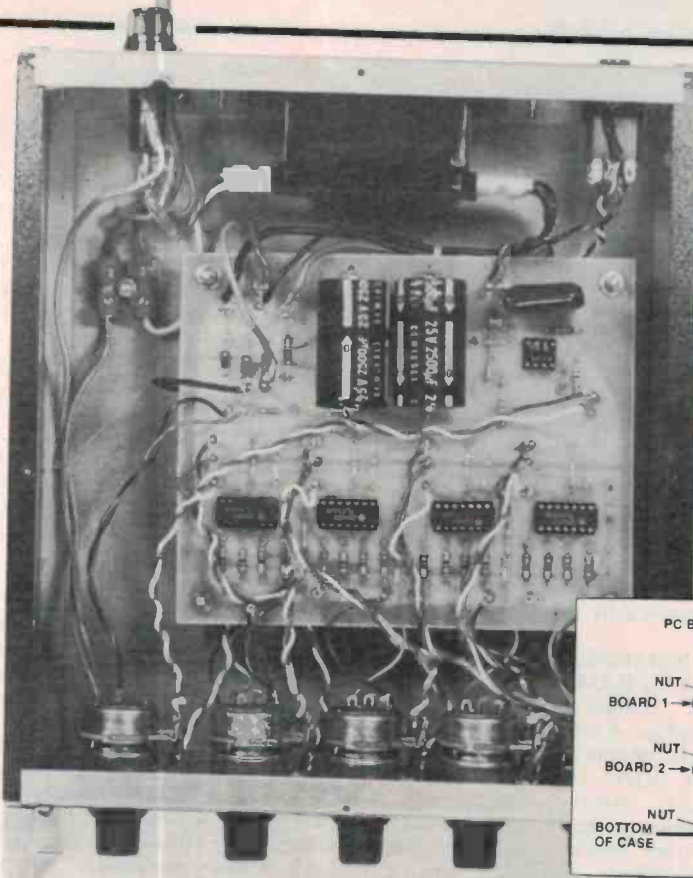

PARTS LIST — ETI-462

- Resistors.....all 1/4W, 5%
 R1.....1k8
 R2, 3, 4, 5, 6, 7, 8,
 9, 10, 11.....82R #
 R12.....15k #
 R13.....10k #
 R14-29.....15R #
 RV1-RV5.....100k/C dual-gang pots
- Capacitors
 C1, C2.....2500µ/25 V axial electro.
 C3.....1µ greencap #
 C4-13.....100n ceramic bypass #
- Semiconductors
 D1-D4.....1N4002 or similar
 IC1.....TL071 #
 IC2, 3, 4, 5.....TL074 #
 LED1.....TIL220R 5 mm red LED

— two of each required

Miscellaneous

- SW1.....SPDT miniature toggle switch
 SK1, 2, 3, 4, 5.....6.5 mm switched Insulated stereo jack sockets
 T1.....Ferguson PL18/20 VA low profile 9-0-9 V secondary transformer.

ETI-462 pc board (two off); 5 mm LED holder; one 3AG panel mount fuse holder; 1A rated 3AG fuse; mains terminal block; 8 x 12 mm long pc board spacers; case — 203 x 76 x 228 mm — Horwood type 93-B/V or similar; Scotchal front panel label; mains cord and plug; clamp type cable grommet or grommet and cable clamp; hookup wire; nuts, bolts, etc.

Price estimate: \$90-\$100

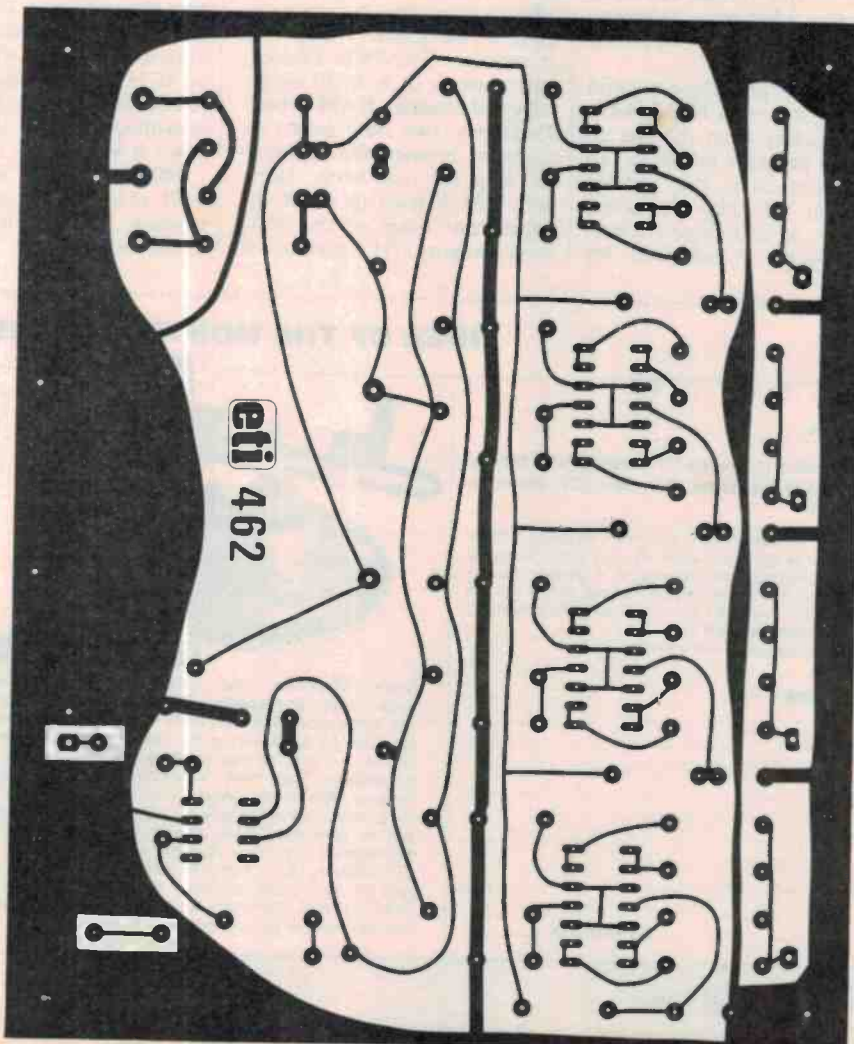

Extended graphics for the Microbee

David Dawes, Granville NSW

Hi-res graphics on the Microbee suffers a severe limitation due to the fact that only 128 PCG characters are available to generate the graphics display. On the normal 64 x 16 screen there are 1024 character locations. Therefore, for unrestricted graphics 1024 PCG characters would be required (for the worst case where each character location needs to be occupied by a different character).

To store data for 1024 characters requires 16K of PCG RAM. This would give complete 512 x 256 hi-res graphics. Even better graphics can be obtained by setting up the VDU in 80 x 16 (not 80 x 24) format. This gives a 25% wider screen, and hence a 25% larger display area with 640 x 256 graphics. A screen of this format has 1280 character locations, requiring 20K of PCG RAM for optimum results.

This circuit provides a method of adding this extra RAM (without detracting from the size of the main program memory). To have more than the present maximum of 256 characters available, an extra byte (or portion thereof) is required for

character specification. Hence an extra RAM chip is required for the screen memory. This extra byte is used to select which of the PCG chips is used for a particular character. The extra screen RAM chip is addressed and enabled identically to the existing one. Its data outputs are, however, connected indirectly to the CS pins of the PCG RAM chips.

The PCG RAMs also have common addressing; this means that all the PCG characters will, as at present, have a lower byte code between 80H and FFH. The result of this is that the standard ASCII characters still require only one byte for their specification i.e. the chip select byte in the additional screen memory has no meaning for character codes between 0 and 7FH.

The screen memory now consists of two identically addressed RAM chips i.e. they are identically connected to the Z80 address buss, thus occupying no more of the memory map than at present. The PCG memory now consists of 8 or 10 identically addressed RAM chips. Therefore, two data ports are necessary to select the appropriate chip for read/write. Here, port 10H is used to select the appropriate chip in the PCG bank and port 11H is used to sel-

ect the appropriate chip in the screen bank (only the LSB of this port is used). The port selection is only of relevance when writing to or reading from RAM.

Port decoding of address lines A0-A7 and IOR0, MWR lines is done by IC1, IC2a,b,c, IC3a and IC4a,b. The data of port 10H (the lowest four bits) is latched by IC8, which may be battery backed-up if required. The LSB of port 11H is latched by IC5.

Screen Ram

In the original setup the data pins of the RAM are connected to the Z80 data buss via tri-state bi-directional buss drivers (74LS245). When read/write is required, pin 19 of IC11 is enabled, connecting the data pins of IC5 to the data buss. The direction of the connection is controlled by the XWR line. In the modified system another 74LS245 (IC6) is used to connect the additional screen RAM (IC7) to the data buss. The data at port 11H selects which of IC6 or IC11 can be enabled by a read/write request, hence providing selection of one or the other RAM chip.

NOTE: All IC numbers in bold refer to IC numbers of existing ICs on the Microbee motherboard.

PCG RAM

In the original system, the address lines of the PCG chips are connected via two-way selectors (74LS157) to either the Z80 address buss when read/write is required or the data outputs of IC5 (existing screen RAM) and address lines generated by IC9 (VDU controller). A similar arrangement is employed in the modified design for controlling the selection of a particular chip in the PCG bank. When read/write is required, the chip selected is determined by the data at port 10H. Otherwise, the chip selected is determined by the data outputs of IC7 (extra screen RAM). IC9, a 74LS157, is used to do the selection and its outputs are decoded by a 74LS154 4-bit binary to 16-line decoder, providing the required number of CS lines.

Since a maximum of 10 CS lines are required a 10-line decoder, such as a 74LS42, may seem a better choice. However, the 74LS42 and all of the other standard TTL 10-line decoders do not have an output disable pin. Therefore, their use in this application would require 10 additional OR gates to provide this function. Hence the choice of 74LS154, which has two output disable pins (pin 18) is driven by the line that was used to

'IDEA OF THE MONTH' CONTEST

COUPON

Cut and send to: Scope/ETI 'Idea of the Month' Contest, ETI Magazine, P.O. Box 227, Waterloo NSW 2017.

"I agree to the above terms and grant *Electronics Today International* all rights to publish my idea in ETI Magazine or other publications produced by it. I declare that the attached idea is my own original material, that it has not previously been published and that its publication does not violate any other copyright."

* Breach of copyright is now a criminal offence.

Title of idea

Signature

Name

Date

Address

Postcode



Scope Panavise
Multi-Purpose
Work Centre.

PRIZE WORTH \$90!

Scope Laboratories, which manufactures and distributes soldering irons and accessory tools, is sponsoring this contest with a prize given away every month for the best item submitted for publication in the 'Ideas for Experimenters' column — one of the most consistently popular features in ETI Magazine. Each month, we will be giving away a Scope Panavise Multi-Purpose Work Centre, Model 376/300/312, comprising a self-centering head (376), standard base (300) and tray base mount (312), all worth about \$90! Selections will be made at the sole discretion of the editorial staff of ETI Magazine. Apart from the prize, each winner will be paid \$10 for the item published. You must submit original ideas of circuits which have not previously been published. You may send as many entries as you wish.

RULES

This contest is open to all persons normally resident in Australia, with the exception of members of the staff of Scope Laboratories, The Federal Publishing Company Pty Limited, ESN, The Litho Centre and/or associated companies.

Closing date for each issue is the last day of the month. Entries received within seven days of that date will be accepted if postmarked prior to and including the date of the last day of the month.

The winning entry will be judged by the Editor of ETI Magazine, whose decision will be final. No correspondence can be entered into regarding the decision.

The winner will be advised by telegram the same day the result is declared. The name of the winner, together with the winning idea, will be published in the next possible issue of ETI Magazine.

Contestants must enter their names and addresses where indicated on each entry form. Photostats or clearly written copies will be accepted but if sending copies you must cut out and include with each entry the month and page number from the bottom of the page of the contest. In other words, you can send in multiple entries but you will need extra copies of the magazine so that you send an original page number with each entry.

This contest is invalid in states where local laws prohibit entries. Entrants must sign the declaration on the coupon that they have read the above rules and agree to abide by their conditions.

IDEA OF THE MONTH

drive the \overline{CS} pin of the original PCG RAM chip.

Battery back-up of port 10H

If required, IC8 can have its positive supply pin connected to the supply used for the CMOS RAM chips. If this is done, the transistor Q1 and associated components should be included. This circuitry is used to detect when the main +5V supply falls; when this happens the output of IC8 goes into a high impedance mode, and the inputs are disabled preventing unwanted changes in the data as the main supply falls.

If this option is not required pins 1 and 10 should be connected to 0V, and IC8 may be a 74LS173 instead of a 74C173.

I successfully used this arrangement on the ROM expansion interface published in ETI, November '83, the 'Microbee MultiPROM interface', where I substituted a 74C173 for the 74LS174 specified. The result was that ROM selection was maintained after power down. **Caution:** These two ICs are *not* pin compatible and should only be used to replace IC9.

Construction

All IC numbers in bold refer to IC numbers of existing ICs on the Microbee motherboard.

Join address lines \overline{WR} , \overline{OE} , \overline{CS} and power lines of IC7 in parallel with those of IC5 on the Microbee. Join address lines, data lines, \overline{WR} , \overline{OE} and power lines of IC11 up to IC(11+n) in parallel with those of IC18 on the Microbee.

Break the line joining pin 19 of IC11 and pin 9 of IC16 on the Microbee. Break the line joining pin 18 of IC18 and pin 3 of IC16 on the Microbee.

The circuitry drawn within the box is to allow the data on the output of IC8 to be maintained by battery backup. If this is not used pins 1 and 10 of IC8 should be connected to earth.

The design of this circuit means that the number of extra PCG RAM chips used could be between one and 15. The actual number used would depend on the individual's expectations and requirements.

Use of the circuit

The advantages of this circuit

can not be fully realised from the existing BASIC graphics routines. The present graphics commands will still work (the same as they used to) provided that the value at port 10H is the same as the value stored in all the locations of the extra screen RAM chip.

To achieve the unrestricted graphics, however, machine code routines will be required (which could be called from BASIC) to cover all the required graphics commands. You might even like to modify the existing graphics routines, or insert a call from the existing routines to routines located in an EPROM somewhere.

Extra Benefits

With this circuit space exists for eight or ten different character sets which could be used simultaneously e.g: PCG 0 could be loaded with inverse characters while PCG 1 is loaded with underlined characters, and the others could have characters with different typefaces e.g: DATA 70 as shown on page 61 of ETI, January '84.

The particular type of character displayed at a particular location would depend entirely on the byte stored in the extra screen RAM. If the graphics facilities were not being used the extra PCG memory could be used for data storage. It is also

possible to locate short machine code routines in this RAM.

Routines

These routines can be used to set up the 80 x 16 format.

1. Using the CRTc table used by BASIC

```
LD A,59H
LD (0D3H),A
LD A,50H
LD (0D4H),A
CALL 85A7H
```

2.

```
LD A,3
OUT (0CH),A
LD A,59H
OUT (0DH),A
LD A,1
OUT (0CH),A
LD A,50H
OUT (0DH),A
```

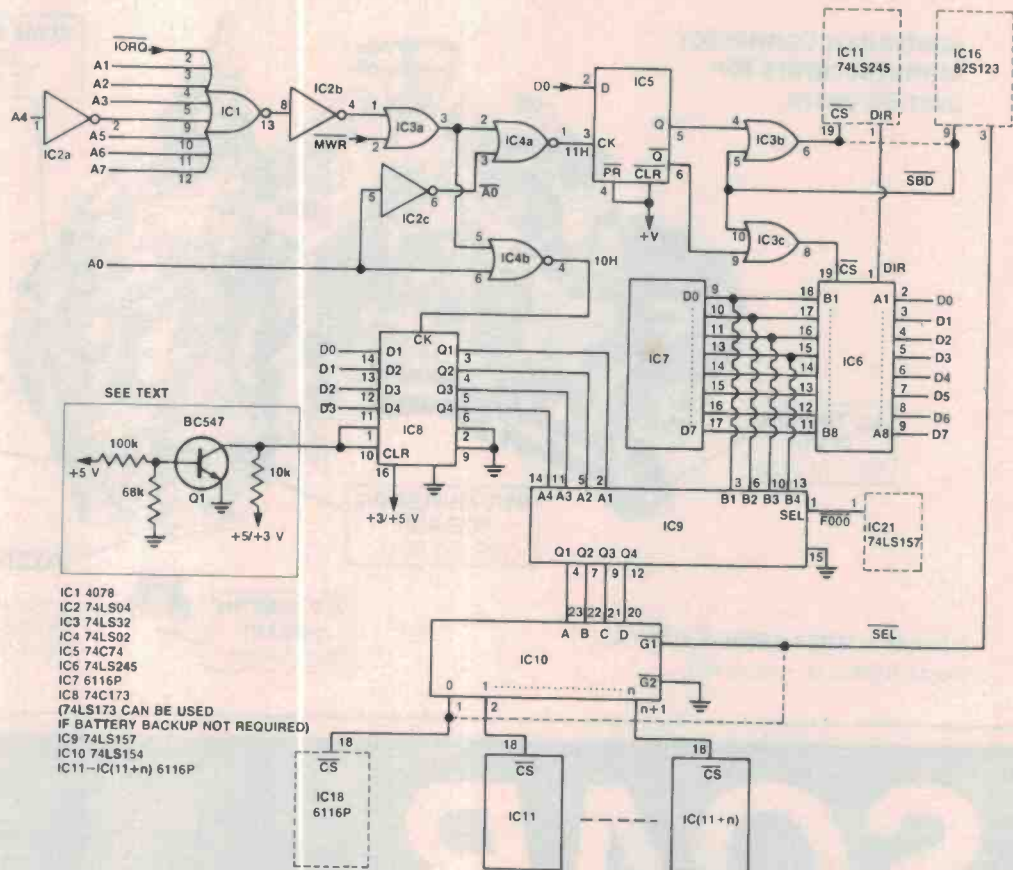

existing ICs on Microbee motherboard.



PROUDLY AUSTRALIAN 

IMMEDIATE DELIVERY
FROM STOCK AT THE FOLLOWING LOCATIONS

**Australian Connector
Manufacturers for
over 30 years.**

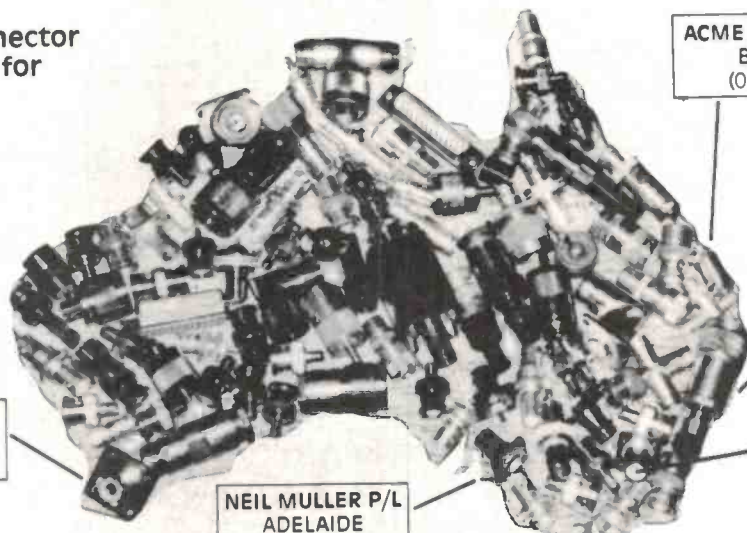

**J.C. THOMAS
PERTH
(09) 272 7122**

**NEIL MULLER P/L
ADELAIDE
(08) 272 8011**

**W.P. MARTIN
HOBART
(002) 34 2811**

**ACME ELECTRONICS
BRISBANE
(07) 44 4131**

**ACME ELECTRONICS
SYDNEY
(02) 648 2255**

**ELECTRONIC
COMPONENTS
(062) 80 4654**

ACME ELECTRONICS

2-18 Canterbury Road, Kilsyth,
Victoria 3137, Australia
Tel: (03) 729 8999 Telex: AA35786

A Division of JAMES HARDIE ELECTRICAL
(Hardie Trading Ltd. - Inc. in Vic.)

SOAR

BENCH TOP DIGITAL MULTIMETER

The model 5030 is part of the 'Soar' range of bench-top multimeters. Quality DMM's that offer high resolution and unparalleled accuracy.

These instruments utilise high quality components that ensure long term stability and the bright, clear LCD display offers quick, positive readings.

The touch-switches for full auto-ranging or manual range makes function selection very simple. Overload protection is built-in on all functions and ranges, with surge protection up to 6000 V.

A fast response continuity

check with a level adjustable 'no look' audible beeper is a feature of this unit and the large LCD readout includes annunciators for function, unit, polarity, decimal, low battery, continuity and diode test.

Housed in a fully RFI/EMI shielded ABS plastic case with U bracket handle/tilt stand, the 5030 is ideal for bench or rugged field use and comes complete with probes, batteries and fuses.

See this and other models in the Soar range at all L&H Sales Centres. With nearly 100 outlets Australia wide, there's bound to be one near you.



LAWRENCE & HANSON

VOICE STORAGE FOR MOBILE RADIO

Motorola Australia has introduced a new dimension to two-way radio communications with 'MVS-20' Mobile Voice Storage.

Used with standard model Motorola radios, 'MVS-20' Mobile Voice Storage is capable of storing 20 seconds of voice communications (up to eight messages). It improves efficiency by eliminating time consuming call backs and repetitious messages, particularly for the user who is frequently away from the vehicle. It also eliminates the need to wait for an available radio channel.

In cases where radio channels are contested and the mobile operator must leave the vehicle, a message can be recorded for dispatcher review and a reply message can be waiting upon return, further contributing to mobile system efficiency. An illuminated message light indicates a dispatcher originated message is stored for review.

Applied microprocessor tech-

nology permits solid state storage of digitized voice, thereby eliminating mechanical hardware associated with conventional tape recording. Four-button operation results in simple mobile operation and messages cannot be accidentally erased or recorded over until they are reviewed.

Throughout the manufacturing cycle, Motorola's unique Accelerated Life Testing (ALT) simulates years of field stress for temperature and shock extremes, ac line voltage variation, plus humidity and extensive duty cycle operation for dependable performance.

Additional information about 'MVS-20' Mobile Voice Storage, its features and benefits, is available from Motorola Australia Pty Ltd, 666 Wellington Rd, Mulgrave Vic. 3170. (03) 561-3555.



ORBITAL FORECASTS

USI 'Using Microcomputer Programs for Radio Amateur Satellite Orbital Prediction' is a new 40-page booklet prepared by AMSAT's Bob Driering, N5AHD.

Designed for the IBM-PC, Radio Shack and other CP/M based computers, it contains Keplerian elements, A-0-10 orbit loading, and information on updating and running programs on many popular micros. It is priced at \$8.50 for AMSAT members and \$10 for all others.

It can be obtained by writing to AMSAT, P.O. Box 27, Washington DC 20044. USA.

POCKET SCANNER



channels. The first 40 of these are normally used to manually store frequencies while the additional 120 are used by the SX-150 to automatically memorize frequencies it has located signals on while in search mode. These top 120 channels can also be manually programmed.

Other features include a priority channel, programmable 0.1 or 2 second scan/search delay, 16 channels/second scan/search speed, LCD display, clock, as well as 'rubber duck' antenna using a BNC Connector.

The SX-150 is supplied with rechargeable NiCad batteries and battery charger. Dimensions are only 175 (H) x 74 (W) x 42 (D) mm and the price \$449 plus \$10 p&p.

For further information contact the Australian distributors, GFS Electronic Imports, 17 McKeon Road, Mitcham Vic. 3132. (03)873-3777.

GFS Electronic Imports has released its new, fully programmable miniature pocket scanning receiver, the Microcomm Model SX-150.

The SX-150 incorporates many unique features, according to GFS. Amongst these are its ability to cover over 45 000 frequencies within the range 30-88, 138-176 and 380 to 514 MHz. It also has a total of 160 memory

QUALITY FINISH FOR PROFESSIONAL PROTOTYPES SPECIAL THIS MONTH

ORBITAL SANDER

For the smoothest of finish in small areas — \$25.00 + Tax.



Jigsaw
12V DC

000-62-108 JIGSAW—\$39.22 incl. S/Tax. Cuts anywhere—1mm radius corners. Wood, plastic, fibreglass, aluminium, PCB's—to 1/4" thick. A MUST!

000-62-117 Coarse, 000-62-144 Fine Blades—\$2.49 Set of 10.



PISTOL DRILL IN STAND
12V DC

000-62-402 Pistol Drill—\$39.22 incl. S/Tax. Single speed unit ideal for production line board assy. and repairs also modelling and prototypes—7000 RPM.
000-64-493. Drill Stand—\$39.22 incl. S/Tax

Send Self Addressed Envelope for full price and accessory list
Microtools include: rotary cutters, blades, burrs, brushes, stones etc.

NAME
ADDRESS
BANKCARD NO.
OR CHEQUE
EXPIRY DATE VALUE SIGNED

minitool
AUSTRALIA PTY. LTD.
134A AYR STREET,
DONCASTER, VIC. 3108
Tel. 850 9887



Post & Pack
To \$25+\$3.50
To \$100+\$5.00
To \$150+\$7.00
To \$400+\$10.00
Over \$400+\$14.00

index 1983

AUDIO

	Date	Page
60 W amplifier module with two nested differentiating feedback loops (E. M. Cherry)	Jan	22
AM radio stations to go stereo (J. Whyte)	Jun	12
Analogue delay lines (R. Marston)	Feb	18
Compact disc players — fact not fiction (L. Challis)	Sep	16
Yamaha multitrack recording system (A. Symaniz)	Nov	22

CIRCUIT FILE

Analogue delay lines (R. Marston)	Feb	18
SCRs, triacs and power control Part 1 (R. Marston)	Mar	16
SCRs, triacs and power control Part 2 (R. Marston)	Apr	56

COMMUNICATIONS

Measuring receiver performance by SINAD (P. Williams)	Aug	123
Scanner antennas	May	18
Scanning the World beyond shortwaves (R. Harrison)	Apr	17
Surface acoustic wave devices Part 1 (P. Hall)	Nov	105
VHF listeners' guide Part 1 26-88 MHz	Oct	137
VHF listeners' guide Part 2 100-400 MHz	Nov	140
VHF listeners' guide Part 3 400-500 MHz	Dec	154

COMPUTING

16K to 32K expansion for your Microbee (T. Moffat)	May	97
Artificial-Intelligence for the Learner's microcomputer (F. Rees)	Oct	83
Clock programs for the TRS-80C (G. Wilson)	Mar	90
Developing the MPF-1B Microprofessor (L. Wilson)	Aug	48
Dick Smith VZ200 computer (J. and R. Harrison)	Jul	32
Fault-finding the ETI-660 Learner's Microcomputer (G. Teesdale)	Jan	77
'pfs-Graph' package (J. Phillips)	Jul	49
HP-75C portable computer (J. Scott)	Apr	97
Hints for Chlp-8 programmers Part 2	Jan	86
Introduction to the STD buss (R. Harrison)	Oct	48
Joystick-operated 'sprite' editor for the Commodore 64 (M. Lingane)	Aug	56
Machine language graphic driver for ETI-640/685 Part 1 (G. Secomb, J. Adamthwaite)	Jun	35
Machine language graphic driver for ETI-640/685 Part 2 (G. Secomb, J. Adamthwaite)	Jul	39
Microprofessor II (R. Harrison, J. Scott)	May	90
Microprofessor MPF-1P (L. Wilson)	Nov	48
Microprofessor sound generation board (L. Wilson)	Dec	53
SME Systems 'Unicorn' computer (M. Street)	Mar	84
Using Soundex codes for approximate matching (T. Moffat)	Sep	58
Wang professional image computer (C. Rivers)	Nov	56

'660 SOFTWARE

Alternative block puzzle	Nov	86
Asteroid shower	Feb	84
Asteroids	Dec	75
Block move	Jun	57
Bombs away	Nov	85
Car race	Dec	75
Character generator	Mar	92
Cure for colour problems	Aug	68
Gobble	Aug	68
Iago for two	Feb	84
Iago for two updated	Nov	86
Lunar blitz	Nov	85
Memory display utility	Jul	53
Nasties	Dec	75
Noughts and crosses	Apr	110
One-byte shifter	Aug	68
Pakman	Sep	72
Pakman problems?	Nov	86
Patches	Feb	84
Polaris	Apr	111
Polaris II	Nov	85
Print routine	May	105
Select-a-game	Feb	84
Sequencer	Aug	67
Squash	Apr	111
TV message maker/inventory	Jul	52
Table tennis	Aug	67
Tank battle	Jun	57
Touchdown	Dec	75

MICROBEE

Cassette backup	Mar	95
Atan below 0.1	Jun	51
Bee-o-Rhythms	Jan	90
Calendar	Sep	69
Character generator	Jun	52
Clock and timer	May	108
Cones and pyramids	Dec	57
Generation of simulated Roehn functions	Apr	103
Hardware-software tips	Apr	103
How to make Microbee software do its tricks	Nov	74
Integer accuracy	Mar	95
Lissajous pattern generator	Feb	77
Operate output at 110 baud	Nov	75
Nominator	Jun	51
Program data generator	Sep	63
Random numbers	May	111
Screen dumper	Sep	63
Screen saver	Aug	61
Test pattern	Dec	57
Typing tutor	Aug	61
Using the 'Bee as an audio frequency counter	Jul	56

VIC-20

Air battle	Nov	80
Alarm clock	Nov	79
Alphabet	Dec	60
England	Oct	88
Gasp	Jul	58
Gladiator	Nov	78
Heart stopper	Jun	54
'Lotto 8' selector	May	100
Machine language graphics	Jun	54
Maze chase	Nov	79
Morse code tutor	Aug	54
Multiplication	Sep	74
Music generator	Jul	58
Road race	Dec	60
Times square display	Oct	88
Using VIC-20 joysticks	Apr	94

ZX80/81 SOFTWARE

Bogart	Nov	90
Bomb	Apr	109
Computer pictures	Nov	90
Encoder	Jul	60
Improving the ZX81	Sep	63
Life for the ZX80	Dec	68
Numbers	Dec	69
Saving memory	Jun	58
Seafight	Dec	69
Simple alphasort	Apr	109
Simpson's rule integration	Sep	63
Speed comparison program for ZX80	Nov	90
Typografix	Jul	60
ZX81 clock	Sep	63
ZX81 User's Handbook reviewed	Nov	90
ZXart	Apr	109

ELECTRONIC TECHNIQUES

	Date	Page
60 W amplifier module with two nested differentiating feedback loops (E. M. Cherry)	Jan	22
Logic troubleshooting	Dec	90
Low dropout voltage regulator (E. Smeda)	Aug	102
Op-amp cookbook — using the 3080	Jul	117
Op-amp cookbook — using the 741	Jul	100
Op-amp cookbook — using the LM3900N	Jul	113
Power MOSFET technology (B. Dance)	Sep	100
The junction FET (B. Dance)	Sep	119
VFETs for everyone Part 1 (W. Parsons)	Sep	107
VFETs for everyone Part 2 (W. Parsons)	Sep	113

GENERAL

Index 1982	Apr	130
Sheridan Electronics	Dec	147
The robots are here (D. Lingane)	Nov	12

IDEAS FOR EXPERIMENTERS

1 kHz clock generator	Dec	128
261 transistor battery clip	Jul	137

Auto program step for the '660	Sep	153
Automatic car aerial	Jan	59
Automatic car aerial correction	Jun	103
Avoid flat batteries	May	67
Battery watchdog	Oct	129
Blown fuse indicator	Feb	60
CMOS monostable	Dec	127
Cheap dc-to-dc inverter	Feb	59
Choke and headlight warning	Apr	66
Colour computer joystick	Apr	63
Discipline for the Turtle robot	May	69
ETI-582 house alarm modification	Dec	130
Etching tank	Jan	60
Flashlight communicator	Sep	153
Frequency operated switch	Oct	127
Fuse fall indicator	Jan	59
GSR monitor modification	Dec	130
Handy hints	Mar	48
Hints for making pc boards	Sep	153
Increase range of IR systems	Apr	63
LED bracket	Apr	63
Logic probe/injector	Jun	104
Low voltage alarm	Nov	126
Making touch switches	Jun	103
Matchbox cabinet	Jul	137
Modification of ETI-330 car alarm	Aug	105
Modification to battery condition indicator	Sep	153
Monster flasher	Jul	134
Mosquito imitator	Dec	128
Novel position for pilot light	Dec	128
Output splitter for stereo	Mar	48
Parking light reminder	Jul	137
Pea-zo whistle	Apr	63
Positive-negative probe	Feb	59
Pushbutton wiper delay	Aug	108
Reuse spent solder braid	Aug	105
Rich harmonics for ETI-905	Aug	105
SCR motor-speed controller	Mar	46
Second keypad for '660	Apr	63
Simple holder for leads	Jul	137
Simple positive/negative probe	Oct	129
Soldering CMOS chips	Jun	103
Soldering iron holder	Mar	48
Spotlamp dimmer	Feb	59
Step through of '660 memory	Jun	103
The humbucker's lament	Jan	60
'Traffic lights' circuit correction	Jun	103
Tone operated switch	Nov	124
Touch motor control	Feb	60
Turn indicators for a pushbike	Oct	127
Two mode light show	Dec	127
Two wires for opto-switch	Apr	66
Valve distortion unit	Jul	134

LAB NOTES

How to use digital voltmeter modules Part 1 (R. Marston)	Apr	46
How to use voltmeter modules Part 2 (R. Marston)	May	54
Optocoupler devices and their applications (B. Dance)	Jun	92
Using BiFET and BiMOS op-amps (B. Dance)	Sep	124
Why some CMOS circuits don't always work as expected (S. Dolding)	Jul	132

PRODUCT TESTS

Dick Smith VZ200 computer (J. and R. Harrison)	Jul	32
Digital disc players — six reviewed (L. Challis)	Sep	30
'pfs: Graph' package (J. Phillips)	Jul	49
HP-15C scientific calculator (J. Scott)	Jan	16
HP-75C portable computer (J. Scott)	Apr	97
Headphones — seven reviewed (L. Challis)	Apr	118
Hip stereo cassette players (L. Challis)	Aug	18
Jamo CBR 1703 loudspeakers (L. Challis)	Jul	20
Linear tracking turntables — six reviewed (L. Challis)	Dec	23
Marantz SC6 preamplifier and SM6 power amplifier (L. Challis)	Jan	98
Microprofessor II (R. Harrison, J. Scott)	May	90
Microprofessor MPF-1P (L. Wilson)	Nov	48
Microprofessor sound generation board (L. Wilson)	Dec	53
Perreux SM2 preamplifier and PMF 1150B amplifier (L. Challis)	Nov	26
Pioneer A-8 amp re-tested (L. Challis)	Mar	105
SME Systems 'Unicorn' computer (M. Street)	Mar	84
Sansui compu-receiver Z-9000 (L. Challis)	Oct	25
Shure V15 type V cartridge (L. Challis)	Mar	106
Sony CDP-101 compact disc player (L. Challis)	Feb	92
Spectravideo's SV-318 (J. Scott)	Oct	44

Tannoy's 'Little Red' monitors (L. Challis)	Jun	20
Video cassette recorder head cleaners (L. Challis)	May	118
Yamaha multitrack recording system (A. Symaniz)	Nov	22

PROJECTS

153 Temperature adaptor for multimeter (G. Nicholls)	Jun	86
163 0-40 V/5 A lab. power supply Part 1 (D. Tilbrook)	May	39
163 0-40 V/5 A lab. power supply Part 2 (D. Tilbrook)	Jun	78
164 Zener diode tester (G. Nicholls)	May	49
166 Function/pulse generator Part 1 (D. Tilbrook)	Jul	68
166 Function pulse generator Part 2 (D. Tilbrook)	Aug	81
166 Function and pulse generator Part 3 (D. Tilbrook)	Sep	140
166 Function and pulse generator Part 4 (D. Tilbrook)	Oct	100
175 Handheld digital frequency/period meter Part 1 (G. Nicholls)	Sep	133
175 Handheld digital frequency/period meter Part 2 (G. Nicholls)	Oct	110
265 'Power down' mains appliance timer (G. Nicholls)	Jul	90
268 NiCad float charger (J. Scott)	Mar	30
272 LED power indicator (J. Scott)	Nov	112
323 Headlight delay unit (J. Whyte)	May	32
334 Auto tester (G. Teesdale)	Jan	41
335 Windscreen wiper controller (G. Nicholls, R. Harrison)	Mar	24
336 Dwell meter (J. Scott)	Aug	94
412 LED peak programme display (D. Tilbrook)	Oct	116
421 Three-way speakers (R. Harrison)	Sep	85
464 IC audio amplifier module (G. Nicholls)	Jul	78
465 Loudhailer (G. Nicholls)	Jul	85
644 Modem follow-up No. 2 (R. Harrison)	Nov	64
648 Micro-grasp robot arm Part 1 (R. Becker)	Apr	24
648 Micro-grasp robot arm Part 2 (R. Becker)	May	24
649 Microbee light pen (G. Nicholls)	Aug	42
654 Apple II interface card (P. McKerrrow)	Mar	36
658 RS232 breakout box (A. Bendili)	Dec	48
668 EPROM programmer for the Microbee (T. Moffat, G. Nicholls)	Feb	45
671 Microbee parallel printer interface (G. Nicholls)	Oct	69
672 Microbee-TTY interface (T. Moffat)	Oct	76
673 Interface board to expand Microbee ROM (R. Harrison)	Nov	58
674 Microbee analogue joystick (G. Nicholls)	Dec	40
688 Bipolar PROM programmer (C. Simmers)	Jun	46
690 'Little Big Board' computer Part 1 (R. Harrison)	Oct	54
690 'Little Big Board' computer Part 2 (R. Harrison)	Nov	67
733 Radioteletype-computer decoder (T. Moffat)	Apr	78
734 'Phony patch' for ham rig (phone patch committee)	May	75
736 Microbee facsimile computer decoder (T. Moffat)	Sep	92
750 Beam for the six metre band (R. Harrison)	Dec	152
905 Polyphonic organ features 'touch sensor' keyboard (B. Wilkinson, R. Harrison)	Jan	31
1502 Sling psychrometer (I. Thomas)	Dec	102
1508 Modification to train controller (J. Scott)	Dec	120
1510 Model railway points controller and indicators (J. Scott)	Jan	49
1511 Immersible temperature controller (J. Scott)	Feb	29
1512 Electric fence tester (G. Teesdale)	Feb	33
1514 Two 'electronic switches' to control devices via your computer (G. Teesdale)	Nov	118
1515 Motor speed controller (J. Scott)	Apr	39
1516 Sure start ignition (J. Scott)	Jun	69
1517 Video distribution amplifier (J. Power)	Sep	147
1518 Video enhancer (J. Power)	Dec	112
1520 Wideband amplifier module (D. Tilbrook)	Jul	71

SCIENCE

AM radio stations to go stereo (J. Whyte)	Jun	12
Hitchhiker's guide to the infrared galaxy (J. Whyte)	Aug	11
Ins and outs of video enhancers (J. Scott)	Oct	16
Magnetic monopoles (J. Whyte)	Jul	10
Robotic arm techniques (R. Harrison)	Mar	82
Robot intelligence (D. Powers)	Dec	15
Surface acoustic wave devices Part 1 (P. Hall)	Nov	105

VIDEO

Ins and outs of video enhancers (J. Scott)	Oct	16
Video cassette recorder head cleaners (L. Challis)	May	118
Video distribution amplifier ETI-1517 (J. Power)	Sep	147
Video enhancer ETI-1518 (J. Power)	Dec	112

index 1983

NOTES AND ERRATA 1983

November '82, '660 Software: Black Jack on page 90. Bill Kreykes suggests the following changes to slow it down and sound evens (i.e: return your bet). change 0CDE to 1D84, enter 2B42 6F10 FF18 1D04. To allow more time to place your bets, change the data at 079C to 400A or 400B or 400C. You can then use keys 0 to C to place bets and to answer yes.

July '83, '660 Software: On page 53 an artistic cut was made to the last line of the Memory Display Utility program. The last line of 0F80 should be 70A0 AF4A F055 00EE. Then it will work.

August '83, '660 Software: On page 68 in the Gobble program there were a few blurred spots. Check that you typed in the correct information at these addresses; 8EE 2E46; B64 A97D; D54 00EE; D36 00EE; E50 1E20.

August '83, '660 Software: In the item at the bottom of page 68 headed 'Cure For Colour Problems', we goofed. The solution is to cut the track between pin 11 of the 4066 (IC21) and the junction of R16-R17, then insert a 10n capacitor across the cut. Sorry about that.

Project 166, Function and pulse generator Part 4, October '83: The following errors crept into the Parts List; C17 should be deleted, C18 — 22p ceramic, C19 — 470p ceramic, C20 — 4n7 greencap, C21 — 47n greencap, C22 — 470n greencap, C23 — 4µ7/16 V RBLL, C24 — 47µ/16 V RBLL. A C24 shown on the circuit as 100n was not put on the pc board. It may be soldered on the copper side between pins 1 and 14 of IC4. There are two R40s on the overlay. The one next to R54 is actually R58. Some relays may not match the board and it will be necessary to drill extra holes and wire them in with links.

Project 175, Digital frequency/period meter Part 2, October '83: Q1 and Q2, shown in the Parts List, do not exist.

Project 268, NiCad float charger, March '83: The curve for 'Typical charging characteristics of NiCad cells' (on page 31) is for one particular type and may not be indicative of most currently on the market. While the shape is generally similar, the maximum terminal voltage reached is generally between 1.4 V and 1.5 V, not 1.7 V as shown.

Project 412, Peak programme display, October '83: The linking for dot/bar mode is shown incorrectly on the circuit and component overlay. For a dot mode display, link pins 9 and 11 (as per the photograph of the board); for the bar mode, link pin 9 to the positive supply.

Project 421, Three-way loudspeakers, Sept. '83: On the pc board overlay on page 86 the labels on the two capacitors are reversed — C1 is the 2 µF capacitor, C2 the 8 µF capacitor. The values shown are in the correct position. The Parts List and circuit diagram are correct.

Project 688, Bipolar PROM programmer, June '83: At date of going to press with this project, page 46, Chuck Simmers had only tried the National bipolar PROMs so check the specifications before attempting to program other makes using this project.

Project 1515, Motor speed controller, April '83: If you find your speed potentiometer has a considerable 'dead band' at the 'top' (towards full speed) end, this indicates your drill has lower back-emf than that designed for. The cure is to increase R3. If all the speed control is crowded over about 60 of rotation, increase R3 to 330k. If you get 90 or 100 of rotation for zero to full speed, change R3 to 220k or 180k, etc. You may need to increase R4 from 27k to 56k or 68k, also. DISCONNECT THE UNIT FROM THE MAINS BEFORE MAKING ANY MODIFICATIONS.

Project 1516, Sure start ignition, June '83: The Parts List on page 74 shows R16 as 18k, but the circuit diagram gives it as 560R. The circuit diagram is correct.

Video 1517, Video distribution amplifier, September '83: There are two errors in the wiring diagram of the Video Distribution Amp. On page 148, the two yellow wires from the 2851 transformer are shown going to the top and bottom tags of the tagstrip — this is incorrect. They should both be moved one tag toward the centre of the tagstrip.

Project 1520, Wideband Amp, July '83: Capacitors C6 and C8 are shown on the overlay on page 74 as 2p2 while the Parts List and circuit shows C6 as 3p3 and C8 as 10p. The latter values are correct.

TO THE ELECTRONICALLY MINDED. (Professionals, Hobbyists, Students & Enthusiasts.)

We carry a wide range of Multimeters, Calculators, Soldering tools, Transformers, Cables, Instrument boxes, Computer Connectors, TV Aerials, Components and just about anything you may require.



E.B.M. FAN
\$22.94



MULTI-METERS

- UNIVERSITY
- FLUKE
- PARAMETER



CALCULATORS

- CASIO
- TEXAS INST
- HEWLETT-PACKARD HP41C

Now in stock.



SOLDERING TOOLS

- WELLER
- ROYAL

RADIO DESPATCH SERVICE



"QUALITY COMES FIRST" has been our trading principle for many years. This enables us to give you the best in service and the best in products...ensuring durability in what you buy and your own guaranteed satisfaction.

MAIL ORDERS TO RADIO DESPATCH SERVICE
869 George St., Sydney 2000 Tel. (02) 211 0191 • 211 0816

869 George St., Sydney NSW 2000 (Near Harris St.)
Tel. 211 0816
211 0191

Open: Mon-Fri 8.30am to 5.30pm
Thursday night late shopping till 6.30pm Sat 8am to 12.00pm

LETTERS

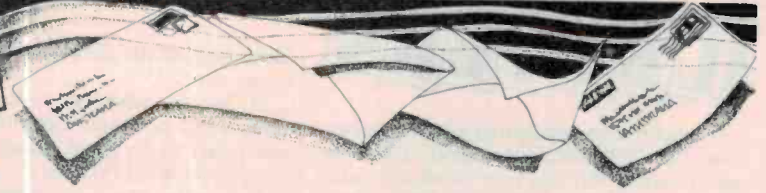

Storm over Sphere Mk III review

Dear Sir,

We were surprised to see that a magazine of your repute had allowed publication of such a poorly researched review in the February 1984 issue.

The following errors were made by your magazine, ETI, in the review of the Sphere Mark III computer and CCT-100 intelligent terminal.

1. What was being reviewed was a Mark III not a Mark II.
2. The computer "sports two slimline 5¼" double density single-sided floppy disk drives" should, in fact, read "it sports two slimline 5¼" double density double-sided floppy disk drives".
3. "The terminal which we received, a CCT-100... is a substantially unintelligent unit..." is a blatant untruth. The terminal is, in fact, an intelligent terminal as it is able to emulate a variety of other terminal modes and, most importantly, it has a microprocessor and memory for special keyboard functions.
4. "It has the usual crude memory examination and modification functions." This is incorrect as it has a quick and efficient memory test function via the monitor diagnostics.
5. "We were surprised that this old sort of monitor..." It is believed that this parochial view only prompts us to say that this monitor is the most commonly used in the world.
6. The writer mentions the inconvenience incurred when typing a 'u' to boot the operating system. This is pure conjecture as it is only a *one* key function — entering in the date which immediately brings one into the operating system. In a business system, the typing of a 'u' and the date with the use of a STARTUP command will put one into a

program such as 'Accounts Receivable' or 'Inventory', etc.

7. "However, the Sphere isn't really up to multi-user operation..." The Sphere is, in fact, able to be used with a number of terminals when running a program called 'Dyna-share' which is a multi-tasking, multi-user overlay.

8. "We were a little disappointed to see that the connections..." Let us clarify this statement. The writer insists that the old gold-plated edge connectors are the standard in most of the upmarket and domestic machines and insinuates that they are the only ones that should be used. He has not fully examined the Sphere to give a fair comparison as they are, in fact, made of Titanium Tin and are really quite an expensive method of interconnection.

9. "The Editor..." This type of editor is by no means a word processing editor. It is only a line editor for simple programming. It was never implied to be a full screen editor yet the writer attempted to refute it.

10. The last paragraph, in our opinion, is unnecessarily harsh. First of all, the writer believed that there were similar terminals synonymous to the CCT-100; why didn't he substantiate it? It is our belief that the writer was capable of amplifying vacuous statements without fully understanding or examining the system he reviewed.

We are hoping that your company will be able to indemnify this situation. For it is of our opinion that the writer reviewed the Sphere Mark III computer and CCT-100 intelligent terminal without the thorough investigation of the documentation supplied.

Jacky Cockinos
Marketing Manager
Sphere Computers
Darlinghurst, NSW

Dear Sir,

As a regular user of the Flex Disk Operating System, I was very pleased to see the favourable comments on it in the review of the Sphere Mk II computer in the February issue of ETI. Flex is a very easy-to-use system with a wide range of application programs to support it. Unfortunately, it has been largely ignored by the technical press in Australia in the past. It's nice to see it being mentioned at last. Thank you.

As the review says, Flex is particularly well documented with a degree of care and detail not found in the handbooks for many other operating systems, with the possible exception of OS-9.

One of the more interesting results from a recent survey was the strong correlation between software piracy and the quality of the manuals normally supplied with the software. Many of these are so poorly written that a large industry has sprung up to write proper manuals. The computer stores and technical bookshops are choked with books containing the information one would normally expect to be provided with the software package.

With the detailed manuals readily available, there is little incentive to pay the full retail price for the software. I note that your magazine is now carrying advertisements for low cost software that is 100% compatible with leading imported packages. I would be surprised if there were any Flex or OS-9 software amongst them. You will have to search very hard to find a shop stocking copies of 'Inside Flex' or 'Inside OS-9'.

A major problem with widespread, poor quality documentation is that nobody bothers to read it. On those few occasions when quality documentation is provided, it's also tossed to one side after the most cursory reading. In studying Mr Scott's comments, I can't help but wonder whether he had time to do more than open the manuals before he wrote the review.

For instance, he appears to have written off XBASIC as a fairly complete, but old fashioned, BASIC with none of the clever or unusual extensions that have appeared recently. XBASIC was, of course, written some years ago and was well ahead of its time.

It's hard to dismiss a BASIC that has 17-digit (digits not bits) precision arithmetic, and can support up to 12 virtual arrays on disk. The virtual arrays can be either single or double dimension, and their size is really only limited by the space available on a disk. As far as the user is concerned, the virtual array is handled the same as any other array. XBASIC also has the ability to call in and run machine code programs, or to 'chain' to any other XBASIC program on the system. ▶



LETTERS

Mr Scott also appears to have misunderstood the COMPILER command. This command merely lets the user store the entire program on disk in tokenised form, rather than in ASCII. X BASIC files are normally stored in ASCII so that they may be written or modified with one of the standard editors.

There is a companion program 'XPC' which is a pre-compiler. This still converts the program to a tokenised form but it also strips out all REM statements, making for more compact and faster code.

The review was less than kind to the Editor, again dismissing it as old fashioned and unfriendly. I am writing this on a Flex system running Stylograph, one of the normal 6809 editors. As far as I can tell, Stylograph has much the same facilities and capabilities as Wordstar, and that is usually referred to as a very friendly Editor.

I also use the TSC Editor which is one of the most comprehensive and easy to use editors available. TSC chose to split the editing and word processing functions into two separate packages, to conserve memory space and for the benefit of those people who don't need the word processing functions. I find Stylograph ideal for short letters and reports, and the TSC EDIT/PR combination more suitable for assembly language programming and the production of handbooks and other documentation.

I would also point out that Flex software is available to let you set up MENU programs to cover almost all cases you could want, from carrying out repetitive functions from a programmer to providing simple 'choose a key' functions for the benefit of non-programmers. This is, of course, the essence of Flex; it's a simple matter to tailor the software to the application. You are not stuck with the set of functions chosen for you by the hardware manufacturer.

On the hardware side, I find difficulty in relating Mr Scott's comments on the CCT-100 terminal with the advertisement on the inside front cover. If Mr Scott's comments are correct, it would appear that you are running a misleading advertisement. If, on the other hand, the terminal really does all those things advertised, then Mr Scott's comments appear to be unfounded.

Now I haven't used a CCT-100 terminal, so I can't comment on it further, except to say I have been offered a number of other terminals with similar specifications at much higher prices.

The review is somewhat critical of using a separate computer and terminal. I thought that most modern business systems used a separate processor to handle the terminal functions, rather than tying up the main CPU for these time-consuming functions. That is, of course, professional business machines and not the tarted-up hobby computers that are often unloaded onto unsuspecting businessmen as office machines. With separate processors for the I/O, it doesn't really matter if they are mounted in the one box or not. The separate box approach has the other advantage of not

cluttering up the desktop with unnecessary equipment.

A further advantage of separating the screen and keyboard from the CPU is the possibility of 'mix and match' i.e. you may select a terminal that has the particular features you need for your application. Again, you are not limited by the manufacturer's choice and you don't have to pay for facilities you don't need.

Again, as a matter of interest, I am writing this on a system that has the CPU in a separate box with the disk drives, and a terminal with about the same amount of intelligence as the CCT-100. It has special function keys with screen labels which can be changed any time under program control, and I can use split screen facilities if I wish. With 9600 baud transmission and simple direct cursor addressing, it's about as fast as a memory mapped display anyway.

The review says that Flex is related to OS-9 and that the Sphere isn't really up to multi-user operation. In the first place, Flex isn't in any way related to OS-9, except that it runs on the same processor. In fact, it is much more closely related to CP/M but it's a more modern and friendly operating system. Both Flex and CP/M were designed as single user, single task systems, although there has been some attempt in both cases to give them multi-user, multi-tasking facilities.

OS-9, on the other hand, was designed from the ground up to allow multi-user, multi-tasking applications. I have only had a relatively limited look at the hardware of the Sphere, but it appears to be generally similar to other 6809 machines running OS-9. I would be surprised if the Sphere couldn't also run OS-9 as well as Flex, making it a very versatile system.

Alan M. Fowler M.I.E. Aust.
Chartered Engineer
North Balwyn, Vic.

Dear Sir,

Reference an article appearing in Electronics Today International, February issue, a review of the Sphere computer system.

The reason for writing is that I have a Sphere computer and terminal as described in the article and believe many of the statements made are damaging and misleading.

Statements such as the unit supporting only single-sided floppy disk drives is incorrect. My unit is fitted with two 80 track double-sided double density Teac FD55F 5¼" drives. These are supplied to Sphere by Electrical Equipment Ltd, who took over Jacoby Mitchell and myself about three years ago; Sphere have only been supplied with double-sided double density 40-80 track floppies.

The Sphere C100 terminal is, in fact, a terminal not a computer with which Mr Scott is apparently making this comparison. It is, as far as terminals are concerned, intelligent, with an on-board microprocessor for emulation of a number of terminal types; special functions are included in the specifications which are provided by a high degree of intelligence.

Regarding booting of the DOS, this method is far from old. I had the oppor-

tunity of evaluating a Sanyo MCB555, the latest in technology, which also requires booting in a similar fashion.

The statement saying the Sphere is unfriendly is strange. As compared to what? A Commodore VIC, Tandy Colour or some other home computer. The Sphere is a business machine and, as with others of similar performances, has to be driven accordingly.

The statement regarding a single user is incorrect. My Sphere is running with two terminals under a program called 'Dynastore' and I am considering going to OS9 which will give me full width user capability.

Referring to the quality of the plug-in connectors; this is a standard SS50 system and I believe the quality of the pins and sockets on the boards has never caused any trouble, even after connections and disconnections of the board.

The last paragraph is what I would call strange. To state that there are many terminals available in several places is false. I looked at what was available and the Sphere CCT-100 offered the best value for money.

I was prompted to write regarding this article, firstly because it certainly inferred that I had made a bad choice of computers, secondly I feel obliged to defend a product against the total misrepresentation without one word of praise appearing in the article.

I would strongly recommend that the product be re-evaluated by someone else without a distorted view of what is, in his opinion, good or bad.

Ken Squires
Bondi, NSW

To continue next month . . .

Jonathan Scott replies:

Despite the complaints which have stimulated some considerable rethinking and concern for my reputation, I must stick by my critique of the Sphere computer.

Two direct typographical errors did creep in i.e. the machine was addressed as a Mk II when it should have been referred to as a Mk III, and it was described as having single not double-sided 5¼ inch disk drives. (Apologies for these — Ed.) However, it does not change my opinion of the system.

I am criticised for describing the terminal as 'unintelligent'. Perhaps the *whole* sentence should be quoted, removing the confusions resulting from taking the clause out of context. "It (the terminal) is a substantially unintelligent unit, all processing power being vested in the main control box's 6809."

Current usage defines an intelligent terminal as one capable of running application programs without recourse to outside resources. By this definition, the terminal we reviewed is entirely unintelligent; the use of the word 'substantially' is some recognition of its processor-based capabilities. It merely relayed characters to the CPU, performing no interpretation of these for itself. Any special protocols it offered were not exercised in the configuration we were given.

The remainder of my description of the terminal was quite praiseworthy. In fact, the use of the term 'unintelligent' in the first place was not intended as criticism of it.

I only discussed the monitor briefly because it is of little concern to most of the people who are likely to be interested in this system. It is also very similar to the monitors supplied many years ago with the first 6800 systems. In many recent computer designs the monitors are invisible to the user unless invoked; they boot an OS and never hesi-

tate or stop. I did not say that it lacked any features, neither did I describe the features it offered. I still do not know why the manual booting is required, although there is probably a good reason for it. Perhaps my critics can give me the answer.

I am criticised for saying "this old sort of monitor" and I am told that it is "the most commonly used monitor in the world". These statements seem to me to be somewhat contradictory. The only value I found in using an old monitor was that I knew how to get some functions out of it without having to look up the documentation.

Until recently it may have been the most commonly used monitor in the world. However, I would be most upset if a new car salesman offered me an old VW 'beetle'. The time taken to adapt a new monitor is minimal. My statement, "The Sphere... is rather old fashioned in its architecture", still stands.

I am criticised for my comment, "... the Sphere isn't really up to multi-user operation". It is a fact that it can be loaded with a system to run multiple terminals, however, the speed of the system and the mass storage supplied are both below the usual typical requirements. One user performing a large sort, something a business system is often required to do, would tie up the system to such a degree that the response time would drop, making it extremely inconvenient to use; the sort would be so slow that it would take hours to complete.

Many users would very quickly use up the available mass storage space. This system should be compared with the high mass storage capabilities vested in personal computers designed for business use; there is no time sharing and the drives are in front of the user for disk exchanging. The mass storage offered by the Sphere could be expanded but the speed would still be slow, and then we would be talking about a system that is double the price.

I am accused of stating that gold-plated edge connectors, not used in Sphere computers, are the standard interconnection arrangement. My critic should have read more carefully. I said, "... the connections to the motherboard were the cheaper pin-and-socket arrangement, rather than gold-plated edge connectors which are standard in a lot of up-market machines and some domestic machines".

I did not say that the connectors used in the Sphere computers are cheap, just cheaper than the gold-plated ones and the Sphere connectors are not as convenient to use. I do prefer the gold-plated edge connectors; the enormous trend towards using them has proved that they are the best choice.

The Sphere computer connectors are the same as the pc board connectors used in previous systems in the 6800 series (in the mid and late seventies — a long time ago in terms of computer technology). One of the major advantages of the Sphere computer is that it is compatible with the 6800 series systems. Boards used in the earlier systems can be used in the Sphere computer, and components of the Sphere system can be used to update the 6800 series systems. However, although the systems are compatible the quality of the connectors is not as good as it could be.

I am criticised for my cursory disposal of the editor and for failing to acknowledge the potential of the on-screen editor. I reviewed the editor with which I was supplied and found it to be downright crude. I did comment that a full screen editor is available but I was not given it to review, nor was I given any information about it.

I am accused of having misunderstood the COMPILER command. This is not the case. However, I was a little surprised by its irreversibility. COMPILER apparently tokenises the command words (which is automatic upon entry in most machines unless countermanded), however, I suspect that it does more as pure tokenisation is immediately reversible; it speeds operation, but not as much as proper BASIC compilation which is a rarer thing.

I am accused of having 'written off' the BASIC. This is hardly the case; I described it as complete and well documented, although not recent. It is old, like a lot of the Sphere code. As one critic admitted, it was very advanced when it first came out, and I'm sure that it was. However, it is missing the more recent innovations which are found in the latest systems. Compare the Sphere BASIC with the Spectravideo BASIC which, although it is ill documented, is very novel and abounds in new ideas. (Spectravideo BASIC is Microsoft, similar to the IBM PC BASIC.)

One comment further needs to be made. The

terminal we received did not come with any documentation. In the role the terminal plays with the Sphere it performs no special functions and in this role it is overpriced, in our opinion. No comment was made or implied as to its capability as a terminal in its own right.

I feel that my conclusions were correct. The Sphere is compatible with the earlier 6800 systems and runs a whole host of their software. If this is of value to you because you own the software, then this computer has merit, otherwise it is not good value at the price offered.

**Jonathan Scott
B.Sc./B.E. (Hons)**

Jonathan Scott MIEEE

Jonathan Scott gained his B.Sc. degree from Sydney University in 1977 and his B.E. (Hons) in Electrical Engineering in 1979. He joined the ETI laboratory staff early in 1979 but returned to Sydney University the following year to work on his Masters degree. He is currently employed as a lecturer in Electronics at the University of Sydney.

Jonathan has considerable experience with a wide range of computers and computer systems, ranging from mainframes to 'personal', portable and 'home' computers. He is 'at home' with a variety of high level languages, operating systems and machine code and, in particular, is familiar with the 6502, 6800 series and 68000 microprocessors.

Over the years, Jonathan has reviewed for us a variety of computers, ranging from the Hewlett-Packard HP-75 professional portable to the Microprofessor II and Spectravideo SV-318 home computers. We know him to be thorough, reliable, fair and honest.

Editor

ME 15 preamp and ME 75 power amplifier — opinions differ

Dear Sir,

This letter is in response to the review of the ME 75 power amplifier and ME 15 preamplifier, published in ETI, March 1984. Several inconsistencies, errors and assumptions occurred in this review.

I would like to thank you for the excellent precis of my handwritten notes as it embodies the important facts in a readable format. Unfortunately, it appears that Louis Challis did not read either the handbook, the brochure or any of the other notes and inclusions he was given.

Further, I can not understand why Louis Challis did not contact me when he required information that did not come readily to hand. As a consequence many value judgements were made, illustrating quite plainly that the design concept was not understood.

As a major part of the review concerns itself with measurements, I would like to begin with the statement "All of the significant measurable and audible parameters including frequency response, total harmonic distortion, slew rate, output imped-

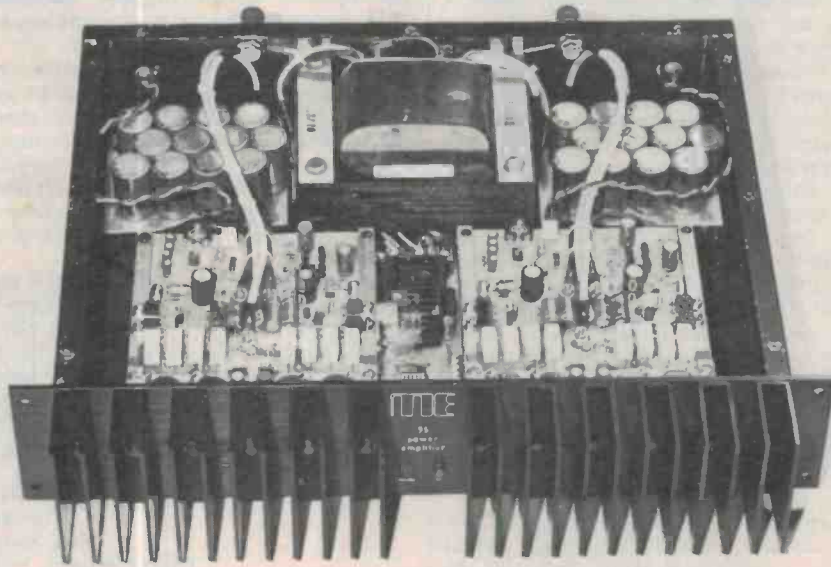

LETTERS

ance, signal-to-noise ratio, audible quality, base response, sound definition as well as overall clarity are claimed to be substantially superior when compared to other amplifiers'. In no part of our official literature do we even remotely intimate that objective measurements such as frequency response, total harmonic distortion, slew rate etc. have credence, let alone claims of superiority.

It is not my intention to design amplifiers with outstanding objective measurements, as I think it is clearly stated in the brochure and owner's handbook. Any electronics engineering graduate could design an amplifier with vanishingly low orders of harmonic distortion, high slew rates and superior signal-to-noise ratios etc. However, the real challenge is to achieve subjective superiority and that is the area that I concern myself with.

There is little, if any, correlation between these established measurements and the subjective performance of audio amplifiers, as evidenced by Louis Challis's statements in his subjective assessment, "... the unit revealed characteristics that are a little different from what I would have expected," and "I found this amplifier particularly pleasant to listen to as it exhibits characteristics which are audibly different ..."

At this point I would also like to refute the implication that our designs are based on Matti Ojala's theories, as the design concepts referred to were embodied in ME amplifiers in 1976 onwards and his theories were not published till much later. I do admit to now utilising Matti Ojala's appellations for ease of understanding and uniformity. I admire Matti Ojala, for it seems that he alone is trying to quantify some of the 'grey' areas of amplifier characteristics. It is enough for me to identify and minimise these characteristics and put them into practice.

It is unfortunate that this comes at a higher cost in terms of components and their matching and while on that subject, I must take exception to the frequent references to unreasonable cost.

In a recently reviewed comparable amplifier system, the preamplifier is very close to twice the price and the power amplifier is the same price as the ME's equivalent; and this particular amplifier system was hailed as a bargain. However, when compared with many far more expensive amplifiers, ME amplifiers have been consistently chosen by retailers and enthusiasts as audibly superior. Consider also that the ME amplifiers can be updated to constantly keep pace with technology and therefore, obviate the need or desire to ever change amplifiers.

Before I get involved with errors and irregularities in Louis Challis's testing procedure, there seems to be a misconception about the class of operation of ME amplifiers. Louis Challis states, "Unlike the majority of amplifiers on the market, this unit features a Class 'AB' power output stage". I would now like to state that the

great majority of hi-fi amplifiers operate in the Class 'AB' mode. The difference between the great majority of amplifiers and an ME amplifier is that a far higher proportion of its operation is in the Class 'A' region.

ME amplifiers exhibit almost identical output powers under both transient and continuous testing into 8 ohm loads (31 volts RMS). Hence they should attract a 0dB dynamic headroom figure. Therefore, the figure of 1.5 dB dynamic headroom, as stated in your review, is erroneous.

The output impedance measurement of 405 milliohms is also incorrect and should be in the order of 80 milliohms, consistent with both our own measurements and those of an independent testing laboratory.

The comment, "Neither does the peak current match the claimed 40 A peak current ... " suggests that the ME 75 should be capable of producing that current into an 8 ohm resistor. Well, simple mathematics would indicate that since voltage = current x resistance, the voltage required would be 320 volts and it would represent a power output of 2560 watts. It is stated in our specification sheet that this peak current is measured using a 0.22 ohm load.

I assume from your measurements of noise and distortion that the preamplifier was positioned above the power amplifier, as per the photographs in the review. These measurements reflect those that I have been able to obtain by testing the sample units in this way. It is clearly stated in the owner's handbook that if the power and preamplifiers are co-located then induced hum may be experienced. The statement, "... a very high level of 50 Hz signal ..." further confirms an incorrect testing procedure.

Further inconsistencies occurred in the measurements of distortion between that of the pre/power amplifier combination and the power amplifier alone. I refer to the higher levels of distortion when the ME 75 power amplifier was tested on its own. This would only be possible if either the ME 15 preamplifier had a negative distortion characteristic or the test equipment was not functioning correctly.

In conclusion, I would like to restate that it was never our intention to design and manufacture amplifiers capable of exemplary conventional measured specifications. Rather, our goal was to design an amplifier system to sound superior to any other amplifier system, even those at significantly higher purchase prices than the price of an ME amplifier.

I am not alone in believing that this goal has been reached. As it is not possible to quantify the feeling of a fine motor car or vintage wine, so too can it be said that an amplifier's dynamic performance cannot be quantified. And so I offer the challenge of actually listening to an ME amplifier through any of our retailers, without obligation of any kind.

Peter A. Stein
Director
ME Sound
Dyers Crossing, NSW

Louis Challis replies:

There appears to be some confusion in Mr Stein's mind as to what we do, what we say and even what we think.

Mr Stein has suggested that I didn't read his notes. Nothing could be further from the truth as I did read them and saw no reason to regurgitate a large number of claims that I could not substantiate. To suggest that I should ring him to hear the words 'direct from the horse's mouth' would not necessarily make them any more believable.

It is not my wish to involve myself, the magazine or its readers in broadside attacks on people, equipment or designers. Likewise, when our testing produces results which do not appear to be right we take more than a considerable amount of time and effort in trying to prove that we were wrong, and not that the equipment is wrong.

These steps and approaches were diligently applied in the testing and reviewing of the ME 75 power amplifier and ME 15 preamplifier. Mr Stein seems to wish to highlight errors and irregularities in our testing procedure and designation of operating class, rather than highlighting the errors and inconsistencies in his own statements. When I originally described the amplifier as operating essentially in the Class 'A' mode, the draft of the review was corrected by one of Mr Stein's close associates who advised the magazine that the amplifier really works in Class 'AB' mode. Having made that correction Mr Stein comes back and now says that we are wrong, it really operates essentially in Class 'A' mode.

Mr Stein says that the claimed 40 A peak current capability is with the amplifier working into a 0.22 ohm resistor. Bully for him; none of my friends own a 0.22 ohm resistor nor a speaker system with 0.22 ohms impedance. If no conventional speaker system is able to absorb his claimed 40 A peak capability, then to make such claims in the technical literature is a little akin to saying that the lowest priced car on the market (say a Suzuki Hatch) is capable of achieving a speed of greater than 300 km per hour when travelling down the side of Mt. Everest (with or without a tail wind)!

To sum up; what we have done is to assess the ME 75 and ME 15 using tried, true and fully accepted laboratory testing procedures which comply with the appropriate I.E.C. and I.H.F. standards. That the amplifier and preamplifier have not performed as well as they might have, and that the testing results were derived on an amplifier that Mr Stein has admitted differs in a number of significant respects from what is normally sold to the public, is also regrettable.

Mr Stein has set out to build and market a range of amplifiers and preamplifiers that sound different to other competitive units on the market. To 'bitch' about the results of our testing does not enhance his products capabilities anymore than some of the other 'enlightened' performance claims he makes in his literature and in his letter to the editor.

Louis A. Challis
Kings Cross, NSW

MINI-MART

For Sale/Wanted/Swap/Join

AUDIO

FOR SALE: Two complete 250 W modules and one power transformer for TAPCO professional power amplifier. Suitable for enthusiast to build up complete amplifier, \$180. Andrew (02)449-5870.

AUDIORAMA TAPE RECORDING club seeks new members: Open to the enthusiast and beginner. Many services available. Write to Secretary, P.O. Box 34, Umina NSW 2257.

REVOX A77 TAPE DECK: Very good condition with recent head replacement and alignment. Service manual and NAB reel adaptors included, \$400. (045)66-4394.

MISCELLANEOUS

WANTED: TEKTRONIX 2215 or better. HP 545A, 546A, 547A. (02)451-4650 after 7 pm.

WANTED: COMPLETE 640 VDU working or not or character generator Motorola type MCM6574, to suit ETI-640 or replacement chip. (002)43-6300 bh.

OSCILLOSCOPE: TEKTRONIX 60 MHz dual trace CRO, good order, \$950. G. Kingsmill, 11 Plunkett St, West Heidelberg Vic. 3081. (03)497-4291 after 6 pm.

SELL: D.S. Q1140 multimeter, \$40. Digital capacitance meter, \$25. 1-30 V power supply, \$20. D.S. soldering iron stand T-5700, \$15. Parts drawer plus 50 transistors, 25 ICs, 350 resistors, electrolytics etc, all for \$30. Tim Dodsworth, P.O. Box 917, Ingham Nth Qld 4850.

WANTED DESPERATELY: Two only Hitachi transistors type 2SC2545. W. Hendry, 11 Chelton Ave, Nth Mackay, Nth Qld. (079)51-1403 bh or (079)42-1043 ah.

WANTED: HP-33C, 33E or similar, working or not. Also Motorola D2 kits or expansion modules. 14 Fashoda St, Hyde Park SA 5061. (08)272-7002.

SELL: BWD539D (similar 820) dual trace oscilloscope dc-25 MHz with probe and manual. Never been used (stroke victim 1979), \$575. (09)349-1919.

FOR SALE: OSCILLOSCOPE Telequipment D51 dual trace, dc-3 MHz, dc-6 MHz. Excellent condition, \$290. Beckman 3010 digital multimeter, \$140. University MVA-100CN multimeter, \$25. M. Johnson. (02)631-2092.

COMPUTERS

FOR SALE: MICROBEE EPROM programmer, new kit, complete, not built, gold wire wrap EPROM socket, \$35. Jim (02)525-2018.

• We'll publish up to 24 words (maximum) free of charge for you, your club or your association. Copy must be with us by the 1st of the month preceding the month of issue. Please — please — print or type advertisements clearly, otherwise it may not turn out as you intended! Every effort will be made to publish all advertisements received; however, no responsibility for so doing is accepted or implied. Private advertisements only will be accepted. We reserve the right to refuse advertisements considered unsuitable.

• Conditions: Your name and address plus phone number (if required) must be included with the 24 words. Reasonable abbreviations, such as 25 W RMS or 240 Vac, count as one word. Advertisements must relate to electronics, audio, communications, computing, etc — general advertisements cannot be accepted. Send your advertisement to:

ETI Mini-Mart,
P.O. Box 227,
Waterloo NSW 2017.

FOR SALE: BROTHER EP22 dot matrix printer and 2K memory typewriter, 80 characters per line, built-in RS232 interface, bonus ribbon cartridges included. In warranty, \$250. M. Gonzalez, 188 Elswick St, Leichhardt NSW 2040. (02)560-1468.

FOR SALE: ATARI monitor. Takes no extra memory, includes reverse B features, take control anytime and disassemble, move, change, search, verify, full disk utilities included. Search with Wildcards, built-in joystick, printer handler, graphics 12, 13, 14, 15 and seven extra split screen modes plus extras such as step/trace etc. W. H. Visser, P.O. Box 507, Beenleigh Qld 4207. (07)209-7891.

FOR SALE: LATEST Rev. 7 Apple II Europlus 64K with lower case chip, 16K RAM card, B & W monitor, colour card with RF modulator, disk drive with controller card, Z80 softcard, 80-column card, GP-80M Selkoshia dot matrix printer, box of fan-fold printer paper, spare printer ribbon, TKC hand paddles, TG Products joystick, includes all manuals plus extra programming books, over \$1500 of original software plus a stack of public domain software, computer fan, box of 10 diskettes, serial printer interface card, plastic protective keyboard cover. \$3250 ono. Brian Knott (089)52-3073.

FOR SALE: ZX81 add-ons, books, magazines, programs, Send SAE for list. Fred A. Brunings, 32 Dorothy St, Brahma Lodge SA 5109. (08)528-5417 ah.

PRINTER: SUIT MICROBEE (RS232 cable) or Tandy (without cable) computer. With extra ribbon cartridge, paper, manual, \$460 ono. (047)53-6690.

FOR SALE: VIC-20 with NTSC standard colour output but no PAL output, \$110. (02)269-8554 bh or (02)969-7277 ah.

FOR SALE: SCREEN editor, word processor for 16K and 32K Microbee, \$12.50. For information send SAE to J. L. Barnett, 5 Rutherglen Ave, Northmead NSW 2152.

FOR SALE: ZX80, 8K ROM, slow mode, inverse video display, psu, manual and programs, \$50 ono. Stuart (02)560-7050.

FOR SALE: EPROM 2716-64 copying, \$5. Apple colour and printer cards, \$50 each. System-80, \$175. P. James, 50 Bayswater Rd, Moonah Tas. 7009. (002)72-6412.

FOR SALE: SORCERER Mk 2, 48K, with G.S. monitor, Micropolis drives, 18 slot expansion chassis, plenty of business, games software on disc and tape, \$2800. (049)48-8742.

FOR SALE: \$100 card cage 21 slot. Apple compatible micro drive, interface cards. Will separate. Eric Lindsay (047)51-2258.

FOR SALE: MOUNTAIN CPS card for Apple III/II+, unused. Manuals slightly worn. N&A to Mr Ben Wu, 20 Gladstone Pde, Lindfield NSW.

FOR SALE: PYRAMID ADVENTURE for Apple 48K. Original program on disk for only \$20 including postage. P. Easdown, c/- Post Office Kew 2439.

FOR SALE: COMPUTER boards, parts and kits mainly, 6800 and 2650, \$90 the lot. 136 ETI and EA magazines between 1975 and 1981, \$40. Ryde NSW. (02)80-4343.

COMMUNICATIONS

FOR SALE: YAESU VHF converter and antenna coupler for FRG 7700. New condition, \$150 for both. Andrew (02) 449-5870.

FOR SALE: SX-200 scanning VHF, UHF receiver, 26-514 MHz, AM and FM, \$450 ono. Power supply to suit, \$30. Steve (02)573-2266 bh.

FOR SALE: TWO C42 transceivers, one working, one for parts, with power supply, \$110 ono. 1980-81 volumes of ETI and EA, \$10 per volume. David Wilkinson (03)469-3171.

FOR SALE: 27 MHz-510 MHz Victorian scanner listings. Over 1200 stations listed in computer sorted frequency order, \$7.95. Keith, P.O. Box 408, Noble Park Vic. 3174.

SELL: COMPLETE one Model 15 teleprinter. One Model 14TT (teletype reperforator) and one tape reader teletype 14TD, partially built demodulator, paper, tape, the lot, \$280 ono. (02)525-2018.

WANTED: MANUAL for KSR 35 teletype. E. Plunkett, Hill St, Eugowra NSW 2806. (068)59-2472.

WANTED: TELETYPE model ASR33. E. Plunkett, 7 Hill St, Eugowra NSW 2806. (068)59-2472.

Mac List

I'm sorry mate, but when I said Apple were on their arse, I didn't mean . . .

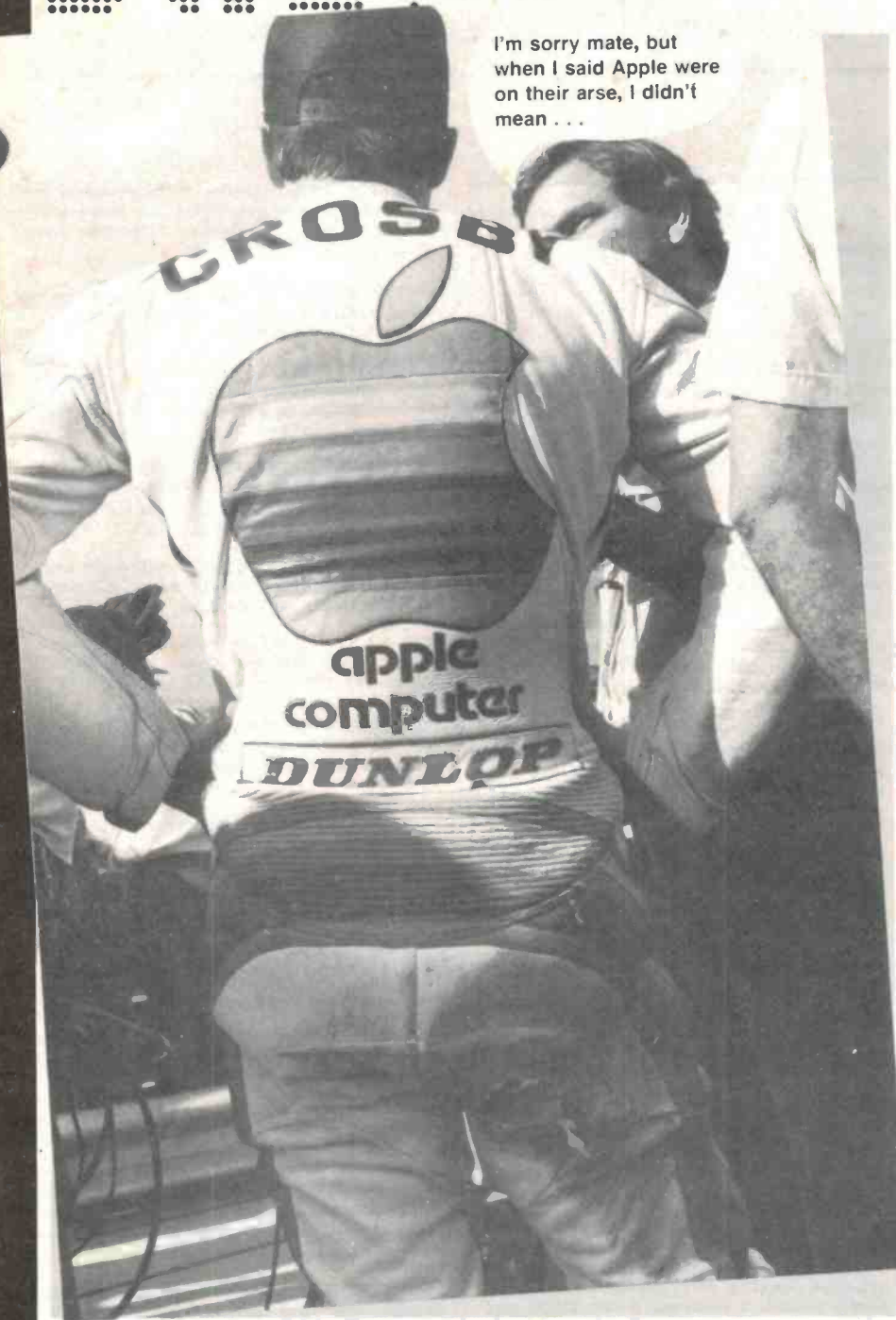

IT MAY SEEM, to regular dregs readers (and that's *all* of you, admit it) that we lampoon the computer industry a bit much here. Well, all we can say is that we just pick up on what they do to themselves. It's their own fault — if they didn't use all the innuendo-riddled, double entendre jargon and double-speak, they'd be less of a target. Ah, but at the same time we must thank them (the industry, that is) for provid-

ing such a wonderfully rich source of material for the hacks that dredge up Dregs doggeral.

In February it was industry jargon (and an industry source) that provided that brilliant exposé of the sex life of PCs. In March, it was the Apple Macintosh press release that provided the jollity. Sorry fellas, but that Macintosh provides us, once again, with a veritable fund of frivolous funnies for our fecund folio fillers.

Mac Language

From Apple's own literature, it seems that the Macintosh has not only spawned a 'new generation' of computers but a whole new language along with it. We shall call it "Mac Language". For example, their wordprocessing program is dubbed Mac Write (Mac Author was, apparently, too Mac Awful a Mac Pun to consider). Then there's Mac Paint and Mac Terminal. It's all sort of self explanatory. And, naturally, Apple is configuring the Macintosh to sell in the 'international market', to suit virtually any country. Our sources indicate that a veritable plethora of 'racially configured' and 'applications configured' models will be launched within 12 months. Here's the 'inside' list:

- Mac Adam** — that was really the first one.
- Mac Coy** — the real thing (served with Coke).
- Big Mac** — 40 kg model.
- Mac Aroni** — Italian model.
- Mac Au** — Chinese model.
- Mac Ro Biotic** — Vegetarians' model.
- Mac Call** — Fashion model.
- Mac Ho** — with Zapata moustache and leather jock strap.
- Mac Arthy** — Anti-communist model.
- Mac lavellian** — Cunning model.
- Mac Ismo** — He-man's model.
- Mac Inaw** — don't care if it rains or freezes.
- Mac Edonia** — Mafia model.
- Mac Meow** — Bitches' model.
- Mac MacMac** — Duck breeders' model.
- Mac Quack** — Medicos' model.
- Mac Arthur** — for round tables.
- Mac Donald** — Agricultural model (signs on with "E I E I O"!).
- Mac K** — Pimps' model.
- Mac Adamia** — will drive you nuts!
- Mac Aque** — you can't Mac a monkey out of me!
- Mac Aroon** — Almond-coloured model (served with biscuits).
- Mac Rame** — will tie you in knots.
- Mac Mammary** — A breast of the times!
- Mac Ectomy** — a gutless wonder.

At the Cupertino factory, the hardware is generally referred to as *Mac Hinery* and the diagnostic software has been dubbed *Mac Debate* as it puts the machine into self-stimulation mode.

If any of our readers get to hear of (or maybe invent) any more words from the Mac Lexicon, we'd be delighted to Mac Pile them in a Mac List for the Mac Wonderment of other Mac Readers. Mac Bye for now!



CDP-101

COMPACT
disc
DIGITAL AUDIO

Hear digital perfection.

Introducing the Sony Compact Disc Player.

When we used our long experience in digital technology to create the CDP-101 Compact Disc Player, we wanted to give you something more than the world's clearest sound.

WIRELESS REMOTE CONTROL Full-function remote control.

3-WAY MUSIC SEARCH Instant direct access to any selection with the 10-key pad on remote control unit. AMS (Automatic Music Sensor) allows access to the beginning of next or previous selection. 2-speed bi-directional search to find any desired music passage.

REPEAT FUNCTION Program to repeat the entire disc, one selection, or a specific portion of music.

3-FUNCTION DIGITAL READOUT DISPLAY Selection number. Time lapse of selection being displayed. Remaining time on the disc.

LINEAR SKATE DISC LOADING Just press the button, platter control and cueing are automatic.

Get even more perfect sound with the Sony Digital Audio Component System, "Precise Series".



It's a Sony

SONY

AUD 0391

How to invest in Yamaha, without living beyond your means.

Yamaha's new top-of-the-range Cassette decks, the K-1000 and K-2000, incorporate the most advanced, state-of-the-art studio component technology at prices \$200 to \$300 less than comparable equipment.

Indeed, they compare favourably in significant performance areas with any cassette decks at any price.

Both decks have been painstakingly designed and uncompromisingly engineered for optimum functionality and reproduction performance.

Each employs a specially designed two-motor, direct drive transport mechanism for

smooth, silent precision, and three low-impedance heads which features a unique Sendust formulation to ensure superb, long lasting reproduction quality. Plus the heads have a lifetime warranty.

The two decks utilise Yamaha's unique Linear Electromagnetic Transduction system which extends linearity to the point where the signal is transferred from the head to the tape—a previously uncontrollable area in the recording chain.

High performance features on both decks also include dbx and Dolby-B* noise reduction, ORBiT

(Optimum Record Bias Tuning), a microcomputer controlled Linear Counter, expanded range level meters and a number of auto memory functions.

For Yamaha the K-1000 and K-2000 cassette decks are a natural progression in 95 years of outstanding accomplishments in musical instruments and audio componentry.

For you they represent the finest natural sound recording and reproduction at a surprisingly affordable cost.

Your Yamaha dealer can show you the full range of Yamaha Cassette decks starting at around \$200. If you'd like further information just complete and post the coupon below.

*Dolby is the registered trade mark of Dolby Laboratories



I'd like further technical information on the new K-1000 and K-2000 cassette decks.

Name _____

Address _____

Postcode _____

Send to: Yamaha Hi-Fi Division,
Rose Music Pty. Ltd.,
17-33 Market Street, South Melbourne,
Victoria 3205.

